

RD-2000

Parameter Guide



Contents

Detailed Settings for a Program (Program Edit)	4
Detailed Settings for Each Zone (Zone Edit)	4
Changing the Key Touch (Key Touch).....	5
Assigning Functions to Pedals (Pedal)	6
Assigning Functions to Controllers (Assign).....	7
List of Functions Assignable to Pedals, Knobs, and Buttons.....	8
Adding Reverberation to the Sound (Reverb).....	9
Adding Spaciousness to the Sound (Delay)	9
Adjusting the Levels of Each Frequency Range (EQUALIZER) ..	9
Detailed Tone Settings (TONE DESIGNER)	10
Piano Designer.....	10
Tone Designer.....	12
Making Detailed Settings for the E. Piano Tones	12
Making Detailed Settings for the CLAV Tones.....	13
Making Detailed Settings for the Other Tones	13
Editing Individual Keys (Indiv. Voicing)	14
Adjusting Resonance When the Damper Pedal Is Depressed (Sym. Resonance).....	15
Editing the Modulation FX (Modulation FX)	15
Editing Tremolo/Amp Simulator (Tremolo/Amp Simulator) ..	16
Simulating the Creation of Organ Tones.....	17
Using the RD-2000 as a Master Keyboard	18
What's MIDI?	18
About MIDI Connectors.....	18
Adjusting the Volume of Each Zone.....	18
Selecting the MIDI Connector to Use for Output	18
Setting the MIDI Transmit Channel.....	19
Selecting Sounds on an External MIDI Device.....	19
Detailed Settings for Transmitted Parts.....	19
Detailed Settings for Each Function	22
Setting Parameters (System).....	22
Tuning to Other Instruments' Pitches (Master Tune)....	22
Selecting the Target Controlled by a Knob (Control Destination)	22
Retaining the Equalizer Settings Even When the Program Is Switched (EQ Mode)	22
Retaining the SELECT Button Settings Even When the Program Is Switched (Select Button Mode).....	22
Retaining the Pedal Settings Even When the Program Is Switched (Pedal Mode)	22
Retaining the MOD WHEEL 1/2 Settings Even When the Program Is Switched (Wheel Mode).....	22
Retaining the Assign 1–9 Controller Settings Even When the Program Is Switched (Assign 1-9 Mode).....	23
Retaining the Delay Settings Even When the Program Is Switched (Delay Mode)	23
Retaining the Reverb Settings Even When the Program Is Switched (Reverb Mode).....	23
Retaining the Rhythm Settings Even When the Program Is Switched (Rhythm Mode)	23
Retaining the Keyboard Touch Settings Even When the Tone or Program Is Switched (Key Touch Mode)....	23
Retaining the Current Tone Even When Tones Are Switched (Tone/Program Remain).....	24
Retaining the Ext Zone On/Off Settings Even When Tones Are Switched (Tone Ext Zone Remain)	24

Preventing Ctrl Messages from Being Transmitted by Ext Zone On/Off (Ext Zone Transmit Control)	24
Selecting the USB Driver (USB Driver).....	24
Selecting the USB MIDI Thru Switch (USB MIDI Thru Switch)	24
Selecting the Function of the MIDI THRU/OUT 2 Connector (MIDI OUT2 Port Mode)	24
Switching the Pedal's Polarity (Damper/FC1/FC2/EXT Pedal Polarity)	25
Setting the Tuning Method (Temperament/Key).....	25
Transmitting Synchronization Messages (Clock Out) ...	25
Transmitting High-Resolution Velocity Data (Hi-Res Velocity Out)	25
Selecting the MIDI Output Port for Rhythm (Rhythm MIDI Output Port)	25
Selecting the MIDI Output Channel for Rhythm (Rhythm MIDI Channel).....	25
Adjusting the Playback Volume of Audio Files	25
Outputting the SUB OUT Output from MAIN OUT (Output Mix/Parallel)	26
Adjusting the Brightness of the Display (LCD Brightness)	26
Making the Power Automatically Turn Off After a Time (Auto Off)	26
Saving System Settings	26
USB Audio Settings	26
Selecting the Parts That Will Produce Sound (PART SW).....	27
Making the System Compressor Settings (COMPRESSOR)....	27
INFORMATION.....	27
Convenient Functions (Utility)	28
Saving a Program File (Program File Save)	28
Calling Up Program Files (Backup Load)	28
Deleting a Program File (Backup Delete)	29
Formatting Memory (Format)	29
Returning to the Factory Settings (Factory Reset)	29
SCENE UTILITY	30
Changing the Order of Scenes (Scene Swap).....	30
Initializing a Scene (Scene Initialize).....	30
Adding a Memo to Each Scene (Scene Memo)	30
Importing Text to Display as the Scene Memo (Scene Memo Import)	31
Exporting a Scene as a Program and Saving It (Scene To Program).....	31
Deleting a Scene (Scene Remove)	31
Other Functions	32
Local Ctrl.....	32
Disconnecting the Controller Section and the Sound Generator Section (Local Switch)	32
Optimizing Settings for Recording on an External Sequencer (Rec Mode).....	32
Selecting the EXP Category	32
Connecting to Your Computer	33
Connecting to a Computer via the USB COMPUTER Port....	33
Switching USB Drivers	33
Using the RD-2000 as a USB MIDI Interface	33

Modulation FX Parameters	34
Tremolo/Amp Simulator Parameters	61
Sympathetic Resonance Parameters.....	64
Delay Parameters.....	65
Reverb Parameters	67
EQ Parameters.....	68
System Compressor Parameters	69
Tone List	70
CONCERT	70
STUDIO	70
VINTAGE	70
MODERN.....	71
CLAV	71
ORGAN	72
STRINGS	73
PAD/CHOIR	73
BASS	74
OTHER.....	76
Program List	80
A.....	80
B	80
C.....	80
D.....	80
E	81
F	81
G.....	81
H.....	81
I.....	82
J.....	82
K	82
L	82
M.....	83
N.....	83
O.....	83

Detailed Settings for a Program (Program Edit)

Here's how to make detailed settings for the eight zones of a Program.

1. Press the [EDIT] button.

The PROGRAM EDIT MENU screen appears.



2. Use the cursor [▲] [▼] [◀] [▶] buttons to select the item you want to edit, and press the [ENTER] button.

The corresponding edit screen appears.

3. Select the parameter that you want to edit, and use the [DEC] [INC] buttons or the value dial to edit the value.

If you press the [EXIT] button, you'll return to the PROGRAM EDIT MENU screen.

4. When you've finished making settings, press the [EXIT] button several times to return to the TONE screen, the PROGRAM screen or the SCENE screen.

NOTE

If you've edited the settings, an "EDITED" indication is shown in the PROGRAM screen or the TONE screen.

If you turn off the power, select another Program, or select another tone in the TONE screen while the "EDITED" indication is shown, the edits you made are discarded. If you want to keep your edits, press the [WRITE] button to save the Program (owner's manual: p. 23).

Parameter	Value	Explanation
DLY Delay Send Level	0-127	Specifies the level of signal sent to delay.
OUT Output	MAIN, SUB	Selects the output destination.
Trans Zone Transpose	-48-0-+48	Allows you to individually transpose zones to a different pitch.
Rng Lo Keyboard Range Lower	A0-C8	Set the keyboard range in which each Zone will sound. This can be used to make notes in different areas of the keyboard play different Tones. Specify the lower limit (Rng Lo) and upper limit (Rng Up) of the key range being set. You can also set this by pressing a specific key and then pressing the [ENTER] button. * Key range is enabled when you change the key range value or turn on the [SPLIT] button. * When key range is off, the indication "Full" is shown. To return to the Off state, turn off the [SPLIT] button or press the [SHIFT] + [KEY RANGE] buttons.
Rng Up Keyboard Range Upper		
Max Velocity Max	1-127	Maximum velocity value for the corresponding key. Lowering this value will produce softer notes even if you play the keyboard strongly. * This setting is disregarded with certain tones.
Sens Velocity Sensitivity	-63-+63	This setting determines how the volume changes in response to the velocity. The volume is increased as the keyboard is played with greater force when a positive value is used; when a negative value is selected, the volume decreases as the keys are played with greater force. * This setting is disregarded with certain tones.
Rng Lo Velocity Range Lower	1-127	Specifies the lower limit (Rng Lo) and upper limit (Rng Up) of the range in which the tone is played according to the velocity.
Rng Up Velocity Range Upper		Make this setting when you want the tone to change depending on the key velocity.
Coarse Coarse Tune	-48-+48	Adjusts the pitch in semitone steps (±4 octaves).
Fine Fine Tune	-50-+50	Adjusts the pitch in one-cent steps (±50 cents). 1 cent = 1/100th of a semitone

Detailed Settings for Each Zone (Zone Edit)

Here's how to edit each zone (INTERNAL/EXTERNAL 1-8).

1. In the PROGRAM EDIT MENU screen, select "Zone Edit" and press the [ENTER] button.

2. Select the parameter that you want to edit, and use the [DEC] [INC] buttons or the value dial to edit the value.

Parameter	Value	Explanation
TONE		Selects the tone. Using the Numeric Keys to Select Tones You can now use the TONE [0]-[9] buttons as numeric keys to directly specify a tone number. 1. While holding down the [SHIFT] button, use the TONE [0]-[9] as numeric keys to enter a tone number. The value blinks while you're entering the tone number. 2. Release the [SHIFT] button. The tone number is finalized.
VOL Volume	0-127	Sets the volume for each of the zones.
PAN Pan	L64-0-R63	Specifies the left/right position of the sound when outputting in stereo.
REV Reverb Send Level	0-127	Specifies the level of signal sent to reverb.

Parameter	Value	Explanation
VC RES Voice Reserve	0–63, Full	Specifies the number of voices that will be reserved for each zone if you attempt to play more than 128 voices.
Damper Damper Control Switch		Specifies whether the damper pedal will (ON) or will not (OFF) control each zone.
FC1 FC1 Control Switch		Specifies whether the pedal connected to the FC1 jack will (ON) or will not (OFF) control each zone. (*1)
FC2 FC2 Control Switch	ON, OFF	Specifies whether the pedal connected to the FC2 jack will (ON) or will not (OFF) control each zone. (*1)
EXT EXT Pedal Control Switch		Specifies whether the pedal connected to the EXT jack will (ON) or will not (OFF) control each zone. (*1)
PCH BND Pitch Bend Control Switch		Specifies whether the pitch bend lever will (ON) or will not (OFF) control each zone.
MOD CTL Modulation Control Switch	ON, OFF	Specifies whether the modulation lever will (ON) or will not (OFF) control each zone.
MOD W1 Mod Wheel 1 Control Switch		Specifies whether the MOD WHEEL 1 will (ON) or will not (OFF) control each zone. (*1)
MOD W2 Mod Wheel 2 Control Switch		Specifies whether the MOD WHEEL 2 will (ON) or will not (OFF) control each zone. (*1)
A1 Assign 1 Control Switch		Specifies whether the ASSIGN [1] knob will (ON) or will not (OFF) control each zone. (*1)
A2 Assign 2 Control Switch		Specifies whether the ASSIGN [2] knob will (ON) or will not (OFF) control each zone. (*1)
A3 Assign 3 Control Switch		Specifies whether the ASSIGN [3] knob will (ON) or will not (OFF) control each zone. (*1)
A4 Assign 4 Control Switch		Specifies whether the ASSIGN [4] knob will (ON) or will not (OFF) control each zone. (*1)
A5 Assign 5 Control Switch	ON, OFF	Specifies whether the ASSIGN [5] knob will (ON) or will not (OFF) control each zone. (*1)
A6 Assign 6 Control Switch		Specifies whether the ASSIGN [6] knob will (ON) or will not (OFF) control each zone. (*1)
A7 Assign 7 Control Switch		Specifies whether the ASSIGN [7] knob will (ON) or will not (OFF) control each zone. (*1)
A8 Assign 8 Control Switch		Specifies whether the ASSIGN [8] knob will (ON) or will not (OFF) control each zone. (*1)
A9 Assign 9 Control Switch		Specifies whether the ASSIGN [9] button will (ON) or will not (OFF) control each zone. (*1)

Parameter	Value	Explanation
TON CLR Tone Color Control Destination		Select the zone that you want to control using the [TONE COLOR] knob. (* 2)
MOD FX Modulation FX Control Destination	Select one zone	Select the zone that you want to control using the MODULATION FX [DEPTH] and [RATE] knobs and [ON/OFF] button. (* 2)
TR/AMP Tremolo/Amp Control Destination		Select the zone that you want to control using the TREMOLO [DEPTH] and [RATE] knobs and [ON/OFF] button, and the AMP SIM [DRIVE] knob and [ON/OFF] button. (* 2)

*1 The parameters that can control each zone are the parameters indicated by (*1) in the “List of Functions Assignable to Pedals, Knobs, and Buttons” (p. 8).

*2 This parameter is enabled only when the SYSTEM setting “Control Destination” is PROGRAM.

Changing the Key Touch (Key Touch)

The setting below allows you to adjust the response you get from the keyboard when you finger the keys.

1. Either press the [KEY TOUCH] button, or use the PROGRAM EDIT MENU screen to select “Key Touch” and press the [ENTER] button (p. 4).
2. Select the parameter that you want to edit, and use the [DEC] [INC] buttons or the value dial to edit the value.

Parameter	Value	Explanation
Key Touch	SUPER LIGHT	An even lighter setting than LIGHT.
	LIGHT	Sets the keyboard to a light touch. You can achieve fortissimo (ff) play with a less forceful touch than MEDIUM, so the keyboard feels lighter. This setting makes it easy to play, even for children.
	MEDIUM	Sets the keyboard to the standard touch. You can play with the most natural touch. This is the closest to the touch of an acoustic piano.
	HEAVY	Sets the keyboard to a heavy touch. You have to finger the keyboard more forcefully than MEDIUM in order to play fortissimo (ff), so the keyboard touch feels heavier. Dynamic fingering adds even more feeling to what you play.
	SUPER HEAVY	An even heavier setting than HEAVY.

Parameter	Value	Explanation
Key Touch Offset	-10→+9	This setting provides even more precise adjustment of the key touch than available with the Key Touch setting alone. The touch sensitivity becomes heavier as the value increases. When this parameter is set to a value that exceeds the upper or lower limit, the setting for Key Touch (one of five possible values) is automatically changed to accommodate the value you've specified.
	REAL	Volume levels and the way sounds are played change in response to the velocity.
Velocity	1-127	Regardless of how strongly you play the keyboard, volume levels and the way sounds are played always reflect the fixed velocity value you specify here.
	-63→+63	As the value is decreased, the timing of the sound is delayed more when more force is used to play the keys. As the value is increased, the timing of the sound is delayed more when less force is used to play the keys.
Velo Delay Sens	-63→+63	As the value is increased, the touch becomes heavier in the upper registers, and lighter in the lower registers.
Velo Key Follow Sens	STANDARD	Note-off occurs at the key depth of a conventional piano.
Key Off Position	DEEP	Note-off occurs at a deeper position. This is suitable for electric piano sounds.

Assigning Functions to Pedals (Pedal)

This setting determines the function of the pedal switches (such as the optional DP series) or expression pedals (such as the optional EV-5) that are connected to the FC1, FC2, and EXT jacks on the rear panel.

1. In the PROGRAM EDIT MENU screen, select "Pedal" and press the [ENTER] button (p. 4).
2. Select the parameter that you want to edit, and use the [DEC] [INC] buttons or the value dial to edit the value.

The assigned function is controlled between the minimum value (Min) and maximum value (Max). If Min is set to a greater value than Max, the change is reversed.

FC1/FC2/EXT pedals

Parameter	Value	Explanation
Func (Function)	Selects the function to be assigned to each pedal. * For details on the values, refer to "List of Functions Assignable to Pedals, Knobs, and Buttons" (p. 8).	
Range Min	0-127	Specifies the value when the pedal is not pressed (minimum value) (*1).
Range Max	0-127	Specifies the value when the pedal is advanced to its fullest extent (maximum value) (*1).

MEMO

By specifying the Range Min/Max settings, you'll be able to control the function in the desired range; this will help you obtain the performance result that you want.

- *1 Depending on the function that you assign, the value might not have the range of 0-127. In this case, the setting of 0-127 is converted appropriately for the function that's assigned. If you assign a function that is switched on/off, it turns off at Min and turns on at Max. If you assign an on/off function to an expression pedal, it switches on/off at the value that is mid-way between Min and Max.

Assigning Functions to Controllers (Assign)

Here's how to assign functions to the MOD WHEEL 1/2, the ASSIGN [1]–[8] knobs and the ASSIGN [9] button.

1. In the PROGRAM EDIT MENU screen, select "Assign" and press the [ENTER] button (p. 4).
2. Select the parameter that you want to edit, and use the [DEC] [INC] buttons or the value dial to edit the value.

MOD WHEEL 1/2

Parameter	Value	Explanation
Func (Function)		Selects the functions that are assigned to the MOD WHEEL 1/2. * For details on the values, refer to "List of Functions Assignable to Pedals, Knobs, and Buttons" (p. 8).

ASSIGN [1]–[8] knobs

Parameter	Value	Explanation
Func (Function)		Selects the functions that are assigned to the ASSIGN [1]–[8] knobs. * For details on the values, refer to "List of Functions Assignable to Pedals, Knobs, and Buttons" (p. 8).
Range Min	0–127	Specifies the value when the ASSIGN [1]–[8] knob is turned all the way to the left (minimum value) (*1).
Range Max	0–127	Specifies the value when the ASSIGN [1]–[8] knob is turned all the way to the right (maximum value) (*1).

MEMO

By specifying the Range Min/Max settings, you'll be able to control the function in the desired range; this will help you obtain the performance result that you want.

- *1 Depending on the function that you assign, the value might not have the range of 0–127. In this case, the setting of 0–127 is converted appropriately for the function that's assigned. If you assign a function that is switched on/off, it turns off at Min and turns on at Max.

ASSIGN [9] button

Parameter	Value	Explanation
Func (Function)		Selects the function that's assigned to the ASSIGN [9] button. * For details on the values, refer to "List of Functions Assignable to Pedals, Knobs, and Buttons" (p. 8).
Switch Type		Specifies the operation of the button.
	LATCH	The function turns on/off each time you press the button.
	MOMENTARY	The function is on only while you hold down the button.

MEMO

Whether the Switch Type setting does anything or not depends on the function that's assigned.

SLIDER

Parameter	Value	Explanation
Slider Func		Selects the functions that are assigned to the slider. * For details on the values, refer to "List of Functions Assignable to Pedals, Knobs, and Buttons" (p. 8).

List of Functions Assignable to Pedals, Knobs, and Buttons

FC1 / FC2 / EXT pedal	Controllers to which a function can be assigned			Mod Wheel 1 / 2	Functions that can be assigned		Explanation
	ASSIGN [1]–[8] knob	ASSIGN [1]–[8] slider	ASSIGN [9] button				
✓	✓	✓	✓	✓	OFF	Nothing is controlled.	
✓	✓	✓	✓	✓	CC0–CC127	Controller number 0–127 (*1)	
✓	---	---	✓	✓	BEND DOWN	Lowers the pitch just as when the pitch bend lever is moved to the left. (*1)	
✓	---	---	✓	✓	BEND UP	Raises the pitch just as when the pitch bend lever is moved to the right. (*1)	
✓	✓	✓	✓	✓	AFTERTOUCH	Controls aftertouch. (*1)	
✓	---	---	✓	---	OCTAVE DOWN	Lowers the key range in octave steps each time you press the button (maximum four octaves).	
✓	---	---	✓	---	OCTAVE UP	Raises the key range in octave steps each time you press the button (maximum four octaves).	
✓	---	---	✓	---	EXT START/STOP	Starts/stops an external sequencer.	
✓	---	---	✓	---	TAP TEMPO	Sets the tempo to match the timing you use when pressing the pedal or the button.	
✓	---	---	✓	---	PLAY/STOP	The same function as the [PLAY/STOP] button.	
✓	---	---	✓	---	SONG RESET	Returns to the beginning of the song.	
---	---	---	✓	---	SONG BWD	Rewinds the song.	
---	---	---	✓	---	SONG FWD	Fast-forwards the song.	
✓	---	---	---	---	MOD FX SWITCH	The same function as the MODULATION FX [ON/OFF] button. (*2)	
✓	✓	---	---	✓	MOD FX DEPTH	The same function as the MODULATION FX [DEPTH] knob. (*2)	
✓	✓	---	---	✓	MOD FX RATE	The same function as the MODULATION FX [RATE] knob. (*2)	
✓	---	---	---	---	TREMOLO SWITCH	The same function as the TREMOLO [ON/OFF] button. (*3)	
✓	✓	---	---	✓	TREMOLO DEPTH	The same function as the TREMOLO [DEPTH] knob. (*3)	
✓	✓	---	---	✓	TREMOLO RATE	The same function as the TREMOLO [RATE] knob. (*3)	
✓	---	---	---	---	AMP SIM SWITCH	The same function as the AMP SIM [ON/OFF] button. (*3)	
✓	✓	---	---	✓	AMP SIM DRIVE	The same function as the AMP SIM [DRIVE] knob. (*3)	
✓	---	---	---	---	DELAY SWITCH	Turns Delay (p. 9) on/off.	
✓	---	---	✓	✓	ROTARY SPEED	When using the rotary effect, switches the rotary effect between fast and slow.	
✓	---	---	---	✓	TONE COLOR	The same function as the [TONE COLOR] knob. (*4)	
✓	---	---	✓	---	PROGRAM DOWN	Switches Programs in descending order.	
✓	---	---	✓	---	PROGRAM UP	Selects Programs in ascending order.	

- * 1 You can specify the zone (or external zone) to which the assigned function will apply. “Detailed Settings for Each Zone (Zone Edit)” (p. 4), “Detailed Settings for Transmitted Parts” (p. 19).
- * 2 If the SYSTEM setting “Control Destination” is PROGRAM, the assigned function applies to the zone that’s selected by “MOD FX (Modulation FX Control Destination)” (p. 5).
- * 3 If the SYSTEM setting “Control Destination” is PROGRAM, the assigned function applies to the zone that’s selected by “TR/AMP (Tremolo/Amp Control Destination)” (p. 5).
- * 4 If the SYSTEM setting “Control Destination” is PROGRAM, the assigned function applies to the zone that’s selected by “TON CLR (Tone Color Control Destination)” (p. 5).

MEMO

Depending on the state of the selected Program or tone, the assigned function might not be supported, meaning that you might not obtain the result you expect.

Adding Reverberation to the Sound (Reverb)

Here's how to make reverb settings.

The available settings will depend on the selected type.

For details on the effects, refer to "Reverb Parameters" (p. 67).

1. In the PROGRAM EDIT MENU screen, select "Reverb" and press the [ENTER] button (p. 4).
2. Select the parameter that you want to edit, and use the [DEC] [INC] buttons or the value dial to edit the value.

Parameter	Value	Explanation
Type	ROOM1, ROOM2	Simulates the reverberation of room interiors. It produces a well-defined and spacious reverberation.
	HALL1, HALL2	Simulates the reverberation exhibited by hall. It provides a deeper reverberation than the Room reverbs.
	PLATE	Simulates a plate reverb unit (a type of artificial reverb that utilized a metal plate).
	GM2 REVERB	This is a GM2 reverb.
Level	0–127	Reverb volume.

Adding Spaciousness to the Sound (Delay)

Here's how to make delay settings.

The available settings will depend on the selected type.

For details on the effects, refer to "Delay Parameters" (p. 65).

1. In the PROGRAM EDIT MENU screen, select "Delay" and press the [ENTER] button (p. 4).
2. Select the parameter that you want to edit, and use the [DEC] [INC] buttons or the value dial to edit the value.

Parameter	Value	Explanation
Type	DELAY	A stereo delay.
	T-CTRL DELAY	A delay that allows you to smoothly change the delay time.
	DELAY → TREMOLO	Tremolo is applied to the delay sound.
	2TAP DELAY	Delayed sound is heard from two locations that you specify.
	3TAP DELAY	Delayed sound is heard from three locations that you specify.
Level	0–127	Delay volume.

Adjusting the Levels of Each Frequency Range (EQUALIZER)

The RD-2000 is equipped with a five-band equalizer.

1. Use the ZONE EFFECTS [SELECT] button to select "EQ."
2. Press the [EQ ON] button to make it light.
3. Turn the knobs to adjust the levels in each range.

NOTE

Sounds may be distorted with certain knob settings. If this occurs, adjust the Input Gain.

MEMO

You can specify that the equalizer settings stay the same even if you switch programs. In "system settings," set EQ Mode (owner's manual: p. 26) to "REMAIN."

Parameter	Value	Explanation
LOW Gain	-12–+12 [dB]	Amount of boost/cut for the low-frequency region
LOW Freq	16–16000 [Hz]	Center frequency of the low-frequency region
MID1 Gain	-12–+12 [dB]	Amount of boost/cut for mid-frequency region 1
MID1 Freq	16–16000 [Hz]	Center frequency of mid-frequency region 1
MID1 Q	0.5, 1.0, 2.0, 4.0, 8.0	Width of mid-frequency region 1 Set a higher value for Q to narrow the range to be affected.
MID2 Gain	-12–+12 [dB]	Amount of boost/cut for mid-frequency region 2
MID2 Freq	16–16000 [Hz]	Center frequency of mid-frequency region 2
MID2 Q	0.5, 1.0, 2.0, 4.0, 8.0	Width of mid-frequency region 2 Set a higher value for Q to narrow the range to be affected.
MID3 Gain	-12–+12 [dB]	Amount of boost/cut for mid-frequency region 3
MID3 Freq	16–16000 [Hz]	Center frequency for mid-frequency region 3
MID3 Q	0.5, 1.0, 2.0, 4.0, 8.0	Width of mid-frequency region 3 Set a higher value for Q to narrow the range to be affected.
HIGH Gain	-12–+12 [dB]	Amount of boost/cut for the high-frequency region
HIGH Freq	16–16000 [Hz]	Center frequency of the high-frequency region
INPUT Gain	-15–+15 [dB]	Amount of boost/cut for the input

Detailed Tone Settings (TONE DESIGNER)

After you've selected a tone, a Program or a Scene, you can use the RD-2000's TONE DESIGNER function to make detailed adjustments to the sound.

1. Press the [TONE DESIGNER] button.



* The items that are displayed will differ depending on the tone that's selected.

The selected zone's TONE DESIGNER MENU screen (for a TW-Organ sound, the TONE WHEEL & DESIGNER MENU screen) appears (owner's manual: p. 22).

In the designer menu you can choose the desired category of tone settings.

2. Use the cursor [▲] [▼] [◀] [▶] buttons to select the item that you want to edit.

3. Press the [ENTER] button.

The edit screen for each item appears.

4. Select the parameter that you want to edit, and use the [DEC] [INC] buttons or the value dial to edit the value.

If you press the [EXIT] button, you will return to the TONE DESIGNER MENU screen.

5. If you want to save the changes you've made, press the [WRITE] button.

You can save your changes in the Program.

NOTE

If you've edited the settings, an "EDITED" indication is shown in the PROGRAM screen, the TONE screen or the SCENE screen.

If you turn off the power, select another Program, or select another tone in the TONE screen while the "EDITED" indication is shown, the edits you made are discarded. If you want to keep your edits, press the [WRITE] button to save the Program (owner's manual: p. 23).

1. As described in "Detailed Tone Settings (TONE DESIGNER)," select "Piano Designer" and press the [ENTER] button.

The PIANO DESIGNER screen appears.

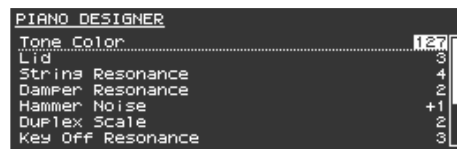

2. Select the parameter that you want to edit, and use the [DEC] [INC] buttons or the value dial to edit the value.

Parameters of V-Piano Technology tones (tone numbers S01–S10)

Parameter	Value	Explanation
Tone Color	0–127	Adjusts an effect that is suitable for each sound, such as the timbre or the acoustic image.
Lid	0–6	Reproduces the way the brightness of a grand piano's sound is affected by how much the piano's lid is opened. The lid is opened more as the value is increased, creating a brighter sound.
String Resonance	0–10	When the keys are pressed on an acoustic piano, the strings for keys that are already pressed also vibrate sympathetically. The function that reproduces this is called "String Resonance." Increasing the value increases the amount of effect.
Damper Resonance	0–10	This adjusts the damper resonance of the acoustic piano sound (the sympathetic vibration produced in strings other than those actually played when you press the damper pedal). Higher settings will make the sympathetic vibration louder.
Hammer Noise	-2–0–+2	This adjusts the sound of the hammer striking the string of an acoustic piano. Higher values will increase the sound of the hammer striking the string.

Piano Designer

If certain piano sounds are selected, Piano Designer appears in the TONE DESIGNER MENU screen.

* For the tones that correspond to certain piano sounds, refer to "Tone List" (p. 70).

In the Piano Designer screen, you can adjust various aspects of the sound of the piano to create a piano sound that's just right for you.

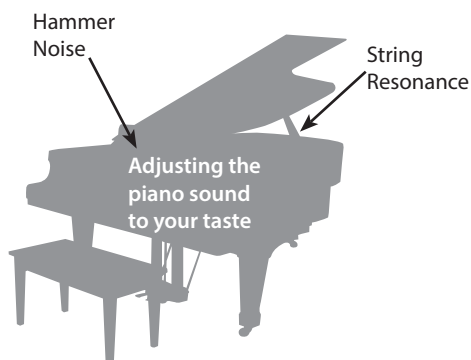

Parameter	Value	Explanation
Duplex Scale	0–10	Adjusts the sound of the sympathetically vibrating aliquot strings on an acoustic piano. Higher values increase the volume of the sympathetic vibration.
		<p>What is Duplex Scale?</p> <p>“Duplex Scale” refers to a system that causes sympathetic vibrations in the sections of the string toward the front and toward the back. It can produce sound that is richer and brighter by adding the string’s higher harmonics.</p> <p>Because no damper (sound-stopping mechanism) is applied to the front or back sections of the string, the resonating sounds linger even after the sound of the string stops when you release the played key.</p>
Key Off Resonance	0–10	Adjusts resonances such as the key-off sound of an acoustic piano (subtle sounds that are heard when you release a key). Higher values increase the volume of the resonances.
Cabinet Resonance	0–10	Adjusts the body resonance of the grand piano itself. Higher values will produce a larger body resonance.
Sound Board Resonator	0–4	When you play a chord, this setting improves the clarity of the individual notes in the chord, creating a more beautiful resonance. Higher settings produce a clearer resonance.
Damper Noise	0–10	Adjusts the damper noise (the sound that occurs when the strings of an acoustic piano are released by pressing the damper pedal). Increasing this value increases the sound that is heard when the strings are released.
Key Off Noise	0–10	This adjusts sympathetic vibrations such as an acoustic piano’s key-off sound (the subtle sound that occurs when you release a note). Higher settings will make the sympathetic vibration louder.

Parameters of SuperNATURAL piano tones (tone numbers 0001–0018, 0028–0039, 0042–0045)

Parameter	Value	Explanation
Tone Color	0–127	Adjusts an effect that is suitable for each sound, such as the timbre or the acoustic image.

Parameter	Value	Explanation
Nuance	TYPE1, TYPE2, TYPE3	Changes the Tone’s subtle nuances by altering the phase of the left and right sounds. * This effect is difficult to hear when headphones are used.
Damper Noise	0–127	Adjusts the damper noise (the sound that occurs when the strings of an acoustic piano are released by pressing the damper pedal). Increasing this value increases the sound that is heard when the strings are released.
Duplex Scale	0–127	Adjusts the sound of the sympathetically vibrating aliquot strings on an acoustic piano. Higher values increase the volume of the sympathetic vibration.
		<p>What is Duplex Scale?</p> <p>“Duplex Scale” refers to a system that causes sympathetic vibrations in the sections of the string toward the front and toward the back. It can produce sound that is richer and brighter by adding the string’s higher harmonics.</p> <p>Because no damper (sound-stopping mechanism) is applied to the front or back sections of the string, the resonating sounds linger even after the sound of the string stops when you release the played key.</p>
String Resonance	0–127	When the keys are pressed on an acoustic piano, the strings for keys that are already pressed also vibrate sympathetically. The function that reproduces this is called “String Resonance.” Increasing the value increases the amount of effect.
Key Off Resonance	0–127	Adjusts resonances such as the key-off sound of an acoustic piano (subtle sounds that are heard when you release a key). Higher values increase the volume of the resonances.
Hammer Noise	-2–0–+2	Adjusts the sound of the hammers striking the strings of an acoustic piano. Higher values increase the sound of the hammers striking the strings.
Character	-5–0–+5	Higher values produce a harder sound; lower values produce a more mellow sound.

Parameter	Value	Explanation
Sound Lift	0-127	<p>Lets you change the way that the sound responds when you play the keyboard softly. For example, this can be adjusted suitably for solo performance, or to prevent your sound from being buried in the rest of the band.</p> <p>Increasing this value will allow fairly loud sounds to be produced even when you play with a light touch, so that your performance will not be obscured by the playing of your band.</p> <p>Changing this value does not affect the way in which the sound responds to velocity.</p>

Parameter	Value	Explanation
Mechanical Key Off Noise	0-127	<p>Adjusts the key-off sound of the electric piano (the operating sound of the key and hammer when the key is released).</p> <p>Higher settings produce a louder key-off sound.</p> <p>* Depending on the tone that's selected, this might have no effect.</p>
Damper Noise	0-127	<p>Adjusts the damper noise (the noise heard when you press the damper pedal to release the tone bars).</p> <p>Increasing this value will make the damper noise louder.</p> <p>* Depending on the tone that's selected, this might have no effect.</p>
Key Off Resonance	0-127	<p>Adjusts resonances such as the key-off sound (the faint sound heard when you release a key).</p> <p>Higher values produce a louder key-off sound.</p> <p>At a setting of 0 there will be no key-off sound at all.</p> <p>* Depending on the tone that's selected, this might have no effect.</p>
Hum Noise	0-127	<p>Adjusts the amount of hum and other noise that leaks into the pickups.</p> <p>Electric pianos were susceptible to various types of noise, and this noise would sometimes be output along with the sounds of the performance. Depending on the effect settings, such noises can produce an authentic, lively atmosphere.</p> <p>Lowering this value makes the sound clearer; raising this value makes the sound dirtier.</p> <p>At a setting of 0 there will be no hum at all.</p> <p>* Depending on the tone that's selected, this might have no effect.</p>

Tone Designer

In the Tone Designer screen you can make detailed settings for the sound. The available parameters will depend on the tone that's selected.

1. As described in "Detailed Tone Settings (TONE DESIGNER)" (p. 10), select "Tone Designer" and press the [ENTER] button.

The Tone Designer screen appears.

The parameters will differ depending on the tone that's selected.

2. Select the parameter that you want to edit, and use the [DEC] [INC] buttons or the value dial to edit the value.

Making Detailed Settings for the E. Piano Tones

If certain electric piano tones are selected, the following parameters will be shown.

* For the tones corresponding to certain electric piano tones, refer to "Tone List" (p. 70).

Parameter	Value	Explanation
Tone Color	0-127	Adjusts an effect that's suitable for each sound, such as timbre or acoustic image.
Mechanical Key On Noise	0-127	<p>Here you can adjust the loudness of the hammer strike on an electric piano's sound-producing mechanism, such as the tine or reed.</p> <p>Higher settings produce a louder hammer strike.</p> <p>* Depending on the tone that's selected, this might have no effect.</p>

Parameter	Value	Explanation
Sound Lift	0–127	Lets you change the way that the sound responds when you play the keyboard softly. For example, this can be adjusted suitably for solo performance, or to prevent your sound from being buried in the rest of the band.
		Increasing this value will allow fairly loud sounds to be produced even when you play with a light touch, so that your performance will not be obscured by the playing of your band. Changing this value does not affect the way in which the sound responds to velocity.

Making Detailed Settings for the CLAV Tones

If certain clav tones are selected, the following parameters appear.

* For details on which clav tones this applies to, refer to “Tone List” (p. 70).

Parameter	Value	Explanation
Tone Color	0–127	Adjusts an effect that’s suitable for each sound, such as timbre or acoustic image.
Pitch Bend Range	0–24 (semitones)	Sets the amount of pitch change to occur when you move the Pitch Bend lever (maximum two octaves).
Key Off Resonance	0–127	Adjusts resonances such as the key-off sound (the faint sound heard when you release a key). Higher values produce a louder key-off sound. At a setting of 0 there will be no key-off sound at all.
Hum Noise	0–127	Adjusts the amount of hum and other noise that leaks into the pickups. Electric clavichords were susceptible to various types of noise, and this noise would sometimes be output along with the sounds of the performance. Depending on the effect settings, such noises can produce an authentic, lively atmosphere.
		Lowering this value makes the sound clearer; raising this value makes the sound dirtier. At a setting of 0 there will be no hum at all. * Depending on the tone that’s selected, this might have no effect.

Making Detailed Settings for the Other Tones

If you’ve selected a tone other than certain piano, electric piano, or clav tones, the following parameters appears.

Parameter	Value	Explanation
Tone Color	0–127	Adjusts an effect that’s suitable for each sound, such as timbre or acoustic image.
Mono/Poly		Specifies whether the tone is to play polyphonically (POLY) or monophonically (MONO). The MONO setting is effective when playing a solo instrument tone, such as sax or flute. Additionally, when this is set to “MONO LEGATO,” you can have monophonic performances be played legato. Legato is a playing style in which the spaces between notes are smoothed, creating a flowing feel with no borders between the notes. This creates a smooth transition between notes, which is effective when you wish to simulate the hammering-on and pulling-off techniques used by a guitarist.
	MONO	Only the last-played note will sound.
	POLY	Two or more notes can be played simultaneously.
	MONO LEGATO	Legato is applied to monophonic performances.
Portamento Switch	ON, OFF	Portamento is a function that causes the pitch to change smoothly from one note to the next note played. With the Mono/Poly parameter set to MONO, portamento is especially effective when simulating playing techniques such as violin glissandos.
Portamento Time	0–127	The Portamento Time setting determines the time for the change in pitch when the portamento effect is applied to the sound. Higher settings cause the pitch change to the next note to take more time.
Pitch Bend Range	0–24 (semitone)	Sets the amount of pitch change to occur when you move the Pitch Bend lever (maximum two octaves).
Attack Time Offset	-64+63	The time it takes after the key is pressed for a sound to reach full volume. Higher values produce a milder attack; lower values produce a sharper attack. * With some Tones, the effect does not work as intended.

Parameter	Value	Explanation
Decay Time Offset		<p>This is the time over which the volume decays after the attack is finished.</p> <p>The time it takes for the volume to fall increases as the value is raised; lowering the value decreases the decay time.</p> <p>* With some Tones, the effect does not work as intended.</p>
Release Time Offset		<p>The time it takes after the key is released for a sound to become inaudible.</p> <p>Higher values produce longer decay; set lower values for a clear-cut sound.</p> <p>* With some Tones, the effect does not work as intended.</p>
Cutoff Offset		<p>Adjusts how much the filter is opened.</p> <p>Higher values brighten the sound; lower values make the sound seem darker.</p> <p>* With some Tones, the effect does not work as intended.</p>
Resonance Offset	-64+63	<p>Emphasizes the overtones in the vicinity of the cutoff frequency, adding character to the sound. Excessively high settings can produce oscillation, causing the sound to distort.</p> <p>Higher values strengthen the distinctive characteristics of the sound; lower values reduce these characteristics.</p> <p>* With some Tones, the effect does not work as intended.</p>
Vibrato Rate Offset		<p>Adjusts the vibrato speed (the rate at which the pitch is modulated). The pitch is modulated more rapidly for higher settings, and more slowly with lower settings.</p>
Vibrato Depth Offset		<p>Adjusts the depth of the vibrato effect (the depth at which the pitch is modulated). The pitch is modulated more greatly for higher settings, and less with lower settings.</p>
Vibrato Delay Offset		<p>For each part, this adjusts the time until vibrato (pitch modulation) begins.</p> <p>Higher settings produce a longer delay time before vibrato begins, while lower settings produce a shorter time.</p>

Editing Individual Keys (Indiv. Voicing)

NOTE

- These settings are available only when editing certain piano tones.
- For details on the tones to which this applies, refer to “Tone List” (p. 70).

1. In the procedure “Detailed Tone Settings (TONE DESIGNER)” (p. 10), choose “Indiv. Voicing” and press the [ENTER] button.
2. Use the cursor buttons to select a parameter.
3. Press a key to specify the key that you want to edit.
4. Use the [DEC] [INC] buttons or the value dial to edit the values.

TUNING

You can make fine adjustments to the tuning of each key.

Parameter	Value	Explanation
Type	OFF, PRST (PRESET), USER	<p>Selects the type of tuning.</p> <p>PRST (PRESET) is the tuning curve that’s factory-set for the RD-2000.</p> <p>If you choose USER, you’ll be able to specify the tuning of each key.</p>
Value	-50.0+50.0	<p>Allows for fine adjustments to the tuning of each key in steps of 0.1 cents, over a range of -50.0 to +50.0 cents.</p>

LEVEL

This is a fine adjustment to the volume of each key.

Parameter	Value	Explanation
Type	OFF, PRST (PRESET)*, USER	<p>If you choose USER, you’ll be able to edit the volume of each key.</p>
Value	-50-0	<p>Lower values cause the key to be softer than the other keys.</p>

* V-Piano Technology tones only (tone numbers S01-S10)

CHARACTER

Relative to the value of the “Character” parameter in Piano Designer, this lets you adjust the offset value for each key.

Parameter	Value	Explanation
Type	OFF, PRST (PRESET)*, USER	<p>If you choose USER, you’ll be able to edit the Character offset value of each key.</p>
Value	-5-0+5	<p>Higher values produce a harder sound; lower values make the tone more mellow.</p>

* V-Piano Technology tones only (tone numbers S01-S10)

MEMO

If you change the value of a key from "OFF" or "PRST," the Type will automatically change to "USER."

Adjusting Resonance When the Damper Pedal Is Depressed (Sym. Resonance)

NOTE

These parameters cannot be specified for some tones (V-Piano Technology tones: tone numbers S01–S10) or for zones 5–8.

For details on the tones to which this applies, refer to "Tone List" (p. 70).

You can adjust this resonance when the damper pedal is depressed (Sympathetic Resonance).

On an acoustic piano, holding down the damper pedal will allow the remaining strings to resonate in sympathy with the sounds that you played from the keyboard, adding a rich resonance. This feature reproduces that resonance sound.

Parameter	Value	Explanation
Switch	OFF, ON	When set to ON, the effect is applied.
Depth	0–127	Depth of the effect
Damper	0–127	Depth to which the damper pedal is pressed (controls the resonant sound)
Pre LPF	16–15000 Hz, BYPASS	Frequency of the filter that cuts the high-frequency content of the input sound (BYPASS: no cut)
Pre HPF	BYPASS, 16–15000 Hz	Frequency of the filter that cuts the low-frequency content of the input sound (BYPASS: no cut)
Peaking Freq	16–15000 Hz	Frequency of the filter that boosts/cuts a specific frequency region of the input sound
Peaking Gain	-15–+15 dB	Amount of boost/cut produced by the filter at the specified frequency region of the input sound
Peaking Q	0.5, 1.0, 2.0, 4.0, 8.0	Width of the frequency region boosted/cut by the Peaking Gain parameter (larger values make the region narrower)
HF Damp Freq	16–15000 Hz, BYPASS	Frequency at which the high-frequency content of the resonant sound will be cut (BYPASS: no cut)
LF Damp Freq	BYPASS, 16–15000 Hz	Frequency at which the low-frequency content of the resonant sound will be cut (BYPASS: no cut)
Level	0–127	Output Level
Damper Offset	0–127	Volume of additional slight resonance when the damper pedal is not pressed

Editing the Modulation FX (Modulation FX)

Here you can edit the modulation FX parameters.

NOTE

These parameters cannot be specified for some tones (V-Piano Technology tones: tone numbers S01–S10) or for zones 5–8.

For details on the tones to which this applies, refer to "Tone List" (p. 70).

1. Make the [ZONE EFFECTS] button light.
2. While holding down the [SHIFT] button, operate the MODULATION FX [DEPTH] (or [RATE]) knob.
The MODULATION FX screen appears.
3. Select the parameter that you want to edit, and use the [DEC] [INC] buttons or the value dial to edit the value.

Parameter	Value	Explanation
Type	Refer to the effect list (p. 34).	Specifies the type of Modulation FX. The editable parameters will depend on the effect type that's selected.
Routing	MOD FX (Modulation FX) → TR/AMP (Tremolo/Amp Simulator) TR/AMP (Tremolo/Amp Simulator) → MOD FX (Modulation FX)	Lets you select the routing of the Modulation FX and the Tremolo/Amp Simulator. By switching the Routing type, you can change the effect that's applied to the sound. For example, suppose that you chose Chorus as the MOD FX and chose E.PIANO for TR/AMP; with the MOD FX → TR/AMP setting, the chorus sound will be output in monaural, but with the TR/AMP → MOD FX setting it will be output in stereo.
Switch	OFF, ON	Turns the Modulation FX on/off.

MEMO

For details, refer to "Modulation FX Parameters" (p. 34).

Editing Tremolo/Amp Simulator (Tremolo/Amp Simulator)

Here's how to edit the Tremolo/Amp Simulator parameters.

NOTE

These parameters cannot be specified for some tones (S tones) or for zones 5–8.

For details on the tones to which this applies, refer to “Tone List” (p. 70).

1. Make the [ZONE EFFECTS] button light.
2. While holding down the [SHIFT] button, operate the TREMOLO/AMP SIM [DEPTH] (or [RATE]) knob.
The Tremolo/Amp Simulator screen appears.
3. Select the parameter that you want to edit, and use the [DEC] [INC] buttons or the value dial to edit the value.

Parameter	Value	Explanation
Type	Refer to “Tremolo/Amp simulator types” (p. 16)	Selects the type of Tremolo/Amp Simulator. The editable parameters will depend on the effect type that's selected.
Routing	MOD FX (Modulation FX) → TR/AMP (Tremolo/Amp Simulator)	Lets you select the routing of the Modulation FX and the Tremolo/Amp Simulator. By switching the Routing type, you can change the effect that's applied to the sound. For example, suppose that you chose Chorus as the MOD FX and chose E.PIANO for TR/AMP; with the MOD FX → TR/AMP setting the chorus sound will be output in monaural, but with the TR/AMP → MOD FX setting it will be output in stereo.
	TR/AMP (Tremolo/Amp Simulator) → MOD FX (Modulation FX)	

Tremolo/Amp simulator types

Type	Explanation
1 NORMAL	This is an amp with a flat frequency response. It allows you to add a tremolo effect and distortion.
2 A.PIANO	In addition to NORMAL, this reproduces the open/closed state of a grand piano's lid. Tremolo types of differing character are available, allowing you to reproduce the character of classic electric pianos when combined with an electric piano sound. Characteristics of the tremolo types OLDCASE MONO Used in conjunction with TINE EP, this simulates an early model of a classic electric piano of the 60s. OLDCASE STEREO Used in conjunction with TINE EP, this simulates a classic electric piano sound of the early 70s.
3 E.PIANO	NEWCASE Used in conjunction with TINE EP, this simulates a classic electric piano sound of the late 70s and early 80s. DYNO This model allows you to vary the shape of the tremolo waveform. Used in conjunction with TINE EP, this simulates an electric piano sound used in many recordings of the early 80s. WURLY Used in conjunction with REED E.PIANO, this simulates a classic electric piano sound of the 60s.
4 GUITAR AMP	Simulates playing through a guitar amp. MEMO Since the [DRIVE] knob faithfully simulates the volume knob of a guitar amp, turning the knob toward the left will also decrease the volume.
5 ROTARY	This simulates a rotary effect suitable for organ sounds.
6 MKS-20 Tremolo	This simulates the tremolo effect that was built into the MKS-20.

MEMO

For details, refer to “Tremolo/Amp Simulator Parameters” (p. 61).

Simulating the Creation of Organ Tones

These settings are available only if a TW-Organ (tonewheel organ) tone is selected.

On a tonewheel organ, you can create original sounds by sliding nine harmonic bars (drawbars) forward or backward to change their relative balance. Each bar is assigned a different footage, and this footage determines the pitch of the sound. 8' is the footage that forms the basic pitch of the sound; this is the center around which you create the tone.

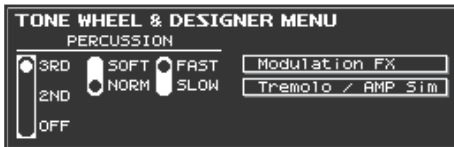

For details, refer to "Creating the Organ Tones" (owner's manual: p. 22).

Using the RD-2000 as a Master Keyboard

By connecting an external MIDI device to the MIDI OUT connectors on the RD-2000's rear panel, you can then control the external MIDI device from the RD-2000.

For each zone, the RD-2000 lets you select either the internal MIDI sound generator (internal: red LED lit) or an external MIDI sound generator (external: green LED lit).

By using an external MIDI sound generator (external), you can control a wide range of settings on the external MIDI sound generator.

You can control internal and external sound generators independently.

If you press the [SHIFT] + [INT/EXT] buttons to make a zone light green, it controls an external MIDI sound generator (external zone). You can press the [SHIFT] + [INT/EXT] button to switch between controlling either the internal zone or the external zone.

You can also make detailed settings for MIDI messages transmitted to external sound modules.

* When Rec Mode (p. 32) is "ON," MIDI messages are not output from external zones.

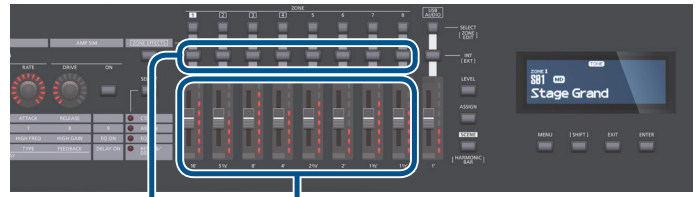

What's MIDI?

MIDI (Musical Instrument Digital Interface) is a standard specification that allows musical data to be exchanged between electronic musical instruments and computers.

If devices equipped with MIDI ports are connected via a MIDI cable, you'll be able to use them in the following ways.

- Use one MIDI keyboard to play multiple instruments
- Play multiple MIDI instruments as an ensemble
- Automatically switch settings as the song progresses

About MIDI Connectors

The RD-2000 has the following three types of MIDI connectors. Their functions differ as described below.

MIDI IN connector

Performance messages from an external MIDI device are received here. These incoming messages may instruct the RD-2000 to play sounds or switch tones.

MIDI OUT connector

MIDI messages are transmitted from these connectors to external MIDI devices. The RD-2000's MIDI OUT connectors are used for sending the performance data of the controller section.

MIDI THRU connector

MIDI messages received at MIDI IN connectors are re-transmitted without change from this connector to an external MIDI device. Use this in situations such as when you use multiple MIDI devices simultaneously.

MEMO

The RD-2000 lets you switch the function of the MIDI THRU/OUT 2 connector (p. 24).

Adjusting the Volume of Each Zone

If the INT/EXT select button is lit green, the INT/EXT select button and slider can control the external zone in the same way as the internal zone (owner's manual: p. 14).

INT/EXT select buttons

You can specify whether MIDI messages including data for your keyboard playing in an external zone is transmitted (or is not transmitted) from the MIDI OUT connector.

For a zone whose INT/EXT select button is lit (green), playing the keyboard will transmit those MIDI messages from MIDI OUT.

For a zone whose button is unlit, playing the keyboard will not transmit MIDI messages.

The INT/EXT select button's on/off status changes each time you press the button.

Sliders

If the [LEVEL] button is lit, the sliders adjust the volume of each zone.

Selecting the MIDI Connector to Use for Output

The RD-2000 provides a MIDI OUT connector, a MIDI connector whose function can be switched between OUT and THRU, and a USB COMPUTER port.

For each zone you can select the MIDI OUT connector or USB COMPUTER port from which its data is to be transmitted.

1. In the ZONE EDIT screen's upper line, select the "EXTERNAL" tab.
[MENU] button → "Program Edit" → "Zone Edit"
2. In the "OUT/PC" tab of the lower line, specify the output destination for each zone.

Zone	Parameter	Settings	Explanation
1			
2			
3		ALL,	The RD-2000's performance data is transmitted from the selected connector.
4	OUT (MIDI OUT Port)	OUT1 (MIDI OUT 1),	
5		OUT2 (MIDI OUT 2),	
6		USB	
7			
8			

MEMO

If the System parameter MIDI OUT2 Port Mode (p. 24) is set to "THRU," the performance data from the RD-2000 will not

be transmitted from the MIDI OUT 2 connector; instead, the performance data received at the MIDI IN connector will be retransmitted without change (MIDI THRU).

Setting the MIDI Transmit Channel

When you have finished connecting the external MIDI device, match the keyboard's Transmit channel and the Receive channel for each of the external MIDI sound generator's Parts. Sound is produced when the MIDI channels for the sending device (the RD-2000) and the receiving device (the external MIDI sound generator) are set to the same MIDI channel.

1. In the ZONE EDIT screen's upper line, select the "EXTERNAL" tab.

[MENU] button → "Program Edit" → "Zone Edit"

2. In the lower line, use the "OUT/PC" tab to specify the Tx Ch of each zone.

Zone	Parameter	Value	Explanation
1			
2			
3			
4	Tx Ch (MIDI Tx Channel)	1–16	RD-2000 performance data is sent over a selected channel.
5			
6			
7			
8			

MEMO

- For details on how to set the receive channel for each part of your external MIDI device, refer to its owner's manual.
- Zones whose INT/EXT select button (p. 18) is off are shown in gray. Also, MIDI messages are not transmitted when you play the keyboard.

Selecting Sounds on an External MIDI Device

To switch the tones of an external MIDI device, the program number and the MSB/LSB of the Bank Select message are entered as numerical values on the RD-2000.

1. In the ZONE EDIT screen's upper line, select the "EXTERNAL" tab.

[MENU] button → "Program Edit" → "Zone Edit"

2. In the lower line, use the "OUT/PC" tab to specify the MSB, LSB, and PC for each zone.

When this setting is "--," bank select and program change messages will not be transmitted.

Parameter	Value
MSB (Bank Select MSB: CC0)	--, 0–127
LSB (Bank Select LSB: CC32)	--, 0–127
PC (Program Change)	--, 1–128

NOTE

- If the external MIDI sound generator receives a Program number or a Bank number for which no Tone has been assigned, an alternate Tone may be selected, or in some cases, there may be no sound played.
- If you do not want to transmit the Program number or Bank Select, use the procedure described above to set the PC/MSB/LSB to "--."
- If this is set to "--," the sound selection data will not be transmitted when you switch Programs.

Detailed Settings for Transmitted Parts

1. In the ZONE EDIT screen's upper line, select the "EXTERNAL" tab.

[MENU] button → "Program Edit" → "Zone Edit"

2. Press the Cursor buttons to move the cursor to the parameter to be set.

3. Use the [DEC] [INC] buttons or value dial to set the value.

If you press the [DEC] button and [INC] button simultaneously, the value will be reset to "--" or to the default setting. The value for the setting won't be transmitted when set to "--."

Parameter	Value	Explanation
OUT MIDI OUT Port	ALL, OUT1, OUT2, USB	The RD-2000's performance data is transmitted from the selected connector.
Tx Ch MIDI Tx Channel	1–16	RD-2000 performance data is sent over a selected channel.
MSB Bank Select MSB (CC0)	--, 0–127	Here you can specify the sound that you want to select on your external MIDI device by entering its program number and bank select MSB/LSB values.
LSB Bank Select LSB (CC32)	--, 0–127	
PC Program Change	--, 1–128	
VOL Volume (CC7)	--, 0–127	Adjusts the volume balance between zones.
PAN Pan (CC10)	--, L64–0–R63	The Pan setting positions the sound image of each zone when the output is in stereo. With an increase in the value for L, more of the sound will be heard as coming from the left side. Similarly, more of the sound will originate at the right if the value of R is increased. When set to 0, the sound is heard as coming from the center.
REV Reverb Send Level (CC91)	--, 0–127	Sets the depth of the reverb effects.
CHO Chorus Send Level (CC93)	--, 0–127	Sets the depth of the chorus effects.

Parameter	Value	Explanation
Mn/Ply Mono (CC126) Poly (CC127)	---, M (Mono), P (Poly)	Specifies whether the tone will play polyphonically (Poly) or monophonically (Mono). The Mono setting is effective when playing a solo instrument tone such as sax or flute.
Trans Zone Transpose	-48--+48	You can perform with each zone transposed to a different pitch. When multiple zones are set to on, you can create a richer sound by setting the two Zones to different octaves. Also, if the Keyboard Mode is set to Split, and you are playing a bass Tone in the lower Part, you can use the Transpose function to play the bass at a lower pitch.
Rng Lo Keyboard Range Lower	A0-C8	Set the keyboard range in which each Zone will sound. This can be used to make notes in different areas of the keyboard play different Tones.
Rng Up Keyboard Range Upper		Specify the lower limit (Rng Lo) and upper limit (Rng Up) of the key range being set.
Rng Lo Velocity Range Lower	1-127	You can also set this by pressing a specific key and then pressing the [ENTER] button.
Rng Up Velocity Range Upper		Specify the lower limit (VR.LWR) and upper limit (VR.UPR) of the range in which the tone is played according to how strongly the keys are played (velocity). Make this setting when you want the tone to change depending on the key velocity.
Attack Attack Time Offset (CC73)		The time it takes after the key is pressed for a sound to reach full volume. Higher values produce a milder attack; lower values produce a sharper attack.
Decay Decay Time Offset (CC75)	---, 0-127	This is the time over which the volume decays after the attack is finished. The time it takes for the volume to fall increases as the value is raised; lowering the value decreases the decay time.
Release Release Time Offset (CC72)		The time it takes after the key is released for a sound to become inaudible. Higher values produce longer decay; set lower values for a clear-cut sound.

Parameter	Value	Explanation
Cutoff Cutoff Offset (CC74)		Adjusts how much the filter is opened. Higher values brighten the sound; lower values make the sound seem darker.
Reso Resonance Offset (CC71)	---, 0-127	Emphasizes the overtones in the vicinity of the cutoff frequency, adding character to the sound. Excessively high settings can produce oscillation, causing the sound to distort. Higher values strengthen the distinctive characteristics of the sound; lower values reduce these characteristics.
POR Sw Portamento Switch (CC65)	---, OFF, ON	Turns portamento on/off. Portamento is a function that causes the pitch to change smoothly from one note to the next note played.
P.Time Portamento Time (CC5)	---, 0-127	The Portamento Time setting determines the time for the change in pitch when the portamento effect is applied to the sound. Higher settings will cause the pitch change to the next note to take more time.
Coarse Coarse Tune	---, -48--+48	Adjusts the pitch in semitone steps (± 4 octaves).
Fine Fine Tune	---, -50--+50	Adjusts the pitch in one-cent steps (± 50 cents). 1 cent = 1/100th of a semitone
BND Rng Pitch Bend Range	---, 0-48	Sets the amount of pitch change to occur when you move the Pitch Bend lever (4 octaves). (RPN: 00H/00H)
MOD Dep Modulation Depth	---, 0-127	Sets the depth of the effect when the Modulation lever is tilted. (RPN: 00H/05H)

Parameter	Value	Explanation
Damper Damper Control Switch		Damper pedal
FC1 FC1 Control Switch	OFF, ON	Pedal connected to the FC1 jack
FC2 FC2 Control Switch		Pedal connected to the FC2 jack
EXT EXT Pedal Control Switch		Pedal connected to the EXT jack
PCH BND Pitch Bend Control Switch		Pitch Bend Lever
MOD CTL Modulation Control Switch	OFF, ON	Modulation Lever
MOD W1 MOD Wheel 1 Control Switch		Modulation wheel 1
MOD W2 MOD Wheel 2 Control Switch		Modulation wheel 2
A1 Assign 1 Control Switch	OFF, ON	ASSIGN [1] knob
A2 Assign 2 Control Switch		ASSIGN [2] knob
A3 Assign 3 Control Switch		ASSIGN [3] knob
A4 Assign 4 Control Switch		ASSIGN [4] knob
A5 Assign 5 Control Switch		ASSIGN [5] knob
A6 Assign 6 Control Switch		ASSIGN [6] knob
A7 Assign 7 Control Switch		ASSIGN [7] knob
A8 Assign 8 Control Switch		ASSIGN [8] knob
A9 Assign 9 Control Switch		ASSIGN [9] button
CC1 User Control Change 1 Number	---, 0–127	You can assign and transmit two different control change messages.
Value User Control Change 1 Value		
CC2 User Control Change 2 Number		
Value User Control Change 2 Value		

Specify whether knobs and other controllers will (ON) or will not (OFF) control an external MIDI device.

Detailed Settings for Each Function

Setting Parameters (System)

Functions that affect the overall operating environment of the RD-2000 are called “system functions.”

[MENU] button → Select “System” → [ENTER] button → “SYSTEM” tab

Parameter	Value	Explanation	
Master Tune	415.3–440.0– 466.2 [Hz]	<h3>Tuning to Other Instruments’ Pitches (Master Tune)</h3> <p>For a cleaner ensemble sound while performing with one or more other instruments, ensure that each instrument’s basic pitch is in tune with that of the other instruments. In general, the tuning of an instrument is indicated by the pitch in Hertz (Hz) of the middle “A” note.</p>	
		<h3>Selecting the Target Controlled by a Knob (Control Destination)</h3> <p>You can select the target that is controlled by the knobs via ZONE EFFECT, CTRL, and ASSIGN.</p>	
Control Destination	SELECT	The knobs affect the zones that are selected by the [SELECT] buttons.	
	PROGRAM	The knobs affect the settings specified by ASSIGN SW and FX DEST in ZONE EDIT.	
EQ Mode		<h3>Retaining the Equalizer Settings Even When the Program Is Switched (EQ Mode)</h3> <p>You can store different equalizer settings (p. 9) for each individual Program (owner’s manual: p. 13). This setting determines whether or not the Program equalizer settings values are to be changed when Programs are switched.</p>	
		PROGRAM	When you switch Programs, the equalizer settings will also switch.
		REMAIN	When you switch Programs, the equalizer settings will not change.
Select Button Mode		<h3>Retaining the SELECT Button Settings Even When the Program Is Switched (Select Button Mode)</h3> <p>SELECT button settings (owner’s manual: p. 8) can be stored individually for each Program (owner’s manual: p. 13). You can specify whether the SELECT button settings will or will not change to the functions stored in each Program when you switch a Program.</p>	
		PROGRAM	When you switch Programs, the SELECT button settings will also change.
		REMAIN	When you switch Programs, the SELECT button settings will not change.
Pedal Mode		<h3>Retaining the Pedal Settings Even When the Program Is Switched (Pedal Mode)</h3> <p>Pedal settings (p. 6) can be stored for each Program (owner’s manual: p. 13). This setting determines whether or not the pedal settings are switched to the values stored in the Program you are switching to.</p>	
		PROGRAM	When you switch Programs, the pedal settings will also change.
		REMAIN	When you switch Programs, the pedal settings will not change.
Wheel Mode		<h3>Retaining the MOD WHEEL 1/2 Settings Even When the Program Is Switched (Wheel Mode)</h3> <p>The settings of the MOD WHEEL 1/2 (p. 7) can be stored for each Program (owner’s manual: p. 13). This setting determines whether or not the settings of the MOD WHEEL 1/2 are switched to the values stored in the Program you are switching to.</p>	
		PROGRAM	When you switch Programs, the settings of the MOD WHEEL 1/2 will also change.
		REMAIN	When you switch Programs, the settings of the MOD WHEEL 1/2 will not change.

Parameter	Value	Explanation
Assign 1-9 Mode		<h3>Retaining the Assign 1–9 Controller Settings Even When the Program Is Switched (Assign 1-9 Mode)</h3> <p>The settings of the Assign 1–9 controllers (p. 7) can be stored individually for each Program (owner's manual: p. 13).</p> <p>You can specify whether the Assign 1–9 controller settings stored in the Program will or will not change when you switch Programs.</p>
	PROGRAM	When you switch Programs, the Assign 1–9 controller settings will also change.
	REMAIN	When you switch Programs, the Assign 1–9 controller settings will not change.
Delay Mode		<h3>Retaining the Delay Settings Even When the Program Is Switched (Delay Mode)</h3> <p>Delay settings (p. 9) can be stored individually for each Program (owner's manual: p. 13).</p> <p>You can specify whether the delay settings will or will not change to the values stored in each Program when you select a Program.</p>
	PROGRAM	When you switch Programs, the delay settings will also change.
	REMAIN	When you switch Programs, the delay settings will not change.
Reverb Mode		<h3>Retaining the Reverb Settings Even When the Program Is Switched (Reverb Mode)</h3> <p>Reverb settings (p. 9) can be stored individually for each Program (owner's manual: p. 13).</p> <p>You can specify whether the reverb settings will or will not change to the values stored in each Program when you select a Program.</p>
	PROGRAM	When you switch Programs, the reverb settings will also change.
	REMAIN	When you switch Programs, the reverb settings will not change.
Rhythm Mode		<h3>Retaining the Rhythm Settings Even When the Program Is Switched (Rhythm Mode)</h3> <p>Rhythm pattern, tempo, and volume (owner's manual: p. 24) can be stored individually for each Program (owner's manual: p. 13).</p> <p>You can specify whether the Rhythm settings will or will not change to the value stored in each Program when you switch a Program.</p>
	PROGRAM	When you switch Programs, the rhythm settings will also change.
	REMAIN	When you switch Programs, the rhythm settings will not change.
Key Touch Mode		<h3>Retaining the Keyboard Touch Settings Even When the Tone or Program Is Switched (Key Touch Mode)</h3> <p>Key Touch settings (p. 5) can be stored individually for each Program (owner's manual: p. 13).</p> <p>You can specify whether the Key Touch settings will or will not change to the values stored in each Program when you switch a Program.</p> <p>You can also specify whether the tone's Key Touch settings (valid only for the zone 1) will or will not be applied when you switch tones.</p>
	TONE/PROGRAM	When you switch tones or Programs, the Key Touch settings will also change. * The setting will not be changed by operations in the Zone Edit screen (p. 4) or when a MIDI message is received to switch tones.
	REMAIN	When you switch tones or Programs, the Key Touch settings will not change.

Parameter	Value	Explanation
Tone/Program Remain		<h3>Retaining the Current Tone Even When Tones Are Switched (Tone/Program Remain)</h3> <p>This setting specifies whether the tone currently being sounded will continue (ON) or not (OFF) when another tone is selected.</p> <p>NOTE</p> <ul style="list-style-type: none"> • Effects (Reverb, Delay, EQ, Sympathetic Resonance) settings change as soon as you switch to a new Tone, without being influenced by the Tone/Program Remain setting. Because of this, certain effects settings can cause notes that were until then sounding to no longer be heard, even though Tone/Program Remain has been set to ON. • Even if Tone/Program Remain is set to ON, the sound of the current tone is not carried over when changing from a Virtual Tone Wheel tone to a non-Virtual Tone Wheel tone. • When you switch between tones of the V-Piano Technology sound generator (MD), the currently sounding tone does not continue.
	OFF, ON	
Tone Ext Zone Remain		<h3>Retaining the Ext Zone On/Off Settings Even When Tones Are Switched (Tone Ext Zone Remain)</h3> <p>This setting specifies whether the on/off settings for zones set to External are maintained (ON) or not maintained (OFF).</p>
	OFF, ON	
Ext Zone Transmit Control		<h3>Preventing Ctrl Messages from Being Transmitted by Ext Zone On/Off (Ext Zone Transmit Control)</h3> <p>This setting specifies whether the pre-specified control change messages are transmitted (ON) or are not transmitted (OFF) when a zone set to External is turned on.</p>
	OFF, ON	
Program Control Channel		<h3>Using Program Change Messages to Switch Programs (Program Control Channel)</h3> <p>You can switch the RD-2000's Programs with MIDI messages from an external MIDI device.</p> <p>MEMO</p> <p>For details, refer to "MIDI Implementation" (PDF).</p>
	OFF	When not switching Programs from an external MIDI device, set this to OFF.
	1–16	Sets the MIDI Receive channel for receiving the MIDI messages (Bank Select and Program Change) from the external MIDI device to be used for switching Programs.
USB Driver		<h3>Selecting the USB Driver (USB Driver)</h3> <p>➔ Refer to "Switching USB Drivers" (p. 33)</p>
USB MIDI Thru Switch		<h3>Selecting the USB MIDI Thru Switch (USB MIDI Thru Switch)</h3> <p>➔ Refer to "Using the RD-2000 as a USB MIDI Interface" (p. 33)</p>
MIDI OUT2 Port Mode		<h3>Selecting the Function of the MIDI THRU/OUT 2 Connector (MIDI OUT2 Port Mode)</h3> <p>This setting specifies the function of the RD-2000's MIDI THRU/OUT 2 connector.</p>
	OUT	If you choose "OUT," the connector will function as MIDI OUT, and will transmit data from the keyboard and controllers to an external MIDI device.
	THRU	If you choose "THRU," the connector will function as MIDI THRU, retransmitting without change the MIDI messages that are received at the MIDI IN connector. Performance data from the RD-2000 itself will no longer be sent from this connector.

Parameter	Value	Explanation
Damper Polarity		Switching the Pedal's Polarity (Damper/FC1/FC2/EXT Pedal Polarity) Switch the polarity of pedals connected to the RD-2000. This can be set individually for each of the Pedal jacks on the rear panel (FC1, FC2, DAMPER, EXT Pedal). On some pedals, the electrical signal output by the pedal when it is pressed or released is the opposite of other pedals. If your pedal has an effect opposite of what you expect, set this parameter to reverse. If you are using a Roland pedal (that has no polarity switch), set this parameter to STANDARD.
FC1 Polarity		
FC2 Polarity	STANDARD, REVERSE	
EXT Pedal Polarity		
Temperament		Setting the Tuning Method (Temperament/Key) This sets the tuning and keynote (tonic). Most modern songs are composed and played with the assumption that equal temperament will be used, but when classical music was composed, there were a wide variety of other tuning systems in existence. Playing a composition with its original tuning lets you enjoy the sonorities of the chords that the composer originally intended. When playing with tuning other than equal temperament, you need to specify the keynote for tuning the song to be performed (that is, the note that corresponds to C for a major key or to A for a minor key). If you choose an equal temperament, there's no need to select a keynote.
	EQUAL	Equal Temperament This tuning divides an octave into 12 equal parts. Every interval produces about the same amount of slight dissonance.
	JUST MAJ	Just (Major): This scale eliminates dissonance in fifths and thirds. It is unsuited to playing melodies and cannot be transposed, but is capable of beautiful sonorities.
	JUST MIN	Just (Minor): The scales of the major and minor just intonations are different. You can get the same effect with the minor scale as with the major scale.
	PYTHAGOREAN	Pythagorean: This scale, devised by the philosopher Pythagoras, eliminates dissonance in fourths and fifths. Dissonance is produced in thirds, but melodies are euphonious.
	KIRNBERGER	Kirnberger: This scale is a modification of the meantone and just intonations that permits greater freedom in transposition to other keys. Performances are possible in all keys (III).
	MEANTONE	Meantone: This scale makes some compromises in just intonation, enabling transposition to other keys.
	WERCKMEISTER	Werckmeister: This is a combination of the meantone and Pythagorean scales. Performances are possible in all keys (first technique, III).
ARABIC	Arabic Scale: This scale is suitable for Arabic music.	
Temperament Key	C, C#, D, EB, E, F, F#, G, G#, A, BB, B	Sets the keynote.
Clock Out	OFF, ON	Transmitting Synchronization Messages (Clock Out) This setting determines whether or not the MIDI messages necessary to synchronize the RD-2000 with external devices are to be transmitted from the MIDI OUT connector.
Hi-Res Velocity Out	OFF, ON	Transmitting High-Resolution Velocity Data (Hi-Res Velocity Out) This specifies whether high-resolution velocity data is to be transmitted from the MIDI OUT connector.
Rhythm MIDI Output Port	ALL, OUT1, OUT2, USB	Selecting the MIDI Output Port for Rhythm (Rhythm MIDI Output Port) This specifies the port from which the rhythm part is to be transmitted.
Rhythm MIDI Out Channel	OFF, 1-16	Selecting the MIDI Output Channel for Rhythm (Rhythm MIDI Channel) This specifies the MIDI channel on which the rhythm part is to be output.
Audio Volume	0-127	Adjusting the Playback Volume of Audio Files This specifies the volume at which audio files play back.

Detailed Settings for Each Function

Parameter	Value	Explanation
Output Mix/ Parallel	MIX, PARALLEL	<h3>Outputting the SUB OUT Output from MAIN OUT (Output Mix/Parallel)</h3> <p>This setting specifies whether the output of zones assigned to be output from SUB OUT is sent from MAIN OUT (Mix) or from SUB OUT (Parallel).</p>
LCD Brightness	1–10	<h3>Adjusting the Brightness of the Display (LCD Brightness)</h3> <p>You can adjust the brightness of the RD-2000's display.</p>
Auto Off	OFF, 30 [min], 240 [min] (default)	<h3>Making the Power Automatically Turn Off After a Time (Auto Off)</h3> <p>With the factory settings, the RD-2000 will automatically be switched off 4 hours after you stop playing or operating the unit.</p> <p>If you don't need the unit to turn off automatically, set "Auto Off" to the "OFF" setting.</p> <p>* When turning the unit back on after it has been shut down due to the Auto Off function, always make sure to allow at least ten seconds to pass after the unit has been shut off before you turn the unit back on. If you turn it back on too rapidly, the Auto Off function will not have had enough time to reset itself, and you may not be able to turn on the unit in the normal way.</p>

Saving System Settings

Changes you make to the system settings are temporary, and will be lost when you turn off the power.

If you want to keep your changes, you must save the system settings.

1. In the SYSTEM EDIT screen, press the [WRITE] button.

A confirmation message appears.

2. Press the [MENU] button.

The system settings are saved in the system memory of the RD-2000.

If you decide to cancel, press the [EXIT] button.

Parameter	Value	Explanation
USB Audio Output Volume	0–127	Specifies the USB audio signal level to an external device.
USB Audio Output Assign	MAIN, SUB	Specifies whether the USB audio signal is output from the MAIN jacks or from the SUB jacks.
USB Audio In/Out Select	IN, OUT	Selects the USB audio signal that is indicated and adjusted by the slider.

Parameters saved in SYSTEM (System parameter)

- SYSTEM
- USB AUDIO
- PART SW
- COMPRESSOR

USB Audio Settings

Here you can make input/output settings for USB audio.

[MENU] button → Select "System" → [ENTER] button → "USB AUDIO" tab

Parameter	Value	Explanation
USB Audio Input Switch	OFF, ON	Specifies whether to enable USB-AUDIO from an external device.
USB Audio Input Volume	0–127	Specifies the USB audio signal level from an external device.
USB Audio Output Switch	OFF, ON	Specifies whether USB audio is output to an external device.

Selecting the Parts That Will Produce Sound (PART SW)

Here you can specify whether or not performance data is to be received from an external MIDI device.

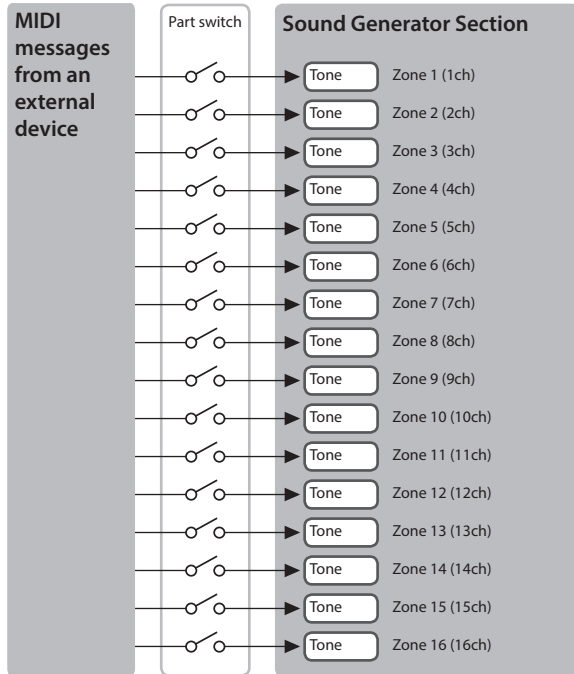

[MENU] button → Select "System" → [ENTER] button → "PART SW" tab

Parameter	Value	Explanation
Part Switch	OFF, ON (Part 1–Part 16)	Part Switch settings can be made individually for each part. NOTE Tone Color and effects are not available for the parts received on channels 5–16. They may sound differently than the sounds played on channels 1–4.

Making the System Compressor Settings (COMPRESSOR)

This is a stereo compressor (limiter) that is applied to the final output.

With separate settings for the high-frequency range, midrange, and low-frequency range, this reduces inconsistencies in volume levels by compressing the sound when the volume exceeds a preset volume level.

[MENU] button → Select "System" → [ENTER] button → "COMPRESSOR" tab

Parameter	Value	Explanation
Compressor Switch	OFF, ON	Turns the compressor on/off.

Parameter	Value	Explanation
Type Compressor Type	When you change this parameter, the Compressor parameters will be automatically adjusted to the optimal values. You can make the settings easily by first setting the Compressor Type and then changing only the necessary parameters.	
	HARD COMP	Applies strong compression.
	SOFT COMP	Applies mild compression.
	LOW BOOST	Boosts the low end.
	MID BOOST	Boosts the midrange.
	HI BOOST	Boosts the high end.
	USER	The saved settings are written.
Split Freq Low	40, 50, 63, 80, 100, 125, 160, 200, 250, 315, 400, 500, 630, 800 [Hz]	Sets the frequency separating the low-frequency range (LOW) and midrange (MID).
Split Freq High	400, 500, 630, 800, 1000, 1250, 1600, 2000, 2500, 3150, 4000, 5000, 6300, 8000 [Hz]	Sets the frequency separating the high-frequency range (HIGH) and midrange (MID).

Common to High, Mid, and Low

Parameter	Value	Explanation
Level	0–24 dB (1 dB Step)	Output Level
Attack Time	0–100	Sets the time it takes until the level is compressed after the input exceeds the Threshold.
Release Time	0–100	Sets the time it takes for the compression to be released after the input falls below the Threshold.
Threshold	-60 dB–0 dB (1 dB Step)	Sets the level at which compression begins.
Ratio	1:1.0, 1:1.1, 1:1.2, 1:1.4, 1:1.6, 1:1.8, 1:2.0, 1:2.5, 1:3.2, 1:4.0, 1:5.6, 1:8.0, 1:16, 1:INF	Compression Ratio

INFORMATION

This shows the RD-2000's system program version and information about additional sounds.

Convenient Functions (Utility)

Saving a Program File (Program File Save)

A single, individual file containing a collection of 200 Programs registered to the RD-2000 is called a "Program file."

This Program file can be saved in the RD-2000's user memory or on a USB flash drive (sold separately) connected to the USB MEMORY/WLAN ADAPTOR port.

MEMO

The Program file will not save unsaved Programs or system parameter settings.

If you want to save these settings, you must first proceed as described in "Saving the Sound Settings in a Program (Program Write)" (owner's manual: p. 24) and "Saving System Settings" (p. 26).

1. In the MENU screen, select "Utility" and press the [ENTER] button (owner's manual: p. 26).
2. Press the cursor [▲] buttons to select "Backup Save," then press the [ENTER] button.
3. Press the cursor [◀] [▶] buttons to move the cursor to the positions where the characters are to be input.



4. Use the [DEC] [INC] buttons or the value dial to enter the name.

Names can consist of up to 16 characters.

Operation	Explanation
[SHIFT] + [◀] button	Delete one character (DELETE)
[SHIFT] + [▶] button	Insert one space (INSERT)
[▲] [▼] buttons	Switch uppercase/lowercase

NOTE

You can't save a Program file with a name that starts with a "." (period). Do not use a "." (period) at the beginning of the name.

5. Repeat steps 3–4 to input the name.
6. Press the [ENTER] button.
The confirmation message appears.
If you do not want to load the Program file, press the [EXIT] button.
7. Press the [MENU] button to save the Program file.
The Program file is saved.

NOTE

- "Processing..." appears in the display while the save is in progress. Be sure never to turn off the power.
- Do not disconnect the USB flash drive while data is being saved.

MEMO

If a file with the same name has already been saved, the confirmation message "Overwrite OK?" appears. To overwrite the Program file, press the [MENU] button; to save the file under a different name, press the [ENTER] button.

Calling Up Program Files (Backup Load)

Here's how to load a previously saved Program file.

NOTE

The current settings are erased when a Program file is called up. Be sure to save any settings you would like to keep first before calling up a Program file (owner's manual: p. 26).

1. In the MENU screen, select "Utility" and press the [ENTER] button (owner's manual: p. 26).
2. Press the cursor [▲] [▼] buttons to select "Backup Load," then press the [ENTER] button.



3. Move the cursor to "Backup File" and use the [DEC] [INC] buttons or the value dial to select the file you want to call up.
4. If you want system parameter (p. 26) settings to also be loaded, move the cursor to "Load System Parameters" and choose "YES."

The system parameters are saved in a Program file that has been stored after the [WRITE] button was pressed to save the settings in the RD-2000.

5. Press the [ENTER] button.
The confirmation message appears.
If you decide to cancel without loading a Program file, press the [EXIT] button.
6. Press the [MENU] button to load the Program file.

The Program file is loaded into the RD-2000.

NOTE

- Be sure never to turn off the power while the load is in progress.
- Do not disconnect the USB flash drive while the file is being loaded.

Deleting a Program File (Backup Delete)

Here's how to delete a previously saved Program file.

1. In the MENU screen, select "Utility" and press the [ENTER] button.
2. Use the cursor [▲] [▼] buttons to select "Backup Delete," and then press the [ENTER] button.

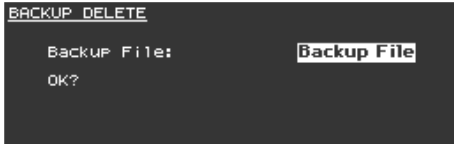

3. Use the [DEC] [INC] buttons or the value dial to select the Program file that you want to delete; then press the [ENTER] button.

The confirmation message appears.

If you decide to cancel without deleting the Program file, press the [EXIT] button.

MEMO

If you choose "ALL," all Program files will be deleted.

4. Press the [MENU] button to delete the Program file.

NOTE

- Be sure never to turn off the power while the delete is in progress.
- Do not disconnect the USB flash drive while the file is being deleted.

Formatting Memory (Format)

"Formatting" is the operation of deleting all Program files from user memory or initializing a USB flash drive so that it can be used with the RD-2000.

USB flash drive cannot be used with the RD-2000 unless it is formatted suitably for the RD-2000.

Before using a new USB flash drive, you'll need to format it.

NOTE

When you format the USB flash drive, all data previously saved on that memory will be erased. Before you carry out a format, make sure that the USB flash drive does not contain important data you need to keep.

1. In the MENU screen, select "Utility" and press the [ENTER] button.
2. Press the cursor [▲] [▼] [◀] [▶] buttons to select "Format USB Memory" and then press the [ENTER] button.

A confirmation message appears.



If you decide to cancel the Format operation, press the [EXIT] button.

3. Carefully read the confirmation message in the screen, and then press the [ENTER] button.
4. Press the [MENU] button to execute the Format operation.

NOTE

- Never turn off the unit while the screen indicates "Executing..."
- Never turn off the power or disconnect the USB flash drive while reading or writing is in progress.

Returning to the Factory Settings (Factory Reset)

The settings stored in the RD-2000 can be returned to their factory settings.

1. In the MENU screen, select "Utility" and press the [ENTER] button.
 2. Press the cursor [▲] [▼] [◀] [▶] buttons to select "Factory Reset" and then press the [ENTER] button.
- A confirmation message appears.
3. Carefully read the confirmation message in the screen, and then press the [ENTER] button.
 4. Press the [MENU] button.

Factory reset is executed.

NOTE

Never turn off the power during Factory Reset (while "Executing... Don't Power OFF" appears in the display).

5. Turn the power of the RD-2000 off, then on again.

SCENE UTILITY

Changing the Order of Scenes (Scene Swap)

You can change the order of the scenes to the order that you prefer. It is convenient to change the order of the scenes to the order in which you use them during a live performance.

1. In the MENU screen, select “Scene Utility” and press the [ENTER] button.
2. Use the cursor [▲] [▼] [◀] [▶] buttons to select “Scene Swap,” and then press the [ENTER] button.
The SCENE SWAP screen appears.
3. Use the cursor [▲] [▼] buttons and the value dial to select the scene whose order you want to change, and press the [ENTER] button.
A confirmation message appears.
4. Press the [MENU] button to execute the swap operation.

If you decide to cancel, press the [EXIT] button.

NOTE

Never turn off the power during execution.

Initializing a Scene (Scene Initialize)

Here’s how to initialize the settings of the currently selected scene.

NOTE

When you initialize a scene, the currently selected scene disappears.

1. In the MENU screen, select “Scene Utility” and press the [ENTER] button.
2. Use the cursor [▲] [▼] [◀] [▶] buttons to select “Scene Initialize,” and then press the [ENTER] button.
The SCENE INITIALIZE screen appears.
3. Press the [ENTER] button.
A confirmation message appears.
4. Press the [MENU] button to execute initialization.

If you decide to cancel, press the [EXIT] button.

NOTE

Never turn off the power during execution.

Adding a Memo to Each Scene (Scene Memo)

You can enter a memo for each recalled scene so that it is shown in the screen (16 characters x 2 lines).

1. In the MENU screen, select “Scene Utility” and press the [ENTER] button.
2. Use the cursor [▲] [▼] [◀] [▶] buttons to select “Scene Memo,” and then press the [ENTER] button.
The SCENE MEMO screen appears.
3. Use the cursor [◀] [▶] buttons to move the cursor to the position at which you want to enter a character.
4. Use the [DEC] [INC] buttons or the value dial to enter the characters.

Operation	Explanation
[SHIFT] + [◀] button	Delete one character (DELETE)
[SHIFT] + [▶] button	Insert one space (INSERT)
[▲] [▼] button	Switch uppercase/lowercase

5. Repeat steps 3–4 to input the memo.
6. Press the [ENTER] button.
A confirmation message appears.
If you decide to cancel, press the [EXIT] button.
7. Press the [MENU] button.
The memo is saved.

Importing Text to Display as the Scene Memo (Scene Memo Import)

The memo displayed for the recalled scene can be imported as a text file from a USB flash drive.

1. In the MENU screen, select “Scene Utility” and press the [ENTER] button.
2. Use the cursor [▲] [▼] [◀] [▶] buttons to select “Scene import,” and then press the [ENTER] button.

The SCENE MEMO IMPORT screen appears.

Files of the following format can be imported.

Item	Explanation
File format	Text file (*.txt)
File name	16 single-byte alphanumeric characters (if greater than 16 characters, only a portion is shown).
Memo content	32 single-byte alphanumeric characters (the 33rd and subsequent characters are not imported) Two lines of up to 16 characters can be shown. If there is a line-return in the first line, the text wraps to the next line, decreasing the number of characters that can be shown. Line-returns of CR+LF and LF are supported.
Characters that can be used	ABCDEFGHIJKLMNOPQRSTUVWXYZ abcdefghijklmnopqrstuvwxyz 0123456789 !#\$%&'()*+,-./:;<=>?@[\\]^_`{ } ? * The last character is a space.

3. Use the value dial to select the text file that you want to import, and press the [ENTER] button.
The SCENE MEMO EDIT screen appears.
4. Use the cursor [◀] [▶] buttons to move the cursor to the position at which you want to enter a character.
5. Use the [DEC] [INC] buttons or the value dial to enter the characters.

Operation	Explanation
[SHIFT] + [◀] button	Delete one character (DELETE)
[SHIFT] + [▶] button	Insert one space (INSERT)
[▲] [▼] button	Switch uppercase/lowercase

6. Repeat steps 4–5 to input the memo.
7. Press the [ENTER] button.
A confirmation message appears.
If you decide to cancel, press the [EXIT] button.
8. Press the [MENU] button.
The memo is saved.

Exporting a Scene as a Program and Saving It (Scene To Program)

Here’s how to export the currently-recalled scene as a program and save it.

The first 16 characters of the memo content are used as the program name.

NOTE

The memo content cannot be shown in the program.

By re-registering the program as a scene, you’ll be able to view and edit the memo.

1. In the MENU screen, select “Scene Utility” and press the [ENTER] button.
2. Use the cursor [▲] [▼] [◀] [▶] buttons to select “Scene To Program,” and then press the [ENTER] button.
The SCENE TO PROGRAM screen appears.
3. Use the value dial to select the save-destination, and press the [ENTER] button.
A confirmation message appears.
If you decide to cancel, press the [EXIT] button.
4. Press the [MENU] button.
The scene is saved as a program.

Deleting a Scene (Scene Remove)

Here’s how to delete the currently-recalled scene.

1. Select the scene that you want to delete.
2. Press the [MENU] button.
3. Use the cursor [▲] [▼] [◀] [▶] buttons to select “Scene Utility” and then press the [ENTER] button.
4. Use the cursor [▲] [▼] [◀] [▶] buttons to select “Scene Remove,” and then press the [ENTER] button.
The SCENE REMOVE screen appears.
5. Press the [ENTER] button.
A confirmation message appears.
If you decide to cancel, press the [EXIT] button.
6. Press the [MENU] button.
The scene is deleted.

Other Functions

Local Ctrl

1. In the MENU screen, select “Local Ctrl” and press the [ENTER] button.

The LOCAL CONTROL screen appears.

Disconnecting the Controller Section and the Sound Generator Section (Local Switch)

The switch that connects and disconnects the MIDI connection between the keyboard controller section and the sound generator section (owner’s manual: p. 12) is called the Local switch. Since essential information describing what is being played on the keyboard won’t reach the sound generator if the Local switch is set to OFF, the Local switch should normally be left ON.

However, if while performing you want to send that performance data to an external sequencer as MIDI messages to be recorded, you should then perform with the externally connected MIDI sequencer set to MIDI Thru (whereby data received from MIDI IN is then output from the MIDI OUT with no changes made to the data), and set the Local switch to OFF.

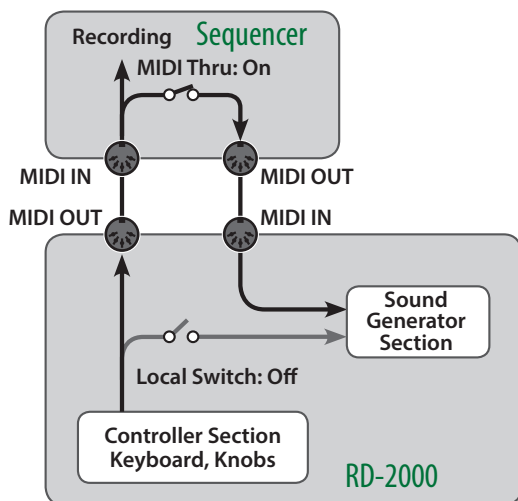

Parameter	Value
Local Switch	OFF, ON (ON when the system is started up)

Optimizing Settings for Recording on an External Sequencer (Rec Mode)

“Rec Mode” is a convenient feature to use when recording to an external sequencer.

When using the Rec Mode function, you can get the most suitable settings for recording the RD-2000’s data to an external sequencer, without having to make all the Part and channel settings.

Parameter	Value
Rec Mode	OFF, ON (OFF when the system is started up)

Ordinarily, this should be set to OFF.

When this is set to ON, settings appropriate for recording are used with respect to the output from MIDI OUT, regardless of the INTERNAL zone settings.

Recording the performance

1. Turn on the external sequencer’s Thru function.
2. The following settings are made.

Parameter	Value
Local Switch	OFF
Rec Mode	ON

3. Record using your external sequencer.

Selecting the EXP Category

These are expansion sound banks specifically for the RD-2000.

Press the [EXP] button to switch between A and B.

A large variety of tones from the Axial sound library site can be added to the RD-2000.

For details, refer to the Axial site.

➔ <http://axial.roland.com/>

Connecting to Your Computer

Connecting to a Computer via the USB COMPUTER Port

If you use a USB cable (sold separately) to connect the USB COMPUTER port located on the RD-2000's rear panel to the USB port of your computer, you'll be able to do the following things.

- Use the RD-2000 to play SMF music files played back by MIDI compatible software.
- By transferring MIDI data between the RD-2000 and your sequencer software, you'll be able to enjoy a wide range of possibilities for music production and editing.

NOTE

Refer to the Roland website for system requirements.

Roland website:

<http://www.roland.com/>

Depending on the type of computer you're using, this may not operate correctly.

For details on supported operating systems, refer to the Roland website.

You can download the original driver from the Roland website.

Specify the USB driver you want to use, and then install the driver. For details, refer to "Switching USB Drivers" (p. 33).

Caution

- A USB cable is not included. If you need to obtain one, ask the dealer where you purchased the RD-2000.
- Switch on power to the RD-2000 before you start up the MIDI application on your computer. Don't turn the RD-2000 on/off while your MIDI application is running.

Switching USB Drivers

The USB driver to be used when a computer is connected to the USB COMPUTER port is determined as follows:

1. Press the [MENU] button.
2. Press the cursor [▲] [▼] buttons to select "System," and then press the [ENTER] button.
3. Press the cursor [▲] [▼] buttons to move the cursor to "USB Driver."



4. Use the [DEC] [INC] buttons or the value dial to select the USB driver you want to use.

Parameter	Value	Explanation
USB Driver	VENDOR	Choose this if you're using the USB driver downloaded from the Roland website.
	GENERIC	Choose this if you're using the default USB driver that came with your computer.

5. Press the [WRITE] button.
6. Press the [MENU] button.
7. Turn the RD-2000 off, then on again.

Using the RD-2000 as a USB MIDI Interface

If the RD-2000 is connected to your computer, performance data from a MIDI device connected to the RD-2000's MIDI IN connector can be sent to your computer.

Parameter	Value	Explanation
USB MIDI Thru Switch	OFF	Performance data from the device connected to the RD-2000's MIDI IN connector will not be sent to your computer.
	ON	Performance data from the device connected to the RD-2000's MIDI IN connector will be sent to your computer.

What is the USB MIDI driver?

The USB MIDI Driver is a software which passes data between the RD-2000 and the application (sequencer software, etc.) that is running on the USB-connected computer.

The USB MIDI Driver sends data from the application to the RD-2000, and passes data from the RD-2000 to the application.

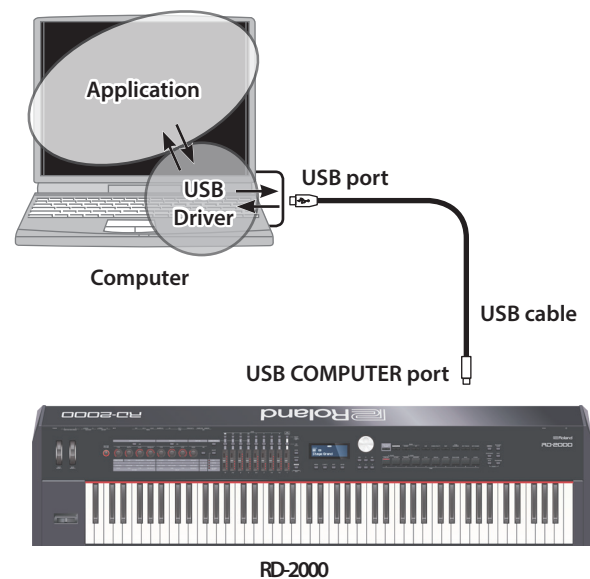

Modulation FX Parameters

Modulation FX effects are included in the tone.

You can choose from 62 types, most of which are effects that modulate the sound.

Parameters marked by a “#” symbol can be controlled from a knob etc. by assigning them to the DEPTH knob, RATE knob, or FEEDBACK knob parameters.

Type	Modulation FX Name	Page
VINTAGE	1 CE-1	p. 35
	2 SDD-320	p. 35
	3 RE-201	p. 35
	4 SBF-325	p. 36
	5 UNI-V	p. 36
	6 SS PHASER	p. 37
	7 SCRIPT PHASER	p. 37
	8 CRY WAH	p. 37
	9 D-COMP	p. 37
	10 T-SCREAM	p. 38
FILTER	11 EQUALIZER	p. 38
	12 SPECTRUM	p. 38
	13 LOW BOOST	p. 39
	14 STEP FILTER	p. 39
	15 ENHANCER	p. 40
	16 AUTO WAH	p. 40
	17 HUMANIZER	p. 40
MODULATION	18 PHASER 1	p. 41
	19 STEP PHASER	p. 41
	20 MULTI STAGE PHASER	p. 42
	21 INFINITE PHASER	p. 42
	22 RING MODULATOR	p. 43
	23 TREMOLO	p. 43
	24 AUTO PAN	p. 43
	25 SLICER	p. 44
CHORUS	26 CHORUS	p. 44
	27 FLANGER	p. 45
	28 STEP FLANGER	p. 45
	29 HEXA-CHORUS	p. 46
	30 TREMOLO CHORUS	p. 46
	31 SPACE-D	p. 47
DYNAMICS	32 OVERDRIVE	p. 47
	33 DISTORTION	p. 47
	34 COMPRESSOR	p. 47
	35 LIMITER	p. 48
	36 SUSTAINER	p. 48
	37 GATE	p. 48
DELAY	38 DELAY	p. 49
	39 MODULATION DELAY	p. 50
	40 3TAP PAN DELAY	p. 50
	41 4TAP PAN DELAY	p. 51
	42 MULTI TAP DELAY	p. 51
	43 REVERSE DELAY	p. 52
	44 TIME CTRL DELAY	p. 52
LO-FI	45 LOFI COMPRESS	p. 53
	46 BIT CRUSHER	p. 53
PITCH	47 PITCH SHIFTER	p. 53
	48 2VOICE PITCH SHIFTER	p. 54

Type	Modulation FX Name	Page
COMBINATION	49 OD → CHORUS	p. 55
	50 OD → FLANGER	p. 55
	51 OD → DELAY	p. 55
	52 DS → CHORUS	p. 56
	53 DS → FLANGER	p. 56
	54 DS → DELAY	p. 56
	55 OD/DS → TWAH	p. 56
	56 OD/DS → AWAH	p. 57
	57 ENHANCER → CHORUS	p. 57
	58 ENHANCER → FLANGER	p. 58
	59 ENHANCER → DELAY	p. 58
	60 CHORUS → DELAY	p. 59
	61 FLANGER → DELAY	p. 59
	62 CHORUS → FLANGER	p. 60

Settings common to all Modulation FX

Parameter	Value	Explanation
Type	Refer to the effect list (p. 34).	Specifies the type of Modulation FX. The editable parameters will depend on the effect type that's selected.
Routing	MOD FX → TR/AMP, TR/AMP → MOD FX	Lets you select the routing of the Modulation FX and the Tremolo/Amp Simulator. By switching the Routing type, you can change the effect that's applied to the sound. For example, suppose that you chose Chorus as the MOD FX and chose E. PIANO for TR/AMP; with the MOD FX → TR/AMP setting, the chorus sound will be output in mono, but with the TR/AMP → MOD FX setting it will be output in stereo.

1: CE-1

This models the classic BOSS CE-1 chorus effect unit. It provides a chorus sound with a distinctively analog warmth.

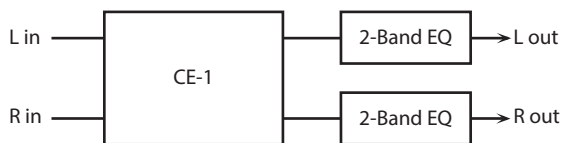

Parameter	Value	Explanation
Switch	OFF, ON	Turns the effect on/off.
Depth Knob	INTENSITY, LEVEL	Specifies the parameter that is controlled by the MODULATION FX [DEPTH] knob.
Rate Knob		Specifies the parameter that is controlled by the MODULATION FX [RATE] knob.
Feedback Knob	OFF, INTENSITY, Level	Specifies the parameter that is controlled by the MODULATION FX [FEEDBACK] knob.
Intensity #	0-127	Chorus depth
Low Gain	-15-+15 [dB]	Gain of the low range
High Gain	-15-+15 [dB]	Gain of the high range
Level #	0-127	Output Level

2: SDD-320

This models Roland's DIMENSION D (SDD-320). It provides a clear chorus sound.

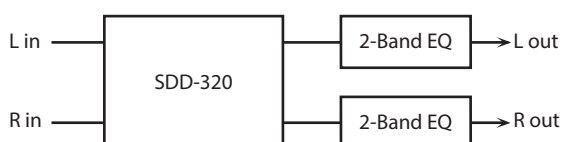

Parameter	Value	Explanation
Switch	OFF, ON	Turns the effect on/off.
Depth Knob	LEVEL, MODE	Specifies the parameter that is controlled by the MODULATION FX [DEPTH] knob.
Rate Knob		Specifies the parameter that is controlled by the MODULATION FX [RATE] knob.
Feedback Knob	OFF, LEVEL, MODE	Specifies the parameter that is controlled by the MODULATION FX [FEEDBACK] knob.
Mode #	1, 2, 3, 4, 1+4, 2+4, 3+4	Switches the mode.
Low Gain	-15-+15 [dB]	Gain of the low range
High Gain	-15-+15 [dB]	Gain of the high range
Level #	0-127	Output Level

3: RE-201

A virtual tape echo that produces a realistic tape delay sound. This simulates the tape echo section of a Roland RE-201 Space Echo.

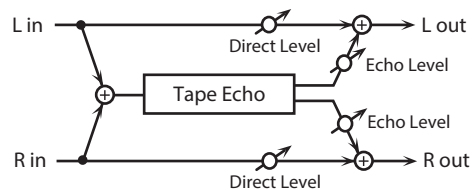

Parameter	Value	Explanation
Switch	OFF, ON	Turns the effect on/off.
Depth Knob	REPEAT RATE, INTENSITY, ECHO LEVEL, DIRECT LEVEL	Specifies the parameter that is controlled by the MODULATION FX [DEPTH] knob.
Rate Knob		Specifies the parameter that is controlled by the MODULATION FX [RATE] knob.
Feedback Knob	OFF, REPEAT RATE, INTENSITY, ECHO LEVEL, DIRECT LEVEL	Specifies the parameter that is controlled by the MODULATION FX [FEEDBACK] knob.
Mode	S, M, L, S+M, S+L, M+L, S+M+L	Combination of playback heads to use. Select from three different heads with different delay times. S: short M: middle L: long
Repeat Rate #	0-127	Tape speed. Increasing this value will shorten the spacing of the delayed sounds.
Intensity #	0-127	Amount of delay repeats
Bass	-15-+15 [dB]	Boost/cut for the lower range of the echo sound

Parameter	Value	Explanation
Treble	-15--+15 [dB]	Boost/cut for the upper range of the echo sound
Head S Pan	L64–63R	Independent panning for the short, middle, and long playback heads
Head M Pan		
Head L Pan		
Tape Distortion	0–5	Amount of tape-dependent distortion to be added This simulates the slight tonal changes that can be detected by signal-analysis equipment. Increasing this value will increase the distortion.
W/F Rate	0–127	Speed of wow/flutter (complex variation in pitch caused by tape wear and rotational irregularity)
W/F Depth	0–127	Depth of wow/flutter
Echo Level #	0–127	Volume of the echo sound
Direct Level #	0–127	Volume of the original sound
Level	0–127	Output Level

4: SBF-325

This effect reproduces Roland's SBF-325 analog flanger. It provides three types of flanging effect (which adds a metallic resonance to the original sound) and a chorus-type effect.



Parameter	Value	Explanation
Switch	OFF, ON	Turns the effect on/off.
Depth Knob	RATE, DEPTH, FEEDBACK	Specifies the parameter that is controlled by the MODULATION FX [DEPTH] knob .
Rate Knob		Specifies the parameter that is controlled by the MODULATION FX [RATE] knob .
Feedback Knob		Specifies the parameter that is controlled by the MODULATION FX [FEEDBACK] knob .
Mode	FL1, FL2, FL3, CHO	Types of flanging effect FL1: A typical mono flanger FL2: A stereo flanger that preserves the stereo positioning of the original sound FL3: A cross-mix flanger that produces a more intense effect CHO: A chorus effect
Rate (sync sw)	OFF, ON	If this is ON, the rate is synchronized to the tempo of the rhythm (owner's manual: p. 24).
Rate (Hz) #	0.02–5.00 [Hz]	Rate at which the flanger sound is modulated
Rate (note) #	note (p. 60)	

Parameter	Value	Explanation
Depth #	0–127	Depth to which the flanger sound is modulated
Manual	0–127	Center frequency at which the flanger effect is applied
Feedback #	0–127	Amount by which the flanging effect is boosted * If Mode is CHO, this setting is ignored.
CH-R Mode Phase	NORM, INV	Phase of the right channel modulation: Typically, you will leave this at Normal (NORM). If you specify Inverted (INV), the modulation (upward/downward movement) of the right channel is inverted.
CH-L Phase		Phase when mixing the flanging sound with the original sound
CH-R Phase		NORM: normal phase INV: inverse phase
Level	0–127	Output Level

5: UNI-V

This models a Uni-Vibe.

This effect is similar to a phaser, but produces a distinctive modulation that cannot be obtained from a normal phaser.

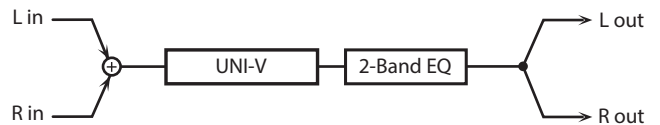

Parameter	Value	Explanation
Switch	OFF, ON	Turns the effect on/off.
Depth Knob	RATE, DEPTH, LEVEL	Specifies the parameter that is controlled by the MODULATION FX [DEPTH] knob .
Rate Knob		Specifies the parameter that is controlled by the MODULATION FX [RATE] knob .
Feedback Knob		Specifies the parameter that is controlled by the MODULATION FX [FEEDBACK] knob .
Rate #	0–100	Adjusts the rate of the UNI-V effect.
Depth #	0–100	Adjusts the depth of the UNI-V effect.
Low Gain	-15--+15 [dB]	Gain of the low range
High Gain	-15--+15 [dB]	Gain of the high range
Level #	0–127	Output Level

6: SS PHASER

This simulates an analog phaser of the past. It is particularly suitable for electric piano.

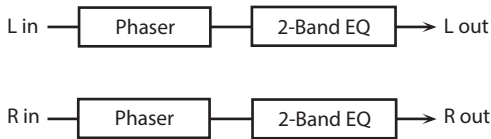

Parameter	Value	Explanation
Switch	OFF, ON	Turns the effect on/off.
Depth Knob	RATE, COLOR	Specifies the parameter that is controlled by the MODULATION FX [DEPTH] knob.
Rate Knob		Specifies the parameter that is controlled by the MODULATION FX [RATE] knob.
Feedback Knob	OFF, RATE, COLOR	Specifies the parameter that is controlled by the MODULATION FX [FEEDBACK] knob.
Rate #	0–100	Frequency of modulation
Color #	1, 2	Modulation character
Low Gain	-15→+15 [dB]	Gain of the low range
High Gain	-15→+15 [dB]	Gain of the high range
Level	0–127	Output Level

7: SCRIPT PHASER

This simulates a different analog phaser than SS PHASER. It is particularly suitable for electric piano.

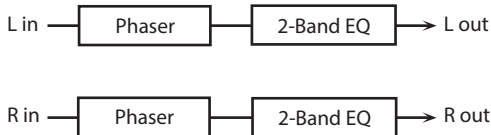

Parameter	Value	Explanation
Switch	OFF, ON	Turns the effect on/off.
Depth Knob	SPEED, DEPTH	Specifies the parameter that is controlled by the MODULATION FX [DEPTH] knob.
Rate Knob		Specifies the parameter that is controlled by the MODULATION FX [RATE] knob.
Feedback Knob	OFF, SPEED, DEPTH	Specifies the parameter that is controlled by the MODULATION FX [FEEDBACK] knob.
Speed #	0–100	Frequency of modulation
Depth #	0–127	Modulation character
Low Gain	-15→+15 [dB]	Gain of the low range
High Gain	-15→+15 [dB]	Gain of the high range
Level	0–127	Output Level

8: CRY WAH

This models the sound of the CRY BABY wah pedal popular in the '70s.

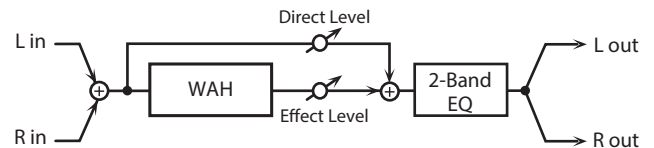

Parameter	Value	Explanation
Switch	OFF, ON	Turns the effect on/off.
Depth Knob	PEDAL POSITION, EFFECT LEVEL, DIRECT LEVEL	Specifies the parameter that is controlled by the MODULATION FX [DEPTH] knob.
Rate Knob		Specifies the parameter that is controlled by the MODULATION FX [RATE] knob.
Feedback Knob		Specifies the parameter that is controlled by the MODULATION FX [FEEDBACK] knob.
Pedal Position #	0–100	Adjusts the position of the wah pedal. * This parameter can also be assigned to a pedal etc. and controlled.
Pedal Min	0–100	Selects the tone produced when the heel of the EXP Pedal is depressed.
Pedal Max	0–100	Selects the tone produced when the toe of the EXP Pedal is depressed.
Low Gain	-15→+15 [dB]	Adjusts the low frequency range tone.
High Gain	-15→+15 [dB]	Adjusts the high frequency range tone.
Effect Level #	0–127	Adjusts the volume of the effect sound.
Direct Level #	0–127	Adjusts the volume of the direct sound.

9: D-COMP

This models a MXR DynaComp.

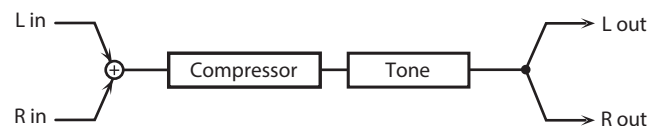

Parameter	Value	Explanation
Switch	OFF, ON	Turns the effect on/off.

Modulation FX Parameters

Parameter	Value	Explanation
Depth Knob		Specifies the parameter that is controlled by the MODULATION FX [DEPTH] knob .
Rate Knob	SENS, RELEASE, LEVEL	Specifies the parameter that is controlled by the MODULATION FX [RATE] knob .
Feedback Knob		Specifies the parameter that is controlled by the MODULATION FX [FEEDBACK] knob .
Sens #	0–100	This controls the input sensitivity.
Release #	0–100	Adjusts the release time.
Tone	-50–+50	Adjusts the tone.
Level #	0–127	Output Level

10: T-SCREAM

This models the analog overdrive of the past. It adds a nice amount of overtones without dirtying the sound.

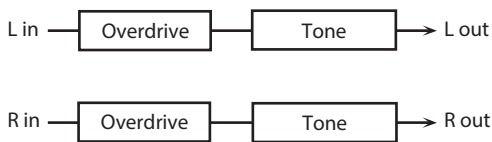

Parameter	Value	Explanation
Switch	OFF, ON	Turns the effect on/off.
Depth Knob		Specifies the parameter that is controlled by the MODULATION FX [DEPTH] knob .
Rate Knob	DISTORTION, TONE	Specifies the parameter that is controlled by the MODULATION FX [RATE] knob .
Feedback Knob	OFF, DISTORTION, TONE	Specifies the parameter that is controlled by the MODULATION FX [FEEDBACK] knob .
Distortion #	0–127	Degree of distortion Also changes the volume.
Tone #	0–127	Sound quality of the Overdrive effect
Level	0–127	Output Level

11: EQUALIZER

This is a four-band stereo equalizer (low, mid x 2, high).

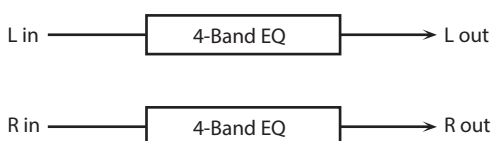

Parameter	Value	Explanation
Switch	OFF, ON	Turns the effect on/off.

Parameter	Value	Explanation
Depth Knob		Specifies the parameter that is controlled by the MODULATION FX [DEPTH] knob .
Rate Knob	LOW GAIN, HIGH GAIN, LEVEL	Specifies the parameter that is controlled by the MODULATION FX [RATE] knob .
Feedback Knob	OFF, LOW GAIN, HIGH GAIN, LEVEL	Specifies the parameter that is controlled by the MODULATION FX [FEEDBACK] knob .
Low Freq	20–400 [Hz]	Frequency of the low range
Low Gain #	-15–+15 [dB]	Gain of the low range
Mid1 Freq	200–8000 [Hz]	Frequency of the middle range 1
Mid1 Gain	-15–+15 [dB]	Gain of the middle range 1
Mid1 Q	0.5, 1.0, 2.0, 4.0, 8.0	Width of the middle range 1 Set a higher value to narrow the range to be affected.
Mid2 Freq	200–8000 [Hz]	Frequency of the middle range 2
Mid2 Gain	-15–+15 [dB]	Gain of the middle range 2
Mid2 Q	0.5, 1.0, 2.0, 4.0, 8.0	Width of the middle range 2 Set a higher value to narrow the range to be affected.
High Freq	2000–16000 [Hz]	Frequency of the high range
High Gain #	-15–+15 [dB]	Gain of the high range
Level #	0–127	Output Level

12: SPECTRUM

This is a stereo spectrum. Spectrum is a type of filter which modifies the timbre by boosting or cutting the level at specific frequencies.

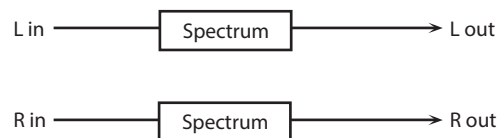

Parameter	Value	Explanation
Switch	OFF, ON	Turns the effect on/off.
Depth Knob		Specifies the parameter that is controlled by the MODULATION FX [DEPTH] knob .
Rate Knob	BAND1, BAND3, LEVEL	Specifies the parameter that is controlled by the MODULATION FX [RATE] knob .
Feedback Knob	OFF, BAND1, BAND3, LEVEL	Specifies the parameter that is controlled by the MODULATION FX [FEEDBACK] knob .

Parameter	Value	Explanation	
Band1 (250 Hz) #			
Band2 (500 Hz)			
Band3 (1000 Hz) #			
Band4 (1250 Hz)			
Band5 (2000 Hz)	-15--+15 [dB]	Gain of each frequency band	
Band6 (3150 Hz)			
Band7 (4000 Hz)			
Band8 (8000 Hz)			
Q	0.5, 1.0, 2.0, 4.0, 8.0		Simultaneously adjusts the width of the adjusted ranges for all the frequency bands.
Level #	0-127		Output Level

13: LOW BOOST

Boosts the volume of the lower range, creating powerful lows.

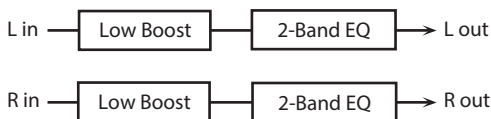

Parameter	Value	Explanation
Switch	OFF, ON	Turns the effect on/off.
Depth Knob	BOOST FREQUENCY, BOOST GAIN, BOOST WIDTH	Specifies the parameter that is controlled by the MODULATION FX [DEPTH] knob.
Rate Knob		Specifies the parameter that is controlled by the MODULATION FX [RATE] knob.
Feedback Knob	OFF, BOOST FREQUENCY, BOOST GAIN, BOOST WIDTH	Specifies the parameter that is controlled by the MODULATION FX [FEEDBACK] knob.
Boost Frequency #	50-125 [Hz]	Basic frequency at which the lower range will be boosted
Boost Gain #	0--+12 [dB]	Amount by which the lower range will be boosted
Boost Width	WIDE, MID, NARROW	Width of the lower range that will be boosted
Low Gain	-15--+15 [dB]	Gain of the low frequency range
High Gain	-15--+15 [dB]	Gain of the high frequency range
Level	0-127	Output level

14: STEP FILTER

This is a filter whose cutoff frequency can be modulated in steps. You can specify the pattern by which the cutoff frequency will change.

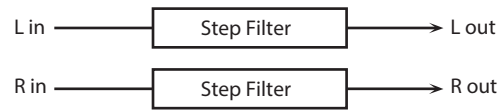

Parameter	Value	Explanation
Switch	OFF, ON	Turns the effect on/off.
Depth Knob	RATE, ATTACK, FILTER RESO	Specifies the parameter that is controlled by the MODULATION FX [DEPTH] knob.
Rate Knob		Specifies the parameter that is controlled by the MODULATION FX [RATE] knob.
Feedback Knob	OFF, RATE, ATTACK, FILTER RESO	Specifies the parameter that is controlled by the MODULATION FX [FEEDBACK] knob.
Step 01 -16	0-127	Cutoff frequency at each step
Rate (sync sw)	OFF, ON	If this is ON, the modulation is synchronized to the tempo of the rhythm (owner's manual: p. 24).
Rate (Hz) #/ Rate (note) #	0.05-10.00 note (p. 60)	Rate of modulation
Attack #	0-127	Speed at which the cutoff frequency changes between steps
Filter Type	LPF, BPF, HPF, NOTCH	Filter type Frequency range that will pass through each filter LPF: frequencies below the cutoff BPF: frequencies in the region of the cutoff HPF: frequencies above the cutoff NOTCH: frequencies other than the region of the cutoff
Filter Slope	-12, -24, -36 [dB]	Amount of attenuation per octave -12 dB: gentle -24 dB: steep -36 dB: extremely steep
Filter Resonance #	0-127	Filter resonance level Increasing this value will emphasize the region near the cutoff frequency.
Filter Gain	0--+12 [dB]	Amount of boost for the filter output
Level	0-127	Output level

15: ENHANCER

Controls the overtone structure of the high frequencies, adding sparkle and tightness to the sound.

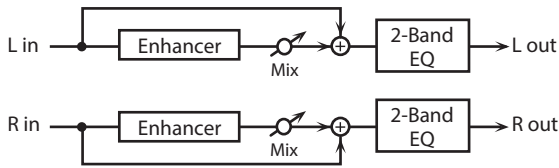

Parameter	Value	Explanation
Switch	OFF, ON	Turns the effect on/off.
Depth Knob	SENS, MIX	Specifies the parameter that is controlled by the MODULATION FX [DEPTH] knob.
Rate Knob		Specifies the parameter that is controlled by the MODULATION FX [RATE] knob.
Feedback Knob	OFF, SENS, MIX	Specifies the parameter that is controlled by the MODULATION FX [FEEDBACK] knob.
Sens #	0–127	Sensitivity of the enhancer
Mix #	0–127	Level of the overtones generated by the enhancer
Low Gain	-15–+15 [dB]	Gain of the low range
High Gain	-15–+15 [dB]	Gain of the high range
Level	0–127	Output Level

16: AUTO WAH

Cyclically controls a filter to create cyclic change in timbre.

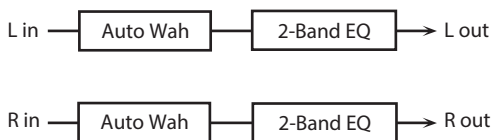

Parameter	Value	Explanation
Switch	OFF, ON	Turns the effect on/off.
Depth Knob	MANUAL, SENS, RATE, DEPTH, PHASE	Specifies the parameter that is controlled by the MODULATION FX [DEPTH] knob.
Rate Knob		Specifies the parameter that is controlled by the MODULATION FX [RATE] knob.
Feedback Knob	OFF, MANUAL, SENS, RATE, DEPTH, PHASE	Specifies the parameter that is controlled by the MODULATION FX [FEEDBACK] knob.
Filter Type	LPF, BPF	Type of filter LPF: The wah effect will be applied over a wide frequency range. BPF: The wah effect will be applied over a narrow frequency range.

Parameter	Value	Explanation
Manual #	0–127	Adjusts the basic frequency at which the effect is applied.
Peak	0–127	Adjusts the amount of the wah effect that will occur in the range of the basic frequency. Set a higher value for Q to narrow the range to be affected.
Sens #	0–127	Adjusts the sensitivity with which the filter is controlled.
Polarity	UP, DOWN	Sets the direction in which the frequency will change when the auto-wah filter is modulated. UP: The filter will change toward a higher frequency. DOWN: The filter will change toward a lower frequency.
Rate (sync sw)	OFF, ON	If this is ON, the modulation is synchronized to the tempo of the rhythm (owner's manual: p. 24).
Rate (Hz) #/ Rate (note) #	0.05–10.00 [Hz] note (p. 60)	Frequency of modulation
Depth #	0–127	Depth of modulation
Phase #	0–180 [deg]	Adjusts the degree of phase shift of the left and right sounds when the wah effect is applied.
Low Gain	-15–+15 [dB]	Gain of the low range
High Gain	-15–+15 [dB]	Gain of the high range
Level	0–127	Output Level

17: HUMANIZER

Adds a vowel character to the sound, making it similar to a human voice.

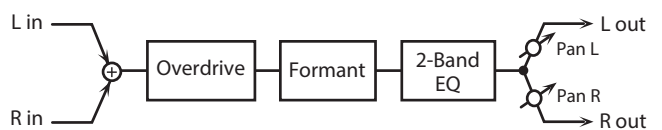

Parameter	Value	Explanation
Switch	OFF, ON	Turns the effect on/off.
Depth Knob	DRIVE, RATE, DEPTH, MANUAL, PAN	Specifies the parameter that is controlled by the MODULATION FX [DEPTH] knob.
Rate Knob		Specifies the parameter that is controlled by the MODULATION FX [RATE] knob.
Feedback Knob	OFF, DRIVE, RATE, DEPTH, MANUAL, PAN	Specifies the parameter that is controlled by the MODULATION FX [FEEDBACK] knob.
Drive Sw	OFF, ON	Turns Drive on/off.

Parameter	Value	Explanation
Drive #	0–127	Degree of distortion Also changes the volume.
Vowel1	A, E, I, O, U	Selects the vowel.
Vowel2	A, E, I, O, U	
Rate (sync sw)	OFF, ON	If this is ON, the modulation is synchronized to the tempo of the rhythm (owner's manual: p. 24).
Rate (Hz) # /	0.05–10.00 [Hz]	Frequency at which the two vowels switch
Rate (note) #	note (p. 60)	
Depth #	0–127	Effect depth
Input Sync Sw	OFF, ON	LFO reset on/off
		Determines whether the LFO for switching the vowels is reset by the input signal (ON) or not (OFF).
Input Sync Threshold	0–127	Volume level at which reset is applied
Manual #	0–100	Point at which Vowel 1/2 switch
		49 or less: Vowel 1 will have a longer duration.
		50: Vowel 1 and 2 will be of equal duration.
		51 or more: Vowel 2 will have a longer duration.
Low Gain	-15–+15 [dB]	Gain of the low frequency range
High Gain	-15–+15 [dB]	Gain of the high frequency range
Pan #	L64–63R	Stereo location of the output
Level	0–127	Output level

Parameter	Value	Explanation
Mode	4-STAGE, 8-STAGE, 12-STAGE	Number of stages in the phaser
Manual #	0–127	Adjusts the basic frequency from which the sound will be modulated.
Rate (sync sw)	OFF, ON	If this is ON, the modulation is synchronized to the tempo of the rhythm (owner's manual: p. 24).
Rate (Hz) # /	0.05–10.00 [Hz]	Frequency of modulation
Rate (note) #	note (p. 60)	
Depth	0–127	Depth of modulation
Polarity	INVERSE, SYNCHRO	Selects whether the left and right phase of the modulation will be the same or the opposite.
		INVERSE: The left and right phase will be opposite. When using a mono source, this spreads the sound. SYNCHRO: The left and right phase will be the same. Select this when inputting a stereo source.
Resonance #	0–127	Amount of feedback
Cross Feedback	-98–+98 [%]	Adjusts the proportion of the phaser sound that is fed back into the effect. Negative “-” settings will invert the phase.
Mix #	0–127	Level of the phase-shifted sound
Low Gain	-15–+15 [dB]	Gain of the low range
High Gain	-15–+15 [dB]	Gain of the high range
Level	0–127	Output Level

18: PHASER 1

A phase-shifted sound is added to the original sound and modulated.

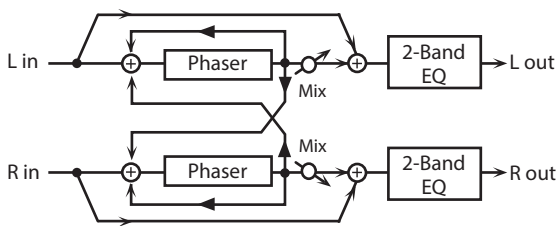

Parameter	Value	Explanation
Switch	OFF, ON	Turns the effect on/off.
Depth Knob	MANUAL, RATE, RESONANCE, MIX	Specifies the parameter that is controlled by the MODULATION FX [DEPTH] knob.
		Specifies the parameter that is controlled by the MODULATION FX [RATE] knob.
Feedback Knob	OFF, MANUAL, RATE, RESONANCE, MIX	Specifies the parameter that is controlled by the MODULATION FX [FEEDBACK] knob.

19: STEP PHASER

This is a stereo phaser. The phaser effect will be varied gradually.

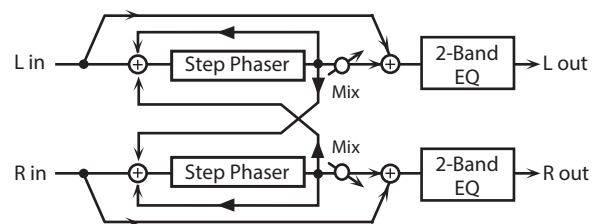

Parameter	Value	Explanation
Switch	OFF, ON	Turns the effect on/off.
Depth Knob	MANUAL, RATE, RESONANCE, MIX	Specifies the parameter that is controlled by the MODULATION FX [DEPTH] knob.
		Specifies the parameter that is controlled by the MODULATION FX [RATE] knob.

Parameter	Value	Explanation
Feedback Knob	OFF, MANUAL, RATE, RESONANCE, STEP RATE, MIX	Specifies the parameter that is controlled by the MODULATION FX [FEEDBACK] knob.
Mode	4-STAGE, 8-STAGE, 12-STAGE	Number of stages in the phaser
Manual #	0–127	Adjusts the basic frequency from which the sound will be modulated.
Rate (sync sw)	OFF, ON	If this is ON, the modulation is synchronized to the tempo of the rhythm (owner's manual: p. 24).
Rate (Hz) #/ Rate (note) #	0.05–10.00 note (p. 60)	Frequency of modulation
Depth	0–127	Depth of modulation
Polarity	INVERSE, SYNCHRO	Selects whether the left and right phase of the modulation will be the same or the opposite. INVERSE: The left and right phase will be opposite. When using a mono source, this spreads the sound. SYNCHRO: The left and right phase will be the same. Select this when inputting a stereo source.
Resonance #	0–127	Amount of feedback
Cross Feedback	-98–+98 [%]	Adjusts the proportion of the phaser sound that is fed back into the effect. Negative “-” settings will invert the phase.
Step Rate (sync sw)	OFF, ON	If this is ON, the modulation is synchronized to the tempo of the rhythm (owner's manual: p. 24).
Step Rate (Hz) #/ Step Rate (note)#	0.10–20 [Hz] note (p. 60)	Rate of the step-wise change in the phaser effect
Mix #	0–127	Level of the phase-shifted sound
Low Gain	-15–+15 [dB]	Gain of the low range
High Gain	-15–+15 [dB]	Gain of the high range
Level	0–127	Output Level

20: MULTI STAGE PHASER

Extremely high settings of the phase difference produce a deep phaser effect.

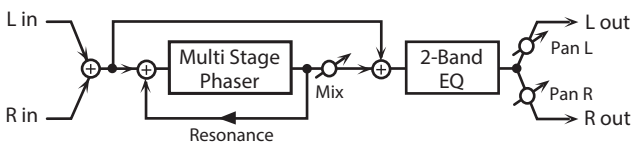

Parameter	Value	Explanation
Switch	OFF, ON	Turns the effect on/off.

Parameter	Value	Explanation
Depth Knob	MANUAL, RATE, RESONANCE, MIX, PAN	Specifies the parameter that is controlled by the MODULATION FX [DEPTH] knob.
Rate Knob	MANUAL, RATE, RESONANCE, MIX, PAN	Specifies the parameter that is controlled by the MODULATION FX [RATE] knob.
Feedback Knob	OFF, MANUAL, RATE, RESONANCE, MIX, PAN	Specifies the parameter that is controlled by the MODULATION FX [FEEDBACK] knob.
Mode	4-STAGE, 8-STAGE, 12-STAGE, 16-STAGE, 20-STAGE, 24-STAGE	Number of phaser stages
Manual #	0–127	Adjusts the basic frequency from which the sound will be modulated.
Rate (sync sw)	OFF, ON	If this is ON, the modulation is synchronized to the tempo of the rhythm (owner's manual: p. 24).
Rate (Hz) #/ Rate (note) #	0.05–10.00 [Hz] note (p. 60)	Frequency of modulation
Depth	0–127	Depth of modulation
Resonance #	0–127	Amount of feedback
Mix #	0–127	Level of the phase-shifted sound
Pan #	L64–63R	Stereo location of the output sound
Low Gain	-15–+15 [dB]	Gain of the low range
High Gain	-15–+15 [dB]	Gain of the high range
Level	0–127	Output Level

21: INFINITE PHASER

A phaser that continues raising/lowering the frequency at which the sound is modulated.

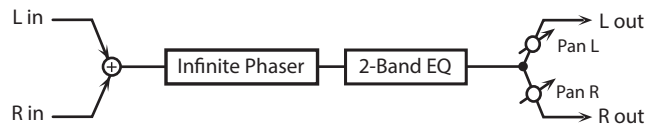

Parameter	Value	Explanation
Switch	OFF, ON	Turns the effect on/off.
Depth Knob	SPEED, RESONANCE, MIX, PAN	Specifies the parameter that is controlled by the MODULATION FX [DEPTH] knob.
Rate Knob	SPEED, RESONANCE, MIX, PAN	Specifies the parameter that is controlled by the MODULATION FX [RATE] knob.
Feedback Knob	OFF, SPEED, RESONANCE, MIX, PAN	Specifies the parameter that is controlled by the MODULATION FX [FEEDBACK] knob.

Parameter	Value	Explanation
Mode	1, 2, 3, 4	Higher values will produce a deeper phaser effect.
Speed #	-100–+100	Speed at which to raise or lower the frequency at which the sound is modulated (+: upward / -: downward)
Resonance #	0–127	Amount of feedback
Mix #	0–127	Volume of the phase-shifted sound
Pan #	L64–63R	Panning of the output sound
Low Gain	-15–+15 [dB]	Gain of the low frequency range
High Gain	-15–+15 [dB]	Gain of the high frequency range
Level	0–127	Output volume

22: RING MODULATOR

This is an effect that applies amplitude modulation (AM) to the input signal, producing bell-like sounds. You can also change the modulation frequency in response to changes in the volume of the sound sent into the effect.

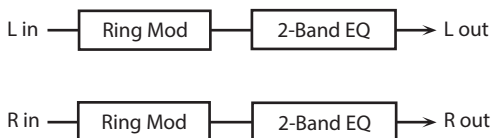

Parameter	Value	Explanation
Switch	OFF, ON	Turns the effect on/off.
Depth Knob	FREQUENCY, SENS, BALANCE	Specifies the parameter that is controlled by the MODULATION FX [DEPTH] knob.
Rate Knob		Specifies the parameter that is controlled by the MODULATION FX [RATE] knob.
Feedback Knob	OFF, FREQUENCY, SENS, BALANCE	Specifies the parameter that is controlled by the MODULATION FX [FEEDBACK] knob.
Frequency #	0–127	Adjusts the frequency at which modulation is applied.
Sens #	0–127	Adjusts the amount of frequency modulation applied.
Polarity	UP, DOWN	Determines whether the frequency modulation moves towards higher frequencies (UP) or lower frequencies (DOWN).
Low Gain	-15–+15 [dB]	Gain of the low frequency range
High Gain	-15–+15 [dB]	Gain of the high frequency range
Balance #	D100:0W–D0:100W	Volume balance between the direct sound (D) and the effect sound (W)
Level	0–127	Output level

23: TREMOLO

Cyclically modulates the volume to add tremolo effect to the sound.

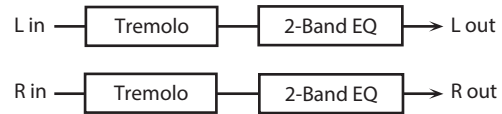

Parameter	Value	Explanation
Switch	OFF, ON	Turns the effect on/off.
Depth Knob	RATE, DEPTH, MOD WAVE	Specifies the parameter that is controlled by the MODULATION FX [DEPTH] knob.
Rate Knob		Specifies the parameter that is controlled by the MODULATION FX [RATE] knob.
Feedback Knob	OFF, RATE, DEPTH, MOD WAVE	Specifies the parameter that is controlled by the MODULATION FX [FEEDBACK] knob.
Mod Wave	TRI, SQR, SIN, SAW1, SAW2	Modulation wave TRI: triangle wave SQR: square wave SIN: sine wave SAW1/2: sawtooth wave
	SAW1 SAW2	
Rate (sync sw)	OFF, ON	If this is ON, the modulation is synchronized to the tempo of the rhythm (owner's manual: p. 24).
Rate (Hz) #/ Rate (note) #	0.05–10.00 [Hz] note (p. 60)	Frequency of the change
Depth #	0–127	Depth to which the effect is applied
Low Gain	-15–+15 [dB]	Gain of the low range
High Gain	-15–+15 [dB]	Gain of the high range
Level	0–127	Output Level

24: AUTO PAN

Cyclically modulates the stereo location of the sound.

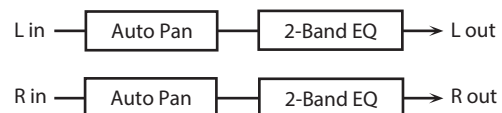

Parameter	Value	Explanation
Switch	OFF, ON	Turns the effect on/off.
Depth Knob	RATE, DEPTH, MOD WAVE	Specifies the parameter that is controlled by the MODULATION FX [DEPTH] knob.
Rate Knob		Specifies the parameter that is controlled by the MODULATION FX [RATE] knob.

Modulation FX Parameters

Parameter	Value	Explanation
Feedback Knob	OFF, RATE, DEPTH, MOD WAVE	Specifies the parameter that is controlled by the MODULATION FX [FEEDBACK] knob .
Mod Wave	TRI, SQR, SIN, SAW1, SAW2	Modulation wave TRI : triangle wave SQR : square wave SIN : sine wave SAW1/2 : sawtooth wave
	SAW1 R L SAW2 R L	
Rate (sync sw)	OFF, ON	If this is ON, the modulation is synchronized to the tempo of the rhythm (owner's manual: p. 24).
Rate (Hz) #/ Rate (note) #	0.05–10.00 [Hz] note (p. 60)	Frequency of the change
Depth #	0–127	Depth to which the effect is applied
Low Gain	-15–+15 [dB]	Gain of the low range
High Gain	-15–+15 [dB]	Gain of the high range
Level	0–127	Output Level

25: SLICER

By applying successive cuts to the sound, this effect turns a conventional sound into a sound that appears to be played as a backing phrase. This is especially effective when applied to sustain-type sounds.

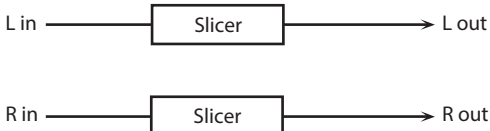

Parameter	Value	Explanation
Switch	OFF, ON	Turns the effect on/off.
Depth Knob	RATE, ATTACK, SHUFFLE	Specifies the parameter that is controlled by the MODULATION FX [DEPTH] knob .
		Specifies the parameter that is controlled by the MODULATION FX [RATE] knob .
Feedback Knob	OFF, RATE, ATTACK, SHUFFLE	Specifies the parameter that is controlled by the MODULATION FX [FEEDBACK] knob .
Step 01–16	0–127	Level at each step
Rate (sync sw)	OFF, ON	If this is ON, the modulation is synchronized to the tempo of the rhythm (owner's manual: p. 24).
Rate (Hz) #/ Rate (note) #	0.05–10.00 [Hz] note (p. 60)	Rate at which the 16-step sequence will cycle
Attack #	0–127	Speed at which the level changes between steps

Parameter	Value	Explanation
Input Sync Sw	OFF, ON	Specifies whether an input note will cause the sequence to resume from the first step of the sequence (ON) or not (OFF)
Input Sync Threshold	0–127	Volume at which an input note will be detected
Mode	LEGATO, SLASH	Sets the manner in which the volume changes as one step progresses to the next. LEGATO : The change in volume from one step's level to the next remains unaltered. If the level of a following step is the same as the one preceding it, there is no change in volume. SLASH : The level is momentarily set to 0 before progressing to the level of the next step. This change in volume occurs even if the level of the following step is the same as the preceding step.
		Timing of volume changes in levels for even-numbered steps (step 2, step 4, step 6...). The higher the value, the later the beat progresses.
Shuffle #	0–127	
Level	0–127	Output level

26: CHORUS

This is a stereo chorus. A filter is provided so that you can adjust the timbre of the chorus sound.

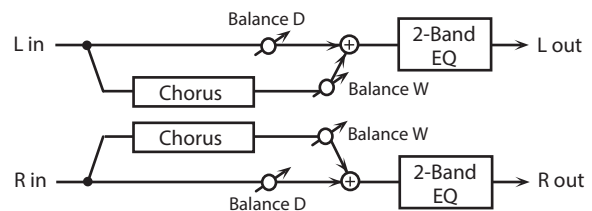

Parameter	Value	Explanation
Switch	OFF, ON	Turns the effect on/off.
Depth Knob	RATE, BALANCE, DEPTH	Specifies the parameter that is controlled by the MODULATION FX [DEPTH] knob .
		Specifies the parameter that is controlled by the MODULATION FX [RATE] knob .
Feedback Knob	OFF, RATE, BALANCE, DEPTH	Specifies the parameter that is controlled by the MODULATION FX [FEEDBACK] knob .

Parameter	Value	Explanation
Filter Type	OFF, LPF, HPF	Type of filter
		OFF: no filter is used LPF: cuts the frequency range above the Cutoff Freq HPF: cuts the frequency range below the Cutoff Freq
Cutoff Freq	200–8000 [Hz]	Basic frequency of the filter
Pre Delay	0.0–100 [msec]	Adjusts the delay time from the direct sound until the chorus sound is heard.
Rate (sync sw)	OFF, ON	If this is ON, the modulation is synchronized to the tempo of the rhythm (owner's manual: p. 24).
Rate (Hz) #/ Rate (note) #	0.05–10.00 [Hz] note (p. 60)	Frequency of modulation
Depth	0–127	Depth of modulation
Phase	0–180 [deg]	Spatial spread of the sound
Low Gain	-15–+15 [dB]	Gain of the low range
High Gain	-15–+15 [dB]	Gain of the high range
Balance #	D100:0W– D0:100W	Volume balance between the direct sound (D) and the chorus sound (W)
Level	0–127	Output Level

27: FLANGER

This is a stereo flanger. (The LFO has the same phase for left and right.) It produces a metallic resonance that rises and falls like a jet airplane taking off or landing. A filter is provided so that you can adjust the timbre of the flanged sound.

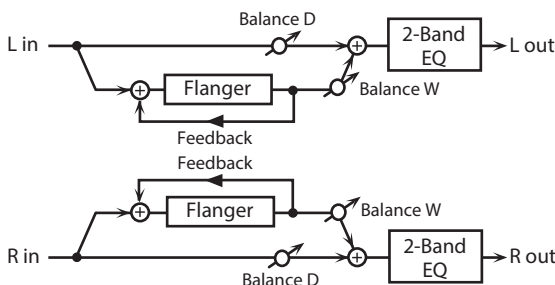

Parameter	Value	Explanation
Switch	OFF, ON	Turns the effect on/off.
Depth Knob	RATE, FEEDBACK, BALANCE	Specifies the parameter that is controlled by the MODULATION FX [DEPTH] knob.
		Specifies the parameter that is controlled by the MODULATION FX [RATE] knob.
Rate Knob	OFF, RATE, FEEDBACK, BALANCE	Specifies the parameter that is controlled by the MODULATION FX [FEEDBACK] knob.
Feedback Knob	OFF, RATE, FEEDBACK, BALANCE	Type of filter
Filter Type	OFF, LPF, HPF	OFF: no filter is used LPF: cuts the frequency range above the Cutoff Freq HPF: cuts the frequency range below the Cutoff Freq

Parameter	Value	Explanation
Cutoff Freq	200–8000 [Hz]	Basic frequency of the filter
Pre Delay	0.0–100 [msec]	Adjusts the delay time from the direct sound until the flanger sound is heard.
Rate (sync sw)	OFF, ON	If this is ON, the modulation is synchronized to the tempo of the rhythm (owner's manual: p. 24).
Rate (Hz) #/ Rate (note) #	0.05–10.00 [Hz] note (p. 60)	Frequency of modulation
Depth	0–127	Depth of modulation
Phase	0–180 [deg]	Spatial spread of the sound
Feedback #	-98–+98 [%]	Adjusts the proportion of the flanger sound that is fed back into the effect. Negative “-” settings will invert the phase.
Low Gain	-15–+15 [dB]	Gain of the low range
High Gain	-15–+15 [dB]	Gain of the high range
Balance #	D100:0W– D0:100W	Volume balance between the direct sound (D) and the flanger sound (W)
Level	0–127	Output Level

28: STEP FLANGER

This is a flanger in which the flanger pitch changes in steps. The speed at which the pitch changes can also be specified in terms of a note-value of a specified tempo.

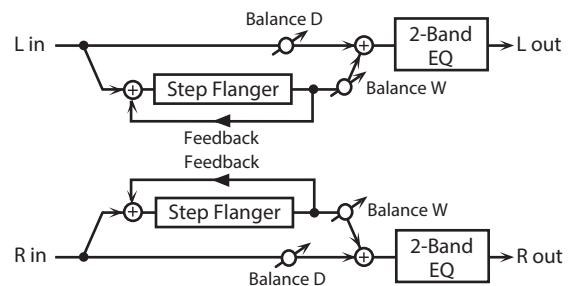

Parameter	Value	Explanation
Switch	OFF, ON	Turns the effect on/off.
Depth Knob	RATE, FEEDBACK, STEP RATE, BALANCE	Specifies the parameter that is controlled by the MODULATION FX [DEPTH] knob.
		Specifies the parameter that is controlled by the MODULATION FX [RATE] knob.
Rate Knob	OFF, RATE, FEEDBACK, STEP RATE, BALANCE	Specifies the parameter that is controlled by the MODULATION FX [FEEDBACK] knob.
Feedback Knob	OFF, RATE, FEEDBACK, STEP RATE, BALANCE	Type of filter
Filter Type	OFF, LPF, HPF	OFF: no filter is used LPF: cuts the frequency range above the Cutoff Freq HPF: cuts the frequency range below the Cutoff Freq
		Basic frequency of the filter
Cutoff Freq	200–8000 [Hz]	

Parameter	Value	Explanation
Pre Delay	0.0–100 [msec]	Adjusts the delay time from the direct sound until the flanger sound is heard.
Rate (sync sw)	OFF, ON	If this is ON, the modulation is synchronized to the tempo of the rhythm (owner's manual: p. 24).
Rate (Hz) #/ Rate (note) #	0.05–10.00 [Hz] note (p. 60)	Frequency of modulation
Depth	0–127	Depth of modulation
Phase	0–180 [deg]	Spatial spread of the sound
Feedback #	-98–+98 [%]	Adjusts the proportion of the flanger sound that is fed back into the effect. Negative “-” settings will invert the phase.
Step Rate (sync sw)	OFF, ON	If this is ON, the modulation is synchronized to the tempo of the rhythm (owner's manual: p. 24).
Step Rate (Hz) #/ Step Rate (note)#	0.10–20.00 [Hz] note (p. 60)	Rate (period) of pitch change
Low Gain	-15–+15 [dB]	Gain of the low range
High Gain	-15–+15 [dB]	Gain of the high range
Balance #	D100:0W– D0:100W	Volume balance between the direct sound (D) and the flanger sound (W)
Level	0–127	Output Level

Parameter	Value	Explanation
Rate (Hz) #/ Rate (note) #	0.05–10.00 [Hz] note (p. 60)	Frequency of modulation
Depth	0–127	Depth of modulation
Pre Delay Deviation	0–20	Adjusts the differences in Pre Delay between each chorus sound.
Depth Deviation	-20–+20	Adjusts the difference in modulation depth between each chorus sound.
Pan Deviation	0–20	Adjusts the difference in stereo location between each chorus sound. 0: All chorus sounds will be in the center. 20: Each chorus sound will be spaced at 60 degree intervals relative to the center.
Balance #	D100:0W– D0:100W	Volume balance between the direct sound (D) and the chorus sound (W)
Level	0–127	Output Level

29: HEXA-CHORUS

Uses a six-phase chorus (six layers of chorused sound) to give richness and spatial spread to the sound.

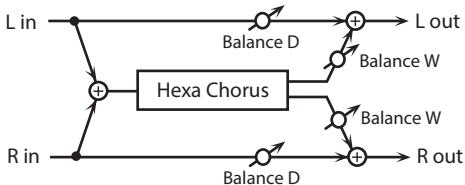

Parameter	Value	Explanation
Switch	OFF, ON	Turns the effect on/off.
Depth Knob	RATE, BALANCE, DEPTH	Specifies the parameter that is controlled by the MODULATION FX [DEPTH] knob.
Rate Knob		Specifies the parameter that is controlled by the MODULATION FX [RATE] knob.
Feedback Knob	OFF, RATE, BALANCE, DEPTH	Specifies the parameter that is controlled by the MODULATION FX [FEEDBACK] knob.
Pre Delay	0.0–100 [msec]	Adjusts the delay time from the direct sound until the chorus sound is heard.
Rate (sync sw)	OFF, ON	If this is ON, the modulation is synchronized to the tempo of the rhythm (owner's manual: p. 24).

30: TREMOLO CHORUS

This is a chorus effect with added Tremolo (cyclic modulation of volume).

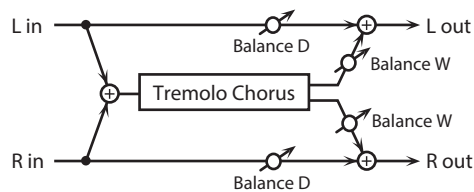

Parameter	Value	Explanation
Switch	OFF, ON	Turns the effect on/off.
Depth Knob	CHORUS RATE, TREMOLO RATE, BALANCE	Specifies the parameter that is controlled by the MODULATION FX [DEPTH] knob.
Rate Knob		Specifies the parameter that is controlled by the MODULATION FX [RATE] knob.
Feedback Knob	OFF, CHORUS RATE, TREMOLO RATE, BALANCE	Specifies the parameter that is controlled by the MODULATION FX [FEEDBACK] knob.
Pre Delay	0.0–100 [msec]	Adjusts the delay time from the direct sound until the chorus sound is heard.
Chorus Rate (sync sw)	OFF, ON	If this is ON, the modulation is synchronized to the tempo of the rhythm (owner's manual: p. 24).
Chorus Rate (Hz) #/ Chorus Rate (note) #	0.05–10.00 [Hz] note (p. 60)	Modulation frequency of the chorus effect
Chorus Depth	0–127	Modulation depth of the chorus effect

Parameter	Value	Explanation
Tremolo Rate (sync sw)	OFF, ON	If this is ON, the modulation is synchronized to the tempo of the rhythm (owner's manual: p. 24).
Tremolo Rate (Hz) #/ Tremolo Rate (note) #	0.05–10.00 note (p. 60)	Modulation frequency of the tremolo effect
Tremolo Separation	0–127	Spread of the tremolo effect
Tremolo Phase	0–180 [deg]	Spread of the tremolo effect
Balance #	D100:0W– D0:100W	Volume balance between the direct sound (D) and the tremolo chorus sound (W)
Level	0–127	Output Level

31: SPACE-D

This is a multiple chorus that applies two-phase modulation in stereo. It gives no impression of modulation, but produces a transparent chorus effect.

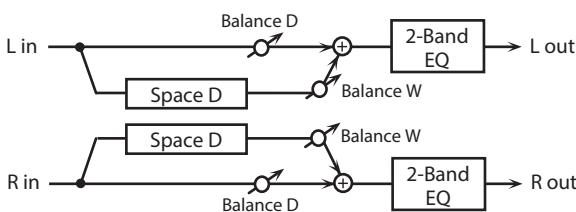

Parameter	Value	Explanation
Switch	OFF, ON	Turns the effect on/off.
Depth Knob		Specifies the parameter that is controlled by the MODULATION FX [DEPTH] knob.
Rate Knob	RATE, BALANCE, DEPTH	Specifies the parameter that is controlled by the MODULATION FX [RATE] knob.
Feedback Knob	OFF, RATE, BALANCE, DEPTH	Specifies the parameter that is controlled by the MODULATION FX [FEEDBACK] knob.
Pre Delay	0.0–100 [msec]	Adjusts the delay time from the direct sound until the chorus sound is heard.
Rate (sync sw)	OFF, ON	If this is ON, the modulation is synchronized to the tempo of the rhythm (owner's manual: p. 24).
Rate (Hz) #/ Rate (note) #	0.05–10.00 [Hz] note (p. 60)	Frequency of modulation
Depth	0–127	Depth of modulation
Phase	0–180 [deg]	Spatial spread of the sound
Low Gain	-15–+15 [dB]	Gain of the low range
High Gain	-15–+15 [dB]	Gain of the high range
Balance #	D100:0W– D0:100W	Volume balance between the direct sound (D) and the chorus sound (W)
Level	0–127	Output Level

32: OVERDRIVE

This is an overdrive that provides heavy distortion.

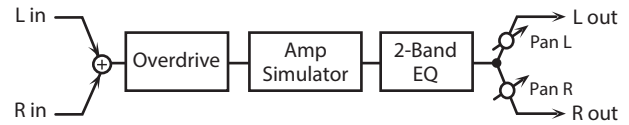

Parameter	Value	Explanation
Switch	OFF, ON	Turns the effect on/off.
Depth Knob		Specifies the parameter that is controlled by the MODULATION FX [DEPTH] knob.
Rate Knob	DRIVE, TONE, PAN, AMP TYPE	Specifies the parameter that is controlled by the MODULATION FX [RATE] knob.
Feedback Knob	OFF, DRIVE, TONE, PAN, AMP TYPE	Specifies the parameter that is controlled by the MODULATION FX [FEEDBACK] knob.
Drive #	0–127	Degree of distortion Also changes the volume.
Tone #	0–127	Sound quality of the Overdrive effect
Amp Sw	OFF, ON	Turns the Amp Simulator on/off.
Amp Type		Type of guitar amp SMALL: small amp BUILT-IN: single-unit type amp 2-STACK: large double stack amp 3-STACK: large triple stack amp
Low Gain	-15–+15 [dB]	Gain of the low range
High Gain	-15–+15 [dB]	Gain of the high range
Pan #	L64–63R	Stereo location of the output sound
Level	0–127	Output Level

33: DISTORTION

This is a distortion effect that provides heavy distortion. The parameters are the same as for "32: Overdrive."

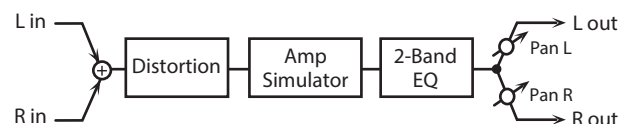

34: COMPRESSOR

Flattens out high levels and boosts low levels, smoothing out fluctuations in volume.

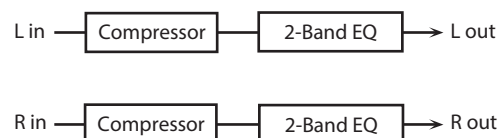

Parameter	Value	Explanation
Switch	OFF, ON	Turns the effect on/off.
Depth Knob	ATTACK, THRESHOLD, LEVEL	Specifies the parameter that is controlled by the MODULATION FX [DEPTH] knob .
Rate Knob		Specifies the parameter that is controlled by the MODULATION FX [RATE] knob .
Feedback Knob	OFF, ATTACK, THRESHOLD, LEVEL	Specifies the parameter that is controlled by the MODULATION FX [FEEDBACK] knob .
Attack #	0–127	Sets the time it takes until the level is compressed after the input exceeds the Threshold.
Threshold #	0–127	Adjusts the volume at which compression begins
Post Gain	0–+18 [dB]	Adjusts the output gain.
Low Gain	-15–+15 [dB]	Gain of the low frequency range
High Gain	-15–+15 [dB]	Gain of the high frequency range
Level #	0–127	Output Level

35: LIMITER

Compresses signals that exceed a specified volume level, preventing distortion from occurring.

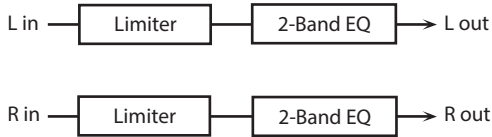

Parameter	Value	Explanation
Switch	OFF, ON	Turns the effect on/off.
Depth Knob	RELEASE, THRESHOLD, LEVEL	Specifies the parameter that is controlled by the MODULATION FX [DEPTH] knob .
Rate Knob		Specifies the parameter that is controlled by the MODULATION FX [RATE] knob .
Feedback Knob	OFF, RELEASE, THRESHOLD, LEVEL	Specifies the parameter that is controlled by the MODULATION FX [FEEDBACK] knob .
Release #	0–127	Adjusts the time after the signal volume falls below the Threshold Level until compression is no longer applied.
Threshold #	0–127	Adjusts the volume at which compression begins
Ratio	1.5:1, 2:1, 4:1, 100:1	Compression ratio
Post Gain	0–+18 [dB]	Adjusts the output gain.
Low Gain	-15–+15 [dB]	Gain of the low frequency range
High Gain	-15–+15 [dB]	Gain of the high frequency range

Parameter	Value	Explanation
Level #	0–127	Output Level

36: SUSTAINER

This effect compresses high input and boosts low input, making the volume consistent and producing undistorted sustain.

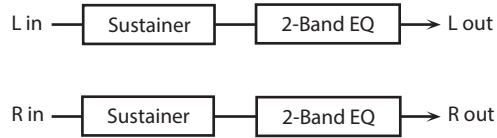

Parameter	Value	Explanation
Switch	OFF, ON	Turns the effect on/off.
Depth Knob	SUSTAIN, ATTACK, RELEASE, LEVEL	Specifies the parameter that is controlled by the MODULATION FX [DEPTH] knob .
Rate Knob		Specifies the parameter that is controlled by the MODULATION FX [RATE] knob .
Feedback Knob	OFF, SUSTAIN, ATTACK, RELEASE, LEVEL	Specifies the parameter that is controlled by the MODULATION FX [FEEDBACK] knob .
Sustain #	0–127	Adjusts the range of volume for which low input signals are boosted to make the volume consistent. Higher settings produce longer sustain.
Attack	0–127	Time until the volume is compressed
Release	0–127	Time until compression ends
Post Gain	-15–+15 [dB]	Adjusts the output gain.
Low Gain	-15–+15 [dB]	Gain of the low frequency range
High Gain	-15–+15 [dB]	Gain of the high frequency range
Level #	0–127	Output Level

37: GATE

Cuts the reverb's delay according to the volume of the sound sent into the effect. Use this when you want to create an artificial-sounding decrease in the reverb's decay.

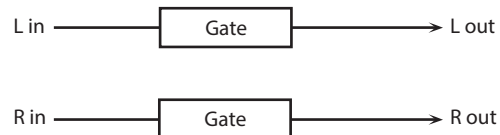

Parameter	Value	Explanation
Switch	OFF, ON	Turns the effect on/off.

Parameter	Value	Explanation
Depth Knob	THRESHOLD, BALANCE	Specifies the parameter that is controlled by the MODULATION FX [DEPTH] knob.
Rate Knob		Specifies the parameter that is controlled by the MODULATION FX [RATE] knob.
Feedback Knob	OFF, THRESHOLD, BALANCE	Specifies the parameter that is controlled by the MODULATION FX [FEEDBACK] knob.
Threshold #	0–127	Volume level at which the gate begins to close
Mode	GATE, DUCK	Type of gate GATE: The gate will close when the volume of the original sound decreases, cutting the original sound. DUCK (Ducking): The gate will close when the volume of the original sound increases, cutting the original sound.
Attack	0–127	Adjusts the time it takes for the gate to fully open after being triggered.
Hold	0–127	Adjusts the time it takes for the gate to start closing after the source sound falls beneath the Threshold.
Release	0–127	Adjusts the time it takes the gate to fully close after the hold time.
Balance #	D100:0W– D0:100W	Volume balance between the direct sound (D) and the effect sound (W)
Level	0–127	Output Level

Parameter	Value	Explanation
Switch	OFF, ON	Turns the effect on/off.
Depth Knob	FEEDBACK, BALANCE, DELAY LEFT	Specifies the parameter that is controlled by the MODULATION FX [DEPTH] knob.
Rate Knob		Specifies the parameter that is controlled by the MODULATION FX [RATE] knob.
Feedback Knob	OFF, FEEDBACK, BALANCE, DELAY LEFT	Specifies the parameter that is controlled by the MODULATION FX [FEEDBACK] knob.
Delay Left (sync switch)	OFF, ON	If this is ON, the modulation is synchronized to the tempo of the rhythm (owner's manual: p. 24).
Delay Left (msec)/ Delay Left (note)	1–1300 [msec] note (p. 60)	Delay time from the original sound until the left delay sound is heard
Delay Right (sync switch)	OFF, ON	If this is ON, the modulation is synchronized to the tempo of the rhythm (owner's manual: p. 24).
Delay Right (msec)/ Delay Right (note)	1–1300 [msec] note (p. 60)	Delay time from the original sound until the right delay sound is heard
Phase Left Phase Right	NORMAL, INVERSE	Phase of the delay sound
Feedback Mode	NORMAL, CROSS	Selects the way in which delay sound is fed back into the effect. (See the figures above.)
Feedback #	-98+98 [%]	Adjusts the amount of the delay sound that's fed back into the effect. Negative "-" settings invert the phase.
HF Damp	200–8000 [Hz], BYPASS	Adjusts the frequency above which sound fed back to the effect is filtered out (BYPASS: no cut).
Low Gain	-15+15 [dB]	Gain of the low frequency range
High Gain	-15+15 [dB]	Gain of the high frequency range
Balance #	D100:0W– D0:100W	Volume balance between the direct sound (D) and the delay sound (W)
Level	0–127	Output Level

38: DELAY

This is a stereo delay.

When Feedback Mode is NORMAL:

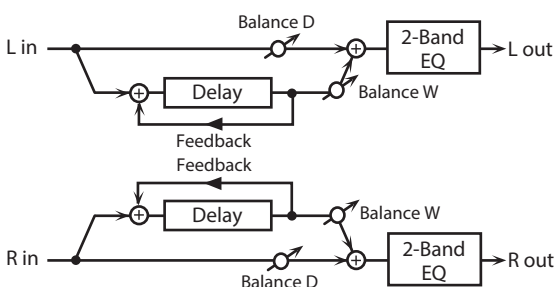

When Feedback Mode is CROSS:

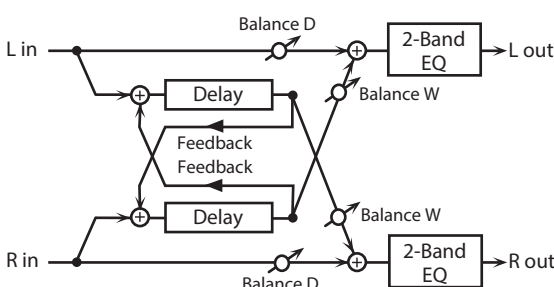

39: MODULATION DELAY

Adds modulation to the delayed sound.
When Feedback Mode is NORMAL:

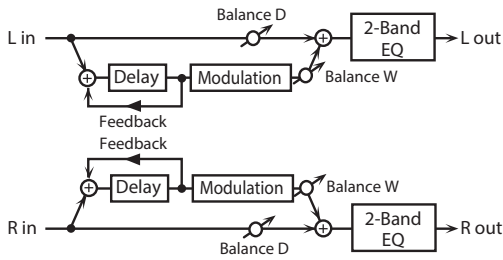

When Feedback Mode is CROSS:

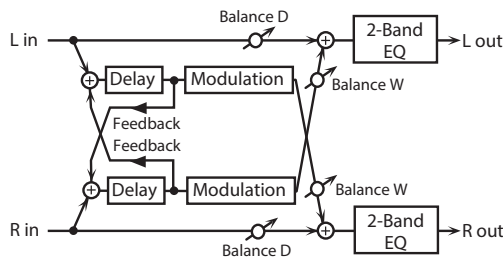

Parameter	Value	Explanation
Switch	OFF, ON	Turns the effect on/off.
Depth Knob	FEEDBACK, RATE, BALANCE	Specifies the parameter that is controlled by the MODULATION FX [DEPTH] knob.
Rate Knob		Specifies the parameter that is controlled by the MODULATION FX [RATE] knob.
Feedback Knob	OFF, FEEDBACK, RATE, BALANCE	Specifies the parameter that is controlled by the MODULATION FX [FEEDBACK] knob.
Delay Left (sync switch)	OFF, ON	If this is ON, the modulation is synchronized to the tempo of the rhythm (owner's manual: p. 24).
Delay Left (msec)/ Delay Left (note)	1–1300 [msec] note (p. 60)	Delay time from the original sound until the left delay sound is heard
Delay Right (sync switch)	OFF, ON	If this is ON, the modulation is synchronized to the tempo of the rhythm (owner's manual: p. 24).
Delay Right (msec)/ Delay Right (note)	1–1300 [msec] note (p. 60)	Delay time from the original sound until the right delay sound is heard
Feedback Mode	NORMAL, CROSS	Selects the way in which delay sound is fed back into the effect (See the figures above.)
Feedback #	-98–+98 [%]	Adjusts the amount of the delay sound that's fed back into the effect. Negative “-” settings invert the phase.

Parameter	Value	Explanation
HF Damp	200–8000 [Hz], BYPASS	Adjusts the frequency above which sound fed back to the effect is filtered out (BYPASS: no cut).
Rate #	OFF, ON	If this is ON, the modulation is synchronized to the tempo of the rhythm (owner's manual: p. 24).
Rate (Hz) #/ Rate (note) #	0.05–10.00 [Hz] note (p. 60)	Frequency of modulation
Depth	0–127	Depth of modulation
Phase	0–180 [deg]	Spatial spread of the sound
Low Gain	-15–+15 [dB]	Gain of the low frequency range
High Gain	-15–+15 [dB]	Gain of the high frequency range
Balance #	D100:0W– D0:100W	Volume balance between the direct sound (D) and the delay sound (W)
Level	0–127	Output Level

40: 3TAP PAN DELAY

Produces three delay sounds; center, left and right.

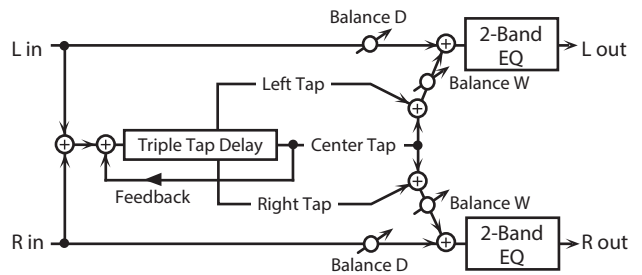

Parameter	Value	Explanation
Switch	OFF, ON	Turns the effect on/off.
Depth Knob	CENTER FEEDBACK, BALANCE, DELAY LEFT	Specifies the parameter that is controlled by the MODULATION FX [DEPTH] knob.
Rate Knob		Specifies the parameter that is controlled by the MODULATION FX [RATE] knob.
Feedback Knob	OFF, CENTER FEEDBACK, BALANCE, DELAY LEFT	Specifies the parameter that is controlled by the MODULATION FX [FEEDBACK] knob.
Delay Left/ Right/Center (sync sw)	OFF, ON	If this is ON, the modulation is synchronized to the tempo of the rhythm (owner's manual: p. 24).
Delay Left/ Right/Center (msec) #/ Delay Left/ Right/Center (note) #	1–2600 [msec] note (p. 60)	Adjusts the time until the delay sound is heard.

Parameter	Value	Explanation
Center Feedback #	-98--+98 [%]	Adjusts the amount of the delay sound that's fed back into the effect. Negative "-" settings invert the phase.
HF Damp	200-8000 [Hz], BYPASS	Adjusts the frequency above which sound fed back to the effect is filtered out (BYPASS : no cut).
Left/Right/Center Level	0-127	Volume of each delay
Low Gain	-15--+15 [dB]	Gain of the low frequency range
High Gain	-15--+15 [dB]	Gain of the high frequency range
Balance #	D100:0W-D0:100W	Volume balance between the direct sound (D) and the delay sound (W)
Level	0-127	Output Level

41: 4TAP PAN DELAY

This effect has four delays.

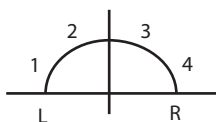
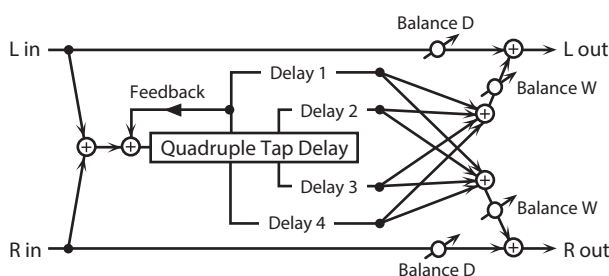

Parameter	Value	Explanation
Switch	OFF, ON	Turns the effect on/off.
Depth Knob	DLY 1 FBACK, BALANCE, DLY 1 TIME	Specifies the parameter that is controlled by the MODULATION FX [DEPTH] knob.
Rate Knob		Specifies the parameter that is controlled by the MODULATION FX [RATE] knob.
Feedback Knob	OFF, DLY 1 FBACK, BALANCE, DLY 1 TIME	Specifies the parameter that is controlled by the MODULATION FX [FEEDBACK] knob.
Delay 1-4 Time (sync sw)	OFF, ON	If this is ON, the modulation is synchronized to the tempo of the rhythm (owner's manual: p. 24).
Delay 1-4 Time (msec)/ Delay 1-4 Time (note)	1-2600 [msec] note (p. 60)	Adjusts the time until the delay 1-4 sound is heard.
Delay 1 Feedback #	-98--+98 [%]	Adjusts the amount of the delay sound that's fed back into the effect. Negative "-" settings invert the phase.

Parameter	Value	Explanation
HF Damp	200-8000 [Hz], BYPASS	Adjusts the frequency above which sound fed back to the effect is filtered out (BYPASS : no cut).
Delay 1-4 Level	0-127	Volume of each delay
Low Gain	-15--+15 [dB]	Gain of the low frequency range
High Gain	-15--+15 [dB]	Gain of the high frequency range
Balance #	D100:0W-D0:100W	Volume balance between the direct sound (D) and the delay sound (W)
Level	0-127	Output Level

42: MULTI TAP DELAY

This effect provides four delays. Each of the Delay Time parameters can be set to a note length based on the selected tempo. You can also set the panning and level of each delay sound.

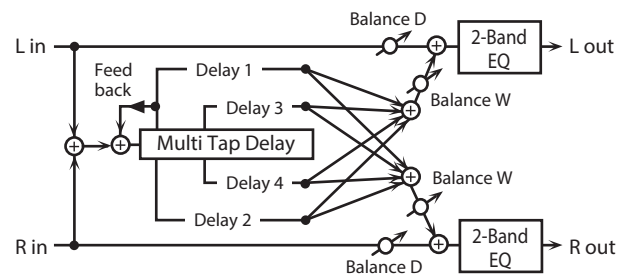

Parameter	Value	Explanation
Switch	OFF, ON	Turns the effect on/off.
Depth Knob	DLY 1 FBACK, BALANCE, DLY 1 TIME	Specifies the parameter that is controlled by the MODULATION FX [DEPTH] knob.
Rate Knob		Specifies the parameter that is controlled by the MODULATION FX [RATE] knob.
Feedback Knob	OFF, DLY 1 FBACK, BALANCE, DLY 1 TIME	Specifies the parameter that is controlled by the MODULATION FX [FEEDBACK] knob.
Delay 1-4 (sync sw)	OFF, ON	If this is ON, the modulation is synchronized to the tempo of the rhythm (owner's manual: p. 24).
Delay 1-4 Time (msec)/ Delay 1-4 Time (note)	1-2600 [msec] note (p. 60)	Adjusts the time until Delays 1-4 are heard.
Delay 1 Feedback #	-98--+98 [%]	Adjusts the amount of the delay sound that's fed back into the effect. Negative "-" settings invert the phase.
HF Damp	200-8000 [Hz], BYPASS	Adjusts the frequency above which sound fed back to the effect is filtered out (BYPASS : no cut).
Delay 1-4 Pan	L64-63R	Stereo location of Delays 1-4

Parameter	Value	Explanation
Delay 1-4 Level	0-127	Output level of Delays 1-4
Low Gain	-15-+15 [dB]	Gain of the low frequency range
High Gain	-15-+15 [dB]	Gain of the high frequency range
Balance #	D100:0W- D0:100W	Volume balance between the direct sound (D) and the effect sound (W)
Level	0-127	Output Level

43: REVERSE DELAY

This is a reverse delay that adds a reversed and delayed sound to the input sound. A tap delay is connected immediately after the reverse delay.

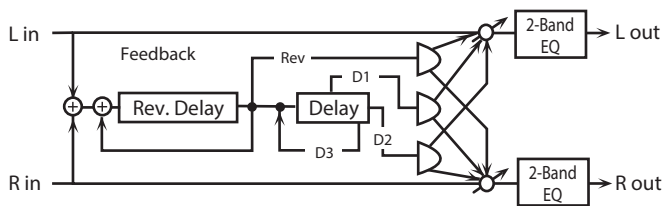

Parameter	Value	Explanation
Switch	OFF, ON	Turns the effect on/off.
Depth Knob	REV DLY FEEDBACK, DLY 3 FEEDBACK, BALANCE	Specifies the parameter that is controlled by the MODULATION FX [DEPTH] knob.
Rate Knob	DLY 3 FEEDBACK, BALANCE	Specifies the parameter that is controlled by the MODULATION FX [RATE] knob.
Feedback Knob	OFF, REV DLY FEEDBACK, DLY 3 FEEDBACK, BALANCE	Specifies the parameter that is controlled by the MODULATION FX [FEEDBACK] knob.
Threshold	0-127	Volume at which the reverse delay will begin to be applied
Rev Delay Time (sync sw)	OFF, ON	If this is ON, the modulation is synchronized to the tempo of the rhythm (owner's manual: p. 24).
Rev Delay Time (msec)/ Rev Delay Time (note)	1-1300 [msec] note (p. 60)	Delay time from when sound is input into the reverse delay until the delay sound is heard
Rev Delay Feedback #	-98-+98 [%]	Proportion of the delay sound that is to be returned to the input of the reverse delay (negative values invert the phase)
Rev Delay HF Damp	200-8000 [Hz], BYPASS	Frequency at which the high-frequency content of the reverse-delayed sound will be cut (BYPASS: no cut).
Rev Delay Pan	L64-63R	Panning of the reverse delay sound
Rev Delay Level	0-127	Volume of the reverse delay sound

Parameter	Value	Explanation
Delay 1-3 Time (sync sw)	OFF, ON	If this is ON, the modulation is synchronized to the tempo of the rhythm (owner's manual: p. 24).
Delay 1-3 Time (msec)/ Delay 1-3 Time (note)	1-1300 [msec] note (p. 60)	Delay time from when sound is input into the tap delay until the delay sound is heard
Delay 3 Feedback #	-98-+98 [%]	Proportion of the delay sound that is to be returned to the input of the tap delay (negative values invert the phase)
Delay HF Damp	200-8000 [Hz], BYPASS	Frequency at which the low-frequency content of the tap delay sound will be cut (BYPASS: no cut).
Delay 1 Pan, Delay 2 Pan	L64-63R	Panning of the tap delay sounds
Delay 1 Level, Delay 2 Level	0-127	Volume of the tap delay sounds
Low Gain	-15-+15 [dB]	Gain of the low frequency range
High Gain	-15-+15 [dB]	Gain of the high frequency range
Balance #	D100:0W- D0:100W	Volume balance of the original sound (D) and delay sound (W)
Level	0-127	Output Level

44: TIME CTRL DELAY

A stereo delay in which the delay time can be varied smoothly.

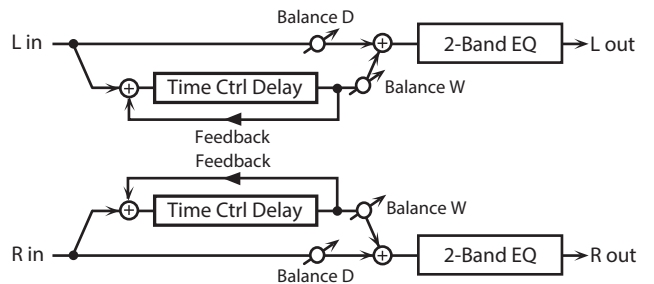

Parameter	Value	Explanation
Switch	OFF, ON	Turns the effect on/off.
Depth Knob	DELAY TIME, FEEDBACK, BALANCE	Specifies the parameter that is controlled by the MODULATION FX [DEPTH] knob.
Rate Knob	DELAY TIME, FEEDBACK, BALANCE	Specifies the parameter that is controlled by the MODULATION FX [RATE] knob.
Feedback Knob	OFF, DELAY TIME, FEEDBACK, BALANCE	Specifies the parameter that is controlled by the MODULATION FX [FEEDBACK] knob.
Delay Time (sync sw) #	OFF, ON	If this is ON, the modulation is synchronized to the tempo of the rhythm (owner's manual: p. 24).

Parameter	Value	Explanation
Delay Time (msec) #/ Delay Time (note) #	1–1300 [msec] note (p. 60)	Adjusts the time until the delay is heard.
Acceleration	0–15	Adjusts the speed which the Delay Time changes from the current setting to a specified new setting. The rate of change for the Delay Time directly affects the rate of pitch change.
Feedback #	-98–+98 [%]	Adjusts the amount of the delay sound that's fed back into the effect. Negative "–" settings invert the phase.
HF Damp	200–8000 [Hz], BYPASS	Adjusts the frequency above which sound fed back to the effect is filtered out (BYPASS : no cut).
Low Gain	-15–+15 [dB]	Gain of the low frequency range
High Gain	-15–+15 [dB]	Gain of the high frequency range
Balance #	D100:0W– D0:100W	Volume balance between the direct sound (D) and the delay sound (W)
Level	0–127	Output Level

45: LOFI COMPRESS

This is an effect that intentionally degrades the tone quality for creative purposes.

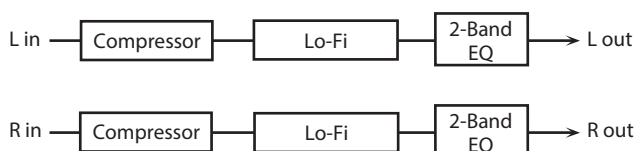

Parameter	Value	Explanation
Switch	OFF, ON	Turns the effect on/off.
Depth Knob	BALANCE, LEVEL	Specifies the parameter that is controlled by the MODULATION FX [DEPTH] knob .
Rate Knob		Specifies the parameter that is controlled by the MODULATION FX [RATE] knob .
Feedback Knob	OFF, BALANCE, LEVEL	Specifies the parameter that is controlled by the MODULATION FX [FEEDBACK] knob .
Pre Filter Type	1–6	Selects the type of filter applied to the sound before it passes through the Lo-Fi effect. 1 : Compressor off 2–6 : Compressor on
LoFi Type	1–9	Degrades the tone quality. The tone quality grows poorer as this value is increased.

Parameter	Value	Explanation
Post Filter Type	OFF, LPF, HPF	Type of filter OFF : no filter is used LPF : cuts the frequency range above the Cutoff HPF : cuts the frequency range below the Cutoff
Post Filter Cutoff	200–8000 [Hz]	Basic frequency of the Post Filter
Low Gain	-15–+15 [dB]	Gain of the low range
High Gain	-15–+15 [dB]	Gain of the high range
Balance #	D100:0W– D0:100W	Volume balance between the direct sound (D) and the effect sound (W)
Level #	0–127	Output Level

46: BIT CRUSHER

This creates a lo-fi sound.

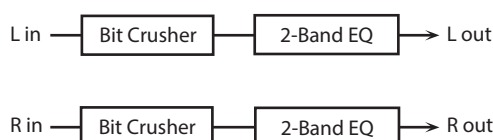

Parameter	Value	Explanation
Switch	OFF, ON	Turns the effect on/off.
Depth Knob	SAMPLE RATE, BIT DOWN, FILTER	Specifies the parameter that is controlled by the MODULATION FX [DEPTH] knob .
Rate Knob		Specifies the parameter that is controlled by the MODULATION FX [RATE] knob .
Feedback Knob	OFF, SAMPLE RATE, BIT DOWN, FILTER	Specifies the parameter that is controlled by the MODULATION FX [FEEDBACK] knob .
Sample Rate #	0–127	Adjusts the sample rate.
Bit Down #	0–20	Adjusts the bit depth.
Filter #	0–127	Adjusts the filter depth.
Low Gain	-15–+15 [dB]	Gain of the low frequency range
High Gain	-15–+15 [dB]	Gain of the high frequency range
Level	0–127	Output Level

47: PITCH SHIFTER

A stereo pitch shifter.

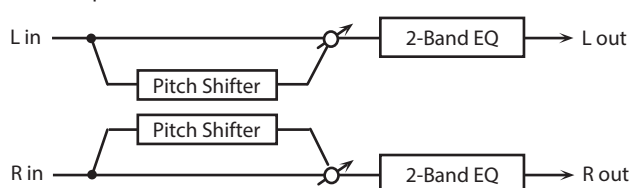

Parameter	Value	Explanation
Switch	OFF, ON	Turns the effect on/off.

Parameter	Value	Explanation
Depth Knob	COARSE, FINE, FEEDBACK, BALANCE	Specifies the parameter that is controlled by the MODULATION FX [DEPTH] knob.
Rate Knob	COARSE, FINE, FEEDBACK, BALANCE	Specifies the parameter that is controlled by the MODULATION FX [RATE] knob.
Feedback Knob	OFF, COARSE, FINE, FEEDBACK, BALANCE	Specifies the parameter that is controlled by the MODULATION FX [FEEDBACK] knob.
Coarse #1	-24--+12 [semi]	Adjusts the pitch of the pitch shifted sound in semitone steps.
Fine #1	-100--+100 [cent]	Adjusts the pitch of the pitch shifted sound in 2-cent steps.
Delay Time (sync sw)	OFF, ON	If this is ON, the modulation is synchronized to the tempo of the rhythm (owner's manual: p. 24).
Delay Time (msec)/	1-1300 [msec]	Adjusts the delay time from the direct sound until the pitch shifted sound is heard.
Delay Time (note)	note (p. 60)	
Feedback #	-98--+98 [%]	Adjusts the proportion of the pitch shifted sound that is fed back into the effect. Negative "-" settings will invert the phase.
Low Gain	-15--+15 [dB]	Gain of the low range
High Gain	-15--+15 [dB]	Gain of the high range
Balance #	D100:0W- D0:100W	Volume balance between the direct sound (D) and the pitch shifted sound (W)
Level	0-127	Output Level

Parameter	Value	Explanation
Depth Knob	PITCH1 COARSE, PITCH1 FINE, PITCH1 FEEDBACK, PITCH1 PAN, PITCH2 COARSE, PITCH2 FINE, PITCH2 FEEDBACK, PITCH2 PAN, BALANCE	Specifies the parameter that is controlled by the MODULATION FX [DEPTH] knob.
Rate Knob	COARSE, FINE, FEEDBACK, BALANCE	Specifies the parameter that is controlled by the MODULATION FX [RATE] knob.
Feedback Knob	OFF, PITCH1 COARSE, PITCH1 FINE, PITCH1 FEEDBACK, PITCH1 PAN, PITCH2 COARSE, PITCH2 FINE, PITCH2 FEEDBACK, PITCH2 PAN, BALANCE	Specifies the parameter that is controlled by the MODULATION FX [FEEDBACK] knob.
Pitch1 Coarse #1	-24--+12 semi	Adjusts the pitch of Pitch Shift 1 in semitone steps.
Pitch1 Fine #1	-100--+100 cent	Adjusts the pitch of Pitch Shift Pitch 1 in 2-cent steps.
Pitch1 Delay (sync sw)	OFF, ON	If this is ON, the modulation is synchronized to the tempo of the rhythm (owner's manual: p. 24).
Pitch1 Delay (msec)/	1-1300 [msec]	Adjusts the delay time from the direct sound until the Pitch Shift 1 sound is heard.
Pitch1 Delay (note)	note (p. 60)	
Pitch1 Feedback #	-98--+98 [%]	Adjusts the proportion of the pitch shifted sound that is fed back into the effect. Negative "-" settings will invert the phase.
Pitch1 Pan #	L64-63R	Stereo location of the Pitch Shift 1 sound
Pitch1 Level	0-127	Volume of the Pitch Shift 1 sound
Pitch2 Coarse #2	-24--+12 semi	Settings of the Pitch Shift 2 sound.
Pitch2 Fine #2	-100--+100 cent	
Pitch2 Delay	OFF, ON	The parameters are the same as for the Pitch Shift 1 sound.
Pitch2 Delay (msec)/	1-1300 [msec]	
Pitch2 Delay (note)	note (p. 60)	
Pitch2 Feedback #	-98--+98 [%]	
Pitch2 Pan #	L64-63R	
Pitch2 Level	0-127	
Low Gain	-15--+15 [dB]	Gain of the low range
High Gain	-15--+15 [dB]	Gain of the high range
Balance #	D100:0W- D0:100W	Volume balance between the direct sound (D) and the pitch shifted sound (W)
Level	0-127	Output Level

48: 2VOICE PITCH SHIFTER

Shifts the pitch of the original sound. This 2-voice pitch shifter has two pitch shifters, and can add two pitch shifted sounds to the original sound.

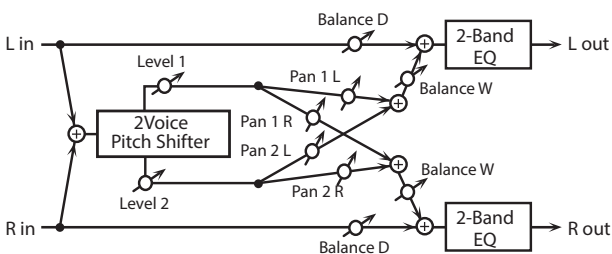

Parameter	Value	Explanation
Switch	OFF, ON	Turns the effect on/off.

49: OD → CHORUS

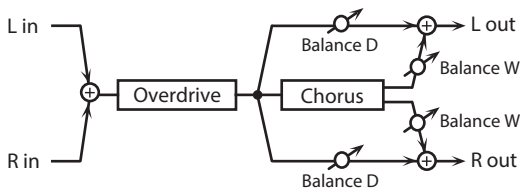

Parameter	Value	Explanation
Switch	OFF, ON	Turns the effect on/off.
Depth Knob	OVERDRIVE DRIVE, OVERDRIVE PAN, CHORUS RATE, CHORUS BALANCE	Specifies the parameter that is controlled by the MODULATION FX [DEPTH] knob.
Rate Knob	OVERDRIVE DRIVE, OVERDRIVE PAN, FLN RATE, FLN FEEDBACK, FLN BALANCE	Specifies the parameter that is controlled by the MODULATION FX [RATE] knob.
Feedback Knob	OFF, OVERDRIVE DRIVE, OVERDRIVE PAN, CHORUS RATE, CHORUS BALANCE	Specifies the parameter that is controlled by the MODULATION FX [FEEDBACK] knob.
Overdrive Drive #	0–127	Degree of distortion Also changes the volume.
Overdrive Pan #	L64–63R	Stereo location of the overdrive sound
Chorus Pre Delay	0.0–100.0 [msec]	Adjusts the delay time from the direct sound until the chorus sound is heard.
Chorus Rate (sync sw)	OFF, ON	If this is ON, the modulation is synchronized to the tempo of the rhythm (owner's manual: p. 24).
Chorus Rate (Hz) #/ Chorus Rate (note) #	0.05–10.00 [Hz] note (p. 60)	Frequency of modulation
Chorus Depth	0–127	Depth of modulation
Chorus Balance #	D100:0W–D0:100W	Adjusts the volume balance between the sound that is sent through the chorus (W) and the sound that is not sent through the chorus (D).
Level	0–127	Output Level

50: OD → FLANGER

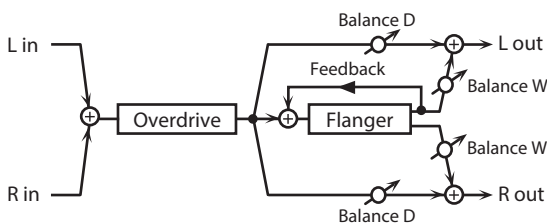

Parameter	Value	Explanation
Switch	OFF, ON	Turns the effect on/off.

Parameter	Value	Explanation
Depth Knob	OVERDRIVE DRIVE, OVERDRIVE PAN, FLN RATE, FLN FEEDBACK, FLN BALANCE	Specifies the parameter that is controlled by the MODULATION FX [DEPTH] knob.
Rate Knob	OVERDRIVE DRIVE, OVERDRIVE PAN, FLN RATE, FLN FEEDBACK, FLN BALANCE	Specifies the parameter that is controlled by the MODULATION FX [RATE] knob.
Feedback Knob	OFF, OVERDRIVE DRIVE, OVERDRIVE PAN, FLN RATE, FLN FEEDBACK, FLN BALANCE	Specifies the parameter that is controlled by the MODULATION FX [FEEDBACK] knob.
Overdrive Drive #	0–127	Degree of distortion Also changes the volume.
Overdrive Pan #	L64–63R	Stereo location of the overdrive sound
Flanger Pre Delay	0.0–100 [msec]	Adjusts the delay time from the direct sound until the flanger sound is heard.
Flanger Rate (sync sw)	OFF, ON	If this is ON, the modulation is synchronized to the tempo of the rhythm (owner's manual: p. 24).
Flanger Rate (Hz) #/ Flanger Rate (note) #	0.05–10.00 [Hz] note (p. 60)	Frequency of modulation
Flanger Depth	0–127	Depth of modulation
Flanger Feedback #	-98–+98 [%]	Adjusts the proportion of the flanger sound that is fed back into the effect. Negative “-” settings will invert the phase.
Flanger Balance #	D100:0W–D0:100W	Adjusts the volume balance between the sound that is sent through the flanger (W) and the sound that is not sent through the flanger (D).
Level	0–127	Output Level

51: OD → DELAY

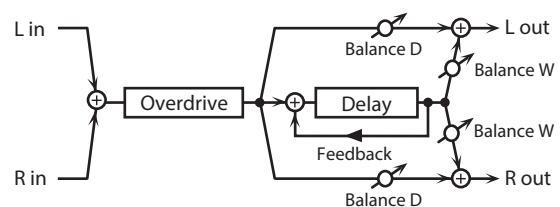

Parameter	Value	Explanation
Switch	OFF, ON	Turns the effect on/off.
Depth Knob	OVERDRIVE DRIVE, OVERDRIVE PAN, DELAY FEEDBACK, DELAY BALANCE	Specifies the parameter that is controlled by the MODULATION FX [DEPTH] knob.
Rate Knob	OVERDRIVE DRIVE, OVERDRIVE PAN, DELAY FEEDBACK, DELAY BALANCE	Specifies the parameter that is controlled by the MODULATION FX [RATE] knob.

Parameter	Value	Explanation
Feedback Knob	OFF, OVERDRIVE DRIVE, OVERDRIVE PAN, DELAY FEEDBACK, DELAY BALANCE	Specifies the parameter that is controlled by the MODULATION FX [FEEDBACK] knob.
Overdrive Drive #	0–127	Degree of distortion Also changes the volume.
Overdrive Pan #	L64–63R	Stereo location of the overdrive sound
Delay Time (sync sw)	OFF, ON	If this is ON, the modulation is synchronized to the tempo of the rhythm (owner's manual: p. 24).
Delay Time (msec)/ Delay Time (note)	1–2600 [msec] note (p. 60)	Adjusts the delay time from the direct sound until the delay sound is heard.
Delay Feedback #	-98–+98 [%]	Adjusts the proportion of the delay sound that is fed back into the effect. Negative “-” settings will invert the phase.
Delay HF Damp	200–8000 [Hz], BYPASS	Adjusts the frequency above which sound fed back to the effect will be cut (BYPASS : no cut).
Delay Balance #	D100:0W– D0:100W	Adjusts the volume balance between the sound that is sent through the delay (W) and the sound that is not sent through the delay (D).
Level	0–127	Output Level

52: DS → CHORUS

The parameters are essentially the same as in “49: OD → CHORUS,” with the exception of the following two.

- Overdrive Drive → Distortion Drive
- Overdrive Pan → Distortion Pan

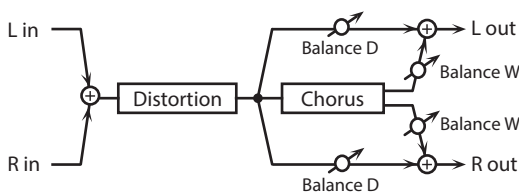

53: DS → FLANGER

The parameters are essentially the same as in “50: OD → FLANGER,” with the exception of the following two.

- Overdrive Drive → Distortion Drive
- Overdrive Pan → Distortion Pan

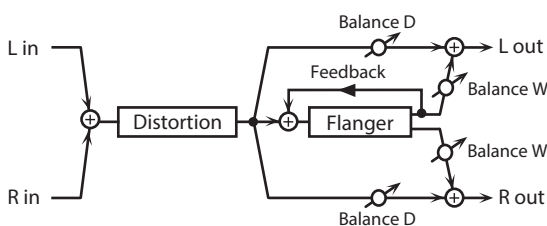

54: DS → DELAY

The parameters are essentially the same as in “51: OD → DELAY,” with the exception of the following two.

- Overdrive Drive → Distortion Drive
- Overdrive Pan → Distortion Pan

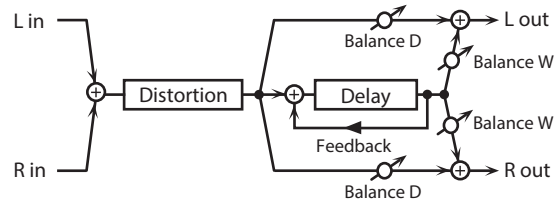

55: OD/DS → TWAH

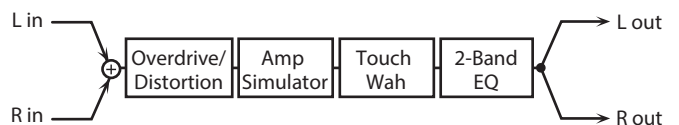

Parameter	Value	Explanation
Switch	OFF, ON	Turns the effect on/off.
Depth Knob	DRIVE, TONE, TWAH SENS, TWAH MANUAL, TWAH PEAK, TWAH BALANCE	Specifies the parameter that is controlled by the MODULATION FX [DEPTH] knob.
Rate Knob		Specifies the parameter that is controlled by the MODULATION FX [RATE] knob.
Feedback Knob	OFF, DRIVE, TONE, TWAH SENS, TWAH MANUAL, TWAH PEAK, TWAH BALANCE	Specifies the parameter that is controlled by the MODULATION FX [FEEDBACK] knob.
Drive Switch	OFF, ON	Turns overdrive/distortion on/off
Drive Type	OVERDRIVE, DISTORTION	Type of distortion
Drive #	0–127	Degree of distortion Also changes the volume.
Tone #	0–127	Sound quality of the Overdrive effect
Amp Switch	OFF, ON	Turns the Amp Simulator on/off.
Amp Type		Type of guitar amp SMALL : small amp BUILT-IN : single-unit type amp 2-STACK : large double stack amp 3-STACK : large triple stack amp
TWah Switch	OFF, ON	Wah on/off
TWah Filter Type	LPF, BPF	Type of filter LPF : Produces a wah effect in a broad frequency range. BPF : Produces a wah effect in a narrow frequency range.

Parameter	Value	Explanation
TWah Polarity	DOWN, UP	Direction in which the filter will move UP: Move toward a higher frequency DOWN: Move toward a lower frequency
TWah Sens #	0-127	Sensitivity with which the filter is modified
TWah Manual #	0-127	Basic frequency at which the wah effect is applied
TWah Peak #	0-127	Width of the frequency region at which the wah effect is applied Increasing this value will make the frequency region narrower.
TWah Balance #	D100:0W- D0:100W	Volume balance of the sound that passes through the wah (W) and the direct sound (D)
Low Gain	-15→+15 [dB]	Gain of the low range
High Gain	-15→+15 [dB]	Gain of the high range
Level	0-127	Output Level

Parameter	Value	Explanation
Amp Type	SMALL, BUILT-IN, 2-STACK, 3-STACK	Type of guitar amp SMALL: small amp BUILT-IN: single-unit type amp 2-STACK: large double stack amp 3-STACK: large triple stack amp
AutoWah Switch	OFF, ON	Wah on/off
AutoWah Filter Type	LPF, BPF	Type of filter LPF: Produces a wah effect in a broad frequency range. BPF: Produces a wah effect in a narrow frequency range.
AutoWah Manual #	0-127	Basic frequency at which the wah effect is applied
AutoWah Peak #	0-127	Width of the frequency region at which the wah effect is applied Increasing this value will make the frequency region narrower.
AutoWah Rate (sync sw)	OFF, ON	If this is ON, the modulation is synchronized to the tempo of the rhythm (owner's manual: p. 24).
AutoWah Rate (Hz) #/ AutoWah Rate (note) #	0.05-10.00 [Hz] note (p. 60)	Rate at which the wah effect is modulated
AutoWah Depth #	0-127	Depth at which the wah effect is modulated
AutoWah Balance #	D100:0W- D0:100W	Volume balance of the sound that passes through the wah (W) and the direct sound (D)
Low Gain	-15→+15 [dB]	Gain of the low range
High Gain	-15→+15 [dB]	Gain of the high range
Level	0-127	Output Level

56: OD/DS → AWAH

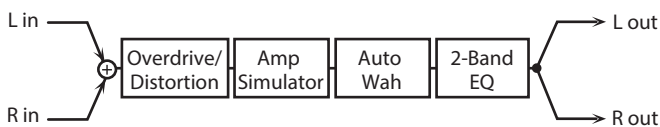

Parameter	Value	Explanation
Switch	OFF, ON	Turns the effect on/off.
Depth Knob	DRIVE, TONE, AUTOWAH MANUAL, AUTOWAH PEAK, AUTOWAH RATE, AUTOWAH DEPTH, AUTOWAH BALANCE	Specifies the parameter that is controlled by the MODULATION FX [DEPTH] knob.
Rate Knob	AUTOWAH PEAK, AUTOWAH RATE, AUTOWAH DEPTH, AUTOWAH BALANCE	Specifies the parameter that is controlled by the MODULATION FX [RATE] knob.
Feedback Knob	OFF, DRIVE, TONE, AUTOWAH MANUAL, AUTOWAH PEAK, AUTOWAH RATE, AUTOWAH DEPTH, AUTOWAH BALANCE	Specifies the parameter that is controlled by the MODULATION FX [FEEDBACK] knob.
Drive Switch	OFF, ON	Overdrive/distortion on/off
Drive Type	OVERDRIVE, DISTORTION	Type of distortion
Drive #	0-127	Degree of distortion Also changes the volume.
Tone #	0-127	Sound quality of the Overdrive effect
Amp Switch	OFF, ON	Turns the Amp Simulator on/off.

57: ENHANCER → CHORUS

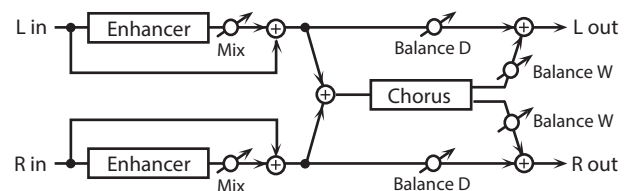

Parameter	Value	Explanation
Switch	OFF, ON	Turns the effect on/off.
Depth Knob	ENHANCER SENS, ENHANCER MIX, CHORUS RATE, CHORUS BALANCE	Specifies the parameter that is controlled by the MODULATION FX [DEPTH] knob.
Rate Knob	CHORUS BALANCE	Specifies the parameter that is controlled by the MODULATION FX [RATE] knob.

Parameter	Value	Explanation
Feedback Knob	OFF, ENHANCER SENS, ENHANCER MIX, CHORUS RATE, CHORUS BALANCE	Specifies the parameter that is controlled by the MODULATION FX [FEEDBACK] knob.
Enhancer Sens #	0–127	Sensitivity of the enhancer
Enhancer Mix #	0–127	Level of the overtones generated by the enhancer
Chorus Pre Delay	0.0–100 [msec]	Adjusts the delay time from the direct sound until the chorus sound is heard.
Chorus Rate (sync sw)	OFF, ON	If this is ON, the modulation is synchronized to the tempo of the rhythm (owner's manual: p. 24).
Chorus Rate (Hz) #/ Chorus Rate (note) #	0.05–10.00 [Hz] note (p. 60)	Frequency of modulation
Chorus Depth	0–127	Depth of modulation
Chorus Balance #	D100:0W–D0:100W	Adjusts the volume balance between the sound that is sent through the chorus (W) and the sound that is not sent through the chorus (D).
Level	0–127	Output Level

Parameter	Value	Explanation
Flanger Rate (sync sw)	OFF, ON	If this is ON, the modulation is synchronized to the tempo of the rhythm (owner's manual: p. 24).
Flanger Rate (Hz) #	0.05–10.0 [Hz]	Frequency of modulation
Flanger Rate (note) #	note (p. 60)	
Flanger Depth	0–127	Depth of modulation
Flanger Feedback #	-98–+98 [%]	Adjusts the proportion of the flanger sound that is fed back into the effect. Negative "-" settings will invert the phase.
Flanger Balance #	D100:0W–D0:100W	Adjusts the volume balance between the sound that is sent through the flanger (W) and the sound that is not sent through the flanger (D).
Level	0–127	Output Level

58: ENHANCER → FLANGER

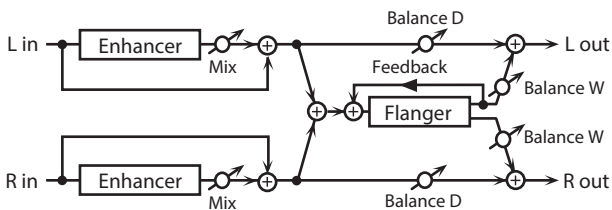

Parameter	Value	Explanation
Switch	OFF, ON	Turns the effect on/off.
Depth Knob	ENHANCER SENS, ENHANCER MIX, FLN RATE, FLN FEEDBACK, FLN BALANCE	Specifies the parameter that is controlled by the MODULATION FX [DEPTH] knob.
Rate Knob	ENHANCER SENS, ENHANCER MIX, FLN RATE, FLN FEEDBACK, FLN BALANCE	Specifies the parameter that is controlled by the MODULATION FX [RATE] knob.
Feedback Knob	OFF, ENHANCER SENS, ENHANCER MIX, FLN RATE, FLN FEEDBACK, FLN BALANCE	Specifies the parameter that is controlled by the MODULATION FX [FEEDBACK] knob.
Enhancer Sens #	0–127	Sensitivity of the enhancer
Enhancer Mix #	0–127	Level of the overtones generated by the enhancer
Flanger Pre Delay	0.0–100 [msec]	Adjusts the delay time from the direct sound until the flanger sound is heard.

59: ENHANCER → DELAY

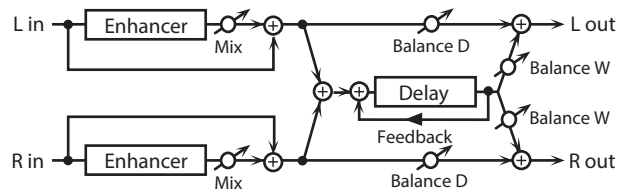

Parameter	Value	Explanation
Switch	OFF, ON	Turns the effect on/off.
Depth Knob	ENHANCER SENS, ENHANCER MIX, DELAY FEEDBACK, DELAY BALANCE	Specifies the parameter that is controlled by the MODULATION FX [DEPTH] knob.
Rate Knob	ENHANCER SENS, ENHANCER MIX, DELAY FEEDBACK, DELAY BALANCE	Specifies the parameter that is controlled by the MODULATION FX [RATE] knob.
Feedback Knob	OFF, ENHANCER SENS, ENHANCER MIX, DELAY FEEDBACK, DELAY BALANCE	Specifies the parameter that is controlled by the MODULATION FX [FEEDBACK] knob.
Enhancer Sens #	0–127	Sensitivity of the enhancer
Enhancer Mix #	0–127	Level of the overtones generated by the enhancer
Delay Time (sync sw)	OFF, ON	If this is ON, the modulation is synchronized to the tempo of the rhythm (owner's manual: p. 24).
Delay Time (msec)/ Delay Time (note)	1–2600 [msec] note (p. 60)	Adjusts the delay time from the direct sound until the delay sound is heard.
Delay Feedback #	-98–+98 [%]	Adjusts the proportion of the delay sound that is fed back into the effect. Negative "-" settings will invert the phase.

Parameter	Value	Explanation
Delay HF Damp	200–8000 [Hz], BYPASS	Adjusts the frequency above which sound fed back to the effect will be cut (BYPASS : no cut).
Delay Balance #	D100:0W– D0:100W	Adjusts the volume balance between the sound that is sent through the delay (W) and the sound that is not sent through the delay (D).
Level	0–127	Output Level

60: CHORUS → DELAY

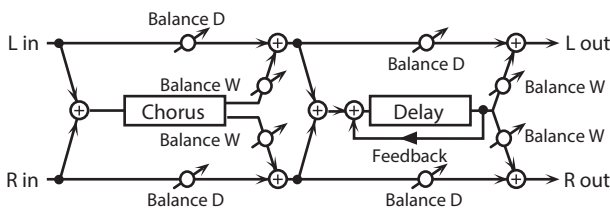

Parameter	Value	Explanation
Switch	OFF, ON	Turns the effect on/off.
Depth Knob	CHORUS RATE, CHORUS BALANCE, DELAY FEEDBACK, DELAY BALANCE	Specifies the parameter that is controlled by the MODULATION FX [DEPTH] knob.
Rate Knob	CHORUS RATE, CHORUS BALANCE, DELAY FEEDBACK, DELAY BALANCE	Specifies the parameter that is controlled by the MODULATION FX [RATE] knob.
Feedback Knob	OFF, CHORUS RATE, CHORUS BALANCE, DELAY FEEDBACK, DELAY BALANCE	Specifies the parameter that is controlled by the MODULATION FX [FEEDBACK] knob.
Chorus Pre Delay	0.0–100 [msec]	Adjusts the delay time from the direct sound until the chorus sound is heard.
Chorus Rate (sync sw)	OFF, ON	If this is ON, the modulation is synchronized to the tempo of the rhythm (owner's manual: p. 24).
Chorus Rate (Hz) #/ Chorus Rate (note) #	0.05–10.00 [Hz] note (p. 60)	Frequency of modulation
Chorus Depth	0–127	Depth of modulation
Chorus Balance #	D100:0W– D0:100W	Volume balance between the direct sound (D) and the chorus sound (W)
Delay Time (sync sw)	OFF, ON	If this is ON, the modulation is synchronized to the tempo of the rhythm (owner's manual: p. 24).
Delay Time (msec)/ Delay Time (note)	1–2600 [msec] note (p. 60)	Adjusts the delay time from the direct sound until the delay sound is heard.

Parameter	Value	Explanation
Delay Feedback #	-98–+98 [%]	Adjusts the proportion of the delay sound that is fed back into the effect. Negative “-” settings will invert the phase.
Delay HF Damp	200–8000 [Hz], BYPASS	Adjusts the frequency above which sound fed back to the effect will be cut (BYPASS : no cut).
Delay Balance #	D100:0W– D0:100W	Adjusts the volume balance between the sound that is sent through the delay (W) and the sound that is not sent through the delay (D).
Level	0–127	Output Level

61: FLANGER → DELAY

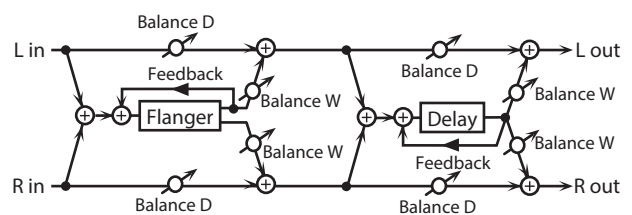

Parameter	Value	Explanation
Switch	OFF, ON	Turns the effect on/off.
Depth Knob	FLN RATE, FLN FEEDBACK, FLN BALANCE, DELAY FEEDBACK, DELAY BALANCE	Specifies the parameter that is controlled by the MODULATION FX [DEPTH] knob.
Rate Knob	FLN RATE, FLN FEEDBACK, FLN BALANCE, DELAY FEEDBACK, DELAY BALANCE	Specifies the parameter that is controlled by the MODULATION FX [RATE] knob.
Feedback Knob	OFF, FLN RATE, FLN FEEDBACK, FLN BALANCE, DELAY FEEDBACK, DELAY BALANCE	Specifies the parameter that is controlled by the MODULATION FX [FEEDBACK] knob.
Flanger Pre Delay	0.0–100 [msec]	Adjusts the delay time from the direct sound until the flanger sound is heard.
Flanger Rate (sync sw)	OFF, ON	If this is ON, the modulation is synchronized to the tempo of the rhythm (owner's manual: p. 24).
Flanger Rate (Hz) #/ Flanger Rate (note) #	0.05–10.00 [Hz] note (p. 60)	Frequency of modulation
Flanger Depth	0–127	Depth of modulation
Flanger Feedback #	-98–+98 [%]	Adjusts the proportion of the flanger sound that is fed back into the effect. Negative “-” settings will invert the phase.
Flanger Balance #	D100:0W– D0:100W	Volume balance between the direct sound (D) and the flanger sound (W)

Parameter	Value	Explanation
Delay Time (sync sw)	OFF, ON	If this is ON, the modulation is synchronized to the tempo of the rhythm (owner's manual: p. 24).
Delay Time (msec)/ Delay Time (note)	1–2600 [msec] note (p. 60)	Adjusts the delay time from the direct sound until the delay sound is heard.
Delay Feedback #	-98–+98 [%]	Adjusts the proportion of the delay sound that is fed back into the effect. Negative “-” settings will invert the phase.
Delay HF Damp	200–8000 [Hz], BYPASS	Adjusts the frequency above which sound fed back to the effect will be cut (BYPASS : no cut).
Delay Balance #	D100:0W– D0:100W	Adjusts the volume balance between the sound that is sent through the delay (W) and the sound that is not sent through the delay (D).
Level	0–127	Output Level

Parameter	Value	Explanation
Chorus Balance #	D100:0W– D0:100W	Volume balance between the direct sound (D) and the chorus sound (W)
Flanger Pre Delay	0.0–100 [msec]	Adjusts the delay time from the direct sound until the flanger sound is heard.
Flanger Rate (sync sw)	OFF, ON	If this is ON, the modulation is synchronized to the tempo of the rhythm (owner's manual: p. 24).
Flanger Rate (Hz) #/ Flanger Rate (note) #	0.05–10.00 [Hz] note (p. 60)	Modulation frequency of the flanger effect
Flanger Depth	0–127	Modulation depth of the flanger effect
Flanger Feedback #	-98–+98 [%]	Adjusts the proportion of the flanger sound that is fed back into the effect. Negative “-” settings will invert the phase.
Flanger Balance #	D100:0W– D0:100W	Adjusts the volume balance between the sound that is sent through the flanger (W) and the sound that is not sent through the flanger (D).
Level	0–127	Output Level

62: CHORUS → FLANGER

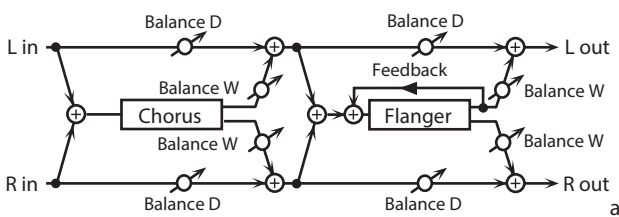

Parameter	Value	Explanation
Switch	OFF, ON	Turns the effect on/off.
Depth Knob	CHORUS RATE, CHORUS BALANCE, FLN RATE, FLN FEEDBACK, FLN BALANCE	Specifies the parameter that is controlled by the MODULATION FX [DEPTH] knob .
Rate Knob	CHORUS RATE, CHORUS BALANCE, FLN RATE, FLN FEEDBACK, FLN BALANCE	Specifies the parameter that is controlled by the MODULATION FX [RATE] knob .
Feedback Knob	CHORUS RATE, CHORUS BALANCE, FLN RATE, FLN FEEDBACK, FLN BALANCE	Specifies the parameter that is controlled by the MODULATION FX [FEEDBACK] knob .
Chorus Pre Delay	0.0–100 [msec]	Adjusts the delay time from the direct sound until the chorus sound is heard.
Chorus Rate (sync sw)	OFF, ON	If this is ON, the modulation is synchronized to the tempo of the rhythm (owner's manual: p. 24).
Chorus Rate (Hz) #/ Chorus Rate (note) #	0.05–10.00 [Hz] note (p. 60)	Modulation frequency of the chorus effect
Chorus Depth	0–127	Modulation depth of the chorus effect

Note

Tremolo/Amp Simulator Parameters

The Tremolo/Amp Simulator effect is included in the tone.

You can choose from six types of tremolo and amp simulator that are optimized in different ways.

1: NORMAL

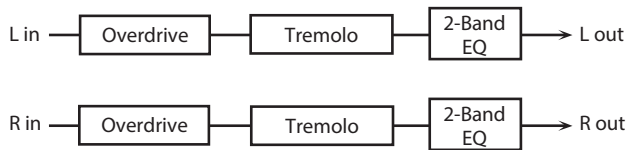

Parameter	Value	Explanation
OD Switch	OFF, ON	Overdrive on/off
OD Drive	0–127	Degree of distortion
Tremolo Switch	OFF, ON	Tremolo on/off
Tremolo Mod Wave	TRI, SQR, SIN, SAW1, SAW2, TRP	Modulation Wave TRI: triangle wave SQR: square wave SIN: sine wave SAW1/2: sawtooth wave TRP: Trapezoidal wave
Tremolo Rate (sync sw)	OFF, ON	If this is ON, the modulation is synchronized to the tempo of the rhythm (owner's manual: p. 24).
Tremolo Rate (Hz)/	0.05–10.00 [Hz]	Rate of the tremolo effect
Tremolo Rate (note)	note (p. 60)	
Tremolo Depth	0–127	Depth of the tremolo effect
Low Gain	-15–+15 [dB]	Gain of the low range
High Gain	-15–+15 [dB]	Gain of the high range
Level	0–127	Output Level

2: A.PIANO

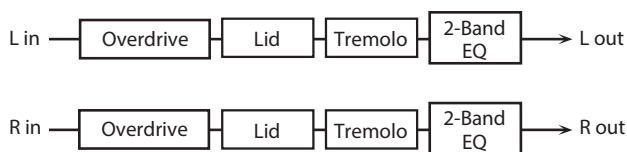

Parameter	Value	Explanation
Lid	1–7	Amount by which the lid of the grand piano is open. Higher settings open the lid more, producing a brighter sound.
OD Switch	OFF, ON	Overdrive on/off
OD Drive	0–127	Degree of distortion
Tremolo Switch	OFF, ON	Tremolo on/off
Tremolo Mod Wave	TRI, SQR, SIN, SAW1, SAW2, TRP	Modulation Wave TRI: triangle wave SQR: square wave SIN: sine wave SAW1/2: sawtooth wave TRP: Trapezoidal wave

Parameter	Value	Explanation
Tremolo Rate (sync sw)	OFF, ON	If this is ON, the modulation is synchronized to the tempo of the rhythm (owner's manual: p. 24).
Tremolo Rate (Hz)/	0.05–10.00 [Hz]	Rate of the tremolo effect
Tremolo Rate (note)	note (p. 60)	
Tremolo Depth	0–127	Depth of the tremolo effect
Low Gain	-15–+15 [dB]	Gain of the low range
High Gain	-15–+15 [dB]	Gain of the high range
Level	0–127	Output Level

3: E.PIANO

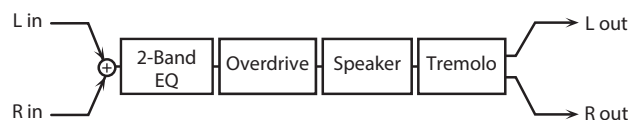

Parameter	Value	Explanation
Bass	-50–+50	Gain of the low range
Treble	-50–+50	Gain of the high range
Tremolo Switch	OFF, ON	Tremolo on/off
Tremolo Type	OLDCASE MONO, OLDCASE STEREO, NEWCASE, DYNO, WURLY	Type of tremolo effect
Tremolo Speed (sync sw)	OFF, ON	If this is ON, the modulation is synchronized to the tempo of the rhythm (owner's manual: p. 24).
Tremolo Speed (Hz)/	0.05–10.00 [Hz]	Rate of the tremolo effect
Tremolo Speed (note)	note (p. 60)	
Tremolo Depth	0–127	Depth of the tremolo effect
Tremolo Shape	0–20	Adjusts the waveform of the tremolo.
AMP Switch	OFF, ON	If this is off, speaker and overdrive are not applied.
Speaker Type	LINE, OLD, NEW, WURLY, TWIN	Type of speaker * If LINE is selected, the sound will not be sent through the speaker simulation.
OD Drive	0–127	Degree of distortion
Level	0–127	Output Level

Characteristics of the tremolo types

Tremolo types of differing character are available, allowing you to reproduce the character of classic electric pianos when combined with an electric piano sound.

Type	Explanation
OLDCASE MONO	Used in conjunction with TINE EP, this simulates an early model of a classic electric piano of the 60s.
OLDCASE STEREO	Used in conjunction with TINE EP, this simulates a classic electric piano sound of the early 70s.
NEWCASE	Used in conjunction with TINE EP, this simulates a classic electric piano sound of the late 70s and early 80s.
DYNO	This model allows you to vary the shape of the tremolo waveform. Used in conjunction with TINE EP, this simulates an electric piano sound used in many recordings of the early 80s.
WURLY	Used in conjunction with REED E. PIANO, this simulates a classic electric piano sound of the 60s.

Parameter	Value	Explanation
Tremolo Mod Wave	TRI, SQR, SIN, SAW1, SAW2, TRP	Modulation Wave TRI: triangle wave SQR: square wave SIN: sine wave SAW1/2: sawtooth wave TRP: Trapezoidal wave
Tremolo Rate (sync sw)	OFF, ON	If this is ON, the modulation is synchronized to the tempo of the rhythm (owner's manual: p. 24).
Tremolo Rate (Hz)/ Tremolo Rate (note)	0.05–10.00 [Hz] note (p. 60)	Rate of the tremolo effect
Tremolo Depth	0–127	Depth of the tremolo effect
Level	0–127	Output Level

4: GUITAR AMP

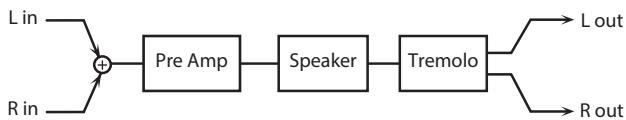

Parameter	Value	Explanation
Pre Amp Switch	OFF, ON	Turns the amp switch on/off.
Pre Amp Type	JC-120, CLEAN TWIN, MATCH DRIVE, BG LEAD, MS1959I, MS1959II, MS1959I+II, SLDN LEAD, METAL 5150, METAL LEAD, OD-1, OD-2 TURBO, DISTORTION, FUZZ	Type of guitar amp
Pre Amp Volume	0–127	Volume and amount of distortion of the amp
Pre Amp Master	0–127	Volume of the entire pre-amp
Pre Amp Gain	Low, Middle, High	Amount of pre-amp distortion
Pre Amp Bass	0–127	Tone of the bass/mid/treble frequency range
Pre Amp Middle	0–127	* Middle cannot be set if "Match Drive" is selected as the Pre Amp Type.
Pre Amp Treble	0–127	
Speaker Switch	OFF, ON	Selects whether the sound will be sent through the speaker simulation (ON) or not (OFF)
Speaker Type	➔ "Specifications of each Speaker Type" (p. 62)	
Tremolo Switch	OFF, ON	Turns the tremolo effect on/off

Specifications of each Speaker Type

The speaker column indicates the diameter of each speaker unit (in inches) and the number of units.

Type	Cabinet	Speaker	Microphone
SMALL 1	Small open-back enclosure	10	Dynamic
SMALL 2	Small open-back enclosure	10	Dynamic
MIDDLE	Open back enclosure	12 x 1	Dynamic
JC-120	Open back enclosure	12 x 2	Dynamic
BUILT-IN 1	Open back enclosure	12 x 2	Dynamic
BUILT-IN 2	Open back enclosure	12 x 2	Condenser
BUILT-IN 3	Open back enclosure	12 x 2	Condenser
BUILT-IN 4	Open back enclosure	12 x 2	Condenser
BUILT-IN 5	Open back enclosure	12 x 2	Condenser
BG STACK 1	Sealed enclosure	12 x 2	Condenser
BG STACK 2	Large sealed enclosure	12 x 2	Condenser
MS STACK 1	Large sealed enclosure	12 x 4	Condenser
MS STACK 2	Large sealed enclosure	12 x 4	Condenser
METAL STACK	Large double stack	12 x 4	Condenser
2-STACK	Large double stack	12 x 4	Condenser
3-STACK	Large triple stack	12 x 4	Condenser

5: ROTARY

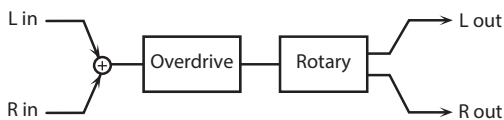

Parameter	Value	Explanation
Speed	SLOW, FAST	Simultaneously switch the rotational speed of the low frequency rotor and high frequency rotor. SLOW: Slows down the rotation to the Slow Rate. FAST: Speeds up the rotation to the Fast Rate.
Rotary Switch	OFF, ON	Switches the rotation of the rotary speaker. When this is turned off, the rotation will gradually stop. When it is turned on, the rotation will gradually resume.
Woofers Slow Speed	0.05–10.00 [Hz]	Slow speed (SLOW) of the low frequency rotor
Woofers Fast Speed	0.05–10.00 [Hz]	Fast speed (FAST) of the low frequency rotor
Woofers Trans Up	0–127	Adjusts the rate at which the woofer rotation speeds up when the rotation is switched from Slow to Fast.
Woofers Trans Down	0–127	Adjusts the rate at which the woofer rotation speeds up when the rotation is switched from Fast to Slow.
Woofers Level	0–127	Volume of the woofer
Tweeters Slow Speed	0.05–10.00 [Hz]	Settings of the tweeter
Tweeters Fast Speed	0.05 - 10.00 [Hz]	
Tweeters Trans Up	0–127	The parameters are the same as for the woofer.
Tweeters Trans Down	0–127	
Tweeters Level	0–127	
Spread	0–10	Sets the rotary speaker stereo image. The higher the value set, the wider the sound is spread out.
Low Gain	-15→+15 [dB]	Gain of the low range
High Gain	-15→+15 [dB]	Gain of the high range
Level	0–127	Output Level
OD Switch	OFF, ON	Overdrive on/off
OD Gain	0–127	Overdrive input level Higher values will increase the distortion.
OD Drive	0–127	Degree of distortion
OD Level	0–127	Volume of the overdrive

6: MKS-20 Tremolo

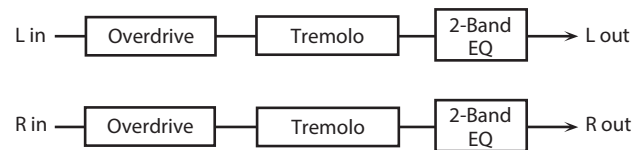

Parameter	Value	Explanation
OD Switch	OFF, ON	Overdrive on/off
OD Drive	0–127	Degree of distortion
Tremolo Switch	OFF, ON	Turns the tremolo effect on/off
Tremolo Rate (sync sw)	OFF, ON	If this is ON, the modulation is synchronized to the tempo of the rhythm (owner's manual: p. 24).
Tremolo Rate (Hz)	0.05–10.00 [Hz]	Rate of the tremolo effect
Tremolo Rate (note)	note (p. 60)	
Tremolo Depth	0–15	Depth of the tremolo effect
Low Gain	-15→+15 [dB]	Gain of the low range
High Gain	-15→+15 [dB]	Gain of the high range
Level	0–127	Output Level

Sympathetic Resonance Parameters

You can adjust this resonance when the damper pedal is depressed (Sympathetic Resonance).

On an acoustic piano, holding down the damper pedal will allow the remaining strings to resonate in sympathy with the sounds that you played from the keyboard, adding a rich resonance. This feature reproduces that resonance sound.

MEMO

This setting is available only for certain piano tones.

For the tones that correspond to certain piano sounds, refer to “Tone List” (p. 70).

Parameter	Value	Explanation
Switch	OFF, ON	When set to ON, the effect is applied.
Depth	0–127	Depth of the effect
Damper	0–127	Depth to which the damper pedal is pressed (controls the resonant sound)
Pre LPF	16–15000 [Hz], BYPASS	Frequency of the filter that cuts the high-frequency content of the input sound (BYPASS: no cut)
Pre HPF	BYPASS, 16–15000 [Hz]	Frequency of the filter that cuts the low-frequency content of the input sound (BYPASS: no cut)
Peaking Freq	16–15000 [Hz]	Frequency of the filter that boosts/cuts a specific frequency region of the input sound
Peaking Gain	-15–+15 [dB]	Amount of boost/cut produced by the filter at the specified frequency region of the input sound
Peaking Q	0.5, 1.0, 2.0, 4.0, 8.0	Width of the frequency region boosted/cut by the Peaking Gain parameter (larger values make the region narrower)
HF Damp Freq	16–15000 [Hz], BYPASS	Frequency at which the high-frequency content of the resonant sound will be cut (BYPASS: no cut)
LF Damp Freq	BYPASS, 16–15000 [Hz]	Frequency at which the low-frequency content of the resonant sound will be cut (BYPASS: no cut)
Level	0–127	Output Level
Damper Offset	0–127	Volume of additional slight resonance when the damper pedal is not pressed

Delay Parameters

This is a delay that is applied to the entire Program. You can choose from five types.

You can also adjust the amount of delay that is applied to each zones by editing the “DLY (Delay Send Level)” (p. 4) from each zones.

Settings common to all Delay types

Parameter	Value	Explanation
Type	DELAY	A stereo delay.
	T-CTRL DELAY	A delay that allows you to smoothly change the delay time.
	DELAY → TREMOLO	Tremolo is applied to the delay sound.
	2TAP DELAY	Delayed sound is heard from two locations that you specify.
	3TAP DELAY	Delayed sound is heard from three locations that you specify.
Level	0–127	Delay volume.

1: DELAY

Parameter	Value	Explanation
Switch	OFF, ON	Delay on/off
Off Mode	IMMEDIATE, REMAIN	Specifies what happens to the delay decays of the previously-played phrase when you turn delay off. IMMEDIATE: The delay sound disappears immediately. REMAIN: The delay sound decays naturally.
Output Select	MAIN, REV, MAIN+REV	Specifies the output destination of the sound from the delay.
Delay (sync sw)	OFF, ON	If this is ON, the modulation is synchronized to the tempo of the rhythm (owner’s manual: p. 24).
Delay (msec)/ Delay (note)	1–1300 [msec] note (p. 60)	Adjusts the delay time from the direct sound until the delay sound is heard.
Feedback	-98–+98 [%]	Adjusts the amount of the delay sound that’s fed back into the effect. Negative “-” settings invert the phase.
HF Damp	200–8000 [Hz], BYPASS	Adjusts the frequency above which sound fed back to the effect is filtered out (BYPASS: no cut).

2: T-CTRL DELAY

Parameter	Value	Explanation
Switch	OFF, ON	Delay on/off

Parameter	Value	Explanation
Off Mode	IMMEDIATE, REMAIN	Specifies what happens to the delay decays of the previously-played phrase when you turn delay off. IMMEDIATE: The delay sound disappears immediately. REMAIN: The delay sound decays naturally.
Output Select	MAIN, REV, MAIN+REV	Specifies the output destination of the sound from the delay.
Delay (sync sw)	OFF, ON	If this is on, the delay is synchronized with the tempo.
Delay (msec)/ Delay (note)	1–1300 [msec] note (p. 60)	Adjusts the delay time from the direct sound until the delay sound is heard.
Acceleration	0–15	Specifies the time over which the current delay time changes to the newly specified delay time when you change the delay time. This changes the speed of the pitch change as well as the delay time.
Feedback	-98–+98 [%]	Adjusts the proportion of the delay sound that is fed back into the effect. Negative (-) settings will invert the phase.
HF Damp	200–8000 [Hz], BYPASS	Adjusts the frequency above which sound fed back to the effect is filtered out (BYPASS: no cut).

3: DELAY “TREMOLO

Parameter	Value	Explanation
Switch	OFF, ON	Delay on/off
Off Mode	IMMEDIATE, REMAIN	Specifies what happens to the delay decays of the previously-played phrase when you turn delay off. IMMEDIATE: The delay sound disappears immediately. REMAIN: The delay sound decays naturally.
Output Select	MAIN, REV, MAIN+REV	Specifies the output destination of the sound from the delay.
Input Mode	MONAURAL, STEREO	MONAURAL: The input is mixed to mono. STEREO: The input is stereo.
Delay (sync sw)	OFF, ON	If this is on, the delay is synchronized with the tempo.
Delay (msec)/ Delay (note)	1–1300 [msec] note (p. 60)	Adjusts the delay time from the direct sound until the delay sound is heard.

Parameter	Value	Explanation
Feedback	-98--+98 [%]	Adjusts the amount of the delay sound that's fed back into the effect. Negative "-" settings invert the phase.
HF Damp	200-8000 [Hz], BYPASS	Adjusts the frequency above which sound fed back to the effect is filtered out (BYPASS: no cut).
Tremolo Switch	OFF, ON	Tremolo on/off
Tremolo Mod Wave	TRI, SQR, SIN, SAW1, SAW2, TRP	Modulation Wave TRI : triangle wave SQR : square wave SIN : sine wave SAW1/2 : sawtooth wave TRP : Trapezoidal wave
Tremolo Rate (sync sw)	OFF, ON	If this is on, the tremolo is synchronized with the tempo.
Tremolo Rate (Hz)/ Tremolo Rate (note)	0.05-10.00 [Hz] note (p. 60)	Rate of the tremolo effect
Tremolo Depth	0-127	Modulation depth of the flanger effect

4: 2TAP DELAY

Parameter	Value	Explanation
Switch	OFF, ON	Delay on/off
Off Mode	IMMEDIATE, REMAIN	Specifies what happens to the delay decays of the previously-played phrase when you turn delay off. IMMEDIATE: The delay sound disappears immediately. REMAIN: The delay sound decays naturally.
Output Select	MAIN, REV, MAIN+REV	Specifies the output destination of the sound from the delay.
Delay (sync sw)	OFF, ON	If this is on, the delay is synchronized with the tempo.
Delay (msec)/ Delay (note)	1-1300 [msec] note (p. 60)	Adjusts the delay time from the direct sound until the delay sound is heard.
Feedback	-98--+98 [%]	Adjusts the amount of the delay sound that's fed back into the effect. Negative "-" settings invert the phase.
HF Damp	200-8000 [Hz], BYPASS	Adjusts the frequency above which sound fed back to the effect is filtered out (BYPASS: no cut).
Delay 1 Pan	L64-63R	Pan position of delay 1
Delay 2 Pan	L64-63R	Pan position of delay 2
Delay 1 Level	0-127	Volume of delay 1
Delay 2 Level	0-127	Volume of delay 2

5: 3TAP TAP DELAY

Parameter	Value	Explanation
Switch	OFF, ON	Delay on/off
Off Mode	IMMEDIATE, REMAIN	Specifies what happens to the delay decays of the previously-played phrase when you turn delay off. IMMEDIATE: The delay sound disappears immediately. REMAIN: The delay sound decays naturally.
Output Select	MAIN, REV, MAIN+REV	Specifies the output destination of the sound from the delay.
Delay Time (sync sw)	OFF, ON	If this is on, the delay is synchronized with the tempo.
Delay Time (msec)/ Delay Time (note)	1-2600 [msec] note (p. 60)	Adjusts the delay time from the direct sound until the delay sound is heard.
Delay 1 Feedback	-98--+98 [%]	Adjusts the amount of the delay sound that's fed back into the effect. Negative "-" settings invert the phase.
HF Damp	200-8000 [Hz], BYPASS	Adjusts the frequency above which sound fed back to the effect is filtered out (BYPASS: no cut).
Delay 1 Pan	L64-63R	Pan position of delay 1
Delay 2 Pan	L64-63R	Pan position of delay 2
Delay 3 Pan	L64-63R	Pan position of delay 3
Delay 1 Level	0-127	Volume of delay 1
Delay 2 Level	0-127	Volume of delay 2
Delay 3 Level	0-127	Volume of delay 3

Reverb Parameters

This is a reverb that is applied to the entire Program. You can choose from six types.

You can also adjust the amount of reverb that is applied to each zones by editing the “REV (Reverb Send Level)” (p. 4) from each zones.

Settings common to all Reverb types

Parameter	Value	Explanation
Type		Type of reverb
	1: Room 1	Room 1/2: Reverb that simulates the reverberation of a room
	2: Room 2	
	3: Hall 1	Hall 1/2: Reverb that simulates the reverberation of a hall
	4: Hall 2	
	5: Plate	Plate: Simulation of a plate echo (a reverb device that uses a metal plate)
	6: GM2 Reverb	GM2 Reverb: GM2 reverb
Level	0–127	Volume of the reverb sound

1–5: Room 1/2, Hall 1/2, Plate

Parameter	Value	Explanation
Pre Delay	0–100 [msec]	Adjusts the delay time from the direct sound until the reverb sound is heard.
Time	0.1–10 [sec]	Time length of reverberation
Density	0–127	Density of reverb
Diffusion	0–127	Adjusts the change in the density of the reverb over time.
		The higher the value, the more the density increases with time. (The effect of this setting is most pronounced with long reverb times.)
LF Damp	0–100	Adjusts the low-frequency portion of the reverb.
HF Damp	0–100	Adjusts the high-frequency portion of the reverb.
Spread	0–127	Reverb spread
Tone	0–127	Tonal character of the reverb

6: GM2 Reverb

Parameter	Value	Explanation
Character	SMALL_ROOM, MEDIUM_ROOM, LARGE_ROOM, MEDIUM_HALL, LARGE_HALL, PLATE	Type of reverb
Time	0–127	Time length of reverberation

EQ Parameters

This is a five-band equalizer that is applied to the entire Program.

Parameter	Value	Explanation
Low Gain	-12--+12 [dB]	Gain of the low range
Low Freq	16-16000 [Hz]	Frequency of the low range
Mid1 Gain	-12--+12 [dB]	Gain of the middle range 1
Mid1 Freq	16-16000 [Hz]	Frequency of the middle range 1
Mid1 Q	0.5, 1.0, 2.0, 4.0, 8.0	Width of the middle range 1 Set a higher value for Q to narrow the range to be affected.
Mid2 Gain	-12--+12 [dB]	Gain of the middle range 2
Mid2 Freq	16-16000 [Hz]	Frequency of the middle range 2
Mid2 Q	0.5, 1.0, 2.0, 4.0, 8.0	Width of the middle range 2 Set a higher value for Q to narrow the range to be affected.
Mid3 Gain	-12--+12 [dB]	Gain of the middle range 3
Mid3 Freq	16-16000 [Hz]	Frequency of the middle range 3
Mid3 Q	0.5, 1.0, 2.0, 4.0, 8.0	Width of the middle range 3 Set a higher value for Q to narrow the range to be affected.
High Gain	-12--+12 [dB]	Gain of the high range
High Freq	16-16000 [Hz]	Frequency of the high range
Input Gain	-15--+15 [dB]	Gain of the Input

System Compressor Parameters

This is a stereo compressor (limiter) that is applied to the final output.

With separate settings for the high-frequency range, midrange, and low-frequency range, this reduces inconsistencies in volume levels by compressing the sound when the volume exceeds a preset volume level.

Parameter	Value	Explanation
Compressor Switch	OFF, ON	Turns the compressor on/off .
Type	When you change this parameter, the Compressor parameters will be automatically adjusted to the optimal values. You can make the settings easily by first setting the Compressor Type and then changing only the necessary parameters.	
	HARD COMP	Applies strong compression.
	SOFT COMP	Applies mild compression.
	LOW BOOST	Boosts the low end.
	MID BOOST	Boosts the midrange.
	HI BOOST	Boosts the high end.
	USER	The saved settings are written.
Split Freq Low	40, 50, 63, 80, 100, 125, 160, 200, 250, 315, 400, 500, 630, 800 [Hz]	Sets the frequency separating the low-frequency range (LOW) and midrange (MID).
Split Freq High	400, 500, 630, 800, 1000, 1250, 1600, 2000, 2500, 3150, 4000, 5000, 6300, 8000 [Hz]	Sets the frequency separating the high-frequency range (HIGH) and midrange (MID).

Common to Low, Mid, and High

Parameter	Value	Explanation
Level	0–24 [dB] (1 dB Step)	Output Level
Attack Time	0–100	Sets the time it takes until the level is compressed after the input exceeds the Threshold.
Release Time	0–100	Sets the time it takes for the compression to be released after the input falls below the Threshold.
Threshold	-60–0 [dB] (1 dB Step)	Sets the level at which compression begins.
Ratio	1:1.0, 1:1.1, 1:1.2, 1:1.4, 1:1.6, 1:1.8, 1:2.0, 1:2.5, 1:3.2, 1:4.0, 1:5.6, 1:8.0, 1:16, 1:INF	Compression Ratio

Tone List

CONCERT

Sub Category	Number	TONE Name	MSB	LSB	PC	
CONCERT PIANO	S01	Stage Grand	(*1)	84	16	1
	S02	Deep Concert	(*1)	84	16	2
	S03	Eastcoast Studio	(*1)	84	16	3
	S04	Contemp Concerto	(*1)	84	16	4
	S05	Symphony Hall	(*1)	84	16	5
	S06	Bold Beauty	(*1)	84	16	6
	S07	Aco Grand1	(*1)	84	16	7
	S08	Aco Grand2	(*1)	84	16	8
	S09	Aco Grand3	(*1)	84	16	9
	S10	Aco Grand4	(*1)	84	16	10
	0001	Concert Grand	(*2)	84	0	1
	0002	Bright Concert	(*2)	84	0	2
	0003	Mellow Concert	(*2)	84	0	3
	0004	Rock Concert Grd	(*2)	84	0	4
	0005	Comp ConcertGrd	(*2)	84	0	5
	0006	Concert Grd Mono	(*2)	84	0	6
	0007	NX Concert Grand	(*2)	84	0	7
	0008	Bright NX Concrct	(*2)	84	0	8
	0009	Mellow NX Concrct	(*2)	84	0	9
	0010	Rock NX Concert	(*2)	84	0	10
	0011	Comp NX Concert	(*2)	84	0	11
	0012	NX Concert Mono	(*2)	84	0	12
	0013	Brilliant Grand	(*2)	84	0	13
	0014	Hard Brill Grand	(*2)	84	0	14
	0015	Soft Brill Grand	(*2)	84	0	15
	0016	Rock Brill Grand	(*2)	84	0	16
	0017	Comp Brill Grand	(*2)	84	0	17
0018	Brill Grand Mono	(*2)	84	0	18	
0019	St.Piano 1		84	0	19	
0020	St.Piano 2		84	0	20	
0021	St.Piano 3		84	0	21	
0022	St.Piano 4		84	0	22	
0023	St.Piano 5		84	0	23	
0024	Piano 1		84	0	24	
0025	Piano 1 w		84	0	25	
0026	European Pf		84	0	26	
0027	Stage Piano		84	0	27	

*1 Piano Designer and Indiv.Voicing can be used

*2 Piano Designer, Indiv.Voicing, and Sym.Resonance can be used

STUDIO

Sub Category	Number	TONE Name	MSB	LSB	PC		
STUDIO PIANO	0028	Upright Piano	(*2)	84	0	28	
	0029	Bright Upright	(*2)	84	0	29	
	0030	Mellow Upright	(*2)	84	0	30	
	0031	Rock Upright Pno	(*2)	84	0	31	
	0032	Comp Upright Pno	(*2)	84	0	32	
	0033	UprightPianoMono	(*2)	84	0	33	
	0034	Studio Grand	(*2)	84	0	34	
	0035	Bright Studio	(*2)	84	0	35	
	0036	Mellow Studio	(*2)	84	0	36	
	0037	Rock StudioGrand	(*2)	84	0	37	
	0038	Comp Studio Grd	(*2)	84	0	38	
	0039	StudioGrand Mono	(*2)	84	0	39	
	0040	Piano 2		84	0	40	
	0041	Piano 2 w		84	0	41	
	HONKY-TONK	0042	Honky-tonk Pno 1	(*2)	84	0	42
		0043	Honky-tonk Pno 2	(*2)	84	0	43
		0044	Honky-tonk Pno 3	(*2)	84	0	44

Sub Category	Number	TONE Name	MSB	LSB	PC	
HONKY-TONK	0045	Honky-tonk Pno 4	(*2)	84	0	45
	0046	Honky Tonk		84	0	46
	0047	Honky-tonk		84	0	47
	0048	Honky-tonk w		84	0	48
SA PIANO	0049	SA Piano		84	0	49
	0050	Modulated SA Pno		84	0	50
	0051	Bright SA Piano		84	0	51
	0052	Comp SA Piano		84	0	52
	0053	Phaser SA Piano		84	0	53
	0054	Lo-Fi SA Piano		84	0	54
SYNTH PIANO	0055	JD Piano		84	0	55
	0056	Bright JD Piano		84	0	56
	0057	Rock JD Piano		84	0	57
	0058	Comp JD Piano		84	0	58
	0059	Comp JD Piano2		84	0	59
	0060	Detuned JD Piano		84	0	60
	0061	Chorus JD Piano		84	0	61
	0062	Phaser JD Piano		84	0	62
	0063	Lo-Fi JD Piano		84	0	63
	0064	Brite Piano		84	0	64
	0065	Pop Piano 1		84	0	65
	0066	Pop Piano 2		84	0	66
	0067	Pop Piano 3		84	0	67
	0068	LoFi Piano		84	0	68

*2 Piano Designer, Indiv.Voicing, and Sym.Resonance can be used

VINTAGE

Sub Category	Number	TONE Name	MSB	LSB	PC	
TINE E.PIANO	2001	1975 Tine EP.	(*3)	84	8	90
	2002	1979 Tine EP.	(*3)	84	8	91
	2003	1975 Mellow EP	(*3)	84	8	92
	2004	1979 Bright EP	(*3)	84	8	93
	2005	1975 Clarity EP	(*3)	84	8	94
	2006	NYC Chorus EP	(*3)	84	8	95
	2007	1975 Phased EP	(*3)	84	8	96
	2008	1979 Phased EP	(*3)	84	8	97
	2009	1979 Envelope EP	(*3)	84	8	98
	2010	1975 Sweet Echo	(*3)	84	8	99
	2011	1979 Flying Echo	(*3)	84	8	100
	2012	1975 ModDelay EP	(*3)	84	8	101
	2013	1975 Driven EP	(*3)	84	8	102
	2014	1979 Comp EP	(*3)	84	8	103
TINE E.PIANO	0069	Tine E.Piano	(*3)	84	0	69
	0070	Silver Top EP.	(*3)	84	0	70
	0071	Tine EP Mkl.	(*3)	84	0	71
	0072	Tine EP Mkl.	(*3)	84	0	72
	0073	Dyno E.Piano.	(*3)	84	0	73
	0074	Small Case Tine	(*3)	84	0	74
	0075	Soft Tine EP	(*3)	84	0	75
	0076	Chorus Tine EP	(*3)	84	0	76
	0077	Chorus Tine EP2	(*3)	84	0	77
	0078	Chorus Dyno EP	(*3)	84	0	78
	0079	Tremolo Cho Tine	(*3)	84	0	79
	0080	Phaser Tine EP	(*3)	84	0	80
	0081	Phaser Dyno EP	(*3)	84	0	81
	0082	Trem Phaser Tine	(*3)	84	0	82
0083	Trem Phaser Dyno	(*3)	84	0	83	
0084	Rotary Tine EP	(*3)	84	0	84	
0085	TouchWah TineEP	(*3)	84	0	85	
0086	Auto Wah Tine EP	(*3)	84	0	86	
0087	Echo Tine EP	(*3)	84	0	87	

Sub Category	Number	TONE Name	MSB	LSB	PC	
TINE E.PIANO	0088	Echo->Trem Tine	(*3)	84	0	88
	0089	Echo->RotaryTine	(*3)	84	0	89
	0090	Comp Tine EP	(*3)	84	0	90
	0091	Comp Tine EP2	(*3)	84	0	91
	0092	Comp Silver Top	(*3)	84	0	92
	0093	Driven Tine EP	(*3)	84	0	93
	0094	Driven SilverTop	(*3)	84	0	94
	0095	Stage EP 1		84	0	95
	0096	Stage EP 2		84	0	96
	0097	Stage EP Trm		84	0	97
	0098	Tremolo EP 1		84	0	98
	0099	E.Piano 3		84	0	99
	0100	E.Piano 4		84	0	100
	0101	E.Piano 5		84	0	101
	0102	E.Piano 6		84	0	102
	0103	E.Piano 7		84	0	103
	0104	E.Piano 8		84	0	104
	0105	Dyno EP		84	0	105
	0106	Dyno EP Trm		84	0	106
	0107	Tremolo EP 2		84	0	107
	0108	Back2the60s		84	0	108
0109	Tine EP		84	0	109	
0110	E.Piano 1		84	0	110	
0111	St.Soft EP		84	0	111	
REED E.PIANO	0112	Reed E.Piano	(*3)	84	0	112
	0113	Round Reed EP	(*3)	84	0	113
	0114	Driven Reed EP	(*3)	84	0	114
	0115	Driven Reed EP2	(*3)	84	0	115
	0116	Comp Reed EP	(*3)	84	0	116
	0117	Comp Reed EP2	(*3)	84	0	117
	0118	Rotary Reed EP	(*3)	84	0	118
	0119	Tremolo Reed EP	(*3)	84	0	119
	0120	Chorus Reed EP	(*3)	84	0	120
	0121	Phaser Reed EP	(*3)	84	0	121
	0122	Echo Reed EP	(*3)	84	0	122
	0123	Echo->Trem Reed	(*3)	84	0	123
	0124	TouchWah ReedEP	(*3)	84	0	124
	0125	AutoWah Reed EP	(*3)	84	0	125
	0126	Pnet Tee		84	0	126
	0127	R&B Pnet		84	0	127
REED E.PIANO	0128	Wurly EP		84	0	128
	0129	Wurly EP Trm		84	1	1
	0130	Curly Wurly		84	1	2
REED E.PIANO	0131	Super Wurly		84	1	3
	0132	Wurly		84	1	4
E.GRAND	0133	E.Grand 1		84	1	5
	0134	E.Grand 2		84	1	6
	0135	E.Grand 3		84	1	7
	0136	Piano 3		84	1	8
	0137	Piano 3 w		84	1	9

*3 Some of the parameters of "Making Detailed Settings for the E. Piano Tones" (p. 12) are shown in the Tone Designer screen.

MODERN

Sub Category	Number	TONE Name	MSB	LSB	PC	
SA E.PIANO	2015	RD-1000 Piano1		84	8	104
	2016	RD-1000 Piano2		84	8	105
	2017	RD-1000 Piano3		84	8	106
	2018	RD-1000 Harpsi		84	8	107
	2019	RD-1000 Clav		84	8	108
	2020	RD-1000 Vibra.		84	8	109
	2021	RD-1000 E.Piano1		84	8	110

Sub Category	Number	TONE Name	MSB	LSB	PC		
SA E.PIANO	2022	RD-1000 E.Piano2		84	8	111	
	2023	RD-1000 Cho Pno		84	8	112	
	2024	RD-1000 Cho EP1		84	8	113	
	2025	RD-1000 Cho EP2		84	8	114	
	0138	SA E.Piano	(*3)	84	1	10	
	0139	SA E.Piano2	(*3)	84	1	11	
	0140	SA E.Piano3	(*3)	84	1	12	
	0141	SA E.Piano4	(*3)	84	1	13	
	0142	SA E.Piano5	(*3)	84	1	14	
	0143	SA EP 1		84	1	15	
	0144	SA EP 2		84	1	16	
	0145	Psy EP		84	1	17	
	FM E.PIANO	0146	FM E.Piano	(*3)	84	1	18
		0147	Woody FM E.Piano	(*3)	84	1	19
		0148	Bright FM EP	(*3)	84	1	20
0149		Detuned FM EP	(*3)	84	1	21	
0150		Tremolo FM EP	(*3)	84	1	22	
0151		EP Legend 3		84	1	23	
0152		80's EP		84	1	24	
0153		FM EP 1		84	1	25	
0154		FM EP 2		84	1	26	
MODERN E.PIANO	0155	Hit EP		84	1	27	
	0156	EP Legend 1		84	1	28	
	0157	EP Belle		84	1	29	
	0158	Sinus EP		84	1	30	
	0159	Spirit Tines		84	1	31	
	0160	E.Piano 2		84	1	32	
	0161	Detuned EP		84	1	33	
	0162	St.FM EP		84	1	34	
	0163	EP Legend 2		84	1	35	
	0164	EP Phase		84	1	36	
	0165	Rox Piano 1		84	1	37	
	0166	Rox Piano 2		84	1	38	
0167	Crummy Piano		84	1	39		
0168	Rox Lute		84	1	40		

*3 Some of the parameters of "Making Detailed Settings for the E. Piano Tones" (p. 12) are shown in the Tone Designer screen.

CLAV

Sub Category	Number	TONE Name	MSB	LSB	PC	
CLAV	0169	Clav CB	(*4)	84	1	41
	0170	Clav CA	(*4)	84	1	42
	0171	Phaser Clav	(*4)	84	1	43
	0172	Phaser Clav2	(*4)	84	1	44
	0173	Touch Wah Clav	(*4)	84	1	45
	0174	Auto Wah Clav	(*4)	84	1	46
	0175	Auto Wah Clav2	(*4)	84	1	47
	0176	Comp Clav	(*4)	84	1	48
	0177	Comp Clav2	(*4)	84	1	49
	0178	Chorus Clav	(*4)	84	1	50
	0179	Chorus Clav2	(*4)	84	1	51
	0180	Chorus Clav3	(*4)	84	1	52
	0181	Driven Clav	(*4)	84	1	53
	0182	Driven Clav2	(*4)	84	1	54
	0183	Clav CB Medium	(*4)	84	1	55
	0184	Clav CA Medium	(*4)	84	1	56
	0185	Clav CB Brillia	(*4)	84	1	57
	0186	Clav CA Brillia	(*4)	84	1	58
	0187	Clav CB Combo	(*4)	84	1	59
	0188	Clav CA Combo	(*4)	84	1	60
0189	Clav		84	1	61	
0190	Clav 2		84	1	62	

Sub Category	Number	TONE Name	MSB	LSB	PC	
CLAV	0191	Pulse Clav	84	1	63	
	0192	Pulse Clav 2	84	1	64	
	0193	Sweepin Clav	84	1	65	
	0194	Analog Clav	84	1	66	
	0195	Biting Clav	84	1	67	
	0196	Pulse Clv St	84	1	68	
HARPSICHORD	0197	Natural Hps.	84	1	69	
	0198	Harpsichord	84	1	70	
	0199	Harpsichord2	84	1	71	
	0200	Coupled Hps	84	1	72	
	0201	Harpsi w	84	1	73	
	0202	Harpsi o	84	1	74	
	0203	Rox Harpsi	84	1	75	
	0204	VX Harpsi	84	1	76	
CELESTA	0205	Celesta	84	1	77	
	0206	Farf Celeste	84	1	78	
BELL	0207	Music Box	84	1	79	
	0208	Music Box 2	84	1	80	
	0209	Kalimbells	84	1	81	
	0210	D50 Fantasy	84	1	82	
	0211	D50 Bell	84	1	83	
	0212	Fantasia	84	1	84	
	0213	Org Bell	84	1	85	
	0214	Dreambell	84	1	86	
	0215	FM Sparkles	84	1	87	
	0216	FM Syn Bell	84	1	88	
	0217	FM Heaven	84	1	89	
	0218	Dreaming Bel	84	1	90	
	0219	Analog Bell	84	1	91	
	0220	Music Bells	84	1	92	
	BELL	0221	Bell 1	84	1	93
		0222	Bell 2	84	1	94
		0223	Crystal	84	1	95
		0224	Tinkle Bell	84	1	96
0225		Icy Keys	84	1	97	
0226		TubularBells	84	1	98	
0227		TubularBell2	84	1	99	
0228		Church Bell	84	1	100	
0229		Carillon	84	1	101	
0230		Carillon 2	84	1	102	
0231		Tower Bell	84	1	103	
0232		Bell Ring	84	1	104	
MALLET	0233	Vibraphone	84	1	105	
	0234	Vibraphone 2	84	1	106	
	0235	VibraphoneTr	84	1	107	
	0236	Vibraphone w	84	1	108	
	0237	Tremolo Vib	84	1	109	
	0238	Jazz Vib	84	1	110	
	0239	Marimba	84	1	111	
	0240	Marimba 2	84	1	112	
	0241	Marimba 3	84	1	113	
	0242	Marimba w	84	1	114	
	0243	BsMarimba 1	84	1	115	
	0244	BsMarimba 2	84	1	116	
	0245	Xylophone	84	1	117	
	0246	Xylophone 2	84	1	118	
	0247	Xylophone 3	84	1	119	
	0248	Ethno Keys	84	1	120	
	0249	Glockenspiel	84	1	121	
	0250	Steel Drums	84	1	122	
0251	Steel Drums2	84	1	123		
MALLET	0252	Soft StdMrm	84	1	124	
	0253	Toy Box	84	1	125	
	0254	Sine Mallet	84	1	126	

ORGAN

Sub Category	Number	TONE Name	MSB	LSB	PC
E.ORGAN	0255	TW-Organ 1	84	1	127
	0256	TW-Organ 2	84	1	128
	0257	TW-Organ 3	84	2	1
	0258	TW-Organ 4	84	2	2
	0259	TW-Organ 5	84	2	3
	0260	TW-Organ 6	84	2	4
	0261	TW-Organ 7	84	2	5
	0262	TW-Organ 8	84	2	6
	0263	TW-Organ 9	84	2	7
	0264	TW-Organ 10	84	2	8
	0265	Rock Organ 1	84	2	9
	0266	Rock Organ 2	84	2	10
	0267	Rock Organ 3	84	2	11
	0268	Rock Organ 4	84	2	12
	0269	Rock Organ 5	84	2	13
	0270	RotaryOrgan1	84	2	14
	0271	RotaryOrgan2	84	2	15
	0272	Perc. Organ	84	2	16
	0273	Perc.Organ 2	84	2	17
	0274	Perc.Organ 3	84	2	18
	0275	Perc.Organ 4	84	2	19
	0276	Organ 1	84	2	20
	0277	Trem. Organ	84	2	21
	0278	Organ 2	84	2	22
	0279	Chorus Organ	84	2	23
	0280	Organ 3	84	2	24
	0281	Animal Mod	84	2	25
	0282	Rising Sun	84	2	26
	0283	Surf Monkeys	84	2	27
	0284	Palisades	84	2	28
	0285	Kitchen Soul	84	2	29
	0286	BreakOnThru	84	2	30
	0287	Calif.Sun	84	2	31
	0288	Steppin' VX	84	2	32
	0289	Costello+Mod	84	2	33
	0290	Archie's Mod	84	2	34
	0291	Telstar VX	84	2	35
	0292	The Sham	84	2	36
0293	Crummy Organ	84	2	37	
0294	VX Religion	84	2	38	
0295	Farfi Combo	84	2	39	
0296	Iron Farf	84	2	40	
0297	Dancin' Queen	84	2	41	
0298	Farf Lite	84	2	42	
0299	Wooly Farfy	84	2	43	
0300	Clark Farf	84	2	44	
0301	Pacemaker	84	2	45	
0302	Rox Organ P	84	2	46	
0303	Rox Organ Ph	84	2	47	
0304	Rox Organ PH	84	2	48	
0305	Rox Organ L	84	2	49	
0306	60's Organ	84	2	50	
0307	70's E.Org 1	84	2	51	
0308	70's E.Org 2	84	2	52	

*4 The parameters of "Making Detailed Settings for the CLAV Tones" (p. 13) are shown in the Tone Designer screen.

Sub Category	Number	TONE Name	MSB	LSB	PC
E.ORGAN	0309	70's E.Organ	84	2	53
	0310	E.Organ 1	84	2	54
	0311	E.Organ 2	84	2	55
	0312	E.Organ 3	84	2	56
	0313	E.Organ 4	84	2	57
	0314	E.Organ 5	84	2	58
	0315	E.Organ 6	84	2	59
	0316	E.Organ 7	84	2	60
	0317	Theater Org	84	2	61
	0318	Ana Organ 1	84	2	62
	0319	Ana Organ 2	84	2	63
	0320	Ana Organ 3	84	2	64
	0321	Ana Organ 4	84	2	65
PIPE ORGAN	0322	Ana Organ 5	84	2	66
	0323	Puff Organ	84	2	67
	0324	Nason Flute	84	2	68
PIPE ORGAN	0325	Massive Pipe	84	2	69
	0326	Mid Pipe Org	84	2	70
	0327	Grand Pipes	84	2	71
	0328	Church Org 1	84	2	72
	0329	Church Org 2	84	2	73
ACCORDION	0330	Church Org 3	84	2	74
	0331	Reed Organ	84	2	75
	0332	Accordion Fr	84	2	76
	0333	Accordion It	84	2	77
	0334	AccordionIt2	84	2	78
	0335	Musette	84	2	79
HARMONICA	0336	Vodkakordion	84	2	80
	0337	Bandoneon	84	2	81
	0338	Harmonica	84	2	82
	0339	Harmonica 2	84	2	83

Sub Category	Number	TONE Name	MSB	LSB	PC
SOLO STRINGS	0370	Violin	84	2	114
	0371	Violin 2	84	2	115
	0372	Slow Violin	84	2	116
	0373	Bright Vln	84	2	117
	0374	Viola	84	2	118
	0375	Cello	84	2	119
SOLO STRINGS	0376	Bright Vc	84	2	120
	0377	Contrabass	84	2	121
	0378	Fiddle	84	2	122
	0379	Tron Violins	84	2	123
ORCHESTRAL	0380	Tron Cello	84	2	124
	0381	Orchestra	84	2	125
	0382	Orc.Unison 1	84	2	126
	0383	Orc.Unison 2	84	2	127
	0384	Full Orc	84	2	128

PAD/CHOIR

Sub Category	Number	TONE Name	MSB	LSB	PC
SYNTH PAD/STR	0385	Wide Soft Pad	84	3	1
	0386	Silky Way	84	3	2
	0387	CalmChoirPad	84	3	3
	0388	Decay Choir Pad	84	3	4
	0389	Soft Pad 1	84	3	5
	0390	Soft Pad 2	84	3	6
	0391	Soft Pad 3	84	3	7
	0392	Soft Pad 4	84	3	8
	0393	Soft Pad 5	84	3	9
	0394	Soft Pad 6	84	3	10
	0395	Soft Pad 7	84	3	11
	0396	Soft Pad 8	84	3	12
	0397	Soft Pad 9	84	3	13
	0398	Soft Pad 10	84	3	14
	0399	Dreamheaven	84	3	15
	0400	Oct Heaven	84	3	16
	0401	VintageStr 1	84	3	17
	0402	VintageStr 2	84	3	18
	0403	VintageStr 3	84	3	19
	0404	VintageStr 4	84	3	20
	0405	VintageStr 5	84	3	21
	0406	VintageStr 6	84	3	22
0407	VintageStr 7	84	3	23	
0408	JX Strings	84	3	24	
0409	JP Strings 1	84	3	25	
0410	JP Strings 2	84	3	26	
0411	106 Strings	84	3	27	
0412	Sol Strings	84	3	28	
0413	Rhapsody STR	84	3	29	
0414	PWM Str 1	84	3	30	
0415	PWM Str 2	84	3	31	
0416	PWM Str 3	84	3	32	
0417	Fading Str	84	3	33	
0418	ParadisePad	84	3	34	
0419	80s Strings	84	3	35	
0420	Stringship	84	3	36	
0421	Airy Pad	84	3	37	
0422	Neo RS-202	84	3	38	

STRINGS

Sub Category	Number	TONE Name	MSB	LSB	PC	
ENSEMBLE STRINGS	0340	Slow FullStrings	84	2	84	
	0341	Full Strings	84	2	85	
	0342	GX Strings	84	2	86	
	0343	Mood Strings	84	2	87	
	0344	Slow Strings	84	2	88	
	0345	DecayStrings	84	2	89	
	0346	Strings	84	2	90	
	0347	Strings 2	84	2	91	
	0348	Strings 3	84	2	92	
	0349	Strings 4	84	2	93	
	0350	Strings 5	84	2	94	
	0351	Strings 6	84	2	95	
	0352	Stage Str 1	84	2	96	
	0353	Stage Str 2	84	2	97	
	0354	Pop Str	84	2	98	
	0355	Hall Strings	84	2	99	
	0356	Marc.Str	84	2	100	
	0357	StringsStacc	84	2	101	
	0358	Oct Strings	84	2	102	
	0359	Tremolo Str	84	2	103	
	0360	Tron Strings	84	2	104	
	0361	Tron Strings2	84	2	105	
	0362	Symphonic Tron	84	2	106	
	0363	Moody Tron	84	2	107	
	0364	TapeStrings1	84	2	108	
	0365	TapeStrings2	84	2	109	
	ENSEMBLE STRINGS	0366	Hybrid Str	84	2	110
		0367	PizzicatoStr	84	2	111
		0368	Pizz 1	84	2	112
		0369	Pizz 2	84	2	113

Sub Category	Number	TONE Name	MSB	LSB	PC
SYNTH PAD/STR	0423	Sawtooth Str	84	3	39
	0424	Syn.Strings1	84	3	40
	0425	Syn.Strings2	84	3	41
	0426	Syn.Strings3	84	3	42
	0427	Pulse Pad	84	3	43
	0428	Hollow Pad 1	84	3	44
	0429	WarmHeaven 1	84	3	45
	0430	WarmHeaven 2	84	3	46
	0431	Heaven Pad 1	84	3	47
	0432	Heaven Pad 2	84	3	48
	0433	Heaven Pad 3	84	3	49
	0434	Heaven Pad 4	84	3	50
	0435	FineWinePad1	84	3	51
	0436	FineWinePad2	84	3	52
	0437	5th Pad 1	84	3	53
	0438	5th Pad 2	84	3	54
	0439	Nu Epic Pad	84	3	55
	0440	Angelis Pad	84	3	56
	0441	TrnsSweepPad	84	3	57
	0442	Giant Sweep	84	3	58
	0443	Voyager	84	3	59
	0444	Digital Pad	84	3	60
	0445	NuSoundtrack	84	3	61
	0446	Xadecimal	84	3	62
	0447	Strobe Pad	84	3	63
	0448	BUBBLE 2	84	3	64
	0449	BUBBLE 3	84	3	65
	0450	Soft PWM Pad	84	3	66
	0451	Org Pad	84	3	67
	0452	Hollow Pad 2	84	3	68
	0453	SavannaPad 1	84	3	69
	0454	SavannaPad 2	84	3	70
	0455	SavannaPad 3	84	3	71
	0456	PWM Pad 2	84	3	72
	0457	Str Machine	84	3	73
	0458	Reso Pad	84	3	74
	0459	BPF Pad	84	3	75
	0460	Sweep Pad	84	3	76
	0461	Sweep Pad 2	84	3	77
	0462	Sweep Pad 3	84	3	78
	0463	Sweep Pad 4	84	3	79
	0464	Scoop Pad 1	84	3	80
	0465	Scoop Pad 2	84	3	81
	0466	Brite Wine	84	3	82
	0467	Wine Pad	84	3	83
	0468	Warm Pad	84	3	84
	0469	Sine Pad	84	3	85
0470	Bowed Glass	84	3	86	
0471	Metal Pad	84	3	87	
0472	Halo Pad	84	3	88	
0473	Soundtrack	84	3	89	
0474	Star Theme	84	3	90	
SYNTH BELLPAD	0475	Air Key 1	84	3	91
	0476	Air Key 2	84	3	92
	0477	Sweet Keys	84	3	93
	0478	Soft Bell	84	3	94
	0479	Stacc Heaven	84	3	95
	0480	DigitalDream	84	3	96
	0481	Analog Dream	84	3	97
SYNTH BELLPAD	0482	Harp Pad	84	3	98
	0483	Ice Rain	84	3	99
	0484	Atmosphere	84	3	100
	0485	Brightness	84	3	101
	0486	Dreaming Box	84	3	102

Sub Category	Number	TONE Name	MSB	LSB	PC
VOX CHOIR	0487	Large Choir	84	3	103
	0488	GX Choir	84	3	104
	0489	Choir Aahs	84	3	105
	0490	Chorus Aahs	84	3	106
	0491	Choir Pad	84	3	107
	0492	Angels Choir	84	3	108
	0493	Aerial Choir	84	3	109
	0494	Voice Oohs	84	3	110
	0495	Doo Pad	84	3	111
	0496	Humming	84	3	112
	0497	Humming 2	84	3	113
	0498	Humming 3	84	3	114
	0499	Gospel Hum	84	3	115
	0500	Decay Choir	84	3	116
	0501	Vox Pad 1	84	3	117
	0502	Vox Pad 2	84	3	118
	0503	Dreamvox 1	84	3	119
	0504	Dreamvox 2	84	3	120
	0505	80s Vox	84	3	121
	SCAT	0506	SynVox	84	3
0507		SynVox 2	84	3	123
0508		SynVox 3	84	3	124
0509		Mini Vox	84	3	125
0510		Chipmunk	84	3	126
0511		Sample Opera	84	3	127
0512		Sad Ceremony	84	3	128
0513		5th Voice	84	4	1
0514		Sop Vox	84	4	2
0515		Analog Voice	84	4	3
0516		Space Voice	84	4	4
0517	Itopia	84	4	5	
0518	Tron Choir	84	4	6	
0519	Tron Vox	84	4	7	
0520	Jazz Scat 1	84	4	8	
0521	Jazz Scat 2	84	4	9	

BASS

Sub Category	Number	TONE Name	MSB	LSB	PC
AC.BASS	0522	Acoustic Bs	84	4	10
	0523	Acoustic Bs2	84	4	11
	0524	Acoustic Bs3	84	4	12
	0525	String Slap	84	4	13
E.BASS	0526	Fingered Bs	84	4	14
	0527	Fingered Bs2	84	4	15
	0528	Fingered Bs3	84	4	16
	0529	Fingered Bs4	84	4	17
E.BASS	0530	Pick Bass	84	4	18
	0531	Picked Bass	84	4	19
	0532	Fretless Bs	84	4	20
	0533	FretlessBs 2	84	4	21
	0534	FretlessBs 3	84	4	22
	0535	Finger Slap	84	4	23
	0536	Finger Slap2	84	4	24
	0537	Slap Bass 1	84	4	25
	0538	Slap Bass 2	84	4	26
	0539	Return2Base!	84	4	27

Sub Category	Number	TONE Name	MSB	LSB	PC
SYNTH BASS	0540	MG Bass 1	84	4	28
	0541	MG Bass 2	84	4	29
	0542	MG Bass 3	84	4	30
	0543	Modular Bs 1	84	4	31
	0544	Modular Bs 2	84	4	32
	0545	PWM Bass 1	84	4	33
	0546	PWM Bass 2	84	4	34
	0547	Big Mini	84	4	35
	0548	Fat Analog	84	4	36
	0549	Spike Bass	84	4	37
	0550	SH Bass	84	4	38
	0551	Intrusive Bs	84	4	39
	0552	Synth Bass 1	84	4	40
	0553	Synth Bass 2	84	4	41
	0554	Synth Bass 3	84	4	42
	0555	Synth Bass 4	84	4	43
	0556	Synth Bass 5	84	4	44
	0557	Synth Bass 6	84	4	45
	0558	Synth Bass 7	84	4	46
	0559	Synth Bass 8	84	4	47
	0560	Synth Bass 9	84	4	48
	0561	Synth Bass10	84	4	49
	0562	Synth Bass11	84	4	50
	0563	Synth Bass12	84	4	51
	0564	Synth Bass13	84	4	52
	0565	Synth Bass14	84	4	53
	0566	Reso Bass 1	84	4	54
	0567	Reso Bass 2	84	4	55
	0568	Reso Bass 3	84	4	56
	0569	Reso Bass 4	84	4	57
	0570	Reso Bass 5	84	4	58
	0571	Reso Bass 6	84	4	59
	0572	Reso Bass 7	84	4	60
	0573	Reso Bass 8	84	4	61
	0574	Reso Bass 9	84	4	62
	0575	Reso Bass 10	84	4	63
	0576	Acid Bass	84	4	64
	0577	Acid Bass 2	84	4	65
	0578	Acid Bass 3	84	4	66
	0579	Acid Bass 4	84	4	67
	0580	Acid Bass 5	84	4	68
	0581	Acid Bass 6	84	4	69
	0582	Acid Bass 7	84	4	70
	0583	TB Bass 1	84	4	71
	0584	TB Bass 2	84	4	72
	0585	TB Bass 3	84	4	73
	0586	TB Bass 4	84	4	74
	0587	Alpha Bass 1	84	4	75
	0588	Alpha Bass 2	84	4	76
	0589	Alpha ResoBs	84	4	77
	0590	Nu Saw Bass	84	4	78
	0591	Nu RnB SawBs	84	4	79
	0592	Storm Bass	84	4	80
	0593	Detune Bass	84	4	81
	0594	Gashed Bass	84	4	82
	0595	Hi-Energy Bs	84	4	83
	0596	Pedal Bass 1	84	4	84
	0597	Pedal Bass 2	84	4	85
	0598	Monster Bass	84	4	86
	0599	JunoSqr Bs 1	84	4	87
0600	JunoSqr Bs 2	84	4	88	

Sub Category	Number	TONE Name	MSB	LSB	PC	
SYNTH BASS	0601	101 Bass	84	4	89	
	0602	106 Bass 1	84	4	90	
	0603	106 Bass 2	84	4	91	
	0604	Compu Bass 1	84	4	92	
	0605	Compu Bass 2	84	4	93	
	0606	Triangle Bs	84	4	94	
	0607	Muffled Bass	84	4	95	
	0608	Garage Bass	84	4	96	
	0609	TransistorBs	84	4	97	
	0610	Fazee Bass	84	4	98	
	0611	Brite Bass	84	4	99	
	0612	Saw Bass	84	4	100	
	0613	Sub Bass	84	4	101	
	0614	Ramp Bass	84	4	102	
	0615	Fat Bass 1	84	4	103	
	0616	Fat Bass 2	84	4	104	
	0617	Fat Bass 3	84	4	105	
	0618	Flat Bass	84	4	106	
	0619	Electro Rubb	84	4	107	
	0620	80s Bass	84	4	108	
	0621	SynthBass101	84	4	109	
	0622	Clav Bass	84	4	110	
	0623	Hammer Bass	84	4	111	
	0624	SynSlap Bass	84	4	112	
	0625	Rubber Bass	84	4	113	
	0626	Attack Pulse	84	4	114	
	AC.GUITAR	0627	Nylon Gtr 1	84	4	115
		0628	Nylon Gtr 2	84	4	116
		0629	Nylon Gtr 3	84	4	117
		0630	Nylon Gtr 4	84	4	118
		0631	Nylon Gtr 5	84	4	119
		0632	Nylon Gtr 6	84	4	120
0633		Wet NyIn Gtr	84	4	121	
0634		Folk Gtr 1	84	4	122	
0635		Folk Gtr 2	84	4	123	
0636		Folk Gtr 3	84	4	124	
0637		Latin Gtr	84	4	125	
AC.GUITAR	0638	Ukulele	84	4	126	
	0639	Ukulele 2	84	4	127	
	0640	Nylon Gtr 1o	84	4	128	
	0641	Steel-str.Gt	84	5	1	
	0642	12-str. Gtr	84	5	2	
	0643	Steel + Body	84	5	3	
	0644	Gt FretNoise	84	5	4	
E.GUITAR	0645	Clean Gtr 1	84	5	5	
	0646	Clean Gtr 2	84	5	6	
	0647	Clean Gtr 3	84	5	7	
	0648	Jazz Guitar	84	5	8	
	0649	Jazz Guitar2	84	5	9	
	0650	Pick E.Gtr	84	5	10	
	0651	Funk Guitar	84	5	11	
	0652	Funk Guitar2	84	5	12	
	0653	Wet E.Gtr	84	5	13	
	0654	Pedal Steel	84	5	14	
	0655	Pedal Steel2	84	5	15	
	0656	Clean Guitar	84	5	16	
	0657	Chorus Gtr	84	5	17	
	0658	Mid Tone Gtr	84	5	18	
	0659	Muted Guitar	84	5	19	
	0660	Funk Pop	84	5	20	
	E.GUITAR	0661	Jazz Man	84	5	21
		0662	Gt Cut Noise	84	5	22

Sub Category	Number	TONE Name	MSB	LSB	PC
DIST GUITAR	0663	Overdrive Gt	84	5	23
	0664	OverdriveGt2	84	5	24
	0665	Guitar Pinch	84	5	25
	0666	Dist Gtr 1	84	5	26
	0667	Dist Gtr 2	84	5	27
	0668	Dist Gtr 3	84	5	28
	0669	DistortionGt	84	5	29
	0670	Gt Feedback1	84	5	30
	0671	Dist Rtm Gtr	84	5	31
	0672	Gt Harmonics	84	5	32
PLUCKED STROKE	0673	Gt Feedback2	84	5	33
	0674	Kalimba	84	5	34
	0675	Harp	84	5	35
	0676	Yang Qin	84	5	36
	0677	Sitar Pad	84	5	37
	0678	Mandolin	84	5	38
	0679	Sitar 1	84	5	39
	0680	Sitar 2	84	5	40
	0681	Sitar 3	84	5	41
	0682	Banjo	84	5	42
	0683	Shamisen	84	5	43
	0684	Koto	84	5	44
	0685	Taisho Koto	84	5	45
	0686	Aerial Harp	84	5	46
	0687	LostParadise	84	5	47
	0688	Indian Frtls	84	5	48
	0689	Santur	84	5	49
	0690	Santur 2	84	5	50
	0691	Santur 3	84	5	51

Sub Category	Number	TONE Name	MSB	LSB	PC	
FLUTE	0717	Piccolo	84	5	77	
	0718	Flute	84	5	78	
	0719	Flute 2	84	5	79	
	0720	Strawberry Flute	84	5	80	
	0721	Pan Flute	84	5	81	
	0722	Pan Flute 2	84	5	82	
	0723	Pan Pipes 1	84	5	83	
	0724	Pan Pipes 2	84	5	84	
	0725	Bottle Blow	84	5	85	
	0726	Shakuhachi	84	5	86	
	0727	Shakuhachi 2	84	5	87	
	0728	Breath Noise	84	5	88	
	0729	Fl.Key Click	84	5	89	
	SAX	0730	Soprano Sax	84	5	90
		0731	Soprano Sax2	84	5	91
0732		Alto Sax	84	5	92	
0733		Tenor Sax	84	5	93	
0734		Tenor Sax 2	84	5	94	
0735		BreathyTenor	84	5	95	
0736		Baritone Sax	84	5	96	
RECORDER	0737	Recorder	84	5	97	
	0738	Whistle	84	5	98	
	0739	Ocarina	84	5	99	
	0740	Ocarina 2	84	5	100	
SYNTH LEAD	0741	Juno SQR	84	5	101	
	0742	Saw Lead 1	84	5	102	
	0743	Saw Lead 2	84	5	103	
	0744	Saw Lead 3	84	5	104	
	0745	Saw Lead 4	84	5	105	
	0746	Saw Lead 5	84	5	106	
	0747	Saw Lead 6	84	5	107	
	0748	Saw Lead 7	84	5	108	
	0749	Saw Lead 8	84	5	109	
	0750	Saw Lead 9	84	5	110	
	0751	Saw Lead 10	84	5	111	
	0752	GR300 Lead 1	84	5	112	
	0753	GR300 Lead 2	84	5	113	
	0754	Classic GR	84	5	114	
	0755	Bright GR	84	5	115	
	0756	Fat GR Lead	84	5	116	
	0757	MODified Ld	84	5	117	
0758	Syn Lead 1	84	5	118		
0759	Syn Lead 2	84	5	119		
0760	Syn Lead 3	84	5	120		
0761	Syn Lead 4	84	5	121		
0762	Syn Lead 5	84	5	122		
0763	Syn Lead 6	84	5	123		
0764	Syn Lead 7	84	5	124		
0765	Pro Fat Ld 1	84	5	125		
0766	Pro Fat Ld 2	84	5	126		
0767	JupiterLead1	84	5	127		
0768	JupiterLead2	84	5	128		
0769	Porta Lead	84	6	1		
0770	Classic Lead	84	6	2		
0771	On Air	84	6	3		
0772	Wormy Lead	84	6	4		
0773	Waspy Lead	84	6	5		
0774	Brite ResoLd	84	6	6		
0775	Brass Lead	84	6	7		
0776	Legato Tkno	84	6	8		
0777	Follow Me	84	6	9		

OTHER

Sub Category	Number	TONE Name	MSB	LSB	PC
ENSEMBLE BRASS	0692	Brass 1	84	5	52
	0693	Brass 2	84	5	53
	0694	Brass 3	84	5	54
	0695	Brass 4	84	5	55
	0696	Brass 5	84	5	56
	0697	Brass 6	84	5	57
	0698	F.Horn Sect	84	5	58
SOLO BRASS	0699	Trumpet	84	5	59
	0700	Trumpet 2	84	5	60
	0701	Dark Trumpet	84	5	61
	0702	MuteTrumpet1	84	5	62
	0703	MuteTrumpet2	84	5	63
	0704	Trombone 1	84	5	64
	0705	Trombone 2	84	5	65
	0706	Bright Tb	84	5	66
	0707	Tuba	84	5	67
	0708	Fr.Horn	84	5	68
WOODWINDS	0709	French Horn	84	5	69
	0710	Oboe	84	5	70
	0711	English Horn	84	5	71
	0712	Bassoon	84	5	72
	0713	Bassoon 2	84	5	73
	0714	Clarinet	84	5	74
	0715	Bagpipe	84	5	75
	0716	Shanai	84	5	76

Sub Category	Number	TONE Name	MSB	LSB	PC
SYNTH LEAD	0778	Octa Juice	84	6	10
	0779	Juicy Jupe	84	6	11
	0780	Octa Saw	84	6	12
	0781	Vintager 1	84	6	13
	0782	Vintager 2	84	6	14
	0783	Sync Lead	84	6	15
	0784	Octa Sync	84	6	16
	0785	Leading Sync	84	6	17
	0786	A Leader	84	6	18
	0787	Hot Coffee	84	6	19
	0788	Hot Sync	84	6	20
	0789	Synchro Lead	84	6	21
	0790	Space Solo	84	6	22
	0791	Squareheads	84	6	23
	0792	Mod Lead	84	6	24
	0793	Alpha Spit	84	6	25
	0794	Air Lead	84	6	26
	0795	Pulstar Lead	84	6	27
	0796	Therasaw	84	6	28
	0797	Warmy Lead	84	6	29
	0798	ResoSawLead	84	6	30
	0799	Soft Reso Ld	84	6	31
	0800	Reso Lead 1	84	6	32
	0801	Reso Lead 2	84	6	33
	0802	Reso Lead 3	84	6	34
	0803	Reso Lead 4	84	6	35
	0804	Reso Lead 5	84	6	36
	0805	Juicy Lead	84	6	37
	0806	DC Triangle	84	6	38
	0807	Soft Lead 1	84	6	39
	0808	Soft Lead 2	84	6	40
	0809	Soft Lead 3	84	6	41
	0810	Soft Lead 4	84	6	42
	0811	Soft Lead 5	84	6	43
	0812	Soft Lead 6	84	6	44
	0813	Soft Lead 7	84	6	45
	0814	Soft Lead 8	84	6	46
	0815	Soft Lead 9	84	6	47
	0816	Soft Lead 10	84	6	48
	0817	Tri Lead	84	6	49
	0818	Pulse Lead 1	84	6	50
	0819	Pulse Lead 2	84	6	51
	0820	Pulse Lead 3	84	6	52
	0821	Pulse Lead 4	84	6	53
	0822	Simple Tri	84	6	54
	0823	Simple Sine	84	6	55
	0824	Whistle Ld 1	84	6	56
	0825	Whistle Ld 2	84	6	57
0826	Square Pipe	84	6	58	
0827	CosmicDrops1	84	6	59	
0828	Spooky Lead	84	6	60	
0829	Pure Lead	84	6	61	
0830	303 NRG	84	6	62	
0831	Round SQR	84	6	63	
0832	Brite SQR	84	6	64	
0833	Square SAW	84	6	65	
0834	Simple SQR	84	6	66	
0835	Sqr Lead	84	6	67	
0836	Atk Lead	84	6	68	
0837	Octa Square	84	6	69	
0838	CS Lead	84	6	70	

Sub Category	Number	TONE Name	MSB	LSB	PC	
SYNTH LEAD	0839	Mini Growl	84	6	71	
	0840	Hoover Again	84	6	72	
	0841	Tranceformer	84	6	73	
	0842	Ramp Lead 1	84	6	74	
	0843	Ramp Lead 2	84	6	75	
	0844	Sine Lead 1	84	6	76	
	0845	Sine Lead 2	84	6	77	
	0846	Dance Saws1	84	6	78	
	0847	Resoform	84	6	79	
	0848	Dance Saws 2	84	6	80	
	0849	Square Wave	84	6	81	
	0850	MG Square	84	6	82	
	0851	2600 Sine	84	6	83	
	0852	Saw Wave	84	6	84	
	0853	OB2 Saw	84	6	85	
	0854	Doctor Solo	84	6	86	
	0855	Natural Lead	84	6	87	
	0856	Syn.Calliope	84	6	88	
	0857	Chiffer Lead	84	6	89	
	0858	Charang	84	6	90	
	0859	Wire Lead	84	6	91	
	0860	Solo Vox	84	6	92	
	0861	5th Saw Wave	84	6	93	
	0862	Bass & Lead	84	6	94	
	0863	Delayed Lead	84	6	95	
	SYNTH BRASS	0864	80s Brass 1	84	6	96
		0865	80s Brass 2	84	6	97
		0866	80s Brass 3	84	6	98
		0867	80s Brass 4	84	6	99
		0868	80s Brass 5	84	6	100
		0869	80s Brass 6	84	6	101
		0870	80s Brass 7	84	6	102
		0871	80s Brass 8	84	6	103
		0872	Soft SynBrs1	84	6	104
		0873	Soft SynBrs2	84	6	105
		0874	Warm SynBrs	84	6	106
		0875	Brite SynBrs	84	6	107
		0876	Express Brs	84	6	108
		0877	EuroExpress1	84	6	109
		0878	JP Brass 1	84	6	110
		0879	JP Brass 2	84	6	111
		0880	Juno Brass	84	6	112
		0881	Ox Brass	84	6	113
		0882	Reso Brass	84	6	114
		0883	Wide SynBrs	84	6	115
		0884	106 Brass	84	6	116
		0885	Octa Brass	84	6	117
		0886	Poly Brass 1	84	6	118
0887		Poly Brass 2	84	6	119	
0888		Dual Saw Brs	84	6	120	
0889		Jump Poly	84	6	121	
0890		Reso Key 1	84	6	122	
0891		EuroExpress2	84	6	123	
0892		Ox Synth	84	6	124	
0893		VintageBrs 1	84	6	125	
0894		VintageBrs 2	84	6	126	
0895		VintageBrs 3	84	6	127	
0896		VintageBrs 4	84	6	128	
0897		JP Brass	84	7	1	
0898		Oct SynBrass	84	7	2	
0899		Jump Brass	84	7	3	
SYNTH BRASS		0900	Synth Brass1	84	7	4
		0901	Synth Brass2	84	7	5
		0902	SynBrass sfz	84	7	6
		0903	Velo Brass	84	7	7
		SYNTH POLY KEY	0904	Syn Mallet	84	7
0905			Heaven Key	84	7	9

Tone List

Sub Category	Number	TONE Name	MSB	LSB	PC
SYNTH POLY KEY	0906	PWM Pad 1	84	7	10
	0907	Poly Synth	84	7	11
	0908	Dream Trance	84	7	12
	0909	Dream Saws	84	7	13
	0910	Dream Pulse	84	7	14
	0911	Trance Synth	84	7	15
	0912	Trancy	84	7	16
	0913	Trance Keys	84	7	17
	0914	Trance Saws	84	7	18
	0915	Auto Trance1	84	7	19
	0916	Super Saws 1	84	7	20
	0917	Analog Saws	84	7	21
	0918	Uni-G	84	7	22
	0919	Digitaless	84	7	23
	0920	Bustranza	84	7	24
	0921	Super Saws 2	84	7	25
	0922	Poly Synth 2	84	7	26
	0923	Poly Synth 3	84	7	27
	0924	Poly Synth 4	84	7	28
	0925	Poly Synth 5	84	7	29
	0926	Poly Synth 6	84	7	30
	0927	Poly Synth 7	84	7	31
	0928	Juno Saw Key	84	7	32
	0929	Saw Key 1	84	7	33
	0930	Saw Key 2	84	7	34
	0931	Waspy Synth	84	7	35
	0932	Vintage Key	84	7	36
	0933	Ju-D Fifths	84	7	37
	0934	Reso Key 2	84	7	38
	0935	Fat Synth	84	7	39
	0936	DOC Stack	84	7	40
	0937	2 Saws	84	7	41
	0938	Hi Saw Band	84	7	42
	0939	Brite Synth	84	7	43
0940	RAVtune	84	7	44	
0941	Pipe Key	84	7	45	
0942	Shroomy	84	7	46	
0943	AnalogDays 1	84	7	47	
0944	Sync Key	84	7	48	
0945	Detune Ramp	84	7	49	
0946	Reso Saw	84	7	50	
0947	EuroExpress3	84	7	51	
0948	Sweep Saw	84	7	52	
SYNTH FX	0949	Shimmer Pad	84	7	53
	0950	BUBBLE 1	84	7	54
	0951	CosmicDrops2	84	7	55
	0952	Enigmatic	84	7	56
	0953	Planetz	84	7	57
	0954	Sci-Fi	84	7	58
	0955	ResoSweep Dn	84	7	59
	0956	Jet Noise	84	7	60
	0957	Brandish	84	7	61
	0958	909 Fx	84	7	62
	0959	Zap	84	7	63
	0960	PolySweep Nz	84	7	64

Sub Category	Number	TONE Name	MSB	LSB	PC
SYNTH FX	0961	Passing By	84	7	65
	0962	Lazer Points	84	7	66
	0963	Crystal Fx	84	7	67
	0964	Crystal Ice	84	7	68
	0965	Mad Noise	84	7	69
	0966	Robot Sci-Fi	84	7	70
	0967	Computer 1	84	7	71
	0968	Computer 2	84	7	72
	0969	S&H Noise	84	7	73
	0970	S&H Ramp	84	7	74
	0971	S&H PWM	84	7	75
	0972	S&H Saw 1	84	7	76
	0973	S&H Saw 2	84	7	77
	0974	Electrostar	84	7	78
	0975	Alpha Said	84	7	79
	0976	FX Ramp	84	7	80
	0977	Goblin	84	7	81
	0978	Echo Drops	84	7	82
	0979	Echo Bell	84	7	83
	SYNTH SEQ PAD	0980	Analog Seq	84	7
0981		Seq Pop	84	7	85
0982		Periscope	84	7	86
0983		Major 7	84	7	87
0984		Juno-D Maj7	84	7	88
0985		Sweet House	84	7	89
0986		Detune Saws	84	7	90
0987		Melodic Drum	84	7	91
0988		Detune Seq	84	7	92
0989		SequencedSaw	84	7	93
0990		Echo Pan	84	7	94
PULSATING	0991	PanninFormnt	84	7	95
	0992	Fairy's Song	84	7	96
	0993	Atmospherics	84	7	97
	0994	StrobeBell 1	84	7	98
	0995	StrobeBell 2	84	7	99
	0996	Flying Pad 1	84	7	100
	0997	Flying Pad 2	84	7	101
	0998	Flying Pad 3	84	7	102
	0999	Flying Pad 4	84	7	103
	1000	Flying Pad 5	84	7	104
	1001	Sine Magic	84	7	105
	1002	Pulsatron	84	7	106
	1003	Motion Bass	84	7	107
	1004	Trance Splt	84	7	108
	1005	Rhythmic 5th	84	7	109
	1006	Rhythmic 1	84	7	110
	1007	Rhythmic 2	84	7	111
	1008	Mega Sync 1	84	7	112
	1009	StrobeBell 3	84	7	113
	1010	Strobe 1	84	7	114
1011	Strobe 2	84	7	115	
1012	Strobe 3	84	7	116	
1013	Strobe 4	84	7	117	
1014	LFO Saw	84	7	118	
1015	Keep Going	84	7	119	
1016	Keep Running	84	7	120	
1017	Electrons	84	7	121	
1018	BriskVortex	84	7	122	
1019	LFO Vox	84	7	123	
1020	Pulsasaw	84	7	124	
PULSATING	1021	Arposphere	84	7	125
	1022	Mega Sync 2	84	7	126

Sub Category	Number	TONE Name	MSB	LSB	PC
BEAT GROOVE	1023	Compusonic 1	84	7	127
	1024	Compusonic 2	84	7	128
	1025	Compusonic 3	84	8	1
	1026	Compusonic 4	84	8	2
	1027	Compusonic 5	84	8	3
	1028	AnalogDays 2	84	8	4
	1029	Groove 007	84	8	5
	1030	Juno Pop	84	8	6
	1031	Auto Trance2	84	8	7
	1032	In Da Groove	84	8	8
HIT	1033	80s Beat	84	8	9
	1034	Cheezy Movie	84	8	10
	1035	Mod Chord	84	8	11
	1036	Housechord	84	8	12
	1037	OrchestraHit	84	8	13
	1038	Bass Hit	84	8	14
	1039	6th Hit	84	8	15
	1040	Euro Hit	84	8	16
SOUND FX	1041	Seashore	84	8	17
	1042	Rain	84	8	18
	1043	Thunder	84	8	19
	1044	Wind	84	8	20
	1045	Stream	84	8	21
	1046	Bubble	84	8	22
	1047	Bird 1	84	8	23
	1048	Dog	84	8	24
	1049	Horse Gallop	84	8	25
	1050	Bird 2	84	8	26
	1051	Telephone 1	84	8	27
	1052	Telephone 2	84	8	28
	1053	DoorCreaking	84	8	29
	1054	Door	84	8	30
	1055	Scratch	84	8	31
	1056	Scratch 2	84	8	32
	1057	Wind Chimes	84	8	33
1058	Helicopter	84	8	34	
1059	Car Engine	84	8	35	
1060	Car Stop	84	8	36	
1061	Car Pass	84	8	37	
1062	Car Crash	84	8	38	
1063	Siren	84	8	39	
1064	Train	84	8	40	
1065	Jetplane	84	8	41	
1066	Starship	84	8	42	
1067	Burst Noise	84	8	43	
SOUND FX	1068	Applause	84	8	44
	1069	Laughing	84	8	45
	1070	Screaming	84	8	46
	1071	Punch	84	8	47
	1072	Heart Beat	84	8	48
	1073	Footsteps	84	8	49
	1074	Gun Shot	84	8	50
	1075	Machine Gun	84	8	51
	1076	Laser Gun	84	8	52
	1077	Explosion	84	8	53
	1078	GM2 SFX	84	8	54

Sub Category	Number	TONE Name	MSB	LSB	PC
PERCUSSION	1079	Timpani	84	8	55
	1080	Ride Cymbal	84	8	56
	1081	Castanets	84	8	57
	1082	Taiko	84	8	58
	1083	Concert BD	84	8	59
	1084	Melo. Tom 1	84	8	60
	1085	Melo. Tom 2	84	8	61
	1086	Synth Drum	84	8	62
	1087	808 Tom	84	8	63
	1088	Elec Perc	84	8	64
	1089	Reverse Cymb	84	8	65
	1090	Agogo	84	8	66
	1091	Woodblock	84	8	67
DRUMS	1092	Standard 1	84	8	68
	1093	Standard 2	84	8	69
	1094	Standard 3	84	8	70
	1095	Rock Kit	84	8	71
	1096	Jazz Kit	84	8	72
	1097	Brush Kit	84	8	73
	1098	Machine Kit	84	8	74
	1099	R&B T-Analog	84	8	75
	1100	R&B Mini Kit	84	8	76
	1101	HipHop Kit	84	8	77
	1102	R&B Kit	84	8	78
	1103	Dance Kit 1	84	8	79
	1104	Dance Kit 2	84	8	80
	1105	Dance Kit 3	84	8	81
	1106	GM2 STANDARD	84	8	82
	1107	GM2 ROOM	84	8	83
1108	GM2 POWER	84	8	84	
1109	GM2 ELECTRIC	84	8	85	
1110	GM2 ANALOG	84	8	86	
1111	GM2 JAZZ	84	8	87	
1112	GM2 BRUSH	84	8	88	
1113	GM2 ORCHSTRA	84	8	89	

Program List

A

Bank-Num	PROGRAM Name	MSB	LSB	PC
A-01	Solo Jazz Grand	84	64	1
A-02	Honest EP Trem	84	64	2
A-03	FC1 Cry Wah Clav	84	64	3
A-04	Piano + ChoirPad	84	64	4
A-05	Tine EP Menu	84	64	5
A-06	1979 Envelope EP	84	64	6
A-07	1975 Flanger EP	84	64	7
A-08	Studio A Grand	84	64	8
A-09	Phaser Bright EP	84	64	9
A-10	1975 EP Burner	84	64	10
A-11	1975 Soul Ballad	84	64	11
A-12	INITIAL PROGRAM	84	64	12
A-13	INITIAL PROGRAM	84	64	13
A-14	INITIAL PROGRAM	84	64	14
A-15	INITIAL PROGRAM	84	64	15
A-16	INITIAL PROGRAM	84	64	16
A-17	INITIAL PROGRAM	84	64	17
A-18	INITIAL PROGRAM	84	64	18
A-19	INITIAL PROGRAM	84	64	19
A-20	INITIAL PROGRAM	84	64	20

B

Bank-Num	PROGRAM Name	MSB	LSB	PC
B-01	1975 Phased EP	84	64	21
B-02	1979 Sp Echo EP	84	64	22
B-03	Resonant Grand	84	64	23
B-04	1975 M-Phaser EP	84	64	24
B-05	1975 UNI-V EP	84	64	25
B-06	Norwegian Grand	84	64	26
B-07	SR Tine 1979	84	64	27
B-08	SR Tine 1975	84	64	28
B-09	DEMO Stage Grand	84	64	29
B-10	DEMO 1975 Tine	84	64	30
B-11	DEMO 1979 Tine	84	64	31
B-12	INITIAL PROGRAM	84	64	32
B-13	INITIAL PROGRAM	84	64	33
B-14	INITIAL PROGRAM	84	64	34
B-15	INITIAL PROGRAM	84	64	35
B-16	INITIAL PROGRAM	84	64	36
B-17	INITIAL PROGRAM	84	64	37
B-18	INITIAL PROGRAM	84	64	38
B-19	INITIAL PROGRAM	84	64	39
B-20	INITIAL PROGRAM	84	64	40

C

Bank-Num	PROGRAM Name	MSB	LSB	PC
C-01	Piano + Strings	84	64	41
C-02	MFX Tine EP Menu	84	64	42
C-03	Funky Keys Split	84	64	43
C-04	Nice SA E.Piano	84	64	44
C-05	an old Friend...	84	64	45
C-06	Piano + FM EP	84	64	46
C-07	R&B Tine EP Set	84	64	47
C-08	Bs+Ride / Grand	84	64	48
C-09	INITIAL PROGRAM	84	64	49
C-10	INITIAL PROGRAM	84	64	50
C-11	INITIAL PROGRAM	84	64	51
C-12	INITIAL PROGRAM	84	64	52
C-13	INITIAL PROGRAM	84	64	53
C-14	INITIAL PROGRAM	84	64	54
C-15	INITIAL PROGRAM	84	64	55
C-16	INITIAL PROGRAM	84	64	56
C-17	INITIAL PROGRAM	84	64	57
C-18	INITIAL PROGRAM	84	64	58
C-19	INITIAL PROGRAM	84	64	59
C-20	INITIAL PROGRAM	84	64	60

D

Bank-Num	PROGRAM Name	MSB	LSB	PC
D-01	Isn't she ...?	84	64	61
D-02	SlapBs/TWahClav	84	64	62
D-03	Maze of Love	84	64	63
D-04	Silver Top Menu	84	64	64
D-05	1978 ElectricPNO	84	64	65
D-06	StarDust Fantasy	84	64	66
D-07	RvrsPno & Pad	84	64	67
D-08	Telephone Piano	84	64	68
D-09	INITIAL PROGRAM	84	64	69
D-10	INITIAL PROGRAM	84	64	70
D-11	INITIAL PROGRAM	84	64	71
D-12	INITIAL PROGRAM	84	64	72
D-13	INITIAL PROGRAM	84	64	73
D-14	INITIAL PROGRAM	84	64	74
D-15	INITIAL PROGRAM	84	64	75
D-16	INITIAL PROGRAM	84	64	76
D-17	INITIAL PROGRAM	84	64	77
D-18	INITIAL PROGRAM	84	64	78
D-19	INITIAL PROGRAM	84	64	79
D-20	INITIAL PROGRAM	84	64	80

E

Bank-Num	PROGRAM Name	MSB	LSB	PC
E-01	Small Jazz Club	84	64	81
E-02	Rock Organ	84	64	82
E-03	R&B Ballad	84	64	83
E-04	Dyno EP Menu	84	64	84
E-05	Healing Piano	84	64	85
E-06	E.Bass /OrganFst	84	64	86
E-07	CmpPno/AnalogStr	84	64	87
E-08	DEMO Concert Grd	84	64	88
E-09	INITIAL PROGRAM	84	64	89
E-10	INITIAL PROGRAM	84	64	90
E-11	INITIAL PROGRAM	84	64	91
E-12	INITIAL PROGRAM	84	64	92
E-13	INITIAL PROGRAM	84	64	93
E-14	INITIAL PROGRAM	84	64	94
E-15	INITIAL PROGRAM	84	64	95
E-16	INITIAL PROGRAM	84	64	96
E-17	INITIAL PROGRAM	84	64	97
E-18	INITIAL PROGRAM	84	64	98
E-19	INITIAL PROGRAM	84	64	99
E-20	INITIAL PROGRAM	84	64	100

G

Bank-Num	PROGRAM Name	MSB	LSB	PC
G-01	FC1 PedalWahClav	84	64	121
G-02	TransistorOrgans	84	64	122
G-03	BrightRainyWaltz	84	64	123
G-04	E.Bass/RockPiano	84	64	124
G-05	WaterRing Piano	84	64	125
G-06	DynoEP /SoloLead	84	64	126
G-07	DEMO ToneColor 1	84	64	127
G-08	DEMO ToneColor 2	84	64	128
G-09	INITIAL PROGRAM	84	65	1
G-10	INITIAL PROGRAM	84	65	2
G-11	INITIAL PROGRAM	84	65	3
G-12	INITIAL PROGRAM	84	65	4
G-13	INITIAL PROGRAM	84	65	5
G-14	INITIAL PROGRAM	84	65	6
G-15	INITIAL PROGRAM	84	65	7
G-16	INITIAL PROGRAM	84	65	8
G-17	INITIAL PROGRAM	84	65	9
G-18	INITIAL PROGRAM	84	65	10
G-19	INITIAL PROGRAM	84	65	11
G-20	INITIAL PROGRAM	84	65	12

F

Bank-Num	PROGRAM Name	MSB	LSB	PC
F-01	Dist L-Org	84	64	101
F-02	Rox Collection	84	64	102
F-03	Wafting Piano	84	64	103
F-04	Garbage EP	84	64	104
F-05	Dream Keys	84	64	105
F-06	E.Bass /OrganSlw	84	64	106
F-07	SuperLight Piano	84	64	107
F-08	DEMO Tine EP	84	64	108
F-09	INITIAL PROGRAM	84	64	109
F-10	INITIAL PROGRAM	84	64	110
F-11	INITIAL PROGRAM	84	64	111
F-12	INITIAL PROGRAM	84	64	112
F-13	INITIAL PROGRAM	84	64	113
F-14	INITIAL PROGRAM	84	64	114
F-15	INITIAL PROGRAM	84	64	115
F-16	INITIAL PROGRAM	84	64	116
F-17	INITIAL PROGRAM	84	64	117
F-18	INITIAL PROGRAM	84	64	118
F-19	INITIAL PROGRAM	84	64	119
F-20	INITIAL PROGRAM	84	64	120

H

Bank-Num	PROGRAM Name	MSB	LSB	PC
H-01	Reed EP Menu	84	65	13
H-02	History of Tine	84	65	14
H-03	Symphonic Grand	84	65	15
H-04	LA Brass Rock	84	65	16
H-05	E.Bass/RockOrgan	84	65	17
H-06	Re:Milian ScPno	84	65	18
H-07	DEMO Upright Pno	84	65	19
H-08	DEMO SA Piano	84	65	20
H-09	INITIAL PROGRAM	84	65	21
H-10	INITIAL PROGRAM	84	65	22
H-11	INITIAL PROGRAM	84	65	23
H-12	INITIAL PROGRAM	84	65	24
H-13	INITIAL PROGRAM	84	65	25
H-14	INITIAL PROGRAM	84	65	26
H-15	INITIAL PROGRAM	84	65	27
H-16	INITIAL PROGRAM	84	65	28
H-17	INITIAL PROGRAM	84	65	29
H-18	INITIAL PROGRAM	84	65	30
H-19	INITIAL PROGRAM	84	65	31
H-20	INITIAL PROGRAM	84	65	32

Program List

I

Bank-Num	PROGRAM Name	MSB	LSB	PC
I-01	Bright FM EP	84	65	33
I-02	Piano + SA EP	84	65	34
I-03	Piano + Choir	84	65	35
I-04	TW-Org w/ LHBass	84	65	36
I-05	+StrgsVelo>High1	84	65	37
I-06	FranDoll ScPiano	84	65	38
I-07	DEMO JD Piano	84	65	39
I-08	DEMO Reed EP	84	65	40
I-09	INITIAL PROGRAM	84	65	41
I-10	INITIAL PROGRAM	84	65	42
I-11	INITIAL PROGRAM	84	65	43
I-12	INITIAL PROGRAM	84	65	44
I-13	INITIAL PROGRAM	84	65	45
I-14	INITIAL PROGRAM	84	65	46
I-15	INITIAL PROGRAM	84	65	47
I-16	INITIAL PROGRAM	84	65	48
I-17	INITIAL PROGRAM	84	65	49
I-18	INITIAL PROGRAM	84	65	50
I-19	INITIAL PROGRAM	84	65	51
I-20	INITIAL PROGRAM	84	65	52

K

Bank-Num	PROGRAM Name	MSB	LSB	PC
K-01	Too Deep Delay!	84	65	73
K-02	JD Piano Menu	84	65	74
K-03	SA Piano Layer	84	65	75
K-04	WitchOfMilkyWay	84	65	76
K-05	+StrgsVelo>High2	84	65	77
K-06	Wedding	84	65	78
K-07	SynPad/TwinBrass	84	65	79
K-08	DEMO FM E.Piano	84	65	80
K-09	INITIAL PROGRAM	84	65	81
K-10	INITIAL PROGRAM	84	65	82
K-11	INITIAL PROGRAM	84	65	83
K-12	INITIAL PROGRAM	84	65	84
K-13	INITIAL PROGRAM	84	65	85
K-14	INITIAL PROGRAM	84	65	86
K-15	INITIAL PROGRAM	84	65	87
K-16	INITIAL PROGRAM	84	65	88
K-17	INITIAL PROGRAM	84	65	89
K-18	INITIAL PROGRAM	84	65	90
K-19	INITIAL PROGRAM	84	65	91
K-20	INITIAL PROGRAM	84	65	92

J

Bank-Num	PROGRAM Name	MSB	LSB	PC
J-01	Tron Split	84	65	53
J-02	Piano + Pad	84	65	54
J-03	Misty as Last.Bs	84	65	55
J-04	SA Piano Menu	84	65	56
J-05	E.Bass / Tine EP	84	65	57
J-06	Grand Piano Menu	84	65	58
J-07	DEMO Tremolo EP	84	65	59
J-08	DEMO SA E.Piano	84	65	60
J-09	INITIAL PROGRAM	84	65	61
J-10	INITIAL PROGRAM	84	65	62
J-11	INITIAL PROGRAM	84	65	63
J-12	INITIAL PROGRAM	84	65	64
J-13	INITIAL PROGRAM	84	65	65
J-14	INITIAL PROGRAM	84	65	66
J-15	INITIAL PROGRAM	84	65	67
J-16	INITIAL PROGRAM	84	65	68
J-17	INITIAL PROGRAM	84	65	69
J-18	INITIAL PROGRAM	84	65	70
J-19	INITIAL PROGRAM	84	65	71
J-20	INITIAL PROGRAM	84	65	72

L

Bank-Num	PROGRAM Name	MSB	LSB	PC
L-01	SynthBrass Ens	84	65	93
L-02	Sweet House Set	84	65	94
L-03	Electro Split	84	65	95
L-04	4-Space Ballad	84	65	96
L-05	DaNCe	84	65	97
L-06	Dream Slice Pad	84	65	98
L-07	Pontyfy	84	65	99
L-08	Trance Synth	84	65	100
L-09	INITIAL PROGRAM	84	65	101
L-10	INITIAL PROGRAM	84	65	102
L-11	INITIAL PROGRAM	84	65	103
L-12	INITIAL PROGRAM	84	65	104
L-13	INITIAL PROGRAM	84	65	105
L-14	INITIAL PROGRAM	84	65	106
L-15	INITIAL PROGRAM	84	65	107
L-16	INITIAL PROGRAM	84	65	108
L-17	INITIAL PROGRAM	84	65	109
L-18	INITIAL PROGRAM	84	65	110
L-19	INITIAL PROGRAM	84	65	111
L-20	INITIAL PROGRAM	84	65	112

M

Bank-Num	PROGRAM Name	MSB	LSB	PC
M-01	INITIAL PROGRAM	84	65	113
M-02	INITIAL PROGRAM	84	65	114
M-03	INITIAL PROGRAM	84	65	115
M-04	INITIAL PROGRAM	84	65	116
M-05	INITIAL PROGRAM	84	65	117
M-06	INITIAL PROGRAM	84	65	118
M-07	INITIAL PROGRAM	84	65	119
M-08	INITIAL PROGRAM	84	65	120
M-09	INITIAL PROGRAM	84	65	121
M-10	INITIAL PROGRAM	84	65	122
M-11	INITIAL PROGRAM	84	65	123
M-12	INITIAL PROGRAM	84	65	124
M-13	INITIAL PROGRAM	84	65	125
M-14	INITIAL PROGRAM	84	65	126
M-15	INITIAL PROGRAM	84	65	127
M-16	INITIAL PROGRAM	84	65	128
M-17	INITIAL PROGRAM	84	66	1
M-18	INITIAL PROGRAM	84	66	2
M-19	INITIAL PROGRAM	84	66	3
M-20	INITIAL PROGRAM	84	66	4

O

Bank-Num	PROGRAM Name	MSB	LSB	PC
O-01	INITIAL PROGRAM	84	66	25
O-02	INITIAL PROGRAM	84	66	26
O-03	INITIAL PROGRAM	84	66	27
O-04	INITIAL PROGRAM	84	66	28
O-05	INITIAL PROGRAM	84	66	29
O-06	INITIAL PROGRAM	84	66	30
O-07	INITIAL PROGRAM	84	66	31
O-08	INITIAL PROGRAM	84	66	32
O-09	INITIAL PROGRAM	84	66	33
O-10	INITIAL PROGRAM	84	66	34
O-11	INITIAL PROGRAM	84	66	35
O-12	INITIAL PROGRAM	84	66	36
O-13	INITIAL PROGRAM	84	66	37
O-14	INITIAL PROGRAM	84	66	38
O-15	INITIAL PROGRAM	84	66	39
O-16	INITIAL PROGRAM	84	66	40
O-17	INITIAL PROGRAM	84	66	41
O-18	INITIAL PROGRAM	84	66	42
O-19	INITIAL PROGRAM	84	66	43
O-20	INITIAL PROGRAM	84	66	44

N

Bank-Num	PROGRAM Name	MSB	LSB	PC
N-01	INITIAL PROGRAM	84	66	5
N-02	INITIAL PROGRAM	84	66	6
N-03	INITIAL PROGRAM	84	66	7
N-04	INITIAL PROGRAM	84	66	8
N-05	INITIAL PROGRAM	84	66	9
N-06	INITIAL PROGRAM	84	66	10
N-07	INITIAL PROGRAM	84	66	11
N-08	INITIAL PROGRAM	84	66	12
N-09	INITIAL PROGRAM	84	66	13
N-10	INITIAL PROGRAM	84	66	14
N-11	INITIAL PROGRAM	84	66	15
N-12	INITIAL PROGRAM	84	66	16
N-13	INITIAL PROGRAM	84	66	17
N-14	INITIAL PROGRAM	84	66	18
N-15	INITIAL PROGRAM	84	66	19
N-16	INITIAL PROGRAM	84	66	20
N-17	INITIAL PROGRAM	84	66	21
N-18	INITIAL PROGRAM	84	66	22
N-19	INITIAL PROGRAM	84	66	23
N-20	INITIAL PROGRAM	84	66	24