

For your safety, read carefully and keep in this vehicle.

2016 Infiniti

Infiniti InTouch Owner's Manual



INFINITI.

INFINITI CONSUMER AFFAIRS DEPARTMENT

For assistance or inquiries about the INFINITI warranty, service or general questions, contact the INFINITI Consumer Affairs Department at:

For U.S. customers

1-800-662-6200

For Canadian customers

1-800-361-4792

INFINITI INTOUCH™ SYSTEM HELP-DESK CONTACT INFORMATION

For assistance or inquiries about the Infiniti InTouch™ system, or to order updated map data, contact the INFINITI NAVIGATION SYSTEM HELPDESK at:

- ADDRESS: P.O. Box 1588 Orem, UT 84059-992
- E-MAIL: infiniti-navi-info@here.com
- WEB SITE: www.InfinitiNavigation.com or www.infiniti.ca.
- PHONES: 1-888-362-8837
- HOURS: Monday – Friday: 8:00 AM - 8:00 PM (Eastern Time) and Saturday: 10:00am - 6:00 PM (Eastern Time)

FOREWORD

Thank you for purchasing an INFINITI vehicle.

This user's manual is for Infiniti InTouch™ and the systems linked to Infiniti InTouch™ offered in your INFINITI vehicle.

Operation instructions for the following systems are included in this manual.

- Heater and air conditioner
- Audio
- Hands-Free Phone
- Infiniti InTouch™ Mobile Apps
- View monitors
- Navigation
- Voice recognition
- Other systems viewable/operable on the dual display

Please read this manual carefully to ensure safe operation of Infiniti InTouch™.

- Because of possible specification changes and optional equipment, some sections of this manual may not apply to your vehicle.

- All information, specifications and illustrations in this manual are those in effect at the time of printing. INFINITI reserves the right to change specifications or design at any time without notice.
- Do not remove this manual from the vehicle when selling this vehicle. The next user of this Infiniti InTouch™ may need the manual.

Table of Contents

1 Introduction

How to use this manual.....	1-2
Safety information	1-3
Laser product	1-4

2 Getting Started

Control buttons and functions	2-2
Starting system	2-7
Touch panel operation	2-8
Menu screen and operation method	2-9
How to operate dual display	2-11
Items to be set initially.....	2-17
Additional system information	2-23

3 Heater and air conditioner

Heater and air conditioner operation precautions.....	3-2
Heater and air conditioner controls.....	3-3

Automatic climate control system	3-6
Heated seats (if so equipped).....	3-9
Heated steering-wheel (if so equipped)	3-10
Rear window and outside mirror defroster	3-11
Heater and air conditioner settings.....	3-11

4 Audio system

Audio operation precautions	4-2
Names and functions of audio control buttons	4-11
Audio operations	4-12
Audio settings	4-32
CD/USB memory device care and cleaning.....	4-34
Gracenote® End User License Agreement	4-34

5 Hands-Free Phone

Bluetooth® Hands-Free Phone System.....	5-2
---	-----

6 Infiniti InTouch™ Mobile Apps

Infiniti InTouch™ Mobile Apps Overview	6-2
Using applications	6-3
Vehicle Apps.....	6-3
Mobile Apps	6-8

7 Monitor system

RearView Monitor (if so equipped) ...	7-2
Around View® Monitor (AVM) (if so equipped)	7-6
Difference between predictive and actual distances	7-20

8 Information and settings

Information screen.....	8-2
SiriusXM Travel Link® (if so equipped)	8-4
Infiniti InTouch™ Services	8-10
Settings screen.....	8-23
Fully customizable digital environment.....	8-29
Driver Assistance settings (if so equipped)	8-32

9 Navigation (if so equipped)

Safety information	9-3
Map data authentication.....	9-3
Map operation	9-4
Setting destination	9-14
Route guidance.....	9-29
Viewing traffic information.....	9-43
Viewing available traffic information.....	9-44
Storing a location/route	9-48

Navigation settings.....	9-56
General information for navigation system.....	9-59

10 Voice recognition

INFINITI voice recognition.....	10-2
---------------------------------	------

11 Troubleshooting guide

Customer assistance.....	11-2
System unit	11-3
Audio system.....	11-5
Bluetooth® Hands-Free Phone System.....	11-14
Monitor system (if so equipped)	11-17
Navigation (if so equipped).....	11-18
Voice recognition	11-26

1 Introduction

How to use this manual.....	1-2	Safety information	1-3
For safe operation	1-2	Laser product	1-4
Reference symbols	1-2	Trademarks	1-4
Screen illustrations	1-2		



1. Introduction

HOW TO USE THIS MANUAL

This manual uses special words, symbols, icons and illustrations organized by function.

Please refer to the following items and familiarize yourself with them.

FOR SAFE OPERATION



WARNING

This is used to indicate the presence of a hazard that could cause death or serious personal injury. To avoid or reduce the risk, the procedures must be followed precisely.



CAUTION

This is used to indicate the presence of a hazard that could cause minor or moderate personal injury or damage to your vehicle. To avoid or reduce the risk, the procedures must be followed carefully.



NOTE:

Indicates items that help you understand and maximize the performance of your vehicle. If ignored, they may lead to a malfunction or poor performance.

REFERENCE SYMBOLS



INFO:

This indicates information that is necessary for efficient use of your vehicle or accessories.



Reference page:

This indicates the title and page that you should refer to.

[]:

This indicates a key/item displayed on the screen.



Voice Command:

This indicates an operation by voice command.

SCREEN ILLUSTRATIONS

Icons and menu items displayed on the screen may be abbreviated or omitted from the screen illustrations when appropriate. The omitted icons and menu items are described as dotted lines as illustrated.

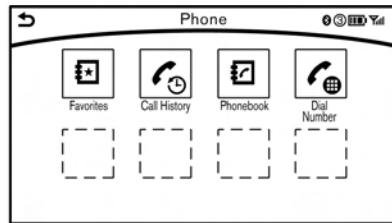
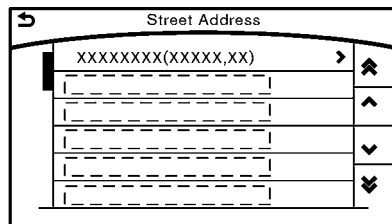

SAFETY INFORMATION

This system is primarily designed to help you support your pleasant driving as outlined in this manual. However, you, the driver, must use the system safely and properly. Information and the availability of services may not always be up to date. The system is not a substitute for safe, proper and legal driving.

Before using the system, please read the following safety information. Always use the system as outlined in this manual.



WARNING

- To operate Infiniti InTouch™ or to use the INFINITI controller, first park the vehicle in a safe location and set the parking brake. Operating the system while driving can distract the driver and may result in a serious accident.
- Exercise extreme caution at all times so full attention may be given to vehicle operation. If the system doesn't respond immediately, please be patient and keep your eyes on the road. Inattentive driving may lead to a crash resulting in serious injuries or death.

- Do not disassemble or modify this system. If you do, it may result in accidents, fire or electrical shock.
- If you notice any foreign objects in the system hardware, spill liquid on the system or notice smoke or a smell coming from it, stop using the system immediately and contact an INFINITI retailer. Ignoring such conditions may lead to accidents, fire or electrical shock.



CAUTION

- Some jurisdictions may have laws limiting the use of video screens while driving. Use this system only where it is legal to do so.
- Extreme temperature conditions [below -4°F (-20°C) and above 158°F (70°C)] could affect the performance of the system.
- The display screen may break if it is hit with a hard or sharp object. If the display screen breaks, do not touch it. Doing so could result in an injury.



NOTE:

Do not keep the system running with the engine or the hybrid system stopped. Doing so may discharge the vehicle battery (12V battery). When you use the system, always keep the engine or the hybrid system running.

1. Introduction

LASER PRODUCT

This Infiniti InTouch™ is certified as a Class 1 laser product.

Infiniti InTouch™ complies with DHHS Rules 21 CFR Chapter 1, Subchapter J.



WARNING

- Do not disassemble or modify this system. There are no user serviceable parts in Infiniti InTouch™.
- If maintenance, adjustments and operations other than those specified in this manual are attempted, injury due to laser radiation and exposure could occur.

TRADEMARKS



HD Radio Technology manufactured under license from iBiquity Digital Corporation. U.S. and Foreign Patents. HD Radio™ and the HD, HD Radio, and “Arc” logos are proprietary trademarks of iBiquity Digital Corp.



SiriusXM services require a subscription after trial period and are sold separately or as a package. Our satellite service is available only to those at least 18 and older in the 48 contiguous USA and DC. For more information visit www.siriusxm.com.



“Made for iPod” and “Made for iPhone” mean that an electronic accessory has been designed to connect specifically to iPod® or iPhone®, respectively, and has been certified by the developer to meet Apple performance standards. Apple is not responsible for the operation of this device or its compliance with safety and regulatory standards. Please note that the use of this accessory with iPod® or iPhone® may affect wireless performance.

Apple, the Apple logo, iPhone®, iPod®, iPod classic®, iPod nano®, and iPod touch® are trademarks of Apple Inc., registered in the U.S. and other countries. Lightning is a trademark of Apple Inc. App

Store is a service mark of Apple Inc.



Music recognition technology and related data are provided by Gracenote®. Gracenote is the industry standard in music recognition technology and related content delivery. For more information visit www.gracenote.com.

CD and music-related data from Gracenote, Inc., copyright © 2000 to present Gracenote. Gracenote Software, copyright © 2000 to present Gracenote. One or more patents owned by Gracenote apply to this product and service. See the Gracenote website for a non-exhaustive list of applicable Gracenote patents. Gracenote, CDDB, MusicID, MediaVOCS, the Gracenote logo and logotype, and the "Powered by Gracenote" logo are either registered trademarks or trademarks of Gracenote in the United States and/or other countries.



The Bluetooth® word mark and logos are registered trademarks owned by Bluetooth SIG, Inc. and any use of such marks by DENSO CORPORATION is under license. Other trademarks and trade names are those of their respective owners.



Required SiriusXM Satellite Radio and SiriusXM Traffic monthly subscriptions are sold separately. SiriusXM Traffic are only available in select markets. For more information,

see www.siriusxm.com/siriusxmtraffic



Required SiriusXM Satellite Radio and SiriusXM Travel Link monthly subscriptions are sold separately. SiriusXM Travel Link is only available in select markets. For more

information,
see www.siriusxm.com/travellink

App StoreSM

Apple and the Apple logo are trademarks of Apple Inc., registered in the U.S. and other countries. App Store is a service mark of Apple Inc.

Google PlayTM

Google Play is a trademark of Google Inc.

Google

© 2012 Google Inc. All rights reserved. Google CalendarTM calendaring application is a trademark of Google Inc.

1. Introduction

MEMO

2 Getting Started

Control buttons and functions	2-2	Lower touch screen display (lower display)	2-14
Dual Display.....	2-2	Functions disabled while driving.....	2-16
INFINITI controller.....	2-5	Items to be set initially	2-17
Steering-wheel switches.....	2-5	Screen Settings	2-17
Media Hub	2-6	Volume settings.....	2-19
Starting system	2-7	Language and unit settings	2-20
Start-up screen	2-7	Clock settings.....	2-21
Log-in screen	2-7	Connecting Bluetooth® device	2-22
Touch panel operation	2-8	Additional system information	2-23
Menu screen and operation method	2-9	System Start-Up	2-23
Scrolling menu icon screen	2-9	System Response Delay.....	2-23
Scrolling message or list.....	2-9	System Reset	2-24
Selecting item.....	2-10	System Updates	2-24
Adjusting volume and settings	2-10	Operating Tips.....	2-24
How to input letters and numbers	2-10	Additional Help.....	2-24
How to operate dual display.....	2-11		
Upper touch screen display (upper display)....	2-11		

2. Getting Started

CONTROL BUTTONS AND FUNCTIONS

Infiniti InTouch™ controls the heater and air conditioner, audio, RearView/Around View® Monitor, navigation system (if so equipped), Infiniti InTouch™ Mobile Apps, Bluetooth® Hands-free phone etc., by using the upper and lower display, INFINITI controller, menu button and steering-wheel switch.

Designs and button layout may vary depending on the specifications and the model.

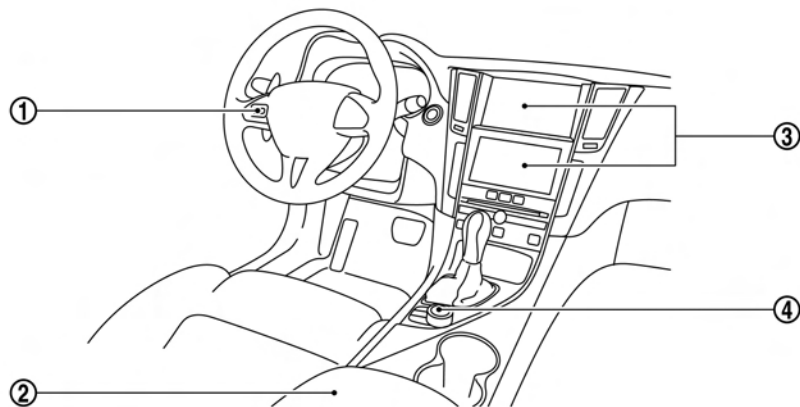

- ① Steering-wheel switch
☞ “Steering-wheel switches”
(page 2-5)
- ② Media Hub
☞ “Media Hub” (page 2-6)
- ③ Dual display
☞ “Dual Display” (page 2-2)
- ④ INFINITI controller
☞ “INFINITI controller” (page 2-5)

DUAL DISPLAY

Both displays can be operated with the touch panel.

The upper touch screen display (upper display) can display various information. The lower touch screen display (lower display) can be used for various operations.

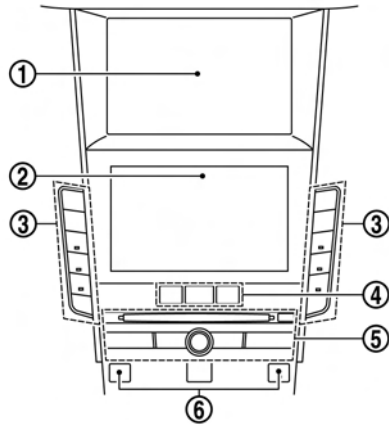

- ① Upper touch screen display (upper display)

Display Information, view monitor system, navigation (if so equipped).

☞ “Upper touch screen display (upper display)” (page 2-11)

☞ “7. Monitor system”

☞ “9. Navigation”

- ② Lower touch screen display (lower display)

The lower display provides touchscreen controls for various vehicle fea-

tures including Infiniti InTouch™ Mobile Apps, the navigation system (if so equipped), audio system and the heater and air-conditioner system, etc.

☞ “Lower touch screen display (lower display)” (page 2-14)

- ③ Heater and air conditioner buttons
Allow you to control the heater and air conditioner.

☞ “Heater and air conditioner controls” (page 3-3)

- ④ Lower display menu buttons
Push **<AUDIO>**, **<MENU>**, or **<CLIMATE>** to display functions on the lower display.

☞ “Lower display and menu buttons” (page 2-14)

- ⑤ Audio main buttons
Allow you to control the audio.

☞ “Audio main buttons” (page 4-11)

- ⑥ **< ⌂ >** Heated seat buttons (if so equipped)

The driver seat and front passenger seat can be heated.

☞ “Heated seats” (page 3-9)

How to handle display

The display is a liquid crystal display and should be handled with care.



Never disassemble the display. Some parts utilize extremely high voltage. Touching them may result in serious personal injury.

Characteristics of liquid crystal display:

- If the temperature inside the vehicle is especially low, the display will stay relatively dim or the movement of the images may be slow. These conditions are normal. The display will function normally when the interior of the vehicle has warmed up.
- Some pixels in the display are darker or brighter than others. This condition is an inherent characteristic of liquid crystal displays, and it is not a malfunction.
- A remnant of the previous display image may remain on the screen. This screen burn is inherent in displays, and it is not a malfunction.

2. Getting Started

The screen may become distorted by strong magnetic fields.

Maintenance of display:



CAUTION

- To clean the display, stop the vehicle in a safe location.
- Clean the display with the ignition switch in the OFF position. If the display is cleaned while the ignition switch is in the ON position, unintentional operation may occur.
- To clean the display, never use a rough cloth, alcohol, benzine, thinner and any kind of solvent or paper towel with a chemical cleaning agent. They will scratch or deteriorate the panel.
- Do not splash any liquid such as water or car fragrance on the display. Contact with liquid will cause the system to malfunction.

shake out the exclusive cloth in order to prevent damaging the display.

- If the display is heavily soiled, moisten the dedicated cleaning cloth and then clean the display. If the exclusive cloth is moistened, be sure to dry it out sufficiently before storing it. Color may be transferred to objects that it comes in contact with.
- The dedicated cleaning cloth retains its cleaning properties even if it is washed repeatedly.
- When washing the exclusive cloth, be sure to rinse it thoroughly so that no detergent remains.
- When ironing the exclusive cloth, iron using a low temperature setting 176 to 248 °F (80 to 120°C).

- When cleaning the display, use the dedicated cleaning cloth.
- Before cleaning, wipe away any sand or dust from the surface of the display and

INFINITI CONTROLLER

The INFINITI controller operates upper display.

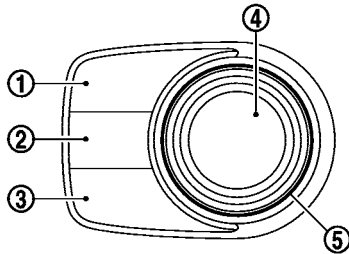

- ① **<MAP/VOICE>** (models with navigation system)

Push to display the vehicle's current location on the map.

Push and hold to hear the current guidance for a programmed route.

<DISP> (models without navigation system)

Push to display the Display View Bar.

"Display View Bar" (page 2-11)

- ② **<↵>**

Push to go back to the previous screen.

- ③ **<CAMERA * / >>** (models with Around View[®] Monitor system)

Push to view the Around View Monitor screen.

Push and hold to control the brightness.

<* / >> (models without Around View Monitor system)

Push for brightness control. Push and hold to turn the display on/off (for the upper and lower displays).

- ④ **<≡ /OK>**

Push to enter the selected item.

Models with navigation system:

If this button is pushed while a map is displayed, the shortcut menu is shown on the upper display.

"Upper touch screen display (upper display)" (page 2-11)

- ⑤ Center dial/Slide switch

Slide or turn to select an item on the upper screen or to adjust a setting (volume, brightness, etc.).

Models with navigation system:

Turn the center dial to adjust the map

scale.

The map can be scrolled in eight directions by sliding this switch.

STEERING-WHEEL SWITCHES

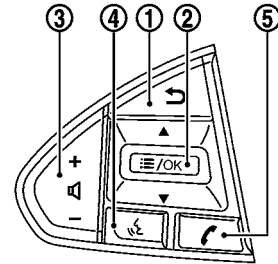

The steering-wheel switches mainly controls the upper display (adjust the volume, select a menu, voice recognition, Hands-free phone).

It can also control audio and Hands-free text messaging assistant features that are shown on the lower display.

- ① **<↵>** (BACK) :

Push this button during a setting operation to return to the previous screen. In a settings screen, this button can also be used to apply the

2. Getting Started

setting.

② < ≡ /OK>:

Tilt to select an item on the screen or adjust a setting. Push to enter the selected item.

For models with navigation system, if this button is pushed while a map is displayed, the shortcut menu is displayed.

 “Upper touch screen display (upper display)” (page 2-11)

Tilt up or down to operate audio system, when the map or display view is display on the upper screen.

 “Steering-wheel mounted audio control buttons” (page 4-12)

③ <- 🔊 +> (Volume control) :

Allows you to adjust the volume.

④ < 🗨️ > (TALK):

Push to enter the voice recognition mode.

 “Giving voice commands” (page 10-2)

⑤ < 📞 > (PHONE):

Push to display the hands-free phone operation screen.

When you receive a phone call, push

this button to answer the call.

 “5. Hands-Free Phone”

MEDIA HUB

The Media Hub is located in the center console and consists of the USB/iPod® interface, auxiliary input jacks and SD card slot.

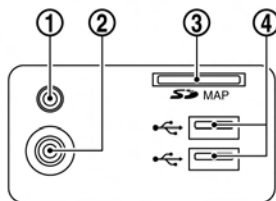

① Auxiliary audio input jack:

Connect an audio player that accepts a 1/8 in (3.5 mm) TRS connector (such as an MP3 player etc.) to play music.

② Auxiliary video input jack:

Connect a video player to play a movie.

③ SD card slot

(models with navigation system):

Insert an SD card. Push the inserted

SD card in and release it to eject the SD card from the slot. An SD card containing map data is provided with the vehicle.

④ USB/iPod® connection port:

Connect to play media from an iPod®, iPhone® or a USB memory.

When using Infiniti InTouch™ Mobile Apps with iPhone®, connect via USB cable.

Refer to your device manufacture's owner information regarding the proper use and care of the device.

CAUTION

- Never insert foreign objects such as coins into the SD card slot. Doing so may result in a malfunction of the device.
- Do not force the SD card into the SD slot. Doing so may result in a malfunction of the device.
- The SD card may be hot when it is removed from the device. This does not indicate a malfunction.
- Depending on size and shape of USB device, the console lid may not fully close. Do not force the console lid closed

as this may damage USB device.

! NOTE:

- Even when iPod® or iPhone® are connected to both of the USB/iPod® interfaces, the system recognizes only one of the connected iPod® or iPhone® at a time.
- Only one of the two connected USB devices can be operated by the voice recognition system.
- Do not remove the SD card containing map data. If the SD card containing map data is accidentally removed, reinsert the SD card containing map data into the slot and place the ignition switch in the OFF position.

STARTING SYSTEM

The system starts when the ignition switch is pushed to the “ACC” or “ON” position.

START-UP SCREEN

For this system, when the ignition switch is pushed to the “ACC” or “ON” position, the start-up screen is displayed.

Touch [OK] after reading and agreeing to the message. If you do not agree to the message, some of Infiniti InTouch™ functions will be disabled.

! NOTE:

Do not keep the navigation system on with the engine or the hybrid system stopped. Doing so may discharge the vehicle battery (12V battery). When you use the navigation system, always keep the engine or the hybrid system running.

i INFO:

Once you select [Decline] on the start-up screen, the [OK]/[Decline] screen will not be displayed for 30 days.

LOG-IN SCREEN

Three unique users can be recognized by the vehicle, with personal settings linked to the Intelligent Key assigned to each user. A welcome guidance screen is displayed with the detected user’s name each time the system starts.

☞ “Fully customizable digital environment” (page 8-29)

When an Intelligent Key is used for the first time, the vehicle will prompt the user to create a new registration with a guidance on the lower display.

☞ “User registration” (page 8-29)

User selection

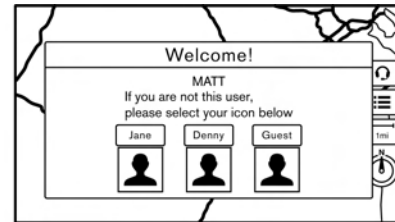

Upper display

1. The system starts when the ignition switch is pushed to the “ON” position. A welcome guidance screen is displayed.

2. Getting Started

2. Check the message that is displayed on the screen. If the name shown in the welcome guidance is incorrect, touch to select the preferred user.

TOUCH PANEL OPERATION

Basic touch panel operation methods are explained here.

- Touch

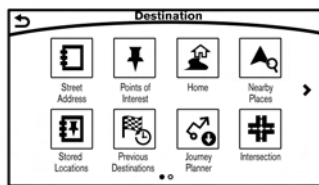
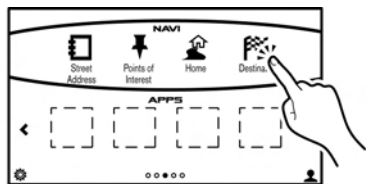

Select and execute the selected key on the screen.

- Swipe

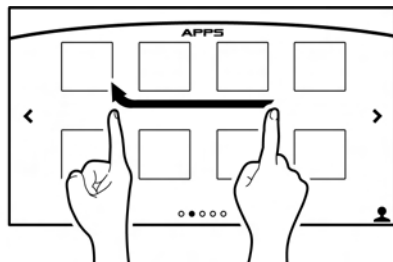

Menu screen pages will skip to the next page.

- Drag

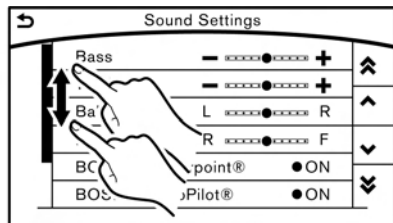

Drag up or down to scroll. You can scroll up and down a list screen.

Models with navigation system:

More various operations are possible for a map screen. For detailed operations of the map screen. Refer to the navigation section.

☞ “Operating with touch panel operation” (page 9-7).

MENU SCREEN AND OPERATION METHOD

SCROLLING MENU ICON SCREEN

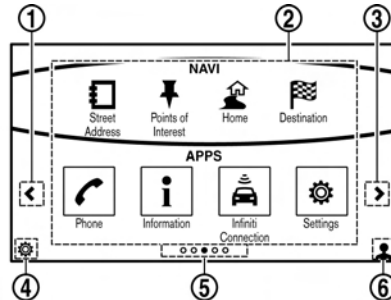

- ① Touch [◀] to scroll to the previous page.
- ② Touch a preferred icon to execute a function and display the next screen.
- ③ Touch [▶] to scroll to the next page.
- ④ Touch [⚙] to access the quick setting menu screen.
☞ “Quick setting menu screen” (page 8-28)
- ⑤ Indicates the position of the currently displayed page.
- ⑥ Touch to display user list screen.
☞ “Fully customizable digital environment” (page 8-29)

A swipe gesture can also be used to move quickly between screens.

SCROLLING MESSAGE OR LIST

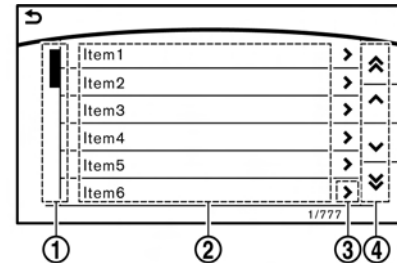

- ① Drag the scroll bar up or down to scroll the message or list up or down.
- ② Touch a preferred item.
- ③ If a listed item name is not completely displayed (due to length), touch [▶] to display the hidden part of the name.
- ④ Touch [^] or [v] to scroll the message or list one item at a time.
Touch [↗] or [↘] to skip to the next page.

2. Getting Started

SELECTING ITEM

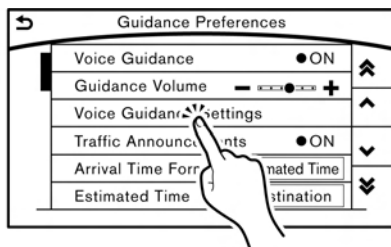

When the item is touched, it is executed and the next screen is displayed.

Touch [↶] to return to the previous screen.

ADJUSTING VOLUME AND SETTINGS

Set the volume and brightness.

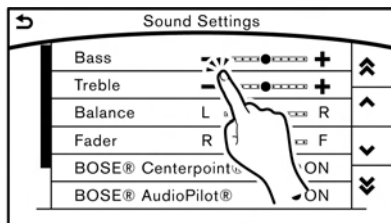

Touch adjustment keys, such as [+]/[-], [L]/[R], etc., to adjust each item. Each time a key is touched, the indicator moves along

the bar.

HOW TO INPUT LETTERS AND NUMBERS

Character (letters and numbers) input screen

Alphanumeric characters are entered using the keyboard screen.

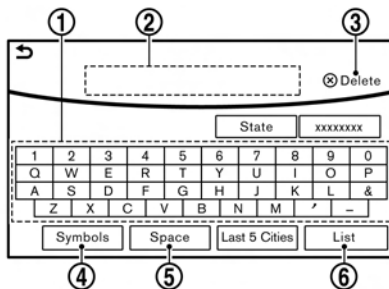

① Touch a character on the displayed keyboard. The selected character is entered.

② Entered characters are displayed here.

③ Touch [Delete] to delete the last character entered.

Touch and hold [Delete] to delete all the characters entered.

④ The symbol keys are displayed by touching [Symbols]. The alphabet keys are displayed by touching [A-Z].

⑤ Touch [Space] to enter a space.

⑥ Touch [OK] or [List] to finalize your input.

INFO:

- Touch [CAPS] to toggle uppercase and lowercase characters on the keyboard screen.
- Touch [<] or [>] to move the character input position.

HOW TO OPERATE DUAL DISPLAY

UPPER TOUCH SCREEN DISPLAY (upper display)

For operating the upper touch screen display (upper display), touch the display directly, push the steering-wheel switch or operate using the INFINITI controller.

Shortcut menu (models with navigation system)

The shortcut menu can be displayed on the upper display. The display may differ according to the map scrolling or the map displaying the current position.

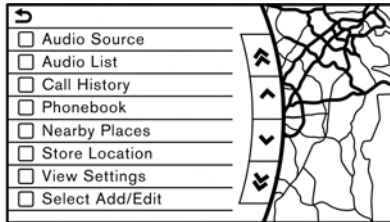

While the current vehicle location is displayed on the map, push **< ≡ /OK >** on the INFINITI controller to display the shortcut menu on the upper display.

The following options are available.

- Audio Source
- Audio List
- Call History
- Phonebook
- Nearby Places
- Store Location
- View Settings
- Select Add/Edit
- (Blank)

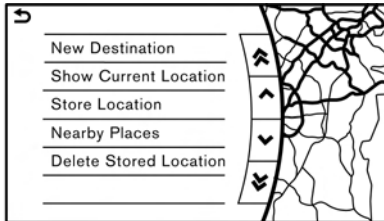

While scrolling the map screen, push **< ≡ /OK >** on the INFINITI controller to display the following options.

- New Destination
- Show Current Location
- Store Location

- Nearby Places
- Delete Stored Location

Edit shortcut menu:

The following procedure can edit or sort the shortcut menu.

1. Select [Select Add/Edit] to register a new item to the menu, or to change an existing menu item.
2. Select preferred setting.
 - [Change Order]
Change the order in which shortcut menu items are shown.
 - [Edit Shortcut Items]
Edit items to be displayed in the shortcut menu.

Display View Bar

Various information screens can be shown on the upper display by selecting from the display view bar.

2. Getting Started

For models with navigation system:

Set display will be shown in addition to the navigation map.

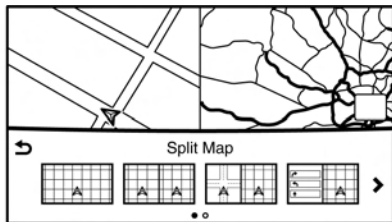

Push **<MAP/VOICE>** (models with navigation system) or **<DISP>** (models without navigation system) to show the display view bar.

Select an icon in the display view bar. The current view will be changed and the display view bar will be closed.

The following display views are available.

Viewing Fuel Economy:

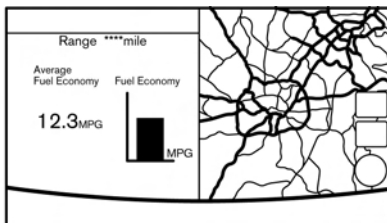

Fuel economy information can be checked while driving.

Viewing Eco Drive Report:

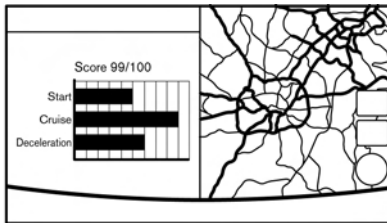

Your driving score will be displayed in real time, with 100 points designated as the score for ideal eco-driving.

For improving your score:

- When starting off, depress the accelerator gently.

- When cruising, accelerate and decelerate as little as possible.
- When decelerating, releasing the accelerator early.

Viewing Split Map (models with navigation system):

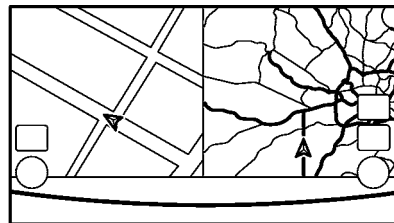

The map can be displayed on a split screen. Each screen can be adjusted independently.

Viewing Intersection (models with navigation system):

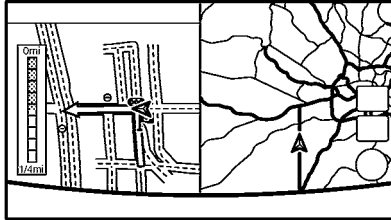

The next intersection is always displayed.

INFO:

When no route is set, the intersection screen is not displayed and the map is displayed on the full screen.

Viewing Turn List (models with navigation system):

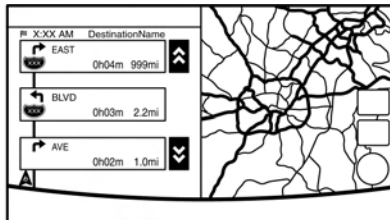

Display the turn list on the left screen. When approaching a guide point, the left screen automatically switches to an enlarged view of the intersection.

INFO:

When no route is set, the turn list screen is not displayed and the map is displayed in the full screen.

Viewing Where am I ? (models with navigation system):



This displays the information about the current vehicle location.

Viewing Turn by Turn (models with navigation system):

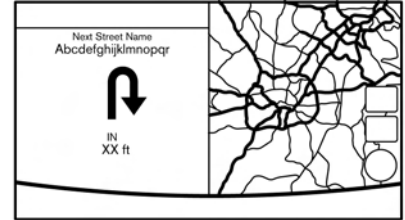

This displays a turn point when driving according to route guidance.

Viewing Analog Clock, Date (models without navigation system):

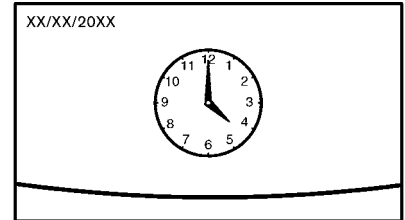

The analog clock and date can always be displayed.

2. Getting Started

Customizing the Display View Bar (models with navigation system)

The menu icons on the display view bar can be customized to your preference.

1. Push **<MENU>** to display the menu screen.
2. Touch [Settings] and touch [Navigation] to display the navigation setting screen.
3. Touch [Map & Display View] and touch [Change Order].
4. Select the screen to be displayed on the display view bar as a shortcut.

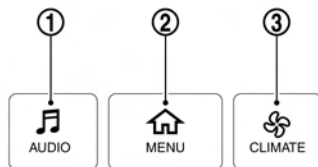

Push **<AUDIO>**, **<MENU>** or **<CLIMATE>** to display functions on the lower display.

The screen for menu button pushed is

LOWER TOUCH SCREEN DISPLAY (lower display)

Lower display and menu buttons

The lower display provides touchscreen controls for various vehicle features including Infiniti InTouch™ Mobile Apps, the navigation system (if so equipped), audio system, and heater and air conditioner system.

This manual explains the basics of menu operation of the lower display.

<AUDIO>, **<MENU>** and **<CLIMATE>** are located on the bottom of the lower display.

displayed on the lower display.

Push **<AUDIO>** ①:

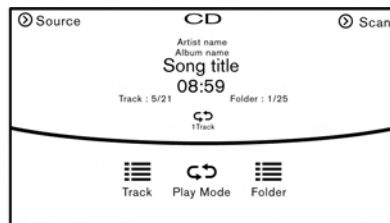

Displays the audio screen.

When **<AUDIO>** is pushed while the audio screen is displayed, the source list screen will be displayed.

☞ “4. Audio system”

Push **<MENU>** ②:

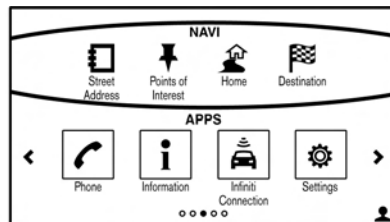

Almost all functions, such as destination setting, route selection, activation and

download of applications, phone connection, information screen display and other settings can be accessed from this menu.

Push **<CLIMATE>** ③:

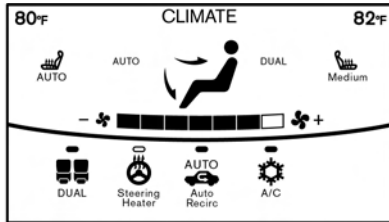

The current climate control information is displayed on the lower display. Directly touch the key to operate the functions of the air conditioner system.

☞ “3. Heater and air conditioner”

Menu screen (models with navigation system)

When **<MENU>** is pushed, the menu screen is displayed. Select a preferred item.

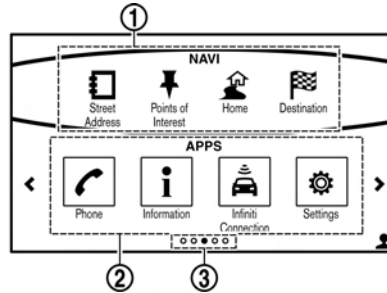

① Displays the navigation operation screen. The available functions will vary based on the current navigation route settings.

☞ “9. Navigation”

② Displays the menu operation screen. Touch [▶]/[◀] to skip to the next or previous screen.

③ Indicates the page displayed.

Menu screen (models without navigation system)

When **<MENU>** is pushed, the menu screen is displayed. Select a preferred item.

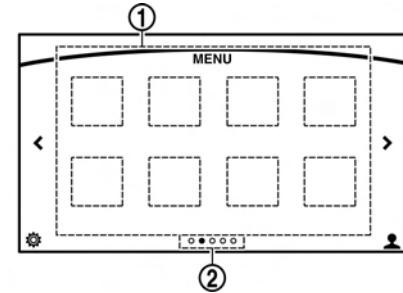

① Displays the menu operations. Touch [▶]/[◀] to skip to the next or previous screen.

② Indicates the page you are on.

2. Getting Started

FUNCTIONS DISABLED WHILE DRIVING

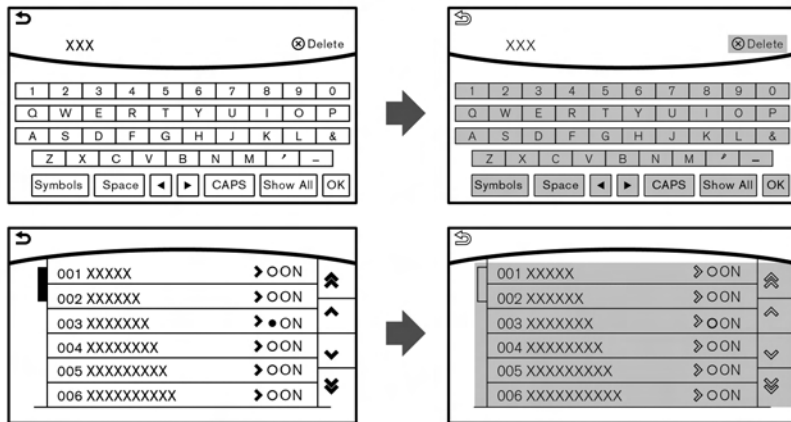

Example

To help ensure safe driving, some functions cannot be operated or have limited operation while the vehicle driving speed is above 5 MPH (8 km/h).

The on-screen text and keys for these restricted functions will be “grayed-out” or muted and cannot be selected while driving. In some cases, a screen message will appear indicating a restricted function.

Restricted functions while driving include:

- Character (letter and number) input screen.
- Scrolling and viewing of certain list screens
- Displaying detail information and touching item on the information screen
- Adding/editing home location, address book entries and current route
- Making a call by dial number and handset phonebook
- Setting phone, Infiniti InTouch™ Services and Bluetooth® functions

These functions will become available again when the vehicle speed is reduced to 5 MPH (8 km/h) or less.

Destination functions available while driving include:

- Home
- Nearby Places
- Stored Locations
- Previous Destinations
- Journey Planner
- Stored Routes
- Map input

ITEMS TO BE SET INITIALLY

The settings included in this section should be performed before using the system for the first time.

SCREEN SETTINGS

This menu turns on and off the display and adjusts the image quality of the upper display and the lower display.

1. Push the **<MENU>** and touch [Settings].
2. Touch [Screen].
3. Touch a preferred adjustment item and adjust to the preferred setting.

Available settings

[Display Settings]	Adjusts the image quality of the upper display and lower display. 🔍 “Display Settings” (page 2-17)
[Display OFF]	Turn the screen on or off. Push and hold the <MENU> , <CAMERA>  * / > button for more than 2 seconds to turn the display on.

[Day/Night]	Adjust the upper and lower screen brightness. Toggle the map color between the day screen and night screen.
[Change Map Color]	Toggle the map color between the day screen and night screen.
[Reset Settings]:	This restores the display settings to the default settings.

Display Settings

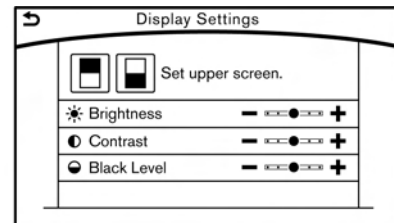

1. Push **<MENU>** and touch [Settings].
2. Touch [Screen] and touch [Display Settings].
3. Select the display to be changed.
 - ☐ : Set upper screen.
 - ☐ : Set lower screen.

2. Getting Started

Available settings

[Brightness]	Adjust the display brightness.
[Contrast]	Adjust the display contrast.
[Black Level]	Adjust the display black level.

VOLUME SETTINGS

This turns on and off, as well as adjusts, the volume for various functions including audio, phone (ringer, incoming, and outgoing volumes), navigation voice guidance (if so equipped), as well as system beeps.

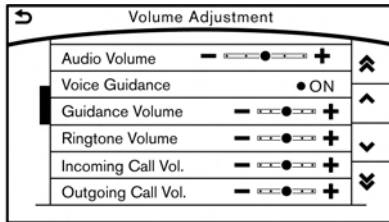

*: For models with navigation system.

Step	Setting item	Action
1. Push <MENU>	[Audio Volume]	Adjust the volume level of the audio system.
2. Touch [Settings]	[Voice Guidance]*	Set on/off of the voice guidance.
3. Touch [Volume Adjustment]	[Guidance Volume]*	Adjust the volume level of guidance voice.
	[Ringtone Volume]	Adjust the volume level of the ringtone.
	[Incoming Call Vol.]	Adjust the incoming call volume.
	[Outgoing Call Vol.]	Adjust the outgoing call volume.
	[InTouch Services Vol]*	Adjust the volume level of the Infiniti InTouch™ Services information channel.
	[Sonar Volume]	Adjust the volume level of the sonar warning volume.
	[Button Beep sound]	Turn the button beep sound and alarm for a prohibited operation to on/off.

2. Getting Started

LANGUAGE AND UNIT SETTINGS

This changes the upper and lower display language and measurement unit used in the system.

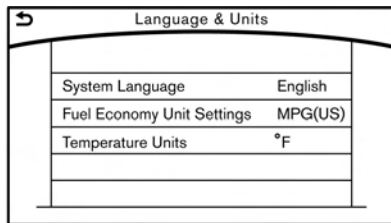

Step 1	Step 2	Setting item	Action
1. Push <MENU>	[Language & Units]	[System Language]	Select the language of the upper and lower display.
2. Touch [Settings]		[Fuel Economy Unit Settings]	Select the preferred unit.
3. Touch [Other]		[Temperature Units]	Select the preferred temperature unit.



INFO:

Do not push the ignition switch while changing the language.

If the selected language is also supported in the combination meter, a confirmation message asking if you would like to also change the meter language is displayed. Select [Yes] to change the language in the meter.

CLOCK SETTINGS

This changes the clock settings.

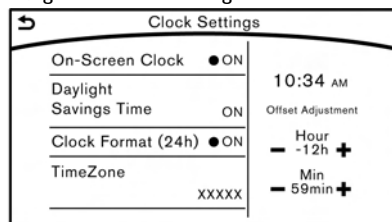

*: For models with navigation system.

** : For models without navigation system.

Step 1	Step 2	Step 3	Menu item	Action
Push <MENU>	[Settings]	[Clock]	[On-Screen Clock]	Set the clock display on/off. When this item is on, the clock display appears.
			[Daylight Savings Time]*	Select the setting for the daylight saving time from ON or OFF. Each time by touching this item changes the setting.
			[Clock Format (24h)]	Select the clock format between 12-hour and 24-hour times. When the indicator light illuminates, the clock is set to the 24-hour format.
			[Time Zone]*	Select an appropriate time zone from the list. When selecting [AUTO]*, the system selects the time zone automatically.
			[Offset Adjustment]*	Adjust the offset value (hour and minutes).
			[>]**	[Adjust Time]
			[Calendar Adjustment]	Adjust the year, month, and day.

2. Getting Started

CONNECTING BLUETOOTH® DEVICE

Your vehicle is equipped with the Bluetooth® Hands-Free Phone System and Bluetooth® audio device. If you are the owner of a compatible Bluetooth® enabled cellular phone or Bluetooth® audio device, you can set up the wireless connection between your cellular phone and the in-vehicle phone module or Bluetooth® audio and in-vehicle audio module. With Bluetooth® wireless technology, you can make or receive a telephone call with your cellular phone in your pocket and listen to Bluetooth® audio.

Connecting cellular phone/audio device

1. Push **<MENU>** and touch [Settings].

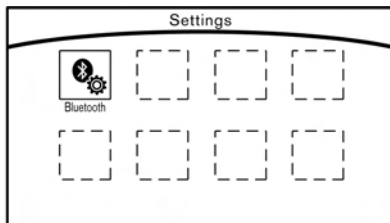

2. Touch [Bluetooth] and touch [Connect Device].

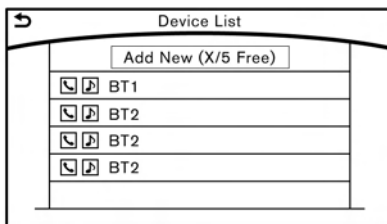

3. Touch [Add New (X/5 Free)] to register a device.
4. When a PIN code appears on the screen, operate the compatible Bluetooth® cellular phone to enter the PIN code.

The pairing procedure of the cellular phone varies according to each cellular phone. See the cellular phone Owner's Manual for the details.

When the pairing is completed, the screen will change to the Bluetooth® setup display.

If the registered device has both audio and phone function, the system displays a message asking if you would like to register the device for another function.

The procedure for connecting a cellular phone/audio device varies according to

each Bluetooth® device. See the Bluetooth® device Owner's Manual for details.



NOTE:

Some cellular phones or other devices may cause interference or a buzzing noise to come from the audio system speakers. Storing the device in a different location may reduce or eliminate the noise.



INFO:

You can also visit www.infiniti.com/bluetooth or call INFINITI Consumer Affairs Department for instructions on pairing INFINITI recommended cellular phones or audio devices.

Bluetooth® settings

The Bluetooth® settings can be fine tuned according to the your preference.

1. Push **<MENU>** and touch [Settings].
2. Touch [Bluetooth].
3. Touch a preferred item.

- [Bluetooth]

Turn the Bluetooth® connection to the vehicle on/off.

- [Connect Device]
Touch this item to connect to the Bluetooth® device. Also, you can delete a registered device and display information of registered device.
- [Select Phone]
Registered Bluetooth® Hands-Free Phones are shown on the list. Select a device from the list to disconnect or connect a Bluetooth® device.
- [Select Audio Device]
Registered Bluetooth® audio players are shown on the list. Select a device from the list to disconnect or connect a Bluetooth® device.
- [Vehicle Bluetooth Device Info.]
The registered device name and the PIN code can be changed.

ADDITIONAL SYSTEM INFORMATION

Infiniti InTouch™ uses an operating system like those found on many computers, tablets and cell phones. Like these devices, processing speed may vary, and system response delays or resets may occur intermittently. This does not indicate a malfunction, and further information on system operation can be found below.

SYSTEM START-UP

Due to the large number of features and capabilities that the Infiniti InTouch™ system needs to load on start-up, it may take up to a minute for all functions (such as Apps) to be available. The system will display “Now Loading All Apps...” during this time. During the start-up period, hard button controls for audio and climate will become available before start-up is complete. Features will become available in the following order:

- Climate Control hard buttons
- Audio volume and music playback
- Audio & Climate Full Screen Access
- Full App Availability - System will display “Loading Completed”

SYSTEM RESPONSE DELAY

Infiniti InTouch™ uses an operating system like those found on many computers, tablets and cell phones. Like these devices, sometimes programs do not respond immediately and this may temporarily delay system use.

In most situations, simply waiting a few moments longer should be sufficient for the pending operations to complete.

If the system temporarily does not respond to commands, the system can be easily reset. Simply push down the Audio Power knob for at least 5 seconds. The system will turn off and restart.

After restart, all functions should be available.

- Audio will resume, but if you were using Bluetooth® Audio or an Audio App, the connection may need to be re-established.
- If a navigation route was set, the route should resume automatically.
- If a phone call was in progress, the call may be temporarily transferred back to the handset.

2. Getting Started

SYSTEM RESET

As noted above, intermittent system resets may occur during normal operation. You may also wish to reset the system if you find that a particular feature is not loading or responding. Often, a quick system reset will resolve any issue you may be experiencing. After restart, all functions will be available as described above.

SYSTEM UPDATES

Like many digital devices, the Infiniti InTouch™ system is designed to allow for software updates as enhancements are developed and additional features added. If you have questions about system performance, contact your retailer to ensure that your vehicle has had the latest available software installed.

OPERATING TIPS

Infiniti InTouch™ provides several methods of operation to suit your preferences. The following are suggested operating tips.

- Operating the INFINITI Controller, Steering Wheel Controls, or other controls too quickly can cause a lag between the control and the display. Operate the controls carefully and allow the system to respond to your request.

- INFINITI recommends using Voice Recognition when ever possible to select options while driving. Some touch screen functionality is intentionally unavailable during driving. Please view the available voice commands by pushing the <  > (TALK) switch and then selecting a category on the display.

- When looking for a street address or Points of Interest (POI), remember that you can use Connected Search and Destination Assistance features within Infiniti InTouch™ Services to expand your search methods and results. The Voice Recognition system recognizes a defined set of commands. These commands can be viewed in the display by pushing the <  > (TALK) switch and then selecting a category from the displayed list. The commands can also be found in the Voice Recognition section under

 “Command list” (page 10-7).

- In some situations, the system may not be able to recognize your command even if you say the exact command. This can be due to noise conditions or an accent.

- In some unique cases, the system may expect a word to be spoken as it is spelled as opposed to the way it is normally pronounced.
- Bluetooth® Compatibility: Some wireless devices do not allow phonebook downloads, text messaging, or other Bluetooth® audio functions. Some wireless devices may only have partial functionality of these features even though the phone is compatible for hands-free communication. If your phone is listed as compatible and you are still experiencing issues, please confirm that your phone also has the latest software updates.

ADDITIONAL HELP

For additional technical information, please contact us online at OWNERS. www.infinitiusa.com or call us at 1-800-662-6200, menu option 6.

3 Heater and air conditioner

Heater and air conditioner operation precautions	3-2	Operating tips	3-8
Heater and air conditioner controls.....	3-3	In-cabin microfilter	3-8
Automatic climate control system	3-6	Servicing heater and air conditioner	3-9
Automatic operation.....	3-6	Heated seats (if so equipped)	3-9
Advanced Climate Control System (if so equipped)	3-7	Heated steering-wheel (if so equipped).....	3-10
		Rear window and outside mirror defroster.....	3-11
		Heater and air conditioner settings	3-11

3. Heater and air conditioner

HEATER AND AIR CONDITIONER OPERATION PRECAUTIONS



WARNING

- The heater and the air conditioner operates only when the engine or the hybrid system is running.
- Never leave children or adults who would normally require the support of others alone in your vehicle. Pets should not be left alone either. On hot, sunny days, temperatures in a closed vehicle could quickly become high enough to cause severe or possibly fatal injuries to people or animals.
- Do not use the recirculation mode for long periods as it may cause the interior air to become stale and the windows to fog up.
- Do not adjust the heating and air conditioning controls while driving so that full attention may be given to vehicle operation.
- Turn off the system when the engine or the hybrid system is not running to prevent battery discharge.



INFO:

- Odors from inside and outside the vehicle can build up in the air conditioner unit. Odor can enter the passenger compartment through the vents.
- When parking, set the heater and air conditioner controls to turn off air recirculation to allow fresh air into the passenger compartment. This should help reduce odors inside the vehicle.
- Vehicles with an automatic climate control system will automatically adjust the passenger compartment to be the set appropriate temperature when the Remote Engine Start feature is used.

For models with Idling Stop System (if so equipped)

The Idling Stop System will not stop the engine under the following conditions:

- The front defroster mode is on.
- The rear window defroster mode is on.

While the engine is stopped by the Idling Stop System, taking one of the following actions will automatically start the engine:

- Turn the front defroster mode on.

- Turn the rear window defroster mode on.

When the engine is stopped by the Idling Stop System, performance of the heater and air conditioner may be reduced to minimize fuel consumption. For the best heating and air conditioning performance, turn on the [Use A/C While Idle] setting.

 “Heater and air conditioner settings” (page 3-11)

HEATER AND AIR CONDITIONER CONTROLS

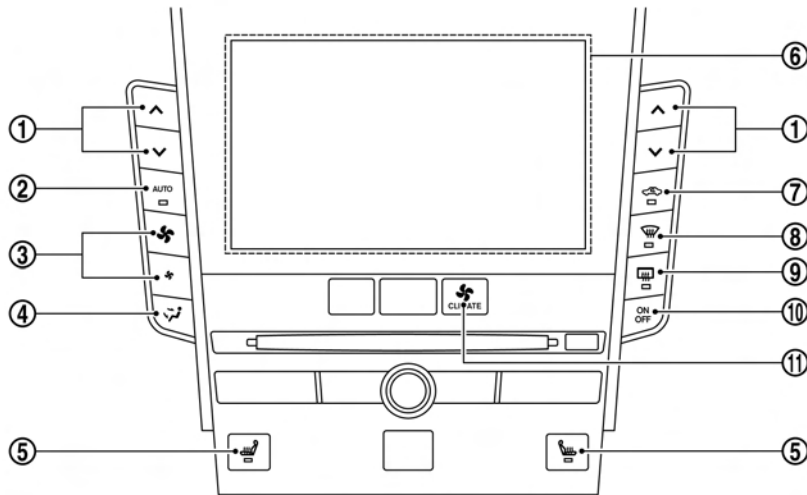

Buttons and lower touch screen display (lower display)

3. Heater and air conditioner

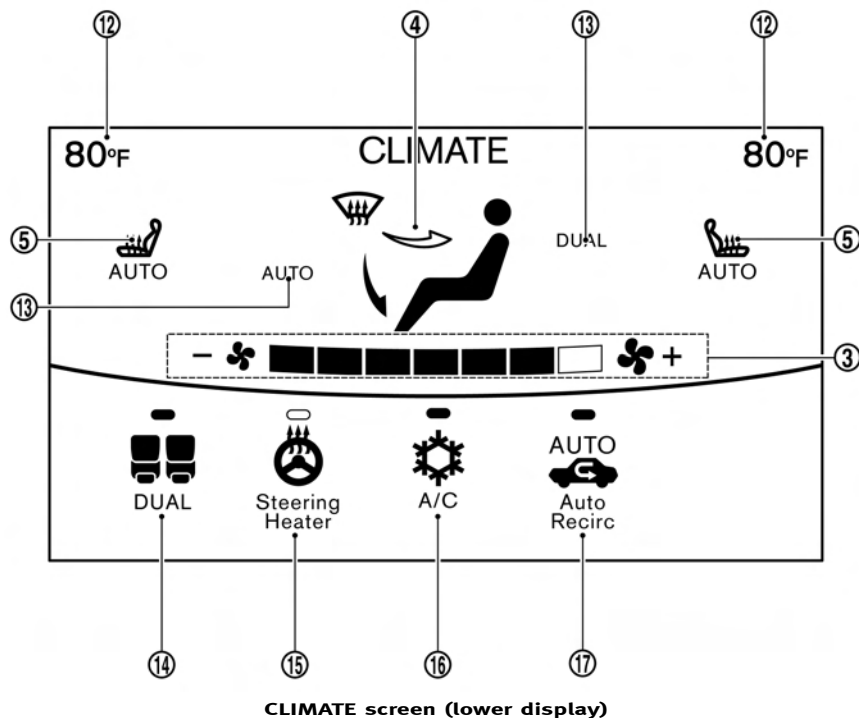

① < ^ > / < v >:

Push < ^ > and < v > to adjust the temperature.

When the dual mode is turned on, the temperature for the driver and the front passenger can be adjusted separately by operating < ^ > and < v > on the corresponding side. When the dual mode is turned off, the temperature for both the driver's seat and the front passenger seat can be adjusted with the temperature control buttons on the driver's side.

② < AUTO >:

Push < AUTO > to set the automatic control mode that keeps the air distribution, temperature and the fan speed automatically.



③ < [fan speed icon] > / < [fan speed icon] > and [fan speed icon +] / [- fan speed icon]:



The fan speed of the air from the ventilators can be changed.



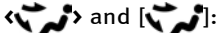

Push < [fan speed icon] > or touch [fan speed icon +] to increase the fan speed. Push < [fan speed icon] > or touch [- fan speed icon] to decrease the fan speed.



For details of the ventilators, refer to the vehicle Owner's Manual.

3. Heater and air conditioner

④  and []:

The current air flow mode is displayed on the CLIMATE screen. Push  to change the air flow mode. The air flow mode can also be changed by touching [] on the lower screen.

	Air flows from the center and side ventilators.
	Air flows from the center and side ventilators, and foot outlets.
	Air flows mainly from the foot outlets.
	Air flows from the defroster and foot outlets.

⑤  and [] (if so equipped):

The driver's seat and front passenger seat can be heated.

 "Heated seats" (page 3-9)

⑥ Lower touch screen display (lower display) :



When **<CLIMATE>** is pushed, the CLIMATE screen will be displayed on the lower display.

⑦ :

Push  to toggle the ventilation between the air recirculation mode

(indicator light on) and the fresh air mode (indicator light off).

⑧ :

Push  to defrost/defog the windshield ([] is displayed lower screen).

When  is pushed, the air conditioner will turn on automatically if the outside temperature is above 23°F (-5°C), and switches to the fresh air mode to for better defogging performance.

⑨ :

Push to activate the rear window and the outside mirror defroster.

 "Rear window and outside mirror defroster" (page 3-11)

⑩ **<ON/OFF>**:

Push to turn on/off the Climate Control system.

⑪ **<CLIMATE>**:

Push to show the CLIMATE screen on the lower display.

⑫ Temperature setting indicators:

Indicates temperature settings. In the dual mode, the driver's side and front passenger side temperatures are dis-

played independently.

⑬ Mode indicators:

The active mode status is displayed.

DUAL	Dual mode is active. Driver/front passenger side temperatures can be set independently.
AUTO	Auto mode is active. Temperature and fan speed are controlled automatically.

⑭ [DUAL]:

Touch to turn on/off the dual mode. When the dual mode is set, the temperature for the driver seat and the front passenger seat can be adjusted independently. When the dual mode is on, the indicator light is on.

⑮ [Steering Heater] (if so equipped):

Touch to turn on/off the steering-wheel heater. When the steering-wheel heater is on, the indicator light is on.

 "Heated steering-wheel" (page 3-10)

⑯ [A/C]:

Touch to turn on/off the A/C mode. Turn on the A/C mode for effective

3. Heater and air conditioner

cooling and dehumidifying. When the A/C mode is on, the indicator light is on.

⑰ [Auto Recirc] (if so equipped):

Touch to turn on/off the auto recirculation mode. When the auto recirculation mode is on, the indicator light is on. When the auto recirculation mode is turned on, the air recirculation and fresh air modes will alternate automatically.

 “Advanced Climate Control System” (page 3-7)

INFO:

The heater and air conditioning system settings can be linked and memorized for each of the Intelligent Keys.

 “Fully customizable digital environment” (page 8-29)

AUTOMATIC CLIMATE CONTROL SYSTEM

AUTOMATIC OPERATION

Cooling and/or dehumidified heating (AUTO)

This mode can be used all year round. The system works automatically to control the inside temperature, air flow distribution and fan speed after the preferred temperature is set manually.

1. Push **<AUTO>**. (The indicator on the button will illuminate and “AUTO” will be displayed on the CLIMATE screen.)
2. Push **<^>** and **<v>** on the driver’s side to set the desired temperature.
 - The temperature of the passenger compartment will be maintained automatically. Air flow distribution and fan speed will also be controlled automatically.
 - When the DUAL mode is turned on, you can individually set the driver’s and front passenger side temperatures by pushing **<^>** and **<v>** on the corresponding side. To turn on the DUAL mode, touch [DUAL] on the lower display (“AUTO” will be displayed on the

lower display). To disable the front passenger side temperature control, touch [DUAL] and turn off the DUAL mode.

INFO:

A visible mist may be seen coming from the ventilators in hot, humid conditions as the air is cooled rapidly. This does not indicate a malfunction.

Heating (A/C off)

The air conditioner does not activate in this mode. When you need to heat only, use this mode.

1. Touch [A/C] on the lower display. The A/C indicator will turn off.
2. Push **<^>** and **<v>** on the driver’s side to set the desired temperature.

INFO:

- When set the AUTO mode, the temperature of the passenger compartment will be maintained automatically. Air flow distribution and fan speed are also controlled automatically.

- Do not set the temperature lower than the outside air temperature. Otherwise, the system may not work properly.
- This mode is not recommended if the windows fog up.

Dehumidified defrosting or defogging

- Push $\langle \text{☁} \rangle$. The indicator light on the button will illuminate.
- Push $\langle \wedge \rangle$ and $\langle \vee \rangle$ on the driver's side to set the desired temperature.



INFO:

- To quickly remove ice from the outside of the windows, set the fan speed to the maximum.
- As soon as possible after the windshield is clean, push **AUTO** to return to the auto mode.
- When $\langle \text{☁} \rangle$ is pushed, the air conditioner will automatically be turned on at outside temperatures above 23°F (-5°C) to defog the windshield, and the air recirculate mode will automatically be turned off. Outside air is drawn into the passenger compartment to improve the defogging

performance.

ADVANCED CLIMATE CONTROL SYSTEM (if so equipped)

The Advanced Climate Control System keeps the air inside of the vehicle clean, using the automatic air circulation control with the exhaust gas/outside odor detecting sensor and with ion control.

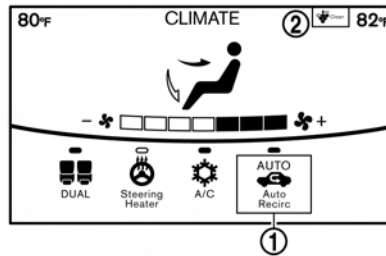

- [Auto Recirc]: Touch to turn on the automatic air recirculation mode.
- Plasmacluster[®] icon: Indicates the Plasmacluster[®] ion emission status.

Automatic air recirculation control with the exhaust gas/outside odor detection sensor:

The Advanced Climate Control system comes with an exhaust gas detection/outside odor sensor. When the automatic air circulation control is activated, the sensor detects odors outside the vehicle such as pulp or chemicals, and exhaust gas such as gasoline or diesel. When such odors or gases are detected, the display and the system automatically change from the fresh air mode to the recirculation mode.

When the automatic air circulation control mode is on, for the first 5 minutes, the air recirculation mode is selected to prevent dust, dirt and pollen from entering the vehicle and to clean the air inside of the vehicle.

After 5 minutes, the sensor detects exhaust gas and automatically alternates between the air recirculation mode and the fresh air mode.

3. Heater and air conditioner

INFO:

The automatic air recirculation mode can be activated under the following conditions.

- The air flow control is not in the windshield defrosting mode (the indicator light on  is turned off).
- The outside temperature is approximately 32 °F (0 °C) or above.

Ion control:

The Advanced Climate Control system unit generates highly concentrated Plasmacluster[®] ions into the air blown from the ventilators to reduce odor absorbed into the interior trim and to suppress airborne bacteria. The high-density Plasmacluster[®] ions also have a proven skin moisture preserving effect.

The Plasmacluster[®] icon on the CLIMATE screen indicates the status of the Plasmacluster[®] ion emission from the system and changes with the amount of the air flow.

OPERATING TIPS

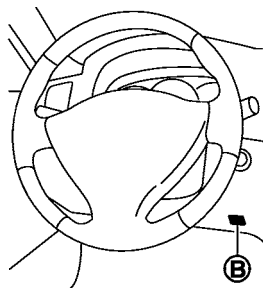
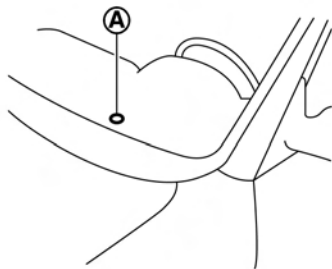

- The sensors **A** and **B** on the instrument panel helps maintain a constant temperature. Do not put anything on or around these sensors.
- When the engine coolant temperature and outside air temperature are low,

the air flow from the foot outlets may not operate. This is not a malfunction. After the coolant temperature warms up, air will flow normally from the foot outlets.

- A visible mist may be seen coming from the ventilators in hot, humid conditions as the air is cooled rapidly. This does not indicate a malfunction.

IN-CABIN MICROFILTER

With Advanced Climate Control system:

The Climate Control system is equipped with a natural grape seed polyphenol filter that collects and neutralizes dirt, pollen, dust, allergens (such as pollen, tick shells), etc. To make sure that the air conditioner heats, defogs and ventilates efficiently, replace the filter in accordance with the maintenance schedule in the INFINITI Service and Maintenance Guide (if so equipped) or the vehicle Owner's Manual. To replace the filter, contact an INFINITI retailer.

The filter should be replaced if the air flow decreases significantly or if windows fog up easily when operating the heater or air conditioner.

Without Advanced Climate Control system:

The Climate Control system is equipped with an in-cabin microfilter that collects dirt, pollen, dust, etc. To make sure that the air conditioner heats, defogs and ventilates efficiently, replace the filter in accordance with the maintenance schedule in the INFINITI Service and Maintenance Guide (if so equipped) or the vehicle Owner's Manual. To replace the filter, contact an INFINITI retailer.

The filter should be replaced if the air flow decreases significantly or if windows fog up easily when operating the heater or air conditioner.

SERVICING HEATER AND AIR CONDITIONER

The heating and air conditioning system in your vehicle is charged with a refrigerant designed with the environment in mind. **This refrigerant will not harm the earth's ozone layer.** However, special charging equipment and lubricant are required when servicing the air conditioner. Using improper refrigerants or lubricants will cause severe damage to your Climate Control system. Refer to Vehicle Owner's Manual for heating and air conditioning system

refrigerant and lubricant recommendations.

Your INFINITI retailer will be able to service your environmentally friendly heater and air conditioning system.



WARNING

The system contains refrigerant under high pressure. To avoid personal injury, any air conditioner service should be done only by an experienced technician with the proper equipment.

HEATED SEATS (if so equipped)



WARNING

Do not use or allow occupants to use the seat heater if you or the occupants cannot monitor elevated seat temperatures or have an inability to feel pain in those body parts in contact with the seat. Use of the seat heater by such people could result in serious injury.



CAUTION

- The battery could run down if the seat heater is operated while the engine or the hybrid system is not running.
- Do not use the seat heater for extended periods or when no one is using the seat.
- Do not put anything on the seat which insulates heat, such as a blanket, cushion, seat cover, etc. Otherwise, the seat may become overheated.
- Do not place anything hard or heavy on the seat or pierce it with a pin or similar object. This may result in damage to the heater.

3. Heater and air conditioner

- Any liquid spilled on the heated seat should be removed immediately with a dry cloth.
- When cleaning the seat, never use gasoline, thinner, or any similar materials.
- If any malfunctions are found or the heated seat does not operate, turn the switch off and have the system checked by an INFINITI retailer.

The front seats are warmed by built-in heaters. The seat heating system of driver's seat and front passenger seat can be operated independently.

Operation with buttons:

Each time  is pushed, the seat heating mode will change in the following order.

AUTO → High → Mid → Low → OFF

When seat heating system is activated, the indicator light on  will illuminate.

Operation with touch screen:

Touch [] on the lower display and select an item from [AUTO], [High], [Mid], [Low] or [OFF].

AUTO mode setting:

When in the AUTO mode, the seat heating will turn on/off automatically according to the conditions such as the temperature inside the vehicle compartment. Depending on the conditions, the seat heating will not turn on even if AUTO is selected. The settings for the seat heating AUTO mode can be changed.

 "Heater and air conditioner settings" (page 3-11)

HEATED STEERING-WHEEL (if so equipped)



WARNING

Do not use or allow occupants to come into contact with the heated steering-wheel if you or the occupants cannot monitor elevated steering-wheel temperatures or have an inability to feel pain in those body parts in contact. Use of the heated steering-wheel by such people could result in serious injuries.



CAUTION

- The battery could run down if the steering-wheel heater is operated while the engine or the hybrid system is not running.
- Do not use the steering-wheel heater for extended periods of time as it may cause burns and overheating.
- Any liquid spilled on the steering-wheel should be removed immediately with a dry cloth.
- When cleaning the steering-wheel, never use gasoline, thinner, or any similar

materials.

- If any malfunctions are found or the steering-wheel heater does not operate, turn the switch off and have the system checked by an INFINITI retailer.

Touch [Steering Heater] on the CLIMATE screen to turn on/off the steering-wheel heating manually. The steering-wheel heating will turn on and will turn off automatically after 30 minutes. When the steering-wheel heating is turned on, the indicator above [Steering Heater] will turn on.

If the surface temperature of the steering-wheel is above the temperature within which the system is designed to operate, the system will not heat the steering-wheel. This is not a malfunction.

Automatic steering-wheel heating can be turned on/off from the climate control settings screen.

 "Heater and air conditioner settings"
(page 3-11)

REAR WINDOW AND OUTSIDE MIRROR DEFROSTER



CAUTION

When cleaning the inner side of the rear window, be careful not to scratch or damage the rear window defroster.

To defog/defrost the rear window glass and outside mirrors, start the engine or the hybrid system and push . The indicator light on the button will illuminate. Push the button again to turn off the defroster.

The defroster will automatically turn off in approximately 15 minutes.

HEATER AND AIR CONDITIONER SETTINGS

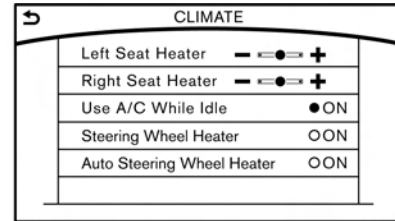

Heater and air conditioner settings can be changed on the screen.

1. Push **<MENU>**.
2. Touch [Settings] and [Other].
3. Touch [CLIMATE].

Available settings

- **Left/Right Seat Heater (if so equipped)**
The driver's seat and front passenger seat temperature settings for the automatic seat heating control mode can be changed separately.
- **Use A/C While Idle (if so equipped)**
Touch to turn on/off the Idling Stop Priority mode. When this item is turned on, using the Climate Control will not be affected by the Idling Stop activation.

3. Heater and air conditioner

Otherwise, the Climate Control system will stop activating with the deactivation of the engine as part of the Idling Stop function.

- **Steering Wheel Heater (if so equipped)**
Touch to turn the steering wheel heater on/off.
- **Auto Steering Wheel Heater (if so equipped)**

The automatic control mode for steering-wheel heating can be turned on/off. When this item is turned on, the steering-wheel heating will turn on automatically if the temperature inside the vehicle compartment is low at the time when the ignition switch is turned on. Regardless of the temperature, the steering-wheel heating will turn off after 30 minutes.

If the steering-wheel heater is turned on/off manually by touching [Steering Heater] on the CLIMATE screen, the automatic steering-wheel heating control mode will be canceled and will return to the manual mode.



INFO:

If the surface temperature of the steering-wheel is above the temperature within which the system is designed to operate, the system will not heat the steering-wheel. This is not a malfunction.

4 Audio system

Audio operation precautions.....	4-2	Radio	4-14
Radio	4-2	Compact Disc (CD) player.....	4-19
Compact Disc (CD) player	4-4	USB (Universal Serial Bus) connection	
USB (Universal Serial Bus) connection port	4-5	port	4-21
Compressed Audio Files (MP3/WMA/AAC)	4-7	iPod® player.....	4-24
Bluetooth® streaming audio.....	4-10	Bluetooth® streaming audio	4-27
Names and functions of audio control buttons....	4-11	Auxiliary (AUX) devices	4-31
Audio main buttons.....	4-11	Audio settings	4-32
Steering-wheel mounted audio		CD/USB memory device care and cleaning.....	4-34
control buttons	4-12	CD.....	4-34
Audio operations.....	4-12	USB memory device.....	4-34
Audio main operation.....	4-12	Gracenote® End User License Agreement	4-34

4. Audio system

AUDIO OPERATION PRECAUTIONS

RADIO

Push the ignition switch to the “ACC” or “ON” position before turning on the radio. If you listen to the radio with the engine or the hybrid system not running, the ignition switch should be pushed to the “ACC” position.

Radio reception is affected by station signal strength, distance from radio transmitter, buildings, bridges, mountains and other external influences. Intermittent changes in reception quality normally are caused by these external influences.

Using a cellular phone in or near the vehicle may influence radio reception quality.

Radio reception

Your radio system is equipped with state-of-the-art electronic circuits to enhance radio reception. These circuits are designed to extend reception range, and to enhance the quality of that reception.

However there are some general characteristics of both FM and AM radio signals that can affect radio reception quality in a

moving vehicle, even when the finest reception area, and do not indicate any malfunction in your radio system.

Reception conditions will constantly change because of vehicle movement. Buildings, terrain, signal distance and interference from other vehicles can work against ideal reception. Described below are some of the factors that can affect your radio reception.

Some cellular phones or other devices may cause interference or a buzzing noise to come from the audio system speakers. Storing the device in a different location may reduce or eliminate the noise.

FM radio reception

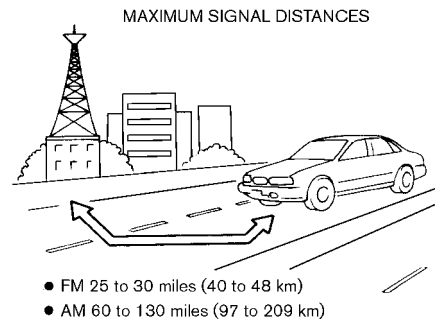

Range: the FM range is normally limited to 25 to 30 miles (40 to 48 km), with monaural (single station) FM having slightly more range than stereo FM. External influences may sometimes interfere with FM station reception even if the FM station is within 25 miles (40 km). The strength of the FM signal is directly related to the distance between the transmitter and receiver. FM signals follow a line-of-sight path, exhibiting many of the same characteristics as light. For example they will reflect off objects.

Fade and drift: As your vehicle moves away from a station transmitter, the signals will tend to fade and/or drift.

Static and flutter: During signal interference from buildings, large hills or due to antenna position, usually in conjunction with increased distance from the station transmitter, static or flutter can be heard. This can be reduced by lowering the treble setting to reduce the treble response.

Multipath reception: Because of the reflective characteristics of FM signals, direct and reflected signals reach the receiver at the same time. The signals may cancel each other, resulting in momentary flutter or loss of sound.

AM radio reception

AM signals, because of their low frequency, can bend around objects and skip along the ground. In addition, the signals can bounce off the ionosphere and be bent back to earth. Because of these characteristics, AM signals are also subject to interference as they travel from transmitter to receiver.

Fading: Occurs while the vehicle is passing through freeway underpasses or in areas with many tall buildings. It can also occur

for several seconds during ionospheric turbulence even in areas where no obstacles exist.

Static: Caused by thunderstorms, electrical power lines, electric signs and even traffic lights.

HD Radio™ Technology reception (for U.S.)

HD Radio™ Technology reception needs to be activated to receive HD Radio broadcasts.

 “Audio settings” (page 4-32)

This enables you to receive radio broadcasts digitally (where available), providing a better quality sound with clear reception. When this feature is not activated or HD Radio broadcasts are not available, you will receive analog radio (AM/FM) broadcasts.

Satellite radio reception

When the satellite radio is used for the first time or the battery has been replaced, the satellite radio may not work properly. This is not a malfunction. Wait more than 10 minutes with the satellite radio ON and the vehicle outside of any metal or large building for the satellite radio to receive

all of the necessary data.

The satellite radio mode requires an active SiriusXM Satellite Radio subscription. The satellite service is available only to those at least 18 and older in the 48 contiguous United States.

The satellite radio performance may be affected if cargo carried on the roof blocks the satellite radio signal.

If possible, do not put cargo near the satellite antenna.

A buildup of ice on the satellite radio antenna can affect satellite radio performance. Remove the ice to restore satellite radio reception.

4. Audio system

COMPACT DISC (CD) PLAYER

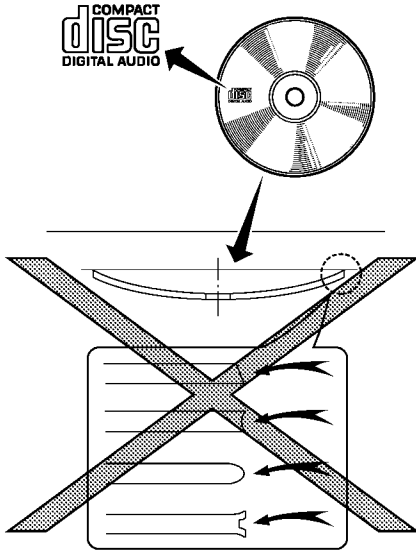

- Do not force a compact disc into the CD insert slot. This could damage the CD and/or CD player.
- Trying to load a CD with the CD door closed could damage the CD and/or CD

player.

- During cold weather or rainy days, the player may malfunction due to the humidity. If this occurs, remove the CD and dehumidify or ventilate the player completely.
- The player may skip while driving on rough roads.
- The CD player sometimes cannot function when the passenger compartment temperature is extremely high. Decrease the temperature before use.
- Only use high quality 4.7 in (12 cm) round discs that have the "COMPACT disc DIGITAL AUDIO" logo on the disc or packaging.
- Do not expose the CD to direct sunlight.
- CDs that are of poor quality, dirty, scratched, covered with fingerprints or that have pin holes may not work properly.
- The following CDs may not work properly:
 - Copy control compact discs (CCCD)
 - Recordable compact discs (CD-R)

— Rewritable compact discs (CD-RW)

- Do not use the following CDs as they may cause the CD player to malfunction.
 - 3.1 in (8 cm) discs
 - CDs that are not round
 - CDs with a paper label
 - CDs that are warped, scratched, or have abnormal edges
- This audio system can only play pre-recorded CDs. It has no capabilities to record or burn CDs.
- If the CD cannot be played, one of the following messages will be displayed.

Disc read error:

Indicates a CLV, Focus, TOC or Access error. Check and reinsert the CD. Make sure that it is inserted correctly.

Eject disc, please:

Indicates a mechanism error. If the CD can be ejected, eject and reinsert the CD. If the CD cannot be ejected, contact an INFINITI retailer.

Unplayable error:

Indicates that a readable file is not found on the inserted CD. Check the

data in your CD.

USB (Universal Serial Bus) CONNECTION PORT



WARNING

Do not connect, disconnect or operate the USB device while driving. Doing so can be a distraction. If distracted you could lose control of your vehicle and cause an accident or serious injury.



CAUTION

- Do not force the USB device into the USB port. Inserting the USB device tilted or up-side-down into the port may damage the port. Make sure that the USB device is connected correctly into the USB port.
- Do not grab the USB port cover (if so equipped) when pulling the USB device out of the port. This could damage the port and the cover.
- Do not leave the USB cable in a place where it can be pulled unintentionally. Pulling the cable may damage the port.

device. USB devices should be purchased separately as necessary.

This system cannot be used to format USB devices. To format a USB device, use a personal computer.

In some jurisdictions, the USB device for the front seats plays only sound without images for regulatory reasons, even when the vehicle is parked.

This system supports various USB memory devices, USB hard drives and iPod® players. Some USB devices may not be supported by this system.

- Partitioned USB devices may not be played correctly.
- Some characters used in other languages (Chinese, Japanese, etc.) are not displayed properly on the display. Using English language characters with a USB device is recommended.

General notes for USB use:

Refer to your device manufacturer's owner information regarding the proper care of the device.

Notes for iPod® use:

- Improperly plugging in the iPod® may cause a checkmark to be displayed on and off (flickering). Always make sure that the iPod® is connected properly.
- Audiobooks may not play in the same order as they appear on an iPod®.
- Large video files cause slow responses in an iPod®. The vehicle dual display may momentarily black out, but it will soon recover.
- If an iPod® automatically selects large video files while in the shuffle mode, the vehicle dual display may momentarily black out, but it will soon recover.

The vehicle is not equipped with a USB

4. Audio system

Specification chart for USB

Supported media	USB2.0
Supported file systems	FAT32
Folder levels	Folder levels: 8, Folders: 512 (including root folder), Files: 5000

Format		Sampling rate	Supported/Not supported
MPEG1	Layer-1	-	Not supported
	Layer-2	-	Not supported
	Layer-3	44.1, 48, 32 kHz	Supported (32-320 kbps)
MPEG2	Layer-1	-	Not supported
	Layer-2	-	Not supported
	Layer-3	22.05, 24, 16 kHz	Supported (16-160 kbps)
MPEG2.5	Layer-1	-	Not supported
	Layer-2	-	Not supported
	Layer-3	11.025, 12, 8 kHz	Supported (16-160 kbps)
WMA *1		32, 44.1, 48 kHz	Supported VER.7/8 (48-192 bps) VER.9/9.1/9.2 (48-320 bps)
AAC (MPEG4) *2 (Extension "m4a" only)		8, 11.025, 12, 16, 22.05, 24, 32, 44.1, 48 kHz	Supported (16-320 kbps)

*1 Professional (Voice, Lossless, multichannel) is not supported.

*2 MPEG-2 AAC is not supported.

COMPRESSED AUDIO FILES (MP3/WMA/AAC)

Explanation of terms

- **MP3** — MP3 is short for Moving Pictures Experts Group Audio Layer 3. MP3 is the most well known compressed digital audio file format. This format allows for near “CD quality” sound, but at a fraction of the size of normal audio files. MP3 conversion of an audio track can reduce the file size by approximately a 10:1 ratio (Sampling: 44.1 kHz, Bit rate: 128 kbps) with virtually no perceptible loss in quality. The compression reduces certain parts of sound that seem inaudible to most people.
- **WMA** — Windows Media Audio (WMA) is a compressed audio format created by Microsoft as an alternative to MP3. The WMA codec offers greater file compression than the MP3 codec, enabling storage of more digital audio tracks in the same amount of space when compared to MP3s at the same level of quality.

- **Bit rate** — Bit rate denotes the number of bits per second used by a digital music file. The size and quality of a compressed digital audio file is determined by the bit rate used when encoding the file.
 - **Sampling frequency** — Sampling frequency is the rate at which the samples of a signal are converted from analog to digital (A/D conversion) per second.
 - **Multisession** — Multisession is one of the methods for writing data to media. Writing data once to the media is called a single session, and writing more than once is called a multisession.
 - **ID3/WMA Tag** — The ID3/WMA tag is the part of the encoded MP3 or WMA file that contains information about the digital music file such as song title, artist, album title, encoding bit rate, track time duration, etc. ID3 tag information is displayed on the Album/Artist/Track title line on the display.
- * Windows® and Windows Media® are registered trademarks or trademarks of Microsoft Corporation in the United States of America and/or other countries.

Playback order

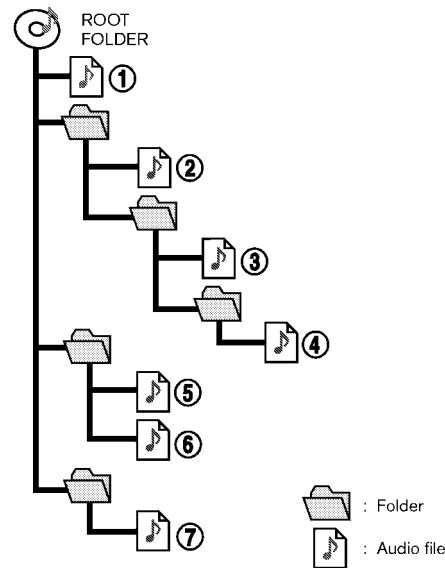

- The folder names of folders not containing compressed audio files are not shown in the display.
- If there is a file in the top level of a disc/USB, “Root Folder” is displayed.

4. Audio system

- The playback order is the order in which the files were written by the writing software, so the files might not play in the desired order.
- Music playback order of compressed audio files is as illustrated.

Specification chart for CD

Supported media		CD, CD-R, CD-RW	
Supported file systems		CD, CD-R, CD-RW	
Supported ver- sions*1	MP3	Version	MPEG1 Audio Layer3, MPEG2 Audio Layer3, MPEG2.5 Audio Layer3
		Sampling frequency	MPEG2.5 Audio Layer3: 8kHz, 11.025kHz, 12kHz MPEG2 Audio Layer3: 16kHz, 22.05kHz, 24kHz MPEG1 Audio Layer3: 32kHz, 44.1kHz, 48kHz
		Bit rate	8 kbps - 320 kbps, VBR
	WMA*2	Version	WMA7, WMA8, WMA9, WMA9.1, WMA9.2
		Bit rate/Sampling frequency	Bit rate: Ver7, Ver8: 32-192kbps Ver9, Ver9.1, Ver9.2: 32-192kbps, VBR Sampling frequency: Ver7, Ver8: 8k/11.025k/16k/22k/32k/44.1k Ver9, Ver9.1, Ver9.2: 8k/11.025k/16k/22k/32k/44.1k/48 kHz
	AAC*4	Bit rate/Sampling frequency	Bit rate: 8-320 kbps, VBR Sampling frequency: 11.025-48kHz
Tag information (Song title, Artist name and Album name)		ID3 tag VER1.0, VER1.1, VER2.2, VER2.3, VER2.4 (MP3 only)	
		WMA tag (WMA only)	
		AAC Tag (AAC only)	
Folder levels		CD, CD-R, CD-RW: Folder levels: 8, Folders: 255 (including root folder), Files: 510 (Max. 255 files for one folder)	
Displayable character codes*3		01: SHIFT-JIS, ASCII, ISO-8859-1, UTF-8, UTF-16 BOM, UTF-16 Big Endian, UTF-16 Little Endian, 02: UNICODE, 03: UTF-16	

*1 Files created with a combination of 48 kHz sampling frequency and 64 kbps bit rate cannot be played.

*2 Protected WMA files (DRM) cannot be played.

*3 Available codes depend on what kind of media, versions and information are going to be displayed.

4. Audio system

*4 Made by iTunes.

Windows Media Player

This product is protected by certain intellectual property right of Microsoft. Use or distribution of such technology outside of this product is prohibited without a license from Microsoft.

BLUETOOTH® STREAMING AUDIO

- Some Bluetooth® audio devices may not be recognized by the in-vehicle audio system.
- It is necessary to set up the wireless connection between a compatible Bluetooth® audio device and the in-vehicle Bluetooth® module before using the Bluetooth® streaming audio.
- The Bluetooth® streaming audio may be stopped under the following conditions:
 - Receiving a hands-free call.
 - Checking the connection to the hands-free phone.
 - Connecting the hands-free phone or the audio device.
 - Downloading the phonebook memory from the connected cellular phone.
- Do not place a Bluetooth® audio device in an area surrounded by metal or far away from the in-vehicle Bluetooth® module to prevent tone quality degradation and wireless connection disruption.
- While an audio device is connected through a Bluetooth® wireless connection, the battery of the device may discharge quicker than usual.
- This system supports the Bluetooth® Advanced Audio Distribution Profile (A2DP) and Audio/Video Remote Control Profile (AVRCP).
- Wireless LAN (Wi-Fi) and the Bluetooth® functions share the same frequency band (2.4 GHz). Using the Bluetooth® and the wireless LAN functions at the same time may slow down or disconnect the communication and cause

undesired noise. It is recommended that you turn off the wireless LAN (Wi-Fi) when using the Bluetooth® functions.

NAMES AND FUNCTIONS OF AUDIO CONTROL BUTTONS

AUDIO MAIN BUTTONS

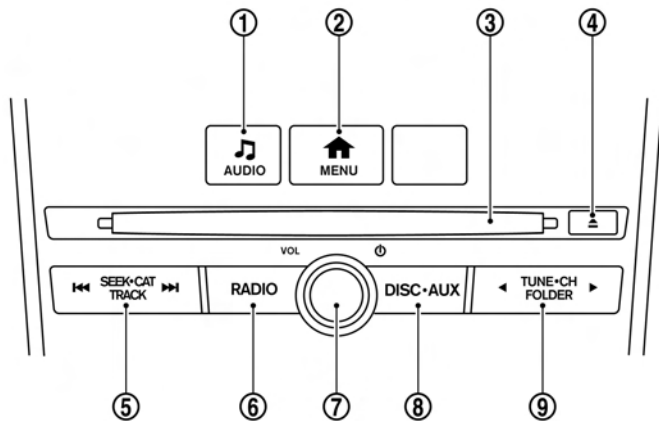

① <AUDIO>:

Push to display the audio screen of the previously selected source.
Push again to display the audio source list screen.

② <MENU>:

Push this button to go to the menu

screen.

③ CD slot:

Insert a CD with the label side facing up.

④ <▲>:

Push to eject a CD.

⑤ <SEEK-CAT-TRACK>:

Functions to change radio stations/channels or to skip and fast-forward/rewind through tracks.

⑥ <RADIO>:

Push to switch to the radio mode. The radio band will shift in the order of AM, FM and SXM (SiriusXM) each time the button is pushed.

⑦ <VOL/ ⏻>:

Push to turn on/off the audio system. Turn to adjust the volume.

⑧ <DISC-AUX>:

Each time the button is pushed, a different audio source (CD, USB, iPod®, Bluetooth® Audio or AUX) will be selected.

⑨ <TUNE-CH-FOLDER>:

Functions to manually tune AM/FM, to select SXM categories, to fast-forward/rewind tracks and to select MP3/WMA/AAC folders.

4. Audio system

STEERING-WHEEL MOUNTED AUDIO CONTROL BUTTONS

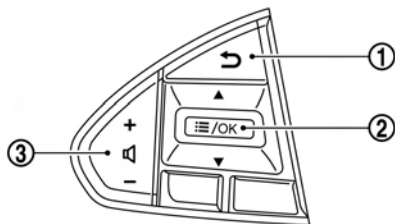

① < ↶ > (BACK):

Push to go back to the previous screen or cancel the selection if it is not completed.

② < ≡ /OK >:

Tilting the switch up/down while the audio system is turned on with the map or display view screen displayed on the upper touch screen display (upper display) can operate the audio system such as changing tracks and radio stations.

Models with navigation system:

Push to select audio source or display the audio list.

☞ “Shortcut menu (models with navigation system)” (page 2-11)

③ < - 🔊 + > (Volume control):

Push the upper (+) or lower (-) side of the switch to increase or decrease the volume.

AUDIO OPERATIONS

AUDIO MAIN OPERATION

Turning audio system on/off

The ignition switch must be in the “ACC” or “ON” position to turn on the audio system. Push <VOL/ 🔊 > to turn on the last audio source that was playing immediately before the system was turned off. To turn off the audio system, push <VOL/ 🔊 > again.

Selecting audio source

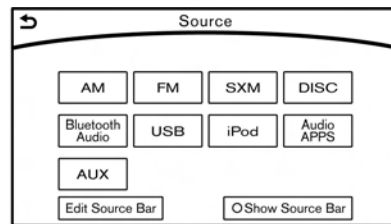

1. Turn on the audio source menu screen by pushing <AUDIO> or touching [Source] on the upper left corner of the audio screen.
2. Select an item from the audio source menu screens.



INFO:

- Pushing <RADIO> or <DISC-AUX> can also change the audio source.
☞ “Audio main buttons” (page 4-11)
- If the audio system has been turned off while the radio, CD, USB memory device or Bluetooth® Streaming Audio device was playing, turning the audio system back on will play the audio source that was playing when the system was turned off.
- The audio source can also be changed with the source bar (if so equipped) on top of the audio screen. The source bar display can be turned on/off.
- The audio system settings can be linked and memorized for each of the Intelligent Keys.
☞ “Fully customizable digital environment” (page 8-29)

Audio source bar

It is possible to display the source select bar on the audio screen

The default setting of the audio source bar display is ON.

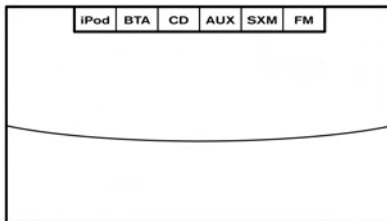

Turning source bar on/off:

1. Touch [Source] on the upper left corner of the audio screen.
2. Touch [Show Source Bar] to turn on/off the indicator.

Setting source bar:

The audio sources to be displayed on the source bar can be set.

1. Touch [Source] on the upper left corner of the audio screen.
2. Touch [Edit Source Bar].
3. Touch one of the keys on the source bar and then touch one of the audio

sources from source list to register the audio source in the source bar.

4. Audio system

RADIO

How to view radio screen

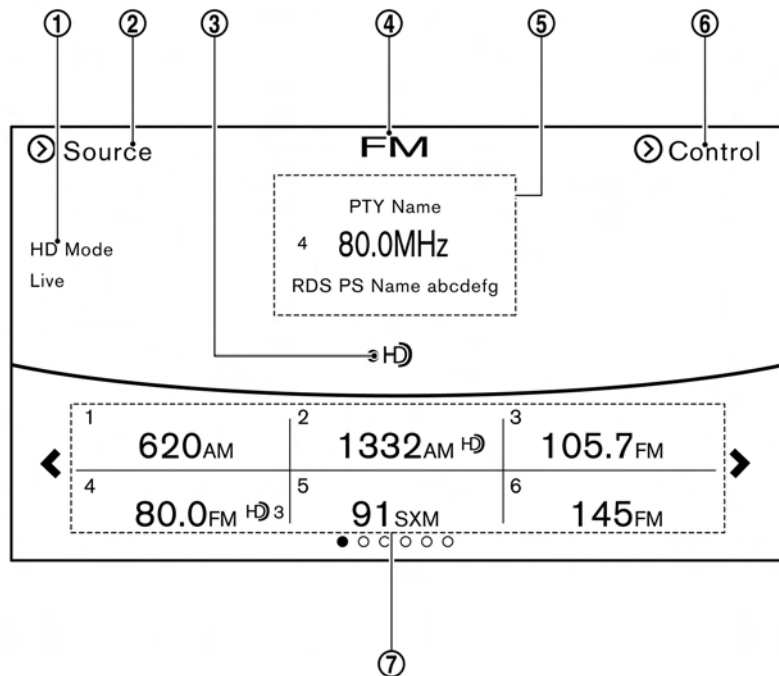

The radio screen can be viewed and operated on the lower touch screen display (lower display).

- 1** Radio mode indicator:
The current radio mode is displayed.
- 2** [Source]:
Touch to switch to the source select screen.
☞ “Selecting audio source”
(page 4-12)
- 3** HD Radio reception status indicator (for AM and FM):
The icon is displayed when HD Radio digital signal is received. The icon flashes when the radio is acquiring the digital signal but the sound output is not yet in the HD mode.
- 4** Radio band indicator:
Current radio band (AM, FM or SXM) is displayed.
- 5** Reception information display:
Reception information available at the time such as frequency, station/channel name, etc. are displayed.
On the SXM screen, touch this area to display the category list.

⑥ [Control]:

Touch to display the control screen.

 “Radio controls” (page 4-16)

⑦ Preset list:

36 stations/channels (FM/AM/SXM) can be registered in the preset list.

 “Presetting” (page 4-15)

**INFO:**

HD Radio reception needs to be activated to receive HD Radio broadcasts. This enables you to receive radio broadcasts digitally (where available), providing a better quality sound with clear reception. When this feature is not activated or HD Radio broadcasts are not available, you will receive analog radio (AM/FM) broadcasts.

Radio operation**Radio activation and band selection:**

Push **<RADIO>** or select the preferred radio band (AM, FM or SXM) from the audio source list to turn on the radio. Each time **<RADIO>** is pushed, the radio band will change.

 “Selecting audio source” (page 4-12)

**INFO:**

When the stereo broadcast signal is weak, the radio will automatically change from stereo to monaural reception.

Seeking stations/channels:**AM and FM radio**

Push **<SEEK-CAT-TRACK>** to tune from low to high or high to low frequencies and to stop at the next broadcasting station.

Tilting and holding **<≡ /OK>** on the steering-wheel will also seek up/down to the next station.

SiriusXM Satellite Radio

Push **<SEEK-CAT-TRACK>** to tune to the first channel of the next or previous category.

Tilting and holding **<≡ /OK>** on the steering-wheel will also fast tune the channels.

Scan tuning:

To scan tune the stations/channels, touch [Control] on the lower display and touch [Scan]. The stations/channels will be tuned from low to high frequencies and stop at each broadcasting station/channel for 5 seconds. Touching [Scan] again during this 5 seconds period will stop scan tuning and

the radio will remain tuned to that station/channel.

Presetting:

Up to 36 stations/channels can be registered for AM, FM and SXM in the preset list.

1. Select a radio band (AM, FM or SXM).
2. Tune to the station/channel you wish to store in the preset list.
3. Touch and hold one of the preset numbers in the preset list.
4. The information such as frequency (AM/FM), channel number (SXM), etc. will be displayed on the preset list.

**INFO:**

- To change the preset stations/channels, touch and hold one of the preset numbers. You can select whether to change the station/channel or to delete the preset setting.
- Tilting **<≡ /OK>** will scroll up/down the preset stations/channels.

Alert Notification (SXM only):

Favorite artists and songs can be registered to receive an alert notice when a song

4. Audio system

of the registered conditions is on the radio. To tune to the respective channel, touch [Listen to be consistent]. The alert can be ignored by touching [Cancel].

 “Radio controls” (page 4-16)



INFO:

Satellite Radio:

- The satellite mode requires an active SiriusXM Satellite Radio subscription. The Satellite service is available only to those at least 18 and older in the 48 contiguous United States.
- It may take some time to receive the activation signal after the initiation of the SiriusXM Satellite Radio subscription. After receiving the activation signal, an available channel list will automatically be updated in the radio. Push the ignition switch from LOCK to ACC to update the SiriusXM channel list.

Radio controls



Touch [Control] on the AM, FM or SXM screen to display the control screen.

The following items are available.

FM/AM:

[Station List]	Touch to display the available station list. While listening to FM radio, Auto Update is not performed.
[Scan]	Touch to scan tune the stations.  “Radio operation” (page 4-15)
[HD mode]	When this item is turned on, the analog and digital reception switches automatically. When this item is turned off, the reception is fixed in the analog mode.
[HD Info]	Touch to display the HD Radio information such as name of song, artist and album. This item is available when [RDS-Info] is not active.
[Tag] (HD Radio broadcasts only)	Touch to register the tag information for iTunes Tagging. If an iPod® is plugged in after the registration, the tag information can be stored in an iPod® and be used to purchase the songs via iTunes.
[RDS Info] (FM only)	Touch to display the RDS information. This item is available when [HD radio Info] is not active.

SXM:

[Categories]	Touch to display the category list.
[Direct Tune]	Touch to display the keypad to enter the frequency and directly tune to the channel.  “Radio operation” (page 4-15)
[Scan]	Touch to scan tune the channels.  “Radio operation” (page 4-15)
[Instant Replay]	Up to 30 minutes of the broadcast of the channel that has been tuned in to can be replayed. Touch to select from [▶], [⏮], [▶▶], [◀◀], [▶▶] and [◀◀].
[Tag]	Touch to register the tag information for iTunes Tagging. If an iPod® is plugged in after the registration, the tag information can be stored in an iPod® and be used to purchase the songs via iTunes.

4. Audio system

[Other]	[Favorite Artists]	Touch to set a favorite artists alert notification. Up to 8 artists can be registered. While a song of your favorite artist is playing, touch the list and touch [Add]/[Update]. To receive the alert notification, select [Notify Alert ON].
	[Favorite Songs]	Touch to set a favorite songs alert notification. Up to 8 songs can be registered. While a song of your favorite artist is playing, touch the list and touch [Add]/[Update]. To receive the alert notification, select [Notify Alert ON].
	[Customize Channel List]	Touch to customize the channel list. Only the selected channels will be tuned in to when you seek or scan the channels. You can select each item or select [All Select]/[Deselect All].
	[Favorite Artists Now Playing]	Touch to display the artist list for an alert notice.
	[Favorite Songs Now Playing]	Touch to display the song list for an alert notice.
	[Favorite Alert Settings]	Touch to turn on/off the alert notice for the registered favorite artists and songs.
	[Channel Locking Settings]	Touch to select or unselect the channel that you wish to lock out. A passcode is required to change the settings. The default passcode is 1234.

COMPACT DISC (CD) PLAYER

How to view CD screen

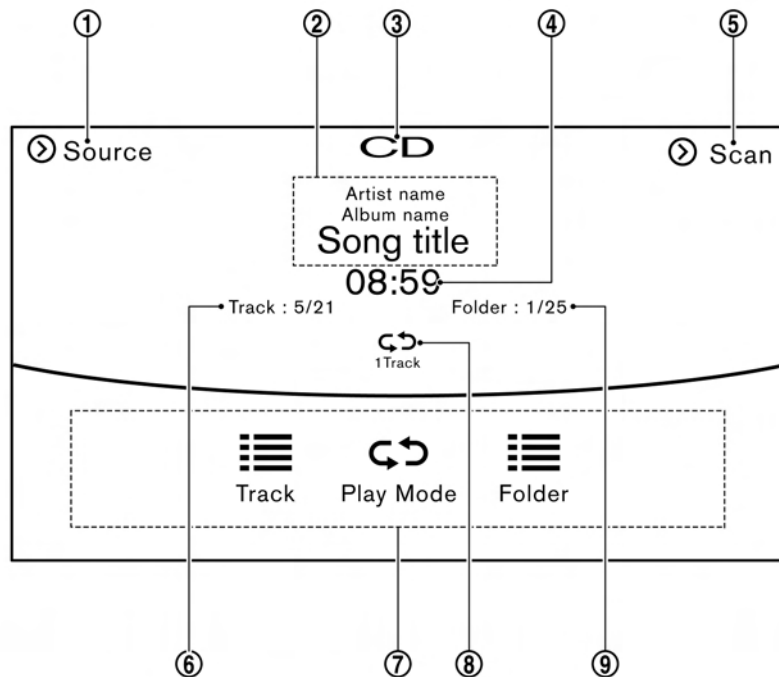

- ① [Source]:
Touch to switch to the source select screen.
☞ “Selecting audio source”
(page 4-12)
- ② Track information:
Track information such as the song title, artist name and album name are displayed.
- ③ Audio source indicator:
Indicates that CD is currently selected among other sources.
- ④ Play time:
The play time of the track is displayed.
- ⑤ [Scan]:
Touch to play the first 10 seconds of all the tracks. Touch again to stop scanning.
- ⑥ Track number:
Indicates the current track number and the total numbers of tracks.
- ⑦ CD menu:
CD menu items are displayed. Touch an icon to display the list or to change the setting.
- [Track]



4. Audio system

- [Folder] (for MP3, WMA, AAC)
- [Play Mode]





⑧ Play Mode Indicator:

Indicates the current play mode. Touch to change the play mode.

For CDs without compressed audio files:

Mode	Screen display
Disc Repeat	 Disc
1 Track Repeat	 1 Track
Disc Random	 Disc

For CDs with compressed audio files:

Mode	Screen display
Disc Repeat	 Disc
1 Folder Repeat	 1 Folder
1 Track Repeat	 1 Track
Disc Random	 Disc
1 Folder Random	 1 Folder

⑨ Folder number (for MP3, WMA, AAC):

Indicates the folder number when a CD with compressed audio files is loaded.

CD player operation

Loading:

Insert the CD into the slot with the label side facing up. The CD will be guided automatically into the slot and start playing.

After loading the CD, the CD screen will appear on the display.

Activation and playing:

The CD mode can be also selected from the source list or by pushing **<DISC-AUX>** with a CD loaded to play the CD.

 “Selecting audio source” (page 4-12)

 “Audio main buttons” (page 4-11)

If the system has been turned off while the CD was playing, pushing the ON-OFF button will start the CD.

Selecting track/folder:

Touch [Track] or [Folder] in the CD menu and select a preferred track or folder from the list.

Push **<SEEK-CAT-TRACK>** or tilt up/down **<≡ /OK>** on the steering-wheel briefly to move to the next or the previous track.

For CDs with compressed audio files, push

<TUNE-CH-FOLDER> or tilt and hold **<≡ /OK>** on the steering-wheel to move to the next or the previous folder.

 “Audio main buttons” (page 4-11)

Fast-forwarding/rewinding:

Push and hold the **<SEEK-CAT-TRACK>** to fast-forward or rewind the track. Release **<SEEK-CAT-TRACK>** to play the track at the ordinary speed.

Scanning:

Touch [Scan] on the lower display to scan the tracks in the CD. While scanning, the CD will play the first 10 seconds of each track and move on to the next track. Pushing [Scan] again within the 10 seconds will stop scanning.

Changing play mode:

Touch [Play Mode] on the lower display to select the play mode.

CD without compressed audio files:

- Disc Repeat
- 1 Track Repeat
- Disc Random

CD with compressed audio files:

- Disc Repeat
- 1 Folder Repeat
- 1 Track Repeat
- Disc Random
- 1 Folder Random

Ejecting CD:

Push <  > to eject a CD. If the CD is ejected and left unremoved, it will be reloaded into the slot for protection.

USB (Universal Serial Bus) CONNECTION PORT

Connecting USB memory device



WARNING

Do not connect, disconnect or operate the USB device while driving. Doing so can be a distraction. If distracted you could lose control of your vehicle and cause an accident or serious injury.



CAUTION

- Do not force the USB device into the USB port. Inserting the USB device tilted or up-side-down into the port may damage

the port. Make sure that the USB device is connected correctly into the USB port.

- Do not grab the USB port cover (if so equipped) when pulling the USB device out of the port. This could damage the port and the cover.
- Do not leave the USB cable in a place where it can be pulled unintentionally. Pulling the cable may damage the port.

Refer to your device manufacturer's owner information regarding the proper use and care of the device.

Two USB connectors are located in the center console box.

 "Media Hub" (page 2-6)

When compatible storage devices are plugged into the jack, compatible audio files on the storage devices can be played through the vehicle's audio system.

4. Audio system

How to view USB screen

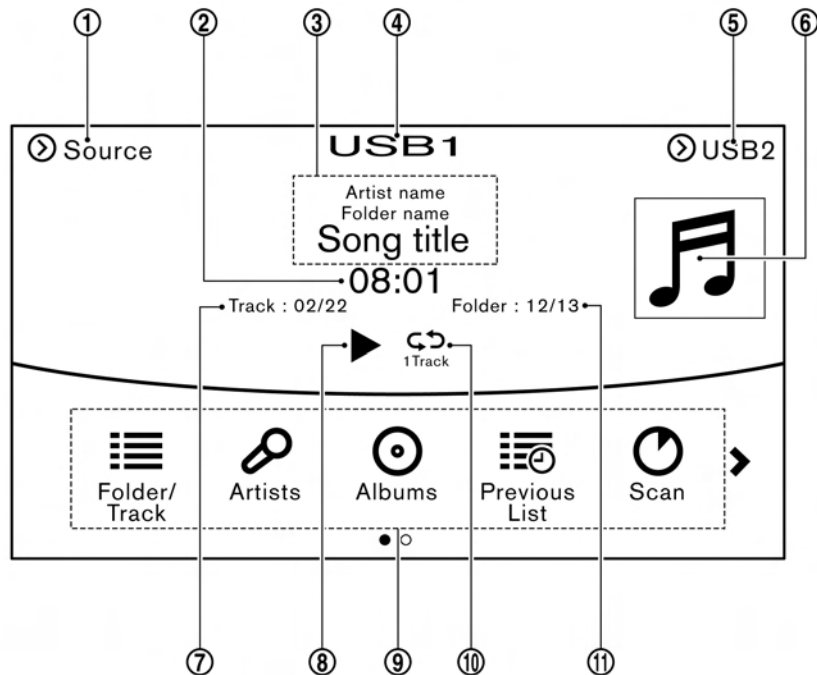

- ① [Source]:
Touch to switch to the source select screen.
🔍 “Selecting audio source”
(page 4-12)
- ② Play time:
The play time of the track is displayed.
- ③ Track information:
Track information such as the song title, artist name and folder name are displayed.
- ④ Audio source indicator:
Indicates which of the two USB memory devices is selected.
- ⑤ [USB1]/[USB2]:
Touch to switch to the other connected USB memory device.
- ⑥ Album artwork:
An image of the album artwork is displayed when available.
- ⑦ Track number:
Indicates the track number and the total number of tracks.
- ⑧ [▶] / [⏸]:
Touch to play or pause the track.





⑨ USB menu:

USB menu items are displayed. Touch an icon to display the list or to change the setting.

- [Folder/Track]
- [Artists]
- [Albums]
- [Previous List]
- [Scan]
- [Play Mode]

⑩ Play mode indicator:

Indicates the current play mode. Touch to change the play mode.

Mode	Screen display
All Track Repeat	 All
1 Folder Repeat	 1 Folder
1 Track Repeat	 1 Track
All Random	 All
1 Folder Random	 1 Folder

⑪ Folder number:

Indicates the folder, artist or album number and the total number of the folders/lists.

USB memory device player operation

Activation and playing:

Connecting the USB memory device into the connector will activate the USB mode.

The USB memory device can also be selected from the audio source list by the touch panel operation or by pushing **<DISC-AUX>**.

 "Selecting audio source" (page 4-12)

 "Audio main buttons" (page 4-11)

To play the USB memory device touch [▶], and to pause the USB memory touch [||].

Selecting play list:

Select a play list in the USB menu.

Available play list:

- [Folder/Track]
- [Artists]
- [Albums]
- [Previous List]
- [Scan]
- [Play Mode]

Skipping tracks/folders:

Push **<SEEK-CAT-TRACK>** or tilt up/down **<≡ /OK>** on the steering-wheel briefly to skip to the next or the previous track.

To skip to the next or the previous folder, push **<TUNE-CH-FOLDER>** or tilt and hold **<≡ /OK>** on the steering wheel.

Fast-forwarding/rewinding:

Push and hold **<SEEK-CAT-TRACK>** to fast-forward or rewind the track. Release to play the track at the ordinary speed.

Scanning:

Touch [Scan] in the USB menu to scan the tracks in the USB memory device. While scanning, the USB memory device will play the first 10 seconds of each track and move on to the next track. Touching [Scan] again within the 10 seconds will stop scanning.

Changing play mode:

Touch [Play Mode] on the lower display to select the play mode.

4. Audio system

iPod® PLAYER

Connecting iPod®



WARNING

Do not connect, disconnect or operate the USB device while driving. Doing so can be a distraction. If distracted you could lose control of your vehicle and cause an accident or serious injury.



CAUTION

- Do not force the USB device into the USB port. Inserting the USB device tilted or up-side-down into the port may damage the port. Make sure that the USB device is connected correctly into the USB port.
- Do not grab the USB port cover (if so equipped) when pulling the USB device out of the port. This could damage the port and the cover.
- Do not leave the USB cable in a place where it can be pulled unintentionally. Pulling the cable may damage the port.

information regarding the proper use and care of the device.

Two USB connectors are located in the center console box.

 “Media Hub” (page 2-6)

The battery of the iPod® will be charged while the device is connected to the vehicle if the iPod® supports charging via a USB connection.

Depending on the model and firmware version of the iPod®, the display on the iPod® shows an INFINITI or Accessory Attached screen when the connection is completed. When the iPod® is connected to the vehicle, the iPod® music library can only be operated by the vehicle audio controls.

Compatibility:

Made for

- iPod touch® (5th generation)
- iPod touch® (4th generation)
- iPod touch® (3rd generation)
- iPod touch® (2nd generation)
- iPod touch® (1st generation)

- iPod touch®
- iPod with video®
- iPod classic®
- iPod nano® (7th generation)
- iPod nano® (6th generation)
- iPod nano® (5th generation)
- iPod nano® (4th generation)
- iPod nano® (3rd generation)
- iPod nano® (2nd generation)
- iPod nano® (1st generation)
- iPhone 5®
- iPhone 4S®
- iPhone 4®
- iPhone 3GS®
- iPhone 3G®
- iPhone®



INFO:

- Make sure that the iPod® firmware is updated.
- The Lightning™ connector works with iPhone 5®, iPod touch® (5th generation),

Refer to your device manufacturer's owner

and iPod nano[®] (7th generation).

The 30-pin connector works with iPhone 4S[®], iPhone 4[®], iPhone 3GS[®], iPhone 3G[®], iPhone[®], iPod touch[®] (1st through 4th generation), iPod classic[®] and iPod nano[®] (1st through 6th generation).



USB works with iPhone 5[®], iPhone 4S[®], iPhone 4[®], iPhone 3GS[®], iPhone 3G[®], iPhone[®], iPod touch[®] (1st through 5th generation) iPod classic[®] and iPod nano[®] (1st through 7th generation).

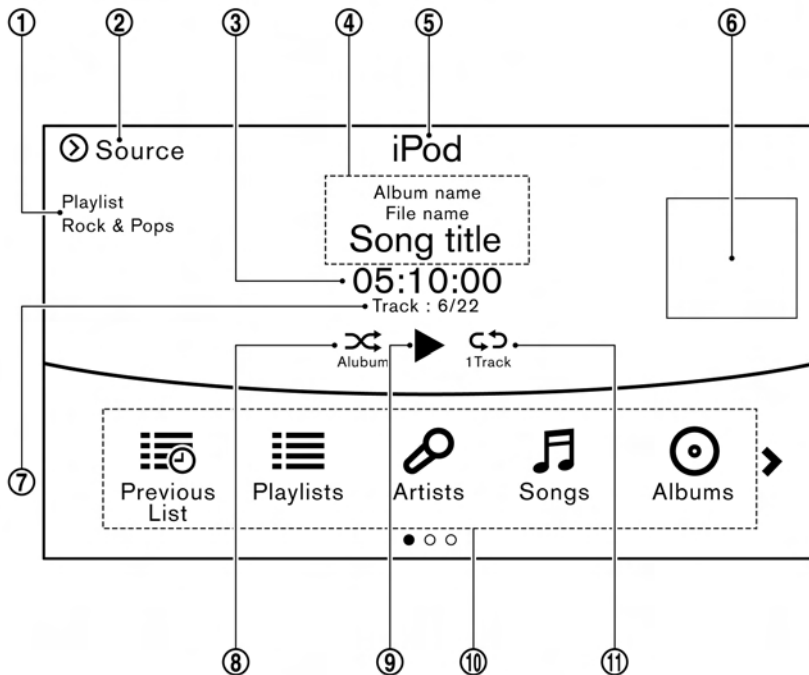

How to view iPod[®] screen





4. Audio system

- ① Search condition indicator:
Indicates the current search condition.
- ② [Source]:
Touch to switch to the source list screen.
 “Selecting audio source”
(page 4-12)
- ③ Play time:
The play time of the track is displayed.
- ④ Track information:
Track information such as the song title, artist name and album name are displayed.
- ⑤ Audio source indicator:
Indicates that iPod® is currently selected among other sources.
- ⑥ Album artwork:
An image of the album artwork is displayed when available.
- ⑦ Track number:
Indicates the track number and the total number of tracks.
- ⑧ Shuffle mode indicator:
Touch to change the shuffle mode.

Mode	Screen display
Shuffle Albums	 Album
All Songs	 Song
Shuffle Off	Shuffle OFF

- ⑨ [] / [] :
Touch to play/pause the track.
- ⑩ iPod® menu:
 - [Previous List]
 - [Playlists]
 - [Artists]
 - [Songs]
 - [Albums]
 - [Genres]
 - [Composers]
 - [Podcasts]
 - [Audiobooks]
 - [Shuffle]
 - [Repeat]
- ⑪ Repeat mode indicator:
Touch to change the repeat mode.

Mode	Screen display
All Track Repeat	 All
1 Track Repeat	 1 Track
Repeat Off	Repeat OFF

iPod® player operation



Activation and playing:

Connecting iPod® to the vehicle via USB cable will activate the iPod® mode.

iPod® can also be selected from the audio sources list by touch [Source] or by pushing **<DISC-AUX>**.

 “Selecting audio source” (page 4-12)

 “Audio main buttons” (page 4-11)

To play and pause the iPod®, touch []/[].

Selecting search method:

A list of search methods is displayed in the iPod® menu. Touch and select an item to play the iPod® in your preferred settings.

Fast-forwarding/rewinding:

Push and hold **<SEEK-CAT-TRACK>** to fast-forward or rewind the song. Release to play the song at the ordinary speed.

Changing play mode:

Touch [Shuffle] or [Repeat] from the iPod® menu to select the play mode.

Skipping songs:

Push <SEEK-CAT-TRACK> or tilt up/down <≡ /OK> briefly to skip to the next or the previous song.



INFO:

- Even when iPod® or iPhone® are inserted into both of the two USB connectors, the system recognizes only one of the connected iPod® or iPhone® at a time.
- Only one the two connected USB devices can be operated by the voice recognition system.

BLUETOOTH® STREAMING AUDIO

Your vehicle is equipped with Bluetooth® Streaming Audio.

If you have a compatible Bluetooth® device with streaming audio (A2DP profile), you can set up a wireless connection between your Bluetooth® device and the in-vehicle audio system. This connection allows you to listen to the audio from the Bluetooth® device using your vehicle speakers. It also

may allow basic control of the device for playing and skipping audio files using the AVRCP Bluetooth® profile. Not all Bluetooth® devices have the same level of controls for AVRCP. Please consult the manual for your Bluetooth® device for more details.

Wireless LAN (Wi-Fi) and the Bluetooth® functions share the same frequency band (2.4 GHz). Using the Bluetooth® and the wireless LAN functions at the same time may slow down or disconnect the communication and cause undesired noise. It is recommended that you turn off the wireless LAN (Wi-Fi) when using the Bluetooth® functions.

Regulatory information

FCC Regulatory information:

FCC ID: HYQDNNS086

NOTE

This device complies with part 15 of the FCC Rules. Operation is subject to the following two conditions: (1) This device may not cause harmful interference, and (2) this device must accept any interference received, including interference that may cause undesired operation.

FCC WARNING

Changes or modifications not expressly approved by the party responsible for compliance could void the user's authority to operate the equipment.

CAUTION: Radio Frequency Radiation Exposure

This equipment complies with FCC radiation exposure limits set forth for uncontrolled environment and meets the FCC radio frequency (RF) Exposure Guidelines. This equipment has very low levels of RF energy that it deemed to comply without maximum permissive exposure evaluation (MPE). But it is desirable that it should be installed and operated with at least 20 cm and more between the radiator and person's body.

Co-location: This transmitter must not be co-located or operated in conjunction with any other antenna or transmitter.

IC Regulatory information:

The antenna cannot be removed (and changed) by user.

4. Audio system

NOTE

This device complies with Industry Canada license-exempt RSS standard(s). Operation is subject to the following two conditions: (1) This device may not cause interference, and (2) this device must accept any interference, including interference that may cause undesired operation of the device.

CAUTION: Radio Frequency Radiation Exposure

This equipment complies with IC radiation exposure limits set forth for uncontrolled environment and meets RSS-102 of the IC radio frequency (RF) Exposure rules. This equipment has very low levels of RF energy that it deemed to comply without maximum permissive exposure evaluation (MPE). But it is desirable that it should be installed and operated with at least 20cm and more between the radiator and person's body.

Co-location: This transmitter must not be co-located or operated in conjunction with any other antenna or transmitter.

This Class B digital apparatus meets all requirements of the Canadian Interference-Causing Equipment Regulations.

Connecting Bluetooth streaming audio device

A Bluetooth streaming audio device must be connected to the vehicle before operation.

 “Connecting Bluetooth® device”
(page 2-22)

How to view Bluetooth® streaming audio screen

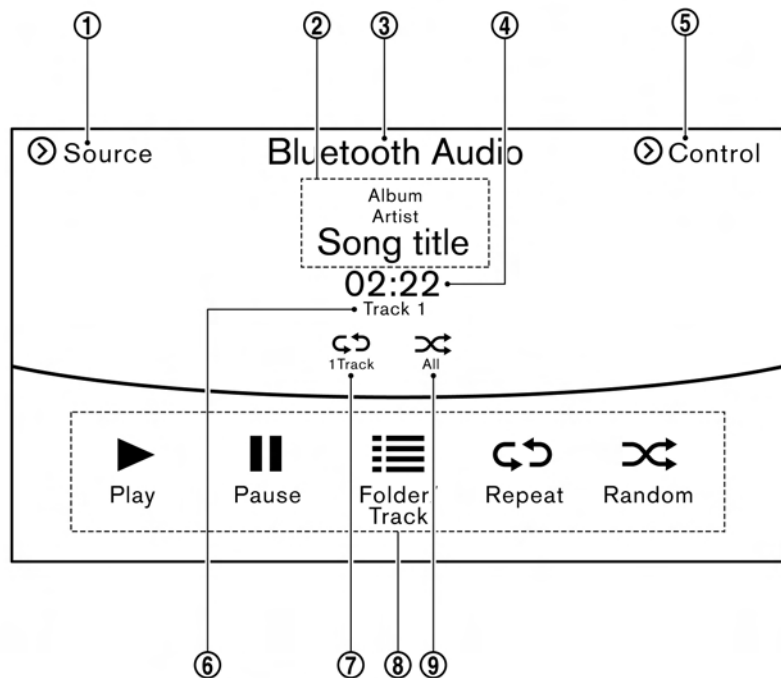

- ① [Source]:
Touch to switch to the source list screen.
👉 “Selecting audio source” (page 4-12)
- ② Track information:
Track information such as the song title, artist name and folder name are displayed.
- ③ Audio source indicator:
Indicates that Bluetooth® streaming audio is currently selected among other sources.
- ④ Play time:
The play time of the track is displayed.
- ⑤ [Control]:
Touch to display the control screen.
👉 “Bluetooth® streaming audio controls” (page 4-30)
- ⑥ Track number
Indicates the track number.
- ⑦ Repeat mode indicator:
Touch to change the repeat mode.

4. Audio system

Mode	Screen display
Repeat Off	↻ Off
All Track Repeat	↻ All
1 Folder Repeat	↻ 1 Folder
1 Track Repeat	↻ 1 Track

⑧ Bluetooth® streaming audio menu:

- [Play]
- [Pause]
- [Folder/Track]
- [Repeat]
- [Random]

⑨ Random mode indicator:

Touch to change the random mode.

Mode	Screen display
Random off	⌘ OFF
All Random	⌘ All
1 Folder Random	⌘ 1 Folder

INFO:

Depending on the audio device that is connected to the vehicle, track information may not be displayed.

Bluetooth® streaming audio operation

The ability to pause, change tracks, fast forward, rewind, randomize and repeat music may be different between devices. Some or all of these functions may not be supported on each device.

INFO:

- Depending on the Bluetooth® audio device that is connected, it may not be possible to perform audio operations.
- Depending on the Bluetooth® audio device that is connected, a time lag may occur before music is played back.

Activation and playing:

A Bluetooth® audio device can be selected from the audio sources list by touching [Source] or by pushing **<DISC-AUX>**.

 “Selecting audio source” (page 4-12)

 “Audio main buttons” (page 4-11)

To play the Bluetooth® audio device touch [Play], and to pause the Bluetooth® audio device touch [Pause] in the Bluetooth® streaming audio menu.

Selecting folder/file:

Touch [Folder/Track] to select a folder/file.

Changing play mode:

Touch [Repeat] or [Random] in the Bluetooth® streaming audio menu to change the play mode.

Fast-forwarding/rewinding:

Push and hold **<SEEK-CAT-TRACK>** to fast-forward or rewind the song. Release to play the song at the ordinary speed.

Skipping songs/folders:

Push **<SEEK-CAT-TRACK>** or tilt up/down **<≡ /OK>** on the steering-wheel briefly to skip to the next or the previous song.

To skip to the next or the previous folder, push **<TUNE-CH-FOLDER>** or tilt and hold **<≡ /OK>** on the steering-wheel.

Bluetooth® streaming audio controls

Touch [Control] on the Bluetooth® audio screen to display the control screen.

[Connect Device]	Touch to connect a new Bluetooth® device.
[Select Audio Device]	Touch to select a different Bluetooth® device from a list of registered Bluetooth® devices.  “Bluetooth® settings” (page 2-22)

AUXILIARY (AUX) DEVICES

Connecting auxiliary devices

The auxiliary input jacks are located in the center console box.

 “Media Hub” (page 2-6)

The auxiliary audio input jack accepts any standard analog audio input such as from a portable cassette player, CD player or MP3 player.

A video player can be connected to the auxiliary video input jack to play movies.

INFO:

Insert a 1/8 in (3.5 mm) stereo mini plug in the audio input jack. If a cable with a mono plug is used, the audio output may not function normally.

How to view AUX screen

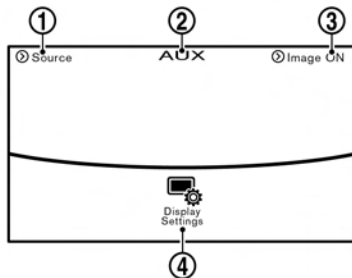

- ① [Source]:
Touch to switch to the source list screen.
 “Selecting audio source” (page 4-12)
- ② Audio source indicator:
Indicates that an AUX device is currently selected among other sources.
- ③ [Image ON]/[Image OFF]:
Touch to turn on/off the image displayed on the upper display. This item cannot be operated while driving.
- ④ [Display Settings]:
Touch to adjust the display settings on the upper display.

AUX operation

Activation and playing:

Turn on an AUX device.

Connecting an AUX device into the jack will activate the AUX mode.

AUX can be selected from the other audio sources by touching [Source] or by pushing **<DISC-AUX>**.

 “Selecting audio source” (page 4-12)

 “Audio main buttons” (page 4-11)

INFO:

Movies are displayed on the upper display while the audio information is displayed on the lower display.

4. Audio system

AUDIO SETTINGS

Audio settings can be adjusted or audio related functions can be turned on/off with the following procedure.

1. Touch **<MENU>**.
2. Touch [Settings].
3. Touch [Audio].

Available setting items may vary depending on models and specifications.

Setting items	Action
[Sound Settings]	
[Bass]	Adjust the speaker tone quality and sound balance by touching [+] / [-], [L] / [R] or [R] / [F].
[Treble]	
[Balance]	
[Fade]	
[Bose® Centerpoint]	When this item is turned on, surround sound playback is generated from a traditional stereo recording. Turn on the item to activate Bose® Centerpoint and to change its effect level with [Surround Vol].
[Bose® AudioPilot]	Adjusts the volume and sound quality depending on the changes of the vehicle speed and the noise picked up by the microphone. It compensates for noise for different road surface conditions and open windows. Turn on the item to activate Bose® AudioPilot.
[Surround Vol.]	Touch [+] / [-] to adjust the Surround Effect level if Bose® Centerpoint [ON].
[Speed Sensitive Vol]	Automatically adjusts the volume depending on the vehicle speed. Touch [+] / [-] to change the sensitivity level.
[Driver's Audio Stage]	When this item is turned on, a better sound will be provided to the driver's position. The driver can enjoy a more crisp and clear sound that is specialized for the driver's seat position. The prominence of the effect of this feature depends on the type of music that is played. For some music, it may be difficult to recognize the effect of the feature.

Setting items		Action
[Display Album Cover Art]		Turn the item on to display image files from the media device. If the media device does not contain images, no image will be displayed.
[Radio Settings]	[HD Mode AM]	When this item is turned on, the analog and digital reception switches automatically. When this item is turned off, the reception is fixed in the analog mode.
	[HD Mode FM]	
[AUX Settings]	[Image ON]/[Image OFF]	The image display on the upper display can be turned on/off.
	[AUX Image Display]	The image display size setting can be selected from [Normal], [Wide] and [Cinema].
	[Volume Setting]	The volume setting can be selected from [Low], [Medium] and [High].

**INFO:**

The [Radio Settings] and [AUX Settings] keys are displayed only while the corresponding audio source is playing.

4. Audio system

CD/USB MEMORY DEVICE CARE AND CLEANING

CD

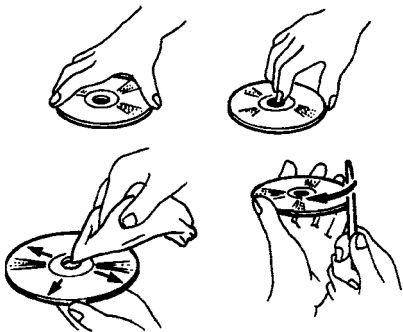

- Handle a CD/DVD by its edges. Never touch the surface of the disc. Do not bend the disc.
- Always place the discs in the storage case when they are not being used.
- To clean a disc, wipe the surface from the center to the outer edge using a clean, soft cloth. Do not wipe the disc using a circular motion.

Do not use a conventional record

cleaner or alcohol intended for industrial use.

- A new disc may be rough on the inner and outer edges. Remove the rough edges by rubbing the inner and outer edges with the side of a pen or pencil as illustrated.

USB MEMORY DEVICE

- Never touch the terminal portion of the USB memory device.
- Do not place heavy objects on the USB memory device.
- Do not store the USB memory device in highly humid locations.
- Do not expose the USB memory device to direct sunlight.
- Do not spill any liquids on the USB memory device.

Refer to the USB memory device Owner's Manual for the details.

GRACENOTE® END USER LICENSE AGREEMENT

This application or device contains software from Gracenote, Inc. of Emeryville, California ("Gracenote"). The software from Gracenote (the "Gracenote Software") enables this application to perform disc and/or file identification and obtain music-related information, including name, artist, track, and title information ("Gracenote Data") from online servers or embedded databases (collectively, "Gracenote Servers") and to perform other functions. You may use Gracenote Data only by means of the intended End-User functions of this application or device.

You agree that you will use Gracenote Data, the Gracenote Software, and Gracenote Servers for your own personal non-commercial use only. You agree not to assign, copy, transfer or transmit the Gracenote Software or any Gracenote Data to any third party. **YOU AGREE NOT TO USE OR EXPLOIT GRACENOTE DATA, THE GRACENOTE SOFTWARE, OR GRACENOTE SERVERS, EXCEPT AS EXPRESSLY PERMITTED HEREIN.**

You agree that your non-exclusive license

to use the Gracenote Data, the Gracenote Software, and Gracenote Servers will terminate if you violate these restrictions. If your license terminates, you agree to cease any and all use of the Gracenote Data, the Gracenote Software, and Gracenote Servers. Gracenote reserves all rights in Gracenote Data, the Gracenote Software, and the Gracenote Servers, including all ownership rights. Under no circumstances will Gracenote become liable for any payment to you for any information that you provide. You agree that Gracenote, Inc. may enforce its rights under this Agreement against you directly in its own name. The Gracenote service uses a unique identifier to track queries for statistical purposes. The purpose of a randomly assigned numeric identifier is to allow the Gracenote service to count queries without knowing anything about who you are. For more information, see the web page for the Gracenote Privacy Policy for the Gracenote service.

The Gracenote Software and each item of Gracenote Data are licensed to you “AS IS.” Gracenote makes no representations or warranties, express or implied, regarding the accuracy of any Gracenote Data from in

the Gracenote Servers. Gracenote reserves the right to delete data from the Gracenote Servers or to change data categories for any cause that Gracenote deems sufficient. No warranty is made that the Gracenote Software or Gracenote Servers are error-free or that functioning of Gracenote Software or Gracenote Servers will be uninterrupted. Gracenote is not obligated to provide you with new enhanced or additional data types or categories that Gracenote may provide in the future and is free to discontinue its services at any time.

GRACENOTE DISCLAIMS ALL WARRANTIES EXPRESS OR IMPLIED, INCLUDING, BUT NOT LIMITED TO, IMPLIED WARRANTIES OF MERCHANTABILITY, FITNESS FOR A PARTICULAR PURPOSE, TITLE, AND NON-INFRINGEMENT. GRACENOTE DOES NOT WARRANT THE RESULTS THAT WILL BE OBTAINED BY YOUR USE OF THE GRACENOTE SOFTWARE OR ANY GRACENOTE SERVER. IN NO CASE WILL GRACENOTE BE LIABLE FOR ANY CONSEQUENTIAL OR INCIDENTAL DAMAGES OR FOR ANY LOST PROFITS OR LOST REVENUES.

copyright © 2000 to present Gracenote

4. Audio system

MEMO

5 Hands-Free Phone

Bluetooth® Hands-Free Phone System	5-2
Phone	5-3
Hands-free text messaging assistant.....	5-6

Phone and text message assistant settings ...	5-9
Bluetooth® information	5-13



5. Hands-Free Phone

BLUETOOTH® HANDS-FREE PHONE SYSTEM



WARNING

- Use a phone after stopping your vehicle in a safe location. If you have to use a phone while driving, exercise extreme caution at all times so full attention may be given to vehicle operation.
- If you find yourself unable to devote full attention to vehicle operation while talking on the phone, pull off the road to a safe location and stop your vehicle before doing so.



CAUTION

To avoid draining the vehicle battery, use a phone after starting the engine or the hybrid system.

Your vehicle is equipped with Bluetooth® Hands-Free Phone System. If you are an owner of a compatible Bluetooth® enabled cellular phone, you can set up the wireless connection between your cellular phone and the in-vehicle phone module. With

Bluetooth® wireless technology, you can make or receive a telephone call with your cellular phone in your pocket.

Once a cellular phone is connected to the in-vehicle phone module, the procedure for connecting the phone does not need to be performed again. Your phone is automatically selected with the in-vehicle phone module when the ignition switch is pushed to the “ON” position with the selected cellular phone turned on and carried in the vehicle.

You can register up to 5 different Bluetooth® cellular phones in the in-vehicle phone module. However, you can talk on only one cellular phone at a time.

The Voice Recognition system supports phone commands, so dialing a phone number using your voice is possible.

“10. Voice recognition”

Before using the Bluetooth® Hands-Free Phone System, refer to the following notes.

- Wireless LAN (Wi-Fi) and the Bluetooth® functions share the same frequency band (2.4 GHz). Using the Bluetooth® and the wireless LAN functions at the same time may slow down or disconnect the communication and cause

undesired noise. It is recommended that you turn off the wireless LAN (Wi-Fi) when using the Bluetooth® functions.

- Set up the wireless connection between a compatible cellular phone and the in-vehicle phone module before using the Bluetooth® Hands-Free Phone System.
- Some Bluetooth® enabled cellular phones may not be recognized by the in-vehicle phone module.
Please visit www.infinitiusa.com/bluetooth/search for a recommended phone list.
- You will not be able to use a hands-free phone under the following conditions:
 - Your vehicle is outside of the telephone service area.
 - Your vehicle is in an area where it is difficult to receive radio waves; such as in a tunnel, in an underground parking garage, behind a tall building or in a mountainous area.
 - Your cellular phone is locked in order to prevent dialing.
- When the radio wave condition is not ideal or ambient sound is too loud, it may be difficult to hear the other

person's voice during a call.

- This Bluetooth® system supports Wideband Speech, which enhances the sound quality of phone calls placed over Bluetooth®. To take advantage of this feature, the mobile device should be used on a carrier supporting Adaptive Multi-Rate Wideband (AMR-WB) or HD Voice technology. The performance of AMR-WB may vary by carrier and calling area. Consult your mobile carrier if you experience issues with call quality or connection.
- Immediately after the ignition switch is pushed to the "ON" position, it may be impossible to receive a call for a short period of time.
- Do not place the cellular phone in an area surrounded by metal or far away from the in-vehicle phone module to prevent tone quality degradation and wireless connection disruption.
- While a cellular phone is connected through the Bluetooth® wireless connection, the battery power of the cellular phone may discharge quicker than usual.
- If the Bluetooth® Hands-Free Phone System seems to be malfunctioning, please visit www.infinitiusa.com/bluetooth for troubleshooting help.
- Some cellular phones or other devices may cause interference or a buzzing noise to come from the audio system speakers. Storing the device in a different location may reduce or eliminate the noise.
- Refer to the cellular phone Owner's Manual regarding the telephone pairing procedure specific to your phone, battery charging, cellular phone antenna, etc.
- The antenna display on the monitor may not coincide with the antenna display of some cellular phones.
- The battery display on the monitor may not coincide with the battery display of some cellular phones.
- Keep the interior of the vehicle as quiet as possible to hear the caller's voice clearly as well as to minimize its echoes.
- If reception between callers is unclear, adjusting the incoming or outgoing call

volume may improve the clarity.

- The microphone is located near the map light.

PHONE

Connecting Bluetooth Hands-free Phone

A cellular phone device must be connected to the Bluetooth Hands-free phone system before operation. Up to 5 cellular phones can be connected to the system.

 "Connecting Bluetooth® device"
(page 2-22)

Phone selection

Select one of the connected devices for operation.

1. Push **<MENU>** and touch [Phone] and touch [Select Phone]. A list of the connected cellular phones is displayed.
2. Touch one of the connected cellular phones from the list.
3. When the device selection is successful, a message on the lower touch screen display (lower display) indicates that the cellular phone was selected.

5. Hands-Free Phone

Making a call

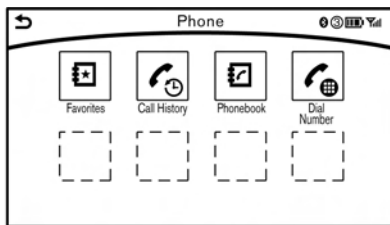

1. Push **<MENU>** and touch [Phone].
2. Select one of the following methods and make a call.

Available methods

- [Favorites]:
Select a telephone number from a list of personally selected numbers.
- [Call History]:
Select a telephone number from recent incoming or outgoing calls.
- [Phonebook]:
Select a telephone number from the phonebook.
The telephone number must be transferred to the phonebook from the cellular phone prior to using this method.
☞ “Phone settings” (page 5-9)

- [Dial Number]:
Input the phone number manually using the keypad displayed on the screen. Touch [Call] to call the number.
☞ “How to input letters and numbers” (page 2-10)
3. Dialing will start and the screen will change to the call in progress screen.

Receiving a call

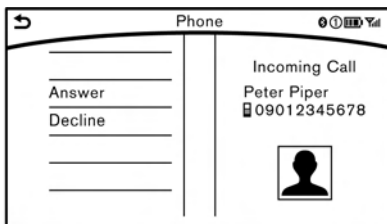

When you receive a phone call, a notification message is displayed on the upper touch screen display (upper display) with a ring tone.

Taking a call:

To answer the call, take one of the following actions.

- Push **< >** on the steering-wheel.

- Touch [Answer].

Rejecting a call:

To reject the call, touch [Decline].

Receiving another phone while on line:

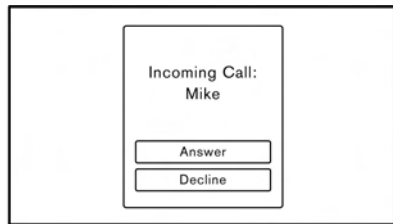

When another phone call is received while on the line, a message box to notify the driver of the incoming call will appear on the upper display.

Available items	
[Answer]	Take the second call and put the first call on hold.
[Decline]	Hang up the second call and keep the first call on the line.

During a call

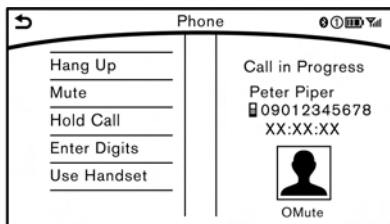

There are some options available during a call. Select one of the following displayed on the screen if necessary.

Available item	Action
[Switch Call]	Answer another incoming call. The person you are talking to will be placed on hold. Push once more to speak to the person on hold again. This item is available when multiple lines are connected.
[Hang Up]	Hang up the line you are currently on and you will be connected to the line that is on hold.
[Mute]/[Cancel Mute]	When muted, your voice will not be heard by the person on the other end of the line.
[Hold Call]	Put the line on hold. This item is available when a single line is connected.
[Enter Digits]	Using the touch tone, send digits to the connected party for using services such as voicemail.
[Use Handset]	Transfer the call to the cellular phone.
[End All Calls]	Hang up all the lines including the ones that were on hold. This item is available when multiple lines are connected.

**INFO:**

- To adjust the person's voice to be louder or quieter, push <- [VOL] +> on the steering-wheel or turn <VOL/ [VOL] > on the audio main button, while talking on the phone.
- Touch [Mute] if you wish your voice to not be heard by the person on the other end of the line.
- **Models with navigation system:**

Push <MAP/VOICE> on the Infiniti Controller during a call to display the map or menu screen. Push < [NAV] > on the steering-wheel to display the phone screen again.

Models without navigation system:

Push <DISP> on the Infiniti Controller during a call to display the clock. Push < [NAV] > on the steering-wheel to display the phone screen again.

5. Hands-Free Phone

HANDS-FREE TEXT MESSAGING ASSISTANT



WARNING

Use the text messaging feature after parking your vehicle in a safe location. If you have to use the feature while driving, exercise extreme caution at all times so full attention may be given to vehicle operation.



CAUTION

This feature is disabled if the connected device does not support the Message Access Profile (MAP). See the phone's Owner's Manual for details and instructions.

Laws in some jurisdictions may restrict the use of "Text-to-Speech." Check local regulations before using this feature.

The system allows for the sending and receiving of text messages through the vehicle interface.

Depending on the device that is connected to the vehicle, some of the items may not be displayed.

Receiving a message

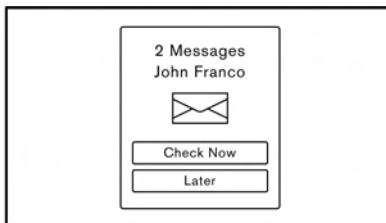

When the cellular phone connected to the vehicle receives a text message, a notification is displayed on the upper display with a tone.

To check the message, touch [Check Now]. Touch [Later] to save the message to be checked later.

Received message screen

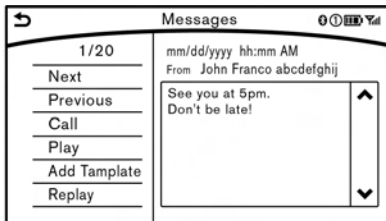

Touching [Check Now] on the new message notification screen or selecting a message

from the message list will show the details of the received message on the lower display.

Available actions:

- **[Next]:**
Touch to read the next message.
- **[Previous]:**
Touch to read the previous message.
- **[Call]:**
If the sender of the message is registered in the Phonebook, touch this icon to make a call to the sender.
- **[Play]/[Stop]:**
Touch [Play] to have the hands-free phone system read out the received message. Touch [Stop] to stop reading.
- **[Add Template]:**
The received text message can be added to the template (text list).
- **[Reply]:**
A reply message can be selected from the template.
 "Sending a text message"
(page 5-8)

i INFO:

- If <▲> or <▼> on the steering-wheel is pushed while the received text message is read out the next or previous message will be read.
- After the message is read out, a message box will appear and an action can be selected.

[Reply]	Create a reply message.  "Sending a text message" (page 5-8)
[Next]	Have the system read out the next message.

- If the sender's name and address is registered in the Phonebook, the name of the sender is displayed as sender information on the screen.

Displaying received message list

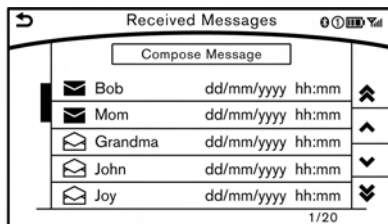

1. Push <MENU> and touch [Phone].
2. Touch [Text Messages].
3. Touch an item on the list to read or reply to the message.

i INFO:

Up to 20 messages can be stored on the message list.

5. Hands-Free Phone

Sending a text message

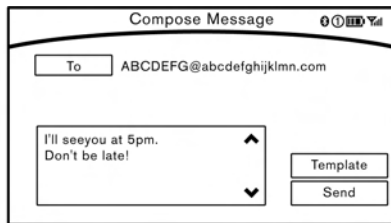

1. Push **<MENU>** and touch [Phone].
2. Touch [Text Messages].
3. Touch [Compose Message].

The following items are available.

Available item		Action
[To]	[Keypad]	Type in the address of the recipient using the keypad. Touch [OK] to confirm the address.
	[Phonebook]	Select a recipient from the phonebook and touch [OK] to confirm.
[Template]	Select from list	Select an item from the message list. The selected text will be added to the message to be sent.
	[Edit Text Message Replies]	Select an item in the message list to be edited. Use the keypad to edit the text and touch [OK] to complete editing.
[Send]		Touch to send the message.

PHONE AND TEXT MESSAGE ASSISTANT SETTINGS

Phone settings

The Bluetooth® Hands-Free Phone System can be set in detail according to the user's preference.

1. Push **◀MENU▶** and touch [Settings].
2. Touch [Phone/Mail] and touch [Phone Settings].

The following phone setting items are available.

[Incoming Calls Settings]:

Setting item	Action
[Ringtone]	Select a type of ringtone.

[Phonebook/Favorites Settings]:

Setting item	Action	
[Configure Phonebook Settings]	[Automatic Transfer Settings] [Phonebook Auto Download]	Turn on/off the automatic download of the phonebook from the cellular phone.
	[Call History Download]	Turn on/off the automatic download of the cellular phone call history.
	[Manual Phonebook Transfer] [Transfer and Overwrite] (Depending on cellular phone)	Manually transfer information from the phonebook in the cellular phone.
	[Transfer and Add] (Depending on cellular phone)	
[Delete Phonebook]	To delete a single item, select an item you wish to delete from the list. Touch [Delete All] to delete all items. To delete multiple items, touch [Multiple Selection].	

5. Hands-Free Phone

Setting item		Action	
[Favorites Settings]	[Delete Favorites]	To delete a single item, select an item you wish to delete from the list. Touch [Delete All] to delete all items. To delete multiple items, touch [Multiple Selection].	
	[Add to Favorites]	[From Phonebook]	Select items from the phonebook of the in-vehicle system to add to the Favorite.
		[From Outgoing Calls]	Select items from the outgoing calls list of the in-vehicle system to add to the Favorite.
		[From Incoming Calls]	Select items from the incoming calls list of the in-vehicle system to add to the Favorite.
		[From Missed Calls]	Select items from the missed calls list of the in-vehicle system to add to the Favorite.
[Delete Call History]	[Delete Outgoing Call History]	To delete a single item, select an item you wish to delete from the list. Touch [Delete All] to delete all items. To delete multiple items, touch [Multiple Selection].	
	[Delete Incoming Call History]		
	[Delete Missed Call History]		
	[Delete All Call History]		

Mail settings

Various settings can be changed from the Mail Settings screen.

1. Push **<MENU>** and touch [Settings].
2. Touch [Phone/Mail].
3. Touch [Mail Settings].

The following mail setting items are available.

Setting item	Action
[Message Download Settings]	The transfer function can be turned on/off. When the transfer function is on, Phonebook in the cell phone will automatically be downloaded to the hands-free phone text messaging system when connected.
[Attempts for Sending]	The number of retrials after failing to send a text message can be selected from numbers between 0 and 3.
[New Message Alert]	The tone type of the notification sound can be selected.
[Edit Text Message Replies]	The template (text to select from when composing an outgoing message) can be edited.

5. Hands-Free Phone

Phonebook

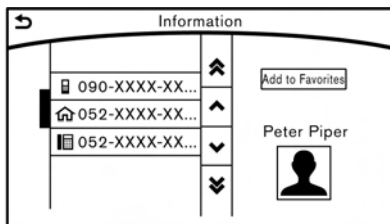

Phonebook information in cellular phones can be downloaded.

☞ “5. Phonebook/Favorites Settings”

1. Push **<MENU>** and touch [Phone].
2. Touch [Phonebook] and touch from the list.

It can be viewed on the lower display and be used to make calls or send text messages

Favorites

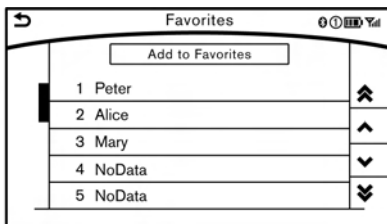

Up to 40 phone numbers can be transferred to the favorites list from a cellular phone.

☞ “5. Phonebook/Favorites Settings”

1. Push **<MENU>** and touch [Phone].
2. Touch [Favorite] and touch from list.

It can be viewed on the lower display and be used to make calls or to send text messages.

Voice Tag:

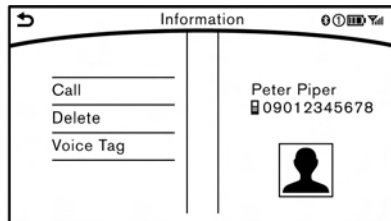

A custom voice tag can be recorded for phone numbers on the favorites list and be used to dial the number by speaking it .

1. Push **< ⌂ >** on the steering wheel.
2. Touch [Favorites].
3. Touch an item on the list.
4. Touch [Voice Tag].

Available Items	Action
[Register]	Touch to record a voice tag for the phone number.
[Re-registration]	Touch to over-record the voice tag.
[Play]	Play the recorded voice tag.
[Delete]	Touch to delete the voice tag.

BLUETOOTH® INFORMATION

Information of the connected Bluetooth® device can be viewed.

1. Push **<MENU>** and touch [Settings].
2. Touch [Bluetooth].
3. Touch [Vehicle Bluetooth Device Info.].

The following items are available.

Available item	Action
[Device Name]	The name of the connected Bluetooth® device is displayed. Touch [Device Name] to display the keyboard input screen for editing.
[Enter PIN Code]	The Passkey of the connected Bluetooth® device is displayed. Touch [Enter PIN Code] to display the keyboard input screen.
Device Address	The device address of the connected Bluetooth® device is displayed.

5. Hands-Free Phone

MEMO

6 Infiniti InTouch™ Mobile Apps

Infiniti InTouch™ Mobile Apps Overview.....	6-2	Examples of how Vehicle Apps is used	6-7
Using applications.....	6-3	Mobile Apps	6-8
Main operation	6-3	Getting user ID and password.....	6-8
Vehicle Apps	6-3	Notes on linking Smartphone App to vehicle	6-8
App Garage screen.....	6-3	Using Smartphone applications	6-9
Vehicle Apps Manager.....	6-5		
The major Apps available for use in this system	6-5		

6. Infiniti InTouch™ Mobile Apps

INFINITI INTOUCH™ MOBILE APPS OVERVIEW

Laws in some jurisdictions may restrict the use of some of the applications and features, such as social networking and texting. Check local regulations for any requirements.

Infiniti InTouch™ provides in-vehicle access to two types of applications: Vehicle Apps and Mobile Apps. Vehicle Apps can be downloaded from App Garage in the Menu screen. Mobile Apps are a limited selection of popular smartphone-based apps that have been customized for in-vehicle use. Mobile Apps can be accessed by connecting your compatible smartphone to the vehicle.

The system allows you to download new applications, update downloaded applications and delete downloaded applications in a similar manner as popular smartphone operating systems.

Some pre-installed Vehicle Apps can be used without taking any extra steps. However, you will need to connect a compatible smartphone to the vehicle in order to update Vehicle Apps or use Mobile Apps.

To view a list of compatible smartphones, visit www.infinitiusa.com/bluetooth.

The usage of applications is only guaranteed for smartphones that have been tested and approved for use with Infiniti InTouch™ Mobile Apps. Only iPhone® and Android devices are currently supported. Android smartphones must support Bluetooth® and SPP (Serial Port Profile).

Using with iPhone®:

To use Infiniti InTouch™ Mobile Apps with your iPhone®, the iPhone® must be connected with a USB cable. If an additional iPhone® is connected by wired connection while an iPod® is being used via a wired connection, the service will not be available. To use the service, it is first necessary to unplug the iPod® cable from the USB port where the iPod® is connected.

 “Media Hub” (page 2-6)

Using with an Android smartphone:

To use Infiniti InTouch™ Mobile Apps with your Android smartphone, the device must be connected via Bluetooth and registered as a hands-free device.

 “Connecting Bluetooth® device” (page 2-22)

A compatible smartphone is required to use Mobile Apps or to access connected features of certain Vehicle Apps. Please visit www.infinitiusa.com/bluetooth for a list of compatible devices.



- To use Mobile Apps, the Infiniti InTouch™ App must be installed and running on the compatible smartphone. This app can be downloaded from the iTunes App Store or Google Play store.
- Mobile Apps also requires an active subscription and valid Infiniti Owner Portal account. Please see <http://www.infinitiusa.com/intouch/support> (for United States) or <http://www.infiniti.ca/InfinitiIntouch> (for Canada) for more information.
- Communication fees may be charged depending on the contents of the contract between the user and the mobile phone carrier.
- Before using this service, some applications may require individual subscriptions (e.g., Facebook, etc.).

- For some applications, the system may not support all of the functions of applications that are installed on your smartphone. Additionally, due to service provider policies, the contents of application services may be changed or terminated.
- If the smartphone is out of the range of communication, some functions cannot be used.
- While driving, some operations are limited in order to prevent distracting the driver. While driving, avoid keeping a close watch on the display.
- Before exchanging ownership of the vehicle, delete application data (Email data, etc.) stored in the in-vehicle device.
- Some application services may be subject to change or termination without prior notice.

USING APPLICATIONS



NOTE:

To use APP functions on the models without navigation system, calendar setting is necessary for checking SSL expiration date.

 “Clock settings” (page 2-21)

MAIN OPERATION

Push **<MENU>** to display menu screen

Touch the icon for the desired application. The selected application will be launched.

The applications shown on the Menu screen and the display order can be customized.

 “App Garage Settings screen” (page 6-4)

Some applications can be set to launch automatically upon vehicle ignition.

VEHICLE APPS

Vehicle Apps are unique applications developed by Infiniti that can be downloaded and installed on the in-vehicle hardware.



INFO:

The Infiniti InTouch™ App must be installed and running on a compatible smartphone in order to download updates or use Vehicle Apps that require a network connection.

 “Getting user ID and password” (page 6-8)

APP GARAGE SCREEN

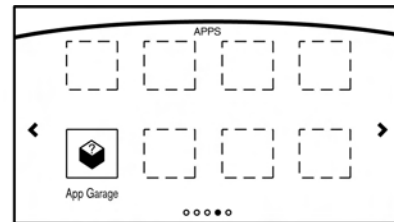

Push **<MENU>** and touch [App Garage].

6. Infiniti InTouch™ Mobile Apps

Available settings

- [Vehicle Apps Manager]
Install, uninstall and update Vehicle Apps.
- [App Garage Settings]
View Apps information, manage Apps, customize shortcuts on the Menu screen and set notifications.
- Available application list
Display the downloaded Vehicle Apps and selected Mobile Apps.
When a listed application is selected, the application will start.

App Garage Settings screen

You can use various application settings.

1. Push <MENU> and touch [App Garage].
2. Touch [App Garage Settings].

Menu Item		Action
[All Apps]		Show all applications. Select an application from the list to modify additional application-specific settings.
[Running Apps]	Applications list	Display all running applications. To display application information or stop an application, select the desired application from the list.
	[Stop All]	Stop all running application.
[Menu Icon Location Setting]	Applications list	Show or hide the application icon on the Menu screen.
	[Delete All]	Delete all application icon on menu screen.
[Auto Start Setting]		Enable this setting to automatically launch the application upon vehicle ignition.
[System Information]		Display system information.
[Install Apps via USB]		Install an application via USB from the INFINITI portal site.
[Automatic Connection]		Sets the connecting interval. Vehicle Apps Manager connects to the server at regular intervals in order to obtain up-to-date information (such as checking for application updates).
[Network Notification]		If Network Notification is on, a pop-up message is displayed when a network connection is established.
[Installation Notification]		If Install Notification is on, a pop-up message is displayed when a new application is installed.
[Factory Data Reset]		Discard the downloaded or stored application data.

! NOTE:

- If the Auto Start Setting is enabled, some applications may be accessible to other drivers of your vehicle.
- when [Network Notification] is turned off, some apps will be started automatically and uses network communication and communication fees will be charged.
- Depending on the type of application, some applications may not be displayed in the [Running Apps] field even if they are running.
- The Auto Start function may not be available for some applications.

VEHICLE APPS MANAGER

On this screen, you can update, uninstall, and install Vehicle Apps.

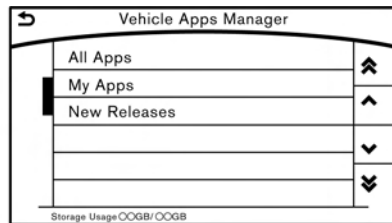

1. Push <MENU> and touch [App Garage].
2. Touch [Vehicle Apps Manager].

future.

Available setting items

- [ALL Apps]
Display all available Vehicle Apps. You can select to display application information, update, install and uninstall application.
- [My Apps]
Display installed Vehicle Apps. You can select to display application information, update and uninstall application.
- [New Releases]
Display newly released Vehicle Apps. You can select to install application.

! NOTE:

In order to display the application list screen or the installation and update screens using Vehicle Apps Manager, connection via a smartphone is required to establish communication.

THE MAJOR APPS AVAILABLE FOR USE IN THIS SYSTEM

The major Apps available for use in Infiniti InTouch™ are as follows.

The Apps are to be updated in the near

6. Infiniti InTouch™ Mobile Apps

APPS	Descriptions
Driving Performance	Vehicle performance such as Fuel Flow, Accel etc. can be understood intuitively.
Maintenance Note	Previous maintenance records such as oil change, vehicle inspection, etc. can be stored in Maintenance note. You can check these from inside the vehicle at your convenience.
Calendar*/** (if so equipped)	Today's schedule can be checked before you leave. Your schedule is linked to web-based services.
Email*/** (if so equipped)	The Email account you use can also be accessed through the vehicle system. You will be informed when a new Email is received.
Compass (models with navigation system)	In addition to the current traveling direction of the vehicle, the direction of the destination is also shown. Accurate information cannot be provided if GPS position information cannot be obtained.
Clock	Clock shows the current time in various kinds of skins.
Mobile Apps**	Many popular applications you usually use in your smartphone can also be used in your vehicle. After registering a subscription in Infiniti InTouch™ App you can use these applications by operating the in-vehicle display.

*: Requires an account to be set up.

** : Requires Infiniti InTouch™ App to be downloaded to your smartphone.



WARNING

- Use the information from the Driving Performance strictly as a reference to make your driving more comfortable. The readings are not meant to prevent acci-

dents caused by reckless driving or poor driving conditions (due to weather, road condition, etc.). Always obey all traffic regulations and posted speed limits.

- Operating the Driving Performance while driving can lead to a crash resulting in serious injuries or death. Always park the vehicle in a safe place before operating the display screen.
- Look at the display screen only briefly while driving. Keep your eyes on the road. Inattentive driving may lead to a crash resulting in serious injuries or death.



INFO:

When Email service and calendar schedule information are displayed in the in-vehicle display, the system controls the display based on the ID and password. Therefore, users are required to manage an ID and password.



NOTE:

A PIN code can be used so that other people cannot see your Email and calendar apps. When the engine or the hybrid system is turned OFF and then ON again, the PIN code has to be input.

After the PIN code is input, regardless of whether your smartphone is connected to the vehicle or not, Email and calendar apps will be

viewable until either the engine or the hybrid system is turned OFF. When the system is set to valet parking, if the relevant account is erased, Email and schedule will be erased from the system.

EXAMPLES OF HOW VEHICLE APPS IS USED

Example 1 Driving Performance application

This allows you to see the vehicle status and the results of driving operation.

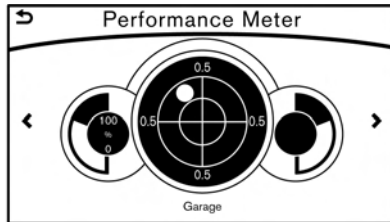

1. Push **<MENU>** and touch [Driving Performance].
2. Touch [**<**] or [**>**] to change the layout of the Driving Performance meter.
Touch the meter illustration on the Performance Meter screen to select another meter to display.



NOTE:

Use the displayed information as a reference. It may differ from actual vehicle information depending on the road surface conditions or temperature. Also, it may differ from what is displayed on the vehicle combination meter.

- **Lateral G (G force) and vertical G:** Due to the inclination of the road surface, G may occur even when the vehicle stops. This is not a malfunction.
- **Fuel economy:** This is a guideline for the level of fuel economy driving. Therefore, it may differ from the actual fuel economy achieved.

Example 2 Email application (if so equipped)

This allows you to access web-based Email through an in-vehicle interface. If you use this application first time, you need to create a new user.

To use the Email application service, connect a smartphone to the vehicle.

1. Push **<MENU>** and touch [Email].
2. Touch [Create New User]. The new user input screen will be displayed.

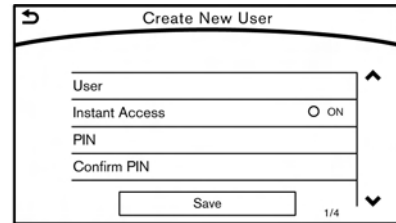

3. Input your name and PIN code and select [Instant Access] ON or OFF, and then touch [Save].



INFO:

If the Instant Access mode is set to ON, it is not necessary to enter a PIN code each time.

4. Stored user name is displayed in the list, touch the user name.
5. Input PIN code and touch [OK]. Display your mail box screen.

If an account is not yet set up, set an account (Google account, etc) in the Manager Account screen displayed.



INFO:

- On receive message screen, touch sender name or address to display sender detail screen.

6. Infiniti InTouch™ Mobile Apps

- System folders (Inbox, Draft, send, etc.) cannot be modified.

MOBILE APPS

Mobile Apps are a limited selection of popular smartphone-based Apps that have been customized for in-vehicle use. Mobile Apps can be accessed by connecting your compatible smartphone to the vehicle.

GETTING USER ID AND PASSWORD

When you activate the Infiniti InTouch™ Mobile Apps service for the first time, you should acquire the user ID and password in advance, the acquisition of a user ID and a setup of a password which logs in to exclusive applications are required.



INFO:

- It is also possible to acquire an ID and a password directly from an INFINITI portal site.
- The vehicle information is required for entering the user information.



NOTE:

Other applications may not operate as a result of installing Infiniti InTouch™ App. (It is impossible to perform verification tests that combine the system with all possible applica-

tions available for a smartphone.)

For details of Mobile Apps, please refer to <http://www.infinitiusa.com/intouch/support> (for United States) or <http://www.infiniti.ca/InfinitiInTouch> (for Canada)

NOTES ON LINKING SMARTPHONE APP TO VEHICLE



NOTE:

- The configuration setting for each application within the Infiniti InTouch™ Mobile Apps must be set to ON in order for the application to be accessible through the in-vehicle interface.
- Some applications may not run unless they are installed on a smartphone.
- The set of applications shown on the in-vehicle display is determined by the user ID information registered in the Infiniti InTouch™ Mobile Apps of the connected smartphone.
- When using each application, it is assumed that the user has already agreed to the user policy of each application in advance. Accuracy of information that is obtained using an application is not guaranteed.

- Even when Mobile Apps are updated, regular Apps used in a smartphone may not always be synchronized.

USING SMARTPHONE APPLICATIONS

1. Connect a smartphone to the vehicle.
2. Push **<Menu>** and touch [App Garage].
3. Touch an application to display information.



INFO:

- The screen shown on the display may not be identical with the that displayed on the smartphone.
- Mobile Apps are not usable if a smartphone is not connected to the vehicle.

6. Infiniti InTouch™ Mobile Apps

MEMO

7 Monitor system

RearView Monitor (if so equipped).....	7-2	Camera aiding sonar function	7-12
RearView Monitor operation precautions	7-2	Moving Object Detection (MOD).....	7-13
How to read displayed lines	7-2	Around View Monitor settings.....	7-17
How to park with predictive course lines	7-3	Camera maintenance	7-19
ReaView Monitor settings.....	7-4	Operating tips	7-19
Operating tips.....	7-5	Difference between predictive and	
Around View [®] Monitor (AVM) (if so equipped)	7-6	actual distances.....	7-20
Around View Monitor operation precautions	7-6	Backing up on a steep uphill	7-20
Around View Monitor Main operation	7-7	Backing up on a steep downhill.....	7-20
How to view Around View Monitor screen.....	7-7	Backing up near a projecting object.....	7-20
Available views	7-8	Backing up behind a projecting object.....	7-21

7. Monitor system

REARVIEW MONITOR (if so equipped)

When the shift lever is shifted into the R (Reverse) position, the upper touch screen display (upper display) shows the view to the rear of the vehicle.

The system is designed as an aid to the driver in situations such as slot parking or parallel parking.

REARVIEW MONITOR OPERATION PRECAUTIONS

The distance between the vehicle and the objects viewed on the monitor may be different from the actual distances.

 “Difference between predictive and actual distances” (page 7-20)



WARNING

Failure to follow the warnings and instructions for proper use of the RearView Monitor could result in serious injury or death.

- The RearView Monitor is a convenience but it is not a substitute for proper backing. Always turn and look out the windows, and check mirrors to be sure that it is safe to move before operating the vehicle. Always back up slowly.

- The system is designed as an aid to the driver in detecting large stationary objects directly behind the vehicle, to help avoid damaging the vehicle.
- The system cannot completely eliminate blind spots and may not detect every object. It does not warn of moving objects.
- Underneath the bumper and the corner areas of the bumper cannot be viewed on the RearView Monitor because of its monitoring range limitation. The system will not detect small objects below the bumper, and may not detect objects close to the bumper or on the ground.
- Objects viewed in the RearView Monitor differ from actual distance because a wide-angle lens is used.
- Objects in the RearView Monitor will appear visually opposite, similar to when viewed in the rear view and outside mirrors
- Make sure that the trunk is securely closed when backing up.
- Do not put anything on the RearView camera. The RearView camera is installed above the license plate.

- When washing the vehicle with high-pressure water, be sure not to spray it around the camera. Otherwise, water may enter the camera unit causing water condensation on the lens, a malfunction, fire or an electric shock.
- Do not strike the camera. It is a precision instrument. Otherwise, it may malfunction or cause damage resulting in a fire or an electric shock.



CAUTION

Do not scratch the camera lens when cleaning dirt or snow from the front of the camera.

HOW TO READ DISPLAYED LINES

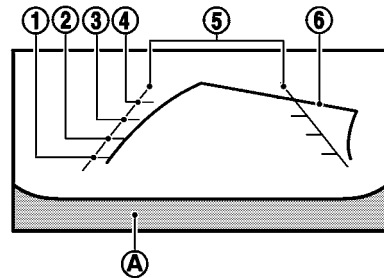

Guiding lines that indicate the vehicle width and distances to objects with reference to the bumper line (A) are displayed on the monitor.

Distance guide lines:

Indicate distances from the bumper.

- Red line (1): approx. 1.5 ft (0.5 m)
- Yellow line (2): approx. 3 ft (1 m)
- Green line (3): approx. 7 ft (2 m)
- Green line (4): approx. 10 ft (3 m)

(5) Vehicle width guide lines:

Indicate the vehicle width when backing up.

(6) Predictive course lines:

Indicate the predictive course when backing up. The predictive course lines will be displayed on the monitor when the shift lever is in the R (Reverse) position and the steering-wheel is turned. The predictive course lines will move depending on how much the steering-wheel is turned and will not be displayed while the steering-wheel is in the neutral position.

The vehicle width guide lines and the width of the predictive course lines are wider than the actual width and course.



WARNING

- Always turn and check that it is safe to park your car before backing up. Always back up slowly.
- If the tires are replaced with different sized tires, the predictive course line may not be displayed correctly.
- On a snow-covered or slippery road, there may be a difference between the predictive course line and the actual course line.
- The displayed lines will appear slightly off to the right because the RearView camera is not installed in the rear center of the vehicle.
- The distance guide line and the vehicle width guide line should be used as a reference only when the vehicle is on a level, paved surface. The distance viewed on the monitor is for reference only and may be different than the actual distance between the vehicle and displayed objects.
- When backing up the vehicle up a hill, objects viewed in the monitor are further than they appear. When backing up the

vehicle down a hill, objects viewed in the monitor are closer than they appear. Use the inside mirror or glance over your shoulder to properly judge distances to other objects.

HOW TO PARK WITH PREDICTIVE COURSE LINES

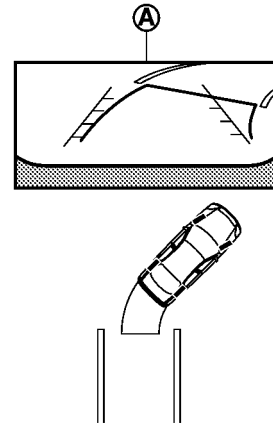

1. Visually check that the parking space is safe before parking your vehicle.

7. Monitor system

- The rear view of the vehicle (A) is displayed as illustrated when the shift lever is shifted to the R (Reverse) position.

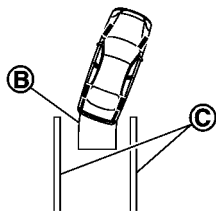
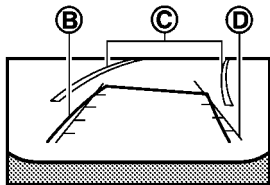

- When the vehicle is parked in the space completely, move the shift lever to the P (Park) position and apply the parking brake.

REVIEW MONITOR SETTINGS

The RearView Monitor settings can be changed with the following procedure.

- Push **<MENU>**.
- Touch [Settings].
- Touch [Camera/Sonar].

- Slowly back up the vehicle adjusting the steering-wheel so that the predictive course lines (B) enter the parking space (C).
- When the back of the vehicle enters the parking space (C), maneuver the steering-wheel to make the vehicle width guide lines (D) parallel to the parking space (C).

Setting Items		Action
[Camera]	[Predictive Course Lines]	When this item is turned on, the predictive course line is displayed on the rear view screen.
[Display Settings] (Available only when camera screen is displayed on the upper display.)	[Brightness]	Adjust display settings by touching [+]/[-].
	[Contrast]	
	[Tint]	
	[Color]	
	[Black Level]	
	[Reset Settings]	Return all settings to default.

OPERATING TIPS

- When the shift lever is shifted to the R (Reverse) position, the upper screen automatically changes to the RearView Monitor mode.
- The following conditions may occur, but it does not indicate a malfunction.
 - When the view is switched, the images on the screen may be displayed with some delay.
 - When the temperature is extremely high or low, the screen may not clearly display objects.
 - When strong light directly comes on to the camera, objects may not be displayed clearly.
- Vertical lines may be seen in objects on the screen due to strong reflected light from the bumper.
- The screen may flicker under fluorescent light.
- The colors of objects on the RearView Monitor may differ somewhat from the actual color of objects.
- Objects on the monitor may not be clear in a dark environment.
- If dirt, rain or snow accumulates on the camera, the RearView Monitor may not display objects clearly. Clean the camera if this happens.

- Do not use alcohol, benzine or thinner to clean the camera. This will cause discoloration. To clean the camera, wipe with a cloth dampened with diluted mild cleaning agent and then wipe with a dry cloth.
- Do not damage the camera as the monitor screen may be adversely affected.
- Do not use wax on the camera window. Wipe off any wax with a clean cloth dampened with mild detergent diluted with water.

7. Monitor system

AROUND VIEW[®] MONITOR (AVM) (if so equipped)

With the ignition switch in the ON position, press the CAMERA button or move the shift lever to the R (Reverse) position to operate the Around View Monitor camera view. The upper touch screen display (upper display) shows the view to the surrounding view of the vehicle. The Around View Monitor shows various views of the position of the vehicle.

Available views:

- Bird's-Eye View
The surrounding view of the vehicle.
- Front-Side View
The view around and ahead of the front passenger's side wheel.
- Front View
An approximately 150-degree view of the front of the vehicle.
- Front-Wide View
An approximately 180-degree view of the front of the vehicle.
- Rear View
An approximately 150-degree view of the rear of the vehicle.

- Rear-Wide View
An approximately 180-degree view of the rear of the vehicle.

AROUND VIEW MONITOR OPERATION PRECAUTIONS

The system is designed as an aid to the driver in situations such as slot parking or parallel parking.

①

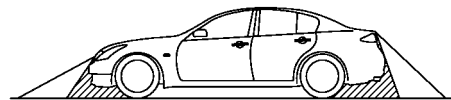

②

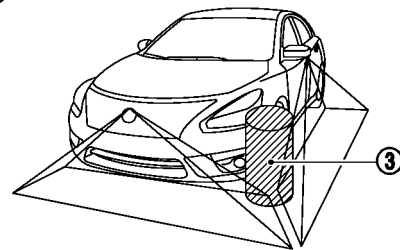

There are some areas where the system will not show objects and the system does not warn of moving objects. When in the front or the rear view display, an object below the bumper or on the ground may not be viewed ①. When in the bird's-eye view, a tall object near the seam ③ of the

camera viewing areas will not appear in the monitor ②.



WARNING

- The Around View Monitor is a convenient feature but it is not a substitute for proper vehicle operation because it has areas where objects cannot be viewed. Always look out the windows and check mirrors to be sure that it is safe to move.
- The driver is always responsible for safety during parking and other maneuvers.
- Do not use the Around View Monitor with the outside mirror in the stored position, and make sure that the trunk lid is securely closed when operating the vehicle using the Around View Monitor.
- The distance between objects viewed on the Around View Monitor differs from the actual distance.
- The cameras are installed above the front grille, the outside mirrors and above the rear license plate. Do not put anything on the cameras.
- When washing the vehicle with high-pressure water, be sure not to spray it

around the cameras. Otherwise, water may enter the camera unit causing water condensation on the lens, a malfunction, fire or an electric shock.

- Do not strike the cameras. They are precision instruments. Doing so could cause a malfunction or cause damage resulting in a fire or an electric shock.



CAUTION

Do not scratch the lens when cleaning dirt or snow from the front of the camera.

AROUND VIEW MONITOR MAIN OPERATION

Starting the system

To start the system, push **<CAMERA>** or change the shift lever position into “R” while the ignition switch is in the ON position.

Switching views

Views on the AVM screen can be switched by pushing **<CAMERA>**, touching [Change View] or by changing the shift lever position.

Push **<CAMERA>**:

When **<CAMERA>** is pushed while another screen is displayed, Around View Monitor operates and the front view and bird’s-eye view are displayed. Push **<CAMERA>** to switch the display to the front view and front-side view screen or front-wide view screen.

Changing shift lever position:

When the shift lever is in the “R” position, the rear or rear-wide view is displayed. When the shift lever is not in the “R” position, the front or front-wide view is displayed.

HOW TO VIEW AROUND VIEW MONITOR SCREEN

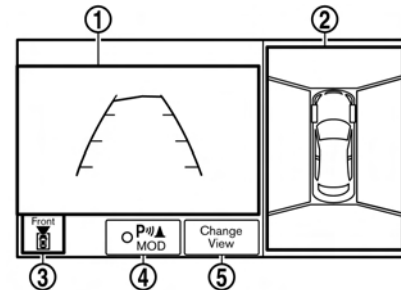

Around view screen

7. Monitor system

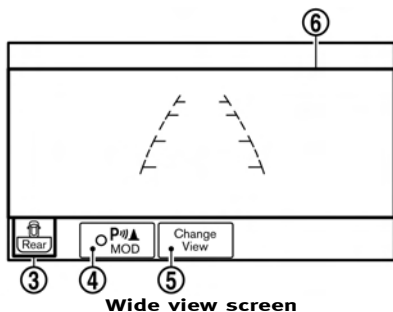

① View on the left side:

The rear view is displayed when the shift lever is in the “R” position.

The front view is displayed when the shift lever is in the “D”, “N” or “P” position.

② View on the right side:

The bird’s-eye view or front-side view is displayed.

③ View indicator:

Indicates whether which one of the front, rear, front-wide or rear-wide is displayed on the left side of the screen.

④ Sonar-MOD key:

Turns on/off the sonar and the Moving Object Detection (MOD) system.

 “Turning sonar system on/off”
(page 7-13)

 “Turning MOD system on/off”
(page 7-15)

⑤ [Change View]:

Each time [Change View] is touched, the view will change among bird’s-eye view, front-side view and wide view.

⑥ Wide view screen:

The front-wide or rear-wide view is displayed.



INFO:

If the vehicle is equipped with the Back-up Collision Intervention (BCI) system,  may be displayed on the Around View Monitor screen when the shift lever is in the “R” position. For details of the BCI system, refer to the vehicle Owner’s Manual.

AVAILABLE VIEWS



WARNING

- The distance guide line and the vehicle width line should be used as a reference only when the vehicle is on a paved, level surface. The distance viewed on the monitor is for reference only and may be different than the actual distance between the vehicle and displayed objects.
- Use the displayed lines and the bird’s-eye view as a reference. The lines and the bird’s-eye view are greatly affected by the number of occupants, fuel level, vehicle position, road condition and road grade.
- If the tires are replaced with different sized tires, the predictive course line and the bird’s-eye view may be displayed incorrectly.
- When driving the vehicle up a hill, objects viewed in the monitor are further than they appear. When driving the vehicle down a hill, objects viewed in the monitor are closer than they appear.

- Use the mirrors or actually look to properly judge distances to other objects.
- The vehicle width and predictive course lines are wider than the actual width and course.
- The distance between objects viewed in the rearview differs from actual distance because a wide-angle lens is used.
- Objects in the monitor will appear visually opposite similar to when viewed in the rearview and outside mirrors.
- On a snow-covered or slippery road, there may be a difference between the predictive course line and the actual course line.
- The displayed lines on the rear view will appear slightly off to the right because the rear view camera is not installed in the rear center of the vehicle.

Front and rearview

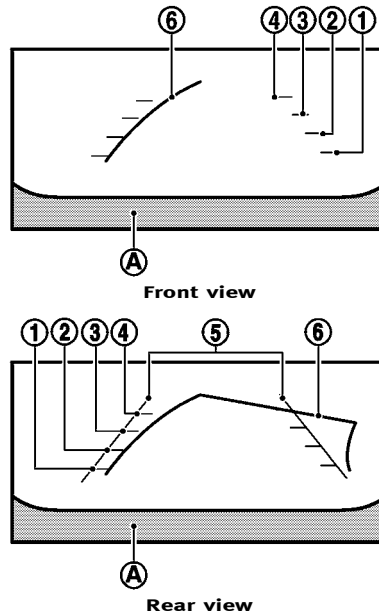

Guiding lines, which indicate the vehicle width and distances to objects with reference to the vehicle body line (A), are displayed on the monitor.

① - ④ Distance guide lines:

Indicate distances from the vehicle body.

- Red line ①: approx. 1.5 ft (0.5 m)
- Yellow line ②: approx. 3 ft (1 m)
- Green line ③: approx. 7 ft (2 m)
- Green line ④: approx. 10 ft (3 m)

⑤ Vehicle width guide lines:

Indicate the vehicle width when backing up.

⑥ Predictive course lines:

Indicate the predictive course when operating the vehicle. The predictive course lines will be displayed on the monitor when the steering-wheel is turned. The predictive course lines will move depending on how much the steering-wheel is turned and will not be displayed while the steering-wheel is in the straight ahead position.

The front view will not be displayed when the vehicle speed is above 5 MPH (8 km/h).

INFO:

When the monitor displays the front view and the steering-wheel turns about 90 degrees or less from the neutral position, both the right

7. Monitor system

and left predictive course lines ⑥ are displayed. When the steering-wheel turns about 90 degrees or more, a line is displayed only on the opposite side of the turn.

Bird's-eye view



WARNING

- Objects in the bird's-eye view will appear further than the actual distance because the bird's-eye view is a pseudo view that is processed by combining the views from the cameras on the outside mirrors, the front and the rear of the vehicle.
- Tall objects, such as a curb or vehicle, may be misaligned or not displayed at the seam of the views.
- Objects that are above the camera cannot be displayed.
- The view for the bird's-eye view may be misaligned when the camera position alters.
- A line on the ground may be misaligned and is not seen as being straight at the seam of the views. The misalignment will increase as the line proceeds away from the vehicle.

- The tire angle display does not indicate the actual tire angle

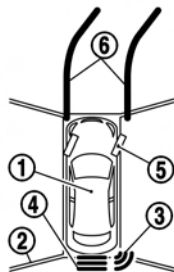

The bird's-eye view shows the overhead view of the vehicle, which helps confirm the vehicle position and the predicted course to a parking space.

① Vehicle icon:

Shows the position of the vehicle. The size of the vehicle icon on the bird's-eye view may differ somewhat from the actual vehicle.

② Non-viewable areas:

The objects in these areas do not appear on the screen. The areas are usually indicated in black but will be highlighted

in yellow for several seconds after the bird's-eye view is displayed for the first time after the switch is placed in the "ON" position, to remind the driver of the non-viewable areas.

③ Corner sonar:

Indicates that the sonar detected an object around the corner of the vehicle.

④ Center sonar:

Indicates that the sonar detected an object around the center of the vehicle.

⑤ Tire angle indicator:

Indicates the angle of the tires to help the driver in instances such as parking.

⑥ Predictive course lines:

Displayed when the steering-wheel is turned and is out of the straight-ahead position. The lines will move according to how much the steering-wheel is turned. When the monitor displays the rear view, the predictive course lines are shown at the rear of the vehicle.

Front-side view

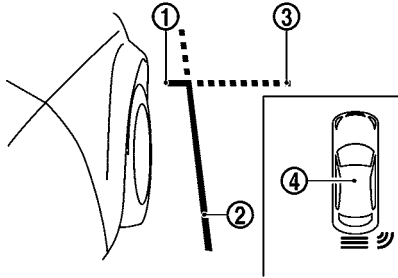

Guiding lines that indicate the width and the front end of the vehicle are displayed on the monitor.

① Front-of-vehicle line:

Shows the front part of the vehicle.

② Side-of-vehicle line:

Shows the vehicle width including the outside mirrors.

③ Extension lines:

Extensions of the front-of-vehicle line and the side-of-vehicle line are displayed with a green dotted line.

④ Sonar indicator:

Displayed when objects are detected. The sonar indicator can be turned off. “Around View Monitor settings” (page 7-17).



CAUTION

The turn signal light may look like the side-of-vehicle line. This is not a malfunction.

Front-wide/rear-wide view

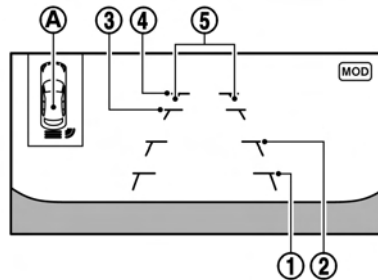

Front-wide view

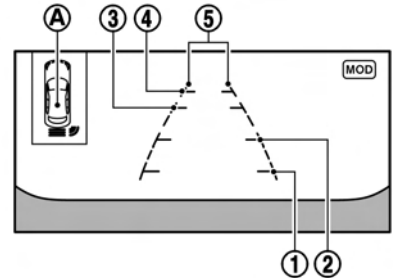

Rear-wide view

The front-wide/rear-wide view shows a wider area on the entire screen and allows the checking of the blind corners on the right and left sides. The front-wide/rear-wide view displays an approximately 180-degree area while the front view and the rear view display an approximately 150-degree area. The predictive course lines are not displayed when using the front-wide/rear-wide view.

① - ④ Distance guide lines:

Indicates distances from the vehicle body.

- Red line ①: approx. 1.5 ft (0.5 m)
- Yellow line ②: approx. 3 ft (1 m)
- Green line ③: approx. 7 ft (2 m)

7. Monitor system

- Green line (4): approx. 10 ft (3 m)

(5) Vehicle width guide lines:

Indicates the vehicle width when backing up.

(A) Sonar indicator:

Appears when the vehicle moves closer to an object.

CAMERA AIDING SONAR FUNCTION

The sonar (parking sensor) sounds a tone to inform the driver of obstacles near the bumper.



WARNING

- The sonar is a convenience feature. It is not a substitute for proper parking.
- The driver is always responsible for safety during parking and other maneuvers.
- Always look around and check that it is safe to move before parking.
- Read and understand the limitations of the sonar as contained in this section.
- The colors of the sonar indicators and the distance guide lines in the front, front-wide, rear and rear-wide views indicate

different distances to the object.

- Inclement weather or ultrasonic sources such as an automatic car wash, a truck's compressed-air brakes or a pneumatic drill may affect the function of the system; this may include reduced performance or a false activation.
- This function is designed as an aid to the driver in detecting large stationary objects to help avoid damaging the vehicle.
- The system is not designed to prevent contact with small or moving objects.
- The system will not detect small objects below the bumper, and it may not detect objects close to the bumper or on the ground.
- The system may not detect the following objects:
 - Fluffy objects such as snow, cloth, cotton, grass or wool.
 - Thin objects such as rope, wire or chain.
 - Wedge-shaped objects.
- If your vehicle sustains damage to the bumper fascia, leaving it misaligned or bent, the sensing zone may be altered

causing inaccurate measurement of objects or false alarms.



CAUTION

- Excessive noise (such as audio system volume or an open vehicle window) will interfere with the tone and it may not be heard.
- Keep the surface of the sonar sensors (located on the front and rear bumper fascia) free from accumulations of snow, ice and dirt. Do not scratch the surface of the sonar sensors when cleaning. If the sensors are covered, the accuracy of the sonar function will be diminished.

The system sounds the tone for front objects when the shift lever is in the D (Drive) position and both front and rear objects when the shift lever is in the R (Reverse) position.

When the camera image is shown on the display, the system shows the sonar indicator regardless of the shift lever position.

The system is deactivated at speeds above

5 MPH (8 km/h). It is reactivated at lower speeds.

When objects are detected, the indicator (green) appears and blinks and the tone sounds intermittently. When the vehicle moves closer to the object, the color of the indicator turns yellow and the rate of the blinking and the rate of the tone increase. When the vehicle is very close to the object, the indicator stops blinking and turns red, and the tone sounds continuously.

The intermittent tone will stop after three seconds when an object is detected by only the corner sonar and the distance does not change. The tone will stop when the object is no longer near the vehicle.

Warning tone and indicator

As the vehicle approaches the detected objects, the color of the warning indicator and the tone will change from green to yellow and then to red.

Indicator	Tone
green (blink slow)	intermittent (slow)
yellow (blink fast)	intermittent (fast)

red (no blinking)	continuous
----------------------	------------

The intermittent tone will stop after three seconds when an object is detected by only the corner sonar and the distance does not change.

The tone will stop when the object is away from the vehicle.

Turning sonar system on/off

When the Sonar-MOD key is touched, the indicator light on the key will turn off and the sonar will turn off temporarily. The Moving Object Detection (MOD) system will also be turned off at the same time.

 “Moving Object Detection (MOD)”
(page 7-13)

When the Sonar-MOD key is touched again, the indicator light will illuminate and the sonar will turn back on.

In the cases below, the sonar will be turned back on automatically:

- When the shift lever is in the R (Reverse) position.
- When **<CAMERA>** is pushed and a screen other than the camera view is shown on the display.

- When the vehicle speed decreases below approximately 5 MPH (8 km/h).
- When the ignition switch is placed in the “OFF” position and turned back to the “ON” position again.

When the Sonar-MOD key is touched, the MOD function will also be turned off.

To prevent the sonar system from activating altogether, change the status the camera settings menu.

 “Around View Monitor settings”
(page 7-17)

INFO:

Touching the sonar switch will also turn on/off the sonar system temporarily.

MOVING OBJECT DETECTION (MOD)

The Moving Object Detection (MOD) system can detect and inform the driver of moving objects around the vehicle using a visual indicator and chime. MOD is useful when driving out of garages, maneuvering in parking lots, and other similar situations.

The MOD system operates in the following conditions when the camera view is displayed:

7. Monitor system

- When the shift lever is in the P (Park) or N (Neutral) position and the vehicle is stopped, the MOD system detects the moving objects in the bird's-eye view. The MOD system will not operate if the outside mirror is moving in or out or if either door is opened.
- When the shift lever is in the D (Drive) position and the vehicle speed is below approximately 5 MPH (8 km/h), the MOD system detects moving objects in the front view or front-wide view.
- When the shift lever is in the R (Reverse) position and the vehicle speed is below approximately 5 MPH (8 km/h), the MOD system detects moving objects in the rear view or rear-wide view. The MOD system will not operate if the trunk lid is open.

INFO:

- The MOD system does not detect moving objects in the front-side view. The MOD indicator is not displayed on the screen when in this view.
- While the sonar/BCI warning tone is beeping, the MOD system does not chime.



WARNING

- The MOD system is not a substitute for proper vehicle operation and is not designed to prevent contact with the objects surrounding the vehicle. When maneuvering, always use the outside mirror and rearview mirror and turn and check the surrounding area to ensure it is safe to maneuver.
- The system is deactivated at speeds above 5 MPH (8 km/h). It is reactivated at lower speeds.
- The system is not designed to prevent contact with objects.
- The MOD system does not have the function to detect the surrounding stationary objects.
- Excessive noise (for example, audio system volume or open vehicle window) will interfere with the chime sound, and it may not be heard.
- The MOD system performance will be limited according to environmental conditions and surrounding objects such as:
 - When there is low contrast between background and the moving objects.

- When there is a blinking source of light.
- When strong light such as another vehicle's headlight or sunlight is present.
- When camera orientation is not in its usual position, such as when a mirror is folded.
- When there is dirt, water drops or snow on the camera lens.
- When the position of the moving objects in the display is not changed.
- The MOD system might detect something like flowing water droplets on the camera lens, white smoke from the muffler, moving shadows, etc.
- The MOD system may not function properly depending on the speed, direction, distance or shape of the moving objects.
- If your vehicle sustains damage to the parts where the camera is installed, leaving it misaligned or bent, the sensing zone may be altered and the MOD system may not detect objects properly.

- When the temperature is extremely high or low, the screen may not display objects clearly. This is not a malfunction.

How to view MOD information on the screen

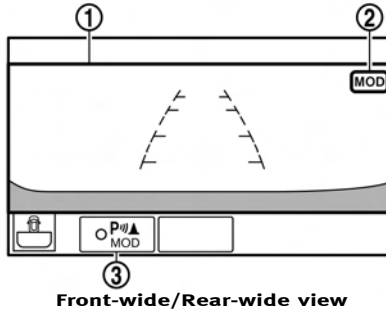
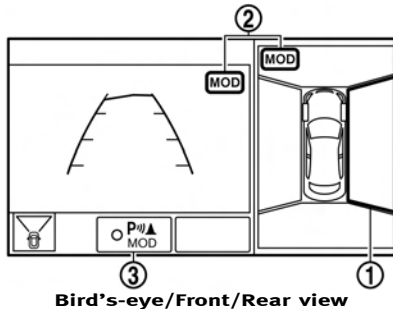

- Detection warning frame (yellow):**
Displayed on each view depending on where the moving object is detected (a chime will sound once). While the MOD system continues to detect moving objects, the yellow frame continues to be displayed.
- MOD indicator:**
A blue MOD indicator is displayed in the view where the MOD system is operative. A gray MOD indicator displayed in the view where the MOD system is not operative. When MOD system is turned off the MOD indicator will not be displayed.

- Sonar-MOD key:**

Turns on/off the sonar and the MOD system. When sonar or MOD system is completely turned off from the setting menu, “P MOD” or “MOD” will disappear from the key. The key will disappear from the screen when both of the systems are completely turned off from the setting menu.

☞ “Around View Monitor settings”
(page 7-17)

Turning MOD system on/off

Touching the Sonar-MOD key turns the sonar and the MOD system on/off temporarily. When the key is touched again, the indicator will turn on and the MOD system will turn back on.

The MOD system will turn on automatically under the following conditions:

- When the shift lever is in the R (Reverse) position.
- When the CAMERA button is pushed to switch from a different screen to the camera view on the display.
- When vehicle speed decreases below approximately 5 MPH (8 km/h).

7. Monitor system

- When the ignition switch is placed in the “OFF” position and then back to the “ON” position.

To completely turn off the MOD system so that it remains off at all times, change the status in the camera settings menu.

 “Around View Monitor settings”
(page 7-17)

AROUND VIEW MONITOR SETTINGS

Around View Monitor settings can be changed with the following procedure.

1. Push **<MENU>**.
2. Touch [Settings].
3. Touch [Camera/Sonar].

Available setting item		Action				
[Camera]	[Back-up Collision Intervention]	Turns on/off the Back-up Collision Intervention (BCI) system. Refer to the vehicle Owner's Manual for details.				
	[Moving Object Detection]	Turns on/off the MOD system.  "Turning MOD system on/off" (page 7-15)				
	[MOD Volume]	Adjust the volume level of the Moving Object Detection warning.				
	[Non-viewable Area Reminder]	When this item is turned on, the non-viewable area is highlighted in yellow for several seconds after the bird's-eye view is displayed for the first time after the ignition switch is positioned in the "ON" position.				
	[Predictive Course Lines]	When this item is turned on, the predictive course line is displayed in the front, rear and bird's-eye view screen.				
	[Camera View Priority]	<table border="1"> <tr> <td>[1st Screen]</td> <td rowspan="3">The priority order of the view type (Top, Side, Wide) can be changed.</td> </tr> <tr> <td>[2nd Screen]</td> </tr> <tr> <td>[3rd Screen]</td> </tr> </table>	[1st Screen]	The priority order of the view type (Top, Side, Wide) can be changed.	[2nd Screen]	[3rd Screen]
	[1st Screen]	The priority order of the view type (Top, Side, Wide) can be changed.				
[2nd Screen]						
[3rd Screen]						
[Automatic Display with Sonar]	The automatic sonar display can be turned on/off.					

7. Monitor system

Available setting item		Action	
[Sonar]	[Sonar]	Turns on/off the sonar system.	
	[FR Sensor Only]	Turns on the front sonar and turns off the rear sonar.	
	[Interrupt Display]	Turns on/off the automatic sonar display.	
	[Sonar Sensitivity]	Adjust the sonar sensitivity by touching [+] / [-].	
	[Sonar Volume]	Adjust the warning tone volume by touching [+] / [-].	
[Display] (Available only when the camera screen is displayed on the upper display.)	[Display Settings]	[Brightness]	Adjust the display settings by touching [+] / [-].
		[Contrast]	
		[Black Level]	
		[Tint]	
		[Color]	
	[Reset Settings]	Return all the settings to default.	

Malfunction indicators

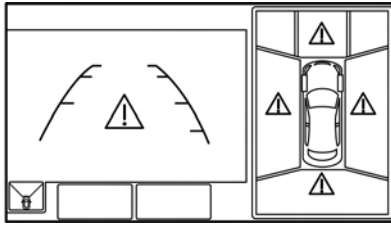

When ⚠ is displayed on the screen, there will be abnormal conditions in the Around-View Monitor. This will not hinder normal driving operation, but the system should be inspected by an INFINITI retailer.

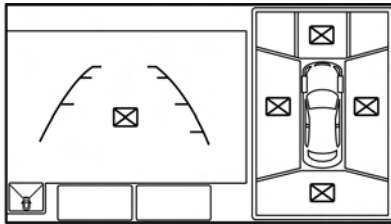

When ⊠ is displayed on the screen, the camera image may be receiving temporary electronic disturbances from surrounding devices. This will not hinder normal driving operation, but the system should be inspected by an INFINITI retailer if it occurs

frequently.

CAMERA MAINTENANCE

If dirt, rain or snow accumulates on a camera, the MOD system may not operate properly. Clean the camera.

OPERATING TIPS



CAUTION

- Do not use alcohol, benzine or thinner to clean the camera. This will cause discoloration. To clean the camera, wipe with a cloth dampened with a diluted mild cleaning agent and then wipe with a dry cloth.
- Do not damage the camera as this may cause the monitor screen to display a distorted image.
- The screen displayed on the Around View Monitor will automatically return to the previous screen 3 minutes after <CAMERA> has been pushed while the shift lever is in a position other than the R (Reverse) position.
- When the view is switched, the display images on the screen may be displayed with some delay.
- When the temperature is extremely high or low, the screen may not display objects clearly. This is not a malfunction.
- When strong light is directly coming on the camera, objects may not be displayed clearly. This is not a malfunction.
- The screen may flicker under fluorescent light. This is not a malfunction.
- The colors of objects on the Around View Monitor may differ somewhat from the actual color of objects. This is not a malfunction.
- Objects on the monitor may not be clear and the color of the object may differ in a dark environment. This is not a malfunction.
- There may be differences in sharpness between each camera view of the bird-eye view.
- Do not use wax on the camera lens. Wipe off any wax with a clean cloth that has been dampened with a mild detergent diluted with water.

7. Monitor system

DIFFERENCE BETWEEN PREDICTIVE AND ACTUAL DISTANCES

BACKING UP ON A STEEP UPHILL

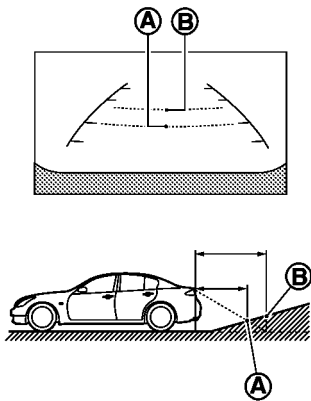

When backing up the vehicle up a hill, the distance guide lines and the vehicle width guide lines are shown closer than the actual distance. For example, the display shows 3 ft (1 m) to the place **(A)**, but the actual 3 ft (1 m) distance on the hill is the place **(B)**. Note that any object on the hill is further than it appears on the monitor.

BACKING UP ON A STEEP DOWNHILL

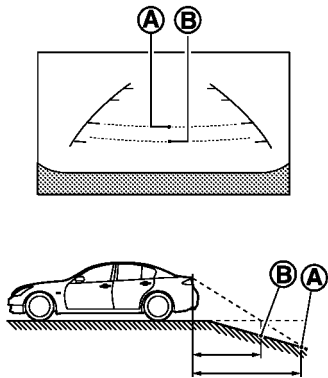

When backing up the vehicle down a hill, the distance guide lines and the vehicle width guide lines are shown further than the actual distance. For example, the display shows 3 ft (1 m) to the place **(A)**, but the actual 3 ft (1 m) distance on the hill is the place **(B)**. Note that any object on the hill is closer than it appears on the monitor.

BACKING UP NEAR A PROJECTING OBJECT

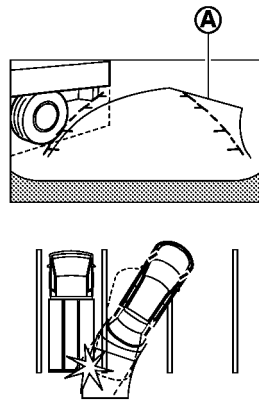

The predictive course lines **(A)** do not touch the object in the display. However, the vehicle may hit the object if it projects over the actual backing up course.

BACKING UP BEHIND A PROJECTING OBJECT

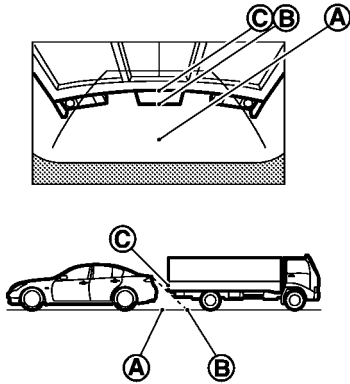

The position (C) is shown further than the position (B) in the display. However, the position (C) is actually at the same distance as the position (A). The vehicle may hit the object when backing up to the position (A) if the object projects over the actual backing up course.

7. Monitor system

MEMO

8 Information and settings

Information screen	8-2	Infiniti InTouch™ Services settings	8-18
SiriusXM Travel Link® (if so equipped).....	8-4	Volume setting	8-21
Viewing SiriusXM Travel Link®	8-4	Emergency support.....	8-21
Infiniti InTouch™ Services	8-10	Settings screen.....	8-23
Subscription to Infiniti InTouch™ Services.....	8-10	Quick setting menu screen	8-28
Important information regarding access to		Fully customizable digital environment	8-29
Infiniti InTouch™ Services.....	8-10	User registration.....	8-29
Infiniti InTouch™ Services features	8-11	Editing user information	8-30
Connecting to Interactive Voice Menu.....	8-16	Setting Infiniti InTuition feature	8-31
Using My Schedule	8-17	Driver Assistance settings (if so equipped).....	8-32
Viewing information feeds.....	8-17		

8. Information and settings

INFORMATION SCREEN

The information screen sets or displays various information that is helpful for using the vehicle. Available items include the vehicle information, traffic information, current location information and navigation software version.

*: For models with navigation system.

Step 1	Step 2	Menu item	Result
Push ◀MENU▶	[Information]	[Energy Flow] (models with hybrid system)	Energy information is displayed on the screen. Touch [Fuel Economy History] to display the Energy Flow History screen.
		[Fuel Economy History] (models with hybrid system)	Fuel Economy History is displayed on the screen. The Fuel Economy History screen can be scrolled. To go back to Energy Flow screen, touch [Energy Flow].
		[Fuel Economy]	Display the Fuel Economy screen. The current and average fuel economy, the distance to empty [Range] can be confirmed.
		[History]	The Fuel Economy history screen can be scrolled. Display Fuel Economy history screen. Touch [◀]/[▶] will display a older history or the newest history.
		[Reset]	Reset the average Fuel Economy. The average for the Reset-to-Reset period is stored as a fuel economy history. When reset average Fuel Economy on the screen, the average fuel consumption on the trip computer is also reset at the same time.

Step 1	Step 2	Menu item	Result
Push ◀MENU▶	[Information]	[Eco Drive Report]	Displays the Eco Drive Report for “Start”/“Cruise”/“Deceleration”.
		[History]	The Eco Drive Report History screen can be scrolled. Display the Eco Drive Report History screen. Touch [◀]/[▶] to display an older history or the newest history.
		[Reset]	Reset the Eco Drive Report screen. The average for the Reset-to-Reset period is stored as an Eco Drive Report history.
		[Where am I?]*	The name and distance of the next/previous street, and other information that indicates the current vehicle location are displayed.
		[Traffic Info]*	Allows traffic information setup.  “Viewing traffic information” (page 9-43)
		[Map Information]*	Display the map version, software version and Navi ID.

**INFO:**

- A SiriusXM Traffic subscription is necessary to view Traffic Info.
- The fuel economy information may differ from the information displayed on the vehicle information display. This is due to the timing difference in updating the information and does not indicate a malfunction.

8. Information and settings

SiriusXM TRAVEL LINK® (if so equipped)

SiriusXM Travel Link information is a subscription service offered by SiriusXM Satellite Radio. It is necessary to subscribe to use the SiriusXM Travel Link information.

This service provides real-time information regarding current weather, fuel prices, sports scores, stock tickers and movie times where available. The SiriusXM Travel Link is broadcast to the vehicle by SiriusXM Satellite Radio.

The service enables you to view the following information on the navigation system:

*Current information around the destination

*Detailed information and forecasts of an area of interest

*Countrywide and local maps with the current weather, temperature, warnings and road condition information

*List of warning/watches events detected around the current location

*Pop-up messages on the navigation screen with voice announcements when warnings and watches are detected around

the current location



WARNING

SiriusXM Travel Link information is not a substitute for attentive driving. Weather conditions change constantly and emergency situations can arise without warning. Relying only on SiriusXM Travel Link information could result in serious personal injury.

VIEWING SiriusXM TRAVEL LINK®

SiriusXM Travel Link information is available in limited markets. To subscribe to or check if this service is available in the area, call 1-866-635-2349 or access <http://www.siriusxm.com/travellink>.



INFO:

- If a contract is not completed for the SiriusXM Travel Link information service, a message appears and it will not be possible to check the information on the traffic information system.
- The weather information is available only for areas that provide weather information to SiriusXM Travel Link.

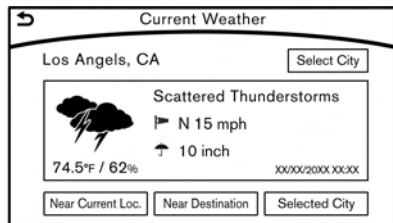

example

Automotive Weather information

Step 1	Step 2	Menu item		Action
Push <MENU>	[SXM Info]	[Automotive Weather]	[Current Weather]	<p>Models with navigation system Display current weather condition information. Touch [Near Destination] to display the current weather condition for the area near the destination, touch [Near Current Loc.] to display the current weather conditions near the vehicles current location. Touch [Selected City] to change the city.</p> <p>Models without navigation system Display default setting city current weather condition information. Touch [Selected City] to change the city.</p>
			[5-DAY Forecast]	<p>Models with navigation system Display the current five-day weather forecast. Touch [Near Destination] to display the five-day weather forecast for area near the destination, touch [Near Current Loc.] to display the five-day weather forecast for the area near the vehicle's current location. Touch [Selected City] to change the city.</p> <p>Models without navigation system Display the five-day weather forecast information for the default setting city. Touch [Selected City] to change the city.</p>
			[Graphical Map]*	<p>Display a graphical map of the weather information on the upper display. Touch [+] / [-] to change the map scale to 320 miles (640 km) (U.S), 32 miles (64 km) (Middle scale) or 5 miles (10 km) (Detail scale). Touch [Radar] to display the weather radar map. Touch [Chart] to display weather surface features and pressure, when the map scale is U.S. (320 miles (640 km)). Touch [Storm] to display Storm information, when the map scale is U.S. (320 miles (640 km)) or Middle scale (32 miles (64 km)). Touch [Winds] to display wind information, when map scale is Detail scale (5 miles (10 km)).</p>

8. Information and settings

Step 1	Step 2	Menu item		Action
Push <MENU>	[SXM Info]	[Automotive Weather]	[Alert Map]*	Show Alert Map information on the upper display. Touch [Legend] to display the detailed contents of information used for the current warning/advisory map by type. Touch [+] / [-] to change the map scale to 320 miles (640 km) (U.S.), 32 miles (64 km) (Middle scale) or 5 miles (10 km) (Detail scale). Touch [Radar] to display the weather radar map. Touch [Chart] to display weather surface features and pressure, when the map scale is U.S. (320 miles (640 km)). Touch [Storm] to display Storm information, when the map scale is U.S. (320 miles (640 km)) or Middle scale (32 miles (64 km)). Touch [Winds] to display wind information, when the map scale is Detail scale (5 miles (10 km)).
			[Alert List]*	Display the list of weather alert. Models with navigation system Touch [Near Current Loc.] to display nearby current alert, touch [Near Destination] to display nearby destination alert.

Fuel Prices information

Step 1	Step 2	Menu item	Action
Push <MENU>	[SXM Info]	[Fuel Prices]	Display fuel prices. Select gas station from the fuel prices list to display detail information or a call a selected gas station from the list. Touch [Select Fuel Type] to select fuel type information, touch [Prices] to display the fuel price list. Models with navigation system Touch [Distance] / [Prices] to sort by distance or sort by prices from the list. Set destination selected gas station from the list.

Sports Score information

Step 1	Step 2	Menu item	Action		
Push ◀MENU▶	[SXM Info]	[Sports Scores]	Select from list	Display current event state (scheduled game, during the game, match results)	
			XM channels to display information	Select to listen to the radio.	
		[Select League]	[Add League]	Add favorite sports genre for the list. When the number of registration is 10, it will be grayed out.	
			[Delete League]	[Multi Select]	Delete multiple selected sports scores.
				[Delete All]	Delete all sports scores.
			Select from list	Delete a selected sports score.	
Select from list.	Display the detail of a score.				

Stock Tickers information

Step 1	Step 2	Menu item	Action		
Push ◀MENU▶	[SXM Info]	[StockTicker]	Display stock names, stock prices, fluctuation contents, variable stock prices, and the receiving date/time.		
			[Add Stock]	Add displaying stock.	
			[Delete Stock]	[Delete All]	Delete all stocks.
				[Multi Select]	Delete multiple selected stock.
Select from list.	Delete a selected stock.				

8. Information and settings

Movie Times information

Step 1	Step 2	Menu item			Action	
Push ◀MENU▶	[SXM Info]	[Movie Listings]	[Select City]	Select from list.		Select the city.
			[Theater]	[Movies]	Select from list	Display detailed movie information.
					[Theater Info]	Display theater information.
					[GO]*	Set a destination selected from the list of theaters.
					[Near Destination]*	Display the theater near the vehicle's destination.
					[Near Current Loc.]*	Display the theater near the vehicle's current location.
		[Selected City]	Change the city.			
		[Movie]	Select from list.		Display information for the movie theater selected from the list.	
			[Details]		Display movie title, rating and run time.	

SXM Info Settings information

Step 1	Step 2	Menu items		Action
Push <MENU>	[SXM Info]	[SXM Info Settings] (if so equipped)	[Weather Alert]	Set weather alert on/off.

Default City Settings information

Step 1	Step 2	Menu items		Action
Push <MENU>	[SXM Info]	[Default City] **	State list	Set the current location. This setting is necessary to display weather information and movie information.
			[Change Country]	

* : For models with navigation system.

** : For models without navigation system.

Notes on SiriusXM Traffic information

- The SiriusXM Traffic information service is not provided for some cities. In addition, the cities for which the traffic information service is provided may be changed.
- In some cases, infrastructure problems may prevent the complete display of the traffic information. This is not a malfunction.

- Due to infrastructure problems, or due to the time when the traffic information service broadcast is received, the displayed information may differ from the actual traffic conditions.
- Depending on the traffic information, a detour route may be slower than the original route.
- SiriusXM Traffic is a service of Sirius XM Radio. SiriusXM Traffic is only available in select markets and is subject to data availability. Reception of the XM signal may vary depending on location. It

requires a monthly premium subscription. The service provider is solely responsible for the quality and accuracy of the information provided. All fees and programming are subject to change. For more details on the SiriusXM Traffic service, terms and conditions, please visit www.siriusxm.com.

You can also contact SiriusXM at 1-866-635-2349.

- SiriusXM Traffic is available in over 130 metropolitan markets. For the most

8. Information and settings

current list of markets covered, please refer to

www.siriusxm.com/siriusxmtraffic, or call SiriusXM Listener Care at 1-866-635-2349.

- Due to road maintenance, infrastructure problems (e.g. malfunction of road sensors, outage of central computer of infrastructure) or natural disasters, there are times when some or all traffic information may not be available.
- Incident information is based on human collection. Not all incidents that have happened are collected and provided.
- Due to infrastructure problems, or transmission delay, there are times when the information may differ from the actual condition. Always observe safe driving practices and follow all traffic regulations.
- Due to the coverage and quality of traffic information and road conditions, it is not always possible for the system to provide the shortest time route even when traffic information is considered.

- Traffic information that is displayed may differ from information from other media (e.g., radio), as other media may use different information sources.

INFINITI INTOUCH™ SERVICES

SUBSCRIPTION TO INFINITI INTOUCH™ SERVICES

Subscription is required to use the Infiniti InTouch™ Services. For the details about the subscription, visit the INFINITI Owner's Portal Website or contact an INFINITI retailer.

IMPORTANT INFORMATION REGARDING ACCESS TO INFINITI INTOUCH™ SERVICES

*Driving is serious business. Only use Infiniti InTouch™ Services and Infiniti InTouch™ Services Premier when safe to do so. Services, including automatic crash notification and SOS, require an active subscription, and are dependent upon the telematics device being in an operative condition, its ability to connect to a wireless network, compatible wireless network availability, navigation map data, and GPS satellite signal receptions, the absence of which can limit or prevent the ability to reach Infiniti InTouch™ Services Customer Care or receive support. Services require compatible 3G GSM/GPRS cellular network provided by AT&T. 3G cellular

network not available in all areas and/or available at all times. Cellular technology is evolving, and changes to cellular networks provided by independent companies are not within Infiniti's control. Certain vehicle services, including Google® compatible services, provided by independent companies are not within Infiniti's control and are subject to change without notice or liability to Infiniti and its affiliates and agents. 6 month trial subscription begins on your date of purchase or lease of a new Infiniti. Subsequently, your credit card (if on file) will be charged at the then current subscription rate and your service will continue for 1 year periods under the terms of your Subscription Agreement. Standard text rates and/or data usage may apply. Terms and conditions of Subscription Agreement apply. See usa.infinitiintouch.com for more information.

†Remote Engine Start available on select models. You are responsible for using Remote Engine Start in accordance with any laws, rules or ordinances in effect in your vehicle's location.

Google Calendar™ is a trademark of Google Inc.

INFINITI INTOUCH™ SERVICES FEATURES

Infiniti InTouch™ Services provides various types of information and services by connecting your vehicle to the Infiniti InTouch™ Services Data Center and Infiniti InTouch™ Services Response Center using the TCU (Telematics Control Unit) installed in your vehicle.



WARNING

- Radio waves could adversely affect electric medical equipment. Individuals who use a pacemaker should contact the device manufacturer regarding any possible effects before using the system.
- The TCU antenna is installed inside the upper central part of the instrument panel. An occupant should not get any closer to the antenna than specified by the pacemaker manufacturer. The radio waves from the TCU antenna may adversely affect the operation of the pacemaker while using the Infiniti InTouch™ Services.
- Please note that the Automatic Collision Notification service and Emergency Call function cannot be used in the following

conditions:

- Infiniti InTouch™ Services subscription has expired or was cancelled.
- The vehicle is outside the area where the cellular network service is receivable.
- The vehicle is in a location with poor signal reception such as tunnels, underground parking garages, behind buildings or in mountainous areas.
- The line is busy.
- The TCU (Telematics Control Unit) or other systems of your vehicle are not working properly.
- The Infiniti InTouch™ Services network or call center is disabled.
- It may not be possible to make an emergency call in all accidents or emergencies, or if you are in a location without reception.
- Park the vehicle in a safe location and set the parking brake before operating <SOS>.
- Inappropriate use of the service may be a violation of local laws and result in a

8. Information and settings

criminal penalty.



INFO:

- Infiniti InTouch™ Services features are dependent upon subscription enrollment and the telematics device being in operative condition, cellular connectivity, navigation map data and GPS satellite signal reception. Terms and conditions of the Infiniti InTouch™ Services Subscription Agreement apply.
- Enrollment is required in order to use Infiniti InTouch™ Services. The services that can be received vary depending on the plan in which you are enrolled.
- After the complimentary trial period, you will be charged for the service at the then subscription rate. The services that can be received vary depending on the plan to which you subscribe.
- Laws in some jurisdictions may restrict the use of “Text-to-Speech.” Check local regulations before using this feature.

Infiniti InTouch™ Services may be updated. The latest detailed information is available on the following websites or from

the support line.

Infiniti InTouch™ Services website:

usa.infinitiintouch.com (for U.S.)

canada.infinitiintouch.com (for Canada)

Infiniti InTouch™ Services support line:

1-800-334-7858 (for U.S.)

1-855-892-7418 (for Canada)

- **Automatic Collision Notification:**

The TCU (Telematics Control Unit) generates a signal automatically to the Infiniti InTouch™ Services Response Center in the case of an accident severe enough to trigger one of the vehicle’s air bags. Upon the signal, a Response Specialist receives the vehicle location and customer information and notifies the proper authorities in accordance with established policies and procedures.

- **Curfew Alert:**

Curfew Alert allows you to monitor the time and day when your vehicle is driven. If your Infiniti is operated outside of the pre-determined schedule, you will receive a notification according

to your preference (email, text message, or automated phone call).

- **Emergency Call:**

The Emergency Call feature provides emergency assistance by connecting to a Response Specialist. In the event of an emergency, by push the in-vehicle <SOS> button to use this feature. The Response Specialist provides various assistance depending on the situation  “Emergency support” (page 8-21)

- **Enhanced Roadside Assistance:**

Enhanced Roadside Assistance allows you to receive assistance from the Roadside Response Specialist for a non-emergency incident that requires a towing or third-party response service. The service is accessed by touching the IVR (Interactive Voice Response) soft button on the navigation screen or by pushing the in-vehicle <SOS> button. Roadside Assistance may also be used in conjunction with the Emergency Assistance service, if warranted.

 “Emergency support” (page 8-21)

- **My Schedule:**

The My Schedule feature allows you to access your personal online Google

Calendar™ via the navigation system, and can display the calendar or read out the schedule. This service will also allow you to review your appointments and meetings, and select the meeting location as a destination.

 “Using My Schedule” (page 8-17)

- **Report Stolen Vehicle:**

A Response Specialist will attempt to obtain location information from a reported stolen vehicle and provide that information to local law enforcement agencies to assist in the recovery of your stolen vehicle.

- **Remote Door Lock/Unlock:**

The Remote Door Lock/Unlock feature allows you to access the vehicle remotely by calling to an Infiniti InTouch™ Services Response Specialist or from the Infiniti InTouch™ Services website to send lock or unlock commands to the vehicle.

 “Connecting to Interactive Voice Menu” (page 8-16)

- **Remote Sound Horn and Flash Lights:**

Remote Horn and Lights allows you to remotely flash the lights and sound the horn on your Infiniti. It is most often

used to help you locate your vehicle.

- **Remote Engine Start:**

Remote Engine Start provides you the convenience of being able to start your Infiniti from the website or from your mobile phone. Once started, your car will run for 10 minutes. If you need a little extra time before you get to your car, you can extend the run time by making a second Remote Engine Start request. The car will run for an additional 10 minutes from the time of your second request.

- **Alarm Notification:**

The Alarm Notification feature will notify you via the chosen notification method on the Infiniti InTouch™ Services website when your vehicle alarm system is activated.

- **Scheduled Maintenance Notification:**

The Maintenance Alert Notification provides your vehicle’s mileage data to INFINITI. INFINITI notifies you of maintenance notifications using this mileage data.

- **Maintenance Alert:**

Maintenance Alert allows you to receive

notifications via the chosen notification method set in the Infiniti InTouch™ Services website in the event of a vehicle sub-system malfunction. The service is managed through the Infiniti InTouch™ Services website.

- **Destination Assistance:**

The Destination Assistance helps you to search a destination via the Interactive Voice Response (IVR) system or a live Response Specialist by pushing the IVR soft button on the navigation screen. The IVR system will ask you for a name, item or address, etc. to locate your requested point of interest and accesses a third-party service to bring up the most applicable results. A Response Specialist will assist you if your request is not recognized in the IVR session.

- **Destination Send-to Vehicle:**

Destination Send-to-Vehicle feature allows you to find the point of interest information from the latest database within the Infiniti InTouch™ Services website and download the information to the vehicle.

 “Using Destination Send to Car” (page 9-27)

8. Information and settings

- **Connected Search:**

Connected Search gives you the ability to conduct a point of interest search around the vehicle location via the Destination menu of the navigation system. This search links to the Infiniti InTouch™ Services database which may have destination information that is more up-to-date than your Infiniti hard-drive navigation system.

 “Searching by connecting Data Center” (page 9-25)

- **Drive Zone:**

The Drive Zone feature allows you to monitor the movement of your vehicle in and out of specified regions. Using the Infiniti InTouch™ Services website or the Interactive Voice Response (IVR), you can define a series of allowed or restricted regions, and are then alerted via your chosen notification method when the vehicle enters or leaves a designated region. You can also query the Infiniti InTouch™ Services website to see a listing of alert notifications received.

- **Max Speed Alert:**

Max Speed Alert allows you to monitor

the speed of your vehicle by receiving alerts. You can set the maximum speed via the Infiniti InTouch™ Services website, and if your vehicle exceeds the specified speed threshold, you will receive a notification via the chosen method. You can also query the Infiniti InTouch™ Services website to view a listing of Max Speed Alert notifications.

- **Mobile Information Service (if so equipped):**

Mobile Information Service (MIS) delivers information such as the latest news headlines, stock quotes and sports scores set in the Infiniti InTouch™ Services website to be displayed on your navigation screen or to be read out.

 “Viewing information feeds”
(page 8-17)

- **Valet Alert:**

Valet Alert notifies you if the vehicle moves outside a 0.2 mile radius of the location set on the Infiniti InTouch™ Services website. You can activate Valet Alert from the “Voice Menu” and saying “Valet Alert” when the call is connected.

 “Connecting to Interactive Voice

Menu” (page 8-16)

- Journey Planner feature allows you to set the route according to the route plan created in advance by the INFINITI Owner’s Portal Website.

 “Using Journey Planner”
(page 9-22)

Notice to Bluetooth® Hands-free phone users

The Bluetooth® Hands-free phone system will be disabled and not be able to take phone calls while the vehicle is connected to the Infiniti InTouch™ Services Response Specialists or the emergency support staff at the Infiniti Response Center.

This is to avoid various services by Infiniti InTouch™ Services Response Specialists (such as route guidance) and Infiniti InTouch™ Services emergency support staff being interrupted by incoming calls. Incoming phone calls received while the vehicle is connected to the Service Center will not be listed in the call history of the Bluetooth® Hands-free phone system. However those incoming calls may be listed in the call history of your mobile phone, depending on its capabilities. After disconnecting communication with the

Infiniti InTouch™ Services Response Specialist or Infiniti InTouch™ Services emergency support staff, check the incoming call history on your mobile phone when it is safe to do so.

Service application

A separately purchased Infiniti InTouch™ Services subscription is required. For detailed information, contact an INFINITI retailer or refer to the following Infiniti InTouch™ Services website:

usa.infinitiintouch.com (for U.S.)

canada.infinitiintouch.com (for Canada)



INFO:

If the vehicle is owned by another person and is resold, the subscription for this service must be canceled and all data stored on the device must be deleted.

Operating tips



WARNING

- Use the Infiniti InTouch™ Services after stopping your vehicle in a safe location. If you have to use the Infiniti InTouch™ Services while driving, exercise extreme



caution at all times so full attention may be given to vehicle operation.

- If you are unable to devote full attention to vehicle operation while talking with the Infiniti InTouch™ Services, pull off the road to a safe location and stop your vehicle.
- Do not use the Infiniti InTouch™ Services with the engine or the hybrid system stopped. Doing so may discharge the vehicle battery.
- The Infiniti InTouch™ Services cannot be used under the following conditions:
 - The Infiniti InTouch™ Services subscription has expired.
 - The vehicle is outside the area where the cellular network service is receivable.
 - The vehicle is in a location with poor signal reception such as tunnels, underground parking garages, behind buildings or in mountainous areas.
 - The line is busy.
 - The TCU (Telematics Control Unit) or other systems of your vehicle are not working properly.

— The Infiniti InTouch™ Services network system is disabled.

- Information Feeds download cannot be used when the vehicle is connected to the Infiniti InTouch™ Services Data Center and Infiniti InTouch™ Services Response Center.
- Communication with the Infiniti InTouch™ Services Data Center is related to the data communication mode and may cause occasional difficulty in receiving signals, and the signal receivable area may be limited compared to regular mobile phones.
- You may hear clicks or experience interruptions while speaking with the Infiniti InTouch™ Services Response Specialists. This is due to a shift in the connection zone and is not a malfunction.
- Depending on the line used, the sound volume may decrease. Adjust the volume as necessary.
- Received sounds may be distorted or ambient noise may sound like voices of a crowd. This is due to the use of the digital line and is not a malfunction.

8. Information and settings

- You may hear your own voice from the speaker when talking with the Infiniti InTouch™ Services Response Specialist due to a network disturbance. When this occurs, reconnect the line after a few minutes or at a different location.
- This vehicle incorporates a communication device that is called a TCU (Telematics Control Unit). The communication connection between this unit and the Infiniti InTouch™ Services Data Center allows for various services. When the system connects to the Infiniti InTouch™ Services Data Center, an antenna icon will appear on the screen. Use the service in a location where the symbol representing good signal reception appears on the screen.
 : When the signal reception is good
 : When the signal reception is bad
- The Infiniti InTouch™ Services use the TCU (Telematics Control Unit) for communications. Even if the signal strength bar of the in-vehicle data communication module indicates good reception, connection to the Infiniti InTouch™ Services Data Center may be disabled. This does not indicate a malfunction.

Operate the system again after a few minutes.

CONNECTING TO INTERACTIVE VOICE MENU

Various services to support your driving are available by answering Interactive Voice Menu.

For more details, contact the Infiniti InTouch™ Services support line at 1-800-334-7858 (for U.S.) /1-855-892-7418 (for Canada) or refer to the Infiniti InTouch™ Services website usa.infinitiintouch.com (for U.S.)/canada.infinitiintouch.com (for Canada).

- Push **<MENU>** and touch [InTouch Services].
- Touch [Connect to Voice Menu].
- The system connects to the Infiniti InTouch™ Services Response Center and menu options will be announced. Speak your preferred option.
 - Destination Assistance
Set a destination using a Interactive Voice Response (IVR) system.
 - Roadside Assistance
Connect to the Roadside Response Specialist.

- Valet Alert
Turns on the Valet Alert function and monitors the vehicle movement within a certain range.
- Personal Assistance
Connects to the Infiniti InTouch™ Services Response Specialist.

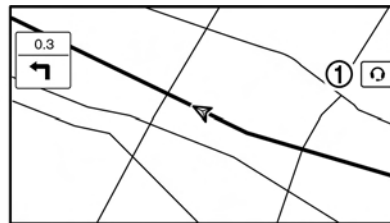

INFO:

- You can also connect to an Infiniti InTouch™ Services Interactive Voice Menu by touching the IVR soft button ① on the map.
- After selecting [Connect to Voice Menu], it may take some time until the system initiates connection, depending on the technical environment and whether the TCU (Telematics Control Unit) is being used by other services.

- To avoid disconnecting the line, do not turn off the engine or hybrid system.

USING MY SCHEDULE

Allows you to provide in-vehicle access to your personal Google Calendar™.

1. Push **<MENU>**.
2. Touch [InTouch Services].
3. Touch [My Schedule].

My Schedule allows you to see your Google Calendar™ events in your vehicle.

VIEWING INFORMATION FEEDS

Contents of the various Infiniti InTouch™ Services information can be downloaded.

Downloading information feeds

1. Push **<MENU>**.
2. Touch [InTouch Services].
3. Touch [Mobile Info. Service]. A folder list screen is displayed.
4. Touch the preferred folder. A Channel list screen is displayed.
5. Touch the preferred channel.
6. Touch the preferred information feed. The content is announced by the system (Text-to-Speech) while the vehi-

cle is being driven, or if parked, you can read the content on the display.



INFO:

- Touch [Menu] during communication with the Infiniti InTouch™ Services Data Center to cancel the connection.
- A message is displayed when the communication is disconnected while downloading information due to a poor communication status. Select [Yes] to restart the download.
- Laws in some jurisdictions may restrict the use of “Text-to-Speech.” Check local regulations before using this feature.
- Some terminology such as personal names, place names, special terms, symbols, etc. may not be announced correctly. This is not a malfunction.
- The system will pause announcements when interrupted by the voice guidance given by the navigation system. When the voice guidance finishes, the system will restart the announcement.
- The volume can be adjusted when the system announces the information.
🔊 “Volume settings” (page 2-19)

- The selected content is read out while the vehicle is being driven, or if parked, you can read the content on the display.
- Content settings can be made using the Infiniti InTouch™ Services website. For more details, contact the Infiniti InTouch™ Services support line at 1-800-334-7858 (for U.S.) /1-855-892-7418 (for Canada) or refer to the Infiniti InTouch™ Services website usa.infinitiintouch.com (for U.S.)/canada.infinitiintouch.com (for Canada).

Screen information:

When information feeds are downloaded from the Infiniti InTouch™ Services Data Center, the contents of the information are displayed while the vehicle is stopped.

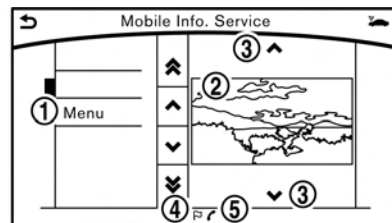

① Menu:

Stop to announce the content is announced (Text-to-Speech), and dis-

8. Information and settings

plays the operation menu.

② Contents:

The contents of the Infiniti InTouch™ Services feeds are displayed.

③ [^]/[v]:

Turns to the next or previous page if the information has a number of content pages.

④ :

If the information contains map information, the icon be displayed. It can be set as the destination.

⑤ :

If the information contains phone number information, the icon is displayed. It is possible to make a phone call to the facility.

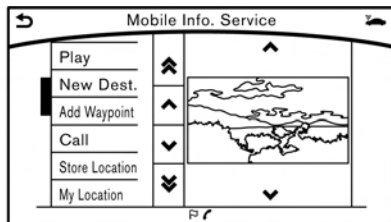

After parking the vehicle in a safe location

and touching [Menu], the operation menu is displayed on the right side of the screen.



INFO:

The availability of the operation menu items differs depending on the contents of the selected information feeds.

Updating All Information Feeds

It is possible to synchronize with the list updated Infiniti InTouch™ Services website, such as “Destination Send to Car”, “My Schedule”, “Mobile Info. Service” or “Journey Planner”, etc.

For details of the services and settings, refer to the Infiniti InTouch™ Services website: usa.infinitiintouch.com (for U.S.)/canada.infinitiintouch.com (for Canada), or contact the Infiniti InTouch™ Services support line at 1-800-334-7858 (for U.S.) /1-855-892-7418 (for Canada).

1. Push **<MENU>**.
2. Touch [InTouch Services].
3. Touch [Sync All Feeds].
4. The latest information is sent from the Infiniti InTouch™ Services Response Center and an updated list is displayed.

Viewing information feeds history

The information feeds that were previously referred to are displayed.

1. Push **<MENU>**.
2. Touch [InTouch Services].
3. Touch [History].

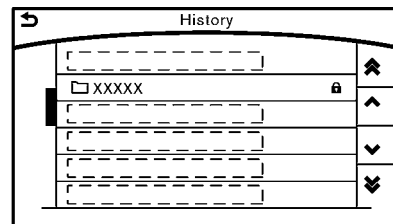

4. Touch the preferred item.
5. A history list is displayed. Touch the preferred information feed.

INFINITI INTOUCH™ SERVICES SETTINGS

You can delete Infiniti InTouch™ Services history, return to the default settings, and display user information from the setting screen.

8. Information and settings

Step 1	Step 2	Step 3	Menu	Action	
Push <MENU>	[Settings]	[InTouch Services]	[Vehicle Information Settings]	[Send Vehicle Information]	When this item is turned on, the vehicle information (the data regarding your driving information such as vehicle location, driving history, fuel economy, etc.) can be sent to the Infiniti InTouch™ Services center.
				[Delete Vehicle Information]	Delete all Vehicle Information.
			[Delete Search History]	[Delete Mobile Info. Service History]	Delete all Mobile Info. Service history.
				[Delete Voice Menu History]	Delete all Voice Menu history.
				[Delete Connected Search History]	Delete all Connected Search history.
				[Delete InTouch Services History]	Delete Infiniti InTouch™ Services histories.
				[Reset All InTouch Services Settings]	All Infiniti InTouch™ Services settings are returned to the default settings.
				[Unit ID Information]	Display the Unit ID, TCU (Telematics Control Unit) ID, SIM ID and VIN Information necessary for user registration.

8. Information and settings

			[Vehicle Data Transmission Setting]	When [OK] is touched, data transmission to the Infiniti InTouch™ Services Data Center is enabled. Touch [Decline] to disable the Infiniti InTouch™ Services functions.
--	--	--	-------------------------------------	--

VOLUME SETTING

The Infiniti InTouch™ Services Text-to-Speech and Infiniti InTouch™ Services Response Specialist volume can be set.

EMERGENCY SUPPORT

Infiniti InTouch™ Services provides various services to support dealing with emergencies of the subscribed vehicle and the driver.

For example, in case of an illness or serious injury, you can seek support by pushing the in-vehicle <SOS> button and connecting to the Infiniti InTouch™ Services Response Center. The Infiniti InTouch™ Services Response Center can specify the location of the vehicle via GPS, and the information will be sent to the police or other agencies as needed.

For information about other Infiniti InTouch™ Services emergency support related services, contact the Infiniti InTouch™ Services support line at 1-800-334-7858 (for U.S.) /1-855-892-7418 (for Canada) or refer to the Infiniti InTouch™ Services website usa.infinitiintouch.com (for U.S.)/canada.infinitiintouch.com (for Canada).



WARNING

- Please note that the Automatic Collision Notification service and Emergency Call function cannot be used in the following conditions:
 - Infiniti InTouch™ Services subscription has expired or was cancelled.
 - The vehicle is outside the area where the cellular network service is receivable.
 - The vehicle is in a location with poor signal reception such as tunnels, underground parking garages, behind buildings or in mountainous areas.
 - The line is busy.
 - The TCU (Telematics Control Unit) or other systems of your vehicle are not working properly.
 - The Infiniti InTouch™ Services network system is disabled.
 - It may not be possible to make an emergency call in all accidents or emergencies, or if you are in a location without reception.

- Park the vehicle in a safe location and set the parking brake before operating <SOS>.
- Only use this service in case of an emergency. There may be a penalty for inappropriate use of the service.

Making an emergency call

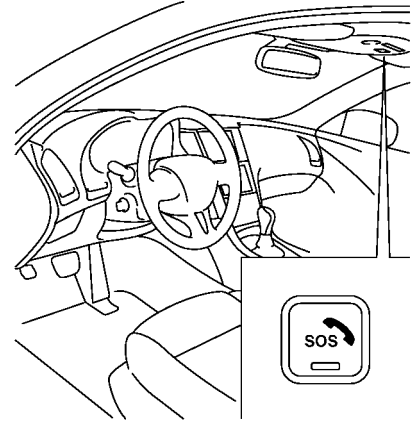

1. Push <SOS>.
2. When the line is connected, speak to the Response Specialist.

8. Information and settings



INFO:

- After **<SOS>** is pushed, it may take some time until the system initiates connection, depending on the technical environment and whether the TCU (Telematics Control Unit) is being used by other services.
- An indicator light on **<SOS>** shows the readiness of the emergency support system. If the indicator light is not illuminated, pushing **<SOS>** does not connect your vehicle to the Response Specialist.
The indicator light blinks while connected to the Infiniti InTouch™ Services Response Center.
- Even when the indicator light is illuminated, connection to the Infiniti InTouch™ Services Response Center may not be possible. If this occurs in an emergency situation, contact the authorities by other means.
- To avoid disconnecting the line, do not turn off the engine or hybrid system.

SETTINGS SCREEN



The system can be customized to make it easier for you to use.

The displayed items vary depending on the equipped options.

The order of displayed items can be sorted.

Step 1	Step 2	Setting item	Result	
Push <Menu>	[Settings]	[Bluetooth]	Set the Bluetooth® Audio and Phone. ☞ “Bluetooth® settings” (page 2-22)	
		[Phone/Mail]	Display the Phone & Mail setting screen. ☞ “Phone and text message assistant settings” (page 5-9)	
		[Vehicle]	[Lamp ON When Door Unlocks]	When this item is turned to ON, the interior lights illuminate when any door is unlocked.
			[Light Sensitivity]	Set the Auto Light sensitivity.
			[Light Off Delay]	Set the Auto Light Delay Timer.
			[Remote Engine Start]	Set the Remote Engine Start.
			[Speed Sensing Wiper Interval]	Set the wiper interval is adjusted automatically according to the vehicle speed.
			[Auto Lock]	Set the Auto lock conditions.
			[Auto Unlock (I-key)]	Set the Auto unlock (I-key) conditions.
			[Rain Sensor]	Set the rain-sensing auto wiper system.
[Answer Back]	Select the Answer back timing.			
[Battery Saver Mode]	Setting Battery Saver Mode.			

8. Information and settings

Step 1	Step 2	Setting item		Result
Push <Menu>	[Settings]	[Vehicle]	[Lock/Unlock by Door Handle]	When this item is turned ON, the Lock/Unlock vehicle doors with Intelligent Key system is available. When this item is OFF, this system is not available.
			[Touch Sensitive Door Sensor]	When this item is turned ON, you can unlock vehicle doors by touching the inside of the door handle. When it is OFF, you can unlock vehicle doors by pushing the request switch. Refer to the vehicle Owner's Manual for details.
			[Lane Change (3 Flashes)]	Setting Lane change 3 flash.
			[Wipe Drip]	Setting Drip wipe.
			[Answer Back Exterior Light]	Setting Signature Lamp.
			[Selective Door Unlock]	When this item is turned ON you can use this function to unlock an assigned door. When this item is turned OFF, all doors will unlock.
			[Lift Steering upon Exit]	Setting Lift steering-wheel on Exit.
			[Slide Driver Seat Back on Exit]	Setting Driver Seat Back on Exit.
		[Reset Settings]	All the vehicle setting values are returned to an initial setting.	
		[Navigation]	Display the Navigation setting screen.  "Navigation settings" (page 9-56)	
[Audio]	Display the Audio setting screen.  "Audio settings" (page 4-32)			
[Screen]	Set the Screen display to the preferred settings.  "Screen Settings" (page 2-17)			





8. Information and settings

Step 1	Step 2	Setting item			Result
Push <Menu>	[Settings]	[Volume Adjustment]			Set the Volume Adjustment.  "Volume settings" (page 2-19)
		[Meter]	[Main Menu Selection]	[Average Speed]	Select the preferred item to display on the meter.
				[Trip Distance & Time]	Refer to the vehicle Owner's Manual for details.
				[Range]	
				[Fuel Economy]	
				[Tire Pressures]	
				[Navigation]	
				[Audio]	
				[Driving Aids]	
				[Chassis Control]	
				[Blank]	
				[Idoling Stop]	
				[Idoling Stop (Accumulation)]	
				[Energy Flow]	
				[EV Odometer]	
[Coolant Temperature]					
	[Eco Mode Settings]	[Display Mode]	Switch the display mode between Pedal and Instant Fuel Economy.		

8. Information and settings

Step 1	Step 2	Setting item			Result	
Push <Menu>	[Settings]	[Meter]	[Maintenance]	[Oil and Filter]	The following settings are available for each maintenance item. [Distance]: Set the interval (mileage) of the maintenance schedule. To determine the recommended maintenance interval, refer to your “INFINITI Service and Maintenance Guide” (if so equipped) or vehicle Owner’s Manual. [Show Alerts]: To display the reminder automatically when the desired distance is reached, select the [Show Alerts] key. [Reset Dist]: Reset the driving distance to the new maintenance schedule.	
				[Tire]		
				[Other]		
				[Alarms]	[Outside Temperature]	Set Low temperature alert to on/off.
					[Timer Alert]	Adjust the alert timer setting.
					[Navigation]	Set turn by turn to on/off.
				[Display Effect]		Set Illumination effect to on/off.
				[Language]		Set the preferred language.
				[TPMS setting]	[Tire Pressures Unit]	Set the preferred tire pressure unit to display appearance.
				[Factory Reset]		Reset the meter to the default values.
		[Clock]			Set the Clock to your preferred settings.  “Clock settings” (page 2-21)	

8. Information and settings

Step 1	Step 2	Setting item	Result	
Push <Menu>	[Settings]	[InTouch Services]	Set Infiniti InTouch™ Services to your preferred settings.  “Infiniti InTouch™ Services” (page 8-10)	
		[Voice Recognition]	Set Minimize Voice Feedback to on/off and the audio setting for voice recognition use.	
		[Camera/Sonar]	Set the Camera·Sonar to your preferred settings.  “Around View Monitor settings” (page 7-17)	
		[Drive Mode Enhancement]	[ECO Pedal]	Set the Eco Pedal to [OFF], [Soft], or [Standard] Refer to the vehicle Owner’s Manual for details.
			[NAVI Shift Control]	Turn on/off the NAVI Shift Control. This item functions only on the models with NAVI Shift Control. Refer to the vehicle Owner’s manual for details.
		[Other]	[CLIMATE]	Set the heater and air conditioner to your preferred settings.  “Heater and air conditioner settings” (page 3-11)
			[Language & Units]	Set the Language & Units to your preferred settings.  “Language and unit settings” (page 2-20)
			[Keyboard Type]	Set the Keyboard Type to [QWERTY] or [ABC].
			[Low on Fuel Alert]	Set the fuel low notification to on/off.
			[Software Information]	Display the Software Information.

8. Information and settings

QUICK SETTING MENU SCREEN

Touch [⚙] on the lower touch screen display (lower display) to set the display of the setting menu items.

The following items are available settings.

Setting item	Result
[Day/Night]:	Adjust the upper and lower screen brightness. Toggle the map color between the day screen and night screen.
[Bass]:	Adjust the speaker tone quality and sound balance by touching [+]/[-], [L]/[R] or [R]/[F].
[Treble]:	
[Balance]:	
[Fade]:	
[Volume Adjustment]:	This turns on and off, as well as adjusts, the volume for various functions including, phone, navigation voice guidance (if so equipped), as well as system beeps

FULLY CUSTOMIZABLE DIGITAL ENVIRONMENT

The system will automatically recognize the user upon turning on the vehicle, after Setting up the user information. There will be a personalized welcome guidance and a prompt to log-in.

This feature allows 3 drivers to use their own registration, drive mode, driving position, air conditioner and audio settings, and memorizes these custom settings.

Log-in user can be changed from welcome guidance screen or User List screen.



NOTE:

- Vehicle Apps settings and configurations are not linked to specific Intelligent Keys.
- A maximum of four Intelligent Keys can be registered to store settings for three profiled users and one guest. One user setting information can be stored per key.
- When the ignition switch is pushed to the "OFF" position, the user settings at that point will be memorized by the Intelligent Key that is used.

USER REGISTRATION

The driving position, navigation, and air conditioner, etc., settings can be memorize for each user. The settings can be restored when deactivating the system.

Up to three users can be registered.

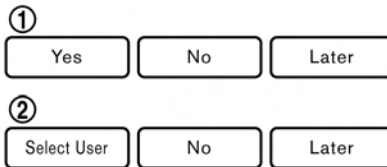

1. When a system is started with an Intelligent Key that had not been registered, a message asking if you wish to register yourself as a user is displayed.

To register:

- If you are the first user to register, touch [Yes] on the user registration screen ①.
- If you are the second or the third user to register, touch [Select User] on the user registration screen ②.

2. The New User register screen. Enter the user information on the New User register screen is displayed.
3. After inputting user information, touch [End] to complete user registration.



INFO:

- Do not push the ignition switch to the "OFF" position during user registration. The registration may not complete.
- If [Later] is selected on the pop-up message screen, the user will log in as a guest. If the same Intelligent Key is used again the next time the vehicle is used, the same pop-up message will be displayed.
If [No] is selected, the user will log in as a guest and the pop-up message will not be displayed again with the same Intelligent Key.



INFO:

- To change the registered user information, press <MENU> then touch [Infiniti InTuition] to show [User List] where the user can be selected for editing.

8. Information and settings

EDITING USER INFORMATION

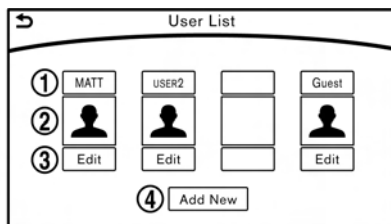

1. Touch the user icon of the lower right of the lower display to show user list screen.
2. Display user list screen.

① Name:

Display user name. Touch to change log-in user.

② User icon:

Display user select icon.

③ [Edit]:

Select to edit user settings.

④ [Add New]:

Add a new user. It can register a maximum three persons. This key will not be displayed when three users have been already registered.

3. Touch [Edit] of the user you want edit.



INFO:

- User name and user icon of the guest user cannot be edited.
 - The User List can also be accessed for editing using the following procedure.
1. Push **<MENU>** and touch [Infiniti InTuition]
 2. Touch [User List].

User edit screen

Touching [Edit] on the User List screen will display the User Edit screen.

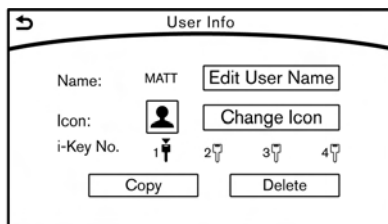

Available setting items:

Setting item	Action
[Edit User Name]	Edit the user name.

[Change Icon]	Edit the user picture. The user icon can be selected from the pre-installed pictures and registered via a USB memory device.
Intelligent-Key No.	<ul style="list-style-type: none"> • Indicates the key number. • The key icon that is highlighted indicates that the key is linked to the user. • The “▼” mark above the key icon indicates which one of the keys is currently being used.
[Copy]	Copy user settings. <ul style="list-style-type: none"> • Navigation (if so equipped) and audio settings • Drive assistance settings • PERSONAL Mode settings • Air conditioner settings
[Delete]	Delete a user.

i INFO:

- The number of characters for the user name is limited.
- When a current user is deleted, the user is changed to a guest user.
- When the ignition switch is pushed to the “OFF” position, the current user settings will be stored by the Intelligent Key that is used.

Change the user picture

When you connect USB device with image data, you can download image and setting picture.

1. Display User Edit screen and touch [Change Icon].
2. Connect USB device and touch [].
3. Touch preferred picture file name.
4. Touch [Select] to setting user picture.

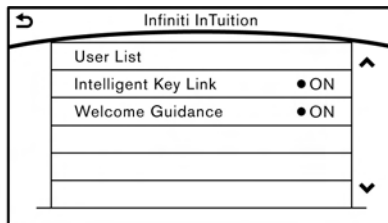

When display picture-preview screen, touch [Update Only] to only update picture list from USB device.

SETTING INFINITI INTUITION FEATURE



Push **<MENU>** and touch [Infiniti InTuition].

The following items can be setting.

- [User List]
Edit user information, copy user settings and delete user setting.
 “Editing user information” (page 8-30)
- [Intelligent Key Link]
Turn on or off Intelligent Key Link function.
- [Welcome Guidance]
Set the Welcome guidance on or off.
 “Log-in screen” (page 2-7)

i INFO:

- When [Intelligent Key Link] is turned off, the users will be logged in as a guest.
- When [Intelligent Key Link] is turned off, the welcome guidance will not be displayed.

8. Information and settings

DRIVER ASSISTANCE SETTINGS (if so equipped)

Various functions for supporting your drive can be set. Refer to the vehicle Owner's Manual for the detail of the each function. The displayed items vary depending on the equipped options.

Step 1	Step 2	Step 3	Setting Item	Action
Push <MENU>	[Driver Assistance]	[Forward Assist]	[Distance Control Assist]	Setting Distance Control Assist Enable/Disable.
		[Lane Assist]	[Lane Departure Warning]	Setting Lane Departure Warning on/off.
			[Lane Departure Prevention]	Setting Lane Departure Prevention Enable/Disable.
			[Active Lane Control]	Setting Active Lane Control on/off.
			[Active Lane Control Setting]	Setting Active Lane Control setting [High]/[Low].
		[Blind Spot Assist]	[Blind Spot Warning]	Setting Blind Spot Warning on/off.
			[Blind Spot Intervention]	Setting Blind Spot Intervention Enable/Disable.
			[Side Indicator Brightness]	Setting Side Indicator Brightness from Bright, Standard or Dark.
		[Emergency Assist]	[Forward emergency braking]	Setting Forward Emergency Braking/Predictive Forward Collision Warning on/off. * The forward emergency braking system will be automatically turned ON when the engine is restarted.

NOTE:

It is necessary to push the dynamic driver assistance switch on the steering-wheel, to turn on the Distance Control Assist, Lane Departure Prevention and Blind Spot Intervention.

9 Navigation (if so equipped)

Safety information.....	9-3	Searching from Stored Locations	9-24
Map data authentication	9-3	Setting by phone number	9-24
Map operation.....	9-4	Setting from stored routes.....	9-25
Map types.....	9-4	Setting by Infiniti InTouch™ Services.....	9-25
Road color	9-6	Setting point on map.....	9-27
Displaying current vehicle location.....	9-7	Procedures after setting route	9-27
Moving map.....	9-7	Route guidance.....	9-29
Changing scale of map.....	9-8	About route guidance	9-29
Change map.....	9-9	Guidance screen settings.....	9-34
Setting split screen	9-10	Canceling Route	9-34
Map view settings.....	9-10	Route menu screen.....	9-35
Setting information on map.....	9-13	Editing route	9-35
Traffic information on map	9-13	Recalculating route.....	9-38
Setting destination.....	9-14	Searching for detour route using	
Changing region.....	9-14	traffic information.....	9-38
Destination screen	9-15	Setting detour route	9-39
Finding address	9-18	Route guidance settings	9-39
Finding points of interest	9-19	Viewing traffic information	9-43
Setting home as destination	9-21	Viewing available traffic information	9-44
Setting intersection.....	9-21	Viewing traffic information list.....	9-45
Finding nearby place.....	9-22	Display urgent traffic information	9-46
Using Journey Planner.....	9-22	Traffic Information Settings.....	9-46
Searching from history.....	9-23	Traffic information on map.....	9-47
Setting freeway entrance/exit	9-23	Storing a location/route.....	9-48
Setting city center.....	9-23	Storing location.....	9-48

Storing route.....	9-49	General information for navigation system	9-59
Storing avoid area.....	9-50	Current vehicle location.....	9-59
Editing stored information.....	9-50	Route calculation.....	9-63
Deleting stored item.....	9-53	Route guidance	9-64
Transferring information to/from		Map data.....	9-66
address book.....	9-55	How to handle the SD card.....	9-70
Navigation settings	9-56		

SAFETY INFORMATION

The navigation system is primarily designed to help you reach your destination. However, you, the driver, must use the system safely and properly. Information concerning road conditions, traffic signs and the availability of services may not always be up to date. The system is not a substitute for safe, proper, and legal driving.



WARNING

- Do not rely on route guidance alone. Always be sure that all driving maneuvers are legal and safe in order to avoid accidents.

MAP DATA AUTHENTICATION

When using a navigation system for the first time, map data authentication is necessary.

1. The system starts when the ignition switch is pushed to the “ACC” or “ON” position for the first time. The map data authentication screen is displayed.
2. Enter the 16 alphanumeric characters in four parts containing four characters each. Each of the four parts is displayed separately.

9. Navigation (if so equipped)

MAP OPERATION

MAP TYPES

Maps are displayed on the upper touch screen display (upper display).

Two types of map views are available: 2D map and Birdview™ (3D) map.

2D map

The 2D map displays the map in a two-dimensional environment similar to a road map.

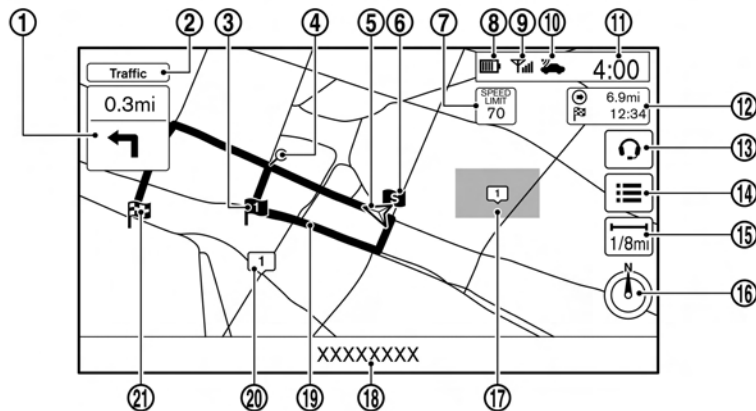

Screen information:

- ①  Arrow:

Indicates the distance to the next guide point and the turning direction at that guide point.

- ② Traffic indicator:

Displays the reception condition of traffic information transmitted from the traffic information provider.

When the reception condition of traffic information transmitted from the provider is not detected, the traffic in-

dicator will be “grayed-out”.

- ③  Waypoint:

















Displays the set locations between the starting point and the destination. A maximum of five waypoints can be set.

- ④  Guide point:

Indicates a guide point on the route.

- ⑤  Vehicle icon:

Indicates the current vehicle location and the direction of travel.

- ⑥  Starting point:
Displays the vehicle location, with which the route is set, as the starting point.
- ⑦  Speed limit icon:
Displays the speed limit of the current driving road.
- ⑧ Battery status:
Indicates the battery status of the connected cellular phone in four levels.
- ⑨ Reception level indication:
Indicates the approximate level of reception of the connected cellular phone.
- ⑩  Infiniti InTouch™ Services antenna icon
When the system connects to the Infiniti InTouch™ Services Data Center, an antenna icon will appear on the screen.
 “Infiniti InTouch™ Services features” (page 8-11)
- ⑪ Clock
Display current time.
 “Clock settings” (page 2-21)
- ⑫  Remaining time and distance to the destination:
Indicates the approximate remaining time and distance to the destination or waypoint. This indicator will appear when a destination or waypoint is set and route guidance is started.
- ⑬ IVR soft button (if so equipped):
Touch the icon to connect to the Infiniti InTouch™ Services Interactive Voice Menu.
 “Connecting to Interactive Voice Menu” (page 8-16)
- ⑭  Upper display icon:
Touch the icon to display the shortcut menu.
 “Upper touch screen display (upper display)” (page 2-11)
- ⑮  Scale indicator:
Indicates the scale of the map.
Touch the icon to display the scale bar. The map scale can be adjusted using the scale bar.
 “Changing scale of map” (page 9-8)
- ⑯  /  Direction indicator:
Indicates the directional setting of the map. Touch the icon to change the setting.
- Ⓜ : North always pointing up.
Ⓝ : Direction of the vehicle always pointing up.
- ⑰  Avoid area (green):
Displays the areas to avoid that are stored in the Address Book. During the route search, the route guidance is performed by searching for a route that avoids those areas.
- ⑱ Street name:
Displays the name of the street that the vehicle is currently driving on.
- ⑲ Suggested route:
Appears in bold blue during route guidance.
- ⑳  Stored location (yellow):
Displays the locations that are stored in the Address Book. The icons can be changed according to your preferences.
- ㉑  Destination:
Indicates the destination location of the route guidance.
Upon reaching the destination, the

9. Navigation (if so equipped)

address will be displayed on the map screen.

Birdview™ (3D) map

Birdview™ displays the map from an elevated perspective. In Birdview™, it is easy to recognize an image of the route because it provides a panoramic view over a long distance.

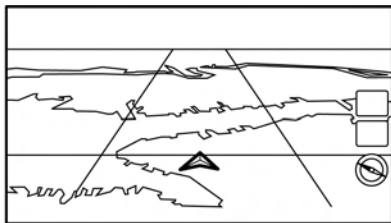

INFO:

Note the following items about the Birdview™ display.

- “Birdview™” is a registered trademark of Clarion Co., Ltd.
- The map in Birdview™ always appears with the current forward direction facing up.

Building graphics

In an area where the building graphics are stored in the map data, the building graphics are displayed when the map is zoomed in. On the 2D map display, these are called “Building footprint graphics”, and on the Birdview™ display, these are called “3D building graphics”.

The way of looking at the map is the same for the 2D and Birdview™ maps.

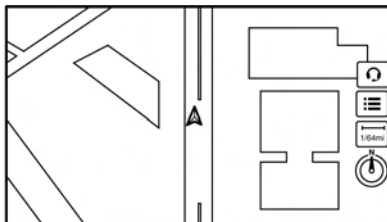

Building footprint graphics (2D map)

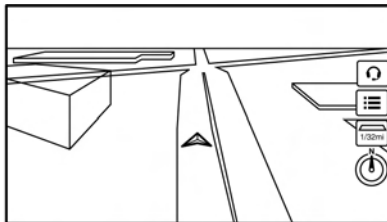

3D building graphics (Birdview™ map)

INFO:

In an area where the building graphics are not stored in the map data, the normal map is displayed even when the map is zoomed in.

ROAD COLOR

The road types are differentiated by color.

Freeway: Red or light red (zoomed in)

Main road: Brown or dark yellow

Narrow street: Gray

Road with incomplete map data: Dark green

DISPLAYING CURRENT VEHICLE LOCATION

Operating with INFINITI controller

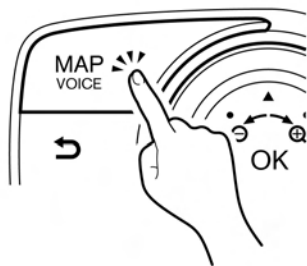

The basic map screen displays the current location (the position where the vehicle mark is located). Push **<MAP/VOICE>** to display the current location on the map while on any screen.

Operating with touch panel operation

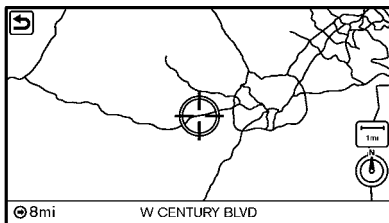

After moving the map, touch [] on the map screen to display the current location map screen.

MOVING MAP

The operations for moving across the map are different between the 2D and Bird-view™ maps.

2D map

Touch panel operation:

Touch

Touch the screen. The cross pointer is displayed, and the position touched is set as the center of the screen.

Long touch

Touch the direction to move to. The map continues to scroll while the screen is touched.

Drag

Drags the map while the screen is touched.

Flick

Flick to momentum scroll the map.

Using INFINITI controller:

1. Slide the slide switch to move continuously across the map in a direction.
2. While moving on the map, the cross pointer appears.



INFO:

While driving, one-touch continuous scrolling is disabled. Touch the screen again to scroll further.

If the map screen is set to display the building footprint graphics, the map cannot be scrolled while driving.

Map scrolling operations are limited and not fully available while driving.



9. Navigation (if so equipped)

Birdview™ (3D) map

Touch panel operation:

Touch

Touch the screen. The cross pointer is displayed, and the position touched is set as the center of the screen.

Touch  or  to change the direction of the map.

Long touch

Touch the direction to move to. The map continues to scroll while the screen is touched.

Flick

Flick the touch panel to scroll the map screen quickly.

Use INFINITI controller:

1. Slide the slide switch to move continuously across the map in a direction.
2. While moving on the map, the cross pointer appears.

INFO:

While driving, one-touch continuous scrolling is disabled. Touch the screen again to scroll further.

If the map screen is set to display the building footprint graphics, the map cannot be scrolled while driving.

Map scrolling operations are limited and not fully available while driving.

CHANGING SCALE OF MAP

There are several methods for changing the map scale.

Touch panel operation

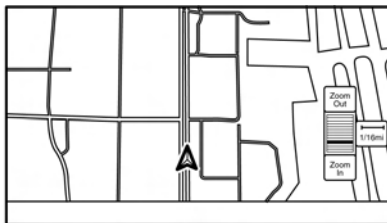

1. Touch  .
The scale bar is displayed.
2. Touch [Zoom In] or [Zoom Out] to change the scale.



Pinch-in

To view a wider area, pinch-in the map screen.



Pinch-out

To view the map in detail, pinch-out the map screen.

Using INFINITI controller

1. Turn the center dial when the map screen is displayed.
2. Use the center dial to adjust the map scale.

Clockwise: Zoom in

Counterclockwise: Zoom out

Free zoom:

Depending on the setting, using the center dial to change the map scale may adjust the scale normally, or it may engage the free zoom (finer scale adjustment in smaller steps).

 “Settings screen” (page 8-23)

Map scale

Any required map scale (map coverage) between 320 miles (640 km) and 1/32 mile (25 m) can be selected.

US Units	Metric Units
320 miles	640 km
80 miles	160 km
32 miles	64 km
8 miles	16 km
5 miles	10 km
2 miles	4 km



1 mile	2 km
1/2 mile	1 km
1/4 mile	500 m
1/8 mile	200 m
1/16 mile	100 m
1/32 mile	50 m
1/64 mile	25 m



INFO:

The traffic information icons are not displayed on the map screen when the map scale is set to 8 miles (16 km) or higher.

 “Traffic information on map” (page 9-47)

CHANGE MAP

The map view type can be changed by touching [] / [] on the map screen.

The screen will change to North Up, Heading Up and Birdview™ each time [] / [] is touched.

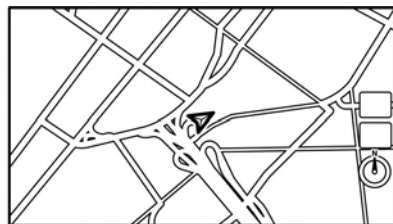

North Up



Heading Up

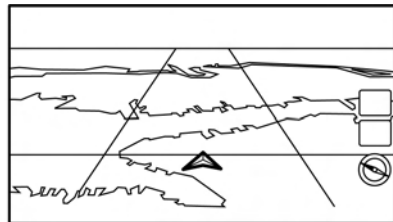

Birdview™

You can also set the map view by pushing **<MENU>** and touching [Settings] and touch

9. Navigation (if so equipped)

[Navigation].

 “Map view settings” (page 9-10)

SETTING SPLIT SCREEN

It is possible to view the two types of map view or the map view, and other information at the same time. The right screen displays the map screen, and the left screen displays a turn list or an information screen.

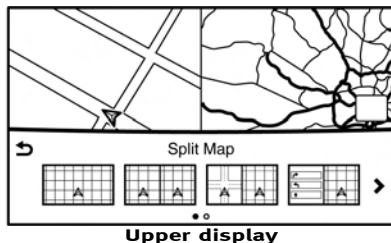

1. Push **<MAP/VOICE>** on the Infiniti Controller while the current location map screen is displayed, the display view bar is displayed.
2. Select the screen you would like to set.
 “Display View Bar” (page 2-11)

MAP VIEW SETTINGS

The setup for the map view is performed from the Settings menu on the lower touch screen display (lower display).

1. Push **<MENU>** and touch [Settings].
2. Touch [Navigation].

The following settings are available.

9. Navigation (if so equipped)

Menu item		Action
[Map & Display View]	[Change Order]	Select the items to be applied to the display view bar on the upper display.
	[Full Map]	Display full map screen.
	[Split Map]	Select one of the upper displays to be applied.
	[Intersections]	 “Display View Bar” (page 2-11)
	[Turn List]	
	[Where Am I?]	
	[Turn by Turn]	
	[Energy Flow] (models with hybrid system)	
	[Fuel Economy]	
[ECO Drive Report] (models with gasoline system)		

Menu item		Action	
[Map Preferences]	[Map View]	[North Up]	Select one of the map views to be applied to the map screen.
		[Heading Up]	
		[Birdview (3D)]	
	[Long Range Heading Up]	The position of the vehicle icon can be changed to view a wider area in the traveling direction. The vehicle icon is located slightly lower than the center of the screen. Long Range Map View is available only when the map view is “Heading Up”.	
[Map Color]	Select a preferred map color.		

9. Navigation (if so equipped)

Menu item		Action	
	[Map Text Size]	[Large]	Sets the font size.
		[Medium]	
		[Small]	
	[Birdview Angle]	Adjusts the Birdview™ angle.	
	[Auto North Up]	Sets the top of the map to remain oriented to the north.	
	[Show FWY Exit]	Sets the display of the freeway exit information icon on/off.	
	[Automatic Display in Fwy Mode]	The turn list can be set to on or off to be displayed automatically while driving on a freeway.	
	[Names Displayed on Map]	[Place Names]	Allows place names to be displayed on the map screen.
[POI Names]		Allows facilities names to be displayed on the map screen.	
[Road Names]		Allows road names to be displayed on the map screen.	

Menu item		Action	
[Map Preferences]	[Left Split Map Settings]	[Left Side Map Orientation]	The map view for the left side of split screen can be selected from North Up or Heading Up.
		[Long Range Driving Direction]	Allows the map view for the left side of the split screen to change the position of the vehicle icon so that a wider area in the traveling direction can be viewed. The vehicle icon is located slightly lower than the center of the screen.
		[Map Scale]	Allows the map view for the left side of the split screen to display a scale on the left side of the screen. Use this to change the scale of a map.

SETTING INFORMATION ON MAP

Some information on the map can be displayed or hidden.

Displaying facility icons





The facility icons can be displayed or hidden by type.

1. Push **<MENU>** and touch [Settings].
2. Touch [Navigation].
3. Touch [POI Icons Displayed on Map].
4. Touch the preferred icon. The indicator of the selected icon illuminates.

INFO:

- The map icons are not displayed on the map screen when the map scale is set to 0.1 mile (500 m) or higher in the 2D and Birdview™ map.
- If brand icons are registered in the map data, the brand they will be displayed on the map instead of the general map icons listed.

Available setting icon

- : Restaurant
- : Gas Station
- : Hotel
- : ATM
- : Rest Area

Displaying map scrolling information

Information about the location, on which the center of the cross pointer is placed by scrolling on the map, can be set to be displayed.

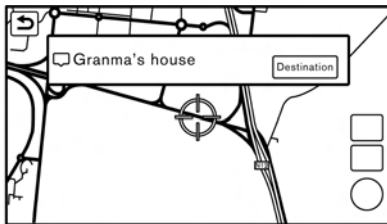

1. Push **<MENU>** and touch [Settings].
2. Touch [Navigation] and touch [Other Settings].
3. Touch [Map Scrolling Information].

4. Touch the preferred information item.
The following information items are available.
 - [Destination/Waypoint Icon Info]
 - [Latitude/Longitude Info]
 - [Stored Location Icon Info]

TRAFFIC INFORMATION ON MAP

With a subscription to the SiriusXM Traffic, traffic information is displayed.

 "Traffic information on map"
(page 9-47)

Free Flow: Green arrow

Moderate traffic: Yellow arrow

Heavy traffic: Red

Section affected by serious traffic event:
Purple

The following traffic information icons may be displayed

 : Accident

 : Closed road

 : Information

9. Navigation (if so equipped)

- ◆ : Road work
- ◆ : Slippery road
- ☁ : Weather
- ◆ : Incident

SETTING DESTINATION

CHANGING REGION

When setting a destination, the location can be narrowed down by specifying the region or city.

Specifying state/province

The state to be searched will be changed when searching for a destination by entering an address: [Street Address], [Points of Interest] or [Intersection], etc.

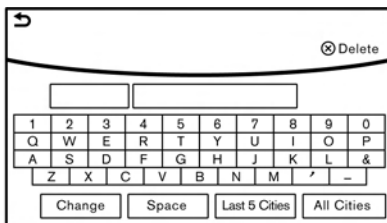

1. Push **<MENU>** and touch [Destination].
2. Touch the key of the desired search method to be set.
3. Touch [State/Province].
4. Enter the name of the state and then touch [List]. A list screen is displayed.

5. Touch the preferred region from the list. After setting, the display automatically returns to the Destination screen.



INFO:

- It is not possible to search for a route from the continental United States to Hawaii.
- When the system is restarted, it sets the state to that automatically detected by the GPS.

Specifying city

When searching for a destination, the search can be narrowed down by specifying the city.

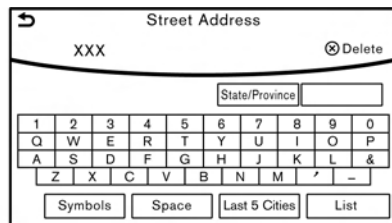

1. Touch [City]. A character input screen is displayed.
2. Enter the name of the city and then touch [List]. A list screen is displayed.

INFO:

- The same screen will be displayed when a location is searched from a street.
 - Touch [Last 5 Cities] to display the last five cities set as destinations.
3. Touch the city of the destination from the list.

Other Settings:

Touch [City] on the upper display and then display city input screen on the lower display.

INFO:

In some cases, when a city name has been entered, the number of matching destinations in the “Matches” column may be different from the number displayed on the list screen. If this occurs, enter more characters to further reduce the number of matches.

DESTINATION SCREEN



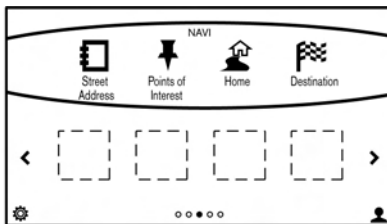









There are several methods that can be used to set a destination. Understand the advantages of each method and select the best method for finding and setting a preferred destination.











Push **<MENU>** and touch destination to display destination screen.

* When a destination is not set yet, [Street Address], [Point of interest], [Home] and [Destination] will be displayed when pushing **<MENU>**.

9. Navigation (if so equipped)

Step 1	Step 2	Setting item	Action	
Push <MENU>	[Street Address]		Searches for a destination by address.  "Finding address" (page 9-18)	
	[Points of Interest]		Searches for a destination from various categories of businesses or locations.  "Finding points of interest" (page 9-19)	
	[Home]		Searches for a route from the current location to the previously stored home destination.  "Setting home as destination" (page 9-21)	
	[Destination]	[Street Address]		Searches for a destination by address.  "Finding address" (page 9-18)
		[Points of Interest]		Searches for a destination from various categories of businesses or locations.  "Finding points of interest" (page 9-19)
		[Home]		Searches for a route from the current location to the previously stored home destination.  "Setting home as destination" (page 9-21)
		[Nearby Places]		Searches for points of interest near the current vehicle location, such as restaurants and charging stations, etc.  "Finding nearby place" (page 9-22)
		[Stored Locations]		Searches for a destination from the list of the stored locations.  "Searching from Stored Locations" (page 9-24)
		[Previous Destinations]		Sets the previous starting point as the destination. Searches for the destination from the previous destinations.  "Searching from history" (page 9-23)
		[Journey Planner]		Sets a route plan downloaded from the INFINITI Owner's Portal Website.  "Using Journey Planner" (page 9-22)
[Intersection]			Searches for a destination from an intersection.  "Setting intersection" (page 9-21)	
[Freeway Entrance/Exit]			Searches for a destination from a freeway entrance/exit.  "Setting freeway entrance/exit" (page 9-23)	

9. Navigation (if so equipped)

Step 1	Step 2	Setting item	Action
Push <MENU>	[Destination]	[City Center]	Sets the center of a city as the destination.  “Setting city center” (page 9-23)
		[Phone Numbers]	Searches for a point of interest by a telephone number.  “Setting by phone number” (page 9-24)
		[Stored Routes]	Selects a stored route.  “Setting from stored routes” (page 9-25)
		[Connected Search]	Input a keyword of a point of interest and connect and search the Infiniti InTouch™ Services Data Center.  “Searching by connecting Data Center” (page 9-25)
Scroll map and push < ≡ /OK>	[New Destination] (on the upper display)		Set a location scrolled to on the map as the destination
Push IVR soft button (on the upper display)	Speak your choice, or ask the Infiniti InTouch™ Services Response Specialists directly to search for your destination.		Set the destination with the assistance of an Infiniti InTouch™ Services Response Specialist.
Push <MENU>	[InTouch Services]	[Connected Search]	Input a keyword of a point of interest and connect and search the Infiniti InTouch™ Services Data Center.  “Searching by connecting Data Center” (page 9-25)
		[Send to Car]	Search for a location using Google maps, and download the information to set the destination via the Infiniti InTouch™ Services Data Center.  “Using Google send-to-car” (page 9-26)
		[Destination Send to Car]	Search for destinations from a point of interest (POI) database accessed within the Infiniti InTouch™ Services website.  “Using Destination Send to Car” (page 9-27)
		[Journey Planner]	Sets a route plan downloaded from the INFINITI Owner’s Portal Website.  “Using Journey Planner” (page 9-22)
		[Connect to Voice Menu]	Connects to the Infiniti InTouch™ Services Interactive Voice Menu.

9. Navigation (if so equipped)

	[My schedule]	Allows accessing to your personal online Google Calendar™ via the navigation system and displaying the calendar or read out the schedule.
	[Mobile Info. Service]	Delivers information such as the latest news headlines, stock quotes and sports scores set in the Infiniti InTouch™ Services website to be displayed on your navigation screen or be read out.
	[Sync All Feeds]	Updates information list by connecting to the Infiniti InTouch™ Services Data Center.



INFO:

- If the route is already set, the selected location becomes a waypoint.
- After setting a destination, the location of the destination can be adjusted and the location can be stored in the Address Book, etc.
 - ☞ “Procedures after setting route” (page 9-27)
- The destination can be deleted.
 - ☞ “Canceling Route” (page 9-34)

FINDING ADDRESS

Searches for a destination by address.

1. Push **<MENU>**.
2. Touch [Street Address]. A number input screen is displayed.

Street Address

1234

State/Province

1	2	3
4	5	6
7	8	9
0		

Intersection

A-Z City City Center OK

3. Input the street address.
 - Touch [City] to enter the city name.
 - Touch [Intersection] to enter the intersection.
 - If the house number is not available, touch [No House #].
 - Touch [City Center] to set the center of a city as the destination.
4. When information about house number, street, city, and state are entered, the destination is proposed on the upper display. Touch [OK].



INFO:

- Touch [State/Province] or [City] to narrow down the specified region and city.
 - ☞ “Changing region” (page 9-14)
5. Enter the name of the street. After finishing the entry, touch [List]. A list of streets is displayed.
 6. Touch the street of the destination from the list.

Calculate Route

Start

Fastest Route 2:30 520mi Turn List

Show Loc. Map

Energy-Saving 2:30 580mi Turn List

Add Waypoint

Move Loc. Shortest Distance 2:30 500mi Turn List

Lower display without waypoint

INFO:

Touch [↩] on the lower display or [↩] on the upper display to return to the previous screen.

7. Touch [Start] to start route guidance.

INFO:

- After setting a destination, the location of the destination can be adjusted and the location can be stored in the Address Book, etc.

 “Procedures after setting route”
(page 9-27)

Voice command

1. Push <🗲> located on the steering-wheel.
2. After the tone sounds, speak a command.

To searches for a destination by address:
“Navigation”, “Street Address”

FINDING POINTS OF INTEREST

This allows you to find a facility by name or by category. Specify the region and city of the destination to find it more quickly.

NOTE:

Locations and business hours of facilities are subject to change, which may not be reflected in the map data. Double-check this information before you go to an emergency facility to ensure that you can receive the proper support. Otherwise, you may not receive emergency help when you arrive at the destination.

A confirmation message also appears on the navigation screen. Follow the displayed instructions and check the items required.

Searching by a landmark name

1. Push <MENU>.
2. Touch [Points of Interest].
3. Touch [Spell Name]. A character input screen is displayed.

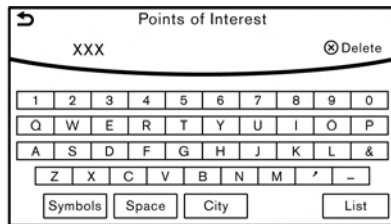

INFO:

Touch [City] and touch [Last 5 Cities] to display the last five cities recently set as destinations.

4. Enter the name of the destination facility. After finishing the entry, touch [List]. A list screen is displayed.
5. Touch the preferred destination facility from the list.

Narrow down conditions:

- [Sort]:
 - [By Distance]: Shows a list of facilities that are near the current vehicle location.
 - [By Name]: Shows a list of facilities sorted alphabetically by name order.

9. Navigation (if so equipped)

- [By Category]:

Display the list that summarizes the entered names into categories. Select the category to narrow down the search.

- [City/Area]:

- [Within a City]:

Input the city to narrow down the target city.

- [Near Destination]:

When the destination is set, this indicates a list of facilities around the destination.

- [Show Along Route]:

The system displays the facilities located along the route.

INFO:

- Touch [ⓘ] in the list screen to display the detailed information about the POI that is selected on the upper display.
- Touch [Call] on the upper display to make a call to the facility.

6. Whole route map is displayed the upper display. Touch [Start] to start route guidance.

INFO:

- If [Space] is touched and a keyword is inputted, a search will be possible after entering two or more words.
- After setting a destination, the location of the destination can be adjusted and the location can be stored in the Stored Locations, etc.
 - “Procedures after setting route” (page 9-27)

Searching from the landmark category

1. Push <MENU>.
2. Touch [Points of Interest]. The main category menu is displayed.
3. Touch the main category. The subcategory list is displayed.
4. Touch the subcategory. A list screen is displayed.

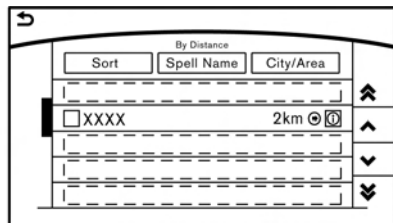

Narrow down conditions:

- [Sort]:
 - [By Distance]: Shows a list of facilities that are near the current vehicle location.
 - [By Name]: Shows a list of facilities sorted alphabetically by name order.
- [Spell Name]: Enter the facilities name to narrow down the search.
- [City/Area]:
 - [Within a City]: Input the city to narrow down the target city.
 - [Near Destination]: When the destination is set, this indicates a list of facilities around

the destination.

— [Show Along Route]:

The system displays the facilities located along the route.

5. Touch the preferred destination facility from the list.

Touch [Start] to start route guidance.

INFO:

- After setting a destination, the location of the destination can be adjusted.
 “Procedures after setting route” (page 9-27)
- If the nearest POI cannot be searched, a message asking whether to search from an extended area will be displayed. When [Yes] is selected, the system starts to search for POI in a wider area.

SETTING HOME AS DESTINATION

The home location can be set as the destination if the home location is stored in advance. This function is especially useful when searching for a route to return to the home location.

1. Push **<MENU>** and touch [Home].

2. The home location is displayed on the upper display, and the system sets the home location as the destination.

INFO:

If the home location is not stored yet, the system will automatically display a screen for storing it.

 “Storing home location” (page 9-48)

3. The selected destination is displayed at the center of the map. Touch [Start] to start route guidance.

Voice command

1. Push **<  >** located on the steering-wheel.
2. After the tone sounds, speak a command.

To set the home location as the destination:

“Home”

SETTING INTERSECTION

It is possible to set an intersection of any two streets as the destination and have the system calculate a route.

1. Push **<MENU>** and touch [Destination].
2. Touch [Intersection].
3. A character input screen is displayed on the lower display.
4. Enter the name of the first street. After finishing the entry, touch [List]. A list screen is displayed.
5. Touch a street as the first street from the list.
6. A second street input screen is displayed on the lower display.
7. Enter the name of the second street. After finishing the entry, touch [List]. A list screen is displayed.
8. Touch a street as the second street from the list. An intersection list screen is displayed.

INFO:

Touch [Map] to display intersection at the center of the map on the upper display.

9. Navigation (if so equipped)

9. Touch intersection from the list.
10. The selected destination is displayed at the center of the map on the upper display. Touch [Start] to start route guidance.

FINDING NEARBY PLACE

A facility located near the current vehicle location or another location that you move to by scrolling the map can be set as the destination. This allows you to set the destination to a facility located near the current vehicle location or another location that you move to by scrolling the map.

1. Push **<MENU>** and touch [Destination].
2. Touch [Nearby Places]. The category list is displayed.
3. Select [Emergency Facilities] for example.
4. Select preferred category from the sub category list.
5. Touch the preferred destination from the list. The position of the selected location is displayed in the preview on the upper display.



INFO:

- If the suggested route is already set, by touching [Show Along Route] on the lower display, the system displays only the facilities located along the route.
- A maximum of 100 facilities can be displayed on the list screen.

6. Touch [Start] to start route guidance.



INFO:

You can also set the destination by touching [≡] when scrolling the map and selecting [Nearby Places] from the shortcut menu.

USING JOURNEY PLANNER

It is possible to set the route according to the route plan created in advance by the INFINITI Owner's Portal Website.



INFO:

Use of Infiniti InTouch™ Services features is dependent upon a valid subscription and the telematics device being in operative condition, as well as cellular connectivity, navigation map data and GPS satellite signal reception being available.

1. Push **<MENU>** and touch [Destination].
2. Touch [Journey Planner]. The system will connect to the Infiniti InTouch™ Services Data Center and display the Journey Planner list screen.

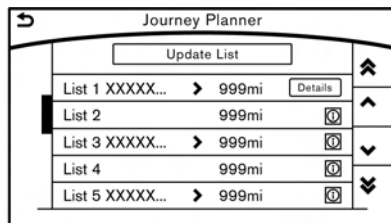

3. Select the preferred route plan from the list.



INFO:

- Touch [Update List] to update the list information.
 - Touch [Details] to preview the route on the upper display.
 - Touch ⓘ to display facility information.
4. The selected route plan is displayed. Touch [Start] after confirming the location of the displayed destination.

INFO:

- Journey Planner is an Infiniti InTouch™ Services feature. Subscription is required to use the Infiniti InTouch™ Services.
- Journey Planner cannot be used if [Decline] is touched on the Start-up Screen.
- Refer to the INFINITI Owner's Portal Website for how to set the destination using Journey Planner.

SEARCHING FROM HISTORY

A previous destination can be set as the destination.

Up to 100 previous destinations will be automatically stored. If the number of previous destinations exceeds 100, the oldest one will be replaced by the newest one.

1. Push **<MENU>** and touch [Destination].
2. Touch [Previous Destinations]. A list screen is displayed.
3. Touch the previous start point or the previous destination from the list.
4. Touch [Start] to start route guidance.

Voice command

1. Push **<V>** located on the steering-wheel.
2. After the tone sounds, speak a command.

To display the previous destinations list:
“Previous Destinations”

SETTING FREEWAY ENTRANCE/EXIT

It is possible to set the destination to an entrance or exit of a freeway.

1. Push **<MENU>** and touch [Destination].
2. Touch [Freeway Entrance/Exit]. A character input screen is displayed.
3. Enter the name of the freeway. After finishing entry, touch [List].
4. Touch the preferred freeway.

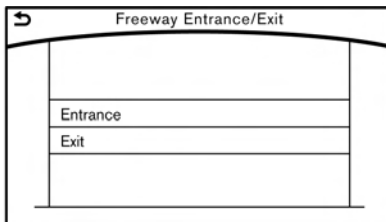

INFO:

Touch [Sort] and touch [By Distance] to sort the list by the nearest distance. Touch [By Road No.] to sort by the road no.

7. Touch [Start] to start route guidance.

SETTING CITY CENTER

It is possible to set the center of a specified city as a destination.

1. Push **<MENU>** and touch [Destination].
2. Touch [City Center]. A character input screen is displayed.
3. Enter the name of the city and touch [List]. A list screen is displayed.

INFO:

Touch [Last 5 Cities] to display the last five cities recently set as destinations.

9. Navigation (if so equipped)

4. Touch the preferred destination from the list.



INFO:

Touch [Map] to preview on the upper display.

5. The selected destination is displayed on the upper display. Touch [Start] after confirming the location of the displayed destination.

SEARCHING FROM STORED LOCATIONS

Storing frequently used destinations in the Address Book makes it easy to set a destination. Locations should be stored in the Address Book before using this function.

“Storing location” (page 9-48)

1. Push **<MENU>** and touch [Destination].
2. Touch [Stored Locations].

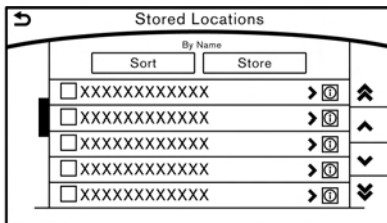

3. Touch the preferred location from the list.



INFO:

Selecting [Sort] displays a list of various sort functions.

- [By Number]:
The Address Book entries are displayed in ascending numerical order.
- [By Name]:
The Address Book entries are displayed in alphabetic order.
- [By Icon]:
By selecting a particular icon, a list that contains only the Address Book entries associated with that icon is displayed.
- [By Group]:
By selecting a particular group (family, friends, leisure, etc.), the selected group

is displayed at the top of the list.

4. The selected destination is displayed on the upper display. Touch [Start] to start route guidance.



Voice command

1. Push **<V>** located on the steering-wheel.
2. After the tone sounds, speak a command.

To set the destination from the Stored Locations:

“Stored Locations”

SETTING BY PHONE NUMBER

If the phone number of a facility is known, it is possible to search for a facility by entering the phone number.



INFO:

- If the area code of the specified telephone number does not exist in the map data, the system cannot search for the location.
- Only the locations included in the database in the map data can be searched for by phone number. Residential phone numbers

cannot be used to search for a location.

1. Push **<MENU>** and touch [Destination].
2. Touch [Phone Numbers]. The telephone number input screen is displayed.
3. Enter the telephone number including the area code. After finishing entry, touch [OK].

INFO:

A list screen is displayed if there are two or more search results. The upper screen displaying the place name, address and the location. Touch the preferred destination from the list.

4. The selected destination is displayed on the upper display. Touch [Start] after confirming the location of the displayed destination.

SETTING FROM STORED ROUTES

It is possible to select a preferred route from the stored routes.

1. Push **<MENU>** and touch [Destination].
2. Touch [Stored Routes]. A list screen is displayed.
3. Touch the preferred route from the list.

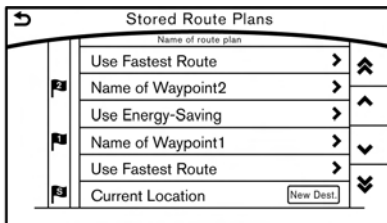

4. The stored route is displayed, touch [New Dest.].
5. The entire route is shown on the map. Touch [Start] to start route guidance.

INFO:

- The stored route only includes locations (destination and waypoints) and route calculation conditions, not the route itself. Therefore, when the destination is set using a stored route, a different route may be suggested if the current vehicle location is different from the one when the route was stored.

SETTING BY INFINITI INTOUCH™ SERVICES

It is possible to set the destination using the Infiniti InTouch™ Services features.

 “Infiniti InTouch™ Services”
(page 8-10)

INFO:

Use of Infiniti InTouch™ Services features is dependent upon a valid subscription and the telematics device being in operative condition, as well as cellular connectivity, navigation map data and GPS satellite signal reception being available.

Searching by connecting Data Center

It is possible to find a point of interest by inputting a keyword and connecting to the Infiniti InTouch™ Services Data Center. The searched location can be set as a destination.

1. Push **<MENU>** and touch [InTouch Services].
2. Touch [Connected Search].
3. Enter the keyword and touch [Search]. The system will connect to the Infiniti InTouch™ Services Data Center and the

9. Navigation (if so equipped)

search results will be displayed.

INFO:

The search history can also be reused by touch [History].

4. Touch the preferred destination from the list.

INFO:

- Touch [info] to display the facility information on the upper display.
 - Touch [Details] to display the information feeds screen.
 “Screen information” (page 8-17)
5. The entire destination is shown on the upper display. Touch [Start] to start route guidance.

Searching by using IVR soft button on map

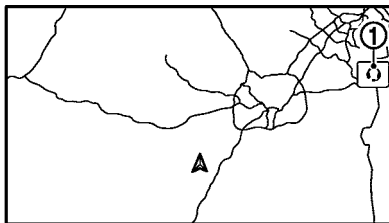

It is possible to set a destination by touching the IVR (Interactive Voice Response) soft button ① on the map. You can choose from the options provided by the voice guidance and speak your choice, or ask the Infiniti InTouch™ Services Response Specialists directly to search for your destination.

 “Connecting to Interactive Voice Menu” (page 8-16)

Using Google send-to-car

It is possible to search for a location using Google maps, and to download the information to set the destination via the Infiniti InTouch™ Services Data Center.

1. Push <MENU> and touch [InTouch Services].

2. Touch [Send to Car].

The system connects to the Infiniti InTouch™ Services Data Center and the destination list is downloaded.

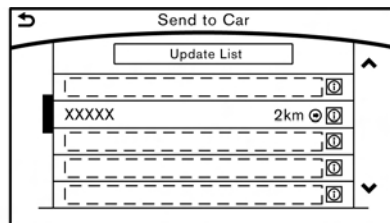

3. Select the preferred destinations from the list. The position of the selected location is displayed in the preview on the upper display.

INFO:

Select [Update List] to update the list information.

4. The selected destination is displayed. Touch [Start] to start route guidance.

INFO:

Refer to the INFINITI Owner's Portal Website for the destination setting using Google send to car.

Using Destination Send to Car

Destination Send-to-Vehicle enables you to search for destinations from a point of interest (POI) database accessed within the Infiniti InTouch™ Services website.

1. Push **<MENU>**.
2. Touch [InTouch Services].
3. Touch [Destination Send to Car].
4. Select preferred folder.
5. Select preferred channel. The list of destinations which you set at the Infiniti InTouch™ Services website is displayed.
6. Select preferred destination from the list.

INFO:

Select [Update List] to update the list of point of interest.

SETTING POINT ON MAP

It is possible to set a location scrolled to on the map as the destination and have the system calculate a route.

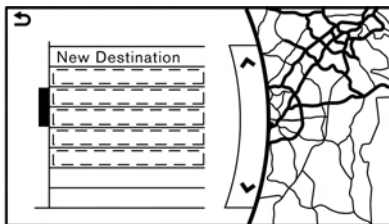

Upper display

1. Scroll the map, place the cross pointer over the preferred location, and touch [☰].

INFO:

- The point on the blinking road where the center of the cross pointer is located can be set as a destination.
2. Touch [New Destination].
 3. The entire route is shown on the upper display. Touch [Start] to start route guidance.

PROCEDURES AFTER SETTING ROUTE

The system sets the destination to the selected location and starts calculating a route. After performing a route search, route guidance can be started. Also, it is possible to confirm or change a route.

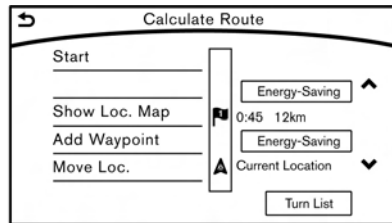

Lower display with waypoint

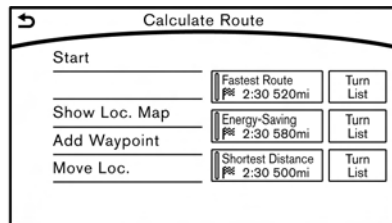

Lower display without waypoint

9. Navigation (if so equipped)

Available items after setting route

- [Start]:
Starts route guidance to the selected destination.

INFO:

If no operations have been performed on the system for several seconds, [Start] is automatically selected, and the system starts route guidance. When the vehicle is being driven, [Start] is automatically selected and the system will start the route guidance function.

- [Show Loc. Map]:
Display destination on the upper display.
- [Add Waypoint]:
Allows you to edit the route by adding a destination or waypoint.
 - If a waypoint is added, three alternative routes cannot be selected.
 - If a destination is added, the prior destination becomes a waypoint.
 - It is possible to edit or add a destination or waypoints to the route that is already set.
 “Editing route” (page 9-35)

- [Move Loc.]
The location of the destination or waypoint can be adjusted by moving the cross pointer across the map on the upper display.
 “Moving location of destination” (page 9-28)
- Available route conditions:
 - [Fastest Route] :
Prioritizes the shortest time.
 - [Energy-Saving] :
Energy-Saving route.
 - [Shortest Distance] :
Prioritizes the shortest distance.

INFO:

- The three routes may not always be different.
- When using waypoints, you can change the route between each waypoint.
- [Turn List]:
Display the turn list.

Moving location of destination

The location of the destination can be adjusted by moving the cross pointer across the map.

1. After setting destination, touch [Move Loc.].
2. Touch map screen on the upper display. A map screen with the destination located on the map center is displayed.
3. Adjust the location by moving the cross pointer across the map and touch [OK]. The location of the destination is modified.

INFO:

- The screen for adjusting the location also changes when the map screen displayed on the right side of the screen is touched.
- The map scale can be changed by touching .

ROUTE GUIDANCE

ABOUT ROUTE GUIDANCE

After setting the route, select [Start] to start route guidance.

Throughout route guidance, the system navigates you through the guide points using visual and voice guidance.



CAUTION

- The navigation system's visual and voice guidance is for reference purposes only. The contents of the guidance may be inappropriate depending on the situation.
- Follow all traffic regulations when driving along the suggested route (e.g., one-way traffic).

"Route guidance" (page 9-64)

Voice guidance during route guidance

Basics of voice guidance:

Voice guidance announces which direction to turn when approaching an intersection for which a turn is necessary.



INFO:

- There may be some cases in which voice guidance and actual road conditions do not correspond. This may occur because of discrepancies between the actual road and the information on the map data, or may also be due to the vehicle's speed.
- In case voice guidance does not correspond to the actual road conditions, follow the information obtained from traffic signs or notices on the road.
- Route guidance provided by the navigation system does not take carpool lane driving into consideration, especially when carpool lanes are separated from other road lanes.
- The system will only announce street names when the system language is set to English. Street names are not announced when the system is set to French or Spanish.



INFO:

When approaching a guide point (intersection or corner), destination, etc. during route guidance, voice guidance announces the remaining distance and/or turning direction. Push and hold **<MAP/VOICE>** to repeat voice guidance.

9. Navigation (if so equipped)

Example of voice guidance:

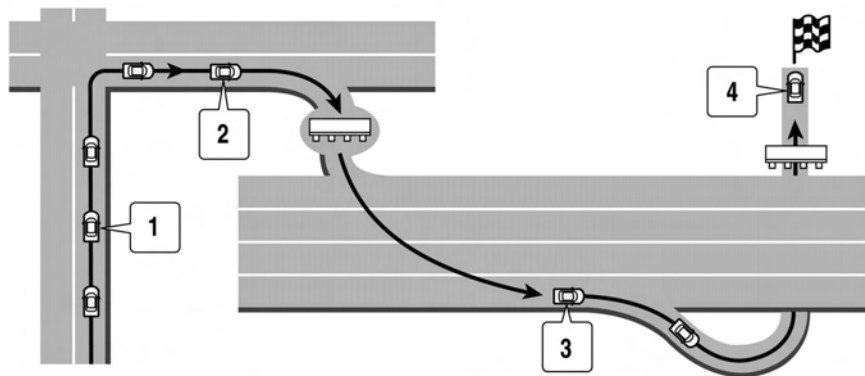

- ① “In about one quarter mile (400 meters), right (left) turn.”
“Right (left) turn ahead.”
- ② “In about one quarter mile (400 meters) freeway entrance on your right onto (road number and direction).”
“Freeway entrance on your right onto (road number and direction).”
- ③ “In about one mile (two kilometers), exit on your right.”

“Exit on your right.”

- ④ “You have arrived at your destination.
Ending route guidance.”

Directions will differ, depending on the road type.



INFO:

Distances may vary, depending on the vehicle speed.

Notification of intersection on ordinary road:

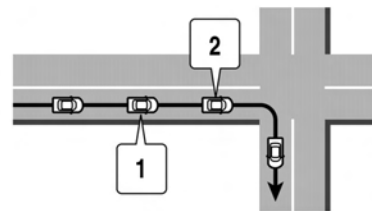

1. “In about one quarter mile (400 meters), right (left) turn.”
2. “Right (left) turn ahead.”

Notification of consecutive intersections on ordinary roads:

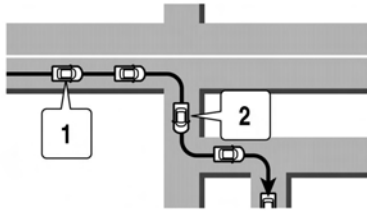

When the road has three or more consecutive intersections ahead, voice guidance will announce the following.

1. “In about one quarter mile (400 meters), right (left) turn, then in about one quarter mile (400 meters) left (right) turn.”
2. “Left (right) turn ahead, then in about one quarter mile (400 meters) right (left) turn.”

Notification of freeway entrance:

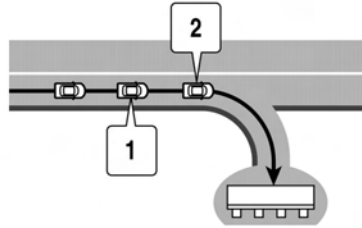

1. “In about one quarter mile (400 meters) freeway entrance on your right onto (road number and direction).”
2. “Freeway entrance on your right onto (road number and direction).”

9. Navigation (if so equipped)

Notification of freeway junction:

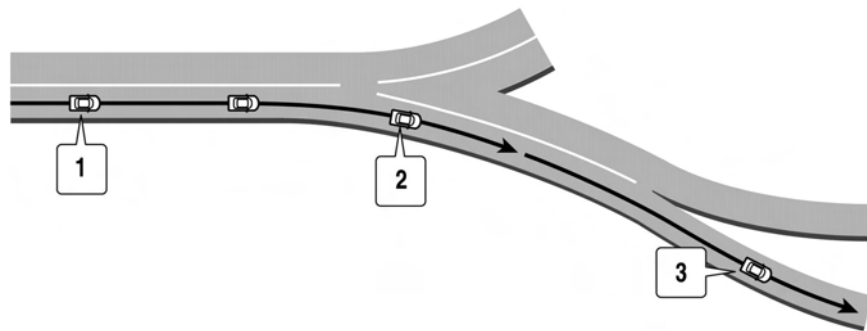

1. “In about one mile (two kilometers), keep to the right (left) onto (road number and direction), then in about one quarter mile (400 meters) keep to the right (left).”
2. “Keep to the right (left) onto (road number and direction), then in about one quarter mile (400 meters) keep to the right (left) onto (road number and direction).”
3. “Keep to the right (left) onto (road number and direction).”

Notification of freeway exit:

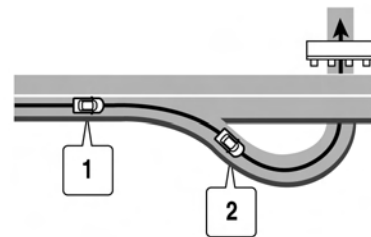

1. “In about one mile (two kilometers), exit on your right.”
2. “Take the second exit on your right.”

Notification when approaching destination:

Ordinary road:

When approaching the destination, voice guidance will announce, “You have arrived at your destination. Ending route guidance.” To reach your final destination, refer to the map screen.

Dark green road:

After passing the last turning point on a suggested route, voice guidance will announce, “The route to your destination

includes roads through incomplete map areas. Voice guidance will not be provided in these areas.” When approaching the endpoint of the suggested road, voice guidance will announce, “Entering the road with incomplete map data. Please use the direction arrow and distance information to proceed to your destination.”

Route guidance screens

Various guidance screens are displayed on the upper display during route guidance.

Route guidance on map screen:

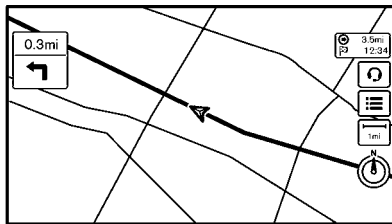

When route guidance starts, the small turn arrow on map is displayed in the upper left corner of the map screen. This arrow indicates the turning direction at the next guide point (corner or intersection). The distance is also displayed. At the top of the screen, the distance to the next guide point

and the name of the next street to turn on to are displayed. Also, there may be cases where next street names are announced.

Enlarged intersection view:

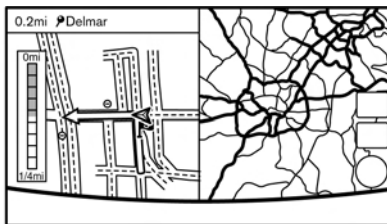

When approaching a guide point, the system automatically changes to the split screen and shows an enlarged view of the intersection on the left screen. To switch to the previous screen while the enlarged intersection view is displayed, push **<MAP/VOICE>** on the INFINITI controller.

Junction guidance:

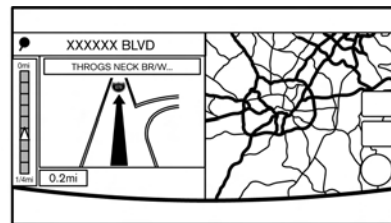

While driving on a freeway, when the vehicle is approximately one mile (approximately two km) from a junction, the system automatically switches to the split screen and displays an enlarged view of the junction on the left screen. After passing the junction, the system automatically returns to the full screen mode. To switch to the previous screen while the enlarged junction view is displayed, push **<MAP/VOICE>** on the INFINITI controller.

9. Navigation (if so equipped)

Turn list:

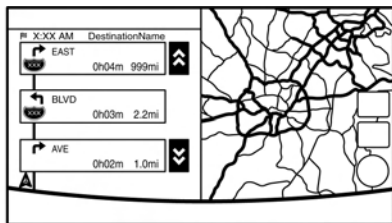

When approaching a guide point, the left screen automatically switches to an enlarged view of the intersection. To switch to the previous screen push **<MAP/VOICE>** on the INFINITI controller.

Depending on the setting, the system can constantly display the split screen as the display view screen.

Showing freeway exit information:

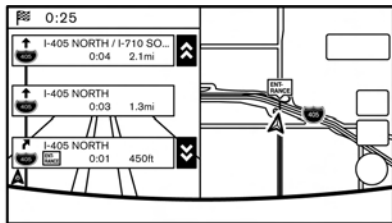

When [Show FWY Exit] is set to ON and the 9-34

route includes a freeway or toll road, all exits along the route which have exit information will be shown in the turn list. The exit information is shown as icons.

Selecting a waypoint from the exit information list:

When exit information is displayed on the turn list, a waypoint to a facility located near the freeway exit can be set as a waypoint. The facility categories that are not shown with an icon cannot be selected.

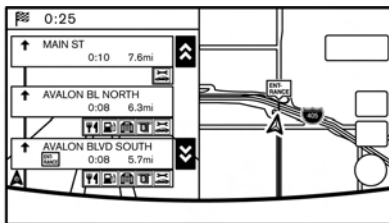

1. Touch the exit where the exit information icon is displayed. The category list screen is displayed.
2. Touch the landmark category. The list screen for showing facilities located near the freeway exit is displayed.

INFO:

The facility categories that are not shown with an icon cannot be selected.

3. Touch the preferred facility for the waypoint.
4. The waypoint is set, and the route search is performed.
☞ “Procedures after setting route” (page 9-27)

GUIDANCE SCREEN SETTINGS

The guidance screen can be displayed at all times even when the vehicle is located away from the guide point. Various types of screens can be set.

☞ “Display View Bar” (page 2-11)

CANCELING ROUTE

It is possible to delete a destination and all waypoints that have already been set.

1. Push **<MENU>**.
2. Touch [Cancel Route].
3. A confirmation message is displayed.
The destination and the waypoints are deleted.

INFO:

The deleted destination and waypoints cannot be reactivated.

ROUTE MENU SCREEN

WARNING

Always stop the vehicle in a safe location before modifying the route conditions. Modifying the route conditions while driving may cause an accident.



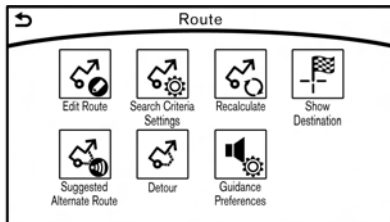

During route guidance, the route conditions can be modified and the route information can be confirmed. Set route conditions according to your personal preference.





Route menu screen display only when a destination is already set

1. Push **<MENU>** and touch [Route].
2. The following items are available.

Available settings

- [Edit Route]:
Edit or add a destination or waypoint to the route that is already set.
 “Editing route” (page 9-35)
- [Search Criteria Settings]:
Change the route calculation conditions anywhere along the route.
 “Route Settings” (page 9-41)
- [Recalculate]
Manually search for the route again after changing the search conditions and have the system calculate a route.
 “Recalculating route” (page 9-38)
- [Show Destination]:
The destination is displayed on the map screen of the upper display.
- [Suggested Alternate Route]:
Manually search for an alternative detour route taking the traffic information into consideration.
 “Searching for detour route using

traffic information” (page 9-38)

- [Detour]:
A detour of a specified distance can be calculated.
 “Setting detour route” (page 9-39)
- [Guidance Preferences]:
Activate or deactivate a route, voice guidance and/or traffic announcements and adjust the volume level of voice guidance.
 “Route guidance settings” (page 9-39)

EDITING ROUTE

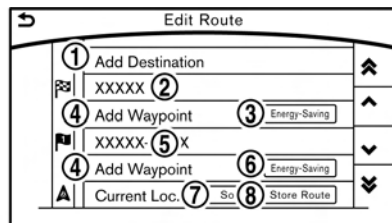

1. Push **<MENU>** and touch [Route].
2. Touch [Edit Route].
3. Set the preferred conditions.

9. Navigation (if so equipped)

Available settings

① [Add Destination]

Touch to add a destination.

 “Setting destination or waypoint” (page 9-36)

② Current destination:

Changes or deletes the destination.

 “Editing/deleting destination or waypoint” (page 9-36)

③ Condition for calculating a route to the destination:

Changes the conditions for calculating a route to the destination.

 “Changing route calculation conditions” (page 9-37)

④ [Add Waypoint]

 “Setting destination or waypoint” (page 9-36)

⑤ Current waypoint:

Changes or deletes the waypoint.

 “Editing/deleting destination or waypoint” (page 9-36)

⑥ Condition for calculating a route to a waypoint:

Changes the conditions for calculating a route to a waypoint.

 “Changing route calculation conditions” (page 9-37)

⑦ [Sort]:

Sorts the waypoint and the destination.

⑧ [Store Route]:

Stores route include a destination, waypoints, and route condition. A maximum of five routes can be stored. Stored routes can be easily retrieved and set as the suggested route.

Setting destination or waypoint

A destination or waypoint can be added to a route that has already been set. A total of six destinations or waypoints can be set.

1. Push **<MENU>** and touch [Route].
2. Touch [Edit Route].

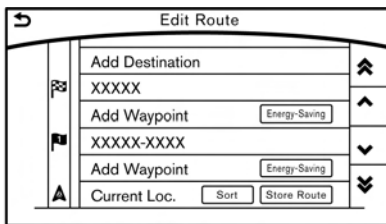

3. Touch [Add Destination] or [Add Waypoint].

INFO:

If [Add Destination] is selected, the current destination changes to a waypoint.

4. Set a destination or waypoint. The method of searching for a destination or waypoint is the same as the one for a destination.

 “Setting destination” (page 9-14)

5. The system will recalculate the routes. After the route search is completed, the display will automatically return to the menu screen. Set the route conditions as necessary.

 “Editing/deleting destination or waypoint” (page 9-36)

INFO:

- The prior route is automatically deleted.

Editing/deleting destination or waypoint

A destination or waypoint that has already been set can be modified or deleted. If a location is modified or deleted when a

suggested route is already set, the prior suggested route will be recalculated accordingly.

1. Touch a destination or waypoint that is already set.

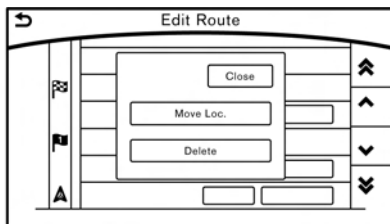

2. Touch the item you would like to set.

Available settings

- [Move Loc.]:
The location of the destination or waypoint can be adjusted by moving the cross pointer across the map on the upper display.
- [Delete]:
A destination or waypoint that has already been set can be deleted.

INFO:

If the destination is deleted, the final waypoint of the route becomes the destination.

Changing route calculation conditions

Each section of the route between waypoints can have different route calculation conditions. After setting these conditions, the entire route can be recalculated.

1. Touch the preferred section of the route to the destination or waypoint.

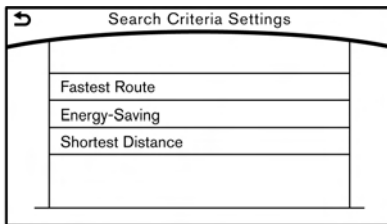

2. Touch the preferred condition.
3. The conditions are changed and the display returns to the Edit Route screen.

INFO:

- The recalculated route may not be the shortest route because the system prioritizes roads that are easy to drive on for safety reasons.

Changing order of destination and waypoints

The order of a destination and waypoints that are already set can be changed.

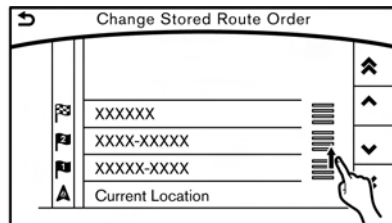

1. Touch [Sort]. A list of the destination and waypoints is displayed.
2. Touch a preferred destination or waypoint to replace the previously selected destination or waypoint.
3. A message is displayed and the order of the destination or waypoints is changed.

9. Navigation (if so equipped)

RECALCULATING ROUTE

A route can be manually searched again after changing the search conditions.

1. Push **<MENU>** and touch [Route].
2. Touch [Recalculate]. A message is displayed and the route is recalculated.



INFO:

- When a waypoint has been set on the route, the system will search for only one route, even if route recalculation is performed.
- When the vehicle deviates from the suggested route, the route from the current location to the destination is automatically searched again by the Auto Reroute function.

“Route Settings” (page 9-41)

SEARCHING FOR DETOUR ROUTE USING TRAFFIC INFORMATION

When a serious traffic event occurs on the route, or if the system finds a faster route, a detour alert will display automatically. If the automatic alert is not noticed, a detour can also be searched for manually.

1. Push **<MENU>** and touch [Route].

2. Touch [Suggested Alternate Route].

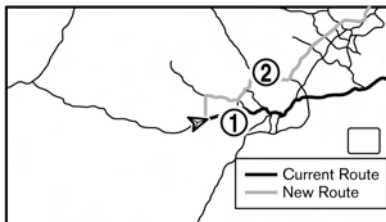

Upper display

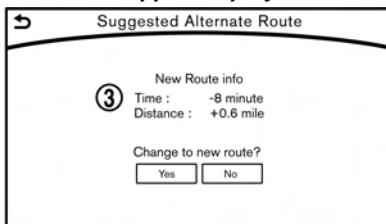

Lower display

3. When the detour search is successful, detailed information about the detour route (lower display) and the comparison screen of the two routes (upper display) are displayed.

- ① Original route (blue)
- ② Detour route (purple)
- ③ The change of distance and estimated travel time to destination

when the detour route is taken.

4. To accept the suggested detour route, touch [Yes].



INFO:

- If no route is set, or [Use Traffic Info] is turned off, this function cannot be operated.
- If a detour route is not selected and no further action is performed, the detour route will be automatically canceled.
- The detour suggestion can be retrieved even after the message disappears by manually selecting [Suggested Alternate Route]. The system will then search for the detour again and will suggest a detour if one is available at that time.
- Without a subscription to SiriusXM Traffic, it will not be possible to receive traffic detour information or apply settings for functions related to traffic information. A message appears when a related menu item is selected.

“Notes on SiriusXM Traffic information” (page 8-9)

Automatic detour guidance

When [Auto Reroute] and [Use Traffic Info] are turned on in the detailed route settings, a message will be displayed automatically when the system finds a detour.

 “Route Settings” (page 9-41)

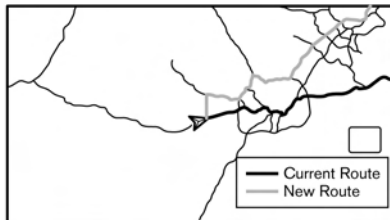

Upper display

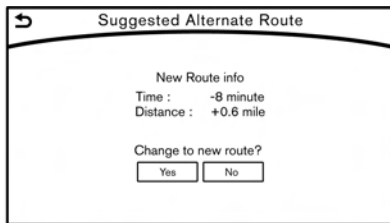

Lower display

To accept the suggested detour route, touch [Yes].

INFO:

- If no operation is performed for one minute after the message is displayed, the message disappears. The detour will not be accepted, and the current suggested route will remain unchanged.
- When [Traffic Announcements] is turned on in the guidance settings, the system will announce voice guidance at the same time that the message appears on the screen.
 “Guidance settings” (page 9-39)

SETTING DETOUR ROUTE

To detour from the suggested route, a route detouring for a specified distance can be calculated.

1. Push **<MENU>** and touch [Route] on the upper half display.
2. Touch [Detour].
3. Touch a detour distance select from 1/2 mile, 1 mile, 3 miles or 5 miles. After calculating the detour, the system displays the detour route on the map.

INFO:

- When the vehicle has deviated from the suggested route, [Detour] cannot be selected.
- If the system cannot calculate a detour with the specified conditions the previous suggested route is displayed.
- If the vehicle is traveling very fast, the detour route may start from a location that the vehicle has already passed.

ROUTE GUIDANCE SETTINGS

The route search conditions and route guidance can be set.

1. Push **<MENU>** and touch [Settings].
2. Touch [Navigation].
3. Touch the item you would like to set.



Guidance settings

Various guidance information can be set to be played during route guidance and the route and/or voice guidance can be activated or deactivated.

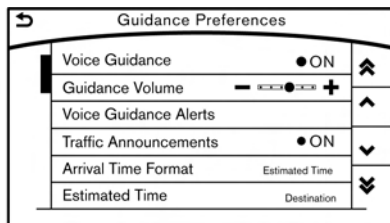
9. Navigation (if so equipped)



Setting item		Action
[Guidance Preferences]	[Voice Guidance]	Activates or deactivates voice guidance.
	[Guidance Volume]	Adjusts the volume level of voice guidance.
	[Voice Guidance Set-tings]	Sets advanced settings for the voice guidance announced or chime at guide points.
	[Turn Point]	Turns on the sound that chimes when a maneuver should be performed.
	[Simple Guide]	The system announces voice guidance twice: "Simple Guidance 1" and "Simple Guidance 2".
	[Normal Guide]	The system announces voice guidance three times : "Simple Guidance 1", "Simple Guidance 2" and "Turn Point".
	[Full Guide]	The system announces voice guidance at all times.
	[Traffic Announcements]	Activate/deactivate the traffic announcement. When this item is activated, the system provides an announcement of a traffic information event on the route. The indicator illuminates if traffic announcement is activated.
	[Arrival Time Format]	
	[Estimated Time of Arrival]	Displays the estimated arrival time.
	[Trip Time Remaining]	Displays the time required to travel to the destination.

Setting item			Action
[Guidance Preferences]	[Estimated Time]	[Destination]	Switches the display of the estimated travel time to the destination or waypoint that is displayed on the map screen. Display  of the travel time to the destination.
		[Waypoints]	Display  of the travel time to the waypoint.
	[Set Average Speeds]	[Auto]	If set to ON, the system automatically calculates the time required to travel to the destination.
		[Freeway]	Adjust the average vehicle speed on a freeway.
		[Main Road]	Adjust the average vehicle speed on a main road.
		[Town Road]	Adjust the average vehicle speed on a town road.
		[Residential]	Adjust the average vehicle speed in a residential area.
	[Reset Settings]	Sets the average vehicle speeds to the default values.	
	[Auto Reroute]	If the vehicle deviates from the suggested route, the system automatically recalculates a route that guides the vehicle to the suggested route.	



INFO:

The guidance volume can also be adjusted by turning the audio system volume control button or pushing <+>/<-> on the steering-wheel while voice guidance is being announced.

Route Settings

It is possible to set the conditions of the route search.

9. Navigation (if so equipped)

Setting Item		Action		
[Search Criteria Settings]	[Search Criteria]	[Fastest Route]	Prioritizes using freeway.	
		[Energy-Saving]	Prioritizes the route with the lowest fuel consumption.	
		[Shortest Distance]	Prioritizes the shortest route.	
	[Route Preferences]	[Minimize Toll Roads]		Minimizes the use of toll roads.
		[Use Time Restricted Roads]	[Use Restricted Roads (Recommended)]	Uses any roads subject to time restrictions.
			[Ignore Restrictions]	Does not use any roads subject to restrictions.
			[Avoid Restricted Roads]	Uses roads subject to restrictions sparingly.
		[Use Real Time Traffic Info]		Uses the latest traffic information received via the SiriusXM Traffic broadcast.
		[Use Avoid Area Settings]		Enables the avoid area setting.  "Storing avoid area" (page 9-50)
		[Use Ferries]		Includes the use of ferries.
		[Use Learned Routes]		Uses the roads that are most frequently traveled with the help of self-learning technology.
[Use HOV Lanes]		Uses the HOV lanes.		
[Auto Reroute]		If the vehicle deviates from the suggested route, the system automatically recalculates a route that leads the vehicle to the suggested route.		



INFO:

- Only one of these route condition can be utilized at a time.
- The recalculated route may not be the shortest route because the system prioritizes roads that are easy to drive on for safety reasons.
- If route conditions are set from [Search Criteria], all sections in the route are subject to the same route conditions even though different route conditions have been set for different sections in [Edit Route].
- If [Use Time Restricted Roads] is deactivated, the system calculates a route without any consideration of the regulations concerning the time or day of the week. Therefore, the suggested route may include a road subject to traffic regulations concerning the time or day of the week. When driving along the route, always follow all traffic regulations regardless of whether [Use Time Restricted Roads] is set to be considered or not.
- If the system cannot calculate any alternative routes, the previous route is displayed.

- If the vehicle greatly deviates from the suggested route, the system calculates a new route.
- Traffic jam information displayed on the map screen is not statistical traffic information.
- Even when [Use Real Time Traffic Info] is turned on, if traffic information has not been provided for the area, a detour may not always be indicated in a location where a traffic jam occurs.
- The system may not lead to a detour if traffic closure or a traffic jam occurs far from the present location.
- The system calculates to reduce the time required for the entire route from the start to the destination. If there are no appropriate routes, the system may lead to a route where a traffic jam occurs instead of leading to a detour.

VIEWING TRAFFIC INFORMATION

SiriusXM Traffic information is a subscription service offered by SiriusXM Satellite Radio.

This service provides real-time information regarding traffic flow, accidents, road construction and other incidents, where available.

SiriusXM Traffic combines information from commercial and public traffic data providers including government departments of transportation, police, emergency services, road sensors, cameras and aircraft reports. The traffic information is broadcast to the vehicle by the SiriusXM satellites. Traffic information available for the route the driver selected is shown on the navigation screen so traffic conditions between you and the destination are known. Three types of real-time traffic information for major roadways are shown on the navigation system:

- Unscheduled traffic data for example, accidents and disabled vehicles.
- Scheduled traffic data, for example road construction and road closures.

9. Navigation (if so equipped)

- Traffic flow information (rate of speed data).



WARNING

SiriusXM Traffic information is not a substitute for attentive driving. Traffic conditions change constantly and emergency situations can arise without warning. Relying only on SiriusXM Traffic information may lead to a collision and could result in serious personal injury.



NOTE:

Flow information is provided only for roads equipped with traffic sensors and is not available in all markets covered by the service. Flow data may not be available on portions of a road that is under construction.

SiriusXM Traffic information is available in limited markets. To subscribe or to check if this service is available in the area:

call 1-866-635-2349 or see www.siriusxm.com/siriusxmtraffic



INFO:

If a contract is not completed for SiriusXM Traffic information service, a message appears, and it will not be possible to check the information on the traffic information system.

VIEWING AVAILABLE TRAFFIC INFORMATION

NavTraffic information is a subscription service offered by SiriusXM Satellite Radio.

This service provides real-time information regarding traffic flow, accidents, road construction and other incidents, where available.

NavTraffic combines information from commercial and public traffic data providers including government departments of transportation, police, emergency services, road sensors, cameras and aircraft reports. The traffic information is broadcast to the vehicle by the SiriusXM satellites. Available traffic information on the route the driver selected is shown on the navigation screen so traffic conditions between you and the destination are known. Three types of real-time traffic information for major roadways are shown on the navigation system:

- * Unscheduled traffic data for example, accidents and disabled vehicles.
- * Scheduled traffic data, for example road construction and road closures.
- * Traffic flow information (rate of speed

data).



WARNING

NavTraffic information is not a substitute for attentive driving. Traffic conditions change constantly and emergency situations can arise without warning. Relying only on NavTraffic information may lead to a collision and could result in serious personal injury.



NOTE:

Flow information is provided only for roads equipped with traffic sensors and is not available in all markets covered by the service. Flow data may not be available on portions of a road that is under construction.

 "SiriusXM Travel Link[®]" (page 8-4)

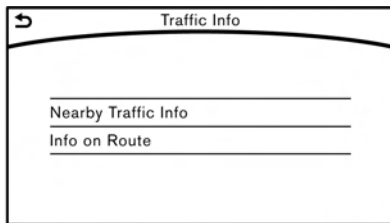

1. Push **<MENU>** and touch [Information].
2. Touch [Traffic Info.].
3. Touch the preferred information.

Available item	Action
[Nearby Traffic Info]	The list of available traffic information around the current vehicle location is displayed.
[Info on Route]	This is only available when a route is set. The list of traffic information found on the recommended route from the current vehicle location to the destination is displayed. The detailed information about displayed events can also be checked.

VIEWING TRAFFIC INFORMATION LIST

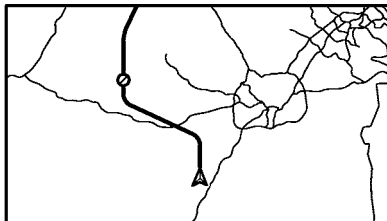

Upper display

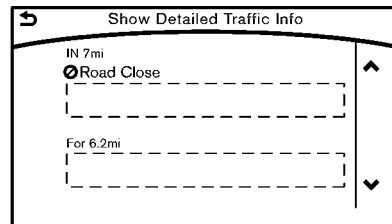

Lower display

The list of traffic information found on the recommended route from the current vehicle location to the destination is displayed. The detailed information about displayed events can also be checked.

1. Touch the preferred information from Traffic info screen.
2. Touch the event to check the detailed information. Touch [Map] to display traffic information location on the upper screen.
3. The map screen centered around the selected event is displayed on the upper display. On the lower display, the detailed information about the event is displayed. The message can be scrolled.
4. Touch [>] to return to the previous screen.

9. Navigation (if so equipped)

DISPLAY URGENT TRAFFIC INFORMATION

When an urgent event is found around the current vehicle location, a message pops up automatically on the upper display with a voice announcement.

The message includes the icon, event type, event information and the direct distance from the current location to the event.



INFO:

- Urgent traffic information is displayed regardless of whether the traffic information system is on or off.
- When there are multiple urgent events, the event with the shortest direct distance from the current location is displayed.
- If the urgent event is on the recommended route, and if a detour is found, the detour route notification screen is displayed when the vehicle approaches the detour point.

TRAFFIC INFORMATION SETTINGS

This displays or changes the settings for the traffic information related functions.

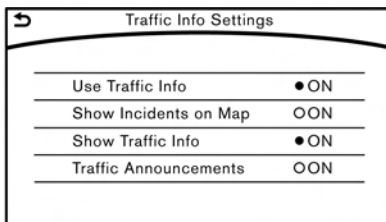

1. Push **<MENU>**.
2. Touch [Settings] and touch [Navigation].
3. Touch [Traffic Info Settings].
4. Touch the preferred setting. The indicator for the selected setting illuminates.

Available setting items

- [Use Traffic Info]:
Enables all traffic information related functions.
- [Show Incidents on Map]:
Displays the traffic incidents (e.g., accident) on the map screen.

- [Show Traffic Info]:
Displays the traffic flow with an arrow on the map screen.
- [Traffic Announcements]:
Announces the traffic information event on the route.



INFO:

- Even when [Show Traffic Info] and [Show Incidents on Map] are set to off, the list display of [Info on Route] and [Nearby Traffic Info] will not be affected.
- Even when [Traffic Announcement] is set to off, the route guidance will not be affected. Also, the announcement of emergency information and weather information will not be turned off.



Voice command

1. Push **< < > >** located on the steering wheel.
2. After the tone sounds, speak a command.

To turn the traffic information system on or off:

“Traffic Information”

TRAFFIC INFORMATION ON MAP

With a subscription to SiriusXM Traffic service, traffic information is displayed on both 2D map and Birdview™ map screen.

☞ “Notes on SiriusXM Traffic information” (page 8-9)

Screen information

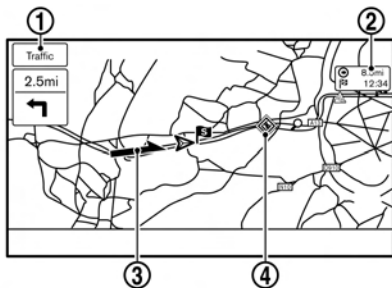

- ① **Traffic indicator:**
Displays the reception condition of traffic information transmitted from the provider. When reception condition of traffic information transmitted from the provider is not detected, the traffic indicator will be “grayed-out”.
- ② **Estimated travel time to destination** calculated with consideration of traffic information on route.

- ③ **Road conditions**
Free Flow: Green arrow
Moderate traffic: Yellow arrow
Heavy traffic: Red arrow
Section affected by serious traffic event: Purple arrow
- ④ **Traffic information icon:**
If a route is not already set, all of the traffic information icons on the map screen are displayed in color. When a route is already set, the icons on the route are displayed in color, and the icons outside the route are displayed in gray.
 - ◆ : Accident
 - ⓧ : Closed road
 - ℹ : Information
 - ⚙ : Road work
 - ⚠ : Slippery road
 - ☁ : Weather
 - ◆ : Incident

1/2 mile	1 km
1/4 mile	400 m
1/8 mile	200 m
1/16 mile	100 m
1/32 mile	50 m
1/64 mile	25 m

Traffic information display and scale levels

2D map and Birdview Map	
5 miles	10 km
2 miles	4 km
1 mile	2 km

9. Navigation (if so equipped)

STORING A LOCATION/ROUTE

STORING LOCATION

Often visited locations can be stored in the Stored Locations. The stored addresses can be easily retrieved to set them as a destination or waypoint. The Stored Locations can store up to 200 locations.

Storing home location

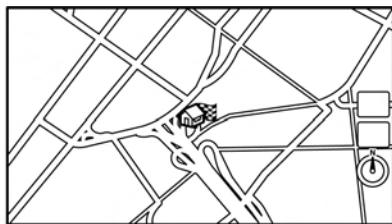

1. Push **<MENU>** and touch [Destination].
2. Touch [Home].
3. If the home location is not registered, the system asks to store it.
4. Set the Home location using the same procedure as setting a destination.
☞ “Setting destination” (page 9-14)

5. A message is displayed on the lower display and the home location is stored.

Other Settings

1. Push the **<MENU>** and touch [Settings].
2. Touch [Navigation] and touch [Edit/Delete Stored Locations].
3. Touch [Stored Locations] and touch [Home Location (None)].
4. Touch the appropriate method to set a location. The search methods are the same as for setting a destination.
☞ “Setting destination” (page 9-14)
5. When the stored location is displayed at the center of the map on the upper display.
6. Adjust the location of the stored item and edit the contents of the stored item as necessary. After finishing the setting, touch [↵].

Storing location by searching

It is possible to store a location by searching in various ways.

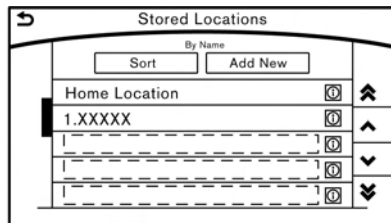

1. Push the **<MENU>** and touch [Settings].
2. Touch [Navigation].
3. Touch [Edit/Delete Stored Locations].
4. Touch [Stored Locations].
5. Touch [Add New].
6. Touch the appropriate method to set a location. The search methods are the same as for setting a destination.
☞ “Setting destination” (page 9-14)
7. A message is displayed, and the address of the location is stored in the Stored Locations.
8. Adjust the location of the stored item and edit the contents of the stored item as necessary.
☞ “Editing stored home and location” (page 9-51)

- After finishing the setting, touch [➤].

INFO:

- When the location is stored in the Stored Locations, [Stored Locations] can be used to search for the location.
- When 200 store locations are already stored, a new store location cannot be stored until a currently stored store location is deleted.

Storing location by moving map

- Move to the preferred location on the map and touch [≡] on the upper display.



Upper display

- Touch [Store Location]. A message is displayed.

- The icon representing the stored location is displayed on the map. Touch [➤] on the upper display to return to the current location map screen.

INFO:

The address is stored in the first available position number in the Store Location list.

STORING ROUTE

A maximum of five calculated routes can be stored. Stored routes can be easily retrieved and set as the suggested route.

If any waypoints are not set on the route, the route cannot be stored.

- Push <MENU> and touch [Route] and touch [Edit Route].
- Touch [Store Route]. A confirmation message is displayed. Select [Yes] to store the current route.

Other settings

A route can also be stored using the following procedure.

- Push <MENU> and touch [Settings].
- Touch [Navigation] and touch [Edit/Delete Stored Locations].
- Touch [Stored Route Plans].
- Touch [Store Current Route]. A confirmation message is displayed.
- Confirm the contents of the message then touch [Yes]. The current route is stored.

INFO:

- A stored route includes only locations (destination and waypoints) and route calculation conditions, not the route itself.
- The route is stored in the first available position number in the store current route list.
- When five routes are already stored in the address book, a new route cannot be stored until a route is deleted.
☞ “Deleting stored item” (page 9-53)

9. Navigation (if so equipped)

STORING AVOID AREA

An Avoid Area can be stored. The Avoid Area is an area that can be excluded from a route, such as a road that is always congested. Once Avoid Areas are stored, the system avoids those areas when calculating a route. Up to 10 Avoid Areas can be stored.

1. Push **<MENU>** and touch [Settings].
2. Touch [Navigation] and touch [Edit/Delete Stored Locations].
3. Touch [Avoid Areas].

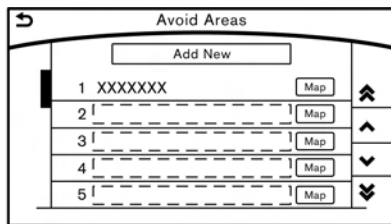

4. Touch [Add New].
Touch the appropriate method to search for a location.
 “Setting destination” (page 9-14)
5. Adjust the location edit the contents of the Avoid area as necessary.
 “Editing avoid area” (page 9-53)

6. After finishing the setting, touch [↵].



INFO:

- A maximum of 10 Avoid Areas can be stored. When 10 Avoid Areas are already stored, a new Avoid Area cannot be stored until a currently stored Avoid Area is deleted.
 “Deleting stored item” (page 9-53)

EDITING STORED INFORMATION

Items stored in the system can be modified. These settings can be edited to make the navigation system more useful.

Editing stored home and location

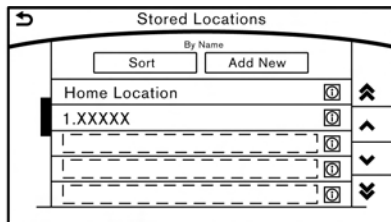

Step 1	Step 2	Step 3	Step 4	Action
1. Push <MENU> 2. Touch [Settings] 3. Touch [Navigation] 4. Touch [Edit/Delete Stored Locations] 5. Touch [Stored Locations]	[Add New]			"Storing location by searching" (page 9-48)
	[Home Location]	[Edit]	[Move Location]	Adjust the location of the stored location on the upper display.
			[Phone No.]	Stores the telephone number of the home location.
			[Icon]	Changes the icon of the home to the preferred one.
			[Show Icon on Map]	Displays the home icon on the map.
			[Alarm Sounds]	Sets the tone of the alarm that sounds when the vehicle approaches the home.
			[Alarm Direction]	Sets the alarm to sound when approaching from a specific direction.
	[Alarm Distance]	Sets the alarm to sound when reaching a specific distance to the home.		
	[Delete]		Delete the stored home location.	

9. Navigation (if so equipped)

Step 1	Step 2	Step 3	Step 4	Action
1. Push <MENU> 2. Touch [Settings] 3. Touch [Navigation] 4. Touch [Edit/Delete Stored Locations] 5. Touch [Stored Locations]	Touch the preferred stored address from the list.	[Edit]	[Move Location]	Adjust the location of the stored location on the upper display.
			[Name]	Changes the name of a stored location.
			[Phone No.]	Stores the telephone number of a stored location.
			[Icon]	Changes the icon of a stored location to the preferred one.
			[Show Icon on Map]	Displays the icon on the map of a stored location.
			[Group]	Groups the stored locations.
			[Alarm Sounds]	Sets the tone of the alarm that sounds when the vehicle approaches a stored location.
			[Alarm Direction]	Sets the alarm to sound when approaching from a specific location.
		[Alarm Distance]	Sets the alarm to sound when reaching a specific distance to a stored location.	
		[Delete]		Delete the stored location.



INFO:

- By changing the icons, the usage of the [By Icon] option of the sort function can be optimized more effectively.
- By grouping the stored addresses, the [By Group] option of the sort function can be used more effectively in the [Sort] mode.
- Once the direction and the distance to sound an alarm are set, the system will sound the alarm when the vehicle enters the triggering zone.

Editing avoid area

Step 1	Step 2	Step 3	Action
1. Push <MENU> 2. Touch [Settings] and touch [Navigation] 3. Touch [Edit/Delete Stored Locations] 4. Touch [Avoid Areas] 5. Touch the preferred Avoid Area from the list	[Edit]	[Move Location]	Display the Avoid Area on the upper screen, and adjusts the location of the Avoid Area.
		[Rename]	Changes the name of an Avoid Area.
		[Resize Area]	Adjusts the range of the Avoid Area.
		[Minimize Toll Roads]	Sets the route to include or not include freeways.
	[Delete]		Delete an Avoid Area.

**INFO:**

- The Avoid Area is displayed in green if it includes a freeway or in blue if it does not include a freeway.
- If the current vehicle location is set to an Avoid Area, the system will not provide route guidance.

Editing stored route

1. Push **<MENU>** and touch [Settings].
2. Touch [Navigation] and touch [Edit/Delete Stored Locations].
3. Touch [Stored Route Plan].

4. Touch the preferred stored route from the list.

Available setting items

- [Rename]:
Changes the stored route name.
- [Delete]:
Delete the stored route.

DELETING STORED ITEM

The locations and routes in the Address Book can be deleted. Two deletion methods are available: deleting an individual item and deleting all stored items.

**INFO:**

- Deleted items cannot be restored. Before deleting an item, always make sure that the item is no longer needed.

9. Navigation (if so equipped)

Deleting stored item individually

1. Push **<MENU>** and touch [Settings].
2. Touch [Navigation] and touch [Edit/Delete Stored Locations].

Step 1	Step 2	Step3	Action
[Delete Stored Items]	[Delete Stored Locations]	[Delete All]	Delete all stored locations.
		[Multi Select]	Delete the selected stored locations. Touch [Select All] to select all stored locations. Touch [Clear All] to reset the selected stored location.
		[Sort]	Sort stored locations in [By Number]/[By Name]/[By Icon]/[By Group].
		Stored location list	Touch the preferred item from the list, delete the selected stored location individually.
	[Delete Stored Route Plans]	[Delete All]	Delete all stored routes.
		Touch the preferred item from the list	Delete the selected stored routes.
	[Delete Avoid Areas]	[Delete All]	Delete all Avoid Areas.
		Touch the preferred item from the list	Delete the selected Avoid Area.
	[Reset Learned Routes]		Delete the learned routes.

Deleting individual item on map

This operation is performed on the upper display.

1. Align the cross pointer over the preferred stored location for deletion by moving on the map, and then touch [≡].

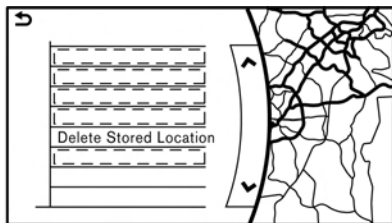

2. Touch [Delete Stored Location]. A confirmation message is displayed.
3. Touch [Yes]. The stored location is deleted from the Stored Locations.
4. Touch [↩] to return to the current location.

TRANSFERRING INFORMATION TO/ FROM ADDRESS BOOK

The information of the stored home and addresses can be exported and imported using a USB memory device.

INFO:

A USB memory device can be used to transfer data but it is not possible to edit the data using a personal computer, etc.

Two USB ports are located in the center console box.

 “Media Hub” (page 2-6).

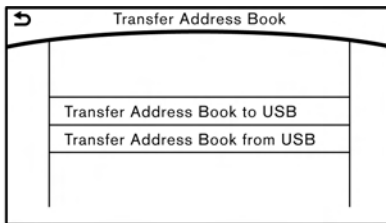

1. Insert a USB memory device and push the <MENU> button and touch [Settings].
2. Touch [Navigation] and touch [Edit/Delete Stored Locations].
3. Touch [Transfer Address Book].
4. Touch [Transfer Address Book to USB] or [Transfer Address Book from USB].
5. Touch [All], [Home Location] or [Stored Locations].

NOTE:

Do not remove the USB memory until the system completely imports or exports the data.

INFO:

- If the USB memory already has the data for a stored address, a confirmation message is displayed. Once overwritten, the original data cannot be recovered.

9. Navigation (if so equipped)

NAVIGATION SETTINGS

The navigation system can be customized according to the user's preference.

1. Push the **<MENU>** and touch [Settings].
2. Touch [Navigation].
3. Touch the item you would like to set.

Available setting items may vary depending on models and specifications.

[Map & Display View]

Setting Map & Display View.

 "Map view settings" (page 9-10)

[Map Preferences]

Setting map view, orientation, font size or map color etc.

 "Map view settings" (page 9-10)

[POI Icons Displayed on Map]

The facility icons can be displayed or hidden by type.

 "Displaying facility icons" (page 9-13)

[Guidance Preferences]

Various guidance information can be set to be played during route guidance and the route and/or voice guidance can be activated or deactivated.

 "Guidance settings" (page 9-39)

[Search Criteria Settings]

It is possible to set the condition of the route search.

 "Route Settings" (page 9-41)

[Traffic Info Settings]

Displays or changes the settings for the traffic information

 “Traffic Information Settings” (page 9-46)

[Safety Guide]

Setting item	Action
[Speed Limit Info]	Display speed limit information.
[Curve Guide]	Display curve warning information.

[Edit/Delete Stored Locations]

Stored Locations, Route Plans and Avoid Area. You can also edit stored Items.

 “Storing a location/route” (page 9-48)

[Delete Previous Destinations]

Setting item	Action	
[Multiple Selection]	Select from list	Select to delete previous destination.
	[Select All]	Select all previous destinations to delete.
	[Delete]	Clear the selected previous destination.
[Delete All]	Delete all previous destination.	
[Previous Start]	Delete previous start point.	
Touch the preferred previous destination from the list.	Delete previous destination.	

9. Navigation (if so equipped)

[Other Settings]

Setting item	Action	
[Small Step Zoom With Dial]	Sets the free zoom function on or off. It is possible to adjust the scale in smaller steps than with normal scale adjustment.	
[Map Scrolling Information]	Information about the location, on which the center of the cross pointer is placed by scrolling on the map, can be set to be displayed.	
[Destination/Waypoint Icon Info]		
[Latitude/Longitude Info]		
[Stored Location Icon Info]		
[Customize Nearby Places]	Item List	Customize the five nearby categories to show the categories that you frequently use.
	[Restore Default Settings]	Reset the five nearby categories that you have set.
[Tracking Dots Displayed on Map]	[Show Tracking Dots on Map]	Displays a stored tracked route on the map.
	[Dist. Between Tracking Dots]	Select tracking dot interval.
	[Delete Track to Current Location]	Deletes the stored tracked route.
[Adjust Current Location]		If the vehicle icon indicating the current vehicle location is not in the correct position, the location of the vehicle icon on the map screen can be adjusted.

[Reset Settings]

This resets various settings (display, volume level, etc.) to the default settings.

GENERAL INFORMATION FOR NAVIGATION SYSTEM

CURRENT VEHICLE LOCATION

Display of current vehicle location

This navigation system combines the data obtained from the vehicle (by gyro sensor) and from GPS (Global Positioning System) satellites to calculate the current location of the vehicle. This position is then displayed throughout route guidance to a destination.

What is GPS (Global Positioning System)?

GPS is a position detecting system that uses satellites deployed by the U.S. government. This navigation system receives radio signals from three or more different satellites that orbit 13,049 miles (21,000 km) above the earth in space, and detect the position of the vehicle by utilizing the principle of triangulation.

Positioning adjustment:

When the system judges that the vehicle position is not accurate based on vehicle speed and gyro sensor data calculations,

the system will automatically adjust the position of the vehicle icon using GPS signals.

Receiving signals from GPS satellites:

The reception of GPS signals can be weak, depending on the environment. Vehicles in the following areas/environments may not receive GPS signals.

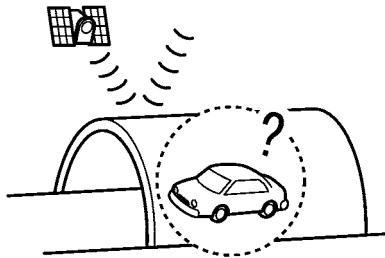

- Inside tunnels or parking garages

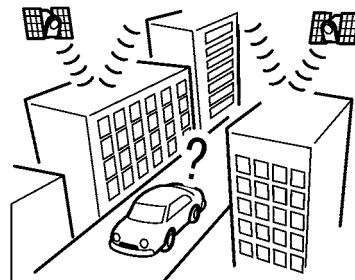

- In areas with numerous tall buildings

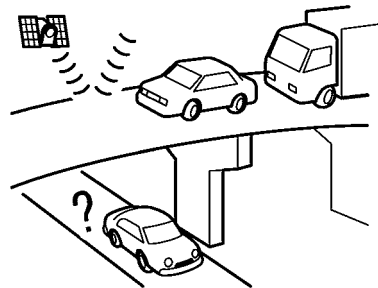

- Under multi-layered highways

9. Navigation (if so equipped)

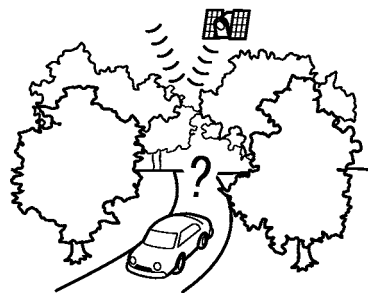

- Areas with numerous tall trees

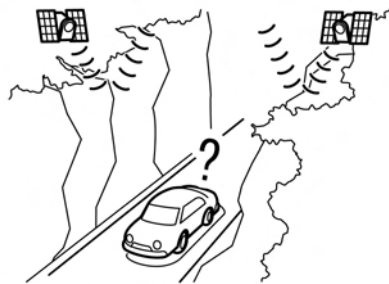

- In a canyon

INFO:

The GPS antenna is located on the instrument panel inside the vehicle. Do not place any objects, especially cellular phones or transceivers, on the instrument panel. Because the strength of the GPS signal is approximately one billionth of that of TV waves, phones and transceivers will affect or may totally disrupt the signal.

Incorrect display of vehicle position

The following cases may affect the display accuracy of the vehicle's position or traveling direction. The accuracy will return to normal if the driving conditions return to normal.

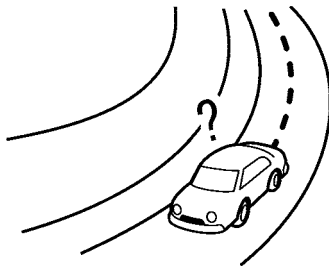

- When there is a similar road nearby.

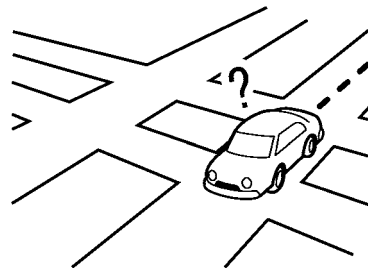

- When the vehicle is traveling in an area with a grid pattern road system.

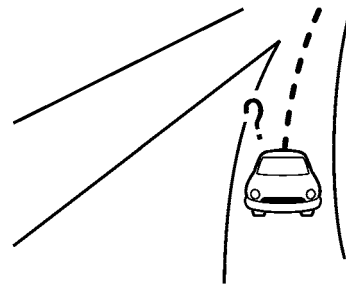

- When the vehicle is passing through a large Y-shaped intersection/junction.

9. Navigation (if so equipped)

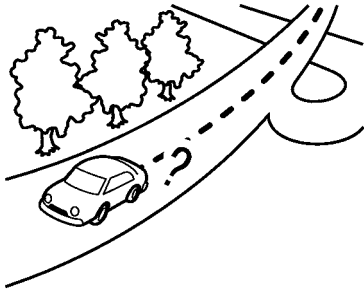

- When the vehicle is traveling on a continuous, slowly curving road.

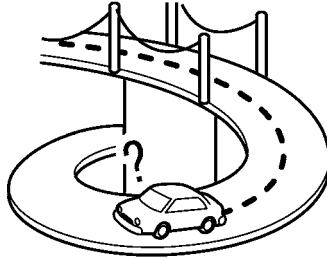

- When the vehicle is on a loop bridge.

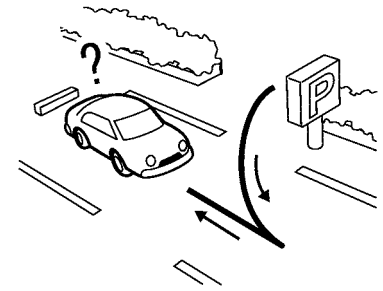

- When repeatedly turning left or right, or driving in zigzags.

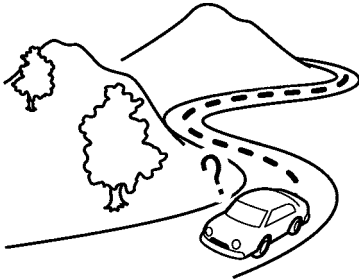

- When the vehicle is traveling on a road with repeating S-shaped curves.



- When the vehicle is on a snow-covered or unpaved road.

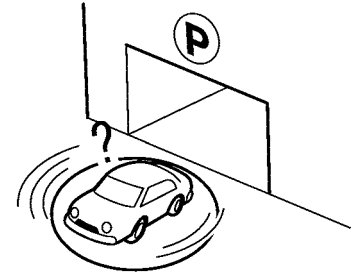

- When the vehicle is rotated on a parking lot turntable while the ignition switch is off.

9. Navigation (if so equipped)

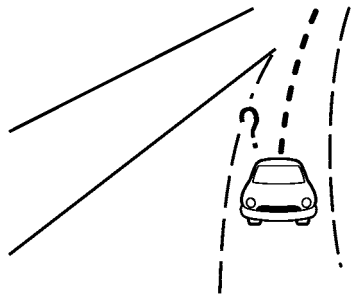

- When driving on a road not displayed on the map screen or a road that has been changed due to additional construction or other reasons.

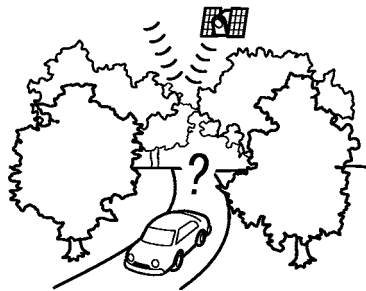

- When the GPS positioning accuracy is low.

INFO:

- The vehicle icon may be misaligned when starting the vehicle just after starting the engine or the hybrid system.
- The vehicle icon may also be misaligned if different sized tires or tire chains are installed.
- The system has a function that automatically corrects the vehicle icon position when it is misaligned from the actual position.
- Vehicle position correction by GPS may not function when the vehicle is stopped.
- If the vehicle icon position does not return to normal even after driving for a while, correct the vehicle icon position manually.

Detailed Map Coverage Areas (MCA) for navigation system

This system is designed to help guiding to the destination, and it also performs other functions as outlined in this manual. However, the system must be used safely and properly. Information concerning road conditions, traffic signs and the availability of services may not always be up-to-date. The system is not a substitute for safe, proper and legal driving.

Map data covers select metropolitan areas in the United States and Canada.

Map data includes two types of areas: “Detailed coverage areas” providing all detailed road data and other areas showing “Main roads only”.

INFO:

Detailed map data is not available in many areas and is generally limited to select major metropolitan areas.

When gray road is displayed on map

- When you are driving on a road displayed in gray after the vehicle has deviated from the suggested route during route guidance, automatic re-routing may not start immediately.
- The navigation system does not provide route guidance for roads displayed in dark green. Therefore, if the destination is set on a road displayed in dark green, the enlarged map display will return to the ordinary map screen at some point on a suggested route that is near the destination. Also, voice guidance will stop at some point on a

suggested route that is near the destination.

- Places information and street names near roads displayed in gray may not be contained in the map data.

ROUTE CALCULATION

- There may be cases where carpool lanes are included on a suggested route when the automatic rerouting function is activated, even if the [Use Time Restricted Roads] is set to [Use Restriction Info].
 “Route Settings” (page 9-41)
- The navigation system does not provide route guidance for roads displayed in dark green.
- If the destination is set on a dark green road, the enlarged map display will switch to the ordinary map screen at some point and suggest a route that is near the destination. The distance and direction to the endpoint of the suggested route will be displayed in the lower right corner of the screen. Also, at this time, voice guidance will announce, “The route to the destination includes roads through incomplete map areas. Voice guidance will not be

provided in these areas.”

When approaching the endpoint of the suggested route, voice guidance will announce, “Entering the road with incomplete map data. Use the direction arrow and distance information to proceed to your destination.”

To reach the destination, refer to the map screen. Always follow actual roads and regulations and drive safely.

- The suggested route may not be the shortest, nor are other circumstances such as traffic jams considered.
- Because of the inevitable difference in road conditions and circumstances between the time you use this system and the time the information was produced for the map data, there may be discrepancies in roads and regulations. In such cases, actual road conditions and regulations take precedence over map data information.
- During route calculation, the map will not scroll, however the vehicle icon will move according to the actual vehicle’s movement.

- During route calculation, buttons such as the **<MAP/VOICE>** and the **<MENU>** will be disabled.
- In some cases, after the calculation is complete, the calculated route may not be immediately displayed.
- Waypoints that have been passed will be disregarded by rerouting calculation.
- If you scroll the map while the suggested route is being drawn, it may take more time to finish drawing.
- Route calculation may not be completed in the following cases.
 - If there is no main road within a range of 1.5 miles (2.5 km) from the vehicle, a message saying so will appear on the screen. Try recalculating when the vehicle is closer to a main road.
 - If there is no main road within a range of 1.5 miles (2.5 km) from the destination or waypoint, a message saying so will appear on the screen. Try setting the location closer to a main road.
 - If the vehicle is too close to the destination or if there are no roads to the destination, a message saying so will

9. Navigation (if so equipped)

appear on the screen.

- If it is impossible to reach the destination or waypoints because of traffic regulations, etc.
- If the only route to reach the destination or waypoints is extremely complicated.
- The following may occur when the route is displayed.
 - If you calculate a route on a main road, the starting point of the route may not exactly match the current vehicle location.
 - The endpoint of the route may not exactly match the destination.
 - If you calculate a route on a main road, the system may display a route from another main road. This may be because the position of the vehicle icon is not accurate. In this case, park the vehicle in a safe location and reset the vehicle icon, or continue driving to see if the position of the vehicle icon is automatically adjusted before recalculating the route.
- There are cases in which the system shows an indirect route to reach the destination or waypoints, if you set them

from stored or facility information. In order to correct this, you must be careful about the traffic direction, especially when lanes with different travel directions are shown separately, such as interchanges and service areas.

- This system makes no distinction between limited traffic control and total control (blockage). It may show an indirect route even if the road is usable.
- Even if the freeway preference is set to OFF, a route that uses the freeway may be suggested.
- Even if the ferry preference is set to OFF, a route that uses a ferry line may be suggested.

ROUTE GUIDANCE



The system will only announce street names when the system language is set to English. Street names are not announced when the system is set to French/Spanish.

Repeating voice guidance



This function is available throughout route guidance, from the time after the route calculation is completed until the vehicle arrives at the destination. Push and hold the **<MAP/VOICE>**. Voice guidance will be repeated.



- If the **<MAP/VOICE>** is pushed and held when the vehicle is deviating from the suggested route and when the automatic reroute function is off, voice guidance will announce, “Proceed to the highlighted route.”
- If the **<MAP/VOICE>** is pushed and held when the vehicle is going in the wrong direction, voice guidance will announce: “Please make a legal U-turn if possible.”

Notes on voice guidance

- Voice guidance in this system should be regarded as a supplementary function. When driving the vehicle, check the route on the map and follow the actual roads and traffic regulations.

- Voice guidance is activated only for intersections with certain conditions. There may be cases where the vehicle has to turn, but voice guidance is not provided.
- Voice guidance contents may vary, depending on the direction of the turn and the type of intersection.
- The voice guidance timing will vary depending on the situation.
- When the vehicle has deviated from the suggested route, voice guidance is not available. The system will not announce this. Refer to the map and recalculate the route.
 “Recalculating route” (page 9-38)
- Voice guidance may not accurately correspond with road numbers and directions at freeway junctions.
- Voice guidance may not accurately correspond to street names at freeway exits.
- The displayed street names may sometimes differ from the actual names, or “UNKNOWN STREET NAME” may be displayed.
- Voice guidance is not available when the [Voice Guidance] is turned off.
 “Volume settings” (page 2-19)
- Voice guidance will start when the vehicle enters the suggested route. Refer to the map for directions to the starting point of the route.
- When approaching a waypoint, voice guidance will announce, “You have arrived at waypoint 1 (2, 3, 4,...).” Voice guidance will switch to the next section of the route. When voice guidance is not available, refer to the map for directions.
- In some cases, voice guidance ends before arrival at the destination. Refer to the destination icon on the map to reach the destination.
- If the system recognizes on which side the destination (waypoint) is located, voice guidance will announce “on the right/left” after announcing the arrival at the destination.
- Voice guidance may be partially operational or inoperative due to the angle of roads at an intersection.
- Because freeway lane information is available only for approximately 7,000 major freeways in North America, it is not possible to display information for all junctions and exits.
- Freeway exit information may differ from the information on the actual exit signs.
- Because it is not possible to consider data concerning roads that are seasonally available or unavailable, a route may be displayed that does not match the actual traffic restrictions. Be sure to follow the actual traffic restrictions while driving.
- Canada and Alaska contain many roads with incomplete map data. As a result, when searching for a route, the route may include roads with incomplete data. In regions where road data is not complete, voice guidance may stop for long periods of time. Be sure to follow the actual traffic restrictions while driving.

9. Navigation (if so equipped)

MAP DATA

How to handle the Map SD card

An SD card that includes the map data is inserted. When handling the Map SD card, please be careful and adhere to the following instructions:

- An SD card is inserted in the slot. This is the SDHC card that is exclusively used for this device. This card includes the map data. The SDHC card is necessary to operate the device. Do not remove this card except when updating the map data is required.
- Never analyze, modify, delete or format the map data. Doing so may cause an improper operation of the device.
- The SDHC card that is exclusively used for this device does not work properly if it is inserted in another device.
- The map data cannot be used even if it is copied to another SDHC card.
- Do not remove the SDHC card containing map data from the system. Using the system with the SDHC card containing map data removed will prevent some functions from operating.



NOTE:

Do not remove the SD card containing map data that is inserted in the slot. When this SD card containing map data is removed the navigation system will not operate. If the SD card containing map data is accidentally removed, after reinserting the SD card containing map data into the slot, place the ignition switch in the OFF position and then place it back in the ON position again.

How to order map data updates

To order updated map data, contact the INFINITI NAVIGATION SYSTEM HELPDESK. See the contact information on the inside front cover of this manual.

About map icons

The marks of companies displayed by this product to indicate business locations are the marks of their respective owners. The use of such marks in this product does not imply any sponsorship, approval, or endorsement by such companies of this product.

About map data

1. This map data has been prepared by CLARION CO., LTD. (CLARION), under license from HERE. has added, processed and digitized data based on the digital road map data of HERE. Due to the production timing of the map data, some new roads may not be included in this map data or some of the names or roads may be different from those at the time you use this map data.
2. Traffic control and regulation data used in this map data may be different from those at the time you use this map data due to the data production timing. When driving your vehicle, follow the actual traffic control signs and notices on the roads.
3. Reproducing or copying this map software is strictly prohibited by law.

Published by Nissan North America, Inc.

© 2015 HERE. All Rights Reserved.

© ZENRIN CO., LTD. 2015. All rights reserved.

Certain business data provided by In-fogroup © 2015, All Rights Reserved.



WARNING

- This navigation system should not be used as a substitute for your own judgement. Any route suggestions made by this navigation system may never override any local traffic regulations, your own judgement, and/or knowledge of safe driving practices. Disregard route suggestions by the navigation system if such suggestions would: cause you to perform a hazardous or illegal maneuver, place you in a hazardous situation, or route you into an area you consider unsafe.
- The advice provided by the navigation system is to be regarded only as a suggestion. There may be situations where the navigation system displays the vehicle's location incorrectly, fails to suggest the shortest course, and/or fails to direct you to your desired destination. In such situations, rely on your own driving judgement, taking into account current driving conditions.
- Do not use the navigation system to route you to emergency services. The database does not contain a complete listing of locations of emergency service providers

such as police, fire stations, hospitals and clinics. Please use your judgement and your ability to ask for directions in these situations.

- As the driver you solely are responsible for your driving safety.
 - In order to avoid traffic accidents, do not operate the system while driving.
 - In order to avoid traffic accidents, operate the system only when the vehicle is stopped at a safe place and the parking brake is set.
 - In order to avoid traffic accidents or traffic offence, remember that actual road conditions and traffic regulations take precedence over the information contained on the navigation system.
 - Accordingly, the Software may contain inaccurate or incomplete information due the passage of time, changing circumstances, and due to the nature of the sources used. Please observe the actual traffic circumstances and regulations at all times while driving.
 - In a situation when actual road conditions and traffic regulations differ from the information contained on the

navigation system, then abide by traffic rules.

- The navigation system does not provide, or account for in any way, information regarding traffic and road laws; speed restrictions; road conditions including road slope, grade, and/or surface conditions; obstruction information including bridge and tunnel height and width, and/or other prevailing driving and/or road conditions. Always rely on your own driving judgement, taking into account current driving conditions.
- Minimize the amount of time spent viewing the screen while driving.

The marks of companies displayed by this product to indicate business locations are the marks of their respective owners. The use of such marks in this product does not imply any sponsorship, approval, or endorsement by such companies of this product.

End-user terms

The data (“Data”) is provided for your personal, internal use only and not for

9. Navigation (if so equipped)

resale. It is protected by copyright, and is subject to the following terms and conditions which are agreed to by you, on the one hand, and CLARION CO., LTD. (“CLARION”) and its licensors (including their licensors and suppliers) on the other hand.

© 2015 HERE. All rights reserved.

This data includes information taken with permission from Canadian authorities, including © Her Majesty, © Queen’s Printer for Ontario, © Canada Post, GeoBase®, © Department of Natural Resources Canada. All rights reserved.

HERE holds a non-exclusive license from the United States Postal Service® to publish and sell ZIP+4® information.

© United States Postal Service® 2015. Prices are not established, controlled or approved by the United States Postal Service®. The following trademarks and registrations are owned by the USPS: United States Postal Service, USPS, and ZIP+4.

Terms and conditions:

Personal Use Only. You agree to use this Data together with Nissan Automotive Products for the solely personal, non-commercial purposes for which you were licensed, and not for service bureau, time-sharing or other similar purposes. Accordingly, but subject to the restrictions set forth in the following paragraphs, you agree not to otherwise reproduce, copy, modify, decompile, disassemble or reverse engineer any portion of this Data, and may not transfer or distribute it in any form, for any purpose, except to the extent permitted by mandatory laws. Multi-disc sets may only be transferred or sold as a complete set as provided by CLARION and not as a subset thereof.

Restrictions. Except where you have been specifically licensed to do so by CLARION, and without limiting the preceding paragraph, you may not (a) use this Data with any products, systems, or applications installed or otherwise connected to or in communication with vehicles, capable of vehicle navigation, positioning, dispatch, real time route guidance, fleet management or similar applications; or (b) with or in communication with any positioning

devices or any mobile or wireless-connected electronic or computer devices, including without limitation cellular phones, palmtop and handheld computers, pagers, and personal digital assistants or PDAs.

Warning. The Data may contain inaccurate or incomplete information due to the passage of time, changing circumstances, sources used and the nature of collecting comprehensive geographic data, any of which may lead to incorrect results.

No Warranty. This Data is provided to you “as is,” and you agree to use it at your own risk. CLARION and its licensors (and their licensors and suppliers) make no guarantees, representations or warranties of any kind, express or implied, arising by law or otherwise, including but not limited to, content, quality, accuracy, completeness, effectiveness, reliability, fitness for a particular purpose, usefulness, use or results to be obtained from this Data, or that the Data or server will be uninterrupted or error-free.

Disclaimer of Warranty: CLARION AND ITS LICENSORS (INCLUDING THEIR LICENSORS AND SUPPLIERS) DISCLAIM ANY WARRANTIES, EXPRESS OR IMPLIED, OF QUALITY, PERFORMANCE, MERCHANTABILITY, FITNESS FOR A PARTICULAR PURPOSE OR NON-INFRINGEMENT. Some States, Territories and Countries do not allow certain warranty exclusions, so to that extent the above exclusion may not apply to you.

Disclaimer of Liability: CLARION AND ITS LICENSORS (INCLUDING THEIR LICENSORS AND SUPPLIERS) SHALL NOT BE LIABLE TO YOU: IN RESPECT OF ANY CLAIM, DEMAND OR ACTION, IRRESPECTIVE OF THE NATURE OF THE CAUSE OF THE CLAIM, DEMAND OR ACTION ALLEGING ANY LOSS, INJURY OR DAMAGES, DIRECT OR INDIRECT, WHICH MAY RESULT FROM THE USE OR POSSESSION OF THE INFORMATION; OR FOR ANY LOSS OF PROFIT, REVENUE, CONTRACTS OR SAVINGS, OR ANY OTHER DIRECT, INDIRECT, INCIDENTAL, SPECIAL OR CONSEQUENTIAL DAMAGES ARISING OUT OF YOUR USE OF OR INABILITY TO USE THIS INFORMATION, ANY DEFECT IN THE INFORMATION, OR THE BREACH OF THESE TERMS OR CONDITIONS, WHETHER IN AN ACTION IN CONTRACT OR TORT OR BASED ON A WARRANTY, EVEN IF

CLARION OR ITS LICENSORS HAVE BEEN ADVISED OF THE POSSIBILITY OF SUCH DAMAGES. Some States, Territories and Countries do not allow certain liability exclusions or damages limitations, so to that extent the above may not apply to you.

Export Control. CLARION shall not export from anywhere any part of the Data or any direct product thereof except in compliance with, and with all licenses and approvals required under, applicable export laws, rules and regulations, including but not limited to the laws, rules and regulations administered by the Office of Foreign Assets Control of the U.S. Department of Commerce and the Bureau of Industry and Security of the U.S. Department of Commerce. To the extent that any such export laws, rules or regulations prohibit NT from complying with any of its obligations hereunder to deliver or distribute Data, such failure shall be excused and shall not constitute a breach of this Agreement.

Entire Agreement. These terms and conditions constitute the entire agreement between CLARION (and its licensors, including their licensors and suppliers) and you pertaining to the subject matter hereof, and supersedes in their entirety any and all written or oral agreements previously existing between us with respect to such subject matter.

Governing Law. The above terms and conditions shall be governed by the laws of the State of Illinois, without giving effect to (i) its conflict of laws provisions, or (ii) the United Nations Convention for Contracts for the International Sale of Goods, which is explicitly excluded. You agree to submit to the jurisdiction of the State of Illinois for any and all disputes, claims and actions arising from or in connection with the Data provided to you hereunder.

Government End Users. If the Data is being acquired by or on behalf of the United States government or any other entity seeking or applying rights similar to those customarily claimed by the United States government, the Data is a “commercial item” as that term is defined at 48 C.F.R. (“FAR”) 2.101, is licensed in accordance with the End-User Terms under which this

9. Navigation (if so equipped)

Data was provided, and each copy of the Data delivered or otherwise furnished shall be marked and embedded as appropriate with the following “Notice of Use,” and shall be treated in accordance with such Notice:

NOTICE OF USE

CONTRACTOR (MANUFACTURER/ SUPPLIER)
NAME: HERE
CONTRACTOR (MANUFACTURER/SUPPLIER) AD-
DRESS:
c/o Nokia 425 West Randolph Street, Chicago,
Illinois 60606
This Data is a commercial item as defined in FAR
2.101 and is subject to the End-User Terms under
which this Data was provided.
© 2015 HERE – All rights reserved.

If the Contracting Officer, federal government agency, or any federal official refuses to use the legend provided herein, the Contracting Officer, federal government agency, or any federal official must notify HERE prior to seeking additional or alternative rights in the Data

HOW TO HANDLE THE SD CARD

When handling the SD card, please be careful and adhere to the following instructions:

- Always follow the instructions described in this manual and in the handbook attached to the SD card when using an SD card in this device.
- Do not handle an SD card with wet hands. Doing so may cause electric shock or a malfunction.
- Do not allow hands or metal objects to contact the terminal area of SD cards.
- Do not place SD cards on the instrument panel, on any place with direct sunlight or in moist circumstances. Doing so may damage or deform the SD card.
- Do not use any conventional cleaner, benzene, thinner or antistatic spray.
- Do not use SD cards in any place where static electricity or electric noise adversely affects SD cards. This may cause data corruption or data loss.
- SD card optimization must not be performed.

- Always place the SD card in its storage case when not in use.
- If an SD card is disposed of when it is not used, it is recommended not only to delete the stored data but also to physically break the card.

10 Voice recognition

INFINITI voice recognition	10-2
Using Voice Recognition System.....	10-2
Before starting.....	10-2

Giving voice commands.....	10-2
Voice recognition settings.....	10-17



10. Voice recognition

INFINITI VOICE RECOGNITION

USING VOICE RECOGNITION SYSTEM

Initialization

When the ignition switch is turned on, Voice Recognition is initialized. When completed, the system is ready to accept voice commands. If  on the steering-wheel is pushed before the initialization completes, the display will show a message to wait until the system has been ready.

BEFORE STARTING

To get the best recognition performance from Voice Recognition, observe the following items.

- The interior of the vehicle should be as quiet as possible. Close the windows to eliminate the surrounding noises (traffic noise, vibration sounds, etc.), which may prevent the system from correctly recognizing the voice commands.
- Wait until the tone sounds before speaking a command.

- Speak in a natural conversational voice without pausing between words.

GIVING VOICE COMMANDS

1. Push  located on the steering-wheel.

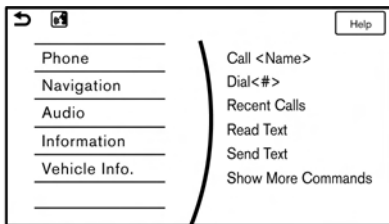





2. A list of commands appears on the screen, and the system provides the voice menu prompt.

When this screen is displayed, almost all of the commands can be recognized. Available commands for each categories can be shown on the right side of the screen. Highlight a category listed in the left side of the screen with the INFINITI controller or the steering-wheel switch to find your preferred command.



INFO:

Selecting a category by touching the screen or pushing  /**OK** will execute the command. After executing the category command, only the commands related to the selected category can be recognized.

 “Command list” (page 10-7)

3. After the tone sounds and the icon on the screen changes from  to , speak a command. You can also select a command by directly touching the screen or by tilting up or down and pushing  /**OK** on the steering-wheel.

INFO:

The Voice Recognition system will pause its operation when  /**OK** on the steering-wheel is tilted up or down or the INFINITI controller is moved. To resume the operation, push  on the steering-wheel

4. Continue to follow the voice menu prompts and speak after the tone sounds until the preferred operation is completed.

**INFO:**

To cancel a voice command, push and hold . Also touch the lower touch screen display (lower display) to cancel the voice command. You can interrupt the voice prompt at any time by pushing .

Operating tips

- Speak a command after the tone.
- If the command is not accepted, the system announces, “Please say again”. Repeat the command in a clear voice.
- Push on the steering-wheel switch once to return to the previous screen.
- Voice commands spoken from the passenger seat cannot be recognized.
- When the on the steering wheel is pressed while the air conditioner is set to the Auto mode, the system controls the air conditioner fan speed in order to improve voice recognition performance. When the fan speed is set higher than the 4th speed position, the fan speed is decreased to 4th speed. When the air conditioner is set to the manual mode, the fan speed does not change. The

accuracy of voice recognition may be affected depending on the fan speed and the air direction.

- To skip the voice guidance function and give the command immediately, push on the steering-wheel to interrupt the system. Remember to speak after the tone.
- To cancel the command, push and hold or on the steering-wheel.
- Push on the steering-wheel to stop the voice prompt and give the command at once. Remember to wait for the tone before speaking.
- To adjust the volume of the system feedback, push the on the steering-wheel or use the audio system while the system is making an announcement.
- For searching with Street Address, Point of Interest and City Center, the searching area is automatically set to the state where your vehicle is located. Use Change State/Province to change the search area to another state if necessary.
 “Changing region” (page 9-14)

How to see voice command screen

1. Push to display the first screen of the voice command list.
2. Speak a command or select an item from the voice command list. The Second screen is displayed.
3. Speak a command. The list screen is displayed.
4. Speak preferred number from the list to perform operation.

**INFO:**

- The voice commands can be spoken one at a time following prompts step by step or the command can be spoken successively in one step.

10. Voice recognition

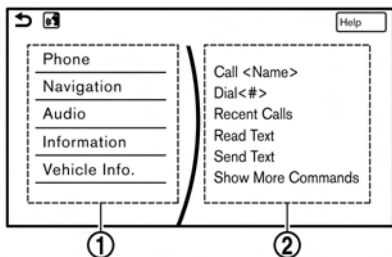

First screen

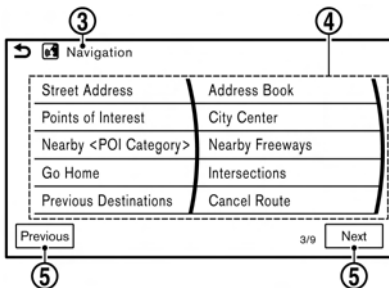

Second screen

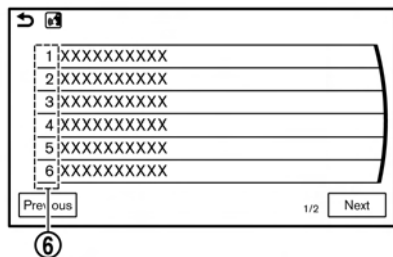

List screen

- ① Shows available command list. It is also available to select a command from this list by touching or using the INFINITI controller.
- ② Shows available command list. Displayed commands are only available to execute through voice recognition. You can say commands from the left screen and the right screen continuously.

- ③ Previously selected command.
- ④ Command list
You can say a command from the list, touch the screen directly or select, using steering switch or the INFINITI controller. You can say preferred word for < > enclosed part of the command.
- ⑤ [Previous]/[Next]
Say as a command or touch to go to the previous/next screen. It cannot be selected using the steering switch or INFINITI controller.

- ⑥ Speak 1 to 6 numbers to select. Also, you can touch the screen directly, using the steering switch or INFINITI controller.

How to speak numbers

Voice Recognition requires the user to speak numbers in a certain way when giving voice commands.

General rule:

Only single digits 0 (zero) to 9 can be used. (For example, if speaking 500, “five zero zero” can be used, but “five hundred” cannot.)

Examples:

1-800-662-6200

“One eight zero zero six six two six two zero zero”

INFO:

For the best recognition, speak “zero” for the number “0” and “oh” for the letter “o”.

Voice command examples

As examples, some additional basic operations that can be performed by voice commands are described here.

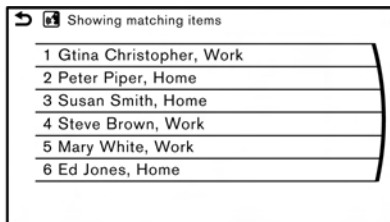
Example 1 Placing call from handsfree phonebook:

1. Push  located on the steering-wheel.

2. Wait for the indicator to change to . Speak “Phone”.

INFO:

- You can also speak “Phone” “Call <Name>” continuously. After “Dial” is spoken, no name listed in Phonebook can be recognized. Only telephone numbers can be recognized.

3. Speak “Call <Name>”.

When an option is set in the contact list of a cell phone, the option can be commanded directly. For example, “Call John Smith Work” or “Call John Smith Other”, etc.

INFO:

- Names in Phonebook can be recognized by speaking the person’s first and last name, or just their first name. When a name is spoken in the order of last name and then first name, or when only the last name is spoken, the name cannot be recognized.
- Even if words describing family relations, such as “Dad” or “Mom”, are registered in a cell phone, the system can only

recognize names. If you want the system to recognize words like “Dad” or “Mom”, register “Dad/Mom” in Favorites from [Phonebook/Favorites Settings] or register “Dad/Mom” as a name in a cell phone.

 “Phone settings” (page 5-9)



4. The system announces, “Please say or select an item number from the displayed list.” To select the displayed matching item, speak a number from 1 to 6.

INFO:

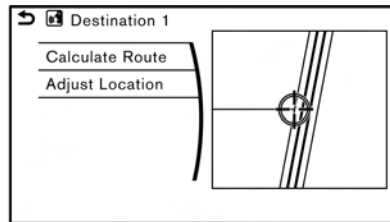
- If the selected number has more than one phone number registered to it, the phone number list screen is displayed.

Example 2 Setting destination by address:

10. Voice recognition

1. Push  located on the steering-wheel.
2. Wait for the indicator change to  .
Speak “Navigation”.
3. Speak “Street Address”.
4. Speak the full address.

For example : “123 Main Street”, followed by the city name.



INFO:

- You can also speak or select “Within a City” and “Change State”. When selecting “Within a City”, the search address will become more successful.
- State is set automatically to the state of the vehicle’s current location. To search for an address in another state, speak the “Change State”, and then speak the state to be recognized.
- Even when the state has been changed using voice recognition, it is reset the next time voice input is used. The state of the vehicle’s current location is automatically set.
- Letters of the alphabet cannot be included in house numbers. If there is no appropriate house number, a represen-

tative point is displayed.

5. The matching address will be displayed. Select from number 1 to 6 .
6. Speak “Calculate Route” to set the destination.

Example 3 Playing Radio:

1. Push  located on the steering-wheel.
2. Wait for the indicator change to  .
Speak “Audio”.
3. Speak “Play FM”. The radio turns on and plays the previously selected station.

INFO:

- You can also speak “FM <station number>” to turn the radio on and tune in a preferred radio station.
- Using “FM <frequency> HD <channel number>” allows you to specify the HD sub-channel directly.

Command list

To use the Voice Recognition function, you can speak commands in the order of 1st command, 2nd command and 3rd command. You can also operate the system by directly speaking the 2nd or 3rd command.

Variable numbers or words such as names can be applied in the < > when speaking a command.

Some navigation commands are only for English.

General Command

Command	Action
Show More Commands	Display other commands of the same category.
Go Back	Corrects the last recognition result to return to the previous screen.
Exit	Cancels Voice Recognition.
Help	Announces how to use voice guidance.
Next	Skip to the next page.
Previous	Skip to the previous page.

General phone command

The following commands can be used during a phone Voice Recognition session.

Command	Action
Change Number	Change a spoken phone number.
Dial	The system makes a call to the spoken phone number.

10. Voice recognition

Phone Command

1st Command	2nd Command	3rd Command	4th Command	Action	
Phone	Call <Name>	<1 - 6>		Makes a call to a contact that is stored in the mobile phone. Select from the list of displayed on the right side screen.	
	Call	<phonebook name>		Makes a call to a contact that is stored in the mobile phone.	
		<phonebook name> <type>		Makes a call to a contact that is stored in the mobile phone. You can select type from <Work>, <Mobile>, <Home> or <Other>.	
	Dial <#>	Dial		Makes a call to a spoken phone number.	
		Change Number		Change a spoken phone number.	
	Dial	<area code>		Makes a call to a spoken phone number. Speak "3 columns or 4 columns (1-***)".	
		<phone number static>		Makes a call to a spoken phone number. Speak "7 columns or 10 columns or 11 columns or 3 columns" ("911" or "411" or "611").	
	Recent Calls	<1 - 6>		Makes a call to the recent incoming, outgoing or missed call number.	
	Read Text	<1 - 6>	Play		You can listen to recent text messages received. Reads out a text message. Select from the list of current received message.
			Reply		Reply to a received message.
			Call		Call to the sender of the message.
	Send Text	<phonebook name>		You can select a text message from a list and send it a contact name. You can select the type from <Work>, <Mobile>, <Home> or <Other>.	
		<phonebook name> <type>			
	Phonebook	<phonebook name>		Makes a call to a contact that is stored in the mobile phone. You can select the type from <Work>, <Mobile>, <Home> or <Other>. Select [Reply] to reply by a message. Select [Call] to call the sender.	
<phonebook name> <type>					

1st Command	2nd Command	3rd Command	4th Command	Action
Phone	Favorites	<favorite name> <1 - 6>		Access frequently called contacts by storing into the favorite list.
		<favorite name> <Type>		
	Redial			Makes a call to the last outgoing phone number.
	International Call	<phone number>		Makes an international call by allowing more than 11 digits to be spoken. You may need to include the international call prefixes and country codes.
	Add Phone			Use this command to connect a compatible Bluetooth device to system. Follow the on-screen instructions to complete the pairing process from your handset.
	Call <Name> Home	<1 - 6>		“Call” followed by a contact name stored in your phonebook from the cellular phone and the location name “Home”.
	Call <Name> Mobile	<1 - 6>		“Call” followed by a contact name stored in your phonebook from the cellular phone and the location name “Mobile”.
	Call <Name> Work	<1 - 6>		“Call” followed by a contact name stored in your phonebook from the cellular phone and the location name “Work”.
Call <Name> Other	<1 - 6>		“Call” followed by a contact name stored in your phonebook from the cellular phone and the location name “Other”.	

**INFO:**

- The system can read out SMS text messages in voice. However, it cannot always read the text correctly.

10. Voice recognition

General navigation command

The following commands can be used during the Navigation voice recognition session.

Command	Action
Within a City	Search a destination from the specified city.
Change State	Change the state to search.
Calculate Route	Calculate a route.
Adjust Location	Fine-tune the destination.

Navigation Command

1st Command	2nd Command	3rd Command	Action
Navigation	Street Address	<House number>, <Street>, <City>	Used to search for a street address. Follow the prompts to enter the street address.
	Points of Interest	<POI name>	Used to search for the POI within a specified state or city. Follow the prompts to enter the place name.
	Nearby <POI Category>	<1 - 6>	Say “Nearby” followed by a POI category name such as Gas station, Restaurant or Parking. You can say any category name that appears when using manual controls. The system will always search for nearby matches regardless of the current state location.
	Nearby	Near Current Location	If a route is already set, you can search a destination from “Near Current Location”.
		Along Route	If a route is already set, you can search a destination from “Along Route”.
Near Destination		If a route is already set, you can search destination from “Near Destination”.	
Go Home			Sets a route to your home location.

1st Command	2nd Command	3rd Command	Action	
Navigation	Previous Destinations	<1 - 6>	Sets a route to a previously entered destination.	
	Address Book	<Stored location name> <1 - 6>	Sets a route to a location stored in the Stored Locations.	
	City Center	<City name>	Sets a route to a city center.	
	Nearby Freeways	<1 - 6>	Sets a route to a nearby entrance to a freeway.	
	Intersections	<city name>	Sets a route to an intersection.	
	Cancel Route			Delete a destination and way point.
	Recalculate Route	Fastest Route		Sets the route search condition to find the fastest time.
		Energy-Saving		Sets the route search condition to find the energy-saving route.
		Shortest Distance		Sets the route search condition to find the shortest distance.
	Traffic Detour			Sets the route search condition to detour traffic jam and traffic accident.
	Zoom In <1-13>			Increases the magnification of the map by the number of steps specified.
	Zoom Out <1-13>			Decreases the magnification of the map by the number of steps specified.
	Zoom Streets			Change to the street map.
	North Up			Sets the 2D full map to North Up.
	Heading Up			Sets the 2D full map to Heading Up.
2D Map			Change the current map to a 2D Heading Up map.	
3D Map			Change the current map to a 3D map.	

10. Voice recognition

1st Command	2nd Command	3rd Command	Action
Navigation	Repeat Instruction		Speaks the current navigation guidance.
	Voice Guidance OFF / Voice Guidance ON		Turns the navigation guidance on and off.
	Show POI Icons		Display the icon of <POI Category> in MAP.
	Remove POI Icons		Remove the icon of <POI Category> in MAP.



NOTE:

- When searching for an address, the state cannot be specified by voice commands. Speak an address within the state or change the state setting prior to starting the voice recognition session.



INFO:

- When the current car position is in Puerto Rico and Guam, the system does not recognize the general navigation commands.
- Searching by Points of Interest is limited to the area of the current state or the state set in Change State. The Points of Interest command is a function that recognizes the POI names registered in the navigation system.
- When the “Points of Interest” command is spoken in voice recognition, some POI cannot be used for “Points of Interest” search with voice command operations.

The following POI main categories do not support voice recognition operation:

Others, Repair, Rental Car Agency, Parking, Police Station, Administration, ATM, Other Leisure, Bars & Clubs, Other Dealers, Motorcycle Dealership, Medical Offices, Post Office, Auto Parts, Banquets & Food Delivery, Carwash, Copying, Day Care, Fire Station, Laundry & Cleaners, Office Supply, Other Services, Other Shopping, Package Delivery

For “Nearby” search, all registered categories can be recognized by the voice recognition system.

It may be possible to change some of the categories shown above.

Audio Command

1st Command	2nd Command	3rd Command	Action	
Audio	AM		Turns to the AM band, selecting the station last played.	
	FM <87.7-107.9>		Turns to the FM band, selecting the station of the preferred frequency.	
	FM		Turns to the FM band, selecting the station last played.	
	SXM <Channel #>		Turns to the SiriusXM Satellite Radio band, selecting the preferred channel.	
	SXM		Turns to the SiriusXM Satellite Radio band, selecting the channel last played.	
	USB Play Artist <Name>	<1-6>		Turns on the USB, selecting the artist.
	iPod Play Artist <Name>	<1-6>		Turns on the iPod®, selecting the artist.
	USB Play Artist	<Artist>		Turns on the USB, selecting the artist.
	iPod Play Artist	<Artist>		Turns on the iPod®, selecting the artist.
	USB			Turns on the USB, selecting the last played mode.
	iPod			Turns on the iPod®, selecting the last played mode.
	USB Play Album <Name>	<1 - 6>		Turns on the USB selecting the album.
	iPod Play Album <Name>	<1 - 6>		Turns on the iPod®, selecting the album.
	USB Play Album	<Album>		Turns on the USB, selecting the album.
	iPod Play Album	<Album>		Turns on the iPod®, selecting the album.
	AM <530-1710>			Turns to the AM band, selecting the preferred station.
	FM <87.7-107.9> HD <#>			Turns to the FM HD band, selecting the preferred station.
CD Track <#>			Turns on the CD, selecting the track number.	

10. Voice recognition

USB Play Song <Name> iPod Play Song <Name>	<1 - 6>	Turns on the USB or iPod®, selecting the track. You can speak the commands successively.
USB Play Song iPod Play Song	<Song>	Turns on the USB or iPod®, selecting the track. You can speak the commands successively
Play <Source Name>		Play the audio source which you said.
Play	AM	Turns to the AM band, selecting the station last played.
	FM	Turns to the FM band, selecting the station last played.
	SXM	Turns to the SiriusXM Satellite Radio band, selecting the channel last played.
	USB	Turns on the USB, selecting the last played mode.
	iPod	Turns on the iPod®, selecting the last played mode.
	CD	Turns on the CD, selecting the last played mode.
	Bluetooth Audio	Turns on the Bluetooth Audio, selecting the last played mode.
	AUX	Turns on the AUX audio, selecting the last played mode.
iPod Playlist <Name>	<1 - 6>	Turns on the iPod®, playing the playlist which you said.
iPod Play Playlist	<playlist>	Turns on the iPod®, playing the playlist which you said.
USB All Artists		Display the USB all artists list.
USB All Albums		Display the USB all albums list.
USB All Folders		Display the USB all folders list.
iPod All Artists		Display the iPod® all artists list.
iPod All Albums		Display the iPod® all albums list.
iPod All Songs		Display the iPod® all songs list.

Notes on operating audio by voice recognition:

- An audio device connected via Bluetooth cannot be operated with the Voice Recognition system. Source change is only available for Bluetooth® streaming Audio.
- If two USB devices are connected at the same time, voice operation will only be available for use with one registered and selected device. When selecting “YES” in the pop-up screen that displays after a new USB audio device is connected, the USB audio device is registered in the voice recognition system and is selected automatically. You can select the device for voice recognition after “No” on the pop-up screen is selected by restarting the engine with the device connected or remove the device and connect again. One iPod® and one USB device can be registered in the system. If a USB audio device is newly registered, old data is overwritten. It may take a few moments to register an audio device.
 “Voice recognition settings” (page 10-17) Even when a device has been previously registered, simply connecting the device will not result in it being selected automatically.
- The Artist, Album, Song and Play lists of audio stored in the connected USB device can be searched in voice. However, the maximum number of items that can be registered is limited. If there are a lot of audio items registered in the USB device, it may take some time for the system to prepare for audio search by voice.
- The Voice Recognition system may not function when the song information is too long (artist names, album titles, song titles and play lists, etc.).
- The SXM function will not operate without a subscription to SiriusXM Satellite Radio.

Information Command

1st Command	2nd Command	3rd Command	Action
Information	Voice Menu		Connect to the Infiniti InTouch™ Services Response Specialists.
	Where am I?		Displays the information of the current position.
	Fuel Prices		Displays the fuel prices.
	Weather Forecast		Display the weather forecast.
	Current Weather		Display the nearby weather (current weather).
	Sports Scores		Display the sports scores.

10. Voice recognition

	Traffic Information	Turns the traffic information system on or off.
	Route Information	Display the route information.

- The Fuel Prices, Weather Forecast, Current Weather, Sports Scores and Traffic Information will not operate without a subscription to Sirius XM Radio.

Vehicle Information Command

1st Command	2nd Command	Action
Vehicle Info.	Temperature <60-90 (°F)>/<18-32 (°C)>	Change the set temperature.
	Climate Control ON/OFF	Turns on/off the Climate Control system.
	Fuel Economy	Displays fuel economy information.
	Energy Flow (models with hybrid system)	Displays energy flow information.

VOICE RECOGNITION SETTINGS

The voice recognition functions can be set.

1. Push **◀MENU▶** and touch [Settings].
2. Touch [Voice Recognition].
3. Touch the item you would like to set.

Available settings

- [Minimum Voice Feedback]:
Sets the Minimise Voice Feedback function ON (short feedback) or OFF (long feedback).
- [Audio Device Settings]:
Select an audio device to be operated via the Voice Recognition system from the audio devices connected to the USB connectors. A device with an indicator light illuminated can be operated with the Voice Recognition system.

10. Voice recognition

MEMO

11 Troubleshooting guide

Customer assistance	11-2	Monitor system (if so equipped)	11-17
System unit.....	11-3	Navigation (if so equipped).....	11-18
Liquid crystal display	11-3	Basic operations.....	11-18
Audio system	11-5	Vehicle icon.....	11-19
HD Radio technology.....	11-5	Route calculation and visual guidance	11-21
Compact Disc (CD) player	11-7	Voice guidance	11-23
iPod® player	11-9	Traffic information	11-24
USB memory	11-11	Infiniti InTouch™ Services	11-25
Bluetooth® streaming audio.....	11-12	Voice recognition	11-26
Bluetooth® Hands-Free Phone System.....	11-14		



11. Troubleshooting guide

CUSTOMER ASSISTANCE

For assistance or inquiries about the INFINITI Navigation System, or to order updated map data, contact the INFINITI NAVIGATION SYSTEM HELPDESK. See the contact information on the inside front cover of this manual.

SYSTEM UNIT

LIQUID CRYSTAL DISPLAY

Symptom	Possible cause	Possible solution
The screen is too dark.	The cabin temperature is too low.	Wait until the cabin temperature becomes moderate.
	Screen brightness is set to the maximum darkness.	Adjust the brightness setting of the screen.  "Screen Settings" (page 2-17)
The screen is too bright.	Screen brightness is set to the maximum brightness.	Adjust the brightness setting of the screen.  "Screen Settings" (page 2-17)
A small black spot or a small bright spot appears on the screen.	This is a typical phenomenon for liquid crystal displays.	This is not a malfunction.
A dot or stripe pattern appears on the screen.	Electromagnetic waves that are generated from neon billboards, high voltage electric power cables, ham radios or other radio devices equipped to other vehicles may adversely affect the screen.	This is not a malfunction.
Image lag appears on the screen.	This is a typical phenomenon for liquid crystal displays.	This is not a malfunction.
Image motion displayed on the screen is slow.	The cabin temperature is less than 50°F (0°C).	Wait until the cabin temperature rises to within 50°F (0°C) and 122°F (50°C).
When looking at the screen from an angle, the screen lightens or darkens.	This is a typical phenomenon for liquid crystal displays.	Adjust the brightness setting of the screen.  "Screen Settings" (page 2-17)

11. Troubleshooting guide

Symptom	Possible cause	Possible solution
The screen turns blue or an error message is displayed on the upper display.	A system malfunction has occurred.	Contact an INFINITI retailer for an inspection.
	The SD card is not inserted into the slot correctly.	If the SD card containing map data is accidentally removed, after reinserting the SD card containing map data into the slot, place the ignition switch in the OFF position and then place back in the ON position again.

AUDIO SYSTEM

HD RADIO TECHNOLOGY

Sound

Symptom	Possible cause	Possible solution
Delay in digital audio on HD Radio broadcasts.	The radio acquires an analog station first and blends to an digital signal.	This is not a malfunction.
Audio skip, stutter or echo.	The radio station has not properly aligned the digital and analog audio.	Verify correct operation on another station. Report any station with poor performance.
Volume changing up/down.	The radio station has not properly aligned digital and analog audio level.	Verify correct operation on another station and check www.hdradio.com for stations in the area. Report any station with poor performance.
Sound fading in and out.	The transition between analog and digital is taking place (blending).	Verify transition performance on several stations in the area. Report any stations with poor alignment.
Excessive blending (Transition between analog and digital).	The receiver is located near the edge of the digital coverage area.	Refer to hdradio.com to verify radio stations in your coverage area.
Digital audio not better than analog audio.	Audio processing on the digital audio at a station can potentially decrease the digital audio sound quality.	Verify correct operation on another station. Report any station with poor performance.

11. Troubleshooting guide

Functional

Symptom	Possible cause	Possible solution
Keep losing my local stations.	The digital coverage is slightly less than the analog signal coverage.	Verify correct operation on another station. This is expected behavior.
	Shadowing (urban / terrain) can cause reduced digital coverage.	Verify correct operation on another station.
Some data fields are blank.	Text information is sent at the broadcaster's discretion.	Verify correct operation on another station. Report station issues.
Text information is truncated / appears to be more available.	The display is limited to a fixed number of characters and more data is being sent than can be shown.	This is intended behavior. Refer to the Owners Manual for ability to access addition.
AM reception changes at night	AM stations are required by the government (FCC) to lower their power at night.	This is not a malfunction.

COMPACT DISC (CD) PLAYER

Symptom	Possible cause	Possible solution
Music cannot be played back.	The disc is inserted upside down.	Insert a CD with the label side facing up.
	Moisture condensation occurs inside the unit.	Wait until the moisture evaporates (approximately 1 hour).
	The cabin temperature is too high.	Wait until the cabin temperature becomes moderate.
	The disc is scratched or dirty. A disc is not always playable if it is scratched.	Wipe off any dirt from the disc.
	Depending on the condition in which they are stored, discs may become unreadable due to deterioration (for example, keeping the discs in the passenger compartment, etc.).	Change the disc with a deterioration-free disc. Do not use a deteriorated disc. The label surface of the disc may crack or chip, and the layer of the label surface may eventually peel off.
The compressed audio files cannot be played back.	If both music CD files (CD-DA data) and compressed audio files (MP3 data, etc.) are mixed on one disc, the audio compression files cannot be played back.	Prepare a disc that includes compressed audio files only.
	The files are not named using characters that are compliant with the specifications.	Use the character codes and the number of characters that are compliant with the specifications for folder names and file names. In addition, always use “.MP3”, “.WMA”, “.mp3” or “.wma” for file extensions.
It takes a long time before the music starts playing.	The disc contains a large amount of data.	Some time may be required to check the files. It is recommended that unnecessary folders or any files other than compressed audio files should not be recorded in a disc.
The sound quality is poor.	The disc is dirty.	Wipe off any dirt from the disc.

11. Troubleshooting guide

Symptom	Possible cause	Possible solution
No sounds are played though the CD play time is displayed.	The system plays back the first track of the mix mode disc. (Mix mode is a format in which data except music is recorded on the first track and music data is recorded on one other than the first track in a session.)	Play back music data that are recorded on one other than the first track.
Music cuts off or skips.	The combination of writing software and hardware might not match; or the writing speed, writing depth, writing width, etc. might not match the specifications.	Create a disc using different writing speed settings, etc.
The system skips the selected track and moves to the next track.	A non-MP3/WMA file is given an extension of “.MP3”, “.WMA”, “.mp3” or “.wma”.	Prepare MP3/WMA files.
	The system plays back a file that is prohibited due to copyright protection.	Prepare playable files.
The tracks do not play back in the desired order.	The folder locations in the disc are changed by the writing software while the files are written in the disc.	Check the settings of the writing software, and create a new disc.

iPod® PLAYER

Symptom	Possible cause	Possible solution
The system does not recognize an iPod®.	A connector cable is not correctly connected, or the iPod® does not correctly operate.	Connect the connector cable again. If the system does not recognize the iPod® after performing this procedure above, reset the iPod®.
	The iPod® that is to be connected is not compatible with the system.	Check the iPod® model and firmware versions available for the system.
	A USB extension cable is not correctly connected.	Do not use a USB extension cable.
	The cable is rapidly connected to or disconnected from the USB connector.	Slowly connect or disconnect the USB cable.
An iPod® cannot be operated.	The iPod® is connected to the in-vehicle audio system while headsets, etc. are connected to the iPod®.	Remove all equipment from the iPod® after disconnecting the iPod® from the system, and then connect it to the system again.
	The iPod® is not operating normally.	Disconnect the iPod® from the in-vehicle audio system, and then connect it to the system again.
	The system plays back an album/track that includes a particular album art.	Disconnect the iPod® from the in-vehicle audio system, and then reset the iPod®. Disable the album art, and then connect the iPod® to the system.
An iPod® does not respond.	There are too many tracks in a category.	Decrease the number of tracks in a category (less than 3,000 tracks).
	The shuffle function is turned on.	Turn off the shuffle function if many tracks are stored on the iPod®.
Music cannot be played back.	A connector is not connected to the iPod®.	Firmly connect the connector until it clicks.
Playback cuts out.	The sound cuts due to vibration resulting from an unstable location of the iPod®.	Place the iPod® on a stable location where it does not roll over.
Distorted sound occurs.	The EQ (equalizer) function of the iPod® is turned on.	Turn off the EQ (equalizer) function.

11. Troubleshooting guide

Symptom	Possible cause	Possible solution
Battery charge of an iPod® takes longer.	Battery charge of the iPod® may take longer while an iPod® is playing back.	If the iPod® is requires charging, it is recommended to stop playback.
Battery charge of an iPod® is unavailable.	The cable that is connected to the iPod® may deteriorate (cable disconnection, etc.).	Check the cable currently in use.
Functions cannot be operated using an iPod® that is connected to the in-vehicle audio system.	-	The operation of an iPod® must be performed using the in-vehicle audio system after the iPod® is connected to the system.
Sound skips.	Surrounding circumstances (noise, etc.) may cause sound skip.	This does not indicate a malfunction.
	A USB extension cable is not correctly connected.	Do not use a USB extension cable.

USB MEMORY

Symptom	Possible cause	Possible solution
The system does not recognize a USB device.	A USB extension cable is used.	Do not use a USB extension cable.
	A USB hub is used.	Do not use a USB hub.
	A USB device is rapidly connected to or disconnected from the USB connector.	Slowly connect or disconnect the USB device.

11. Troubleshooting guide

BLUETOOTH® STREAMING AUDIO

Symptom	Possible cause	Possible solution
Registration cannot be performed.	The Bluetooth® audio device is not compatible with the in-vehicle audio system.	Check the Owner's Manual for the Bluetooth® audio device.
	The PIN code is incorrect.	Check the PIN code for the Bluetooth® audio device that is to be registered.
		Check that the PIN code for the Bluetooth® audio device is consistent with that for the in-vehicle audio system.
Another Bluetooth® device is used in the vehicle.	Turn off the other Bluetooth® device until the registration is completed.	
Music cannot be played back.	The Bluetooth® audio device is not compatible with the in-vehicle audio system.	Check the Owner's Manual for the Bluetooth® audio device.
	The system is not set to the Bluetooth® audio mode.	Push <AUDIO> to select the Bluetooth® audio mode.
	A Bluetooth® adapter is turned off.	Turn on a Bluetooth® adapter when it is used for a Bluetooth® audio device.
Playback stops.	The Bluetooth® audio device is not compatible with the in-vehicle audio system.	Visit www.infiniti.com/bluetooth/ to search for a recommended the Bluetooth® audio device.
	A cellular phone is connected.	This is not a malfunction.
	Sound may cut out when a Bluetooth® audio device is operated.	Push <AUDIO> to select the Bluetooth® audio mode, and then operate a function on the vehicle's display screen.

11. Troubleshooting guide

Symptom	Possible cause	Possible solution
Audio operation cannot be performed.	A Bluetooth® audio device that does not support audio operations is in use.	This is not a malfunction. Refer to the Owner's Manual of the Bluetooth® audio device.
	An error occurs when connecting to a Bluetooth® audio profile.	Turn the power source of the Bluetooth® audio player off and on, and then resume connection with the system.

11. Troubleshooting guide

BLUETOOTH® HANDS-FREE PHONE SYSTEM

Symptom	Possible cause	Possible solution
A cellular phone cannot be registered.	The cellular phone is not compatible with the in-vehicle hands-free phone system.	Use a cellular phone compatible with the system. Visit the website (www.infiniti.com/bluetooth) for model compatibility.
	Registration of the cellular phone has been performed incorrectly.	Check the registration procedure, and then register the cellular phone again.
A cellular phone cannot be connected or is disconnected after the registration is completed.	The Bluetooth® setting of the in-vehicle hands-free phone system is turned off.	Turn on the Bluetooth® setting of the system.
	The Bluetooth® setting of the cellular phone is turned off.	Turn on the Bluetooth® setting of the cellular phone.
	The remaining battery level of the cellular phone is low.	Charge the battery of the cellular phone.
	The wireless Bluetooth® connection may be disrupted depending on the location of the cellular phone.	Do not place the cellular phone in an area surrounded by metal or far away from the in-vehicle hands-free phone system. Do not place the cellular phone close to the seats or your body.
	Registration of the cellular phone is not completed.	Perform registration of the cellular phone.
A call to a particular phone number fails.	If the system tries to make a call several times to the same phone number (for example: the party does not respond to the call, the party is out of the service area, or the call is abandoned before the party responds), the system may reject a request to make a call to the phone number.	Turn off the cellular phone and turn it on again to reset the connection.

11. Troubleshooting guide

Symptom	Possible cause	Possible solution
The system does not recognize the connection of a cellular phone. The system does not receive or make a call.	The cellular phone is not compatible with the in-vehicle hands-free phone system.	Use a cellular phone compatible with the system. Visit the website (www.infiniti-usa.com/bluetooth) for model compatibility.
	The cellular phone is not connected.	Check the registration procedure, and then register the cellular phone again.
	The phone operation is limited by the functions (such as dial lock, etc.) of the registered cellular phone.	Remove any settings that are limiting use of the cellular phone, and then perform registration again.
The other party cannot hear your voice. The other party can hear your voice, but it cracks or cuts out.	The cellular phone is not connected.	Check the registration procedure, and then register the cellular phone again.
	The fan speed of the air conditioner is too fast.	Decrease the fan speed of the air conditioner.
	The ambient noise level is excessive. (For example: heavy rain, construction sites, inside a tunnel, oncoming vehicles, etc.)	Close the windows to shut out ambient noise.
	The noise generated by driving the vehicle is too loud.	Reduce the vehicle speed, and then speak a command.
	The incoming or outgoing voice level is too loud.	Adjust the incoming or outgoing voice level properly.
The voice is cut out or noise is heard during a call.	The wireless Bluetooth® connection may be disrupted depending on the location of the cellular phone.	Do not place the cellular phone in an area surrounded by metal or far away from the in-vehicle hands-free phone system. Do not place a cellular phone close to the seats or your body.
When a cellular phone is operated to make a call, the hands-free function becomes unavailable.	Some models of a cellular phone do not switch to the hands-free mode when they are operated to make a call.	This is not a malfunction. Make a call again using the hands-free function.
The other party's voice cannot be heard. There is no ring tone.	The volume level is set to the minimum.	Adjust the volume level.
	A cellular phone is not connected.	Check the registration procedure, and then register the cellular phone again.

11. Troubleshooting guide

Symptom	Possible cause	Possible solution
Each volume level (ring tone, incoming voice or outgoing voice) is different.	Each volume level is not adjusted properly.	Adjust each volume level properly.
The antenna display is different between the navigation screen and a cellular phone screen. Making or receiving a call is unavailable even though the antenna display shows that it is possible to do so.	The antenna display varies depending on the model of cellular phone.	This does not indicate a malfunction. The antenna display and remaining battery level shown on the navigation screen may be different from those shown on the cellular phone screen. Use them as a reference.
A voice cannot be heard clearly when using a cellular phone behind tall buildings.	Some structures such as tall buildings, etc. may cause irregular reflection of radio waves or completely shut out radio waves that are used for cellular phones.	This is not a malfunction.
Noise is heard when using a cellular phone under/near areas of elevated railroads, high voltage electric power cables, traffic signals, neon billboards, etc.	Electromagnetic waves that are generated from radio devices may adversely affect the cellular phone.	This is not a malfunction.
Noise is heard in the sound from the audio system while using a cellular phone.	Radio waves that are generated from a cellular phone may adversely affect the sound from the audio system.	This is not a malfunction.
Sound skip.	The cellular phone may have turned on wireless LAN (Wi-Fi).	Turn off the wireless LAN (Wi-Fi).
Phonebook cannot be downloaded.	An error occurred during the phone pairing process.	Please delete the Bluetooth pairing information from both the mobile phone and vehicle system before registering it again.

MONITOR SYSTEM (if so equipped)

Symptom	Possible cause	Possible solution
The image on the display is not clear.	The front glass of the camera lens is dirty.	Gently wipe off the dirt with a damp soft cloth.
	Moisture drops such as rain or snow form on the camera lens.	Gently wipe off the drops with a soft cloth.
	Light such as sunlight or a headlight beam from another vehicle directly enters the camera.	This is not a malfunction. It will return normal when the light disappears.
	Moisture condensation occurs in the camera lens due to rapid temperature change.	This is not a malfunction. It will return normal after driving for a short period of time.
	Objects on the display may not be clear in a dark place or at night.	Adjust the brightness or the contrast settings of the screen.
The image on the display flickers.	The vehicle is under fluorescent light.	This is not a malfunction.
The colors of the object on the display look different from those of the actual object.	This is a typical phenomenon for cameras.	This is not a malfunction.
Image does not appear on the display.	The shift lever is not shifted to the "R" position.	Shift the shift lever to the "R" position.
	[Automatic Display with Sonar] is OFF.	Set [Automatic Display with Sonar] to ON
The image appears on the display from the wrong angle.	The trunk is opens.	Close the rear hatch.
The image on the display is not clearly visible.	Strong light or reflected light enters the camera.	This is not a malfunction.
The sensor is not detective	There is ice or snow on the sensor.	Flush out ice and snow with warm water.
	There is dirt, mud or wax on the sensor.	Gently wipe off the dirt with a damp soft cloth.
Vertical lines appear on the image.	Strong reflected light from the bumper enters the camera.	This is not a malfunction.



11. Troubleshooting guide

NAVIGATION (if so equipped)

BASIC OPERATIONS

Symptom	Possible cause	Possible solution
No image is displayed.	The brightness is at the lowest setting.	Adjust the brightness of the display.  “Screen Settings” (page 2-17)
	The display is turned off.	Push the and hold <MENU> to turn on the display.
No voice guidance is available. or The volume is too high or too low.	The volume is not set correctly, or it is turned off.	Adjust the volume of voice guidance.
	Voice guidance is not provided for certain streets (roads displayed in gray).	This is not a malfunction.
No map is displayed on the screen.	A screen other than a map screen is displayed.	Push <MAP/VOICE> .
The screen is too dim. The movement is slow.	The temperature in the interior of the vehicle is low.	Wait until the interior of the vehicle has warmed up.
Some pixels in the display are darker or brighter than others.	This condition is an inherent characteristic of liquid crystal displays.	This is not a malfunction.
Some menu items cannot be selected.	Some menu items become unavailable while the vehicle is driven.	Park the vehicle in a safe location, and then operate the navigation system.

VEHICLE ICON

Symptom	Possible cause	Possible solution
Names of roads and locations differ between Plan View and Birdview™.	This is because the quantity of the displayed information is reduced so that the screen does not become too cluttered. There is also a chance that names of the roads or locations may be displayed multiple times, and the names appearing on the screen may be different because of a processing procedure.	This is not a malfunction.
The vehicle icon is not displayed in the correct position.	The vehicle was transported after the ignition switch was pushed off, for example, by a ferry or car transporter.	Drive the vehicle for a period of time on a road where GPS signals can be received.
	The position and direction of the vehicle icon may be incorrect depending on the driving environments and the levels of positioning accuracy of the navigation system.	This is not a malfunction. Drive the vehicle for a period of time to automatically correct the position and direction of the vehicle icon.  "Current vehicle location" (page 9-59)
When the vehicle is traveling on a new road, the vehicle icon is located on another road nearby.	Because the new road is not stored in the map data, the system automatically places the vehicle icon on the nearest road available.	Updated road information will be included in the next version of the map data.
The screen does not switch to the night screen even after turning on the headlights.	The daytime screen was set the last time the headlights were turned on.	Set the screen to the night screen mode using  when turning on the headlights.  "Screen Settings" (page 2-17)
The map does not scroll even when the vehicle is moving.	The current location map screen is not displayed.	Push <MAP/VOICE> .
The vehicle icon is not displayed.	The current location map screen is not displayed.	Push <MAP/VOICE> .

11. Troubleshooting guide

Symptom	Possible cause	Possible solution
The location of the vehicle icon is misaligned from the actual position.	When using tire chains or replacing the tires, speed calculations based on the speed sensor may be incorrect.	Drive the vehicle for a period of time (at approximately 19 MPH (30 km/h) for about 30 minutes) to automatically correct the vehicle icon position. If this does not correct the vehicle icon position, contact an INFINITI retailer.
	The map data has a mistake or is incomplete (the vehicle icon position is always misaligned in the same area).	Updated road information will be included in the next version of the map data.

ROUTE CALCULATION AND VISUAL GUIDANCE

Symptom	Possible cause	Possible solution
Waypoints are not included in the auto reroute calculation.	Waypoints that have been already passed are not included in the auto reroute calculation.	To go to that waypoint again, edit the route.
Route information is not displayed.	Route calculation has not yet been performed.	Set the destination and perform route calculation.
	The vehicle is not on the suggested route.	Drive on the suggested route.
	Route guidance is set to OFF.	Turn on route guidance.
	Route information is not provided for certain types of roads (roads displayed in dark green).	This is not a malfunction.
The auto reroute calculation (or detour calculation) suggests the same route as the one previously suggested.	Route calculations took priority conditions into consideration, but the same route was calculated.	This is not a malfunction.
A waypoint cannot be added.	Five waypoints are already set on the route, including ones that the vehicle has already passed.	A maximum of 5 waypoints can be set on the route. To go to 6 or more waypoints, perform route calculations multiple times as necessary.
The suggested route is not displayed.	Roads near the destination cannot be calculated.	Reset the destination to a main or ordinary road, and recalculate the route.
	The starting point and destination are too close.	Set a more distant destination.
	The starting point and destination are too far away.	Divide the trip by selecting one or two intermediate destinations, and perform route calculations multiple times.
	There are time restricted roads (by the day of the week, by time) near the current vehicle location or destination.	Set [Use Time Restricted Roads] to OFF.  "Route Settings" (page 9-41)
A part of the route is not displayed.	The suggested route includes narrow streets (roads displayed in gray).	This is not a malfunction.

11. Troubleshooting guide



Symptom	Possible cause	Possible solution
The part of the route that the vehicle has already passed is deleted.	A route is managed by sections between waypoints. If the vehicle passed the first waypoint, the section between the starting point and the waypoint is deleted (it may not be deleted depending on the area).	This is not a malfunction.
An indirect route is suggested.	If there are restrictions (such as one-way streets) on roads close to the starting point or destination, the system may suggest an indirect route.	Adjust the location of the starting point or destination.
	The system may suggest an indirect route because route calculation does not take into consideration some areas such as narrow streets (gray roads).	Reset the destination to a main or ordinary road, and recalculate the route.
The landmark information does not correspond to the actual information.	This may be caused by insufficient or incorrect map data.	Updated information will be included in the next version of the map data.
The suggested route does not exactly connect to the starting point, waypoints or destination.	There is no data for route calculation closer to these locations.	Set the starting point, waypoints and destination on a main road, and perform route calculation.

VOICE GUIDANCE

Symptom	Possible cause	Possible solution
Voice guidance is not available.	Voice guidance is only available at certain intersections marked with  . In some cases, voice guidance is not available even when the vehicle makes a turn.	This is not a malfunction.
	The vehicle has deviated from the suggested route.	Go back to the suggested route or request route calculation again.
	Voice guidance is set to OFF.	Turn on voice guidance.
	Route guidance is set to OFF.	Turn on route guidance.
The guidance content does not correspond to the actual road conditions.	The content of voice guidance may vary, depending on the types of intersections at which turns are made.	Follow all traffic rules and regulations.

11. Troubleshooting guide

TRAFFIC INFORMATION

Symptom	Possible cause	Possible solution
Traffic information is not displayed.	Traffic information is not set to ON.	Set the traffic information to ON.
	The vehicle is in an area where traffic information is not available.	Scroll to an area where traffic information is available.
	The subscription to SiriusXM Traffic is incomplete, or the subscription to SiriusXM Traffic has expired.	Check the subscription status of SiriusXM Traffic.
	The map scale is set at a level where the display of icons is impossible.	Check that the map scale is set at a level in which the display of icons is possible.  "Traffic information on map" (page 9-47)
With the automatic detour route search ON, no detour route is set to avoid congested areas.	There is no faster route compared to the current route, based on the road network and traffic information.	The automatic detour search is not intended for avoiding traffic jams. It searches for the fastest route taking into consideration conditions as traffic jams. Follow the current route. Also see "NOTES ON TRAFFIC INFORMATION" for further information.  "Notes on SiriusXM Traffic information" (page 8-9)
The route does not avoid a road section with traffic information stating that it is closed due to road construction.	The navigation system is designed not to avoid this event because the actual period of closure may differ from the declared roadwork period.	Observe the actual road conditions and follow the instructions on the road for a detour when necessary. If the road is closed, use the detour function and set the detour distance to avoid the road section that is closed.

INFINITI INTOUCH™ SERVICES





Symptom	Possible cause	Possible solution
The system cannot connect to the Infiniti InTouch™ Services Data Center.	A subscription for the Infiniti InTouch™ Services has not been established.	Sign up for a subscription to the Infiniti InTouch™ Services. For details about subscriptions, contact the Infiniti InTouch™ Services support line at 1-800-334-7858 (for U.S.) /1-855-892-7418 (for Canada).
	The communication line is busy.	Try again after a short period of time.
	The vehicle is in a location where it is difficult to receive radio waves.	When the vehicle moves to an area where radio waves can be transmitted sufficiently, communication will be restored. When the icon on the display shows that the vehicle is inside the communication area, the system can be used.
	TCU (Telematics Control Unit) is not turned on.	If the icon does not show that the vehicle is inside the communication area despite the fact that the vehicle is in that location, contact the Infiniti InTouch™ Services support line at 1-800-334-7858 (for U.S.) /1-855-892-7418 (for Canada).
	Radio wave reception is not sufficient for TCU operation.	When the vehicle moves to an area where radio waves can be transmitted sufficiently, communication will be restored. When the icon on the display shows that the vehicle is inside the communication area, the system can be used.
Some of the items that are displayed on the menu screen cannot be selected.	The vehicle is being driven and some menu items are disabled.	The vehicle is being driven. Stop the vehicle in a safe location and apply the parking brake before operating the functions.
Some parts of the screen are not displayed.	The vehicle is being driven and some menu items are disabled.	Operate the system after stopping the vehicle in a safe location and applying the parking brake.
The system does not announce information.	The volume level is set to the minimum.	Adjust the volume level by operating the VOLUME control knob located on the control panel or on the steering-wheel switch while the system is announcing information.

11. Troubleshooting guide

VOICE RECOGNITION

Symptom	Possible cause	Possible solution
The system does not operate or fails to interpret the command correctly.	The interior of the vehicle is too noisy.	Close the windows or have the other occupants be quiet.
	The fan speed of the air conditioner is too fast.	Decrease the fan speed of the air conditioner.
	The noise generated by driving the vehicle is too loud.	Reduce the vehicle speed, and then speak the command.
	The voice command is spoken in a low voice.	Speak the command in a louder voice.
	The timing of speaking a command is too fast.	Speak the command after confirming the following: a voice guidance is announced, a tone sounds, and an icon on the screen changes from white to orange.
	The command is spoken too slowly.	Speak in a natural voice without pausing between words.
The system prompt to say command again.	Pronunciation is unclear.	Speak clearly.
	The command is spoken too late after the tone.	Speak the command within 5 seconds after confirming the following: a voice guidance is announced, a tone sounds, and an icon on the screen changes from white to orange.
	An improper command is spoken.	Speak the command or a number that is displayed in white on the screen.
Speak a command that is shown in the command list.		
The system does not correctly recognize a number spoken.	Many numbers are spoken at once.	Place a pause between the appropriate digits for correct recognition by the system. When speaking a telephone number, place a pause between area codes, dial codes, etc.

11. Troubleshooting guide

Symptom	Possible cause	Possible solution
Voice recognition does not operate, and a tone sounds twice after pushing the  .	The  button is pushed immediately after starting the engine or the hybrid system.	Push the  again after a short period of time.
USB memory device cannot operate with voice recognition.	Depending on the device, iPhone® or iPod® may be recognized as a USB memory device.	This is not malfunction
	More than one audio device is connected to USB port.	Only one audio device can be operated with the voice recognition system even when multiple numbers of devices are connected. Select an audio source to operate with the voice recognition system.
The USB/iPod® operation screen is grayed out.	The audio device is not connected.	Connect an audio device to the system.
	An audio source to be operated with the voice recognition system has not been selected.	Select an audio source to be operated with the voice recognition system.
An error message is displayed when trying to select a track and operate USB/iPod®.	The track information is being processed for registration by the system.	Song information will be loaded into the system when a new audio device is registered for the first time or when the song information in the pre-registered device has been changed. Please wait for the loading to complete which may take a few minutes to up to an hour.
	Exceeding number of songs are stored in the connected audio device than it can hold.	Decrease the number of songs stored in the audio device.
	No song is stored in the audio device.	Store songs in the connected audio device. Storing songs with information such as artist name, album name, song name, playlist, etc., will make voice recognition song search available.
The Navigation item is not displayed in the voice operation menu screen.	Voice Recognition command preparation for the navigation system is not completed immediately after the system is started.	Display any screen other than the Voice Recognition screen, and then push  .

11. Troubleshooting guide

Symptom	Possible cause	Possible solution
The system does not correctly recognize a Point of Interest (POI) name spoken.	There are some rare cases where a POI is unavailable by Voice Recognition but the location can be found on the map.	This is not a malfunction. Consider using an alternate search method, like street address.
	Partial or Alias name is spoken.	For best results, speak the full name.
	Some POI category name can only search from Nearby.	This is not malfunction.

MEMO

11. Troubleshooting guide

MEMO

A

- About route guidance..... 9-29
- Adjusting volume and settings 2-10
- Advanced Climate Control system 3-7
- Air conditioner
- In-cabin microfilter..... 3-8
- Air filter
- In-cabin microfilter..... 3-8
- App Garage screen..... 6-3
- App Garage Settings screen 6-4
- Around View Monitor (AVM) 7-6
- Audio operation precautions 4-2
- Audio operations 4-12
- Audio Source bar setting..... 4-13
- Audio system
- Steering-wheel audio controls..... 4-12
- Automatic
- Automatic climate control system..... 3-6
- Auxiliary (AUX) devices..... 4-31

B

- Bluetooth® Hands-Free Phone System..... 5-2
- Bluetooth® information..... 5-13
- Bluetooth® streaming audio..... 4-10, 4-27
- Building graphics..... 9-6

C

- Cabin air filter..... 3-8
- Canceling Route 9-34
- CD/USB memory device care and cleaning..... 4-34
- Changing map view..... 9-9
- Changing order of destination and waypoints 9-37
- Changing region 9-14
- Changing scale of map..... 9-8
- Clock settings 2-21
- Command list..... 10-7
- Compact Disc (CD) player 4-4, 4-19
- Compressed Audio Files (MP3/WMA/AAC)..... 4-7
- Connecting Bluetooth® audio device 2-22
- Connecting Bluetooth® device..... 2-22
- Connecting Bluetooth Hands-free Phone ... 5-3
- Connecting cellular phone..... 2-22
- Connecting to Interactive Voice Menu..... 8-16
- Control buttons and functions..... 2-2
- Current vehicle location 9-59
- Customer assistance 11-2

D

- Defroster switch
- Rear window and outside mirror defroster switch..... 3-11
- Deleting stored item 9-53
- Destination screen..... 9-15
- Display Settings..... 2-17
- Display urgent traffic information..... 9-46
- Display View Bar..... 2-11
- Displaying current vehicle location..... 9-7
- Download application 6-3
- Driver Assistance settings 8-32
- Dual Display 2-2
- During a call 5-5

E

- Editing route 9-35
- Editing stored information..... 9-50
- Editing user settings 8-30
- Emergency support 8-21
- Examples of how Vehicle Apps is used..... 6-7

F

- Favorites 5-12

Index

- Finding address 9-18
Finding nearby place..... 9-22
Finding points of interest 9-19
Fully customizable digital environment.... 8-29
Functions disabled while driving 2-16
- G**
Giving voice commands 10-2
Guidance screen settings 9-34
- H**
Hands-free text messaging assistant..... 5-6
Heated seats..... 3-9
Heated steering-wheel 3-10
How to handle display 2-3
How to handle the Map SD card..... 9-66
How to handle the SD card 9-70
How to see voice command screen..... 10-3
- I**
In-cabin microfilter..... 3-8
INFINITI voice recognition 10-2
INFINITI controller 2-5
Infiniti InTouch™ Services..... 8-10
Infiniti InTouch™ Services application..... 8-15
Infiniti InTouch™ Services feature 8-11
Infiniti InTouch™ Services settings..... 8-18
Infiniti InTuition 8-31
Information feeds..... 8-17
Information screen 8-2
iPod® player 4-24
Items to be set initially 2-17
- L**
Laser product..... 1-4
Linking Smartphone..... 6-8
Log-in screen 2-7
Lower display and menu buttons 2-14
Lower touch screen display (lower display) 2-14
- M**
Making a call 5-4
Map data 9-66
Map data authentication 9-3
Map operation 9-4
Map types..... 9-4
Map view settings..... 9-10
Media Hub 2-6
Menu screen (models with navigation system)..... 2-15
Menu screen (models without navigation system)..... 2-15
Menu screen and operation method..... 2-9
Mobile Apps 6-8
Monitor, RearView Monitor..... 7-2
Moving map..... 9-7
My Schedule 8-17
- N**
Navigation settings 9-56
Notes on SiriusXM Traffic information 8-9
- P**
Phone 5-3
Phone selection 5-3
Phone settings..... 5-9
Phonebook 5-12
Procedures after setting route 9-27
- R**
Radio 4-2, 4-14
Rear window and outside mirror defroster switch 3-11

- RearView Monitor..... 7-2
 - ReaView Monitor settings..... 7-4
 - Recalculating route 9-38
 - Receiving a call..... 5-4
 - Route calculation 9-63
 - Route guidance..... 9-29, 9-64
 - Route guidance settings..... 9-39
 - Route menu screen 9-35
- S**
- Safety information 1-3, 9-3
 - Screen Settings 2-17
 - Scrolling message or list..... 2-9
 - Searching for detour route using traffic information 9-38
 - Searching from history..... 9-23
 - Searching from Stored Locations..... 9-24
 - Selecting item..... 2-10
 - Servicing heater and air conditioner..... 3-9
 - Setting at information on map 9-13
 - Setting by Infiniti InTouch™ Services 9-25
 - Setting by phone number..... 9-24
 - Setting city center..... 9-23
 - Setting detour route..... 9-39
 - Setting freeway entrance/exit 9-23
 - Setting from stored routes 9-25
 - Setting home as destination 9-21
 - Setting intersection..... 9-21
 - Setting point on map 9-27
 - Settings screen..... 8-23
 - Shortcut menu (models with navigation system)..... 2-11
 - SiriusXM Travel Link..... 8-4
 - split screen..... 9-10
 - Start-up screen 2-7
 - Steering
 - Steering-wheel-mounted controls for audio 4-12
 - Steering-wheel switches 2-5
 - Storing a location/route..... 9-48
 - Storing avoid area 9-50
 - Storing home location..... 9-48
 - Storing location 9-48
 - Storing route 9-49
 - Subscription to Infiniti InTouch™ Services..... 8-10
 - Switch
 - Rear window and outside mirror defroster switch..... 3-11
- T**
- Text message settings..... 5-9
 - Touch panel 2-8
 - Trademarks..... 1-4
 - Traffic information on map 9-47
 - Traffic information settings 9-46
 - Transferring information to/from address book..... 9-55
- U**
- Updating All Information Feeds 8-18
 - Upper display 2-11
 - Upper touch screen display (upper display) 2-11
 - USB (Universal Serial Bus) connection port 4-5, 4-21
 - USB/iPod® interface and Auxiliary input jack 2-6
 - User edit screen..... 8-30
 - User registration 8-29
 - User selection..... 2-7
 - Using applications 6-3
 - Using Destination Send to Car 9-27
 - Using Google send-to-car 9-26
 - Using Journey Planner..... 9-22

V

Vehicle Apps	6-3
Vehicle Apps Manager.....	6-5
Viewing available traffic information	9-44
Viewing information feeds history	8-18
Viewing SiriusXM Travel Link®	8-4
Voice recognition (Troubleshooting)	11-26
Voice recognition settings	10-17
Volume settings	2-19

