



**HarmonicGuard® Series Drive-Applied Harmonic
Filter Installation, Operation, and Maintenance
Manual**

Including information for:

PQconnect



TCI, LLC
W132 N10611 Grant Drive
Germantown, Wisconsin 53022

Phone: 414-357-4480
Fax: 414-357-4484
Helpline: 800-824-8282
Web Site: www.transcoil.com
© 2019 TCI, LLC All rights reserved

Product No: 28557-1 Effective: 04/06/21 Version: P

No part of this publication may be reproduced, stored in a retrieval system, or transmitted in any form or by any means, mechanical, electronic, photocopying, recording, or otherwise, without the prior written permission of TCI, LLC. The information in this manual is subject to change without notice. Every precaution has been taken in the preparation of this manual. TCI, LLC assumes no responsibility for errors or omissions. Neither is any liability assumed for damages resulting from the use of the information contained in this publication.

Revision	Description	Date
A	Release	10/16/13
B	Added Fuse Monitor Option	02/03/14
C	Added Heater & Vibration Pad Options	09/10/14
D	Added 600V Option Changed P/N to 28557-1	11/24/14
E	Updated Part Numbering System Added Floor Stand Option	01/04/16
F	Updated 480V Watts Loss Updated tables	03/28/17
G	Updated 600V and 400V Fuse Recommendation Table	06/19/17
H	Updated 480V and 600V Watt Loss Updated Part Numbering System Update Fuse Tables	01/31/18
I	Added PQconnect information Modbus Register Maps PQconnect Hardware/Software Troubleshooting the board	11/01/18
J	Edits to PQconnect Hardware/Software Edits to PQconnect parameters tables	1/23/19
K	Reformat of Manual and addition of 50Hz option	7/11/19
L	Addition of Bluetooth PQconnect App	10/23/19
M	Updates to PQconnect section	01/06/20
N	Updates to PQconnect Section Updates to part numbering	07/29/20
O	Updates to PQconnect Parameter tables	01/27/21
P	Updates to Installation Checklist and Over- Temperature Switch, minor updates to PQconnect section	04/06/21

Performance Guarantee

Select and install the appropriate HarmonicGuard® Passive Harmonic Filter in a variable torque, variable frequency AC drive application, within our published technical specifications and we guarantee that the input current distortion will be less than or equal to 5% THID for standard HGP Series filters at full load, and less than 8% at 30% load. If a properly sized and installed filter fails to meet its specified THID level, TCI will provide material for necessary modifications or replacement filter at no charge.

HG filters can also provide similar performance in other drive applications such as constant torque, DC drives and other phase-controlled rectifiers, but actual THID levels can vary by load and/or speed and therefore cannot be guaranteed. Consult factory for assistance when applying HGP filters on these types of equipment.

MINIMUM SYSTEM REQUIREMENTS:

The guaranteed performance levels of this filter will be achieved when the following system conditions are met:

Frequency: 50 Hz / 60Hz \pm 0.75Hz

System Voltage: Nominal System Voltage (line to line) \pm 10%

Balanced Line Voltage: Within 0.5%

Background Voltage Distortion: < 0.5% THVD

The input VFD current waveform shall be consistent with that of a VFD with 3% AC line reactance at full load.

NOTE: The presence of background voltage distortion will cause motors & other linear loads to draw harmonic currents.

Additional harmonic currents may flow into the HGP filter if there is harmonic voltage distortion already on the system.

If higher levels of harmonic voltage distortion (2%-5%) are present, please use the high background distortion version of the HGP filter.

***For PQconnect:** To run PQvision software, minimum system requirements are Windows 7 and 1280x720 resolution.

Table of Contents

1.0	Safety	1
	Safety Instructions Overview.....	1
	Warnings and Cautions	1
	General Safety Instructions.....	2
2.0	General Information	3
	Intended Audience.....	3
	Receiving Inspection.....	3
	Storage Instructions.....	3
	TCI Limited Warranty Policy.....	3
3.0	Pre-Installation Planning	5
	Verify the Application	5
	HGP Drive-Applied Filter.....	5
	Nameplate Data	5
	Part Numbering System.....	6
	HGP Filter Overview.....	7
4.0	Installation Guidelines	11
	Installation Checklist.....	11
	Select a Suitable Location	11
	Mounting	12
	Power Wiring.....	12
	HGP Filter Operation	12
	SCCR Fusing Requirements.....	13
5.0	PQconnect Connectivity	20
	HGP Drive-Applied Filter with PQconnect	20
	PQvision PC application Screen Elements.....	20
	Example Application Using “Simply Modbus Master 8.1.0”	27
	USPTL4 RS485 Converter Dip Switch settings	27
	Example Setup Instructions to Read Data from the PQconnect Unit:.....	27
	Example Setup Instructions to Write Data to the PQconnect Unit:	28
	PQconnect Quick Start Unit Software Setup	30
	PQconnect Bluetooth® App Setup	30
	PCB Connections	32
	Modbus RTU.....	34
	Wiring and Configuration	34
	PQvision Display Connections	35
	Register Map.....	37
6.0	PQconnect Troubleshooting	55
	HarmonicGuard® Passive Filter Status Warning	55
	Receiving Inspection.....	55
	Connectivity Board Problem.....	55
	Communication Problems.....	57
	Debug Status Conditions	58
	Contactors Problem.....	59
7.0	Maintenance and Service	62
	HGP Filter Reliability and Service Life.....	62
	Periodic Maintenance	62
	Troubleshooting.....	62
	Warning.....	62
	Replacement Parts	62
	Factory Contacts and Tech Support.....	62

1.0 Safety

Safety Instructions Overview

This section provides the safety instructions which must be followed when installing, operating, and servicing the HarmonicGuard® Passive (HGP) filter. If neglected, physical injury or death may follow, or damage may occur to the filter or equipment connected to the HGP filter. The material in this chapter must be read and understood before attempting any work on or with the product.

The HGP filter is intended to be connected to the input terminals of one or more VFDs. Three-phase power is connected to the input terminals of the HGP and power is supplied to the VFD or VFDs through the HGP. The instructions, and particularly the safety instructions for the VFDs, motors, and any other related equipment must be read, understood, and followed when working on any of the equipment.



Warnings and Cautions

This manual provides two types of safety instructions. Warnings are used to call attention to instructions that describe steps that must be taken to avoid conditions that can lead to a serious fault condition, physical injury, or death.

Cautions are used to call attention to instructions that describe steps that must be taken to avoid conditions that can lead to a malfunction and possible equipment damage.

Warnings

Readers are informed of situations that can result in serious physical injury and/or serious damage to equipment with warning statements highlighted by the following symbols:

<p>Warning</p> 	<p>Dangerous Voltage Warning: warns of situations where high voltage can cause physical injury and/or damage equipment. The text next to this symbol describes ways to avoid the danger.</p>
<p>Warning</p> 	<p>General Warning: warns of situations that can cause physical injury and/or damage equipment by means other than electrical. The text next to this symbol describes ways to avoid the danger.</p>
<p>Warning</p> 	<p>Electrostatic Discharge Warning: warns of situations in which an electrostatic discharge can damage equipment. The text next to this symbol describes ways to avoid the danger.</p>







Cautions

Readers are informed of situations that can lead to a malfunction and possible equipment damage with caution statements:

<p>Caution</p> 	<p>General Caution: identifies situations that can lead to a malfunction and possible equipment damage. The text describes ways to avoid the situation.</p>
---	---

General Safety Instructions

These safety instructions are intended for all work on the HGP. Additional safety instructions are provided at appropriate points on other sections of this manual.

<p>Warning</p> 	<p>Be sure to read, understand, and follow all safety instructions.</p>
<p>Warning</p> 	<p>Only qualified electricians should carry out all electrical installation and maintenance work on the HGP filter.</p>
<p>Warning</p> 	<p>All wiring must be in accordance with the National Electrical Code (NEC) and/or any other codes that apply to the installation site.</p>
<p>Warning</p> 	<p>Disconnect all power before working on the equipment. Do not attempt any work on a powered HGP filter.</p>
<p>Warning</p> 	<p>The HGP filter, drive, motor, and other connected equipment must be properly grounded.</p>
<p>Warning</p> 	<p>After switching off the power, always allow 5 minutes for the capacitors in the HGP filter and in the drive to discharge before working on the HGP, the drive, the motor, or the connecting wiring. It is a good idea to check with a voltmeter to make sure that all sources of power have been disconnected and that all capacitors have discharged before beginning work.</p>

2.0 General Information

Thank you for selecting the HarmonicGuard® Passive (HGP) filter. TCI has produced this filter for use in many variable frequency drive (VFD) applications that require input power line harmonic current reduction. This manual describes how to install, operate and maintain the HGP filter. Please contact TCI Technical Support or visit transcoil.com/Support.htm for additional information.

Intended Audience

This manual is intended for use by all personnel responsible for the installation, operation and maintenance of the HGP filters. Such personnel are expected to have knowledge of electrical wiring practices, electronic components and electrical schematic symbols.

Receiving Inspection

The HGP filter has been thoroughly inspected and functionally tested at the factory and carefully packaged for shipment. When you receive the unit, you should immediately inspect the shipping container and report any damage to the carrier that delivered the unit. Verify that the part number of the unit you received is the same as the part number listed on your purchase order.

Storage Instructions

If the HGP filter is to be stored before use, be sure that it is in a location that conforms to published storage humidity and temperature specifications stated in the HarmonicGuard® Passive Filter Technical Specifications. Store the unit in its original packaging.

TCI Limited Warranty Policy

TCI, LLC ("TCI") warrants to the original purchaser only that its products will be free from defects in materials and workmanship under normal use and service for a period originating on the date of shipment from TCI and expiring at the end of the period described below:

Product Family	Warranty Period
KLR, KDR	For the life of the drive with which they are installed.
HGA, KLC, KLCUL, KMG, MSD, V1K	One (1) year of useful service, not to exceed 18 months from the date of shipment.
PF Guard, HGP, HGL, HG7, HSD, KRF	Three (3) years from the date of shipment.
KCAP, KTR,	Five (5) years from the date of shipment.
All Other Products	One (1) year of useful service, not to exceed 18 months from the date of shipment.

The foregoing limited warranty is TCI's sole warranty with respect to its products and TCI makes no other warranty, representation, or promise as to the quality or performance of TCI's products. THIS EXPRESS LIMITED WARRANTY IS GIVEN IN LIEU OF AND EXCLUDES ANY AND ALL EXPRESS OR IMPLIED WARRANTIES INCLUDING, WITHOUT LIMITATION, ANY IMPLIED WARRANTY OF MERCHANTABILITY OR FITNESS FOR A PARTICULAR PURPOSE.

This warranty shall not apply if the product was:

- a) Altered or repaired by anyone other than TCI;
- b) Applied or used for situations other than those originally specified; or
- c) Subjected to negligence, accident, or damage by circumstances beyond TCI's control, including but not limited to, improper storage, installation, operation, or maintenance.

If, within the warranty period, any product shall be found in TCI's reasonable judgment to be defective, TCI's liability and the Buyer's exclusive remedy under this warranty is expressly limited, at TCI's option, to (i) repair or replacement of that product, or (ii) return of the product and refund of the purchase price. Such remedy shall be Buyer's sole and exclusive remedy. TCI SHALL NOT, IN ANY EVENT, BE LIABLE FOR INCIDENTAL DAMAGES OR FOR CONSEQUENTIAL DAMAGES INCLUDING, BUT NOT LIMITED TO, LOSS OF INCOME, LOSS OF TIME, LOST SALES, INJURY TO PERSONAL PROPERTY, LIABILITY BUYER INCURS WITH RESPECT TO ANY OTHER PERSON, LOSS OF USE OF THE PRODUCT OR FOR ANY OTHER TYPE OR FORM OF CONSEQUENTIAL DAMAGE OR ECONOMIC LOSS.

The foregoing warranties do not cover reimbursement for removal, transportation, reinstallation, or any other expenses that may be incurred in connection with the repair or replacement of the TCI product.

The employees and sales agents of TCI are not authorized to make additional warranties about TCI's products. TCI's employees and sales agents' oral statements do not constitute warranties; these shall not be relied upon by the Buyer and are not part of any contract for sale. All warranties of TCI embodied in this writing and no other warranties are given beyond those set forth herein.

TCI will not accept the return of any product without its prior written approval. Please consult TCI Customer Service for instructions on the Return Authorization Procedure.

3.0 Pre-Installation Planning

Verify the Application

Make sure that the HGP filter is correct for the application. The voltage rating of the filter must match the input voltage rating of the connected drive. The horsepower and current ratings of the filter must be appropriate for the connected load.

HGP Drive-Applied Filter

The HGP is a drive-applied harmonic filter designed and developed by TCI to reduce the harmonic currents drawn from the power source by VFDs. The published HGP voltage, Power (HP or kW) and current ratings apply to matching power (Hp or kW) rated standard VFDs with six-pulse diode bridge rectifiers. The HGP may also be sized to filter other loads such as SCR six-step drives, SCR Direct Current (DC) motor drives, thyristor furnaces, battery chargers, electroplating supplies or other types of nonlinear loads. In many cases, the filter power rating (Hp or kW) will differ from load power rating (Hp or kW). Please contact TCI Technical Support for additional information and support on sizing HGP harmonic filters for your non-six-pulse diode front end VFD applications.

The HGP is a passive filter connected in series with the input terminals of a VFD or several VFDs that operate as a group. It is designed to provide a low impedance path for the major harmonic currents demanded by the drive. The filter is a stand-alone device that can be furnished in its own enclosure and mounted adjacent to the drive. It is also available on an open panel for mounting within an enclosure with the drive or other equipment.

The HGP filters consist minimally of the following features and components:

- A KDR tuned series reactor to prevent system interaction and improve filter performance
- An L-C-L filter circuit with:
 - A TCI three-phase tuning reactor specifically designed for the HGP filter
 - High-endurance, harmonic-rated capacitors
 - Larger filters may have multiple tuned circuits. Consult fuse tables to determine if the filter in question has "parallel" branches.
 - Bleeder resistors to ensure safe capacitor discharge upon filter shutdown
 - Cooling fans (on select models) to ensure adequate cooling and safe operating temperatures
 - Compression terminals for ease and integrity of all power and control wiring
 - Fuses - sized to protect the capacitor wiring

Nameplate Data

The following information is marked on the nameplate:

- Part number: encoding is explained on the following page
- FLA: the rated continuous operating current (RMS amps)
- System Voltage: the rated three-phase line voltage (RMS volts)
- Hz: the rated frequency
- Phase: 3 – The HGP filter is designed for use only with three-phase power
- Drawing #: outline and mounting dimension drawing number
- Schematic #: schematic diagram drawing number
- Manufacturing #: for TCI internal use
- Enclosure Type: UL designation or "Open" panel construction

Part Numbering System

Figure 1 below identifies the significance of each character in the HGP part number. The example part number, HGP0150AW1C1000 designates an HGP filter that is rated 150Hp, 480 volts, 60 Hz, Type 1 Enclosure, with contactor, PQconnect with Modbus RTU, no other options. It includes a line reactor, tuning reactor, and capacitors in a UL Type 1 enclosure. It is designed for use with a 150Hp drive.

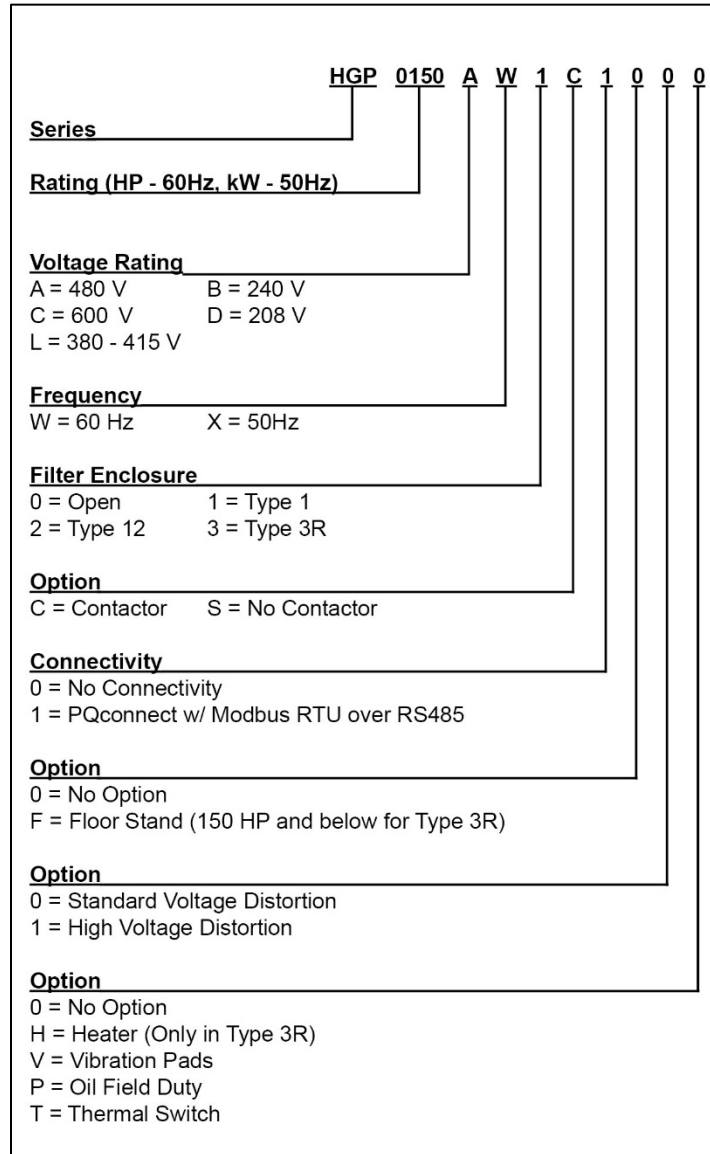





Figure 1: HGP Part Number Encoding

Table 1: HGP Technical Specifications

Electrical Characteristics	
Voltage / Frequency Rating	208, 240, 480, 600 VAC- 60 Hz 380 - 415 VAC- 50 Hz
Phase	3Ø
Motor drive input power rating range	208, 240 VAC: 5 - 100 Hp 380 - 415 VAC: 4 - 1000 KW 480, 600 VAC: 5 - 1250 Hp
THID	Less than 5% at full load
SCCR (Short Circuit Current Rating)	100 kA
Immunity from Voltage Distortion	Less than 5% THID at full load with THVD as high as 5%*
Efficiency	Greater than 99%
Overload Capability	200% of current rating for up to 3 minutes/hour
Communication Options	Modbus RTU over RS485
Environmental Conditions	
Operating Temperature	Open: -40°C (-40°F) - 50°C (122°F), Enclosed: -40°C (-40°F) - 40°C (104°F)
Storage Temperature	-40°C (-40°F) - 60°C (140°F)
Elevation	Up to 2,000 m without derating. Consult factory for higher elevations.
Humidity	95% non-condensing
Protection Category	Open Chassis, UL Type 1, UL Type 3R, and UL Type 12 enclosure
Cooling Method	Natural or Forced Air Convection
Agency Approvals	
  	

*When configured for High Voltage Background Distortion.

HGP Filter Overview

The HarmonicGuard® Passive (HGP) Filter provides a low impedance path for the major harmonic currents demanded by Variable Frequency Drives (VFDs). This greatly reduces the amount of harmonic currents flowing through the electrical power distribution system, bringing those harmonic currents in line with the IEEE-519 standard for harmonic distortion mandated by an increasing number of utilities.

The HGP Filter includes branch fuses on the harmonic trap circuit capacitors. These fuses are included in the design to prevent damage to the capacitors in the event of excessive harmonic trap current if the filter is misapplied.

Contacting Option (C)

This option includes a contactor, control power transformer and connection terminals in the filter circuit which allows the VFD user to control the insertion of this circuit with a relay contact in the VFD. It is recommended that the VFD contact be programmed to open the contactor below 33% motor power. For variable torque (fan) loads this will be approximately below 70% speed, so the at-speed contact may be used. This reduces the possibility of leading power factor interacting with other devices on the power system. Contactor logic should also maintain the contactor closed in cases where the VFD is bypassed and the filter is not bypassed.

No Contacting Option (S)

This option includes high quality harmonic-grade capacitors and line reactors. This filter will meet most application requirements found today. This cost-effective product is available as an open panel version, in a UL Type 1 or UL Type 12 enclosure, or in an UL Type 3R enclosure. The open panel is perfect for inclusion in an MCC section or easy installation into industry standard enclosures. The UL Type 1 enclosed units maintain the same vertical profile as the open panel design. This design is perfect for applications where floor space is at a premium. The UL Type 3R enclosure protects the filter from harsh conditions.

Typical Voltage Distortion Option (0)

The Typical Voltage Distortion Option, intended for applications with levels of background voltage distortion less than 2%, is a configuration that enables the HGP filter to achieve lower levels of current harmonic distortion in applications with low background voltage distortion. This performance option is available in all the package options.

High Voltage Distortion Option (1)

The High Voltage Distortion Option, intended for applications with levels of background voltage distortion of 2% or higher, is a configuration that enables the HGP filter to achieve lower levels of current harmonic distortion in applications with high background voltage distortion. This performance option is available in all the package options.

Heater Option (H)

The Heater Option is intended for use in applications which require the environmental protection of a NEMA 3R enclosure. The heater is mounted to the interior of the enclosure and protects sensitive electronic equipment from the harmful effects of corrosion and condensation. The Heater option is available for all 3R enclosures. When using a Type 12 or Type 3R Enclosure and in a high humidity environment, set thermostat to 37°C (100°F) or max temperature below 37°C (100°F).

Vibration Pad Option (V)

The Vibration Pad Option is intended for use in applications which require environmental noise protection. The resilient mounting material is placed between the reactor and the interior of the enclosure and dampens noise produced by the reactor. The Vibration Pad option is available for all enclosure types.

Floor Stand Option (F)

The Floor Stand Option is intended for use in applications which require the HGP enclosure to be elevated from the floor. The Floor Stand option consists of 12" steel feet available for Type 3R enclosures 150Hp and below.

Oilfield Duty Option (P)

The Oilfield Duty Option features components designed specifically for oil and gas field applications to handle the additional electrical stress. Designed for cyclical loads these units will be available in Type 3R enclosures and will be for use with Hp ranges from 40 to 200Hp.

Over-temperature/Thermal Switch (T)

This option includes an over-temperature switch installed on both the Line Reactor and the Tuning Reactor. On each reactor, over-temperature switches are wired to a terminal block separate from the power terminals. The over-temperature switch opens if unpredicted heating occurs. An interlocking circuit should be used with the over-temperature switch to turn off the VFD to prevent filter damage in the event of filter overheating. The over-temperature switch contact is rated 6 amps at 120 VAC. The over-temperature switches are normally closed, open on temperature rise and typically have the following trip points:

- On a Class R 220°C insulation reactor, the switch opens on rise above 200°C
- On a Class H 180°C insulation reactor, the switch opens on rise above 160°C

Wire the over-temperature switches according to the reactor schematic using T1 and T2 locations on the over-temperature switch terminal block.

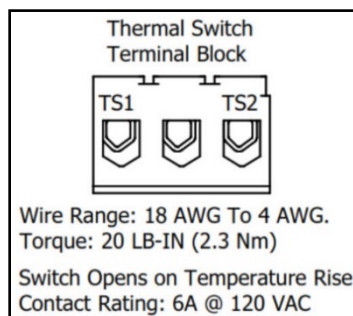

Figure 2: Terminal Block

If this option is ordered with the PQconnect, the Thermal switch feedback will be wired to the PQconnect board, and the PQconnect will indicate whether there is an over-temperature problem. The PQconnect fault relay (J10 header) can be used to be alerted when there is an Over-temp issue as an additional measure. For further detail please refer to the pin out references in section PCB Connections.

4.0 Installation Guidelines

Installation Checklist

- The following are the key points to be followed for a successful installation. These points are explained in detail in the following sections of this manual.
- Make sure that the installation location will not be exposed to corrosive or combustible airborne contaminants.
- Select a mounting area that will allow adequate cooling air and maintenance access.
- Make sure that all wiring conforms to the requirements of the National Electrical Code (NEC) and/or other applicable electrical codes.
- Connect the HGP equipment-grounding lug to the system ground of the premises wiring system.
- Use a properly sized grounding conductor.
- Connect three-phase power to the input terminals of the HGP, L1, L2 & L3.
- Connect the output power terminals, of the HGP, T1, T2 & T3, to the input power terminals of the VFD.

Select a Suitable Location

Environment

Locating the HGP in a suitable environment will help ensure proper performance and a normal operating life. Refer to the environmental specifications listed above and/or noted on the drawings furnished with the unit.

<p>Warning</p> 	<p>Unless specifically labeled as approved for such use, this equipment is not suitable for use in an explosive atmosphere or in a "Hazardous (Classified) Location" as defined in article 500 of the National Electrical Code (NEC).</p>
---	---

The unit must be installed in an area where it will not be exposed to:

- Rain or dripping liquids (unless filter is in a Type 3R enclosure)
- Corrosive liquids or gasses
- Explosive or combustible gases or dust
- Excessive airborne dirt and dust
- Excessive vibration

Working Space

Provide enough access and working space around the unit to permit ready and safe installation, operation and maintenance. Make sure that the installation conforms to all working space and clearance requirements of the National Electrical Code (NEC) and/or any other applicable codes. Provide enough unobstructed space to allow cooling air to flow through the unit. Keep the widest or deepest portion of the unit enclosure having ventilation openings a minimum of six inches from adjacent walls or other equipment. The unit enclosure sides that do not have ventilation openings should be kept a minimum of three inches from adjacent walls or other equipment.

Mounting

The HGP must be mounted vertically on a smooth, solid surface, free from heat, dampness, and condensation.

If you are mounting an open panel unit in your own enclosure, you must provide an enclosure that is adequately sized and ventilated sufficiently to prevent overheating. The rating and dimension tables for open panel units list the watts of heat loss dissipated by the HGP filter. The maximum temperature of the air around the HGP filter capacitors, line reactor, and tuning reactor should not exceed 50°C (122°F).

Power Wiring

When selecting a mounting location for the HGP filter, plan for the routing of the power wiring. Route the conduit and wiring from the power source to the filter and then to the VFD. The HGP is provided with internal fuses.

Cable Entry Locations

The enclosed HGP filters are not provided with enclosure wiring knockouts. A location can be selected at the time of installation. Typical or recommended cable entry locations are shown on the drawings which can be found on the TCI website.

Field Wiring Connection Terminals

Compression type terminals are provided for all field wiring connections. The wire size capacity ranges and tightening torque for all field wiring connections are listed in the drawings and other information shipped with the unit.

Grounding

The HGP panel equipment-grounding lug must be connected to the ground of the wiring system. The equipment-grounding connection must conform to the requirements of the National Electrical Code (NEC) and/or any other codes that apply to the installation site. The ground connection must be made using a wire conductor. Metallic conduit is not a suitable grounding conductor. The integrity of all ground connections should be periodically checked.

<p>Caution</p> 	<p>Use copper wire that is appropriate for the voltage and current rating of the equipment. The wire selection must conform to the requirements of the National Electrical Code (NEC) and/or other applicable electrical codes.</p> <p>For units rated less than 100 amps, use wire with an insulation temperature rating of 60°C or higher.</p> <p>For units rated 100 amps or more, use wire with an insulation temperature rating of 75°C or higher.</p>
---	---

Connect three-phase power of the appropriate voltage and current capacity to the circuit protective device to the HGP input power terminals.

Note: *in large units, the input power conductors are connected directly to the input terminals on the line reactors.*

Connect the output terminals of the HGP to the input power terminals of the VFD.

Note: *in large units, the output power conductors are connected directly to the output terminals on the line reactors. Refer to the VFD installation instructions for additional information.*

HGP Filter Operation

<p>Caution</p> 	<p>Thoroughly check the installation before applying power and operating the equipment for the first time.</p>
---	--

Before Applying Power for the First Time

Inspect the installation to make sure that all equipment has been completely and correctly installed in accordance with the **Installation Guidelines** section of this manual.

- Check to see that the cooling fan(s) are operating in units so equipped.
- Check to make sure power connections are torqued to recommended torque value.

Since the HGP is a passive filter, it is always operating whenever the drive is operating.

The Schematic shown below is an illustration of typical HGP filter wiring.

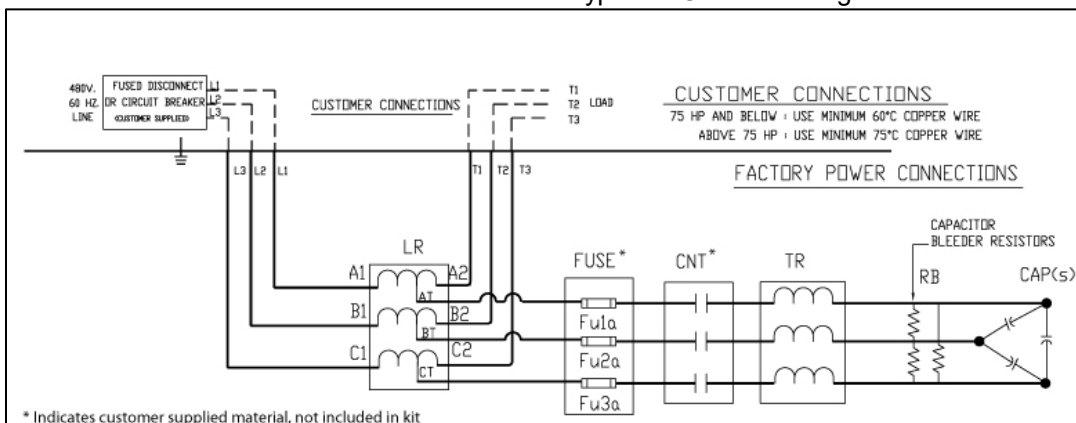

Figure 3: Typical HGP Filter Wiring for up to 480 V/800 HP

Always refer to the drawings and other information shipped with your unit. Consult applicable wiring codes, UL and NEC, for current limiting and disconnect requirements.

SCCR Fusing Requirements

See the table below for line fusing requirements that must be supplied to comply with the 100kA SCCR.

Table 2: Customer Installed Line Fuse Requirements to comply with the 100kA SCCR

Voltage	Size	Customer Installed Line Fuse Requirements to Comply with the 100 kA SCCR
600	≤ 40	Use appropriately rated Class J, T, or L fuse less than or equal to 60 A
600	> 40	No requirement for SCCR
480	≤40	Use appropriately rated Class J, T, or L fuse less than or equal to 60 A
480	> 40	No requirement for SCCR
440	≤30	Use appropriately rated Class J, T, or L fuse less than or equal to 60 A
440	> 30	No requirement for SCCR
415	≤30	Use appropriately rated Class J, T, or L fuse less than or equal to 60 A
415	> 30	No requirement for SCCR
240	≤ 10	Use appropriately rated Class J, T, or L fuse less than or equal to 60 A
240	> 10	No requirement for SCCR
208	≤ 10	Use appropriately rated Class J, T, or L fuse less than or equal to 60 A
208	> 10	No requirement for SCCR

Provisional 480 V Fuse Table

The fuse tables provided below show the fuse ratings of the included branch circuit fuse internal to the HGP unit as a fuse replacement reference.

The fuse tables also show a typical line fuse or circuit breaker current rating for overcurrent protection, given the unit’s nameplate power rating, if necessary, based on the installation. The line current fuses listed below are typical values given the unit power rating, not required values. Line fusing ratings are determined by the installer, based on input conductor sizing and protection required for downstream equipment. Any drawings or documentation included with the unit literature kit take precedence over the fuse tables below.

Note that to achieve a 100kA SCCR, the customer provided line fuse must be installed as per the requirements provided and sized following NEC (National Electrical Code) guidelines for the source conductors selected by the installer. The branch fuses are required to be installed at the shown ratings.

Table 3: Fuse Table for HGP 480 Volt, 60Hz Models

HGP Rating (HP)	Branch Circuit Fuse Current Rating (Included Internal to HGP Unit)	Typical Line Current Fuse or Circuit Breaker Rating (Customer Supplied)
	(J or T)	
1.5	20	30
3	20	30
5	20	30
7.5	20	30
10	20	30
15	20	30
20	20	60
25	20	60
30	20	60
40	30	60
50	30	80
60	50	90
75	50	125
100	60	150
125	80	200
150	100	225
200	125	300
250	150	350
300	175	450
350	200	500
400	225	600
450	250	600
500	300	800
600	350	800
700	400	1000
800	500	1100
900	250/250 (Parallel Branches)	1200
1000	300/300 (Parallel Branches)	1400
1100	350/350 (Parallel Branches)	1500
1200	350/350 (Parallel Branches)	1600
1250	400/400 (Parallel Branches)	1800

Table 4: Fuse Table for HGP 240 Volt, 60Hz Models

HGP Rating (HP)	Branch Circuit Fuse Current Rating (Included Internal to HGP Unit)	Typical Line Current Fuse or Circuit Breaker Rating (Customer Supplied)
	(J or T)	
5	20	30
7.5	20	30
10	20	60
15	30	60
20	50	70
25	50	80
30	60	80
40	80	120
50	100	150
60	125	200
75	150	225
100	175	300
125	200	400
150	225	450
200	250	600
250	500	800
300	250/250 (Parallel Branches)	900
400	400/400 (Parallel Branches)	1100

Table 5: Fuse Table for HGP 208 Volt, 60Hz Models

HGP Rating (HP)	Branch Circuit Fuse Current Rating (Included Internal to HGP Unit)	Typical Line Current Fuse or Circuit Breaker Rating (Customer Supplied)
	(J or T)	
5	20	30
7.5	20	30
10	30	60
15	50	60
20	50	70
25	60	80
30	80	100
40	125	150
50	125	175
60	150	200
75	175	250
100	225	350
150	350	450
200	500	600
250	300/300 (Parallel Branches)	800
300	400/400 (Parallel Branches)	900

Table 6: Fuse Table for HGP 600 Volt, 60Hz Models

HGP Rating (HP)	Branch Circuit Fuse Current Rating (Included Internal to HGP Unit)	Typical Line Current Fuse or Circuit Breaker Rating (Customer Supplied)
	(J or T)	
5	20	30
7.5	20	30
10	20	30
15	20	30
25	20	35
30	20	40
40	20	50
50	30	60
60	30	80
75	40	100
100	45	125
125	60	150
150	70	175
200	80	250
250	100	300
300	125	350
350	150	400
400	175	500
450	175	500
500	200	600
600	300	700
700	300	800
800	300	1000
900	350	1100

Table 7: Fuse Table for HGP 380-415 Volt, 50Hz Models

HGP Rating (kW)	Branch Circuit Fuse Current Rating (Included Internal to HGP Unit)	Typical Line Current Fuse or Circuit Breaker Rating (Customer Supplied)
	(J or T)	
2.2	20	20
3	20	20
4	20	20
5.5	20	20
7.5	20	20
9.3	20	25
11	20	30
15	20	40
18.5	30	50
22	30	60
30	30	80
37	40	100
45	40	125
55	60	150
75	75	200
90	100	225
110	125	300
132	125	350
160	150	400
200	200	500
250	250	600
315	300	800
355	350	800
400	400	900
450	450	1000
500	500	1200
560	300/300 (Parallel Branches)	1200
630	300/300 (Parallel Branches)	1400
710	350/350 (Parallel Branches)	1600
800	400/400 (Parallel Branches)	1800
900	450/450 (Parallel Branches)	2000

<p>Caution</p> 	<p>This manual provides general information describing your HGP filter. Be sure to carefully review the more specific information that is provided by the drawings shipped with the unit. Information provided by the drawings takes precedence over the information provided in this manual.</p> <p>The ratings, dimensions and weights given in this manual are approximate and should not be used for any purpose requiring exact data. Contact the factory in situations where certified data is required. All data is subject to change without notice.</p>
---	--

Table 8: 480 V HGP Watts loss

HP	Open	Type 1	Type 3R
3	110	110	125
5	110	110	125
7.5	140	140	160
10	160	160	175
15	215	215	230
20	260	260	275
25	310	310	325
30	265	265	280
40	460	460	500
50	490	490	525
60	650	650	675
75	800	800	850
100	775	775	800
125	900	900	900
150	1150	1150	1200
200	1425	1500	1500
250	1575	1625	1650
300	1975	2020	2025
350	1800	1875	1875
400	1950	2000	2025
450	2175	2550	2275
500	2500	2875	2575
600	1975	2375	2075
700	2150	2550	2575
800	2200	2600	2600
900	3650	4100	4100
1000	4050	4500	4500

Table 9: 600 V HGP Watts loss

HP	Open	Type 1	Type 3R
15	170	170	185
30	275	275	295
40	450	450	480
50	450	450	500
60	620	620	660
75	775	775	800
100	800	800	850
125	850	850	900
150	1100	1100	1175
200	1350	1400	1400
250	1500	1575	1575
300	1450	1500	1500
350	1825	1900	1900
400	1450	1875	1550
450	1950	2350	2010
500	1800	2200	1875
600	1850	2250	1925
700	2100	2500	2500
800	2400	2800	2800
900	2450	2850	2850

5.0 PQconnect Connectivity

HGP Drive-Applied Filter with PQconnect

The PQconnect is an integrated controls option for TCI's industry leading passive harmonic filter used for filtering the input of variable frequency motor drives (VFDs). In the passive harmonic filter, the PQconnect provides basic tuned circuit contactor control and provides unit status detection, metering, waveforms and power quality data. The PQconnect data is made available via basic Modbus RTU over RS485 serial connection. The PQconnect is UL listed and intended for commercial and industrial applications. By default, the PQconnect is manufactured to close the contactor at 30% load.

***Please verify you have the latest manual version for your PQconnect software by visiting <https://transcoil.com/products/hgp-5-passive-harmonic-filter/>**

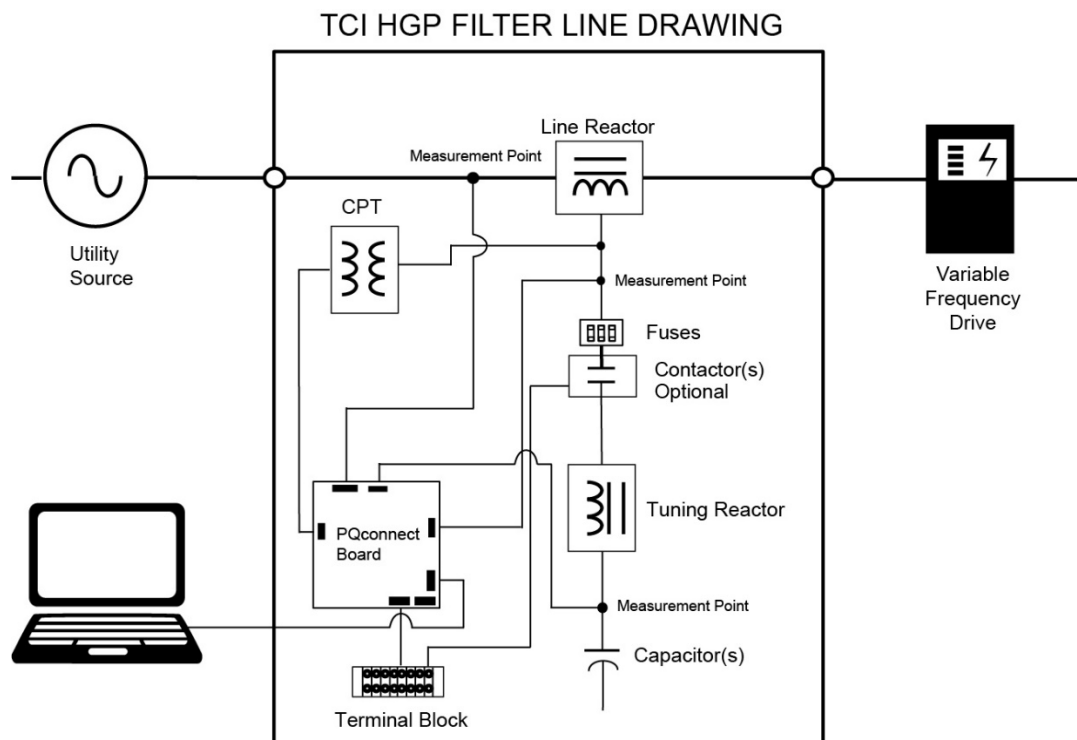

Figure 4: HGP Filter with PQconnect Typical Connection Diagram

PQvision PC application Screen Elements

This section focuses on the operation of the PQvision application. The PC application contains several screens that allow the user to monitor the status of the HarmonicGuard® Passive filter. Additionally, the PQvision application can be used for contactor control and basic setup of the HarmonicGuard® Passive filter. Enter password **08252014** to enable tech access.

Please ensure the latest version of PQvision is downloaded to your PC by accessing the software at <https://transcoil.com/products/hgp-5-passive-harmonic-filter/pqvision-software/>

To run the PQvision software, an RS485 to USB converter will need to be connected to terminal J5 on the PQconnect PCB with pin orientation as described in Table 18, the USB connector will need to run to a laptop or PC.

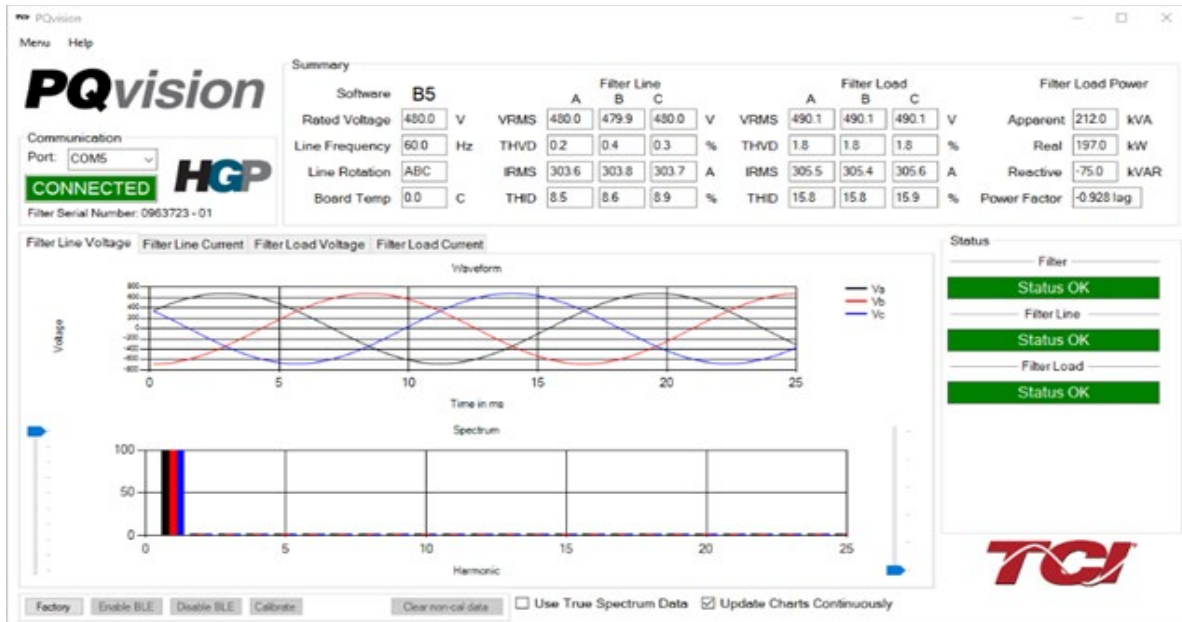

Figure 5: PQvision Desktop Application

Table 10: PQvision PC Navigation

Options	Description
Toolbar	Communication Status and Communication Port
	To determine the COM port, go to Device Manager Ports (COM & LPT) and finding "USB Serial Port"
	Note: If Modbus settings differ from the default values shown in Table 20; Set and save desired Modbus settings, then cycle power of the HarmonicGuard® Passive filter.
	DSP Rev: Latest software revision will be displayed
	Filter Serial Number – Displays below the Communication status.
	Menu: Save settings, about screen, software update, tech access
Summary Data	Settings – Modbus, contactor control, kVAR settings, alert management view Figure 7-Figure 9
	Help – Direct links to the TCI Home page and tech support contact information.
	(THVD) Displays the Total Harmonic Distortion of the utility Line/Load voltage as a percentage
	(THID) Displays the Total Harmonic Distortion of the utility Line/Load current as a percentage
	Displays three-phase real power (P) of the filter output in kW*
	Displays three-phase reactive power (Q) of the filter output in kVAR*
	Displays three-phase apparent power (S) of the filter output in kVA*
	Displays filters output power factor. 1.00 indicates unity power factor. A negative power factor indicates lagging power factor
	Displays the current utility line frequency in Hz
	Displays the supply voltage into the HarmonicGuard® Passive filter
Waveforms	Displays the filters input/output phase current in Amps RMS
	Displays Line rotation
	Displays board temperature
	The PQconnect PC application supports capture and display of real time system voltage and current data. Three phase waveform data can be viewed for Filter Line/Load Voltage, and Filter Line/Load Current.
	Phase A – Black Phase B – Red Phase C – Blue

	Harmonic Spectrum (Left toggle to zoom in on the spectrum and right to increase the spectrum to the 50 th harmonic) the value of the fundamental is 100.
Status Detections	Status alerts for the input, output and of the filter will display according to severity of the alerts. Hovering over status alert will give a brief description of what the problem may be.

*Line/Load power values are calculated using fundamental values.

To access the settings page as seen in Figure 8 under the Menu toolbar select Tech Access and Enter password **08252014** to enable. In the PQvision settings a user can set their desired Modbus settings, however this will require the PQconnect reset command. As well as controlling the contactor and enabling/ disabling alerts. The tables below describe the different settings menus.

PQconnect Reset command: if changing the Modbus settings, the user will be required to reset the PCB after saving settings. This can be easily done through the menu by clicking menu and Reset PQconnect. The reset command will only work if the PCB is communicating to the desktop application or Modbus network. Note: resetting the board will open the contactor if contactor state is closed.

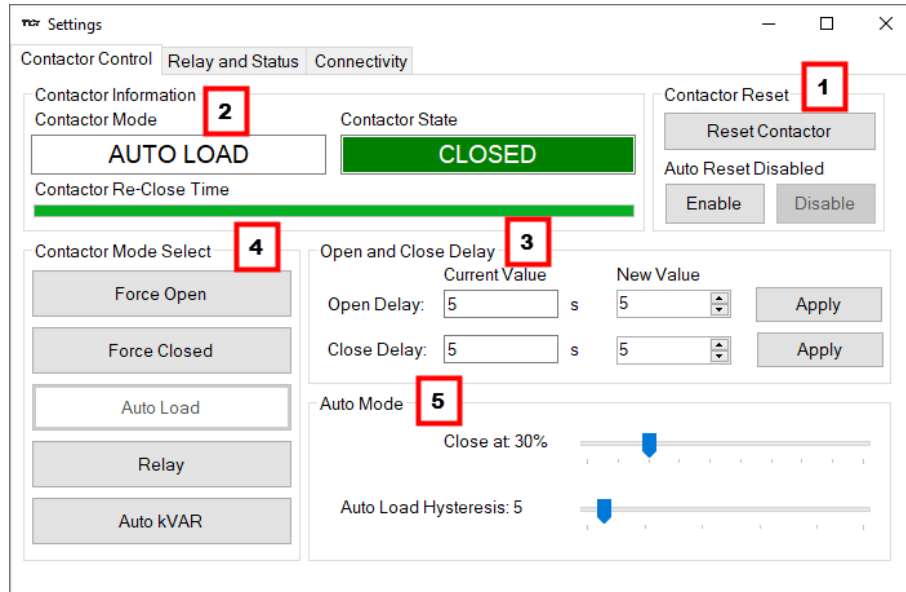

Figure 6: Contactor Control Settings Menu

Table 11: Contactor Control Settings Menu

Designators	Name	Description
1.	Contactor Reset	Allows the user to reset the state of the contactor. By default, the contactor is set to Auto reset the contactor
2.	Contactor information	Explains the contactor control mode and state.
3	Open and Close Delay	Contactor delays in seconds. After selecting desired new value apply and save settings.
4	Contactor Mode Select	There are multiple ways to control the contactor. Force Open will leave the contactor in an open state. Force Closed will leave the contactor in a closed state. Auto Load will close the contactor based on the load percentage selected Relay will open/close the contactor depending on relay input configuration. By default, these are disabled. Auto kVAR: Based on the size of the filter the user can adjust their target kVAR settings to open/close the contactor When changing the contactor control state, save settings to make the change final. Saving settings will open the contactor.
5	Auto Mode	Auto Mode allows the user to adjust the conditions how the contactor closes. Example in Figure 8 above the user can close the contactor between 10-100% load.

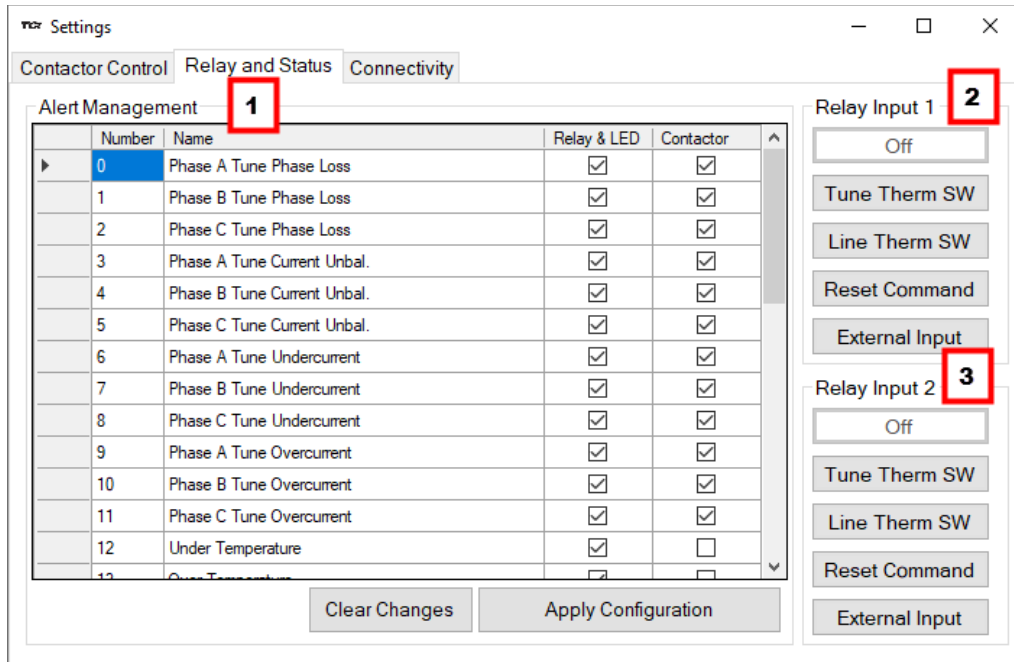

Figure 7: Relay and Status Settings Menu

Table 12: Relay and Status Settings Menu

Designators	Name	Description
1.	Alert Management	<p>Enable and Disable status detections. Depending on which status conditions the user would like to view</p> <p>The column labeled Relay & LED will show the LED pattern of the status detection and send a warning.</p> <p>The column labeled Contactor will open the contactor if the selected status is checked and send the warning.</p> <p>After selecting all desired status conditions, the user will need to select apply configuration and save settings.</p>
2.	Relay Input 1	<p>Relay Inputs are based on how the board is connected to digital inputs. There is the option of having a thermal switch on the line reactor or tuning reactor. There is also an external control input option.</p> <ul style="list-style-type: none"> J7 of the PCB is configured as Relay input 1 Select desired relay action if applicable and save settings
3.	Relay Input 2	<p>Relay Inputs are based on how the board is connected to digital inputs. There is the option of having a thermal switch on the line reactor or tuning reactor. There is also an external control input option.</p> <ul style="list-style-type: none"> J8 of the PCB is configured as Relay input 2 Select desired relay action if applicable and save settings

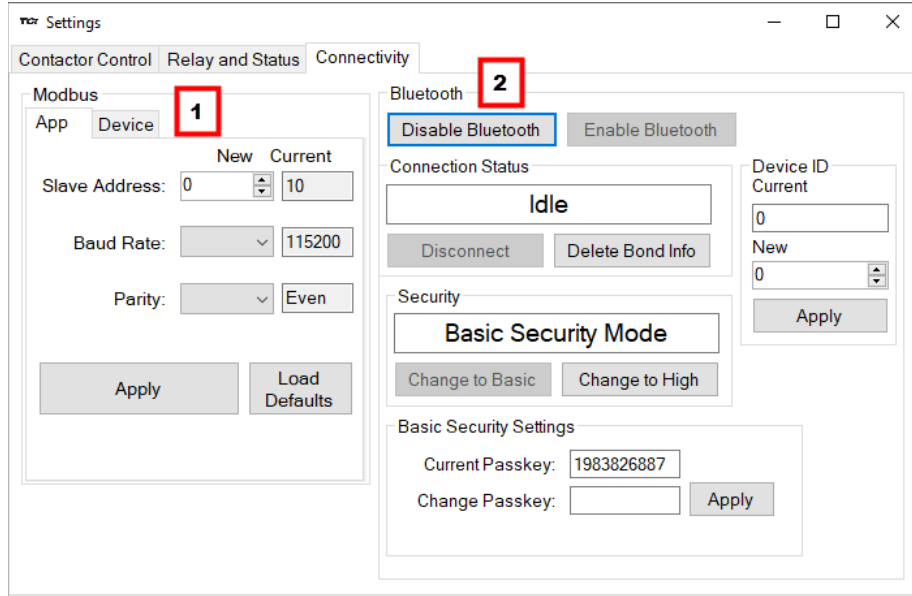

Figure 8: Connectivity Settings Menu

Table 13: Connectivity Settings Menu

Designators	Name	Description
1.	Modbus	<p>Allows the user to change Modbus settings of the App and device. When changing Modbus settings of the device the user will select apply and save settings. Afterwards the user will need to reset the board, this can be done by selecting “Reset PQconnect” from the drop down menu.</p> <p>Note: After the user has changed the Modbus settings of the Device they will need to change the PQvision App Modbus settings to reconnect..</p>
2.	Bluetooth	<p>By default, Bluetooth will be enabled.</p> <p>Connection status will determine if the device is paired with another device.</p> <p>There are two security modes the user can select.</p> <ul style="list-style-type: none"> • High security Mode: has the option of accepting and denying new connections to the device. • Basic security Mode: has the option of changing the passkey if the user would like to change from the default values. <p>Save settings after making all selections</p>

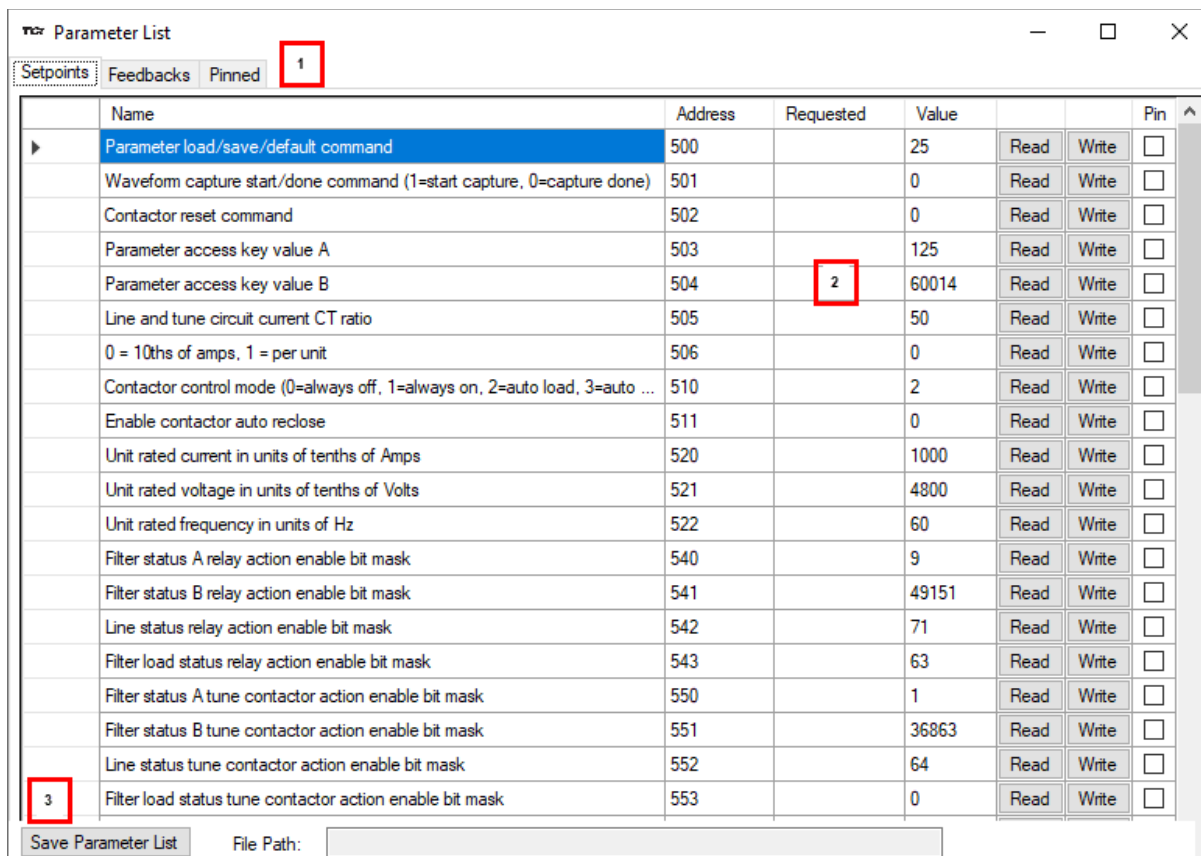

Figure 9: Parameter List

Table 14: Parameter List

Designators	Name	Description
	Parameter List	The parameter list allows the user to view feedbacks and setpoints reported by the PQconnect. The parameter list can be accessed by clicking Parameter List in the Menu drop down. To view the full parameter list, Tech Access will need to be enabled.
1.	Setpoints and Feedbacks	The Parameter List allows you to view both Setpoints (read and write values), and Feedbacks (read only values). The user can switch between the two by clicking the tab designator. Additionally, each of the setpoints and feedbacks can be viewed in the Pinned tab by clicking the corresponding checkbox in the <i>Pin</i> column.
2.	Setpoint Write	The user can write values to the DSP setpoints by first entering a value into the <i>Requested</i> column, and then clicking the Write button. Once all desired setpoints are entered, save the settings by navigating to the main PQvision screen and clicking Save Settings in the menu drop down. For information on each of the setpoints, see the Register Map section below, starting with Table 23.
3.	Parameter List Save to Text File	The parameters can be saved to a comma separated text file (.csv) by clicking the Save Parameter List button. Upon clicking this, a file dialog browser will appear, prompting the user to select a file location for the .csv file to be saved to.

Example Application Using “Simply Modbus Master 8.1.0”

The Modbus RTU network interface port is configured for RS-485 signal levels. The following example uses an RS-485 to USB converter to connect the PQconnect to a laptop PC running the Modbus RTU master application. The picture below shows an example “B&B SmartWorx, Inc Model: USPTL4” model RS-422/485 converter. As another alternative RS-485 converter there is WINGONEER USB 2.0 to RS485 Serial Converter Adapter CP2104.



Figure 10: B&B SmartWorx, Inc Model: USPTL4 model RS-422/485 converter

With the example converter above, the user can make proper connections from the RS485 converter to the PQconnect J5 communication header. The table below indicates the positions where the RS485 connections lead to. Please ensure the correct dip switch settings are applied before installing.

Table 15: USPTL4 Converter to J5 Header Connections

J5 Header Pinout	B&B Converter USPTL4Pin Out	Signal Name	Signal Type
1	-	No connect	-
2	TDB(+)	D+	RS-485 B (non-inverting)
3	GND	GND	RS-485 SC/G
4	TDA(-)	D-	RS-485 A (inverting)
5	-	No connect	-

USPTL4 RS485 Converter Dip Switch settings

All four switches of the B&B converter from the factory should be set to the ON position and should look like the following.



Figure 11: Dip Switch settings

Example Setup Instructions to Read Data from the PQconnect Unit:

- Connect the cable to the “J5” communication header
- Connect USB end to the computer
 - Determine the assigned COM port number for the RS-485 to USB converter using the computer device manager control panel.
 - The converter used in this example typically enumerates between the range of COM5 to COM20 on a standard laptop computer running the Microsoft windows operating system
- Open the Simply Modbus Master software
 - Can be downloaded from the link below:
 - <http://www.simplymodbus.ca/manual.htm>
 - The trial version of the software is free and fully functional for this task hence no License

key is necessary

- Next, configure the fields in the screen as shown below. These are again the default settings of the PQconnect COM port.
 - Note: The “notes” section of the display data registers is filled in manually

Example Setup Instructions to Write Data to the PQconnect Unit:

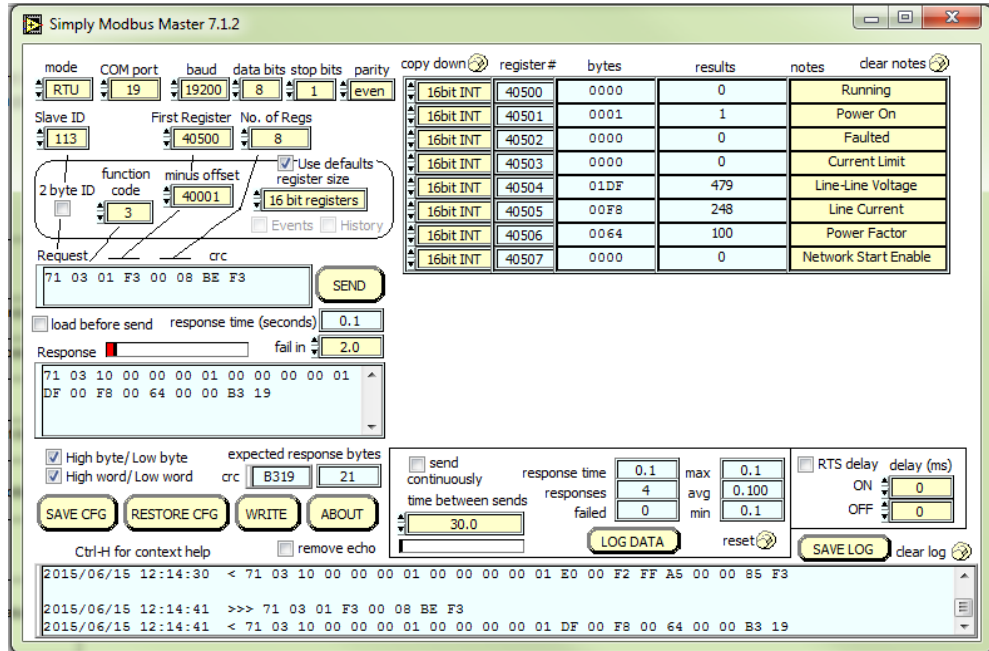

- To control the contactor in the unit, first the user will need tech access by writing the parameter keys
 - Navigate to the settings menu and then select force open or force close button.
 - The contactor state box will indicate if the contactor is open or closed.
- Next, select the “WRITE” button on the screen shown above.
- The screen below will be shown. Configure the fields as shown in the picture.

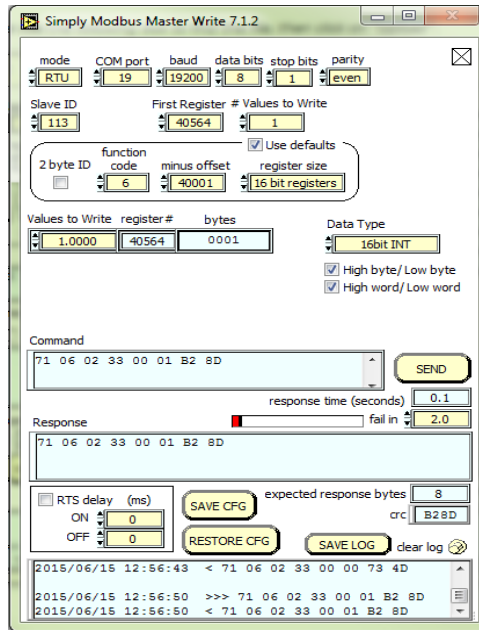

- Select “0” in the field “Values to Write” to close the contactor or “1” to open the contactor.

PQconnect Quick Start Unit Software Setup

- Verify connections to the PCB via ModbusRTU over RS485 before filter is energized
- Download PQvision software found on our website:
<https://transcoil.com/products/pqvision-software/>
- Enter password: **08252014** to access software package
- Select communication port (Data should be shown after the board communicates)
 - Note: Default Modbus settings of the application are below.
 - Baud rate: 115200
 - Parity: Even
 - Slave Address: 10
 - See PQconnect Display connections section for changing the default settings

PQconnect Bluetooth® App Setup

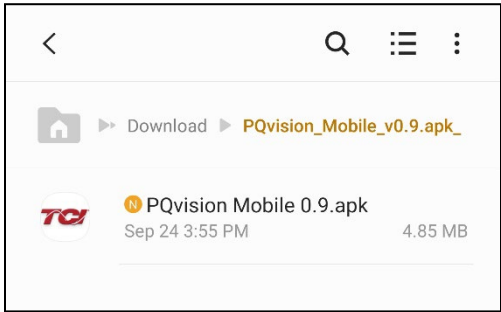
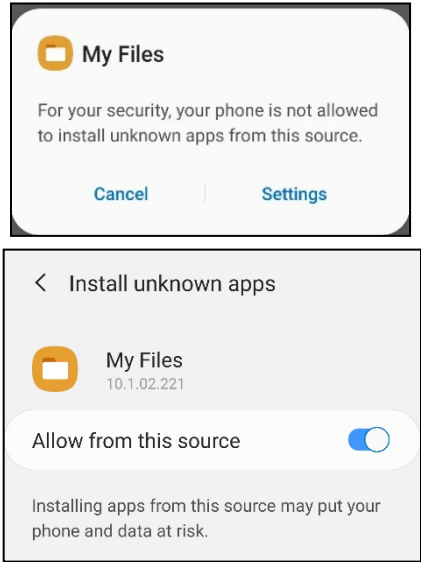
<p>System Requirements:</p>	<p>Android OS 5.0 or higher Bluetooth 4.2</p>
<p>Installation Instructions</p>	
<ol style="list-style-type: none"> 1. Download the app using your mobile device. 2. Extract the contents of the downloaded zip folder. 3. Tap on the APK file to install. Note: The Android system may require permission to install apps from sources other than the Play Store. 	
<ol style="list-style-type: none"> 4. A warning may appear. Click on settings and click slider for “allow from this source.” 	

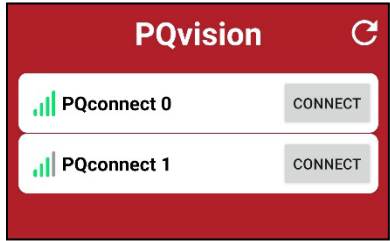
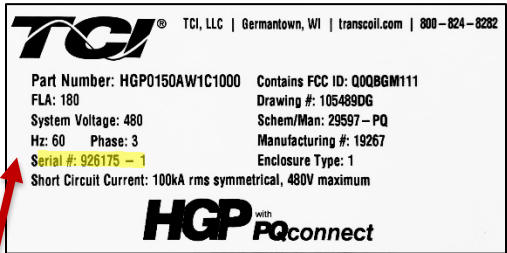
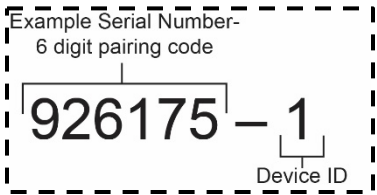
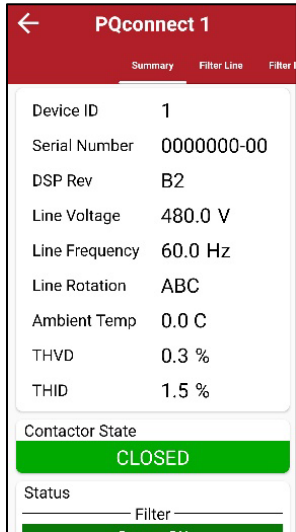
Pairing Instructions	
<ol style="list-style-type: none"> Once installed, open the PQvision mobile app. (You must allow PQconnect to use Bluetooth.) Any Bluetooth capable PQconnect devices in range will be automatically displayed on the connection screen. Tap CONNECT next to your target PQconnect device. Each PQconnect device in the app will be identified by their Device ID. 	
<ol style="list-style-type: none"> A prompt to enter the Bluetooth pairing passkey will pop up automatically. Enter the 6-digit serial number found on the product nameplate. Do not include the Device ID number. <p>The Serial number can be found on the product nameplate on the front of each passive filter.</p>	 <p>Nameplate Example found on outside of filter enclosure</p> 
<ol style="list-style-type: none"> Once the passkey is successfully entered, all filter data will be presented. 	

Changing Settings	
<ol style="list-style-type: none"> Once connected to a PQconnect device, scroll to the bottom of the Summary page, and tap Settings to open the Settings screen Change any setting or tap the unlock button to unlock parameter access. 	
<ol style="list-style-type: none"> If prompted, enter the tech password – 08252014 – to unlock parameter access. 	
Troubleshooting	
<ol style="list-style-type: none"> Ensure Bluetooth is enabled on the Android device. If no PQconnect devices are displayed on the connect screen: <ul style="list-style-type: none"> Move closer to the unit to ensure the device is in range. Verify that the PQconnect is powered on and that the CPU LED is blinking. Restart the app. If the pairing prompt does not appear automatically: <ul style="list-style-type: none"> Wait up to 15 seconds for the prompt to appear. Close the app completely and reopen it. <p>Please report any issues to TCI: tech-support@transcoil.com</p>	

PCB Connections

Most customer connections to PQconnect will be made on the PCB. Refer to connection diagrams in Figure 14. The details of the power and communications terminals are shown in Table 18. Form C relays are available on the PCB, these connections are shown in Table 19.

Two relay outputs are available on the PCB. When drilling holes for wire access please ensure no metal shavings are on the PQconnect board.

The relay contactor control command input connection on J11 of the PCB allows the user to open/close the contactor of the HarmonicGuard® Passive filter. The second relay (input connections on J12) is optional and could be used for a second contactor for dual tuned circuit filters or as a secondary status detection.

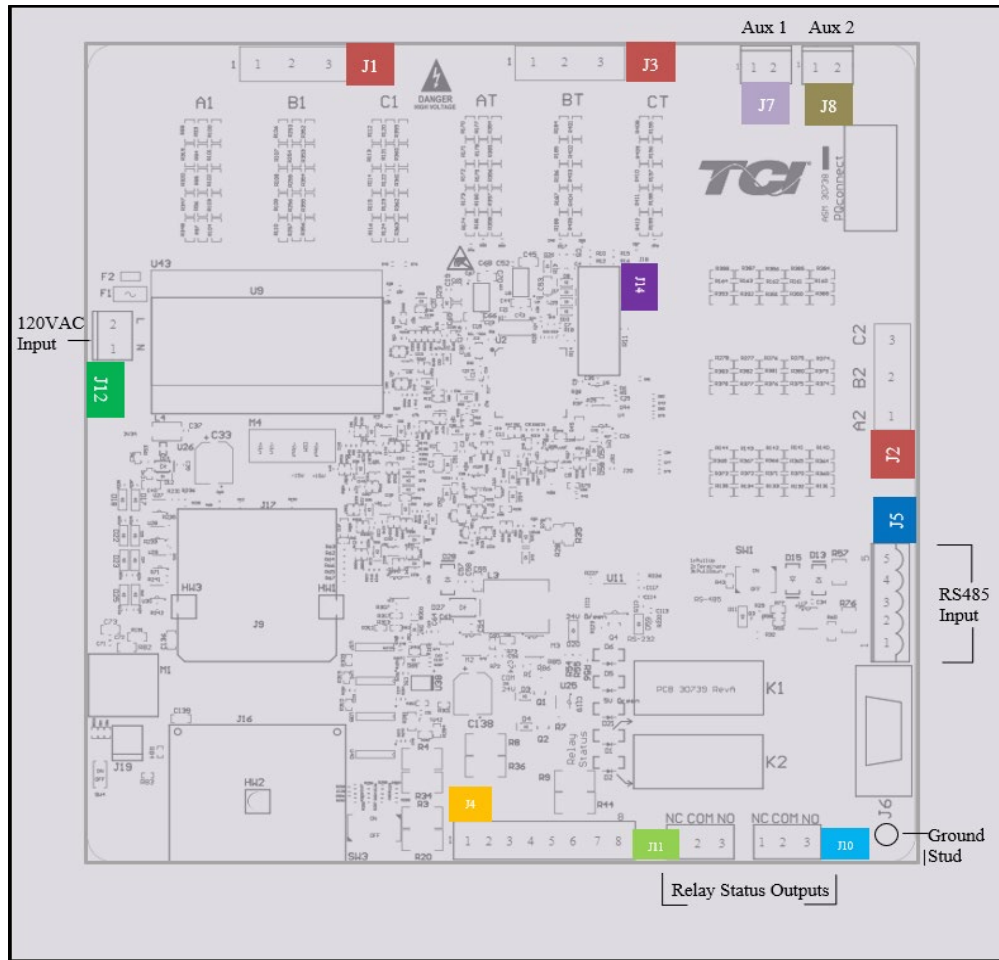

Figure 12: PQconnect Connections

Table 16: Power & Communications Terminals

Terminal	Pin	Description	Label	Rating
J1, J2, J3	1	Phase A	For factory use; Measurement connection points	600VAC
	2	Phase B		
	3	Phase C		
J4	1,2,3,4	Not Connected		N/A
	5,6,7,8	Current transformer connections	For factory use; Only used for filters with dual tuned circuits	N/A
J5	1	RS485	Not Connected	N/A
	2		B (non-inverting)	
	3		Ground	
	4		A (inverting)	
	5		Not connected	
J12	1	Input Power from control power transformer	Neutral	120 VAC
	2		Line	
J14	1-14	Micro Programming	For factory use	N/A

Note: The power terminals on the PQconnect accepts 28 to 14 AWG stranded wire, with a tightening torque of 4.4 in-lb. (0.5 Nm).

Table 17: Form C Relay Contacts

Terminal	Pin	Description	Label	Tightening Torque	Wire Range
J7	1, 2	Multi-functional digital Input 1	Customer contacts	3.5 lb.-in (0.4 Nm)	28-12 AWG
J8	1, 2	Multi-functional digital Input 2	Customer contacts	3.5 lb.-in (0.4 Nm)	28-12 AWG
J11	1	Digital output form C Contact 1	Normally Closed (NC)	4.4 lb.-in (0.5 Nm)	28-14 AWG
	2		Common (COM)		
	3		Normally Open (NO)		
J10	1	Digital output form C Contact 2	Normally Closed (NC)	4.4 lb.-in (0.5 Nm)	28-14 AWG
	2		Common (COM)		
	3		Normally Open (NO)		

Note: Form-C relay contacts are gold plated with a load rating of 5.0A @ 120VAC

The filter is set to control the contactor pickup/drop-out at 30% of load current by factory default. This setting can be changed in the tech access page from the settings menu.

Multi-functional digital inputs have the following functions:

- DEFAULT: 0 = Disabled
- 1 = Tuning Reactor Thermal Switch Input
- 2 = Line Reactor Thermal Switch Input
- 3 = Reset Command
- 4 = External Control Input

Digital Output form C Contact

- J11 reserved for contactor control
- J10 used for status detection

Modbus RTU

The PQconnect Modbus RTU network communication interface transmits and receives command and status data from the PQconnect Modbus master over a RS-485 serial link. Modbus RTU is a simple serial communications protocol originally developed by Modicon for use with Programmable Logic Controllers (PLCs) in control of industrial devices. Modbus RTU is commonly supported by most PLCs and is an open, royalty-free communications standard.

Wiring and Configuration

The PQconnect implements a Modbus RTU Master/Slave device, which supports two-wire RS-485 signal levels. The PQconnect communication port used for the Modbus RTU interface is connected directly to the PCB. The communication port is located on the side of the PQconnect board.

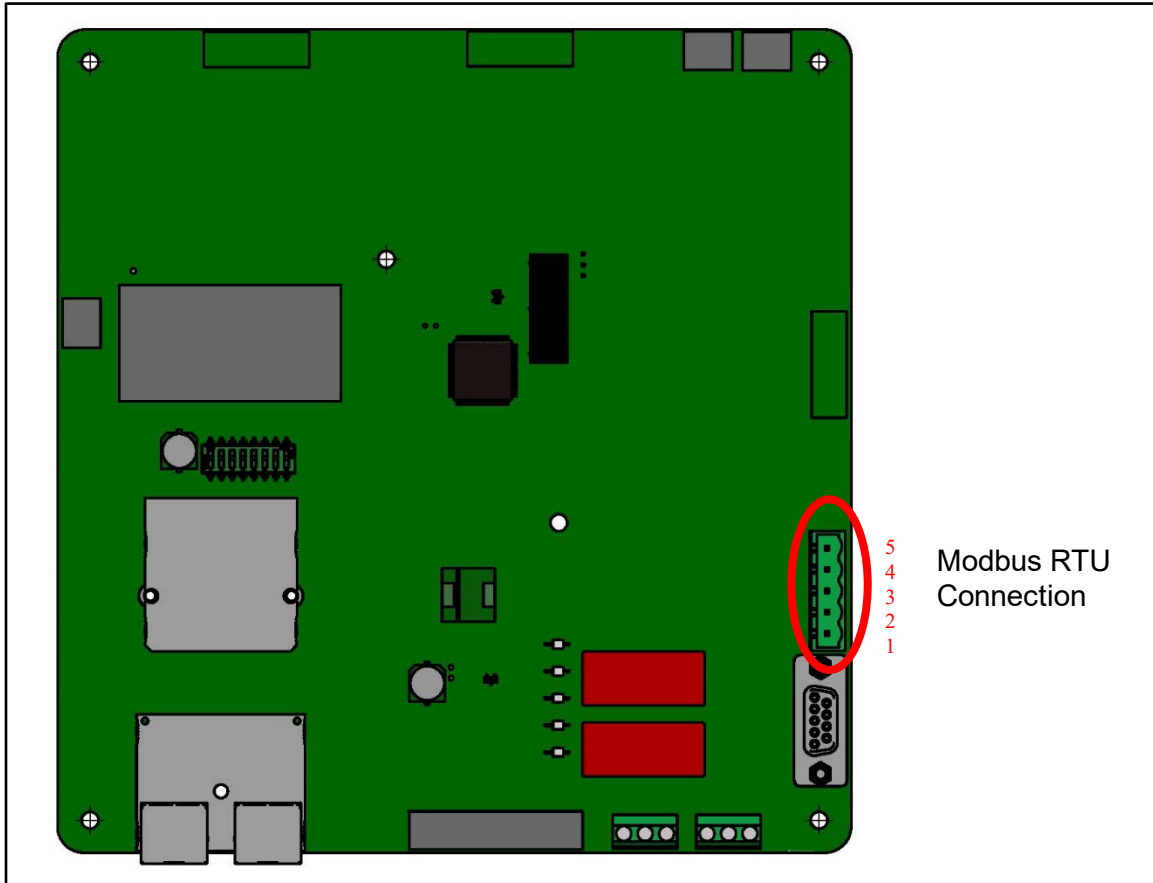

Figure 13: PQconnect Modbus RTU Connection

PQvision Display Connections

The hardware pinout for the J5 communication header and default settings is shown below.

Table 18: Modbus Connector Pin Definitions

J5 Header Pinout	Signal Name	Signal Type
1	No connect	-
2	D+	RS-485 B (non-inverting)
3	GND	RS-485 SC/G
4	D-	RS-485 A (inverting)
5	No connect	-

The default protocol settings for the RS-485 Modbus RTU interface are shown below.

Table 19: Modbus RTU Protocol Settings

Parameter	Default Value	Units
Baud Rate	115200	Bd
Data Bits	8	Bits
Stop Bits	1	Bits
Parity	Even	-
Slave ID	10	-

The default settings can be modified via the PQconnect system menu. A Tech level access password is required to change these parameters. Ensure the board communicates to the desktop app and then First go to Menu → Settings → Device settings → Change to desired Modbus parameters → Apply → Menu → Save Settings. Finally, go to Menu → Reset PQconnect, this will reboot the PQconnect with the desired Modbus parameters. Note: if the contactor state is closed it will open when clicking the reset command.

The network interface on the PQconnect allows the user to control the contactor and show internal status data of the HGP filter. The PQconnect PC application (PQvision) access a ModbusRTU master device for the network interface (see the PQvision application display connections).

Table 20: Configuration Switches

SW1	Configure Modbus Connection on J5 Header	1 – Enable 560Ω bias resistor on D-.
		2 – Enable 120Ω termination resistor.
		3 - Enable 560Ω pull-up on D+.
J20	Remove jumper to use default Modbus settings on next reboot.	

The input and output registers from the HarmonicGuard® Passive filter are mapped to the Modbus Analog Output Holding Registers starting at address 40000. See Table 22 - Table 24 for definitions of the input register maps and Table 28 - Table 33 for definitions of the output register maps. All input and output registers are two bytes in size and formatted as 16-bit signed integers.

Note: All parameters with an asterisk (*) in the description will require the Tech level access codes parameter key A: 0x007D (125) and parameter key B: 0xEA6E (60014).

Register Map

Write Parameters:

Table 21: Network Interface INPUT/Setpoint Register Map

Parameter Name	I/O Reg Address Offset	Direction	Data Values and Examples	Description
PARAM_USER_CMD_REQ	500	Input	9 = Save Current Values to Flash 21 = Set User Access 25 = Set Access to Tech Access (access key needs to be set to 125 for key A and 60014 for key B) 150 = Load Values from Flash 200 = Restore Defaults to Flash 300 = Restore Calibration Defaults	Note that defaulting the flash will clear all calibration data and require that the calibration procedure be re-run..
TRACE_GO_DONE	501	Input	0 = Capture Done 1 = Start Capture	Trace Data points for waveforms
SYS_RESET	502	Input	0 = No Command 1 = Reset Contactor Closed	Reset contactor
PARAM_KEY_A	503	Input	Enter Key A	Read/write parameters under Tech Access
PARAM_KEY_B	504	Input	Enter Key B	
CT_RATIO	505	Input	XXXX:5 where XXXX is the primary turns count of the CT 1000 = 1000:5 Range 5 to 10000	Dual Tuned Circuit Current Transformer (CT) ratios* Note: Only required for units with dual tuned circuits
CURRENT_WAVEFORM_DATA_FORMAT	506	Input	Default: 0 = 10ths of amps 1 = per unit	Changes the scaling of the waveforms displayed on PQvision.
SYS_CONTROL_MODE	510	Input	0 = Always Open 1 = Always Closed DEFAULT: 2= Auto load 3 = Auto kVAR 4 = External 5 = No contactor	Contactor control; keep contactor always off/on, auto turn on/off based on desired load or kVAR, external relay input. *
SYS_AUTO_CONTACTOR_CLOSED	511	Input	0 = Disable DEFAULT: 1 = Enable	Contactor auto reclose, this will attempt to reclose the contactor after it has been open through a status condition. *
RATED_CURRENT	520	Input	1000 = 100 A Range: 3 to 1500 A	Filter rated current*
RATED_VOLTAGE	521	Input	4800 = 480Vrms Range: 120 to 690 Vrms	Filter rated voltage*
RATED_FREQUENCY	522	Input	50 = 50 Hz 60 = 60 Hz	Filter rated frequency*

Write Parameters:

Table 22: Network Interface INPUT/Setpoint Register Map

Parameter Name	I/O Reg Address Offset	Direction	Data Values and Examples	Description
STATUS_FILTER_A_RELAY_ACTION	540	Input	0 = Disabled DEFAULT: 9 Range: 0 to 65535	To Enable desired status detections, enter bit mask from table by converting to decimal.
STATUS_FILTER_B_RELAY_ACTION	541	Input	0 = Disabled DEFAULT: 49151 Range: 0 to 65535	If a status is active and the bit corresponding to that status in this mask is set, the relay will be activated. Reference Table 25 below for filter status detection bits. *
STATUS_LINE_RELAY_ACTION	542	Input	0 = Disabled DEFAULT: 71 Range: 0 to 65535	To Enable desired status detections, enter bit mask from table by converting to decimal. If a status is active and the bit corresponding to that status in this mask is set, the relay will be activated Reference Table 26 below for line status detection bits. *
STATUS_FILTER_LOAD_RELAY_ACTION	543	Input	0 = Disabled DEFAULT: 63 Range: 0 to 65535	To Enable desired status detections, enter bit mask from table by converting to decimal. If a status is active and the bit corresponding to that status in this mask is set, the relay will be activated. Reference Table 27 below for load status detection bits. *
STATUS_FILTER_A_CNT_ACTION	550	Input	0 = Disabled Default: 1 Range: 0 to 65535	Filter status A tune contactor action enable bit mask.
STATUS_FILTER_B_CNT_ACTION	551	Input	0 = Disabled Default: 36863 Range: 0 to 65535	Filter status B tune contactor action enable bit mask.
STATUS_LINE_CNT_ACTION	552	Input	0 = Disabled Default: 64 Range: 0 to 65535	Line status tune contactor action enable bit mask.
STATUS_FILTER_LOAD_CNT_ACTION	553	Input	0 = Disabled Default: 0 Range: 0 to 65535	Filter load status tune contactor action enable bit mask.
CNT_CLOSE_LOAD_THERSHOLD	570	Input	DEFAULT: 30 = 30% Range: 10 to 100 %	Contactor close threshold in percent rated current*
CNT_CLOSE_LOAD_HYSTERESIS	571	Input	DEFAULT: 5 = 5% Range: 2 to 50 %	Contactor will open when it reaches the hysteresis *
CNT_CLOSE_KVAR_THERSHOLD	572	Input	DEFAULT: 50 = 50 kVAR Range: 0 to 1000 kVAR	Contactor close threshold for kVAR control*
CNT_CLOSE_KVAR_HYSTERESIS	573	Input	DEFAULT: 10 = 10% Range: 5 to 100 %	Contactor will open when it reaches the hysteresis *

CNT_CLOSE_DELAY	574	Input	DEFAULT: 5 = 5 seconds Range: 1 to 3600 seconds	Contactor Close Delay*
CNT_OPEN_DELAY	575	Input	DEFAULT: 5 = 5 seconds Range: 1 to 3600 seconds	Contactor Open Delay*

Write Parameters:**Table 23: Network Interface INPUT/Setpoint Register Map**

Parameter Name	I/O Reg Address Offset	Direction	Data Values and Examples	Description
SYS_PF_STEP_1_KVAR	576	Input	DEFAULT: 5 = 5 kVAR Steps Range: 1 to 200 kVAR	Desired filter kVAR for contactor to enable*
SYS_PF_STEP_2_KVAR	577	Input	DEFAULT: 5 = 5 kVAR Steps Range: 1 to 200 kVAR	Filter Second Tuned Circuit kVAR (Only used for filters with dual tuned circuits) *
CNT_AUTO_RECLOSE_DELAY	580	Input	DEFAULT: 10 = 10 seconds Range: 10 to 3600 seconds	Contactor auto re-close delay time*
CNT_POWER_ON_DELAY	581	Input	DEFAULT: 1 = 1 second Range: 0 to 3600 seconds	System Power on Delay*
CNT_AUTO_RECLOSE_ATTEMPTS	582	Input	DEFAULT: 5 = 5 attempts Range: 1 to 15	Maximum number of contactors auto re-close attempts allowed*
CNT_AUTO_RECLOSE_TIMESPAN	583	Input	DEFAULT: 600 = 600 seconds Range: 300 to 3600 seconds	Maximum number of contactors auto re-close attempts time span*
MB_SLAVE_ADDRESS	600	Input	DEFAULT: = 10 Range: 0 to 255	Modbus RTU Device Slave Address*
MB_BAUD_RATE	601	Input	DEFAULT: 11520 = 115200 baud rate 3840 = 38400 baud rate 960 = 9600 baud rate	Modbus RTU Device Baud Rate*
MB_PARITY	602	Input	0 = None 1 = Odd DEFAULT: 2 = Even	Modbus RTU Device Parity*
BOOTLOADER_START	604	Input	DEFAULT: 0 = No Action 1 = Start Bootloader 2 = Start Recovery	Used to navigate to bootloader, which launches the main program.
SYS_INPUT_1_CONFIG	610	Input	DEFAULT: 0 = Disabled 1 = Tuning Reactor Thermal Switch Input 2 = Line Reactor Thermal Switch Input 3 = Reset Command 4 = External Control Input	Customer external control input 1* J7 of the PCB

SYS_INPUT_2_CONFIG	611	Input	DEFAULT: 0 = Disabled 1 = Tuning Reactor Thermal Switch Input 2 = Line Reactor Thermal Switch Input 3 = Reset Command 4 = External Control Input	Customer external control input 2* J8 of the PCB
V_LINE_OV_ONSET	620	Input	DEFAULT: 130 = 130% Range: 100-150%	Line overvoltage onset threshold in percent rated voltage.
V_LINE_OV_CLEAR	621	Input	DEFAULT: 125 = 125% Range: 90-140%	Line overvoltage clear threshold in percent rated voltage.
V_LINE_OV_DELAY	622	Input	DEFAULT: 20 = 20 seconds Range: 1-3600 seconds	Line overvoltage delay in seconds.
V_LINE_UV_ONSET	623	Input	DEFAULT: 75 = 75%	Line undervoltage onset threshold in percent rated voltage.
V_LINE_UV_CLEAR	624	Input	DEFAULT: 80 = 80%	Line undervoltage clear threshold in percent rated voltage.
V_LINE_UV_DELAY	625	Input	DEFAULT: 20 = 20 seconds Range: 1-3600 seconds	Line undervoltage delay in seconds.
I_LINE_OC_ONSET	626	Input	DEFAULT: 155 = 155% Range: 100-200%	Line overcurrent onset threshold in percent rated current.
I_LINE_OC_CLEAR	627	Input	DEFAULT: 150 = 150% Range: 90-190%	Line overcurrent clear threshold in percent rated current.
I_LINE_OC_DELAY	628	Input	DEFAULT: 20 = 20 seconds Range: 1-3600 seconds	Line overcurrent delay in seconds.
I_LOAD_BALANCE_ONSET	640	Input	DEFAULT: 65 = 65% Range: 10-90%	Load current balance onset threshold in percent rated current.
I_LOAD_BALANCE_CLEAR	641	Input	DEFAULT: 70 = 70% Range: 10-90%	Load current balance clear threshold in percent rated current.
I_LOAD_BALANCE_DELAY	642	Input	DEFAULT: 20 = 20 seconds Range: 1-3600 seconds	Load current balance delay in seconds.
I_LOAD_BALANCE_MIN_CURRENT	643	Input	DEFAULT: 50 = 50% Range: 10-100%	Load current balance minimum detect current in percent rated current.
I_TUNE_OC_ONSET	660	Input	DEFAULT: 155 = 155% Range: 100-200%	Tune overcurrent onset threshold in percent rated current.
I_TUNE_OC_CLEAR	661	Input	DEFAULT: 150 = 150% Range: 90-190%	Tune overcurrent clear threshold in percent rated current.
I_TUNE_OC_DELAY	662	Input	DEFAULT: 20 = 20 seconds Range: 1-3600 seconds	Tune overcurrent delay in seconds.
I_TUNE_UC_ONSET	663	Input	DEFAULT: Varies depending on unit rating. 55 = 55% Range: 10-100%	Tune circuit fundamental undercurrent onset threshold in percent rated current.
I_TUNE_UC_CLEAR	664	Input	DEFAULT: Varies depending on unit rating 60 = 60% Range: 10-90%	Tune circuit fundamental undercurrent clear threshold in percent rated current.

I_TUNE_UC_DELAY	665	Input	DEFAULT: 20 = 20 seconds Range: 1-3600 seconds	Tune circuit fundamental undercurrent delay in seconds.
I_TUNE_BALANCE_ONSET	666	Input	DEFAULT: 65 = 65% Range: 10-90%	Tune circuit current balance onset threshold in percent rated current.
I_TUNE_BALANCE_CLEAR	667	Input	DEFAULT: 70 = 70% Range: 10-90%	Tune circuit current balance clear threshold in percent rated current.
I_TUNE_BALANCE_DELAY	668	Input	DEFAULT: 20 = 20 seconds Range: 1-3600 seconds	Tune circuit current balance delay in seconds.
T_AMBIENT_OT_ONSET	680	Input	DEFAULT: 750 = 75.0°C Range: 10.0-85.0°C	Internal ambient overtemperature onset threshold in tenths of degrees C.
T_AMBIENT_OT_CLEAR	681	Input	DEFAULT: 700 = 70.0°C Range: 5.0-80.0°C	Internal ambient overtemperature clear threshold in tenths of degrees C.
T_AMBIENT_OT_DELAY	682	Input	DEFAULT: 20 = 20 seconds Range: 1-3600 seconds	Internal ambient overtemperature delay in seconds.
FAULT_HIGH_THD_ONSET	690	Input	DEFAULT: 120 = 12% Range: 2-20%	High line voltage THD onset threshold in unit of tenths of a percent.
FAULT_HIGH_THD_CLEAR	691	Input	DEFAULT: 110 = 11% Range: 2-20%	High line voltage THD clear threshold in unit of tenths of a percent.
FAULT_HIGH_THD_DELAY	692	Input	DEFAULT: 20 = 20 seconds Range: 1-3600 seconds	High line voltage THD delay time in seconds.
PHASE_ROTATION	693	Input	DEFAULT: 1 = ABC Rotation Expected 2 = ACB Rotation Expected	Filter expected input phase orientation*
SYS_MAG_CAL_ENABLE	700	Input	0 = Disable 1 = Enable	System magnitude Calibration
SYS_I_LINE_CAL_A	710	Input	1000 = 100A Range: 3 to 1500 A	Input current measured on A phase of the filter* Note: For calibration setup
SYS_I_LINE_CAL_B	711	Input	1000 = 100A Range: 3 to 1500 A	Input current measured on B phase of the filter* Note: For calibration setup
SYS_I_LINE_CAL_C	712	Input	1000 = 100A Range: 3 to 1500 A	Input current measured on C phase of the filter* Note: For calibration setup
SYS_I_TUNE_CAL_A	713	Input	1000 = 100A Range: 3 to 1500 A	Tune circuit current measured on A phase of the filter* Note: For calibration setup

SYS_I_TUNE_CAL_B	714	Input	1000 = 100A Range: 3 to 1500 A	Tune circuit current measured on B phase of the filter* Note: For calibration setup
SYS_I_TUNE_CAL_C	715	Input	1000 = 100A Range: 3 to 1500 A	Tune circuit current measured on C phase of the filter* Note: For calibration setup
SYS_MAG_CAL_TOL	716	Input	0 = Calibration Command not active 1 = Enter calibration state	System mag calibration state
I_LINE_EST_A_SCALAR	720	Input	Range: -32768 to 32767	Magnitude scalar for current calculation line phase A. Note: Value set by Factory.
I_LINE_EST_B_SCALAR	721	Input	Range: -32768 to 32767	Magnitude scalar for current calculation line phase B. Note: Value set by Factory.
I_LINE_EST_C_SCALAR	722	Input	Range: -32768 to 32767	Magnitude scalar for current calculation line phase C. Note: Value set by Factory.
I_TUNE_EST_A_SCALAR	723	Input	Range: -32768 to 32767	Magnitude scalar for current calculation tune phase A. Note: Value set by Factory.
I_TUNE_EST_B_SCALAR	724	Input	Range: -32768 to 32767	Magnitude scalar for current calculation tune phase B. Note: Value set by Factory.
I_TUNE_EST_C_SCALAR	725	Input	Range: -32768 to 32767	Magnitude scalar for current calculation tune phase C. Note: Value set by Factory.
V_LINE_SCALAR_A	730	Input	Range: -32768 to 32767	Magnitude scalar for line voltage phase AB. Note: Value set by Factory.
V_LINE_SCALAR_B	731	Input	Range: -32768 to 32767	Magnitude scalar for line voltage phase BC. Note: Value set by Factory.
V_LINE_SCALAR_C	732	Input	Range: -32768 to 32767	Magnitude scalar for line voltage phase CA. Note: Value set by Factory.
V_LOAD_SCALAR_A	733	Input	Range: -32768 to 32767	Magnitude scalar for load voltage phase AB. Note: Value set by Factory.
V_LOAD_SCALAR_C	734	Input	Range: -32768 to 32767	Magnitude scalar for load voltage phase CA. Note: Value set by Factory.

V_TUNE_SCALAR_A	735	Input	Range: -32768 to 32767	Magnitude scalar for tune voltage phase AB. Note: Value set by Factory.
V_TUNE_SCALAR_C	736	Input	Range: -32768 to 32767	Magnitude scalar for tune voltage phase CA. Note: Value set by Factory.
I_LINE_SCALAR_A	737	Input	Range: -32768 to 32767	Magnitude scalar for line current CT phase A. Note: Value set by Factory.
I_LINE_SCALAR_C	738	Input	Range: -32768 to 32767	Magnitude scalar for line current CT phase C. Note: Value set by Factory.
I_TUNE_SCALAR_A	739	Input	Range: -32768 to 32767	Magnitude scalar for tune current CT phase A. Note: Value set by Factory.
I_TUNE_SCALAR_C	740	Input	Range: -32768 to 32767	Magnitude scalar for tune current CT phase A. Note: Value set by Factory.
V_LINE_RMS_SCALAR	750	Input	Range: -32768 to 32767	RMS calculation scalar for line voltage. Note: Value set by Factory.
V_LOAD_RMS_SCALAR	751	Input	Range: -32768 to 32767	RMS calculation scalar for load voltage. Note: Value set by Factory.
I_LINE_RMS_SCALAR	752	Input	Range: -32768 to 32767	RMS calculation scalar for line current. Note: Value set by Factory.
I_LOAD_RMS_SCALAR	753	Input	Range: -32768 to 32767	RMS calculation scalar for load current. Note: Value set by Factory.
I_TUNE_TAP_GAIN	801	Input	Value specific to filter model.	Line reactor tap turn coupling gain. Note: Value set by Factory.
V_THD_SCALAR	802	Input	Range: -32768 to 32767	Voltage THD gain adjustment factor. Note: Value set by Factory.
I_THD_SCALAR	803	Input	Range: -32768 to 32767	Current THD gain adjustment factor. Note: Value set by Factory.
V_THD_OFFSET	804	Input	% THVD 1 = 0.1% THVD	Voltage THD offset adjustment factor. Note: Value set by Factory.
I_THD_OFFSET	805	Input	% THID 1 = 0.1% THID	Current THD offset adjustment factor. Note: Value set by Factory.
BLUETOOTH_ENABLE	900	Input	Default: 1 = Enabled 0 = Disabled	Set to Enable BGM.
DSP_MODEL_NUM	902	Input	103 = HGP	Filter Model Number

BGM_STATIC_PASSKEY_A	970	Input	Range: 0 to 15	BGM password set high bytes.
BGM_STATIC_PASSKEY_B	971	Input	Range: 0 to 65535	BGM password set low bytes.
BGM_SECURITY_LEVEL	972	Input	Default: 0 = Low Security 1 = High Security	BGM Security level. High Security mode blocks new pairing requests. Passkey changes each time a connection is attempted.
BGM_NUMERIC_ID	973	Input	DEFAULT: 0	BGM Numeric Identifier.
BGM_PAIRING_MODE	974	Input	0 = No active request 1 = Active request	BGM pairing mode.
BGM_COMMAND	975	Input	DEFAULT: 0	BGM command input.

Table 24: Filter Status References

16-bit values	
<i>Register B</i>	
Bit	Status Detection
0	TUNE_PHASE_LOSS_A
1	TUNE_PHASE_LOSS_B
2	TUNE_PHASE_LOSS_C
3	TUNE_BALANCE_LOSS_A
4	TUNE_BALANCE_LOSS_B
5	TUNE_BALANCE_LOSS_C
6	TUNE_UNDERCURRENT_A
7	TUNE_UNDERCURRENT_B
8	TUNE_UNDERCURRENT_C
9	TUNE_OVERCURRENT_A
10	TUNE_OVERCURRENT_B
11	TUNE_OVERCURRENT_C
12	UNDER_TEMP
13	OVER_TEMP
14	CPU_ERROR
15	TUNE_REACTOR_THERMAL_SW
<i>Register A</i>	
0	RECLOSE_LIMIT
1	NCP_FAULT_A
2	NCP_FAULT_B
3	LINE_REACTOR_THERMAL_SW

Table 25: Filter Line Status References

16-bit values	
Bit	Status Detection
0	PHASE_LOSS_A
1	PHASE_LOSS_B
2	PHASE_LOSS_C
3	OVERVOLTAGE_A
4	OVERVOLTAGE_B
5	OVERVOLTAGE_C
6	FILTER_FREQ_MISMATCH
7	HIGH_VOLTAGE_THD
8	LINE_PHASE_ROTATION

Table 26: Filter Load Status References

16-bit values	
Bit	Status Detection
0	BALANCE_A
1	BALANCE_B
2	BALANCE_C
3	OVERCURRENT_A
4	OVERCURRENT_B
5	OVERCURRENT_C

Read Parameters:

Table 27: Network Interface OUTPUT/Feedback Register Map

Parameter Name	I/O Reg Address Offset	Direction	Data Values and Examples	Description
USER_STATE	10	Output	9 = Save Current Values to Flash 21 = Set User Access 25 = Set Access to Tech Access (access key needs to be set to 125 for key A and 60014 for key B) 150 = Load Values from Flash 200 = Restore Defaults to Flash	User state parameters. Read only value.
DSP_SW_VER	12	Output	Two 8bit ASCII Characters 0x0141 = ASCII for "A1"	Software revision code for processor.
DSP_MODEL_NUM_RO	13	Output	103 = HGP	System Model Number
HMS_SW_VER	14	Output	Two 8bit ASCII Characters 0x0141 = ASCII for "A1"	Software revision code for Ethernet module.
HMS_MODEL_NUM_RO	15	Output	DEFAULT: 0	Ethernet module Model Number
BGM_SW_VER	16	Output	Two 8bit ASCII Characters 0x0141 = ASCII for "A1"	Software revision code for the Bluetooth module.
BGM_MODEL_NUM_RO	17	Output	DEFAULT: 1	Bluetooth module Model Number
LINE_VOLTAGE	20	Output	4800 = 480 Vrms Range: 120 to 690 Vrms	Filter input voltage
LINE_FREQ	21	Output	60 = 60 Hz 50 = 50 Hz	Filter input frequency
LINE_ROT	22	Output	1 = ABC Rotation Expected 2 = ACB Rotation Expected	Filter input phase orientation
V_LINE_AB_RMS	30	Output	Volts RMS 4800 = 480 Vrms Range: 0 to 1000 Vrms	Source Utility Line Phase to Phase Voltage (A-B)
V_LINE_BC_RMS	31	Output		Source Utility Line Phase to Phase Voltage (B-C)
V_LINE_CA_RMS	32	Output		Source Utility Line Phase to Phase Voltage (C-A)
V_LOAD_AB_RMS	50	Output		Filter Output Phase to Phase Voltage (A-B)
V_LOAD_BC_RMS	51	Output		Filter Output Phase to Phase Voltage (B-C)
V_LOAD_CA_RMS	52	Output		Filter Output Phase to Phase Voltage (C-A)
V_TRAP_A_RMS	70	Output		Filter Tuned Circuit Phase A Voltage
V_TRAP_B_RMS	71	Output		Filter Tuned Circuit Phase B Voltage
V_TRAP_C_RMS	72	Output		Filter Tuned Circuit Phase C Voltage
I_LINE_A_RMS	36	Output		Amps RMS 1,000 = 1,000 ARMS Range: 0 to 1000 Arms
I_LINE_B_RMS	37	Output	Filter Input Current Phase B	
I_LINE_C_RMS	38	Output	Filter Input Current Phase C	
I_LOAD_A_RMS	56	Output	Filter Output Current Phase A	
I_LOAD_B_RMS	57	Output	Filter Output Current Phase B	
I_LOAD_C_RMS	58	Output	Filter Output Current Phase C	
I_TUNE_A_RMS	76	Output	Filter Tuned Circuit Current Phase A	

I_TUNE_B_RMS	77	Output		Filter Tuned Circuit Current Phase B
I_TUNE_C_RMS	78	Output		Filter Tuned Circuit Current Phase C
I_LINE_A_THD	39	Output	% THID 50 = 5.0% THID	Phase A THID for line current feedback
I_LINE_B_THD	40	Output		Phase B THID for line current feedback
I_LINE_C_THD	41	Output		Phase C THID for line current feedback
I_LOAD_A_THD	59	Output		Phase A THID for load current feedback
I_LOAD_B_THD	60	Output		Phase B THID for load current feedback
I_LOAD_C_THD	61	Output		Phase C THID for load current feedback

Read Parameters:

Table 28: Network Interface OUTPUT/Feedback Register Map

Parameter Name	I/O Reg Address Offset	Direction	Data Values and Examples	Description
I_TUNE_A_THD	79	Output	% THID 50 = 5.0% THID	Phase A THID for tuned circuit current feedback
I_TUNE_B_THD	80	Output		Phase B THID for tuned circuit current feedback
I_TUNE_C_THD	81	Output		Phase C THID for tuned circuit current feedback
V_LINE_AB_THD	33	Output	% THVD 50 = 5.0% THVD	A-B Phase to Phase THVD
V_LINE_BC_THD	34	Output		B-C Phase to Phase THVD
V_LINE_CA_THD	35	Output		C-A Phase to Phase THVD
V_LOAD_AB_THD	53	Output		A-B Phase to Phase THVD
V_LOAD_BC_THD	54	Output		B-C Phase to Phase THVD
V_LOAD_CA_THD	55	Output		C-A Phase to Phase THVD
V_TRAP_A_THD	73	Output		Tuning circuit A Phase THVD
V_TRAP_B_THD	74	Output		Tuning circuit B Phase THVD
V_TRAP_C_THD	75	Output		Tuning circuit C Phase THVD
I_LINE_A_TDD	42	Output		% iTDD 50 = 5.0% iTDD
I_LINE_B_TDD	43	Output	Filter input total Demand Distortion Phase B iTDD	
I_LINE_C_TDD	44	Output	Filter input total Demand Distortion Phase C iTDD	
SYS_POWER_ON	201	Output	0 = Power Off 1 = Power On	Indicates if the filter has input power available
SYS_STATUS_OK	202	Output	0 = Filter is operating 1 = Filter has indicated status warning	Indicates filters status
SYS_AT_CAPACITY	203	Output	0 = Nominal 1 = At Capacity	Indicates if the filter is running at its maximum current capacity
SYS_STATE	256	Output	0,1 = Initialization 2 = Power on Delay 3 = Unit Self State Inhibit 4 = Reset 5 = Force Open Contactor 6 = Force Close Contactor 7 = Auto Load Open 8 = Auto Load Close 9 = Auto kVAR Close 10 = Auto kVAR Open 11 = External Open 12 = External Close 13 = No Contactor 14 = Contactor Closed Inhibited 15 = Calibrate offsets 16 = Calibrate Magnitude 17 = No Communication 18 = Communication configuration 19 = Calibrate Check	Indicates the present state of the system state machine.

Read Parameters:

Table 29: Network Interface OUTPUT/Feedback Register Map

Parameter Name	I/O Reg Address Offset	Direction	Data Values and Examples	Description
P_LINE_APPARENT_TOTAL	100	Output	100 = 100 kVA Range: 0 to 1000 kVA	Total Filter input apparent power.
P_LINE_REAL_TOTAL	101	Output	100 = 100kW Range: 0 to 1000 kW	Total Filter input real power.
P_LINE_REACTIVE_TOTAL	102	Output	100 = 100 kVAR Range: 0 to 1000 kVAR	Total Filter input reactive power; Negative number indicates inductive power; Positive number indicates capacitive power.
P_LINE_POWER_FACTOR	103	Output	1,000 = 1.00 Unity PF -95 = 0.95 Lagging PF 95 = 0.95 Leading PF Range: -99 to 1000	Filter input Displacement Power Factor – Negative value indicates lagging power factor.
P_LOAD_APPARENT_TOTAL	120	Output	100 = 100 kVA Range: 0 to 1000 kVA	Total Filter output apparent power.
P_LOAD_REAL_TOTAL	121	Output	100 = 100kW Range: 0 to 1000 kW	Total Filter output real power.
P_LOAD_REACTIVE_TOTAL	122	Output	100 = 100 kVAR Range: 0 to 1000 kVAR	Total Filter output reactive power; Negative number indicates inductive power. Positive number indicates capacitive power.
P_LOAD_POWER_FACTOR	123	Output	1,000 = 1.00 Unity PF -95 = 0.95 Lagging PF 95 = 0.95 Leading PF Range: -99 to 1000	Filter output Displacement Power Factor – Negative values indicates lagging power factor.
I_LINE_A_HARM_1	140	Output	Fundamental = 1000 = 100% Range: 0 to 100 %	Filter input phase A spectrum data. Data points from the fundamental to the 25 th harmonic. If the user would like the full spectrum data points up to the 50 th harmonic; the user will have to run the full data capture command.
I_LINE_A_HARM_3	141	Output		
I_LINE_A_HARM_5	142	Output		
I_LINE_A_HARM_7	143	Output		
I_LINE_A_HARM_11	144	Output		
I_LINE_A_HARM_13	145	Output		
I_LINE_A_HARM_17	146	Output		
I_LINE_A_HARM_19	147	Output		
I_LINE_A_HARM_23	148	Output		
I_LINE_A_HARM_25	149	Output		
I_LINE_B_HARM_1	160	Output	Fundamental = 1000 = 100% Range: 0 to 100 %	Filter input phase B spectrum data. Data points from the fundamental to the 25 th harmonic. If the user would like the full spectrum data points up to the 50 th harmonic; the user will have to run the full data capture command.
I_LINE_B_HARM_3	161	Output		
I_LINE_B_HARM_5	162	Output		
I_LINE_B_HARM_7	163	Output		
I_LINE_B_HARM_11	164	Output		
I_LINE_B_HARM_13	165	Output		
I_LINE_B_HARM_17	166	Output		
I_LINE_B_HARM_19	167	Output		
I_LINE_B_HARM_23	168	Output		
I_LINE_B_HARM_25	169	Output		
I_LINE_C_HARM_1	180	Output		

I_LINE_C_HARM_3	181	Output	Fundamental = 1000 = 100% Range: 0 to 100 %	Filter input phase C spectrum data. Data points from the fundamental to the 25 th harmonic. If the user would like the full spectrum data points up to the 50 th harmonic; the user will have to run the full data capture command.
I_LINE_C_HARM_5	182	Output		
I_LINE_C_HARM_7	183	Output		
I_LINE_C_HARM_11	184	Output		
I_LINE_C_HARM_13	185	Output		
I_LINE_C_HARM_17	186	Output		
I_LINE_C_HARM_19	187	Output		
I_LINE_C_HARM_23	188	Output		
I_LINE_C_HARM_25	189	Output		

Read Parameters:

Table 30: Network Interface OUTPUT/Feedback Register Map

Parameter Name	I/O Reg Address Offset	Direction	Data Values and Examples	Description	
BOARD_TEMP	204	Output	Range -40C to 75C	Board will give a status condition of overtemp if it exceeds 75C or undertemp if the temperature descends past -40C	
CNT_CLOSED	200	Output	0 = Contactor Closed 1 = Contactor Open	Indicates the status of the Filters tuned circuit contactor.	
STATUS_FILTER_A	210	Output	0 = Disabled To Enable desired status detections, enter bit mask from table by converting to decimal Range: 0 to 65535	Reference Table 25 above for filter status detections.	
STATUS_FILTER_B	211	Output			
STATUS_FILTER_A_ENABLE_RO	220	Output			
STATUS_FILTER_B_ENABLE_RO	221	Output			
STATUS_FILTER_A_RELAY_ACTION_RO	230	Output			
STATUS_FILTER_B_RELAY_ACTION_RO	231	Output			
STATUS_FILTER_A_CNT_ACTION_RO	240	Output		Reference Table 26above for line status detections.	
STATUS_FILTER_B_CNT_ACTION_RO	241	Output			
STATUS_LINE	212	Output			
STATUS_LINE_ENABLE_RO	222	Output			
STATUS_LINE_RELAY_ACTION_RO	232	Output		Reference Table 27above for load status detections.	
STATUS_LINE_CNT_ACTION_RO	242	Output			
STATUS_FILTER_LOAD	213	Output			
STATUS_FILTER_LOAD_ENABLE_RO	223	Output			
STATUS_FILTER_LOAD_RELAY_ACTION_RO	233	Output		0 = Always Open 1 = Always Closed DEFAULT: 2= Auto load 3 = Auto kVAR 4 = External Control Input 5 = No contactor	Contactor control; keep contactor always off/on, auto turn on/off based on desired load percentage or kVAR, external relay input.
STATUS_FILTER_LOAD_CNT_ACTION_RO	243	Output			
SYS_CONTROL_MODE_RO	250	Output			
TRACE_GO_DONE_RO	251	Output	0 = Capture Done 1 = Start Capture	Indicates waveform data	

SYS_AUTO_FAULT_RESET_RO	252	Output	0 = Disabled 1 = Enabled	Displays auto contactor reset
CT_RATIO_RO	253	Output	XXXX:5 where XXXX is the primary turns count of the CT 1000 = 1000:5 Range 5 to 10000	Dual Turned Circuit Current Transformer (CT) ratios Note: Only required for units with two tuned circuits
PARAM_ACCESS_LEVEL_RO	254	Output	0 = Base access 1 = Tech access	Level of parameter access to read and/or change parameter inputs
PARAM_STATE	255	Output	0-11, 13-17 = restore, parameter load, save, reboot in progress. 12 = parameter load complete	Indicates the present state of the parameter state machine. Read only value.

Read Parameters:

Table 31: Network Interface OUTPUT/Feedback Register Map

Parameter Name	I/O Reg Address Offset	Direction	Data Values and Examples	Description
CNT_STATUS	257	Output	0 = Contactor Closed 1 = Contactor Open	Contactor command status
RATED_VOLTAGE_RO	260	Output	4800 = 480Vrms Range: 120 to 690 Vrms	Filter rated voltage
RATED_CURRENT_RO	261	Output	1000 = 100 A Range: 3 to 1500 Arms	Filter rated current
RATED_FREQUENCY	262	Output	50 = 50 Hz 60 = 60 Hz	Filter rated frequency
CNT_CLOSE_LOAD_THRESHOLD_RO	270	Output	DEFAULT: 30 = 30% Range: 10 to 100 %	Contactor close threshold based on the load *
CNT_CLOSE_LOAD_HYSTERESIS_RO	271	Output	DEFAULT: 5 = 5% Range: 2 to 50 %	Contactor will open when it reaches the hysteresis percentage
CNT_CLOSE_KVAR_THRESHOLD_RO	272	Output	100 = 100 kVAR Range: 0 to 1000 kVAR	Contactor close threshold for kVAR control*
CNT_CLOSE_KVAR_HYSTERESIS_RO	273	Output	DEFAULT: 10 = 10% Range: 5 to 100 %	Contactor will open when it reaches the hysteresis percentage
CNT_CLOSE_DELAY_RO	274	Output	DEFAULT: 5 = 5 seconds Range: 1 to 3600 seconds	Displays set value of contactor closed delay time
CNT_OPEN_DELAY_RO	275	Output	DEFAULT: 5 = 5 seconds Range: 1 to 3600 seconds	Displays set value of contactor open delay time
CNT_AUTO_RECLOSE_DELAY_RO	280	Output	DEFAULT: 300 = 300 seconds Range: 120 to 3600 seconds	Indicates contactor auto reclose delay time
CNT_POWER_ON_DELAY_RO	281	Output	DEFAULT: 0 = 0 seconds Range: 0 to 3600 seconds	Indicates contactors power on delay time
CNT_AUTO_RECLOSE_ATTEMPS_RO	282	Output	DEFAULT: 5 = 5 attempts Range 1 to 15	Indicates set value of attempts
CNT_AUTO_RECLOSE_TIMESPAN_RO	283	Output	DEFAULT: 1800 = 1800 seconds Range: 300 to 3600 seconds	Displays timespan of contactor to reclose
CNT_AUTO_RECLOSE_TIMER_RO	284	Output		Displays count down time for contactor to reclose

SYS_CNT_MIN_OFF_TIME_RO	285	Output	DEFAULT: 60 = 60 seconds Range: 30 to 300 seconds	Minimum time off for contactor re-closures
SYS_CNT_MIN_OFF_TIMER	286	Output		Displays count down time for contactor re-closures
MB_SLAVE_ADDRESS_RO	300	Output	DEFAULT: = 10 Range: 0 to 255	Modbus slave address
MB_BAUD_RATE_RO	301	Output	960 = 9600 moderate 3840 = 38400 baud rate DEFAULT: 11520 = 115200 baud rate	Modbus baud rate
BGM_PASSKEY_A	375	Output	Range: 0 to 15	Read Only value of BGM password high bytes.
BGM_PASSKEY_B	376	Output	Range: 0-65535	Read Only value of BGM password set low bytes.
BGM_SECURITY_LEVEL_RO	377	Output	Default: 0 = Low Security 1 = High Security	BGM Security level. High Security mode blocks new pairing requests. Passkey changes each time a connection is attempted.
BGM_NUMERIC_ID_RO	378	Output	DEFAULT: 0	Read only value of BGM Numeric ID.
BGM_PAIRING_MODE_RO	379	Output	0 = No active request 1 = Active request	Read Only value of BGM pairing mode.
BGM_MODULE_STATUS	380	Output	0 = Idle 1 = Advertising 2 = Connected	Current status of the BGM (Bluetooth LE module).

Read Parameters:

Table 32: Network Interface OUTPUT/Feedback Register Map

Parameter Name	I/O Reg Address Offset	Direction	Data Values and Examples	Description
MB_PARITY_RO	302	Output	0 = None 1 = Odd DEFAULT: 2 = Even	Modbus Parity
RELAY_INPUT_STATUS	320	Output	0 = Enabled DEFAULT: 1 = Disabled	Digital relay status
RELAY_INPUT_1_CONFIG_RO	321	Output	DEFAULT: 0 = Disabled 1 = Tuning Reactor Thermal Switch Input 2 = Line Reactor Thermal Switch Input 3 = Reset Command 4 = External Control Input	Customer external control input 1
RELAY_INPUT_2_CONFIG_RO	322	Output	DEFAULT: 0 = Disabled 1 = Tuning Reactor Thermal Switch Input 2 = Line Reactor Thermal Switch Input 3 = Reset Command 4 = External Control Input	Customer external control input 2
SYS_SERIAL_NUM_2_RO	350	Output	Parameter contains UUUU in the UUUULLLL-NN serial number format.	Unit serial number section - upper 16 bits of 32-bit unit job number
SYS_SERIAL_NUM_1_RO	351	Output	Parameter contains LLLL in the UUUULLLL-NN serial number format.	Unit serial number section - lower 16 bits of 32-bit unit job number
SYS_SERIAL_NUM_0_RO	352	Output	Parameter contains NN in the UUUULLLL- NN serial number format.	Unit serial number section - two-digit unit number
SYS_DS_MODE	360	Output	DEFAULT: 0 = Not in Data Sim Mode 1 = Data Sim Mode	Indicates if the processor is in data simulation mode.
SYS_NULL_STAT	400	Output	0 = Not calibrated 1 = Unit is calibrated	System auto null status *
SYS_NULL_TMR	401	Output	0 = Unit is not calibrating 1 = Unit is Calibrating	System null timer; indicates whether the unit is calibrating*
SYS_INT_HB	402	Output	Range: 0 to 65535	Processor internal heartbeat. Internal counter that counts and rolls over to zero used to verify processor clock operation. *
SYS_BG_HB	403	Output	Range: 0 to 65535	Processor background heartbeat. Internal counter that counts and rolls over to zero used to verify processor clock operation *
SYS_MAG_CAL_STATUS	404	Output	DEFAULT: 0 = No Action 1 = Start Calibration	Read Only version of current calculation magnitude calibration enable.

Waveform Data:

The waveform data displayed by the PQconnect is available in the Modbus read analog input register data space. Use function code 4 for reading inputs.

Table 33: Waveform Data

Waveform	Address	Length
Filter Line Voltage Phase A	0	192
Filter Line Voltage Phase B	192	192
Filter Line Voltage Phase C	384	192
Filter Line Current Phase A	576	192
Filter Line Current Phase B	768	192
Filter Line Current Phase C	960	192
Filter Load Voltage Phase A	1152	192
Filter Load Voltage Phase B	1344	192
Filter Load Voltage Phase C	1536	192
Filter Load Current Phase A	1728	192
Filter Load Current Phase B	1920	192
Filter Load Current Phase C	2112	192
Filter Line Voltage Phase A Spectrum	2304	50
Filter Line Voltage Phase B Spectrum	2354	50
Filter Line Voltage Phase C Spectrum	2404	50
Filter Line Current Phase A Spectrum	2454	50
Filter Line Current Phase B Spectrum	2504	50
Filter Line Current Phase C Spectrum	2554	50
Filter Load Voltage Phase A Spectrum	2604	50
Filter Load Voltage Phase B Spectrum	2654	50
Filter Load Voltage Phase C Spectrum	2704	50
Filter Load Current Phase A Spectrum	2754	50
Filter Load Current Phase B Spectrum	2804	50
Filter Load Current Phase C Spectrum	2854	50

6.0 PQconnect Troubleshooting

HarmonicGuard® Passive Filter Status Warning

If the desktop interface indicates a status warning, hover over the status detection for a brief description. Depending on the condition there are multiple ways to try and clear the status warnings.

<p>Warning</p> 	<p>Only qualified electricians should carry out all electrical installation & maintenance work on the HGP. Disconnect all sources of power to the HGP and connected equipment before working on the equipment. Do not attempt any work on a powered HGP.</p> <p>This HGP unit contains high voltages and capacitors. Wait at least five minutes after disconnecting power from the filter before attempting to service the conditioner. Check for zero voltage between all terminals on the capacitors. Also, check for zero voltage between all phases of the input and output lines. All maintenance and troubleshooting must be done by a qualified electrician. Failure to follow standard safety procedures may result in death or serious injury. Unless an external disconnect means has been provided everything ahead of the filter circuit breaker, including the reactors, will still be energized.</p>
---	---

Receiving Inspection

The connectivity board has been thoroughly inspected and functionally tested at the factory and carefully packaged for shipment. After receiving the unit, immediately inspect the shipping container and report any damage to the carrier that delivered the unit. Verify that the part number of the unit received is the same as the part number listed on the purchase order.

Connectivity Board Problem

The HGP is comprised of five major components; the PQconnect connectivity board, the line reactor, the tuning reactor, the contactor and the capacitors. The PQconnect PCB contains diagnostic LEDs. The locations of the LEDs are shown in Figure 16 and their functions are listed in Table 34: LED Functions below.

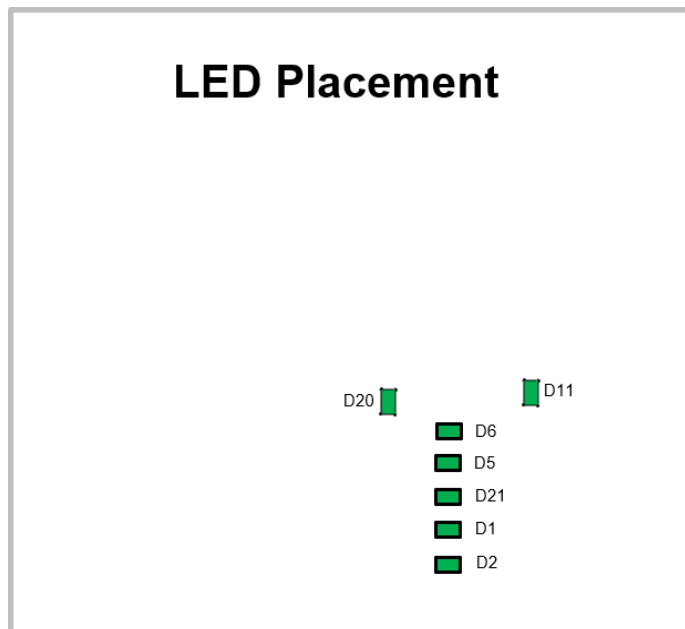

Figure 14: PQconnect LED Placements

Table 34: LED Functions

LED	LED Color	Description
D1	Green	Tuned circuit contactor control 1
D2	Green	Optional 2 nd Status LED/ tuned circuit contactor control 2
D5	Green	Status LED
D6	Green	Microprocessor Status LED
D11	Green	RS485 Communication is active
D20	Green	24V LED
D21	Green	5V LED

Note: Status LED's will blink according to the filter status. The microprocessor status LED will blink 1hz if the filter is okay, however if there has been an alert the LED will blink according to the status detection. It will initially start with a slow blink (2 = filter lower, 3 = filter upper, 4 = filter input, 5 = filter load) then blink fast depending on the status code.

The table below shows the specified blinks for each status condition.

Table 35: Specified Blinks for Each Status Condition

Status Condition	Group (Slow blinks)	LED Specifier (Fast Blinks)
Tune Phase A Loss	2	1
Tune Phase B Loss		2
Overvoltage Phase C		3
Tune Balance Loss Phase A		4
Tune Balance Loss Phase B		5
Tune Balance Loss Phase C		6
Tune Undercurrent Phase A		7
Tune Undercurrent Phase B		8
Tune Undercurrent Phase C		9
Tune Overcurrent Phase A		10
Tune Overcurrent Phase B		11
Tune Overcurrent Phase C		12
Under Temperature		13
Over Temperature		14
CPU Error		15
Tune Reactor Thermal		16
Reclose Limit	3	1
Line Reactor Thermal		4
Filter Line Phase A Loss	4	1
Filter Line Phase B Loss		2
Filter Line Phase C Loss		3
Filter Line Overvoltage Phase A		4
Filter Line Overvoltage Phase B		5
Filter Line Overvoltage Phase C		6
Filter Line Frequency Mismatch		7
Filter Line High THVD		8
Filter Line Phase Rotation		9
Filter Load Phase A imbalance	5	1
Filter Load Phase B imbalance		2
Filter Load Phase C imbalance		3
Filter Load Phase A Overcurrent		4
Filter Load Phase B Overcurrent		5
Filter Load Phase C Overcurrent		6

Communication Problems

- J5 Communication Header
 - With the power de-energized from the filter, check wiring leading to J5 header
 - If the user is using a different RS485 converter than the example above, please follow the datasheet for the A & B signals and ground for proper setup
- Ensure the drivers of the RS485 to USB converter is installed to the computer. Simple way of checking while the RS485 converter connected is to go to the device manager and scroll down to ports. There will be a device connected to the ports. If your device is not listed, the user will need to install the correct drivers of the RS485 converter.

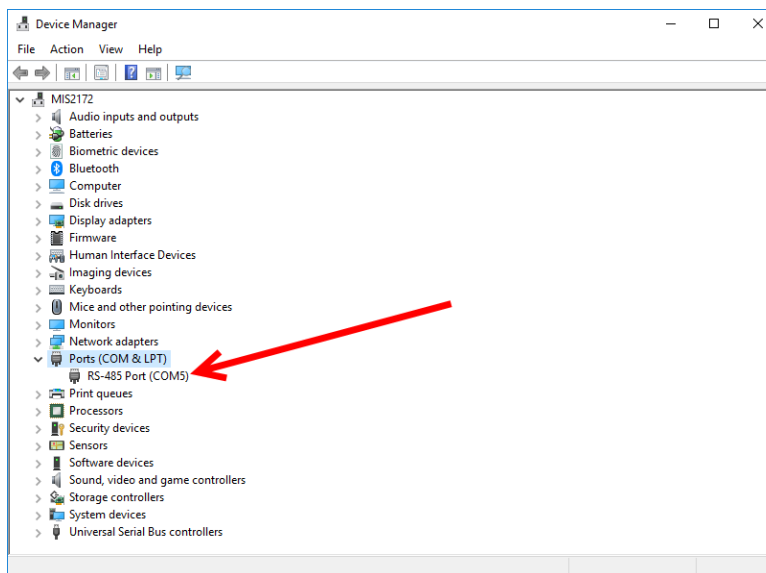

- PQvision App Load Defaults
 - With the RS485 Converter connected to the circuit board
 - Energize Filter
 - Open PQvision desktop interface
 - Go to **Settings**
 - Select Load Defaults
 - Select Apply
 - Default Modbus settings should be applied. Try connecting to the COM port
 - If this doesn't work de-energize power to the filter and try flipping the A and B signal wires leading to the J5 header of the circuit board.
- Hard Reset Modbus settings (Worst Case)
 - To perform a hard reset of Modbus settings the user will need to remove jumper J20 with the power de-energized from the filter. Once the jumper is removed connect the RS485 converter to J5 header and energize filter.
 - Open PQvision
 - Confirm there is a COM port under Communication and try to connect
 - Note if connecting to the COM port does not work, try flipping the A and B signal wires leading to the J5 header of the circuit board
 - Load defaults and apply
 - Save settings and de-energize filter
 - Connect jumper to J20
 - Energize filter
 - Try connecting to PCB
 - All Modbus settings should be set to default settings at this point
 - If the board doesn't connect after trying hard reset contact TCI Tech-Support

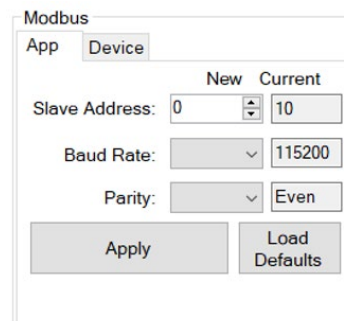

Debug Status Conditions

Based on the status condition there are various ways a status can appear. Some status conditions are not critical are used as warnings. Before investigating the filter internally, disengage supply voltage to the filter. If problems persist after initial checks, please contact TCI Tech-Support.

Table 36: Status Conditions

Status Condition	Description	Debug/ Resolution
Filter Tune Phase Loss A, B, or C	Phase loss in one of the phases of the filter tune circuit	Check fuses of the tune circuit Check power connections of the tune circuit Check voltage sense wires leading to the board and reactor, make sure they are properly connected
Filter Tune balance Loss Phase A, B, or C	Filter tune imbalance on one of the phases.	Check power connections of the tune circuit Check voltage sense wires leading to the board and reactor, make sure they are properly connected
Filter Tune Undercurrent Phase A, B, or C	Filter tune current is seeing less current than expected	Make sure you have the right size filter selected for the application. Based on the model number the filter will expect a certain amount of current in the tune circuit. Check voltage sense wires leading to the board and reactor, make sure they are properly connected
Filter Tune Overcurrent Phase A, B, or C	Filter tune current is seeing more current than expected	Make sure you have the right size filter selected for the application. Based on the model number the filter will expect a certain amount of current in the tune circuit. Check voltage sense wires leading to the board and reactor, make sure they are properly connected
Under Temperature	Filter ambient temperature is operating below threshold (-40C)	Check fuses of control power transformers leading to the heater.
Over Temperature	Filter ambient temperature is operating above threshold (+75C)	Check fuses of control power transformers leading to fans. Make sure fans are operating
CPU Error	Processor Malfunction	Power cycle unit and if issue persists upgrade firmware and/or contact tech support
Reactor Thermal Switch	Reactor Thermal Switch is open	Check thermal switch connections to PCB and check if thermal switch is damaged
Reclose Limit	Contact Reclose is at its limit	The contactor will close for many reasons if you are experiencing any issues with the contactor view Table 37 for further details.
Filter Line Phase Loss A, B, or C	Filter line phase loss	Check fused disconnect or circuit breaker upstream of the filter. Check input power connections to the filter
Filter Line Overvoltage Phase A, B, or C	Filter overvoltage on one of the phases.	Check input power connections to filter Check voltage setpoint, based on the filter model number entered the filter is expecting a certain input voltage.
Filter Frequency Mismatch	Line Frequency does not match program setpoint	During the user calibration the filter frequency is set based on the model number entered. Verify the frequency
Filter Line High THVD	High voltage Total Harmonic Distortion	Check fuses leading to filter capacitors If fuses are not blown, measure Capacitance of the capacitors Check power connections of the unit
Filter Line Rotation	Filter phase rotation	Phase rotation differs from default setting. Status condition can be turned off or switched to ACB
Filter Load Phase Imbalance A, B, or C	Phase imbalance between the phases	Check power connections of the line side of the filter Check voltage sense wires leading to the board and reactor, make sure they are properly connected
Filter load Overcurrent Phase A, B, or C	Filter output current is more than expected	Make sure you have the right size filter selected for the application. Based on the model number the filter will expect a certain amount of current in the tune circuit. Check voltage sense wires leading to the board and reactor, make sure they are properly connected

Contactor Problem

Parameter 257 Contactor Status can be used to determine why the PQconnect board is not closing the tuned circuit contactor. The following tables define what a specific contactor status code value means and list potential resolutions to allow the contactor to close.

Note that some setpoint parameters require tech level parameter access to be viewable over the serial connection or via the PQvision software. The tech level parameter access key is available above.

Table 37: Contactor Codes

Code	Description	Resolution
1	Contactor is already commanded closed.	The PQconnect is presently commanding the tuned circuit contactor to be closed. If the contactor is not closing check the wiring from the PCB J11 control relay header to the tuned circuit contactor and 120VAC control power transformer.
2	Contactor is open due to a Force Open control mode.	The present contactor control mode (feedback parameter 250) is set to Force Open. This control mode will always keep the contactor open. To change the control mode, see setpoint parameter 510.
3	Contactor is open due to an automatic load control mode and insufficient load Amps to close the contactor.	The present contactor control mode (feedback parameter 250) is set to Automatic Load Control and the measured filter load Amps are below the configured close threshold (feedback parameter 270). The contactor will be closed when the filter load Amps exceed the close threshold. The contactor close filter load current threshold can be adjusted via setpoint parameter 570. The contactor close threshold parameter is scaled in units of percent rated nameplate filter current.
4	Contactor is open due to an automatic kVAR control mode.	The present contactor control mode (feedback parameter 250) is set to Automatic kVAR Control and closing the contactor would exceed the max allowable kVAR flowing to the source to be exceeded (feedback parameter 272). The contactor will be closed when the inductive load kVAR minus the capacitive tuned circuit kVAR of the passive filter is below the max kVAR setpoint parameter. The max kVAR setpoint parameter can be adjusted via setpoint 572.
5	Contactor is open due to an external contactor open command.	The present contactor control mode (feedback parameter 250) is set to External Control and the external command is set to open the contactor. The external contactor control command is wired to the PQconnect PCB header J7 where shorting pins 1 and 2 of that header equal a close command. The internal state of the external control command can be audited via feedback parameter 320 in bit position 0. If an external contactor close command is correctly being input to the PQconnect board then confirm the J7 header input is configured as the external control command by verifying feedback parameter 321 is set to a value of 2=external command input. If the input configuration parameter 321 is not set to 2=external command input the input configuration can be changed via setpoint parameter 610.
6	Contactor is open because the PQconnect has been configured without a contactor.	The present contactor control mode (feedback parameter 250) is set to No Contactor Mode. No Contactor mode is typically reserved for HGP units that do not include a tuned circuit control contactor. If your HGP unit does include a tuned circuit contactor but the PQconnect is configured to not support a contactor, please call TCI technical support.

Table 38: Contactor codes

Code	Description	Resolution
7	Contactor is open due status detection.	<p>The contactor is open due to a filter, filter line, or filter load status detection being detected that is configured to open the tuned circuit contactor when detected. The PQconnect continuously monitors the internal conditions of the HGP passive filter and the external conditions of the filter line and load currents and voltages. Some status conditions, such as tuned circuit overcurrent, are configured to open the tuned circuit contactor when detected as a self-protection feature.</p> <p>The presently configured contactor open actions can be audited using feedback parameters 240-Filter A, 241-Filter B 242-Filter Line and 243 Filter Load. The set or clear status of these contactor open status detections can be viewed via feedback parameters 210-Filter A, 211-Filter B 212-Filter Line and 213 Filter Load. Also, the present value of all status detections and wither they are configured to open the tune circuit contactor when detected can be viewed via the PQvision software settings menu screen.</p> <p>To reset all status conditions and attempt to re-close the contactor the unit can be power cycled, a serial command can be sent over the network interface via setpoint parameter 502, or an external wired reset command can be input to the PQconnect PCB at header J8 where shorting pins 1 and 2 of that header equal a close reset command. The internal state of the external wired reset command can be audited via feedback parameter 320 in bit position 1. If an external reset command is correctly being input to the PQconnect board then confirm the J8 header input is configured as the external reset command by verifying feedback parameter 322 is set to a value of 1=external reset command input. If the input configuration parameter 322 is not set to 1=external reset command input the input configuration can be changed via setpoint parameter 611.</p>
8	Contactor is open due to a parameter inhibit condition.	The contactor is open because the PQconnect is still loading stored parameters in flash memory. This condition should clear shortly after the unit is powered up. If this contactor status condition persists power cycle the unit and call TCI technical support if the condition does not clear.
9	Contactor is open due to a unit power on delay.	The contactor is open because the PQconnect is waiting for the configured power on delay time to expire. The power on delay time in units of seconds can be viewed via feedback parameter 281. The power on delay time can be adjusted via setpoint parameter 581.
10	Contactor is open due to a calibration inhibit.	The contactor is open because the unit is presently undergoing an internal calibration procedure, or no calibration data has been stored to the unit's flash memory. If this contactor status condition persists power cycle the unit and call TCI technical support if the condition does not clear.
11	Contactor is being held open due to the minimum reclose timer.	<p>An internal contactor close event is pending but the contactor is being held open because it was recently closed, and the minimum reclose time has not been yet achieved. The minimum contactor re-close time in units of seconds is viewable via feedback parameter 285. This time out period allows any residual stored charge in the tune circuit capacitors to be dissipated by bleeder resistors before the tune circuit is re-energized.</p> <p>If a minimum time is not enforced between repeated contactor close events the contactor may re-close and apply line voltage out of phase with the residual voltage on the tuned circuit capacitors. This could cause high currents to flow through the tuned circuit contactor and potentially blow the contactor protective fuses. The remaining time on the minimum contactor re-close timer can be viewed on feedback parameter 286.</p>
12	Contactor is being held open due to close delay timer.	An internal contactor close event is pending but the contactor is being held open because the configured contactor close delay time out period has not yet been achieved. The automatic contactor control modes (load current control and line kVAR control) are configured with contactor close and open delay timers to avoid changing the contactor state due to short transient conditions. The presently configured contactor close delay time in units of seconds is viewable via feedback parameter 274. The contactor close delay time can be adjusted via setpoint parameter 574
13	Contactor is being held open due to the auto reclose delay	<p>An internal contactor automatic reclose event is pending but the contactor is being held open because the configured automatic re-close time has not been achieved yet.</p> <p>The PQconnect continuously monitors the internal conditions of the HGP passive filter and the external conditions of the filter line and load currents and voltages. Some status conditions are configured to open the tuned circuit contactor when detected as a self-protection feature. An optional feature can be enabled (feedback parameter 252) to attempt to re-close the tuned circuit contactor after a status condition has been detected. The auto reclose enable setpoint parameter is parameter 511 and the auto reclose delay time setpoint parameter is parameter 580.</p>

Table 39: Contactor codes

Code	Description	Resolution
14	<p>Contactor is being held open due to auto reclose limit being reached.</p>	<p>An internal contactor automatic reclose event is pending but the contactor is being held open because the number of re-close attempts in a set time has been exceeded.</p> <p>The PQconnect continuously monitors the internal conditions of the HGP passive filter and the external conditions of the filter line and load currents and voltages. Some status conditions are configured to open the tuned circuit contactor when detected as a self-protection feature. An optional feature can be enabled (feedback parameter 252) to attempt to re-close the tuned circuit contactor after a status condition has been detected. However, if too many re-close attempts (parameter 282) are made within a set time (parameter 283) the unit will stop attempting to auto reclose.</p> <p>To debug which status conditions caused the contactor open event the presently configured contactor open actions can be audited using feedback parameters 240-Filter A, 241-Filter B 242-Filter Line and 243 Filter Load. The set or clear status of these contactor open status detections can be viewed via feedback parameters 210-Filter A, 211-Filter B 212-Filter Line and 213 Filter Load. Also, the present value of all status detections and wither they are configured to open the tune circuit contactor when detected can be viewed via the PQvision software settings menu screen.</p> <p>When the auto re-close limit has been reached a power cycle of the passive filter unit is required to clear the condition and allow the contactor to re-close.</p>

<p>Warning</p> 	<p>Many electronic components located within the filter are sensitive to static electricity. Voltages imperceptible to human touch can reduce the life, affect performance and/or destroy sensitive electronic devices. Use proper electrostatic discharge (ESD) procedures when servicing the filter and its circuit boards.</p>
---	---

7.0 Maintenance and Service

HGP Filter Reliability and Service Life

The HGP has been designed to provide a service life that equals or exceeds the life of the VFD. It has been thoroughly tested at the factory to assure that it will perform reliably from the time it is put into service. It is recommended that the following maintenance is performed once a year to ensure that the HGP filter will always operate reliably and provide the expected service life.

Periodic Maintenance

Warning



Only qualified electricians should carry out all electrical installation and maintenance work on the HGP filter. Disconnect all sources of power to the drive and HGP before working on the equipment. Do not attempt any work on a powered HGP.

Check to see that the installation environment remains free from exposure to excessive dirt and contaminants. Refer to the **Pre-installation Planning** section of this manual.

Check to make sure that the enclosure ventilation openings are clean and unobstructed.

Clean the air filter in units that have filtered air inlets. Clean as often as necessary to prevent dirt build-up from impeding air flow.

Check the operation of the cooling fan.

Inspect the interior of the enclosure for signs of overheated components. Clean the interior of the enclosure whenever excess dirt has accumulated.

Torque all power wire connections, loose connections can overheat and damage the filter. All electrical connections must be re-torqued annually.

Troubleshooting

Warning



Only qualified electricians should carry out all electrical installation and maintenance work on the HGP filter. Disconnect all sources of power to the drive and HGP before working on the equipment. Do not attempt any work on a powered HGP filter. The harmonic filter contains high voltages and capacitors. Wait at least five minutes after disconnecting power from the filter before you attempt to service the harmonic filter. Check for zero voltage between all terminals on the capacitors. Also, check for zero voltage between all phases of the line side of the fuses, Fu1(a)–Fu2(a)–Fu3(a), and all input terminals L1, L2 and L3 of the line reactor (KDR). All setup, maintenance, and troubleshooting must be done by a qualified electrician. Failure to follow standard safety procedures may result in death or serious injury.

Note: when disconnecting wires from components and terminations, mark the wires to correspond to their component and terminal connection.

Replacement Parts

If replacement parts are needed, please contact your TCI representative. To ensure that the HGP filter continues to perform to its original specifications, replacement parts should conform to TCI specifications.

Factory Contacts and Tech Support

For technical support, contact your local TCI distributor or sales representative. You can contact TCI directly at 800-TCI-8282. Select "Customer Service" or "Tech Support" and have your HGP filter nameplate information available.



TCI, LLC
W132 N10611 Grant Drive
Germantown, Wisconsin 53022

Phone: 414-357-4480
Fax: 414-357-4484
Helpline: 800-824-8282
Web Site: www.transcoil.com
© 2019 TCI, LLC All rights reserved

Product No: 28557-1

Effective: 04/06/2021 Version: P