

**ATTENTION:**

- GENERAL MANAGER
- PARTS MANAGER
- CLAIMS PERSONNEL
- SERVICE MANAGER

IMPORTANT - All Service Personnel Should Read and Initial in the boxes provided, right.



QUALITY DRIVEN® SERVICE

© 2018 Subaru of America, Inc. All rights reserved.

**PRODUCT CAMPAIGN BULLETIN**

<p><b>APPLICABILITY:</b> 2009-2013 model year Legacy          2009-2013 model year Outback          2009-2013 model year Forester          2009-2013 model year Tribeca          2009-2011 model year Impreza          2009-2013 model year WRX and STI</p> <p><b>SUBJECT:</b> Takata Front Passenger Airbag Inflator Replacement          (2018 Calendar year expansion)</p>	<p><b>NUMBERS:</b> TKA-18          TKB-18          TKC-18</p> <p><b>DATE:</b> 02/09/18</p> <p><b>NHTSA ID:</b> 18V-012          18V-013          18V-014</p>
---	--

SUBARU OF AMERICA, INC. has determined that a defect, which relates to motor vehicle safety, exists in certain Subaru vehicles listed above, equipped with a non-desiccated Takata-sourced passenger side frontal airbag containing the propellant Phase Stabilized Ammonium Nitrate (certain specific vehicles only).

This phase of the Takata recall expansion includes the following model year vehicles:

- Zone A vehicles – 2013 model year and older (Recall code TKA-18)
- Zone B vehicles – 2010 model year and older (Recall code TKB-18)
- Zone C vehicles – 2009 model year and older (Recall code TKC-18)

In addition, any older models not previously recalled which have established registration within Zones A or B since recalls TKA17 and TKB17 were implemented last year will also be included in this phase of the expansion.

**DESCRIPTION OF THE SAFETY DEFECT AND SAFETY HAZARD**

The affected vehicles are equipped with a Takata-sourced passenger side frontal airbag that may be susceptible to moisture intrusion. Over time, that could cause the inflator to rupture when the passenger’s frontal airbag deploys in a crash. If the inflator ruptures, metal fragments could strike vehicle occupants, potentially resulting in serious injury or death.

**BACKGROUND**

The National Highway Traffic Safety Administration (NHTSA) is expanding and prioritizing the recalls of all non-desiccated Takata-sourced passenger side Takata airbag inflators based on the risk of injury or death to vehicle occupants.

*Continued...*

<p><b>CAUTION: VEHICLE SERVICING PERFORMED BY UNTRAINED PERSONS COULD RESULT IN SERIOUS INJURY TO THOSE PERSONS OR TO OTHERS.</b></p> <p>Subaru Service Bulletins are intended for use by professional technicians ONLY. They are written to inform those technicians of conditions that may occur in some vehicles, or to provide information that could assist in the proper servicing of the vehicle. Properly trained technicians have the equipment, tools, safety instructions, and know-how to do the job correctly and safely. If a condition is described, DO NOT assume that this Service Bulletin applies to your vehicle, or that your vehicle will have that condition.</p>	<p><b>SUBARU OF AMERICA, INC. IS ISO 14001 COMPLIANT</b></p> <p>ISO 14001 is the international standard for excellence in Environmental Management Systems. Please recycle or dispose of automotive products in a manner that is friendly to our environment and in accordance with all local, state and federal laws and regulations.</p>
--	--

The combination of time, high temperature fluctuations, and humidity contribute to the degradation of the propellant in the inflators. Therefore, NHTSA is prioritizing the Takata recalls by age and location of the vehicles. To do so, NHTSA has established three geographical Zones – A, B, and C – based on the level of heat and humidity as listed below:

**Zone A: Hot and Humid**

Alabama, California, Florida, Georgia, Hawaii, Louisiana, Mississippi, South Carolina, Texas, Puerto Rico, American Samoa, Guam, the Northern Mariana Islands (Saipan), and the U.S. Virgin Islands.

**Zone B: Less Hot and Humid**

Arizona, Arkansas, Delaware, District of Columbia, Illinois, Indiana, Kansas, Kentucky, Maryland, Missouri, Nebraska, Nevada, New Jersey, New Mexico, North Carolina, Ohio, Oklahoma, Pennsylvania, Tennessee, Virginia, and West Virginia.

**Zone C: Least Hot and Humid**

Alaska, Colorado, Connecticut, Idaho, Iowa, Maine, Massachusetts, Michigan, Minnesota, Montana, New Hampshire, New York, North Dakota, Oregon, Rhode Island, South Dakota, Utah, Vermont, Washington, Wisconsin, and Wyoming.

This phase of the Takata recall expansion includes the following model year vehicles:

- Zone A vehicles – 2013 model year and older (Recall code TKA-18)
- Zone B vehicles – 2010 model year and older (Recall code TKB-18)
- Zone C vehicles – 2009 model year and older (Recall code TKC-18)

Future phases of the Takata recalls will be implemented each year until the year 2020, to include additional vehicles until all non-desiccated Takata-sourced passenger side Takata airbag inflators are recalled.

**REPAIR**

Subaru will replace either the inflator for the front passenger airbag or the airbag module assembly at no cost to the customer.

**OWNER NOTIFICATION**

Owners of the vehicles included in this phase of the Takata recall expansion is expected to begin in February, 2018.

**AFFECTED VEHICLES**

Listed below are the models affected by this phase of the Takata recall expansion. Not all vehicles within these ranges are affected by this phase of the Takata recall, since some of the vehicles within these ranges have already been affected by previous Takata recalls. Therefore, coverage must be confirmed by using the Vehicle Coverage Inquiry function on [subarunet.com](http://subarunet.com). Coverage information will be available prior to owner notification.

*Continued...*

**Recall Code TKA-18 (NHTSA ID 18V-012) - Zone A MY 2013 & Older:**

- 2009-2013 Legacy & Outback
- 2009-2011 Impreza
- 2009-2013 WRX & STI
- 2009-2013 Forester
- 2009-2013 Tribeca

**Recall Code TKB-18 (NHTSA ID 18V-013) - Zone B MY 2010 & Older:**

- 2009-2010 Impreza, WRX & STI
- 2009-2010 Tribeca
- 2009-2010 Legacy & Outback
- 2009-2010 Forester

**Recall Code TKC-18 (NHTSA ID 18V-014) - Zone C MY 2009 & Older:**

- 2009 Impreza, WRX & STI
- 2009 Tribeca
- 2009 Legacy & Outback

**RETAILER AFFECTED VIN LISTS**

Each Subaru retailer will receive an affected VIN list from their Zone office when owner notification begins. Vehicles will be assigned to retailers in the affected VIN list as follows:

- Original vehicle owners are assigned to the original selling retailer when their current address is within a 100-mile radius of that retailer.
- If the original selling retailer is inactive, the VIN has been assigned to the nearest active retailer.
- For any new owners or when original owners live more than 100 miles from the original selling retailer, the VIN has been assigned to the nearest active retailer.

**IMPORTANT: Retailer affected VIN lists include owner name and address information for vehicles affected by this recall. This information will enable retailers to follow-up with owners of potentially affected vehicles. The lists contain owners' names and addresses obtained from State Motor Vehicle Registration Records. The use of such motor vehicle registration data for any other purpose is unlawful. Accordingly, retailers are urged to limit the use of these lists for the purpose of completion of this safety recall.**

**RETAILER PROGRAM RESPONSIBILITY**

Any vehicles listed in a recall/campaign that are in retailer stock must be:

- Immediately identified.
- Tagged or otherwise marked to prevent their delivery or use prior to inspection and/or repair.
- Repaired in accordance with the repair procedures outlined in this Product Campaign Bulletin.

Retailers are to promptly perform the applicable service procedures to correct all affected vehicles in their inventory (used, demo & SSLP) for which parts are available to complete this recall. Additionally, whenever a vehicle subject to this recall is taken into retailer inventory, or in for service, necessary steps should be taken to ensure the recall correction has been made before selling or releasing the vehicle, provided that parts are available to complete this recall.

*Continued...*

## PARTS INFORMATION

The parts required for this recall are the passenger airbag inflator kits or modules listed below.

Until sufficient parts supply is available for Subaru to re-notify owners, recall coverage status for the affected vehicles will show as “Open-Limited Parts Available.” Limited parts supply will become available prior to owner re-notification therefore, this status is not intended to discourage scheduling these repairs and will not affect the retailer’s ability to file a claim for repairs performed prior to owner re-notification.

Airbag Module Part Number	Inflator Kit Part Number	Applicability / Description	Order Quantity
TBD	98279SC010	Forester (2009-2013)	1
98279FG07A	98279FG010	Impreza (2009-2011)	1
		WRX and STI (2009-2013)	
N/A	98279AG00A	2009 Legacy / Outback, Inflator Type 1	1
N/A	98279AG05A	2009 Legacy / Outback, Inflator Type 2	
TBD	98279AJ02A	Legacy (2010-2013)	1
		Outback (2010-2013)	
N/A	98279XA02A	Tribeca (2009-2013)	1
N/A	SOA963W110	2009 Legacy / Outback Non-Woven Material, 8" X 11" Sheet	1

As a reminder, if a customer requests a loaner car, retailers should make every effort to comply with this request and follow normal warranty procedures to obtain reimbursement for the loaner car. See Section 8.4.7 of the Claims Policies and Procedures Manual on [subarunet.com](http://subarunet.com) for details on rental authorizations.

## PART RETURN PROCEDURES

Please review the ‘Inflator/Module Return’ instructions included as ‘Appendix A’ of this bulletin carefully.

- A company called Takata XPO will arrange pick up of the removed inflators/modules and return them to Takata.
- FedEx will no longer handle the return shipments as with previously issued Takata recalls. However, if you do not have a large amount of inflators/modules to pick up, you may be directed to use FedEx for return. Please follow the instructions given to you by Takata XPO.
- Once a month or upon accumulating 200 kits for return (whichever comes first), please call Takata XPO at 1-877-650-3476 for pick up. Please see step 6 (on pg. 30) of the return instructions.

- If you continue to receive inventory of inflators with the original FedEx documentation, please follow the instructions in step 4b. of the new ‘Inflator Returns’ instructions. **DO NOT CALL FEDEX.**

- Upon claim approval and where applicable, Subaru of America, Inc. will generate a Part Return Notice requesting the old and new inflator serial number information only. **DO NOT WAIT FOR TAKATA XPO TO PICK UP THE INFLATOR/MODULE TO SEND THIS**

*Continued...*

## INFORMATION TO THE PARTS COLLECTION CENTER (PCC).

- **IMPORTANT:** Each removed airbag inflator/module must be returned directly to the supplier, Takata USA, in the same box in which the new one was received.

The shipping box contains a bar code label, which will be used by Takata USA to document the replacement of the old inflator/module with the new inflator/module. **Therefore, it is very important for the removed inflator/module be returned in the exact same box which contained the newly-installed inflator/module for that vehicle.** If the original box cannot be re-used, please refer to the shipping instructions under “Requesting a new box/ shipping labels.”

- **IMPORTANT:** When affixing the shipping label to the shipping box do not obstruct the bar code label.
- A completed SOA Warranty Parts Tag (MSA5W402A) must be attached to the returned inflator/module. The tag must contain the following information: claim number, repair date, full 17-digit VIN, and mileage.

## SOA PART RETURN NOTICE INFORMATION



**IMPORTANT NOTE:** The following information is applicable to SOA and Subaru Distributors Corporation (SDC) retailers **ONLY**. Subaru New England (SNE) retailers will continue to follow the procedures currently in place as supplied below.

All SOA and SDC retailers are required to enter **BOTH** the newly-installed (replacement) and the removed (original) serial numbers for the airbag inflator (or module assembly) into the supplied fields as shown in the screen shot below. Claims will not receive an “Approved” status without the serial number information being entered in the appropriate fields in the Recall Claim Entry system. As a result of adding these new required entry fields, Part Return Notices will no longer be generated.

The image shows a screenshot of the Subaru UNET Recall Claim Entry form. The form includes several fields: Claim Type (Recall Campaign), Recall Code (TKC16), Auth Code, Total Amount (\$0.00), VIN (37308358), RO Start Date (11/7/2017), Misc Detail, Status (Working), RO # (756389), RO Completion Date (11/7/2017), Dealer #, Job (A), Rental (\$0.00), Mileage (100,098), Towing (\$0.00), Resultant Damage (checkbox), Tech Name, and SA Name. The 'Installed Serial#' field (XMBLH552899) and the 'Removed Serial#' field (XMBLA242204) are highlighted with red circles.

### The information below is applicable to SNE retailers only:

- Upon claim approval and where applicable, Subaru of America, Inc. will generate a Part Return Notice requesting information only.
- To ensure proper claim credit where applicable, the old and new inflator/module serial numbers must be recorded on the Part Return Notice and sent to SOA Part Collection Center (PCC) as instructed on the return notice.

*Continued...*

- Where applicable, the completed Part Return Notice should then be sent using the YRC web portal and utilizing the “Ship Small Parcel” link which will direct the user to the appropriate UPS web page application to complete the shipment. Please keep the UPS tracking number for your records.
- **DO NOT WAIT FOR TAKATA XPO TO PICK UP THE INFLATOR/MODULE TO SEND THIS INFORMATION TO THE PCC.**

**Under no circumstances should any airbag inflators or modules be sent to Subaru of America, Inc.**

## SERVICE PROCEDURE

This Campaign involves the replacement of the inflator portion of the passenger-side front airbag assembly or the complete module assembly. The subject inflators/modules could have been assembled with improperly manufactured propellant components which may affect how the assembly inflates in the event of a collision resulting in an increased risk of injury to vehicle occupants. This procedure will outline removal of the passenger-side airbag assembly and replacement of either the inflator component and related wiring harness or, the complete module assembly.

**VERY IMPORTANT: Failure to follow these service procedures carefully and correctly may result in an accidental deployment of the inflator and potentially cause serious injury. Please read through and understand these procedures COMPLETELY before beginning repairs. In addition, proper operation of the airbag after reassembly may be compromised if these service procedures are not followed.**

As additional service procedures are developed for the other models affected by the expansion and implementation of this recall campaign, they will be added to this document and also made available on STIS.

## TABLE OF CONTENTS – SERVICE PROCEDURES

Description	Starting Page Number
<a href="#">Service Procedure for 2009MY Legacy/Outback Models, Inflator Type 1</a>	<a href="#">9</a>
<a href="#">Service Procedure for 2009MY Legacy/Outback Models, Inflator Type 2</a>	<a href="#">19</a>
<a href="#">Service Procedure for 2010-2013MY Legacy / Outback Models</a>	<a href="#">30</a>
<a href="#">Service Procedure for 2009-2013MY Forester and 2009-2011MY Impreza, and 2009-2013MY WRX &amp; STI models</a>	<a href="#">37</a>
<a href="#">Service Procedure for 2009-2013MY Tribeca Models</a>	<a href="#">43</a>

### Tools Required

DESCRIPTION	BRAND OR TYPE	QUANTITY
Pliers	-	1
Wire Cutters	-	1
Needle-Nose Pliers	-	1
Torque Wrench	Inch-Pound	1
Safety Goggles	-	1
Flat-Blade Screwdriver	-	1
Scissors	-	1
Ratchet	1/4" Drive	1
8 mm and 10 mm Socket		1 ea.
Airbag Deployment Fixture	J-39401-B	1
Tether Clip Release Tool *See Page 8 for more information	SOA635147	1

**CAUTION:** Before starting this service procedure, perform a visual inspection of both front airbags looking for any damage or abnormality. Next, turn the ignition switch to the “ON” position and confirm the airbag warning lamp illuminates then extinguishes normally. If it does not or if **ANY** concern is noted with the airbag system, **STOP** and report these findings to the customer **BEFORE** proceeding further. Any concerns identified with the airbag system (when no airbag deployment has occurred), are not related to this campaign and must be addressed separately. Even if the system has a concern, this may not preclude completion of this campaign. If you are unsure about proceeding, document and fully diagnose the concern then contact the SOA Technical Helpline to review your findings. It is in the best interest of the retailer to fully document any concerns found during this preliminary inspection and review with the customer **BEFORE** proceeding with the campaign service procedure.

- **Vehicles that do not contain Genuine Subaru airbags are not eligible for this recall repair.** For more information on identifying counterfeit airbags and how to address related customer situations, please refer to STIS for the “Counterfeit Airbag Information” Dealer Advisory Bulletin dated October 25, 2012 by going to [Subarunet>Service>STIS>Online Reference](#) - choose Publication Type: ‘Other/Miscellaneous’ and search keywords: ‘Airbag’).
- **Do not proceed with this repair if your inspection reveals a non-Genuine Subaru airbag module has been installed in the vehicle.** Follow the instructions described in the “Counterfeit Airbag Information” Dealer Advisory Bulletin.
- **IMPORTANT:** Always examine airbag modules closely before and during removal. Confirm they match the photos of the Genuine Subaru airbag components supplied throughout this bulletin **BEFORE** proceeding. The photo below shows an example of an aftermarket or counterfeit airbag inflator. This photo is being provided as an example of what may be a wide variety of non-OEM components.
- If an aftermarket or counterfeit passenger airbag or inflator is identified at any point during the campaign service procedure, **STOP IMMEDIATELY. NEVER attempt to remove or otherwise disable any aftermarket or counterfeit device.**
- Document the presence of the aftermarket or counterfeit device on the repair order and with photos. Report this information immediately on a Quality Monitoring Report (QMR). **IMPORTANT:** When entering a related QMR, use failure code **ULF** and **NOT** the campaign fail code.

*Continued...*

- Once the QMR has been submitted, contact the Subaru Claims Helpline to discuss the details. They will advise you on how to proceed with treatment of the open campaign.

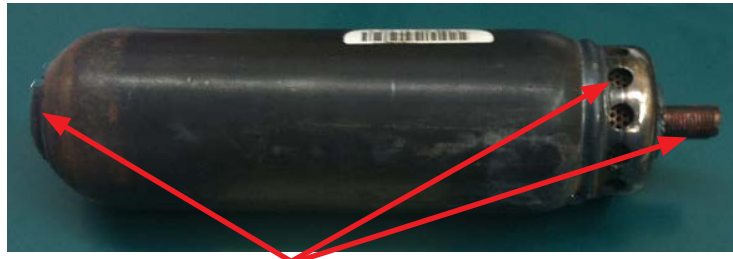

The shape, holes, and copper-colored stud indicate this not a Genuine Subaru inflator.

**NOTE:** Some models utilize a “tether clip” to secure the upper portion of the “A” pillar trim. The tether clip is located just below where the “A” pillar trim meets the head liner. If the tether clip becomes damaged, it **MUST** be replaced. The illustrations and photos below show the location of the tether clip and how to release it. It is **STRONGLY RECOMMENDED** to use the release tool (p.n. **SOA635147**) specifically designed for tether clip removal. Each Retailer has been supplied with 2 of these tools. If the tool is unavailable, a needle-nosed plier can be used to **CAREFULLY** release the tether clip as shown in the illustration below.

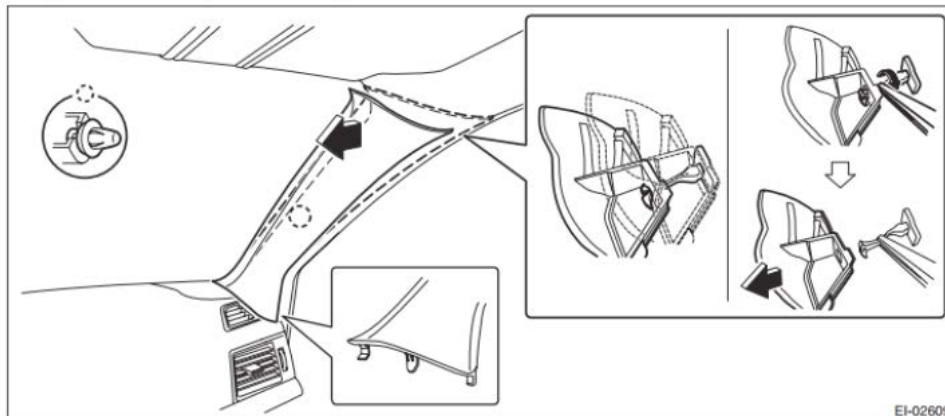

*Continued...*



**\*SERVICE PROCEDURE FOR 2009MY LEGACY / OUTBACK MODELS\***  
**INFLATOR TYPE 1, Inflator Kit Part Number: 98279AG00A**

**CAUTION: Refer to the “CAUTION” section in the General Description portion of Airbag System AB in the Body Section of the Service Manual before handling or servicing any airbag module!**

**STEP 1- PREPARATION:**

- Turn the ignition “OFF”.
- Disconnect the Negative (ground) cable from the battery and wait **at least 60 seconds** before proceeding further.
- Follow the procedures in the applicable Service Manual for removing the instrument panel assembly as required to access the passenger side airbag module.
- Disconnect the wiring harness and remove the airbag module.
- Secure the airbag module to the Airbag Deployment Fixture (part number J-39401-B) as shown in the photo below.

**IMPORTANT: Whenever beginning to remove (or install) the airbag assembly, and periodically while performing the procedure or after stepping away, remove any possible static charge from your body by momentarily touching a clean, bare metal ground point on the vehicle (e.g. the door striker). Remove from your person all electronic devices including cell phones before proceeding.**

**IMPORTANT: DO NOT destroy or damage the Kit Box as it MUST be used for the original inflator’s return shipping.**

**Open the Kit Box and confirm all the necessary components are included**

- 4 Self-Locking nuts
- New Inflator (yellow tape applied to one end to identify it as the replacement part)
- New Inflator Harness
- Electro-Tap (red shorting crimp connector)
- New Stopper Plate with D-Shaped hole
- Self-Adhesive Foam Protector
- Shipping Documentation



*Continued...*

To access the passenger's airbag module, the complete instrument panel assembly must be removed. Follow the procedures in the applicable Service Manual for removing the instrument panel assembly in addition to the necessary related interior trim components.

**NOTE:** When removing the "A" pillar trim, be **VERY CAREFUL** not to damage the upper metal retaining clip. The clip is located just below where the trim panel meets the head liner. If the metal retaining clip becomes damaged or separated from the trim panel, the trim panel **MUST** be replaced as the clip is not available separately. Use a plastic trim tool to push and release the upper portion of the metal clip from the body. Be careful to not pull the trim panel open any further than necessary to gain access for releasing the clip. There is a plastic retaining clip in the lower portion of the trim panel which will release easily once the upper retaining clip is loose. At reassembly and using a plastic trim tool, make sure the inner lip of the door weatherstrip overlaps the outer fabric edge of the trim panel to help secure it.

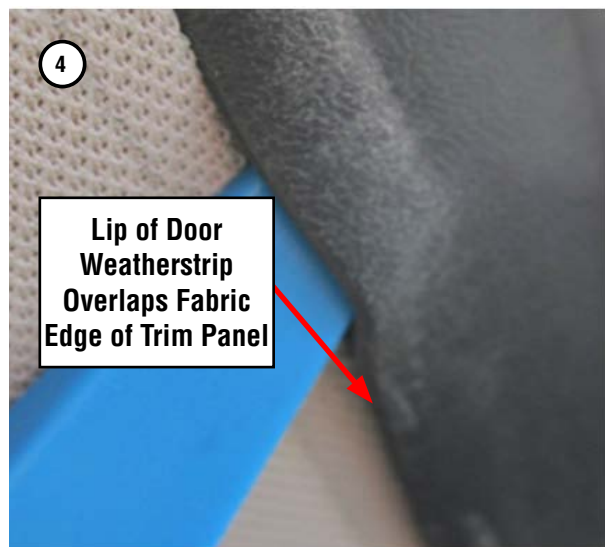
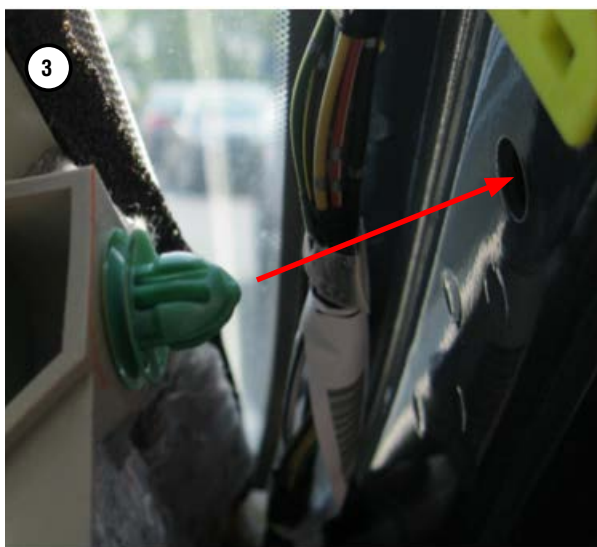
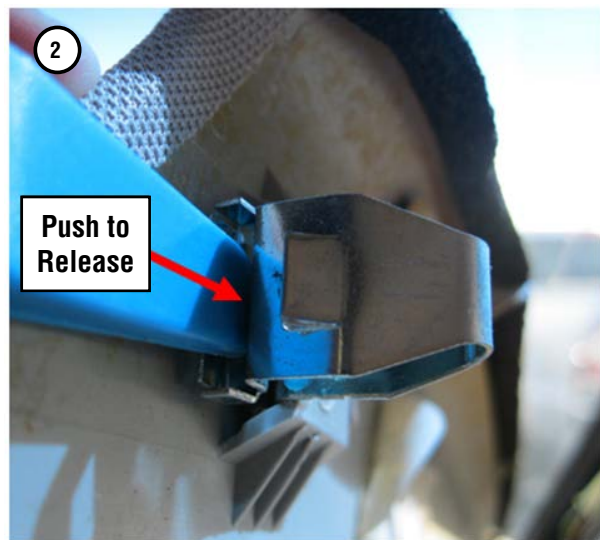
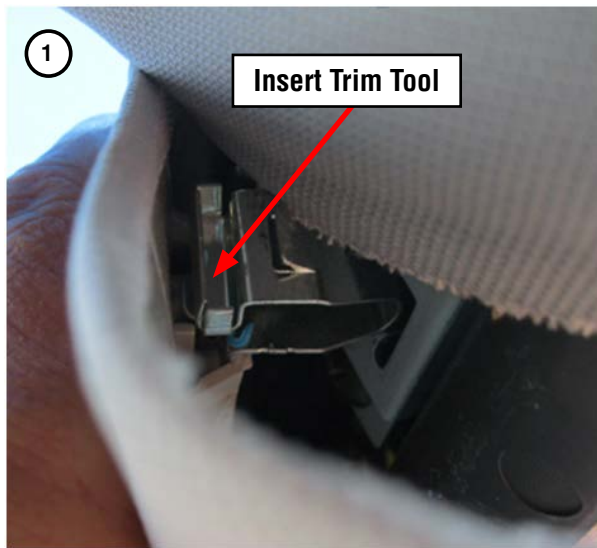

Once the instrument panel assembly has been removed from the vehicle, **CAREFULLY** separate the airbag module from it.

**IMPORTANT: The removed airbag module must be mounted to the Airbag Deployment Fixture (part number J-39401-B) as shown in the photo below to better secure it during the inflator and wiring harness component replacement procedures.** When mounting the module to the fixture, pay close attention to the harness routing as shown in the photo below. Always perform this work in an area away from others to reduce chances of inadvertent injury should any deployment occur. Take your surroundings into account to avoid possible hazards should inadvertent deployment occur or sources of static or other electricity that could potentially induce such a deployment.

**STEP 2-** Remove both sides of the harness from the retainer bracket holders then secure the airbag module to the Airbag Deployment Fixture as shown in the photos below.

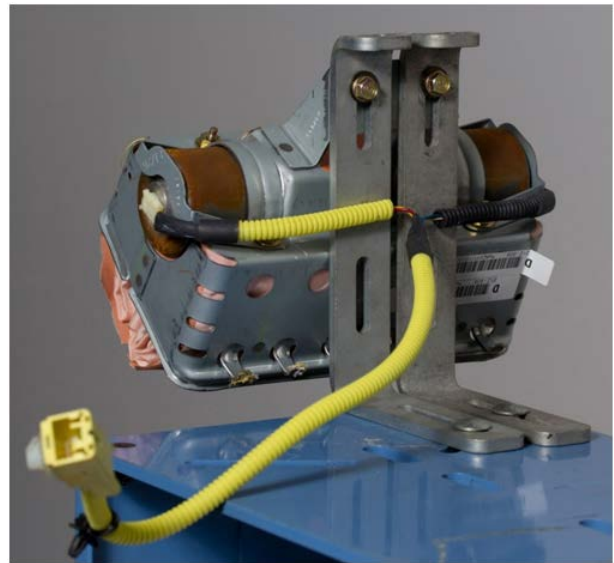
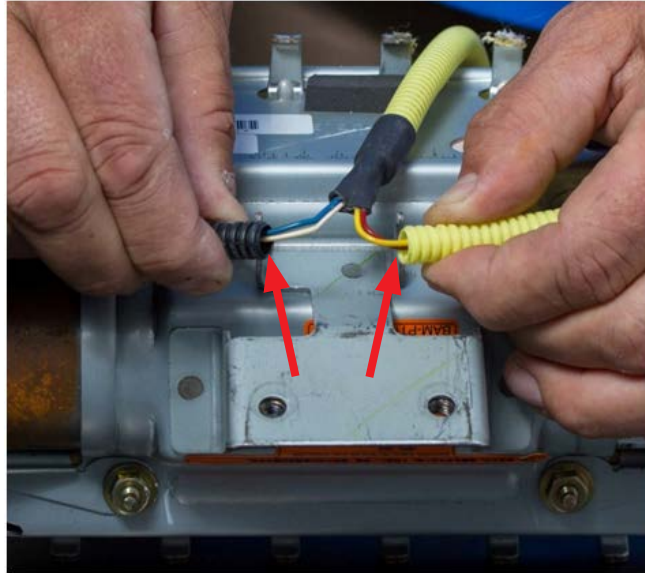

*Continued...*

**STEP 3- CAREFULLY** cut the yellow harness cover (approximately 1 1/2 inches) enough to expose the 2 yellow and red wires inside and provide enough room to install the Electro-Tap (shorting) connector using a scissor or wire cutter (no knives or razors).

**TAKE YOUR TIME AND BE CAREFUL TO NOT CUT THE 2 WIRES!**

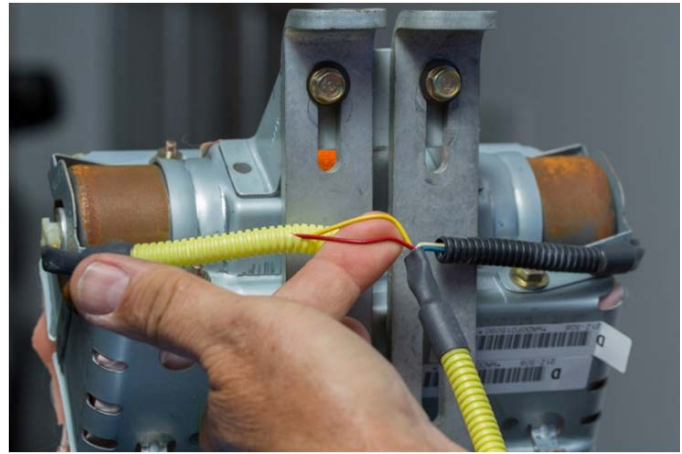

**STEP 4-** Short the yellow and red wires together by installing the Electro-Tap connector. The connector creates a short circuit which acts as a safeguard to prevent against static discharge that may deploy the removed inflator. The tab portion of the Electro-Tap connector **MUST** be cut off prior to use to insure a good short-circuit is made as shown in the illustration below. **Follow the sequence below** for installing the Electro-Tap connector. Use pliers to squeeze closed the two sections of the connector together, **one section at a time**.

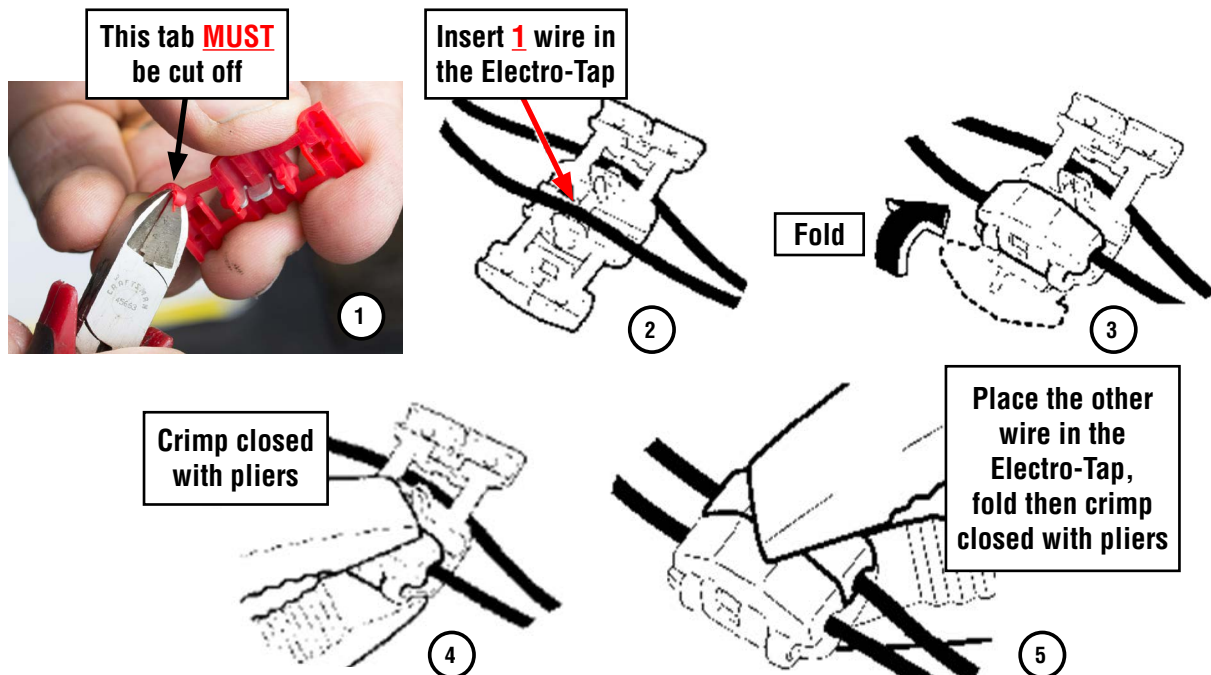

*Continued...*

**STEP 5-** Once the Electro-Tap connector is fully crimped in place, cut the yellow and red wires on the **body harness connector side** of the Electro-Tap connector as shown below.

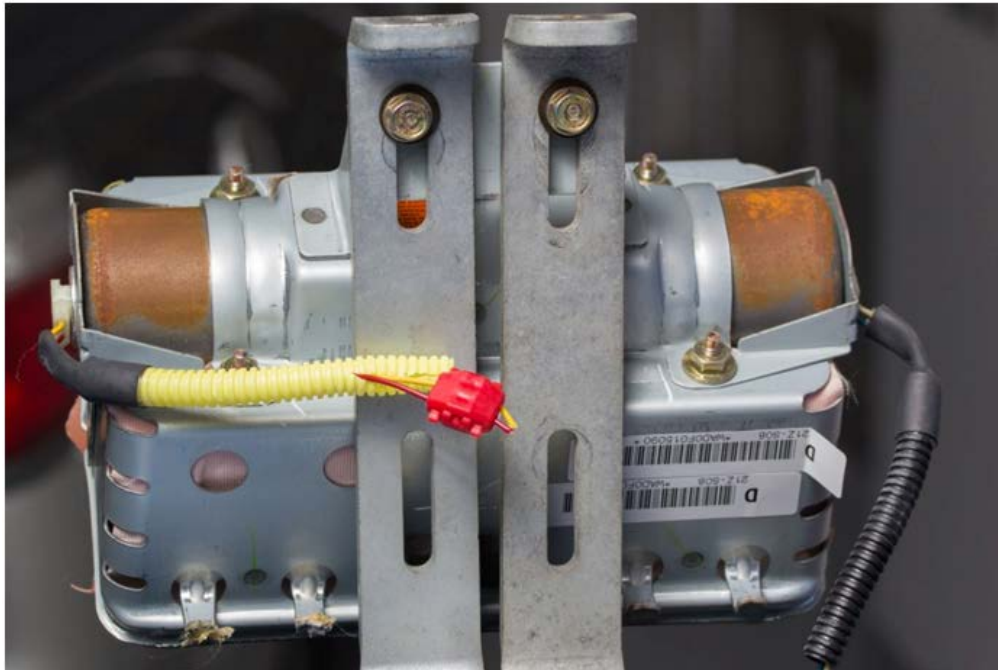

**VERY IMPORTANT: Under no circumstances should any impact or power tools be used when performing these procedures. HAND TOOLS ONLY!**

**STEP 6-** Loosen but **do not remove** the two 10mm self-locking nuts securing the stopper plate securing the end of the inflator with the blue and white wires as leaving them in place will help keep the airbag assembly together. Remove the two nuts and the stopper plate on the on the opposite end of the inflator mounting bracket and discard them. **NEVER ATTEMPT TO REMOVE THE HARNESS CONNECTORS FROM THE INFLATOR!** With the stopper plate removed and the other 2 self-locking nuts loosened, slide the original inflator out of the mounting bracket while feeding the cut off portion of the wiring harness under the remaining stopper plate. Place the removed original airbag inflator in the “cradle” of the Kit Box insert.

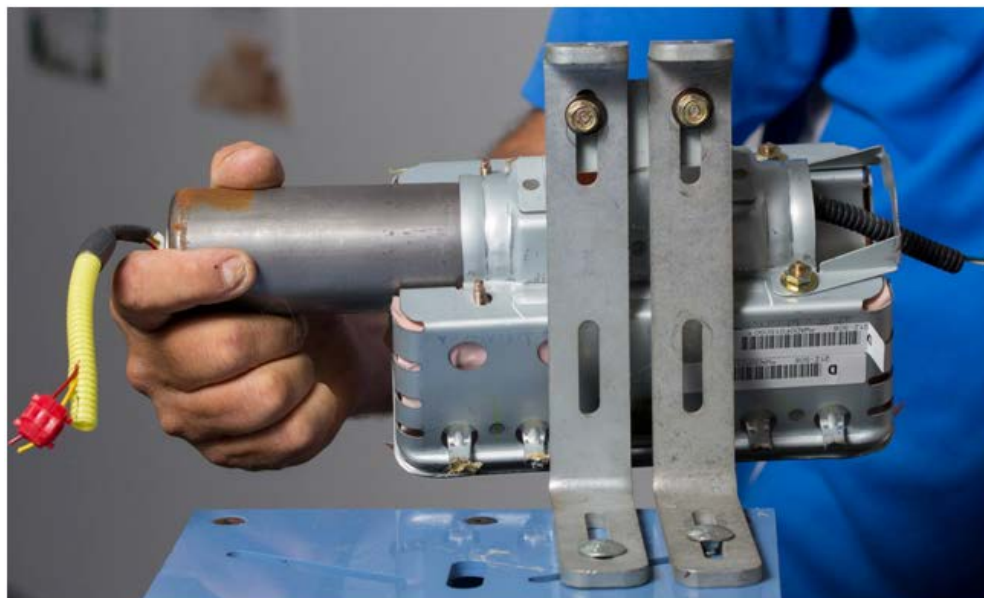

*Continued...*

**STEP 7 - VERY IMPORTANT:** Record the **11-digit alpha-numeric serial number** for both the **new and the removed inflators** on the hard copy of the Repair Order. **For SOA and SDC Retailers ONLY**, this information will be required for claim approval. **For SNE retailers**, this information will be required for completion of the Part Return Notice which will be forwarded by the retailer to the PCC.



**STEP 8-** Install the new inflator into the mounting bracket so the yellow taped end aligns with the stopper plate still installed on the mounting bracket. Make sure the “D-shaped” portion of the inflator harness connector boss aligns with the “D-shaped” portion of the hole in the new replacement stopper plate as shown below. Do not peel the white harness connection dust cover at this time. Use 2 NEW self-locking nuts to secure the new stopper plate but do not fully tighten them. Remove the other 2 nuts securing the other stopper plate on the mounting bracket and replace them with 2 NEW self-locking nuts. When properly installed, both ends of the inflator will be seated tight against both stopper plates with no gaps.

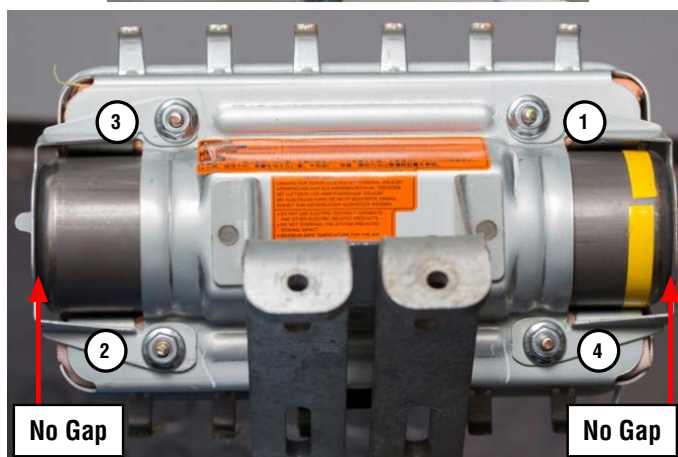
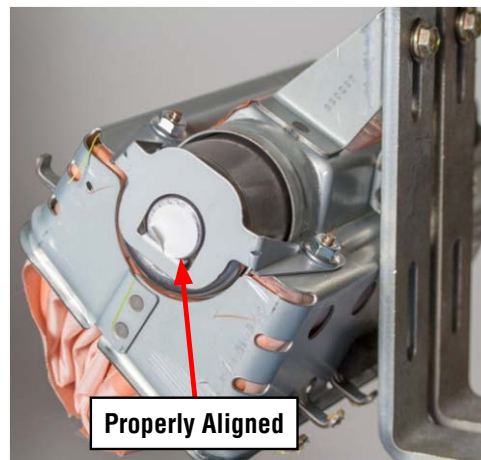

*Continued...*

**STEP 9-** Once all 4 **NEW** nuts are in place, **torque to 31 - 38 inch pounds in the sequence shown above.** Use a marker to mark the nuts after torquing to indicate they have been fully tightened.

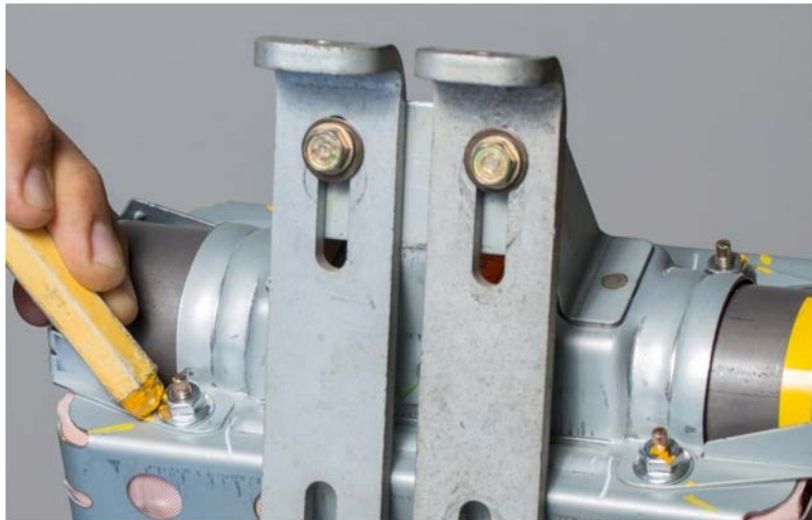

**STEP 10-** Install the black foam self-adhesive protector onto the D-Shaped stopper and mounting bracket positioned as shown in the photo sequence below. Once adhered in place on the new stopper plate, fold over the excess as shown. Always make sure the placement area for the protector is free of any grease or dirt before application.

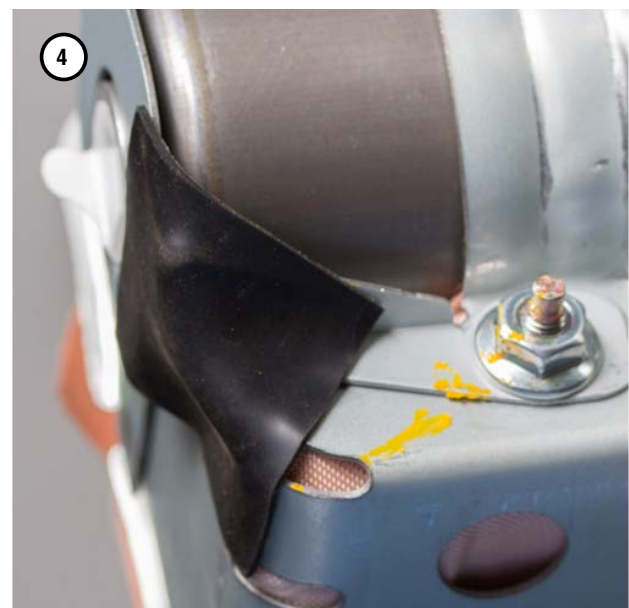
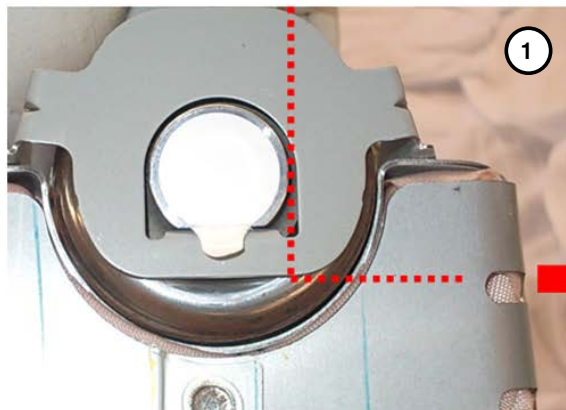

*Continued...*

**STEP 11-** The new inflator wiring harness has 2 “sides” with round 2-pin connectors on both ends. The side with the yellow corrugated tube and red / yellow wires will connect to the end of the inflator with the D-Shaped wiring harness connector boss, new stopper plate and foam protector as shown below. Peel off the white dust cover from the D-Shaped end of the inflator **ONLY**. **IMPORTANT: NEVER PEEL BOTH THE WHITE DUST COVERS OFF AT THE SAME TIME!** CAREFULLY align the pins with the female terminals of the harness connector (red / yellow wires) as shown in the photos below. Once pin alignment is confirmed, push down firmly to engage the connector’s 3 locking tangs into the locking groove inside the connector boss. Confirm the connector is locked by prying up **LIGHTLY** with a small flat-blade screwdriver. Repeat the procedure on the opposite end with the blue / white wires.

**VERY IMPORTANT:** When connecting the new harness to the inflator, both sides of the harness **MUST** be routed toward the module’s mounting brackets as shown in the photos below.

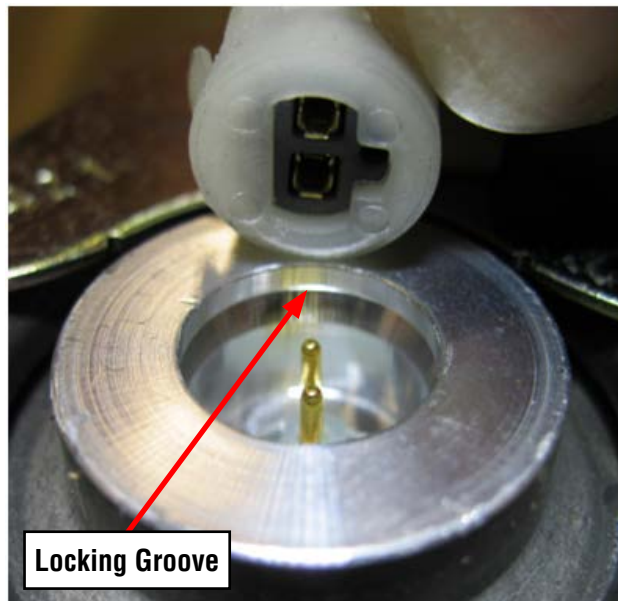
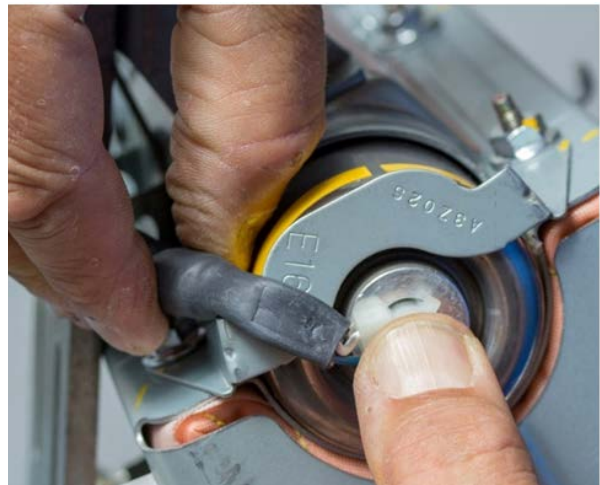

*Continued...*



**STEP 12-** Refit the ends of the harness corrugated tubes to the retaining grooves of the mounting bracket as shown to complete the airbag module reassembly.

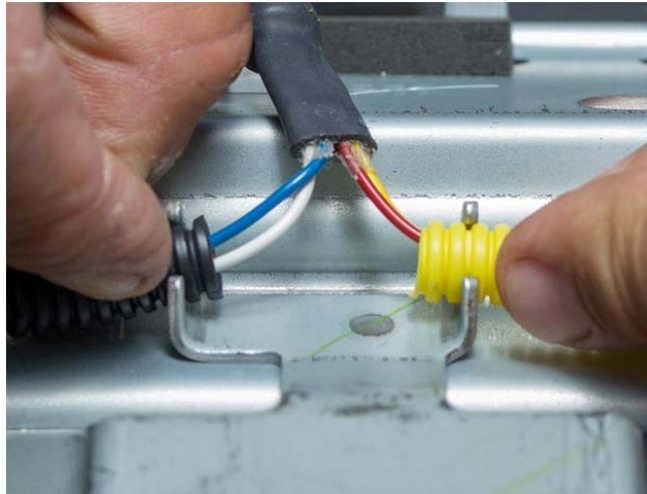

**STEP 13- CAREFULLY** reinstall the airbag module assembly into the instrument panel as shown below.



**STEP 14-** To eliminate a possible source of a rattling sound from the dash, wrap the 2 hooks and locator pin with non-woven material, p.n. SOA963W110 (or an equivalent self-adhesive foam) as shown below.

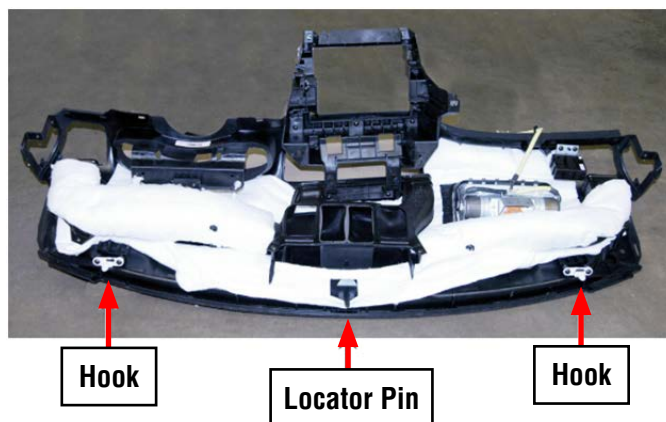

**REMINDER:** 1 sheet of the SOA963W110 non-woven material is enough for approximately 8 vehicles.

*Continued...*

**STEP 15-** Reinstall the instrument panel assembly into the vehicle in reverse order of disassembly. Once the negative battery cable has been reconnected, turn the ignition key “ON” and confirm the AIRBAG warning light comes on then cycles off properly. Once proper warning light operation is confirmed, reinstall the remaining components to complete the procedure.

**STEP 16-** Place the removed original airbag inflator in the “cradle” of the Kit Box insert, with a completed SOA warranty parts tag (MSA5W402A) attached to it. The tag must contain the following information: **Claim Number, Repair Date, 17-digit VIN, and vehicle mileage.** Refer to the “PART RETURN PROCEDURES” section of this bulletin (page 4) for further return shipping instructions and information. **Ensure both the removed and installed inflator serial numbers have been recorded correctly as previously instructed on the repair order hard copy before returning the removed part to your Parts Department.**

**IMPORTANT: UNDER NO CIRCUMSTANCES SHOULD ANY AIRBAG INFLATORS BE RETURNED TO SUBARU OF AMERICA, INC.**

*Continued...*

**\*SERVICE PROCEDURE FOR 2009MY LEGACY / OUTBACK MODELS\***  
**INFLATOR TYPE 2, Inflator Kit Part Number: 98279AG05A**

**CAUTION: Refer to the “CAUTION” section in the General Description portion of Airbag System AB in the Body Section of the Service Manual before handling or servicing any airbag module!**

**STEP 1- PREPARATION:**

- Record the customer’s radio station presets (and Navigation favorites where applicable).
- Turn the ignition “OFF”.
- Disconnect the Negative (ground) cable from the battery and wait **at least 60 seconds** before proceeding further.
- Follow the procedures in the applicable Service Manual for removing the instrument panel assembly as required to access the passenger side airbag module.
- Disconnect the wiring harness and remove the airbag module.
- Secure the removed airbag module to the Airbag Deployment Fixture (part number J-39401-B).

**IMPORTANT NOTE:** The photos available at the time of this procedure’s preparation do not show the removed airbag module assembly as being secured to the J-39401-B Airbag Deployment Fixture during inflator replacement. Subaru of America, Inc. **STRONGLY RECOMMENDS ALWAYS** utilizing a J-39401-B fixture whenever performing **ANY** airbag inflator replacement service procedure.

**IMPORTANT: Whenever beginning to remove (or install) the airbag assembly, and periodically while performing the procedure or after stepping away, remove any possible static charge from your body by momentarily touching a clean, bare metal ground point on the vehicle (e.g. the door striker). Remove from your person all electronic devices including cell phones before proceeding.**

**IMPORTANT: DO NOT destroy or damage the Kit Box as it MUST be used for the original inflator’s return shipping.**

Open the Kit Box and confirm all the necessary components are included:

- 4 Self-Locking nuts
- New **Type 2** Inflator (pink collars on each end identify it as the replacement part)
- New Inflator Harness
- 1 new Stopper Plate (A)
- Heat Insulating Plate
- Electro-Tap (red shorting crimp connector)
- Shipping Documentation



*Continued...*

Inspect the new **Type 2** inflator to confirm the locating protrusions on each of the pink collar portions are aligned as shown below. The “short” collar can be rotated as needed to align it with the protrusion on the “long” collar if necessary.

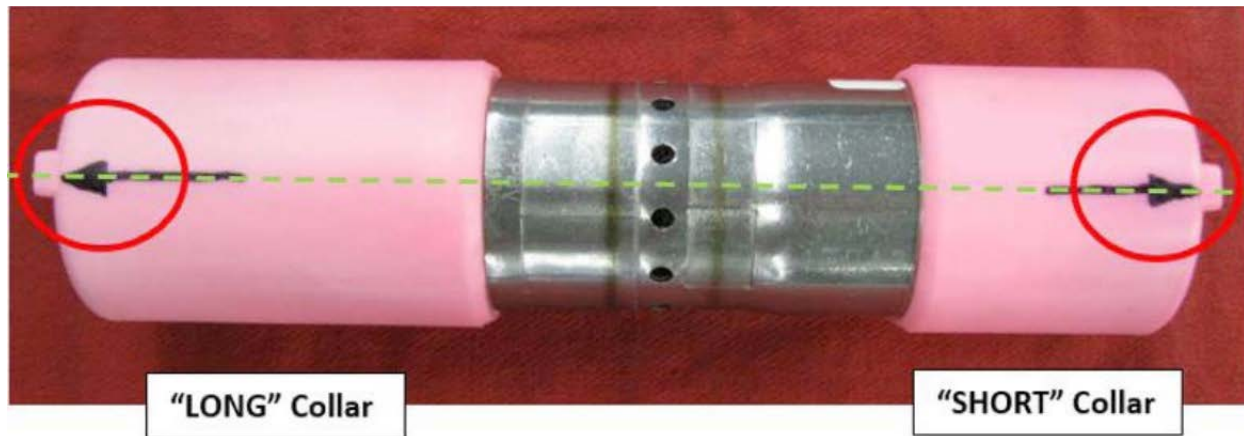

**STEP 2-** To access the passenger’s airbag module, the complete instrument panel assembly must be removed. Follow the procedures in the applicable Service Manual for removing the instrument panel assembly in addition to the necessary related interior trim components.

**NOTE:** When removing the “A” pillar trim, be **VERY CAREFUL** not to damage the upper metal retaining clip. The clip is located just below where the trim panel meets the head liner. If the metal retaining clip becomes damaged or separated from the trim panel, the trim panel **MUST** be replaced as the clip is not available separately. Use a plastic trim tool to push and release the upper portion of the metal clip from the body. Be careful to not pull the trim panel open any further than necessary to gain access for releasing the clip. There is a plastic retaining clip in the lower portion of the trim panel which will release easily once the upper retaining clip is loose. At reassembly and using a plastic trim tool, make sure the inner lip of the door weatherstrip overlaps the outer fabric edge of the trim panel to help secure it.

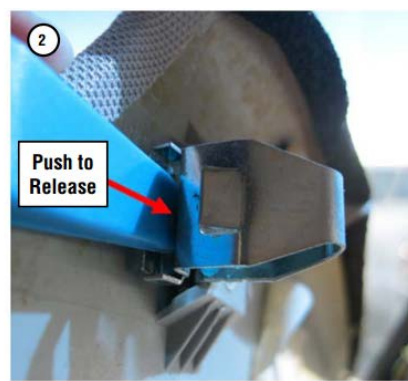
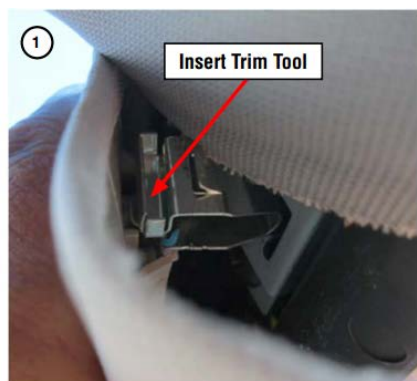

*Continued...*

Once the instrument panel assembly has been removed from the vehicle, **CAREFULLY** release the retaining claws and separate the airbag bag module.

**REMINDER:** It is **STRONGLY RECOMMENDED** the removed airbag module **ALWAYS** be mounted to the Airbag Deployment Fixture (part number J-39401-B and file photo shown below) to better secure it during the inflator replacement procedure. When mounting the module to the fixture, pay close attention to the harness routing. Always perform this work in an area away from others to reduce chances of inadvertent injury should any deployment occur. Take your surroundings into account to avoid possible hazards should an inadvertent deployment occur or sources of static or other electricity that could potentially induce such a deployment.



**STEP 3-** Remove the harness tube from the retainer bracket holders.

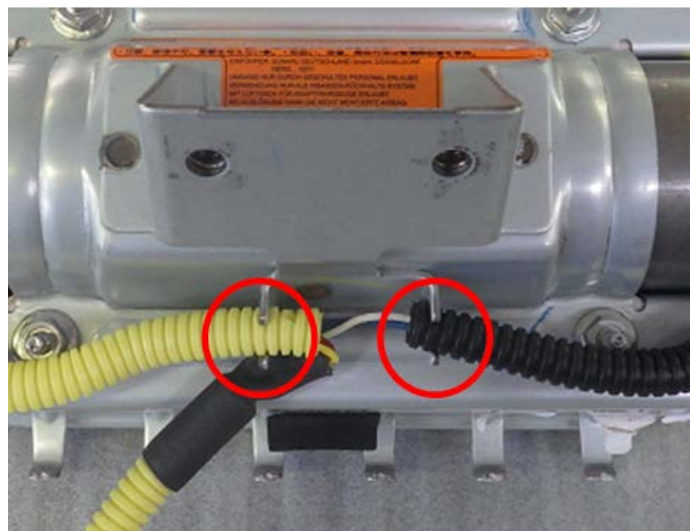

**STEP 4-** Using a scissor or wire cutter (no knives or razors) **CAREFULLY** cut the black harness cover tube (approximately 1 1/2 inches) enough to expose the blue and white wires inside and provide enough room to install the Electro-Tap (shorting) connector.

**TAKE YOUR TIME AND BE CAREFUL TO NOT CUT THE 2 WIRES!**

*Continued...*

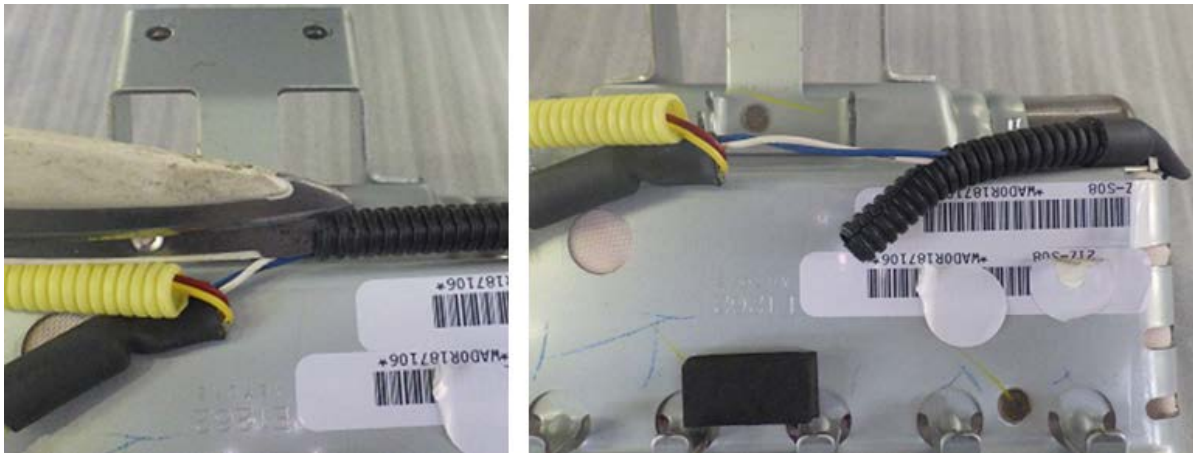

**STEP 5-** Short the white and blue wires together by installing the Electro-Tap connector. The connector creates a short circuit which acts as a safeguard to prevent against static discharge that may deploy the removed inflator. The tab portion of the Electro-Tap connector **MUST** be cut off prior to use to insure a good short-circuit is made as shown in the illustration below. **Follow the sequence below** for installing the Electro-Tap connector. Use pliers to squeeze closed the two sections of the connector together, **one section at a time**.

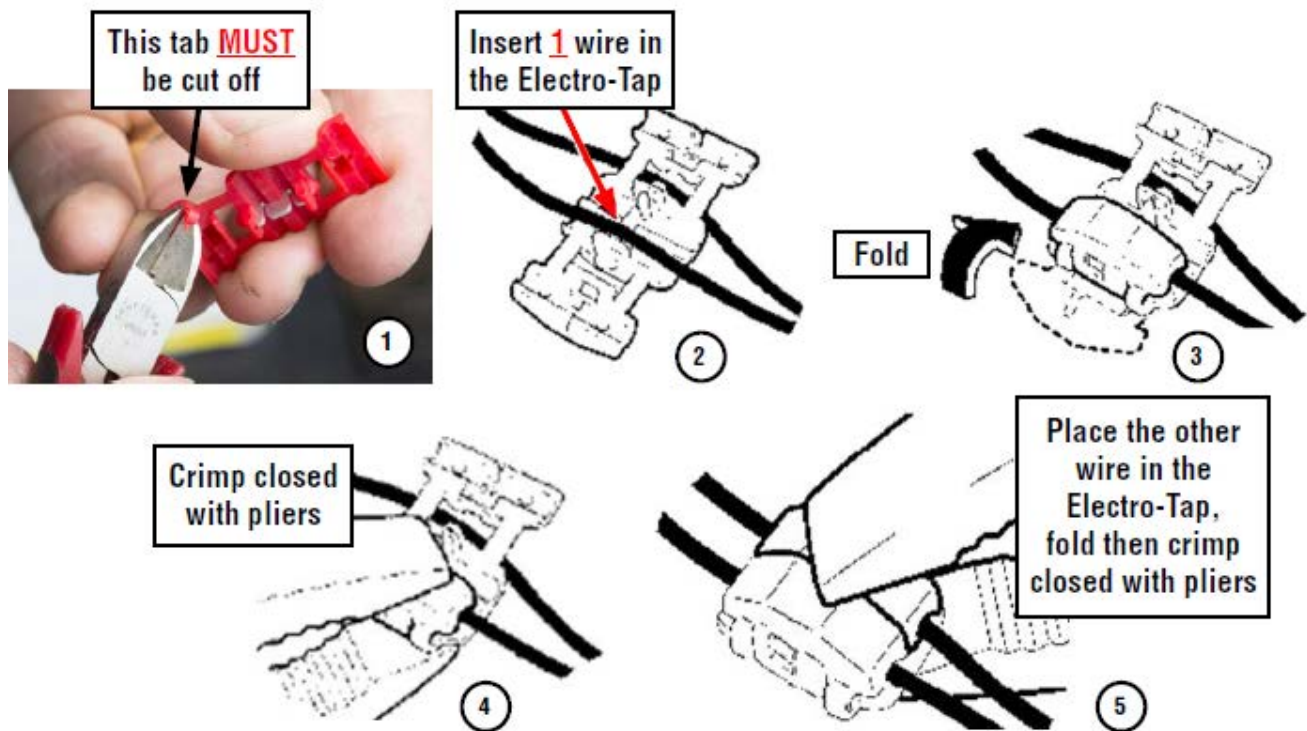

*Continued...*

**STEP 6-** Once the Electro-Tap connector is fully crimped in place, cut the white and blue wires **on the body harness connector side** of the Electro-Tap connector.



**STEP 7-** Loosen and remove the five (4) 10mm self-locking nuts and discard them.

**VERY IMPORTANT: Under no circumstances should any impact or power tools be used when performing these procedures. HAND TOOLS ONLY!**

**NOTE: NEVER ATTEMPT TO REMOVE THE HARNESS CONNECTORS FROM THE INFLATOR!**

**STEP 8-** With the self-locking nuts removed, slide the original inflator out of the mounting bracket. Place the removed original airbag inflator back into the “cradle” of the Kit Box insert.

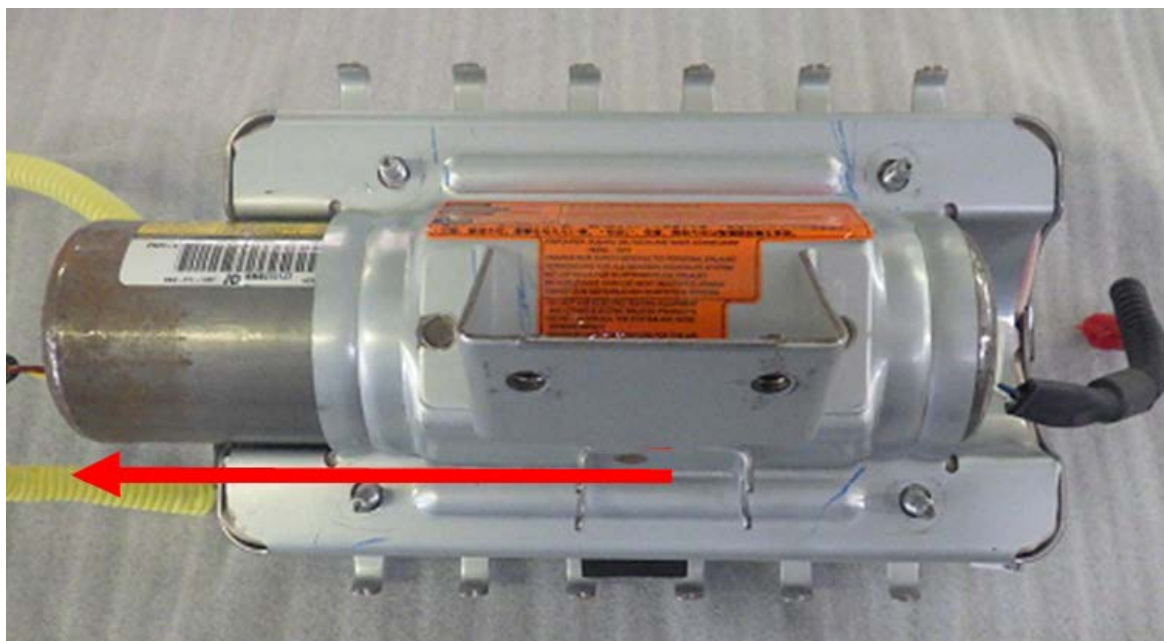

*Continued...*

**STEP 9 - VERY IMPORTANT:** Record the **11-digit alpha-numeric serial number** for both the **new Type 2** and the **original Type 1 inflators** on the hard copy of the Repair Order. **For SOA and SDC Retailers ONLY**, this information will be required for claim approval. **For SNE retailers**, this information will be required for completion of the Part Return Notice which will be forwarded by the retailer to the PCC.



**STEP 10- CAREFULLY** remove the airbag from the mounting bracket (case).

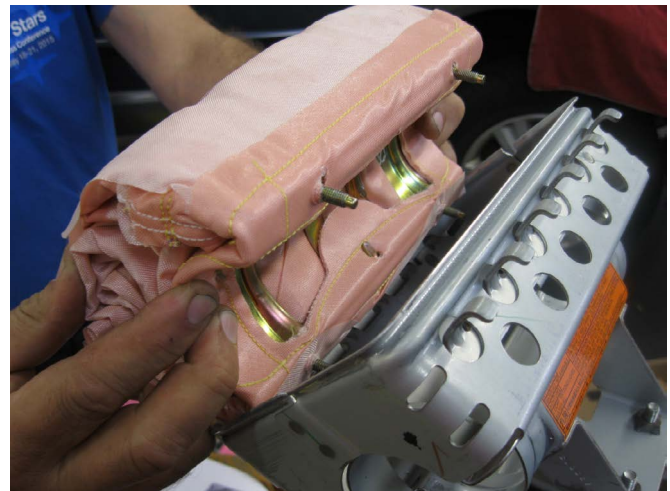
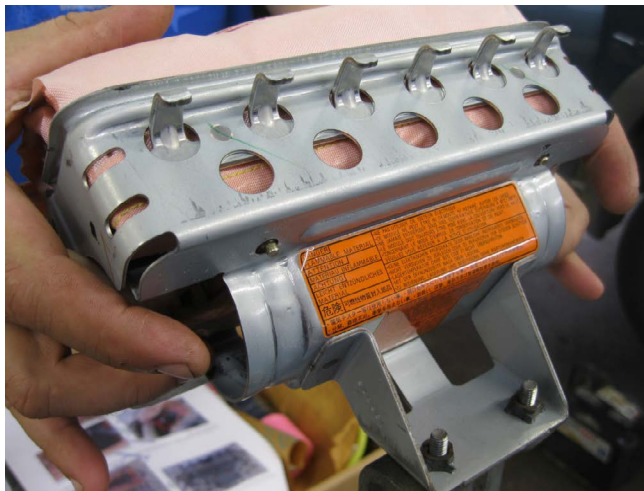

*Continued...*



**STEP 11- CAREFULLY** Install the heat insulating plate into the back (inflator) side of the airbag as shown in photo 1 below. **The plate can only be installed in one direction.** Make sure the 2 retaining claws come through the corresponding holes in the insulator plate as shown in photo 2. The airbag is ready to refit to the mounting bracket in photo 3 and is being reinstalled in photo 4.

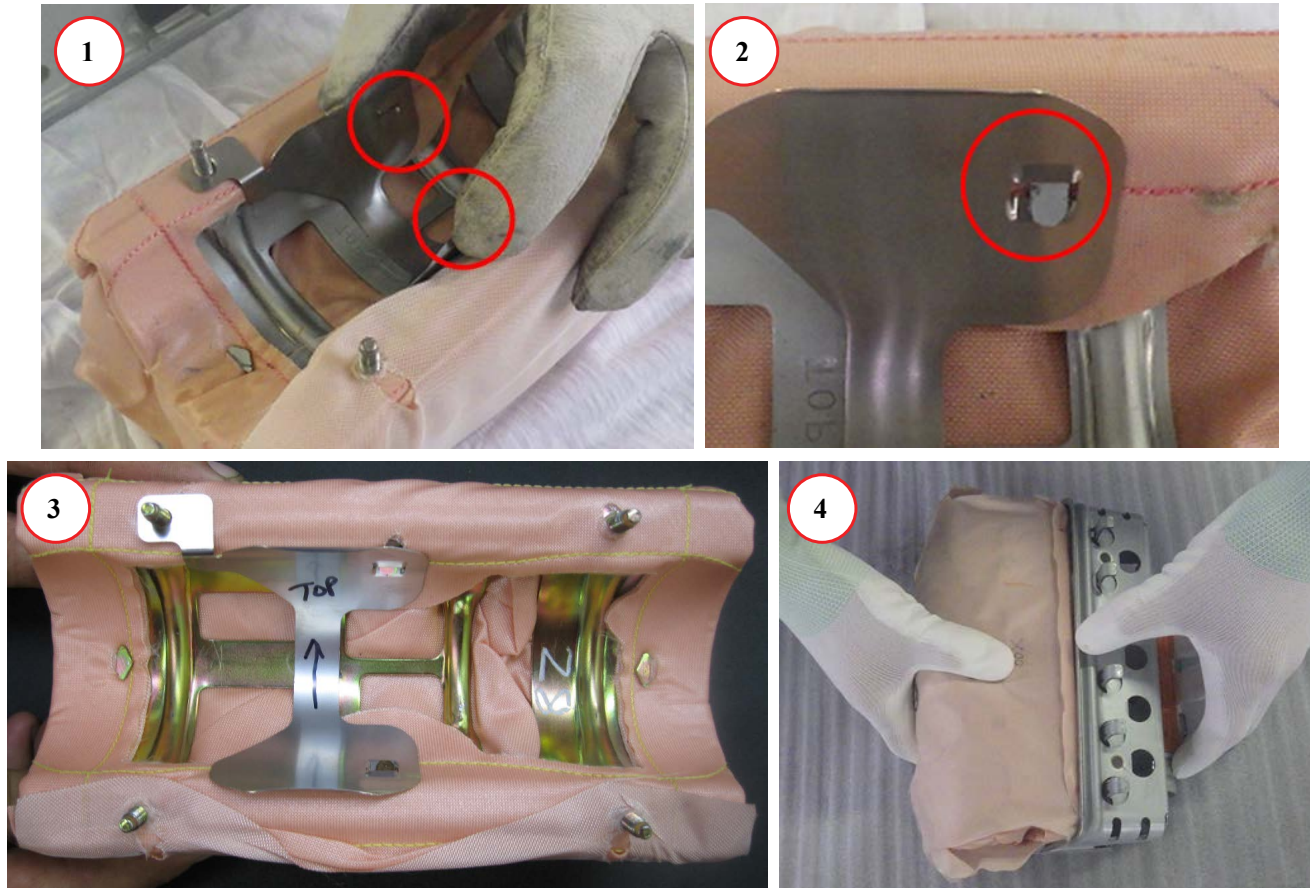

**STEP 12-** Install the new Stopper Plate (A) onto the mounting bracket.

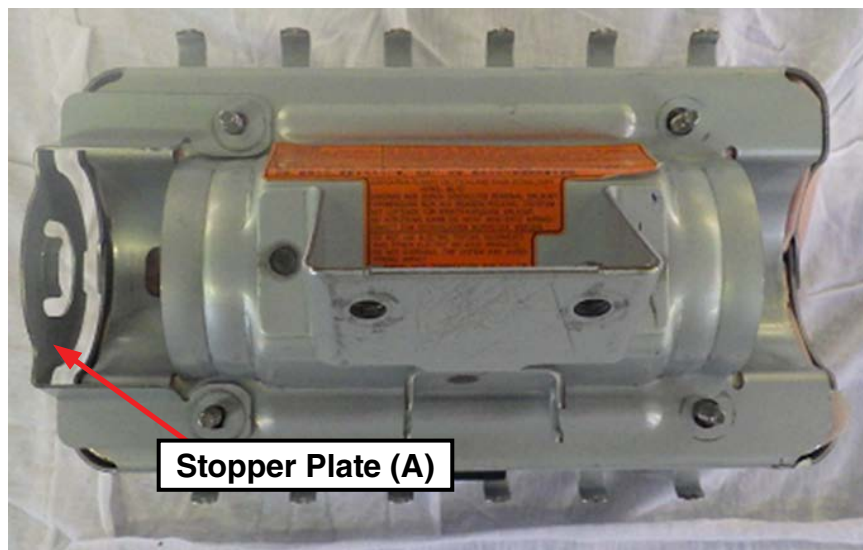

*Continued...*

**STEP 13-** Install the new inflator into the mounting bracket with the short pink collar end toward the new Stopper Plate (A). Align the protrusion on the end of the collar with the notch in the stopper plate. There is also a tab on the inside of Stopper Plate (A) which will align with the notch in the end of the collar. When properly installed the collar will be tight against the plate with no gap.

**IMPORTANT: Do not peel the white harness connection dust cover at this time.**

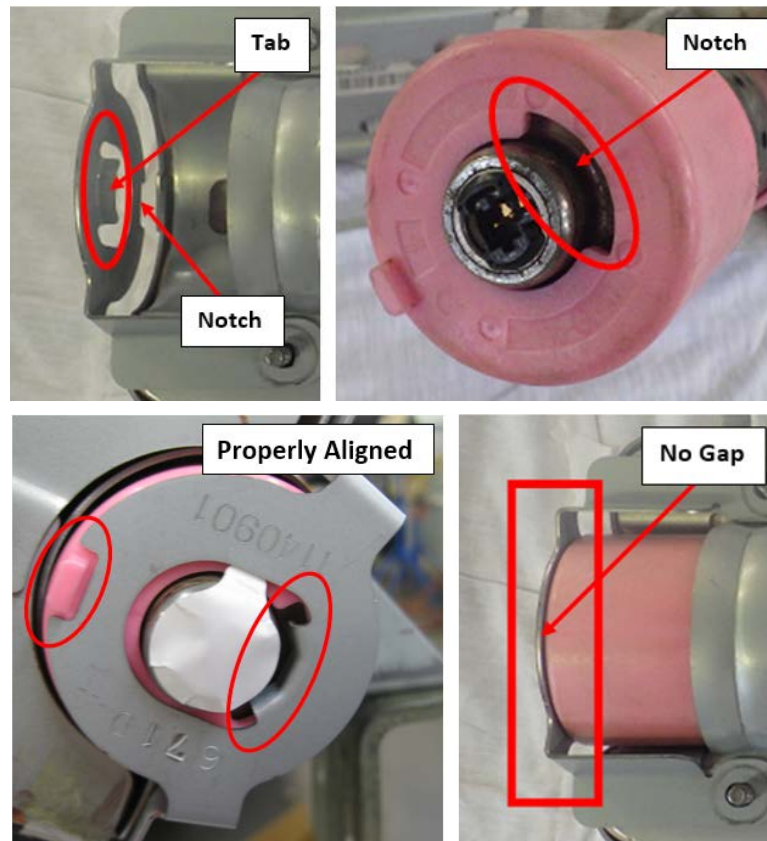

**STEP 14-** Install the original stopper plate onto the opposite end of the mounting bracket / inflator in the same manner as described in STEP 13 above. Rotate the inflator as needed to insure there is no gap between the collar and stopper plate. **NOTE:** Stopper plates only fit one way as their holes are offset.



*Continued...*

**STEP 15-** Reinstall the 4 **NEW** self-locking nuts. **SLOWLY** tighten (to prevent over-tightening) then torque the nuts to 31-38 inch-pounds. When complete, use a marker to indicate they have been fully tightened.



**STEP 16-** The new inflator wiring harness has 2 “sides” with 2-pin connectors on both ends. The side with the black harness tube goes with the black inflator connector and the other side (yellow harness tube) will connect to the orange connector. The end of the inflator aligned with the new Stopper Plate (A) will have a black harness connector while the connector on the opposite end of the inflator will be orange. This makes it impossible to install the harness backwards as the tangs (shown in Step 17) are also in different positions.

**BEFORE** connecting the harness to the inflator, make sure the harness is not twisted as shown below.



**STEP 17-** Peel off **one** white dust cover and **CAREFULLY** align the tang of the new harness connector with the receiving slot in the inflator connector. This assures proper routing of the harness in relation to the airbag assembly mounting bracket.

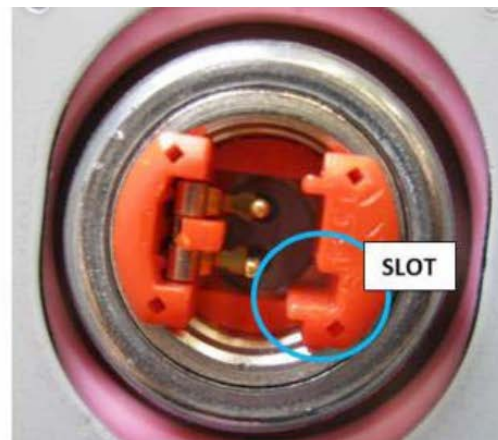

*Continued...*

**IMPORTANT: NEVER PEEL BOTH THE WHITE DUST COVERS OFF AT THE SAME TIME!**



Once alignment is confirmed, push down firmly to engage the connector. When fully seated, press down on the yellow tab locking the connector to the inflator.

**STEP 18-** After connecting both sides of the harness, refit the harness cover tube back into the mounting brackets.



**VERY IMPORTANT:** After connecting the new harness to the inflator, **both sides MUST be routed as shown** in the “New Harness Properly Installed” photo below.



*Continued...*

**STEP 19-** Refit the airbag module to the instrument panel.

**STEP 20-** Reinstall the instrument panel assembly into the vehicle in reverse order of disassembly. Once the negative battery cable has been reconnected, turn the ignition key “ON” and confirm the AIRBAG warning light comes on then cycles off properly. Once proper warning light operation is confirmed, reinstall the remaining components and reset the radio station presets (and Navigation favorites where applicable) to complete the procedure.

**STEP 21-** If not already done, place the removed original airbag inflator in the “cradle” of the Kit Box insert, with a completed SOA warranty parts tag (MSA5W402A) attached to it. The tag must contain the following information: **Claim Number, Repair Date, 17-digit VIN, and vehicle mileage.** Refer to the “PART RETURN PROCEDURES” section of this bulletin for further return shipping instructions and information. **Ensure both the removed and installed inflator serial numbers have been recorded correctly as previously instructed on the repair order hard copy before returning the removed part to your Parts Department.**

**IMPORTANT: UNDER NO CIRCUMSTANCES SHOULD ANY AIRBAG INFLATORS BE RETURNED TO SUBARU OF AMERICA, INC.**

*Continued...*

**\*SERVICE PROCEDURE FOR 2010-13MY LEGACY / OUTBACK MODELS\***

**Inflator Kit Part Number: 98279AJ02A**

**CAUTION: Refer to the “CAUTION” section in the General Description portion of Airbag System AB in the Body Section of the Service Manual before handling or servicing any airbag module!**

**STEP 1- PREPARATION:**

- Record the customer’s radio station presets (and Navigation favorites where applicable).
- Turn the ignition “OFF”.
- Disconnect the Negative (ground) cable from the battery and wait **at least 60 seconds** before proceeding further.
- Follow the procedures in the applicable Service Manual for removing the instrument panel assembly as required to access the passenger side airbag module.
- Disconnect the wiring harness and remove the airbag module.
- Secure the removed airbag module to the Airbag Deployment Fixture (part number J-39401-B).

**IMPORTANT NOTE:** The photos available at the time of this procedure’s preparation do not show the removed airbag module assembly as being secured to the J-39401-B Airbag Deployment Fixture during inflator replacement. Subaru of America, Inc. **STRONGLY RECOMMENDS ALWAYS** utilizing a J-39401-B fixture whenever performing **ANY** airbag inflator replacement service procedure.

**IMPORTANT: Whenever beginning to remove (or install) the airbag assembly, and periodically while performing the procedure or after stepping away, remove any possible static charge from your body by momentarily touching a clean, bare metal ground point on the vehicle (e.g. the door striker). Remove from your person all electronic devices including cell phones before proceeding.**

**IMPORTANT: DO NOT destroy or damage the Kit Box as it MUST be used for the original inflator’s return shipping.**

Open the Kit Box and confirm all the necessary components are included:

- 5 Self-Locking nuts
- New Inflator (yellow tape applied to one end to identify it as the replacement part)
- New Inflator Harness
- Electro-Tap (red shorting crimp connector)
- Shipping Documentation



**STEP 2-** To access the passenger’s airbag module, the complete instrument panel assembly must be removed. Follow the procedures in the applicable Service Manual for removing the instrument panel assembly in addition to the necessary related interior trim components.

*Continued...*

**NOTE:** When removing the “A” pillar trim, be **VERY CAREFUL** not to damage the upper trim retaining (tether) clip. The clip is located just below where the trim panel meets the head liner. If the tether clip becomes damaged, it **MUST** be replaced. The illustrations below show how to release the tether clip and remove the “A” pillar trim. It is **STRONGLY RECOMMENDED** to use the release tool (p.n. SOA635147) specifically designed for tether clip removal. See pg. 8 of this bulletin for more information.

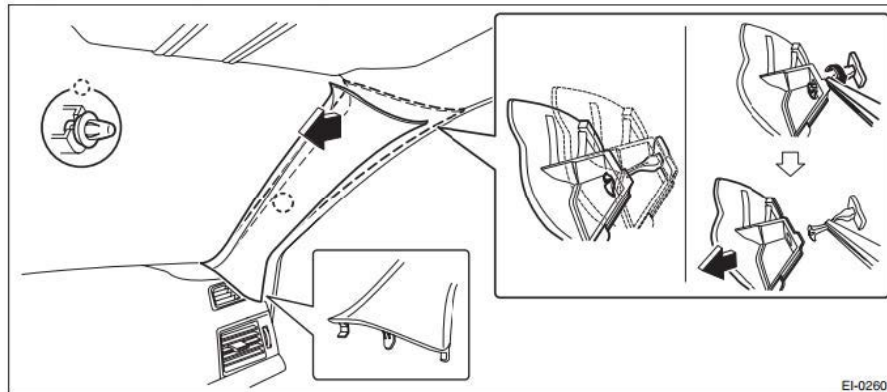

Once the instrument panel assembly has been removed from the vehicle, **CAREFULLY** release the retaining claws and separate the airbag bag module.

**REMINDER:** It is **STRONGLY RECOMMENDED** the removed airbag module **ALWAYS** be mounted to the Airbag Deployment Fixture (part number J-39401-B and file photo shown below) to better secure it during the inflator replacement procedure. When mounting the module to the fixture, pay close attention to the harness routing. Always perform this work in an area away from others to reduce chances of inadvertent injury should any deployment occur. Take your surroundings into account to avoid possible hazards should an inadvertent deployment occur or sources of static or other electricity that could potentially induce such a deployment.

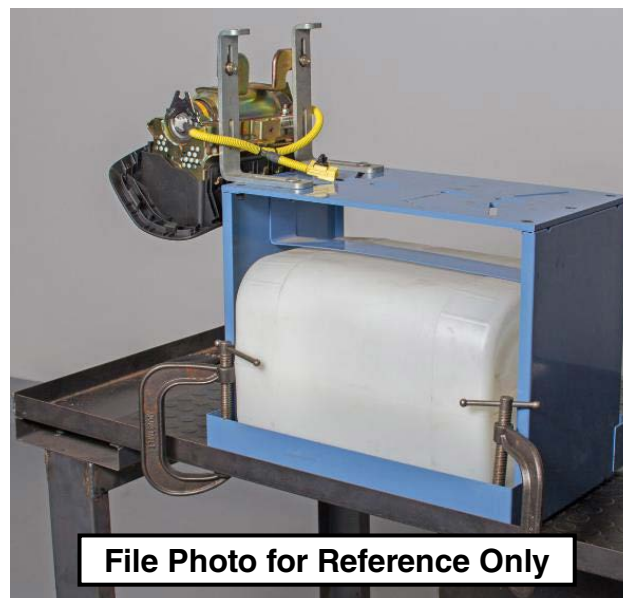

*Continued...*

**STEP 3-** Remove the harness tube from the retainer bracket holders.

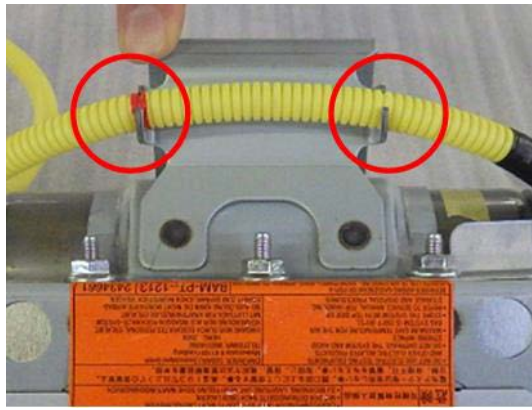

**STEP 4-** Using a scissor or wire cutter (no knives or razors) **CAREFULLY** cut the yellow harness cover tube (approximately 1 1/2 inches) enough to expose the yellow and red wires inside and provide enough room to install the Electro-Tap (shorting) connector.

**TAKE YOUR TIME AND BE CAREFUL TO NOT CUT THE 2 WIRES!**

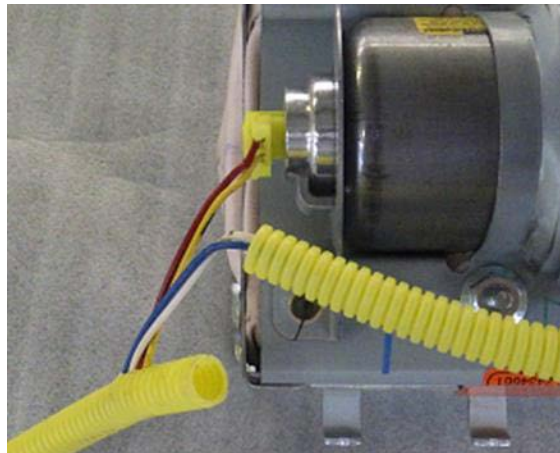

**STEP 5-** Short the yellow and red wires together by installing the Electro-Tap connector. The connector creates a short circuit which acts as a safeguard to prevent against static discharge that may deploy the removed inflator. The tab portion of the Electro-Tap connector **MUST** be cut off prior to use to insure a good short-circuit is made as shown in the illustration below. **Follow the sequence below** for installing the Electro-Tap connector. Use pliers to squeeze closed the two sections of the connector together, **one section at a time**.

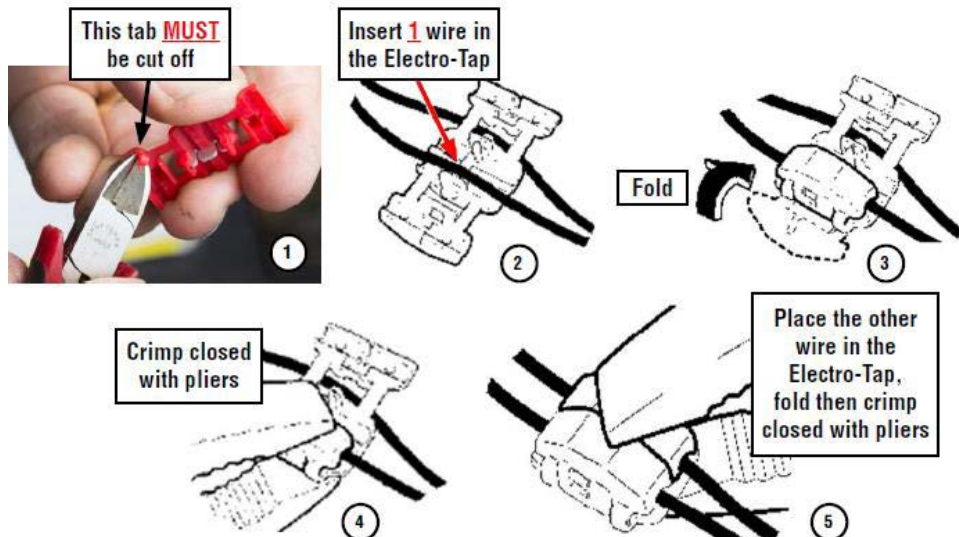

*Continued...*



**STEP 6-** Once the Electro-Tap connector is fully crimped in place, cut the yellow and red wires **on the body harness connector side** of the Electro-Tap connector.

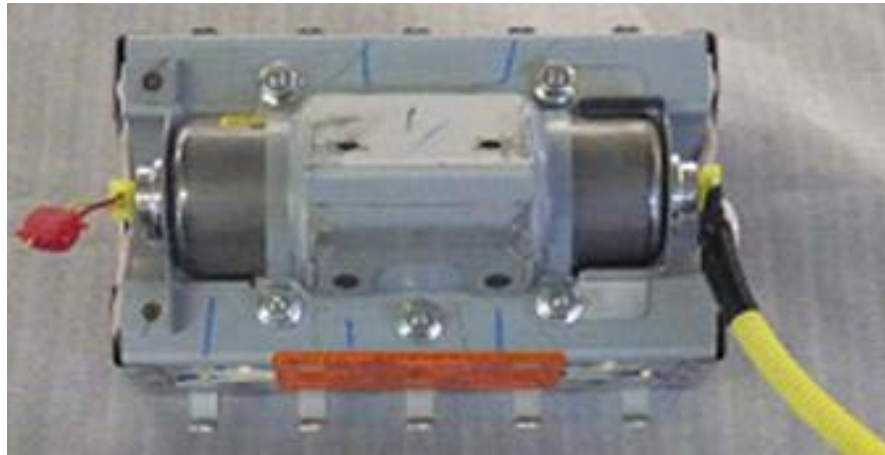

**STEP 7-** Loosen and remove the five (5) 10mm self-locking nuts along with the stopper plate. **DO NOT DISCARD** the removed stopper plate as it will be reused during reassembly. Discard the 5 10mm nuts.

**VERY IMPORTANT: Under no circumstances should any impact or power tools be used when performing these procedures. HAND TOOLS ONLY!**

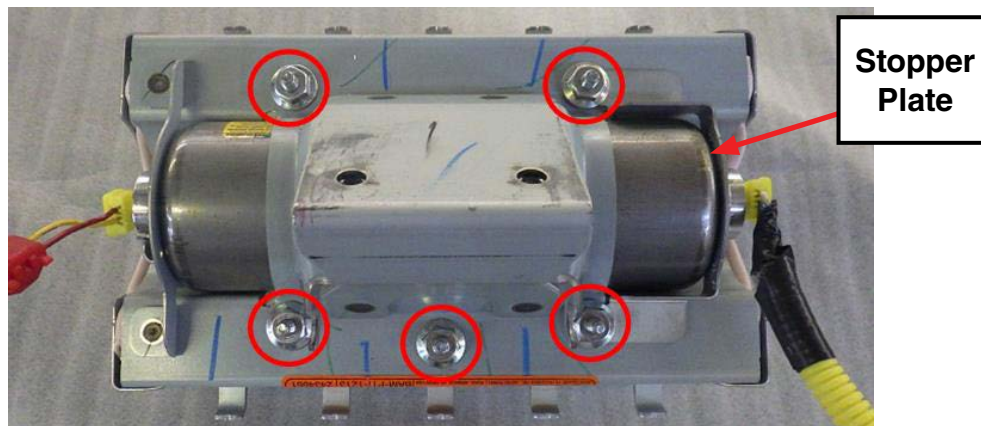

**NOTE: NEVER ATTEMPT TO REMOVE THE HARNESS CONNECTORS FROM THE INFLATOR!**

**STEP 8-** With the self-locking nuts and stopper plate removed, slide the original inflator out of the mounting bracket while feeding the cut off portion of the wiring harness under the remaining stopper plate. Place the removed original air bag inflator back into the “cradle” of the Kit Box insert.

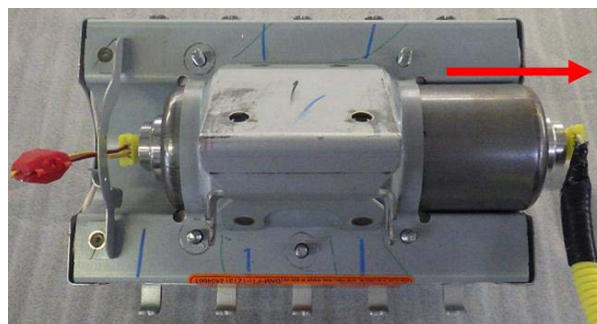

*Continued...*

**STEP 9 - VERY IMPORTANT:** Record the **11-digit alpha-numeric serial number** for both the **new and the removed inflators** on the hard copy of the Repair Order. **For SOA and SDC Retailers ONLY**, this information will be required for claim approval. **For SNE retailers**, this information will be required for completion of the Part Return Notice which will be forwarded by the retailer to the PCC.



**STEP 10-** Install the new inflator into the mounting bracket so the yellow taped end will align with the stopper plate when reinstalled on the mounting bracket. When properly installed, both ends of the inflator will be seated tight against the stopper plates with no gaps.

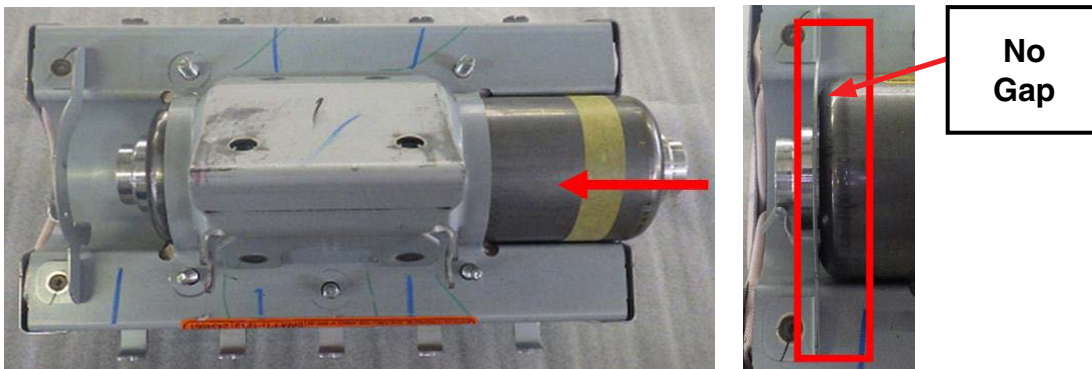

Make sure the “D-shaped” portion of the inflator harness connector boss aligns with the “D-shaped” portion of the original stopper plate as shown below. **Do not peel the white harness connection dust cover at this time.**



*Continued...*

**STEP 11-** Reinstall the original stopper plate and the 5 **NEW** self-locking nuts. **SLOWLY** tighten (to prevent over-tightening) then torque the nuts to 31-38 inch-pounds. When complete, use a marker to indicate they have been fully tightened.



**STEP 12-** Peel the white dust cover from the d-shaped end of the new inflator. The new inflator wiring harness has 2 “sides” with round 2-pin connectors on both ends. The “short” side with the yellow tape and red / yellow wires will connect to the end of the inflator with the D-Shaped wiring harness connector boss as shown below. Peel the white dust cover from the D-Shaped end of the inflator **ONLY**.



**IMPORTANT: NEVER PEEL BOTH THE WHITE DUST COVERS OFF AT THE SAME TIME!**

**CAREFULLY** align the pins of the inflator with the female terminals of the harness connector (red / yellow wires) end as shown in the photos below. Once pin alignment is confirmed, push down firmly to engage the connector’s 3 locking tangs into the locking groove inside the connector boss. Confirm the connector is locked by prying up **LIGHTLY** with a small flat-blade screwdriver. Repeat the procedure on the opposite “long” side with the blue / white wires. When complete, refit the harness cover tube back into the mounting brackets.

*Continued...*

**VERY IMPORTANT:** When connecting the new harness to the inflator, **both sides MUST be routed as shown** in the “New Harness Properly Installed” photo below.

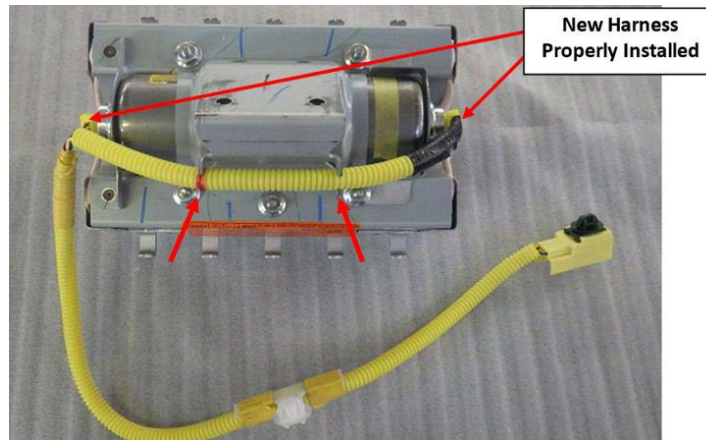

**STEP 13-** Refit the airbag module to the instrument panel.

**STEP 14-** Reinstall the instrument panel assembly into the vehicle in reverse order of disassembly. Once the negative battery cable has been reconnected, turn the ignition key “ON” and confirm the AIRBAG warning light comes on then cycles off properly. Once proper warning light operation is confirmed, reinstall the remaining components and reset the radio station presets (and Navigation favorites where applicable) to complete the procedure.

**STEP 15-** If not already done, place the removed original air bag inflator in the “cradle” of the Kit Box insert, with a completed SOA warranty parts tag (MSA5W402A) attached to it. The tag must contain the following information: **Claim Number, Repair Date, 17-digit VIN, and vehicle mileage.** Refer to the “PART RETURN PROCEDURES” section of this bulletin for further return shipping instructions and information. **Ensure both the removed and installed inflator serial numbers have been recorded correctly as previously instructed on the repair order hard copy before returning the removed part to your Parts Department.**

**IMPORTANT: UNDER NO CIRCUMSTANCES SHOULD ANY AIR BAG INFLATORS BE RETURNED TO SUBARU OF AMERICA, INC.**

*Continued...*

**\*SERVICE PROCEDURE FOR 2009-13MY FORESTER and 2009-11MY IMPREZA and 2009-2013 MY WRX and STI MODELS\***

**Inflator Kit Part Numbers: 98279SC010 (Forester) and 98279FG010 (Impreza, WRX and STI)  
Replacement Airbag Module Assembly Part Number 98279FG07A**

**CAUTION: Refer to the “CAUTION” section in the General Description portion of Airbag System AB in the Body Section of the Service Manual before handling or servicing any airbag module!**

**STEP 1- PREPARATION:**

- Record the customer’s radio station presets (and Navigation favorites where applicable).
- Turn the ignition “OFF”.
- Disconnect the Negative (ground) cable from the battery and wait **at least 60 seconds** before proceeding further.
- Follow the procedures in the applicable Service Manual for removing the instrument panel assembly as required to access the passenger side airbag module.
- Disconnect the wiring harness and remove the airbag module.
- Secure the removed airbag module to the Airbag Deployment Fixture (part number J-39401-B).

**IMPORTANT NOTE:** The photos available at the time of this procedure’s preparation do not show the removed airbag module assembly as being secured to the J-39401-B Airbag Deployment Fixture during inflator replacement. Subaru of America, Inc. **STRONGLY RECOMMENDS ALWAYS** utilizing a J-39401-B fixture whenever performing **ANY** airbag inflator replacement service procedure.

**IMPORTANT: Whenever beginning to remove (or install) the airbag assembly, and periodically while performing the procedure or after stepping away, remove any possible static charge from your body by momentarily touching a clean, bare metal ground point on the vehicle (e.g. the door striker). Remove from your person all electronic devices including cell phones before proceeding.**

**IMPORTANT: DO NOT destroy or damage the Kit Box as it MUST be used for the original inflator’s return shipping.**

Open the Kit Box and confirm all the necessary components are included:

- 4 Self-Locking nuts
- New Inflator (yellow tape applied to one end to identify it as
- New Inflator Harness
- Electro-Tap (red shorting crimp connector)
- Shipping Documentation

**NOTE:** The contents of both kit part numbers are virtually identical except for the vinyl tape color (black / white).



*Continued...*

**STEP 2-** To access the passenger's airbag module, the complete instrument panel assembly must be removed. Follow the procedures in the applicable Service Manual for removing the instrument panel assembly in addition to the necessary related interior trim components.

**NOTE:** On **FORESTER** models, when removing the "A" pillar trim, be **VERY CAREFUL** not to damage the upper trim retaining (tether) clip. It is **STRONGLY RECOMMENDED** to use the release tool (p.n. SOA635147) specifically designed for tether clip removal. See pg. 8 of this bulletin for more information. The clip is located just below where the trim panel meets the head liner. If the tether clip becomes damaged, it **MUST** be replaced. The illustrations below show how to release the tether clip and remove the "A" pillar trim.

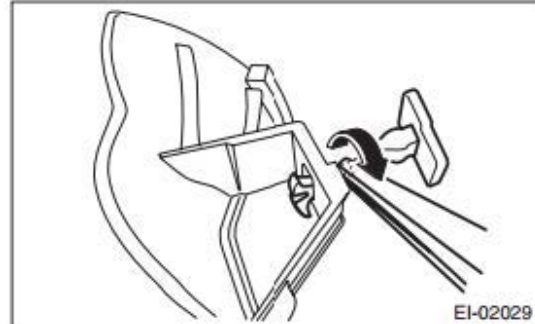
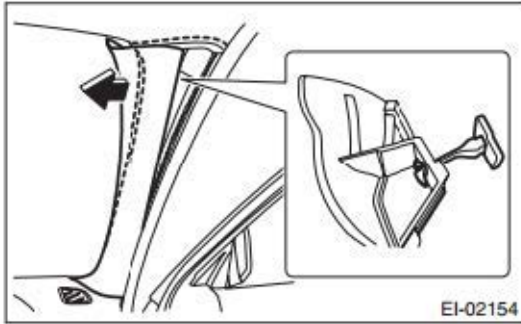

On **IMPREZA** models, in place of the tether clip, the trim is secured by a screw accessible by removing the small access cover.

Once the instrument panel assembly has been removed from the vehicle, **CAREFULLY** release the retaining claws and separate the airbag bag module. When replacing the complete module assembly, proceed directly to **Step 13**.

**REMINDER:** It is **STRONGLY RECOMMENDED** the removed airbag module **ALWAYS** be mounted to the Airbag Deployment Fixture (part number J-39401-B and file photo shown below) to better secure it during the inflator replacement procedure. When mounting the module to the fixture, pay close attention to the harness routing. Always perform this work in an area away from others to reduce chances of inadvertent injury should any deployment occur. Take your surroundings into account to avoid possible hazards should an inadvertent deployment occur or sources of static or other electricity that could potentially induce such a deployment.

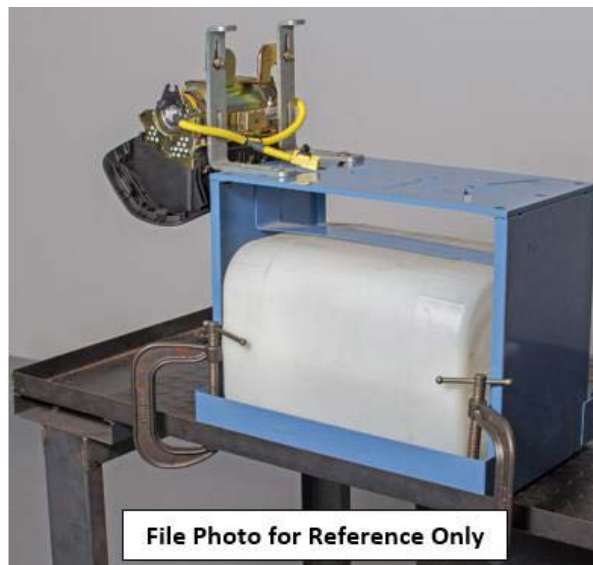

File Photo for Reference Only

*Continued...*

**STEP 3-** Remove the harness clip from the retainer bracket by pushing the tangs inward with a flat-blade screwdriver as shown below.

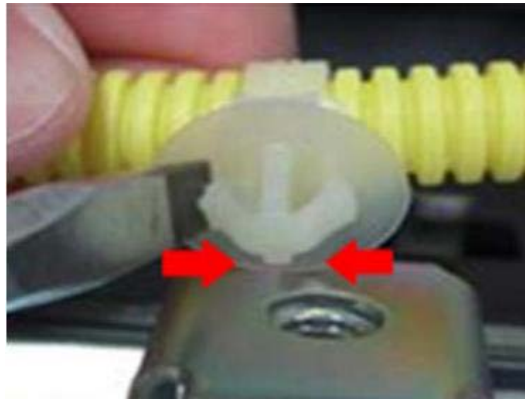

**STEP 4-** Using a scissor or wire cutter (no knives or razors) **CAREFULLY** cut the yellow harness cover tube (approximately 1 1/2 inches) enough to expose the yellow and red wires inside and provide enough room to install the Electro-Tap (shorting) connector.

**TAKE YOUR TIME AND BE CAREFUL TO NOT CUT THE 2 WIRES!**

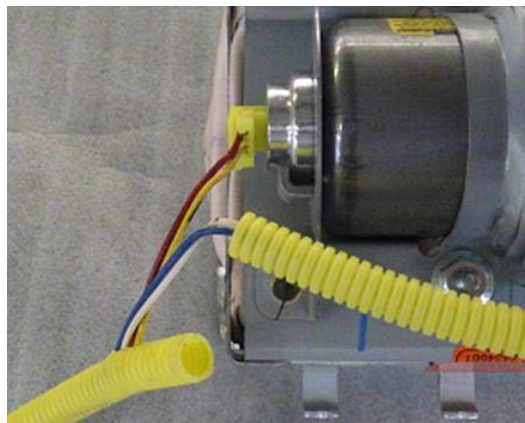

**STEP 5-** Short the yellow and red wires together by installing the Electro-Tap connector. The connector creates a short circuit which acts as a safeguard to prevent against static discharge that may deploy the removed inflator. The tab portion of the Electro-Tap connector **MUST** be cut off prior to use to insure a good short-circuit is made as shown in the illustration below. **Follow the sequence below** for installing the Electro-Tap connector. Use pliers to squeeze closed the two sections of the connector together, **one section at a time**.

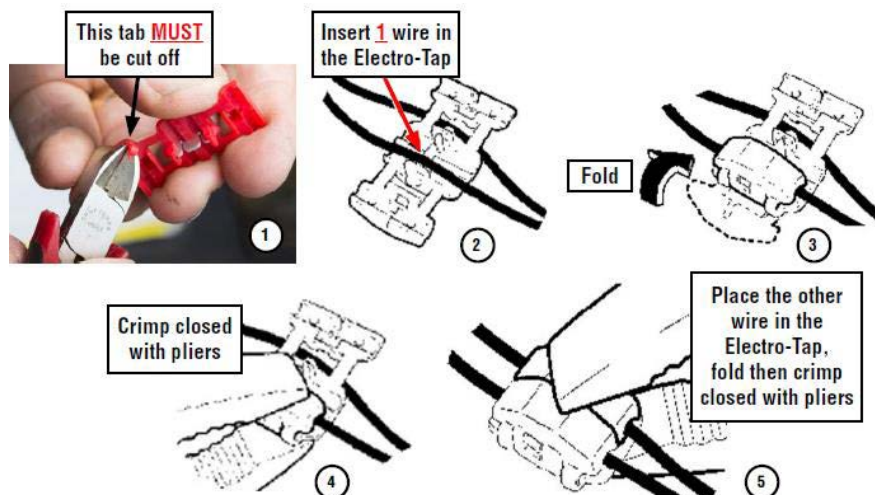

*Continued...*

**STEP 6-** Once the Electro-Tap connector is fully crimped in place, cut the yellow and red wires **on the body harness connector side** of the Electro-Tap connector.

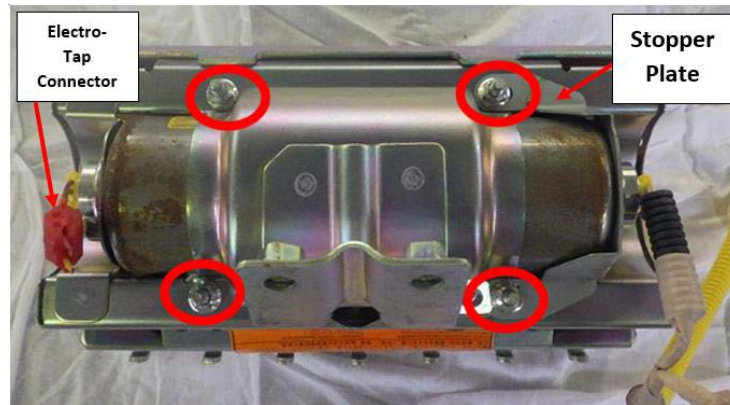

**STEP 7-** Loosen and remove the four (4) 10mm self-locking nuts along with the stopper plate. **DO NOT DISCARD** the removed stopper plate as it will be reused during reassembly. Discard the 4-10mm nuts.

**VERY IMPORTANT: Under no circumstances should any impact or power tools be used when performing these procedures. HAND TOOLS ONLY!**

**STEP 8-** With the self-locking nuts and stopper plate removed, slide the original inflator out of the mounting bracket while feeding the cut off portion of the wiring harness under the remaining stopper plate. Place the removed original air bag inflator back into the “cradle” of the Kit Box insert.

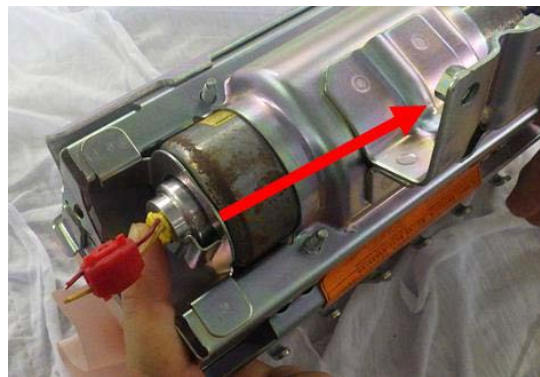

**STEP 9 - VERY IMPORTANT:** Record the **11-digit alpha-numeric serial number for both the new and the removed inflators** on the hard copy of the Repair Order. **For SOA and SDC Retailers ONLY**, this information will be required for claim approval. **For SNE retailers**, this information will be required for completion of the Part Return Notice which will be forwarded by the retailer to the PCC.



*Continued...*



**STEP 10-** Install the new inflator into the mounting bracket so the yellow taped end will align with the stopper plate when reinstalled on the mounting bracket. When properly installed, both ends of the inflator will be seated tight against the stopper plates with no gaps.



Make sure the “D-shaped” portion of the inflator harness connector boss aligns with the “D-shaped” portion of the original stopper plate as shown below. Do not peel the white harness connection dust cover at this time.

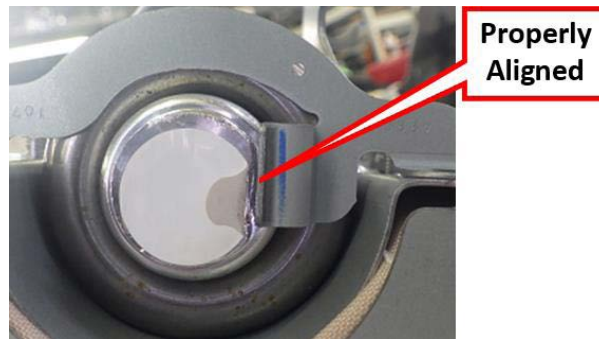

**STEP 11-** Reinstall the original stopper plate and the 4 **NEW** self-locking nuts. **SLOWLY** tighten (to prevent over-tightening) then torque the nuts to 31-38 inch-pounds. When complete, use a marker to indicate they have been fully tightened.



**STEP 12-** Peel the white dust cover from the d-shaped end of the new inflator. The new inflator wiring harness has 2 “sides” with round 2-pin connectors on both ends. The “long” side with the yellow / red wires will connect to the end of the inflator with the D-Shaped wiring harness connector boss as shown below. Peel the white dust cover from the D-Shaped end of the inflator **ONLY**.

*Continued...*



**IMPORTANT: NEVER PEEL BOTH THE WHITE DUST COVERS OFF AT THE SAME TIME!**

**CAREFULLY** align the pins of the inflator with the female terminals of the harness connector (red / yellow wires) as shown in the photos below. Once pin alignment is confirmed, push down firmly to engage the connector's 3 locking tangs into the locking groove inside the connector boss. Confirm the connector is locked by prying up **LIGHTLY** with a small flat-blade screwdriver. Repeat the procedure on the opposite "short" side with the blue / white wires.

**VERY IMPORTANT: When connecting the new harness to the inflator, both sides MUST be routed and the retaining clip installed** as shown in the "New Harness Properly Installed" photo below.

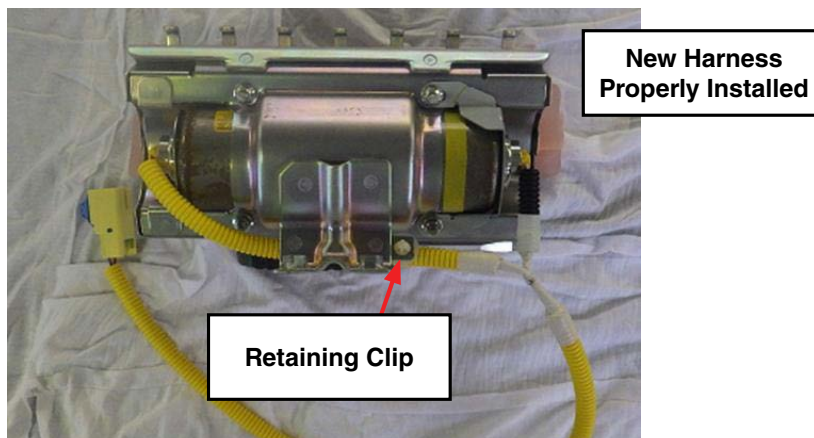

**STEP 13-** Refit the airbag module to the instrument panel.

**STEP 14-** Reinstall the instrument panel assembly into the vehicle in reverse order of disassembly. Once the negative battery cable has been reconnected, turn the ignition key "ON" and confirm the AIRBAG warning light comes on then cycles off properly. Once proper warning light operation is confirmed, reinstall the remaining components and reset the radio station presets (and Navigation favorites where applicable) to complete the procedure.

**STEP 15-** If not already done, place the removed original air bag inflator (or module assembly) in the "cradle" of the Kit Box insert (or into the returnable shipping box), with a completed SOA warranty parts tag (MSA5W402A) attached to it. The tag must contain the following information: **Claim Number, Repair Date, 17-digit VIN, and vehicle mileage.** Refer to the "PART RETURN PROCEDURES" and Appendix "A" sections of this bulletin for further return shipping instructions and information. **Ensure both the removed and installed inflator serial numbers have been recorded correctly as previously instructed on the repair order hard copy before returning the removed part to your Parts Department.**

**IMPORTANT: UNDER NO CIRCUMSTANCES SHOULD ANY AIR BAG INFLATORS OR MODULE ASSEMBLIES BE RETURNED TO SUBARU OF AMERICA, INC.**

*Continued...*

**\*SERVICE PROCEDURE FOR 2009-13MY Tribeca MODELS\***

**Inflator Kit part number: 98279XA02A**

**CAUTION: Refer to the “CAUTION” section in the General Description portion of Airbag System AB in the Body Section of the Service Manual before handling or servicing any airbag module!**

**STEP 1- PREPARATION:**

- Record the customer’s radio station presets (and Navigation favorites where applicable).
- Turn the ignition “OFF”.
- Disconnect the Negative (ground) cable from the battery and wait **at least 60 seconds** before proceeding further.
- Follow the procedures in the applicable Service Manual for removing the instrument panel (IP) assembly. IP assembly removal is required to access the passenger side airbag module.
- Once the IP is removed, remove the airbag module and secure the it to the Airbag Deployment Fixture (part number J-39401-B).

**IMPORTANT NOTE:** The photos available at the time of this procedure’s preparation do not show the removed airbag module assembly as being secured to the J-39401-B Airbag Deployment Fixture during inflator replacement. Subaru of America, Inc. **STRONGLY RECOMMENDS ALWAYS** utilizing a J-39401-B fixture whenever performing **ANY** airbag inflator replacement service procedure.

**IMPORTANT: Whenever beginning to remove (or install) the airbag assembly, and periodically while performing the procedure or after stepping away, remove any possible static charge from your body by momentarily touching a clean, bare metal ground point on the vehicle (e.g. the door striker). Remove from your person all electronic devices including cell phones before proceeding.**

**IMPORTANT: DO NOT destroy or damage the Kit Box as it MUST be used for the original inflator’s return shipping.** Open the Kit Box and confirm all the necessary components are included:

- New Self-Locking nuts (4)
- New Inflator (pink caps on both ends identify it as the replacement part)
- New Inflator Harness
- Electro-Tap (red shorting crimp connector, not shown)
- Black Thermal Insulator
- Stopper Plate
- Protective Sheet
- Anti-Wrinkling Tapes (3)
- Shipping Documentation



**NOTE: Discard this CE label as it is not applicable to the US market.**

*Continued...*

**STEP 2-** To access the passenger's airbag module, the complete instrument panel assembly must be removed. Follow the procedures in the applicable Service Manual for removing the instrument panel assembly in addition to the necessary related interior trim components. Always take proper precautions to protect trim panel surfaces from damage. Additional tips are provided below to assist with the IP removal.

- Remove the harness connectors from components as needed to access the IP retaining screws as per the Service Manual. Release the harness retaining clips shown below using needle-nosed pliers and push them through to allow additional movement of the IP.

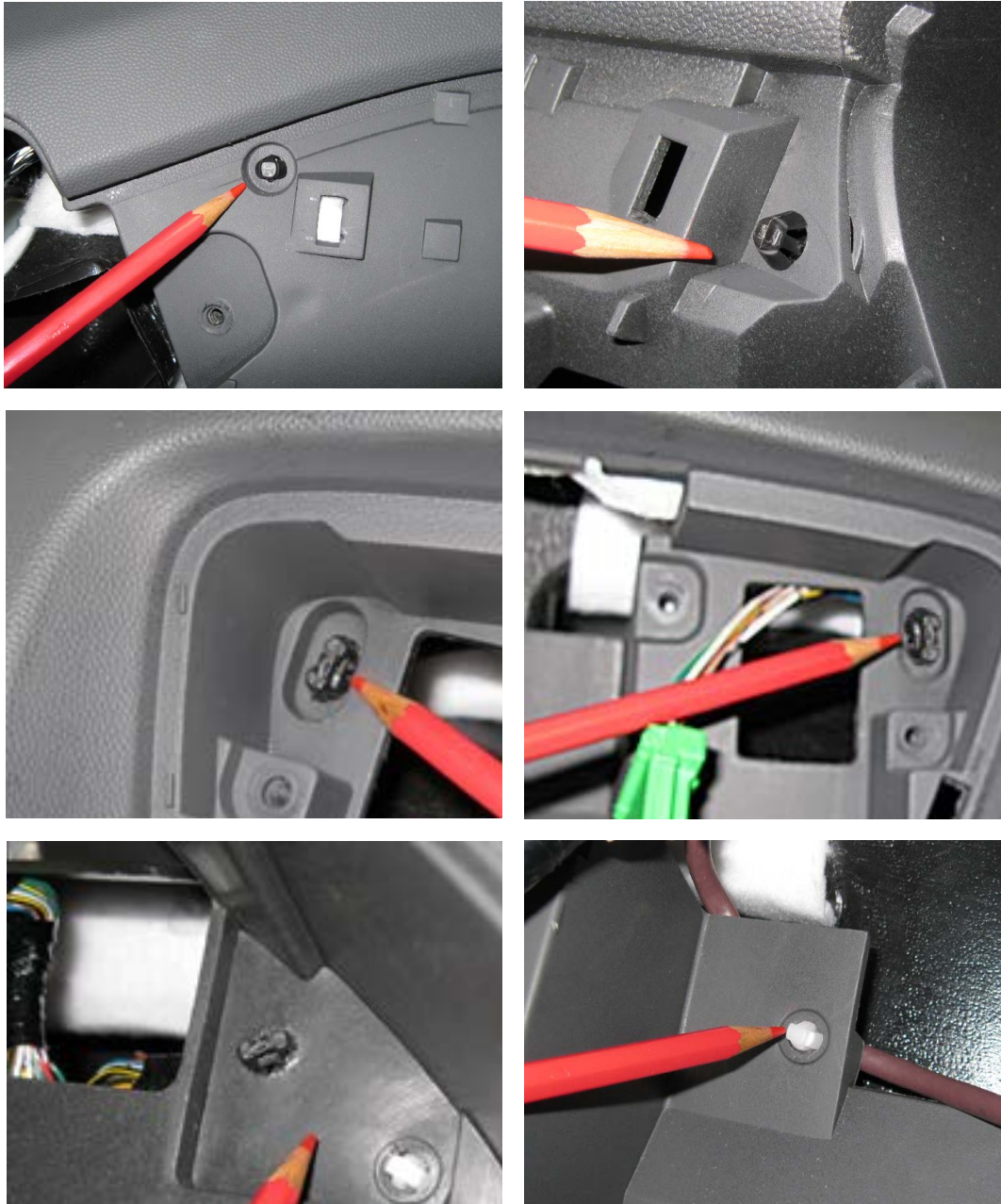

- Release the steering column locking lever, extend the steering column fully and set the column to its lowest position. It is **not necessary** to remove the steering column or the bolts securing it to the support beam in order to remove the IP.

*Continued...*

- **IMPORTANT:** Always cover the steering column cover to protect it along with the top of the HVAC blower case to keep out any removed hardware (e.g. airbag module retaining bolts) with clean shop cloth.



- Once the instrument panel assembly has been removed from the vehicle, remove the 4 retaining nuts and separate the airbag bag module from the IP.

**REMINDER:** It is **STRONGLY RECOMMENDED** the removed airbag module **ALWAYS** be mounted to the Airbag Deployment Fixture (part number J-39401-B and file photo shown below) to better secure it during the inflator replacement procedure. When mounting the module to the fixture, pay close attention to the harness routing. Always perform this work in an area away from others to reduce chances of inadvertent injury should any deployment occur. Take your surroundings into account to avoid possible hazards should an inadvertent deployment occur or sources of static or other electricity that could potentially induce such a deployment.

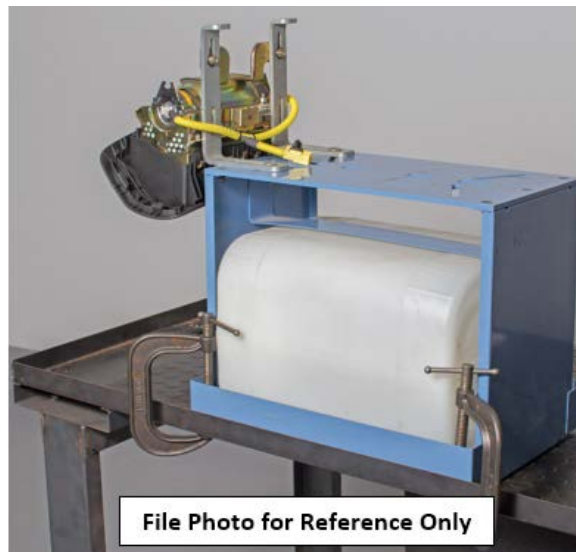

**STEP 3-** Remove both harness tubes from the retainer bracket.



*Continued...*

**STEP 4-** Using a scissor or wire cutter (no knives or razors) **CAREFULLY** cut the black harness cover tube (approximately 1 1/2 inches) enough to expose the blue and white wires inside. Provide enough room to install the Electro-Tap (shorting) connector.

**TAKE YOUR TIME AND BE CAREFUL TO NOT CUT THE 2 WIRES!**

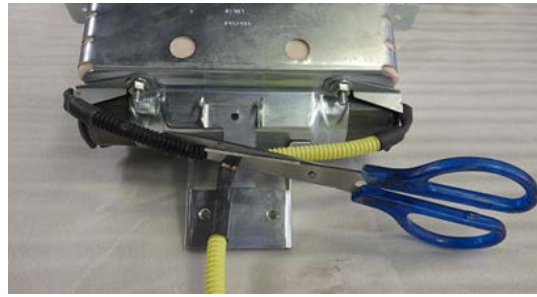

**STEP 5-** Short the blue and white wires together by installing the Electro-Tap connector. The connector creates a short circuit which acts as a safeguard to prevent against static discharge that may deploy the removed inflator. The tab portion of the Electro-Tap connector **MUST** be cut off prior to use to insure a good short-circuit is made as shown in the illustration below. **Follow the sequence below** for installing the Electro-Tap connector. Use pliers to squeeze closed the two sections of the connector together, **one section at a time**.

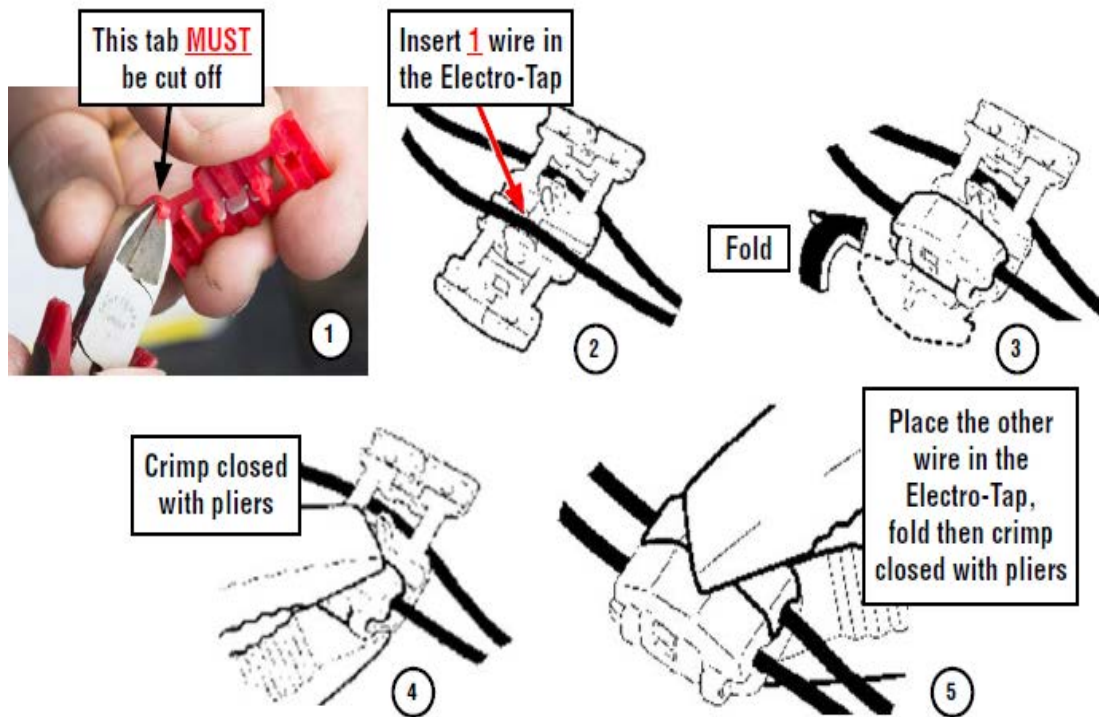

**STEP 6-** Once the Electro-Tap connector is fully crimped in place, cut the blue and white wires **on the body harness connector side** of the Electro-Tap connector. **NEVER ATTEMPT TO REMOVE THE HARNESS CONNECTORS FROM THE INFLATOR!**

*Continued...*

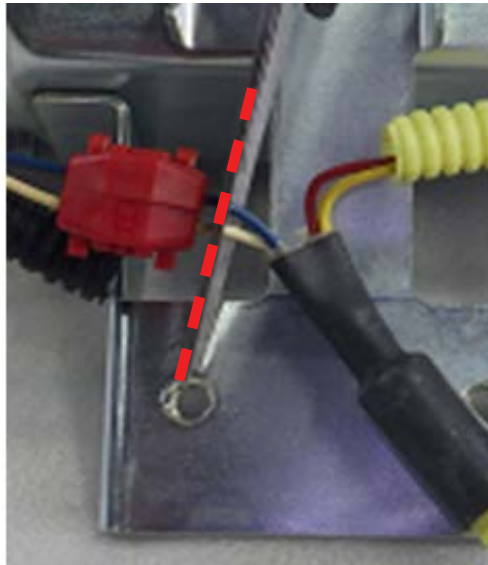

**STEP 7- USING HAND TOOLS ONLY**, loosen and remove the four (4) 10mm self-locking nuts along with both stopper plates. **RETAIN the stopper plate circled in GREEN** (Left-side bracket in image below) as it will be used during reassembly. Discard the removed stopper plate circled in **YELLOW** as it is no longer needed along with the 4 removed 10mm nuts.

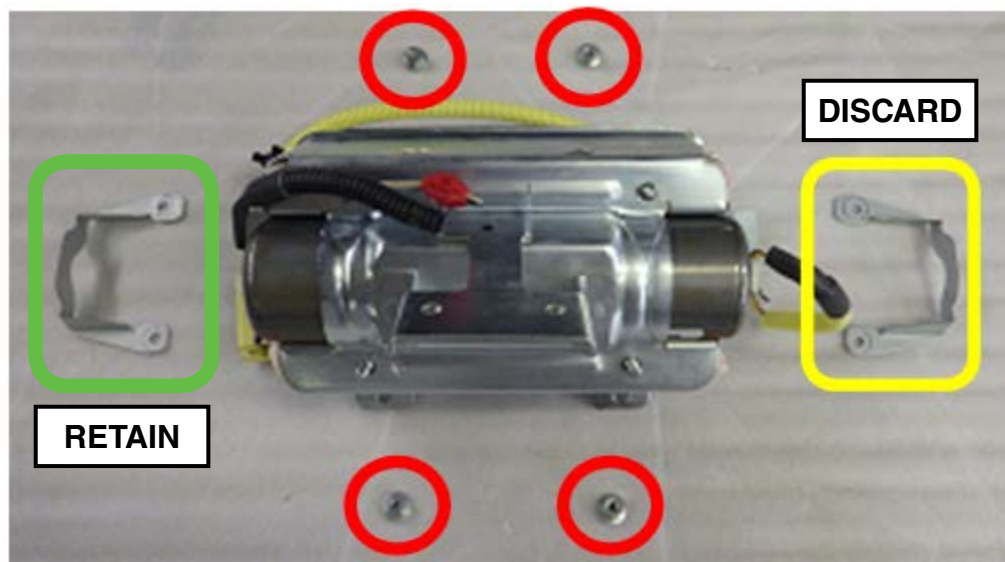

**VERY IMPORTANT REMINDERS:**

- **Under no circumstances should any impact or power tools be used when performing these procedures. HAND TOOLS ONLY!**
- **NEVER ATTEMPT TO REMOVE THE HARNESS CONNECTORS FROM THE INFLATOR!**

**STEP 8-** With the self-locking nuts and stopper plate removed, slide the original inflator out of the mounting bracket. Place the removed original air bag inflator back into the “cradle” of the Kit Box.

*Continued...*

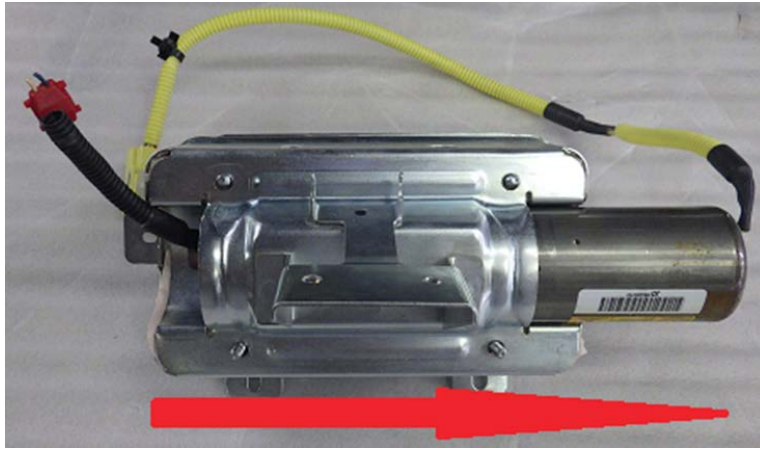

**STEP 9- VERY IMPORTANT:** Record the serial number for **both the new and the removed inflators** on the hard copy of the Repair Order. **For SOA and SDC Retailers ONLY**, this information will be required for claim approval. **For SNE retailers**, this information will be required for completion of the Part Return Notice which will be forwarded by the retailer to the PCC.



*Continued...*



**STEP 10-** CAREFULLY remove the airbag from the mounting bracket (case).

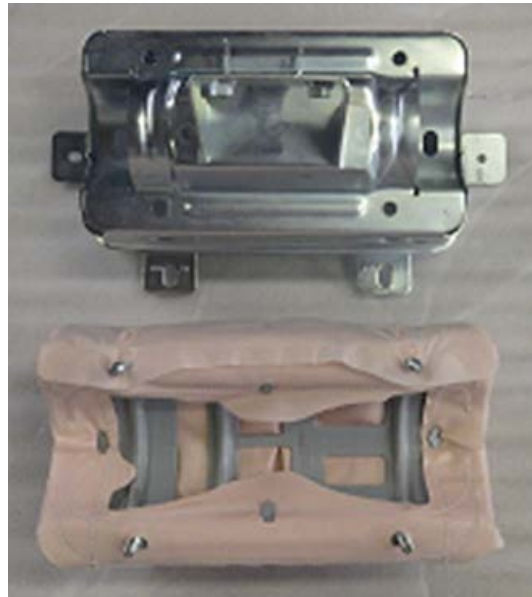

**STEP 11-** CAREFULLY install the black thermal insulator into the back (inflator) side of the airbag as shown in photo 1 below. **CAUTION:** Gloves are recommended when doing this as edges of the thermal insulator can be very sharp. **TAKE YOUR TIME** and do not bend or twist the insulator any more than necessary to make it fit. The insulator can only be installed in one direction as shown in photo 3 otherwise, the airbag will not fit back into the module frame properly. Confirm both retaining claws come through the corresponding insulator holes like the example shown in photo 2.

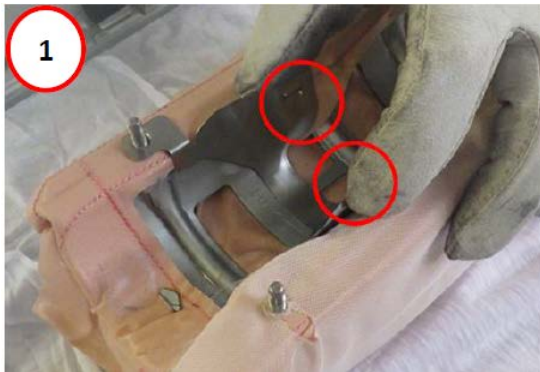

Thermal Insulator Properly Installed

*Continued...*

**STEP 12-** Install the protective sheet onto the studs of the airbag with the black mark in the position specified in the photo below. Due to the different spacing of the studs, the protective sheet will only fit properly when installed in this manner.



**STEP 13-** The protective sheet is properly installed when: **a)** it fits squarely on the studs, **b)** the black oval-shaped mark is facing up and **c)** the excess is laying over the top of the airbag and folded as shown in the side view photos below.

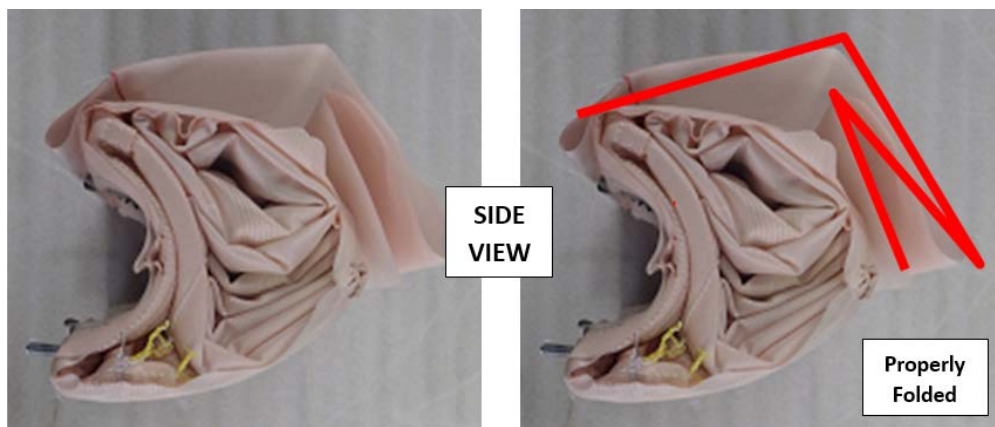

**STEP 14- CAREFULLY** refit the airbag back into the mounting bracket as shown in the sequence below.

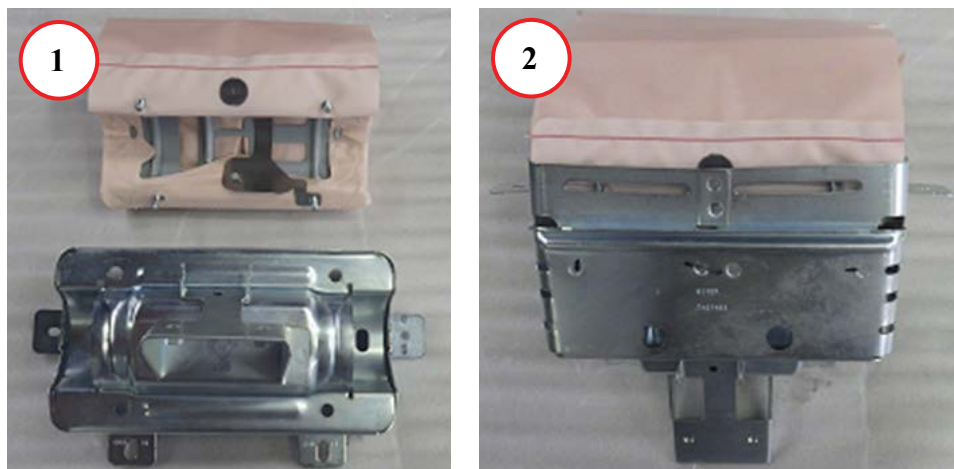

*Continued...*

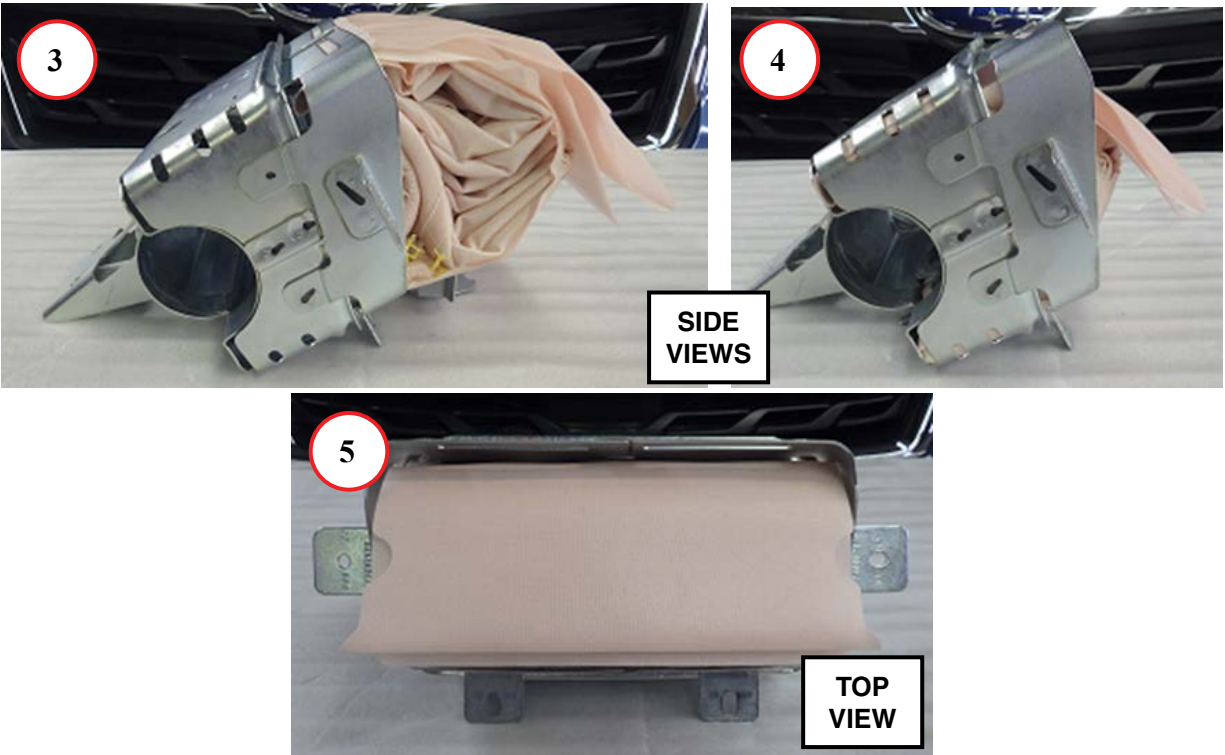

**STEP 15-** Apply the 3 anti-wrinkling tapes to the module frame as shown below to retain the protective sheet. The yellow rectangles represent the tapes and the red lines indicate where the tapes are to be positioned. Approximately 200mm (13/16") from each end of the 2tape should be applied to the module frame.

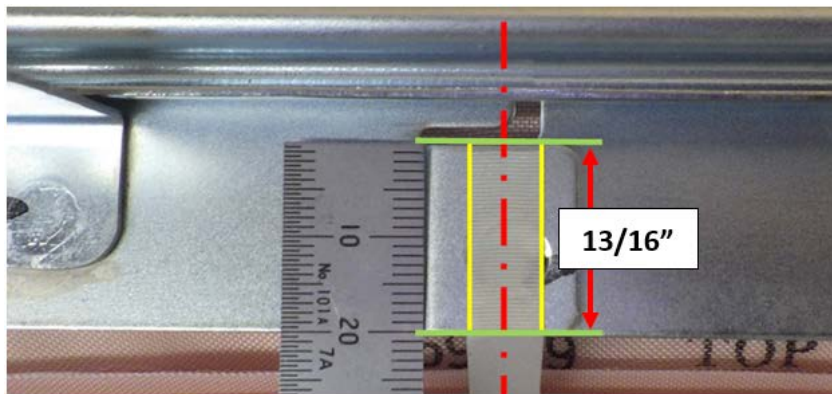
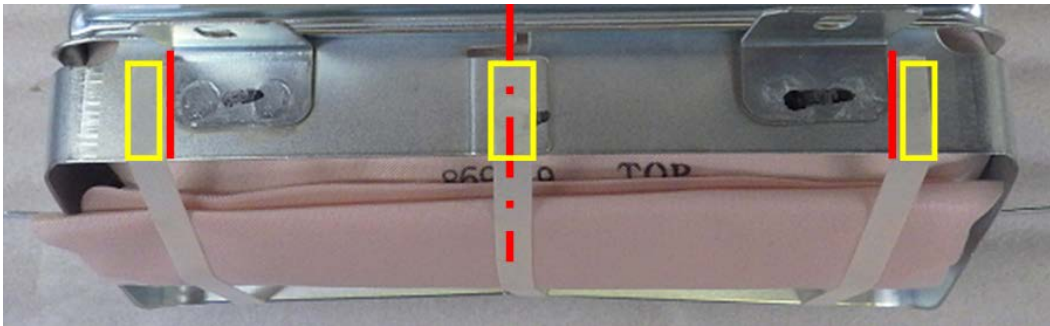

*Continued...*



Airbag Reinstallation Complete

**STEP 16-** Inspect the new inflator to confirm the locating protrusions on each of the pink collars are aligned as shown below. The “short” collar can be rotated as needed to align it with the protrusion on the “long” collar if necessary.

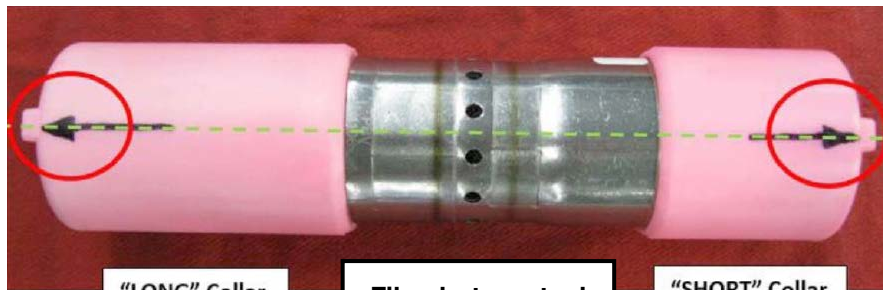

“LONG” Collar

File photo, actual replacement inflator may differ slightly.

“SHORT” Collar

**STEP 17-** Install the new stopper plate supplied with the kit and start 2 of the new nuts onto the studs but do not tighten them.

**STEP 18-** Slide the new inflator back into the mounting bracket, short collar end first. Align the tab on the new stopper plate with the notch on the end of the collar. When properly installed, the inflator will be tight against the stopper plate with no gap.

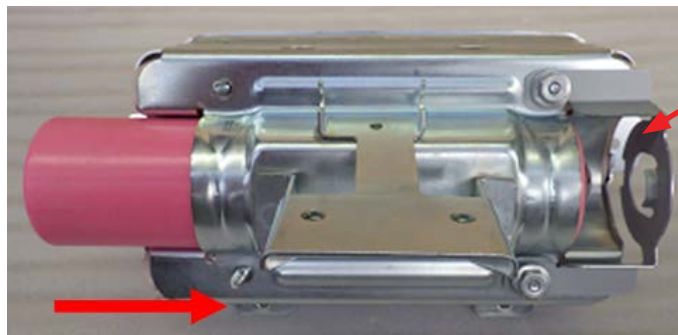

New Stopper Plate Supplied with Kit.

*Continued...*

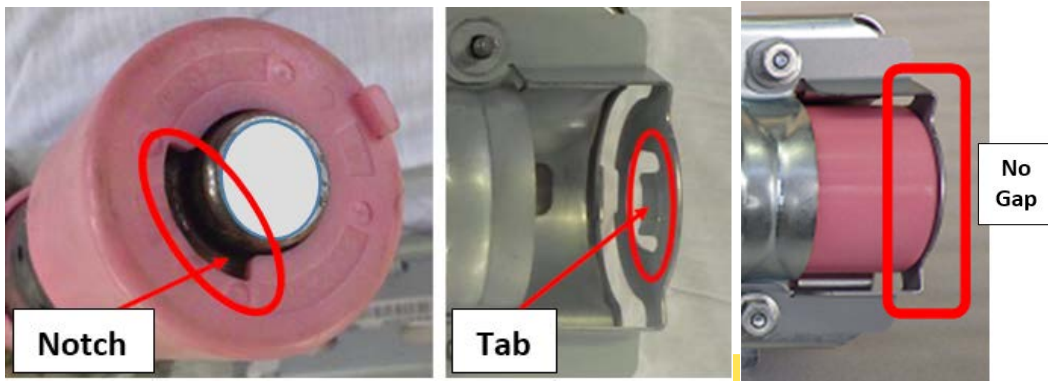

**STEP 19-** Reinstall the original (retained from **STEP 7**) stopper plate and the other 2 **NEW** self-locking nuts. **SLOWLY** tighten (to prevent over-tightening) while making sure both stopper plates stay tight against both ends of the inflator. **HAND TOOLS ONLY!** Torque the nuts to 31-38 inch-pounds. When complete, use a marker to indicate they have been fully tightened.

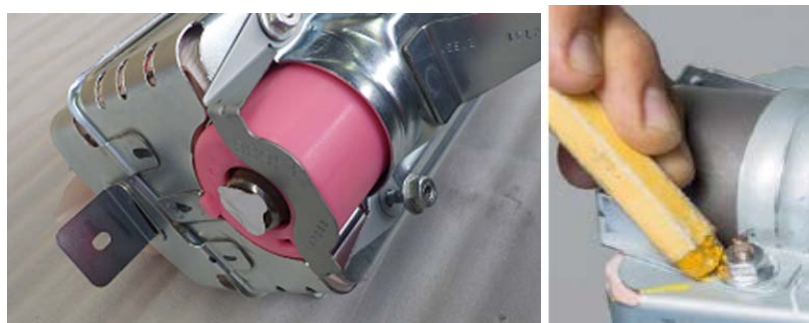

**STEP 20-** Peel the white dust cover from **ONE** end of the new inflator. One end will have a black harness connector while the connector on the opposite end will be orange. The new inflator wiring harness has 2 “sides” with 2-pin connectors on both ends.

- The side with the **black** harness tube and connector goes with the **black** inflator connector.
- The side with the **yellow** harness tube with **orange** connector) will connect to the orange inflator connector.

**IMPORTANT: NEVER PEEL BOTH OF THE WHITE DUST COVERS OFF AT THE SAME TIME!**

**BEFORE** connecting the harness to the inflator, make sure the harness is not twisted as shown below.

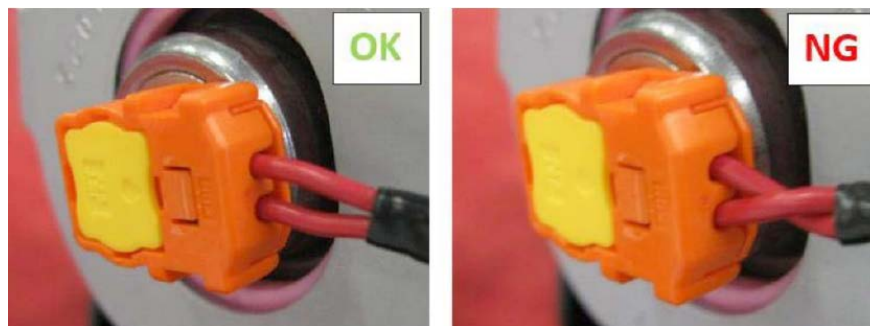

*Continued...*

**CAREFULLY** align the tang of the inflator with the slot on the inflator harness connector as shown below. Push down firmly on the yellow lock tab to engage the connector's locking claws into the groove inside the connector boss on the inflator end. Confirm the connector is locked by prying up **LIGHTLY** with a small flat-blade screwdriver. Repeat the procedure on the opposite end.

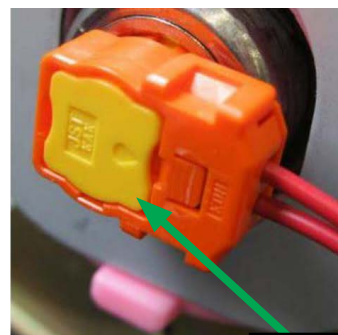
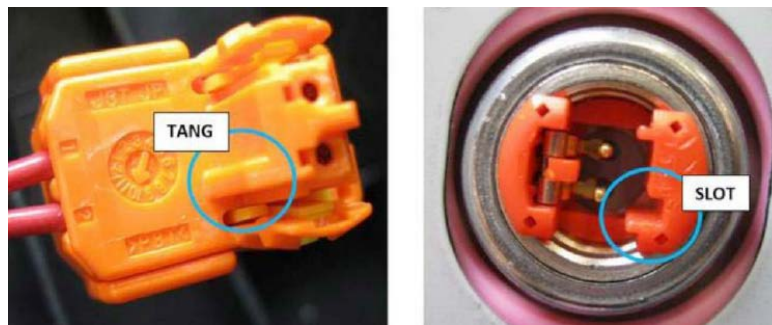

Once alignment is confirmed, push down firmly to engage the connector. When fully seated, press down on the yellow tab locking the connector to the inflator.

**Lock Tab**

**STEP 21-** After connecting both sides of the harness, refit the harness cover tube back into the retaining bracket.

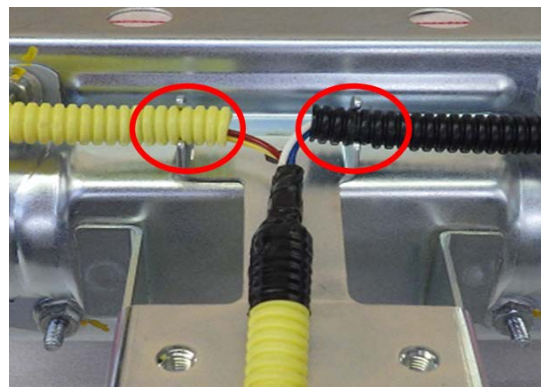

**STEP 22-** Refit the airbag module to the instrument panel while making sure the anti-wrinkling tapes stay in their proper positions.

**STEP 23-** Reinstall the instrument panel assembly into the vehicle in reverse order of disassembly. Once the negative battery cable has been reconnected, turn the ignition key "ON" and confirm the AIRBAG warning light comes on then cycles off properly. Once proper warning light operation is confirmed, reinstall the remaining components and reset the radio station presets (and Navigation favorites where applicable) to complete the procedure.

*Continued...*

**STEP 24-** If not already done, place the removed original air bag inflator in the “cradle” of the Kit Box insert, with a completed SOA warranty parts tag (MSA5W402A) attached to it. The tag must contain the following information: **Claim Number, Repair Date, 17-digit VIN, and vehicle mileage.** Refer to the “PART RETURN PROCEDURES” section of this bulletin for further return shipping instructions and information. **Ensure both the removed and the installed inflator serial numbers have been recorded correctly as previously instructed on the repair order hard copy before returning the removed part to your Parts Department.**

**IMPORTANT REMINDER: UNDER NO CIRCUMSTANCES SHOULD ANY AIR BAG INFLATORS BE RETURNED TO SUBARU OF AMERICA, INC.**

*Continued...*

## RECALL IDENTIFICATION LABEL

Type or print the necessary information on a Recall Identification Label. The completed label should be attached to the vehicle's upper radiator support.

Additional labels are available through normal parts ordering channels. The part number is MSA6P1302, which comes as one sheet of 20 labels.

Part Number	Applicability	Description	Order Quantity
MSA6P1302	All models	Campaign Completion Labels (contains one sheet of 20 labels)	1

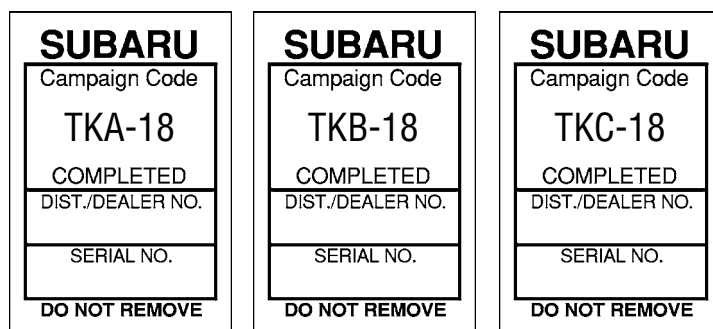

## CLAIM REIMBURSEMENT AND ENTRY PROCEDURES

Credit to perform this recall will be based on the submission of properly completed repair order information. Retailers may submit claims through 'Vehicle Claim Entry' on [Subarunet.com](http://Subarunet.com).

Until sufficient parts supply is available for Subaru to re-notify owners, the status will show as "Open-Limited Parts Available." This coverage status will not affect claim entry.

Listed below is claim entry information:

Claim Type & Campaign Code		Model	Labor Time	Labor Operation Number and Description
RC	TKA-18 TKB-18 TKC-18	Forester (2009-2013)	1.6	A182-031 Front Passenger Air Bag Inflator Replacement
RC	TKA-18 TKB-18 TKC-18	Impreza (2009-2011) WRX and STI (2009-2013)	1.6	A182-031 Front Passenger Air Bag Inflator Replacement
RC	TKA-18 TKB-18 TKC-18	Legacy (2009) Outback (2009)	1.8	A182-031 Front Passenger Air Bag Inflator Replacement
RC	TKA-18 TKB-18 TKC-18	Legacy (2010-2013) Outback (2010-2013)	3.0	A182-031 Front Passenger Air Bag Inflator Replacement
RC	TKA-18 TKB-18 TKC-18	Tribeca (2009-2013)	1.8	A182-031 Front Passenger Air Bag Inflator Replacement

*Continued...*



Airbag Module Part Number	Inflator Kit Part Number	Applicability / Description	Claim Quantity
TBD	98279SC010	Forester (2009-2013)	1
98279FG07A	98279FG010	Impreza (2009-2011)	1
		WRX and STI (2009-2013)	
N/A	98279AG00A	2009 Legacy / Outback, Inflator Type 1	1
N/A	98279AG05A	2009 Legacy / Outback, Inflator Type 2	
TBD	98279AJ02A	Legacy (2010-2013)	1
		Outback (2010-2013)	
N/A	98279XA02A	Tribeca (2009-2013)	1
N/A	SOA963W110**	2009 Legacy / Outback Non-Woven Material, 8" X 11" Sheet	1

**\*\*NOTE:** For claim entry, use part # SOA635079 for the non-woven material. This part # is non-orderable and used for claim purposes only.

<b>For SOA and SDC Retailers: Serial Number Entry</b>	Upon entry of a recall claim, <b>BOTH</b> the newly-installed (replacement) and the removed (original) serial numbers are required to be entered in the appropriate fields in the Recall Claim Entry system. As a result of adding these new required entry fields, Part Return Notices will no longer be generated.
---	--

<b>For SNE Retailers ONLY Miscellaneous Detail Field</b>	The serial number of the NEW air bag inflator or Module installed <b>MUST</b> be entered in the "Misc. Detail" field.
--	---

*Continued...*

## OWNER NOTIFICATION LETTER

**URGENT**  
**IMPORTANT SAFETY RECALL**  
**This notice applies to the VIN below**



**Subaru of America, Inc**  
Subaru Plaza  
PO Box 6000  
Cherry Hill, NJ 08034-6000  
800-782-2783  
www.subaru.com

**Subaru Recall Campaign TKA-18**  
**NHTSA Recall No. 18V-012**  
**Zone A: Legacy, Outback, Tribeca**  
**February 2018**

**Dear Subaru Owner:**

This notice is sent to you in accordance with the National Traffic and Motor Vehicle Safety Act.

SUBARU OF AMERICA, INC. has decided that a defect, which relates to motor vehicle safety, exists in certain 2009 model year Legacy and Outback vehicles and certain 2009-2013 model year Tribeca vehicles, equipped with a non-desiccated Takata-sourced passenger side frontal air bag containing the propellant Phase Stabilized Ammonium Nitrate.

You received this notice because our records indicate that you currently own one of these vehicles.

### **DESCRIPTION OF THE SAFETY DEFECT AND SAFETY HAZARD**

The affected vehicles are equipped with a Takata-sourced passenger side frontal air bag that may be susceptible to moisture intrusion. Over time, this could cause the inflator to explode when the passenger's frontal air bag deploys in a crash. If the inflator explodes, sharp metal fragments could strike vehicle occupants, potentially resulting in serious injury or death.

***Parts are available.***

### **WHAT YOU SHOULD DO**

You should immediately contact your Subaru retailer (dealer) for an appointment to have the front passenger air bag inflator replaced with a new one, free of charge. To minimize your inconvenience while the repair is being performed, please ask your retailer for alternative transportation options.

***Until this repair is performed, do not allow passengers to ride in the front passenger seat.***

### **HOW LONG WILL THE AIR BAG INFLATOR REPLACEMENT TAKE?**

The time to replace the front passenger air bag inflator is approximately one hour and 48 minutes. It may be necessary to leave your vehicle for a longer period of time on the day of your scheduled appointment. Please present this letter to your Subaru retailer at the time this repair procedure is performed.

### **CHANGED YOUR ADDRESS OR SOLD YOUR SUBARU?**

If you have moved or sold your vehicle, please complete the enclosed prepaid postcard and mail it to us. Or if you prefer to update this information online, please go to [www.subaru.com](http://www.subaru.com), select 'Customer Support,' then select 'Address Update' or 'Ownership Update' from **the drop-down menu**.

***Continued...***

**IF YOU NEED FURTHER ASSISTANCE:**

To locate the nearest Subaru retailer, you can access our website at [www.subaru.com](http://www.subaru.com) and select 'Find a Retailer.'

For additional information and the most Frequently Asked Questions, please go to:  
<http://www.subaru.com/vehicle-recalls/airbags.html>.

Para información visite nuestro sitio web específico de Takata en español  
<http://www.subaru.com/es/vehicle-recalls/airbags.html>, o llame al 1-844-373-6614.

If you need additional assistance, please contact us directly:

- By e-mail: Go to [www.subaru.com](http://www.subaru.com) and select "Contact Us"
- By telephone: 1-844-373-6614  
Monday through Friday between 8:00 a.m. and 7:00 p.m. ET
- By U.S. Postal mail: Write us at Subaru of America, Inc.  
Attn: Customer-Retailer Services Department  
P.O. Box 6000, Cherry Hill, NJ 08034-6000

To subscribe to the NHTSA Recall Notification email System, please go to:  
<https://www-odi.nhtsa.dot.gov/nhtsa/subscriptions>.

Please contact us immediately if the Subaru retailer fails or is unable to make the necessary repairs free of charge.

You may also contact the Administrator, National Highway Traffic Safety Administration, 1200 New Jersey Ave. SE, West Building, Washington, DC 20590 or call the toll-free Auto Safety Hotline at 1-888-327-4236 (TTY: 1-800-424-9153) or go to <http://www.safercar.gov> if you believe the Subaru retailer has failed or is unable to remedy your vehicle without charge within a reasonable amount of time.

Your continued satisfaction with your Subaru is important to us. Please understand that we have taken this action in the interest of your safety and your vehicle's proper operation. We sincerely apologize for any inconvenience this matter may cause and urge you to schedule an appointment as soon as possible.

Sincerely,  
Subaru of America, Inc.

***Notice to Lessors:** Under Federal law the lessor of a vehicle who receives this letter must provide a copy of it to the vehicle lessee(s) within 10 business days from receipt. The lessor must also keep a record of the lessee(s) to whom this letter is sent, the date sent, and the applicable vehicle identification number (VIN). (For the purposes of this section, a lessor means a person or entity that in the last twelve months prior to the date of this notification has been the owner, as referenced on the vehicle's title, of any five or more leased vehicles. A leased vehicle is a vehicle leased to another person for a term of at least four months.)*

*A subsidiary of Fuji Heavy Industries Ltd.*

*Continued...*

## OWNER NOTIFICATION LETTER

**URGENT**  
**IMPORTANT SAFETY RECALL**  
**This notice applies to the VIN below**



**Subaru of America, Inc**  
Subaru Plaza  
PO Box 6000  
Cherry Hill, NJ 08034-6000  
800-782-2783  
www.subaru.com

**Subaru Recall Campaign TKB-18**  
**NHTSA Recall No. 18V-013**  
**Zone B: Legacy, Outback, Tribeca**  
**February 2018**

**Dear Subaru Owner:**

This notice is sent to you in accordance with the National Traffic and Motor Vehicle Safety Act.

SUBARU OF AMERICA, INC. has decided that a defect, which relates to motor vehicle safety, exists in certain 2009 model year Legacy and Outback vehicles and certain 2009-2010 model year Tribeca vehicles, equipped with a non-desiccated Takata-sourced passenger side frontal air bag containing the propellant Phase Stabilized Ammonium Nitrate.

You received this notice because our records indicate that you currently own one of these vehicles.

### **DESCRIPTION OF THE SAFETY DEFECT AND SAFETY HAZARD**

The affected vehicles are equipped with a Takata-sourced passenger side frontal air bag that may be susceptible to moisture intrusion. Over time, this could cause the inflator to explode when the passenger's frontal air bag deploys in a crash. If the inflator explodes, sharp metal fragments could strike vehicle occupants, potentially resulting in serious injury or death.

***Parts are available.***

### **WHAT YOU SHOULD DO**

You should immediately contact your Subaru retailer (dealer) for an appointment to have the front passenger air bag inflator replaced with a new one, free of charge. To minimize your inconvenience while the repair is being performed, please ask your retailer for alternative transportation options.

***Until this repair is performed, do not allow passengers to ride in the front passenger seat.***

### **HOW LONG WILL THE AIR BAG INFLATOR REPLACEMENT TAKE?**

The time to replace the front passenger air bag inflator is approximately one hour and 48 minutes. It may be necessary to leave your vehicle for a longer period of time on the day of your scheduled appointment. Please present this letter to your Subaru retailer at the time this repair procedure is performed.

### **CHANGED YOUR ADDRESS OR SOLD YOUR SUBARU?**

If you have moved or sold your vehicle, please complete the enclosed prepaid postcard and mail it to us. Or if you prefer to update this information online, please go to [www.subaru.com](http://www.subaru.com), select 'Customer Support,' then select 'Address Update' or 'Ownership Update' from the drop-down menu.

***Continued...***

**IF YOU NEED FURTHER ASSISTANCE:**

To locate the nearest Subaru retailer, you can access our website at [www.subaru.com](http://www.subaru.com) and select 'Find a Retailer.'

For additional information and the most Frequently Asked Questions, please go to:  
<http://www.subaru.com/vehicle-recalls/airbags.html>.

Para información visite nuestro sitio web específico de Takata en español  
<http://www.subaru.com/es/vehicle-recalls/airbags.html>, o llame al 1-844-373-6614.

If you need additional assistance, please contact us directly:

- By e-mail: Go to [www.subaru.com](http://www.subaru.com) and select "Contact Us"
- By telephone: 1-844-373-6614  
Monday through Friday between 8:00 a.m. and 7:00 p.m. ET
- By U.S. Postal mail: Write us at Subaru of America, Inc.  
Attn: Customer-Retailer Services Department  
P.O. Box 6000, Cherry Hill, NJ 08034-6000

To subscribe to the NHTSA Recall Notification email System, please go to:  
<https://www-odi.nhtsa.dot.gov/nhtsa/subscriptions>.

Please contact us immediately if the Subaru retailer fails or is unable to make the necessary repairs free of charge.

You may also contact the Administrator, National Highway Traffic Safety Administration, 1200 New Jersey Ave. SE, West Building, Washington, DC 20590 or call the toll-free Auto Safety Hotline at 1-888-327-4236 (TTY: 1-800-424-9153) or go to <http://www.safercar.gov> if you believe the Subaru retailer has failed or is unable to remedy your vehicle without charge within a reasonable amount of time.

Your continued satisfaction with your Subaru is important to us. Please understand that we have taken this action in the interest of your safety and your vehicle's proper operation. We sincerely apologize for any inconvenience this matter may cause and urge you to schedule an appointment as soon as possible.

Sincerely,  
Subaru of America, Inc.

***Notice to Lessors:** Under Federal law the lessor of a vehicle who receives this letter must provide a copy of it to the vehicle lessee(s) within 10 business days from receipt. The lessor must also keep a record of the lessee(s) to whom this letter is sent, the date sent, and the applicable vehicle identification number (VIN). (For the purposes of this section, a lessor means a person or entity that in the last twelve months prior to the date of this notification has been the owner, as referenced on the vehicle's title, of any five or more leased vehicles. A leased vehicle is a vehicle leased to another person for a term of at least four months.)*

*A subsidiary of Fuji Heavy Industries Ltd.*

*Continued...*

## OWNER NOTIFICATION LETTER

### IMPORTANT SAFETY RECALL

This notice applies to the VIN identified in the address section printed below.



**SUBARU**

Subaru of America, Inc

Subaru Plaza

PO Box 6000

Cherry Hill, NJ 08034-6000

800-782-2783

www.subaru.com

**Subaru Recall Campaign TKC-18  
NHTSA Recall No. 18V-014  
Zone C: Legacy, Outback, Tribeca  
February 2018**

**Dear Subaru Owner:**

This notice is sent to you in accordance with the National Traffic and Motor Vehicle Safety Act.

SUBARU OF AMERICA, INC. has decided that a defect, which relates to motor vehicle safety, exists in certain 2009 model year Legacy and Outback vehicles and certain 2009 model year Tribeca vehicles, equipped with a non-desiccated Takata-sourced passenger side frontal air bag containing the propellant Phase Stabilized Ammonium Nitrate.

You received this notice because our records indicate that you currently own one of these vehicles.

### DESCRIPTION OF THE SAFETY DEFECT AND SAFETY HAZARD

The affected vehicles are equipped with a Takata-sourced passenger side frontal air bag that may be susceptible to moisture intrusion. Over time, this could cause the inflator to explode when the passenger's frontal air bag deploys in a crash. If the inflator explodes, sharp metal fragments could strike vehicle occupants, potentially resulting in serious injury or death.

### ***Parts are available.***

### WHAT YOU SHOULD DO

You should immediately contact your Subaru retailer (dealer) for an appointment to have the front passenger air bag inflator replaced with a new one, free of charge. To minimize your inconvenience while the repair is being performed, please ask your retailer for alternative transportation options.

***Until this repair is performed, do not allow passengers to ride in the front passenger seat.***

### HOW LONG WILL THE AIR BAG INFLATOR REPLACEMENT TAKE?

The time to replace the front passenger air bag inflator is approximately one hour and 48 minutes. It may be necessary to leave your vehicle for a longer period of time on the day of your scheduled appointment. Please present this letter to your Subaru retailer at the time this repair procedure is performed.

### CHANGED YOUR ADDRESS OR SOLD YOUR SUBARU?

If you have moved or sold your vehicle, please complete the enclosed prepaid postcard and mail it to us. Or if you prefer to update this information online, please go to [www.subaru.com](http://www.subaru.com), select 'Customer Support,' then select 'Address Update' or 'Ownership Update' from the drop-down menu.

*Continued...*

**IF YOU NEED FURTHER ASSISTANCE:**

To locate the nearest Subaru retailer, you can access our website at [www.subaru.com](http://www.subaru.com) and select 'Find a Retailer.'

For additional information and the most Frequently Asked Questions, please go to:  
<http://www.subaru.com/vehicle-recalls/airbags.html>.

Para información visite nuestro sitio web específico de Takata en español  
<http://www.subaru.com/es/vehicle-recalls/airbags.html>, o llame al 1-844-373-6614.

If you need additional assistance, please contact us directly:

- By e-mail: Go to [www.subaru.com](http://www.subaru.com) and select "Contact Us"
- By telephone: 1-844-373-6614  
Monday through Friday between 8:00 a.m. and 7:00 p.m. ET
- By U.S. Postal mail: Write us at Subaru of America, Inc.  
Attn: Customer-Retailer Services Department  
P.O. Box 6000, Cherry Hill, NJ 08034-6000

To subscribe to the NHTSA Recall Notification email System, please go to:  
<https://www-odi.nhtsa.dot.gov/nhtsa/subscriptions>.

Please contact us immediately if the Subaru retailer fails or is unable to make the necessary repairs free of charge.

You may also contact the Administrator, National Highway Traffic Safety Administration, 1200 New Jersey Ave. SE, West Building, Washington, DC 20590 or call the toll-free Auto Safety Hotline at 1-888-327-4236 (TTY: 1-800-424-9153) or go to <http://www.safercar.gov> if you believe the Subaru retailer has failed or is unable to remedy your vehicle without charge within a reasonable amount of time.

Your continued satisfaction with your Subaru is important to us. Please understand that we have taken this action in the interest of your safety and your vehicle's proper operation. We sincerely apologize for any inconvenience this matter may cause and urge you to schedule an appointment as soon as possible.

Sincerely,  
Subaru of America, Inc.

***Notice to Lessors:** Under Federal law the lessor of a vehicle who receives this letter must provide a copy of it to the vehicle lessee(s) within 10 business days from receipt. The lessor must also keep a record of the lessee(s) to whom this letter is sent, the date sent, and the applicable vehicle identification number (VIN). (For the purposes of this section, a lessor means a person or entity that in the last twelve months prior to the date of this notification has been the owner, as referenced on the vehicle's title, of any five or more leased vehicles. A leased vehicle is a vehicle leased to another person for a term of at least four months.)*

*A subsidiary of Fuji Heavy Industries Ltd.*

*Continued...*

# SHIPPING DOCUMENTATION AND INSTRUCTIONS (Appendix A)

**IMPORTANT NOTE:** There are 2 different sets of instructions supplied in this section. The first page outlines the procedure for INFLATOR returns while the following page provides instructions for returning a COMPLETE MODULE assembly.

**NOTE**  
**INFLATOR RETURNS**

**These Return Instructions are for the Continental US dealerships (48 States).**

**NOTE: Locations outside of the Continental United States (Hawaii, Alaska, Puerto Rico, Virgin Islands INCLUDING Mexico and Canada CANNOT follow below shipping instructions.** Instead, dealerships in these locations MUST contact the following Takata/XPO USA representative directly for shipping instructions: Miguel Prigadaa – Tel #: 210-250-5078 or Email: MLGTakataRestrains\_international@menlowworldwide.com

**1. Shipping Documents**

a) **Box Label**

- Supplied with each Kit
- To be affixed to each box



b) **Over-pack Label**

- To be supplied by XPO.
- To be affixed to the outside of each pallet

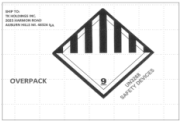

c) **Bill of Lading**

- To be supplied by XPO.
- Print 2 copies: 1 for Dealer Records, 1 for LTL Driver



d) **ERG Document**

- To be supplied by XPO.
- To be provided by the Dealer to the LTL Driver for each shipment



**4b. Shipping Instructions – Label each Box**

a) If you continue receiving Inflator Kits with the original Fedex Documentation:

1. Peel off the backing of the Fedex Ground PRP Shipping label and affix to top of box to left of the Class 9 label.
  - Use the scribe line on the box as a guide
  - The FedEx Ground PRP Shipping label must not touch any portion of the printing to the right of the scribe line.
2. Discard the remaining Documentation
3. **Do Not** contact FedEx



**2. Packing Instructions**

a) Confirm box is in acceptable condition. If a new box is needed, follow the New Box instructions located in Box 8 of this page.

b) Place the un-deployed air bag inflator in the “cradle” of the box insert.





**5. Shipping Instructions – Prepare the Pallet**

- Accumulate and palletize Kits
- Arrange Kits on Pallet as pictured here
  - 20 boxes per row/layer (5x4)
  - 10 rows/layers per pallet (200 boxes)
- Shrink-wrap Kits to Pallet
- Affix Over-pack Label on (1) side of Pallet (Not on Top)

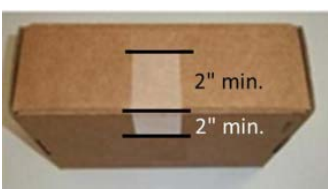

**3. Closure Instructions**

a) Close the top box flap, per box closure instructions located on front panel of box.

**6. Shipping Instructions – Schedule LTL Pickup**

a) Upon Accumulating 200 kits (1 Over-pack/Pallet) Minimum

- Call XPO at 1-877-650-3476
- If 200 Kits have not been accumulated in 30 days, please call XPO for direction

c) Have the following Information Available

- Dealer #
- Quantity of Over-packs/Pallets
- Quantity of Passenger Inflator Kits on each Pallet
- Email Address where shipping Documentation can be received

**4a. Shipping Instructions - Label each Box**

a) New Labels will begin shipping in each kit starting mid August, 2015

1. Subaru Inflator Kit will contain this two-part label.
2. Peel off 'Ship To' Label.
3. Affix Label to Box. Do not cover up Class 9 Marking.

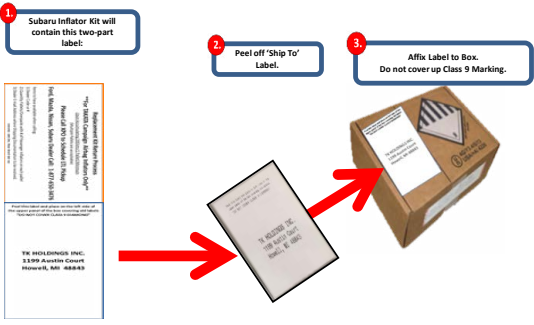

**7. Shipping Instructions – Ship**

- Give 1 Copy of BOL and 1 Copy of ERG to Driver
- Retain 1 Copy of BOL for Dealership records and archive for 2 Years

**8. Requesting a New Box / Shipping Labels**

If a new box or replacement shipping labels are needed, please contact the representative listed below by phone or email to request replacement materials.

Primary Contact: **Armando Gonzalez - Tel #: 210-250-5079**  
E-Mail: [FieldAction.14305@menlowworldwide.com](mailto:FieldAction.14305@menlowworldwide.com)

To help expedite your request, please be prepared to provide the following information:

- Serial number on the original box
- What Type of shipping material needed
  - Replacement Box
  - Two Part Return Label
  - Bill of Lading
  - ERG Form
- Dealer Shipping Information
  - Contact name
  - Dealer Address
  - Phone Number





**NOTE**  
**FULL MODULE RETURNS**

**These Return Instructions are for the Continental US dealerships (48 States).**

**NOTE: Locations outside of the Continental United States (Hawaii, Alaska, Puerto Rico, Virgin Islands INCLUDING Mexico and Canada CANNOT follow below shipping instructions.** Instead, dealerships in these locations MUST contact the following Takata/XPO USA representative directly for shipping instructions: Miguel Prigadaa – Tel #: 210-250-5078 or Email: [MLGTakataRestraints\\_International@menlowworldwide.com](mailto:MLGTakataRestraints_International@menlowworldwide.com)

**1. Shipping Documents**

**a) Box Label**

- Supplied with each Kit
- To be affixed to each box



**b) Over-pack Label**

- To be supplied by XPO.
- To be affixed to the outside of each pallet



**c) Bill of Lading**

- To be supplied by XPO.
- Print 2 copies: 1 for Dealer Records, 1 for LTL Driver



**d) ERG Document**

- To be supplied by XPO.
- To be provide by the Dealer to the LTL Driver for each shipment



**5. Shipping Instructions – Prepare the Pallet**

- a) Accumulate and palletize Kits
- b) Arrange Kits on Pallet as pictured here
  - 15 boxes per row/layer (5x3)
  - 5 rows/layers per pallet (75 boxes)
- c) Shrink-wrap Kits to Pallet
- d) Affix Over-pack Label on (1) side of Pallet (Not on Top)



**6. Shipping Instructions – Schedule LTL Pickup**

- a) Upon Accumulating 75 kits (1 Over-pack/Pallet) Minimum
  - Call XPO at 1-877-650-3476
  - If 75 Kits have not been accumulated in 30 days, please call XPO for direction
- c) Have the following Information Available
  - Dealer #
  - Quantity of Over-packs/Pallets
  - Quantity of Passenger Inflator Kits on each Pallet
  - Email Address where shipping Documentation can be received

**2. Packing Instructions**

a) Confirm box is in acceptable condition. If a new box is needed, follow the New Box instructions located In Box 8 of this page.

b) Place the un-deployed air bag module in the “cradle” of the box insert.



**3. Closure Instructions**

a) Close the top box flap, per box closure instructions located on front panel of box.



**7. Shipping Instructions – Ship**

- a) Give 1 Copy of BOL and 1 Copy of ERG to Driver
- b) Retain 1 Copy of BOL for Dealership records and archive for 2 Years

**8. Requesting a New Box / Shipping Labels**

If a new box or replacement shipping labels are needed, please contact the representative listed below by phone or email to request replacement materials.

Primary Contact: **Armando Gonzalez - Tel #: 210-250-5079**

E-Mail: [FieldAction.14305@menlowworldwide.com](mailto:FieldAction.14305@menlowworldwide.com)

To help expedite your request, please be prepared to provide the following information:

- a) Serial number on the original box
- b) What Type of shipping material needed
  - Replacement Box
  - Two Part Return Label
  - Bill of Lading
  - ERG Form
- c) Dealer Shipping Information
  - Contact name
  - Dealer Address
  - Phone Number



**4. Shipping Instructions - Label each Box**

a) New Labels will begin shipping in each kit starting mid August, 2015

1. Subaru Module Kit will contain this two-part label:



2. Peel off 'Ship To' Label.

3. Affix Label to Box. Do not cover up Class 9 Marking.

