

0-10 V Control Topology

Introduction

0-10 V topology is a common control topology that can be found all across the lighting industry. It was originally developed for control of fluorescent ballasts, but in the growing market of LEDs, it has become one of the most common control topologies. While there are some standard details to how 0-10 V works as a topology, there are many details that can affect the quality of the end solution.

0-10 V topology is often looked at as an open topology and that 0-10 V products work together without any issues. As the industry expands and advances, this logic becomes flawed. There are a number of details that can determine how a 0-10 V solution should be designed and how well a solution will work. This document will provide a summary of these details for the varying Lutron 0-10 V products, as well as provide background and explanation of different 0-10 V topics.

However, it is important to note that even after all of these details have been collected and examined to determine the compatibility between a 0-10 V ballast/driver and a control, there is no guarantee that the dimming performance will be of high quality. Dimming performance is ultimately limited by the quality and design of the ballast/driver. For these reasons, Lutron recommends EcoSystem ballasts/drivers. For more details, see the **How can Lutron EcoSystem technology alleviate the issues that exist with 0-10 V topology?** section.

Table of Contents

Lutron Equipment	2
Lutron Equipment Detail Explanations	4
0-10 V vs. 10-0 V vs. 1-10 V	4
Wire Colors	4
Sink vs. Source	4
0-10 V mA Rating	6
Relay Rating	6
NEMA® 410-2015 Rating (National Electrical Manufacturers Association)	7
Linear vs. Logarithmic Dimming	9
Other Technology Considerations	13
Inrush Current.	13
Emergency Lighting	14
Polarity of Low-Voltage Wiring	15
Class 1 vs. Class 2 Wiring	15
Dimming Curves	16
FAQs	17
How can I guarantee compatibility between the 0-10 V control and ballast/driver?	17
How far can I run a low-voltage 0-10 V circuit?	17
How many fixtures can I put on a 0-10 V control circuit?	18
What do I do if the load is not called out as NEMA® 410-2015 compliant?.	18
Can I run 0-10 V wires with line voltage wires?	19
Can I control a 0-10 V circuit without a relay?.	19
What voltage do the 0-10 V controls sit at in the “off” position?	19
What happens to the 0-10 V signal if the controller loses power and the ballast/driver does not?	19
What if I want the 0-10 V device to control another load type?	20
How can Lutron EcoSystem technology alleviate the issues that exist with 0-10 V topology?.	20

Lutron Equipment

Table 1: Lutron 0-10 V Devices

	Input Signal	Operating Voltage (V~)	Control Capability	Relay Rating (A)	0-10V Line Rating (mA)	Sink/Source	Linear vs Logarithmic	NEMA® 410-2015 Compliant
DIN Power Module (LQSE-4T5) 	QS link	120	0-10 V	5 each zone 10 total module	50 each zone	Auto sink/ source	Linear	Yes
Vive PowPak dimming module with 0-10V control (RMJS-8T-DV-B, -8TN-DV-B, and -8T-DV-B-EM) 	Clear Connect wireless	120-277	0-10 V	8	60	Auto sink/ source	Linear	Yes
Vive PowPak dimming module with 0-10V control (RMJS-5T-347) 	Clear Connect wireless	347	0-10 V	5	60	Sink	Linear	Yes
PowPak wireless fixture controller (FCJS-010) 	Clear Connect wireless	120-277	0-10 V	1	6	Auto sink/ source	Linear	Yes
Vive Maestro RF 0-10V sensor dimmer (MRF2S-8SD010) 	Clear Connect wireless	120-277	0-10 V	8	50	Sink	Linear	Yes
Energi Savr Node for 0-10 V (QSN) 	QS link	120-277	0-10 V, 10-0 V	16	50	Sink	Linear	Yes
International Energi Savr Node for 0-10 V (QSNE/LQSE) 	QS link	220-240	0-10 V, 10-0 V	5 each zone 10 total module	50 each zone	Auto sink/ source	Linear	No ⁵
TVM module (GRX-TVM) 	Panel load	24	0-10 V, 10-0 V	16 ¹	50	Auto sink/ source	Linear	Yes ²
EcoSystem to 0-10 V interface (TVI-LMF-2A) 	EcoSystem	120, 220/240, 277	0-10 V	2	25	Sink	Linear	Yes

¹ Depending on the panel type, 16 A is the maximum for a single circuit. Uses panel modules to switch line voltage.

² Both “X” modules and “U” modules are NEMA® 410-2015 rated.







³ Need either high/low-end trim or 3-wire fluorescent signal.

⁴ PP-DV is NEMA® 410-2015 compliant and is assumed to be switching the load in this application.

⁵ Rated for resistive, inductive, or capacitive loads as defined by IEC®/EN 60669-2-1.

Lutron Equipment (continued)

Table 1: Lutron 0-10 V Devices (continued)

	Input Signal	Operating Voltage (V~)	Control Capability	Relay Rating (A)	0-10V Line Rating (mA)	Sink/Source	Linear vs Logarithmic	NEMA® 410-2015 Compliant
0-10V control interface (GRX-TVI) 	Forward, Reverse, Center ³	100-277	0-10 V	16	300	Sink	Linear	Yes
Nova T★ controls (NTSTV) 	—	120-277	0-10 V	8	30	Sink	Logarithmic	Yes
Diva 0-10V controls (DVSTV) 	—	120-277	0-10 V	8	50	Sink	Linear	Yes
Diva 0-10V controls (DVSTV-453) 	—	120-277	0-10 V	450 W 3.75 (120 V~) 1.62 (277 V~)	50	Sink	Linear	Yes
Diva 0-10V controls (DVTV) 	—	24 V==	0-10 V	16 (with PP-DV)	30	Sink	Logarithmic	Yes ⁴
Maestro 0-10V dimmer sensor (MS-Z101) 	—	120-277	0-10 V	8	50	Sink	Selectable	Yes

Lutron Equipment Detail Explanations

0-10 V vs. 10-0 V vs. 1-10 V

0-10 V is a topology defined by the International Electrotechnical Commission (IEC®) 60929 Annex E standard and uses a varying DC voltage between 1 and 10 V to determine the lighting level. The fixture outputs a minimum light level below 1 V. It is not defined whether this is off or low-end, which means you can get differing functionality depending on the manufacturer. Between 1 and 10 V, the signal corresponds to levels between the minimum and maximum output level. A signal above 10 V corresponds to the maximum light level. Sometimes it is referred to as 1-10 V, as that is the actual range in which the light levels will vary.

10-0 V is a topology that is not defined in the IEC® standard, but it also makes use of a varying DC voltage. The levels are inverse of a 0-10 V topology, with 10 V being low-end and 1 V being high-end. This topology was made popular in certain metal halide dimming systems, but has almost disappeared as a result of the decline of metal halide as a high output light source.

Wire Colors

Prior to 2021, the 0-10 V control wires were traditionally purple and gray. A change effective January 1, 2022 made to the 2020 edition of the NEC® prohibits field-connected control wires from being gray to avoid confusion with gray 277 V~ neutral wires. To accommodate this change, 0-10 V signal wires will use purple and pink insulation starting in 2021. Depending on the date of manufacture of the devices (control and/or driver), the 0-10 V wires may be purple/pink or purple/gray.

Sink vs. Source

The concept of sink vs. source in 0-10 V topology relates to the small amount of current being provided on the 0-10 V channel that is used to drive the circuit and create the DC voltage difference. When looking at the control and the ballast(s)/driver(s) being used in a particular application, one will always be providing the current (source), and one will be dissipating it (sink).

In order for the control and the ballast/driver to be able to work together, you must have one device that can source and one that can sink, allowing for a complete circuit to exist between the devices. There are some devices that are capable of being sink or source (often by auto sink/source detection) which allow them to take either role. As a note, there can sometimes be issues if connecting two auto sink/source devices together. Depending on how the devices perform their auto-detect, they might continue to misread each other and create issues with operability.

When using Lutron EcoSystem devices, the sinking and sourcing of low-voltage current is taken care of as part of the EcoSystem definition. This will continue to hold true as Lutron maintains a review of all products (by Lutron or other manufacturers) that are part of the EcoSystem system.

Continued on next page...

Lutron Equipment Detail Explanations (Continued)

Sink vs. Source (Continued)

IEC. 60929 Ballast Control Standard

This standard dictates that the ballast shall be the source of the current and the control should sink that current. Not all ballasts/drivers use this standard, so it is important to determine whether the ballast/driver is sink or source so that a matching control can be selected. The IEC. 60929 standard is the standard most commonly applied in commercial and residential applications.

American National Standards Institute (ANSI.) C82.11 Ballast/Driver Control Standard

This standard is very similar to the IEC. 60929 standard in that the ballast/driver is called out as the source and the control as the sink.

Figure 1: Ballast/Driver as Source

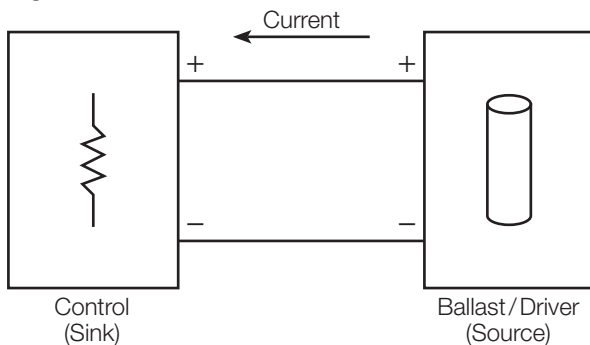

ANSI. E1.3 Entertainment Lighting Control Standard

Written by the Entertainment Services and Technology Association (ESTA), this standard was specifically designed around theatrical lighting control. In this standard, the control is the source and the ballast/driver is the sink. This standard is usually only used with legacy devices because the DMX standard has become the most commonly used control standard within the theatrical world.

Figure 2: Control as Source

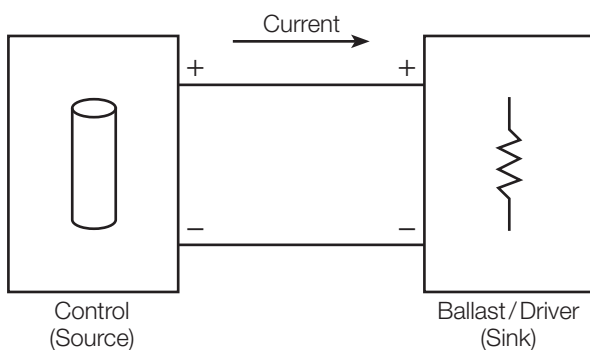

ANSI. C137.1 Lighting Systems - 0-10 V Dimming Interface For LED Drivers, Fluorescent Ballasts and Controls

ANSI C137.1 is an optional standard that controls and drivers can follow which defines the 0-10 V control interface methods and performance requirements for 0-10 V controls and drivers where output power is adjustable between minimum/off and maximum via a control input signal. It defines an optional 0-10 V voltage level which the control can set in order to indicate to the driver that it should be in an “electronic off” state without the control having to switch off line voltage power. Both the control and the driver need to follow the standard for the system to support the electronic off functionality. In most cases, Lutron recommends using the control to switch off line voltage to the fixture to ensure they turn off.

Refer to the control and driver product spec sheets to determine if they are ANSI C137.1 compliant.

Lutron Equipment Detail Explanations *(Continued)*

0-10 V mA Rating

Directly related to the previous notes on sink vs. source, every 0-10 V device has a rating for how much current (in mA) that it sources or sinks. In addition to stating that the ballast shall source the current, the IEC® 60929 standard dictates a minimum ballast source current of 10 μ A and a maximum of 2 mA. Not all ballasts/drivers follow this standard (2 mA maximum), but it can be used as an approximation if no information can be determined about the ballast/driver being used.

Knowing the sinking/sourcing capabilities of the control and the ballast/driver are necessary to determine the maximum number of ballasts/drivers that can be controlled by a single control circuit. The maximum number of ballasts/drivers can be found by taking the sink capability of the control and dividing by the source current of each ballast/driver. The mA rating and the relay rating are the two limiting factors for how many ballasts/drivers can be used with a control. With LED lamps, it is very common for the mA rating to be the limiting factor.

When using Lutron EcoSystem devices, the limit for the low-voltage communication loop is based on the number of device addresses. The current needed to run the low-voltage circuit is already accounted for in the address limit.

Relay Rating

The rating of the relay is the traditional current rating that is discussed with regards to switching controls (e.g., 16 A relay). It represents the total amount of power that can be run through the control device to power the total load of the connected fixtures. It is very common to see a rating of 16 A because that is the maximum allowable current that a 20 A lighting circuit can have (the NEC® mandates derating the circuit to 80% for lighting circuits). The mA rating and the relay rating are the two limiting factors for how many ballasts/drivers can be used with a control. With fluorescent loads, it is very common for the relay rating to be the limiting factor.

When using Lutron EcoSystem devices, a relay is not required because EcoSystem ballasts/drivers are capable of electronic off.

Continued on next page...

Lutron Equipment Detail Explanations *(Continued)*

NEMA® (National Electrical Manufacturers Association) 410-2015 Rating

NEMA® 410-2015 is a voluntary testing standard that defines an inrush current limit. It was developed soon after fluorescent dimming ballasts were introduced to the market. The lamp and dimmer manufacturers agreed to create the testing standard to manage inrush currents.

High inrush current is also a concern for LED lamps and can often be the limiting factor over steady state current of how many LED lamps can be part of a control circuit. The NEMA® 410-2015 standard dictates a defined level of acceptable inrush current for different levels of steady state current. When using NEMA® 410-2015 compliant loads and controls, this allows the user to use just the steady state current to determine how much load can be put on a circuit. NEMA® 410-2015 specifically applies to loads that are switched on and off (as opposed to line voltage dimming) because it specifically examines peak inrush. When examining phase control dimming loads using line voltage, repetitive inrush is the larger concern.

Table 2 is an excerpt from the NEMA® 410-2015 standard which outlines the acceptable inrush current for different steady state currents at 120 V~ and 277 V~. Based on the steady state current of the load, you can look up the acceptable peak current, pulse width, and the I²t value. A ballast/driver manufacturer would have to ensure that when the ballast/driver is set up under the prescribed test conditions it does not exceed the peak current and I²t value for the steady state current.

Table 2: NEMA® 410-2015 Peak Current Requirements

Steady State Current (A)	Peak Current (A) 120 V~	Pulse Width 120 V~ (ms)*	I ² t (A ² sec) 120 V~**	Peak Current (A) 277 V~	Pulse Width 277 V~ (ms)*	I ² t (A ² sec) 277 V~**
0.5	75	0.34	11	77	0.50	11
1	107	0.48	24	131	0.71	27
2	144	0.70	41	205	0.85	76
3	166	0.89	55	258	0.98	111
5	192	1.20	74	320	1.20	205
8	221	1.25	98	370	1.25	274
10	230	1.50	106	430	1.50	370
12	235	1.80	110	440	1.80	387
15	239	2.00	114	458	2.00	420
16	242	2.10	117	480	2.10	461

* Pulse widths shown in the table above are shown in Figures 3-14 of the NEMA® 410-2015 **Performance Testing for Lighting Controls and Switching Devices with Electronic Drivers and Discharge Ballasts** document and will provide adequate performance with electronic devices having pulse widths up to 2 ms, in accordance with ANSIR C82.11 or ANSIR C82.14 standards.

** The values used to calculate I²t are the peak current shown in the table above and a pulse duration of 2 ms (t).

Continued on next page...

Lutron Equipment Detail Explanations *(Continued)*

NEMA® (National Electrical Manufacturers Association) 410-2015 Rating *(Continued)*

Table 3 is an excerpt from the NEMA® 410-2015 standard which outlines the acceptable inrush current for different steady state currents at 347 V~. Based on the steady state current of the load, you can look up the acceptable peak current, pulse width, and the I²t value. A ballast/driver manufacturer would have to ensure that when the ballast/driver is set up under the prescribed test conditions it does not exceed the peak current and I²t value for the steady state current.

Table 3: NEMA® 410-2015 Peak Current Requirements with Pulse Widths

Steady State Current (A)	Peak Current (A) 347 V~	Pulse Width 347 V~ (ms)*	I ² t (A ² sec) 347 V~**
0.5	198	0.34	92
1	270	0.47	173
2	354	0.70	294
3	396	0.86	369
5	450	1.15	476
8	492	1.50	569
10	508	1.67	606
12	529	1.86	658
15	550	2.05	711
16	552	2.10	716

* Pulse widths shown in the table above are shown in Figures 3-14 of the NEMA® 410-2015 **Performance Testing for Lighting Controls and Switching Devices with Electronic Drivers and Discharge Ballasts** document and will provide adequate performance with electronic devices having pulse widths up to 2 ms, in accordance with ANSIR C82.11 or ANSIR C82.14 standards.

** The values used to calculate I²t are the peak current shown in the table above and a pulse duration of 2 ms (t).

All Lutron EcoSystem ballasts/drivers are NEMA® 410-2015 compliant. EcoSystem ballasts/drivers are wired directly to the distribution power and are not switched by control gear. Also, the electronic off capability of the EcoSystem ballasts/drivers means that full inrush is only ever experienced when power is turned off and returned to the ballasts/drivers.

Continued on next page...

Lutron Equipment Detail Explanations *(Continued)*

Linear vs. Logarithmic Dimming

Linear vs. Logarithmic describes two different things:

1. For the control, it is the shape of the curve plotted using the commanded % of light from the system against the output voltage on the 0-10 V line.
2. For the ballast/driver, it is the shape of the curve plotted by 0-10 V voltage vs. light output.

This concept is used to allow for compensation between measured and perceived light (Figure 3). This relationship is due to the changes in the human eye as the light level decreases. The dilation of the pupil allows more light to enter the eye so that the measured light level could be 10% but the light level perceived by the eye would be around 32%.

Figure 3: Measured vs. Perceived Light Levels

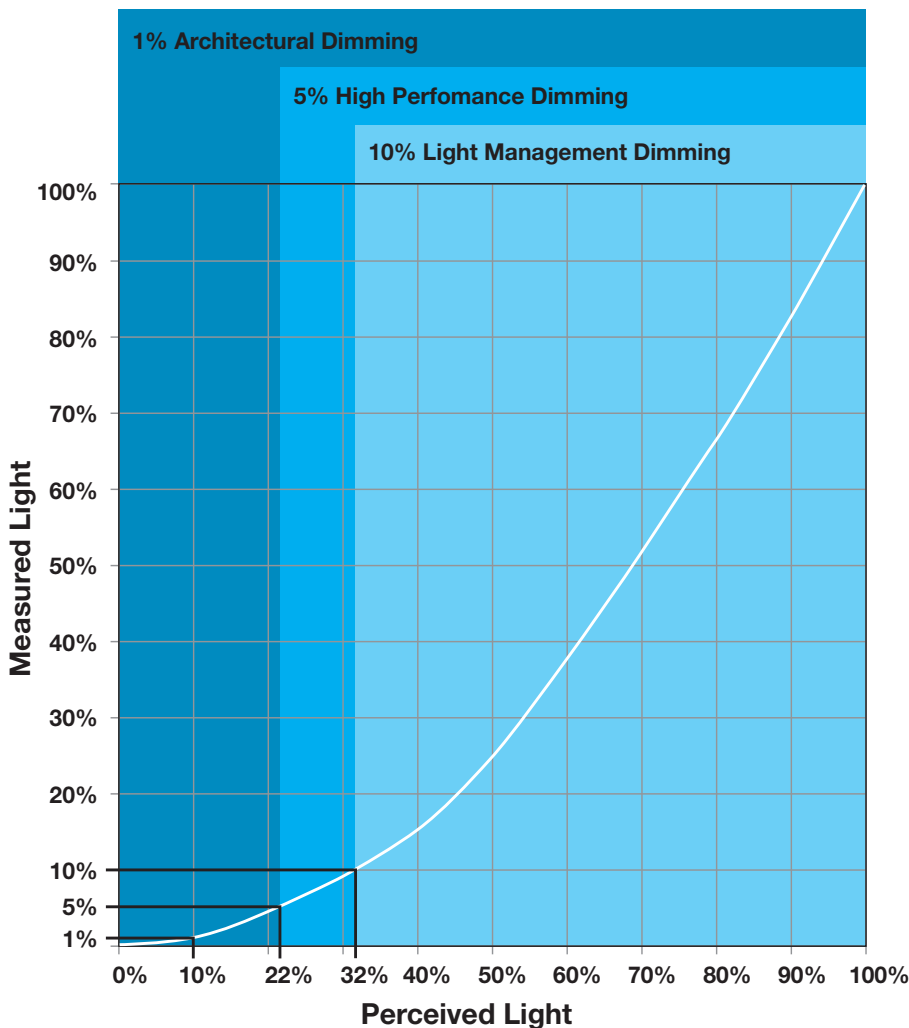

Continued on next page...

Lutron Equipment Detail Explanations *(Continued)*

Linear vs. Logarithmic Dimming *(Continued)*

When pairing two controls together, it is important to ensure that the right combination is selected. There are three different options.

1. The control and the ballast/driver are both linear. The result is that you get a linear power curve. Because power is linear, the measured light will be linear, which means that the perceived light is parabolic. There will not appear to be much change when dimmed down from 100% and granularity will be lost at low-end. Figure 4 shows the perceived light output and ballast/driver power based on commanded % when both the control and the ballast/driver are linear. This is ideal for applications focused on energy savings because the % of dimming is a direct linear relationship with the % of energy savings.

Figure 4: Linear/Linear Output Curve

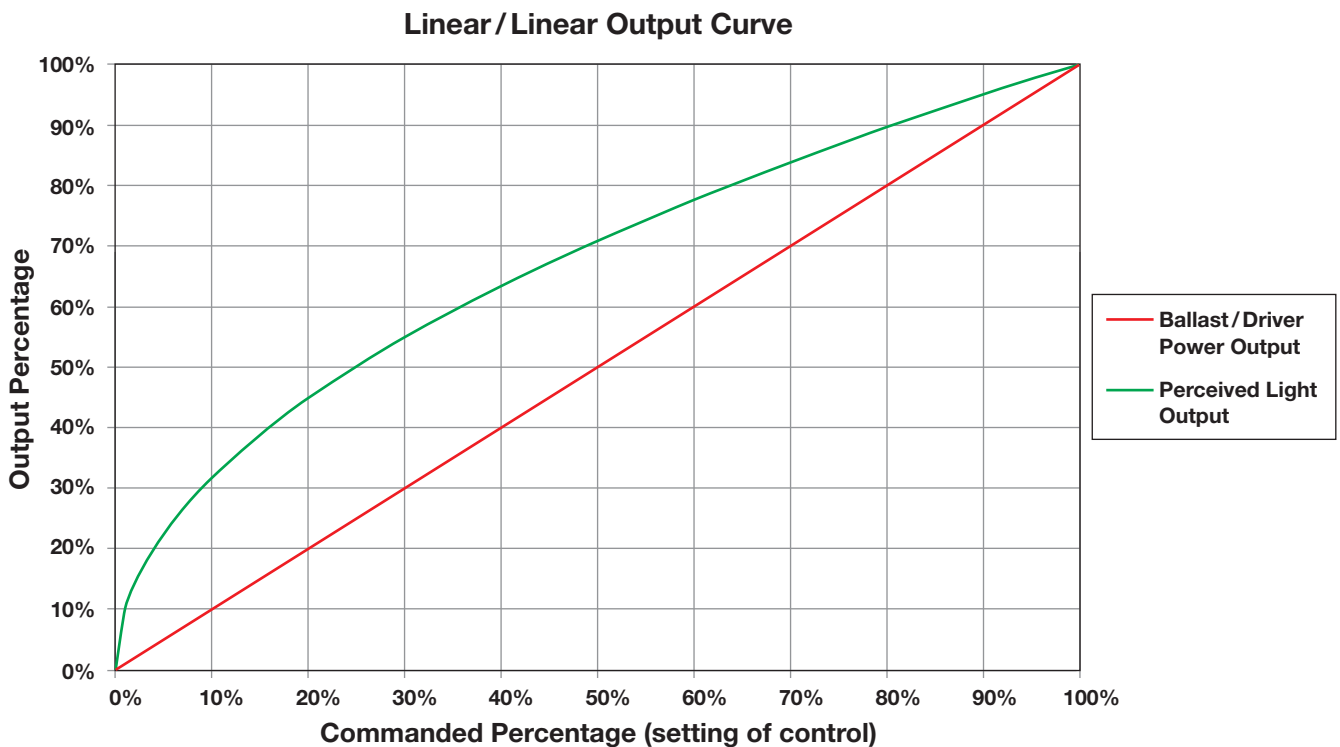

Continued on next page...

Lutron Equipment Detail Explanations *(Continued)*

Linear vs. Logarithmic Dimming *(Continued)*

2. Either the control or the ballast/driver is logarithmic (only one of them). The result is a linear perceived light curve. The power curve is “bent” as a logarithmic function, which means that it is also the shape of the measured light curve. The perceived light curve becomes linear, giving the perception of continuous, even dimming. Figure 5 shows what the perceived light output and ballast/driver power would be based on commanded % for cases in which either the control or the ballast/driver is logarithmic. This is ideal for applications where the user perception of the dimming performance is important because the % of perceived light is a direct linear relationship with the % of the dimming level.

Figure 5: Linear/Logarithmic Output Curve

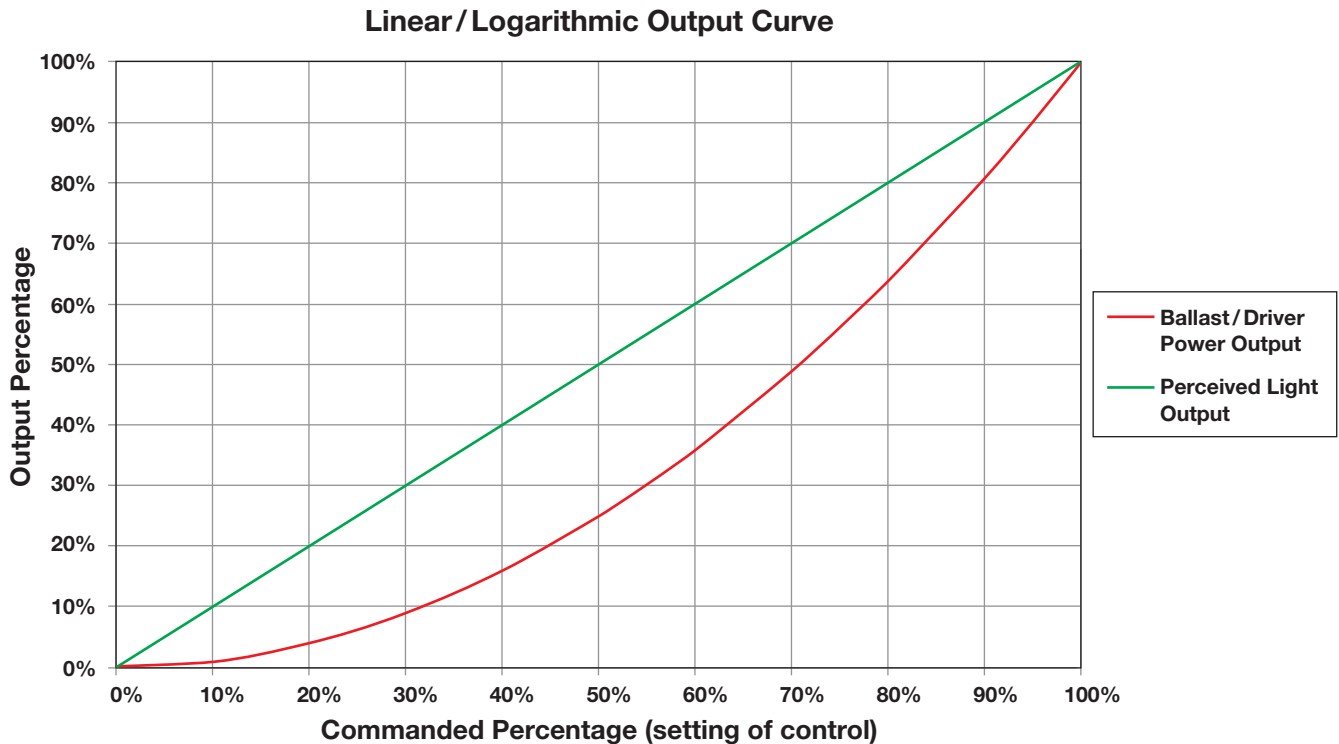

Continued on next page...

Lutron Equipment Detail Explanations *(Continued)*

Linear vs. Logarithmic Dimming *(Continued)*

- Both the control and the ballast/driver are logarithmic. The power curve, measured light, and perceived light are all non-linear. This is undesirable because continuous dimming would no longer be perceived in the space at low-end. Figure 6 shows what perceived light output and ballast/driver power there would be based on commanded % for cases in which both the control and the ballast/driver are logarithmic. This is not ideal.

Figure 6: Logarithmic/Logarithmic Output Curve

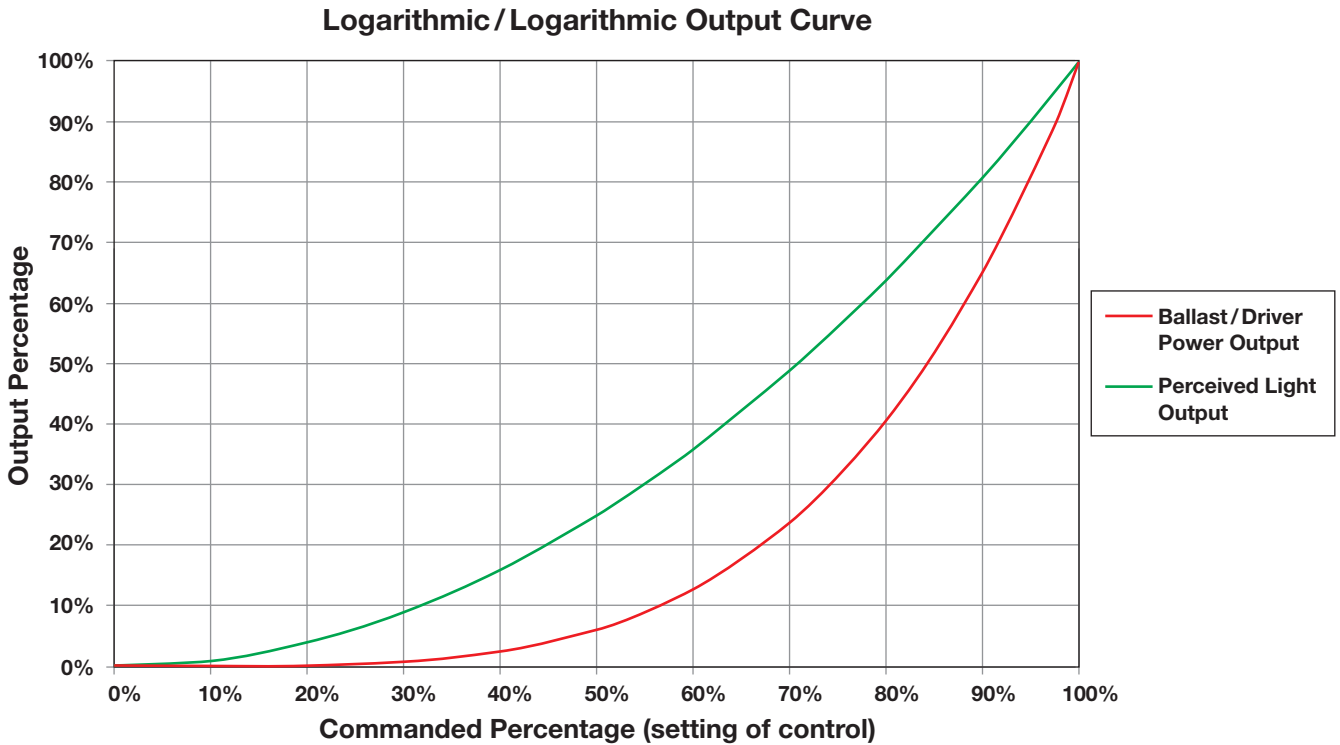

Other Technology Considerations

Inrush Current

When lighting loads are turned on, there is a momentary spike in current running through the load that is much higher than the steady state current. For incandescent loads, that inrush current is fairly standard for various wattages and bulb sizes and is accounted for in controls based on the steady state power rating. This means that any controller that is rated for 600 W of incandescent load is designed to handle the 10× inrush current that is known to come along with 600 W of the incandescent load.

Due to the capacitive nature of LED loads and drivers, the inrush current is not a standard known for each steady state power rating. The initial charging of the capacitors, which depends on the LED driver design, can require a huge amount of current, sometimes 100-300× the steady state current. This is drastically different than the inrush current of incandescent lamps which the control industry is accustomed to handling. If this is not accounted for properly when adding loads to a circuit, the huge inrush has the potential to cause damage to relays and cause them to fail quicker than their expected/rated life. This issue can also cause nuisance tripping of circuit breakers.

The NEMA® 410-2015 standard attempts to create a common inrush value that control companies can account for in the design of their products. If all ballasts/drivers and controls in an application are specified to be NEMA® 410-2015 compliant, then the inrush current issue is no longer a concern.

Other Technology Considerations (Continued)

Emergency Lighting

Emergency lighting refers to the performance expectations of lights during a power outage and how those required performance expectations are achieved. 0-10 V ballasts/drivers provide an additional challenge over traditional emergency applications. In addition to ensuring that emergency power will be supplied to the lights, the 0-10 V signal also needs to be able to be overridden/bypassed. If power is lost to the 0-10 V controller and the 0-10 V signal is not overridden/bypassed, then the fixture may remain at the last dimmed level prior to the power loss. If the ballast/driver is set up to be the source in the circuit and the controller is just performing a voltage adjustment on that circuit, a specific emergency bypass device would need to be used. This emergency bypass device would need to be specifically designed for 0-10 V applications that handle emergency power and be able to override/bypass the 0-10 V signal. An example of this can be seen in Figure 7. For more details, see Lutron Emergency Lighting Application Note #106 (P/N 048106) at www.lutron.com

Figure 7: 0-10 V Emergency Wiring Example

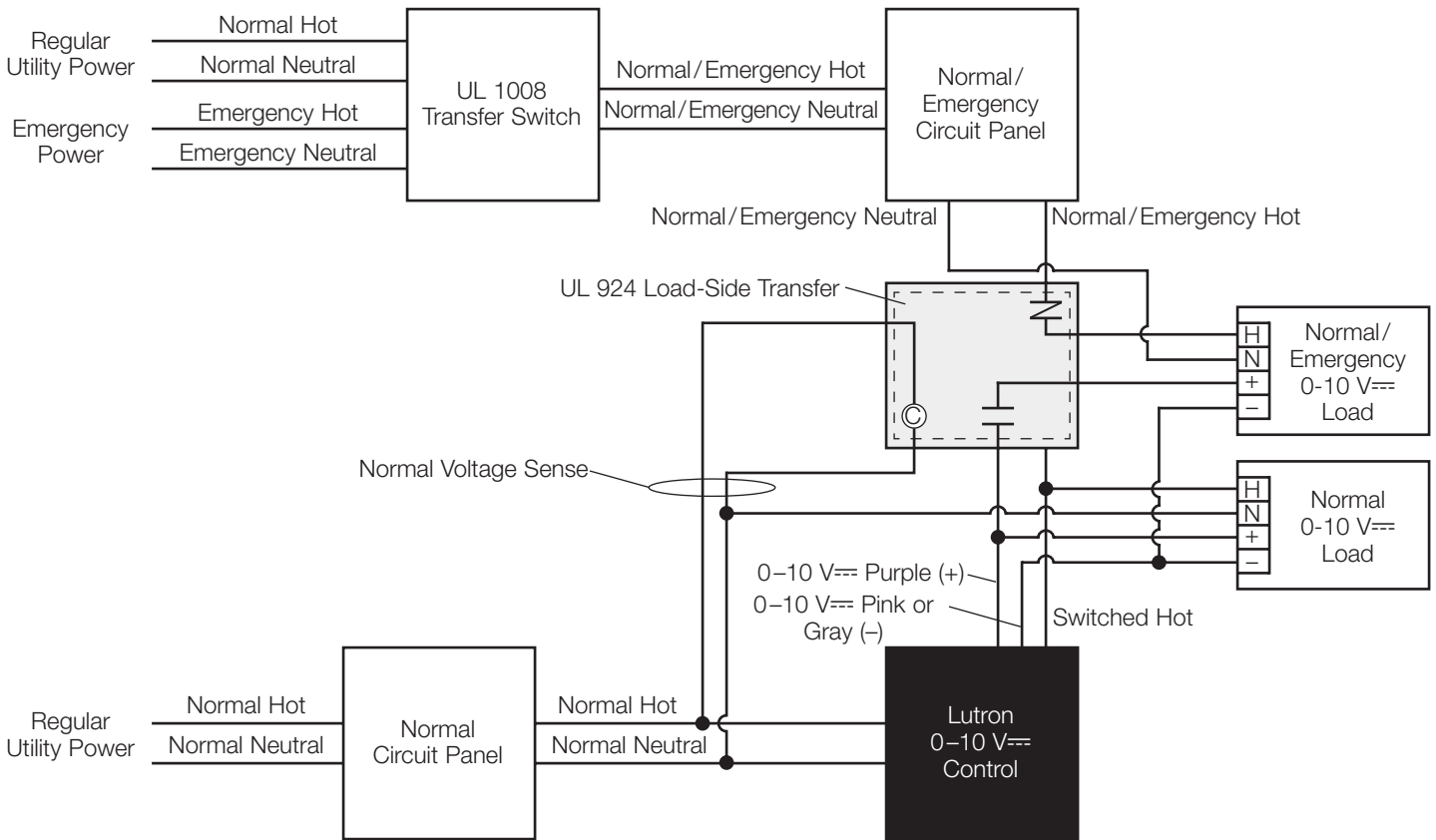

When using Lutron EcoSystem devices, emergency lighting can be achieved by providing normal/emergency power to the ballast/driver and a way to disconnect the EcoSystem loop. When communication between the controller and the ballast/driver is lost, the fixtures will go to high-end.

Continued on next page...

Other Technology Considerations *(Continued)*

Polarity of Low-Voltage Wiring

0-10 V topology is an analog technology that is based on referencing the voltage difference between the two wires. The result is that the low-voltage control wires are polarity sensitive. The connection of the wires is important because if the wires are switched, the ballast/driver and the entire 0-10 V link will not function properly. For example, wire 1 must tie to connection 1 on every device and wire 2 must tie to connection 2 on every device.

When using Lutron EcoSystem devices, the E1 and E2 digital connections are NOT polarity sensitive. As long as both wires are connected to the ballast/driver, the communication will not be affected by which wire is connected to which terminal.

Class 1 vs. Class 2 Wiring

The issue of Class 1 (line voltage) and Class 2 (low-voltage) wiring has to do with whether or not the low-voltage 0-10 V signal can be run in the same conduit as the line voltage wiring. This is often a question that deals with local codes and the capabilities of the ballast/driver and control. Both the control and the ballast/driver should list whether their 0-10 V link is rated as Class 1 or Class 2. Local codes that allow Class 2 wiring to be run as Class 1 will call out requirements for re-classification. These requirements often include adding “Class 1” labels over the “Class 2” markings on devices, larger wire gauges, and different insulation requirements. Some jurisdictions do not allow for re-classification.

Issues may arise if the manufacturer-provided rating (Class 1 or Class 2) varies between the control and the fixture. For example, if the control’s 0-10 V wires are rated “Class 1”, and the fixture’s 0-10 V wires are rated “Class 2”, then it is unclear which wiring practice to follow. Before reclassifying any product, check with the manufacturer first. For example, it may not be possible to reclassify a fixture’s 0-10 V wires from Class 2 to Class 1, as that may affect the classification of other aspects of the fixture that are electrically connected (for example, other control links or exposed electrical elements, such as the LED module).

Running the 0-10 V signal as Class 1 wiring does introduce some other concerns, including noise/interference caused by coupling between the line voltage and low-voltage wires. This noise/interference can cause a voltage fluctuation on the 0-10 V wires which can create a difference between the light level requested by the control and the light level signal being received by the ballast/driver.

When using Lutron EcoSystem devices, the EcoSystem loop is capable of being run as Class 1 or Class 2 wiring (if allowable by local codes) by following the proper re-classification steps. The digital nature of the communication eliminates the noise/interference concern because the communication does not rely on measuring small changes in the voltage.

Continued on next page...

Other Technology Considerations *(Continued)*

Dimming Curves

Of the few 0-10 V standards that exist, none of them have details concerning dimming performance or dimming curve performance. Therefore, different 0-10 V ballasts/drivers may have different dimming curves. This difference can even exist between ballasts/drivers made by the same manufacturer. This can create issues when mixing different ballasts/drivers in the same zone/area. Also, it can be troublesome when replacing a ballast/driver because the new ballast/driver might have a different dimming curve than the original ballast/driver. If an exact replacement of the original ballast/driver is unavailable, it is possible that all of the ballasts/drivers in that zone/area may need to be replaced. Figure 8 shows a comparison between different driver manufacturers and different drivers from the same manufacturer. Figure 9 shows the difference in perceived light from the data in Figure 8. At 2 V, there is 23% difference in perceived light between the different drivers.

Figure 8: Dimming Curve Comparison

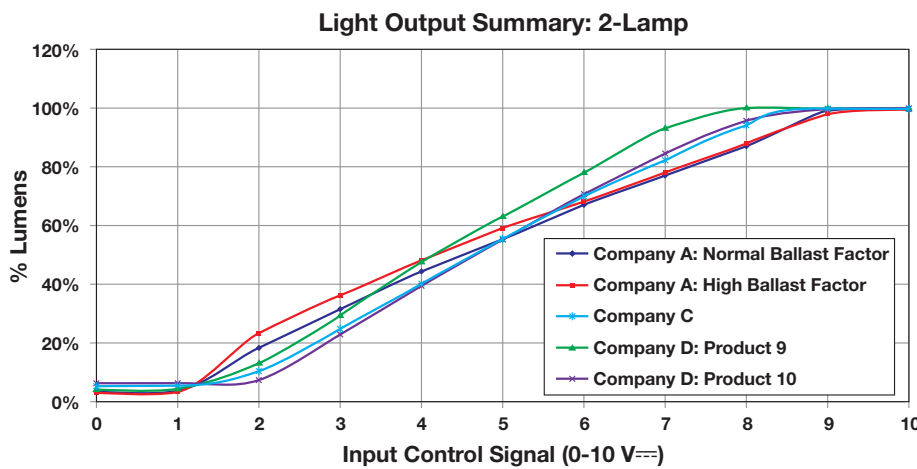

Note: The data in the graphs on this page are from the Fluorescent Dimming Ballast Study Report prepared by ADM Associates, Inc. and submitted to the Sacramento Municipal Utility District.

Figure 9: Impact of Variation Between Drivers on Perceived Light

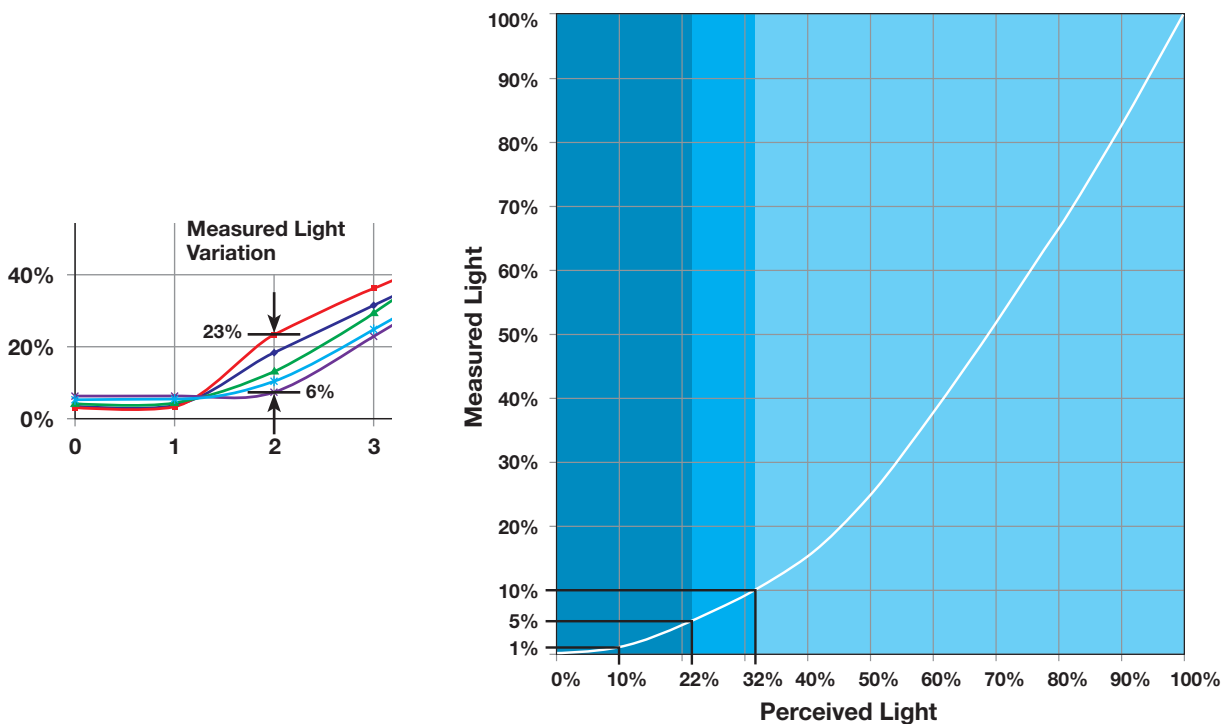

FAQs

How can I guarantee compatibility between the 0-10 V control and ballast/driver?

Compatibility between a 0-10 V control and ballast/driver cannot be guaranteed. Using controls and ballasts/drivers that follow the different standards (e.g., NEMA® 410-2015, IEC® 60929) can make it easier to answer some of the questions that need to be answered. Once all of the necessary information is collected and if the control lines up with the ballast/driver, then there is a good chance that they will work together. Unfortunately, there is no way to guarantee the performance because the 0-10 V standard does not define performance. It is recommended to do a live mock-up to visually inspect the performance.

Lutron EcoSystem controls and ballasts/drivers are specifically designed to work with each other. Lutron guarantees compatibility and performance when using EcoSystem controls and ballasts/drivers.

How far can I run a low-voltage 0-10 V circuit?

There are a number of variables that affect how long a 0-10 V circuit can be run. Some of these variables include: the number of ballasts/drivers, the source rating of each ballast/driver, the gauge of the wire, any noise that might be experienced by the wire run, and what voltage drop will allow the control to maintain a minimum light level. If the 0-10 V circuit is going to be run as Class 2 wiring (assuming no significant noise), a standard voltage drop equation can be calculated to find out the voltage drop for a given distance. Due to the number of variables that exist, Lutron cannot provide a number that can be used in all applications. The IEC® 60929 Annex E standard states that at 1 V, the ballast/driver should be at a minimum light level. Since the ballast/driver is the source, that means the voltage will drop along the wire and be lower at the control. For example, if the control is capable of pulling the voltage down to 0.7 V and the voltage drop along the wire is 0.3 V, the voltage at the ballast/driver will be 1 V. As a general rule, keeping the voltage drop to 0.3 V or lower is a good practice.

The total voltage drop for a wire run can be calculated using the following equation:

$$V_D = R \times d \times n \times I$$

- “ V_D ” is the voltage drop in volts (V).
- “ R ” is the resistance of the wire per foot in ohms (Ω),
- “ d ” is the distance of the wire run in feet (ft),
- “ n ” is the number of ballasts/drivers, and
- “ I ” is the current (A) sourced by each ballast/driver.

If the equation is re-arranged to solve for distance, it becomes:

$$d = \frac{V_D}{R \times n \times I}$$

This equation provides the maximum distance based on known information. “ V_D ” is the maximum allowable voltage drop that will maintain the minimum (1 V) and maximum (10 V) light levels as defined in IEC® 60929 Annex E. Unfortunately, the maximum output voltage of the ballast/driver and the minimum voltage of the control are usually unknown. Therefore, minimizing the voltage drop as much as possible provides the best opportunity to achieve both the minimum and maximum light levels. Using 0.3 V for “ V_D ” is good practice in the absence of additional information. Taking into account the resistance of the wire, the total number of ballasts/drivers, the current sourced by each ballast/driver, and the allowable voltage drop, the maximum distance run of a given circuit can be approximated.

Continued on next page...

FAQs *(Continued)*

How far can I run a low-voltage 0-10 V circuit? *(Continued)*

However, this equation only accounts for voltage drop due to the resistance of the wire. Other influences (e.g., noise, inductance, line voltage coupling) can cause additional voltage fluctuations that cannot be accounted for. Due to these other influences, this calculation should be used as a guide and a factor of safety should be included if site conditions are unknown.

Lutron EcoSystem controls and ballasts/drivers specify exactly how far wire can be run based on the wire gauge. In addition, the wiring topology is completely flexible and polarity free, allowing for easier wiring. Digital communication eliminates the noise/voltage drop concern because the communication does not rely on measuring small changes in voltage.

Wire Gauge	Maximum EcoSystem Digital Loop Wire Length
12 AWG (4.0 mm ²)	2200 ft (671 m)
14 AWG (2.5 mm ²)	1400 ft (427 m)
16 AWG (1.5 mm ²)	900 ft (275 m)
18 AWG (1.0 mm ²)	570 ft (175 m)

How many fixtures can I put on a 0-10 V control circuit?

There are three limiting factors that come into play when determining how many ballasts/drivers you can have on a 0-10 V circuit.

1. Steady state current
2. Inrush current
3. The mA sink/source on the 0-10 V circuit

The application needs to be within the wattage rating of the 0-10 V control, within the 0-10 V current sink/source capability, and able to handle the inrush of the loads to be connected. If the capabilities of the control (found in Table 1) and the specs of the ballast/driver are known, the maximum number of ballasts/drivers on a circuit can be determined.

Lutron EcoSystem controls specify how many EcoSystem addresses can be controlled (usually 64 devices per EcoSystem link).

What do I do if the load is not called out as NEMA® 410-2015 compliant?

If a load is not called out as NEMA® 410-2015 compliant on the load specification sheet, that information should be requested from the load manufacturer. The NEMA® 410-2015 standard calls out peak current, pulse duration, and I^2t . Knowing the peak in-rush current of the ballast/driver is not enough to ensure NEMA® 410-2015 compliance.

Lutron ballasts/drivers are specifically designed to have a very low inrush current. In addition, EcoSystem ballasts/drivers are powered by the distribution feed and are not powered down during normal operation. As a result, inrush current is only experienced during the power up of the ballasts/drivers following a power outage.

Continued on next page...

FAQs *(Continued)*

Can I run 0-10 V wires with line voltage wires?

This question relates directly to the Class 1 vs. Class 2 wiring discussion that can be found in the **Class 1 vs. Class 2 Wiring** section. Whether or not Class 2 wiring can be re-classified as Class 1 wiring depends on the local codes and if the ballast/driver allows for re-classification.

Can I control a 0-10 V circuit without a relay?

This is a mixed issue because it is dependent on the interpretation of the IEC® 60929 standard. The standard specifies that when a low-end signal (between 0 V and 1 V) is read, the load will go to “minimum light output”. Different manufacturers interpret “minimum light output” differently. Most manufacturers treat that as the low-end of the fixture and require a line voltage relay in order to turn the fixtures on/off. Other manufacturers treat that as off and do not require a relay to turn on/off. Lutron 0-10 V controls always pair a line voltage relay with the 0-10 V signal so that the ballast/driver can be controlled whether a relay is required or not.

All EcoSystem devices are manufactured by Lutron and therefore interoperability and high quality dimming performance can be guaranteed. In addition, EcoSystem ballasts/drivers do not require a line voltage control because they are powered as “constant hot”, and go to an “electronic off” state when commanded to do so by the control.

What voltage do the 0-10 V controls sit at in the “off” position?

Lutron 0-10 V controls hold below 1 V when “off” (although the exact voltage may vary based on product). Diva 0-10 V controls are an exception because the 0-10 V output is determined by the slider position which is controlled separately from the switch.

What happens to the 0-10 V signal if the controller loses power but the ballast/driver does not?

If the ballast/driver is sourcing the current, the 0-10 V signal will still be active when the control loses power. The state of the 0-10 V controller will affect the 0-10 V signal and cause the ballast/driver to go to some light level. Every control is different so consult Lutron for detailed application concerns. If the desired functionality is for the light to go to high-end, a low-voltage relay will have to be used to open the 0-10 V circuit which will send the ballast/driver to high-end.

If the controller is sourcing the current, the ballast/driver will go to low-end or off (depending on the ballast/driver manufacturer) because it will read 0 V. As a safety measure, some manufacturers design the ballast/driver so that it goes to high-end if no current is present on the 0-10 V circuit.

When using Lutron EcoSystem ballasts/drivers, if the EcoSystem loop drops out for any reason, any ballast/driver that has power will go to the emergency level (default is 100%).

Continued on next page...

FAQs *(Continued)*

What if I want the 0-10 V device to control another load type?

After a control system has been designed, there are certain times when changes to the load type might make it necessary to control other load types on a 0-10 V circuit. In these instances, Lutron had an interface (BCI-0-10) that could translate 0-10 V current for Lutron 3-wire fluorescent control types. As a result, Lutron could pair the BCI-0-10 with other interfaces (e.g., PHPM-WBX) in order to obtain phase control of loads. For more information, see **Phase Adaptive Control from a 0-10 V Controller** Application Note #516 (P/N 048516) at www.lutron.com

How can Lutron EcoSystem technology alleviate the issues that exist with 0-10 V topology?

Lutron manufactures EcoSystem controls and ballasts/drivers which are specifically designed to work with each other. Lutron guarantees the compatibility between EcoSystem controls and ballasts/drivers. Since Lutron knows the details of each product, the guess work is removed when dealing with questions regarding distance limitations, maximum number of ballasts/drivers allowed per wire run, compatibility, and performance. Some direct benefits include:

1. Digital communication – Compared to the analog communication of 0-10 V, digital communication allows for a much higher level of flexibility. With digital communication, fixtures that will be controlled separately can be wired together and programmed to function independent of the wire runs.
2. Inrush negation – Lutron ballasts/drivers are specifically designed to have a very low inrush current. In addition, EcoSystem ballasts/drivers are powered by the distribution feed and are not powered down during normal operation. As a result, inrush current is only experienced during the power up of the ballasts/drivers following a power outage.
3. Noise immunity – Digital communication eliminates the noise/voltage drop concern because the communication does not rely on measuring small changes in voltage.
4. Guaranteed performance and compatibility – All EcoSystem devices are manufactured by Lutron and therefore interoperability and high quality dimming performance can be guaranteed.
5. Emergency lighting functionality – If the EcoSystem loop drops out for any reason, any ballast/driver that has power will go to the emergency level (default is 100%). This default emergency lighting functionality allows any ballast/driver that has normal/emergency power to go to 100% if the controller turns off due to loss of normal power.

Lutron, EcoSystem, Nova T⁺, Diva, Maestro, Vive, Clear Connect, Energi Savr Node, and PowPak are trademarks or registered trademarks of Lutron Electronics Co., Inc. in the US and/or other countries.

All other product names, logos, and brands are property of their respective owners.

Lutron Contact Numbers

WORLD HEADQUARTERS USA

Lutron Electronics Co., Inc.
7200 Suter Road
Coopersburg, PA 18036-1299
TEL: +1.610.282.3800
FAX: +1.610.282.1243
support@lutron.com
www.lutron.com/support

North & South America Customer Assistance

USA, Canada, Caribbean:
1.844.LUTRON1 (1.844.588.7661)
Mexico:
+1.888.235.2910
Central/South America:
+1.610.282.6701

UK AND EUROPE: Lutron EA Limited

125 Finsbury Pavement
4th floor, London EC2A 1NQ
United Kingdom
TEL: +44.(0)20.7702.0657
FAX: +44.(0)20.7480.6899
FREEPHONE (UK): 0800.282.107
Technical Support: +44.(0)20.7680.4481
lutronlondon@lutron.com

ASIA:

Lutron GL Ltd.

390 Havelock Road
#07-04 King's Centre
Singapore 169662
TEL: +65.6220.4666
FAX: +65.6220.4333
Technical Support: 800.120.4491
lutronsea@lutron.com

Asia Technical Hotlines

Northern China: 10.800.712.1536
Southern China: 10.800.120.1536
Hong Kong: 800.901.849
Indonesia: 001.803.011.3994
Japan: +81.3.5575.8411
Macau: 0800.401
Taiwan: 00.801.137.737
Thailand: 001.800.120.665853
Other Countries: +65.6220.4666