

# TOSHIBA

Leading Innovation >>>

## Portégé<sup>®</sup> A30-C Series User's Guide

(Windows 10)

If you need assistance:

Technical support is available online at Toshiba's Web site at [support.toshiba.com](http://support.toshiba.com). At this Web site, you will find answers for many commonly asked technical questions plus many downloadable software drivers, BIOS updates, and other downloads.

For more information, see "If Something Goes Wrong" on [page 128](#) in this guide.

---

---

## California Prop 65 Warning

**▲ WARNING**

This product contains chemicals, including lead, known to the State of California to cause cancer and birth defects or other reproductive harm. ***Wash hands after handling.***

---



For the state of California only.

## Model: Portégé A30-C Series

### Recordable and/or ReWritable Drive(s) and Associated Software Warranty

The computer system you purchased may include Recordable and/or ReWritable optical disc drive(s) and associated software, among the most advanced data storage technologies available. As with any new technology, you must read and follow all set-up and usage instructions in the applicable user guides and/or manuals enclosed or provided electronically. If you fail to do so, this product may not function properly and you may lose data or suffer other damage.

**TOSHIBA AMERICA INFORMATION SYSTEMS, INC.**

**(“TOSHIBA”), ITS AFFILIATES AND SUPPLIERS DO NOT WARRANT THAT OPERATION OF THE PRODUCT WILL BE UNINTERRUPTED OR ERROR FREE. YOU AGREE THAT TOSHIBA, ITS AFFILIATES AND SUPPLIERS SHALL HAVE NO RESPONSIBILITY FOR DAMAGE TO OR LOSS OF ANY BUSINESS, PROFITS, PROGRAMS, DATA, NETWORK SYSTEMS OR REMOVABLE STORAGE MEDIA ARISING OUT OF OR RESULTING FROM THE USE OF THE PRODUCT, EVEN IF ADVISED OF THE POSSIBILITY THEREOF.**

---

## Protection of Stored Data

For your important data, please make periodic back-up copies of all the data stored on the hard disk or other storage devices as a precaution against possible failures, alteration, or loss of the data. **IF YOUR DATA IS ALTERED OR LOST DUE TO ANY TROUBLE, FAILURE OR MALFUNCTION OF THE HARD DISK DRIVE OR OTHER STORAGE DEVICES AND THE DATA CANNOT BE RECOVERED, TOSHIBA SHALL NOT BE LIABLE FOR ANY DAMAGE OR LOSS OF DATA, OR ANY OTHER DAMAGE RESULTING THEREFROM. WHEN COPYING OR TRANSFERRING YOUR DATA, PLEASE BE SURE TO CONFIRM WHETHER THE DATA HAS BEEN SUCCESSFULLY COPIED OR TRANSFERRED. TOSHIBA DISCLAIMS ANY LIABILITY FOR THE FAILURE TO COPY OR TRANSFER THE DATA CORRECTLY.**

## Critical Applications

The computer you have purchased is not designed for any “critical applications.” “Critical applications” means life support systems, medical applications, connections to implanted medical devices, commercial transportation, nuclear facilities or systems or any other applications where product failure could lead to injury to persons or loss of life or catastrophic property damage. **ACCORDINGLY, TOSHIBA, ITS AFFILIATES AND SUPPLIERS DISCLAIM ANY AND ALL LIABILITY ARISING OUT OF THE USE OF THE COMPUTER PRODUCTS IN ANY CRITICAL APPLICATIONS. IF YOU USE THE COMPUTER PRODUCTS IN A CRITICAL APPLICATION, YOU, AND NOT TOSHIBA, ASSUME FULL RESPONSIBILITY FOR SUCH USE.**

## FCC Notice “Declaration of Conformity Information”

This equipment has been tested and found to comply with the limits for a Class B digital device, pursuant to Part 15 of the FCC rules. These limits are designed to provide reasonable protection against harmful interference in a residential installation.

This equipment generates, uses and can radiate radio frequency energy and, if not installed and used in accordance with the instructions, it may cause harmful interference to radio communications. However, there is no guarantee that interference will not occur in a particular installation. If this equipment does cause harmful interference to radio or television reception, which can be determined by turning the equipment off and on, the user is

---

encouraged to try to correct the interference by one or more of the following measures:

- ❖ Reorient or relocate the receiving antenna.
- ❖ Increase the separation between the equipment and receiver.
- ❖ Connect the equipment to an outlet on a circuit different from that to which the receiver is connected.
- ❖ Consult the dealer or an experienced radio/TV technician for help.

---

**NOTE**

Only Peripherals complying with the FCC Class B limits may be attached to this equipment. Operation with noncompliant peripherals or peripherals not recommended by Toshiba is likely to result in interference to radio and TV reception. Shielded cables must be used between the external devices and the computer's ports. Changes or modifications made to this equipment not expressly approved by Toshiba or parties authorized by Toshiba could void the user's authority to operate the equipment.

---

This device complies with Part 15 of the FCC Rules. Operation is subject to the following two conditions:

- ❖ This device may not cause harmful interference.
- ❖ This device must accept any interference received, including interference that may cause undesired operation.

Contact Toshiba's Support Web site at [support.toshiba.com](http://support.toshiba.com).

## **Bluetooth® Wireless Technology Interoperability**

---

**NOTE**

This section is only applicable if your system has a *Bluetooth* module.

---

*Bluetooth* modules are designed to be interoperable with any product with *Bluetooth* wireless technology that is based on Frequency Hopping Spread Spectrum (FHSS) radio technology, and is compliant to:

- ❖ *Bluetooth* Specification as defined and approved by The *Bluetooth* Special Interest Group.
- ❖ Logo certification with *Bluetooth* wireless technology as defined by The *Bluetooth* Special Interest Group.

**CAUTION**

*Bluetooth* modules enable wireless networks over two or more (up to a total of seven) TOSHIBA portable devices. Please contact TOSHIBA computer product support on Web site <http://www.toshiba-europe.com/computers/tnt/bluetooth.htm> in Europe or [support.toshiba.com](http://support.toshiba.com) in the United States for more information.

When you use a *Bluetooth* module close to 2.4 GHz Wireless LAN devices, *Bluetooth* transmissions might slow down or cause errors. If you detect certain interference while you use a *Bluetooth* device, always change the frequency, move your device to the area outside of the interference range of 2.4 GHz Wireless LAN devices (40 meters/43.74 yards or more) or stop transmitting from your device. Please contact TOSHIBA computer product support on Web site <http://www.toshiba-europe.com/computers/tnt/bluetooth.htm> in Europe or [support.toshiba.com](http://support.toshiba.com) in the United States for more information.

*Bluetooth* and Wireless LAN devices operate within the same radio frequency range and may interfere with one another. If you use *Bluetooth* and Wireless LAN devices simultaneously, you may occasionally experience a less than optimal network performance or even lose your network connection. If you should experience any such problem, immediately turn off either one of your *Bluetooth* or Wireless LAN. Please contact Toshiba computer product support on Web site <http://www.toshiba-europe.com/computers/tnt/bluetooth.htm> in Europe or [support.toshiba.com](http://support.toshiba.com) in the United States for more information.

## **Bluetooth Wireless Technology and Your Health**

The products with *Bluetooth* wireless technology, like other radio devices, emit radio frequency electromagnetic energy. The level of energy emitted by devices with *Bluetooth* wireless technology however is much less than the electromagnetic energy emitted by wireless devices such as mobile phones.

Because products with *Bluetooth* wireless technology operate within the guidelines found in radio frequency safety standards and recommendations, TOSHIBA believes *Bluetooth* wireless technology is safe for use by consumers. These standards and recommendations reflect the consensus of the scientific community and result from deliberations of panels and committees of scientists who continually review and interpret the extensive research literature.

In some situations or environments, the use of *Bluetooth* wireless technology may be restricted by the proprietor of the building or

---

responsible representatives of the organization. These situations may for example include:

- ❖ Using the equipment with *Bluetooth* wireless technology on board airplanes, or
- ❖ In any other environment where the risk of interference to other devices or services is perceived or identified as harmful.

If you are uncertain of the policy that applies on the use of wireless devices in a specific organization or environment (e.g. airports), you are encouraged to ask for authorization to use the device with *Bluetooth* wireless technology prior to turning on the equipment.

---

**CAUTION**

Exposure to Radio Frequency Radiation

The radiated output power of the *Bluetooth* module is far below the FCC radio frequency exposure limits.

Nevertheless, the *Bluetooth* module shall be used in such a manner that the potential for human contact during normal operation is minimized.

---

## Wireless Interoperability

Wireless LAN products are designed to be interoperable with any wireless LAN product that is based on Direct Sequence Spread Spectrum (DSSS) radio technology, and is compliant to:

- ❖ The IEEE 802.11 Standard on Wireless LANs (Revision a/b/g/n/ac), as defined and approved by the Institute of Electrical and Electronics Engineers.
- ❖ The Wireless Fidelity (Wi-Fi<sup>®</sup>) certification as defined by the Wi-Fi Alliance<sup>®</sup>. The “Wi-Fi CERTIFIED” logo is a certification mark of the Wi-Fi Alliance.

---

**CAUTION**

*Bluetooth* and Wireless LAN devices operate within the same radio frequency range and may interfere with one another. If you use *Bluetooth* and Wireless LAN devices simultaneously, you may occasionally experience a less than optimal network performance or even lose your network connection.

If you should experience any such problem, immediately turn off your *Bluetooth* or Wireless LAN device.

Please contact Toshiba computer product support on Web site <http://www.toshiba-europe.com/computers/tnt/bluetooth.htm> in Europe or [support.toshiba.com](http://support.toshiba.com) in the United States for more information.

---

---

## Wireless LAN and Your Health

Wireless LAN products, like other radio devices, emit radio frequency electromagnetic energy. The level of energy emitted by Wireless LAN devices however is far much less than the electromagnetic energy emitted by wireless devices like for example mobile phones.

Because Wireless LAN products operate within the guidelines found in radio frequency safety standards and recommendations, TOSHIBA believes Wireless LAN is safe for use by consumers. These standards and recommendations reflect the consensus of the scientific community and result from deliberations of panels and committees of scientists who continually review and interpret the extensive research literature.

In some situations or environments, the use of Wireless LAN may be restricted by the proprietor of the building or responsible representatives of the organization. These situations may for example include:

- ❖ Using the Wireless LAN equipment on board airplanes, or
- ❖ In any other environment where the risk of interference to other devices, such as medical equipment or services, is perceived or identified as harmful.

If you are uncertain of the policy that applies on the use of wireless devices in a specific organization or environment (e.g. airports), you are encouraged to ask for authorization to use the Wireless LAN device prior to turning on the equipment.

---

**CAUTION**

Exposure to Radio Frequency Radiation

This device complies with FCC RF exposure requirements.

The radiated output power of the Wireless LAN is far below the FCC radio frequency exposure limits. The antenna(s) used for this transmitter must not be co-located or operating in conjunction with any other antenna or transmitter.

---

## Optical Disc Drive Safety Instructions

**NOTE** This section is only applicable if your system has an Optical Disc Drive.

**⚠ DANGER** This appliance contains a laser system and is classified as a CLASS 1 LASER PRODUCT. To use this model properly, read the User's Guide carefully and keep it for your future reference.

CLASS 1 LASER PRODUCT  
LASERKLASSE 1

Never attempt to disassemble, adjust or repair an optical disc drive. You could damage the drive. You would also be exposed to laser light or other safety hazards, resulting in serious injury. Always contact an authorized Toshiba service provider, if any repair or adjustment is required.

### Location of the Required Label

(Sample shown below. Location of the label and manufacturing information may vary.)

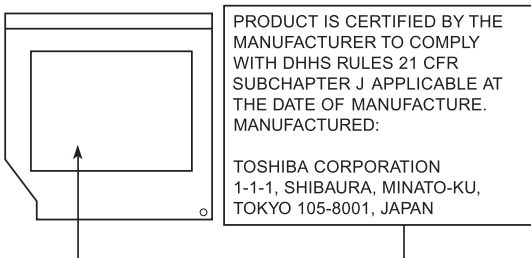

### Canada – Industry Canada (IC)

This device complies with Industry Canada license-exempt RSS standard(s).

Operation is subject to the following two conditions: (1) this device may not cause interference, and (2) this device must accept any interference, including interference that may cause undesired operation of the device.

*Le présent appareil est conforme aux CNR d'Industrie Canada applicables aux appareils radio exempts de licence.*

*L'exploitation est autorisée aux deux conditions suivantes: (1) l'appareil ne doit pas produire de brouillage; (2) l'utilisateur de l'appareil doit accepter tout brouillage radioélectrique subi, même si le brouillage est susceptible d'en compromettre le fonctionnement.*

**CAUTION**

To comply with the Canadian RF exposure compliance requirements, this device and its antenna must not be co-located or operating in conjunction with any other antenna or transmitter.

*Pour être conforme aux exigences canadiennes en matière d'exposition aux fréquences radio, l'appareil et son antenne ne doivent pas être situés au même endroit qu'une autre antenne ou un autre émetteur ni fonctionner en même temps.*

**CAUTION**

This device is restricted to indoor use due to its operation in the 5.15 GHz to 5.25 GHz frequency range. Industry Canada requires this product to be used indoors for frequency range 5.15 GHz to 5.25 GHz to reduce the potential for harmful interference to co-channel Mobile Satellite systems.

High-power radars are allocated as primary users of the 5.25 GHz to 5.35 GHz and 5.65 GHz to 5.85 GHz bands. These radar stations can cause interference with and/or damage this device.

*Les dispositifs fonctionnant dans la bande 5150-5250 MHz sont réservés uniquement pour une utilisation à l'intérieur afin de réduire les risques de brouillage préjudiciable aux systèmes de satellites mobiles utilisant les mêmes canaux.*

*Veillez noter que les utilisateurs de radars de haute puissance sont désignés utilisateurs principaux (c.-à-d., qu'ils ont la priorité) pour les bandes 5250-5350 MHz et 5650-5850 MHz et que ces radars pourraient causer du brouillage et/ou des dommages aux dispositifs LAN-EL.*

**NOTE**

The above caution applies to products that operate with an 802.11a radio device.

*La mise en garde ci-dessus ne s'applique qu'aux appareils ayant un transmetteur opérant en mode 802.11 a.*

## Regulatory statements

This product complies with any mandatory product specification in any country/region where the product is sold. In addition, the product complies with the following:

## EU Declaration of Conformity

TOSHIBA declares that this product conforms to the following Standards:



Supplementary Information:

\*The product complies with the requirements of the Low Voltage Directive 73/23/EEC, the EMC Directive 89/336/EEC and/or the R&TTE Directive 1999/5/EC, compatible with the RoHS Directive 2011/65/EU and the Eco Design Directive 2009/125/EC (ErP) and the related implementing measures.

This product is carrying the CE-Mark in accordance with the related European Directives. The party responsible for CE-Marking is TOSHIBA Europe GmbH, Hammfelddamm 8, 41460 Neuss, Germany.

## The European Union WEEE (Waste from Electrical and Electronic Equipment) Directive Information

The European Union WEEE (Waste from Electrical and Electronic Equipment) Directive is intended to protect the quality of the environment and human health through the responsible use of natural resources and the adoption of waste management strategies that focus on recycling and reuse. This Directive requires producers of electrical and electronic products put on the market in European Union (EU) member countries after August 2005 to mark such products with a crossed-out wheeled bin with a black bar symbol. If the product's battery or accumulator contains more than the specified values of lead (Pb), mercury (Hg), and/or cadmium (Cd) defined in the Battery Directive (2006/66/EC), then the chemical symbols for lead (Pb), mercury (Hg) and/or cadmium (Cd) will appear below the crossed out wheeled bin symbol on the battery.



Pb, Hg, Cd

In the European Union, these symbols indicate that when the last end user wishes to discard this product, it must be sent to appropriate facilities for recovery and recycling. This Directive applies to EU member countries only and does not apply to end users in other countries such as the United States.

Although the initial emphasis is in Europe, Toshiba is already working with design engineers, suppliers, and other partners to determine appropriate worldwide product life cycle planning and end-of-life strategies for our products. Please contact your local government for applicable laws and regulations governing the disposal of this product. For information on how to trade-in or recycle your product, visit [www.reuse.toshiba.com](http://www.reuse.toshiba.com).

## Europe - Restrictions for use of 2.4 GHz Frequencies in European Community Countries

België/ Belgique:	For private usage outside buildings across public grounds over less than 300m no special registration with IBPT/BIPT is required. Registration to IBPT/BIPT is required for private usage outside buildings across public grounds over more than 300m. For registration and license please contact IBPT/BIPT.
	Voor privé-gebruik buiten gebouw over publieke grond over afstand kleiner dan 300m geen registratie bij BIPT/IBPT nodig; voor gebruik over afstand groter dan 300m is wel registratie bij BIPT/IBPT nodig. Voor registratie of licentie kunt u contact opnemen met BIPT.
	Dans le cas d'une utilisation privée, à l'extérieur d'un bâtiment, au-dessus d'un espace public, aucun enregistrement n'est nécessaire pour une distance de moins de 300m. Pour une distance supérieure à 300m un enregistrement auprès de l'IBPT est requise. Pour les enregistrements et licences, veuillez contacter l'IBPT.
Deutschland:	License required for outdoor installations. Check with reseller for procedure to follow.
	Anmeldung im Outdoor-Bereich notwendig, aber nicht genehmigungspflichtig. Bitte mit Händler die Vorgehensweise abstimmen.
France:	Restricted frequency band: only channels 1 to 7 (2400 MHz and 2454 MHz respectively) may be used outdoors in France. Please contact A.R.T. ( <a href="http://www.art-telecom.fr">http://www.art-telecom.fr</a> ) for applicable procedures to follow.

	Bande de fréquence restreinte: seuls les canaux 1- 7 (2400 et 2454 MHz respectivement) doivent être utilisés endroits extérieur en France. Vous pouvez contacter l'Autorité de Régulation des Télécommunications ( <a href="http://www.art-telcom.fr">http://www.art-telcom.fr</a> ) pour la procédure à suivre.
Italia:	License required for indoor use. Use with outdoor installations not allowed.
	È necessaria la concessione ministeriale anche per l'uso interno. Verificare con i rivenditori la procedura da seguire.
Nederland:	License required for outdoor installations. Check with reseller for procedure to follow.
	Licentie verplicht voor gebruik met buitenantennes. Neem contact op met verkoper voor juiste procedure.

### Europe - Restrictions for Use of 5 GHz Frequencies in European Community Countries

European Community Countries	5150-5250 MHz Channels: 36, 40, 44, 48 Indoor Only	5250-5350 MHz Channels: 52, 56, 60, 64 Indoor Only	5470-5725 MHz Channels: 100, 104, 108, 112, 116, 120, 124, 128, 132, 136, 140 Indoor/Outdoor
Austria	O	x	x
Belgium, France, Switzerland/ Liechtenstein	O	O	x
Denmark, Finland, Germany, Greece, Ireland, Italy, Luxembourg, Netherlands, Norway, Portugal, Sweden, UK	O	O	O
Iceland, Spain	O	O	O

O: allowed x: forbidden

- ❖ To remain in conformance with European spectrum usage laws for Wireless LAN operation, the above 2.4 GHz and 5 GHz channel limitations apply. The user should use the wireless LAN utility to check the current channel of operation. If operation is occurring outside of the allowable frequencies as

listed above, the user must cease operating the Wireless LAN at that location and consult the local technical support staff responsible for the wireless network.

- ❖ The 5 GHz Turbo mode feature is not allowed for operation in any European Community country.
- ❖ This device must not be operated in ad-hoc mode using channels in the 5 GHz bands in the European Community. Ad-hoc mode provides a direct communication between two client devices without a Wireless LAN Access Point.
- ❖ This device must be used with Access Points that have employed and activated a radar detection feature required for European Community operation in the 5 GHz bands. This device will operate under the control of the Access Point in order to avoid operating on a channel occupied by any radar system in the area. The presence of nearby radar operation may result in temporary interruption of operation of this device. The Access Point's radar detection feature will automatically restart operation on a channel free of radar. You may consult with the local technical support staff responsible for the wireless network to ensure the Access Point device(s) are properly configured for European Community operation.

## Taiwan

Article 14	Unless approved, for any model accredited low power radio frequency electric machinery, any company, trader or user shall not change the frequency, increase the power or change the features and functions of the original design.
Article 17	Any use of low power radio frequency electric machinery shall not affect aviation safety and interfere with legal communications. In the event interference is caused, the use of such electric machinery shall be immediately discontinued. Operation of such products can be resumed only when they are modified and can no longer cause interference.

The legal communications mentioned in the above item refer to radio communications operated in accordance with telecommunication laws and regulations.

Low power radio frequency electric machinery shall resist against interference from legal communications or from industrial, scientific and medical radio emission electric machinery.

## Using this Equipment in Japan

In Japan, the frequency bandwidth of 2,400 MHz to 2,483.5 MHz for second generation low-power data communication systems such as this equipment overlaps that of mobile object identification systems (premises radio station and specified low-power radio station).

### 1. Sticker

Please put the following sticker on devices incorporating this product.

The frequency bandwidth of this equipment may operate within the same range as industrial devices, scientific devices, medical devices, microwave ovens, licensed radio stations and non-licensed specified low-power radio stations for mobile object identification systems (RFID) used in factory product lines (Other Radio Stations).

1. Before using this equipment, ensure that it does not interfere with any of the equipment listed above.
2. If this equipment causes RF interference to other radio stations, promptly change the frequency being used, change the location of use, or turn off the source of emissions.
3. Contact TOSHIBA Direct PC if you have problems with interference caused by this product to Other Radio Stations.

### 2. Indication

The indication shown below appears on this equipment.

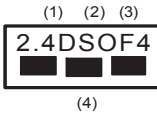

- 1 2.4: This equipment uses a frequency of 2.4 GHz.
- 2 DS: This equipment uses DS-SS modulation.  
OF: This equipment uses OFDM modulation.
- 3 The interference range of this equipment is less than 40m.
- 4 ■ ■ ■ This equipment uses a frequency bandwidth from 2,400 MHz to 2,483.5 MHz.

It is possible to avoid the band of mobile object identification systems.

The indication shown below appears on this equipment.

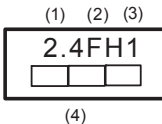

- 1 2.4: This equipment uses a frequency of 2.4 GHz.
- 2 FH: This equipment uses FH-SS modulation.

- 3 The interference range of this equipment is less than 10m.
- 4 This equipment uses a frequency bandwidth from 2,400 MHz to 2,483.5 MHz.

### 3. TOSHIBA Direct PC

Monday – Friday: 10:00 – 17:00

Toll Free Tel: 0120-15-1048

Direct Dial: 03-3457-4850

Fax: 03-3457-4868

## VCCI Class B Information

この装置は、情報処理装置等電波障害自主規制協議会（VCCI）の基準に基づくクラスB情報技術装置です。この装置は、家庭環境で使用することを目的としていますが、この装置がラジオやテレビジョン受信機に近接して使用されると、受信障害を引き起こすことがあります。

取扱説明書に従って正しい取り扱いをして下さい。

## Device Authorization

This device obtains the Technical Regulation Conformity Certification and the Technical Conditions Compliance Approval, and it belongs to the device class of radio equipment of low-power data communication system radio station stipulated in the Radio Law and the Telecommunications Business Law of Japan.

## Copyright

This guide is copyrighted by Toshiba America Information Systems, Inc. with all rights reserved. Under the copyright laws, this guide cannot be reproduced in any form without the prior written permission of Toshiba. No patent liability is assumed, however, with respect to the use of the information contained herein.

© 2015 by Toshiba America Information Systems, Inc. All rights reserved.

---

## Export Administration Regulation

This document contains technical data that may be controlled under the U.S. Export Administration Regulations, and may be subject to the approval of the U.S. Department of Commerce prior to export. Any export, directly or indirectly, in contravention of the U.S. Export Administration Regulations is prohibited.

## Notice

The information contained in this manual, including but not limited to any product specifications, is subject to change without notice.

**TOSHIBA CORPORATION AND TOSHIBA AMERICA INFORMATION SYSTEMS, INC. (TOSHIBA) PROVIDES NO WARRANTY WITH REGARD TO THIS MANUAL OR ANY OTHER INFORMATION CONTAINED HEREIN AND HEREBY EXPRESSLY DISCLAIMS ANY IMPLIED WARRANTIES OF MERCHANTABILITY OR FITNESS FOR ANY PARTICULAR PURPOSE WITH REGARD TO ANY OF THE FOREGOING. TOSHIBA ASSUMES NO LIABILITY FOR ANY DAMAGES INCURRED DIRECTLY OR INDIRECTLY FROM ANY TECHNICAL OR TYPOGRAPHICAL ERRORS OR OMISSIONS CONTAINED HEREIN OR FOR DISCREPANCIES BETWEEN THE PRODUCT AND THE MANUAL. IN NO EVENT SHALL TOSHIBA BE LIABLE FOR ANY INCIDENTAL, CONSEQUENTIAL, SPECIAL, OR EXEMPLARY DAMAGES, WHETHER BASED ON TORT, CONTRACT OR OTHERWISE, ARISING OUT OF OR IN CONNECTION WITH THIS MANUAL OR ANY OTHER INFORMATION CONTAINED HEREIN OR THE USE THEREOF.**

---

## Trademarks

Portégé, eco Utility, and AccuPoint are either registered trademarks or trademarks of Toshiba America Information Systems, Inc. and/or Toshiba Corporation.

Adobe and Photoshop are either registered trademarks or trademarks of Adobe Systems Incorporated in the United States and/or other countries.

The *Bluetooth*<sup>®</sup> word mark and logos are registered trademarks owned by Bluetooth SIG, Inc. and any use of such marks by Toshiba is under license.

For DTS patents, see <http://patents.dts.com>. Manufactured under license from DTS Licensing Limited. DTS, the Symbol, & DTS and the Symbol together are registered trademarks and DTS Premium Voice Pro is a trademark of DTS, Inc. ©DTS, Inc. All Rights Reserved.

The terms HDMI and HDMI High-Definition Multimedia Interface, and the HDMI logo are trademarks or registered trademarks of HDMI Licensing LLC in the United States and other countries.

Celeron, Centrino, Intel, Intel Core and Pentium are trademarks of Intel Corporation in the U.S. and/or other countries.

Microsoft, Outlook, Windows, Windows Media, and Cortana are either registered trademarks or trademarks of Microsoft Corporation in the United States and/or other countries.

MultiMediaCard and MMC are trademarks of MultiMediaCard Association.

microSD and SD are trademarks of SD-3C, LLC.

Wi-Fi<sup>®</sup> is a registered trademark of the Wi-Fi Alliance<sup>®</sup>.

All other brand and product names are trademarks or registered trademarks of their respective companies.

## Licenses

This Product is licensed under the AVC, the VC-1 and the MPEG-4 Part 2 Visual patent portfolio licenses for the personal and non-commercial use of a consumer to (i) encode video in compliance with the above standards (“Video Standards”) and/or (ii) decode AVC, VC-1 and MPEG-4 Part 2 Visual that was encoded by a consumer engaged in personal and non-commercial activity or was obtained from a video provider licensed to provide such video. None of the licenses extend to any other product regardless of whether such product is included with this product in a single article. No license is granted or shall be implied for any other use. Additional information may be obtained from MPEG LA, LLC. See [www.mpegla.com](http://www.mpegla.com).

---

## Computer Recycling Information

As part of a commitment to people and the future, Toshiba promotes the efficient use of resources by working to achieve our zero-waste-to-landfill goal at all our production sites. In addition to our existing waste reduction and recycling policies, Toshiba is strongly committed to reducing electronic waste. In order to ensure efficient use of resources and appropriate treatment of hazardous substances, in accordance with recycling regulations in each state, country, and territory, Toshiba wants to make it easy for customers to recycle products at the end of the life cycle. To learn more about Toshiba's sustainability commitment, visit [toshiba.com/recycle](https://www.toshiba.com/recycle).

### Reuse, Donation, Recycling

Functional computers can be donated to a local charity or resold easily through a Toshiba-branded program.

Non working Toshiba computers can be mailed-back for free recycling.

For additional details, please visit [toshiba.com/recycle](https://www.toshiba.com/recycle).

# Contents

---

Introduction.....	26
This guide .....	28
Safety icons .....	29
Other icons used.....	29
Your computer's features and specifications .....	30
Documentation .....	30
Service options .....	30
Chapter 1: Getting Started.....	31
Selecting a place to work .....	31
Setting up a work environment .....	31
Keeping yourself comfortable .....	32
Computer user comfort recommendations....	32
Good Working Posture .....	32
Using the notebook with an external keyboard, mouse or monitor .....	33
Typing style.....	34
Taking breaks and varying tasks .....	35
Mobile computing tips .....	35
Transporting the notebook .....	35
Seeking additional help.....	36

---

Check list .....	36
Precautions .....	37
Important information on your computer's cooling fan.....	39
Setting up your computer .....	39
Adding memory .....	40
Connecting to a power source .....	40
Charging the main battery .....	42
Using the computer for the first time .....	42
Initial setup.....	42
Using the Start menu .....	43
Registering your computer with Toshiba .....	44
To Shut down your computer .....	44
To Restart your computer .....	45
To place your computer in Sleep mode.....	45
Adding optional external devices.....	46
Recovering the Internal Storage Drive .....	46
Creating a recovery drive using TOSHIBA Recovery Media Creator .....	47
Restoring from recovery media created by TOSHIBA Recovery Media Creator .....	50
Recovering from the Internal Storage Drive .....	51
Reset your PC .....	52
Installing drivers and applications.....	54
Using the TOSHIBA Dual Pointing Device .....	55
Using the touchpad .....	55
Adjusting touchpad settings .....	58
Disabling or enabling the touchpad .....	59
Connecting an external device .....	59
Using external display devices .....	60
Selecting video cables .....	60
Connecting an HDMI-compatible television or display device .....	60
Connecting an external monitor or projector .....	61

---

Directing the display output when you turn on the computer .....	61
Adjusting the quality of the external display .....	62
Customizing your computer's settings .....	62
Caring for your computer.....	63
Cleaning the computer.....	63
Moving the computer .....	63
Using a computer lock.....	64
<b>Chapter 2: Learning the Basics .....</b>	<b>65</b>
Computing tips .....	65
Using the keyboard.....	67
Function keys.....	67
Special Windows keys .....	67
Overlay keys .....	68
Backlit keyboard .....	69
Touch screen .....	69
Touch screen navigation.....	69
Mouse properties.....	70
Starting an app .....	71
Saving your work .....	72
Backing up your work.....	72
Using the optical disc drive .....	72
Optical disc drive components .....	73
Inserting an optical disc .....	74
Playing optical media.....	75
Recording optical media.....	75
Removing a disc with the computer on .....	76
Removing a disc with the computer off.....	76
Toshiba's online resources .....	76
<b>Chapter 3: Mobile Computing .....</b>	<b>77</b>
Toshiba's energy-saver design.....	77
Running the computer on battery power.....	77
Battery Notice .....	78
Power management.....	79
Charging batteries .....	79
Charging the RTC battery .....	80

Monitoring battery power .....	81
Determining remaining battery power.....	82
What to do when the main battery runs low.....	83
Setting battery notifications .....	83
Conserving battery power .....	84
Power Plans .....	85
Using the eco power plan .....	86
Changing the main battery .....	87
Removing the battery from the computer.....	87
Inserting a charged battery .....	89
Taking care of your battery .....	90
Safety precautions .....	90
Maintaining your battery .....	90
Disposing of used batteries .....	91
Traveling tips.....	92
<b>Chapter 4: Exploring Your Computer's Features....</b>	<b>93</b>
Exploring the desktop.....	93
Finding your way around the desktop .....	94
Windows Store.....	98
Setting up for communications.....	98
Connecting your computer to a network .....	99
Exploring audio features .....	100
Recording sounds.....	100
Using external speakers or headphones .....	101
Using the Web Camera.....	102
Using the Smart Card Slot.....	102
Using the Memory card reader .....	103
Inserting memory media .....	103
Removing memory media .....	104
Using the Expansion port .....	105
<b>Chapter 5: Utilities .....</b>	<b>106</b>
eco Utility .....	107
Password Utility .....	108
Using a supervisor password .....	108
Using a user password .....	110
Deleting a user password .....	112

---

System Settings.....	113
Sleep Utilities .....	116
USB Sleep and Charge.....	116
Enabling/Disabling USB Sleep and Charge.....	118
Power supply mode settings .....	118
TOSHIBA Recovery Media Creator.....	120
Service Station.....	120
TOSHIBA Application Installer .....	121
PC Health Monitor .....	122
Display Utility .....	123
Fingerprint Authentication Utility.....	124
Fingerprint utility limitations .....	124
Using the Fingerprint Authentication Utility .....	124
Fingerprint Logon.....	125
Care and maintenance of your fingerprint reader.....	125
Fingerprint reader limitations .....	127
<b>Chapter 6: If Something Goes Wrong.....</b>	<b>128</b>
Problems that are easy to fix .....	128
Problems when you turn on the computer .....	129
The Windows operating system is not working .....	131
Using Startup options to fix problems .....	131
Internet problems.....	133
Power and the batteries.....	134
Keyboard help.....	135
Perform a complete power cycle.....	135
Uninstall the keyboard driver .....	136
Download the latest keyboard driver .....	137
Perform a system restore.....	137
Clean the keyboard.....	137
Touchpad help .....	138
Disable then enable the touchpad .....	138
Install an external mouse .....	138
Perform a complete power cycle.....	138
Uninstall the touchpad driver.....	139

Download the latest touchpad driver.....	140
Perform a system restore.....	140
Adjust the touchpad properties .....	140
Display problems .....	141
Disk or storage drive problems.....	142
Error-checking .....	142
Optical disc drive problems.....	144
Web Camera help .....	145
Testing your internal Web Camera .....	145
Uninstall the Web Camera driver .....	146
Perform a system restore.....	146
Check for problems with third party applications.....	147
System Recovery .....	147
Sound help.....	147
Use the Sound troubleshooter.....	147
Check and set default speakers .....	148
Uninstall the audio driver .....	149
Download the latest sound driver .....	150
Perform a system restore.....	150
Printer problems .....	151
Wireless networking problems.....	152
Connecting to the Internet.....	153
Using a wireless connection .....	154
Troubleshooting an Internet connection – Verify network status.....	154
Troubleshooting an Internet connection – Verify hardware .....	155
Uninstall the network adapter driver.....	155
Troubleshooting an Internet connection – How to verify TCP/IP.....	156
Downloading drivers and updates.....	158
Using Toshiba Service Station.....	158
Manually download and install drivers and updates .....	158
How to determine the correct drivers to download .....	159
DVD operating problems .....	160

---

Develop good computing habits.....	161
Data and system configuration backup in the Windows operating system.....	162
Additional help .....	167
If you need further assistance.....	167
Contacting Toshiba.....	168
Other Toshiba Internet Web sites .....	168
Toshiba's worldwide offices .....	168
<b>Appendix A: TOSHIBA Function Keys .....</b>	<b>170</b>
Functions .....	170
Volume Mute.....	171
Lock (Instant security).....	171
Power plan .....	171
Sleep mode.....	171
Hibernation mode .....	172
Output (Display switch) .....	172
Display brightness.....	173
Disabling or enabling wireless devices .....	173
Disabling or enabling the touchpad .....	173
Disabling or enabling the cursor control overlay.....	174
Disabling or enabling the numeric overlay.....	174
Disabling or enabling the scroll lock .....	174
Keyboard backlight.....	174
Zoom In/Out.....	174
Volume control.....	175
Zoom (Display resolution) .....	175
Cortana .....	175
<b>Appendix B: Power Cord/Cable Connectors.....</b>	<b>176</b>
<b>Glossary .....</b>	<b>177</b>
<b>Index .....</b>	<b>191</b>

# Introduction

---

Thank you for purchasing your new Toshiba computer. With your Toshiba computer, your work and entertainment can accompany you wherever you go.



Your computer is ENERGY STAR® qualified.

Toshiba is a partner in the Environmental Protection Agency's (EPA) ENERGY STAR Program and has designed this computer to meet the latest ENERGY STAR guidelines for energy efficiency. Your computer ships with the power management options preset to a configuration that will provide the most stable operating environment and optimum system performance for both AC power and battery modes.

To conserve energy, your computer's power management features have been pre-configured to activate the display Sleep mode after no later than 15 minutes of inactivity; the system Sleep mode is activated after no later than 30 minutes of user inactivity. We recommend that you leave these and other energy saving features active, so that your computer will operate at its maximum energy efficiency. You can wake the computer from Sleep mode by pressing the power button. See the "Mobile Computing" section of the Toshiba User's Guide for more information on using power management settings to conserve computer energy.

---

When considering additions to your home office, purchase products that have earned the ENERGY STAR for all your equipment needs, which can save you money, save energy, and help protect the climate.

Visit <http://www.energystar.gov> or <http://www.energystar.gov/powermanagement> for more information regarding the ENERGY STAR Program.

---

**NOTE**

This computer is compatible with European Union Directive 2011/65/EU, Restriction of the use of certain Hazardous Substances in electrical and electronic equipment (RoHS), which restricts use of certain chemicals including, but not limited to, lead, cadmium, mercury, hexavalent chromium, PBB, and PBDE. Toshiba requires its computer component suppliers to meet RoHS requirements and verifies its suppliers' commitment to meeting RoHS requirements by conducting component sampling inspections during the product design approval process.

---

---

**NOTE**

Certain Microsoft® software product(s) included with this computer may use technological measures for copy protection. IN SUCH EVENT, YOU WILL NOT BE ABLE TO USE THE PRODUCT IF YOU DO NOT FULLY COMPLY WITH THE PRODUCT ACTIVATION PROCEDURES. Product activation procedures and Microsoft's privacy policy will be detailed during initial launch of the product, or upon certain reinstallations of the software product(s) or reconfigurations of the computer, and may be completed by Internet or telephone (toll charges may apply).

Some software may differ from its retail version (if available), and may not include user manuals or all program functionality.

---

**NOTE**

The product specifications and configuration information are designed for a product Series. Your particular model may not have all the features and specifications listed or illustrated. For more detailed information about the features and specifications on your particular model, please visit Toshiba's Web site at [support.toshiba.com](http://support.toshiba.com).

While Toshiba has made every effort at the time of publication to ensure the accuracy of the information provided herein, product specifications, configurations, prices, system/component/options availability are all subject to change without notice. For the most up-to-date product information about your computer, or to stay current with the various computer software or hardware options, visit Toshiba's Web site at [support.toshiba.com](http://support.toshiba.com).

---

## This guide

This guide introduces the computer's features as well as some basic procedures needed to perform tasks in Windows 10.

You can:

- ❖ Read the entire guide from beginning to end.
- ❖ Skim through and stop when a topic interests you.
- ❖ Use the table of contents and the index to find specific information.

## Safety icons

This manual contains safety instructions that must be observed to avoid potential hazards that could result in personal injuries, damage to your equipment, or loss of data. These safety cautions have been classified according to the seriousness of the risk, and icons highlight these instructions as follows:



Indicates an imminently hazardous situation which, if not avoided, will result in death or serious injury.



Indicates a potentially hazardous situation which, if not avoided, could result in death or serious injury.



Indicates a potentially hazardous situation which, if not avoided, may result in minor or moderate injury.



Indicates a potentially hazardous situation which, if not avoided, may result in property damage.



Provides important information.

## Other icons used

Additional icons highlight other helpful or educational information:



TECHNICAL NOTE: This icon indicates technical information about the computer.



HINT: This icon indicates helpful hints and tips.



DEFINITION: This icon indicates the definition of a term used in the text.

## Your computer's features and specifications

Certain computer chassis are designed to accommodate all possible configurations for an entire product Series. Your select model may not have all the features and specifications corresponding to all of the icons or switches shown on the computer chassis, unless you have selected all those features.

This information applies to all the features and icons described in this guide.

Below are examples of some of the many possible icons used on your computer:



*(Sample Illustration) System icons*

## Documentation

The following documentation is provided:

- ❖ An electronic version of the User's Guide (this document)
- ❖ A Quick Start document
- ❖ Warranty information
- ❖ It may also include other documentation

For accessory information, visit Toshiba's Web site at [accessories.toshiba.com](http://accessories.toshiba.com).

## Service options

Toshiba offers a full line of service programs to complement its standard limited warranty. Toshiba's standard limited warranty, extended warranty, and service upgrade terms and conditions are available at [warranty.toshiba.com](http://warranty.toshiba.com).

To stay current on the most recent software and hardware options for your computer, and for other product information, be sure to regularly check the Toshiba Web site at [support.toshiba.com](http://support.toshiba.com).

If you have a problem or need to contact Toshiba, see "If Something Goes Wrong" on page 128.

# Chapter 1

## Getting Started

---

This chapter provides tips for using your computer effectively, summarizes how to connect components, and explains what to do the first time you use your computer.

Please read the safety instruction information on the Quick Start document (that shipped with your computer) carefully and make sure you fully understand the instructions before you attempt to use your computer in order to avoid potential hazards that could cause bodily injury, property damage, or damage the computer.

### Selecting a place to work

Your computer is portable and designed to be used in a variety of circumstances and locations.

### Setting up a work environment

Place the computer on a hard flat surface that is large enough for the computer and any other items you are using, such as a printer. Leave enough space around the computer and other equipment to provide adequate ventilation. Otherwise, they may overheat.

To keep your computer in prime operating condition, protect your work area from:

- ❖ Dust, moisture, and direct sunlight.

- ❖ Equipment that generates a strong electromagnetic field, such as stereo speakers (other than speakers that are connected to the computer) or speakerphones.
- ❖ Rapid changes in temperature or humidity and sources of temperature change such as air conditioner vents or heaters.
- ❖ Extreme heat, cold, or humidity.
- ❖ Liquids and corrosive chemicals.

## **Keeping yourself comfortable**

This section provides information for setting up your work environment and tips for working comfortably throughout the day.

## **Computer user comfort recommendations**

### **Good Working Posture**

- ❖ Adjust your chair height: your feet should be flat on the floor and the bottom of your thighs should be evenly supported by the seat. If your feet cannot reach the floor, use a foot rest. Avoid pressure points behind the knee or under the thigh.
- ❖ The space under your desk should be free of clutter so that your legs and feet are not restricted, and you can get close enough to your notebook and other items that you use frequently.
- ❖ Adjust the chair back rest: it should match the curve of your back and provide comfortable back support.
- ❖ Adjust the chair arm rests: they should be about the same height as the keyboard and comfortably support your arms, allowing your shoulders to relax.
- ❖ When using the keyboard, it should be centered in front of you.
- ❖ The keyboard and pointing device should be close to your elbow level. The keyboard should be flat so that your wrists are straight when typing. However, if the notebook is on a work surface that is above your elbow height you may need to slope the notebook to keep your wrists straight.
- ❖ Work with relaxed shoulders.

- ❖ When typing, keep your wrists straight and try not to rest your wrists on the notebook. Support your arms on your forearm area. The forearms can be supported by the chair arm supports or the desk surface.
- ❖ The notebook display should be tilted so that the image on the screen is clear.
- ❖ Avoid glare: position the notebook so that light sources (lamps or windows) do not shine or reflect directly into your eyes. Place the notebook display away from bright light sources or reduce the light intensity from windows by using blinds. Glare on the notebook display may cause eye strain, eye fatigue or headaches.
- ❖ Certain notebook displays have a brightness approaching that of a TV device. We recommend that you adjust the brightness of your notebook display to a comfortable level to prevent possible eye strain.
- ❖ Keep your head level, facing forward and balanced over your torso.
- ❖ Adjust the font size of text on your screen to make viewing comfortable.
- ❖ Rest your eyes periodically by focusing on objects that are farther away.

## Using the notebook with an external keyboard, mouse or monitor

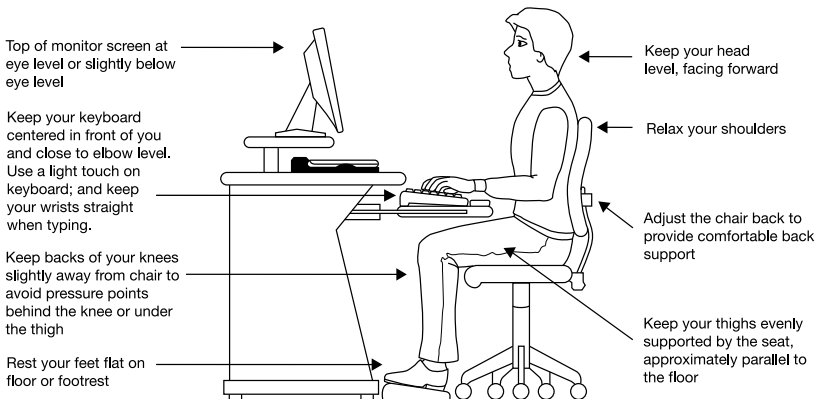

*(Sample Illustration) Correct posture*

- ❖ When using a notebook for long hours, it may be more comfortable to dock the notebook and use an external keyboard, mouse and monitor.
- ❖ The keyboard and mouse (or trackball) should be close to your elbow level.
- ❖ The mouse should be next to the keyboard to avoid a reach. If you have to reach, the arm should be supported in the forearm area by the desk surface or the chair arm supports.
- ❖ Alternative keyboards, such as the split curved keyboard, may improve shoulder and arm comfort.
- ❖ Select a mouse that is comfortable for you to use.
- ❖ Do not rest your wrists on the edge of the keyboard or on the work surface when typing.
- ❖ The monitor should be about an arm length away while sitting back in the chair.
- ❖ The monitor should be centered in front of your body.
- ❖ The top of the monitor should be at or slightly below eye level. A monitor that is too high or too low can cause awkward head and neck postures and may lead to discomfort in the neck muscles.
- ❖ If you use bifocals you may need to lower the monitor. Alternatively, you might consider customized prescription computer glasses.

### Typing style

- ❖ Learn to touch type so that you do not have to look down at the keyboard.
- ❖ Type with straight wrists.
- ❖ Type lightly.
- ❖ Learn the keyboard shortcuts for your applications. You will be more productive.
- ❖ Use the pointing device (e.g., touchpad, AccuPoint® II, or tablet pen whichever is available with your notebook computer, or other optional pointing devices like mouse or trackball) with a comfortable hand posture. Avoid awkward hand postures or high gripping force.
- ❖ It is helpful to change the type of pointing device that you use on a regular basis to avoid working in just one hand posture.

## Taking breaks and varying tasks

- ❖ Change the way you work so that you are not stuck in the same posture for long periods of time. Some people find it comfortable to occasionally stand while using the notebook. To do this properly, the notebook needs to be on an elevated surface. Make sure you follow the Good Working Posture points mentioned above while working.
- ❖ Take short, strategically spaced rest breaks to avoid eye strain and body fatigue. For example, stand up and walk around or stretch for a few minutes every hour.
- ❖ Taking regular breaks is especially important if you are working long hours on your computer or working on a deadline.
- ❖ If stress at work is affecting your health, try to identify the sources of the stress and evaluate ways to reduce the stress.

## Mobile computing tips

- ❖ When using the notebook at airports, on airplanes or trains, or at meetings, make sure that you take the time to consider the points just mentioned.
- ❖ When working on the road it may be difficult to set up the notebook in an optimal position. In these situations it is important that you take frequent breaks and change your posture frequently to relieve the excess loads on your body.
- ❖ Be creative, when in a hotel room, use a rolled up blanket or pillows to provide back support, or to provide arm support. To position the computer at a good height, remember to operate the computer on a hard flat stable surface. Using your computer on a carpet, blanket or other soft materials can block the air vents including those located at the base of the computer and possibly cause overheating of your computer.

## Transporting the notebook

Although your notebook is light, carrying it for a long time may lead to shoulder and arm fatigue. If you carry your notebook with other items, consider using an ergonomically-designed computer case.

## Seeking additional help

Follow the advice from your employer's company health and safety staff. Contact them if you need assistance making adjustment to your workstation or adjusting the lighting.

Again, if you experience persistent or recurrent pain, ache, numbness, burning, or stiffness you should promptly see a qualified health care provider. These sensations may be caused by serious medical conditions that can be treated.

For more specific recommendations on the safety and comfort of your computer environment, customers in the United States may visit the United States Department of Labor, Occupational Safety & Health Administration Web site at: <http://www.osha.gov/SLTC/etools/computerworkstations/>.

## Check list

- Is your chair comfortable - does it support your back and arms well?
- Are your feet flat on the ground?
- Is there adequate space under your desk for your legs?
- Are the keyboard and mouse at elbow level?
- Are your shoulders relaxed when using the keyboard?
- Are your shoulders relaxed when using a mouse or other optional pointing device?
- Are your hands and wrists aligned in a comfortable, straight posture?
- Are your arms supported in the forearm area (not at the wrist)?
- Do you hold the mouse or trackball with a loose, relaxed hand?
- Do you use a light touch when typing or using the mouse?
- Do you clean your mouse or trackball regularly?
- Is the top of your monitor close to eye level?
- Is the monitor about an arm length away?
- Have you eliminated the glare on the monitor?
- Is the monitor tilted so that it is easy to read?
- Do you change postures regularly?
- Do you take breaks, at least once an hour?

---

## Precautions

Your computer is designed to provide optimum safety and ease of use, and to withstand the rigors of travel. You should observe certain precautions to further reduce the risk of personal injury or damage to the computer.

- ❖ Avoid prolonged physical contact with the underside or surface of the computer.

---

### **⚠ WARNING**

Never allow any liquids to spill into any part of your computer, and never expose the computer to rain, water, seawater or moisture. Exposure to liquid or moisture can cause electric shock or fire, resulting in damage or serious injury. If any of these eventualities should accidentally occur, immediately:

1. Turn off the computer.
2. Disconnect the AC adaptor from the power plug socket and computer.
3. Remove the battery pack, if applicable.

Failure to follow these instructions could result in serious injury or permanent damage to the computer.

Do not turn on the power again until you have taken the computer to an authorized service center.

---

---

### **⚠ CAUTION**

- ❖ Avoid prolonged physical contact with the underside or surface of the computer.
  - ❖ Computer base and palm rest can become hot! Avoid prolonged contact to prevent heat injury to skin.
- 

Today's performance computers generate heat under normal operating conditions, as a function of system activity. Avoid extended contact between the computer base or palm rest and your skin. Under certain operating conditions such prolonged contact between the computer base or palm rest and your skin may result in skin irritation and/or heat injury.

Consider using a hard computer insulating pad or similarly suitable hard insulating material when using a computer on your lap.

---

**CAUTION** Never place a heavy object on the computer and be careful not to drop a heavy object onto the computer. It could damage the computer or cause system failure.

---

- ❖ Never turn off the computer if a drive light indicates a drive is active.

Turning off the computer while it is reading from or writing to a disk/disc or flash media may damage the disk/disc or flash media, the drive, or both.

- ❖ Keep the computer and disks away from objects that generate strong magnetic fields.

Information on some disks is stored magnetically. Placing a magnet too close to a disk can erase important files.

---

**CAUTION** Handle discs carefully. Avoid touching the surface of the disc. Grasp it by its center hole and edge. If you handle the disc incorrectly, you could damage the disc and possibly lose data.

---

- ❖ Scan all new files for viruses.

This precaution is especially important for files you receive via email or download from the Internet. Occasionally, even new programs you buy from a supplier may contain a computer virus. You need a special program to check for viruses.

---

## Important information on your computer's cooling fan

Your computer may have a CPU cooling fan that cools the CPU by drawing outside air into the computer.

---

### **WARNING**

Always make sure your computer and AC adaptor have adequate ventilation and are protected from overheating when the power is turned on or when an AC adaptor is connected to a power outlet (even if your computer is in Sleep mode). In this condition, observe the following:

- ❖ Never cover your computer or AC adaptor with any object.
- ❖ Never place your computer or AC adaptor near a heat source, such as an electric blanket or heater.
- ❖ Never cover or block the air vents including those located at the underside of the computer.
- ❖ Always operate your computer on a hard flat surface. Using your computer on a carpet or other soft material can block the vents located at the underside of the computer.

Overheating your computer or AC adaptor could cause system failure, computer or AC adaptor damage or a fire, possibly resulting in serious injury.

---

---

### **NOTE**

The cooling fan location will vary depending on the computer.

---

## Setting up your computer



**TECHNICAL NOTE:** You must complete all setup steps up to and including “[Initial setup](#)” on [page 42](#) before adding external or internal components to your computer. These components include, but are not limited to, a mouse, keyboard, and printer.

---

Your computer contains a rechargeable main battery that needs to be charged before you can use it.

To use external power or to charge the battery you must attach the AC adaptor. See [“Connecting to a power source” on page 40.](#)

---

**NOTE** Please handle your computer carefully to avoid scratching or damaging the surface.

---

## Adding memory

Toshiba will not be responsible for any product damage, data loss, service or part replacement made necessary by improper installation of a memory module.

## Connecting to a power source

Your computer requires power to operate. Use the power cord/cable and AC adaptor to connect the computer to a live electrical outlet, or to charge the computer's battery.

---

**▲ WARNING** Never pull on a power cord/cable to remove a plug from a socket. Always grasp the plug directly. Failure to follow this instruction may damage the cord/cable, and/or result in a fire or electric shock, possibly resulting in serious injury.

---

**▲ WARNING** Always confirm that the power plug (and extension cable plug if used) has been fully inserted into the socket, to ensure a secure electrical connection. Failure to do so may result in a fire or electric shock, possibly resulting in serious injury.

Be careful if you use a multiple connector. An overload on one socket could cause a fire or electric shock, possibly resulting in serious injury.

---

**▲ WARNING** Always use the TOSHIBA AC adaptor that was provided with your computer, or use AC adaptors specified by TOSHIBA to avoid any risk of fire or other damage to the computer. Use of an incompatible AC adaptor could cause fire or damage to the computer possibly resulting in serious injury. TOSHIBA assumes no liability for any damage caused by use of an incompatible adaptor.

---

---

To connect AC power to the computer:

- 1 Connect the power cord/cable to the AC adaptor.

---

## California Prop 65 Warning

**▲ WARNING** This product contains chemicals, including lead, known to the State of California to cause cancer and birth defects or other reproductive harm. **Wash hands after handling.**

---

-  2 Plug the AC adaptor cord into the DC-IN on the side of the computer.

---

**NOTE** To locate your DC-IN port, please refer to your Quick Start document.

---

- 3 Connect the power cord/cable to a live electrical outlet.  
 The AC power light on the indicator panel glows white.

---

**▲ WARNING** Never attempt to connect or disconnect a power plug with wet hands. Failure to follow this instruction could result in an electric shock, possibly resulting in serious injury.

---

The computer's main battery light gives you an indication of the main battery's current charge:

- ❖ Glows amber while the main battery is being charged (AC adaptor connected)
- ❖ Glows white when the main battery is fully charged
- ❖ Is unlit when the main battery has discharged, the battery is not charging, or the AC adaptor is not plugged into the computer or AC outlet
- ❖ Flashes amber when the main battery charge is low and it is time to recharge the main battery or plug in the AC adaptor

---

**NOTE** If the AC power light flashes amber during charging, either the main battery is malfunctioning, or it is not receiving correct input from the AC power supply.

---

## Charging the main battery

Before using the battery to power the computer, you must charge the it.

To charge the battery, leave the computer plugged into an AC power source with the computer turned off until the battery light glows white. After that, the battery will be completely charged and ready to power the computer.

---

**NOTE**

Battery life and charge time may vary depending on the applications power management settings, and features used.

---

## Using the computer for the first time

The computer is now ready for you to turn it on and begin using it, see [“Exploring Your Computer’s Features”](#) on page 93.

---

**CAUTION**

To avoid damaging the display panel, do not force it beyond the point where it moves easily and never lift the computer by the display panel.

Do not press or push on the display panel and be careful to remove any pens or other objects from the keyboard area before closing the display panel.

---

**NOTE**

When opening or closing the display panel, place one hand on the palm rest to hold the computer in place and use the other hand to slowly open or close the display panel.

---

## Initial setup

After turning on your computer for the first time, follow the on-screen instructions on each screen in order to properly install the operating system and begin using your computer.

---

**CAUTION**

When you turn on the computer for the first time, do not turn off the power again until the operating system has loaded completely.

---

## Using the Start menu

Click or touch the **Start** (☰) button in the lower-left corner of the Desktop or press the **Windows** (☰) key to open the Start menu. Here you can perform various commands, including basic tasks like turning off the power and advanced PC settings.

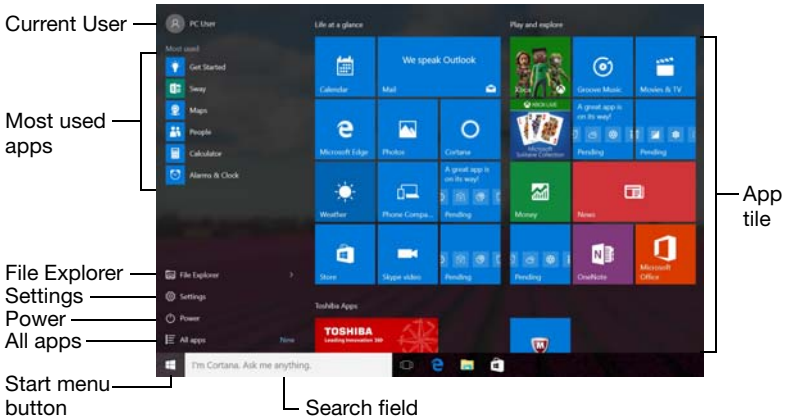

*(Sample Image) Start menu*

You can use the Start menu button to:

- ❖ Change the Current User
- ❖ Select an app
- ❖ Find a file on the local drive
- ❖ Change the system Settings
- ❖ Shut down the computer
- ❖ View All apps

For more information, see [“Starting an app”](#) on page 71 and [“Start button”](#) on page 95.

## Registering your computer with Toshiba

Product registration is strongly recommended, and allows Toshiba to send you periodic updates, announcements, and special offers applicable to your Product.

Product registration can be completed by visiting the Toshiba Web site at [register.toshiba.com](http://register.toshiba.com). Type in the requested information and complete the registration process.

Failure to complete Product Registration will not diminish your rights under the Toshiba Standard Limited Warranty.

---

**NOTE** To register online, an Internet connection is required.

---

## To Shut down your computer

- 1 Click or touch the **Start** (☰) button in the lower-left corner of the Desktop or press the **Windows** (⊞) key.  
The Start menu opens.
- 

**CAUTION**

Pressing the power button before shutting down the Windows® operating system could cause you to lose your work. Make sure the system indicator panel's storage drive light and the drive in-use light are off. If you turn off the power while a disk/disc is being accessed, you may lose data or damage the disk/disc and/or drive.

---

- 2 Click or touch the **Power** (⏻) icon in the Start menu.

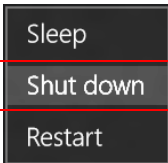

*(Sample Image) Shut down*

---

**NOTE** To perform a Hybrid Shut down, (instead of performing a Shut down), click or touch the **Shut down** option but do NOT hold the SHIFT key.

---

- 3 Highlight **Shut down** while holding the SHIFT key, and then click or touch the **Shut down** option in the pop-up window.

The computer closes all open applications, shuts down the operating system, and then turns off.

To perform a Full Shutdown:

- 1 In the Search field, type **SHUTDOWN /S /T 00**.
- 2 Click or touch the **SHUTDOWN /S /T 00** option in the results list.

The device closes all open applications, shuts down the operating system, and then turns off.

## To Restart your computer

- 1 Click or touch the **Start** (☰) button in the lower-left corner of the Desktop or press the **Windows** (⊞) key.  
The Start menu opens.
- 2 Click or touch the **Power** (⏻) icon in the Start menu.

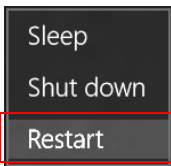

*(Sample Image) Restart*

- 3 Highlight, and then click or touch the **Restart** option.  
The computer closes all open applications, and restarts the operating system.

## To place your computer in Sleep mode

- 1 Click or touch the **Start** (☰) button in the lower-left corner of the Desktop or press the **Windows** (⊞) key.  
The Start menu opens.

### CAUTION

If you power down using the Sleep command and the battery discharges fully, your unsaved information will be lost. Be sure to save your work first.

- 2 Click or touch the **Power** (⏻) icon in the Start menu.

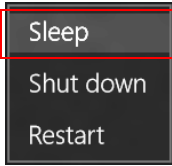

*(Sample Image) Sleep*

- 3 Highlight, and then click or touch the **Sleep** option.

Sleep mode saves the current state of the computer to memory so that, when you restart the computer, you can continue working from where you left off.

## Adding optional external devices

**NOTE** Before adding external devices, Toshiba recommends setting up your software. See [“Initial setup” on page 42](#).

After starting your computer for the first time you may want to:

- ❖ Connect external devices (see [“Connecting an external device” on page 59](#))
- ❖ Connect an external monitor (see [“Using external display devices” on page 60](#))

## Recovering the Internal Storage Drive

Your computer includes recovery utilities to allow you to recover your internal storage drive if necessary.

The following internal storage drive recovery options are available:

<b>Recovery option</b>	<b>Description</b>
Creating a recovery drive (USB flash), using TOSHIBA 51 Recovery Media Creator	This option allows you to create the recovery drive you will use to restore your computer, using TOSHIBA Recovery Media Creator. See <a href="#">“Creating a recovery drive using TOSHIBA Recovery Media Creator” on page 47</a> .
Booting from a recovery drive to Restore your computer	This option allows you to restore your computer from the recovery drive (USB flash) you created with TOSHIBA Recovery Media Creator. See <a href="#">“Restoring from recovery media created by TOSHIBA Recovery Media Creator” on page 50</a> .

---

<b>Recovery option</b>	<b>Description</b>
Using the Internal Storage Drive to Restore your computer	This option allows you to restore your computer using the Internal Storage drive. See <a href="#">“Recovering from the Internal Storage Drive” on page 51.</a>
Reset your PC	This option allows you to remove all data or choose to keep your files, and then reinstall Windows. See <a href="#">“Reset your PC” on page 52.</a>

A recovery image of your computer is stored on the internal storage drive, and the image can be restored by running the recovery utilities directly from your internal storage drive as described in the sections below. However, it is strongly recommended that you create a recovery drive (USB flash). If the recovery files on your internal storage drive become corrupted or are deleted, you can restore your system from the recovery drive. Also, if your original internal storage drive fails, you can restore your system to a new internal storage drive from your recovery drive. It is strongly recommended that you create a recovery drive before using your system for the first time. See [“Creating a recovery drive using TOSHIBA Recovery Media Creator” on page 47](#) and [“Restoring from recovery media created by TOSHIBA Recovery Media Creator” on page 50.](#)

## Creating a recovery drive using TOSHIBA Recovery Media Creator

---

**NOTE** During the recovery process your computer must be connected to an external power source via the AC adaptor.

---

It is strongly recommended that you create a recovery drive (USB flash) using TOSHIBA Recovery Media Creator. If the recovery files on your internal storage drive become corrupted or are deleted, you can restore your system from your recovery drive. Also, if your original internal storage drive fails, you can restore your system to a new internal storage drive from your recovery drive.

**NOTE** When you create a recovery drive (USB flash), only the operating system files and drivers originally shipped with the computer are backed up to the USB flash drive and can be restored from this drive. Any files that you created are not backed up on the recovery drive. You will need to separately back up the files you created; for more information, see [“Backing up your work” on page 72](#).

---

To create a recovery drive:

- 1 Connect a USB flash drive to your computer.
- 2 In the **Search** field, type **TOSHIBA Recovery Media Creator**.
- 3 Click or touch **TOSHIBA Recovery Media Creator**.

A message may appear asking you to allow this app to make changes to your PC. Click or touch the **Yes** button.

---

**CAUTION** All information stored on your USB flash drive will be erased during the process of creating the recovery drive. Be sure to save the information stored on your USB flash drive to another storage computer before executing this procedure.

---

- 4 Click or touch **Create**.  
A prompt appears stating, “The Recovery USB media will be created now. Please insert a USB flash drive...”
- 

**NOTE** The size of the required USB flash drive will vary, minimum 16GB, depending upon your system.

---

- 5 Click or touch **OK** to continue.  
A prompt appears stating, “The USB flash drive will be formatted.”
- 6 Click or touch **OK** to continue.  
This may take a few minutes.  
A pop-up window appears when the **TOSHIBA Recovery Media Creator** process is complete.

- 7 Click or touch **OK** to finish.
- 8 Click or touch **Close** to close the TOSHIBA Recovery Media Creator.

A message appears asking, “Would you like to free up drive space by deleting the HDD recovery data?”
- 9 Click or touch **OK** to delete the HDD recovery data, or **Cancel** to abort the process without deleting the HDD recovery data.
- 10 If you selected **OK** in step 9 to delete the HDD data, a message appears warning, “If you remove the HDD recovery data, you will not be able to create the System Recovery media again. Are you sure you want to continue?”
- 11 Click or touch **OK** again to agree to remove the HDD recovery data.

You will see the message, “The HDD recovery data has been removed and the new Windows partition D: has been created.”
- 12 Click or touch **OK** to finish.

You will be asked to format the disk.
- 13 If you wish to format the disk, click or touch the **Format disk** button.
- 14 Click or touch **Start** to format the Start button.
- 15 Click or touch **OK** when prompted to format the disk.
- 16 Click or touch **OK** when completed.
- 17 Click or touch **Close** to close the Format utility.

For information on using the recovery drive you have created with the preceding steps, see [“Restoring from recovery media created by TOSHIBA Recovery Media Creator”](#) on page 50.

---

## Restoring from recovery media created by TOSHIBA Recovery Media Creator

---

**CAUTION**

The recovery process deletes information stored on the internal storage drive. Be sure to save your work to external media before executing the recovery (see [“Backing up your work” on page 72](#)).

---

**NOTE**

During the recovery process your computer must be connected to an external power source via the AC adaptor.

---

If you have created a recovery drive for your system, you can restore your system from this drive, if necessary. For example, if your original internal storage drive fails, you can restore your system to a new internal storage drive from your recovery drive. For instructions on creating a recovery drive, see [“Creating a recovery drive using TOSHIBA Recovery Media Creator” on page 47](#).

---

**NOTE**

When you restore your system, only the operating system files and drivers originally shipped with the computer are restored. Any applications you installed or files that you created are not restored during this process. Be sure to separately save the files you have created to external media using Windows or another backup program. For more information, see [“Backing up your work” on page 72](#).

---

To recover your internal storage drive from a recovery drive:

- 1 Make sure your computer is turned off, see [“To Shut down your computer” on page 44](#).
- 2 Connect the recovery USB media you created to your computer.
- 3 Turn on your computer while pressing the  key on the keyboard.  
The Boot menu displays.
- 4 Select the **USB Flash** option and press the ENTER key.  
A Warning screen appears.

- 5 Click or touch **Yes** to continue.  
The Selecting a process screen appears.
- 6 Choose the desired option, and then click or touch **Next**.

## Recovering from the Internal Storage Drive

- 1 Make sure your computer is turned off; see “To Shut down your computer” on page 44.
- 2 Turn on your computer while pressing the () key on the keyboard.  
The Boot menu displays.
- 3 Click or touch **HDD Recovery**.  
A Warning screen appears, stating that when the recovery is executed all data will be deleted and rewritten.
- 4 Click or touch **Yes** to continue.  
A Warning screen appears, displaying the following statement “The Hard Drive Recovery Process has been selected.”

---

**CAUTION**

The recovery process deletes information stored on the internal storage drive. Be sure to save your work to external media before executing the recovery.

---

- 5 Click or touch **Troubleshoot (Reset your PC or set advance options)**.
- 6 Click or touch **TOSHIBA Maintenance Utility**.
- 7 Select **TOSHIBA Recovery Wizard** and press **Next** to continue.  
A Warning screen appears, displaying the following statement “When the recovery is executed all data will be deleted and rewritten. If you are restoring from a backup, did you make sure to backup all important data and configure Windows the way you want it restored?”
- 8 Click or touch **Yes** to continue.  
The Selecting a process screen appears.

- 9 Select the option you want and follow the on-screen instructions.

The process will begin and may take approximately 2 hours.

## Reset your PC

The Reset process allows you to choose to keep your files or remove them, and then reinstall Windows.

### CAUTION

Toshiba does not guarantee successful data backup. Be sure to save your work to external media before executing the recovery. See [“Backing up your work” on page 72](#).

### NOTE

During the Reset process your computer must be connected to an external power source via the AC adaptor.

- 1 Click or touch the **Start** (☰) button in the lower-left corner of the Desktop or press the **Windows** (⊞) key.  
The Start menu opens.
- 2 Click or touch **Settings** (⚙️) in the Start menu.
- 3 Select **Update & security** (🔄) in the Settings window.  
The Update & security window appears.

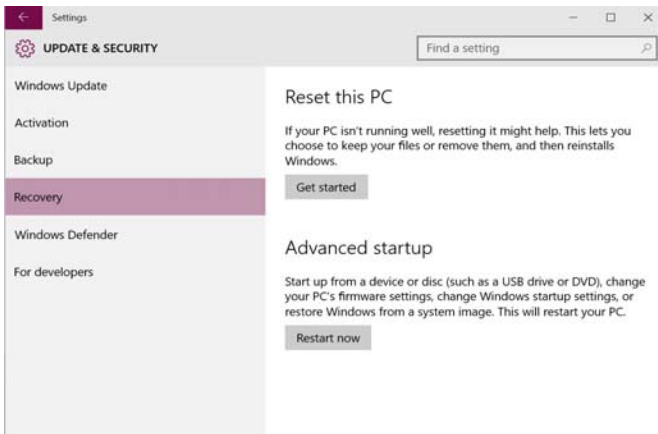

*(Sample Image) Update & security window*

- 4 Select **Recovery** in the left pane of the Update & security window.
- 5 Click or touch the **Get started** button.

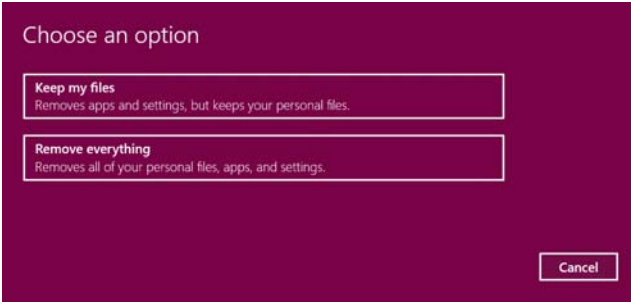

*(Sample Image) Choose an option window*

- 6 In the Choose an option window, select one of the following options:
  - ❖ **Keep my files**—Removes apps and settings, but keeps your personal files.

---

**CAUTION**

Removing files and cleaning the drive may delete all data on the drive. Be sure to create recovery media and back up your data to external media before erasing the internal storage drive.

---

- ❖ **Remove everything**—Removes all of your personal files, apps, and settings, or removes all files and wipes clean the entire drive.
- ❖ **Just remove my files**—This option is quicker, but less secure. Use this option if you are keeping the PC.
- ❖ **Remove Files and clean the drive**—This option might take a few hours, but will make it harder for someone to recover your removed files. Use this option if you are recycling the PC.

## Installing drivers and applications

The TOSHIBA Application Installer allows you to reinstall the drivers and applications that were originally bundled with your computer.

**NOTE** You must have an Internet connection to reinstall applications.

To reinstall drivers and applications:

- 1 In the **Search** field, type **TOSHIBA Application Installer**.
- 2 Click or touch **TOSHIBA Application Installer**.  
A message may appear asking you to allow this app to make changes to your PC.
- 3 Click or touch the **Yes** button.

The TOSHIBA Application Installer window appears.

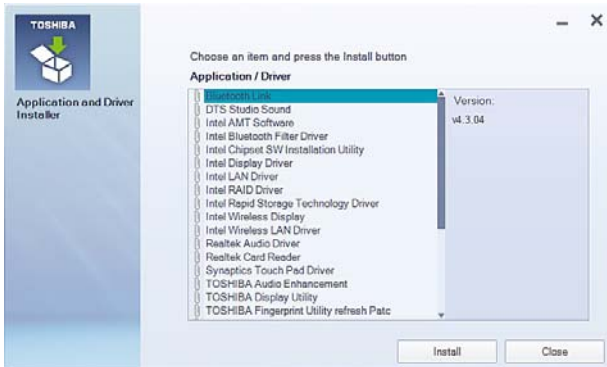

*(Sample Image) TOSHIBA Application Installer window*

- 4 Click or touch the item you want to install.
- 5 Click or touch **Install**.
- 6 Follow the on-screen prompts to complete the installation process, see [“TOSHIBA Application Installer”](#) on page 121.

## Using the TOSHIBA Dual Pointing Device

(Available on certain models.)

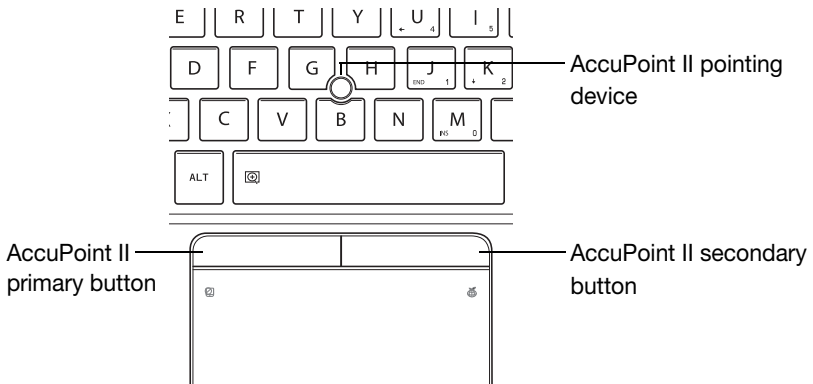

*(Sample Illustration) TOSHIBA AccuPoint II and buttons*

**AccuPoint II pointing device**—Moves the cursor and selects items on the screen.

To move the cursor, gently push the pointing device in the direction you want the cursor to move. Pushing harder on the pointing device moves the cursor faster.

**AccuPoint II Primary button**—Performs the same function as the left button on a mouse.

When a step instructs you to click on or choose an item, move the cursor to the item, then press and release the primary button. To double-click, press the primary button twice in rapid succession.

**AccuPoint II Secondary button**—Performs the same function as the right button on a mouse.

## Using the touchpad

**NOTE** Some of the touchpad operations described in this section are only supported in certain applications, and only on certain models.

You can use the touchpad (the small, touch-sensitive area in front of the keyboard) and the adjacent control buttons to:

- ❖ Move the pointer on the screen
- ❖ Select an item on the screen

- ❖ Open or activate an item on the screen
- ❖ Scroll through a document or information
- ❖ Zoom in for a close-up view
- ❖ Zoom out to see more information at once

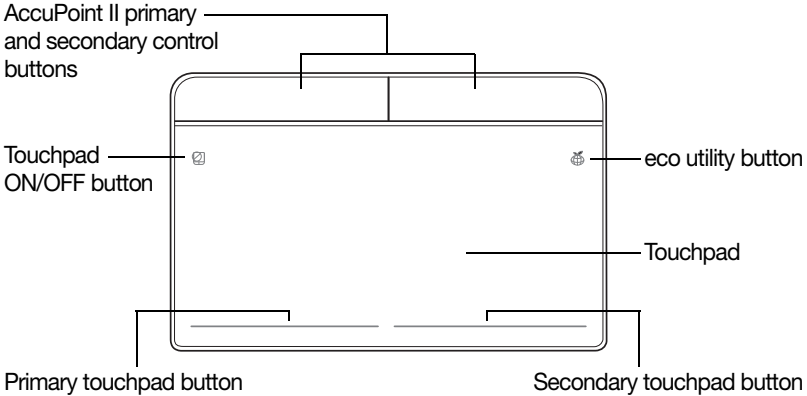



*(Sample Illustration) The touchpad and associated control buttons*

Refer to the table below for specific instructions on performing each operation.

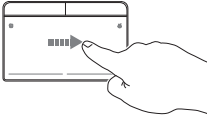
**NOTE** The *pointer* is the icon (usually an arrow) that moves on the screen when you slide your finger across the touchpad or move a mouse connected to your computer.

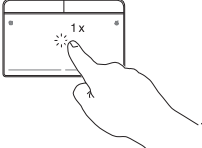
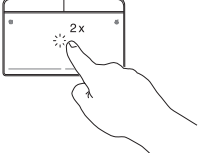
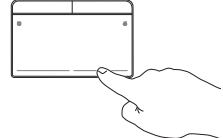
<i>To:</i>	<i>Do the following:</i>	<i>Example:</i>
Move the on-screen pointer	Slide your finger across the touchpad in the direction you want to move the pointer.  To move the pointer a longer distance, slide your finger several times across the touchpad in the preferred direction.	 <p><i>(Sample Illustration) Pointer moves to the right</i></p>

<i>To:</i>	<i>Do the following:</i>	<i>Example:</i>
Select an item	<ol style="list-style-type: none"><li>1 Move the pointer to the item you want to select.</li><li>2 Do one of the following:<ul style="list-style-type: none"><li>❖ Tap the touchpad once</li><li>OR</li><li>❖ Press and release the primary (left-hand) control button</li></ul></li></ol>	 <p><i>(Sample Illustration)</i> <i>Tap once to select</i></p>
Open or activate an item	<ol style="list-style-type: none"><li>1 Move the pointer to the item you want to open/activate.</li><li>2 Do one of the following:<ul style="list-style-type: none"><li>❖ Tap the touchpad twice in rapid succession</li><li>OR</li><li>❖ Press and release the primary control button twice in rapid succession</li></ul></li></ol>	 <p><i>(Sample Illustration)</i> <i>Tap twice to open</i></p>
Right-click an item	<ol style="list-style-type: none"><li>1 Move the pointer to the item you want to right-click.</li><li>2 Press and release the secondary control button.</li></ol> <p>This feature varies by program. Check your program documentation for specific instructions on right-clicking.</p>	 <p><i>(Sample Illustration)</i> <i>Click the secondary (right-hand) control button</i></p>
Scroll vertically	Slide your finger along the touchpad in the direction you want to scroll. Repeat to scroll a longer distance.	 <p><i>(Sample Illustration)</i> <i>Vertical scrolling active area</i></p>

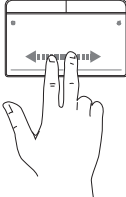
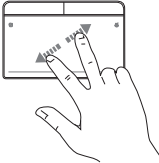
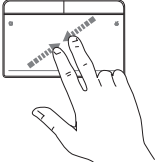
<i>To:</i>	<i>Do the following:</i>	<i>Example:</i>
Scroll horizontally	Slide your finger along the touchpad in the direction you want to scroll. Repeat to scroll a longer distance.	 <p data-bbox="681 432 914 496"><i>(Sample Illustration)</i> <i>Horizontal scrolling active area</i></p>
Zoom in/out	<p data-bbox="296 517 427 544">To zoom in:</p> <ul data-bbox="335 555 664 639" style="list-style-type: none"> <li>❖ Place two fingers close together on the touchpad and then slide them apart.</li> </ul>	 <p data-bbox="681 691 860 738"><i>(Sample Illustration)</i> <i>Zooming in</i></p>
	<p data-bbox="296 754 443 782">To zoom out:</p> <ul data-bbox="335 793 664 898" style="list-style-type: none"> <li>❖ Place two fingers slightly apart on the touchpad and then slide them together.</li> </ul>	 <p data-bbox="681 930 860 978"><i>(Sample Illustration)</i> <i>Zooming out</i></p>

## Adjusting touchpad settings

While you are typing, the on-screen pointer may seem to move or jump around “by itself” to random locations on the screen. The on-screen pointer may also seem to automatically select text, click buttons, and activate other user interface elements. For help with these problems, try one or more of the following:

- ❖ Try adjusting your typing technique to avoid accidental contact with the touchpad. You may be inadvertently brushing the touchpad with the heel of your hand as you type. Also, accidental light touches or taps on the touchpad may select an item or text on the screen, and potentially the item or text may be replaced by the next character you type.

- ❖ Temporarily disable the touchpad, so that it does not respond to touch or button presses while you type. See “Disabling or enabling the touchpad” on page 59.
- ❖ Adjust the sensitivity of the touchpad, so that it is less responsive to accidental light taps and lighter finger pressure.

---

**NOTE** Touchpad setting options vary by computer model. The touchpad settings are accessible through the Mouse Properties option of the Windows Control Panel. For more information, please visit [support.toshiba.com](http://support.toshiba.com).

---

## Disabling or enabling the touchpad

The touchpad is enabled by default. To enable/disable the touchpad, press the FN + (F9) keys or press the Touchpad ON/OFF (ON/OFF) button located on the touchpad. For more information, see “Disabling or enabling wireless devices” on page 173.

## Connecting an external device

---

**NOTE** Depending on your system, some models may include USB 3.0 port(s). To distinguish these ports, please look for the blue inset within the USB 3.0 port (if available).

---

You can easily attach an external device your computer.

To do this:

- 1 Read the directions that came with the device to see if you first need to install new software.
- 2 Connect the device’s video or USB cable to the port on the computer and to the device.
- 3 Connect the device’s power cable to a live electrical outlet (if applicable).
- 4 Turn on the external device (if applicable).

Your computer may automatically detect the external device.



## Using external display devices

Your computer comes with a built-in display, however you can also connect the following types of external display devices to the video ports described below:

**NOTE** To locate your HDMI Out port\* and RGB (monitor) port\*, please refer to your Quick Start document.

- ❖ A HDMI-compatible television or external display device via the HDMI Out port\*
- ❖ An external monitor or projector via the RGB (monitor) port\*

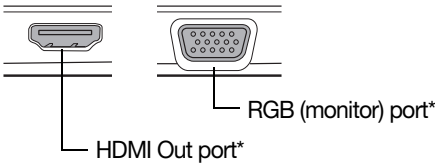

\*Available on certain models

*(Sample Illustration) Video ports on side of computer*

## Selecting video cables

To connect a device to the HDMI Out port, you must purchase an HDMI cable.

## Connecting an HDMI-compatible television or display device

To connect an HDMI-compatible television or display device to the computer:

- ❖ Connect one end of an HDMI cable (not included with your computer) to the HDMI Out port on the side of your computer, and then connect the other end of the cable to your television or display device. Refer to the manual that came with the television or display device for more information.

Your computer should automatically detect the external display device.

---

## Connecting an external monitor or projector

You can easily attach an external monitor or projector to your computer if you need a larger screen.

To do this:

- 1 Read the directions that came with the monitor to see if you first need to install new software.
- 2 Connect the monitor's video cable to the RGB (monitor) port on the side of the computer.
- 3 Connect the device's power cable to a live electrical outlet.
- 4 Turn on the external device.



Your computer will automatically detect the external display device.

---

### NOTE

You can change the display settings by pressing the **Windows** (⊞) + P keys, or by configuring the display properties settings.

---

## Directing the display output when you turn on the computer

Once you have connected an external display device, you can choose to use the internal display only, the external device only, or both simultaneously.

---

### NOTE

Some modes are only available with the appropriate device attached and turned on.

---

- 1 Press the FN + () keys.

The Display options window opens displaying the available options.

The FN + () keys allow you to cycle through the display options and highlights the available options in the following order (only the first option is available when you do not have an external monitor attached):

- ❖ PC screen only
- ❖ Duplicate
- ❖ Extend

---

❖ Second screen only

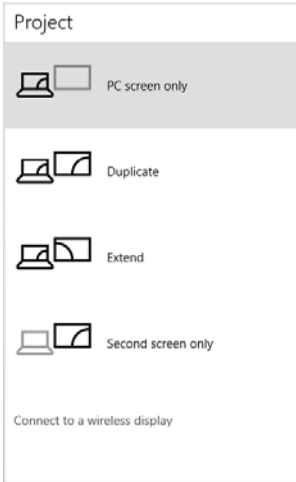

*(Sample Image) Display options window*

- 2 Select the desired display setting.
- 3 Press ENTER to activate your selection.

---

**NOTE**

Press the **Windows** (⊞) + P keys to navigate through the options without activating a selection. Press ENTER to activate a selection.

---

## Adjusting the quality of the external display

To obtain the best picture quality from your television (or other video display device), you may need to adjust the video settings. See the video device documentation for additional configuration steps.

## Customizing your computer's settings

You can go into your computer settings to make adjustments to your computer to suit your needs.

- 1 Click or touch the **Start** (⊞) button in the lower-left corner of the Desktop or press the **Windows** (⊞) key.  
The Start menu opens.
- 2 Click or touch **Settings** (⚙️) in the Start menu, and then choose a category you wish to change.

---

Refer to your operating system documentation or Help and Support for details.

You may also wish to customize your power usage settings. For more information, see [“Power Plans” on page 85](#). There are additional custom settings you can choose. See [“Utilities” on page 106](#).

## Caring for your computer

This section gives tips on cleaning and moving your computer. For information about taking care of your computer’s battery, see [“Taking care of your battery” on page 90](#).

---

**NOTE** Please handle your computer carefully to avoid scratching or damaging the surface.

---

## Cleaning the computer

---

**CAUTION** Keep liquids, including cleaning fluid, out of the computer’s keyboard, speaker, and other openings. Never spray cleaner directly onto the computer and/or display. Never use harsh or caustic chemical products to clean the computer.

---

To keep your computer clean, gently wipe the display panel and exterior case with a lightly dampened cloth.

## Moving the computer

Before moving your computer, even across the room, make sure all drive activity has ended (the internal storage drive indicator lights stops glowing) and all external peripheral cables are disconnected.

---

**CAUTION** Do not pick up the computer by its display panel or by the back. Doing so could damage the system.

---

## Using a computer lock

You may want to secure your computer to a heavy object such as your desk. The easiest way to do this is to purchase an optional computer lock cable. For more information on purchasing a cable lock, visit [accessories.toshiba.com](http://accessories.toshiba.com).

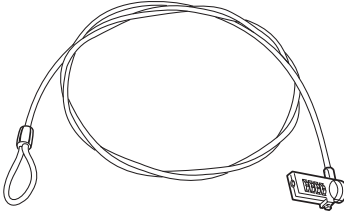

*(Sample Illustration) Computer lock cable*

To secure the computer:

- 1 Wrap the cable through or around some part of a heavy object.

Make sure there is no way for a potential thief to slip the cable off the object.

- 2 Pass the locking end through the loop.



- 3 Insert the cable's locking end into the security lock slot on your computer, then engage the locking device.

The computer is now securely locked.

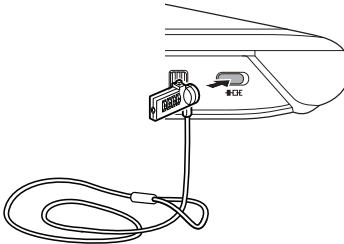

*(Sample Illustration) Attaching security lock cable*

# Chapter 2

## Learning the Basics

---

This chapter gives some computing tips and provides important information about basic features.

### Computing tips

- ❖ Save your work frequently.

Your work stays in the computer's temporary memory until you save it to the internal storage drive. If the network you are using goes down and you must restart your computer to reconnect, or your battery runs out of charge while you are working, you will lose all work since you last saved.

See [“Saving your work” on page 72](#) for further information.



**HINT:** Some programs have an automatic save feature that can be activated. This feature saves your file to the internal storage drive at preset intervals. See your software documentation for details.

---

- ❖ Back up your files to external media on a regular basis. Label the backup copies clearly and store them in a safe place.

It is easy to put off backing up because it takes time. However, if your internal storage drive suddenly fails, you will lose all the data on it unless you have a separate backup copy. For more information, see [“Data and system configuration backup in the Windows operating system”](#) on page 162.

- ❖ Use Error-checking and Disk Defragmenter regularly to check and optimize disk space and improve performance.
- ❖ Scan all new files for viruses.

This precaution is especially important for files you receive via external media, email, or download from the Internet.

- ❖ Take frequent breaks to avoid repetitive-motion injuries and eyestrain.
- ❖ Do not turn off the computer if a drive indicator light indicates a drive is active.

Turning off the computer while it is reading from or writing to a disk may damage the disk, the drive, or both.

---

**NOTE**

The Windows operating system records information, such as your desktop setup, during its shutdown procedure. If you do not let the Windows operating system shut down normally, details such as new icon positions may be lost.

---

## Using the keyboard

Your computer's keyboard contains character keys, control keys, function keys, and special Windows keys.

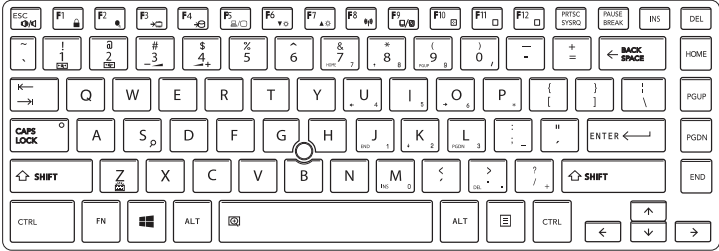

(Sample Illustration) Keyboard

## Function keys

The function keys (not to be confused with the FN key) are the 12 keys at the top of the keyboard.



(Sample Illustration) Function keys

F1 through F12 are called function keys because they execute programmed functions when pressed. Used in combination with the FN key, function keys marked with icons execute specific functions on the computer. For example, the FN + (F9) keys turns the touchpad ON/OFF. For more information, see [“TOSHIBA Function Keys”](#) on page 170.

## Special Windows keys

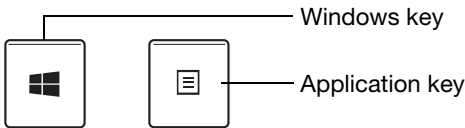

(Sample Illustration) Special Windows keys

Your computer's keyboard has two keys that have special functions in Windows:

- ❖ **Windows key**—Launches the Start menu. For more information refer to Help & Support, or see [“Finding your way around the desktop”](#) on page 94
- ❖ **Application key**—Has a similar function as the secondary mouse button

## Overlay keys

The keys with gray numbers and symbols on the front of them form the numeric and cursor overlay. This overlay lets you enter numeric data or control the cursor as you would using the 10-key keypad on a desktop computer's keyboard.

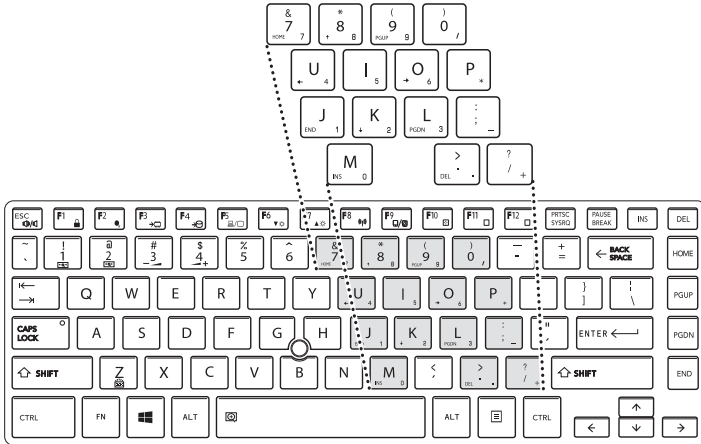

*(Sample Illustration) Numeric and cursor control overlay*

## Using the overlay to type numeric data

The keys with the numbers on their right front are the numeric overlay keys.



To turn the numeric overlay on, press FN and (F11) simultaneously. A Toast notification pops up to indicate the state of the function, when the numeric overlay is enabled.

To disable the numeric overlay, hold down the FN key and press (F11) again. A Toast notification pops up to indicate the state of the function, when the numeric overlay is disabled.

## Using the overlay for cursor control

The keys with the gray arrows and symbols on their left front are the cursor control overlay keys.



To turn the cursor control overlay on, press FN and (F12) simultaneously. The cursor control overlay light glows when the cursor control overlay is on.

To disable the cursor control overlay, hold down the FN key and press (F12) again. The cursor control overlay light goes out.

## Backlit keyboard

(Available on certain models.)

Your keyboard may have a backlight illumination feature. If the keyboard backlight setting is set to Auto, the backlight turns on when you type on the keyboard and turns off after a certain interval when you stop typing. You can modify the time-out interval or change the keyboard backlight setting to Always On or Always Off.



+



This TOSHIBA Function key enables/disables the keyboard backlight.

## Touch screen

(Available on certain models.)

Your computer may come with a touch screen, enabling direct interaction with displayed apps and programs through simple or multi-touch gestures.

## Touch screen navigation

Use your finger to manipulate the on-screen icons, buttons, menu items, and other items on the touch screen. You can also change the screen's orientation.

### **CAUTION**

The screen is made of glass so avoid contact with sharp, rough, or abrasive objects or substances as the screen may break or scratch if not handled properly. If you see a crack in the glass, discontinue use of the device to avoid injury.



**Touch**—Touch to activate items displayed on the screen, such as app and setting icons or on-screen buttons. Touch to type using the keyboard.



**Touch & hold**—Touch and hold an item on the screen by touching and holding the item in place until an action occurs.



**Drag**—Touch and hold an item for a moment and then, without lifting your finger, move the item until you reach the target position. For example, drag items on any app screen to reposition them.



**Swipe or slide**—To swipe or slide, quickly move your finger across the surface of the screen without pausing. For example, swipe your finger to the left from the right edge of the screen to display the current Notifications.



**Double-tap**—Tap quickly twice to zoom in. For example, double-tap a section of a Web page to zoom in on that section. Double-tap again to zoom out.



**Zoom out**—Place and pinch two fingers together to zoom out. (Applicable to apps that support this function.)



**Zoom in**—Place and spread two fingers apart to zoom in. (Applicable to apps that support this function.)



**Rotate**—Place two or more fingers on an item and rotate your hand. The item rotates in the direction you turn your hand. (Not functional in all apps.)



**Swipe from right edge**—Swipe in from the right edge to display the current Notifications.



**Swipe from left edge**—Swipe in from the left edge to display an open app.

Snaps open apps (swipe in from the left edge and slide the divider to adjust the app size).

Displays recently opened apps (swipe in from left edge, holding your finger down, and then push the app back toward the left edge).

## Mouse properties

Mouse properties allow you to change your pointing device or mouse settings.

To access Mouse properties:

- 1 Click or touch the **Start** (Windows logo) button in the lower-left corner of the Desktop or press the **Windows** (Windows logo) key.

The Start menu opens.

- 2 Click or touch **Settings** (gear icon) in the Start menu.

- 3 Click or touch **Devices** (mouse icon).

The Devices window appears.

- 4 Click or touch **Mouse & touchpad** in the left pane of the window.  
The Mouse screen appears.
- 5 Make the desired changes to the Mouse settings.
- 6 Click or touch **Close** (✕) to save the changes and close the window.

## Starting an app

To start an app, click or touch the **Start** (☰) button in the lower-left corner of the Desktop or press the **Windows** (⊞) key.

The **Most used** list on the left side of the Start screen displays the apps most often used on your computer.

Click or touch the **All apps** (≡) icon to display a list of all apps installed on your computer. This list appears in alphabetical order. Click or touch the **Back** (←) icon to return to the **Most used** list.

You may also enter your search in the **Search** field.

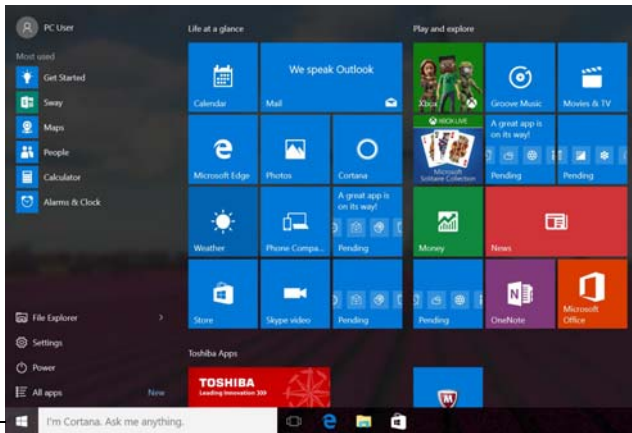

Start menu  
button

Search field

*(Sample Image) Start menu*

For more information, see [“Using the Start menu”](#) on page 43 and [“Start button”](#) on page 95.

---

## Saving your work

Before you turn off the computer using the Shut down command, save your work on the internal storage drive, external media, flash media, or optical disc. This is one of the most important rules of computing.

Many applications offer a feature that saves documents at regular intervals. Check your program's documentation to see if it has an automatic save feature.

## Backing up your work

Back up all the files you create in case something happens to your computer. You can back up your files to different types of media such as USB Flash, optical media, external storage media, or to a network, if available.

To back up several files at one time, use the Microsoft Windows file recovery program preinstalled on the computer's internal storage drive. Also see [“Backing up your data or your entire computer with the Windows operating system”](#) on page 164.



**HINT:** Backing up all the files on your internal storage drive may take a considerable amount of time and multiple CDs/DVDs. You may prefer to use a high-capacity file recovery system, such as an external hard drive.

---

## Using the optical disc drive

**(Available on certain models.)**

Optical storage is a popular medium for software, music, and video. Digital versatile discs (DVDs) provide a significant increase in data storage and support features that were not available on previous video platforms. These features include wide-screen movies, multiple language tracks, digital surround sound, multiple camera angles, and interactive menus.



**TECHNICAL NOTE:** Your optical disc drive is set to play region 1 (North America) DVD-ROMs. A DVD disc of a region other than the above mentioned cannot be played unless you manually change it in the Properties setting of the optical disc drive. The drive will allow you to change regions four times. On the fourth change, the region will be “locked in.” That is, the drive will only play DVDs from that last region. Note that changing from region 1 to region 2 and back to region 1 is counted as two changes.

**NOTE** For optimum DVD performance, it is recommended that you play DVDs while running the computer on AC power.

**NOTE** When viewing DVD movies use the DVD Player software that came with your computer.

## Optical disc drive components

The optical disc drive is located on the side of the computer.

Your optical disc drive may look like this:

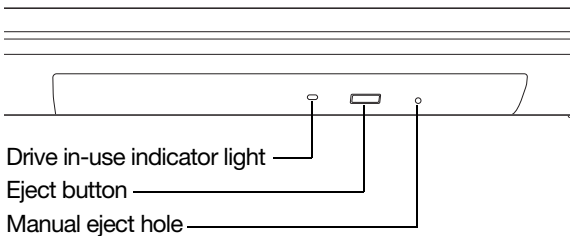

*(Sample Illustration) Optical disc drive*

**Drive in-use indicator light**—Indicates when the drive is in use.

**Eject button**—Press to release the disc tray.

**CAUTION**

Do not press the eject button or turn off the computer while the drive in-use indicator light is glowing. Doing so could damage the disc or the drive.

When the disc tray is open, be careful not to touch the lens or the area around it. Doing so could cause the drive to malfunction.

---

**Manual eject hole**—Use if you need to release the disc tray when the power is off. Use a straightened paper clip or other narrow object to press the manual eject button located inside the hole.

---

**CAUTION**

Never use a pencil to press the manual eject button. Pencil lead can break off inside the computer and damage it.

---

## Inserting an optical disc

To insert an optical disc into the drive:

- 1 Make sure the computer is turned on.
- 2 Make sure the drive's in-use indicator light is off.
- 3 Press the drive's eject button.
- 4 Hold the disc by its edges and check that it is free of dust.

If the disc is dusty, clean it.

- 5 Place the disc carefully in the disc tray, label side up, and gently press the disc onto the center spindle until it clicks into place.
- 

**CAUTION**

Handle DVDs and CDs carefully, making contact only with the center hole and edge. Do not touch the surface of the disc. Do not stack discs. If you incorrectly handle the discs, you could lose data.

---

- 6 Push the disc tray in by pressing gently on the center of the tray until it clicks into place.
- 

**CAUTION**

If you insert the disc incorrectly, it may jam the drive. If this happens, contact Toshiba support for assistance.

---

---

## Playing optical media

If you insert an optical disc into the optical disc drive and the Auto-Run feature does not automatically start your disc, try launching the optical disc manually. To do this, follow these steps:

- 1 Press the **Windows** (⊞) + E keys.
- 2 Double-click or touch the optical disc drive icon.

The drive will run the optical disc.

If your disc does not run using this method, try using an application that is associated with the media on the disc. For example, if it is a music CD, open Windows Media® Player and use it to select and then play the CD. For other types of media, use the associated software to open the files on the disc.

## Recording optical media

Depending on the configuration, your computer may come with an optical disc drive that allows you to:

- ❖ Play pre-recorded and recorded optical media.
- ❖ Read/write data and multi-media files to recordable optical media.

For more information regarding supported optical media formats please refer to your computer's detailed specifications at [support.toshiba.com](http://support.toshiba.com).

---

### NOTE

Due to manufacturing and quality variations in third party optical media (e.g., CD or DVD) or optical media players/recorders, in certain cases, your Toshiba optical disc drive may not record on certain optical media that bear the applicable logo, or play back optical media recorded by other computers or optical media recorders. Additionally, certain optical media recorded on your optical disc drive may not play back or operate properly on other computers or optical media players. These problems are not due to any defect in your Toshiba computer or optical disc drive. Please refer to your computer's product specification for listing of specific format compatibilities.

Copy protection technology may also prevent or limit recording or viewing of certain optical media.

---

For details on how to use the software, please refer to the respective Online Help menus.

## Removing a disc with the computer on

To remove an optical disc with the computer turned on:

- 1 Press the eject button on the drive.
- 

**CAUTION**

Do not press the eject button while the drive in-use indicator light is glowing. Doing so could damage the disc or the drive.

Also, if the disc is still spinning when you open the disc tray, wait for it to stop spinning before you remove it.

---

- 2 Pull the tray out until it is fully open, remove the disc, and place it in its protective cover.
- 3 Gently press the tray in to close it.

## Removing a disc with the computer off

To remove a disc with the computer turned off:

- 1 Insert a slender object, such as a straightened paper clip, into the manual eject hole.

The disc tray slides partially out of the drive.

---

**CAUTION**

Never use a pencil to press the manual eject button. Pencil lead can break off inside the computer and damage it.

---

- 2 Pull the tray out until it is fully open, remove the disc, and place it in its protective cover.
- 3 Gently press the tray in to close it.

## Toshiba's online resources

Toshiba maintains a number of online sites to which you can connect. These sites provide information about Toshiba products, give help with technical questions and keep you up to date with future upgrades. For more information, see ["Contacting Toshiba" on page 168](#).

# Chapter 3

## Mobile Computing

---

This chapter covers all aspects of using your computer while traveling.

### **Toshiba's energy-saver design**

Your computer enters a low-power suspension mode when it is not being used, thereby conserving energy and saving money in the process. It has a number of other features that enhance its energy efficiency.

Many of these energy-saving features have been preset by Toshiba. We recommend you leave these features active, allowing your computer to operate at its maximum energy efficiency, so that you can use it for longer periods while traveling.

### **Running the computer on battery power**

The computer contains a Lithium-Ion (Li-Ion) battery that provides power when you are away from an AC outlet. You can recharge it many times.

## Battery Notice

Battery life rating is for comparison purposes only, and does not indicate the battery life that will be obtained by any individual user. Actual battery life may vary considerably from specifications depending on product model, configuration, applications, power management settings and features utilized, as well as the natural performance variations produced by the design of individual components. The battery life rating is only achieved on the select models and configurations tested by Toshiba under the specific test settings at the time of publication and is not an estimate of a system's battery life under any conditions other than the specific test settings.

Recharge time varies depending on usage. Battery may not charge while the computer is consuming full power. After a period of time, the battery will lose its ability to perform at maximum capacity and will need to be replaced. This is normal for all batteries.

To ensure that the battery maintains its maximum capacity, operate the computer on battery power at least once a month. The Lithium-Ion battery has no memory effect so it is not necessary to let the battery fully discharge each time. However, for better accuracy of the battery meter, it is helpful to fully discharge the battery periodically. Please see [“Maintaining your battery” on page 90](#) for procedures. If the computer is continuously operated on AC power, either through an AC adaptor or a port replicator (if applicable to your system), for an extended period (more than a month), the battery may fail to retain a charge. This may shorten the life of the battery, and may cause the battery meter to be inaccurate.

---

**NOTE** For best performance when playing streaming media (especially streaming video), either power the computer from its AC adaptor, or set up a power plan that keeps the computer running at full performance even when powered from its battery. For more information about Windows power plans, see [“Power Plans” on page 85](#).

---

The computer may also have an internal real-time-clock (RTC) battery.

---

The RTC battery powers the RTC memory that stores your system configuration settings and the current time and date information. It maintains this information for up to a month while the computer is turned off.



**TECHNICAL NOTE:** Depending on your system, the RTC battery may only charge while the computer is turned on.

---

## Power management

Your computer ships with the power management options preset to a configuration that will provide the most stable operating environment and optimum system performance for both AC power and battery modes.

### **CAUTION**

Changes to these settings may result in system performance or stability issues. Users who are not completely familiar with the power management component of the system should use the preset configuration. For assistance with setup changes, contact Toshiba's Customer Support Center.

---

## Charging batteries

The battery needs to be charged before you can use it to power the computer.

### **CAUTION**

Always use the AC adaptor specified by Toshiba. You can order a Toshiba AC adaptor from Toshiba's Web site at [accessories.toshiba.com](http://accessories.toshiba.com).

---

### **NOTE**

Battery charge time may vary depending on the applications, power management settings, and features used.

---

To charge the main battery, plug the computer into a live electrical outlet. The battery charges whether the computer is on or off.



**TECHNICAL NOTE:** The recharging of the battery may not occur when your computer is using all of the power provided by the AC adaptor to run applications, features, and devices. Your computer's Power Options utility can be used to select a power level setting that reduces the power required for system operation and will allow the battery to recharge.

---

The battery may not start charging immediately under the following conditions:

- ❖ The battery is extremely hot or cold.  
To ensure that the battery charges to its full capacity, wait until it reaches room temperature (50 to 80 degrees Fahrenheit, 10 to 26 degrees Celsius).
  - ❖ The battery is almost completely discharged.  
Leave the power connected and the battery should begin charging after a few minutes.
- 



**HINT:** Once the battery is fully charged, we recommend that you periodically operate your computer on battery power until the battery discharges completely.

---

**CAUTION**

Please make a complete back up of your data to external media before discharging the battery. For more information, see [“Backing up your work” on page 72](#)

---

## Charging the RTC battery

Your computer may have an internal real-time clock (RTC) battery. The RTC battery powers the System Time Clock and BIOS memory used to store your computer's configuration settings. When fully charged, it maintains this information for up to a month when the computer is powered off.

The RTC battery may have become completely discharged while your computer was shipped, resulting in a CMOS error message during startup. The error message may vary by computer model.

---

**NOTE** Depending on your system, the RTC battery may only charge while the computer is turned on.

---

To recharge the RTC battery, plug the computer into a live electrical outlet and leave the computer powered on for 24 hours.

---

**NOTE** It is seldom necessary to charge the RTC battery because it charges while the computer is on. If the RTC battery is low, the real-time clock and calendar may display the incorrect time and date or stop working. When the RTC battery is completely discharged, a warning prompts you to reset the real-time clock.

---

The computer can be used while the RTC battery is being charged, although the charging status of the RTC battery cannot be monitored.

## Monitoring battery power

---

**NOTE** To locate your system indicator lights, please refer to your Quick Start document.

---



The computer's main battery light gives you an indication of the main battery's current charge.

- ❖ Glows amber while the main battery is being charged (AC adaptor connected)
- ❖ Glows white when the main battery is fully charged

---

**NOTE** Battery life and charge time may vary, depending upon power management settings, applications and features used.

---

- ❖ Flashes amber when the main battery charge is low and it is time to recharge the main battery or plug in the AC adaptor

---

**NOTE** If the AC power light flashes amber during charging, either a battery pack is malfunctioning, or it is not receiving correct input from the AC power supply.

---



**HINT:** Be careful not to confuse the AC power light/Battery light (➔/🔋) and the power button (⏻) light.

When the AC power light/Battery light or power button light flashes amber, it indicates that the system is suspended (using the Windows operating system Sleep command).

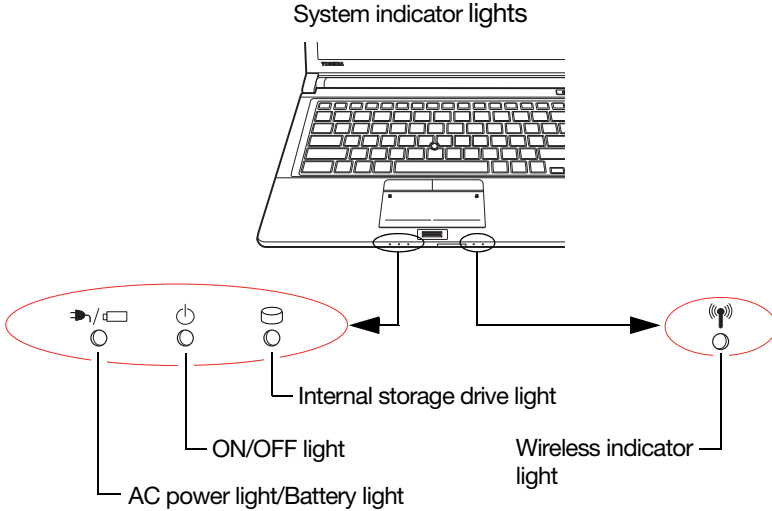

*(Sample Illustration) Power and battery light locations*

## Determining remaining battery power

### NOTE

Wait a few moments after turning on the computer before trying to monitor the remaining battery power. The computer needs this time to check the battery's remaining capacity and perform its calculations.



Click or touch the **Power** icon in the notification area, see [“Finding your way around the desktop” on page 94](#) for more information on the notification area. A pop-up message displays the remaining battery power as a percentage.

With repeated discharges and recharges, the battery's capacity gradually decreases. A frequently used older battery does not power the computer for as long as a new battery, even when both are fully charged.



**TECHNICAL NOTE:** The computer drains the battery faster at low temperatures. Check your remaining charge frequently if you are working in temperatures below 50 degrees Fahrenheit.

The computer calculates the remaining battery charge based on your current rate of power use and other factors such as the age of the battery.

## What to do when the main battery runs low

When the main battery runs low you can plug the computer into an external power source and recharge the main battery, or save your work and shut down your computer.

## Setting battery notifications

You can set two notifications. Each notification can be set to alert you when a specified percentage of remaining battery power has been reached. You can also set the computer to enter Sleep mode or to completely shut down when the notification goes off.

To change the default notification settings:

- 1 Right-click or touch & hold the **Battery** (🔋) icon in the notification area.
- 2 Click or touch **Power Options** in the pop-up menu.
- 3 Click or touch **Change plan settings** under the plan you wish to change.  
The Edit Plan Settings window appears.
- 4 Click or touch **Change advanced power settings**.  
The **Advanced settings** tab of the Power Options window appears.
- 5 Double-click or touch **Battery** to display the battery options.

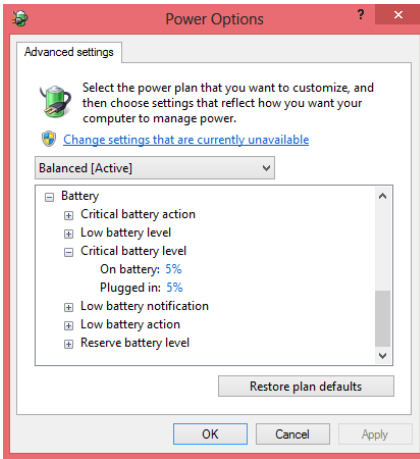

*(Sample Image) Advanced settings tab of Power Options screen*

- 6 Configure the alarm settings to suit your needs.
- 7 Click or touch **OK**.

## Conserving battery power

How long a fully charged battery pack lasts when you are using the computer depends on a number of factors, such as:

- ❖ How the computer is configured
- ❖ How much you use the internal storage drive, optical disc drive, or other optional devices
- ❖ Where you are working, since operating time decreases at low temperatures

There are various ways in which you can conserve power and extend the operating time of your battery:

- ❖ Enable Sleep, which saves power when you turn off the computer and turn it back on again
- ❖ Use the Windows power-saving option plans

These power-saving options control the way in which the computer is configured. By using them, you can increase the length of time you can use the computer before you need to recharge the battery.

Microsoft has combined these options into preset Power Plans. Using one of these power plans lets you choose between maximum power savings and peak system performance. You may also set individual power-saving options to suit your own needs.

The following sections describe how to choose a Power Plan and discuss each power-saving option.

## Power Plans

You can choose a predefined Power Plan or select your own combination of power options.

To do this:

- 1 Click or touch the **Battery** (🔋) icon in the notification area.
- 2 Click or touch **Power & sleep settings**.
- 3 In the System window, click or touch **Power & Sleep**.
- 4 Click or touch **Additional power settings**.

The Windows Power Options window appears.

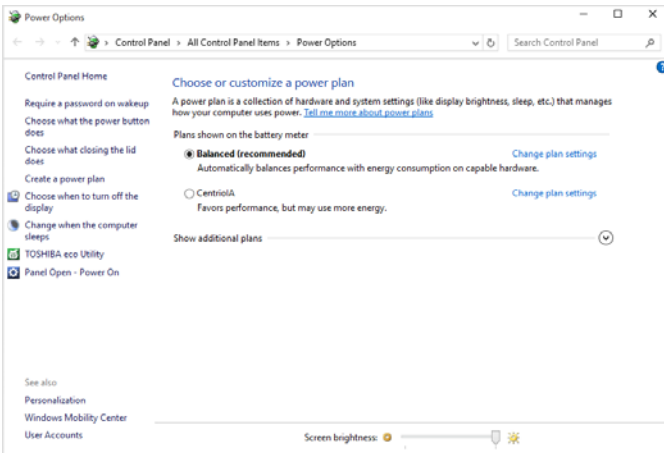

*(Sample Image) Windows Power Options window*

- 5 Select an appropriate plan for your work environment or create your own custom plan.

---

**NOTE** To edit a plan or to edit advanced settings, continue to the following steps.

---

- 6 Click or touch **Change plan settings** under the selected power option to choose the plan you wish to edit.

This screen allows you to change basic settings.

- 7 Click or touch **Change advanced power settings** to access settings for battery notification levels, internal storage drive power save time, etc.

You can click or touch the plus signs to expand each item and to see what settings are available for each item.

- 8 Click or touch **OK** to save the plan changes you have performed.

Depending on your model, the two power plans eco and Balanced are satisfactory for most people and do not need to be edited. The eco plan is the best used for maximum battery time. The Balanced plan is a compromise between battery time and performance.

## Using the eco power plan

This computer is equipped with the eco power plan. Operating the computer with this power plan enabled reduces electrical power consumption by slightly lowering system performance. For example, when this power plan is enabled, the brightness of the display is reduced and the interval before Sleep mode takes effect is shortened. To enable or disable the eco power plan, see [“Power Plans” on page 85](#).

The eco Utility<sup>®</sup> monitors your power savings from using the eco power plan by tracking real-time power consumption and accumulated savings over time. To learn how to access the utility, see [“eco Utility” on page 107](#).

For more information on the eco power plan, see the Help file in the eco Utility window.

---

## Changing the main battery

When your main battery has run out of power, plug in the AC adaptor.

If you find that a new battery is needed, contact the location where you purchased the computer for more information on replacing the battery. Toshiba will not be responsible for any product damage, data loss, service, or part replacement made necessary by improper installation of a new battery.

---

**▲ WARNING**

If the computer is leaking or its case is cracked, put on protective gloves to handle it.

---

---

**▲ WARNING**

Never short circuit the battery pack by either accidentally or intentionally bringing the battery terminals in contact with another conductive object. This could cause serious injury or fire, and could also damage the battery pack and computer.

Never expose a battery pack to abnormal shock, vibration or pressure. The battery pack's internal protective device could fail, causing it to overheat or ignite, resulting in caustic liquid leakage, or explosion or fire, possibly resulting in death or serious injury.

---



**TECHNICAL NOTE:** To avoid losing any data, save your files, and then completely shut down your computer before changing the battery.

---

## Removing the battery from the computer

To remove the battery:

- 1 Save your work.
- 2 Turn off the computer, see [“To Shut down your computer” on page 44.](#)
- 3 Unplug and remove any cables connected to the computer, including the AC adaptor.
- 4 Close the display panel and turn the computer upside down.

- 5 Slide the battery release lock to the unlocked position.

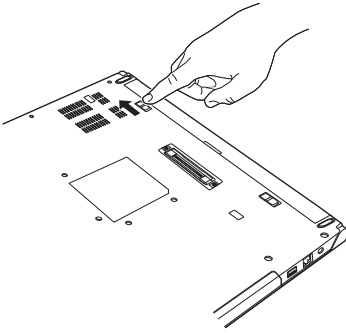

*(Sample Illustration) Unlocking the battery*

- 6 Slide and hold the battery release latch to release the battery.
- 7 Pull the discharged battery out of the computer.

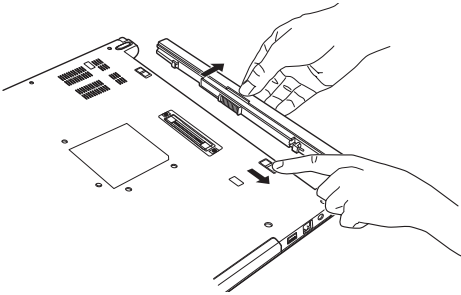

*(Sample Illustration) Removing the battery*

**⚠ WARNING**

If the battery is leaking or its case is cracked, put on protective gloves to handle it, and discard it immediately. Always dispose of used battery packs in compliance with all applicable laws and regulations. Put insulating tape, such as cellophane tape, on the electrode during transportation to avoid a possible short circuit, fire or electric shock. Failure to do so could possibly result in serious injury.

## Inserting a charged battery

To insert a battery:

- 1 Wipe the terminals of the charged battery with a clean cloth to ensure a good connection.
- 2 Insert the charged battery into the slot until the latch clicks.

The battery pack has been designed so that you cannot install it with reverse polarity.

**CAUTION**

If the battery does not slide into the slot easily, move the battery release lock to the unlocked position and try again. Do not force the battery into position.

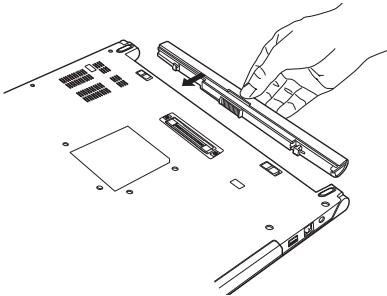

*(Sample Illustration) Inserting the battery*

- 3 Slide the battery release lock to the locked position.

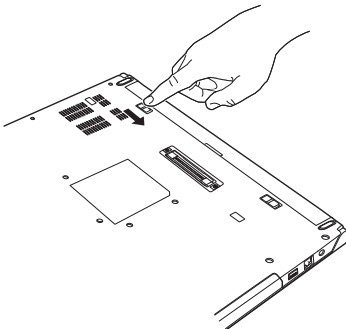

*(Sample Illustration) Locking the battery*

- 4 Turn the computer right side up.
- 5 Reconnect any cables that were removed in step 3 of “Removing the battery from the computer” on page 87.
- 6 Restart the computer.

---

## Taking care of your battery

The following sections offer tips on how to take care of your battery and prolong its life.

### Safety precautions

---

**⚠ WARNING**

Always immediately turn the power off and disconnect the power cable/cord plug from the plug socket and stop using the computer if you observe any of the following conditions:

- ❖ Offensive or unusual odor
- ❖ Excessive heat
- ❖ Discoloration
- ❖ Deformation, cracks, or leaks
- ❖ Smoke
- ❖ Other unusual events during use, such as abnormal sound

Do not expose the computer to fire. The battery could explode.

Do not turn on the computer's power again until an authorized Toshiba service provider has checked it for safety. Continued use could cause a fire or rupture possibly resulting in serious injury or computer failure including but not limited to the loss of data.

---

### Maintaining your battery

Fully discharging your battery pack will allow better accuracy of the battery meter.

To fully discharge your battery pack:

- ❖ Periodically, disconnect the computer from a power source and operate it on battery power until the battery pack fully discharges.
- ❖ If you have extra battery packs, rotate their use (for models with an accessible battery only).
- ❖ If you will not be using the system for an extended period, more than one month, remove the battery pack (for models with an accessible battery only).
- ❖ Store spare battery packs in a cool dry place out of direct sunlight (for models with an accessible battery only).

---

## Disposing of used batteries

The life of a battery pack depends on usage. When the battery pack needs replacing, the battery light flashes amber shortly after you have fully recharged the battery.

You must discard a battery if it becomes damaged.

---

**⚠ WARNING**

Never attempt to dispose of a computer by burning or by throwing it into a fire, and never allow exposure to a heating apparatus (e.g., microwave oven). Heat can cause a computer to explode and/or release caustic liquid, both of which may possibly cause serious injury.

Always dispose of used battery packs in compliance with all applicable laws and regulations. Put insulating tape, such as cellophane tape, on the electrode during transportation to avoid a possible short circuit, fire or electric shock. Failure to do so could possibly result in serious injury.

---

---

**⚠ WARNING**

Always use the battery pack supplied as an accessory or an equivalent battery pack specified in the User's Manual. Other battery packs have different voltage and terminal polarities. Use of non-conforming battery packs could generate smoke or cause fire or rupture, possibly resulting in serious injury.

---

After repeated use, the batteries will finally lose their ability to hold a charge and you will need to replace them. Under certain applicable laws and regulations, it may be illegal to dispose of old batteries by placing them in the trash.

Please be kind to our shared environment. Check with your local government authority for details regarding where to recycle old batteries or how to dispose of them properly.

In addition, Toshiba's recycling initiatives include recycling programs, events and consumer promotions. For details, please visit [toshiba.com/recycle](http://toshiba.com/recycle).

Toshiba is dedicated to preserving the environment by sponsoring **Call2Recycle™**, a program of the Rechargeable Battery Recycling Corporation. For more information and for free drop-off locations, visit <http://www.call2recycle.org/locator/> or call 1-800-822-8837.

Notice regarding CR coin cell batteries, applicable to California, U.S.A. only:

Perchlorate Material - special handling may apply. See <http://www.dtsc.ca.gov/hazardouswaste/perchlorate/>.

## Traveling tips

The environmental precautions listed in “[Selecting a place to work](#)” on page 31, also apply while traveling.

- ❖ Never leave your computer on a sunny ledge or in a place where it could get wet or covered in dust.
- ❖ Always travel with the computer in a carrying case. Toshiba offers a choice of carrying cases for the computer. They all provide plenty of extra space for manuals, power cords, and compact discs. Contact your authorized Toshiba representative for more information or visit Toshiba’s Web site at [accessories.toshiba.com](http://accessories.toshiba.com).



**TECHNICAL NOTE:** When traveling by air, you may be required to pass your computer through airport security equipment. The X-ray equipment will not harm your computer.

---

### NOTE

Before using your computer aboard an aircraft, make sure the Wireless antenna is OFF (Airplane mode is ON) if your computer has wireless LAN capability.

---

### NOTE

To enable or disable wireless communication, use the FN + () keys. For more information see “[TOSHIBA Function Keys](#)” on page 170.

---

# Chapter 4

## Exploring Your Computer's Features

---

In this chapter, you will explore some of the special features of your computer.

### Exploring the desktop

You can use its features to start applications, find documents, set up system components, and perform most other computing tasks.



**HINT:** The illustrated examples in this guide may appear slightly different from the screens displayed by your system. The differences are not significant and do not indicate any change in the functionality of your system.

---

## Finding your way around the desktop

Your computer's desktop includes several standard features: icons, Start button, taskbar, notification area, notifications, and background pattern.

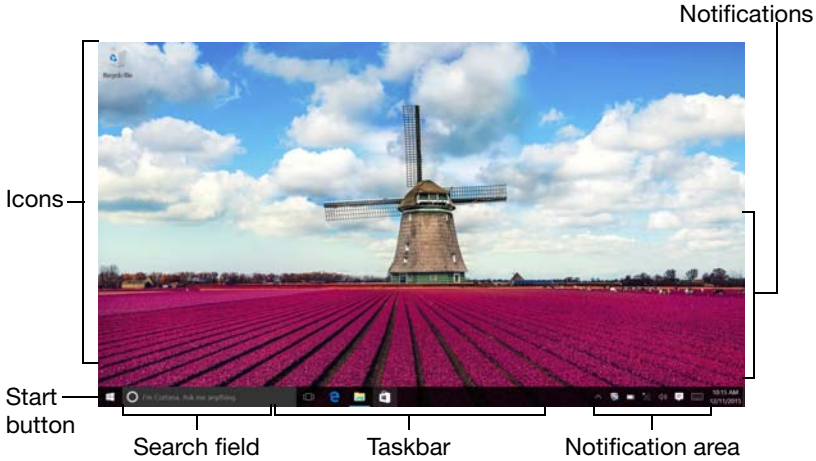

*(Sample Image) Windows Desktop screen*

### Icons

An icon represents a folder, file, or program that can be quickly activated by double-clicking or touching the icon.

You can create a new desktop icon for any folder, file, or program by dragging the element's icon from its location in a window to the desktop area.

You may see various icons displayed on your system desktop, for example:



**Recycle Bin**—Holds files you have deleted. You may be able to retrieve these files until you empty the Recycle Bin.



- ❖ **TECHNICAL NOTE:** If you delete a large number of files or very large files from the internal storage drive, there may be insufficient space available in the Recycle Bin to hold these files. In this case, Windows will prompt you to either permanently delete the file(s) or cancel the deletion.
- ❖ If you delete a file (of any size) from an external media or flash media, it does not go into the Recycle Bin. The file is permanently deleted.
- ❖ Permanently deleted files cannot be recovered from the Recycle Bin.

For more information on the Recycle Bin, see Windows online Help.

---

**NOTE** If you place the pointer over an icon, a popup description of the file contents may appear.

---

Your desktop may contain other icons depending on your configuration. See Windows online Help for more specific information on each icon and how to use it.

## Start button

---

**NOTE** When a procedure in this User's Guide instructs you to click or touch the **Start** () button, it is in reference to this button.

---

Click or touch the **Start** () button to open the Start menu. Here you can perform various commands, including basic tasks like turning off the power and advanced PC settings.

---

**NOTE** You may also press the **Windows** () key to open the Start menu.

---

You can use the **Start menu** button to:

- ❖ Start apps
- ❖ Open documents
- ❖ Adjust system settings
- ❖ Find files
- ❖ Access Toshiba Utilities

- ❖ Use the Search function
- ❖ Shut down the computer

For more information, see “Using the Start menu” on page 43 and “Starting an app” on page 71.

## Task view

The **Task view** (☰) icon tiles the currently open windows and desktops so that they are visible at one time and allows you to manage multiple desktops.

## Adding desktops

After clicking or touching the **Task view** (☰) icon, you can add, close, or switch between desktops.

Click or touch a desktop thumbnail at the bottom of the screen to select it. When you place your pointer over a desktop thumbnail or touch & hold it, an **X** appears allowing you to close that desktop.

Click or touch the **New desktop** (+) icon to add a new desktop.

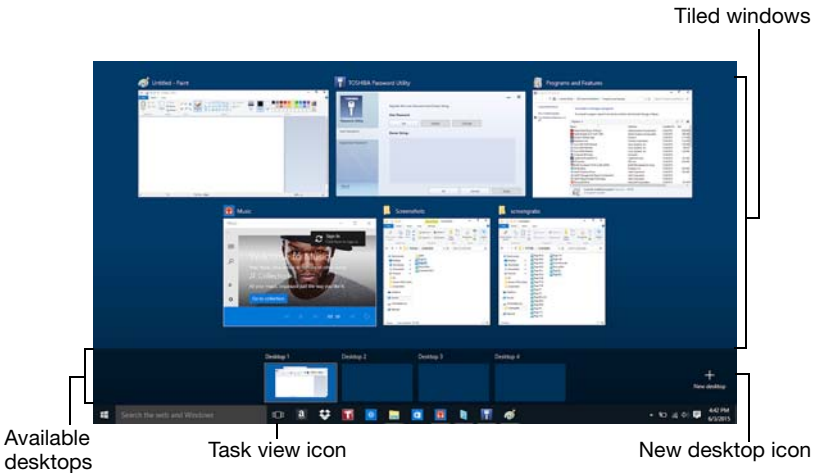

*(Sample Image) Task view - managing multiple desktops*

## App tiles

The app tiles can be accessed and launched from the Start menu.

Typical app tiles are the Calendar tile and Mail tile, as well as tiles representing all other applications downloaded to your system.

## Taskbar

Each time you open a program, an icon associated with that program appears on the taskbar. With some programs, an icon appears on the taskbar for each document or window you open. You can use these icons to quickly switch between the programs or windows.

To make a program or window the currently active one, click or touch the associated taskbar icon.

## Notification area

The notification area displays icons of tasks or programs that run continuously in the background and displays notifications. To learn more about each task, position the pointer over the icon for a few moments and a short description of the task appears.

Typical tasks in the notification area are Current time, Power usage mode, network connectivity status, and speaker volume.

To activate a specific task, click or touch the appropriate notification area icon.

## Notifications

There are many types of notifications you can employ to help you with the many tasks you perform every day.

User experience notifications can be set for toast, tile, badge, and raw notifications.

**Toast notifications**—Designed for time-sensitive delivery of personalized content, such as an instant message from a friend.

**Tile notifications**—Used by applications that are not currently running with an at-a-glance characteristic, giving you a quick preview of the subject line of your latest email or the current weather conditions.

**Badge notifications**—A specialized type of tile notification (shown on the Start menu tile) using symbols to indicate the number of applications that have updates available or the status of a running application.

**Raw notifications**—These run a background task on behalf of an application while that application is not running in order to make available the latest content, such as an online newspaper.

## Windows Store

Although many applications will be pre-installed or built-in to your computer, you will also have the ability to download many other applications with a touch or the click of your mouse.

Click or touch the **Windows Store** () icon in the taskbar.

In the Windows Store you can search for and browse thousands of apps, all grouped into easy to find categories.

## Setting up for communications

To connect to the Internet you need:

- ❖ A browser or communications program
- ❖ An Internet Service Provider (ISP) or online service if you plan to use the Internet
- ❖ A way to connect to the ISP (for example Wi-Fi/broadband connection, etc.)

## Connect to the Internet

---

### NOTE

Wireless connectivity and some features may require you to purchase additional software, external hardware or services. Availability of public wireless LAN access points may be limited.

---

Follow the steps below to set up your Wireless connection:

- 1 Click or touch the **Start** () button in the lower-left corner of the Desktop or press the **Windows** () key.  
The Start menu opens.
- 2 Click or touch **Settings** () in the Start menu.
- 3 Select **Network & Internet** () in the Settings window.

The Network & Internet window allows you to choose from several options in the left pane of the window:

- ❖ Wi-Fi
- ❖ Airplane mode
- ❖ Data usage
- ❖ VPN
- ❖ Dial-up

- 
- ❖ Proxy
  - ❖ Ethernet
- 4 To set up your Wi-Fi connection, select **Wi-Fi**.
  - 5 Select your network.
  - 6 Select the **Connect automatically** checkbox to automatically connect to the selected network on startup.
  - 7 Click or touch **Connect**.
  - 8 Enter the network security key, (if applicable).
  - 9 Click or touch **Close** (✕) to save the changes and close the window.

Your computer should then be connected.

---

**NOTE** To enable or disable wireless communication, use the FN + () keys. For more information see [“TOSHIBA Function Keys” on page 170](#).

---

---

**NOTE** When Airplane mode is OFF, the wireless indicator light () will be lit.

---

For help with common Wi-Fi networking problems, see [“Wireless networking problems” on page 152](#).

## Connecting your computer to a network

You can connect your computer to a network to increase its capabilities and functionality.

### Accessing a network

For specific information about connecting to the network, consult your network administrator. Many hotels, airports, and offices offer Wi-Fi access.

---

## Exploring audio features

---

**NOTE** You can only plug one external audio device (i.e. headphones or microphone) into the available headphone/microphone jack.

---

You can use your computer to record sounds using the computer's internal microphone(s) (available on certain models) or an optional external microphone. You can listen to sound files or audio CDs using the built-in speakers, headphones, or external speakers.

### Recording sounds

You may record sounds using the computer's internal microphone(s) (available on certain models) or by connecting an optional external microphone.

#### Using a microphone



- 1 If you wish to use an external microphone, connect it to the computer.
- 2 In the **Search** field, type **Voice Recorder**.
- 3 Click or touch **Voice Recorder**.

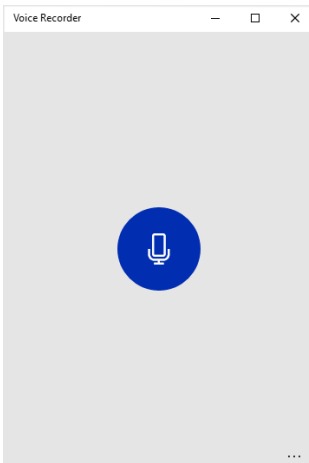

*(Sample Image) Voice Recorder screen*

- 4 Speak normally into the microphone.

- 5 When you have finished recording, click or touch the **Stop Recording** button.

Your recording file is created and automatically saved for you.

## Using external speakers or headphones

### **CAUTION**

Before putting on headphones to listen, turn the volume down. Do not set the volume too high when using headphones. Continuous exposure to loud sound can harm your hearing.

### **NOTE**

You can only plug one external audio device (i.e. headphones or microphone) into the available headphone/microphone jack.

Your computer is equipped with a full stereo sound system with internal speakers. Instead of using the internal speakers, you can connect headphones or a pair of external stereo speakers.



**TECHNICAL NOTE:** When using amplified speakers, use speakers that require an external power source. Other types of speakers will be inadequate to produce sound from the computer.

To play back sound files through external speakers or headphones:



- 1 Locate the headphone/microphone jack on the computer.
- 2 Using any necessary adapters, plug the cable from the headphones or external speakers into the headphone/microphone jack.

The headphone/microphone jack requires a 16-ohm stereo mini connector.

To adjust the volume:

- ❖ For external speakers, use the volume controls on each speaker.
- ❖ For headphones, use the computer's volume control.



## Using the Web Camera

Your computer may come with a built-in Web Camera. With this Web Camera you can do the following:

- ❖ Take pictures and record videos with your computer
- ❖ Participate in video chats while using instant messaging (IM) programs
- ❖ Have video conference calls

**NOTE** To email, instant message or video conference, you must be connected to the Internet.

Depending on your computer model, the process of sending email, taking pictures or recording video messages may vary.

To access the Web Camera:

In the **Search** field, type **Camera**, and then click or touch the **Camera** icon. The Web Camera indicator light glows when the Web Camera is active.

**NOTE** When the Web Camera is not active the indicator light is Off.

## Using the Smart Card Slot

(Available on certain models.)

**NOTE** To locate your Smart Card slot please refer to your Quick Start document.

Your computer may include a Smart Card slot. This allows you to use a Smart Card for added security purposes. There are several different Smart Cards available for purchase as well as the software application needed. Visit your local electronics store or check the Web for other sources.

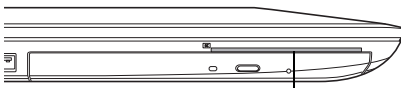

Smart Card slot\*

\*Available on certain models

*(Sample Illustration) Smart Card slot on side of computer*

---

## Using the Memory card reader

The Memory card reader supports the use of Secure Digital™ (SD™, SDHC™, SDXC™), miniSD™, microSD™, or MultiMediaCard™ (MMC™) media. These media can be used with a variety of digital products: digital music players, smartphones, digital cameras, digital video camcorders, etc.

---

**CAUTION** To use a microSD Card or miniSD Card, an SD adapter is required.

---

The Memory card reader may also support other types of media.

---

**NOTE** Do not use the Copy Disk function for this type of media. To copy data from one media to another, use the drag-and-drop feature of the Windows operating system.

---

## Inserting memory media

---

**NOTE** To locate your Memory card reader, please refer to your Quick Start document.

---

The following instructions apply to all types of supported media devices.

- 1 Turn the media so that the contacts (metal areas) are face down.
- 2 Push the media into the adapter until it stops.

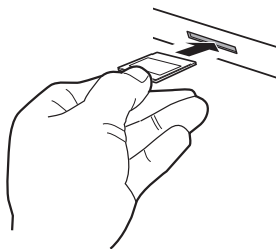

*(Sample Illustration) Inserting memory media*

**CAUTION**

When inserting memory media, do not touch the metal contacts. You could expose the storage area to static electricity, which can destroy data.

**NOTE**

Always remove memory media when not in use.

## Removing memory media

- 1 Prepare the card for removal by clicking on or touching the **Show hidden icons** (▲) button, if necessary, in the notification area and then selecting the **Safely Remove Hardware and Eject Media** (🗑️) icon.
- 2 Highlight, and then click or touch the item you would like to eject.

If the system is unable to prepare the media for safe removal, a message will tell you to try again later. If the media can be removed now, the system displays **Safe to Remove Hardware**.

If the computer has a spring-loaded adapter slot, see step 3; otherwise, skip to step 4.

- 3 Gently press the card inward to release it.  
The card pops out slightly.
- 4 Grasp the card and pull it straight out.

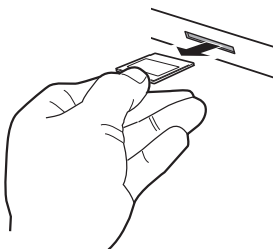

*(Sample Illustration) Removing memory media*

**CAUTION**

Do not remove memory media while data is being written or read. Even when the Windows message “copying...” disappears, writing to the media might still be in progress and your data could be destroyed.

## Using the Expansion port

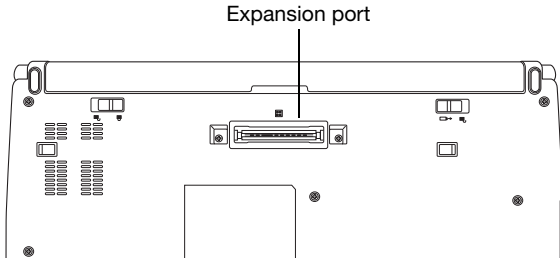

*(Sample Illustration) Expansion port on the underside*

The expansion port, located on the bottom of your computer, is used to attach expansion devices such as a Port Replicator (not shipped with your system). A Port Replicator is an excellent investment if you are using your computer both in and out of the office. While you are using your computer away from your desk, you can leave network cables and external devices (such as printers, a mouse, speakers, and USB devices) connected to a Port Replicator on your desk. When you return to your desk, you can then quickly connect your computer to the Port Replicator and have immediate access to all of your network resources and external devices. This eliminates the time-consuming process of connecting each external device individually, and saves wear and tear on the ports and cables.

To achieve a proper connection between your computer and the Port Replicator, your computer must be properly aligned with the Port Replicator. For more information, consult the user's manual that came with your Port Replicator, or visit [support.toshiba.com](http://support.toshiba.com).

On some computer models, you can attach an extended life battery to the expansion port. To find expansion devices compatible with your computer model, please visit [accessories.toshiba.com](http://accessories.toshiba.com).

# Chapter 5

## Utilities

---

Your computer includes several utilities designed to help you to reconfigure your system to best meet your individual needs. Together, these allow you to ascertain certain system details, set additional options, or change default options. These utilities are described in this chapter.

---

**NOTE** The utilities described in this chapter, and the icons shown in the sample images are applicable only if the related utility is available on your system.

---

- ❖ [eco Utility](#)
- ❖ [Supervisor password](#)
- ❖ [User password](#)
- ❖ [System Settings](#)
- ❖ [Sleep Utilities](#)
- ❖ [TOSHIBA Recovery Media Creator](#)
- ❖ [Service Station](#)
- ❖ [TOSHIBA Application Installer](#)
- ❖ [PC Health Monitor](#)
- ❖ [Display Utility](#)
- ❖ [Fingerprint Authentication Utility](#)

## eco Utility

The eco Utility monitors your power savings from using the eco power plan by tracking real-time power consumption and accumulated savings over time.

To access the eco Utility:

- 1 In the **Search** field, type **eco Utility**.
- 2 Click or touch **eco Utility** (🌿).

The eco Utility window appears.



*(Sample Image) eco Utility window*

- 3 To activate the eco power plan, select **eco Mode** on the left side.
- 4 Slide the **eco Mode** switch to the On position to enable eco Mode.
- 5 Click or touch **Close**.

For more information on the eco power plan and utility, click or touch the **Help** button at the bottom of the window.

## Password Utility

Setting a password lets you walk away from your computer while providing additional protection for your files. When you set a password, you must enter the password before you can work on your computer again.

TOSHIBA supports different types of passwords on your computer:

- ❖ A supervisor password—Prohibits unauthorized users from accessing certain functions such as System Settings. This is useful if more than one person uses the computer.
- ❖ A user password—Prevents unauthorized users from starting the computer.

When setting up passwords, keep the following in mind:

- ❖ The supervisor password must be set before the user password, or the user password must be deleted and then re-entered after the supervisor password is set.
- ❖ The user password can be set up under the supervisor password.

## Using a supervisor password

A supervisor password prevents other users from changing hardware configuration options.

## Setting a supervisor password

---

**CAUTION**

If you choose to set a supervisor or user password, TOSHIBA strongly recommends that you save your password in a location where you can later access it should you not remember it.

TOSHIBA is not responsible for any losses that may occur to you, your organization or others as a result of the inability to access your computer.

---

To set a supervisor password:

- 1 In the **Search** field, type **Password Utility**.
- 2 Click or touch **Password Utility** (🔑).
- 3 Click or touch **Supervisor Password**.



*(Sample Image) Supervisor Password tab*

- 4 Click or touch **Set**.
- 5 Enter your password, and then enter it again to verify.
- 6 Click or touch **Set**.

---

**NOTE** Under User Policy, this option may or may not ask for password verification.

- 7 Click or touch **OK** to save your password as a text file.

---

**NOTE** Password Utility will suggest "memo.txt" for the text file name. If you have saved a password previously, using the same name may overwrite your password text file with the new password. By using a different name, you can prevent overwriting your previously stored passwords.

- 8 Click or touch **Save**.
- 9 Click or touch **OK**.

## Deleting a supervisor password

To delete a supervisor password:

- 1 In the **Search** field, type **Password Utility**.
- 2 Click or touch **Password Utility** (  ).  
A pop-up screen appears asking for a password.
- 3 Enter your password, and then click or touch **Verify**.
- 4 Click or touch **Supervisor Password**.
- 5 Click or touch **Delete**.  
An authority verification pop-up screen appears.
- 6 Click or touch **Delete**.
- 7 Enter the password, and then click or touch **Verify**.
- 8 Click or touch **OK** to exit.

## Using a user password

A user password provides power-on password protection.

## Setting a user password

---

**CAUTION**

If you choose to set a supervisor or user password, TOSHIBA strongly recommends that you save your password in a location where you can later access it should you not remember it.

TOSHIBA is not responsible for any losses that may occur to you, your organization or others as a result of the inability to access your computer.

---

To register a password for the power-on password functions:

- 1 In the **Search** field, type **Password Utility**.
- 2 Click or touch **Password Utility** (🔑).
- 3 Click or touch **User Password**.

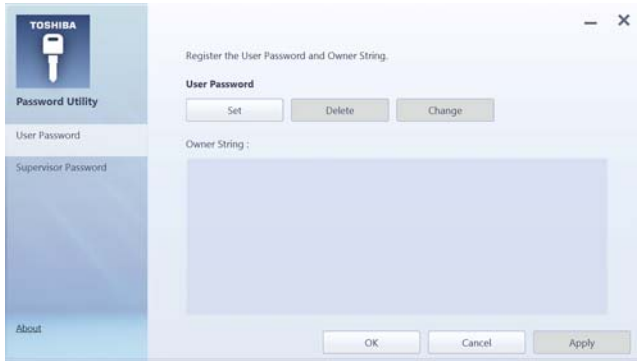

*(Sample Image) User Password tab*

- 4 Click or touch **Set**.
- 5 Enter your password, and then enter it again to verify.
- 6 Click or touch **Set**.
- 7 Click or touch **OK** to save your password as a text file.

**NOTE**

Password Utility will suggest “memo.txt” for the text file name. If you have saved a password previously, using the same name may overwrite your password text file with the new password. By using a different name, you can prevent overwriting your previously stored passwords.

- 8 Click or touch **Save**.
- 9 Click or touch **OK**.

## Deleting a user password

To cancel the power-on password function:

- 1 In the **Search** field, type **Password Utility**.
- 2 Click or touch **Password Utility** (🔍).
- 3 A pop-up screen appears asking for a password.
- 4 Enter your password, and then click or touch **Verify**.
- 5 Click or touch **Delete**.  
An authority verification pop-up screen appears.
- 6 Click or touch **Delete**.
- 7 Enter the password, and then click or touch **Verify**.
- 8 Click or touch **OK** to exit.

## System Settings

System Settings is the TOSHIBA configuration management tool available through the Windows operating system. To access it:

- 1 In the **Search** field, type **System Settings**.
- 2 Click or touch **System Settings** (  ).

The System Settings screen appears.

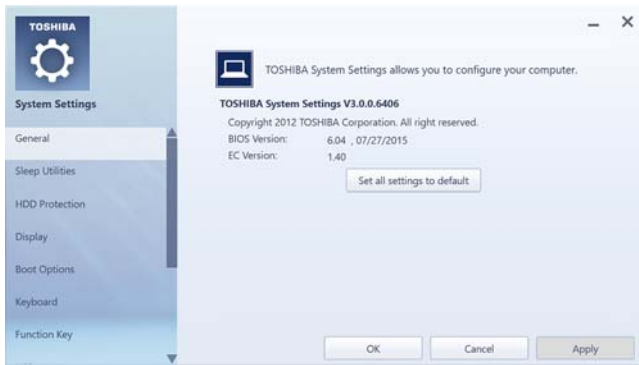

*(Sample Image) System Settings screen – General tab options*

The System Settings screen may have the following tabs:

- ❖ **General**—Allows you to view the current BIOS version or change certain settings back to their default values
- ❖ **Sleep Utilities**—Allows you to enable or disable Sleep and Charge.
  - ❖ **Sleep and Charge**—Allows you to charge USB compatible external devices.
- ❖ **Display**—Allows you to change various default settings for the built-in display

### NOTE

When the computer restarts, it remembers the last configuration. If data does not appear on the display you are using after starting in Sleep mode, press the **Windows** (  ) + P keys to toggle the display. For more information, see [“Directing the display output when you turn on the computer” on page 61](#).

- ❖ **Boot Options**—Allows you to change the sequence in which your computer searches the drives for the operating system
  - ❖ **Boot Priority**—Allows you to configure boot priority settings.
    - ❖ **Boot Speed**—Reduces the time needed for the BIOS to initialize, using either the Fast or Normal settings.
  - ❖ **Panel open/Power on**—Allows you to turn on the computer when opening the display panel while the computer is turned off.
  - ❖ **Power On By AC**—Allows you to turn on the computer by plugging in the AC adaptor.
- ❖ **Keyboard**—Allows you to access the wake-on keyboard function, or to configure the function keys
- ❖ **USB**—Allows you to enable or disable USB Legacy Emulation and internal USB 3.0 controller
  - ❖ **Internal USB 3.0 Controller**—Allows you to save power. If disabled the USB 3.0 ports will function like the USB 2.0 ports.
  - ❖ **System ON CDP Charge Mode**—Allows you to enable CDP (Charging Downstream Port) to use rapid USB charge while the computer is powered on.
- ❖ **Function Key**—Allows you to set options for the notifications from the Function key
- ❖ **SATA**—Allows you to set conditions for SATA
- ❖ **LAN**—Allows you to set networking functions
- ❖ **Undock and Sleep**—Allows you to set sleep conditions when undocking

- 
- ❖ **Advanced Options**—Allows you to set conditions for various functions:
    - ❖ **Web Camera**—Allows you to enable/disable the Web Camera.
    - ❖ **SD Host Controller**—Allows you to enable/disable the SD Host Controller.
    - ❖ **Intel® Turbo Boost Technology 2.0**—Allows you to enable/disable the Intel® Turbo Boost Technology 2.0 function.
    - ❖ **Memory Performance Mode**—Allows you to set the memory mode.
    - ❖ **Critical Battery Wake-up**—Allows you to enable/disable the system wake-up when remaining battery life is critical.

---

## Sleep Utilities

This utility displays whether the “USB Sleep and Charge function” is enabled or disabled and shows the position of the USB port that supports the “USB Sleep and Charge function.”

- 1 In the Search field type **System Settings**.
- 2 Click or touch **System Settings** .
- 3 Click or touch **Sleep Utilities**.

### USB Sleep and Charge

Your computer can supply USB bus power (DC 5V) to the USB port even when the computer is in Sleep mode, Hibernation mode or shutdown state (powered off).

This function can only be used for the port that supports the USB Sleep and Charge function (hereinafter called “compatible port”).

Compatible ports are USB ports that have the  symbol icon.

You can use the “USB Sleep and Charge function” to charge certain USB compatible external devices such as mobile phones or portable digital music players. However, the “USB Sleep and Charge function” may not work with certain external devices even if they are compliant with the USB specification. In those cases, power on the computer to charge the device.

- NOTE**
- ❖ When “USB Sleep and Charge function” is set to Enabled, USB bus power (DC 5V) will be supplied to the compatible port even when the power of the computer is turned OFF. USB bus power (DC 5V) is similarly supplied to the external devices which are connected to the compatible ports. However, some external devices cannot be charged solely by supplying USB bus power (DC 5V). As for the specifications of the external devices, please contact the device manufacturer or check the specifications of the external devices thoroughly before use.
  - ❖ If USB Sleep and Charge is enabled, the computer’s battery will discharge during standby and hibernation or when the computer is turned off. It is recommended that you connect the AC adaptor to the computer when enabling the USB Sleep and Charge function.
  - ❖ Using the “USB Sleep and Charge function” to charge external devices will take longer than charging the devices with their own chargers.
  - ❖ If an external device is connected to the compatible port when the AC adaptor is not connected to the computer, the battery of the computer will be depleted even when the power of the computer is turned OFF. As such, we recommend that you connect the AC adaptor to the computer when using the “USB Sleep and Charge function.”
  - ❖ External devices connected to the USB bus power (DC 5V) function that interfaces with the power ON/OFF of the computer may always be in an operational state.
  - ❖ When there is a current overflow of the external device connected to the compatible port, USB bus power (DC 5V) supply may be stopped for safety reasons.
  - ❖ When “USB Sleep and Charge function” is set to Enabled, the “USB Wakeup function” does not work for the compatible port. In that case, if there is a USB port that does not have the USB Sleep and Charge function-compatible icon () , attach the mouse or keyboard to it. The “USB Wakeup function” will now work, but the “USB Sleep and Charge function” will be disabled.
-

---

**⚠ WARNING** Metal paper clips or hair pins/clips will generate heat if they come into contact with USB ports. Do not allow USB ports to come into contact with metal products, for example when carrying the computer in your bag.

---

## Enabling/Disabling USB Sleep and Charge

This utility can be used to enable or disable the USB Sleep and Charge function. To enable this function, select **Enabled**. To disable this function, toggle the Enabled button to the **Disabled** position.

You can also control whether charging takes place when the computer is running on battery power. To do so, slide the on-screen **Function under Battery Mode** switch to enable or disable it.

If you enable charging when the computer is running on battery power, you can specify that charging stops when battery power drops below a certain level. Use the slider at the bottom of the utility window (beneath the “Disable features when the battery level reaches 10%” heading) to specify when charging should stop. For example, if you set the slider to 10%, charging will stop when 10% or less of the battery power remains.

## Power supply mode settings

Your computer may provide two different charging modes, to support various types of USB devices. If your computer provides more than one charging mode, the charging mode you should select depends on the USB device you want to charge. For example, **Auto Mode**, which is the default mode, will charge a wide variety of digital audio players. If your device does not charge in Auto Mode, try using **Alternate Mode**. To select a different charging mode, use the **Power supply mode** drop-down list in the utility.



*(Sample Image) Sleep and Charge screen*

**NOTE**

With certain external devices, the USB Sleep and Charge function may not work no matter which charging mode you select. In those cases, disable USB Sleep and Charge in the utility and turn the computer on to charge the device, or use a different charging device.

## TOSHIBA Recovery Media Creator

The TOSHIBA Recovery Media Creator utility enables you to create recovery media that can be used to return your system to its out-of-box state, if necessary. For detailed information on using the utility to create recovery media, see [“Creating a recovery drive using TOSHIBA Recovery Media Creator”](#) on page 47.

## Service Station

The Service Station helps you keep your new computer running at its best by notifying you when updated software, firmware, documentation or other information is available for your computer. The Service Station will alert you when updates are available, and you can then choose to install the updates if you wish, or you can follow the instructions below to open the Service Station:

- 1 In the **Search** field, type **Service Station**.
- 2 Click or touch **Service Station** ().
- 3 Follow the on-screen instructions.

## TOSHIBA Application Installer

**NOTE** You must have an Internet connection to reinstall applications.

The TOSHIBA Application Installer allows you to reinstall the drivers and applications that were originally bundled with your computer.

To reinstall drivers and applications:

- 1 In the **Search** field, type **TOSHIBA Application Installer**.
- 2 Click or touch **TOSHIBA Application Installer** (  ).  
The TOSHIBA Application Installer window appears.

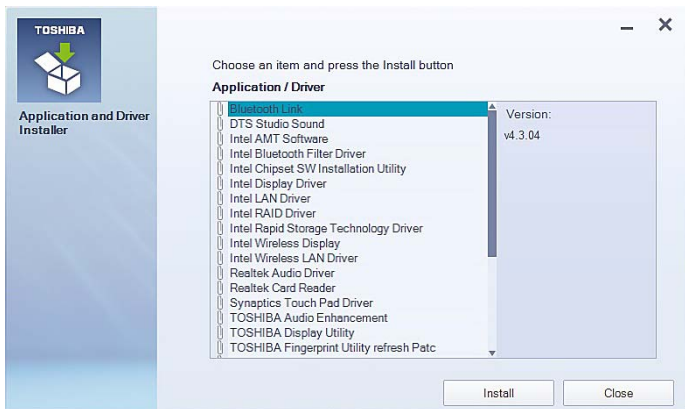

*(Sample Image) TOSHIBA Application Installer selection screen*

- 3 Click or touch the item you want to install.
- 4 Click or touch **Install**, then follow the on-screen prompts to complete the installation process.

---

## PC Health Monitor

The PC Health Monitor software program monitors device system functions such as power consumption, the cooling system and the 3D Accelerometer (available on certain models). It alerts users to specific system conditions via pop-up messages. It also tracks the usage of the device and related devices and logs service-relevant information on the device's internal storage drive.

The collected information includes device operation time and number of actuations or status changes (e.g.: number of power button and FN key combination uses, and AC adaptor, battery, LCD, fan, HDD, sound volume, wireless communication, docking, and USB information), date of initial system use, and also computer and device usage (e.g.: power settings, battery temperature and recharging, CPU, memory, and temperatures for various devices). The collected information is not limited to the examples specified here. The stored data uses a very small portion of the total hard disk capacity (approximately 3 MB or less per year).

This information is used to identify and provide a notification of system conditions that may affect the performance of your TOSHIBA device. It may also be used to help diagnose problems should the device require service by TOSHIBA or TOSHIBA's authorized service providers. Additionally, TOSHIBA may use this information for quality assurance analysis.

Subject to the use restrictions above, the data logged on the internal storage drive may be transferred to entities located outside of your country or region of residence (e.g., European Union). Those countries may or may not have the same data protection laws or data protection levels as required by your home country or region.

You may disable the PC Health Monitor at any time by uninstalling the software via the Windows Control Panel. Doing so will automatically delete all collected information from the internal storage drive.

The PC Health Monitor software does not extend or modify TOSHIBA's obligations under its standard limited warranty in any way. TOSHIBA's standard limited warranty terms and limitations apply.

## Display Utility

The Display Utility allows you to adjust your display settings.

To make changes:

- 1 In the **Search** field, type **Display Utility**.
- 2 Click or touch **Display Utility**.

The Display Utility window appears.

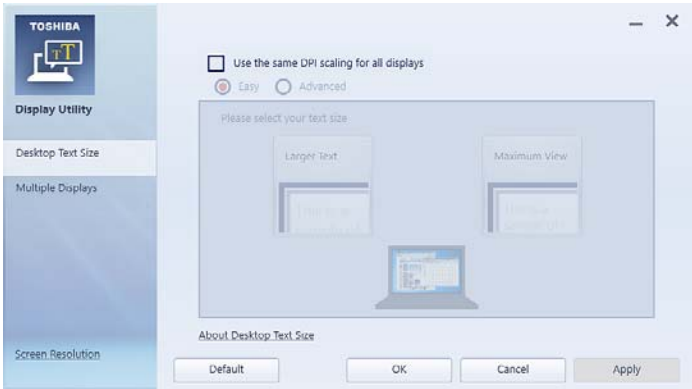

*(Sample Image) Display Utility screen*

- 3 Click or touch the option you wish to change and follow the on-screen instructions.

## Fingerprint Authentication Utility

(Available on certain models.)

The fingerprint authentication utility can be used to replace the keyboard-based user password authentication system when booting up.

The fingerprint authentication utility can also be used for user logon. The user's fingerprint is read; if the system recognizes the fingerprint, the user is automatically logged on.

### Fingerprint utility limitations

TOSHIBA does not guarantee that the fingerprint utility technology will be completely secure or error-free. TOSHIBA does not guarantee that the fingerprint utility will accurately screen out unauthorized users at all times. TOSHIBA is not liable for any failure or damage that might arise out of the use of the fingerprint software or utility.

### Using the Fingerprint Authentication Utility

To access the Fingerprint Authentication Utility from the Start screen begin typing **Fingerprint Utility**, then click or touch the **Fingerprint Utility**. For information on enrolling fingerprints and using the utility please refer to your online Help file.

---

#### **NOTE**

It is recommended that you complete the Fingerprint practice tutorial before starting fingerprint enrollment. The Fingerprint practice tutorial shows how to achieve the highest quality fingerprint samples.

If you choose to use this utility it is strongly recommended that you delete your fingerprint template data before transferring ownership or disposing of your computer. Otherwise, personal information and/or proprietary information on the internal storage drive may be viewed by a third party. For details on how to delete the fingerprint data, see your online Help file.

---

## Fingerprint Logon

The fingerprint utility enables logon to your computer using fingerprints. During user enrollment, fingerprint samples are saved and associated with the user's Windows user account. When the user attempts to log on again, the user's fingerprint is read and compared with the user's enrolled fingerprints; if the fingerprint is recognized, user logon is completed.

The Fast User Switching feature of the Windows operating system is also supported. If user A is logged on and the fingerprint utility verifies the fingerprint of user B (who is already enrolled), the utility recognizes the fingerprint and switches the users.

If your system supports power-on security, existing fingerprint samples can be used also for power-on authentication.

## Care and maintenance of your fingerprint reader

Failure to follow these guidelines and/or procedures might result in damage to the reader or cause reader failure, finger recognition problems, or lower finger recognition success rate.

- ❖ Do not scratch or poke the reader with your nails or any hard or sharp objects.
- ❖ Do not press the reader with too much pressure.
- ❖ Do not touch the reader with a wet finger or any wet objects. Keep reader surface dry and free of water vapor.
- ❖ Do not touch the reader with a soiled finger. Minute foreign particles on a soiled or dirty finger may scratch the reader.
- ❖ Do not paste stickers or write on the reader.
- ❖ Do not touch the reader with a finger or any object with built-up static electricity.

Observe the following before you swipe your finger on the reader, whether for fingerprint enrollment/registration or recognition.

- ❖ Wash and dry your hands thoroughly.

- ❖ Remove static electricity from your fingers by touching any metal surface. Static electricity is a common cause of reader failures, especially during dry seasons such as winter.
- ❖ Clean the reader with a lint-free cloth. Do not use detergent to clean the reader.
- ❖ Avoid the following finger conditions for enrollment or recognition as they may result in fingerprint enrollment errors or a drop in the fingerprint recognition success rate.
  - ❖ Soaked or swollen finger (e.g., after taking bath)
  - ❖ Injured finger
  - ❖ Wet finger
  - ❖ Soiled or oily finger
  - ❖ Extremely dry skin condition on finger

Observe the following to improve the fingerprint recognition success rate.

- ❖ Enroll two or more fingers.
- ❖ Enroll additional fingers if recognition failure occurs often using enrolled fingers.
- ❖ Check your finger condition. Changed conditions, such as injured, rough, extremely dry, wet, soiled, dirty, oily, soaked or swollen fingers, may lower the recognition success rate. Also if the fingerprint is worn down or the finger becomes thinner or fatter, the recognition success rate may be lowered.
- ❖ The fingerprint for each finger is different and unique. Please ensure that only the registered or enrolled fingerprint or fingerprints are used for identification.
- ❖ Check sliding position (see illustration below).

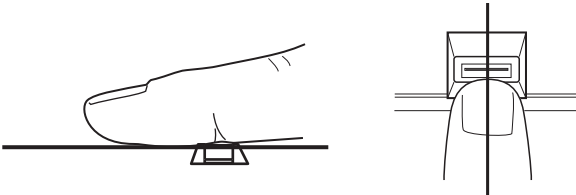

*(Sample Illustration) Aligning the finger on the reader*

## Fingerprint reader limitations

- ❖ The fingerprint reader compares and analyzes the unique characteristics in a fingerprint. However, there may be instances where certain users are unable to register their fingerprints due to insufficient unique characteristics in their fingerprints.
- ❖ A warning message will be displayed when recognition is abnormal or recognition is not successful within a fixed duration.
- ❖ The recognition success rate may differ from user to user.
- ❖ TOSHIBA does not guarantee that this fingerprint recognition technology will be error-free.

TOSHIBA does not guarantee that the fingerprint reader will recognize the enrolled user or accurately screen out unauthorized users at all times. TOSHIBA is not liable for any failure or damage that might arise out of the use of this fingerprint recognition software or utility.

# Chapter 6

## If Something Goes Wrong

---

Some problems you may encounter when using your computer are relatively easy to identify and solve. Others may require help from your network administrator or the manufacturer of the software program.

This chapter aims to help you solve many problems by yourself. It covers the problems you are most likely to encounter.

If all else fails, contact Toshiba. You will find information on Toshiba's support services at the end of this chapter.

### Problems that are easy to fix

#### Your program or application stops responding.

If you are working in a program that suddenly freezes, chances are the program has stopped responding. You can exit the program without shutting down the operating system or closing other programs.

To close a program that has stopped responding:

- 1 Press Ctrl, Alt, and Del simultaneously (once), and then click or touch **Task Manager**.

The Task Manager window appears.

- 2 Select the program or application you want to close, and then click or touch **End Task** in the lower right corner.  
Closing the failed program should allow you to continue working. If it does not, continue with the next step.
- 3 Close the remaining programs one by one by selecting the program name, then select **End Task**.  
Closing all programs should allow you to continue working. If it does not, power off your computer, and then restart it.

## **Problems when you turn on the computer**

These problems may occur when you turn on the power.

### **The computer will not start.**

Make sure you attached the AC adaptor and power cord/cable properly.

Press and hold the power button for at least 10 seconds.

If you are using the AC adaptor, check that the wall outlet is working by plugging in another device, such as a lamp.

Verify that the computer is on by looking at the Power button. If the button is glowing, the computer is on. If the button is not lit, try turning the computer off and then on again.

If you are using an AC adaptor, verify that the computer is receiving power from the external power source by checking the AC power light located on the left side of the computer. If the indicator is glowing, the computer is connected to a live external power source.

### **The computer displays the WARNING RESUME FAILURE/Windows Error Recovery – Windows did not shut down successfully message.**

To continue, select the appropriate option, if prompted. This can happen if the computer was put into Sleep mode and the battery has discharged. If you performed a shutdown before this message was displayed, a program or driver may have prevented Windows from shutting down.

Data stored in the computer's memory has been lost. Data stored in the computer's internal storage drive may not be affected.

Always save your data even when you are using Sleep mode. If your battery fully discharges, information that has not been saved will be lost. Your computer can be configured to warn you when the battery is running low see [“Setting battery notifications” on page 83](#).

If you are running on battery power, it is recommended that you do not leave the computer in Sleep mode for long periods of time.

To charge the battery, leave the computer plugged into a live wall outlet for several hours. For more information see [“Charging batteries” on page 79](#).

### **The AC power light is blinking.**

If the AC power light is blinking, try the following steps:

- 1 Connect the AC adaptor to a different power outlet, preferably in a different room. If the computer starts normally, there may be a problem with the AC outlet itself, or the voltage level available from it.
- 2 Verify that the AC adaptor is the correct unit for your computer model. The computer may not be able to start from an AC adaptor that is rated for less current (amperage) than the computer requires, even if the rated voltage is correct, and the plug fits correctly in the DC-IN socket. The labels on the bottom of the computer and the AC adaptor show the specifications for voltage (“V”) and current (“A”) for each device. The voltage level must match exactly. The amperage rating of the AC adaptor must be equal to or greater than that required by the computer.
- 3 If your computer has a removable battery, connect the AC adaptor to the computer. Leave the battery out of the computer. Try turning the computer on again.

If the computer starts normally, the battery may need charging, may be depleted, or may be defective. Turn the computer off, insert the battery, turn the computer on, and then leave the computer running for several hours, which will deliver a slow, steady “trickle-charge to the battery. Once the battery has been trickle charged, it may begin working correctly again.

If the trickle-charging does not prove effective, you can connect to Support Online by going to Toshiba support at [support.toshiba.com](http://support.toshiba.com).

## The battery light is blinking when the computer is on.

If the battery light is blinking when the computer is on, this indicates a power mismatch. Do the following:

- 1 Check the OUTPUT specifications on the AC adaptor (for example, DC 19V – 3.95A)
- 2 Check the INPUT specifications on the bottom of the computer.

The output specifications of the AC adaptor must match the input specifications of the computer.

- 3 If the specifications do **not** match, locate and use the AC adaptor that shipped with your computer. If the specifications **do** match, contact Toshiba. See “Contacting Toshiba” on page 168.

## The Windows operating system is not working

Once you are familiar with your computer and used to the way the operating system responds to your work routine, you can easily detect if the operating system is not working correctly. For example:

- ❖ The operating system fails to start after the initial startup appears.
- ❖ The operating system takes a long time to start.
- ❖ The operating system responds differently from the normal routine.
- ❖ The screen does not look right.

Unless a hardware device has failed, problems usually occur when you change the system in some way such as installing a new program or adding a device.

If you experience any of these problems, use the options in the Startup menu to fix the problem.

## Using Startup options to fix problems

If the operating system fails to start properly, you may need to troubleshoot the Operating System and/or its settings. There are several options to choose from depending on the severity of the problem and your level of expertise with computers.

If Windows fails to start properly twice, the Windows Boot menu will launch. To enter the Advanced Startup options manually:

- 1 In the **Search** field, type **Recovery Options**.
- 2 Click or touch **Recovery Options**.
- 3 Scroll down to view the **Restart Now** option.
- 4 Click or touch **Restart Now** under **Advanced Startup**.

The computer restarts.

- 5 Click or touch **Troubleshoot** from the menu.

After Restart, you now have several options:

### **Reset your computer**

- ❖ All of your personal files and apps are removed
- ❖ Your computer settings are changed back to their defaults

For more information, see [“Reset your PC” on page 52](#).

### **Advanced options**

Choosing this option presents you with another set of options:

#### **System Restore**

- ❖ System Restore allows you to use a Restore point to return the computer to a state at which it was performing properly. Restore points may be created:
  - ❖ When new hardware or software is installed
  - ❖ Manually by the user

#### **System Image Recovery**

Windows will “Recover” the Operating system using a specific image provided by the user.

#### **Startup Repair**

This feature automates the repair process. The Operating System will automatically look for problems and repair them if possible.

#### **Command Prompt**

The command prompt is a very powerful tool for advanced users.

## Startup Settings

In previous Operating Systems the majority of the options found on this menu were available by pressing the (F8) key during the Windows boot process:

- ❖ Enable low resolution video mode  
Restarts Windows using your current video driver at low resolution. This allows you to reset your display settings in the event they have been improperly set.
- ❖ Enable debugging mode  
Starts Windows in an advanced troubleshooting mode
- ❖ Enable boot logging  
Creates a file that lists all the drivers that are installed during startup
- ❖ Enable Safe Mode  
Starts Windows with a minimal set of drivers and services. If the computer starts and runs in Safe Mode, you will know the Operating System is most likely working properly and that you should look to third-party applications or drivers for the source of your problem.
- ❖ Disable driver signature enforcement  
Allows drivers containing improper signatures to be installed
- ❖ Disable early-launch anti-malware protection  
Allows drivers to initialize without being measured by the Anti-malware driver
- ❖ Disable automatic restart on system failure  
Prevents Windows from automatically restarting if an error causes it to fail. Choose this option only if Windows is stuck in a loop where it fails, attempts to restart, and fails again repeatedly.

## Internet problems

### **My Internet connection is very slow.**

Many factors contribute to the speed with which you can surf the Internet. They include: network speed, network conditions, time of day (when everyone else is surfing, your access can be slow) and popularity of the sites you are trying to access. If accessing a particular site is very slow, try later.

**My browser cannot find the URL address I typed in.**

Make sure you separated the domain names of the address with the forward slash (/). Check the spelling of each name and the syntax of the address carefully. A single incorrect letter or missed character will make it impossible for your browser to locate the site.

**My browser cannot find a site I bookmarked.**

The World Wide Web is constantly changing. A site you bookmarked yesterday may not be available today or its server may be down for temporary repair. Try again later.

**Power and the batteries**

Your computer receives its power through the AC adaptor and power cord/cable or from the system batteries. Power problems are interrelated. For example, a faulty AC adaptor or power cord/cable will neither power the computer nor recharge the batteries.

Here are some typical problems and how to solve them:

**The AC power light does not come on when you plug in the AC adaptor and power cord/cable.**

Make sure the AC adaptor and power cord/cable are firmly plugged into both the wall outlet and the computer.

If the AC power light still does not come on, check that the wall outlet is working properly by plugging in a lamp or other appliance.

**The AC adaptor and power cord/cable work correctly, but the battery will not charge.**

The battery does not charge while the computer is consuming full power. Try turning off the computer.

The battery may not be inserted correctly in the computer. Turn off the computer, remove the battery, clean the contacts with a soft dry cloth (if necessary) and replace the battery. See [“Removing the battery from the computer” on page 87](#).

The battery may be too hot or too cold to charge properly. If you think this is the probable cause, let the battery reach room temperature and try again.

If the battery has completely discharged, it will not begin charging immediately. Leave the AC adaptor and power cord/cable connected, wait 20 minutes and see if the battery is charging.

If the battery light is glowing after 20 minutes, let the computer continue charging the battery for at least another 20 minutes before you turn on the computer.

---

If the battery light does not glow after 20 minutes, the battery may have reached the end of its useful life.

**The battery appears not to power the computer for as long as it usually does.**

If you frequently repeat shallow charge and discharge, the battery meter may become inaccurate. Let the battery discharge completely, then try charging it again.

Check the power options via your Power Plans (see “[Power Plans](#)” on page 85). Have you added a device that takes its power from the battery? Is your software using the internal storage drive more? Is the display power set to turn off automatically? Was the battery fully charged to begin with? All these conditions affect how long the charge lasts.

After a period of time, the battery will lose its ability to perform at maximum capacity and will need to be replaced. This is normal for all batteries. To purchase a new battery pack, see your accessories information included with your computer, or visit the Toshiba Web site at [accessories.toshiba.com](http://accessories.toshiba.com). Refer to this site often to stay current on the most recent software and hardware options for your computer, and for other product information.

For more information on maintaining battery power, see “[Changing the main battery](#)” on page 87.

## Keyboard help

---

**NOTE** If the problem is with an external keyboard connected to your computer, you may need to update your keyboard driver. Refer to the documentation that came with the keyboard or to the keyboard manufacturer’s Web site.

---

If you are experiencing problems with the functionality of any of the computer’s keyboard keys, (i.e. wrong characters displayed, or multiple characters displayed) when pressing keys on the keyboard, try any of the following troubleshooting tips that may help to restore the keyboard to its proper operation.

### Perform a complete power cycle

- 1 Shut down your computer, see “[To Shut down your computer](#)” on page 44.
- 2 Remove all accessories, and unplug all cables. This includes USB flash drives, SD Card, and the power cord/cable.

- 3 If your computer has a user-removable battery, remove the battery and hold down the power button for approximately 10 seconds.
- 4 Reconnect the battery (if you removed it) and the power cord/cable.
- 5 Turn On the computer, and try the keyboard again.

## Uninstall the keyboard driver

You can Uninstall the keyboard driver to allow Windows to automatically reinstall the driver.

- 1 In the **Search** field, type **Device Manager**.
- 2 Click or touch the **Device Manager** application.
- 3 In the “Device Manager” double-click or touch **Keyboards**.
- 4 Right-click or touch **Standard PS/2 Keyboard** and select **Uninstall**.

### NOTE

Do **NOT** select the “Delete the driver software for this device” box.

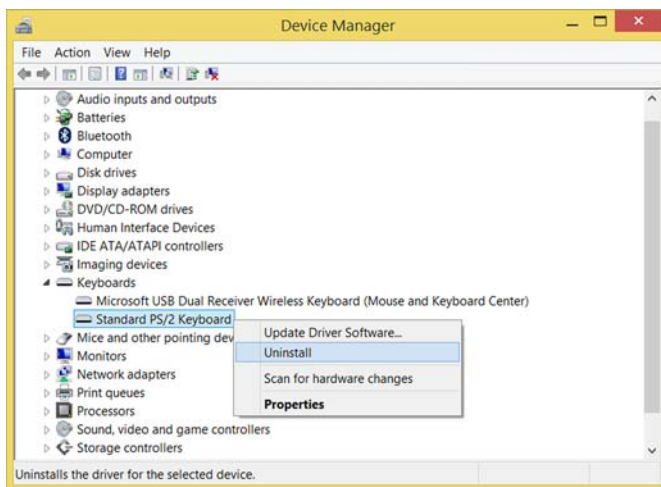

*(Sample Image) Device Manager - Keyboard uninstall*

- 5 After the driver uninstalls, restart your computer, see “[To Restart your computer](#)” on page 45.  
The driver is then reinstalled automatically.

---

## Download the latest keyboard driver

- 1 In your Web browser go to <http://support.toshiba.com/drivers>.
- 2 Enter your computer's serial number.
- 3 Filter your search by **Keyboard driver** to find and download the **Toshiba Function Key** driver for your computer.
- 4 Install the **Toshiba Function Key** driver.
- 5 Restart your computer, see ["To Restart your computer" on page 45](#).

## Perform a system restore

You can perform a system restore to a period in time at which the keyboard was working properly.

---

**NOTE** If no restore points have been previously created then this method will not work, see ["Saving system configuration with restore points" on page 162](#).

---

- 1 In the **Search** field, type **Create a restore point**.
- 2 Click or touch **Create a restore point**.
- 3 Select the **System Restore** button on the **System protection** tab.
- 4 Select **Recommended Restore** or **Choose a different restore point** to restore the system to a point at which your keyboard was working properly.

## Clean the keyboard

- 1 Turn Off your computer and unplug all cords/cables and connections, see ["To Shut down your computer" on page 44](#).
- 2 Leaving the lid to the computer physically open, turn it upside-down and very gently shake your computer to dislodge any foreign objects that might be under the keys.

---

**NOTE** Please be very gentle when cleaning the keyboard.

---

## Touchpad help

If you are having problems with your touchpad or your touchpad is not working correctly. The information below will help guide you through checking some of the most common causes of touchpad problems.

### Disable then enable the touchpad

Press the FN + () keys to enable/disable the touchpad. For more information, see [“Disabling or enabling the touchpad” on page 173](#).

### Install an external mouse

Without a touch screen it may be challenging to navigate your way around the operating system without a working touchpad. To help you troubleshoot the issue you may want to install an (optional) external mouse.

- 1 Plug a USB mouse into an open USB port on your computer.
- 2 If prompted, follow the on-screen instructions for installation.

---

**NOTE**

The computer may automatically download the needed driver for your mouse (Internet connection required).

---

### Perform a complete power cycle

- 1 Shut down your computer, see [“To Shut down your computer” on page 44](#).
- 2 Remove all accessories, and unplug all cables. This includes USB flash drives, SD Card, and the power cord/cable.
- 3 If your computer has a user-removable battery, remove the battery and hold down the power button for approximately 10 seconds.
- 4 Reconnect the battery (if you removed it) and the power cord/cable.
- 5 Turn On the computer, and try the keyboard again.

## Uninstall the touchpad driver

You can Uninstall the touchpad driver to allow Windows to automatically reinstall the driver.

- 1 In the **Search** field, type **Device Manager**.
- 2 Click or touch the **Device Manager** application.
- 3 In the “Device Manager” select **Mice and other pointing devices**.
- 4 Right-click or touch the device with **touchpad** in the name and select **Uninstall**.

**NOTE** Do **NOT** select the “Delete the driver software for this device” box.

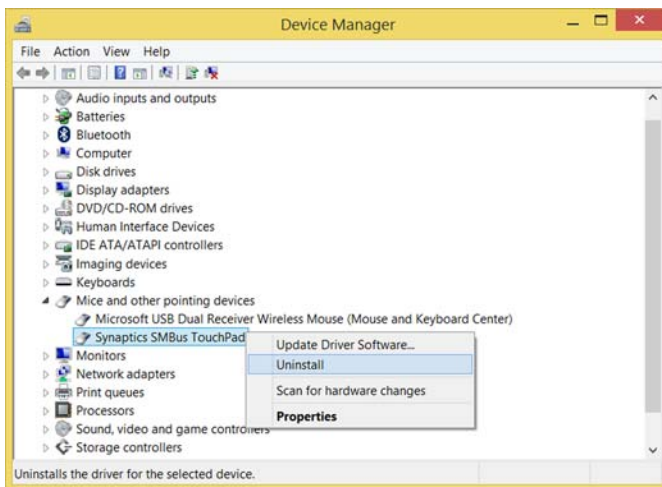

*(Sample Image) Device Manager - touchpad uninstall*

- 5 After the driver uninstalls, restart your computer, see “[To Restart your computer](#)” on page 45.  
The driver is then reinstalled automatically.

## Download the latest touchpad driver

- 1 In your Web browser go to <http://support.toshiba.com/drivers>.
- 2 Enter your computer's serial number.
- 3 Filter your search by **Touchpad driver** to find and download the touchpad driver for your computer.

---

**NOTE**

In order to determine the correct driver to download, you can look in Device Manager on your computer for the device you wish to update and make note of the device name. See [“How to determine the correct drivers to download”](#) on page 159.

---

- 4 Install the **touchpad** driver.
- 5 Restart your computer, see [“To Restart your computer”](#) on page 45.

## Perform a system restore

You can perform a system restore to a period in time at which the touchpad was working properly.

---

**NOTE**

If no restore points have been previously created then this method will not work, see [“Saving system configuration with restore points”](#) on page 162.

---

- 1 In the **Search** field, type **Create a restore point**.
- 2 Click or touch **Create a restore point**.
- 3 Select the **System Restore** button on the **System protection** tab.
- 4 Select **Recommended Restore** or **Choose a different restore point** to restore the system to a point at which your touchpad was working properly.

## Adjust the touchpad properties

- 1 In the **Search** field, type **Change your mouse settings**.
- 2 Click or touch **Change your mouse settings**.

---

**NOTE** Some computers may have an **Advanced** tab (or similar) to change the touchpad properties.

---

- 3 You can now change the configuration settings of your touchpad.

## Display problems

Here are some typical display problems and their solutions:

### The screen is blank.

Display Auto Off may have gone into effect. Press any key to activate the screen.

If you are using the built-in screen, make sure the display priority is not set for an external monitor. To do this, press the FN + (F<sub>8</sub>) keys. If this does not correct the problem, press the FN + (F<sub>7</sub>) keys again to return the display priority to its previous setting.



**HINT:** Pressing the FN + (F<sub>8</sub>) keys several times will advance you through the display options.

---

If you are using an external monitor:

- ❖ Check that the monitor is turned on.
- ❖ Check that the monitor's power cord/cable is firmly plugged into a working power outlet.
- ❖ Check that the cable connecting the external monitor to the computer is firmly attached.
- ❖ Try adjusting the contrast and brightness controls on the external monitor.
- ❖ Press the FN + (F<sub>8</sub>) keys to make sure the display priority is not set for the built-in screen.

### The screen does not look correct.

To choose a theme for your desktop background:

- 1 In the **Search** field, type **Change the theme**.
- 2 Click or touch **Change the theme**.
- 3 Select one of the available options.

You can also change the settings for individual components separately by selecting each item.

For more information, see the Windows online Help.

**A message displays saying that there is a problem with your display settings and that the adapter type is incorrect or the current settings do not work with your hardware.**

Reduce the size of the color palette to one that is supported by the computer's internal display.

To change the display properties:

- 1 Right-click or touch & hold in a blank area of the Windows desktop.
- 2 Click or touch **Display settings**.
- 3 Scroll down and select **Advanced display settings**.
- 4 Use the menu to adjust the display options.

**The display mode is set to “Simultaneous” and the external display device does not work.**

Make sure the external monitor is capable of displaying at resolutions of 1280 x 800 or higher. Devices that do not support this resolution will only work in Internal/External mode, and not simultaneous mode.

## **Disk or storage drive problems**

Problems with the storage drive or with external media usually show up as an inability to access the drive or as sector errors. Sometimes a drive problem may cause one or more files to appear to have garbage in them.

## **Error-checking**

---

**NOTE** This feature is not available for optical disc drives.

---

Run Error-checking, which analyzes the directories and files on the storage drive and repairs any damage it finds.

To run Error-checking:

- 1 In the **Search** field, type **computer**.
- 2 Click or touch **This PC** from the list that appears.

- 3 Right-click or touch the drive you wish to check.

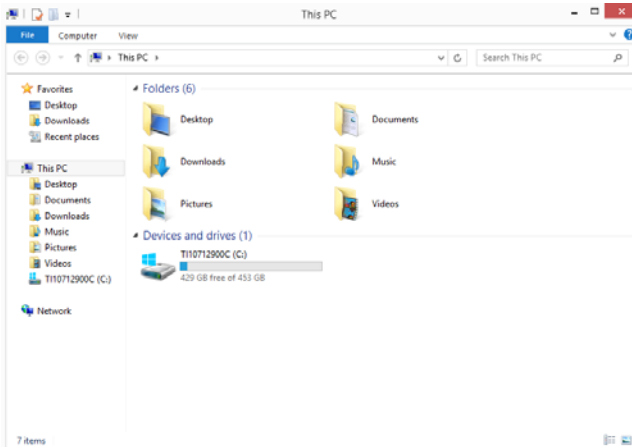

*(Sample Image) Clicking on or touching the drive*

- 4 In the pop-up menu, click or touch **Properties**.  
The drive's Properties box appears.
- 5 Click or touch the **Tools** tab.
- 6 Click or touch the **Check** button.  
The Error Checking box appears.  
The system will alert you if you need to scan the drive.
- 7 Even if you do not need to scan the drive for errors you can scan by clicking or touching **Scan drive**.  
Error-checking tests and repairs the storage drive.

### Your hard disk seems very slow.

If you have been using your computer for a long time, your files may have become fragmented. Run Disk Defragmenter.

To do this:

- 1 In the **Search** field, type **Defragment**.
- 2 Click or touch **Defragment and Optimize your Drives**.
- 3 From the Optimize Drives menu click or touch the drive you wish to defragment.
- 4 Click or touch the **Optimize** button.  
The system will display the status as it optimizes and defragments the drive.

**Your data files are damaged or corrupted.**

Refer to your software documentation for file recovery procedures. Many software packages automatically create backup files.

You may also be able to recover lost data using utility software. Consult your network administrator.

**Some programs run correctly but others do not.**

This is probably a configuration problem. If a program does not run properly, refer to its documentation and check that the hardware configuration meets its needs.

**Optical disc drive problems****You cannot access a disc in the drive.**

If the optical disc drive is an external drive, make sure the two USB cables or the AC adaptor cable are properly connected to the computer and refer to the documentation that came with your drive.

Make sure the tray that holds the optical disc is closed properly. Press gently until it clicks into place.

Open the tray and remove the disc. Make sure the tray is clean. Any dirt or foreign object can interfere with the laser beam.

Examine the disc to see if it is dirty. If necessary, wipe it with a clean cloth dipped in water or a neutral cleaner.

Replace the disc in the tray. Make sure that the disc is lying flat against the tray, label side up. Close the tray carefully, making sure it has shut completely.

**You press the disc eject button, but the drive tray does not slide out.**

Make sure the computer is connected to a power source and turned on. The optical disc drive eject mechanism requires power to operate.

Make sure a program is not accessing the drive and preventing it from ejecting.

If you need to remove a disc and cannot turn on the computer (for example, if the battery is completely discharged), use a narrow object, such as a straightened paper clip, to press the manual eject button. This button is in the small hole next to the optical disc drive eject button on the face of the optical disc drive tray.

**CAUTION**

Never use a pencil to press the manual eject button. Pencil lead can break off inside the computer and damage it.

**Some discs run correctly but others do not.**

Check that the type of disc you are using is compatible with your optical disc drive. For more information regarding supported optical media formats, refer to the complete detail specifications for your computer at [support.toshiba.com](http://support.toshiba.com).

If the problem is with an optical data disc, refer to the software's documentation and check that the hardware configuration meets the program's needs.

**The disc will not come out of the drive when you click the eject button on the screen.**

Press the button on the optical disc drive itself. For additional information see ["You press the disc eject button, but the drive tray does not slide out."](#) on page 144.

## Web Camera help

There are a few easy steps to troubleshooting and fixing Web Camera issues. Any one of the steps below may fix the problem. After each step, test the Web Camera. If it works, stop troubleshooting. If you do not wish to go through each troubleshooting step, you may skip to ["Perform a system restore"](#) on page 146.

### Testing your internal Web Camera

- 1 In the **Search** field, type **Camera**.
- 2 Click or touch the **Camera** application.

**NOTE**

If the Camera application is not available you can download the Camera application from the Windows store.

- 3 If the internal Web Camera works using the default camera application but does not work with your third party camera application contact the provider.

---

## Uninstall the Web Camera driver

You can Uninstall the Web Camera driver to allow Windows to automatically reinstall the driver.

- 1 In the **Search** field, type **Device Manager**.
- 2 Click or touch the **Device Manager** application.
- 3 Double-click or touch **Imaging devices**.
- 4 Right-click or touch **Web Camera** and select **Uninstall**.

---

**NOTE** Do **NOT** select the “Delete the driver software for this device” box.

---

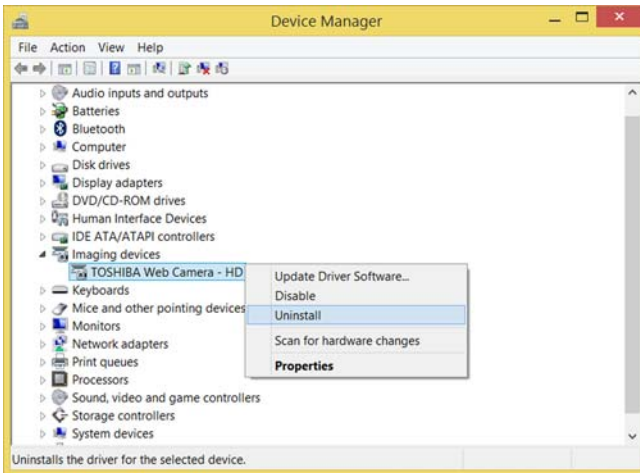

*(Sample Image) Web Camera driver - uninstall window*

- 5 After the driver uninstalls, restart your computer, see “[To Restart your computer](#)” on page 45.

The driver is then reinstalled automatically.

## Perform a system restore

You can perform a system restore to a period in time at which the Web Camera was working properly.

---

**NOTE** If no restore points have been previously created then this method will not work, see “[Saving system configuration with restore points](#)” on page 162.

---

- 1 In the **Search** field, type **Create a restore point**.

- 2 Click or touch **Create a restore point**.
- 3 Select the **System Restore** button on the **System protection** tab.
- 4 Select **Recommended Restore** or **Choose a different restore point** to restore the system to a point at which your Web Camera was working properly.

## Check for problems with third party applications

Uninstall all other applications that use the Web Camera except the pre-installed camera application. If uninstalling the other applications does not fix the problem, reinstall them. If it does fix the problem, try reinstalling them again to check if the Web Camera continues to work. If it stops working again, the problem may be with that specific third-party application.

## System Recovery

The final troubleshooting step is to perform a system recovery. Recovering the computer to its original, out-of-the-box state is one way to eliminate software as a possible cause of the problem. Note that doing a system recovery will return the computer to its default conditions, completely wiping all data (personal documents, installed application, and everything else).

To access system recovery options:

- 1 In the **Search** field, type **recovery options**.
- 2 Click or touch **Recovery Options**.
- 3 Select the recovery option of your choice and then read and follow the on-screen prompts and warnings.

For more information, see [“Recovering the Internal Storage Drive” on page 46](#).

## Sound help

Many sound problems may be caused by hardware that isn't set up properly. The following troubleshooting tips may help you check your software and hardware.

### Use the Sound troubleshooter

- 1 In the **Search** field, type **Find and fix audio playback problems**.
- 2 Click or touch **Find and fix audio playback problems**.

- 3 Click or touch **Next** in the troubleshooter and follow the on-screen instructions.

## Check and set default speakers

- 1 In the **Search** field, type **Change system sounds**.
- 2 Click or touch **Change system sounds**.
- 3 Click or touch the **Playback** tab.
- 4 Select a playback device.
- 5 Click or touch the **Set Default** button.

**NOTE** If only one playback device is listed, that device is set as the default automatically.

- 6 With the default playback device selected, click or touch the **Configure** button.

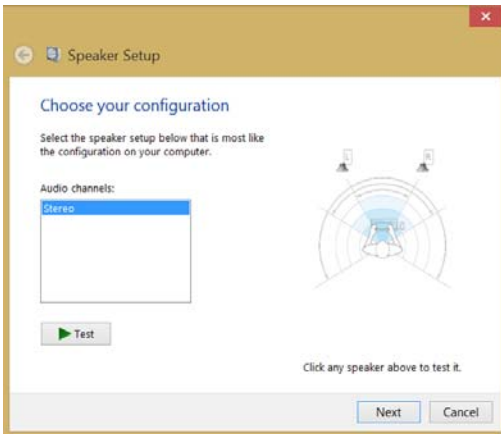

*(Sample Image) Speaker Setup window*

- 7 Click or touch **Stereo** in the “Audio channels” box.

**NOTE** If “Stereo” is not available select any other available option.

- 8 Click or touch the **Test** button to send sound to each speaker, or click or touch an individual speaker to send sound to it.
- 9 If sound is heard correctly from each speaker, your speaker setup is complete.

- 10 If no sound is heard from all or one of the speakers, or if the configuration type was changed, continue with the speaker setup by clicking or touching **Next**. Follow the on-screen instructions to complete the speaker setup.

## Uninstall the audio driver

You can Uninstall the audio driver to allow Windows to automatically reinstall the driver.

- 1 In the **Search** field, type **Device Manager**.
- 2 Click or touch the **Device Manager** application.
- 3 Double-click or touch **Sound, video and game controllers**.
- 4 Right-click or touch **Sound Audio driver** and select **Uninstall**.

### NOTE

- ❖ Do **NOT** select the “Delete the driver software for this device” box.
- ❖ Take note of the audio driver name(s) in the event you may need to manually download the audio driver from [support.toshiba.com/drivers](http://support.toshiba.com/drivers).

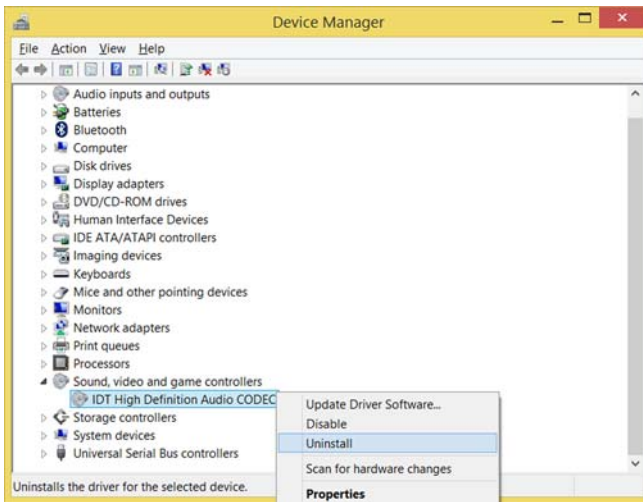

*(Sample Image) Audio driver - uninstall window*

- 5 After the driver uninstalls, restart your computer, see “[To Restart your computer](#)” on page 45.

The driver is then reinstalled automatically.

## Download the latest sound driver

- 1 In your Web browser go to <http://support.toshiba.com/drivers>.
- 2 Enter your computer's serial number.
- 3 Filter your search by **Sound driver** to find and download the Sound driver for your computer.

---

**NOTE**

To determine which device requires a driver, follow the procedure below:

- a In the **Search** field, type **Device Manager**.
  - b Click or touch the **Device Manager** application.
  - c Select **Sound, video and game controllers**.
  - d The various Audio drivers will be listed under "Sound, video and game controllers."
  - e Take note of the Audio driver name(s) in order to locate the proper driver on the Toshiba support Web site, "Drivers & Software" page.
- 
- 4 Install the desired Audio driver.
  - 5 Restart your computer, see "[To Restart your computer](#)" on page 45.

## Perform a system restore

You can perform a system restore to a period in time at which the sound system was working properly.

---

**NOTE**

If no restore points have been previously created then this method will not work, see "[Saving system configuration with restore points](#)" on page 162.

---

- 1 In the **Search** field, type **Create a restore point**.
- 2 Click or touch **Create a restore point**.
- 3 Select the **System Restore** button on the **System protection** tab.
- 4 Select **Recommended Restore** or **Choose a different restore point** to restore the system to a point at which your sound system was working properly.

---

## Printer problems

This section lists some of the most common printer problems.

### **The printer will not print.**

Check that the printer is connected to a working power outlet, turned on and ready (on line).

Check that the printer has plenty of paper. Some printers will not start printing when there are just two or three sheets of paper left in the tray.

Make sure the printer cable is firmly attached to the computer and the printer.

Run the printer's self-test to check for any problem with the printer itself.

Make sure you installed the proper printer drivers as shown in the instructions that came with the printer.

You may have connected the printer while the computer is on. Disable Sleep mode, turn off the computer, and turn off the printer. Turn the printer back on, make sure it is online, and then turn the computer back on.

Try printing another file. For example, you could create and attempt to print a short test file using Notepad. If a Notepad file prints correctly, the problem may be in your original file.

If you cannot resolve the problem, contact the printer's manufacturer.

### **The printer will not print what you see on the screen.**

Many programs display information on the screen differently from the way they print it. See if your program has a print preview mode. This mode lets you see your work exactly as it will print. Contact the software manufacturer for more information.

---

## Wireless networking problems

---

**NOTE**

This section provides general troubleshooting tips for networking problems, specifically wireless (Wi-Fi) networking.

The terms and concepts used assume a basic understanding of networks, and may be for more advanced users. If you need assistance or if you are not familiar with the terminology, please see Windows Help and Support or contact your computer technician.

---

- ❖ If your computer is equipped with an internal Wi-Fi adapter, verify that Airplane mode is OFF (the wireless indicator light  will be lit).
- ❖ Verify that your computer can detect access points or routers. If it can detect a Wi-Fi access point or router then it may be a configuration issue.
- ❖ Verify that signal strength is good using the utility provided with the Wi-Fi adapter.
- ❖ If another computer is on the same network, verify that it has network access, and can connect to the Internet. If, for example, the other computer cannot browse to a public Web site, the ISP's (Internet Service Provider) service may be disrupted.
- ❖ Verify that the Service Set Identifier (SSID), or network name, is correct - i.e., that it matches the SSID assigned to the access point you are attempting to connect through. SSIDs are case-sensitive.
- ❖ Check the Windows Control Panel's Device Manager to verify that the Wi-Fi adapter is recognized by the Windows operating system, and that the driver is loaded. To access the Device Manager, in the **Search** field, type **Device Manager**. Click or touch **Device Manager**, select **System and security**, and then **System**. Launch the Device Manager and carefully note any error messages - these will be very helpful if you should confer with a support technician at a later time.

---

**NOTE**

To enable or disable wireless communication, use the FN + () keys. For more information see "[TOSHIBA Function Keys](#)" on page 170.

---

- ❖ Use IPCONFIG to verify that the computer has a useful IP address – one other than the private address of 169.254.xxx.xxx assigned by Windows.

- 1 In the **Search** field, type **Cmd**.

- 2 Click or touch **Command Prompt**.

- 3 Enter **IPCONFIG/ALL**, and then press **ENTER**.

The IP address for each active network adapter will be displayed.

- ❖ Connect your computer directly to your router or broadband modem, by plugging a standard CAT5 Ethernet patch cable (sold separately) into your computer's RJ45 Ethernet port. If your connection problem disappears, the problem lies in the Wi-Fi part of your network.
- ❖ If you have enabled any security provisions (closed system, MAC address filtering, Wired Equivalent Privacy [WEP], etc.), check the access point vendor's Web site for recent firmware upgrades. Problems with WEP keys, in particular, are frequently addressed in new firmware releases.

## Connecting to the Internet

To connect to the Internet, you'll need an Internet Service Provider (ISP) and additional hardware.

- ❖ **ISP:** An ISP is a company that gives you access to the Internet. You sign up for an account with an ISP just as you do for telephone service or utilities. ISPs are usually phone companies (for a DSL or fiber optic connection) or TV providers (for a cable or satellite connection).
- ❖ **Hardware:** For a broadband connection, such as DSL, fiber optic, or cable, you may need a broadband modem. This might be included as part of the start-up hardware from your ISP when you sign up for a broadband account or you might need to rent or purchase a modem separately. If you plan to share Internet access with multiple computers by using a home network, you may also need a router. (Sometimes a modem and router are combined in one device.)

## Using a wireless connection

After you have an ISP and you've connected your hardware by following the ISP's instructions, you might already be connected to the Internet. To find out, open your Web browser and try visiting a Web site. If the Web site doesn't appear, try connecting to a network.

Click or touch the **Network** (📶) icon on the taskbar. Click or touch the network you wish to connect to, and then click or touch **Connect**.

## Troubleshooting an Internet connection – Verify network status

The appearance of the **Network** (📶) icon in the taskbar indicates the following conditions:

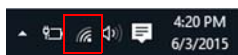

The network connection is set to wireless and you are connected to a wireless access point.

Check with your ISP for network difficulties.

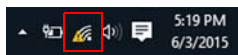

The network connection is set to wireless and you are connected to a wireless access point, but have no Internet connectivity.

Check with your ISP for network difficulties.



The network connection is set to wireless and you are **NOT** connected to a wireless access point.

Check your home router and try moving your computer closer to the wireless access point.



You are connected using a wired connection.

Check your modem and ISP for difficulties.



The network connection is set to Airplane mode.

Toggle Airplane mode using the FN + (F8) keys.



The wireless network adapter is disabled.

Double-click or touch the **Network** icon and set Wi-Fi to **On**.

---

## Troubleshooting an Internet connection – Verify hardware

Before troubleshooting any problem you are having with connecting to the Internet, verify the following:

- 1 Make sure all cords/cables are connected, (e.g. modem connection from the wall and connection cables to the router).

---

**NOTE** The modem and router may be combined into one device.

---

- 2 Remove the power cord/cable from the modem and the router.
- 3 Wait approximately 10 seconds, then plug the modem and the router back in.
- 4 Wait for the modem and router to completely startup before continuing.

---

**NOTE** This may take a few minutes to complete. Most devices have indicator lights that indicate the progress. If it is not apparent you may need to contact the manufacturer for assistance.

---

- 5 Verify your Wi-Fi is turned On. Check the **Network**  icon in the taskbar for signal strength.

## Uninstall the network adapter driver

You can Uninstall the network adapter driver to allow Windows to automatically reinstall the driver.

- 1 In the **Search** field, type **Device Manager**.
- 2 Click or touch the **Device Manager** application.
- 3 In the “Device Manager” double-click or touch **Network Adapters**.
- 4 Right-click or touch the device that has “Wireless” in the name and select **Uninstall**.

**NOTE** Do **NOT** select the “Delete the driver software for this device” box.

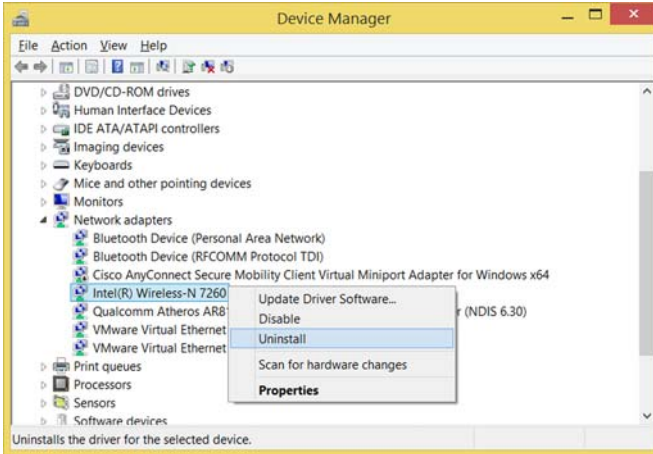

*(Sample Image) Device Manager - Network adapter uninstall*

- 5 After the driver uninstalls, open the **Action** menu in Device Manager.
- 6 Select **Scan for hardware changes**.
- 7 After the driver uninstalls, restart your computer, see [“To Restart your computer” on page 45](#).

The driver is then reinstalled automatically.

If you are still unable to connect to a wireless network, you may have a hardware issue that will require further troubleshooting.

## Troubleshooting an Internet connection – How to verify TCP/IP

If the wireless network is not detected, you can check that the hardware in the computer is working correctly by using the PING command to verify that the network adapter and TCP/IP is working properly. This can be done by performing the following steps:

- 1 Open the command prompt by pressing the **Windows** (⊞) + **X** keys, then selecting **Command Prompt (Admin)** in the pop-up window.
- 2 At the command prompt, type **ping 127.0.0.1** and press **ENTER**.

- 3 If the network adapter and TCP/IP are functioning correctly, you should receive a response that looks similar to the following:

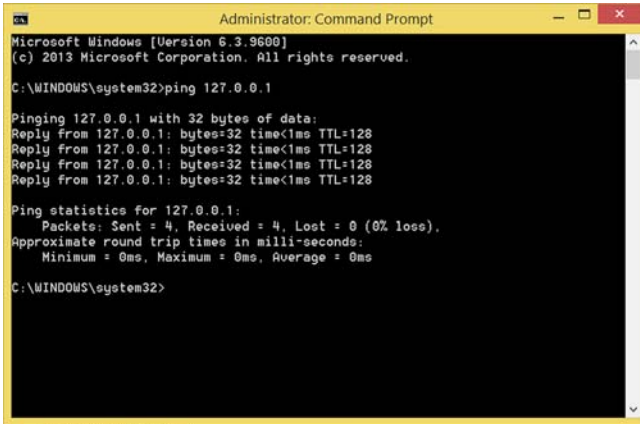

```
Administrator: Command Prompt
Microsoft Windows [Version 6.3.9600]
(c) 2013 Microsoft Corporation. All rights reserved.

C:\WINDOWS\system32>ping 127.0.0.1

Pinging 127.0.0.1 with 32 bytes of data:
Reply from 127.0.0.1: bytes=32 time<1ms TTL=128
Reply from 127.0.0.1: bytes=32 time<1ms TTL=128
Reply from 127.0.0.1: bytes=32 time<1ms TTL=128
Reply from 127.0.0.1: bytes=32 time<1ms TTL=128

Ping statistics for 127.0.0.1:
    Packets: Sent = 4, Received = 4, Lost = 0 (0% loss),
    Approximate round trip times in milli-seconds:
        Minimum = 0ms, Maximum = 0ms, Average = 0ms

C:\WINDOWS\system32>
```

*(Sample Image) Command Prompt window*

If you receive an error message at this point, TCP/IP may not be properly installed. To remove and reinstall TCP/IP, perform the following steps:

- 1 In the command prompt window type **netsh int ip reset resetlog.txt** (with the spaces as indicated) and press ENTER.

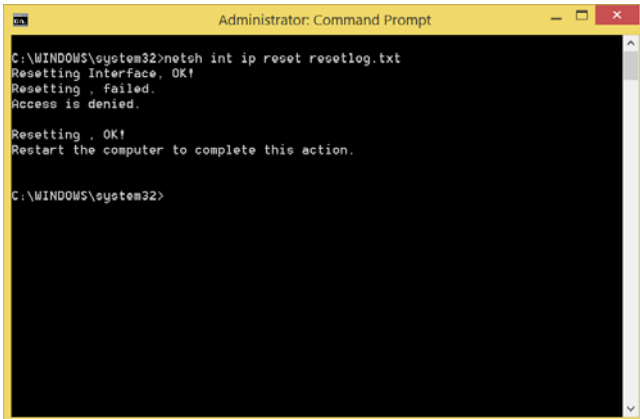

```
Administrator: Command Prompt

C:\WINDOWS\system32>netsh int ip reset resetlog.txt
Resetting interface, OK!
Resetting failed.
Access is denied.

Resetting . OK!
Restart the computer to complete this action.

C:\WINDOWS\system32>
```

*(Sample Image) Command Prompt window*

When you run this command, it will rewrite the registry keys used for TCP/IP settings and have the same result as removing and reinstalling the protocols.

- 2 Restart your computer and try connecting to your home network and Internet again.

If the computer still does not detect a wireless network, the driver for the network adapter may need to be removed and reinstalled. During this process, the network adapter will be removed, Windows will go through a hardware detection process, and the driver will be reinstalled automatically.

## Downloading drivers and updates

### Using Toshiba Service Station

The easiest way to update your computer with the latest components and drivers is to use Toshiba Service Station.

To access TOSHIBA Service Station:

- 1 In the **Search** field, type **Service Station**.
- 2 Click or touch the **Service Station** Utility.
- 3 Read and accept “TOSHIBA Service Station Utility Software Notice & Acceptance,” (if required).
- 4 Click or touch **Check for Updates** and install any available updates.

---

**NOTE**

It may be necessary to move the “TSS” application screen to the right side of the display to reveal any warning notices that may appear.

---

## Manually download and install drivers and updates

---

**NOTE**

An Internet connection is required.

---

Follow the instructions below to download and install component drivers and updates from Toshiba:

- 1 In your Web browser go to <http://support.toshiba.com/drivers>.
- 2 Enter your computer’s model and/or serial number.
- 3 Filter your search to specify the type of driver needed.
- 4 Download and install the most recent drivers.

- 5 Follow the on-screen instructions.
- 6 Restart your computer, see “To Restart your computer” on page 45.

## How to determine the correct drivers to download

When downloading or updating drivers, it is important to choose the correct driver that will work properly for the specific device in (or connected to) your computer. On the “Drivers & Software” area of the Toshiba support Web site, there may be several drivers listed for the same device. Often, a particular device is made by several vendors, each may require a specific driver made by that vendor.

The following steps will help ensure you choose the correct drivers for your computer by using the Device Manager application in Windows:

- 1 In the **Search** field, type **Device Manager**.
- 2 Click or touch the **Device Manager** application.
- 3 Locate the device for which you wish to update the driver. (e.g. If you want to find the touchpad driver you would look under **Mice and other pointing devices**.)

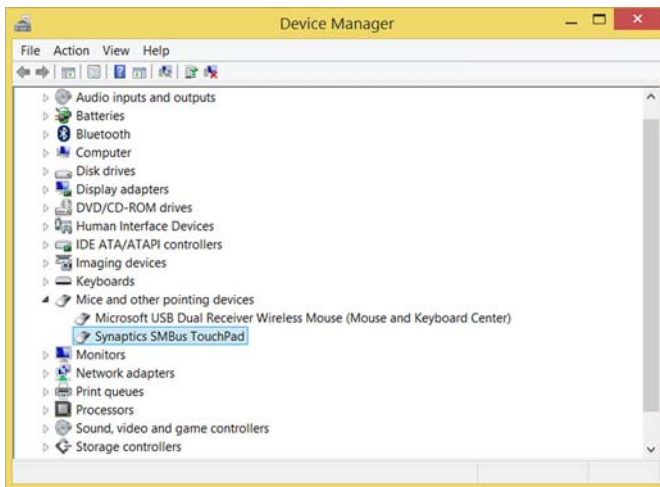

*(Sample Image) Driver install window*

- 4 The above example indicates the touchpad vendor's name.

This tells you that when you go to <http://support.toshiba.com/drivers> and enter your computer's model and/or serial number to find drivers, you should filter your search by **Touchpad driver** to find the latest driver from that vendor.

## DVD operating problems

If you experience a problem playing DVDs, you may be able to fix the problem yourself.

For general problems playing a DVD title, try the following steps:

- 1 Verify that the disc is in a format that the drive supports.
- 2 Ensure that the disc is properly inserted in the drive tray.
- 3 Use the DVD Player software that came with your computer to view DVD movies.

- 4 Clean the disc and try again.

A dirty drive can also cause audio problems. If you have tried several discs and all fail, consider sending your drive to an authorized service provider to get it cleaned.

- 5 In the **Search** field, type **Computer**. Click or touch **This PC** from the list that appears.

The optical disc drive should appear in the list.

- 6 See “[Downloading drivers and updates](#)” on page 158 for instructions on using Device Manager to view the optical disc drive properties.
- 7 Check the Toshiba Web site for new information on optical disc drives and their operation.

### **A blank screen appears while watching a DVD-ROM movie or title.**

Change the setting for when to turn off the display using the following steps:

- 1 In the **Search** field, type **Power options**.
- 2 Click or touch **Power options**.
- 3 From the search list, click or touch **Choose when to turn off display**.
- 4 To keep the display from turning off, click or touch **Never** in both drop down lists.
- 5 Click or touch **Save changes**.

---

**The screen saver runs while you are watching a movie or title.**

If the screen saver is enabled, it runs on top of any movie or title you are watching. To disable the screen saver:

- 1 In the **Search** field, type **Change screen saver**.
- 2 Click or touch **Change screen Saver**.
- 3 Select **None** from the **Screen saver** drop-down list.
- 4 Click or touch **OK**.

## Develop good computing habits

### Save your work frequently.

You can never predict when your computer will lock, forcing you to close a program and lose unsaved changes. Many software programs build in an automatic backup, but you should not rely solely on this feature. Save your work! See [“Computing tips” on page 65](#) for instructions.

### On a regular basis, back up the information stored on your internal storage drive.

Use Windows to back up files, or the entire computer, to a flash drive, or external hard disk. Here are some ways you can do this:

- ❖ Use the Windows operating system to back up files or your entire computer to a flash drive, or external hard disk.
- ❖ Copy files to a rewritable external storage device.
- ❖ Connect your computer to the office network and copy files to your network partition.

Some people use a combination of these methods, backing up all files weekly and copying critical files to external media on a daily basis.

If you have installed your own programs, you should back up these programs as well as your data files. If something goes wrong that requires you to reformat your internal storage drive and start again, reloading all your programs and data files from a backup source will save time.

### Read the documentation.

It is very difficult to provide a fail-safe set of steps you can follow every time you experience a problem with the computer. Your ability to solve problems will improve as you learn about how the computer and its software work together.

Get familiar with all of the documentation provided with your computer, as well as the information that may come with the programs and devices you purchase.

Your local computer store or book store sells a variety of self-help books you can use to supplement the information in the manuals.

### Data and system configuration backup in the Windows operating system

The Windows operating system offers some easy-to-use features for backing up your Windows settings and your data – documents and other important files. Take advantage of these features to protect yourself from much more difficult and time-consuming restoration procedures, and to safeguard your valuable data from loss.

#### Saving system configuration with restore points

The System Restore feature of the Windows operating system quickly creates restore points – ‘snapshots’ of your Windows operating system configuration – and saves them for later recall. If you experience problems after installing some new hardware or software, you can easily select a previously established Control Point to ‘turn back the clock,’ restoring the Windows operating system to the state it was in just prior to the installation. This is much easier and more effective than uninstalling the hardware or software, which often leaves behind unwanted files and settings. It is also easy to undo a restore point selection, if you change your mind.

Follow these steps to create a restore point using the System Restore utility:

- 1 In the **Search** field, type **Create a restore point**. Click or touch **Create a restore point** from the list that appears.

The **System Protection** tab of the System Properties window appears.

- 
- 2 Click or touch **Configure**.
  - 3 Under **Restore settings**, select **Turn on System Protection**.
  - 4 Click or touch **Apply**.
  - 5 Click or touch **OK**.
  - 6 In the input field, enter a name that is descriptive enough to be easily understood in the future, such as “Before installing Brand X Accounting app.” Then click or touch **Create**.

The Windows operating system creates the restore point, automatically stamps it with the current date and time, and displays a message that the restore point was successfully created.

- 7 Click or touch **Close**.

Then, at a later time, you can re-establish your Windows configuration using the saved restore point.

To do this:

- 1 In the **Search** field, type **Create a restore point**. Click or touch **Create a restore point** from the list that appears.

The **System Protection** tab of the System Properties window appears.

- 2 Click or touch **System Restore...**
- 3 Click or touch **Next**.
- 4 Click or touch the Restore point you wish to use, then click or touch **Next**.

The time stamp and description of each Restore point is displayed.

---

**NOTE**

At this point you can click or touch “Scan for affected programs” to determine what the impact of using the chosen Restore Point will be.

---

- 5 Verify that the Restore point you chose is the correct one. If it is not, click or touch **Back** to return to the previous step.
- 6 Close all programs and save all open files.

- 7 Click or touch **Finish**, and then **Yes** to begin the system restore.

Your Windows operating system configuration will now be restored to the state it was in when the chosen restore point was created, and then the computer will be automatically restarted.

## Backing up your data or your entire computer with the Windows operating system

The most valuable component of your computer system is the data you create and store on its internal storage drive. Since problems with either hardware or software can make the data inaccessible or even destroy it, the next most valuable component of your computer system may be a recent backup of your data.

Fortunately, the Windows operating system offers a convenient way to back up your computer or just your important files to a flash drive, or external hard drives. An external hard drive is recommended in case the internal storage drive fails.

Follow these steps to back up your computer or files to a flash drive, or an external storage drive:

---

**NOTE** You cannot back up the computer while running on battery power. Connect the AC adaptor before continuing.

---

- 1 In the **Search** field, type **Save backup copies of your files with File History**.
- 2 Click or touch **Save backup copies of your files with File History** and follow the on-screen instructions to back up your files.

For additional Help, press the FN + (F1) keys to launch the Windows Help and Support screen. Search for “back up files.”

## General tips for installing hardware and software

Here are a few tips to help ensure safe and easy installation of new hardware (printers, pointing devices, external hard drives, optical disc drive writers, scanners, etc.) and software applications like Microsoft® Office and Adobe® Photoshop®, or utility software such as special toolbars for your web browser.

- ❖ Create a restore point (refer to [“Saving system configuration with restore points” on page 162](#)). Before installing anything, use the System Restore utility to set a restore point (see the section titled restore points). If anything goes wrong, you will then be able to easily restore the Windows operating system to the state it was in prior to the installation, undoing any changes that the installation process introduced.
- ❖ Back up your critical data (see [“Backing up your data or your entire computer with the Windows operating system” on page 164](#)).
- ❖ Have your back up media on hand in case you need any files from them.
- ❖ Do not guess – follow directions carefully! It is often necessary to run an installation utility first – before connecting a new hardware item to the computer. If the device is connected first, it may be very difficult to complete the installation successfully. Always carefully follow the installation instructions that accompany the hardware or software.
- ❖ Restart the Windows operating system. Always restart the Windows operating system after each installation, even if the installation utility does not prompt you to do so. This will ensure that the installation is completed, and will clean up anything that the installation utility left behind.
- ❖ Do one installation at a time. If you have several new items to add to your computer system, install just one at a time, creating restore points immediately before each successive installation. This will make it much easier to determine the origin of any new problems. For best results, follow this sequence:
  - 1 Back up critical data.
  - 2 Create a restore point.

- 3 Install one item of hardware or software.
- 4 Restart the Windows operating system.
- 5 Use the new hardware or software for a while, noting any new problems. Make sure that your critical applications (email, business applications, etc.) are working correctly, and verify that important devices are still functioning.
- 6 For each additional hardware or software item, repeat these steps, starting at step 1 if any of your critical data has changed, or starting at step 2 if no critical data has changed.

### **USB Sleep and Charge is not working.**

USB Sleep and Charge may be disabled. Open the TOSHIBA Sleep and Charge utility from the System Settings window to check if the feature is disabled and to enable it if necessary. See [“Sleep Utilities” on page 116](#).

- ❖ Make sure that the device you want to charge is connected to a port that supports the USB Sleep and Charge function. Ports that support this feature are identified with the (⚡) icon.
- ❖ USB Sleep and Charge may be disabled. Open the TOSHIBA Sleep and Charge utility from the System Settings window (see [“Sleep Utilities” on page 116](#)) to check if the feature is disabled and to enable it if necessary. For more information, see [“Enabling/Disabling USB Sleep and Charge” on page 118](#).
- ❖ Try selecting a different charging mode in the TOSHIBA Sleep and Charge utility, (see [“Sleep Utilities” on page 116](#)), if your computer provides more than one charging mode. For more information, see [“Power supply mode settings” on page 118](#).
- ❖ If you are attempting to charge a device without an AC adaptor connected to the computer, the computer's battery power may be below the limit specified in the TOSHIBA Sleep utility or the battery may be depleted. Lower the limit in the Sleep and Charge utility to enable charging at the current battery power level, or, if battery power is running low or is depleted, connect the AC adaptor to your computer. For more information, see [“Power supply mode settings” on page 118](#).

- ❖ The USB Sleep and Charge function may not work with certain external devices even if they are compliant with the USB specification. In those cases, power on the computer to charge the device or use a different charging device.

### The “USB Wakeup function” does not work.

- ❖ When the “USB Sleep and Charge function” is set to Enabled the “USB Wakeup function” does not work for ports that support the “USB Sleep and Charge function.” In that case, use a USB port that does not have the “USB Sleep and Charge function”-compatible icon (⚡), if you have a non-Sleep and Charge USB port available or disable the “USB Sleep and Charge function.” For more information, see “Sleep Utilities” on page 116.

## Additional help

### If you need further assistance

If you have followed the recommendations and are still having problems, you may need additional technical assistance.

- ❖ Since some problems may be related to the operating system or the application you are using, it is important to investigate all sources.
- ❖ Review the troubleshooting information for your operating system.
- ❖ If the problem occurs while you are running a application, consult the application’s documentation for troubleshooting suggestions. Contact the software company’s technical support group for their assistance.
- ❖ Consult the dealer from whom you purchased your computer and/or application. Your dealer is your best source for current information.

Technical support is available online at Toshiba’s support Web site at [support.toshiba.com](http://support.toshiba.com). At this Web site you will find answers for many commonly asked technical questions in addition to downloadable software drivers, BIOS updates, and many other downloads.

## Contacting Toshiba

### Toshiba's Technical Support Web site

For technical support, or to stay current on the most recent software and hardware options for your computer, and for other product information, be sure to regularly check the Toshiba Web site at [support.toshiba.com](http://support.toshiba.com).

## Other Toshiba Internet Web sites

<a href="http://toshiba.com">toshiba.com</a>	Toshiba corporate site
<a href="http://us.toshiba.com">us.toshiba.com</a>	Marketing and product information in the USA
<a href="http://accessories.toshiba.com">accessories.toshiba.com</a>	Accessories information in the USA
<a href="http://www.toshiba.ca">www.toshiba.ca</a>	Canada
<a href="http://www.toshiba-Europe.com">www.toshiba-Europe.com</a>	Europe
<a href="http://www.toshiba.co.jp/index.htm">www.toshiba.co.jp/index.htm</a>	Japan
<a href="http://latin.toshiba.com">latin.toshiba.com</a>	Mexico and all of Latin America
<a href="http://acclaim.toshiba.com">acclaim.toshiba.com</a>	Toshiba USA Self-Service support web site
<a href="http://laptopforums.toshiba.com">laptopforums.toshiba.com</a>	Community discussion forums for Toshiba laptop users

## Toshiba's worldwide offices

### Australia

Toshiba (Australia) Pty. Limited  
84-92 Talavera Road  
North Ryde NSW 2113  
Sydney  
Australia

### France

Toshiba Systèmes (France) S.A.  
7, Rue Ampère; B. P. 131  
92800 Puteaux Cédex  
France

### Canada

Toshiba Canada Ltd.  
191 McNabb Street  
Markham, Ontario  
L3R - 8H2  
Canada

### Germany

Toshiba Europe GmbH  
Leibnizstraße 2  
D-93055 Regensburg  
Germany

**Italy**

Centro Direzionale Colleoni  
Palazzo Perseo  
Via Paracelso 10  
20041, Agrate Brianza  
Milano, Italy

**Latin America and Caribbean**

Toshiba America Information  
Systems, Inc.  
9740 Irvine Boulevard  
Irvine, California 92618  
United States

**Spain**

Toshiba Information Systems  
(España) S.A.  
Parque Empresarial San Fernando  
Edificio Europa, 1a Planta  
Escalera A  
28831 (Madrid) San Fernando de  
Henares  
Spain

**United States**

Toshiba America Information  
Systems, Inc.  
9740 Irvine Boulevard  
Irvine, California 92618  
United States

**Japan**

Toshiba Corporation, PCO-IO  
1-1, Shibaura 1-Chome  
Minato-Ku, Tokyo, 105-8001  
Japan

**Mexico**

Toshiba de México S.A. de C.V.  
Sierra Candela No.111, 6to. Piso  
Col. Lomas de Chapultepec.  
CP 11000 Mexico, DF.

**United Kingdom**

Toshiba Information Systems  
(U.K) Ltd.  
Toshiba Court  
Weybridge Business Park  
Addlestone Road  
Weybridge, Surrey KT15 2UL  
United Kingdom

**The Rest of Europe**

Toshiba Europe (I.E.) GmbH  
Hammfelddamm 8  
D-4-1460 Neuss  
Germany

For more information on additional Toshiba worldwide locations, please visit: [www.toshiba.co.jp/index.htm](http://www.toshiba.co.jp/index.htm).

# Appendix A

## TOSHIBA Function Keys

---

TOSHIBA Function keys provide a quick way to modify selected system functions and to launch applications.

### Functions

TOSHIBA Function keys are used to set or modify the following system functions:

- ❖ Mute
- ❖ Lock (Instant security)
- ❖ Power Plan
- ❖ Sleep
- ❖ Hibernation
- ❖ Output (Display switch)
- ❖ Brightness control
- ❖ Wireless
- ❖ Touchpad
- ❖ Cursor control
- ❖ Numeric overlay
- ❖ Scroll lock
- ❖ Keyboard backlight

- ❖ Zoom In/Out
- ❖ Volume
- ❖ Zoom (Display resolution)
- ❖ Cortana®

## Volume Mute

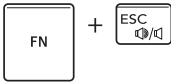

This TOSHIBA Function key enables/disables volume mute.

When volume mute is enabled, no sound will come from the speakers or headphones.

## Lock (Instant security)

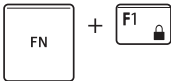

This TOSHIBA Function key activates instant security.

The user logon screen will appear and a user with a valid account will need to log back on to gain access to the computer.

## Power plan

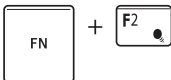

This TOSHIBA Function key displays the currently selectable power plans and cycles through the power plans.

The properties of each power plan, and the power plans that are displayed by this function, are set in the Power Options window (see [“Power Plans” on page 85](#)).

This TOSHIBA function key also allows you to enable notifications for power plans. The notifications are disabled by default.

## Sleep mode



This TOSHIBA Function key places the computer into Sleep mode.

## Hibernation mode



This TOSHIBA Function key places the computer into Hibernation mode.

If Hibernation mode is disabled, this Function key will not respond.

## Output (Display switch)



This TOSHIBA Function key cycles through the display options and highlights the available options. Press ENTER to activate your selection.

- ❖ PC screen only
- ❖ Duplicate
- ❖ Extend
- ❖ Second screen only

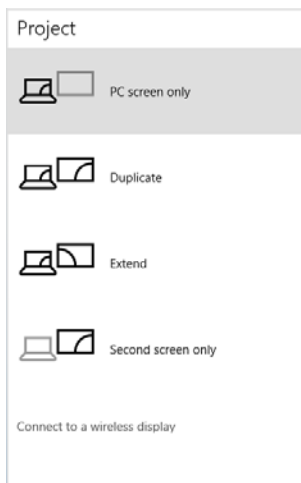





*(Sample Image) Display mode options window*

### NOTE



All of the above modes are always displayed on the screen, however only the available modes for your system are functional, depending on the attached external display(s).

## Display brightness

 +  This TOSHIBA Function key decreases the screen brightness.

 +  This TOSHIBA Function key increases the screen brightness.

## Disabling or enabling wireless devices

 +  This TOSHIBA Function key enables/disables the Wi-Fi antenna in your computer.

---

**NOTE** Allow about 5 seconds to switch between modes.

---

The wireless modes are:

- ❖ Disables the wireless antenna (Airplane mode is ON).
- ❖ Enables the wireless antenna (Airplane mode is OFF).

## Disabling or enabling the touchpad

 +  This TOSHIBA Function key enables/disables the touchpad.

To enable/disable the touchpad press the FN +  keys.

For more information on using the touchpad, see [“Using the touchpad” on page 55](#).

---

**NOTE** The FN +  Function keys apply only to the touchpad and not to the AccuPoint II pointing device.

---

## Disabling or enabling the cursor control overlay

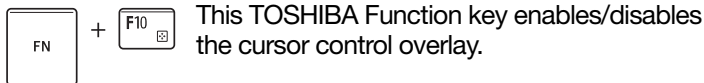

## Disabling or enabling the numeric overlay

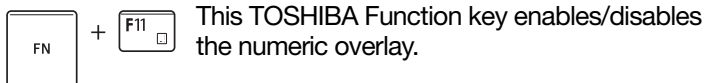

## Disabling or enabling the scroll lock

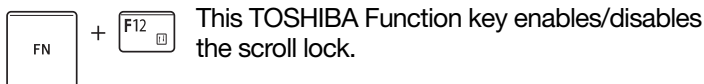

## Keyboard backlight



- ❖ Always On
- ❖ Always Off
- ❖ Keyboard activated (with timer)

**(Available on certain models.)**

## Zoom In/Out

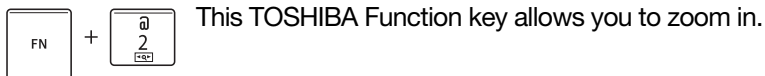
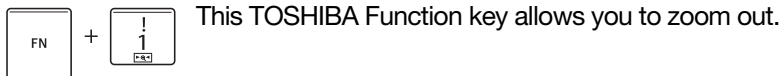

## Volume control

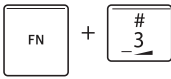

This TOSHIBA Function key decreases the speaker volume.

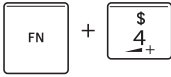

This TOSHIBA Function key increases the speaker volume.

## Zoom (Display resolution)

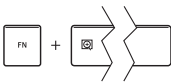

This TOSHIBA Function key switches screen resolution.

Fn+ [Space bar]

Cycle through the screen resolutions, and then select the desired resolution.

## Cortana

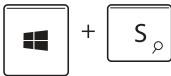

Use these keys for quick access to Cortana.

Cortana is a personal digital assistant that can help you search for content on your device or the Web, manage your calendar, and much more.

# Appendix B

## Power Cord/Cable Connectors

---

Your computer ships with the correct power supply for the country of purchase. This appendix shows the shapes of the typical AC power cord/cable connectors for various parts of the world.

### USA



UL approved

### Canada



CSA approved

### United Kingdom

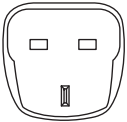

BS approved

### Europe



VDA approved  
NEMKO approved

### Australia



AS approved

# Glossary



TECHNICAL NOTE: Some features defined in this glossary may not be available on your computer.

## Acronyms

The following acronyms may appear in this User's Guide.

<b>AC</b>	Alternating Current
<b>BIOS</b>	Basic Input/Output System
<b>BD-ROM</b>	Blu-ray Disc Read-Only Memory
<b>bps</b>	bits per second
<b>CD</b>	Compact Disc
<b>CD-ROM</b>	Compact Disc Read-Only Memory
<b>CD-RW</b>	Compact Disc Rewrite Memory
<b>CMOS</b>	Complementary Metal-Oxide Semiconductor
<b>CPU</b>	Central Processing Unit
<b>DC</b>	Direct Current
<b>DMA</b>	Direct Memory Access
<b>DIMM</b>	Dual Inline Memory Module
<b>DOS</b>	Disk Operating System

<b>DPI</b>	Dots Per Inch
<b>DVD</b>	Digital Versatile (or Video) Disc
<b>DVD-ROM</b>	Digital Versatile (or Video) Disc Read-Only Memory
<b>FAT</b>	File Allocation Table
<b>FCC</b>	Federal Communications Commission
<b>GB</b>	gigabyte
<b>GBps</b>	gigabytes per second
<b>HDD</b>	Hard Disk Drive
<b>HDMI</b>	High-Definition Multimedia Interface
<b>HDMI CEC</b>	High-Definition Multimedia Interface Consumer Electronics Control
<b>HTML</b>	Hypertext Markup Language
<b>IEEE</b>	Institute of Electrical and Electronics Engineers
<b>I/O</b>	Input/Output
<b>IRQ</b>	interrupt request
<b>ISP</b>	Internet Service Provider
<b>KB</b>	kilobyte
<b>LAN</b>	Local Area Network
<b>LCD</b>	Liquid Crystal Display
<b>LED</b>	Light Emitting Diode
<b>MB</b>	megabyte
<b>MBps</b>	megabytes per second
<b>PC</b>	Personal Computer
<b>RAM</b>	Random Access Memory
<b>RGB</b>	Red, Green Blue light (monitor)
<b>RFI</b>	Radio Frequency Interference
<b>ROM</b>	Read-Only Memory
<b>RTC</b>	Real-Time Clock
<b>SD</b>	Secure Digital
<b>SDRAM</b>	Synchronous Dynamic Random Access Memory
<b>SSD</b>	Solid State Drive

---

<b>TFT</b>	Thin Film Transistor
<b>USB</b>	Universal Serial Bus
<b>URL</b>	Uniform Resource Locator
<b>WAN</b>	Wide Area Network
<b>www</b>	World Wide Web

## Terms

The following terms may appear in this User's Guide.

### A

**active-matrix display**—A liquid crystal display (LCD) made from an array of liquid crystal cells using active-matrix technology. Also known as a “TFT display,” in its simplest form there is one thin film transistor (TFT) for each cell. This type of display works well with computers because of its shallow depth and high-quality color. Active-matrix displays are viewable from wider angles than most passive-matrix displays.

**adapter**—A device that provides a compatible connection between two units. For example, the computer's internal display adapter receives information from the software and translates it into images on the screen. An adapter can take a number of forms, from a microprocessor to a simple connector. An intelligent adapter (one that is capable of doing some processing) may also be called a controller.

**Alternating Current (AC)**—The type of power usually supplied to residential and commercial wall outlets. AC reverses its direction at regular intervals. Compare *Direct Current (DC)*.

**application**—A computer program that you use to perform tasks of a specific type. Applications include word processors, spreadsheets, and database management systems. See also *program*.

### B

**backup**—A copy of a file, usually on a removable disk, kept in case the original file is lost or damaged.

**Basic Input/Output System (BIOS)**—See *BIOS*.

**baud rate**—The speed at which a communication device, such as a printer or modem, transmits information. Baud rate is the number of signal changes per second (not necessarily the same as bits per second). See also *bits per second*.

**Blu-ray Disc (BD)**—Offering more storage capacity than DVDs, the format was developed to allow for more data storage and to enable recording and playback of high-definition video (HD).

**BIOS (Basic Input/Output System)**—Basic instructions, stored in read-only memory (ROM), containing the information the computer needs to check hardware and load the operating system when you start up the computer.

**bits per second (bps)**—A way of measuring the speed at which information is passed between two devices. This is the basic unit of measure used in modem communications, and is similar, but not identical, to the baud rate. See also *baud rate*.

**boot**—To start the computer. The term “boot” originates from bootstrap program (as in “pulling itself up by its bootstraps”), a program that loads and initializes the operating system. See also *reboot*.

**boot disk**—See *system disk*.

**boot priority (startup sequence)**—The order in which the computer accesses its internal storage drives to locate the startup files. Under the default startup sequence, the computer looks for the startup files in the external media before checking the internal storage drive.

**bus**—An electrical circuit that connects the central processing unit (CPU) with other parts of the computer, such as the video adapter, disk drives, and ports. It is the pathway through which data flows from one device to another. See also *bus speed*, *frontside bus*.

**bus speed**—The speed at which the central processing unit (CPU) communicates with the other parts of the computer.

- C** **cache**—A section of very fast memory in which frequently used information is duplicated for quick access. Accessing data from cache is faster than accessing it from the computer's main memory. See also *CPU cache*, *L1 cache*, *L2 cache*.
- CD**—An individual compact disc. See also *CD-ROM*.
- CD-ROM (Compact Disc Read-Only Memory)**—A form of high-capacity storage that uses laser optics instead of magnetic means for reading data. See also *CD*. Compare *DVD-ROM*.
- Central Processing Unit (CPU)**—The chip that functions as the “brain” of the computer. It takes information from outside sources, such as memory or keyboard input, processes the information, and sends the results to another device that uses the information.
- character**—Any letter, number, or symbol you can use on the computer. Some characters are non-printing characters, such as a paragraph break in a word-processing program. A character occupies one byte of computer storage.
- chip**—A small piece of silicon containing computer logic and circuits for processing, memory, input/output, and/or control functions. Chips are mounted on printed circuit boards.
- click**—To press and release the pointing device's primary button without moving the pointing device. In the Windows operating system, this refers to the pointing device's left button, unless otherwise stated. See also *double-click*.
- compatibility**—The extent to which computers, programs, or devices can work together harmoniously, using the same commands, formats, or language as another.
- configuration**—(1) The collection of components that make up a single computer system. (2) How parts of the system are set up (that is, configured).
- controller**—A device that controls the transfer of data from a computer to a peripheral device and vice versa. For example, disk drives, monitors, keyboards, and printers all require controllers.
- CPU**—See *Central Processing Unit (CPU)*.

**CPU cache**—A section of very fast memory residing between the CPU and the computer's main memory that temporarily stores data and instructions the CPU will need to execute commands and programs. See also *cache*, *L1 cache*, *L2 cache*.

**cursor**—An on-screen symbol (usually a flashing vertical line) that indicates the position where characters will appear when you enter data.

**D**

**Desktop**—Offers the traditional look and feel of the Windows desktop found in Windows 7 and earlier releases of the Windows operating system.

**default**—The setting selected by a program when the user does not specify an alternative setting.

**device**—A component attached to the computer. Devices may be external (outside the computer's case) or internal (inside the computer's case). Printers, disk drives, and modems are examples of devices.

**device driver**—A program (called a "driver") that permits a computer to communicate with a device.

**dialog box**—An on-screen window displayed by the operating system or a program giving a direction or requesting input from the user.

**Direct Current (DC)**—The type of power usually supplied by batteries. DC flows in one direction. Compare *Alternating Current (AC)*.

**Direct Memory Access (DMA)**—A dedicated channel, bypassing the CPU, that enables direct data transfer between memory and a device.

**directory**—See *folder*.

**disable**—To turn a computer option off. See also *enable*.

**disc**—A round, flat piece of material, designed to be read from and written to by optical (laser) technology, and used in the production of optical discs, such as CDs and DVDs. Compare *disk*.

**disk**—A round, flat piece of material that can be magnetically influenced to hold information in digital form, and used in the production of magnetic disks, such as hard disks. Compare *disc*. See also *hard disk*.

**disk drive**—The device that reads and writes information and programs on external media or hard disk. It rotates the disk at high speed past one or more read/write heads.

**document**—Any file created with an application and, if saved to disk, given a name by which it can be retrieved. See also *file*.

**double-click**—To press and release the pointing device's primary button rapidly twice without moving the pointing device. In the Windows operating system, this refers to the pointing device's left button, unless otherwise stated.

**download**—(1) In communications, to receive a file from another computer through a modem or network. (2) To send font data from the computer to a printer. See also *upload*.

**drag**—To hold down the mouse button while moving the pointer to drag a selected object. In the Windows operating system, this refers to the left mouse button, unless otherwise stated.

**driver**—See *device driver*.

**DVD**—An individual digital versatile (or video) disc. See also *DVD-ROM*.

**DVD-ROM (Digital Versatile [or Video] Disc Read-Only Memory)**—A very high-capacity storage medium that uses laser optics for reading data. Each DVD-ROM can hold as much data as several CD-ROMs. Compare *CD-ROM*.

**E** **enable**—To turn on a computer option. See also *disable*.

**executable file**—A computer program that is ready to run. Application programs and batch files are examples of executable files. Names of executable files usually end with a .com or .exe extension.

**expansion device**—A device that connects to a computer to expand its capabilities. Other names for an expansion device are port expander, port replicator, docking station, or network adapter.

**extension**—See *file extension*.

**external device**—See *device*.

**F** **file**—A collection of related information, saved on disk with a unique name. A file may be a program, information used by a program, or a document. See also *document*.

**File Allocation Table (FAT)**—The section of a storage drive that keeps track of the location of stored files.

**file name**—A set of characters that uniquely identifies a file within a particular folder. It consists of two parts: the actual name and the file name extension. See also *file extension*.

**file extension**—The three characters following the period (pronounced “dot”) at the end of a file name. The extension indicates the type of file. Examples are .exe for program files and .hlp for help files. See also *file name*.

**folder**—Also called directory. A container for organizing files saved to a disk. A folder is symbolized on screen by a graphical image (icon) of a file folder. A folder can contain files and other folders.

**format**—(verb) To prepare a blank disk for use with the computer’s operating system. Formatting creates a structure on the disk so the operating system can write information to the disk or read information from it.

**frontside bus**—The primary pathway (bus) between the CPU and the computer’s main memory. Also called “system bus.” See also *bus*.

**G** **ground**—A conductor to which all components of an electric circuit are connected. It has a potential of zero (0) volts, is connected to the earth, and is the point of reference for voltages in the circuit.

**H** **hard disk**—A storage device composed of a rigid platter or platters that can be magnetically coded with data. Hard disks hold much more information than some external media and are used for long-term storage of programs and data. The primary (or only) hard disk in a computer is usually fixed, but some computers have secondary hard disks that are removable.

**hardware**—The physical components of a computer system. Compare *software*.

**HDMI (High-Definition Multimedia Interface)**—An interface used to transmit high quality audio and video signal via a single cable in digital format, providing better picture quality than analog signal.

**HDMI-CEC (HDMI Consumer Electronics Control)**—One A/V component can control another while using this function, if connected with HDMI cables. See also *HDMI*.

**hot swapping**—The ability to add or remove devices from a computer while the computer is running and have the operating system automatically recognize the change.

**I icon**—A small image displayed on the screen that represents a function, file, or program.

**interlaced**—A method of refreshing a computer screen, in which only every other line of pixels is refreshed. Interlaced monitors take two passes to create a complete screen image. Compare *non-interlaced*.

**internal device**—See *device*.

**Internet**—The decentralized, world-wide network of computers that provides electronic mail, the World Wide Web, and other services. See also *World Wide Web*.

**K keyboard shortcut**—A key or combination of keys that you use to perform a task instead of using a pointing device such as a mouse.

**L L1 (level one) cache**—Memory cache built into the processor to help improve processing speed. See also *cache, CPU cache, L2 cache*.

**L2 (level two) cache**—Memory cache installed on the motherboard to help improve processing speed. It is slower than L1 cache and faster than main memory. See also *cache, CPU cache, L1 cache*.

**LAN (Local Area Network)**—A group of computers or other devices dispersed over a relatively limited area and connected by a communications link that enables any device to interact with any other on the network.

**LED (Light Emitting Diode)**—A solid state lamp (SSL) that uses light-emitting diodes (LEDs) as the source of light, which offers long life and high efficiency output. Multiple diodes are used together, since the light created by individual light-emitting diodes is small compared to incandescent and compact fluorescent lamps.

**LCD (Liquid Crystal Display)**—A type of display that uses a liquid substance between two transparent electrode panels. When an electric current passes through the electrodes, the molecules in the liquid form a crystalline pattern that polarizes the light passing through it. A filter over the electrodes permits only non-polarized light to pass to the surface of the display, creating light and dark pixels.

**load**—To move information from a storage device (such as a hard disk) into memory for processing.

**local area network**—See *LAN*.

**logical drive**—A section of a disk that is recognized by the operating system as a separate disk drive. A system's logical drives may differ from its physical drives. For example, a single hard disk drive may be partitioned into two or more logical drives.

## M

**memory**—Typically refers to the computer's main memory, where programs are run and data is temporarily stored and processed. Memory can be volatile and hold data temporarily, such as RAM, or it can be non-volatile and hold data permanently, such as ROM. A computer's main memory is RAM. See also *RAM*, *ROM*.

**microprocessor**—See *Central Processing Unit (CPU)*.

**motherboard**—The computer's main circuit board that contains the processor, memory, and other primary components.

**MS-DOS prompt**—See *system prompt*.

**multi-function drive**—A DVD drive that can read and write to CD and DVD media.

**multimedia**—A combination of two or more media, such as sound, animation, and video in a computer program or presentation.

- N** **network**—A collection of computers and associated devices that are connected by communications facilities. A network allows you to share data and peripheral devices, such as printers, with other users and to exchange electronic mail.
- non-interlaced**—A method of refreshing a computer screen, in which each pixel of every line is refreshed as the electron beam scans across and down the screen. Compare *interlaced*.
- non-system disk**—A disk for storing programs and data that cannot be used to start the computer. Compare *system disk*.
- O** **online**—Available through the computer. Online may refer to information being read from your own computer's internal storage drive, such as online documentation or online Help, or to information coming from another company on a company network or the Internet.
- operating system**—A set of programs that controls how the computer works. Examples of operating systems are the Windows Vista, Windows 7, and Windows 8 operating systems.
- optical disc drive**—A drive which reads plastic coated discs on which information is recorded digitally, and uses a laser to read data, music, or videos.
- P** **password**—A unique string of characters entered by a user to verify his or her identity to the computer or the network.
- peripheral**—Any device, such as a printer or joystick, that is attached to the computer and controlled by the computer's CPU.
- pixel**—Short for "picture element." The smallest dot that can be produced on a screen or printer.
- Plug and Play**—Generally, refers to the computer's ability to automatically configure itself to work with peripheral devices. When capitalized, refers to a standard that, when followed by a device manufacturer, allows a computer to configure itself automatically to work with the device.

**pointer**—An icon (usually an arrow) that moves on the screen when you slide your finger across the touchpad or move a mouse. Used to point to and select/activate on-screen items, such as icons, menu items, and buttons. The shape and purpose of the pointer varies depending on the program you are using and what you are doing.

**pointing device**—Any device, such as the touchpad or a mouse, that enables you to move the pointer on the screen.

**port**—A socket on the computer where you plug in a cable for connection to a network or a peripheral device.

**processor**—See *Central Processing Unit (CPU)*.

**program**—A set of instructions that can be executed by a computer. The general classes of programs (also called software) are operating system, application, and utility. See also *operating system, application, utility*.

**properties**—The attributes of an object or device. For example, the properties of a file include the file's type, size, and creation date.

## R

**RAM (Random Access Memory)**—*Volatile* memory that can be written to as well as read. *Volatile* here means that information in RAM is lost when you turn off your computer. This type of memory is used for your computer's main memory. See also *memory*. Compare *ROM*.

**Random Access Memory**—See *RAM*.

**Read-Only Memory**—See *ROM*.

**reboot**—See *boot, restart*.

**removable disk**—A disk that can be removed from a disk drive. A Flash drive is one example of a removable disk.

**resolution**—A measure of the sharpness of the images that can be produced by a printer or displayed on a screen. For a printer, resolution is expressed in dots per inch (dpi). For a screen, it is expressed as the number of pixels available horizontally and vertically.

**restart**—Synonymous with reboot. To reset the computer by reloading the operating system without turning the computer off. See also *boot*.

**RGB (Red, Green, Blue) monitor**—A monitor that reproduces all colors by mixing red, green, and blue light in various combinations.

**RJ45 connector**—An eight-wire connector used to connect a computer to a network.

**ROM (Read-Only Memory)**—Non-volatile memory that can be read but not written to. *Non-volatile* here means that information in ROM remains whether or not the computer is receiving power. This type of memory is used to store your computer's BIOS, which is essential instructions the computer reads when you start it up. See also *BIOS, memory*. Compare *RAM*.

## S

**Secure Digital (SD)**—A small, portable, non-volatile memory card used to store and transfer data between digital products, providing encryption capability for content security.

**select**—To highlight or otherwise specify text, data, or graphics with the intent to perform some operation on it.

**shortcut**—See *keyboard shortcut*.

**Sleep**—A feature of some Windows operating systems that allows you to turn off the computer without exiting your open applications and to continue from where you left off when you turn the computer on again.

**software**—See *program*. Compare *hardware*.

**solid state drive**—A data storage device that utilizes solid-state memory as opposed to a hard disk (see also *hard disk*). Solid state drives hold a large amount of information and are used for storage of programs and data.

**Swipe**—Swipe an open window to the left or right of the screen to display the next or previous window.

**system prompt**—The symbol (in the MS-DOS® operating system, generally a drive letter followed by a “greater than” sign) indicating where users are to enter commands.

- T** **TFT display**—See *active-matrix display*.
- Touch**—To activate items displayed on the screen, such as apps, setting icons, and on-screen buttons by touching them with your finger.
- Tile/Tiles**—A list of square or rectangular icons on the Start menu representing applications that can be accessed by selecting them.
- U** **Universal Serial Bus (USB)**—USB is a serial bus that supports data transfer. USB allows hot swapping of peripherals. See also *bus*, *hot swapping*, *serial*.
- upload**—To send a file to another computer through a modem or network. See also *download*.
- USB**—See *Universal Serial Bus (USB)*.
- USB Flash drive**—A small, portable flash memory card that plugs into a computer's USB port and functions as a portable hard drive. They are smaller and more durable than an external hard drive because they do not contain any internal moving parts, but have less storage capacity. See also *Universal Serial Bus (USB)*.
- utility**—A computer program designed to perform a narrowly focused operation or solve a specific problem. Utilities are often related to computer system management.
- W** **Web**—See *World Wide Web*.
- Wi-Fi**—A registered trademark term of the Wi-Fi Alliance that stands for Wireless Fidelity, and is another term for the communication protocol to permit an Ethernet connection using wireless communication components.
- World Wide Web (www)**—The worldwide network of Web sites linked together over the Internet. A user of the Web can jump from site to site regardless of the location of the computer hosting the site. See also *Internet*.

# Index

---

## A

- AC adaptor 40
- AC power 79
- AC power light 40
- accessing
  - network 99
- AccuPoint II 55
  - primary button 55
  - secondary button 55
- adding
  - memory 40
  - optional external devices 46
- adding desktops 96
- adequate ventilation
  - cooling fan 39
- adjusting
  - touchpad settings 58
- Advanced Startup options 132
- App tiles
  - Start menu 96
- app, starting 71
- audio features 100

## B

- backing up files 66, 72

- Backlit keyboard 69

- battery

- battery life 78
- Call2Recycle 91
- care 90
- changing 87
- charge indicator light 41
- charge time 79
- charger 79
- charging 42, 79
- charging the real-time clock (RTC) 80
- conserving power 84
- determine remaining power 82
- disposal 91
- indicator light 82
- installation 89
- low charge 83
- maintaining 90
- maximum capacity 78
- monitoring power 41, 81
- power management 79
- power options 83
- real-time clock (RTC) 79

- recharge time 78
- removing 87
- RTC memory 79
- running computer on battery
  - power 77
- safety precautions 90
- setting notifications 83
- taking care of 90

battery indicator light 82

BIOS Setup

see System Settings

button

eject, optical disc drive 73

## C

Call2Recycle

battery 91

caring for your computer 63

changing

battery 87

charging the battery 42

cleaning the computer 63

communications

set up 98

computer

caring for 63

cleaning 63

environmental precautions 31,  
92

moving 63

running on battery power 77

setting up 39

computer lock 64

computer will not start

troubleshooting 129

computing habits

troubleshooting 161

computing tips 65

connecting

AC adaptor 40

AC adaptor cord to (DC-IN) 41

computer to a network 99

external device 59

HDMI-compatible TV or

display device 60

monitor 61

power cord/cable 41

power source 41

cooling fan

adequate ventilation 39

customize

computer settings 62

## D

data/entire system backup

troubleshooting 164

desktop

adding desktops 96

creating new icon 94

exploring the 93

icons 94

notification area 97

notifications 97

recycle bin 94

standard features 94

Start button 95

Task view 96

taskbar 97

Windows Store 98

desktop notifications

Badge notifications 97

Raw notifications 97

Tile notifications 97

Toast notifications 97

directing

display output 61

disabling

touchpad 59

display

troubleshooting 142

display devices

external 60

Display Utility 123

display, external

- adjusting 62
- disposal information 18
- disposing of used batteries 91
- documentation 30
- downloading drivers/updates
  - determine correct drivers 159
  - manually download/install 158
  - Toshiba Service Station 158
- drivers
  - downloading 158
- DVD
  - removing with computer off 76
  - removing with computer on 76
- DVD player
  - troubleshooting 160
- DVDs
  - using 72

## E

- eco power plan 86
- eco Utility 107
- eject button
  - optical disc drive 73
- eject, optical disc drive 74
- enabling
  - touchpad 59
- ENERGY STAR 26
- Expansion capability 105
- Expansion port
  - using 105
- exploring
  - desktop 93
- external display device
  - HDMI Out port 60
  - RGB (monitor) port 60
- external display, adjusting 62

## F

- files
  - backing up 66, 72
  - saving 72
- fingerprint
  - authentication 124

- Fingerprint Authentication Utility
  - using 124
- Function Keys
  - disabling or enabling wireless devices 173
- Function keys 174
  - Cortana 175
  - disabling touchpad 173
  - Disabling/enabling cursor control overlay 174
  - Disabling/enabling numeric overlay 174
  - Disabling/enabling scroll lock 174
  - display brightness 173
  - Hibernation mode 172
  - Lock (Instant security) 171
  - Output (Display switch) 172
  - Power plan 171
  - Sleep mode 171
  - volume mute 171
  - Zoom (Display resolution) 175
  - Zoom In/Out 174, 175

- function keys 67

## H

- headphones
  - using 101

## I

- icon
  - desktop 94
  - moving to desktop 94
  - Power 44, 45
  - recycle bin 94
  - safety 29
- Initial setup
  - using your computer for the first time 42
- installing
  - a charged battery 89
- internal storage drive
  - recovery 46

## Internet

- connecting 153

## Internet connection

- troubleshooting 154, 155, 156

- wireless connection 154

## K

### keyboard

- Function keys 67

- function keys 67

- overlay keys 68

- special Windows keys 67

- troubleshooting 135

- using 67

### keyboard backlight 174

### keys

- function keys 67

- overlay for cursor control 68

- overlay keys 68

- overlay to type numeric data 68

## L

### LEDs

- system indicator lights 82

  - AC adaptor light 81

  - AC power light 40, 41

  - battery light 41, 42

  - Web Camera light 102

### Licenses 17

### lock

- computer, using 64

## M

### maintaining your battery 90

### manual eject hole

- optical disc drive 74

### memory

- adding 40

### Memory card reader

- inserting memory media 103

- removing memory media 104

- using 103

### microphone

- using 100

### monitor

- connecting 61

### monitor problems

- troubleshooting 141

### monitoring battery power 81

### mouse properties 70

### moving the computer 63

## N

### network

- accessing 99

- connecting your computer 99

### networking

- wireless 98

## O

### online resources

- Toshiba 76

### optical disc

- Auto-Run feature 75

- handling 74

- inserting 74

- playing optical media 75

- positioning 74

- recording optical media 75

- removing with computer off 76

- removing with computer on 76

### optical disc drive

- components 73

- drive in-use indicator light 73

- eject button 73

- handling an optical disc 74

- inserting an optical disc 74

- manual eject hole 74

- playing optical media 75

- recording optical media 75

- removing a disc 76

- troubleshooting 144

- using 72, 73

### optical discs

- troubleshooting 145

### optical media

- recording 75
- optional external devices
  - adding 46
- P**
- password
  - deleting a supervisor 110
  - deleting a user 112
  - instant password 108
  - power-on password 108
  - setting 108
  - setting a supervisor 108
  - setting a user 110
  - supervisor password 108
  - user password 108
  - utility 108
- PC Health Monitor 122
- port
  - HDMI 60
  - HDMI Out 60
  - RGB 60
- Power
  - icon 44, 45
- power
  - connecting cable to AC
    - adaptor 41
  - cord/cable 41
  - cord/cable connectors 176
  - energy-saving features 77
- power down
  - shut down 44
- power light 82
- power management 79
  - optimum performance 79
- power plans
  - selecting power plan options 85
- power saving options 84
- precautions
  - safety 37
- printer
  - troubleshooting 151
- problem solving
  - contacting Toshiba 168
  - Startup options 131
- projector
  - connecting 61
- R**
- real-time clock (RTC)
  - battery 79
- recording sounds 100
- recovery
  - creating a recovery drive 47
  - installing drivers and applications 54
  - internal storage drive 46
  - recover from the Internal Storage Drive 51
  - reset your PC 52
  - restoring from a recovery drive 50
  - TOSHIBA Recovery Media Creator 47, 50
- recycle bin icon 94
- registering computer 44
- removing
  - an optical disc with computer on 76
  - and optical disc with computer off 76
  - battery from the computer 87
- Restart
  - computer 45
- restart computer 45
- restore points
  - troubleshooting 162
- running computer on battery power 77
- S**
- safety
  - computer 92
  - disposing of batteries 91
  - icons 29

- precautions 37
- safety precautions
  - battery 90
- saving files 72
- selecting
  - a place to work 31
  - power plan options 85
  - video cables 60
- Service Station 120
- setting
  - low battery notifications 83
- setting up
  - AC adaptor 40
  - communications 98
  - computer 39
  - software 42
  - work environment 31
- settings
  - customize computer settings 62
- Shut down
  - computer 44
- Sleep
  - computer 45
- Sleep mode 45
- Sleep Utilities 116
- Smart Card slot
  - using 102
- sounds
  - recording 100
- speakers
  - using external 101
- Special Windows keys
  - Application key 67
  - Windows key 67
- starting an app 71
- Startup menu
  - problem solving 131
- Startup options
  - Advanced options 132
  - Reset your computer 132
- supervisor password, deleting 110
- supervisor password, set up 108
- system indicator lights
  - AC power 40
  - drive in-use indicator 73
  - LEDs 41, 42, 81, 82, 102
- System Settings 113
- T**
- taking care of battery 90
- Task view
  - taskbar 96
- television
  - adjusting display 62
- tips
  - for computing 65
- Toast notifications 68
- Toshiba
  - online resources 76
  - registering computer
    - Toshiba Web site 44
  - worldwide offices 168
- TOSHIBA Application Installer 121
- Toshiba Dual Pointing Device 55
- TOSHIBA Function Keys
  - functions 170
- TOSHIBA Recovery Media Creator 120
- touch screen navigation 69
- touchpad
  - troubleshooting 138
  - using 55
- traveling tips 92
- troubleshoot Internet connection, verify hardware 155
- troubleshoot Internet connection, verify network status 154
- troubleshoot Internet connection, verify TCP/IP 156
- troubleshooting 141
  - AC power light is blinking 130
  - battery light is blinking 131
  - bookmarked site not found 134

- computer will not start 129
  - contacting Toshiba 167
  - corrupted/damaged data files 144
  - data/entire system backup 164
  - display error message 142
  - display problems
    - screen is blank 141
  - DVD player 160
  - eject button 144
  - error message, warning
    - resume failure 129
  - Error-checking 142
  - external display problems 142
  - external monitor 141
  - good computing habits 161
  - hard disk drive is slow 143
  - installing hardware/software 165
  - keyboard 135
  - missing files/trouble accessing a drive 142
  - on-screen eject button 145
  - optical disc drive 144
  - power and batteries 134
  - printer 151
  - restore points 162
  - screen does not look correct/flickers 141
  - slow Internet connection 133
  - sound 147
  - touchpad 138
  - trouble running discs 145
  - trouble running programs 144
  - URL address not found 134
  - USB Sleep and Charge
    - cannot use 166
  - USB Wakeup function
    - does not work 167
  - Web Camera 145
  - Windows operating system not working 131
  - wireless networking 152
  - troubleshooting keyboard
    - clean the keyboard 137
    - latest keyboard driver 137
    - power cycle 135
    - system restore 137
    - uninstall/reinstall driver 136
  - troubleshooting network adapter
    - uninstall/reinstall driver 155
  - troubleshooting sound
    - check and set default speakers 148
    - latest sound driver 150
    - system restore 150
    - uninstall/reinstall driver 149
    - use the sound troubleshooter 147
  - troubleshooting touchpad
    - disable/enable 138
    - install external mouse 138
    - latest driver 140
    - power cycle 138
    - system restore 140
    - touchpad properties 140
    - uninstall/reinstall driver 139
  - troubleshooting Web Camera
    - System Recovery 147
    - system restore 146
    - testing 145
    - third party apps 147
    - uninstall/reinstall driver 146
- U**
- updates
    - downloading 158
  - USB Sleep and Charge
    - cannot use 166
  - USB Wakeup function
    - does not work 167
  - user password, deleting 112

- user password, setting 110
- using
  - a microphone 100
  - computer lock 64
  - DVDs 72
  - eco power plan 86
  - Expansion port 105
  - Memory card reader 103
  - optical disc drive 72
  - Smart Card slot 102
  - touchpad 55
  - Web Camera 102
- using the keyboard 67
- using the overlay for cursor control
  - 68
- using the Toshiba Dual Pointing Device 55
- Utilities 106
- V**
- video projector
  - adjusting display 62
- W**
- warranty
  - standard limited warranty 30
- Web Camera
  - using 102
- Web sites 168
- Wi-Fi
  - wireless networking 98
- Windows operating system
  - desktop 93
  - troubleshooting 131
- wireless networking 98
  - troubleshooting 152