



Thermo Scientific

Dionex Integrion HPIC System

Operator's Manual

22153-97003 Revision 04 August 2016

Thermo
SCIENTIFIC

© 2016 Thermo Fisher Scientific Inc. All rights reserved.

Chromeleon and ERS are registered trademarks of Thermo Fisher Scientific Inc. in the United States. Acrobat, Adobe, and Adobe Reader are registered trademarks of Adobe Systems Incorporated in the United States and other countries. Microsoft and Windows are registered trademarks of Microsoft Corporation in the United States and other countries.

The following are registered trademarks in the United States and possibly other countries: Kel-F is a registered trademark of 3M Corporation. KIMWIPES is a registered trademark of Kimberly-Clark Corporation. Ultem is a registered trademark of General Electric Company.

PEEK is a trademark of Victrex PLC.

All other trademarks are the property of Thermo Fisher Scientific Inc. and its subsidiaries.

Thermo Fisher Scientific Inc. provides this document to its customers with a product purchase to use in the product operation. This document is copyright protected and any reproduction of the whole or any part of this document is strictly prohibited, except with the written authorization of Thermo Fisher Scientific Inc.

The contents of this document are subject to change without notice. All technical information in this document is for reference purposes only. System configurations and specifications in this document supersede all previous information received by the purchaser.

Thermo Fisher Scientific Inc. makes no representations that this document is complete, accurate or error-free and assumes no responsibility and will not be liable for any errors, omissions, damage or loss that might result from any use of this document, even if the information in the document is followed properly.

This document is not part of any sales contract between Thermo Fisher Scientific Inc. and a purchaser. This document shall in no way govern or modify any Terms and Conditions of Sale, which Terms and Conditions of Sale shall govern all conflicting information between the two documents.

Release history: Revision 01 released February 2016; initial release of instrument
Revision 02 released March 2016; international compliance section updated
Revision 03 released May 2016; international compliance section updated
Revision 04 released August 2016; international compliance section updated

Software version: Chromeleon 7.2 SR4 and later

For Research Use Only. Not for use in diagnostic procedures.

Contents

	Preface	vii
	Related Documentation	vii
	Safety Information	viii
	Safety and Special Notices	viii
	Safety Symbols	viii
	Regulatory Compliance	ix
	FCC/IC Notices	x
	AVIS FCC/IC	x
	International Compliance	xi
	Notice on Lifting and Handling of Thermo Scientific Instruments	xvii
	Notice on the Proper Use of Thermo Scientific Instruments	xvii
	WEEE Compliance	xviii
	Conformité DEEE	xviii
	WEEE Konformität	xviii
Chapter 1	Introduction	1
	Introduction to Ion Chromatography (IC)	1
	Deionized Water Requirements for IC	3
	Introduction to the Dionex Integrion	3
	Standard System Configurations	4
	Options	5
	System Control	6
Chapter 2	Functional Description	9
	System Overview	10
	Status LEDs	11
	Mobile Device	11
	Chromeleon 7 Chromatography Data System	12
	Electrolytic Device Connections	14
	Consumable Device Tracking	15
	Eluent Reservoirs	19

Pump Compartment Features	20
Shutoff Valve	20
Eluent Degas System	20
Pump	20
Pump Seal Wash System	22
Eluent Generator (EG) Features	22
Eluent Generator Cartridge (Dionex EGC)	24
Continuously Regenerated Trap Column (Dionex CR-TC)	25
Dionex RFIC Eluent Degasser	25
Dionex EPM 500 Electrolytic pH Modifier and Carbonate Mixer	25
Column Compartment Features	26
High-Pressure Valves	27
Detector Compartment Features	29
Temperature-Controlled Detector Compartment	29
Leak Sensor	29
Conductivity Detector (CD)	30
Suppressors, CRD, and SRN	31
Electrochemical Detector (ED)	31
Temperature Control Zones	34
Rear Panel Features	35
Gas Regulator and Low-Pressure Valve Mounting Locations	35
Tubing Chase and Waste Lines	36
Drain Valve	36
Vacuum Port	36
Drain Port	36
Low-Pressure Valve Connectors	37
Relay, Power, Analog Output, and TTL Connectors	37
USB Status LED and USB Connectors	37
Power Switch, Fuse Holder, and Power Receptacle	37
Low-Pressure Valve Options	38
System Flow Schematics	39

Chapter 3	Operation	45
	Starting Up the System (Overview)	46
	Setting Up the Reservoir	46
	Setting Up the Seal Wash System	49
	Turning On the System Power	49
	Connecting to Chromeleon	49
	Priming the Pump	50
	Equilibrating the System	52
	Preparing Samples	53
	Collecting and Storing Samples	53
	Pretreating Samples	53
	Diluting Samples	54
	Loading Samples into the Loop or Concentrator	54

Performing Sample Analyses	56
System Shutdown	57
Consumables Storage.	57
ED Cell Storage.	57
Operating the EG	58
Selecting an Eluent Concentration	58
Entering the Eluent Concentration	59
Operating the ED	60
ED Cell Operating Precautions	60
Electrochemical Detection Modes	62
Waveforms	65
Collecting and Storing Amperometry Data	66
Using Rear Panel Inputs and Outputs	67
Connecting the I/O Connectors	67
Assigning TTL Input Functions	69
Controlling Relay and TTL Outputs.	72
Selecting Analog Output Settings	73
Chapter 4 Dionex Integrion Mobile App Operation.	77
Overview of Mobile App Operation	78
Device Selection Bar	78
Quick Access Toolbar	79
Using the Mobile App with Chromeleon.	80
Home Page Details	81
Pump Page	84
Pump Controls	84
Valves Page	87
Detector Page	88
Conductivity Detector (CD)	88
Electrochemical Detector (ED)	90
Electrolytics Page.	92
Temperature Page	95
Plot Page.	96
Analog Page.	98
TTL/Relay Page	100
TTL Input Page	101
Consumables Page.	102
Calibration Pages.	104
Information Page.	105
Chapter 5 Maintenance	107
Daily Maintenance	107
Weekly Maintenance.	107
Periodic Maintenance	108
Annual Maintenance	108

Chapter 6	Troubleshooting	109
	Troubleshooting Error Messages	109
	Troubleshooting System Component Symptoms.....	137
	No Communication with Chromeleon	137
	Liquid Leaks	138
	Low or Decreasing System Backpressure	140
	High or Increasing System Backpressure	142
	Unstable System Backpressure.....	144
	Pump Does Not Start	145
	Pump Stops.....	145
	Degas Vacuum Pump Low Vacuum	145
	Degas Vacuum Pump Does Not Run	146
	EG Stops Operation	146
	ED Cell pH Readouts Incorrect	147
	Troubleshooting Chromatogram Symptoms	149
	Tailing Peaks.....	150
	Fronting Peaks.....	153
	Low Efficiency (Peak Broadening).....	156
	Loss of Resolution.....	158
	Split Peak or Dip.....	161
	Low Detector Output	164
	Non-Reproducible Peak Area	165
	Varying Peak Retention Times	166
	Unknown Peaks	168
	Missing Peaks	169
	Noisy Baseline.....	171
	Drifting Baseline	173
	High Background	174
Chapter 7	Service	177
	Replacing Tubing and Fittings	178
	Fitting and Tube Connection Guidelines	180
	Installing and Tightening Ferrule Fittings	180
	Installing and Tightening IC PEEK Viper Fittings	181
	Cutting Tubing.....	182
	Servicing Pump Components	183
	Replacing Pump Check Valves	183
	Replacing Pump Seals	185
	Replacing a Pump Piston.....	190
	Replacing the Seal on the Pump Priming Valve Knob.....	192
	Servicing Eluent Generator Components.....	193
	Replacing a Dionex EGC	193
	Replacing a Dionex CR-TC 600.....	197

Servicing High-Pressure (Injection) Valves	199
Rebuilding a High-Pressure Valve	199
Replacing a High-Pressure Valve Pod	200
Servicing a Dionex Integrion Conductivity Detector	201
Calibrating a CD Cell	202
Replacing a CD	203
Removing Trapped Air from a CD Cell	203
Replacing a Suppressor	204
Servicing a Dionex Integrion Electrochemical Detector	205
Disconnecting an ED Cell	205
Replacing an ED	206
Replacing a Disposable Working Electrode Gasket	206
Replacing a Conventional Working Electrode Gasket	207
Polishing a Conventional Working Electrode	209
Replacing a pH-Ag/AgCl Reference Electrode	211
Replacing a PdH Reference Electrode	214
Changing the Main Power Fuses	218
Appendix A Specifications	221
Appendix B Reordering Information	225

Contents

Preface

This manual describes the functional features of the Thermo Scientific™ Dionex™ Integrion™ HPIC™ System and provides instructions for system startup, shutdown, operation, maintenance, troubleshooting, and service. The system is available in two models: the Dionex Integrion and the Dionex Integrion RFIC™. For convenience, the Dionex Integrion name is used throughout this manual. Unless otherwise specified, all references apply to both models.

Contents

- [Related Documentation](#)
- [Safety Information](#)
- [Regulatory Compliance](#)

Related Documentation

In addition to this guide, the following related documents are provided on the Thermo Scientific Reference Library DVD (P/N 60-053891).

- *Dionex Integrion HPIC System Installation Instructions* (Document No. 22153-97002)
- *Dionex AS-AP Autosampler Operator's Manual* (Document No. 065361)
- *Dionex AS-DV Autosampler Operator's Manual* (Document No. 065259)
- Manuals for Dionex consumable products (columns, suppressors, Dionex EGC, Dionex CR-TC 600, Dionex CRD)
- *Chromeleon 7 Installation Guide* (Document No. 7729.0003)
- *Chromeleon 7 Quick Start Guide* (Document No. 7729.0004)

Safety Information

The Dionex Integrion was manufactured by Thermo Fisher Scientific at the following location: Thermo Finnigan LLC 355 River Oaks Parkway, San Jose, CA 95134 U.S.A. The Dionex Integrion is designed for ion chromatography (IC) applications and should not be used for any other purpose. Operation of a Dionex Integrion in a manner not specified by Thermo Fisher Scientific may result in personal injury.

If there is a question regarding appropriate usage, contact Technical Support for Dionex products. In the U.S. and Canada, call 1-800-532-4752. Outside the U.S. and Canada, call the nearest Thermo Fisher Scientific office.

Safety and Special Notices

Make sure you follow the precautionary statements presented in this guide. The safety and other special notices appear in boxes.

Safety and special notices include the following:



CAUTION Highlights hazards to humans, property, or the environment. Each CAUTION notice is accompanied by an appropriate CAUTION symbol.

IMPORTANT Highlights information necessary to prevent damage to the system or software, loss of data, or invalid test results; or might contain information that is critical for optimal performance of the system.

Note Highlights information of general interest.

Tip Highlights helpful information that can make a task easier.

Safety Symbols

These symbols appear on the Dionex Integrion HPIC System or on labels affixed to the system:



Alternating current.



Primary protective conductor terminal.



Secondary protective conductor terminal.



Power supply is on.



Power supply is off.



Indicates a potential hazard. Refer to this operator's manual for an explanation of the hazard and how to proceed.

Regulatory Compliance

Thermo Fisher Scientific performs complete testing and evaluation of its products to ensure full compliance with applicable domestic and international regulations. When the system is delivered to you, it meets all pertinent electromagnetic compatibility (EMC) and safety standards.

Changes that you make to your system may void compliance with one or more of these EMC and safety standards. Changes to your system include replacing a part or adding components, options, or peripherals not specifically authorized and qualified by Thermo Fisher Scientific. To ensure continued compliance with EMC and safety standards, replacement parts and additional components, options, and peripherals must be ordered from Thermo Fisher Scientific or one of its authorized representatives.

The regulatory marks on the model/data label of the Dionex Integrion HPIC System indicate that the system is in compliance with the following Safety and EMC standards:

- UL 61010-1:2012
- UL 61010-2-010:2015
- CAN/CSA-C22.2 No. 61010-1-12
- CAN/CSA-C22.2 No. 61010-2-010:15
- FCC Part 15 Subpart B (per ANSI C63.4: 2009) and Industry Canada ICES-003 Issue 5, August 2012 for a Class B Device
- Standards of countries other than Canada and the United States, as applicable (see [“International Compliance”](#) on [page xi](#))

The CE mark on the model/data label of the Dionex Integrion HPIC System indicates that the system is in compliance with the following European Union Directives as is evidenced by compliance to the associated standard where appropriate:

- LVD Directive: 2014/35/EU by conforming to IEC/EN 61010-1:2010 (3rd edition) and IEC/EN 61010-2-010:2014 (3rd edition)
- EMC Directive: 2014/30/EU by conforming to EN 61326-1:2013, EN 61326-2-6:2006
- R&TTE Directive: 1999/5/EC by conforming to ETSI EN 301 489-1 V1.9.2 (2011-09)

FCC/IC Notices

This product may contain:

	Wi-Fi Module	RFID Module
FCC ID:	YOPGS2011MIZ	WZ4-NOVA001
IC:	9154A-GS2011MIZ	5893A-NOVA2011

These devices comply with Part 15 of the FCC rules and Industry Canada license-exempt RSS standards. Operation of this device is subject to the following two conditions:

1. This device may not cause harmful interference, and
2. This device must accept any interference received, including interference that may cause undesired operation.

This equipment has been tested and found to comply with the limits for a Class B digital device, pursuant to Part 15 of the FCC Rules. These limits are designed to provide reasonable protection against harmful interference in a residential installation. This equipment generates, uses and can radiate radio frequency energy and, if not installed and used in accordance with the instructions, may cause harmful interference to radio communications. However, there is no guarantee that interference will not occur in a particular installation. If this equipment does cause harmful interference to radio or television reception, which can be determined by turning the equipment off and on, the user is encouraged to try to correct the interference by one or more of the following measures:

- Reorient or relocate the receiving antenna.
- Increase the separation between the equipment and receiver.
- Connect the equipment into an outlet on a circuit different from that to which the receiver is connected.
- Consult the dealer or an experienced radio/TV technician for help.

Any modifications could void the user's authority to operate the equipment.

Refer to the Wi-Fi or RFID module data sheets for additional module information.

AVIS FCC/IC

Ce produit peut contenir:

	Wi-Fi Module	RFID Module
FCC ID:	YOPGS2011MIZ	WZ4-NOVA001
IC:	9154A-GS2011MIZ	5893A-NOVA2011

Cet appareil est conforme à la partie 15 des règles de la FCC et d'Industrie Canada RSS normes exemptes de licence. Le fonctionnement de cet appareil est soumis à la deux conditions suivantes:

1. Ce dispositif ne doit pas causer d'interférences nuisibles, et

2. Cet appareil doit accepter toute interférence reçue, y compris les interférences qui peuvent causer un mauvais fonctionnement.

Cet équipement a été testé et déclaré conforme aux limites d'un appareil numérique de classe B, conformément à la partie 15 des règles de la FCC. Ces limites sont conçues pour fournir une protection raisonnable contre les interférences nuisibles dans une installation résidentielle. Cet équipement génère, utilise et peut émettre de l'énergie radiofréquence et, se il ne est pas installé et utilisé conformément aux instructions, peut causer des interférences nuisibles aux communications radio. Cependant, il ne est pas garanti que des interférences ne se produiront pas dans une installation particulière. Si cet équipement provoque des interférences nuisibles à la réception radio ou de télévision, ce qui peut être déterminé en mettant l'équipement hors et sous tension, l'utilisateur est encouragé à essayer de corriger l'interférence par une ou plusieurs des mesures suivantes:

- Réorienter ou déplacer l'antenne de réception.
- Augmentez la distance entre l'équipement et le récepteur.
- Branchez l'appareil dans une prise sur un circuit différent de celui sur lequel le récepteur est branché.
- Consulter le revendeur ou un technicien radio / TV expérimenté.

Toute modification peut annuler le droit de l'utilisateur à utiliser l'équipement.

Pour plus d'information sur les modules Wi-Fi et RFID, veuillez-vous référer à leurs fiches techniques.

International Compliance

Brazil

System	Wi-Fi module	RFID module
Dionex Integrion Dionex Integrion RFIC	Gainspan GS2011M  1219-16-3693	Skyetek (now Jadak) SM-NV  1431-16-2716

India

System	Wi-Fi module	RFID module
Dionex Integrion Dionex Integrion RFIC	Gainspan GS2011M ETA-824/2016/ERLO	Jadak SM-NV ETA-876/2016/ERLO

Japan

System	Wi-Fi module	RFID module
Dionex Integrion Dionex Integrion RFIC	Gainspan GS2011MIZ  R 211-140401	Jadak SM-NV  R 005-101231

Singapore

System	Wi-Fi module	RFID module
Dionex Integrion	N/A	Complies with IDA Standards Dealer's Licence No. N0373-16
Dionex Integrion RFIC	Complies with IDA Standards Dealer's Licence No. N0374-16	Complies with IDA Standards Dealer's Licence No. N0375-16

Thailand

System

เครื่องโทรคมนาคมและอุปกรณ์นี้ มีความสอดคล้องตามข้อกำหนดของ กทช.

This telecommunication equipment is in compliance with NTC requirements.

UAE

System

Dionex Integrion	TRA REGISTERED No: DA48560/16 DEALER No: ER44279/16
Dionex Integrion RFIC	TRA REGISTERED No: DA48560/16 DEALER No: ER442266/16

Notice on Lifting and Handling of Thermo Scientific Instruments

For your safety, and in compliance with international regulations, the physical handling of this Thermo Fisher Scientific instrument *requires a team effort* to lift and/or move the instrument. This instrument is too heavy and/or bulky for one person alone to handle safely.

Notice on the Proper Use of Thermo Scientific Instruments

In compliance with international regulations: Use of this instrument in a manner not specified by Thermo Fisher Scientific could impair any protection provided by the instrument.

WEEE Compliance

This product is required to comply with the European Union's Waste Electrical & Electronic Equipment (WEEE) Directive 2002/96/EC. It is marked with the following symbol:



Thermo Fisher Scientific has contracted with one or more recycling or disposal companies in each European Union (EU) Member State, and these companies should dispose of or recycle this product. See www.thermoscientific.rohs for further information on Thermo Fisher Scientific's compliance with these Directives and the recyclers in your country.

Conformité DEEE

Ce produit est conforme avec la directive européenne (2002/96/EC) des Déchets d'Equipements Electriques et Electroniques (DEEE). Il est marqué par le symbole suivant:



Thermo Fisher Scientific s'est associé avec une ou plusieurs sociétés de recyclage dans chaque état membre de l'Union Européenne et ce produit devrait être collecté ou recyclé par celle(s)-ci. Pour davantage d'informations, rendez-vous sur la page www.thermoscientific.fr/rohs.







WEEE Konformität

Dieses Produkt entspricht der EU Waste Electrical & Electronic Equipment (WEEE) Richtlinie 2002/96/EC. Es ist mit dem folgenden Symbol gekennzeichnet:



Thermo Fisher Scientific hat Vereinbarungen mit Verwertungs-/Entsorgungsfirmen in allen EU-Mitgliedsstaaten getroffen, damit dieses Produkt durch diese Firmen wiederverwertet oder entsorgt werden kann. Weitere Informationen finden Sie unter www.thermoscientific.de/rohs.

CAUTION Symbol	CAUTION	VORSICHT	ATTENTION	PRECAUCION	AVVERTENZA
	Electric Shock: This instrument uses high voltages that can cause personal injury. Before servicing, shut down the instrument and disconnect the instrument from line power. Keep the top cover on while operating the instrument. Do not remove protective covers from PCBs.	Elektroschock: In diesem Gerät werden Hochspannungen verwendet, die Verletzungen verursachen können. Vor Wartungsarbeiten muß das Gerät abgeschaltet und vom Netz getrennt werden. Betreiben Sie das Gerät nicht mit abgenommenem Deckel. Nehmen Sie die Schutzabdeckung von Leiterplatten nicht ab.	Choc électrique: L'instrument utilise des tensions capables d'infliger des blessures corporelles. L'instrument doit être arrêté et débranché de la source de courant avant tout intervention. Ne pas utiliser l'instrument sans son couvercle. Ne pas enlever les étuis protecteurs des cartes de circuits imprimés.	Descarga eléctrica: Este instrumento utiliza altas tensiones, capaces de producir lesiones personales. Antes de dar servicio de mantenimiento al instrumento, éste deberá apagarse y desconectarse de la línea de alimentación eléctrica. No opere el instrumento sin sus cubiertas exteriores quitadas. No remueva las cubiertas protectoras de las tarjetas de circuito impreso.	Shock da folgorazione. L'apparecchio è alimentato da corrente ad alta tensione che può provocare lesioni fisiche. Prima di effettuare qualsiasi intervento di manutenzione occorre spegnere ed isolare l'apparecchio dalla linea elettrica. Non attivare lo strumento senza lo schermo superiore. Non togliere i coperchi a protezione dalle schede di circuito stampato (PCB).
	Chemical: This instrument might contain hazardous chemicals. Wear gloves when handling toxic, carcinogenic, mutagenic, or corrosive or irritant chemicals. Use approved containers and proper procedures to dispose waste oil.	Chemikalien: Dieses Gerät kann gefährliche Chemikalien enthalten. Tragen Sie Schutzhandschuhe beim Umgang mit toxischen, karzinogenen, mutagenen oder ätzenden/reizenden Chemikalien. Entsorgen Sie verbrauchtes Öl entsprechend den Vorschriften in den vorgeschriebenen Behältern.	Chimique: Des produits chimiques dangereux peuvent se trouver dans l'instrument. Portez des gants pour manipuler tous produits chimiques toxiques, cancérigènes, mutagènes, ou corrosifs/irritants. Utiliser des récipients et des procédures homologuées pour se débarrasser des déchets d'huile.	Química: El instrumento puede contener productos químicos peligrosos. Utilice guantes al manejar productos químicos tóxicos, carcinógenos, mutágenos o corrosivos/irritantes. Utilice recipientes y procedimientos aprobados para deshacerse del aceite usado.	Prodotti chimici. Possibile presenza di sostanze chimiche pericolose nell'apparecchio. Indossare dei guanti per maneggiare prodotti chimici tossici, cancerogeni, mutageni, o corrosivi/irritanti. Utilizzare contenitori aprovo e seguire la procedura indicata per lo smaltimento dei residui di olio.
	Heat: Before servicing the instrument, allow any heated components to cool.	Hitze: Warten Sie erhitzte Komponenten erst nachdem diese sich abgekühlt haben.	Haute Temperature: Permettre aux composants chauffés de refroidir avant tout intervention.	Altas temperaturas: Permita que los componentes se enfríen, ante de efectuar servicio de mantenimiento.	Calore. Attendere che i componenti riscaldati si raffreddino prima di effettuare l'intervento di manutenzione.
	Fire: Use care when operating the system in the presence of flammable gases.	Feuer: Beachten Sie die einschlägigen Vorsichtsmaßnahmen, wenn Sie das System in Gegenwart von entzündbaren Gasen betreiben.	Incendie: Agir avec précaution lors de l'utilisation du système en présence de gaz inflammables.	Fuego: Tenga cuidado al operar el sistema en presencia de gases inflamables.	Incendio. Adottare le dovute precauzioni quando si usa il sistema in presenza di gas infiammabili.
	Eye Hazard: Eye damage could occur from splattered chemicals or flying particles. Wear safety glasses when handling chemicals or servicing the instrument.	Verletzungsgefahr der Augen: Verspritzte Chemikalien oder kleine Partikel können Augenverletzungen verursachen. Tragen Sie beim Umgang mit Chemikalien oder bei der Wartung des Gerätes eine Schutzbrille.	Danger pour les yeux: Des projections chimiques, liquides, ou solides peuvent être dangereuses pour les yeux. Porter des lunettes de protection lors de toute manipulation de produit chimique ou pour toute intervention sur l'instrument.	Peligro par los ojos: Las salicaduras de productos químicos o partículas que saltan bruscamente pueden causar lesiones en los ojos. Utilice anteojos protectores al manipular productos químicos o al darle servicio de mantenimiento al instrumento.	Pericolo per la vista. Gli schizzi di prodotti chimici o delle particelle presenti nell'aria potrebbero causare danni alla vista. Indossare occhiali protettivi quando si maneggiano prodotti chimici o si effettuano interventi di manutenzione sull'apparecchio.
	General Hazard: A hazard is present that is not included in the above categories. Also, this symbol appears on the instrument to refer the user to instructions in this manual. When the safety of a procedure is questionable, contact your local Technical Support organization for Thermo Fisher Scientific Sunnyvale Products.	Allgemeine Gefahr: Es besteht eine weitere Gefahr, die nicht in den vorstehenden Kategorien beschrieben ist. Dieses Symbol wird im Handbuch außerdem dazu verwendet, um den Benutzer auf Anweisungen hinzuweisen. Wenn Sie sich über die Sicherheit eines Verfahrens im unklaren sind, setzen Sie sich, bevor Sie fortfahren, mit Ihrer lokalen technischen Unterstützungsorganisation für Thermo Fisher Scientific Sunnyvale Produkte in Verbindung.	Danger général: Indique la présence d'un risque n'appartenant pas aux catégories citées plus haut. Ce symbole figure également sur l'instrument pour renvoyer l'utilisateur aux instructions du présent manuel. Si la sûreté d'une procédure est incertaine, avant de continuer, contacter le plus proche Service Clientèle pour les produits de Thermo Fisher Scientific Sunnyvale.	Peligro general: Significa que existe un peligro no incluido en las categorías anteriores. Este símbolo también se utiliza en el instrumento par referir al usuario a las instrucciones contenidas en este manual. Cuando la certidumbre acerca de un procedimiento sea dudosa, antes de proseguir, pongase en contacto con la Oficina de Asistencia Técnica local para los productos de Thermo Fisher Scientific Sunnyvale.	Pericolo generico. Pericolo non compreso tra le precedenti categorie. Questo simbolo è utilizzato inoltre sull'apparecchio per segnalare all'utente di consultare le istruzioni descritte nel presente manuale. Quando è in dubbio la misura di sicurezza per una procedura, prima di continuare, si prega di mettersi in contatto con il Servizio di Assistenza Tecnica locale per i prodotti di Thermo Fisher Scientific Sunnyvale.

CAUTION Symbol	CAUTION	危険警告	危險警告
	Electric Shock: This instrument uses high voltages that can cause personal injury. Before servicing, shut down the instrument and disconnect the instrument from line power. Keep the top cover on while operating the instrument. Do not remove protective covers from PCBs.	電撃: この計測器は高電圧を使用し、人体に危害を与える可能性があります。保守・修理は、必ず作業を停止し、電源を切ってから実施して下さい。上部カバーを外したままで計測器を使用しないで下さい。プリント配線板の保護カバーは外さないで下さい。	電撃: 儀器設備使用會造成人身傷害的高伏電壓。在維修之前，必須先關儀器設備並切除電源。務必要在頂蓋蓋上的情況下操作儀器。請勿拆除PCB保護蓋。
	Chemical: This instrument might contain hazardous chemicals. Wear gloves when handling toxic, carcinogenic, mutagenic, or corrosive or irritant chemicals. Use approved containers and proper procedures to dispose waste oil.	化学物質: 危険な化学物質が計測器中に存在している可能性があります。毒性、発がん性、突然変異性、腐食・刺激性などのある薬品を取り扱う際は、手袋を着用して下さい。廃油の処分には、規定の容器と手順を使用して下さい。	化学品: 儀器設備中可能存在有危險性的化學物品。接觸毒性致痛、誘變或腐蝕／刺激性化學品時，請配帶手套。處置廢油時，請使用經過許可的容器和程序。
	Heat: Before servicing the instrument, allow any heated components to cool.	熱: 熱くなった部品は冷えるのを待ってから保守・修理を行って下さい。	高温: 請先等高温零件冷卻之後再進行維修。
	Fire: Use care when operating the system in the presence of flammable gases.	火災: 可燃性のガスが存在する場所でシステムを操作する場合は、充分な注意を払って下さい。	火災: 在有易燃氣體的場地操作該系統時，請務必小心謹慎。
	Eye Hazard: Eye damage could occur from splattered chemicals or flying particles. Wear safety glasses when handling chemicals or servicing the instrument.	眼に対する危険: 化学物質や微粒子が飛散して眼を傷つける危険性があります。化学物質の取り扱い、あるいは計測器の保守・修理に際しては防護眼鏡を着用して下さい。	眼睛傷害危険: 飛濺の化学品或顆粒可能造成眼睛傷害。處理化學品或維修儀器設備時請佩戴安全眼鏡。
	General Hazard: A hazard is present that is not included in the above categories. Also, this symbol appears on the instrument to refer the user to instructions in this manual.	一般的な危険: この標識は上記以外のタイプの危険が存在することを示します。また、計測器にこの標識がついている場合は、本マニュアル中の指示を参照して下さい。	一般性危険: 説明未包括在上述類別中的其他危險。此外，儀器設備上使用這個標誌，以指示用戶本使用手冊中的說明。
	When the safety of a procedure is questionable, contact your local Technical Support organization for Thermo Fisher Scientific Sunnyvale Products.	安全を確保する手順がよくわからない時は、作業を一時中止し、お近くのサーモエレクトロンサンローゼプロダクトのテクニカルサポートセンターご連絡ください。	如對安全程序有疑問，請在操作之前與當地的菲尼根技術服務中心聯繫。

Introduction

Introduction to Ion Chromatography (IC)

An ion chromatography system typically consists of an *eluent* (a liquid that helps to separate the sample ions), a high-pressure pump, a sample injector, an analytical column, a detector cell, and a data collection system.

Before running a sample, the ion chromatography system is calibrated using a standard solution. By comparing the data obtained from a sample to that obtained from the known standard, sample ions can be identified and quantitated. The data collection system (typically a computer running chromatography software) produces a *chromatogram* (a plot of the detector output vs. time). The chromatography software converts each peak in the chromatogram to a sample concentration.

IC analysis consists of the five stages shown in [Figure 1](#).

Figure 1. Ion analysis process

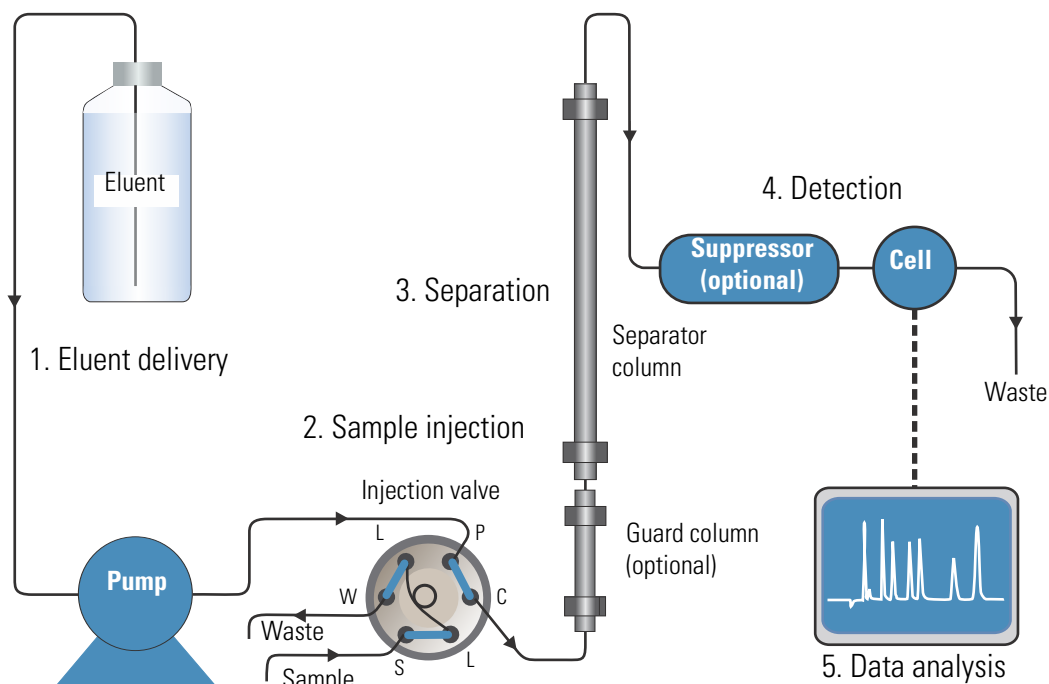

1. Eluent Delivery

- The pump pushes eluent through the ion chromatography system.

2. Sample Injection

- The liquid sample is loaded into the injection valve either manually or by an automated sampler. When triggered, the sample is injected into the eluent stream.
- The pump pushes the eluent and sample through the analytical column (a chemically-inert tube packed with a polymeric resin). If installed, a guard column removes contaminants that might foul the analytical column.

3. Separation

- As the eluent and sample are pumped through the analytical column, the sample ions are separated. In the Dionex Integriion HPIC System, the mode of separation is called ion exchange chromatography. This is based on the premise that different sample ions migrate through the IC column at different rates, depending upon their interactions with the ion exchange sites.
- In conductivity detection applications, the eluent and sample ions flow through a suppressor after they leave the column. The suppressor selectively enhances detection of the sample ions while simultaneously decreasing the background signal and noise.

4. Detection

- In conductivity detection, a conductivity cell measures the electrical conductance of the sample ions as they emerge from the suppressor.
- In electrochemical detection, an amperometric cell measures the current resulting from the oxidation or reduction of the sample ions as they emerge from the column.
- For each detection type, the cell produces a signal based on the measurements and transmits the signal to a data collection system.

5. Data Analysis

- The data collection system identifies the ions based on retention time, and quantifies each analyte by integrating the peak area or peak height. The data is quantitated by comparing the sample peaks in a chromatogram to those produced from a standard solution. The results are displayed as a chromatogram and the concentrations of ionic analytes can be automatically determined and tabulated.

Deionized Water Requirements for IC

For electrolytic eluent generation or when manually preparing eluent and regenerant, use ASTM Type I (18 megohm-cm) filtered and deionized water that meets the specifications listed in Table 1.

Table 1. ASTM filtered, Type I deionized water specifications for ion chromatography

Contaminant	Specification
Ions–Resistivity	>18.0 (megohm-cm)
Organics–TOC	<10 ppb
Iron/Transition Metals*	<1 ppb
Pyrogens	<0.03 (Eu/mL)
Particulates > 0.2 µm	<1 (units/mL)
Colloids–Silica	<10 ppb
Bacteria	<1 (cfu/mL)
* Iron/transition metal content not specified for ASTM Type I Water	

Introduction to the Dionex Integrion

The Dionex Integrion HPIC System is an integrated HPIC (high-pressure ion chromatography) system that provides the components and electronics required for performing a wide range of ion analysis applications. The basic system includes an eluent area, system status LEDs, an insulated compartment for housing columns and valves, a compartment for housing pump components, and a compartment for housing a detector and related devices (for example, a suppressor and carbonate removal device).

Figure 2. Front view of Dionex Integriion

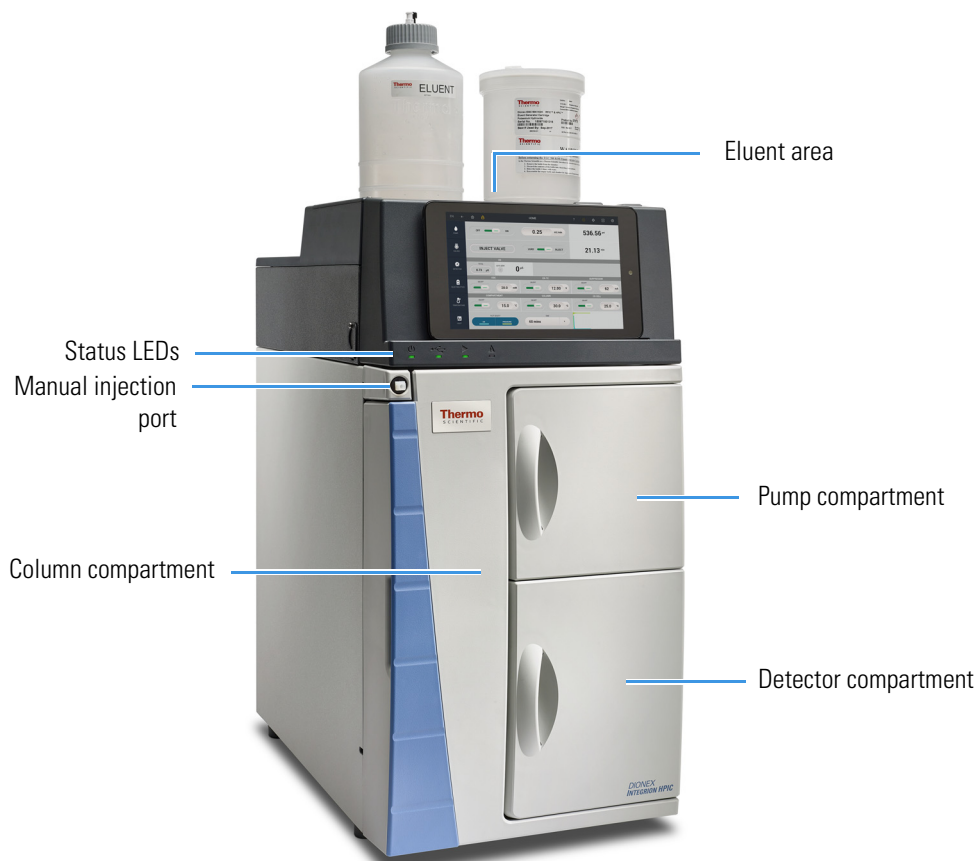

Standard System Configurations

All standard configurations include the following features:

- Eluent area and reservoir
- System status LEDs
- Pump compartment with analytical pump installed
- Column compartment with 6-port injection valve installed
- Detector compartment with either a Thermo Scientific™ Dionex™ Integriion Conductivity Detector (CD) or Thermo Scientific™ Dionex™ Integriion Electrochemical Detector (ED) installed

Table 2 shows the additional components typically included in three standard system configurations.

Table 2. Dionex Integrion standard system configurations

Model	Eluent Generator	Degas ^a	Detector	TEC ^b	Column heater ^c	Device Monitoring ^d	Mobile device ^d
Dionex Integrion	✗	✗	✓ CD	✗	✗	✗	✗
Dionex Integrion RFIC	✓	✓	✓ ED	✗	✓	✓	✓
Dionex Integrion RFIC	✓	✓	✓ CD	✓	✓	✓	✓

^a Online eluent degas system

^b Temperature-controlled detector compartment (optional)

^c Heated column compartment (optional)

^d The wireless transmitter devices may not be authorized as required by the laws of your country. These features will not be offered for sale or lease, or sold or leased, until proper authorization is obtained. Please consult your local sales representative for details.

Options

Many of the options described below are included in one or more of the standard system configurations (see Table 2). In addition, if an option was not installed at the factory, most can be ordered at any time and installed on site either by the customer or by Thermo Fisher Scientific field service personnel. However, the temperature-controlled detector compartment must be ordered with the system and installed at the factory.

Factory-Only Installable Options

The following option must be ordered with the system and installed at the factory before it is shipped:

- Temperature-controlled detector compartment

Field Service-Installable Options

The following items can be ordered at any time and installed on-site by Thermo Fisher Scientific field service personnel:

- Dionex eluent generator (EG) for generating high purity acid or base eluents online from deionized water
- Eluent degas system for continuous, online eluent degassing

- RFID (radio-frequency identification) for identifying and tracking usage of various consumable devices (for example, columns)
- Heated column compartment
- Power supplies for controlling electrolytic devices. Depending on the devices required, a 1-channel or 3-channel option is available. To control the maximum of five devices, a 2-channel and 3-channel option must be installed. (The 2-channel option cannot be installed by itself.)

Electrolytic devices include the suppressor, eluent generator cartridge (Thermo Scientific Dionex EGC), continuously-regenerated trap column (Thermo Scientific Dionex CR-TC 600), electrolytic pH modifier (Thermo Scientific Dionex EPM), and electrolytic water polisher.

Customer-Installable Options

The following options can be ordered any time and installed on-site by either Thermo Fisher Scientific field service personnel or by the customer:

- Mobile device for monitoring system status and controlling basic operating functions
- Detectors
 - CD
 - ED

The system can also be configured without a detector and connected to an external detector (for example, a UV-Vis detector or mass spectrometer).

- Dionex CR-TC 600, Dionex EPM, Dionex EGC (if the optional 3-channel electrolytic power supply is installed)
- Pump seal wash system
- Auxiliary high-pressure valve
- Up to two auxiliary low-pressure valves for controlling or directing low-pressure flow streams
- Pressure regulator, gauge assembly, and mounting bracket for pressurization of eluent reservoirs

System Control

Two types of system controls are available for the Dionex Integriion:

- The Thermo Scientific™ Dionex™ Chromeleon™ 7 Chromatography Data System provides complete instrument control, data acquisition, and data processing functions. Communication between the system and Chromeleon is through connection to a USB (Universal Serial Bus) port on the computer or a USB hub.

- The Thermo Scientific™ Dionex™ Integrion HPIC Mobile App installed on the optional mobile device can be used for controlling basic instrument functions and for displaying system status information. The mobile app can display a real-time plot of detector output, but it cannot store data or provide data processing functions.

1 Introduction

Options

Functional Description

This chapter describes the principal components of the Dionex Integrion HPIC System and their functions.

Contents

- System Overview
- Status LEDs
- Mobile Device
- Chromeleon 7 Chromatography Data System
- Electrolytic Device Connections
- Consumable Device Tracking
- Eluent Reservoirs
- Pump Compartment Features
- Eluent Generator (EG) Features
- Column Compartment Features
- Detector Compartment Features
- Temperature Control Zones
- Rear Panel Features
- Low-Pressure Valve Options
- System Flow Schematics

System Overview



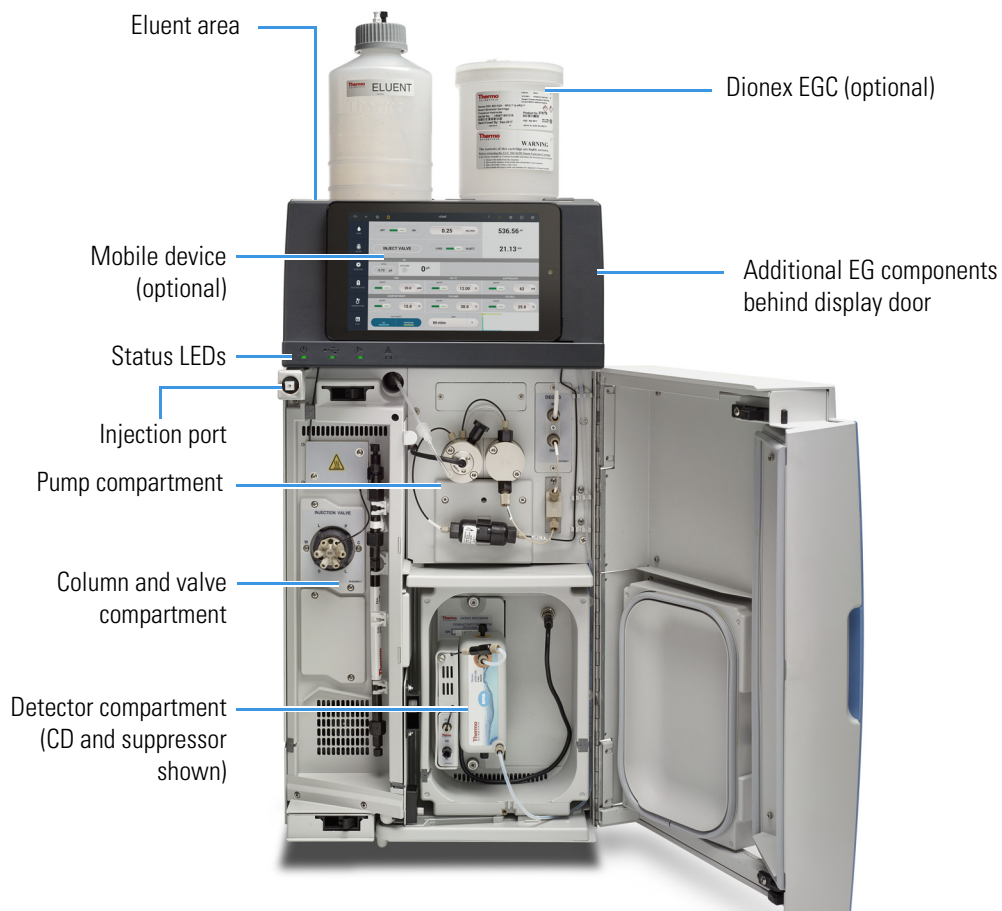

Figure 3 shows the principal operating components of a Dionex Integrion HPIC System configured for conductivity detection.

Figure 3. Example interior components of a Dionex Integrion



Status LEDs

The front panel includes the following status LEDs:

-  The power LED is on (green) when the system power is on.
-  The connected LED is on (green) when the system is connected via USB to a Chromeleon instrument.
-  The running LED is on (green) when a Chromeleon sequence is running.
-  The alert LED is flashing (red) when a system problem has occurred. Check the Chromeleon Instrument Audit Trail or the mobile app Error list for the cause.

Mobile Device

The optional Dionex Integrion HPIC Mobile App installed on a mobile device provides front panel control of the Dionex Integrion. The mobile app can be used to view system status information and to directly control system functions.

The Home page (see [Figure 4](#)) shows the current status and operation settings for the most commonly used system functions. You can select basic operating parameters from this page and also navigate to detailed status and control pages for system components. For details about the mobile app, see [“Dionex Integrion Mobile App Operation”](#) on [page 77](#).

Figure 4. Example mobile app Home page for a conductivity detection system



Chromeleon 7 Chromatography Data System

The Chromeleon 7 Chromatography Data System is used to control the Dionex Integriion and to acquire and process data.

Two modes of software control are available: automated control and direct control.

- With automated control, you create a list of control commands to be executed in chronological order. For more information about automated control, see “[Performing Sample Analyses](#)” on page 56.
- With direct control, you use the controls on an ePanel Set to issue commands and enter operating parameters. Direct control commands and parameter settings are executed as soon as they are entered.

Individual tabs on the ePanel Set provide access to detailed status and control functions for each system component (pump, detector, EG, and so on). A Home tab includes system status information, a signal plot, and controls for the most commonly used system functions.

Figure 5. Example Chromeleon ePanel Set

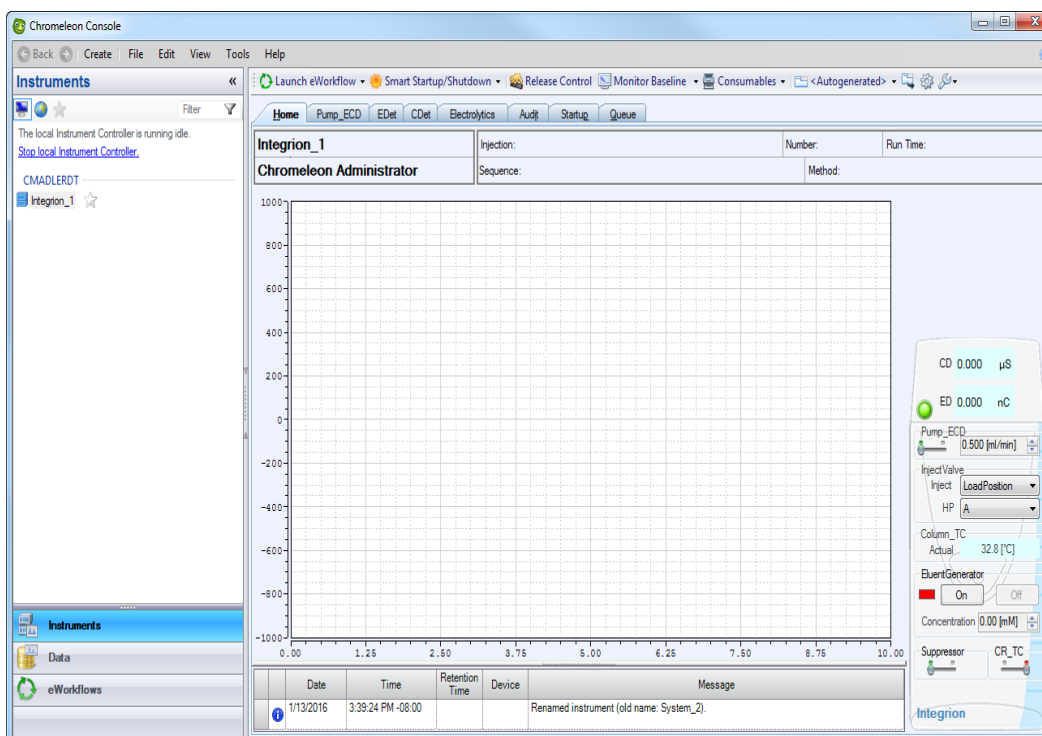

For instructions on how to connect to the ePanel Set, see “[Connecting to Chromeleon](#)” on page 49.

If the function to be performed is not available on the ePanel Set, click the **Command**  icon on the Instrument toolbar above the ePanel Set or press the **F8** key to open the Chromeleon Command window (see Figure 6). From there, you can access all commands available for the system.

Figure 6. Chromeleon Command window



Electrolytic Device Connections

The Dionex Integriion can be configured with up to five connectors for controlling electrolytic devices. Four connectors are in the eluent area and one is in the detector compartment (see Figure 7). The number of connectors available depends on the power supply option configured in your system. Table 3 lists the connectors available for each power supply option and the electrolytic devices that can be connected to them.

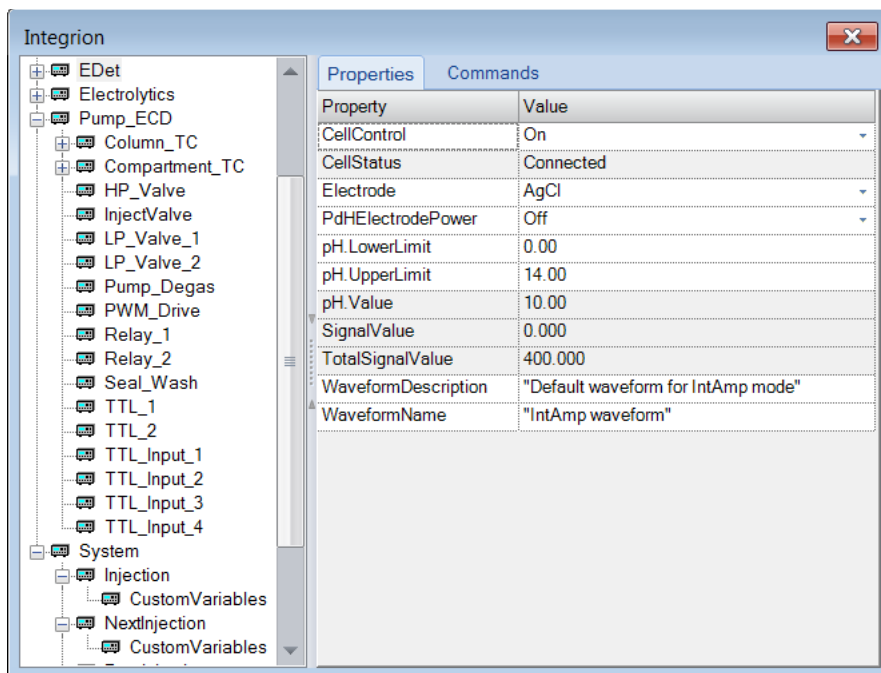
Figure 7. Electrolytic connector locations

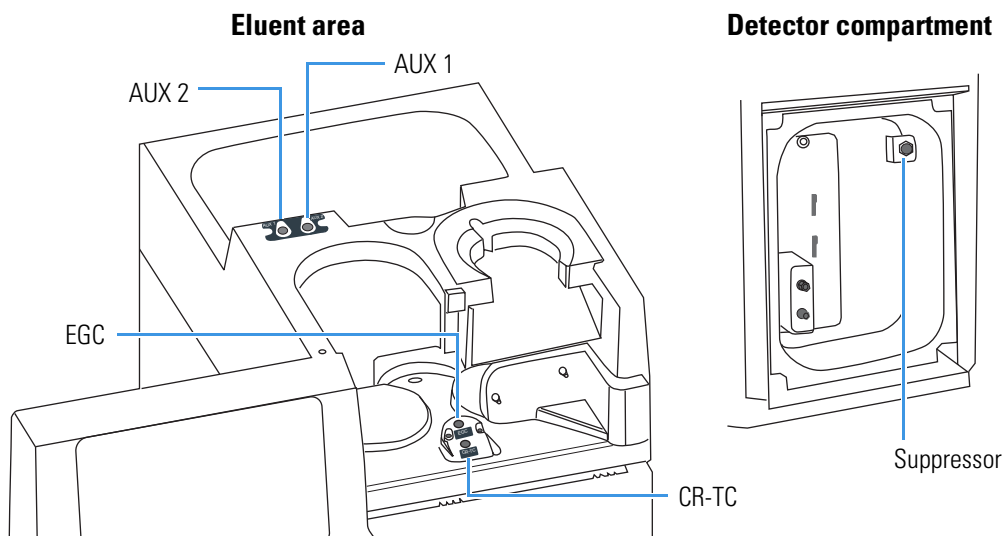

Table 3. Connectors and supported devices for each power supply option

Power supply option	Connector	Electrolytic device supported
1-channel	Suppressor	Electrolytic suppressor
3-channel	Suppressor	Electrolytic suppressor
	CR-TC	Dionex CR-TC 600 or Dionex EPM ^a
	EGC	Dionex EGC
3-channel + 2-channel	Suppressor	Electrolytic suppressor
	EGC	Dionex EGC
	CR-TC	Dionex CR-TC 600 or Dionex EPM ^a
	AUX 1	Dionex CR-TC 600, electrolytic suppressor, or auxiliary power supply
	AUX 2	Dionex EGC or auxiliary power supply

^a Requires a Dionex EGC 500 K₂CO₃

Consumable Device Tracking

Many of the consumable devices used with the Dionex Integriion are equipped with a memory chip that allows automatic identification of the device and tracking of various usage parameters. Depending on the type of device, either a wired communication system or an RFID (radio-frequency identification) system is used to track device information. If the RFID option is not installed in the system, only devices equipped with wired communication can be tracked.

Wired communication is used for devices that have electrical cables (for example, Dionex EGCs and electrolytic suppressors). RFID communication is used for non-powered devices (for example, columns).

Two information types are stored on the memory chip of consumable devices equipped with device tracking:

- Identification parameters are stored in the device's memory at the factory. This information remains constant over the lifetime of the device. See [Table 4](#) for a list of these parameters.
- Usage parameters are stored in the device's memory after the device is installed in the system. This information is updated as necessary to maintain a record of the status of the device. See [Table 5](#) for a list of these parameters.

Identification and usage parameter information can be viewed in Chromeleon in the Consumables Inventory window. To view the window, click  **Consumables** on the Instrument toolbar above the ePanel Set. Information about RFID devices is also shown on the Consumables page of the mobile app (see “[Consumables Page](#)” on [page 103](#)).

Table 4. Consumable tracking information entered at the factory

Parameter	Device type	Description
Serial number	All	Nine-digit number that uniquely identifies each device.
Product type	All except Dionex EGCs	Identifies the device type. This information is used to determine compatibility among the various devices installed in a system.
Product ID	All except Dionex EGCs	Manufacturing part number.
Best use by date	All except Dionex EGCs	Last date the device can be installed in the system before additional validation tests are recommended to ensure proper operation.
Lot number	Devices that contain resin: guard and separator columns, etc.	Manufacturing lot of the resin used in the device.

Table 4. Consumable tracking information entered at the factory, continued

Parameter	Device type	Description
Capacity	Columns	Separation capacity of the resin in the column.
Maximum pump pressure allowed	Columns	Maximum pressure at which the column can be used.
Maximum temperature allowed	Guard, separator, and concentrator columns	Highest temperature at which the column can be used.
Column length Column ID Particle Size	Guard and separator columns	Length and interior diameter (in mm) of the column. The particle size (in μm) of the resin in the column.
QAR retention time QAR efficiency QAR asymmetry QAR resolution QAR pressure QAR flow rate	Separator columns	Various peak and system parameters from the column Quality Assurance Report.
Typical backpressure of column	Guard, concentrator, and trap columns	Backpressure typically created by the column.

Table 5. Consumable tracking information updated during use

Parameter	Device type	Description
Date of first installation	All	Date the device was first installed in the system.
Eluent types exposed to	All except Dionex EGCs	List of the last 10 eluents used with the device.
Total eluent volume seen	All except concentrator columns, Dionex EGCs	Total volume of eluent that has flowed through the device in its lifetime.
Number of injections	All except concentrator and trap columns, Dionex EGCs	Number of sample injections that have occurred while the device was installed in the system. The count increments when the injection valve is switched from Load to Inject during a sequence.

Table 5. Consumable tracking information updated during use, continued

Parameter	Device type	Description
Weekly pump pressure data	All columns	Average of the pump pressure values measured at time 0.5 min of each Chromeleon instrument injection run during the week. Averages from the last 26 weeks are stored, as well as all values for weeks 1–2 of the life of the device.
Weekly pump flow rate data		Average of the pump flow rate values measured at time 0.5 min of each Chromeleon instrument injection run during the week. Averages from the last 26 weeks are stored, as well as all values for weeks 1–2 of the life of the device.
Total volume of injections	Guard and separator columns	Total volume of sample injected through the column in its lifetime.
Maximum flow rate seen	Guard, separator, and trap columns	Maximum flow rate the column has been exposed to during its lifetime. Uses sample volume entered in Chromeleon injection.
Maximum temperature seen	Guard and separator columns	Maximum temperature the column has been exposed to during its lifetime.
Maximum pressure seen	Guard and separator columns	Maximum pressure the column has been exposed to during its lifetime.
Last separator column paired with	Guard, concentrator, and trap columns	Serial number and product ID of the separator column last used with the column.
Last guard column paired with	Separator, concentrator, and trap columns	Serial number and product ID of the guard column last used with the column.
Number of samples concentrated	Concentrator columns	Number of sample injections that have occurred while the concentrator column was installed in the system. The count increments when the injection valve is switched from Load to Inject during a sequence and a concentrator column is installed on the valve.
Total volume concentrated	Concentrator columns	Total volume of sample (in mL) injected through the concentrator column in its lifetime. Uses sample volume entered in Chromeleon injection.

Table 5. Consumable tracking information updated during use, continued

Parameter	Device type	Description
Weekly background conductivity data	All suppressors	Average of the background conductivity values measured at time 0.5 min of each Chromeleon instrument injection run during the week. Averages from the last 26 weeks are stored, as well as all values for weeks 1–2 of the life of the device.
Weekly current data	Electrically regenerated suppressors and Dionex CR-TC 600	Average of the current values measured at time 0.5 min of each Chromeleon instrument method run during the week. For constant current devices, the current is the set value. Averages from the last 26 weeks are stored, as well as all values for weeks 1–2 of the life of the device.
Weekly voltage data	Electrically regenerated suppressors	Average of the voltage values at time 0.5 min of each Chromeleon instrument injection run during the week. For constant current suppressors, the voltage is the measured value; for constant voltage suppressors, the voltage is the set value. Averages from the last 26 weeks are stored, as well as all values for weeks 1–2 of the life of the device.
Maximum voltage seen	Constant current suppressors	Maximum voltage applied to the suppressor during its lifetime.
Maximum current seen	Dionex CR-TC 600	Maximum current applied to the suppressor or Dionex CR-TC 600 during its lifetime.
Total voltage hours seen	Constant current suppressors	Total number of hours voltage has been applied to the suppressor during its lifetime.
Ion count	Dionex EGC	Ions remaining in the Dionex EGC, expressed as a percentage.

Eluent Reservoirs

The area on top of the Dionex Integriion (see [Figure 8](#)) can hold up to two 2-liter reservoirs and one 4-liter reservoir, depending on the system configuration. A 2-liter reservoir is typically installed in the front section of the tray, on the left side (with a Dionex EGC installed on the right side). An additional 2-liter reservoir and a 4-liter reservoir can be installed in the back section of the tray. If two Dionex EGCs are installed in the system, the left front section is used for the second Dionex EGC.

Figure 8. Eluent area features

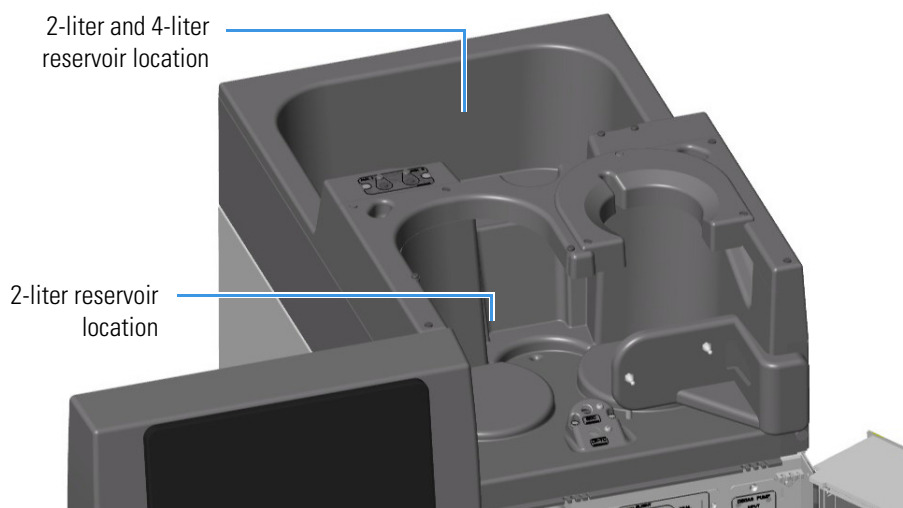

The following reservoirs are available for use with the Dionex Integriion HPIC System:

- 2-liter reservoir (P/N 062510)
- 4-liter reservoir (P/N 063292)



CAUTION Do not use the plastic reservoirs for offline vacuum degassing of eluents. The reservoirs were not designed for this purpose.



MISE EN GARDE N'utilisez pas le réservoir en plastique pour le dégazage à vide hors ligne d'éluants. Le réservoir n'a pas été conçu à cette fin.



VORSICHT Verwenden Sie keine Plastikbehälter zum Offline Vakkum-Entgasen von Eluenten. Die Behälter sind dafür nicht ausgelegt.

If a spill occurs, the spilled liquid (up to 4 liters) can be retained in the eluent tray without being automatically drained to waste. A drain valve on the rear panel controls whether the liquid is retained or allowed to drain to waste (see [“Rear Panel Features”](#) on [page 35](#)).

Pump Compartment Features

Figure 9. Pump compartment features

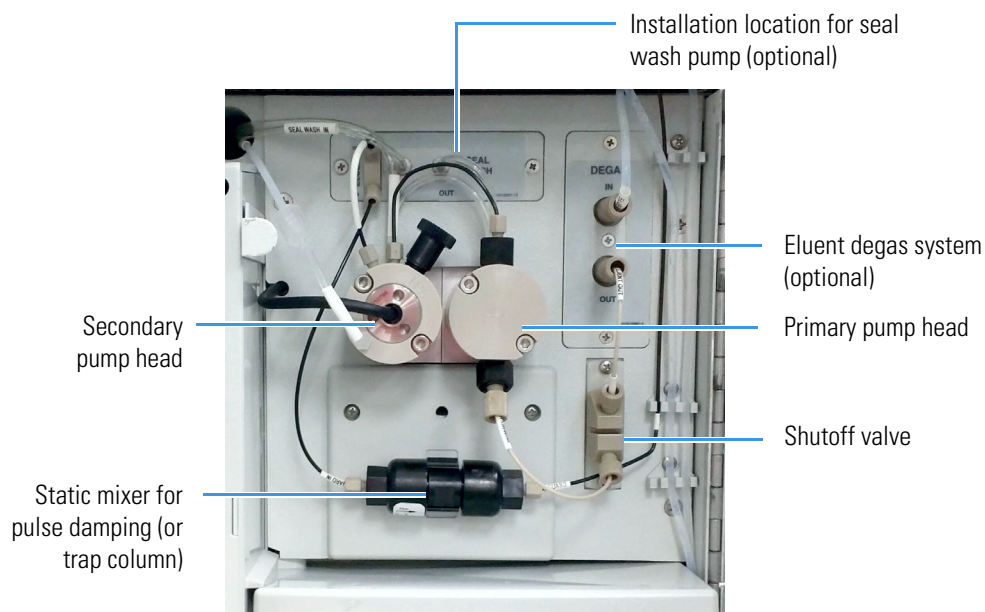

Shutoff Valve

The shutoff valve in the pump compartment controls the flow from the eluent reservoir. The valve opens automatically when the pump is started and closes when the pump is stopped. The valve cannot be manually controlled.

Eluent Degas System

The optional low-pressure eluent degas system provides continuous, online eluent degassing. Liquid from the eluent reservoir is directed to the degas vacuum chamber before it enters the system flow path. Dissolved gas in the eluent significantly affects pump performance, and vacuum degassing eluents is one way to ensure a low level of dissolved gas in the eluent. Degassing helps prevent bubbles (caused by eluent outgassing) from forming in the pump heads and detector cell. Degassing eluents is especially important when combining aqueous and nonaqueous components (for example, water and acetonitrile).

Pump

The pump is a low-pulsation, serial dual-piston pump with electronic compressibility compensation. Pump flow components are chemically inert, made with high-quality PEEK™ heads and fittings, inert polymer seals, sapphire pistons, and sapphire check valve components.

Two pump heads—a primary head and a secondary head—are connected in series. Eluent passes through both pump heads in succession. The primary pump head delivers eluent at the selected flow rate, while simultaneously filling the secondary pump head. The latter serves as a reservoir and delivers eluent while the primary head carries out the refill stroke.

The secondary pump head contains a built-in pressure transducer to measure the system pressure. The instrument control firmware controls the pump motor speed to ensure flow rate accuracy and to maintain constant flow and stable pressure.

Static Mixer

A GM-4 static mixer is installed after the secondary pump head. The mixer functions as a pulse damper for the pump.

High-Pressure Trap Column

If the system does not include a continuously-regenerated trap column (Dionex CR-TC 600), a high-pressure trap column can be installed. The trap column installs in place of the static mixer shown in [Figure 9](#). In this case, the trap column will function as the pulse damper.

[Table 6](#) lists the Thermo Scientific high-pressure trap columns available for use with the Dionex Integriion. For details about a column, refer to the column manual. Column manuals are provided on the Thermo Scientific Reference Library DVD (P/N 60-053891).

Table 6. Thermo Scientific Dionex High-Pressure Trap Columns

High-pressure trap column	Part number
Dionex MFC 500	079017
Dionex ATC 500, 2 mm	079018
Dionex CTC 500, 2 mm	079019
Dionex ATC 500, 4 mm	075976
Dionex CTC 500, 4 mm	075977
Dionex ATC-HC 500	075978
Dionex ATC-HC 500 Borate	075979

Pump Seal Wash System

The optional seal wash system rinses the seal on each pump head. When using manually-prepared eluent, rinsing the seals prolongs seal lifetime by preventing eluent crystallization on the piston surfaces.

The seal wash system consists of a seal wash pump, a reservoir containing wash solution, connecting tubing, and an eluent ground. The wash solution is usually ASTM Type I (18 megohm-cm) filtered and deionized water that meets the specifications listed in “Deionized Water Requirements for IC” on page 3. The seal wash solution is pumped first to the secondary pump head seal, then to the primary pump head seal, and then out to waste. When the seal wash system is installed, eluent flows through the eluent ground after it exits the primary pump head.

A Seal Wash Kit (P/N 22153-62010) is available that provides the parts for adding a seal wash system to the Dionex Integrion HPIC System. For installation instructions, refer to *Dionex Integrion HPIC System Installation Instructions* (Document No. 22153-97002) provided on the Thermo Scientific Reference Library DVD (P/N 60-053891).

Eluent Generator (EG) Features

The Dionex Integrion EG electrolytically generates high purity acid, base, or carbonate/bicarbonate eluents online from deionized water. The EG consists of the following components:

- A high-precision programmable current source (power supply). Several power supply options are available, depending on the number of electrolytic devices installed in a system. For example, a 3-channel option is needed for a system with a suppressor, Dionex EGC, and Dionex CR-TC 600.
- A disposable eluent generator cartridge (Dionex EGC) that contains an electrolyte concentrate solution, appropriate for the type of eluent being generated. The Dionex EGC is ordered separately.
- A Continuously Regenerated Trap Column (Dionex CR-TC 600) is used to remove any extraneous contaminants from the deionized water source. The Dionex CR-TC 600 is electrolytically- regenerated, which allows it to operate for extended periods without chemical regeneration. The Dionex CR-TC 600 is ordered separately.
- For carbonate/bicarbonate eluent, a Thermo Scientific Dionex EPM 500 Electrolytic pH Modifier (Dionex EPM) is required. The Dionex EPM produces a carbonate/bicarbonate mixture when installed with the Dionex EGC 500 K_2CO_3 . The Dionex EPM is ordered separately.

IMPORTANT Do not install a Dionex CR-TC 600 if a Dionex EGC 500 K_2CO_3 or a Dionex EPM 500 Electrolytic pH Modifier is installed.

- A Dionex RFIC Eluent Degasser (P/N 075522) that contains a tubing assembly that purges the electrolysis gas from the freshly-generated eluent before it is directed to the separator column. The eluent degasser is included with the power supply.

The Dionex EGC, Dionex CR-TC 600, Dionex EPM, and eluent degasser are installed in the eluent area of the Dionex Integration HPIC System (see Figure 10).

Figure 10. Eluent area with EG components installed

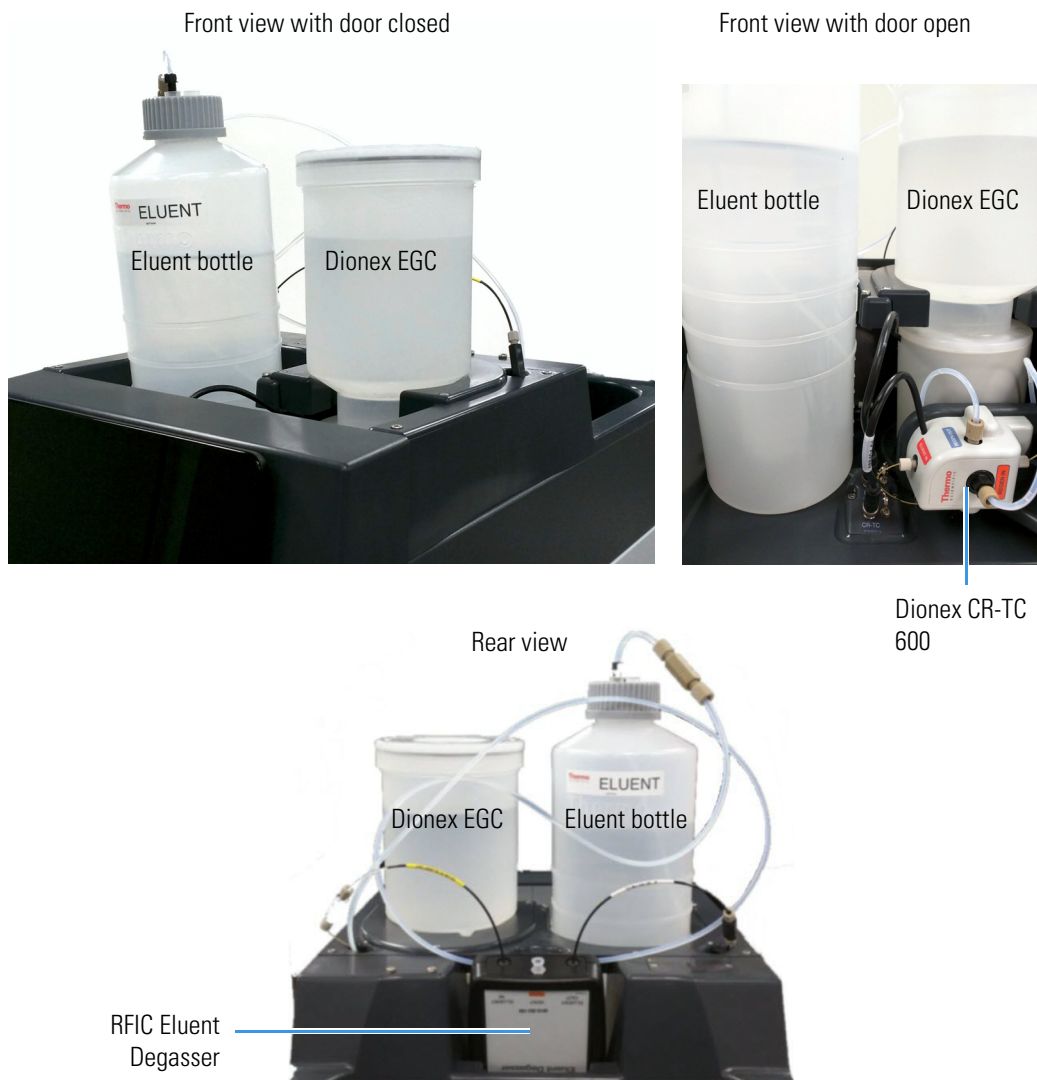

Eluent Generator Cartridge (Dionex EGC)

Dionex EGCs are available for use at standard system operating pressures (up to 21 MPa; 3000 psi) or at high system operating pressures (up to 35 MPa; 5000 psi). [Table 7](#) lists the versions of eluent generator cartridges available for use with the Dionex Integrion EG. Each Dionex EGC contains an electrolyte concentrate solution appropriate for a particular type of eluent.

Table 7. Dionex EGCs and accessories

Dionex EGC version	Part number	Eluent generated	System pressure
<i>Eluent generator cartridges and accessories for anion exchange separations</i>			
Dionex EGC 500 K ₂ CO ₃	088453	Potassium carbonate	High pressure or standard pressure
Dionex EPM 500 Electrolytic pH Modifier	088471	Carbonate/bicarbonate mixture Requires a Dionex EGC 500 K ₂ CO ₃ and a carbonate mixer: 2 mm (P/N 088467); 4 mm (P/N 088468)	High pressure or standard pressure
Dionex EGC 500 KOH	075778	Potassium hydroxide	High pressure
Dionex EGC III KOH	074532	Potassium hydroxide	Standard pressure
Dionex EGC III LiOH	074534	Lithium hydroxide	Standard pressure
Dionex EGC III NaOH	074533	Sodium hydroxide	Standard pressure
<i>Eluent generator cartridges for cation exchange separations</i>			
Dionex EGC 500 MSA	075779	Methanesulfonic acid	High pressure
Dionex EGC III MSA	074535	Methanesulfonic acid	Standard pressure

For more information, refer to the Dionex EGC manual provided on the Thermo Scientific Reference Library DVD (P/N 60-053891).

You can select the concentration of eluent to be generated from either Chromeleon or from the mobile app Home page. For details, see [“Operating the EG”](#) on [page 58](#).

Continuously Regenerated Trap Column (Dionex CR-TC)

The Dionex CR-TC 600 (the only CR-TC compatible with the Dionex Integrion) is a high-pressure, electrolytically-regenerated trap column that removes anionic or cationic contaminants in the eluent or deionized water. Table 8 lists the Dionex CR-TC 600 versions available for use with the Dionex Integrion EG. All other versions are incompatible with Dionex Integrion.

Table 8. Dionex CR-TC 600 versions

Dionex CR-TC 600 version	Part number
Dionex CR-ATC 600 Continuously Regenerated Anion Trap Column	088662
Dionex CR-CTC 600 Continuously Regenerated Cation Trap Column	088663

For more information, refer to the Dionex CR-TC 600 manual provided on the Thermo Scientific Reference Library DVD (P/N 60-053891).

IMPORTANT Do not install a Dionex CR-TC 600 if a Dionex EGC 500 K_2CO_3 or a Dionex EPM 500 Electrolytic pH Modifier is installed. Use only products that are compatible with the Dionex CR-TC 600.

Note Thermo Scientific Dionex IonPac™ trap columns can be used with the Dionex Integrion EG. However, Dionex IonPac trap columns require off-line chemical regeneration. Contact Thermo Fisher Scientific for more information.

Dionex RFIC Eluent Degasser

A Dionex RFIC Eluent Degasser (P/N 075522) contains a tubing assembly that purges the electrolysis gas from the freshly-generated eluent before it is directed to the separator column.

Dionex EPM 500 Electrolytic pH Modifier and Carbonate Mixer

The Dionex EGC 500 K_2CO_3 can be used with a Dionex EPM 500 Electrolytic pH Modifier (P/N 088471) and a carbonate mixer (2 mm, P/N 088467; 4 mm, P/N 088468) to produce a carbonate/bicarbonate mixture for use in anion exchange separations on carbonate-based Dionex IonPac columns.

After the Dionex EGC generates potassium carbonate eluent, the Dionex EPM adjusts the eluent pH to produce the carbonate/bicarbonate mixture. The carbonate mixer provides mixing necessary to produce a homogeneous solution of electrolytically-generated K_2CO_3 and $KHCO_3$ eluent.

For more information about these products, refer to the Dionex EGC manual provided on the Thermo Scientific Reference Library DVD (P/N 60-053891).

Column Compartment Features

Figure 11. Column compartment features (heated column compartment option shown)

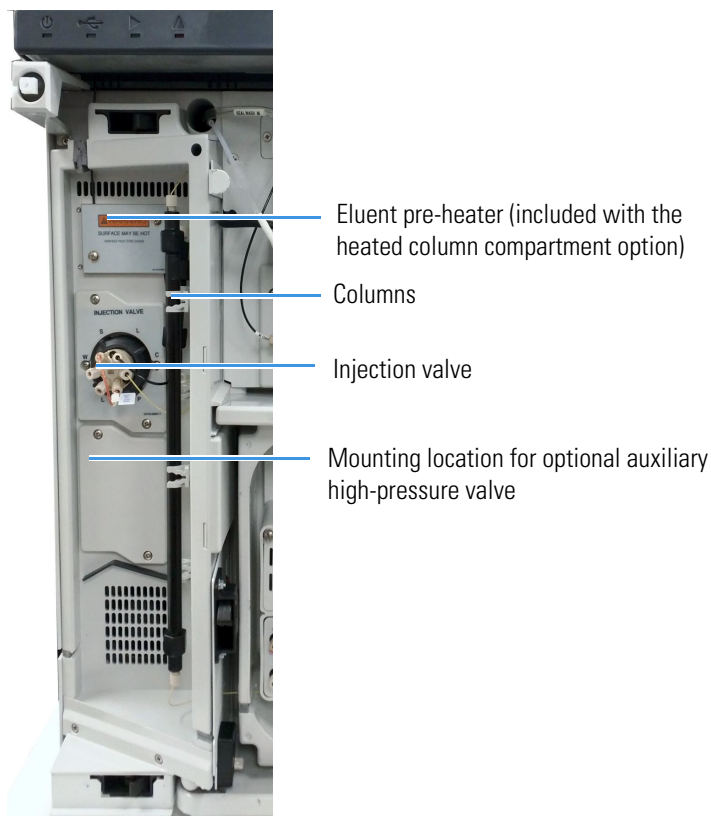

The column compartment is an insulated environmental chamber that can house a guard column, a separator column, an injection valve, and an optional auxiliary high-pressure valve. The compartment protects the housed components from fluctuations in ambient temperature.

Heated Column Compartment

If the heated column compartment option is installed, the compartment can maintain a constant temperature of 5 °C above ambient up to 80 °C. The heated compartment also includes an eluent pre-heater that heats the eluent to the compartment setpoint before it enters the columns. For additional temperature specifications, see “[Temperature Control Zones](#)” on [page 34](#).



CAUTION Before servicing the instrument, allow heated components to cool.

RFID for Columns

If the RFID (radio-frequency identification) option is configured, the system will store and manage information about the various columns used in the system. This stored information will be available for use when configuring the system in Chromeleon and for troubleshooting. For details, see [“Consumable Device Tracking”](#) on [page 15](#).

High-Pressure Valves

Up to two high-pressure valves can be installed in the Dionex Integriion: an injection valve and an optional auxiliary valve. The following valve models are available (all models are electrically-activated, two-position valves):

- 4-port high-pressure valve (P/N 22153-60016), which can be configured for use as an injection valve. The 4-port valve has a 0.4 μL internal sample loop.
- 6-port high-pressure valve (P/N 22153-60014), which can be configured as an injection valve or an auxiliary valve. You can install either an external sample loop (for example, a 10 μL PEEK sample loop (P/N 042949)) or a concentrator column on the 6-port valve.
- 10-port high-pressure valve (P/N 22153-60015), which can be configured as an injection valve or an auxiliary valve. The 10-port valve can be plumbed in various configurations, depending on your application. For example, if your application requires loading sample onto a concentrator column, the 10-port valve can be plumbed with a sample loop and a concentrator column.

Injection Valve Operation

When a 4-port or 6-port high-pressure valve is configured as an injection valve, both valve operating positions (Load and Inject) deliver liquid flow through the system as follows:

- In the Load position, sample flows from the syringe or autosampler line, through the valve, and into the sample loop, where it is held until injection. Excess sample flows out to waste. Eluent flows from the pump, through the valve, and to the column, bypassing the sample loop.
- In the Inject position, eluent flows from the pump, through the sample loop, and on to the column, carrying the contents of the sample loop with it.

Figure 12 shows the flow schematic for a 4-port injection valve. Figure 13 shows the flow schematic for a 6-port injection valve.

Figure 12. Injection valve flow schematics (4-port valve)

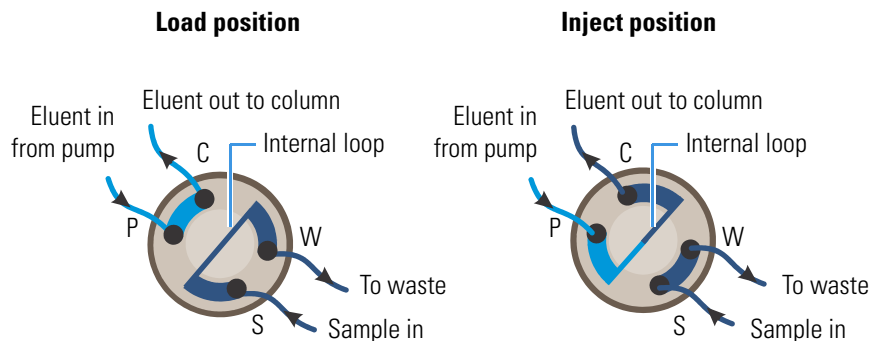
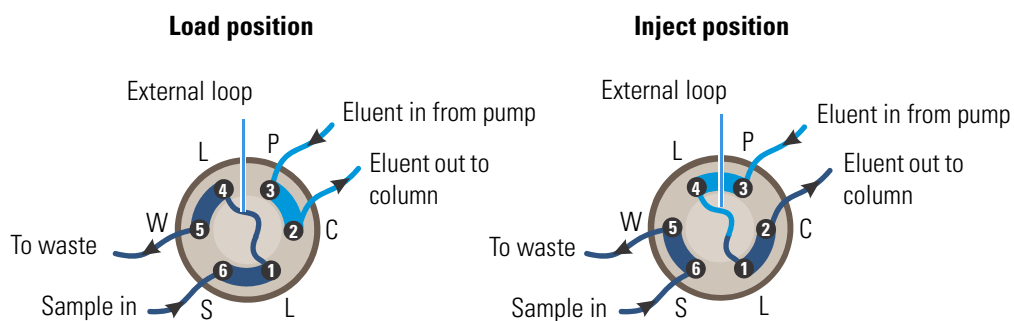

Figure 13. Injection valve flow schematics (6-port valve)



Auxiliary Valve Operation

When a high-pressure valve is configured as an auxiliary valve, the two valve positions are designated as A position and B position. Figure 14 shows the liquid flow paths through the valve ports at each valve position.

Figure 14. 6-port and 10-port high-pressure valve flow schematics



Connections from chromatography components to the valve ports depend on the application to be run.

Valve Control

To control high-pressure valves, use one of the following methods:

- Select commands on the Pump_ECD ePanel in Chromeleon.
- Select commands on the mobile app Valves page.
- Add commands to a Chromeleon instrument method.

Detector Compartment Features

The detector compartment can house either a Dionex Integrion Conductivity Detector (CD) (P/N 22153-60036) or a Dionex Integrion Electrochemical Detector (ED) (P/N 22153-60037). Installation of an ED requires the Dionex Integrion RFIC configuration.

For details about a detector, see:

- “[Conductivity Detector \(CD\)](#)” on [page 30](#)
- “[Electrochemical Detector \(ED\)](#)” on [page 31](#)

Temperature-Controlled Detector Compartment

If the temperature control option is installed, the detector compartment can maintain a minimum temperature of 15 °C *or* 20 °C below ambient (whichever is higher). For additional temperature specifications, see “[Temperature Control Zones](#)” on [page 34](#).

Note A temperature-controlled detector compartment is highly recommended when an electrochemical detector (ED) is installed.

Leak Sensor

If liquid collects in the drip tray below the detector components (see [Figure 15](#)), the leak sensor reports the leak and an error message is displayed in the Chromeleon audit trail and in the mobile app error list. In addition, the alert LED on the front panel lights. For troubleshooting information, see “[Liquid Leaks](#)” on [page 138](#).

Leaks from the detector compartment, pump compartment, column compartment, and the top front section of the eluent area are all directed to this leak sensor.

Conductivity Detector (CD)

Figure 15. Detector compartment features (CD configuration)

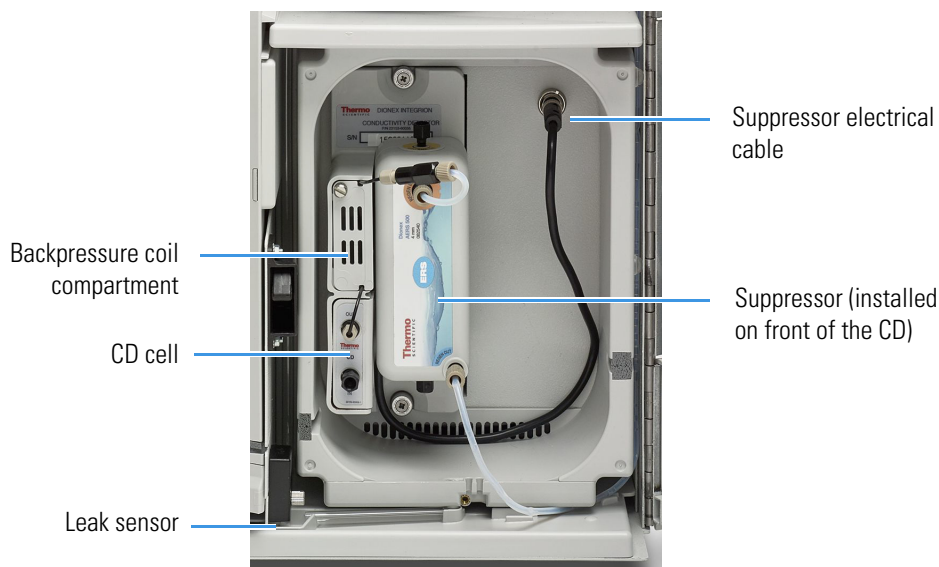

The CD consists of a heated conductivity cell and the electronics required for collecting the conductivity data and sending it to the computer and the analog output.

The flow-through conductivity cell measures the electrical conductance of analyte ions as they pass through the cell. Two passivated 316 stainless steel electrodes are permanently sealed into the PEEK cell body. The cell design provides efficient sweep-out, low volume (<1 μL), and low dispersion.

CD Temperature Control

Temperature directly affects the conductivity of a solution. For example, laboratory heating and air conditioning systems can cause a regular slow cycling in the baseline. This, in turn, can affect the reproducibility of an analysis. The higher the conductivity, the more pronounced the effect. To reduce the effect of temperature variation, the Dionex Integriion provides temperature control of the cell and optional temperature control of the detector compartment. The heater inside the cell regulates the cell temperature. For temperature specifications, see [“Temperature Control Zones”](#) on page 34.

CD Temperature Compensation

Built-in temperature compensation helps minimize changes in the baseline or in peak heights if the operating temperature is different from the temperature at which the cell was calibrated. The default temperature compensation is 1.7% per $^{\circ}\text{C}$. This can be reset to between 0% and 3.0% per $^{\circ}\text{C}$, depending on the eluent. If you notice that the baseline shifts up when the ambient laboratory temperature increases, the compensation factor is too low and should be reset to a higher value. You can set the compensation factor in Chromeleon or on the mobile app Detector page (see [“Detector Page”](#) on page 88).

Suppressors, CRD, and SRN

A suppressor is used in conductivity detection applications to reduce the eluent conductivity and enhance the conductivity of the sample ions, thereby increasing detection sensitivity. The CD can operate with a variety of suppressors, including the Thermo Scientific Dionex ERS™ 500 Electrolytically Regenerated Suppressor and Thermo Scientific Dionex CRS™ 500 Chemically Regenerated Suppressor. The suppressor is installed on the CD to the right of the cell inlet and outlet ports (see Figure 15).

Installation of a Thermo Scientific Dionex Carbonate Removal Device (Dionex CRD 200 or Dionex CRD 300) is an option for anion applications. The Dionex CRD 200 removes the carbonate peak contributed by the sample in hydroxide eluent chemistries. The Dionex CRD 300 removes carbonic acid from suppressed eluent in carbonate eluent chemistries. The CRD is plumbed after the suppressor and attaches to the front of the suppressor.

A Thermo Scientific Dionex SRN™ 300 Self-Regenerating Neutralizer (Dionex SRN 300) can be used for neutralizing basic or acidic matrices. The Dionex SRN 300 mounts on a bracket in the eluent area.

For details about a suppressor, Dionex CRD, or Dionex SRN, refer to the manual for the device. The manuals are provided on the Thermo Scientific Reference Library DVD (P/N 60-053891).

Electrochemical Detector (ED)

Figure 16. Detector compartment features (ED configuration)

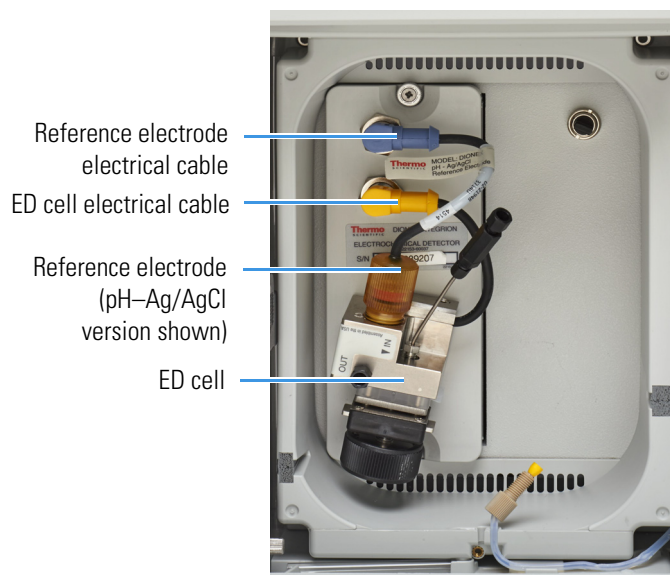

The ED consists of an amperometric detection cell and the detector electronics required to collect data and send it to the computer and the analog output.

The ED can perform the following electrochemical detection modes:

- Direct current (DC) amperometry
- Integrated amperometry, including pulsed amperometric detection (PAD) and integrated pulsed amperometric detection (IPAD)

ED Cell

The ED cell is a miniature flow-through amperometric detection cell with a titanium cell body (the counter electrode), a reference electrode, and a working electrode. The reference electrode can be a combination pH-Ag/AgCl reference electrode or a PdH reference electrode. Several disposable and conventional (nondisposable) working electrode types are available. The type of working electrode used depends on the application. Four conventional (nondisposable) working electrode types are available: gold, platinum, silver, and glassy carbon. Five disposable working electrode types are available: gold (on either a polyester or a polytetrafluoroethylene (PTFE) substrate), silver, platinum, and carbon.

The ED cell is a thin-layer design. Eluent flows in a thin channel parallel to the surface of a flat disk electrode. The resulting smooth flow minimizes noise. The cell design minimizes the electrical resistance between the working electrode and the counter electrode by positioning the counter electrode (the cell body) directly across the thin-layer channel from the working electrode. This results in a wide linear dynamic range.

ED Cell Solvent Compatibility

The ED cell can be used with common reversed-phase solvents such as methanol and acetonitrile. If a disposable working electrode on polyester substrate is used, the percentage of methanol should not exceed 30% and the percentage of acetonitrile should not exceed 5%. In addition, prolonged exposure (more than 8 hours) of disposable gold electrodes on polyester substrate to eluents containing hydroxide concentrations greater than 100 mM is not recommended. Shorter rinse periods of 10 to 20 minutes (for example, the carbonate removal step during monosaccharide and disaccharide chromatography) at high hydroxide concentrations do not affect the electrode performance. If sustained highly alkaline eluent conditions are required, use a disposable gold electrode on a PTFE substrate or a conventional gold electrode. Refer to the disposable electrode manual (Document No. 065040) for additional eluent compatibility information.

Because conventional working electrode blocks are made of Kel-F® and use a gasket made of Ultem®, there is no restriction on the concentration of organic solvents that can be used with them (providing the solvent is compatible with PEEK tubing).

There is also no restriction on the use of organic solvents when disposable gold electrodes on PTFE substrate and PTFE gaskets are used.

Combination pH–Ag/AgCl Reference Electrode

The pH–Ag/AgCl reference electrode is a standard combination pH electrode containing a glass membrane pH half-cell and a Ag/AgCl half-cell. The combination pH electrode monitors eluent pH. The Ag/AgCl half-cell is typically used as the cell reference electrode. To minimize changes in the baseline, the combination pH–Ag/AgCl electrode can be used as the reference electrode during a pH gradient.

IMPORTANT Do not allow the pH–Ag/AgCl reference electrode to dry out. Make sure that eluent is being pumped continuously through the cell. If the cell will not be used for a short time (less than 2 days), disconnect the tubing from the inlet and outlet fittings and install fitting plugs. For longer shutdowns, remove the electrode from the cell and store it in its storage cap filled with saturated KCl solution. For details, see “ED Cell Storage” on page 57.

Monitoring the ED Cell pH Readout

Monitoring the pH readout of a solution with a known composition lets you detect any reference potential shift that may occur over time. This allows you to determine when the pH–Ag/AgCl reference electrode needs regenerating or replacing, thus improving the reproducibility of your analyses. For instructions on how to monitor the pH readout, see “ED Cell Operating Precautions” on page 60.

Note Monitor the pH when the pH–Ag/AgCl reference electrode is used in the Ag mode as well as in the pH mode.

Palladium Hydrogen (PdH) Reference Electrode

The PdH reference electrode consists of palladium and platinum electrodes immersed in an aqueous solution. With a potential applied between the two electrodes, palladium is connected as a cathode and platinum as an anode. As a consequence of the applied potential, hydrogen gas is generated at the palladium electrode and oxygen gas at the platinum electrode. Whereas the oxygen gas is swept out of the cell in the liquid stream, a portion of the hydrogen gas is taken up by palladium metal. An equilibrium develops between molecular hydrogen in the liquid phase and the adsorbed hydrogen in palladium. The palladium hydrogen electrode becomes a reference electrode with a half reaction of:

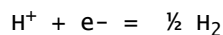

Where the hydrogen is supplied by the following process:

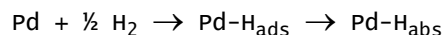

The PdH reference electrode is a pH electrode. The potential of the PdH reference electrode is pH dependent. When the PdH reference electrode is selected, you will be asked to input the eluent type (acid or base), concentration of the eluent and the detection temperature. From those inputs, Chromeleon can calculate the offset potential of the PdH reference electrode versus the Ag/AgCl reference electrode. After selection of a built-in waveform for an application in Chromeleon, the software can create a waveform for use with the PdH reference electrode by adjusting the offset potential.

No pH Readout with the PdH Reference Mode

If the PdH electrode were connected to another reference electrode (for example, a Ag/AgCl electrode), the PdH electrode could serve as a pH indicator electrode. However, when the PdH electrode functions as a reference electrode, it cannot indicate pH. In the same manner, a glass electrode alone cannot measure pH; it must be used with a suitable reference electrode.

The pH readout of the ED cell is disabled when the PdH reference mode is selected.

Temperature Control Zones

The Dionex Integrion provides the following temperature control zones:

- Heated column compartment (optional)
- Temperature-controlled detector compartment (factory-installed option)
- Conductivity cell temperature control

The temperatures achieved for a particular zone can vary from the control range, depending on the ambient temperature (see [Table 9](#)).

Table 9. Temperatures achieved for each of the temperature zones

Temperature zone	Control range	Achieved temperatures (based on ambient)
Heated column compartment	10 to 80 °C	From 5 °C above ambient to 80 °C
Temperature-controlled detector compartment	15 to 40 °C	Minimum temperature 15 °C <i>or</i> 20 °C below ambient (whichever is higher)
Conductivity cell (<i>without</i> a temperature-controlled detector compartment)	30 to 60 °C	From 7 °C above ambient to 60 °C
Conductivity cell (<i>with</i> a temperature-controlled detector compartment)	20 to 60 °C	From 7 °C above the detector compartment's set temperature to 60 °C

Minimum temperatures are also affected by the ambient humidity. If the humidity is high, the minimum temperature achieved for a temperature zone is not as low as that achieved in a low ambient humidity environment.

Rear Panel Features

Figure 17. Dionex Integrion rear panel features

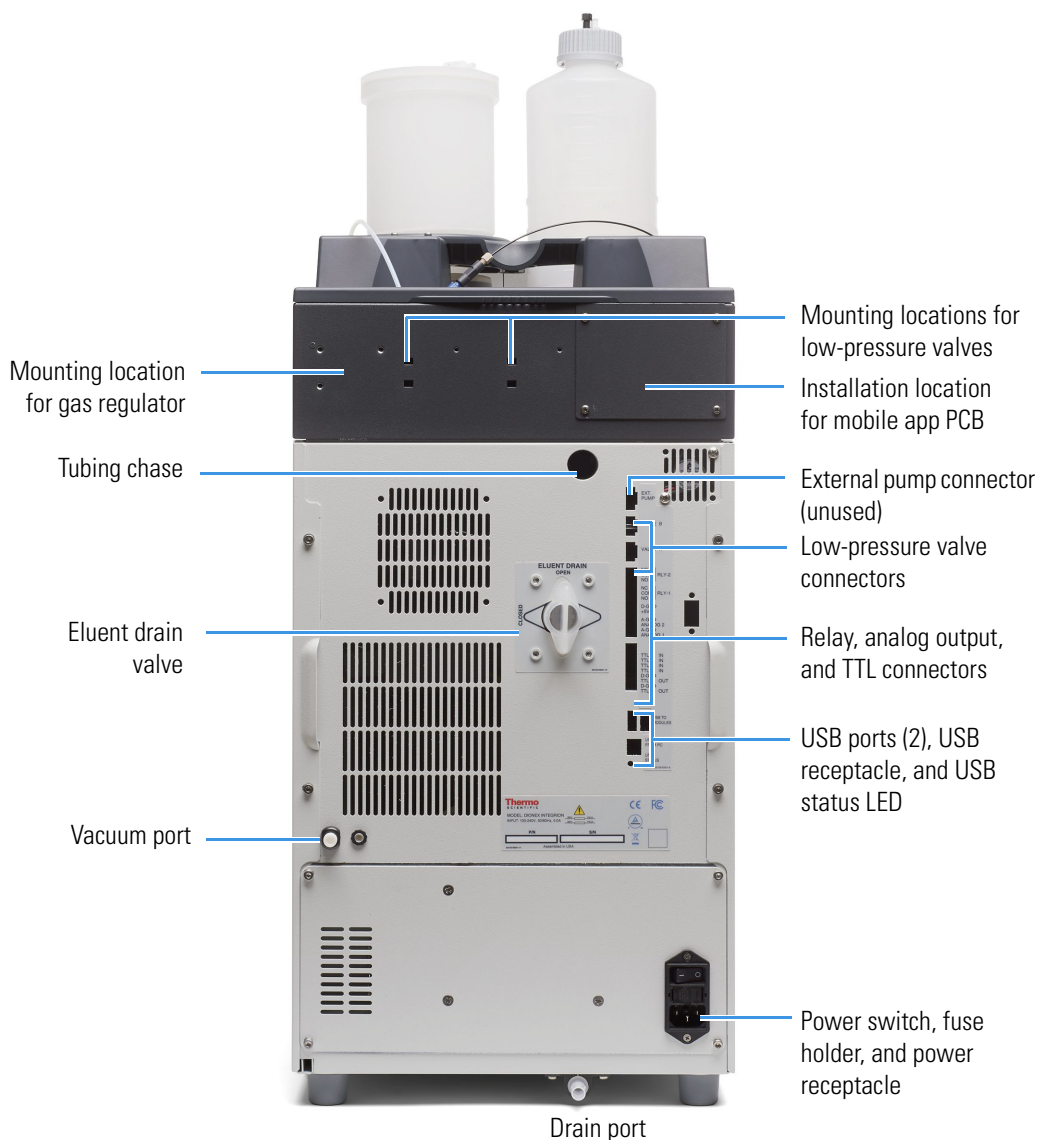

Gas Regulator and Low-Pressure Valve Mounting Locations

An optional gas regulator for pressurizing the eluent, regenerant, or reagent reservoirs can be installed. A kit (P/N 078520) that includes the regulator, mounting bracket, and other items needed must be ordered separately. For installation instructions, refer to *Dionex Integrion HPIC System Installation Instructions* (Document No. 22153-97002) provided on the Thermo Scientific Reference Library DVD (P/N 60-053891).

Mounting locations for two optional low-pressure valves are provided. Low-pressure valves can be used for on/off control of liquid flow (for example, to turn flow on and off from a reagent or external regenerant reservoir). For valve details, see “[Low-Pressure Valve Options](#)” on [page 38](#).

Tubing Chase and Waste Lines

The tubing chase routes system waste from the front of the Dionex Integrion, through the interior of the system, and to the rear panel. The waste line is grounded to avoid spikes.

Drain Valve

The drain valve controls whether liquid in the eluent area accumulates in the tray or flows to waste. When the drain valve is closed, liquid that has spilled or leaked into the eluent area is contained in the tray. The tray can hold up to 4 L of fluid. When the drain valve is open, liquid drains from the tray through internal tubing to the drain port and then out to waste.

Vacuum Port

The vacuum port can provide a vacuum for various applications, including a Dionex RFIC Eluent Degasser, a Dionex Carbonate Removal Device, or the vacuum degas module in a Dionex AS-AP Autosampler.

The optional Dionex AS-AP degas module is used to degas the autosampler’s wash liquid. A Dionex AS-AP Degas Kit (P/N 079883) is available that includes the degas module, tubing, and fittings required to install the degasser in the AS-AP and connect it to the Dionex Integrion HPIC System.

Note If the vacuum port is not connected, make sure the plug remains installed in the port. This prevents vacuum loss from the system.

Drain Port

Any leaks or condensation that may occur in the system are routed to the drain port on the rear of the system. A drain line is connected to this port during installation. Place the drain line into a waste container. To maintain a positive siphon, position the waste container below the level of the Dionex Integrion.

IMPORTANT For correct drainage, make sure the drain line is not bent, pinched, or elevated at any point. Do not allow the end of the line to be submerged in waste liquid.

Low-Pressure Valve Connectors

Up to two optional low-pressure valves can be connected. The valves can then be controlled from Chromeleon or the mobile app. For details, see [“Low-Pressure Valve Options”](#) on [page 38](#).

Relay, Power, Analog Output, and TTL Connectors

The 8-pin I/O connector strip provides connections for TTL output and input functions. The 12-pin I/O connector strip provides connections for relay, power, and analog output functions. The relay and power outputs can be used to control functions in external devices.

- The two analog outputs supply a voltage signal proportional to the current measured by a detector cell. The outputs can be connected to an analog-to-digital (A/D) converter such as an integrator or other recording device.
- When connected to a controlling device, the TTL inputs can be programmed to perform various system functions (for example, switch the injection valve, turn the pump on and off).
- The TTL outputs can be used to control functions in external devices.

For details about the I/O connectors, including connection instructions, see [“Using Rear Panel Inputs and Outputs”](#) on [page 67](#).

USB Status LED and USB Connectors

The USB status LED is lighted when the system is connected to Chromeleon. The LED flashes when communication is occurring between the system and Chromeleon.

The USB (“B” type connector) allows connection to the PC on which Chromeleon software is installed.

The two USB ports (“A” type connectors) allow connection to other USB devices in the system.

A 1.8 m (6 ft) USB cable (P/N 960777) is included in the Dionex Integriion Ship Kit (RFIC, P/N 22153-62003; non-RFIC, P/N 22153-62002). For connection instructions, refer to *Dionex Integriion HPIC System Installation Instructions* (Document No. 22153-97002), provided on the Thermo Scientific Reference Library DVD (P/N 60-053891).

Power Switch, Fuse Holder, and Power Receptacle

The rear panel power switch provides on/off control of power to the Dionex Integriion.

The fuse cartridge contains two 5 A, 250 V, 5 x 20 mm IEC 60127-2 fast-blow fuses (P/N 00006-03-00016). To change the fuses, see [“Changing the Main Power Fuses”](#) on [page 218](#).

The IEC 320 C13 power cord plugs into the IEC 320 three-prong receptacle.



CAUTION The power supply cord is used as the main disconnect device. Make sure the socket-outlet is located near the system and is easily accessible.



MISE EN GARDE Le cordon d'alimentation principal est utilisé comme dispositif principal de débranchement. Veillez à ce que la prise de base soit située/installée près du module et facilement accessible.



VORSICHT Das Netzkabel ist das wichtigste Mittel zur Stromunterbrechung. Stellen Sie sicher, daß sich die Steckdose nahe am Gerät befindet und leicht zugänglich ist.

Low-Pressure Valve Options

Up to two low-pressure valves can be mounted on the rear panel. The valves are two-way valves (P/N 079848) or three-way valves (P/N 061971). Two-way valves provide on/off control of liquid flow in one direction. Three-way valves provide flow control in two directions (see Figure 18).

Figure 18. Three-way low-pressure valve flow schematics

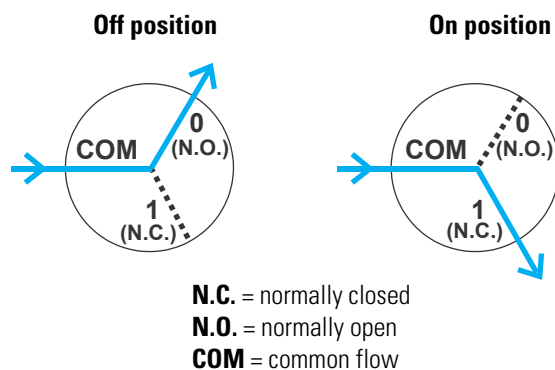

Note: When the valve is off (not energized), port 0 is open (N.O.) and port 1 is closed (N.C.). Conversely, when the valve is on, port 1 is open and port 0 is closed.

Valve port connections to chromatography components vary, depending on the application. To control the valves, use one of the following methods:

- Select commands on the Pump_ECD ePanel in Chromeleon.
- Select commands on the mobile app Valves page.
- Add commands to a Chromeleon instrument method.

System Flow Schematics

This section includes flow schematics for the following system configurations:

- Conductivity detection using suppression in recycle mode (see [Figure 19](#))
- Conductivity detection using suppression in recycle mode with Reagent-Free™ IC eluent generation (RFIC-EG); cation system (see [Figure 20](#))
- Conductivity detection using suppression in recycle mode with RFIC-EG; anion system (see [Figure 21](#))
- Electrochemical detection with RFIC-EG (see [Figure 22](#))

Figure 19. System flow schematic for conductivity detection using suppression in recycle mode

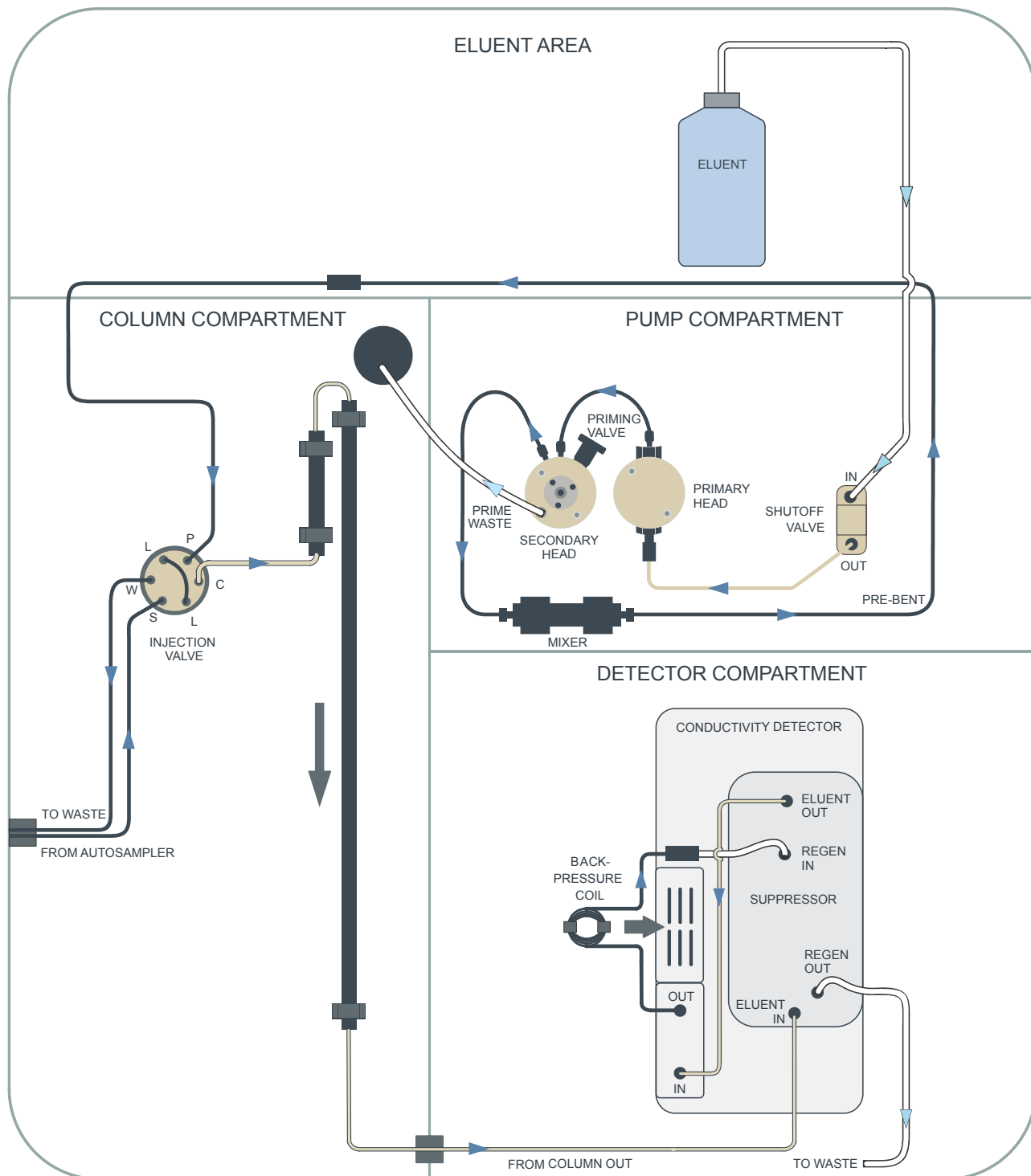

Figure 20. System flow schematic for conductivity detection with RFIC-EG, using suppression in recycle mode

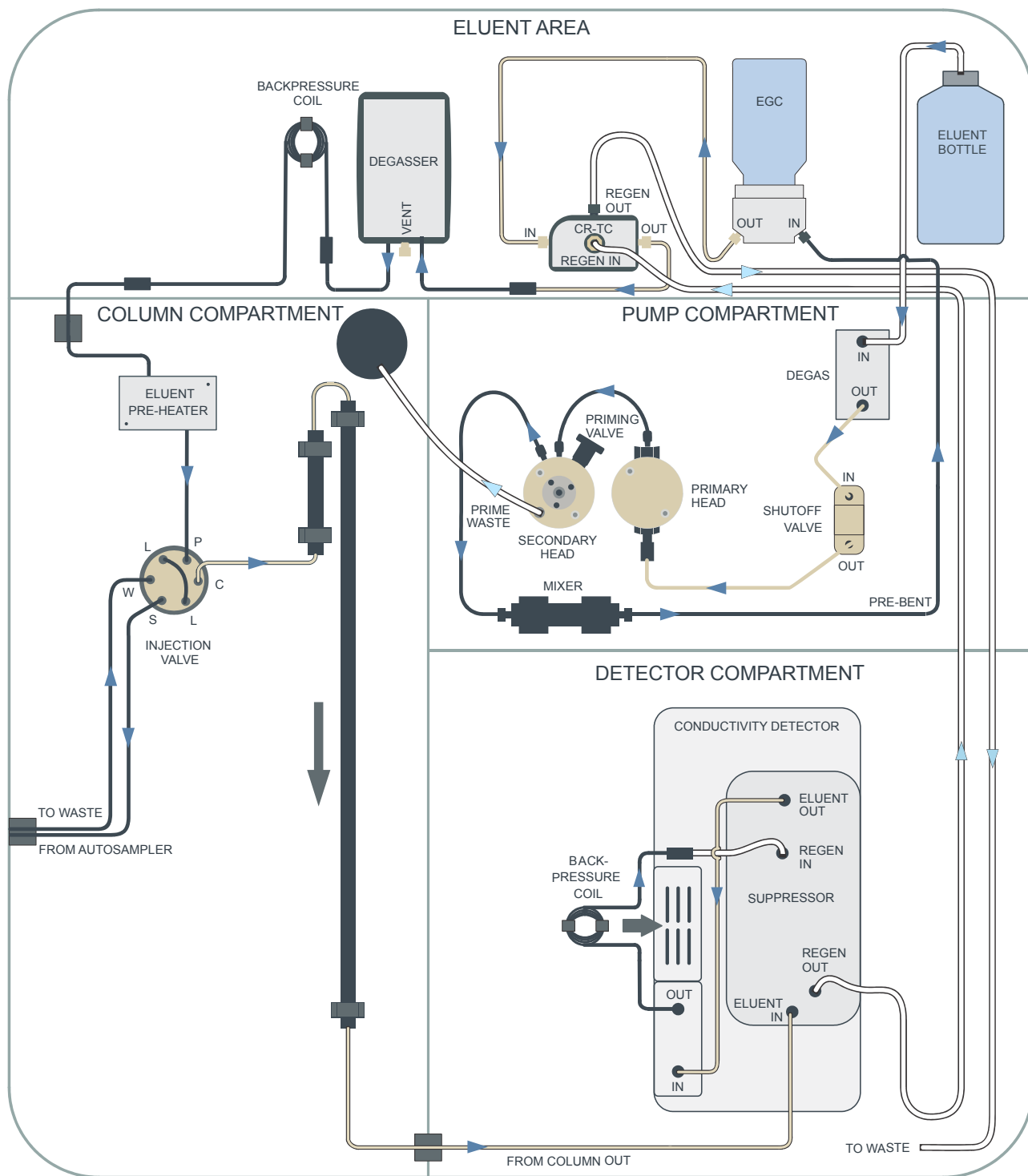

Figure 21. System flow schematic for conductivity detection with RFIC-EG, using suppression in recycle mode; anion system with a Dionex CRD

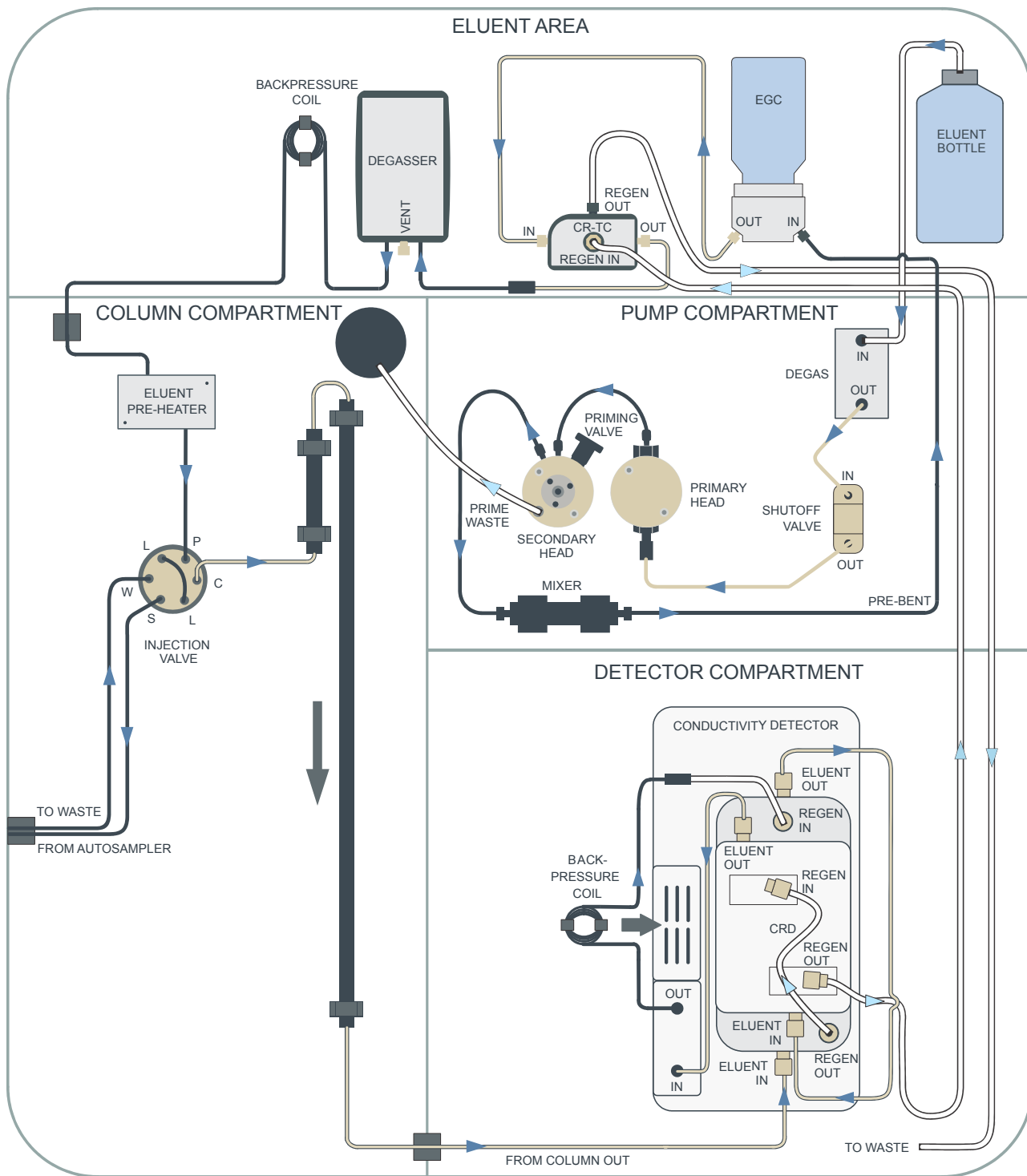
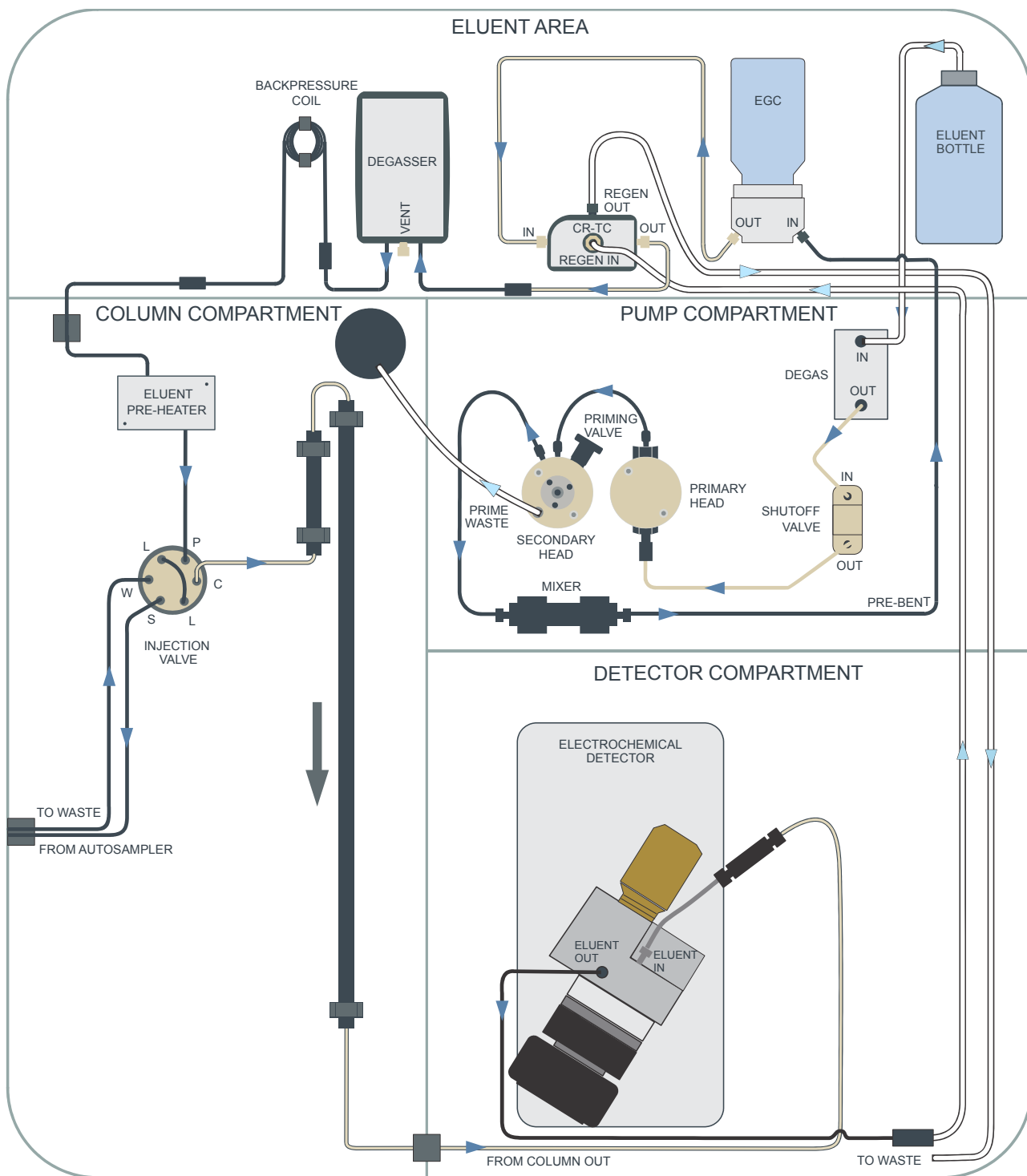

Figure 22. System flow schematic for electrochemical detection with RFIC-EG



2 Functional Description

System Flow Schematics

Operation

This chapter describes routine startup, operation, and shutdown procedures for the Dionex Integrion HPIC System.

Note The instructions in this chapter assume that the initial setup of the Dionex Integrion HPIC System has already been completed (including configuring the Dionex Integrion HPIC System in a Chromeleon instrument). If this is not the case, refer to *Dionex Integrion HPIC System Installation Instructions* (Document No. 22153-97002) for instructions before beginning operation.

Contents

- [Starting Up the System \(Overview\)](#)
- [Setting Up the Reservoir](#)
- [Setting Up the Seal Wash System](#)
- [Turning On the System Power](#)
- [Connecting to Chromeleon](#)
- [Priming the Pump](#)
- [Equilibrating the System](#)
- [Preparing Samples](#)
- [Loading Samples into the Loop or Concentrator](#)
- [Performing Sample Analyses](#)
- [System Shutdown](#)
- [Operating the EG](#)
- [Operating the ED](#)
- [Using Rear Panel Inputs and Outputs](#)

Starting Up the System (Overview)

Before starting sample analyses, perform the following tasks to start up the system and equilibrate it.

- Set up the reservoir (see [page 46](#))
- Set up the seal wash system (if installed) (see [page 49](#))
- Turn on the power (see [page 49](#))
- Connect to Chromeleon (see [page 49](#))
- Prime the pump (if necessary) (see [page 50](#))
- Set operating parameters (see [page 52](#))
- Equilibrate the system and verify operational readiness (see [page 52](#))

Setting Up the Reservoir

IMPORTANT To rinse and fill reservoirs used for eluent generation or seal washing, or to manually prepare eluent, always use ASTM filtered, Type I (or better) (18 megohm-cm) deionized water that meets the specifications in “[Deionized Water Requirements for IC](#)” on [page 3](#).

❖ To set up the reservoir

1. Rinse the eluent reservoir with deionized water.

If the reservoir still appears dirty, or has a slimy film on the inside, clean it as instructed on [page 108](#).
2. If you are using an EG, fill the reservoir with deionized water. If not, fill the reservoir with the prepared eluent.
3. Place the reservoir in the eluent area on top of the Dionex Integrion.
4. If an end-line filter (P/N 045987) is not installed, locate the filter in the Dionex Integrion Ship Kit (RFIC, P/N 22153-62003; non-RFIC, P/N 22153-62002) and install the filter on the end of the reservoir’s eluent line.
5. Thoroughly rinse the end-line filter with deionized water.
6. Install the reservoir cap, making sure the end of the line extends to the bottom of the reservoir, and that the filter is submerged in liquid. This prevents air from being drawn through the eluent lines. Hand-tighten the cap.

7. Verify that the inlet line from the pump is connected to the **ELUENT BOTTLE OUT** line from the reservoir cap (see [Figure 23](#)).

Figure 23. Eluent reservoir connections (system with an EG and 2-liter reservoir shown)

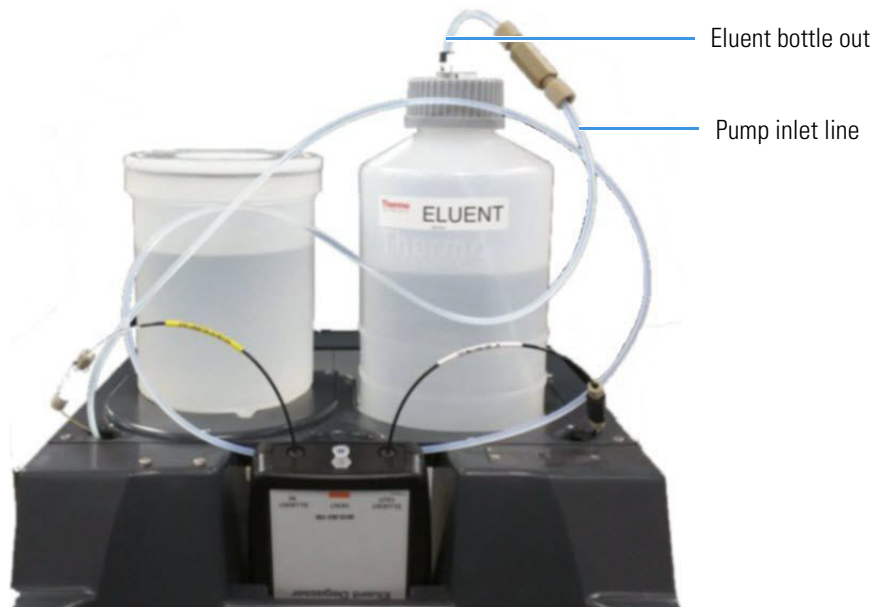

Pressurizing Reservoirs

The eluent reservoirs available for use with the Dionex Integriion can be pressurized to <math><0.07\text{ MPa}</math> (<math><10\text{ psi}</math>). For a list of reservoirs, see [page 20](#). Although not *required*, pressurizing reservoirs with helium or nitrogen is recommended under the following circumstances:

- When using eluents that are sensitive to contamination.
- When combining aqueous and non-aqueous components (for example, water and acetonitrile). Pressurizable reservoirs allow eluents to be stored under a specific atmosphere.

The gas regulator accessory bracket and other items needed for pressurizing the eluent reservoir must be ordered separately (P/N 078520). For installation instructions, refer to *Dionex Integriion HPIC System Installation Instructions* (Document No. 22153-97002) provided on the Thermo Scientific Reference Library DVD (P/N 60-053891).

❖ To pressurize the reservoir

1. Connect the liquid line from the pump to the reservoir and fill the reservoir.
2. Turn the gas regulator knob fully counterclockwise (to the left) (see [Figure 24](#)) to ensure that there is no pressure to the reservoir when the gas source is turned on.

Figure 24. Gas connections to the regulator and reservoir

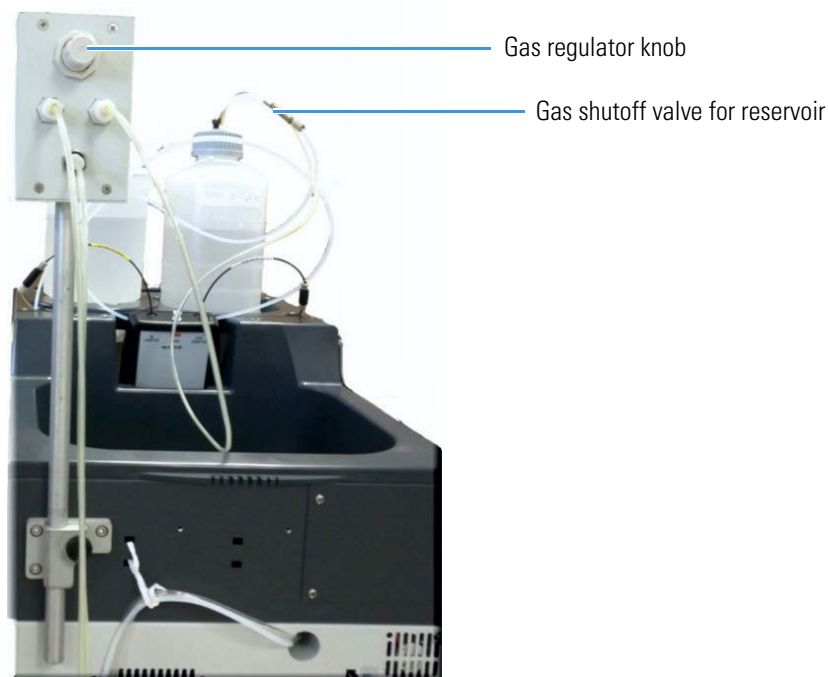

3. Close the gas shutoff valve on the reservoir cap.
4. Turn on the gas source to 0.34 MPa (50 psi) \pm 0.07 MPa (10 psi).
5. Turn the gas regulator knob clockwise and adjust the pressure to between 30 and 40 kPa (5 and 6 psi).



CAUTION Never pressurize eluent reservoirs above 70 kPa (10 psi). Pressurizing reservoirs above this limit can cause the reservoir to rupture or crack.



MISE EN GARDE Ne mettez jamais les réservoirs d'élphants sous une pression supérieure à 0,07 MPa (10 lb/po²).



VORSICHT Setzen Sie den Eluentbehälter auf keinen Fall einem Druck über 0,07 MPa aus.

6. If the liquid line from the pump is connected, you may open the gas shutoff valve on the reservoir cap.

Setting Up the Seal Wash System

If the optional seal wash system is installed, follow the instructions below to set up the system.

❖ To set up the seal wash system

1. Rinse the seal wash reservoir with deionized water.
2. Fill the reservoir with deionized water and place it in the eluent area.
3. Install the reservoir cap, making sure the end of the line extends to the bottom of the reservoir.
4. Verify that the seal wash inlet tubing is connected to the fitting on the reservoir cap.

Turning On the System Power



❖ To turn on the system power

1. Flip the power switch on the rear panel (see [Figure 17](#)).
2. Turn on the power to the computer and the autosampler (if used).

At startup, the Dionex Integrion performs an initialization procedure. If the mobile app is configured, a startup screen is displayed during the initialization process. When initialization is complete, the Home page is displayed (see [Figure 4](#) on [page 11](#)).

Connecting to Chromeleon

❖ To start the Chromeleon Instrument Controller Service

On the Windows taskbar, right-click the Chromeleon icon  in the system tray and click **Start Chromeleon Instrument Controller**. The icon changes to  to indicate that the Instrument Controller Service is starting. When the Instrument Controller Service is running (idle), the icon changes to gray .

If the Chromeleon icon is not on the taskbar, click **Start > All Programs > Thermo Chromeleon 7 > Services Manager** to open the Services Manager and click **Start Instrument Controller**.

❖ To start the Chromeleon client

Click **Start > All Programs > Thermo Chromeleon 7 > Chromeleon 7**.

❖ To display the ePanel Set

Click the **Instruments** Category Bar. Select the name of the instrument in which the Dionex Integrion is configured. Chromeleon connects to the instrument and displays the ePanel Set. See the example in [Figure 25](#).

Figure 25. Example Chromeleon ePanel Set

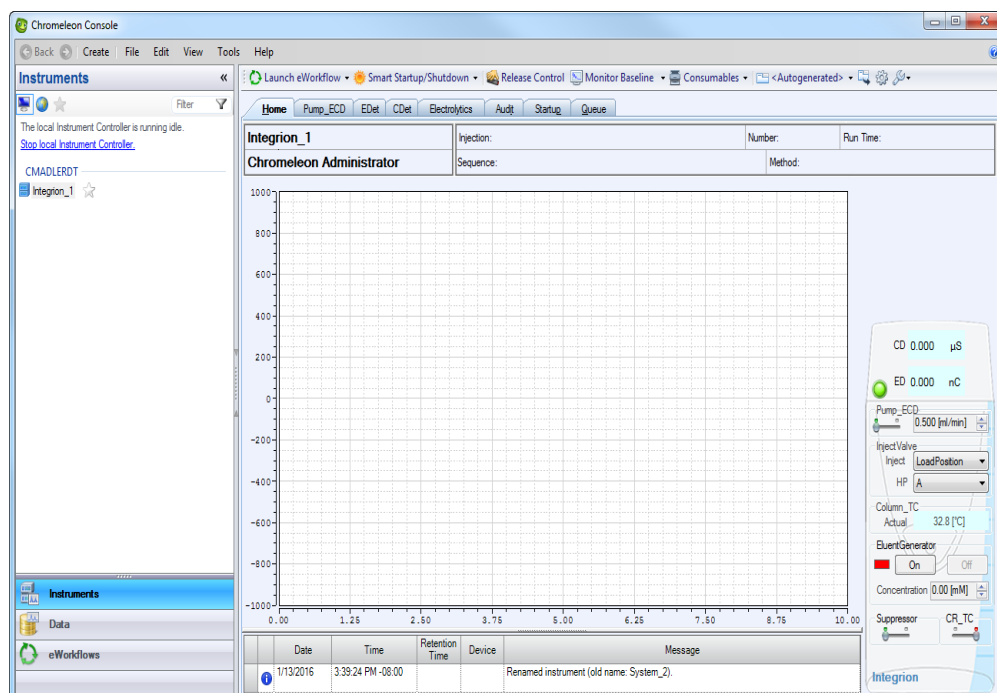

Priming the Pump

Prime the pump before beginning operation if any of the following conditions applies:

- The eluent has been changed.
- The eluent line is new (empty).
- The eluent line contains air.

Note Although a 10 mL syringe (P/N 079803) can be used to prime the pump, using a syringe is recommended only if the eluent line is 100% empty or if the pump is dry.

❖ To prime the pump

1. Verify that the system pressure is less than 0.7 MPa (100 psi). Open the priming valve on the secondary pump head (see Figure 26) by turning the knob one-half turn counterclockwise.

Note If the priming valve is opened too much, air is drawn through the valve and air bubbles can be seen exiting the waste line.

Figure 26. Pump components

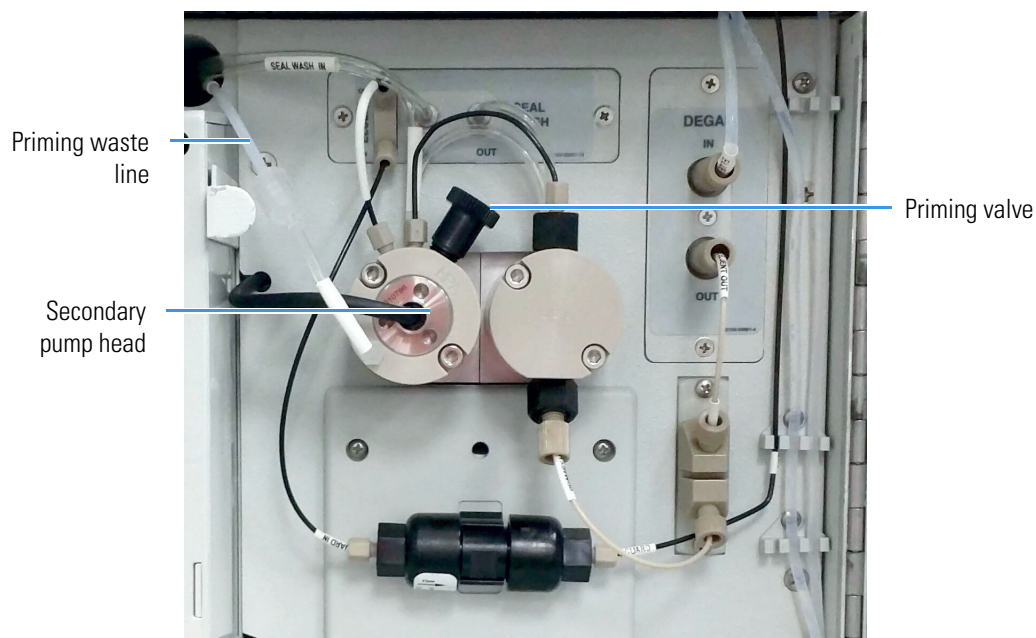

2. You can use either Chromeleon or the mobile app to prime the pump.
 - For Chromeleon operation: On the ePanel Set, click the **Pump_TC** tab.
 - For mobile app operation: Disconnect the system from Chromeleon. Then, tap the **PUMP**  button on the Home page.
3. Select the priming flow rate.
4. Start the priming flow:
 - For Chromeleon operation: On the **Pump_TC** ePanel, click **Prime**. A warning message asks you to verify that the priming valve is open. To start priming, click **Execute despite warnings**.
 - For mobile app operation: On the Pump page, in the **PRIME** group, tap **ON**.
5. Prime the pump until all air is purged and no air bubbles can be seen exiting the priming waste line (see Figure 26). Stop the pump flow.
6. Close the priming valve by turning the knob clockwise. Tighten no more than fingertight.

IMPORTANT Do not use any tools to tighten the priming valve! Overtightening may destroy the cap seal. Open or close the priming valve only when the system pressure is less than 0.7 MPa (100 psi).

7. Enter the flow rate required for your application and turn on the pump flow.
8. After starting the pump, wait at least 5 minutes (longer for flow rates below 1.0 mL/min) before beginning an analysis. This allows the pump to stabilize the flow rate.

Equilibrating the System

This section is an overview of the steps needed to set initial system operating parameters and to equilibrate the system before beginning operation.

Note You can use the Smart Startup feature in Chromeleon to automate system startup and equilibration. Refer to the Chromeleon Help for details.

❖ To set operating parameters

Before beginning operation, use either Chromeleon or the Dionex Integrion HPIC Mobile App to set the following system component parameters and start each component:

- Pump flow rate
- Dionex EGC concentration (if installed)
- Suppressor current or voltage (if installed)
- Temperature of each temperature device installed in the system

The value to set for each operating parameter depends on the application to be run. For the required settings for your application, refer to the column manual or other application documentation.

Note A Virtual Column Separation Simulator is available in Chromeleon that can help you determine the best operating parameters (column, eluent, flow rate, temperature) for a particular analysis. Refer to the Chromeleon Help for details.

❖ To equilibrate the system and verify operational readiness

1. Set operating parameters and turn on devices as described in [“To set operating parameters.”](#)
2. In Chromeleon, click **Monitor Baseline** on the Instrument toolbar above the ePanel Set and select the channels (detector signals, pump pressure) to be monitored.

Chromeleon begins plotting the selected channels.
3. Monitor the detector signals and pump pressure readings on the ePanel in Chromeleon or on the mobile app Plot page.
4. Offset the detector background and zero the reading by clicking **Autozero** on the detector ePanel in Chromeleon or on the mobile app Detector page.
5. Verify that the detector baseline is at the expected reading for your application and is stable. Refer to the column manual for the appropriate background for your application. The column manuals are provided on the Thermo Scientific Reference Library DVD (P/N 60-053891).

6. If the reading is too high, see “[High or Increasing System Backpressure](#)” on page 142. If the baseline is drifting or is excessively “noisy” (there are large fluctuations in readings), see “[Noisy Baseline](#)” on page 171.
7. Monitor the pump pressure and make sure it is at the expected reading for the installed column and is stable.
8. Verify that all installed temperature control devices are at their set temperatures and are stable.

The system is now ready for operation.

Note Equilibration time varies, and it may take some time to reach the expected values.

Preparing Samples

This section provides basic information about collecting, storing, and preparing samples for analysis.

Note Sample preparation can be performed while the system is equilibrating.

Collecting and Storing Samples

Collect samples in high density polyethylene, polystyrene, or polycarbonate containers that have been thoroughly cleaned with ASTM Type I (18 megohm-cm) filtered and deionized water that meets the specifications listed in “[Deionized Water Requirements for IC](#)” on page 3. Do not clean containers with strong acids or detergents as these can leave traces of ions on the container walls. The ions may interfere with the analysis.

If samples will not be analyzed on the day they are collected, filter them through clean 0.45-micron filters immediately after collection; otherwise, bacteria in the samples may cause the ionic concentrations to change over time. Refrigerating the samples at 4° C will reduce, but not eliminate, bacterial growth.

Analyze samples containing nitrite or sulfite as soon as possible. Nitrite oxidizes to nitrate, and sulfite to sulfate, thus increasing the measured concentrations of these ions in the sample. In general, samples that do not contain nitrite or sulfite can be refrigerated for at least one week with no significant change in anion concentration.

Pretreating Samples

Analyze rainwater, drinking water, and air particulate leach solutions directly with no sample preparation (other than filtering, and if required, diluting).

Filter groundwater and wastewater samples through 0.45-micron filters before injection, unless samples were filtered after collection.

A Dionex Low Volume High Pressure Inline Filter (P/N 074505) is available for removing particulates down to 0.45 micron from samples. Connect the inline filter between the autosampler outlet and the sample inlet port on the injection valve. For details, see the instructions provided with the inline filter.

Before injection, pretreat samples that may contain high concentrations of interfering substances by putting them through Dionex OnGuard™ cartridges. Refer to the installation and troubleshooting guide for the OnGuard cartridge for instructions. The guide is provided on the Thermo Scientific Reference Library DVD (P/N 60-053891).

Diluting Samples

Because the concentrations of ionic species in different samples can vary widely from sample to sample, no single dilution factor can be recommended for all samples of one type. In some cases (for example, many water samples), concentrations are so low that dilution is not necessary.

To dilute the sample, use eluent or ASTM Type I (18 megohm-cm) filtered and deionized water that meets the specifications listed in “[Deionized Water Requirements for IC](#)” on [page 3](#). When using carbonate eluents, diluting with eluent minimizes the effect of the water dip at the beginning of the chromatogram. If you dilute the sample with eluent, also use eluent from the same lot to prepare the calibration standards. This is most important for fluoride and chloride, which elute near the water dip.

To improve the accuracy of early eluting peak determinations, such as fluoride, at concentrations below 50 ppb, dilute samples in eluent or spike the samples with concentrated eluent to minimize the water dip. For example, spike a 100 mL sample with 1.0 mL of a 100 X eluent concentrate.

Loading Samples into the Loop or Concentrator

This section describes three methods for loading sample into the sample loop or concentrator column:

- Loading samples with an autosampler
- Loading samples with a syringe, using the push method
- Loading samples with a syringe, using the pull (vacuum) method

❖ To load samples with an autosampler

1. Verify that the autosampler output line is connected to the sample (S) port on the injection valve. Connect a waste line as required for your autosampler model.
2. Prepare and fill the sample vials or well plates and place them in the autosampler tray or carousel. For detailed instructions, refer to the autosampler manual, provided on the Thermo Scientific Reference Library DVD (P/N 60-053891).
3. Create a sequence in Chromeleon that specifies the vials or wells from which to take sample injections and the order in which the injections should be run.

For an overview of creating sequences, see “Performing Sample Analyses.” For details about creating sequences, refer to the Chromeleon Help.

❖ To load samples with a syringe, using the push method

1. Locate the manual injection tubing assembly (P/N 078493) in the Dionex Integrion Ship Kit (RFIC, P/N 22153-62003; non-RFIC, P/N 22153-62002).
2. Connect one end of the tubing to the manual injection port inside the column compartment (see [Figure 27](#)). Connect the other end of the tubing to the sample (S) port on the injection valve.

Figure 27. Manual injection port



3. Fill a syringe with a calibration standard or sample and insert the syringe into the luer adapter on the manual injection port.
4. Verify that the injection valve is in the Load position. If it is not, switch the valve, using the Chromeleon ePanel Set or the mobile app Home page.
5. Push the sample through the tubing into the valve. Overfill the sample loop with several sample loop volumes. Excess sample will exit through the injection valve waste line.
6. Leave the syringe in the luer adapter. This prevents the sample from exiting the valve before injection.
7. Switch the injection valve to the Inject position.

❖ To load samples with a syringe, using the pull (vacuum) method

1. Locate the manual injection tubing assembly (P/N 078493) in the Dionex Integrion Ship Kit (RFIC, P/N 22153-62003; non-RFIC, P/N 22153-62002).
2. Connect one end of the tubing to the manual injection port inside the column compartment (see [Figure 27](#)). Connect the other end of the tubing to the sample (**S**) port on the injection valve.
3. Disconnect the waste line from the injection valve and replace it with a 25 to 30 cm (10 to 12 in) piece of PEEK or PTFE tubing.
4. Place the free end of this line into the sample.
5. Verify that the injection valve is in the Load position. If it is not, switch the valve, using the Chromeleon ePanel Set or the mobile app Home page.
6. Insert the syringe into the luer adapter on the manual injection port and pull out the plunger to draw the sample into the injection valve.
7. Switch the injection valve to the Inject position.

Performing Sample Analyses

This section is an overview of the steps required for performing sample analyses using Chromeleon. For details about how to perform these steps, refer to the Chromeleon Help.

To perform sample analyses with a Dionex Integrion, first add sample injections to a Chromeleon sequence. The sequence determines how a group of injections will be analyzed and the order in which they will be run. For each injection, the sequence typically includes the following elements:

- An *instrument method*—a predefined list of commands and parameters for controlling the system and acquiring sample data.
- The chromatographic data acquired.
- A *processing method*—a predefined set of instructions for evaluating the acquired data.
- Templates for displaying chromatographic data on the screen and for printing reports.

Creating Sequences

Two methods are available for creating a new sequence in Chromeleon:

- eWorkflows provide predefined templates and rules for creating new sequences. If they have been defined for your laboratory, eWorkflows are the preferred method for creating a new sequence.
- The Sequence Wizard provides a series of dialog boxes that guide you through the sequence creation process.

Running Sequences

After creating the sequence, load it into a queue and start the run. Chromeleon performs a Ready Check to verify that the instrument is ready for operation and the instrument methods specified in the sequence are error-free. If the Ready Check passes and another sequence is not currently running, the sequence is started.

Note Chromeleon cannot run a sequence until the list of trackable consumables installed in the Dionex Integrion has been approved in the Consumables Inventory window. For details about how to approve consumables, refer to the Chromeleon Help.

System Shutdown

If you need to shut down the system for any reason (for example, to move it), follow the instructions below.

❖ To shut down the system

Follow any storage requirements for the consumables installed in the system.

Consumables Storage

The columns, suppressors, and other consumable items used with the Dionex Integrion have various short- and long-term storage requirements. Refer to the manuals for the individual products for instructions. These manuals are provided on the Thermo Scientific Reference Library DVD (P/N 60-053891).

ED Cell Storage

Short-term Storage of the ED Cell

If the cell will not be used for a short period of time (less than 2 days), disconnect the tubing from the inlet and outlet fittings and install fitting plugs.

If the pH-Ag/AgCl reference electrode remains in the cell but eluent is not being pumped through the cell, the pH-Ag/AgCl reference electrode frit may partially dry out. If this occurs, regenerate the electrode by soaking it in a solution containing 1 M KCl and 1 M HCl.

Long-term Storage of the pH-Ag/AgCl Reference Electrode

If the cell will not be used for 2 days or more, remove the pH-Ag/AgCl reference electrode and store it in a solution of saturated KCl, as instructed below.

1. Prepare a saturated solution of KCl in ASTM filtered, Type I (18 megohm-cm) deionized water that meets the specifications listed in [“Deionized Water Requirements for IC”](#) on [page 3](#).

2. Locate the cap in which the electrode was shipped and fill it two-thirds full with the prepared KCl solution.
3. Remove the pH-Ag/AgCl reference electrode from the cell.
4. Insert the electrode into the cap and screw on the cap (see [Figure 28](#)).
5. Make sure there is no air bubble in the cap. Add more KCl solution if needed.

Figure 28. pH-Ag/AgCl reference electrode in storage cap



Operating the EG

This section describes how to select and enter the eluent concentration.

Selecting an Eluent Concentration

The allowable eluent concentration depends on the flow rate and the Dionex EGC type. [Table 10](#) lists the concentration ranges for each EGC type.

Table 10. Eluent concentration ranges

Dionex EGC	Eluent Concentration Range
Dionex EGC 500 KOH Dionex EGC III KOH Dionex EGC III NaOH	For 4 mm operation: Up to 100 mM KOH at 1.0 mL/min; up to 50 mM KOH at 2.0 mL/min For 2 mm operation: Up to 100 mM KOH at 0.25 mL/min
Dionex EGC III LiOH	For 4 mm operation: Up to 80 mM LiOH at 1.0 mL/min; up to 40 mM KOH at 2.0 mL/min For 2 mm operation: Up to 80 mM KOH at 0.25 mL/min
Dionex EGC 500 K ₂ CO ₃	For 4 mm operation: Up to 15 mM K ₂ CO ₃ at 1.0 mL/min; up to 7.5 mM K ₂ CO ₃ at 2.0 mL/min For 2 mm operation: Up to 15 mM K ₂ CO ₃ at 0.25 mL/min

Table 10. Eluent concentration ranges

Dionex EGC	Eluent Concentration Range
Dionex EGC 500 K ₂ CO ₃ and Dionex EPM 500	For 4 mm operation: Convert up to 10 mM K ₂ CO ₃ to KHCO ₃ at 1.0 mL/min; up to 5.0 mM at 2.0 mL/min For 2 mm operation: Convert up to 10 mM K ₂ CO ₃ to KHCO ₃ at 0.25 mL/min
Dionex EGC 500 MSA and Dionex EGC III MSA	For 4 mm operation: Up to 100 mM MSA at 1.0 mL/min; up to 50 mM MSA at 2.0 mL/min For 2 mm operation: Up to 100 mM MSA at 0.25 mL/min

For the eluent concentration required for your application, refer to the column manual provided on the Thermo Scientific Reference Library DVD (P/N 60-053891).

Entering the Eluent Concentration

The eluent concentration can either be programmed into a Chromeleon instrument method (for automated operation) or entered on the Chromeleon ePanel Set or mobile app (for direct control of the Dionex EGC).

When the eluent concentration is programmed in a Chromeleon instrument method, gradient delivery, in which the eluent concentration changes over time, is possible.

When the Dionex EGC is under direct control, only isocratic delivery, in which the eluent composition and concentration remain constant throughout the run, is possible.

❖ To enter the eluent concentration on the Chromeleon ePanel

1. On the ePanel Set, click the **Electrolytics** tab.
2. Under **Eluent Generator**, in the **Setpoint** box, enter the concentration of eluent to be generated. If the pump flow is on, the eluent generator turns on automatically.
3. Under **CR-TC** if **Mode Off** is displayed, click the slider to turn on the power to the Dionex CR-TC 600.
4. If the pump flow is off, turn on the flow, and then turn on the power to the Dionex EGC and Dionex CR-TC 600 from either the Home ePanel or the Electrolytics ePanel.

❖ To enter the eluent concentration in the mobile app

1. On the Home page, under **EGC**, tap the concentration button and enter the eluent concentration on the keypad.
2. Tap the pump **OFF/ON** button to turn on the flow.
3. Tap the **ON/OFF** button under **EGC** to turn on the Dionex EGC power.

4. Tap the **ON/OFF** button under **CR-TC** to turn on the Dionex CR-TC 600 power.

Operating the ED

This section describes basic operating information for the Dionex Integriion Electrochemical Detector, including cell operating precautions, detection modes, waveforms, and data collection, display, and reprocessing.

ED Cell Operating Precautions

To maintain good reproducibility of detection results:

- Prepare all eluents with ASTM Type I (18 megohm-cm) filtered and deionized water that meets the specifications listed in [“Deionized Water Requirements for IC”](#) on [page 3](#).
- Avoid contamination of the cell with incompatible eluents.
- Never apply potential to the electrode unless a stream of eluent or water is flowing through the cell.
- Do not allow a pH-Ag/AgCl reference electrode to dry out. Make sure that eluent is pumped continuously through the cell. If the cell will not be used for a period of time, follow the requirements listed in [“ED Cell Storage”](#) on [page 57](#) for short-term (less than 2 days) and long-term (2 days or more) storage.
- Be careful to keep the polished surface of the ED cell body clean and dry when not in use. The gold, spring-loaded (pogo) contact must also remain clean and dry. If a salt bridge forms, it can cause an electrical short between the working electrode contact and the cell body.
- If the conventional (nondisposable) working electrode becomes discolored or if you notice a degradation in performance (baseline noise, tailing peaks, etc.), polish the electrode as instructed in [“Polishing a Conventional Working Electrode”](#) on [page 209](#).
- Over the lifetime of the conventional working electrode, the surface may gradually become pitted or receded. Receded electrodes can be repaired by sanding with 600 grit sandpaper. Continue sanding until the metal surface is again flush with the Kel-F electrode block surface. Then, polish the electrode.
- To help determine when the pH-Ag/AgCl reference electrode needs regenerating or replacing, monitor the pH value displayed on the detector panel in Chromeleon (see [page 61](#)). To have an alarm displayed in the audit trail if the pH exceeds certain values, set pH limits in Chromeleon (see [page 62](#)).
- Replace the PdH reference electrode if its sensing surface is damaged or if the electrode no longer seals properly. Replace the PdH electrode if performance has degraded; for example, you observe lower response, higher background, or spikes. The PdH reference electrode typically lasts several years, depending on use.

❖ **To monitor the pH-Ag/AgCl reference electrode pH**

1. At installation, calibrate the pH electrode (see [page 213](#)).
2. When you run your first chromatographic instrument method, note the pH value displayed on the Chromeleon EDet ePanel (see [Figure 29](#)).

Figure 29. Chromeleon EDet ePanel

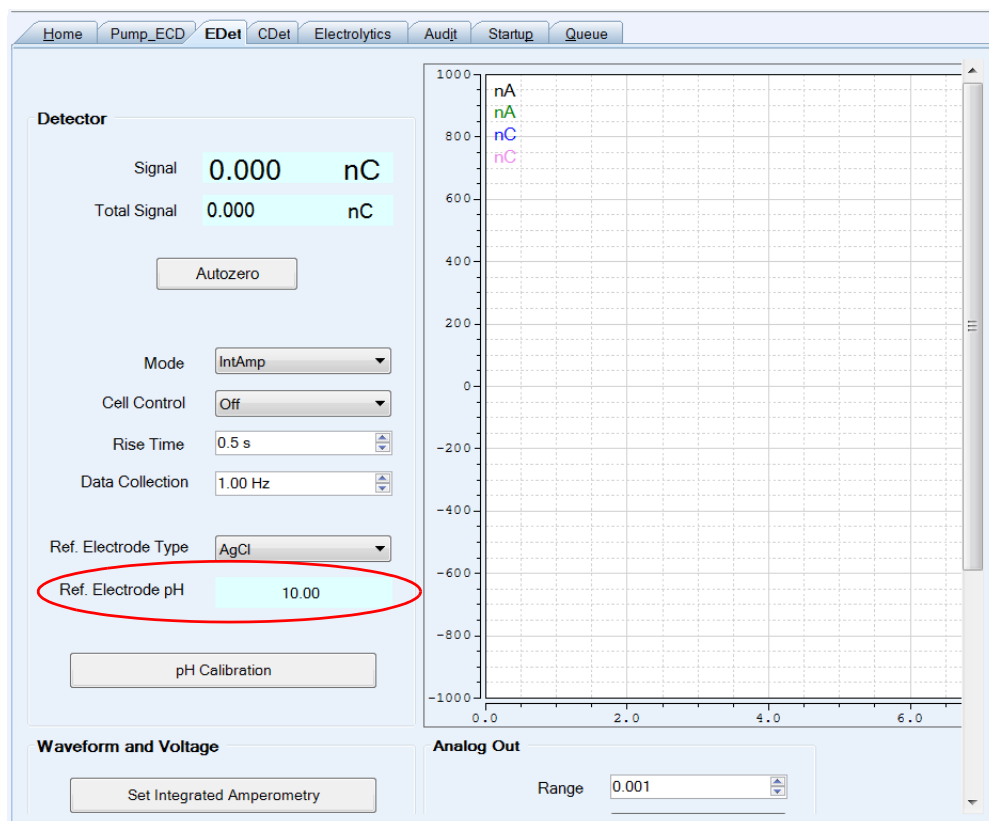

3. Thereafter, monitor the pH value to determine whether there is a shift in the pH. A shift in the pH reading for the same eluent composition indicates a change in the Ag/AgCl reference potential.
4. If the pH value shifts by 0.5 pH unit from the value first observed, check the pH-Ag/AgCl reference electrode. See [“To determine a reference potential shift” on page 148](#).

❖ To set ED cell pH limits

You can set upper and lower pH limits in the Chromeleon Instrument Method Wizard (see Figure 30). The audit trail displays an alarm if the limits are exceeded.

Figure 30. Chromeleon Instrument Method Wizard page for integrated amperometry

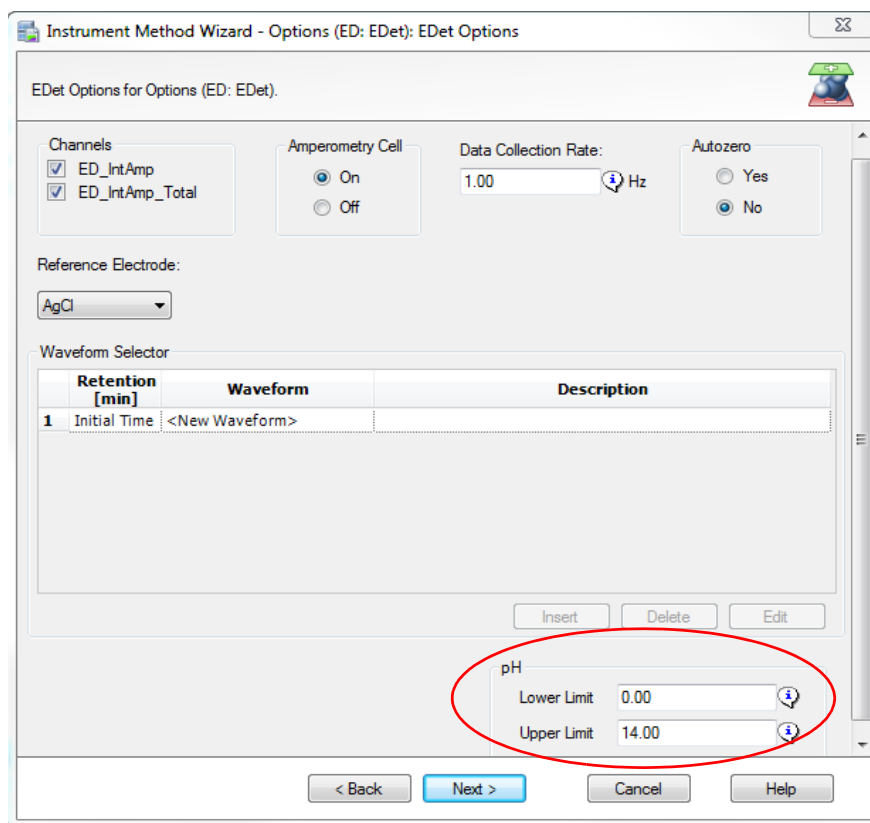

Note To disable the alarm, set the upper limit to 14 and the lower limit to 0.

Electrochemical Detection Modes

The Dionex Integrion Electrochemical Detector can perform the following electrochemical detection modes:

- DC amperometry (see page 63)
- Integrated amperometry, including pulsed amperometric detection (PAD) and integrated pulsed amperometric detection (IPAD) (see page 65)

DC Amperometric Detection

In DC amperometry, a constant potential is applied to the working electrode. For automated control, enter the potential in a Chromeleon instrument method (see [Figure 31](#)). The applied voltage can be changed up to 10 times during the run. The actual number of potential changes allowed depends on the available data storage capacity, which is determined by the length of the run and the data sampling rate.

Figure 31. Chromeleon Instrument Method Wizard page for DC amperometry

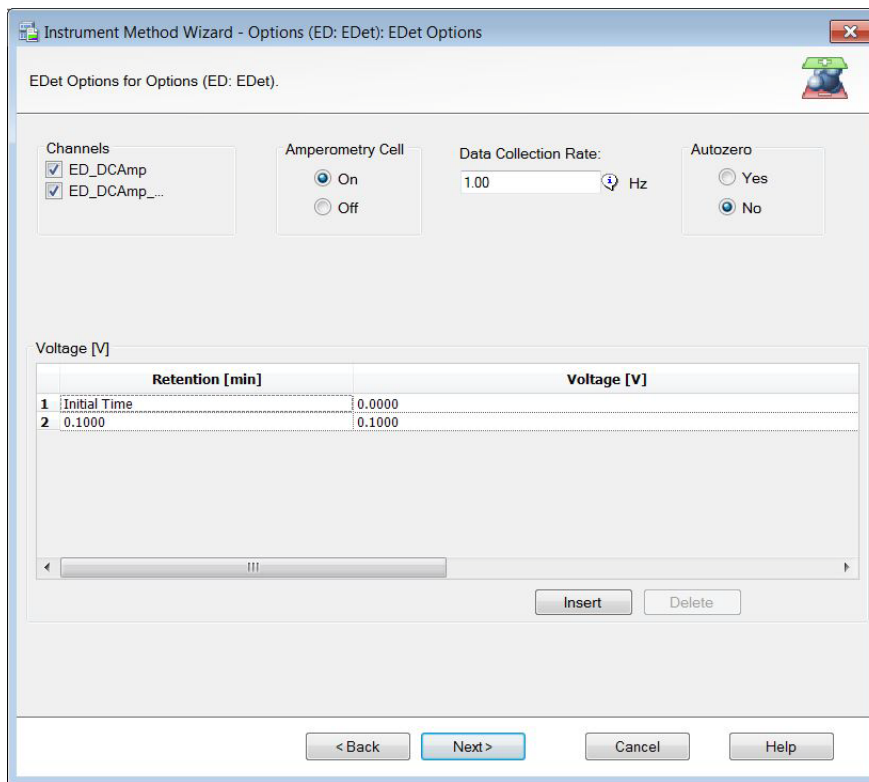

Instrument Method Wizard - Options (ED: EDet): EDet Options

EDet Options for Options (ED: EDet).

Channels

- ED_DCAMP
- ED_DCAMP...

Amperometry Cell

- On
- Off

Data Collection Rate: 1.00 Hz

Autozero

- Yes
- No

Voltage [V]

	Retention [min]	Voltage [V]
1	Initial Time	0.0000
2	0.1000	0.1000

Insert Delete

< Back Next > Cancel Help

For direct control, enter the potential on the EDet ePanel in Chromeleon or on the mobile app Home page.

Integrated and Pulsed Amperometric Detection

Integrated and pulsed amperometric detection are similar to DC amperometry in that molecules are oxidized or reduced at the surface of an electrode. However, with these detection modes, a series of potential changes is repeated over time. By repeatedly pulsing between optimized high positive and negative potentials, the electrode surface is continually regenerated. Current is measured by integration during a portion of the repeating potential vs. time waveform. For more information about waveforms, see [page 65](#).

Pulsed Amperometric Detection

In pulsed amperometric detection (PAD), current is integrated at a single constant potential (see [Figure 32](#)).

Figure 32. Example pulsed amperometry waveform

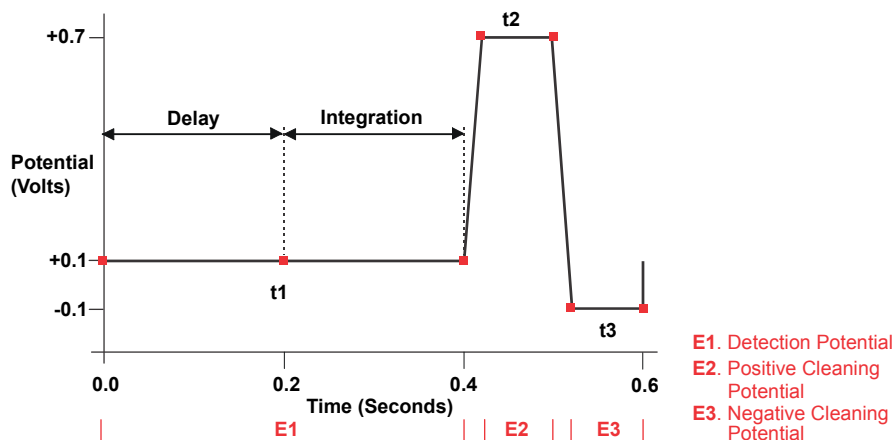

The potentials, labeled E1, E2, and E3, are applied for durations t1, t2, and t3, respectively. At t1, the E1 potential is applied. After a delay, the signal is measured by integrating the current for a fixed time. Current integrated for a fixed time is charge and the units are coulombs. At t2 and t3, positive and negative cleaning pulses are added to the waveform. This waveform period repeats until the end of data acquisition or until another waveform is specified.

Integrated Pulsed Amperometric Detection

With integrated pulsed amperometric detection (IPAD), current is integrated at two or more potentials (see [Figure 33](#)).

Figure 33. Example integrated pulsed amperometry waveform

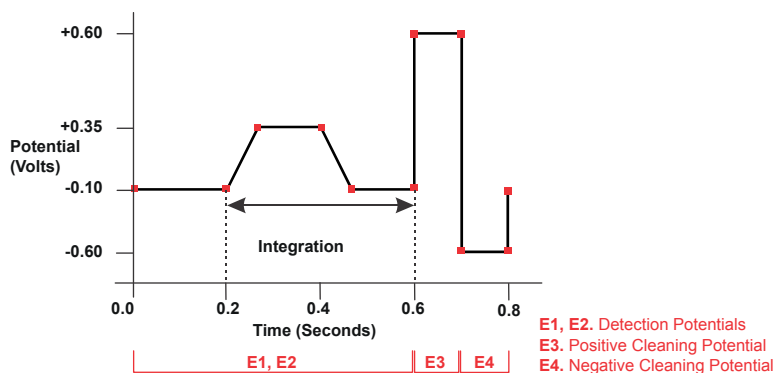

With the example waveform shown in [Figure 33](#), the current is integrated both while the potential is swept across the metal oxide formation wave and also during the reverse sweep across the oxide reduction wave. This technique minimizes baseline shift and the peak dips that can occur when an eluting analyte's effect on oxide suppression is greater than the detector response from the analyte.

As with pulsed amperometric detection, the waveform period repeats until the end of data acquisition or until another waveform is specified.

Waveforms

A waveform is a series of steps, defined as points on a plot of potential vs. time. Waveforms must be defined for the integrated amperometry modes.

Integrated Amperometry Waveforms

Integrated amperometry waveforms have the following characteristics:

- The duration of one waveform period can be between 0.05 and 2.0 s, with a step resolution of 10 ms. A waveform can have no more than 100 steps.
- The maximum waveform period is 2.0 s. However, because only one data point is generated per waveform period, the effective maximum length of a waveform period depends on the data collection rate (the rate at which Chromeleon collects digital data points from the detector). The relationship is as follows:

$$\text{Data Collection Rate} = 1/\text{Waveform Period}$$

- Multiple waveforms can be defined for a single run, provided they all have the same cycle duration. Up to 15 waveform changes per run are allowed.
- Each waveform can have only one integration interval.
- The integration interval generates one integrated data point per waveform.

Pre-programmed integrated amperometry waveforms designed for quantitative analysis of specific compounds (alcohols, amino acids, carbohydrates, etc.) can be included in a Chromeleon instrument method. The waveforms can also be selected on the mobile app “[Electrolytics Page](#)” on [page 92](#). In the Chromeleon Waveform Editor, you can modify a pre-programmed waveform or define a new waveform.

Collecting and Storing Amperometry Data

Chromeleon provides storage of pulsed amperometry and integrated amperometry data. Chromeleon stores the detector's response at each waveform period's integration interval. One integrated data point per waveform period is stored. This allows you to produce a chromatogram similar to the example shown in [Figure 34](#). The retention time (in minutes) is on the x-axis and the detector response (in nanoCoulombs) is on the y-axis.

Figure 34. Example chromatogram for a pulsed amperometry application

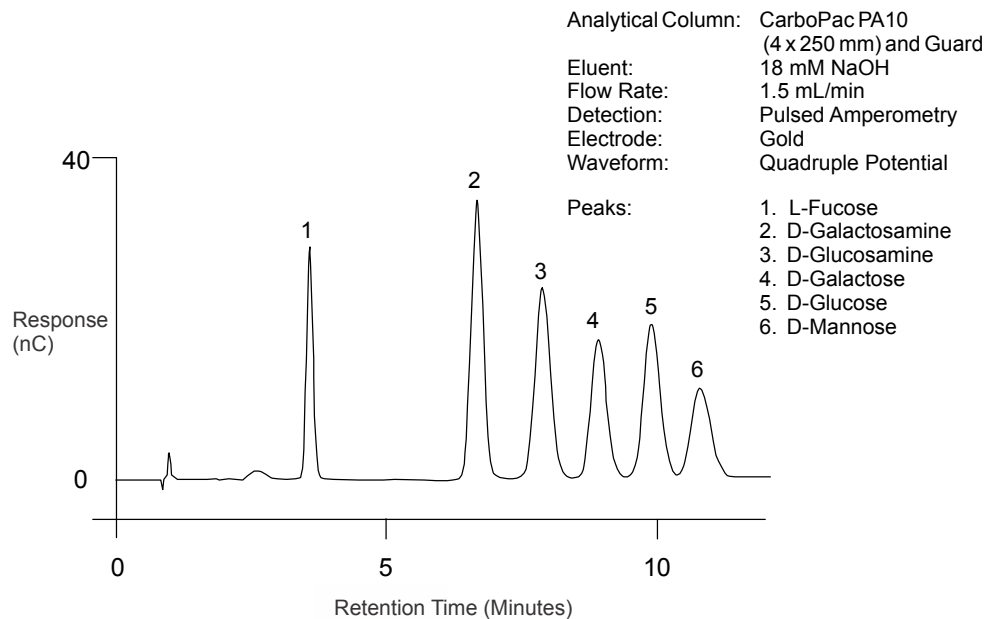

Using Rear Panel Inputs and Outputs

This section includes the following instructions:

- [Connecting the I/O Connectors](#)
- [Assigning TTL Input Functions](#)
- [Controlling Relay and TTL Outputs](#)

Connecting the I/O Connectors

Table 11. Rear panel I/O connector strips

Connector position	Pin function	Description
1	NC	Mechanical relay contacts output #2. Connect for either normally closed (NC) or normally open (NO).
2	COM	
3	NO	
4	NC	Mechanical relay contacts output #1. Connect for either normally closed (NC) or normally open (NO).
5	COM	
6	NO	
7	D-GND	Digital ground
8	+5V	+5 V, 200 mA
9	A-GND	Analog ground
10	ANALOG 2	16-bit analog output from detector
11	A-GND	Analog ground
12	ANALOG 1	16-bit analog output from detector (CD or ED)
1	TTL -4 IN	TTL input #4
2	TTL -3 IN	TTL input #3
3	TTL -2 IN	TTL input #2
4	TTL -1 IN	TTL input #1
5	D-GND	Digital ground
6	TTL-2 OUT	TTL output #2 (332 Ω pull up to +5 V, 100 mA sink)
7	D-GND	Digital ground
8	TTL-1 OUT	TTL output #1 (332 Ω pull up to +5 V, 100 mA sink)

Note: Relays are capable of switching 2 A at 24 VDC.

Relay Output Details

Depending on which pins are connected, the relay connection can be either normally closed (NC) or normally open (NO) (see [Figure 35](#)).

Figure 35. Relay output configuration

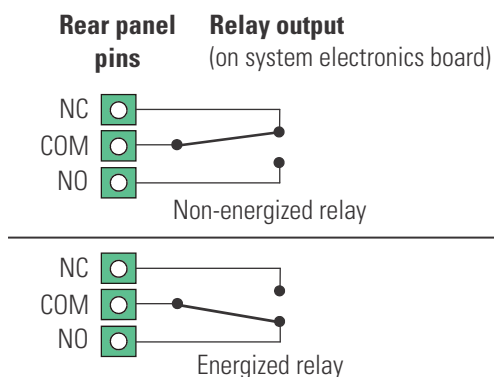

Notes

The relays are capable of switching any low-voltage device. Switched current must be no more than 2 A at 24 VDC.

For a normally closed connection, connect a COM pin and an NC pin.

For a normally open connection, connect a COM pin and an NO pin.

Choose NC or NO based on what you want the state of the connected device to be when the Dionex Integrion power is turned off. A normally open relay is open when the relay is switched off and closed when the relay is turned on. A normally closed relay is closed when the relay is off and is open when the relay is on.

❖ **To connect to the I/O strips**

1. Locate the twisted pair of wires (P/N 043598) and a connector plug (8-position, P/N 924133; 12-position, P/N 923686) (see [Figure 36](#)) provided in the Dionex Integrion Ship Kit (RFIC, P/N 22153-62003; non-RFIC, P/N 22153-62002).

Figure 36. 12-position connector plug

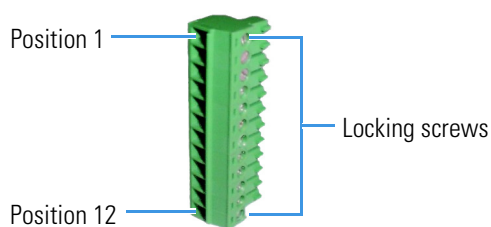

2. For each I/O function to be used, connect an active wire (red) and a ground wire (black) to the connector plug at the pin locations for the selected I/O function. See [Table 11](#) or the label on the rear panel for the connector pin assignments for each I/O function.

3. To attach a wire to the plug, strip the end of the wire, insert it into the plug, and use a screwdriver to tighten the locking screw. If necessary, multiple ground wires can be attached to a single ground pin.



CAUTION When attaching wires to the connector plug, be careful not to allow stray strands of wire to short to an adjoining position on the connector.

4. Plug the connector plug into the corresponding connector strip on the rear panel.
5. Connect the wires from the connector plug to the appropriate connector pins on the other modules. Additional connector plugs are provided with other Dionex modules.

Note Check the polarity of each connection. Connect signal wires to signal (+) pins and ground wires to ground (-) pins.

6. If you connected a TTL input, verify that the correct function is assigned to the input and that the correct input control type is selected. Select different settings if necessary. For instructions, see [“Assigning TTL Input Functions.”](#)

Assigning TTL Input Functions

TTL input functions are assigned in the Chromeleon configuration or on the mobile app TTL/Relay page. When connected to a controlling device, the device can send a signal to the TTL input to trigger the assigned functions.

❖ To select TTL input functions from Chromeleon

1. Open the Chromeleon Instrument Configuration Manager.
2. Double-click the Dionex Integrion HPIC System icon under the instrument.

3. Select the **TTL Inputs** tab (see [Figure 37](#)).

Figure 37. Instrument configuration properties: TTL Inputs

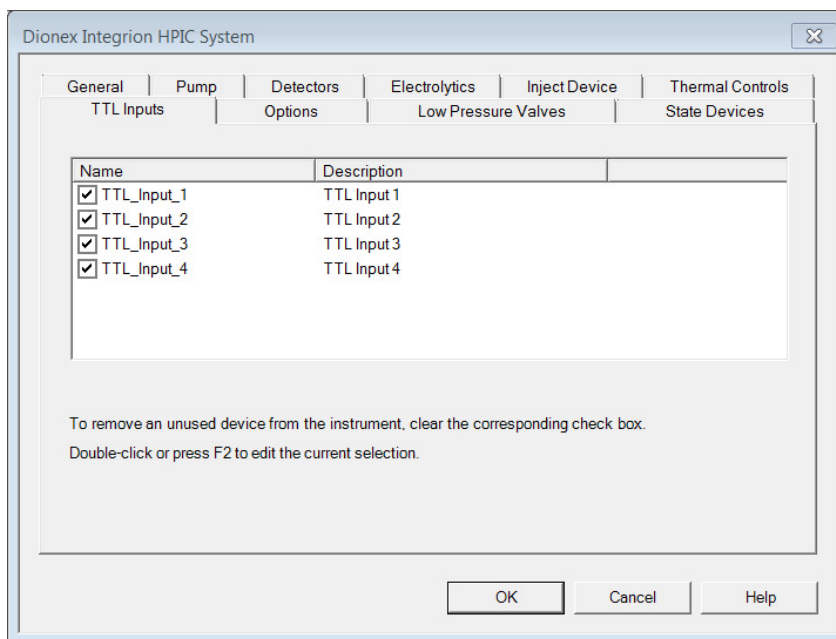

4. Select the name of the input and press the **F2** key (or double-click the name).

The Device Configuration dialog box for the selected input appears (see [Figure 38](#)).

Figure 38. Device Configuration

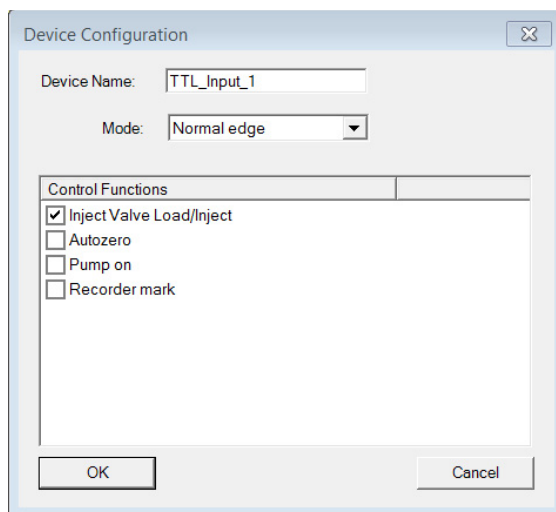

5. In the Control Functions list, select the function to be controlled by this input. When connected to a controlling device, the device can send a signal to the input to trigger the selected functions.
6. If the device connected to the TTL input does not send a normal edge signal, select the control type compatible with the device. To determine the correct type, refer to the

documentation provided with the controlling device and see [“TTL Input Control Types”](#) on [page 71](#).

❖ **To select TTL input functions from the mobile app**

1. On the mobile app quick access toolbar, tap the Accessories  icon and then select **TTL/RELAY** on the menu.
2. On the TTL/Relay page, tap **TTL INPUT**.
3. On the TTL Input page, select the functions to be controlled by each input.
4. If the device connected to the TTL input does not send a normal edge signal, select the control type compatible with the device. To determine the correct type, refer to the documentation provided with the controlling device and to [“TTL Input Control Types.”](#)

TTL Input Control Types

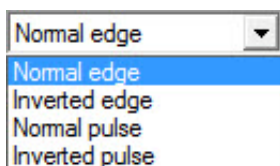

The TTL inputs respond to four types of signals to accommodate different controlling devices. The default control type, Normal Edge, is compatible with the output signals provided by Dionex modules.

TTL Normal Edge

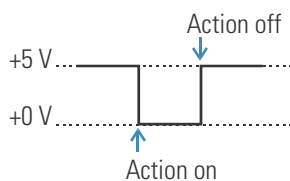

In normal edge operation, the negative (falling) edge of a signal turns on the function.

The action of the positive (rising) edge depends on the function: For on/off or other functions that have two options, the rising edge turns off the function. For functions with only one option, the rising edge has no effect.

For example, for the injection valve position, the falling edge switches the valve to Load and the rising edge switches the valve to Inject. Similarly, for the pump on/off, the falling edge starts the pump and the rising edge stops it. For the offset and chart mark functions, the falling edge turns on the function and the rising edge has no effect.

TTL Inverted Edge

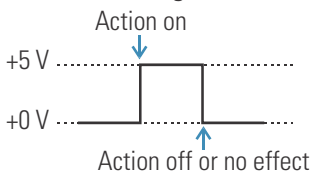

The inverted edge mode works identically to the normal edge mode except that the positive and negative edges are reversed in function.

3 Operation

Using Rear Panel Inputs and Outputs

TTL Normal Pulse

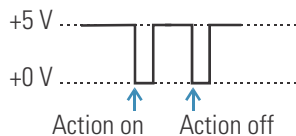

In normal pulse operation, the negative (falling) edge of the TTL signal is the active edge and the positive (rising) edge is ignored.

A pulse width of 50 ms or more is guaranteed to be detected. A pulse width of 4 ms or less is guaranteed to be ignored. The action for pulse widths that are greater than 4 ms and less than 50 ms is undefined.

TTL Inverted Pulse

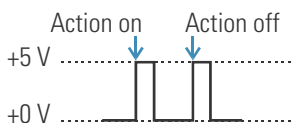

The inverted pulse mode operates identically to the normal pulse mode except that the positive and negative edges are reversed in function.

Controlling Relay and TTL Outputs

You can directly control the relay and TTL outputs from the Chromeleon ePanel Set or the mobile app TTL/Relay page.

❖ To control a relay or TTL output from Chromeleon

1. On the Chromeleon ePanel Set, click the **Pump_ECD** tab.
2. Click the **Relays/TTL** button (see [Figure 39](#)). Under Output Relays and TTLs, select the TTL output and relay output settings.

Figure 39. Chromeleon ePanel output relays and TTL control

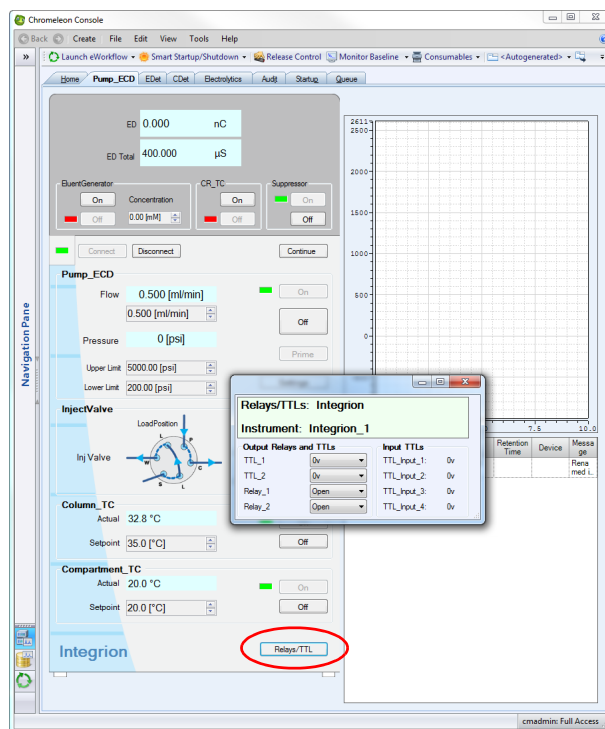

Note It is possible to change the settings for the relay and TTL outputs while a Chromeleon instrument method is running.

❖ **To control a relay or TTL output from the mobile app**

1. On the mobile app quick access toolbar, tap the Accessories  icon and then select **TTL/RELAY** on the menu.
2. Select the TTL output and relay output settings (see “TTL/Relay Page” on page 100).

Selecting Analog Output Settings

Several settings are available that allow you to configure the analog output signal for your detector and connected device (see Table 12). You can select the preferred settings on the Chromeleon ePanel (see Figure 40) or the mobile app Analog page (see “Analog Page” on page 98).

Table 12. Analog output configuration settings

Analog Output Setting	Values	Description
Range	Conductivity: 0.01 to 15,000 μS DC Amperometry: 50 pA to 300 μA Integrated Amperometry: 50 pC to 200 μC	Sets the full-scale detector response value. The range to use depends on the detector readings expected for the application. For example, for conductivity detection, if you select a range of 20 micro Siemens (μS), the recorded response values will be 20 μS or less.
Recorder Calibration (Chromeleon ePanel) –or– Output (mobile app)	Normal, Zero, Full	Select Normal (the default) to output a signal corresponding to the detector output. To calibrate a recording device, select Zero to set the output signal to zero volts. Select Full to set the output signal to the full-scale voltage.
Offset Level (Chromeleon ePanel) –or– Offset (mobile app)	0 to 100%	Use this setting to adjust the zero position of the analog output when it is plotted. The value entered is a percentage of the full-scale analog output. An offset allows a recording device to plot the signal if it becomes negative. The offset level does not affect the magnitude of the output signal.
Polarity	Normal, Inverted	Use this setting to set the polarity of the analog output signal to either Normal (the default) or Inverted. In applications in which the analyte output is lower than the background signal, the polarity must be inverted to display peaks instead of dips on the chromatogram.
Mark (Chromeleon command only)	10% of the full-scale analog output	Use this setting to send a positive pulse to the analog output as an event marker. A mark is typically used to indicate a sample injection.

❖ **To select analog output settings from Chromeleon**

1. On the ePanel Set, click the detector tab.
2. Under Analog Out, select the parameter settings.

Figure 40. Chromeleon Detector ePanel (CD version shown)

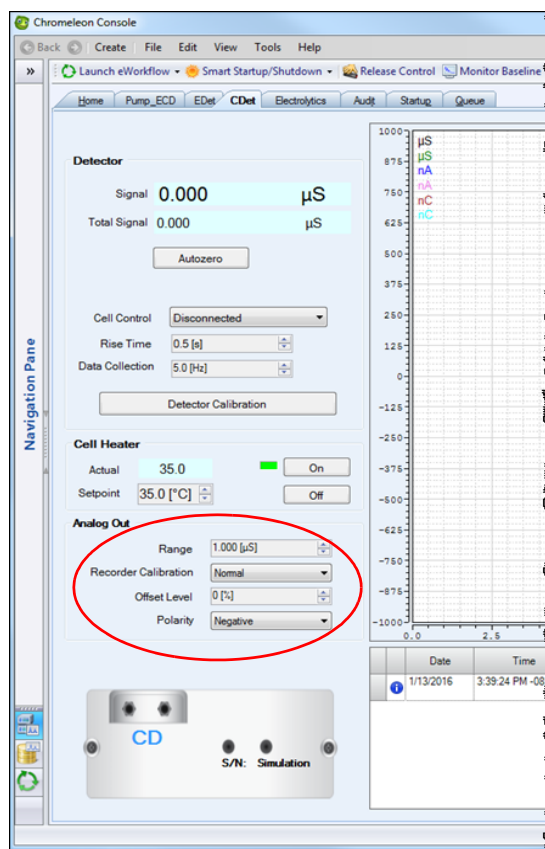

❖ **To select analog output settings from the mobile app**

1. On the mobile app quick access toolbar, tap the Accessories  icon and then select **ANALOG** on the menu.
2. Select the analog output parameter settings. For details, see [“Analog Page”](#) on page 98.

3 Operation

Using Rear Panel Inputs and Outputs

Dionex Integrion Mobile App Operation

This chapter describes the features of the Dionex Integrion HPIC Mobile App when installed on the optional mobile device.

Contents

- [Overview of Mobile App Operation](#)
- [Home Page Details](#)
- [Pump Page](#)
- [Valves Page](#)
- [Detector Page](#)
- [Electrolytics Page](#)
- [Temperature Page](#)
- [Plot Page](#)
- [Analog Page](#)
- [TTL/Relay Page](#)
- [TTL Input Page](#)
- [Consumables Page](#)
- [Calibration Pages](#)
- [Information Page](#)

Overview of Mobile App Operation

The mobile app provides direct control of most Dionex Integrion HPIC System operating functions. When you select an operating command or parameter from the mobile app, the command or parameter is executed immediately.

The Home page (see [Figure 41](#)) provides controls for the most commonly used operating functions. Use the Home page to view status information and enter basic operating parameters for your system. From the Home page, you can also access detailed pages for the various system devices (pump, valves, detector, and so on).

Figure 41. Home page example (CD with RFIC-EG version shown)

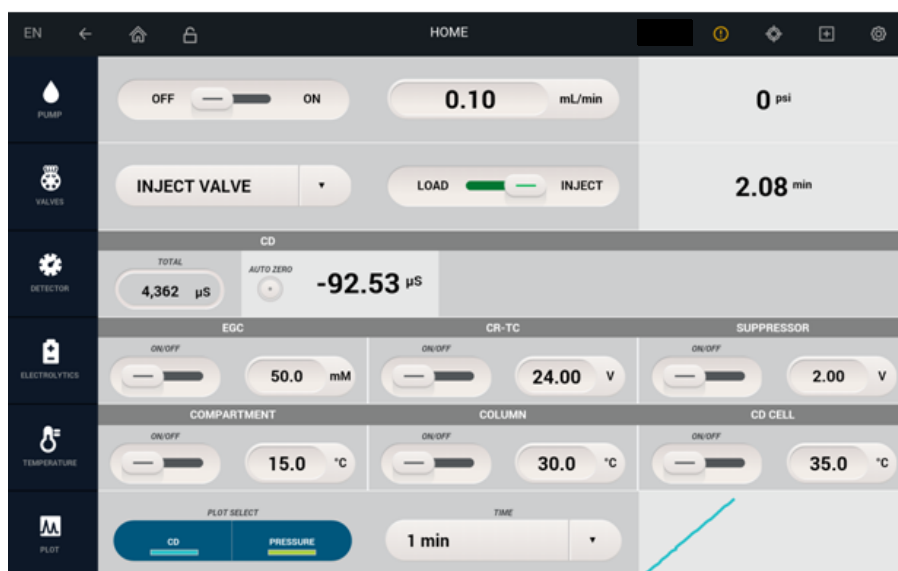

Note If you temporarily connect your mobile device to a Wi-Fi access point that includes a Dionex Integrion other than the one required, be sure to remove or “forget” the profile for the alternate access point (on the Settings->Wi-Fi menu for the mobile device) when you are finished. Otherwise, the required Dionex Integrion will not be able to auto-connect to the correct access point.

Device Selection Bar

Each row on the Home page provides controls for monitoring and controlling a system device (pump, valve, detector, and so on). The column of buttons on the left side provides access to additional controls for each device. Tap a button to go to a detail page for a device. For example, tap the **PUMP** button (see [Figure 42](#)) to access additional pump controls.

Figure 42. Device selection controls on Home page

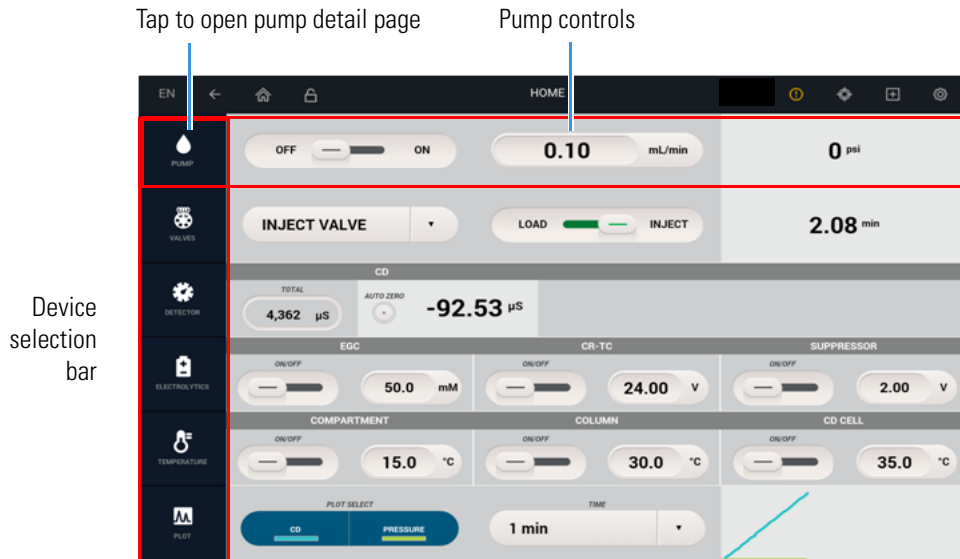

Quick Access Toolbar

A quick access toolbar is available at the top of each mobile app page. The toolbar provides the features and functions described in [Figure 43](#).

Figure 43. Quick access toolbar features

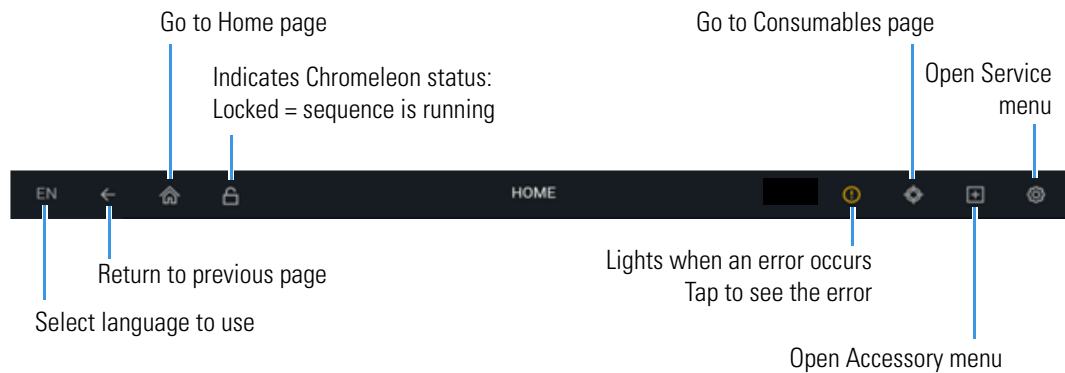

Error Message List

If a problem occur during operation of the Dionex Integrion, a message is displayed in the mobile app, as well as in the Chromeleon audit trail. In the mobile app, the warning  icon lights when an error message is logged. Tap the icon to see the error. You can view error messages either one at a time (see [Figure 44](#)) or in a list view (see [Figure 45](#)). For troubleshooting information about an error message, see “[Troubleshooting Error Messages](#)” on [page 109](#).

Figure 44. Error message list: single-message view

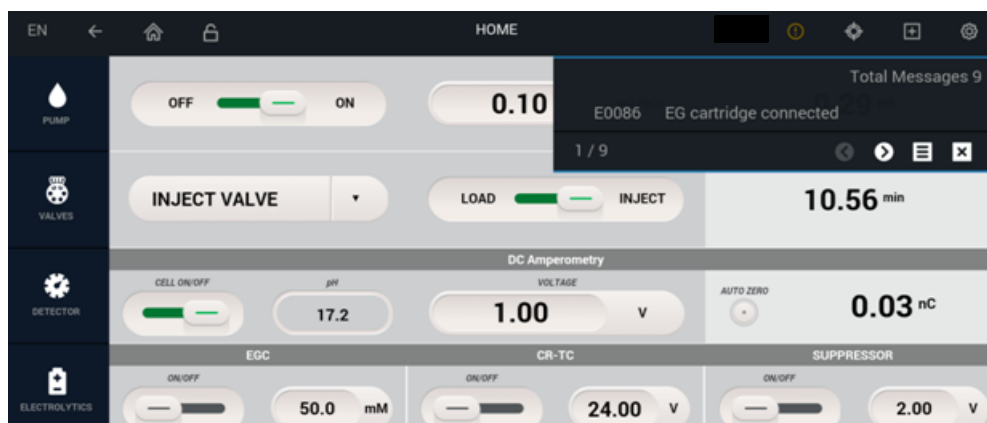
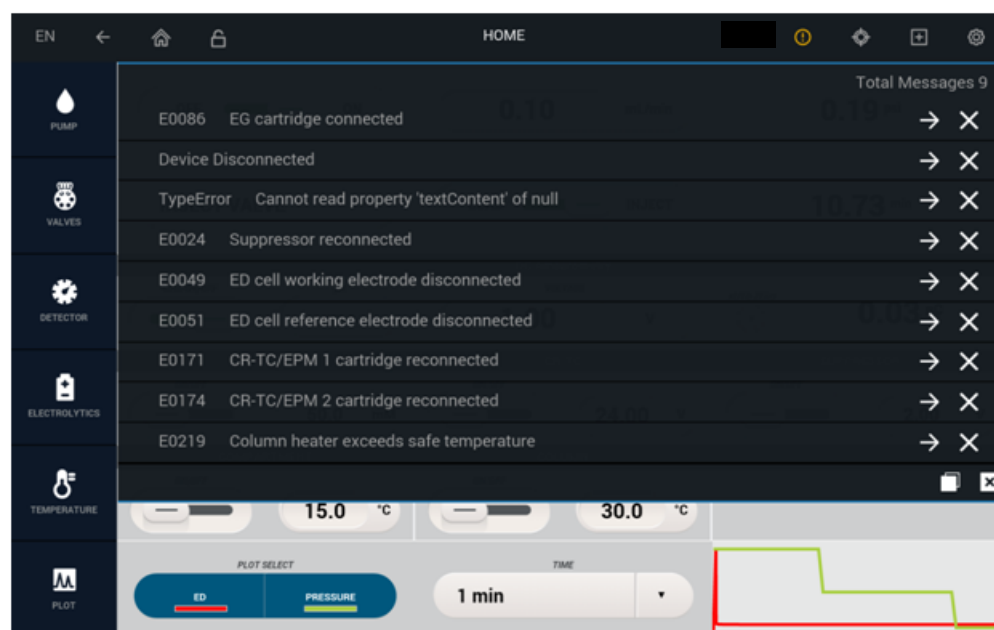



Figure 45. Error message list: list view



Using the Mobile App with Chromeleon

When the Dionex Integrion is connected to Chromeleon and a sequence is not running, you can use either Chromeleon or the mobile app to change operational settings such as flow rate, eluent concentration, and suppressor current. When mobile app operation is enabled, the mobile app quick access toolbar displays an open Lock  icon.

When a Chromeleon sequence is running, mobile app operation is disabled (indicated by a closed Lock  icon). During a sequence run, system status information is updated in the mobile app. However, if you attempt to change an operational setting from the mobile app, a message warns you that you are about to interrupt a running sequence. You can choose to stop the running sequence or wait until the sequence is finished.

Home Page Details

Home Page Pump Controls

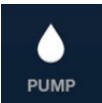
Control	Description
OFF/ON button	Toggles the flow off and on.
mL/min (or µL/min) button	Indicates/sets the flow rate. Tap the value to change the setting. The selected unit is highlighted in blue. Tap a unit to select it. This sets the flow rate unit for all mobile app pages that display flow rates.
pressure value	Indicates the current system pressure in either psi, bar, or MPa.
	Tap the button to select different flow and pressure units and to monitor and control other pump functions (see “ Pump Page ” on page 84).

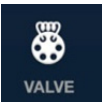

Home Page Valve Controls

Control	Description
Valve name button	Indicates the currently selected valve (INJECT VALVE , HP1 VALVE , LP1 VALVE , or LP2 VALVE). To select a different valve, tap the down arrow.
Time value (min)	Indicates the elapsed time from when the valve position was changed.
	Tap the button to monitor and control all installed valves from one page (see “ Valves Page ” on page 87).

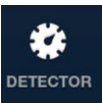

Home Page CD Controls

Control	Description
TOTAL µS value	Indicates the total conductivity (without a background offset).
µS value	Indicates the offset reading (total conductivity minus background conductivity). To determine the background offset, allow the system to equilibrate after startup. At equilibration, the detector reading is the background signal of the eluent before sample injection. Tap the AUTOZERO  button to set the reading to zero.
	Tap the button to control the cell heater, enter a rise time, or enter a temperature compensation factor (see “ Conductivity Detector (CD) ” on page 88).

Home Page ED Controls (Integrated Amperometry Mode)

Control	Description
CELL ON/OFF button	Toggles the ED cell power on and off. The slider position and background color indicate the status (left/black = off; right/green = on). When you turn on the cell, the selected waveform starts running.
pH value	Indicates the pH reading of the pH-Ag/AgCl reference electrode.
REFERENCE ELECTRODE button	Indicates/selects the reference electrode mode. The currently selected mode is highlighted in blue.
nC value	Indicates the offset current reading (total current minus background current). To determine the background offset, allow the system to equilibrate after startup. At equilibration, the detector reading is the background signal of the eluent before sample injection. Tap the AUTOZERO  button to set the reading to zero.
	Tap the button to monitor the total current reading, select the waveform, or change the detector mode (see “ Electrochemical Detector (ED) ” on page 90).

Home Page ED Controls (DC Mode)

Control	Description
CELL ON/OFF button	Toggles the ED cell power on and off. The slider position and background color indicate the status (left/black = off; right/green = on). When you turn on the cell, the selected waveform starts running.
pH value	Indicates the pH reading of the pH-Ag/AgCl reference electrode.
VOLTAGE button	Indicates/sets the voltage setpoint. Tap the value to change the setpoint.
nC value	Indicates the offset current reading (total current minus background current). To determine the background offset, allow the system to equilibrate after startup. At equilibration, the detector reading is the background signal of the eluent before sample injection. Tap the AUTOZERO  button to set the reading to zero.
	Tap the button to monitor the total current reading or change the detector mode (see “ Electrochemical Detector (ED) ” on page 90).

Home Page Electrolytics Controls (EGC, CR-TC, Suppressor)

Control	Description
ON/OFF button	Toggles the power to the electrolytic device. The slider position and background color indicate the status (left/black = off; right/green = on)
EGC mM, CR-TC V, Suppressor mA buttons	Indicates/sets the device setpoint (EGC eluent concentration, Dionex CR-TC 600 voltage, suppressor current). Tap the value to change a setpoint.
	Tap the button to view details about the EGC and to set the suppressor type and format (see “ Electrolytics Page ” on page 92).

Home Page Temperature Controls (Compartment, Column, CD Cell)

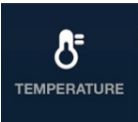
Control	Description
OFF/ON button	Toggles the device power off and on.
°C button	Indicates/sets the temperature setpoint of the device. To change a setpoint, tap the value.
	Tap the button to monitor the current temperature of the device (see “ Temperature Page ” on page 95).

Home Page Plot Controls

Control	Description
PLOT SELECT button	Indicates/selects the signal currently being plotted. A selected signal is highlighted in blue. Tap a signal name to select it. A detector signal and the pressure signal can be plotted simultaneously.
TIME button	Controls the length of time shown on the plot. Tap the button to select a different duration.
plot display	Displays a thumbnail view of the current plot.
	Tap the button to view the plot on a full page and select additional parameters (see “ Plot Page ” on page 96).

Pump Page

Use the Pump page to set pump-related parameters that are not accessible on the Home page and to control optional pump accessories. The page can show either the pump controls or the accessory controls at any one time. Tap the corresponding arrow to see the other set of controls.

Pump Controls

Figure 46. Pump page

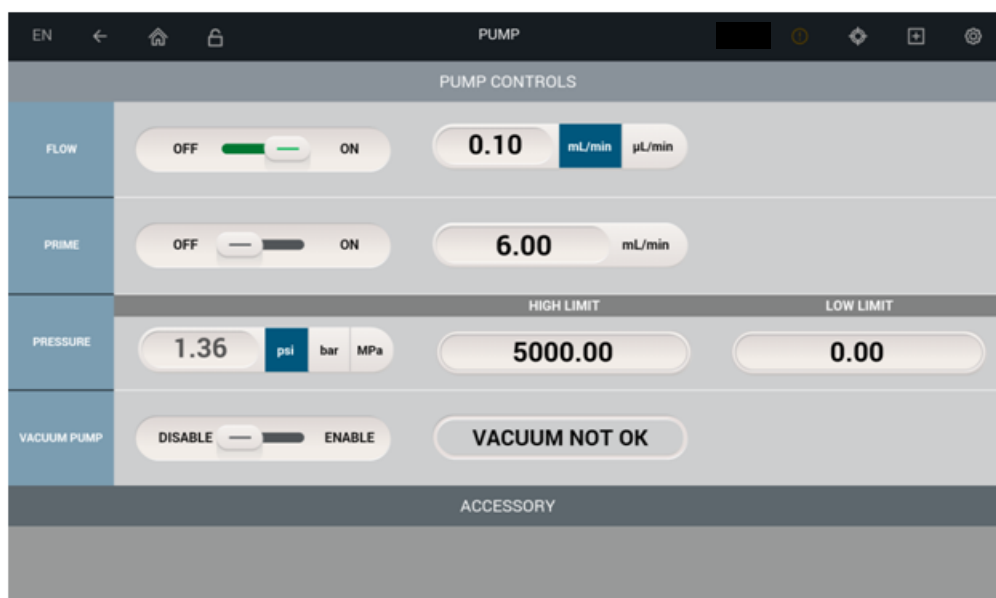

Flow

Control	Description
OFF/ON button	Toggles the flow off and on.
flow rate button mL/min (or µL/min)	Indicates/sets the flow rate. Tap the value to change the setting. The selected unit is highlighted in blue. Tap a unit to select it. This sets the flow rate unit for all mobile app pages that display flow rates.

Prime

Control	Description
OFF/ON button	Toggles the priming function off and on.
flow rate button	Indicates/sets the priming flow rate. Tap the down arrow to select a different flow rate.

For detailed priming instructions, see [“Priming the Pump”](#) on page 50.

Pressure

Control	Description
pressure value/unit selection button (PSI , bar , MPa)	Indicates the current system pressure in either psi, bar, or MPa. The selected unit is highlighted in blue. Tap a unit to select it. This sets the pressure unit for all mobile app pages that display pressure values.
HIGH LIMIT and LOW LIMIT buttons	<p>Indicate/define the allowed pressure range for system operation.</p> <ul style="list-style-type: none"> To set a high and low limit, tap the respective numeric values. The high limit must be at least 0.34 MPa (50 psi) above the low limit. The first time the Dionex Integrion power is turned on, the maximum system pressure limit is 41 MPa (6000 psi) and the minimum pressure limit is 0. The eluent generator requires a maximum high limit of 35 MPa (5000 psi) and a minimum low limit of 1.4 MPa (200 psi).

Vacuum Pump

Control	Description
DISABLE/ENABLE button	Toggles the vacuum pump between disabled (always off) and enabled (always on).
VACUUM OK (or VACUUM NOT OK)	Indicates the status of the vacuum. If the vacuum is not okay, see the troubleshooting information in “ Degas Vacuum Pump Low Vacuum ” on page 145 .

Accessory Controls

Figure 47. Accessory controls

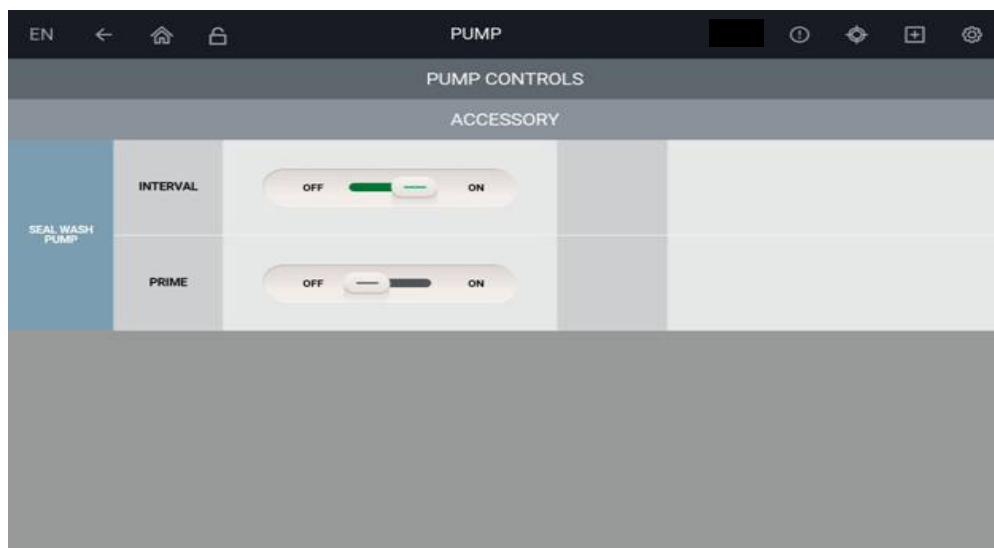

Seal Wash Pump

Control	Description
INTERVAL (ON) button	Determines whether the pump will run in intervals or is off.
PRIME button	Toggles seal wash pump priming off and on.

Valves Page

Use the Valves page to monitor and control each valve installed in the system. The page shows only the valves installed in the system.

Figure 48. Valves page (example page for a system with four valves)

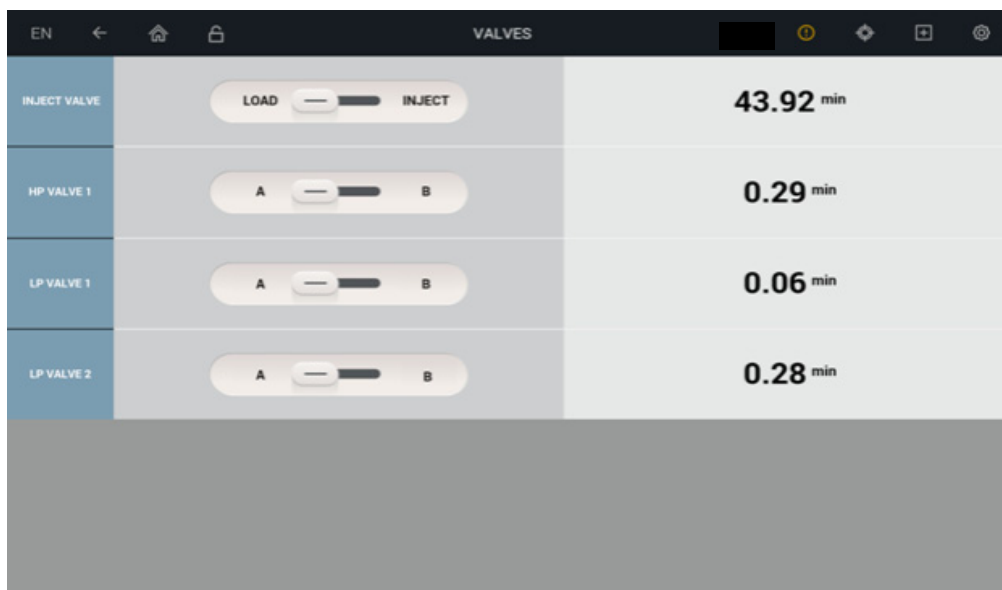

Control	Description
Valve position buttons	Indicates the current position of each installed valve. To change the position, tap the button.
Time value (min)	<ul style="list-style-type: none"> High-pressure valves: Indicates the elapsed time from the last injection. Low-pressure valves: Indicates the elapsed time from the last valve position change.

Detector Page

Use the Detector page to monitor and control the detector.

Conductivity Detector (CD)

Figure 49. CD detector page

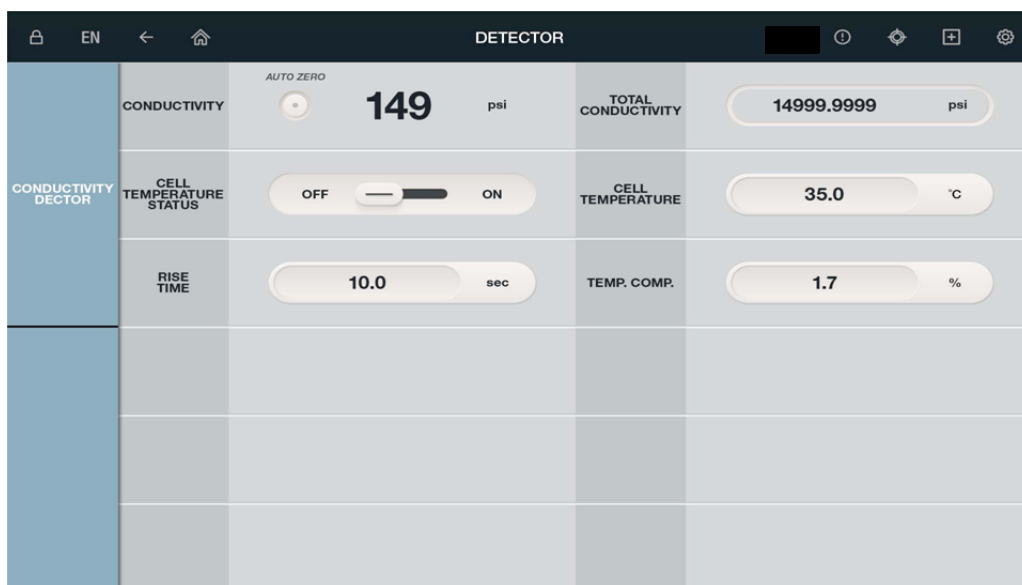

Control	Description
CONDUCTIVITY	Indicates the offset reading (total conductivity minus background conductivity). To determine the background offset, allow the system to equilibrate after startup. At equilibration, the detector reading is the background signal of the eluent before sample injection. Tap the AUTOZERO  button to set the reading to zero.
TOTAL CONDUCTIVITY	Indicates the total conductivity (without a background offset).
CELL TEMPERATURE STATUS button	Toggles the cell heater on and off.
CELL TEMPERATURE button	Indicates/sets the cell heater setpoint. Tap the value to change the setting.

Control	Description
RISE TIME button	Indicates/sets the rise time setting. Tap the value to change the setting. For details, see “Data Rise Time.”
TEMP. COMP. button	<p>Indicates/sets the temperature compensation setting. Tap the value to change the setting.</p> <p>The CD has built-in temperature compensation that helps minimize changes in the baseline or in peak heights if the operating temperature is different from the temperature at which the cell was calibrated. The default temperature compensation is 1.7% per °C. This can be reset to between 0% and 3.0% per °C, depending on the eluent. If you notice that the baseline shifts up when the temperature increases, the temperature compensation is too low and should be reset to a higher value.</p>

Data Rise Time

The data rise time determines the amount of filtering performed on the CD. The rise time is a measure of how quickly the detector responds to a change in signal, and is defined as the time it takes the output signal to rise from 10% of its final value to 90% of its final value. The selected data rise time is used to filter both the digital data output, which is sent to the computer and the Plot screen, and the analog data output. The default rise time is 2 seconds. Choosing an appropriate rise time value can optimize performance by keeping the signal-to-noise ratio at a minimum level. A longer rise time allows averaging of the noise frequencies, and subsequently, the baseline will contain much less short-term noise.

However, longer rise times may have the following effects on peaks:

- The peak shape will become asymmetric.
- The peak maximum will be shifted.
- The peak height will be reduced.

The rise time should be approximately 25% of the peak width at one-half the height of the narrowest peak of interest.

For example, for a peak width of 5 seconds, calculate the rise time as: (5 sec) 25% = 1.25 sec. Because 1.25 sec is not one of the available settings for rise time, select the next fastest rise time, 1 sec.

Electrochemical Detector (ED)

Figure 50. ED detector page: Integrated amperometry mode, AgCl reference electrode

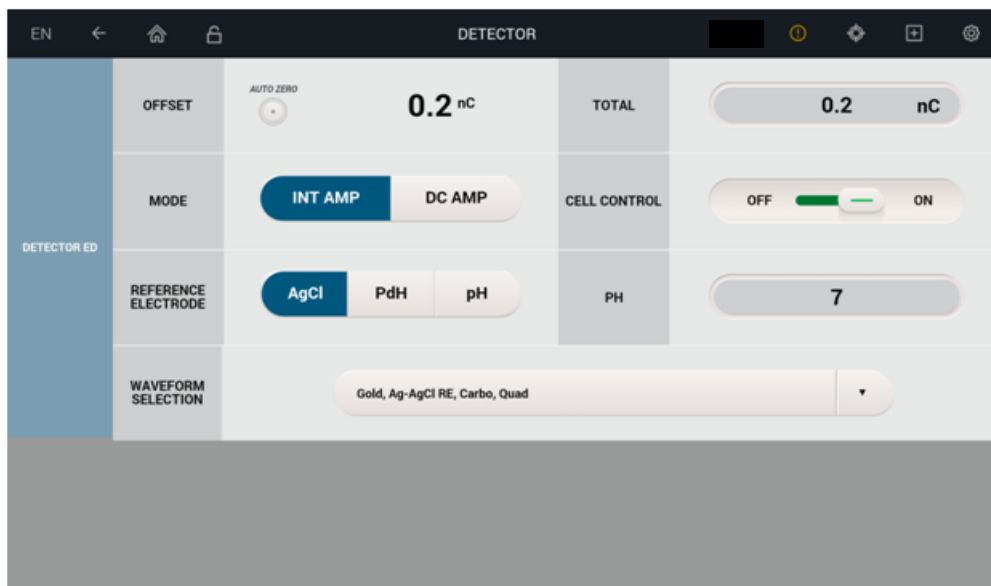

Figure 51. ED detector page: Integrated amperometry mode, PdH reference electrode

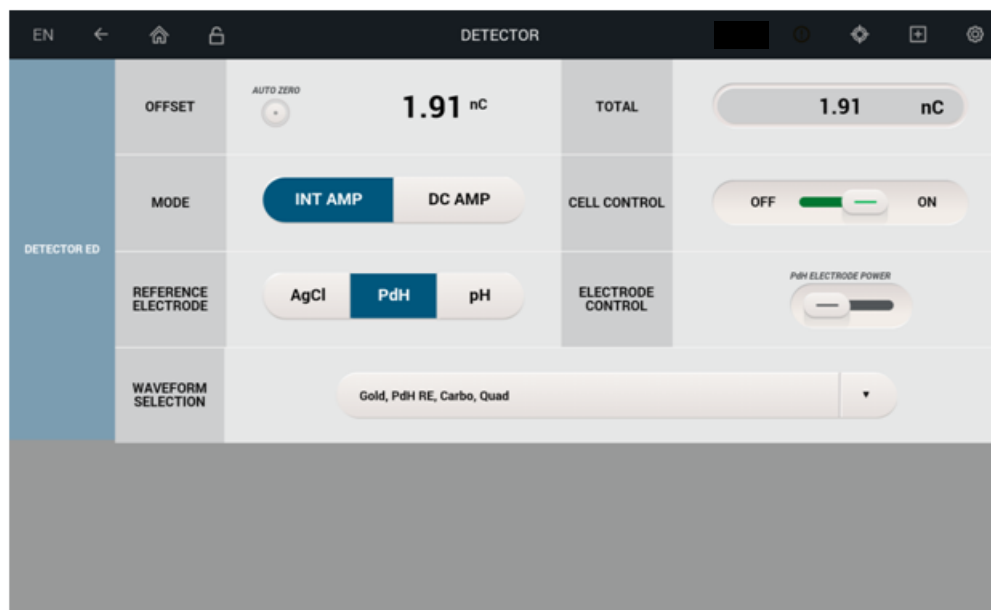
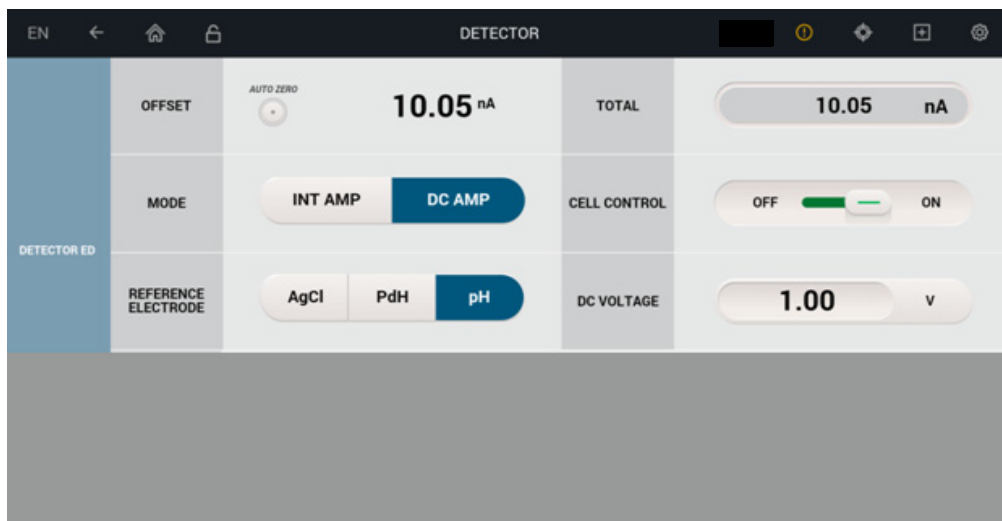



Figure 52. ED detector page: DC amperometry mode



Control	Description
OFFSET	<p>Indicates the offset reading (total current minus background current).</p> <p>To determine the background offset, allow the system to equilibrate after startup. At equilibration, the detector reading is the background signal of the eluent before sample injection. Tap the AUTOZERO  button to set the reading to zero.</p>
TOTAL	Indicates the total current (without a background offset).
MODE	Indicates the current detector mode (integrated amperometry or DC amperometry). The selected mode (Int Amp or DC Amp) is highlighted in blue. Tap the mode name to change the mode locally.
CELL CONTROL button	<p>Toggles the cell power on and off.</p> <ul style="list-style-type: none"> For integrated amperometry: When you turn on the cell, the selected waveform starts running. For DC amperometry: When you turn on the cell, the selected voltage is applied constantly to the working electrode.
REFERENCE ELECTRODE	<p>Indicates the currently selected reference electrode mode (highlighted in blue). Tap a mode to select it.</p> <p>Two reference electrode types are available for the ED:</p> <ul style="list-style-type: none"> Combination pH-Ag/AgCl reference electrode (mode = AgCl or pH) Palladium hydrogen (PdH) reference electrode (mode = PdH)

Control	Description
ELECTRODE CONTROL	(PdH reference electrode mode only) The PdH Electrode Power toggles the electrode power on and off. The button's slider position and background color indicate the status (left/black = off; right/green = on).
DC VOLTAGE	(DC amperometry mode only) Indicates/sets the voltage setpoint. When the cell power is on, this voltage is applied constantly to the working electrode. Tap the button to change the setpoint.



Electrolytics Page

Use the Electrolytics page to monitor and control each electrolytic device installed in the system. The page shows only the electrolytic devices installed in the system. The total number of electrolytic devices that can be installed in a system is determined by the installed power supply option. Power supply options are described on [page 6](#).

Figure 53. Electrolytics page example (1-channel option)

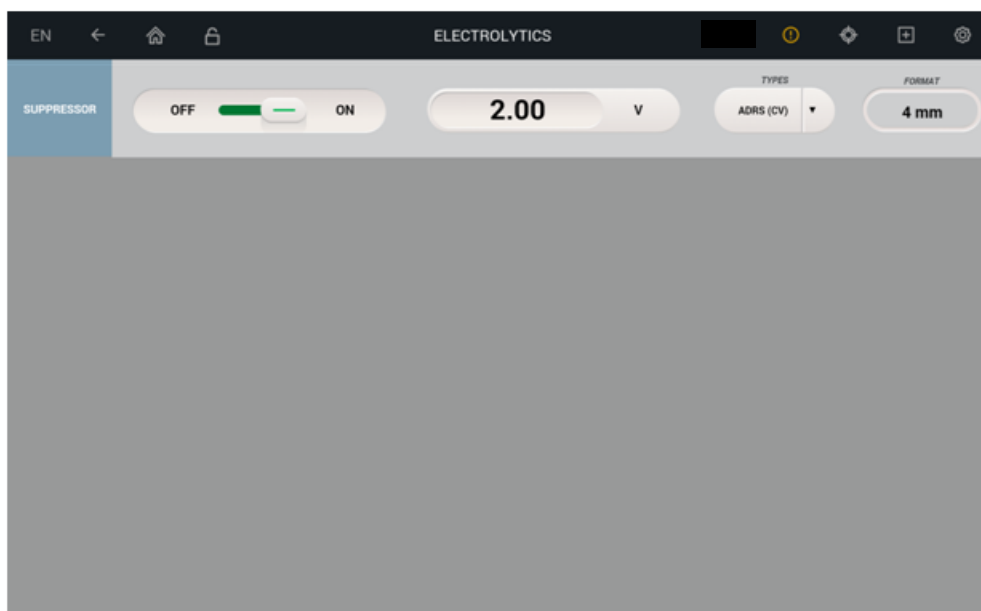

Figure 54. Electrolytics page example (3-channel option)

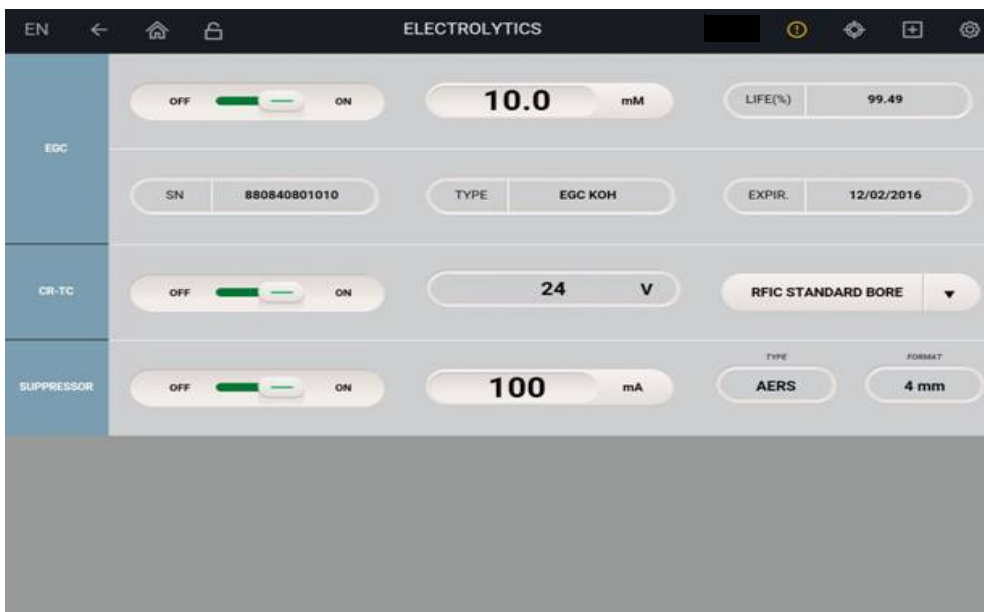
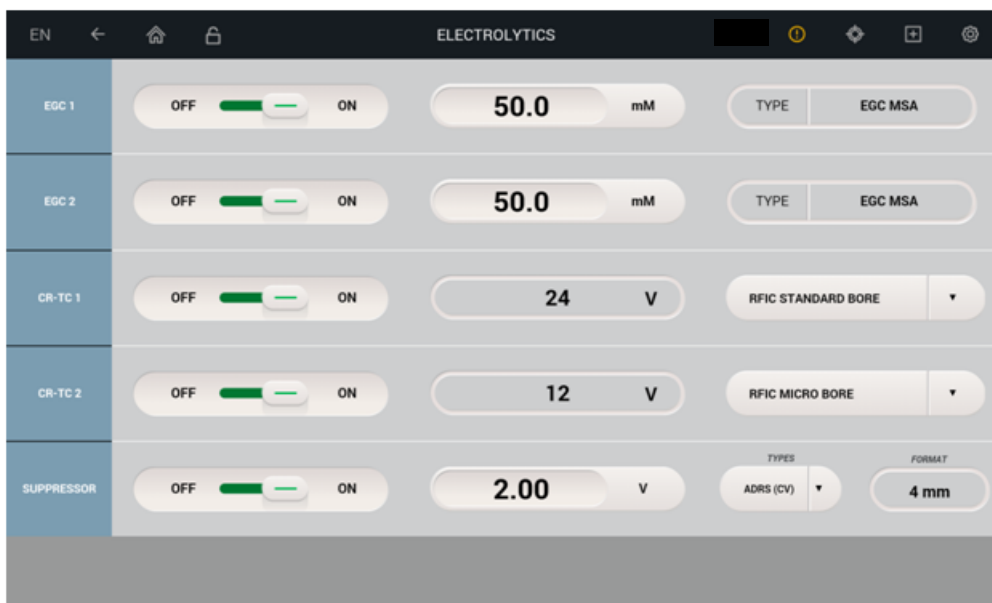

Figure 55. Electrolytics page example (5-channel option)



EGC

Control	Description
OFF/ON button	Toggles the Dionex EGC power off and on. When you turn on the power, the Dionex EGC begins generating eluent at the currently selected concentration setting. Note The Dionex EGC power is always turned off when the pump flow is off.
mM button	Indicates/sets the eluent concentration setpoint. To change the setpoint, tap the value. To determine the eluent concentration required for your application, refer to the column manual provided on the Thermo Scientific Reference Library DVD (P/N 60-053891).
LIFE (%)	Displays the percentage of the remaining ion capacity in the Dionex EGC. (The remaining life is also displayed on the Consumables page.)
SN	Displays the serial number of the installed Dionex EGC.
TYPE	Displays the type of Dionex EGC installed.
EXPIR.	Displays the expiration date of the installed Dionex EGC. The date is 2 years from the date of manufacture. Although you can continue operation with the cartridge after this date, performance may be impaired until a new cartridge is installed.

CR-TC

Control	Description
OFF/ON button	Toggles the Dionex CR-TC 600 power off and on. Note The Dionex CR-TC 600 power is always turned off when the pump flow is off.
V	Indicates the voltage applied to the Dionex CR-TC 600.

Suppressor



Control	Description
OFF/ON button	Toggles the suppressor power off and on. Note The suppressor power is always turned off when the pump flow is off.
mA button	Indicates/sets the suppressor current setpoint. To change the setpoint, tap the value. The appropriate suppressor current setting depends on the suppressor type, the column, and other variables. Refer to the suppressor manual for the recommended current setting for your application. The suppressor manuals are provided on the Thermo Scientific Reference Library DVD (P/N 60-053891). Indicates the voltage applied to the Dionex CR-TC 600.
TYPE	Displays the type of the installed suppressor.
FORMAT	Displays the format of the installed suppressor.

Temperature Page

Use the Temperature page to monitor and control each temperature-controlled device installed in the system. The controls on the page are the same for each device (**COMPARTMENT TEMPERATURE, COLUMN HEATER, CD CELL HEATER**). Only the devices installed in the system are displayed on the page.

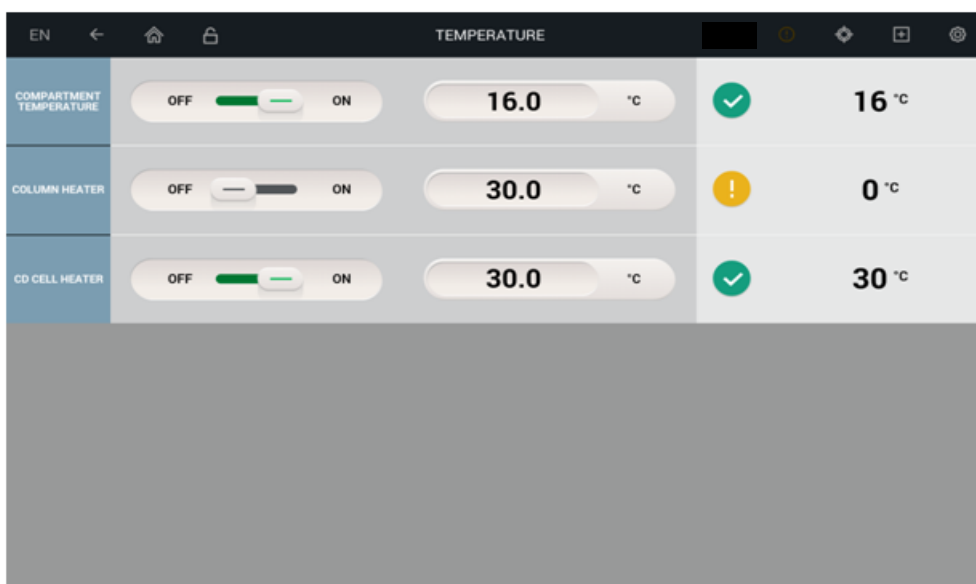
Figure 56. Temperature page



Control	Description
OFF/ON button	Toggles the device power off and on.
°C button	Indicates/sets the temperature setpoint of the device. To change a setpoint, tap the value.
°C value field	Displays the current temperature of the device. <ul style="list-style-type: none"> A yellow exclamation point  icon indicates that the current temperature is either above the setpoint or below the setpoint. A green check mark  icon indicates that the current temperature is at the setpoint.

Plot Page

Use the Plot page to view the most recent detector data and pump pressure data in graphical form. Up to 60 minutes of collected data can be displayed on the plot. Data older than 60 minutes is not saved and is unavailable for plotting. Data points are collected continuously until one of the following events occurs:

- Data acquisition starts for the first signal selected to be plotted.
- Data acquisition stops for the last signal selected to be plotted.

When one of these events occurs, the elapsed time counter, time axis, and data buffer are all reset to zero and the plot restarts.

Figure 57. Plot page



Control	Description
ELAPSED	Displays the elapsed time (in minutes) since data acquisition either started or stopped.
PLOT SELECT button	<p data-bbox="714 388 1461 472">Indicates the signals currently selected for plotting. Selected signals are highlighted in blue. Up to two signals can be plotted.</p> <ul data-bbox="714 472 1461 703" style="list-style-type: none"> <li data-bbox="714 472 1461 556">• The first detector signal selected is plotted on the primary (left) axis. <li data-bbox="714 556 1461 703">• The second detector signal is plotted on the secondary (right) axis. The pressure signal is always plotted on the secondary axis.
TIME	Indicates/sets the length of time displayed on the plot (the horizontal axis scale). Tap the button to select a different number of minutes.
RANGE	<p data-bbox="714 819 1461 934">Indicates the highest detector reading displayed on each signal axis (the scale of each vertical axis). Tap the button to select a different signal range for an axis.</p> <p data-bbox="714 934 1461 1108">If the tops of peaks are cut off, select a higher range. If peaks are short, select a lower range. To have the scaling of the signal plot automatically adjust to the height of the signal, select AUTO. The range for the pressure signal is always Auto.</p>

Plot Screen Saver Page

The screen saver page appears when there is no user activity for 5 minutes. The screen displays the signal plot (based on the last plot page settings) and the last error received from the instrument. Touch the screen to return to the last page viewed.

Figure 58. Plot page screen saver

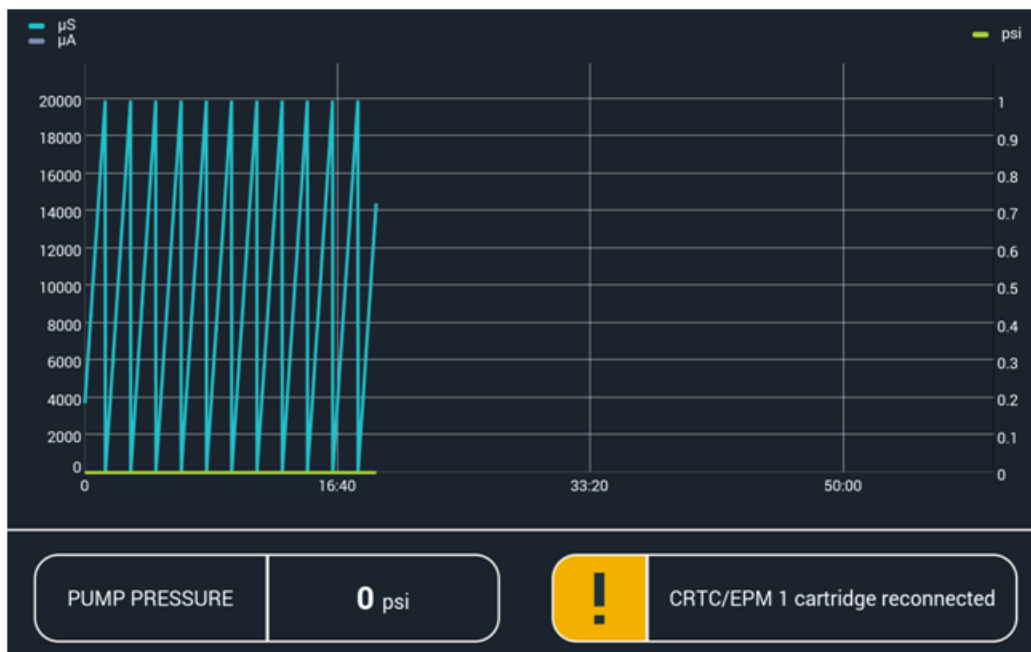

Analog Page

The Analog page provides options for configuring the analog outputs for your connected recording device and application.

Two analog output connectors are provided on the Dionex Integrion rear panel. Each analog output supplies a voltage signal proportional to the current measured by a detector cell. The outputs can be connected to an analog-to-digital (A/D) converter, such as an integrator or other recording device.

Figure 59. Analog page (CD version shown)

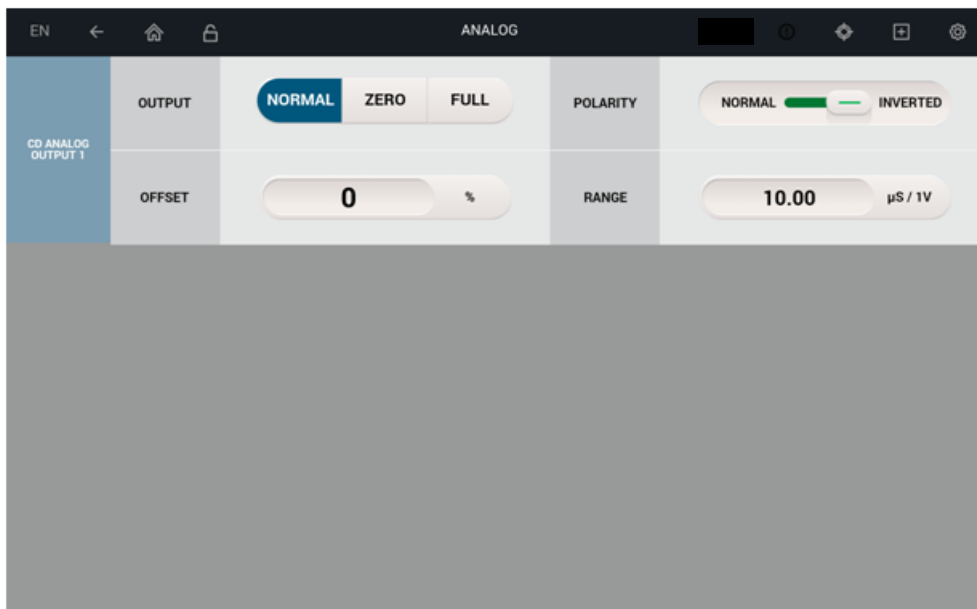

❖ **To open the Analog page**

On the mobile app quick access toolbar, tap the Accessories  icon and then tap **ANALOG** on the menu.

Analog Page Controls

Control	Description
CD ANALOG OUTPUT 1	Indicates/selects the type of signal output. The selected output type is highlighted in blue. Tap a type to select it. <ul style="list-style-type: none"> • NORMAL outputs a signal corresponding to the offset reading from the detector and taking into account the other selected analog parameters (polarity, offset, range). • ZERO sets the output signal to zero volts. This setting is used to calibrate an analog-to-digital converter device. • FULL sets the output signal to a full-scale response. This setting is used to calibrate an analog-to-digital converter device.
—or— ED ANALOG OUTPUT 1	
POLARITY	Indicates/sets the polarity of the output signal: NORMAL (positive) or INVERTED (negative). Tap the button to changed the polarity. In applications in which the analyte output is lower than the background signal, the polarity must be inverted to display peaks instead of dips on the chromatogram.

Control	Description
OFFSET	Indicates/sets the analog output offset as a percentage of the full-scale analog output. The offset adjusts the zero position of the analog output when it is plotted. An offset allows a recording device to plot the signal if it becomes negative, but does not affect the magnitude of the output signal. Tap the button to change the offset.
RANGE ($\mu\text{S}/1\text{V}$)(CD) –or– RANGE ($\text{nC}/1\text{V}$) (ED) (integrated amperometry) –or– RANGE ($\mu\text{A}/1\text{V}$)(ED) (DC amperometry mode)	Indicates the maximum detector signal that will be reported. This corresponds to a full-scale detector response. Tap the button to select a different range. The range to use depends on the detector readings expected for the application. For example, if you expect detector readings for your conductivity detection application to be less than 50 $\mu\text{S}/1\text{V}$, enter 50.

TTL/Relay Page

The TTL/Relay screen displays the status of the TTL inputs, provides access to the TTL Input screen, and provides control of TTL and relay outputs.

Figure 60. TTL/Relay input page



For TTL and relay connection instructions, see “[Connecting the I/O Connectors](#)” on page 67.

❖ To open the TTL/Relay page

On the mobile app quick access toolbar, tap the Accessories  icon and then tap **TTL/RELAY** on the menu.

TTL Input

Control	Description
TTL 1 (2, 3, 4) INPUT STATUS	Indicates the voltage (0 V or 5 V) of each TTL input.

TTL Output

Control	Description
TTL 1 (2) OUTPUT	Indicates/sets the TTL output status, either 0 V (on) or 5 V (off). Tap the button to toggle the output. The TTL outputs are normally at 5 volts. Setting a TTL output to 0 volts turns on the function in the connected device.

Relay Output

Control	Description
RELAY 1 (2) OUTPUT	Indicates/sets the relay output status (CLOSE or OPEN). Tap the button to toggle the position. The relay outputs can be connected to be either normally open or normally closed. For connection instructions, see “ Connecting the I/O Connectors ” on page 67.
LINK TO PUMP FLOW	When this button is selected, the relay closes automatically when the pump motor is on and the flow is greater than 0.

TTL Input Page

Use the TTL Input page to assign functions to the TTL inputs and select input control types.

❖ **To open the TTL Input page**

On the TTL/Relay page, tap the **TTL INPUT**  button.

Figure 61. TTL input page



Control	Description
Functions	<p>For each TTL input, tap the button for the function to be controlled by the input.</p> <ul style="list-style-type: none"> • INJECT VALVE switches the injection valve position. • AUTOZERO offsets the background signal. • PUMP ON turns the pump on and off. • MARK sends a chart mark signal to the analog output. The mark is 10% of the full-scale voltage, and the duration is 0.5 second. A mark can be used, for example, to indicate when the injection occurred.
INPUT CONTROL TYPE	<p>Indicates/selects the input control type. The currently selected type is highlighted in blue. Tap the name of the control type to select it.</p> <p>The TTL inputs respond to four types of signals (NORMAL EDGE, INVERTED EDGE, NORMAL PULSE, or INVERTED PULSE) to accommodate different controlling devices. The default control type, normal edge, is compatible with the output signals provided by Thermo Scientific Dionex modules.</p> <p>If the controlling device connected to the input does not send a normal edge signal, select the appropriate control type. To determine the correct type, refer to the documentation provided with the controlling device and to “TTL Input Control Types” on page 71.</p>

Consumables Page

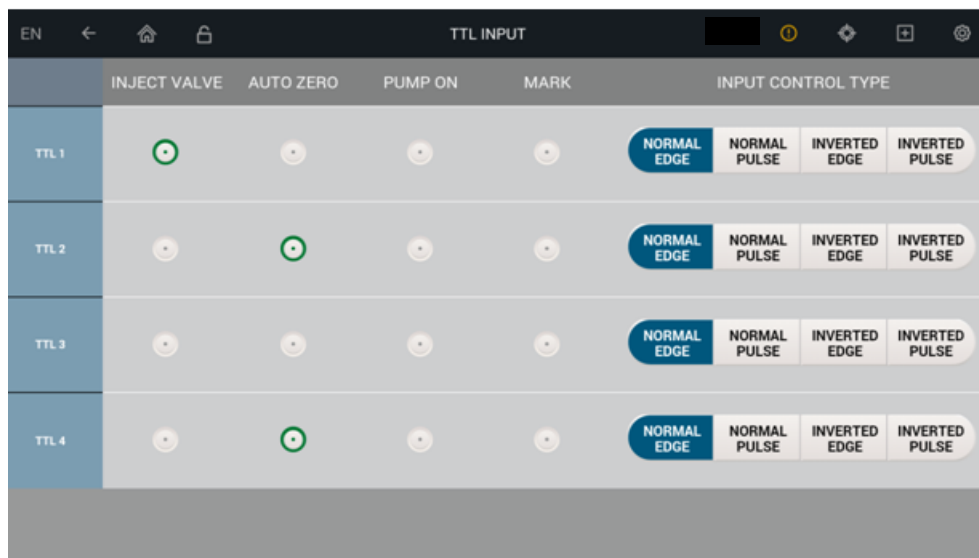
The Consumables page is available if the system is configured with the RFID option. Use this page to view information about RFID-equipped consumable devices detected by the system. From this page, you can also initiate a manual scan for RFID devices, and enable or disable use of detected devices in the system.

The information is presented in a table that includes a row for each detected device and a column for each identification and usage parameter tracked by the system. Up to six rows and three columns are displayed at one time. You can scroll vertically and horizontally to see additional devices and parameters.

For details about the various parameters that are tracked, see “Consumable Device Tracking” on page 15. Not all parameters are available for all devices. If a parameter is not tracked for a particular device, N/A appears in the column.

When a consumable is tracked by a wired communication system rather than RFID, the **Rescan** check box for the consumable is always selected and you cannot initiate a manual scan. If you are unsure how a particular consumable is tracked, scroll to the right until the **Detected by** column is displayed.

❖ To open the Consumables page

On the mobile app quick access toolbar, tap the Consumables  icon.

Figure 62. Consumables page example



	Part Number	Name	Serial Number	Lot Number
<input checked="" type="checkbox"/>	060549	Dionex IonPac AS18 (4mm)	151028019	01427187
<input checked="" type="checkbox"/>	059660	Dionex ATC-3 (4 mm) Anion	151028024	01411115
<input checked="" type="checkbox"/>	060551	Dionex IonPac AG18 (4mm)	151028020	01427187
<input checked="" type="checkbox"/>	063079	Dionex IonPac UTAC-LP1	151028023	01427125B
<input checked="" type="checkbox"/>	123456	Dionex CERS 500 (4 mm)	15021010	00007748
<input checked="" type="checkbox"/>	654321	Dionex CR-CTC 600	87654321	88899900

❖ To initiate a manual scan for RFID devices

Tap the **Rescan** button.

❖ To enable use of a detected RFID device in the system

1. If a detected RFID device is installed in the system, select its check box.
2. The **Rescan** button changes to **Approve**. Tap the button to enable use of the device.

❖ **To disable use of a detected RFID device in the system**

If a detected RFID device is not installed in the system, clear its check box and tap the **Approve** button.

❖ **To remove an unused detected device from the list**

Move the device away from the system (30 cm (2 ft) or more) and then tap the **Rescan** button. The device will no longer be detected.

Calibration Pages

Calibration of the CD cell or ED pH-Ag/AgCl reference electrode can be performed using either the touch screen or the Chromeleon ePanel. For instructions, see “[To calibrate the CD cell](#)” on page 202 or “[To calibrate the pH-Ag/AgCl reference electrode](#)” on page 213.

❖ **To open the Calibration page**

On the mobile app quick access toolbar, tap the Service  icon and then tap **CALIBRATION** on the menu.

Figure 63. Calibration page: conductivity cell

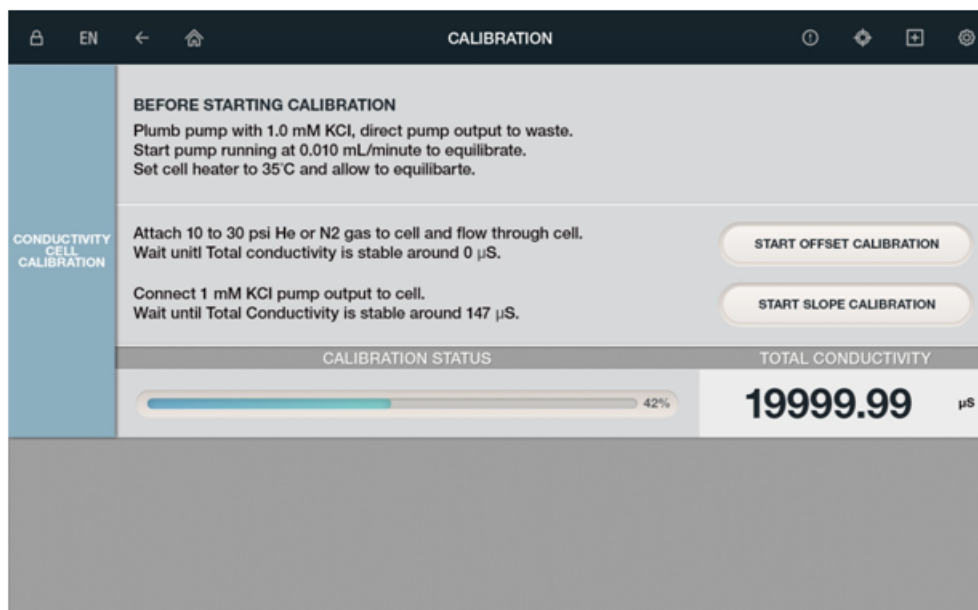
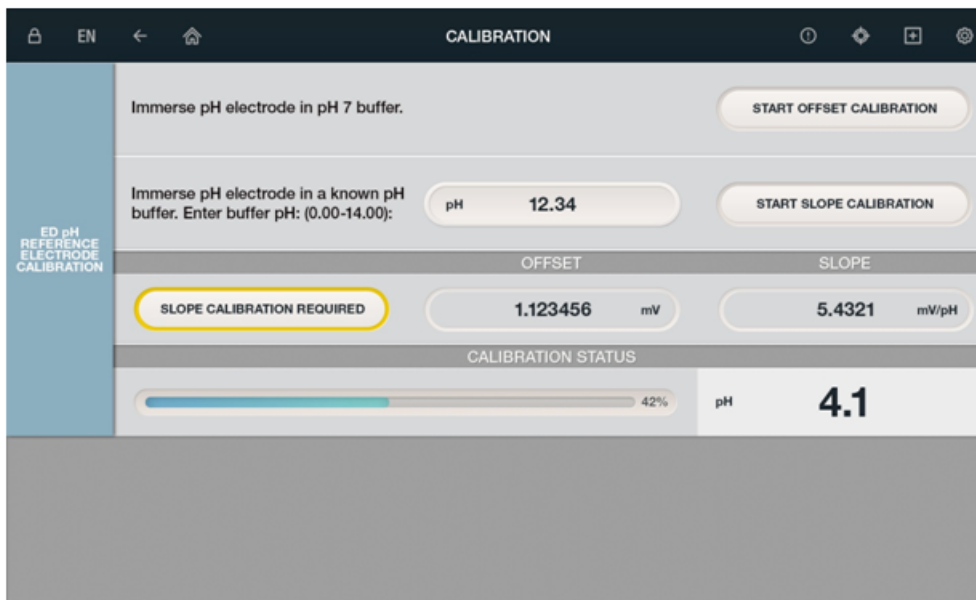

Figure 64. Calibration page: ED pH-Ag/AgCl reference electrode



Information Page

The Information page displays the instrument firmware version, the serial number of the instrument, and the options installed in the system.

❖ To open the Information page

On the mobile app quick access toolbar, tap the Service  icon and then tap **INFORMATION** on the menu.

Figure 65. Information page



4 Dionex Integrion Mobile App Operation

Information Page

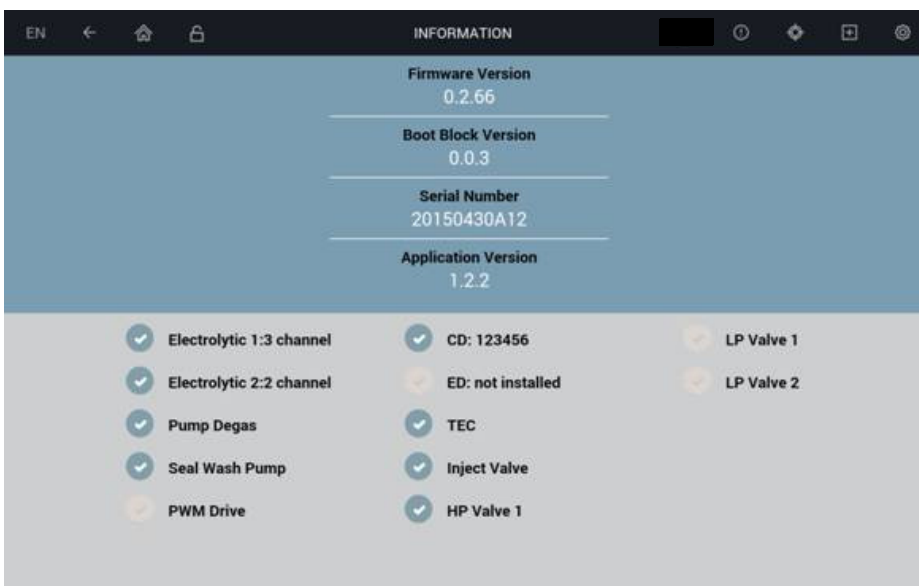
Maintenance

This chapter describes routine maintenance procedures for the Dionex Integrion HPIC System that users can perform. All other maintenance procedures must be performed by Thermo Fisher Scientific personnel.

Daily Maintenance

- Check for leaks, and tighten or replace any leaking fittings.
- Wipe up spills.
- Rinse dried eluent off of components with deionized water. Dry the leak sensor thoroughly; if the sensor is not dry, it will remain activated and continue to report a leak to the Chromeleon audit trail.
- Check the liquid level in the eluent reservoir and refill as required.
- Check the waste container and empty when needed.

Weekly Maintenance

- Check fluid lines for crimping or discoloration. Replace any pinched or damaged lines.
- Check the end-line filter (P/N 045987) and change if needed. When end-line filters are new, they are pure white. If the system is in continuous operation, change the end-line filter weekly, or whenever it becomes discolored. Replace the filter more often if bacterial buildup is visible or if the eluent reservoir does not contain solvent.

Note It is especially important to regularly replace end-line filters when using aqueous eluents, which may contaminate the filter with bacteria or algae. The bacterial buildup may not be visible.

Periodic Maintenance

Clean eluent reservoirs periodically, as instructed below.

❖ To clean a reservoir

1. Dispose of any remaining chemicals according to local municipal regulations.
2. Rinse the reservoir (inside and out) with ASTM Type I (18 megohm-cm) filtered and deionized water that meets the specifications in [“Deionized Water Requirements for IC”](#) on [page 3](#).

Rinse the inside of the reservoir with isopropyl alcohol or methanol.

3. If algae or bacteria have left a slimy film on the reservoir, use an algaecide or disinfectant (dilute hydrogen peroxide, etc.).
4. Rinse cleaning chemicals out of the reservoir with ASTM Type I (18 megohm-cm) filtered and deionized water.
5. Dry the reservoir with clean, particulate-free air.

Annual Maintenance

Thermo Fisher Scientific recommends performing preventive maintenance annually, as well as before scheduled Performance Qualification tests. A Dionex Integrion HPIC System Preventive Maintenance Kit (P/N 22153-62041) is available for this purpose.

Troubleshooting

This chapter is a guide to troubleshooting issues that may arise during operation of the Dionex Integrion HPIC System. If you are unable to resolve a problem by following the instructions here, contact Technical Support for Dionex products. In the U.S. and Canada, call 1-800-532-4752. Outside the U.S. and Canada, call the nearest Thermo Scientific office.

Contents

- [Troubleshooting Error Messages](#)
- [Troubleshooting System Component Symptoms](#)
- [Troubleshooting Chromatogram Symptoms](#)

Note An interactive troubleshooting guide is available in Chromeleon. To access the guide, click **Troubleshooting and Diagnostics**  on the Instrument toolbar above the ePanel Set and select **Pump_ECD Troubleshooting**.



Troubleshooting Error Messages

The instrument control firmware installed in the Dionex Integrion HPIC System periodically checks the status of certain parameters. If a problem is detected, it is reported to Chromeleon and to the Dionex Integrion HPIC Mobile App (if the system includes a mobile device).

In the mobile app, a warning  icon on the toolbar flashes when an error occurs. Tap the icon to display the error.

In Chromeleon, each error message is logged in the audit trail. An icon that identifies the severity of the underlying problem precedes each message (see [Table 13](#)).

Table 13. Error severity levels

Default severity level	Audit trail icon	Description
Warning		A message is displayed, but the current run is not interrupted. The instrument can be started or continue running; however, Thermo Fisher Scientific recommends that you take appropriate action to remedy the situation.
Error		A message is displayed in the audit trail or the Ready Check results, and the system attempts to correct the problem (sometimes by using an alternative parameter), but the current run is not interrupted. If an error occurs during the Ready Check, the queue will not be started until the error is resolved.
Abort		A message is displayed and the running queue is aborted.

[Table 14](#) lists the most frequently observed error messages, their default severity levels, and the pages where troubleshooting information is found.

Table 14. Error messages

Message	Severity	See
2-channel board memory reset to defaults	Warning	page 113
3-channel board memory reset to defaults	Warning	page 113
A method with this name already exists	Abort	page 114
Abnormal drive current for x.x seconds	Warning	page 114
Ambient temperature sensor error	Abort	page 114
Aux_PowerSupply_1 (_2) over current	Abort	page 114
Aux_PowerSupply_1 (_2) over power	Abort	page 115
Aux_PowerSupply_1 (_2) over voltage	Abort	page 115
Aux_PowerSupply_1 (_2) turned off due to flow rate	Abort	page 115
Camshaft index too early	Abort	page 115
Camshaft index too late	Abort	page 115
Camshaft sensor always alight	Abort	page 116
Camshaft sensor missing or dark	Abort	page 116
CD cell memory reset to defaults	Warning	page 116

Table 14. Error messages

Message	Severity	See
CD cell temperature is lower than expected	Abort	page 117
CD cell temperature over safe limit	Abort	page 116
Chromeleon run stopped from tablet	Abort	page 117
Column door opened	Warning	page 117
Column heater exceeds safe temperature limit	Abort	page 117
Column heater memory reset to defaults	Warning	page 118
Column heater temperature calibration failed	Abort	page 118
Column heater temperature is lower than expected	Abort	page 118
Column oven fan disconnected	Abort	page 118
Column temperature sensor error	Abort	page 118
The following CR-TC errors are applicable to CR-TC, CR-TC2, EPM1, and EPM2:		
CR-TC/EPM cartridge disconnected	Warning	page 119
CR-TC/EPM consumable inventory cable memory reset to defaults	Warning	page 122
CR-TC invalid serial number	Abort	page 119
CR-TC over current	Abort	page 119
CR-TC short circuit	Abort	page 120
Detector compartment door opened	Warning	page 121
Detector compartment exceeds safe temperature limit	Abort	page 121
Detector compartment memory reset to defaults	Warning	page 121
Detector compartment temperature calibration failed	Abort	page 121
Detector compartment temperature is lower than expected	Abort	page 122
Detector compartment temperature sensor error	Abort	page 122
ED cell current exceeds limits	Warning	page 122
ED cell memory reset to defaults	Warning	page 123
ED cell off due to flow rate	Abort	page 123
ED cell reference electrode disconnected	Warning	page 123
ED cell working electrode disconnected	Warning	page 124
ED pH offset calibration failed	Warning	page 124
ED pH slope calibration failed	Warning	page 124

Table 14. Error messages

Message	Severity	See
The following EG errors are applicable to EG, EG2, and EG3:		
EG consumable inventory cable access error	Abort	page 125
EG consumable inventory cable memory reset to defaults	Warning	page 125
EG cartridge disconnected	Abort	page 125
EG invalid activation date	Abort	page 126
EG invalid concentration	Abort	page 126
EG invalid flow rate	Abort	page 126
EG invalid ion count	Abort	page 126
EG invalid serial number	Abort	page 127
EG over current	Serious	page 127
EGC over power	Abort	page 127
EGC over voltage	Abort	page 127
EG wrong cartridge type	Abort	page 128
Excessive drive current. Camshaft x.x.	Abort	page 128
Flash memory reset to defaults	Warning	page 128
High-pressure valve busy	Warning	page 128
High-pressure valve failed to reach commanded position	Warning	page 129
Incompatible CD detector installed	Abort	page 129
Incompatible ED detector installed	Abort	page 129
Insufficient CD cell data for this request	Abort	page 116
Internal hardware failure	Abort	page 129
Invalid flow value	Abort	page 129
Leak detected. Flow stopped.	Abort	page 130
Leak sensor wet	Warning	page 130
Load/Inject valve busy	Warning	page 130
Load/Inject valve failed to reach commanded position	Abort	page 130
Motor malfunction	Abort	page 131
Motor position error. The motor is overloaded.	Abort	page 131
No RFID labels found	Warning	page 131
Pressure fallen below lower limit	Abort	page 132
Pump is unlinked from Integrion	Abort	page 132

Table 14. Error messages

Message	Severity	See
RFID label 1–label 10 read/write failed: check label orientation	Warning	page 132
RFID label read failed: check label orientation	Warning	page 132
RFID label write failed: check label orientation	Warning	page 133
RFID product type not recognized	Warning	page 133
Right-hand pump block carryover pressure is too high	Abort	page 133
The following suppressor errors are applicable to Suppressor and Suppressor 2:		
Suppressor not installed	Abort	page 133
Suppressor over current	Abort	page 134
Suppressor over power	Abort	page 134
Suppressor over voltage	Abort	page 134
Suppressor stopped due to flow rate	Warning	page 135
Suppressor type has changed	Warning	page 135
The maximum purge pressure was exceeded	Abort	page 135
The pressure in the right-hand working cylinder exceeded the safety limit	Abort	page 135
The system pressure exceeded the safety limit	Abort	page 135
This function cannot be adjusted by the user	Abort	page 136
Upper pressure limit exceeded	Abort	page 136
Wrong device connected to connector A	Warning	page 137

 **2-channel board memory reset to defaults**

 **3-channel board memory reset to defaults**

This error occurs when there is a diagnostic failure.

❖ **To troubleshoot**

Contact Technical Support for Dionex products for assistance. The control electronics for the electrolytic device may have malfunctioned.

Note The Dionex Integriion electronics components cannot be serviced by the user.

 **A method with this name already exists**

This error occurs when you attempt to save a modified Chromeleon instrument method under the name of an existing method.

❖ **To troubleshoot**

Enter a new name for the modified instrument method or select **Save** to save your changes under the existing method name.

 **Abnormal drive current for x.x seconds**

This error may indicate that the tubing between the pump heads is blocked or that the fitting is overtightened.

❖ **To troubleshoot**

1. Inspect the tubing for blockage or crimping, and replace it as needed (see [“Replacing Tubing and Fittings”](#) on page 178). Be careful not to overtighten fittings.
2. If the error message appears again, contact Technical Support for Dionex products for assistance.

 **Ambient temperature sensor error**

This error indicates that the temperature sensor on the CPU board has failed.

❖ **To troubleshoot**

Contact Technical Support for Dionex products for assistance.

Note The Dionex Integrion electronics components cannot be serviced by the user.

 **Aux_PowerSupply_1 over current**

 **Aux_PowerSupply_2 over current**

This error occurs when an electrolytic device is not properly connected to the auxiliary power supply.

❖ **To troubleshoot**

Verify that the electrical cable from the electrolytic device is connected correctly.

 **Aux_PowerSupply_1 over power**

 **Aux_PowerSupply_2 over power**

This error occurs when the auxiliary power supply draws too much power.

❖ **To troubleshoot**

Check the specifications for the device connected to the power supply for the correct load.

 **Aux_PowerSupply_1 over voltage**

 **Aux_PowerSupply_2 over voltage**

This error may indicate an open circuit in the auxiliary power supply.

❖ **To troubleshoot**

Verify that the electrical cable from the electrolytic device is connected correctly.

 **Aux_PowerSupply_1 turned off due to zero flow**

 **Aux_PowerSupply_2 turned off due to zero flow**

This error occurs when the pump flow stops.

❖ **To troubleshoot**

If the pump stopped unexpectedly, follow the troubleshooting steps in “[Pump Stops](#)” on [page 145](#).

 **Camshaft index too early**

 **Camshaft index too late**

This error occurs when there is an internal error in the pump drive mechanism.

❖ **To troubleshoot**

1. Turn off the pump power for 30 seconds and then turn it on again.
2. If the error message appears again, contact Technical Support for Dionex products for assistance.

 **Camshaft sensor always alight**

 **Camshaft sensor missing or dark**

This error occurs when there is an internal error in the pump drive mechanism.

❖ **To troubleshoot**

Turn off the pump power for 30 seconds and then turn it on again. If the error message appears again, contact Technical Support for Dionex products for assistance.

 **CD cell data collection does not have enough data for the request**

This error occurs when there is an internal communication error.

❖ **To troubleshoot**

Contact Technical Support for Dionex products for assistance.

 **CD cell memory reset to defaults**

This error occurs when there is a CD cell memory read/write failure.

❖ **To troubleshoot**

Contact Technical Support for Dionex products for assistance.

 **CD cell temperature over safe limit**

This error occurs when the temperature of the conductivity detector exceeds the maximum allowed. This error may occur if the system is operating in an environment in which the temperature is greater than 40 °C.

❖ **To troubleshoot**

1. If a temperature-controlled detector compartment is installed, verify that the compartment temperature setting is at least 5 °C less than the CD cell temperature setting.
2. Check the suppressor current setting. Running the suppressor at a higher current than is recommended for the application can cause the CD cell to heat up.

CD cell temperature is lower than expected

This error occurs when the cell temperature is below 2 °C.

To troubleshoot

1. Verify that the cell is installed correctly and that the detector compartment door is closed completely.
2. Verify that the cell temperature control is turned on in the instrument method.

Chromeleon run stopped from tablet

This error occurs if you attempt to change an operational settings from the mobile app while a Chromeleon sequence is running.

To troubleshoot

Stop the running sequence, or wait until the sequence is finished to change operational settings.

Column door opened

This error occurs when the door to the column compartment is opened during a run.

To troubleshoot:

1. Verify that the door is fully closed at the top and bottom (a sensor is installed in both locations).
2. Check for—and remove—any obstruction.
3. If the door is fully closed and the error persists, contact Technical Support for Dionex products for assistance.

Column heater exceeds safe temperature limit

This error occurs when the temperature of the column heater exceeds the maximum allowed. This error may occur if the system is operating in an environment in which the temperature is greater than 40 °C.

To troubleshoot

For environmental specifications, see [Appendix A, “Specifications.”](#)

 **Column heater memory reset to defaults**

This error occurs when no valid data is read from memory after system power-up. As a result, all parameters are reset to their default values.

❖ **To troubleshoot**

Contact Technical Support for Dionex products for assistance.

 **Column heater temperature calibration failed**

This error occurs when the calibration value for the column heater temperature is out of range.

❖ **To troubleshoot**

1. Repeat the calibration procedure. Follow the instructions provided in the Dionex Integrion Temperature Calibration Kit (P/N 22153-62043).
2. If the error message appears again, contact Technical Support for Dionex products for assistance.

 **Column heater temperature is lower than expected**

This error occurs when the temperature of the column compartment is below 2 °C.

❖ **To troubleshoot**

1. Move the system to a warmer location. Make sure the ambient temperature is within the specifications listed in “[Physical Specifications](#)” on [page 224](#).
2. If the error message appears again, contact Technical Support for Dionex products for assistance.

 **Column oven fan disconnected**

This error occurs when the column oven fan is not properly connected, or has stopped working.

❖ **To troubleshoot**

Contact Technical Support for Dionex products for assistance.

 **Column temperature sensor error**

This error indicates that the temperature sensor in the column compartment is not working properly.

❖ **To troubleshoot**

Contact Technical Support for Dionex products for assistance.

CR-TC/EPM cartridge disconnected

This error occurs if Chromeleon sends a command to set a CR-TC 600/EPM parameter when the device is disconnected.

To troubleshoot

1. Verify that the device is securely plugged in.
2. If the error message appears again, contact Technical Support for Dionex products for assistance.

CR-TC/EPM consumable inventory cable memory reset to defaults

This error occurs when no valid data can be read from the consumable inventory cable memory after power-up. As a result, all parameters for the consumable are reset to their default values.

To troubleshoot

1. Replace the consumable.
2. If the error message appears again, contact Technical Support for Dionex products for assistance.

CR-TC invalid serial number

This error occurs when the serial number reported by the Dionex CR-TC 600 is invalid. This may indicate a problem with the memory chip in the Dionex CR-TC 600.

To troubleshoot

1. Verify that the Dionex CR-TC 600 cable is securely plugged in (see [Figure 66](#)).
2. If the error message appears again, contact Technical Support for Dionex products for assistance.

CR-TC over current

This error occurs when the current applied to the Dionex CR-TC 600 exceeds the maximum current allowed. (The Dionex CR-TC 600 current is automatically turned off to prevent damage to the Dionex CR-TC 600.) This error may also occur if liquid flow to the Dionex CR-TC 600 is interrupted.

To troubleshoot

1. Verify that the Dionex CR-TC 600 is securely plugged in (see [Figure 66](#)).
2. If the pump stopped unexpectedly, follow the troubleshooting steps in “[Pump Stops](#)” on [page 145](#).

3. If the error message appears again, contact Technical Support for Dionex products for assistance. The Dionex CR-TC 600 control electronics may have malfunctioned.

Note The Dionex Integrion electronics components cannot be serviced by the user.

CR-TC short circuit

This error occurs when the current applied to the Dionex CR-TC 600 exceeds the maximum current allowed. (The Dionex CR-TC 600 current is automatically turned off to prevent damage to the Dionex CR-TC 600.) This error may also occur if liquid flow to the Dionex CR-TC 600 is interrupted.

To troubleshoot

1. Verify that the Dionex CR-TC 600 is securely plugged in (see [Figure 66](#)).

Figure 66. Dionex EGC and Dionex CR-TC 600 installed on top tray of Dionex Integrion

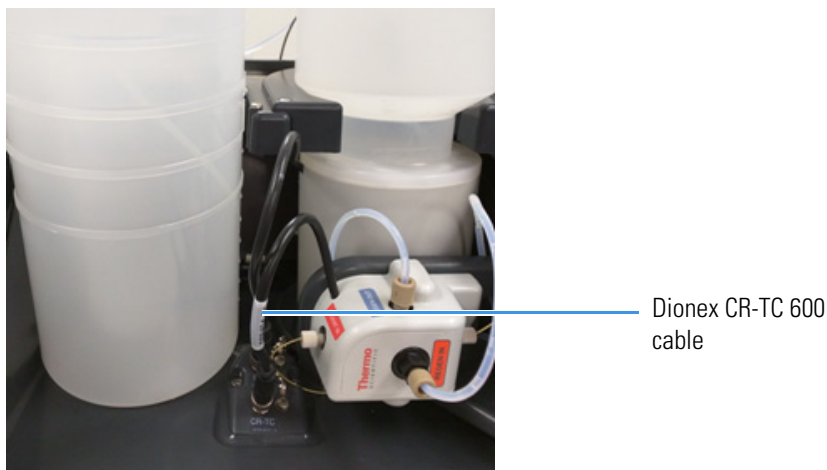

2. If the error message appears again, the Dionex CR-TC 600 may be faulty. Replace the column: Dionex CR-ATC 600 (P/N 088662) or Dionex CR-CTC 600 (P/N 088663). For instructions, see [“Replacing a Dionex CR-TC 600”](#) on [page 197](#).

CR-TC stopped due to flow rate

This error occurs when you turn off the pump flow while the Dionex EGC current (and Dionex CR-TC 600) are on. The Dionex CR-TC 600 current is automatically turned off to prevent damage to the Dionex CR-TC 600.

To troubleshoot

If the pump stops unexpectedly, follow the troubleshooting steps in [“Pump Stops”](#) on [page 145](#).

Detector compartment door opened

This error occurs when you open the detector compartment door during a run.

To troubleshoot

1. Verify that the door is fully closed.
2. Check for—and remove—any obstruction.
3. If the door is fully closed and the error persists, contact Technical Support for Dionex products for assistance.

Detector compartment exceeds safe temperature limit

This error occurs when the temperature of the detector compartment exceeds the maximum allowed. This error may occur if the system is operating in an environment in which the temperature is greater than 40 °C.

To troubleshoot

For environmental specifications, see [Appendix A, “Specifications.”](#)

Detector compartment memory reset to defaults

This error indicates a malfunction in the system electronics.

To troubleshoot

Contact Technical Support for Dionex products for assistance.

Note The Dionex Integriion electronics components cannot be serviced by the user.

Detector compartment temperature calibration error

This error occurs when the calibration values are out of range.

To troubleshoot

1. Repeat the calibration procedure. Follow the instructions provided in the Dionex Integriion Temperature Calibration Kit (P/N 22153-62043).
2. If the error message appears again, contact Technical Support for Dionex products for assistance.

Detector compartment temperature is lower than expected

This error occurs when the temperature of the detector compartment is below 2 °C.

To troubleshoot

1. Move the system to a warmer location. Make sure the ambient temperature is within the specifications listed in “[Physical Specifications](#)” on [page 224](#).
2. If the error message appears again, contact Technical Support for Dionex products for assistance.

Detector compartment temperature sensor error

This error indicates a malfunction in the system electronics.

To troubleshoot

Contact Technical Support for Dionex products for assistance.

Note The Dionex Integrion electronics components cannot be serviced by the user.

ED cell current exceeds limits

This error can have multiple causes (for example, a cell potential that is too high for a given salt concentration, a cell potential that is too high because the reference mode is incorrect, injection of excessive amounts of electroactive analytes, a damaged or incorrectly installed cell gasket, or an electrical short between two of the three electrodes).

To troubleshoot

1. Turn off the cell voltage. Excessive currents can change or even damage the working electrode.
2. Turn off the pump flow.
3. Disassemble the cell (see [page 207](#) for instructions) and check for evidence of liquid and salt bridges that can cause shorts. Rinse the cell surface and dry it with a clean, lint-free towel. Replace the cell gasket.
4. Verify that the correct electrode material, waveform potentials, and reference mode are selected for the application being run.
5. Restart the flow and select the DC amperometry mode. Apply cell potential in steps increasing toward the detection potential (the potential of the integration period in integrated amperometric detection). If the current becomes excessive again, try a new working electrode or another cell, if available.

! ED cell memory reset to defaults

This error occurs when there is an ED cell memory read/write failure.

❖ To troubleshoot

Contact Technical Support for Dionex products for assistance.

✘ ED cell off due to flow rate

This error occurs if the pump flow is turned off while the ED cell is on. The cell is automatically turned off to prevent damage to the cell.

❖ To troubleshoot

If the pump stopped unexpectedly, follow the troubleshooting steps in “[Pump Stops](#)” on [page 145](#).

✘ ED cell reference electrode disconnected

This error occurs when the ED cell reference electrode cable is disconnected from the detector electronics.

❖ To troubleshoot

Check the cable connection: Verify that the cable from the reference electrode is securely connected to the electrical connector on the detector (see [Figure 67](#)).

Figure 67. Detector compartment features (ED configuration)

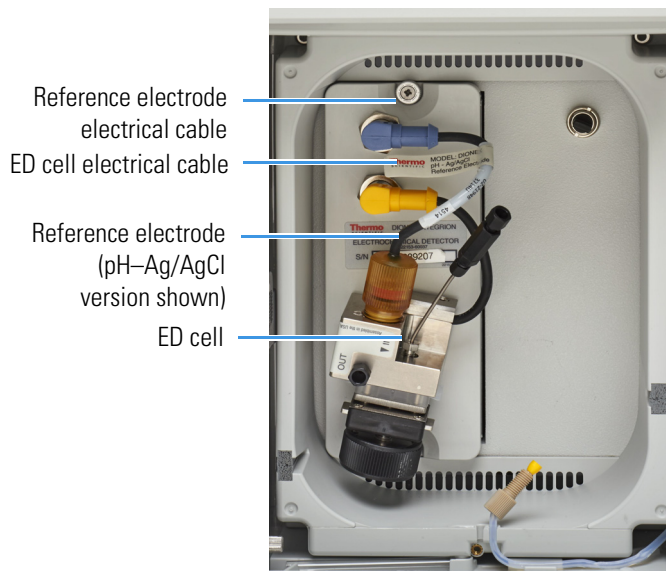

ED cell working electrode disconnected

This error occurs when the ED cell electrical cable is disconnected from the detector electronics.

To troubleshoot

Check the cable connection: Verify that the signal cable from the ED cell is securely connected to the electrical connector on the detector (see [Figure 67](#)).

ED pH offset calibration failed

This error occurs when the pH reading differs by more than 1.0 pH unit from 7.0, which is the value specified for offset calibration. This can be caused by too large a change in the Ag/AgCl reference potential or by a damaged glass membrane in the pH sensing part of the reference electrode

To troubleshoot

1. Check the buffer selection.
2. Verify that the electrode is properly immersed in the calibration buffer.
3. Repeat the calibration procedure (see [page 213](#) for instructions). If the error recurs, repeat the calibration at least one more time.
4. If the error recurs after repeating the calibration at least two times, replace the Ag/AgCl reference electrode (see [page 211](#) for instructions).

ED pH slope calibration failed

This error occurs when the pH-sensing glass membrane of the Ag/AgCl reference electrode is broken or otherwise affected, causing the calibration slope to deviate by more than $\pm 10\%$ from the theoretical slope of 59 mV/pH unit at 25 °C.

To troubleshoot

1. Make sure the calibration temperature is as close as possible to 25 °C.
2. Verify that the correct buffer is being used and that the electrode is properly immersed in the calibration buffer.
3. Repeat the calibration procedure (see [page 213](#) for instructions). If the error recurs, repeat the calibration at least one more time.
4. If the error recurs after repeating the calibration at least two times, replace the Ag/AgCl reference electrode (see [page 211](#) for instructions).

Note The following error is applicable to EG, EG2 and EG3 consumable inventory cable access:

EG cartridge disconnected

This error occurs when the Dionex EGC is disconnected from the eluent generator electronics.

To troubleshoot

1. Verify that the Dionex EGC cable is securely plugged in (see [Figure 66](#)).
2. If the error message appears again, contact Technical Support for Dionex products for assistance. The Dionex EGC control electronics may have malfunctioned.

Note The Dionex Integrion electronics components cannot be serviced by the user.

EG consumable inventory cable access error

This error occurs when the Dionex Integrion firmware is unable to read the memory in the Dionex EGC consumable inventory cable.

To troubleshoot

1. Unplug the Dionex EG cartridge cable from the **EGC** connector on the front tray. Wait for a few seconds, and then plug in the cable again.
2. If the error message appears again, replace the cartridge.
3. If the error message appears again, contact Technical Support for Dionex products.

Note The following errors are applicable to EG, EG2, and EG3:

EG consumable inventory cable memory reset to defaults

This error occurs when the Dionex Integrion firmware is unable to read the memory in the Dionex EGC consumable inventory cable.

To troubleshoot

1. Unplug the Dionex EG cartridge cable from the **EGC** connector on the front tray. Wait for a few seconds, and then plug in the cable again.
2. If the error message appears again, replace the cartridge.
3. If the error message appears again, contact Technical Support for Dionex products.

EG invalid activation date

This error occurs if the activation date for the Dionex EGC is not a valid date. This may indicate a problem with the memory chip in the Dionex EGC.

To troubleshoot

1. Verify that the Dionex EGC cable is securely plugged in (see [Figure 66](#)).
2. If the error message appears again, contact Technical Support for Dionex products for assistance.

EG invalid concentration

This error occurs if the eluent concentration is outside the range allowed by the EG. This may indicate corrupted memory or a problem in the instrument control firmware.

To troubleshoot

Contact Technical Support for Dionex products for assistance.

Note The Dionex Integrion electronics components and instrument control firmware cannot be serviced by the user.

EG invalid flow rate

This error occurs if the flow rate is set to a value the EG does not support. This error also occurs if the pump flow is turned off while the Dionex EGC is on. The Dionex EGC is automatically turned off to prevent damage to the cell.

To troubleshoot

1. Set the flow rate to a value within the allowed range. For the allowed flow rate range, see [Appendix A, “Specifications.”](#)
2. If the pump stopped unexpectedly, follow the troubleshooting steps in [“Pump Stops”](#) on [page 145](#).

EG invalid ion count

This error occurs if the ion count reported by the Dionex EGC is invalid. This may indicate a problem with the memory chip in the Dionex EGC.

To troubleshoot

1. Verify that the Dionex EGC cable is securely plugged in (see [Figure 66](#)).
2. If the error message appears again, contact Technical Support for Dionex products for assistance.

EG invalid serial number

This error occurs if the serial number reported by the Dionex EGC is invalid. This may indicate a problem with the memory chip in the Dionex EGC.

To troubleshoot

1. Verify that the Dionex EGC cable is securely plugged in (see [Figure 66](#)).
2. If the error message appears again, contact Technical Support for Dionex products for assistance.

EG over current

This error occurs when the current applied to the Dionex EGC exceeds the maximum current allowed. (The Dionex EGC current is automatically turned off to prevent damage to the cartridge.) This error may also occur if the liquid flow to the cartridge is interrupted.

To troubleshoot

1. Verify that the Dionex EGC cable is securely plugged in (see [Figure 66](#)).
2. To determine why liquid flow stopped, see “[Pump Stops](#)” on [page 145](#).
3. If the error message appears again, contact Technical Support for Dionex products for assistance. The EG control electronics may have malfunctioned.

Note The Dionex Integriion electronics components cannot be serviced by the user.

EGC over power

This error occurs when, in order to maintain the selected current, the power supply is required to supply a higher voltage than the Dionex EGC can support.

To troubleshoot

Replace the Dionex EGC (see [page 193](#)).

EGC over voltage

This error occurs when the current applied to the Dionex EGC exceeds the maximum current allowed. (The Dionex EGC current is automatically turned off to prevent damage to the cartridge.) This error may also occur if the liquid flow to the cartridge is interrupted.

To troubleshoot

1. To determine why liquid flow stopped, see “[Pump Stops](#)” on [page 145](#).
2. If the error message appears again, contact Technical Support for Dionex products for assistance. The Dionex EGC control electronics may have malfunctioned.

Note The Dionex Integrion electronics components cannot be serviced by the user.

 **EG wrong cartridge type**

This error occurs when a Dionex EGC that is not supported by the Dionex Integrion is plugged into the EG.

❖ **To troubleshoot**

See [Table 7](#) for a list of the Dionex EGC types that can be used with the Dionex Integrion.

 **Excessive drive current. Camshaft x.x.**

This error occurs if the drive current is above the allowed value. When this message appears, the pump stops running.

❖ **To troubleshoot**

One or more tubing connections may be plugged, blocked, or crimped. Check all tubing connections and replace as needed (see [“Replacing Tubing and Fittings”](#) on [page 178](#)). Be careful not to overtighten fittings.

 **Flash memory reset to defaults**

This error indicates a malfunction in the system electronics.

❖ **To troubleshoot**

Contact Technical Support for Dionex products for assistance.

Note The Dionex Integrion electronics components cannot be serviced by the user.

 **High-pressure valve busy**

This error occurs when the high-pressure valve receives a command before it has completed the action required by a previous command.

❖ **To troubleshoot**

Wait until the previous action has been completed, and then retry.

High-pressure valve failed to reach commanded position

This error occurs if an optional high-pressure valve fails to switch position within 1 second of being toggled.

To troubleshoot

1. If a sequence is being executed, terminate the sequence by selecting **Stop** on the Chromeleon ePanel.
2. Flip the power switch on the rear panel to turn off the system power and then flip the switch again to turn on the power.
3. If the optional mobile app is installed, try to toggle the valve from position on the mobile app Valves page.
4. If the problem persists, contact Technical Support for Dionex products for assistance.

Incompatible CD detector installed

Incompatible ED detector installed

This error occurs when a detector that is not supported by the Dionex Integrion is installed.

To troubleshoot

Replace the detector with the appropriate Dionex Integrion product (see [“Reordering Information”](#) on page 225).

Internal hardware failure

This error indicates an internal communication failure.

To troubleshoot

Contact Technical Support for Dionex products for assistance.

Invalid flow value

This error occurs when you attempt to select a flow rate that is outside the valid flow rate range.

To troubleshoot

Enter a valid flow rate (see [“Specifications”](#) on page 221).

 **Leak detected. Flow stopped.**

This error occurs when the leak sensor detects a liquid leak inside the enclosure. When this error occurs, the pump stops running.

❖ **To troubleshoot**

See “[Liquid Leaks](#)” on [page 138](#).

 **Leak sensor wet**

This error occurs when liquid accumulates in the drip tray below the detector compartment.

❖ **To troubleshoot**

See “[Liquid Leaks](#)” on [page 138](#).

 **Load/Inject valve failed to reach commanded position**

This error occurs if the injection valve installed in the column compartment fails to switch position within 1 second of being toggled.

❖ **To troubleshoot**

1. If a sequence is being executed, terminate the sequence by selecting Stop on the Chromeleon ePanel.
2. Flip the power switch on the rear panel to turn off the system power and then flip the switch again to turn on the power.
3. Try to toggle the valve from Load to Inject by pressing the **Load** and **Inject** buttons on the mobile app Home page.
4. If the problem persists, contact Technical Support for Dionex products for assistance.

 **Load/Inject valve busy**

This error occurs if the injection valve has not yet completed the required action.

❖ **To troubleshoot**

Wait until the previous action has been completed, and then retry.

Motor malfunction

This error occurs when there is an internal error in the pump drive mechanism.

To troubleshoot

1. Turn off the pump power for 30 seconds and then turn it on again.
2. If the error message appears again, contact Technical Support for Dionex products for assistance.

Motor position error. The motor is overloaded.

This error occurs if the pump motor is overloaded.

To troubleshoot

1. One or more tubing connections may be plugged or blocked. Check all tubing connections and replace as needed (see “[Replacing Tubing and Fittings](#)” on [page 178](#)). Be careful not to overtighten fittings.
2. If the “Upper pressure limit exceeded” message is also displayed, see [page 136](#) for additional troubleshooting steps.

No RFID labels found

This error occurs if no RFID-enabled consumables are detected.

To troubleshoot

1. If no RFID-enabled consumables are installed, you may disregard the message.
2. If RFID-enabled consumables are installed:
 - a. Check the orientation of all the RFID labels on the installed consumable products. Labels should be free in the air (not wrapped around a column or caught behind something).
 - b. Initiate a manual rescan.
 - For Chromeleon operation: Click **Rescan** in the Consumables Inventory window. (If an RFID consumable is not currently being tracked, the button label is **Track and Get Details**). Refer to the Chromeleon Help for details.
 - For mobile app operation: Tap the **Rescan** button on the Consumables page.

Pressure fallen below lower limit

This error occurs when the pump pressure falls below the low pressure limit specified in Chromeleon.

To troubleshoot

See [“Low or Decreasing System Backpressure”](#) on page 140.

Pump is unlinked from Integrion

This error occurs when the pump and the Dionex Integrion are not configured in the same Chromeleon instrument.

To troubleshoot

In the Instrument Configuration Manager, configure the pump driver (called Integrion HPIC Pump (Wellness)) in the same instrument as the Dionex Integrion. For details, refer to the Chromeleon Help.

RFID label 1–label 10 read/write failed: check label orientation

The label number corresponds to the number of the consumable product listed in the Consumables Inventory window in Chromeleon or on the Consumables page in the mobile app.

To troubleshoot

1. Check the orientation of the RFID label on the corresponding consumable product. The label should be free in the air (not wrapped around a column or caught behind something).
2. If the error message appears again, replace the consumable product.

RFID label read failed: check label orientation

To troubleshoot

1. Check the orientation of all the RFID labels on the installed consumable products. Labels should be free in the air (not wrapped around a column or caught behind something).
2. If the error message appears again, contact Technical Support for Dionex products for assistance.

RFID label write failed: check label orientation

To troubleshoot

1. Check the orientation of all the RFID labels on the installed consumable products. Labels should be free in the air (not wrapped around a column or caught behind something).
2. If the error message appears again, contact Technical Support for Dionex products for assistance.

RFID product type not recognized

This error occurs when the Dionex Integrion cannot identify a particular RFID consumable.

To troubleshoot

1. Initiate a manual rescan.
 - For Chromeleon operation: Click **Rescan** in the Consumables Inventory window. (If an RFID consumable is not currently being tracked, the button label is **Track and Get Details**). Refer to the Chromeleon Help for details.
 - For mobile app operation: Tap the **Rescan** button on the Consumables page.
2. If the error message appears again, it may be necessary to upgrade the firmware version installed in the Dionex Integrion. Contact Technical Support for Dionex products for assistance.
3. If the error message appears again, replace the consumable.

Right-hand pump block carryover pressure is too high

This error occurs if the pressure in the primary pump head exceeds the maximum allowed.

To troubleshoot

1. Make sure that the tubing between the pump heads and the tubing leading to the priming/outlet block is not plugged or blocked. Replace tubing connections as needed (see [“Replacing Tubing and Fittings”](#) on [page 178](#)). Be careful not to overtighten fittings.
2. Inspect the outlet check valve for blockage. Replace the check valve cartridge if needed (see [“Replacing Pump Check Valves”](#) on [page 183](#)).

Suppressor not installed

This error occurs when the suppressor is on, but no suppressor is detected.

To troubleshoot

Verify that the suppressor is installed correctly.

Suppressor over current

This error may be caused by a depleted or dirty suppressor, or by a malfunction in the suppressor controller electronics.

To troubleshoot

1. Follow the instructions in the suppressor manual to regenerate the suppressor. Suppressor manuals are provided on the Thermo Scientific Reference Library DVD (P/N 60-053891).
2. Follow the instructions in the suppressor manual to clean the suppressor.
3. If you suspect a malfunction in the suppressor controller, contact Technical Support for Dionex products for assistance.

Note The Dionex Integrion electronics components cannot be serviced by the user.

Suppressor over power

This error appears when, in order to maintain the selected current, the Dionex Integrion is required to apply a higher voltage than the suppressor can support.

To troubleshoot

1. Reduce the flow rate.
2. Rehydrate the suppressor. Refer to the suppressor manual for instructions. Suppressor manuals are provided on the Thermo Scientific Reference Library DVD (P/N 60-053891).
3. If the error persists, replace the suppressor (see [“Replacing a Suppressor”](#) on page 204).

Suppressor over voltage

This error appears if you turn on the suppressor and the system cannot establish a connection with the suppressor.

To troubleshoot

1. Check the suppressor cable connection.
2. If the error persists, replace the suppressor (see [“Replacing a Suppressor”](#) on page 204).

! Suppressor stopped due to flow rate

This message occurs if the pump flow stops while the suppressor is on. The suppressor is automatically turned off to prevent damage to the suppressor.

❖ **To troubleshoot**

If the pump stopped unexpectedly, see the troubleshooting steps in “[Pump Stops](#)” on [page 145](#).

! Suppressor type has changed

This error occurs when the selected suppressor type is not appropriate for the Dionex EGC.

❖ **To troubleshoot**

For Dionex EGC KOH, select the AERS suppressor. For Dionex EGC MSA, select the CERS suppressor.

✘ The maximum purge pressure was exceeded

If the pump pressure exceeds 5 MPa (725 psi) during priming, this error occurs and the priming process is aborted.

❖ **To troubleshoot**

1. Verify that the priming valve is open. (To open the valve, turn the knob one-half turn counterclockwise.)
2. Check fittings for overtightening. Check tubing for crimping, and replace it as needed (see “[Replacing Tubing and Fittings](#)” on [page 178](#)). Be careful not to overtighten fittings.

✘ The pressure in the right-hand working cylinder exceeded the safety limit

✘ The system pressure exceeded the safety limit

This error may be caused by a blockage in the system or by a problem with the column.

❖ **To troubleshoot**

1. Check all tubing connections for signs of blockage; replace as needed (see “[Replacing Tubing and Fittings](#)” on [page 178](#)). Be careful not to overtighten fittings.
2. To determine the source of the high backpressure, isolate segments of the flow path:
 - a. Remove the pump outlet tubing at the injection valve.
 - b. Turn on the pump.
 - c. On the Chromeleon ePanel Set, set the flow rate to 1.0 mL/min. Record the backpressure.

- d. Disconnect all components after the injection valve.
 - e. One at a time, reconnect each component of the flow path. If reconnecting a component causes an abnormal increase in backpressure, replace the component. Replace as many components as necessary to resume operation at the standard operating backpressure.
3. As columns age, their backpressure increases. It may be necessary to compensate for this by increasing the high pressure limit. If the column is the source of the high backpressure, clean the column. (Refer to the column manual provided on the Thermo Scientific Reference Library DVD (P/N 60-053891) for instructions.) If this does not eliminate the problem, replace the column.
 4. Observe a run to see whether the high pressure limit is triggered when injection occurs; if it is, the injection valve may be the source of the blockage (the rotor seal or stator may need to be replaced). Contact Technical Support for Dionex products for assistance.

 **This function cannot be adjusted by the user**

This error occurs if you attempt to change a pump parameter that users are not allowed to adjust.

❖ **To troubleshoot**

Only qualified personnel can change this parameter. Contact Technical Support for Dionex products for assistance.

 **Upper pressure limit exceeded**

This error occurs if the upper pressure limit specified in the Chromeleon instrument method is exceeded. The running queue is aborted (default) and this message appears.

❖ **To troubleshoot**

1. Check all tubing connections for signs of blockage; replace as needed (see [“Replacing Tubing and Fittings”](#) on [page 178](#)). Be careful not to overtighten fittings.
2. To determine the source of the high backpressure, isolate segments of the flow path:
 - a. Remove the pump outlet tubing at the injection valve.
 - b. Turn on the pump.
 - c. On the Chromeleon ePanel Set, set the flow rate to 1.0 mL/min. Record the backpressure.
 - d. Disconnect all components after the injection valve.
 - e. One at a time, reconnect each component of the flow path. If reconnecting a component causes an abnormal increase in backpressure, replace the component. Replace as many components as necessary to resume operation at the standard operating backpressure.

3. As columns age, their backpressure increases. It may be necessary to compensate for this by increasing the high pressure limit. If the column is the source of the high backpressure, clean the column. (Refer to the column manual provided on the Thermo Scientific Reference Library DVD (P/N 60-053891) for instructions.) If this does not eliminate the problem, replace the column.
4. Observe a run to see whether the high pressure limit is triggered when injection occurs; if it is, the injection valve may be the source of the blockage (the rotor seal or stator may need to be replaced). Contact Technical Support for Dionex products for assistance.

! Wrong device connected to connector A

This error occurs when any device other than a suppressor is connected to connector A in the Dionex Integrion.

❖ To troubleshoot

Remove the device connected to connector A. Reconnect the device to one of the other connectors.

Troubleshooting System Component Symptoms

Table 15 lists symptoms related to problems with system components that may occur during operation of the Dionex Integrion.

Table 15. System component symptoms

Symptom category	Symptom	See
Software	No Communication with Chromeleon	page 138
Leaks	Liquid Leaks	page 138
Pressure	Low or Decreasing System Backpressure	page 140
	High or Increasing System Backpressure	page 142
	Unstable System Backpressure	page 144
Pump	Pump Does Not Start	page 145
	Pump Stops	page 145
Degas	Degas Vacuum Pump Low Vacuum	page 145
	Degas Vacuum Pump Does Not Run	page 146
EG	EG Stops Operation	page 146
ED	ED Cell pH Readouts Incorrect	page 147

No Communication with Chromeleon

Possible cause	Solution
Incorrect USB connections	Check the USB connections. The Dionex Integrion should be connected by a USB cable to the PC on which Chromeleon is installed. For USB connection instructions, refer to <i>Dionex Integrion HPIC System Installation Instructions</i> .
System not configured in Chromeleon	Verify that the system is configured in Chromeleon and is assigned to an instrument. For Chromeleon configuration instructions, refer to <i>Dionex Integrion HPIC System Installation Instructions</i> or to the Chromeleon Help.
Microsoft Windows power management option turned off power to USB devices in the system	When the power management option is enabled, the PC automatically turns off power to USB devices that are idle. For instructions on how to disable the option, refer to <i>Dionex Integrion HPIC System Installation Instructions</i> .

Liquid Leaks

Note After eliminating the source of a leak, always dry the drip tray and the leak sensor thoroughly. If the leak sensor is not dry, it will remain activated and will continue to report a leak to the Chromeleon audit trail.

❖ To troubleshoot

1. Locate the source of the leak by visually inspecting the tubing, fittings, and components. To check for smaller leaks, you can use a paper towel or KIMWIPE™ to dab fittings.
2. Make sure liquid lines are not crimped or otherwise blocked. Make sure waste lines are not elevated at any point after they exit the system. If a line is blocked, replace it (see “Replacing Tubing and Fittings” on page 178).
3. See the sections below for specific troubleshooting information for various components.

Source of leak	Solution
Fitting or broken liquid line	Tighten the fitting, or replace the tubing and fittings as required (see “Replacing Tubing and Fittings” on page 178).

Source of leak	Solution
Bottom seal wash tube (when tubing is not installed)	<p>Liquid dripping from the bottom seal wash tube indicates a defective pump seal. Replace the pump seals:</p> <ul style="list-style-type: none"> – Main seal (P/N 075768) – Seal wash seal (P/N 063382) – O-ring (P/N 040695) <p>For replacement instructions, see “Replacing Pump Seals” on page 185.</p>
Check valve	<ol style="list-style-type: none"> 1. Follow the instructions below to tighten the check valves: <ol style="list-style-type: none"> a. Turn off the pump. b. Loosen the check valve enough to allow it to turn freely. c. Tighten the check valve fingertight, and then tighten it one-quarter turn using a 1/2-inch wrench. d. If the check valve continues to leak, tighten it an additional one-quarter turn using the 1/2-inch wrench. 2. If the leaking check valve is securely tightened but allows leaks despite this, the valve is defective. Replace both check valves: <ul style="list-style-type: none"> – Inlet check valve assembly (P/N 045722) – Outlet check valve assembly (P/N 045721) <p>For replacement instructions, see “Replacing Pump Check Valves” on page 183.</p>
Dionex EGC	<p>Replace the Dionex EGC (see “Replacing a Dionex EGC” on page 193).</p>
Priming valve knob	<ol style="list-style-type: none"> 1. If the knob leaks when open, close the knob <i>completely</i> and then open it one-half to three-quarters turn. If the leak still occurs, replace the seal (see “Replacing the Seal on the Pump Priming Valve Knob” on page 192). 2. If the knob leaks when closed, replace the seal. 3. If the leak still occurs, either the pump head or the knob is damaged and should be replaced. Contact Technical Support for Dionex products for assistance.

Source of leak	Solution
High-pressure valve	<ol style="list-style-type: none"> 1. Verify that the liquid line connections to the valve are tight. Replace any damaged fittings (see “Replacing Tubing and Fittings” on page 178). 2. If the leak is from behind the valve stator, the rotor seal may be scratched. Rebuild the valve: <ul style="list-style-type: none"> – 4-port Valve Rebuild Kit (P/N 074698) – 6-port Valve Rebuild Kit (P/N 075973) – 10-port Valve Rebuild Kit (P/N 079054) <p>For replacement instructions, see “Rebuilding a High-Pressure Valve” on page 199.</p>
Detector cell	<ol style="list-style-type: none"> 1. Check the waste lines for blockage; trapped particles can plug the lines and cause a restriction and/or leak. If necessary, clear the waste lines by reversing the direction of flow. 2. Verify that the plumbing downstream from the cell is clear; a blockage may overpressurize the cell and cause it to leak. To isolate the cause of the blockage, see “To isolate a restriction by working forward through the system” on page 142. 3. If the problem continues, contact Technical Support for Dionex products for assistance.
Suppressor	<ol style="list-style-type: none"> 1. Verify that the plumbing downstream from the suppressor is clear; a blockage may overpressurize the suppressor and cause it to leak. To isolate the cause of the blockage, see “To isolate a restriction by working forward through the system” on page 142. 2. If the suppressor continues to leak when operated within the proper backpressure range, it must be replaced (see “Replacing a Suppressor” on page 204). 3. Refer to the suppressor manual for operating pressure guidelines and for additional troubleshooting information.

Low or Decreasing System Backpressure

Possible cause	Solution
Leak in the system flow path	To determine the source of the leak, see “Liquid Leaks” on page 138.
Eluent supply depleted	Check the eluent reservoir and refill it if needed. Prime the pump before resuming operation (see “Priming the Pump” on page 50).

Possible cause	Solution
Air in eluent line	Check the eluent line for air bubbles. If air is trapped in the line, replace the end-line filter (P/N 045987). Verify that the end of the line extends to the bottom of the reservoir and the filter is submerged in eluent. Prime the pump.
Eluent insufficiently degassed	If the optional eluent degas vacuum pump is installed, verify that the pump is turned on. The vacuum pump can be controlled from the pump ePanel in Chromeleon or the mobile app Pump page.
Loose fitting	Check tubing connections throughout the system (including the check valves, injection valves, and columns) and tighten or replace fittings as needed (see “Replacing Tubing and Fittings” on page 178).
Pump priming valve open	To close the valve, turn the knob clockwise until closed. Tighten no more than fingertight.
Column temperature too high	<ol style="list-style-type: none"> 1. Check the temperature setpoint of the column compartment. 2. If the compartment is set at the correct temperature and the reading is stable, use an external temperature probe to measure the temperature. If the reading does not match the temperature reported by the system, the column compartment heater may need to be replaced. Contact Technical Support for Dionex products for assistance.
Detector compartment temperature too high	<ol style="list-style-type: none"> 1. Check the temperature of the detector compartment. 2. If the compartment is set at the correct temperature and the reading is stable, use an external temperature probe to measure the temperature. If the reading does not match the temperature reported by the system, the compartment heater may need to be replaced. Contact Technical Support for Dionex products for assistance.
Defective pump check valve	Replace the check valves (see page 183).
Internal Dionex EGC leak (from membrane barrier)	Leakage from the membrane barrier may trip the pump low pressure limit and shut down the pump. If all other causes of the low system pressure have been eliminated, replace the Dionex EGC (see “Replacing a Dionex EGC” on page 193).

Note The leak sensor cannot immediately detect leakage from the membrane barrier, as these leaks exit through the Dionex EGC vent line.

High or Increasing System Backpressure

Possible cause	Solution
Restriction in the system plumbing	<ol style="list-style-type: none"> 1. If the pump pressure limit was tripped, isolate the restriction by working forward through the system, adding parts one at a time until an abnormal pressure increase (and hence, the restriction) is found. For instructions, see “To isolate a restriction by working forward through the system” on page 142. 2. If the pump pressure limit was not tripped, you can isolate the restriction by working backward through the system. For instructions, see “To isolate a restriction by working backward through the system” on page 143. 3. Correct the restriction (see “Correcting Restrictions” on page 143).
Sample precipitating in or adsorbing to the column	<ol style="list-style-type: none"> 1. Filter the sample. 2. Dilute the sample. 3. Run the sample through an OnGuard cartridge or an InGuard cartridge.
Mismatched eluent or organic solvent	Refer to the column manual for the correct eluent or solvent for your application.
Column temperature too low	<ol style="list-style-type: none"> 1. Make sure the column is installed correctly on the column clips and the column compartment door is closed completely. 2. Check the temperature setpoint of the column compartment. 3. If the compartment is set at the correct temperature and the reading is stable, use an external temperature probe to measure the temperature. If the reading does not match the temperature reported by the system, the column compartment heater may need to be replaced. Contact Technical Support for Dionex products for assistance.

❖ To isolate a restriction by working forward through the system

1. Remove the pump outlet tubing at the injection valve.
2. Set the flow rate to 1.0 mL/min, start the pump flow, and record the backpressure.
3. Disconnect all components after the injection valve.
4. One at a time, reconnect each component of the flow path. Refer to the flow schematic on the inside door of your system or to the following figures:
 - For conductivity detection, see [Figure 19](#) or [Figure 20](#) (if an EG is installed).

- For electrochemical detection, see [Figure 21](#).
5. The connection at which the pressure increases abnormally indicates the point of restriction (see [“Correcting Restrictions”](#) on [page 143](#)).

❖ **To isolate a restriction by working backward through the system**

1. Begin pumping eluent through the system (including the columns) at the flow rate normally used.
2. Work backward through the system, beginning at the flow cell exit. One at a time, loosen each fitting and observe the pressure. Refer to the flow schematic on the inside door of your system, or to the following figures:
 - For conductivity detection, see [Figure 19](#) (system without an EG), [Figure 20](#) (cation system with an EG), or [Figure 21](#) (anion system with an EG).
 - For electrochemical detection, see [Figure 22](#).
3. The connection at which the pressure drops abnormally indicates the point of restriction (see [“Correcting Restrictions”](#) on [page 143](#)).

Correcting Restrictions

Source of restriction	Solution
Tubing or fitting	Back flush or replace the tubing or fitting (see “Replacing Tubing and Fittings” on page 178). Be careful not to overtighten fittings.
Column	<p>Replace the column inlet bed support or clean the column. For instructions, refer to the column manual provided on the Thermo Scientific Reference Library DVD (P/N 60-053891).</p> <p>If sample precipitation adsorbing onto the column is suspected, filter or dilute the sample, or run the sample through an OnGuard cartridge or InGuard cartridge.</p>
Injection valve	If the injection valve is the suspected source of the high backpressure, observe a run to see whether the high pressure limit is triggered when injection occurs; if it is, the injection valve rotor seal or stator may need to be replaced (see “Rebuilding a High-Pressure Valve” on page 199).
Dionex EGC III	Replace the outlet frit as instructed in the Dionex EGC manual. The manual is provided on the Thermo Scientific Reference Library DVD (P/N 60-053891).

Unstable System Backpressure

Possible cause	Solution
Pump insufficiently primed	Prime the pump (see “Priming the Pump” on page 50).
Insufficient backpressure on the EG degasser	Verify that there is 14 MPa (2000 psi) of backpressure on the EG. Add additional backpressure coils if needed.
Pump component problem	<p>A worn or damaged pump component can often be identified by a cyclic pattern in pressure readings.</p> <ul style="list-style-type: none"> • Replace the pump check valves (see “Replacing Pump Check Valves” on page 183). • Replace the pump seals (see “Replacing Pump Seals” on page 185). <p>4. Contact Technical Support for Dionex products for assistance.</p>
Unstable column temperature	<ul style="list-style-type: none"> • Check the temperature setpoint of the column compartment; verify that the temperature is stable. • Verify that the column is installed correctly on the column clips and the column compartment door is closed completely.
Clogged injection valve	<p>A clogged injection valve may cause unstable pressure whenever the valve position is switched.</p> <p>If the injection valve is the suspected source of the unstable backpressure, the injection valve rotor seal or stator may need to be replaced (see “Rebuilding a High-Pressure Valve” on page 199).</p>

Pump Does Not Start

Possible cause	Solution
Flow rate is set to zero	<ol style="list-style-type: none"> 1. Select a flow rate on the Chromeleon ePanel or the mobile app Home page. 2. Verify that a flow rate is set in the Chromeleon instrument method.
While being primed, pump starts briefly and an alarm occurs	<ol style="list-style-type: none"> 1. If the high pressure limit was tripped, see the troubleshooting steps for “High or Increasing System Backpressure” on page 142. 2. If the low pressure limit was tripped, see the troubleshooting steps for “Low or Decreasing System Backpressure” on page 140 3. If a leak was detected, see the troubleshooting steps for “Liquid Leaks” on page 138. 4. If another Chromeleon audit trail error message is displayed, see the troubleshooting steps listed for the particular message.

Pump Stops

Possible cause	Solution
Instrument method or TTL input instructed the pump to stop	If no error message is displayed in the Chromeleon audit trail, the pump was probably instructed to stop by a command in the Chromeleon instrument method or by a TTL signal from a remote device. If you do not want the pump to stop, edit the instrument method or change the settings of the remote TTL signal source.
Low pressure limit was tripped	See the troubleshooting steps for “Low or Decreasing System Backpressure” on page 140.
High pressure limit was tripped	See the troubleshooting steps for “High or Increasing System Backpressure” on page 142.

Degas Vacuum Pump Low Vacuum

Possible cause	Solution
Leak in the vacuum degas module	Check all tubing connections for leakage; tighten loose fitting connections (see “Fitting and Tube Connection Guidelines” on page 180).

Degas Vacuum Pump Does Not Run

Possible cause	Solution
Degas option disabled	<ol style="list-style-type: none"> 1. Open the Chromeleon Instrument Configuration Manager, right-click the Dionex Integrion HPIC System device in the instrument, and select Properties. 2. Click the Options tab and verify that the Pump_Degas check box is selected. <p>–or–</p> <p>On the mobile app Pump page, verify that the vacuum pump is enabled.</p>
Electrical connections incorrectly installed	There may be a problem with the connections from the degas vacuum pump to the CPU board. Contact Technical Support for Dionex products for assistance. The Dionex Integrion electronics components cannot be serviced by the user.

EG Stops Operation

Possible cause	Solution
Pump flow is off	Turning off the pump automatically turns off the EG and the suppressor. If the pump stopped unexpectedly, see the troubleshooting steps in “ Pump Stops ” on page 145 .
Pump flow rate is too low or too high	Select a flow rate supported by the EG. The pump flow rate range is 0.001 to 10.0 mL/min (or up to 22 mL if high flow rate pump heads are installed); however, when an EG is installed, the allowed range is 0.1 to 3.00 mL/min. The recommended operating range is 0.25 to 2.00 mL/min.
Electrical error detected	To prevent damage to the Dionex EGCs, the pump automatically turns off electrical power to the cartridge when excessive current or voltage is detected. Contact Technical Support for Dionex products for assistance. The Dionex Integrion electronics components cannot be serviced by the user.
Dionex EGC is expended	Replace the cartridge (see “ Replacing a Dionex EGC ” on page 193).

ED Cell pH Readouts Incorrect

ED cell pH readout always 7.0

Possible cause	Solution
Disconnected pH-Ag/AgCl reference electrode	Verify that the electrode cable is securely connected.
pH-Ag/AgCl reference electrode short circuit or a broken or cracked glass membrane	Replace the electrode (see page 211).

Cannot set ED cell pH readout to 7.0

Possible cause	Solution
Inaccurate calibration buffer	Use a pH meter to check the pH of the buffer.
Dry pH-Ag/AgCl reference electrode	<ol style="list-style-type: none"> 1. Regenerate the electrode to restore the potential (see page 148). 2. If regenerating does not restore the electrode potential, replace the electrode (see page 211).

Shift in ED cell pH readout

A shift is indicated if the pH readout is 0.5 pH units or more different from when the electrode was new.

Possible cause	Solution
Faulty pH-Ag/AgCl reference electrode	<ol style="list-style-type: none"> 1. Regenerate the electrode (see page 148). 2. If regenerating the electrode does not remove the shift, replace the electrode (see page 211).

No ED cell pH readout or intermittent readout

Possible cause	Solution
PdH reference electrode selected	Select the AgCl reference electrode mode on the ED ePanel in Chromeleon, the Chromeleon instrument method, or the mobile app Home page.
Disconnected reference electrode	Verify that the reference electrode cable is securely connected.
Uncalibrated pH-Ag/AgCl reference electrode	Calibrate the electrode (see page 213).

Possible cause	Solution
Dry pH-Ag/AgCl reference electrode	<ol style="list-style-type: none"> 1. Regenerate the electrode (see page 148). 2. If regenerating the electrode does not eliminate the problem, replace the electrode (see page 211).
Contaminated pH-Ag/AgCl reference electrode	Replace the electrode (see page 211).

Shift in ED Ag/AgCl reference potential

Possible cause	Solution
Faulty pH-Ag/AgCl reference electrode	<ol style="list-style-type: none"> 1. Regenerate the electrode (see page 148). 2. If regenerating the electrode does not eliminate the problem, replace the electrode (see page 211).

Regenerating the pH-Ag/AgCl Reference Electrode

Soak the pH-Ag/AgCl reference electrode in a solution containing 1 M KCl and 1 M HCl long enough to restore the electrode potential to <30 mV when compared to an unexposed Ag/AgCl reference electrode. To test the electrode potential, see “[Testing the pH-Ag/AgCl Reference Electrode Potential](#)” on [page 148](#).

Note To prevent a pH-Ag/AgCl reference electrode from drying out, make sure that eluent is being pumped continuously through the cell. If the cell will not be used for a short time (less than 2 days), disconnect the tubing from the inlet and outlet fittings and install fitting plugs. For longer shutdowns, see “[ED Cell Storage](#)” on [page 57](#).

Testing the pH-Ag/AgCl Reference Electrode Potential

A shift in reference potential causes a shift in the effective potential applied to the working electrode. For example, when using an electrode with a shift of 50 mV, an applied potential of 0.1 V, is equivalent to an applied potential of 0.15 V for a new pH-Ag/AgCl reference electrode with no shift. Follow the steps below to measure the pH-Ag/AgCl reference electrode potential shift.

Items needed

- An unexposed electrode. A spare pH-Ag/AgCl reference electrode (P/N 061879) stored in 3 M KCl can be kept on hand for this purpose.
- Digital voltmeter

❖ To determine a reference potential shift

1. For each pH-Ag/AgCl reference electrode (the unexposed electrode and the electrode being tested), use a straightened paper clip or short piece of wire of a suitable diameter to

connect the voltmeter's voltage inputs to pin 1 on the reference electrode's cable connector.

To identify the cable connector pins, refer to *Product Information Update for the Electrochemical Detector (PIU_ED_1)*. The document is provided on the Thermo Scientific Reference Library DVD (P/N 60-053891).

2. Immerse both electrodes in a solution of 0.1 M KCl.
3. Read the potential difference (in mV) between the unexposed electrode and the electrode being tested. If it is greater than 30 mV, try regenerating the electrode by soaking it in a solution containing 1 M KCl and 1 M HCl. If this does not reduce the potential shift, replace the electrode (see [page 211](#)).

Troubleshooting Chromatogram Symptoms

Note An interactive troubleshooting guide is available in Chromeleon. To access the guide, click  **Troubleshooting and Diagnostics** on the toolbar above the ePanel Set and select **Pump_ECD Troubleshooting**.

[Table 15](#) lists chromatogram symptoms that may occur during operation of the Dionex Integrion.

Table 16. System chromatogram symptoms

Symptom Category	Symptom	See
Peak Results: Shape	Tailing Peaks	page 150
	Fronting Peaks	page 153
	Low Efficiency (Peak Broadening)	page 156
	Loss of Resolution	page 158
	Split Peak or Dip	page 161
	Noisy Baseline	page 171
Peak Results: Reproducibility	Non-Reproducible Peak Area	page 165
	Varying Peak Retention Times	page 166
Peak Results: Unknown peak	Unknown Peaks	page 168
Peak Results: Missing peak	Missing Peaks	page 169
Baseline	Noisy Baseline	page 171
	Drifting Baseline	page 173
	High Background	page 174

Tailing Peaks

Peak tailing is the abnormal extension of the end of the peak.

Figure 68. Peak tailing

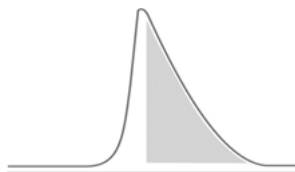

Table 17. Peak tailing troubleshooting

Possible cause	Solution
Restriction in tubing or poor fitting connection	<ol style="list-style-type: none"> 1. Check the tubing for any sharp bends or kinks. <ul style="list-style-type: none"> – Eliminate sharp bends. – Replace tubing, if kinked (see “Replacing Tubing and Fittings” on page 178). 2. Check each fitting connection to verify that the end of the tubing is flat and cut at a 90-degree angle to the direction of the flow. If needed, remove the fitting and ferrule and re-cut the tubing (see “Cutting Tubing” on page 182). 3. If the ferrule is too snug, replace the ferrule. 4. If the fitting is damaged, replace the fitting and ferrule (see “Installing and Tightening Ferrule Fittings” on page 180).
Eluent mismatch for column	<p>Certain columns are optimized for a particular type of eluent. Refer to the column manual for a list of supported eluent types and verify the following:</p> <ul style="list-style-type: none"> • The eluent being used is supported. • The correct eluent concentrate was used when preparing the eluent. • The correct EGC type is installed and the correct EGC type is selected.

Table 17. Peak tailing troubleshooting, continued

Possible cause	Solution
Incorrect column (analyte/stationary phase polarity mismatch)	<ol style="list-style-type: none"> 1. Strongly polar species (for example, iodide, thiosulfate, perchlorate, and long-chain alkyl amines) are not well-suited to columns with medium to high hydrophobicity. If the peaks of non-polar species such as sodium, chloride, and sulfate are symmetric but polar species are tailing, try using an alternative eluent or column. 2. Add a small amount of solvent (5–10% methanol or acetonitrile) to the eluent. This can improve peak shapes of polar species significantly. <p>Note: Check the manuals of all electrolytic components, such as eluent generator cartridges and suppressors, before adding solvent to the eluent. Addition of solvents may not be compatible with all electrolytic components.</p> <ol style="list-style-type: none"> 3. Replace the column with an ultra-low hydrophobicity column such as the Dionex IonPac Dionex AS16, Dionex IonPac AS20 or Dionex IonPac CS17. These columns do not require solvents to provide symmetric peak shapes with polar species.

Excessive backpressure on a membrane-based suppressor

Ideally, the backpressure at the eluent out port should be 0.3–0.7 MPa (40–100 psi); backpressures over 1.0 MPa (150 psi) can cause peak tailing.

❖ **To check the backpressure on the suppressor**

1. Measure the system pressure (P_1) with the suppressor power on.
2. Disconnect the line from the eluent out port on the suppressor; wait 60 seconds for the pressure to stabilize and then measure the system pressure (P_2).
Note: Do not operate the suppressor for more than 5 minutes with this line disconnected.
3. Reconnect the line to the eluent out port on the suppressor.

The difference between P_1 and P_2 ($P_1 - P_2$) is the backpressure at the eluent out port. If the pressure is above 0.7MPa (100 psi), find and eliminate the cause of the excessive backpressure (see [“High or Increasing System Backpressure”](#) on page 142).

Table 17. Peak tailing troubleshooting, continued

Possible cause	Solution
Head space or space between resin in column	<p>A column exposed to high column backpressure or excessive pressure pulsation, or a column that has dried out, may develop a head space between the column inlet and the resin bed or may develop voids within the resin itself.</p> <ol style="list-style-type: none"> 1. Replace the column. 2. Before beginning operation, do the following: <ul style="list-style-type: none"> – Reset the pump maximum pressure setting to the recommended column maximum pressure. This ensures that the pump shuts down before damaging the new column. – Verify that the pump ripple is within specification (see “Specifications” on page 221). Never operate a system with a faulty pump or pump heads. <p>After removing a column from the system, always install column plugs.</p> <p>When shutting down a system for more than one week, follow the storage recommendation procedures provided in the column manual.</p>
High sample concentration or high sample volume	Dilute sample (see “Diluting Samples” on page 54) or inject a smaller volume.
(ED system) Dirty or pitted conventional (nondisposable) working electrode	<ol style="list-style-type: none"> 1. Clean the working electrode with water and dry with pressurized air or nitrogen. 2. If you are using a conventional working electrode, polish the electrode (see “Polishing a Conventional Working Electrode” on page 209). If you are using a disposable electrode, replace it; see Appendix B, “Reordering Information.”

Fronting Peaks

Peak fronting is the extension of the front of the peak.

Figure 69. Peak fronting

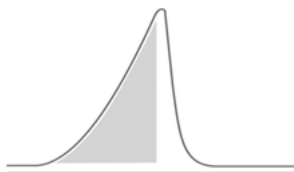

Table 18. Peak fronting troubleshooting

Possible cause	Solution
High sample concentration or high sample volume	Dilute the sample (see “ Diluting Samples ” on page 54) or inject a smaller volume.
Head space or space between resin in column	<p>A column exposed to high column backpressure or excessive pressure pulsation, or a column that has dried out, may develop a head space between the column inlet and the resin bed or may develop voids within the resin itself.</p> <ol style="list-style-type: none"> 1. Replace the column. 2. Before beginning operation, do the following: <ul style="list-style-type: none"> – Reset the pump maximum pressure setting to the recommended column maximum pressure. This ensures that the pump shuts down before damaging the new column. – Verify that the pump ripple is within specification (see “Specifications” on page 221). Never operate the system with a faulty pump or pump heads.

After removing a column from the system, always install column plugs.

When shutting down a system for more than one week, follow the storage recommendation procedures provided in the column manual.

Table 18. Peak fronting troubleshooting, continued

Possible cause	Solution
Restriction in tubing or poor fitting connection	<ol style="list-style-type: none"> 1. Check the tubing for any sharp bends or kinks. <ul style="list-style-type: none"> – Eliminate sharp bends. – Replace tubing, if kinked (see “Replacing Tubing and Fittings” on page 178). 2. Check each 10-32 ferrule fitting connection and verify that the end of the tubing is flat and cut at a 90-degree angle to the direction of the flow. If needed, remove the fitting and ferrule and re-cut the tubing. 3. If the ferrule is too snug, replace the ferrule. 4. If the fitting is damaged, replace the fitting and ferrule (see “Installing and Tightening Ferrule Fittings” on page 180).
<p>Damaged CRD</p> <p>The CRD is sensitive to high pressures and can be damaged by high backpressure at the eluent out port</p>	<p>Replace the CRD if it is leaking from the eluent in port to the regen out port. Before installing a replacement, verify that the backpressure on the CRD is less than 0.4 MPa (60 psi). Backpressures over 0.7 MPa (100 psi) can permanently damage the CRD.</p> <p>❖ To check the backpressure on the CRD</p> <ol style="list-style-type: none"> 1. Unplug the lines from the eluent in and eluent out ports on the CRD and install a union to connect the lines. 2. Measure the system pressure (P_1) with the union in place. 3. Remove the union. Wait 60 seconds for the pressure to stabilize and then measure the system pressure (P_2). Note: Do not operate the suppressor for more than 5 minutes with the eluent in and eluent out lines disconnected. 4. Reconnect the lines to the eluent in and eluent out ports on the CRD. <p>The difference between P_1 and P_2 ($P_1 - P_2$) is the backpressure at the eluent out port. If the pressure is above 0.4 MPa (60 psi), find and eliminate the cause of the excessive backpressure (see “High or Increasing System Backpressure” on page 142).</p>

Table 18. Peak fronting troubleshooting, continued

Possible cause	Solution
Column is contaminated	<p>A column exposed to transition metals, non-ionic surfactants, or highly polar species may become contaminated, leading to peak fronting.</p> <ol style="list-style-type: none"> 1. Clean the column. Refer to the column manual for instructions. 2. If cleaning the column does not eliminate the problem, the column may need to be replaced. 3. To prevent contamination, install a trap column or use a sample preparation procedure before injection.
Suppressor is contaminated	<p>A suppressor exposed to transition metals, non-ionic surfactants, or highly polar species may become contaminated, leading to peak fronting.</p> <ol style="list-style-type: none"> 1. Clean the suppressor. Refer to the suppressor manual for instructions. 2. If cleaning the suppressor does not eliminate the problem, the suppressor may need to be replaced. 3. To prevent contamination, install a trap column or use a sample preparation procedure before injection.

Low Efficiency (Peak Broadening)

Loss of peak efficiency or peak broadening is the broadening of both the front and the tail of the peak.

Figure 70. Low efficiency (peak broadening)



Table 19. Low efficiency (peak broadening) troubleshooting

Possible cause	Solution
Restriction in tubing or poor fitting connection	<p>If all peaks in a chromatogram are broadened, the cause could be excessive dead volume in the system. This often results from poor fittings or excessive restriction.</p> <ol style="list-style-type: none"> 1. Check the tubing for any sharp bends or kinks. <ul style="list-style-type: none"> – Eliminate sharp bends. – Replace tubing, if kinked (see “Replacing Tubing and Fittings” on page 178). 2. Check each 10-32 ferrule fitting connection and verify that the end of the tubing is flat and cut at a 90-degree angle to the direction of the flow. If needed, remove the fitting and ferrule and re-cut the tubing. 3. If the ferrule is too snug, replace the ferrule. 4. If the fitting is damaged, replace the fitting and ferrule (see “Installing and Tightening Ferrule Fittings” on page 180).
Sample adsorbed to column resin	<p>If only one (or a few) of the peaks in a chromatogram are broadened, the cause could be a contaminated column. For example, transition metal contamination usually affects the fluoride and phosphate peaks more than other anions.</p> <ol style="list-style-type: none"> 1. Clean the column. Refer to the column manual for instructions. 2. If cleaning the column does not eliminate the problem, the column may need to be replaced. 3. To prevent contamination, install a trap column or use a sample preparation procedure before injection.

Table 19. Low efficiency (peak broadening) troubleshooting, continued

Possible cause	Solution
Head space in the column	<p>If all peaks in a chromatogram are broadened, the cause could be head space in the column. A column exposed to high column backpressure or excessive pressure pulsation, or a column that has dried out, may develop a head space between the column inlet and the resin bed.</p> <ol style="list-style-type: none"> 1. Replace the column. 2. Before beginning operation, do the following: <ul style="list-style-type: none"> – Reset the pump maximum pressure setting to the recommended column maximum pressure. This ensures that the pump shuts down before damaging the new column. – Verify that the pump ripple is within specification (see “Specifications” on page 221). Never operate a system with a faulty pump or pump heads. <p>After removing a column from the system, always install column plugs.</p> <p>When shutting down a system for more than one week, follow the storage recommendation procedures provided in the column manual.</p>
Excessive pressure fluctuation or pulsation	See “Unstable System Backpressure” on page 144.
Eluent mismatched for column	<p>Certain columns are optimized for a particular type of eluent. Refer to the column manual for a list of supported eluent types and verify the following:</p> <ul style="list-style-type: none"> • The eluent being used is supported. • The correct eluent concentrate was used when preparing the eluent. • The correct EGC type is installed and the correct EGC type is selected.
High sample concentration or high sample volume	<p>Although peak fronting is the most common result of sample overloading, peak broadening can also occur.</p> <p>Dilute the sample (see “Diluting Samples” on page 54) or inject a smaller volume.</p>

Loss of Resolution

Loss of resolution is identified by a pair of peaks that elute more closely together than normal. When resolution falls to a level where the signal does not reach the baseline between peaks, integration of the peaks may be affected.

Figure 71. Loss of resolution

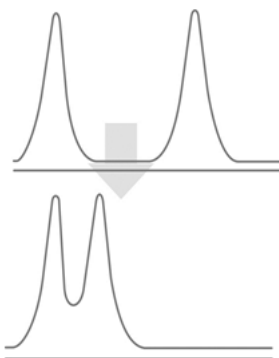

Table 20. Loss of resolution troubleshooting

Possible cause	Solution
Eluent was incorrectly prepared	<p>If the eluent is not prepared properly, analytes that normally separate well may show a loss of resolution.</p> <ol style="list-style-type: none">1. Remake the eluent, taking care to measure out the chemicals accurately and to double-check stoichiometric calculations.2. Remake the eluent concentrate (or use a fresh bottle of prepared eluent concentrate), and then remake the eluent.3. Use an alternate water source for preparing the eluent.4. Use an alternate source of chemicals for the eluent concentrate.5. Filter and degas the eluent.6. Regenerate the eluent trap column, or install a new trap column between the pump and the injection valve.7. For an EG: Check the Dionex EGC settings and verify that the correct cartridge type is selected.

Table 20. Loss of resolution troubleshooting, continued

Possible cause	Solution
Reservoir is dirty	<ol style="list-style-type: none"> 1. Clean the eluent reservoir thoroughly (inside and out) with ASTM Type I (18 megohm-cm) filtered and deionized water that meets the specifications listed in “Deionized Water Requirements for IC” on page 3. 2. Dry with clean, particulate-free air. 3. If the reservoir still appears dirty, or if there is a slimy film on the interior, follow the cleaning instructions on page 108. 4. Replace the end-line filter (P/N 045987).
Peak tailing, fronting, or low efficiency	A degradation of peak shape can cause loss of resolution even if the retention times of the analytes are not affected (see “ Tailing Peaks ” on page 150 , “ Fronting Peaks ” on page 153 , or “ Low Efficiency (Peak Broadening) ” on page 156).

Table 20. Loss of resolution troubleshooting, continued

Possible cause	Solution
Column is contaminated or degraded	<p data-bbox="857 338 1455 548">Loss of column capacity causes retention times to shorten, resulting in loss of resolution. Column capacity loss can be caused by contamination or by column aging. Most columns can be used for 9–15 months under normal conditions before loss of capacity results in unacceptable separation.</p> <ol data-bbox="873 573 1455 863" style="list-style-type: none"> <li data-bbox="873 573 1455 642">1. Clean the column. Refer to the column manual for instructions. <li data-bbox="873 667 1455 737">2. If cleaning the column does not eliminate the problem, the column may need to be replaced. <li data-bbox="873 762 1455 863">3. To prevent contamination, install a trap column or use a sample preparation procedure before injection. <p data-bbox="857 888 1455 921">Possible causes of accelerated column capacity loss:</p> <ul data-bbox="873 926 1455 1505" style="list-style-type: none"> <li data-bbox="873 926 1455 1031">• High temperatures: Turn off ovens when not in use. Store the column in a refrigerator during long-term storage. <li data-bbox="873 1035 1455 1178">• High pH: Before putting a column that has been used with hydroxide eluent into long-term storage, fill the column with 100 mM sodium tetraborate to preserve column capacity. <li data-bbox="873 1182 1455 1320">• Highly reactive sample matrices, such as peroxides: Frequent replacement of the guard column or use of a matrix elimination technique can preserve the separator column. <li data-bbox="873 1325 1455 1505">• Alcohols in the eluent or sample: Some cation separator columns, such as the Dionex IonPac CS12A and CS16, are incompatible with alcohols. Newer columns, such as the Dionex IonPac CS17, are compatible with alcohols.

Split Peak or Dip

A split peak is the presence of two maxima on a single peak.

Figure 72. Split peak

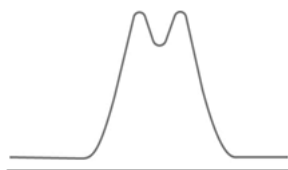

A dip is a negative peak that may be a normal phenomenon, such as the injection dip, or an unwanted artifact that can interfere with peak integration.

Figure 73. Dips following each peak

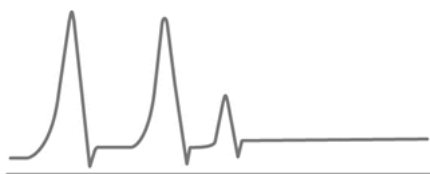

A chromatogram can have either a single split peak or dip (see [Table 21](#)), multiple split dips (see [Table 22](#)), or multiple split peaks (see [Table 23](#)).

Table 21. Single-split peak or dip troubleshooting

Possible cause	Solution
Deionized water source is contaminated	<ol style="list-style-type: none"> 1. Use an alternate water source. 2. Perform preventive maintenance on the current water source.
Reservoir is dirty	<ol style="list-style-type: none"> 1. Clean the eluent reservoir thoroughly (inside and out) with ASTM Type I (18 megohm-cm) filtered and deionized water that meets the specifications listed in “Deionized Water Requirements for IC” on page 3. 2. Dry with clean, particulate-free air. 3. If the reservoir still appears dirty, or if there is a slimy film on the interior, follow the cleaning instructions on page 108. 4. Replace the end-line filter (P/N 045987).

Table 21. Single-split peak or dip troubleshooting, continued

Possible cause	Solution
Eluent is contaminated	<ol style="list-style-type: none"> 1. Prepare new stock solution. 2. Prepare fresh eluent. 3. Filter and degas the eluent. 4. Regenerate the eluent trap column, or install a new trap column between the pump and the injection valve.
Column is contaminated	<ul style="list-style-type: none"> • Clean the column. Refer to the column manual for instructions. • If cleaning the column does not eliminate the problem, the column may need to be replaced. • To prevent contamination, install a trap column or use a sample preparation procedure before injection.
Carbonate eluent	<p>An extra dip may be present when using carbonate as an eluent, due to retention of the eluent itself. This carbonate dip may be normal, and can be ignored unless it interferes with the analyte of interest.</p> <p>If the carbonate dip interferes with an analyte of interest, consider the following:</p> <ol style="list-style-type: none"> 1. Select a different eluent composition. You can use the Virtual Column Separation Simulator to help better determine the appropriate eluent. To open the simulator, click the command on the Tools menu in the Chromeleon Console. 2. Select a different column. 3. Install a Dionex CRD 300. 4. Use a hydroxide eluent: Hydroxide eluents typically do not have a carbonate dip, but instead have a carbonate peak. To eliminate or reduce the carbonate peak from a hydroxide system, install a Dionex CRD 200.

Table 22. Dips following each peak troubleshooting

Possible cause	Solution
Counter-ion presence in the suppressed eluent	<p>Counter-ions (for example, sodium or potassium ions in an anion system, or MSA or sulfate ions in a cation system) can be caused by operating the suppressor without electrical current, insufficient electrical current, or insufficient regenerant flow.</p> <ol style="list-style-type: none"> 1. Regenerate the suppressor. Refer to the instructions in the suppressor manual. 2. Calculate the correct suppressor current for your application and ensure that the correct current is applied throughout the entire instrument method. 3. Always turn on the suppressor immediately after turning on the eluent pump. 4. When shutting down a system for more than one week, follow the storage recommendation procedures in the suppressor manual. Hydrate the suppressor before resuming its use.

Table 23. Multiple split peaks in the chromatogram troubleshooting

Possible cause	Solution
Damaged column resin bed	<ol style="list-style-type: none"> 1. Replace the column. 2. Before beginning operation, do the following: <ul style="list-style-type: none"> – Reset the pump maximum pressure setting to the recommended column maximum pressure. This ensures that the pump shuts down before damaging the new column. – Verify that the pump ripple is within specification (see “Specifications” on page 221). Never operate a system with a faulty pump or pump heads. <p>After removing a column from the system, always install column plugs.</p> <p>When shutting down a system for more than one week, follow the storage recommendation procedures provided in the column manual.</p>

Low Detector Output

Table 24. Low detector output troubleshooting

Possible cause	Solution
Insufficient sample injected	Increase the injection size or concentration.
(ED system) Working electrode fouled	<ol style="list-style-type: none"> 1. If a disposable working electrode is being used, replace the electrode. 2. For conventional (nondisposable) electrodes, clean the working electrode with ASTM Type I (18 megohm-cm) filtered and deionized water that meets the specifications listed in “Deionized Water Requirements for IC” on page 3. Dry with pressurized air or nitrogen. If the electrode is pitted, polish the electrode (see “Polishing a Conventional Working Electrode” on page 209). 3. Check the value of the reference potential shift (see “To monitor the pH-Ag/AgCl reference electrode pH” on page 61). If the value fluctuates by more than 30 mV, electrode passivation may occur because potentials that are too high are being applied. Recalibrate the pH-Ag/AgCl reference electrode (see page 213). If the problem persists, replace the pH-Ag/AgCl reference electrode (see page 211).
Analog output range set too high	Select a more sensitive analog output range.

Non-Reproducible Peak Area

Figure 74. Increasing peak area over time

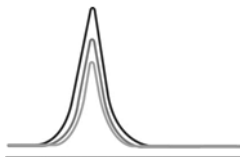

Table 25. Non-reproducible peak area troubleshooting

Possible cause	Solution
Baseline is drifting	Verify that your system has been fully equilibrated. If baseline drift persists, see the troubleshooting information in “Drifting Baseline” on page 173.
Eluent is contaminated	<ol style="list-style-type: none"> 1. Prepare fresh eluent. 2. Clean the eluent reservoir thoroughly (inside and out) with ASTM Type I (18 megohm-cm) filtered and deionized water that meets the specifications listed in “Deionized Water Requirements for IC” on page 3. 3. Check the conductivity of the deionized water source. It should be $<1.0 \mu\text{S cm}^{-1}$ and have a resistance of 18.2 megohm-cm. 4. If the conductivity is too high, use an alternate water source or perform preventive maintenance on the current water source.
Injection valve is leaking	Check the injection valve for leaks. If a leak is present, see the troubleshooting information in “Liquid Leaks” on page 138.
Problem with the autosampler	<p>Issues with the autosampler impact all injections made, including water blanks, standards, and samples. For troubleshooting, see the manual for your autosampler.</p> <p>Consider running a performance qualification. Contact Technical Support for Dionex products for assistance.</p>
Unstable conductivity cell temperature	Verify that the cell temperature control is turned on in the instrument method.

Table 25. Non-reproducible peak area troubleshooting, continued

Possible cause	Solution
Suppressor is contaminated	<ol style="list-style-type: none"> 1. Clean the suppressor. Refer to the suppressor manual for instructions. 2. If cleaning the suppressor does not eliminate the problem, the suppressor may need to be replaced. 3. To prevent contamination, install a trap column or use a sample preparation procedure before injection.
Column is contaminated	<ol style="list-style-type: none"> 1. Clean the column. Refer to the column manual for instructions. 2. If cleaning the column does not eliminate the problem, the column may need to be replaced. 3. To prevent contamination, install a trap column or use a sample preparation procedure before injection.

Varying Peak Retention Times

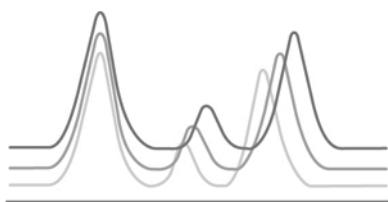
Figure 75. Varying peak retention times over time**Table 26.** Varying peak retention times troubleshooting

Possible cause	Solution
Unstable pump flow	<p>Check the water dip. If it has changed:</p> <ol style="list-style-type: none"> 1. Check for a pump leak. If a leak is present, see the troubleshooting information in “Liquid Leaks” on page 138. 2. Verify that the pump flow rate is correct. 3. Check for other leaks.
Temperature fluctuations	<p>Check for temperature fluctuations in the ambient temperature and the column and detector compartments. Make sure air conditioning vents do not blow directly onto the instrument.</p>

Table 26. Varying peak retention times troubleshooting, continued

Possible cause	Solution
Column is contaminated	<ol style="list-style-type: none"> 1. Clean the column. Refer to the column manual for instructions. 2. If cleaning the column does not eliminate the problem, the column may need to be replaced. 3. To prevent contamination, install a trap column or use a sample preparation procedure before injection.
Restriction in tubing or poor fitting connection	<ol style="list-style-type: none"> 1. Check the tubing for any sharp bends or kinks. <ul style="list-style-type: none"> – Eliminate sharp bends. – Replace tubing, if kinked (see “Replacing Tubing and Fittings” on page 178). 2. Check each 10-32 ferrule fitting connection and verify that the end of the tubing is flat and cut at a 90-degree angle to the direction of the flow. If needed, remove the fitting and ferrule and re-cut the tubing. 3. If the ferrule is too snug, replace the ferrule. 4. If the fitting is damaged, replace the fitting and ferrule (see “Installing and Tightening Ferrule Fittings” on page 180).
Incorrect eluent	<ol style="list-style-type: none"> 1. Refer to the column manual for a list of supported eluent types and verify that the eluent being used is supported. 2. Verify that the correct eluent concentrate was used when preparing the eluent. 3. If using an EG, verify that the correct EGC type is installed and is specified in the instrument method. 4. Consider using the Virtual Column Separation Simulator to help better determine the appropriate eluent. To open the simulator, click the command on the Tools menu in the Chromeleon Console.

Unknown Peaks

Figure 76. Unknown peak in the chromatogram

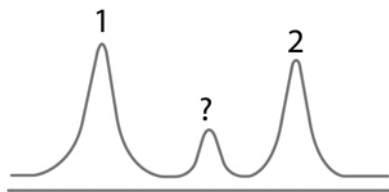
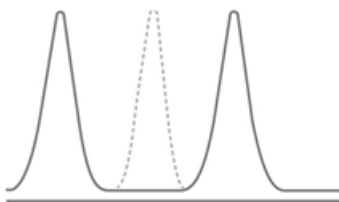

Table 27. Unknown peak troubleshooting

Possible cause	Solution
Sample is contaminated	<p>Rinse a sample vial thoroughly with deionized water and use it to run a deionized water blank.</p> <ol style="list-style-type: none"> 1. If unknown peaks are not present in the deionized water blank, then the injected samples and/or standards have additional analytes. Remake any contaminated standards. 2. If unknown peaks are present in the deionized water blank, then attempt to identify the peaks using Virtual Column Separation Simulation. To open Virtual Column, click the command on the Tools menu in the Chromeleon Console.
Eluent is contaminated	<p>Eluent contamination typically does not cause unknown peaks unless an EG gradient separation is being run. In this case, ions from the deionized water can become concentrated on the separator column and elute when the eluent concentration increases.</p> <ol style="list-style-type: none"> 1. Clean the eluent reservoir thoroughly (inside and out) with ASTM Type I (18 megohm-cm) filtered and deionized water that meets the specifications listed in “Deionized Water Requirements for IC” on page 3. 2. Use an alternate water source. 3. Perform preventive maintenance on the current water source. 4. Manually prepare eluent.

Missing Peaks

Figure 77. A missing peak in the chromatogram



A chromatogram can have either some peaks missing (see [Figure 77](#) and [Table 28](#)) or all peaks missing (see [Table 29](#)).

Table 28. Some peaks missing troubleshooting

Possible cause	Solution
Column is contaminated	<ol style="list-style-type: none"> 1. Clean the column. Refer to the column manual for instructions. 2. If cleaning the column does not eliminate the problem, the column may need to be replaced. 3. To prevent contamination, install a trap column or use a sample preparation procedure before injection.
Suppressor is contaminated	<ol style="list-style-type: none"> 1. Clean the suppressor. Refer to the suppressor manual for instructions. 2. If cleaning the suppressor does not eliminate the problem, the suppressor may need to be replaced. 3. To prevent contamination, install a trap column or use a sample preparation procedure before injection.

Table 29. All peaks missing troubleshooting

Possible cause	Solution
EGC is not turned on or eluent was prepared incorrectly	<ol style="list-style-type: none"> 1. Verify that the Dionex EGC concentration is specified in the Chromeleon instrument method. If you are operating from the mobile app, enter the eluent concentration on the Home page. When the pump is turned on, the Dionex EGC power is automatically turned on. 2. If you are manually preparing eluent, verify that the correct concentrate was used at the prescribed concentration.
Injection valve is not switching	<ol style="list-style-type: none"> 1. Test the valve by manually switching the position on the Chromeleon ePanel Set or from the mobile app Home page. Listen for an audible noise as the valve changes position. 2. If the valve does not change position, contact Technical Support for Dionex products for assistance.
Cell voltage is off (ED only)	Verify that the cell voltage is turned on in the Chromeleon instrument method. If you are operating from the mobile app, turn on the voltage on the Home page.
Autosampler leaking	For troubleshooting, see the manual for your autosampler.

Noisy Baseline

Figure 78. Baseline noise

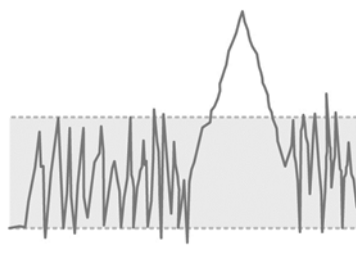

Table 30. Noisy baseline troubleshooting

Possible cause	Solution
Deionized water source is contaminated	<ol style="list-style-type: none"> 1. Check the conductivity of the deionized water source. It should be $<1.0 \mu\text{S cm}^{-1}$ and have a resistance of 18.2 megohm-cm. 2. If the conductivity is too high, use an alternate water source or perform preventive maintenance on the current water source.
Pump ripple increase	See the solutions for unstable system backpressure on page 144 .
Suppressor problem	<ol style="list-style-type: none"> 1. Refer to the suppressor manual for current, backpressure, and temperature guidelines for your suppressor, and then check for the following: <ul style="list-style-type: none"> – Excess current being applied to the suppressor. – If a temperature-controlled detector compartment is present, verify that the temperature is not too high. – Excess backpressure. 2. If needed, correct the current or temperature settings and find and eliminate the cause of excessive backpressure (see “High or Increasing System Backpressure” on page 142). 3. Consider cleaning the suppressor or replacing the suppressor.

Table 30. Noisy baseline troubleshooting, continued

Possible cause	Solution
Air trapped in cell	<ol style="list-style-type: none"> Remove the trapped air: <ul style="list-style-type: none"> See “Removing Trapped Air from a CD Cell” on page 203). See “To remove trapped air from an ED cell” on page 173. Make sure the eluent is sufficiently degassed. <ul style="list-style-type: none"> Manually degas the deionized water or eluent before filling the reservoir. If an eluent degas vacuum pump is installed, verify that it is turned on. The pump can be controlled from the pump ePanel in Chromeleon or the mobile app Pump page. If an EG is installed, check the Dionex RFIC Eluent Degasser (P/N 075522).
Flow system leak ahead of cell	Check all fittings and liquid lines for leaks. Tighten or, if necessary, replace liquid line connections (see “Replacing Tubing and Fittings” on page 178).
Rapid changes in ambient temperature	Make sure the doors to the column and detector compartments are kept closed. Verify that air conditioning vents do not blow directly onto the instrument.
(CD system) Incorrect suppressor operating conditions	Check for excess current, excess temperature, or too much backpressure. Refer to the suppressor manual for detailed troubleshooting information.
(CD system) Temperature compensation setting not optimized	Optimize the selected setting.
(CD system) Cell above or below temperature	Contact Technical Support for Dionex products for assistance.
Detector electronics not functioning correctly	Contact Technical Support for Dionex products for assistance.
(ED system) Plugged pH-Ag/AgCl reference electrode diaphragm (causing frequent, random spikes)	<p>Regenerate the pH-Ag/AgCl reference electrode frit by soaking the electrode in a solution of 1 M KCl plus 1 M HCl.</p> <p>If this does not eliminate the spiking, replace the electrode (P/N 061879).</p>

❖ **To remove trapped air from an ED cell**

1. While wearing gloves and eye protection, and with the pump running and all plumbing connected, generate a slight temporary backpressure by putting your finger over the end of the cell outlet tubing for 2 to 3 seconds.
2. Repeat two or three times.
3. If the baseline does not improve, check the other causes of baseline instability described in this section.

IMPORTANT Do not block the end of the cell outlet tubing for longer than the recommended 2 to 3 seconds. Doing so creates high backpressure, which can break the pH-Ag/AgCl reference electrode glass membrane.

Note To prevent air from becoming trapped in the cell in the future, increase the backpressure on the cell by connecting backpressure tubing to the cell outlet. The backpressure limit for the Dionex Integrion Electrochemical Detector cell is 690 kPa (100 psi). Do not exceed this limit.

Drifting Baseline

Figure 79. Baseline drift

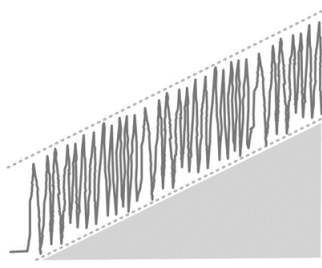

Table 31. Drifting baseline troubleshooting

Possible cause	Solution
Deionized water source is contaminated	<ol style="list-style-type: none"> 1. Check the conductivity of the deionized water source. It should be $<1.0 \mu\text{S cm}^{-1}$ and have a resistance of 18.2 megohm-cm. 2. If the conductivity is too high, use an alternate water source or perform preventive maintenance on the current water source.
Column is contaminated	<ol style="list-style-type: none"> 1. Clean the column. 2. Replace the inlet bed support. 3. Replace the column.

Table 31. Drifting baseline troubleshooting, continued

Possible cause	Solution
Suppressor is contaminated	Clean or replace the suppressor.
Temperature fluctuations	<ol style="list-style-type: none"> 1. Verify that the ambient temperature is within the specification listed in “Physical Specifications” on page 224. 2. Check for temperature fluctuations in the ambient temperature and the column and detector compartments. Verify that air conditioning vents do not blow directly onto the instrument.
Leaking fitting	Tighten or replace the fitting (see “Replacing Tubing and Fittings” on page 178).
Increase in sample	<ol style="list-style-type: none"> 1. Dilute the sample. 2. Reduce the sample injection volume.
Dionex EGC or CR-TC 600 problem	<ol style="list-style-type: none"> 1. Check retention times. Run a Quality Assurance Report (QAR) to help better identify the cause. Refer to the column manual for details. 2. Replace the Dionex EGC or CR-TC 600.

High Background

Table 32. High background troubleshooting

Possible cause	Solution
Dionex CR-TC 600 is contaminated	Clean the device as instructed in the Dionex CR-TC 600 manual.
Wrong eluent	<ol style="list-style-type: none"> 1. Verify that you are using the correct eluent for your application. 2. For an ED, verify that the pH readout is correct for your eluent.
Background signal not offset from detector signal	<ol style="list-style-type: none"> 1. Before injecting sample, allow the background signal to equilibrate, and then select Autozero on the Chromeleon ePanel or mobile app Home page. 2. Verify that an Autozero command is included in the Chromeleon instrument method.
(CD system) Background not suppressed by suppressor	Verify that the suppressor is turned on and the current is set to the correct value. Refer to the suppressor manual for additional troubleshooting guidance.

Table 32. High background troubleshooting, continued

Possible cause	Solution
(CD system) Regenerant fails to suppress background	If you are using a chemically-regenerated suppressor, select a higher regenerant flow rate. Refer to the suppressor manual for the suggested regenerant flow rate for your application.
(ED system) Excessive number or length of integration intervals and/or incorrect potential for the integration	Verify that the length and potential of the integration interval is correct (refer to the column manual for the settings required for your application).
(ED system) Amperometric detection cell working electrode shorted to counter electrode	<ol style="list-style-type: none"> 1. Clean the working electrode with water and dry with pressurized air or nitrogen. 2. Remove any precipitate on the counter electrode by cleaning the spot directly opposite the working electrode with a lint-free tissue. 3. Remove any precipitate with water and a lint-free tissue and then install a new gasket (see “Replacing a Disposable Working Electrode Gasket” on page 206 or “Replacing a Conventional Working Electrode Gasket” on page 207). 4. Turn the yoke knob (see Figure 95) a full 360 degrees to completely engage the knob.

6 Troubleshooting

Troubleshooting Chromatogram Symptoms

Service

This chapter describes Dionex Integrion HPIC System service and repair procedures that users may perform. Procedures not included here, including electronics-related repair procedures, must be performed by Thermo Fisher Scientific personnel. For assistance, contact Technical Support for Dionex products. In the U.S. and Canada, call 1-800-532-4752. Outside the U.S. and Canada, call the nearest Thermo Fisher Scientific office. Use a PEEK tubing cutter to create the PEEK tubing assembly. If necessary, order a PEEK tubing cutter (P/N 049584) from Thermo Fisher Scientific.

Before replacing any part, verify the cause of the problem by referring to the information in [Chapter 6, “Troubleshooting.”](#)

IMPORTANT Substituting non-Dionex/Thermo Fisher Scientific parts may impair system performance, thereby voiding the product warranty. Refer to the warranty statement in the Dionex Terms and Conditions for more information.



CAUTION Before servicing the instrument, allow any heated components to cool.



MISE EN GARDE Permettre aux composants chauffés de refroidir avant toute intervention.



VORSICHT Warten Sie erhitzte Komponenten erst nachdem diese sich abgekühlt haben.

Note Installation videos are available in Chromeleon for various Dionex Integrion consumable devices. To access the videos, click **Consumables**  on the Instrument toolbar above the ePanel Set, and select the device you are replacing.

Contents

- [Replacing Tubing and Fittings](#)
- [Fitting and Tube Connection Guidelines](#)
- [Servicing Pump Components](#)
- [Servicing Eluent Generator Components](#)
- [Servicing High-Pressure \(Injection\) Valves](#)
- [Servicing a Dionex Integrion Conductivity Detector](#)
- [Servicing a Dionex Integrion Electrochemical Detector](#)
- [Changing the Main Power Fuses](#)

Replacing Tubing and Fittings

To replace tubing and fittings, see the tables below and the information in “[Fitting and Tube Connection Guidelines](#)” on page 180. Also, refer to “[System Flow Schematics](#)” on page 39 for plumbing diagrams of the various system configurations.

Table 33. Tubing and fittings for the Dionex Integrion

Part	Part Number	Used to connect...
1.58 mm (0.062 in) ID PTFE tubing	014157 (1 in length)	<ul style="list-style-type: none"> • Eluent reservoir to shutoff valve or degas inlet • (CD systems) Suppressor regen ports • (RFIC systems) Dionex CR-TC 600 regen ports • (ED systems) Cell outlet to Dionex CR-TC 600 regen inlet
Pre-bent, 0.25 mm (0.010 in) ID black PEEK tubing	22153-40111	(Non-RFIC systems) Mixer to column compartment
Pre-bent, 0.25 mm (0.010 in) ID black PEEK tubing	22153-40110	(RFIC-EG systems) Mixer to Dionex EGC inlet
0.25 mm (0.010 in) ID black PEEK tubing	042690 (4 in length)	<ul style="list-style-type: none"> • Primary and secondary pump heads • Injection valve port P (in systems without a heated column compartment)
1.02 mm (0.040 in) ID tan PEEK tubing	054410 (4.81 in length)	<ul style="list-style-type: none"> • Shutoff valve outlet to primary pump inlet check valve • (RFIC-EG systems) Degas to shutoff valve

Table 33. Tubing and fittings for the Dionex Integrion

Part	Part Number	Used to connect...
Prime/waste tubing assembly	063598	Secondary pump head to waste
Backpressure coil for 2 mm suppressor	045878	(CD systems) Backpressure coil to suppressor regen inlet; for 0.5 mL/min flow rate
Backpressure coil for 4 mm suppressor	045877	(CD systems) Backpressure coil to suppressor regen inlet; for 1.0 mL/min flow rate
IC PEEK Viper™ assembly, 0.18 mm (0.007 in), 102 mm (4.0 in)	088805	Guard column outlet to separator column
Viper assembly, 0.18 mm (0.007 in) ID, 140 mm (5.5 in)	088806	Injection valve port C to guard column
Viper assembly, 0.18 mm (0.007 in), 165 mm (6.5 in)	088807	(RFIC systems) Dionex EGC eluent outlet to Dionex CR-TC 600 eluent inlet
Viper assembly, 0.18 mm (0.007 in), 114 mm (4.5 in)	088813	(RFIC systems) Dionex EGC eluent outlet to Dionex CRD eluent inlet
Viper assembly, 0.18 mm (0.007 in), 178 mm (7.0 in)	088808	(CD systems) Separator column to suppressor eluent inlet
Viper assembly, 0.18 mm (0.007 in), 178 mm (7.0 in)	088809	(RFIC systems) Separator column to cell inlet
Viper assembly, 0.18 mm (0.007 in), 229 mm (9.0 in)	088810	(CD systems) Suppressor eluent outlet to CD cell inlet
Viper assembly, 0.18 mm (0.007 in), 241 mm (9.5 in)	088811	(RFIC systems) Dionex CR-TC 600 eluent outlet to Dionex RFIC Eluent Degasser inlet
1/8 in ferrule	048949	1.58 mm (0.062 in) ID PTFE tubing
1/8 in flangeless fitting nut	052276	
10-32 double-cone ferrule	043276	0.25 mm (0.010 in) ID black PEEK tubing
10-32 fitting bolt	22000-98001	
Two-piece ferrule	062511	Degas out to shutoff valve in
1/16 in flangeless fitting nut	052230	
1/8 in ferrule	048949	<ul style="list-style-type: none"> (CD systems) Suppressor regen ports Cell/regen out to waste line
1/8 in flangeless fitting nut (short)	057934	
1/4-28 coupler	039056	Waste line

Table 33. Tubing and fittings for the Dionex Integrion

Part	Part Number	Used to connect...
10-32 coupler	042627	<ul style="list-style-type: none"> • (Non-RFIC systems) Mixer to column compartment • (RFIC systems) Dionex CR-TC 600 eluent outlet to Dionex RFIC Eluent Degasser inlet
1/4-28 to 10-32 coupler	042806	<ul style="list-style-type: none"> • (CD systems) Backpressure coil to suppressor regen inlet • (ED systems) Cell outlet to Dionex CR-TC 600 regen inlet

Fitting and Tube Connection Guidelines

Two types of high-pressure fittings are used in the Dionex Integrion: IC PEEK Viper fittings, and 10-32 fitting bolts (P/N 22000-98001) with 10-32 double-cone ferrules (P/N 043276).

Installation and tightening requirements are different for each fitting type. To ensure a correct seal and avoid damage to fittings and tubing, carefully follow the installation and tightening instructions provided here.

Installing and Tightening Ferrule Fittings

Follow these guidelines to install and tighten a 10-32 fitting bolt (P/N 22000-98001) and 10-32 double-cone ferrule (P/N 043276).

❖ To install a 10-32 double-cone ferrule fitting

1. Install the fitting bolt and ferrule onto the tubing. Position the ferrule 1 to 2 mm (0.04 to 0.08 in) from the end of the tubing (see [Figure 80](#)).

Figure 80. Ferrule and fitting bolt placement for tubing connections

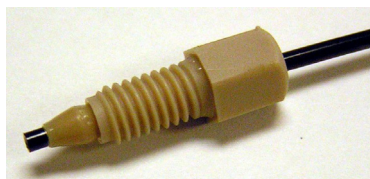

✓ Correct placement of ferrule and fitting on tubing

2. Insert the tubing into the port until it stops.
3. While maintaining pressure on the tubing to keep it in place in the port, tighten the fitting bolt fingertight and then tighten the fitting further by following the instructions below.

❖ To tighten 10-32 double-cone ferrule fittings

1. Use your fingers to tighten the fitting bolt as tight as you can. Then, use a wrench to tighten the fitting an additional three-quarter turn (270 degrees).
2. If leaks occur, replace the fitting bolt, ferrule, and tubing.

Installing and Tightening IC PEEK Viper Fittings

IC PEEK Viper fittings require much less torque to tighten than other types of PEEK fittings (although they may look similar to other fittings). The effort required to create a seal for 34 MPa (5000 psi) of pressure is similar to the effort needed to turn a dial on a combination lock. **Overtightening will damage the fitting and the port.** To avoid damaging the fitting and port, please follow the tightening procedure provided below.



IMPORTANT DO NOT OVERTIGHTEN THE FITTING. Do not use any tools to tighten the fitting. IC PEEK Viper fittings require very little torque to seal.

To extend the life of IC PEEK Viper fittings, do not connect or disconnect a fitting under pressure.

When using IC PEEK Viper fittings with columns, ensure that the columns have the **Viper Fittings Ready** label.

❖ To install an IC PEEK Viper fitting

1. IC PEEK Viper fittings are pre-installed on tubing. Specific tubing assemblies are required for the various system plumbing connections. Verify that you have the correct tubing and fitting assembly for the connection (see [Table 33](#)).
2. Insert the tubing and fitting into the port until it stops.
3. Tighten the fitting by following the instructions below.

❖ To tighten an IC PEEK Viper fitting

1. If the pump is on, stop the pump and allow the system to reach zero pressure.
2. Slide the Viper fitting into the port and use your fingers to gently tighten the bolt until you feel the first contact or resistance. This is the “0” mark. Then, tighten the bolt according to the following guidelines:
 - For the initial installation of the fitting: Use your fingers to tighten the bolt **one-eighth** of a turn from the “0” mark (45° or between 1 and 2 on a clock face) (see [Figure 81](#) on [page 182](#), View A).
 - For subsequent installations: Use your fingers to tighten the bolt **one-sixteenth** of a turn from the “0” mark (22° or 4 minutes past 12 on a clock face) (see [Figure 81](#) on [page 182](#), View B).

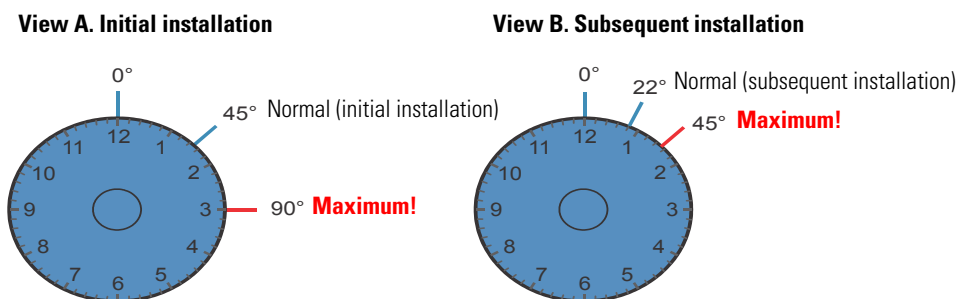
Figure 81. IC PEEK Viper fitting installation

3. Turn on the pump and begin operating the system at the regular operating pressure.
4. Check for leaks. If a leak is present, follow the steps below.

❖ To fix a leaking IC PEEK Viper fitting

1. Gently tighten the fitting a little more:
 - For initial installation of the fitting: Fingertighten the bolt another **one-eighth** turn only.
 - For subsequent installations: Fingertighten the bolt another **one-sixteenth** turn only.
2. If the leak continues, stop the pump and wait for the system to reach zero pressure before continuing.
3. Remove the fitting and clean it thoroughly with deionized water. Also, clean the port with deionized water and inspect it for any foreign objects or damage to the bottom of the port (for example, deformations or scratches).
4. Reinstall the fitting. If the leak continues, replace the fitting.

Cutting Tubing

❖ To cut tubing that uses 10-32 double-cone ferrule fittings

Use a tubing cutter to cut tubing to the required length. Make sure the cut is at a right angle to the length of the tubing and there are no nicks or burrs on the end. If necessary, order a tubing cutter (P/N 049584) from Thermo Fisher Scientific.

Note Do not cut tubing on which IC PEEK Viper fittings are installed.

Servicing Pump Components

This section includes the following procedures:

- “Replacing Pump Check Valves” on page 183
- “Replacing Pump Seals” on page 185
- “Replacing a Pump Piston” on page 190
- “Replacing the Seal on the Pump Priming Valve Knob” on page 192

Replacing Pump Check Valves

A dirty check valve causes erratic flow rates and pressures; in addition, it may cause the pump to lose prime and/or be difficult to re-prime. If a check valve leaks or is dirty, it should be replaced.

Items needed

- Inlet check valve assembly (P/N 045722)
- Outlet check valve assembly (P/N 045721)
- 1/2-inch wrench (P/N 062336)
- Standard disposable laboratory gloves (powder-free, particle-free, and oil-free)
- 0.2 micron filtered, Class 10, isopropyl alcohol (IPA)

❖ To remove the check valves

1. Turn off the pump flow.
2. Begin monitoring the Pressure reading on the pump ePanel in Chromeleon. When the system pressure reaches zero:
 - Disconnect the pump from Chromeleon by clicking **Connected** on the ePanel.
 - Flip the power switch on the rear panel to turn off the system power.
3. Open the pump compartment door.
4. To prevent contamination of pump parts, put on disposable laboratory gloves (powder-free, particle-free, and oil-free) before disassembling the pump head.

Note Never disassemble the pump head with bare hands. Even minute particles of dust, dirt, etc., on the check valves or piston can contaminate the inside of the pump head and result in poor pump performance.

5. Disconnect the tubing connections from the inlet and outlet check valves (see [Figure 82](#)).

Figure 82. Pump components

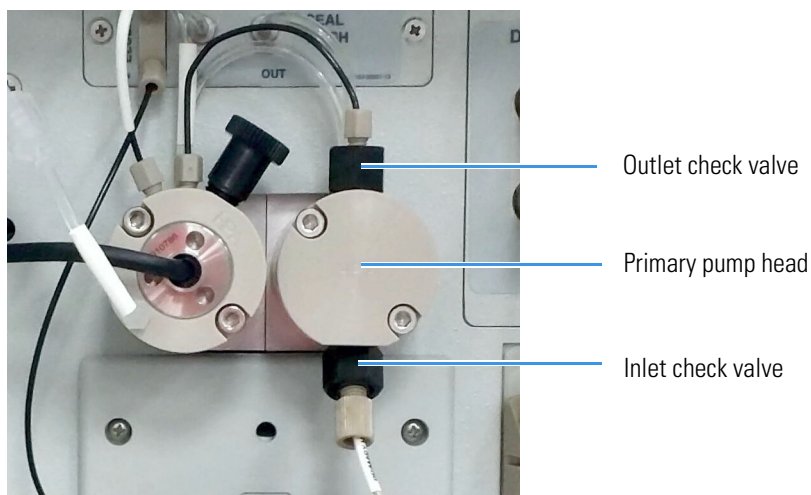

6. Loosen both check valve assemblies, using a 1/2-inch wrench, and remove them from the pump head.

❖ **To install the new check valves**

1. Rinse the bottom of the check valve ports in the pump head with isopropyl alcohol and air-dry the ports. Inspect the bottom of each port for any particulate matter. If necessary, rinse and dry again until they are clean.
2. Identify the *inlet* check valve assembly, which has a 1/4-28 port, and verify that the double-hole end of the cartridge is visible (see [Figure 83](#)). If the double-hole end is not visible, remove the cartridge from the housing and install it correctly.
3. Identify the *outlet* check valve assembly, which has a smaller (10-32) port, and verify that the single-hole end of the cartridge is visible (see [Figure 83](#)). If the single-hole end is not visible, remove the cartridge from the housing and install it correctly.

Figure 83. Inlet and outlet check valve assemblies

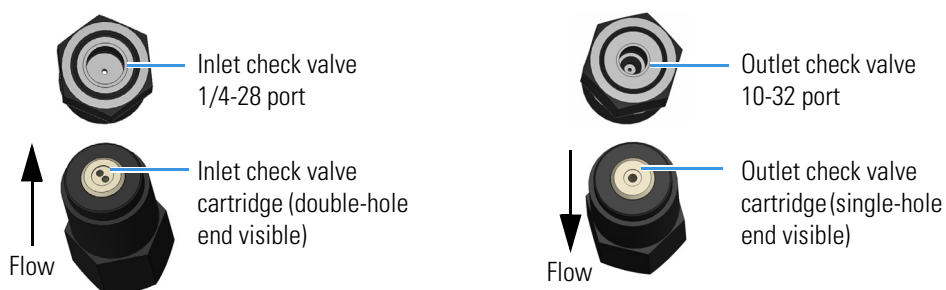

Note For correct pump operation, the check valve cartridges must be installed in their respective housings in the correct orientation. Liquid enters through the check valve in the large single hole and exits through the small double holes.

4. Install the inlet check valve assembly on the *bottom* of the primary pump head. Install the outlet check valve assembly on the *top* of the pump head.
5. Tighten the check valves fingertight, and then use the 1/2-inch wrench to tighten an additional one-quarter to one-half turn.

IMPORTANT Overtightening may damage the pump head and check valve housing and crush the check valve seats.

6. Reconnect the inlet and outlet tubing to the check valves.
7. Close the compartment door.
8. Turn on the system power, reconnect the pump to Chromeleon, and turn on the pump flow.

Replacing Pump Seals

A defective seal allows leakage past the piston. This may cause unstable flow rates and baseline noise; in addition, it may make it difficult to prime the pump.

Items needed

- Main seal (P/N 075768)
- Seal wash seal (P/N 063382)
- O-ring (P/N 040695)
- 10-32 fitting plugs (P/N 042772)
- 10 mL syringe (P/N 079803)

Additional items needed

- Seal insertion tool (P/N 60-078499); provided in the Dionex Integriion Preventive Maintenance Kit (P/N 22153-62041) or ordered separately
- Standard disposable laboratory gloves (powder-free, particle-free, and oil-free)
- Small beaker
- ASTM Type I (18 megohm-cm) filtered and deionized water that meets the specifications listed in [“Deionized Water Requirements for IC”](#) on page 3.
- Methanol (optional)
- 0.2 micron filtered, Class 10, isopropyl alcohol (IPA)
- Lint-free paper towels (KIMWIPES or equivalent)
- Large flat-blade screwdriver

- 3.0 mm hex key (P/N 062338)

❖ **To remove the pump head and piston**

1. Turn off the pump flow.
2. Begin monitoring the Pressure reading on the pump ePanel in Chromeleon. When the system pressure reaches zero:
 - Disconnect the pump from the software by clicking **Connected** on the ePanel.
 - Flip the power switch on the rear panel to turn off the system power.
3. Open the pump compartment door.
4. To prevent contamination of pump parts, put on disposable laboratory gloves (powder-free, particle-free, and oil-free) before disassembling the pump head.

Note Never disassemble the pump head with bare hands. Even minute particles of dust, dirt, etc., on the check valves or piston can contaminate the inside of the pump head and result in poor pump performance.

5. Disconnect all tubing connections to the pump head with the defective seal.
6. Using a 3.0 mm hex key (P/N 062338), alternately loosen both screws on the pump head one-eighth turn at a time. Remove the screws, and then carefully remove the head and place it on a clean surface.
7. When disassembling a pump head, see [Figure 84](#) or [Figure 85](#).

Figure 84. Primary pump head assembly

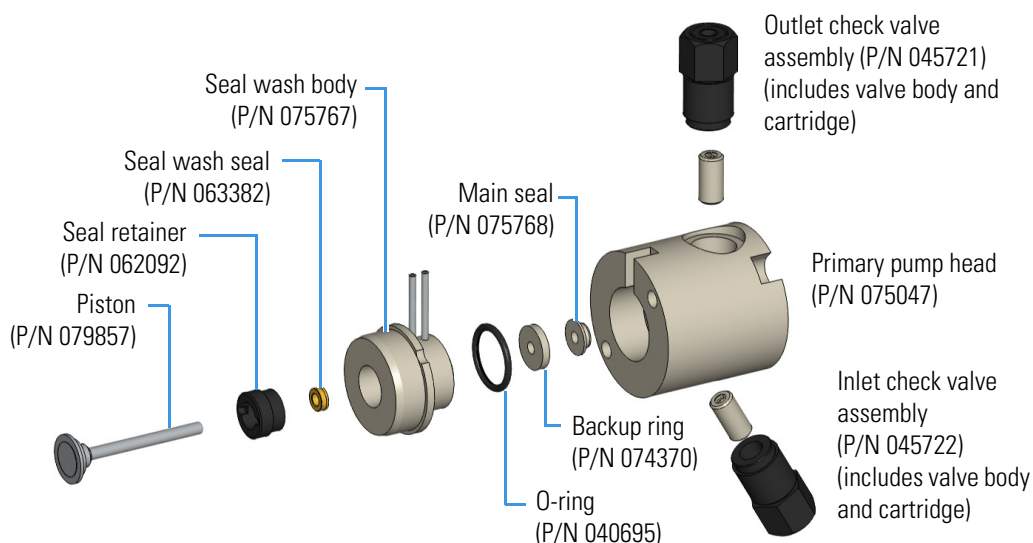
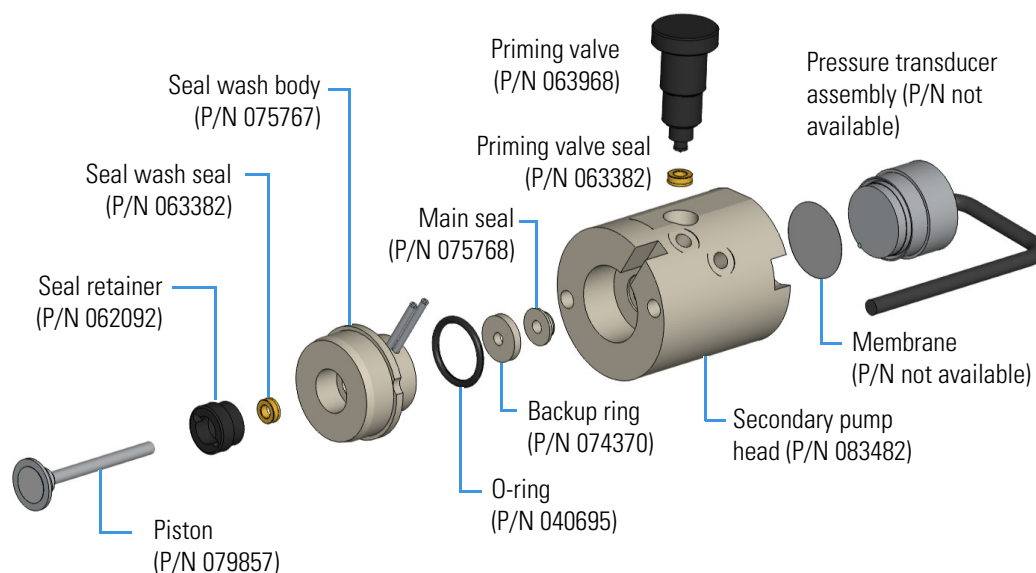

Figure 85. Secondary pump head assembly



8. Remove the seal wash body from the pump head (if present). If the seal wash body remained in the pump mechanism when you removed the pump head, pull it straight out of the pump mechanism at this time.
9. Pull the piston out of the pump mechanism.

Note A magnet secures the piston in place. If the magnetic force makes the piston difficult to remove, tilt the piston to one side and then pull it out of the pump mechanism.

❖ **To clean the piston**

1. Place the piston in a beaker containing either ASTM Type I (18 megohm-cm) filtered and deionized water or methanol. Sonicate for several minutes.
2. After cleaning, rinse the piston thoroughly with ASTM Type I (18 megohm-cm) filtered and deionized water. Dry it with a lint-free paper towel.
3. Inspect the piston for signs of damage. If the piston is scratched or scored, replace it (see [page 190](#)).

IMPORTANT Even minute scratches or particles of dust, dirt, etc. on the check valves or piston can contaminate the inside of the pump head and result in poor pump performance.

❖ **To remove the main seal**

1. For the *primary* pump head, insert a 10-32 fitting plug (P/N 042772) into the 10-32 outlet hole of the check valve nut.

For the *secondary* pump head, insert a 10-32 fitting plug (P/N 042772) into both the 10-32 inlet and outlet holes.

2. Using a 10 mL syringe (P/N 079803), inject a few drops of ASTM Type I (18 megohm-cm) filtered and deionized water through the main seal and into the piston cavity in the pump head.
3. Reinsert the piston approximately 3 mm (0.125 in) into the seal and press gently. The seal should pop out of the head and onto the piston.

IMPORTANT Do not use a sharp tool (such as tweezers) to remove the main seal. This will scratch the inside of the pump housing; these scratches will prevent a proper seal and cause leakage.

4. If the main seal was not removed in [Step 3](#), follow these steps:
 - a. Verify that the 10-32 fitting plugs in the inlet and outlet holes are tightened enough to prevent any leaks from the pump head.
 - b. Fill the piston cavity with water and check for bubbles.
 - c. If there are no bubbles, repeat [Step 3](#).

❖ **To remove the seal wash seal**

1. Remove the O-ring (P/N 040695) and the backup ring (P/N 074370) from the seal wash body.
2. Follow these steps to remove the seal wash seal from the seal wash body:
 - a. Using a large flat-blade screwdriver, remove the seal retainer (P/N 062092) from the seal wash body.
 - b. Insert the piston into the seal wash body from the O-ring side and gently push the seal out of the retainer.

IMPORTANT Do not use a sharp tool (such as tweezers) to remove the seal wash seal. This may scratch the seal and the inside of the pump housing; scratches will prevent a proper seal and cause leakage.

❖ **To install the seals and O-ring**

1. Follow these steps to reassemble the seal wash body:
 - a. Place the seal wash body on a clean work surface.
 - b. Slide the new seal wash seal, with the open side of the seal facing upward, onto the seal insertion tool (P/N 60-078499) (see [Figure 86](#)).

Figure 86. Seal wash seal and seal insertion tool

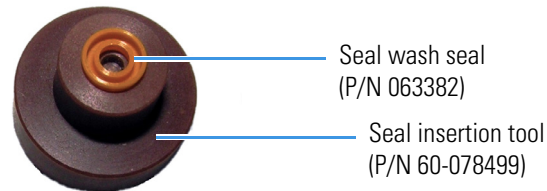

- c. Insert this end of the tool partway into the seal wash body. Make sure the tool is centered and does not rock back and forth. Then, press firmly on the tool and the seal wash body until they snap together.
 - d. Remove the seal insertion tool from the seal wash body.
 - e. The seal wash seal is now partially installed. To complete the seal installation, place the retainer in the seal wash body and use the large flat-blade screwdriver to tighten the retainer.
 - f. Place the new O-ring (P/N 040695) on the seal wash body.

Note When replacing a seal, always replace the O-ring, also. This will prevent leaks.

- g. Place the new backup ring (P/N 074370) on the seal wash body.
2. Rinse the new main seal (P/N 075768) with isopropyl alcohol (IPA) or dip it into a container of IPA. (The seal is easier to install when it is moist.)
3. Insert the piston through the seal wash assembly, and then through the new main seal. Make sure the main seal is centered.

IMPORTANT If the main seal is not centered, applying pressure to it in [Step 7](#) will damage the seal and make it unusable.

4. Remove the 10-32 fitting plugs from the pump head.
5. Place the front of the pump head, flat side down, on a clean work surface. Make sure the open side of the main seal faces away from the retainer for the seal wash seal.
6. Wet the inside of the pump head cavity where the main seal will be installed with 0.2 micron filtered, Class 10, IPA or ASTM Type I (18 megohm-cm) filtered and deionized water.

7. Place the components on the pump head and *gently* press the housing until the main seal snaps into place.

When pressing the seal in place, ensure that the piston is free to move out. This will relieve the pressure in the pump head during seal installation.

IMPORTANT Do not use a sharp tool (such as tweezers) to install the main seal. This will scratch the seal and the inside of the pump housing; these scratches will prevent a proper seal and cause leakage.

❖ **To reinstall the piston and pump head**

1. Slide the piston partway into the pump head; approximately 6 mm (1/4 in) of the sapphire part of the piston should extend from the head.
2. Place the pump head back on the pump.
3. Reinstall the screws in the pump head. Using a 3.0 mm hex key, tighten the screws just until they come into contact with the pump head. Then, tighten the screws another one-quarter to one-half turn, one-eighth of a turn at a time.
4. Reconnect all tubing connections to the pump head. Tighten connections fingertight, and then tighten an additional one-quarter turn only.
5. Close the compartment door.
6. Turn on the system power, reconnect the pump to the software, and turn on the pump flow.

Replacing a Pump Piston

If a new seal leaks (assuming that the pump head is tight), it indicates that the piston is dirty, scratched, or broken, and should be replaced.

Items needed

- Piston for an analytical pump (P/N 079857)
- Standard disposable laboratory gloves (powder-free, particle-free, and oil-free)
- ASTM Type I (18 megohm-cm) filtered and deionized water that meets the specifications listed in [“Deionized Water Requirements for IC”](#) on page 3.

❖ **To remove the pump head and piston**

1. Turn off the pump flow.
2. Begin monitoring the Pressure reading on the pump ePanel in Chromeleon. When the system pressure reaches zero:
 - Disconnect the pump from the software by clicking **Connected** on the ePanel.

- Flip the power switch on the rear panel to turn off the system power.
3. Open the pump compartment door.
 4. To prevent contamination of pump parts, put on disposable laboratory gloves (powder-free, particle-free, and oil-free) before disassembling the pump head.

Note Never disassemble the pump head with bare hands. Even minute particles of dust, dirt, etc., on the check valves or piston can contaminate the inside of the pump head and result in poor pump performance.

5. Disconnect all tubing connections to the pump head with the defective seal.
6. The primary and secondary pump heads have different components. When disassembling a pump head, see [Figure 84](#) for a primary pump head or [Figure 85](#) for a secondary pump head.
7. Locate the 3.0 mm hex key (P/N 062338) in the Ship Kit (RFIC, P/N 22153-62003; non-RFIC, P/N 22153-62002) and then loosen the two screws on the pump head with the defective seal. Remove the screws, and carefully remove the head and place it on a clean surface.
8. If the seal wash body was not removed with the pump head in [Step 7](#), pull it straight out of the pump mechanism now.
9. If the piston was not removed with the pump head or seal wash body, remove the piston now by pulling it straight out of the pump mechanism.

Note A magnet secures the piston in place. If the magnetic force makes the piston difficult to remove, tilt the piston to one side and then pull it out of the pump mechanism.

10. If the piston is broken, be sure to remove all broken pieces. If necessary, flush the pump head with ASTM Type I (18 megohm-cm) filtered and deionized water.

❖ **To install the new piston and reinstall the pump head**

1. Slide the new piston (P/N 079857) partway into the pump head; approximately 6 mm (1/4 in) of the sapphire part of the piston should extend from the head.
2. Place the pump head back on the pump.
3. Reinstall the screws in the pump head. Using the 3.0 mm hex key (P/N 062338), tighten the screws just until they come into contact with the pump head. Then, tighten the screws another one-quarter to one-half turn, one-eighth of a turn at a time.
4. Reconnect all tubing connections to the pump head. Tighten connections fingertight, and then tighten an additional one-quarter turn only.
5. Close the compartment door.

6. Turn on the system power, reconnect the pump to the software, and turn on the pump flow.

Replacing the Seal on the Pump Priming Valve Knob

Replace the seal in the priming valve knob if there is leakage around the valve threads when the valve is open or if the waste port leaks when the valve is closed.

Items needed

- Priming valve seal (P/N 063382)
- Standard disposable laboratory gloves (powder-free, particle-free, and oil-free)

❖ To replace the seal

1. Turn off the pump flow.
2. Begin monitoring the Pressure reading on the pump ePanel in Chromeleon. When the system pressure reaches zero:
 - Disconnect the pump from the software by clicking **Connected** on the ePanel.
 - Flip the power switch on the rear panel to turn off the system power.
3. Open the pump compartment door.
4. To prevent contamination of pump parts, put on disposable laboratory gloves (powder-free, particle-free, and oil-free) before disassembling the pump head.

Note Never disassemble the pump head with bare hands. Even minute particles of dust, dirt, etc., on the check valves or piston can contaminate the inside of the pump head and result in poor pump performance.

5. The priming valve knob is located on the pressure transducer (see [Figure 87](#)). To remove the knob, turn it counterclockwise all the way and then pull it straight off.

Figure 87. Priming valve knob on secondary pump head

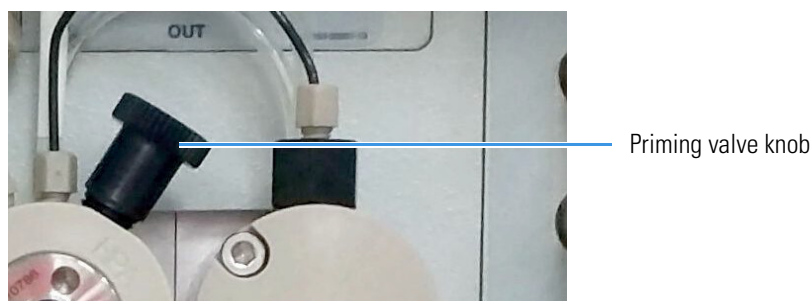

6. Pull the old seal off the end of the priming valve knob.

7. Hold the new seal (P/N 063382) with the groove in the priming valve seal facing away from the knob (see [Figure 88](#)). Carefully slide the seal onto the knob; avoid scratching or nicking the sides.

Figure 88. Priming valve and seal



IMPORTANT Do not use a sharp tool (such as tweezers) to install the seal. This may scratch the seal and the surface of the priming valve knob. These scratches will prevent a proper seal and cause leakage.

8. Insert the priming valve knob into the transducer housing, turn the knob clockwise, and tighten fingertight.
9. Turn on the system power, reconnect the pump to the software, and turn on the pump flow.

Servicing Eluent Generator Components

This section includes the following procedures:

- “[Replacing a Dionex EGC](#)” on [page 193](#)
- “[Replacing a Dionex CR-TC 600](#)” on [page 197](#)

Replacing a Dionex EGC

Replace the Dionex EGC when the cartridge is expended or when it leaks.



CAUTION The Dionex EGC contains one of the following: a corrosive base (KOH, LiOH, or NaOH), a corrosive acid (MSA), or a concentrated K_2CO_3 solution. Wear protective eyewear and gloves when handling the cartridge.



MISE EN GARDE La cartouche d'EGC contient un de ce qui suit: une base corrosive (KOH, LiOH, ou NaOH), un acide corrosif (MSA), ou une solution concentrée de K_2CO_3 . Porter des lunettes et des gants protectives en manipulant la cartouche.



VORSICHT Die EGC-Kartusche enthält eine korrodierende Base (KOH, LiOH oder NaOH), eine korrodierende Säure (MSA) oder eine konzentrierte K_2CO_3 -Lösung. Tragen Sie daher beim Umgang mit Kartusche eine Schutzbrille und Handschuhe.

Items needed

- Dionex EGC compatible with the Dionex Integrion. For a list of compatible models, see “Eluent Generator Cartridge (Dionex EGC)” on page 24.
- Dionex EGC vent fitting (supplied with a high-pressure Dionex EGC) or a 10-32 fitting plug
- Protective eyewear and gloves
- Yellow 0.5 mL/min, 7 MPa (1000 psi) backpressure coil (P/N 053765); provided in the Dionex Integrion Ship Kit (RFIC, P/N 22153-62003)
- Small waste container

For reference, [Figure 89](#) shows the final eluent generator plumbing after all setup steps are complete.

Figure 89. Eluent generator flow schematic (after setup is complete)

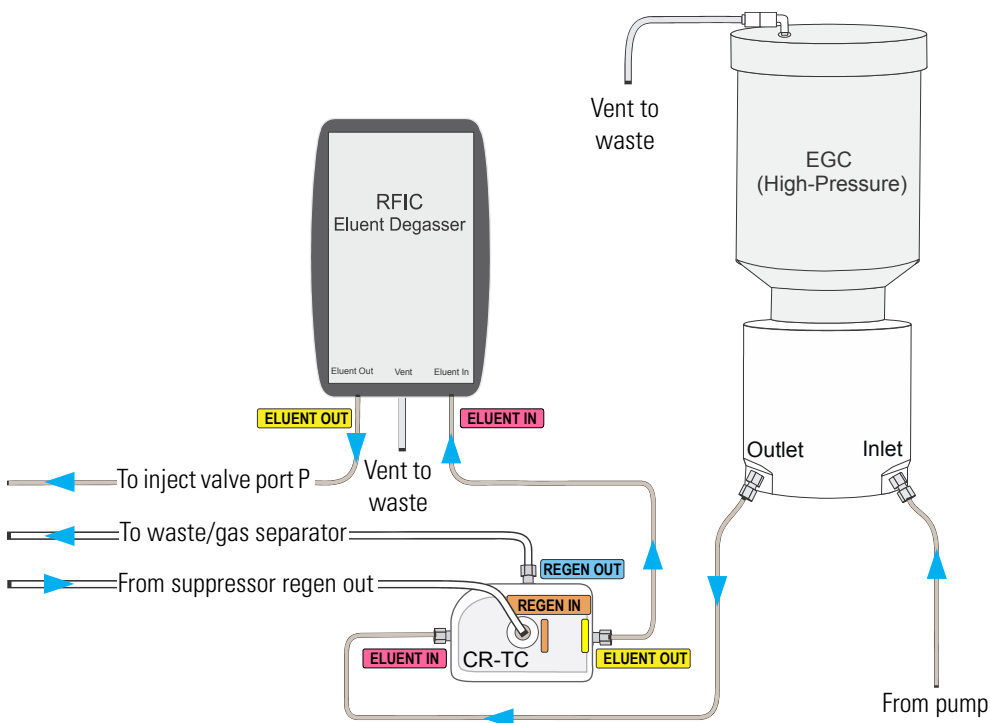

❖ **To remove the old Dionex EGC**

1. Turn off the pump flow. This turns off the Dionex EGC, Dionex CR-TC 600, and suppressor, also.
2. Pull open the display door to access the EG components.
3. Remove the luer fitting and the attached vent line from the Dionex EGC. Install either a vent fitting (supplied with a high-pressure Dionex EGC) (see [Figure 90](#)) or a 10-32 fitting plug in the vent opening. This prevents leakage if the cartridge is turned over during removal.

Figure 90. High-pressure Dionex EGC

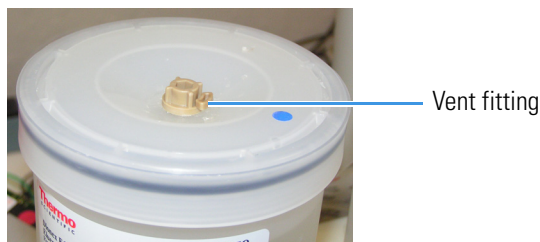

4. Pull the Dionex EGC cable straight out of the electrical connector.
5. Disconnect the eluent inlet line from the Dionex CR-TC 600, pull the cable straight out of the electrical connector, and swing the Dionex CR-TC 600 holder out of the way.
6. Disconnect the Dionex CR-TC 600 eluent inlet line from the Dionex EGC outlet port. Save the line. Disconnect the line from the Dionex EGC inlet port and remove the Dionex EGC from the system.
7. For instructions on disposal of an expended Dionex EGC or storage of a Dionex EGC, refer to the Dionex EGC manual, provided on the Thermo Fisher Scientific Reference Library DVD (P/N 60-053891).

❖ **To prepare the new Dionex EGC**

1. Remove the new Dionex EGC from the shipping container.

Note Save the shipping container; it may be required for storage or disposal of the Dionex EGC.

2. Verify that the vent fitting (on a high-pressure Dionex EGC) or fitting plug (on a standard-pressure Dionex EGC) is tightened. This prevents leaks during installation.
3. Remove the fitting plugs from the inlet and outlet ports on the Dionex EGC.
4. While holding the Dionex EGC with the ports on the bottom, tap the cartridge with the palm of your hand 10 to 15 times to dislodge air bubbles that may be trapped in the electrolysis chamber.

5. Connect the pump outlet line to the Dionex EGC inlet port (see Figure 91).
6. Connect one end of the backpressure coil to the Dionex EGC outlet port. (This is a temporary connection.) Direct the other end of the backpressure coil to a small waste container. A minimum of 14 MPa (2000 psi) of backpressure is required.

Figure 91. Flow schematic for conditioning the Dionex EGC

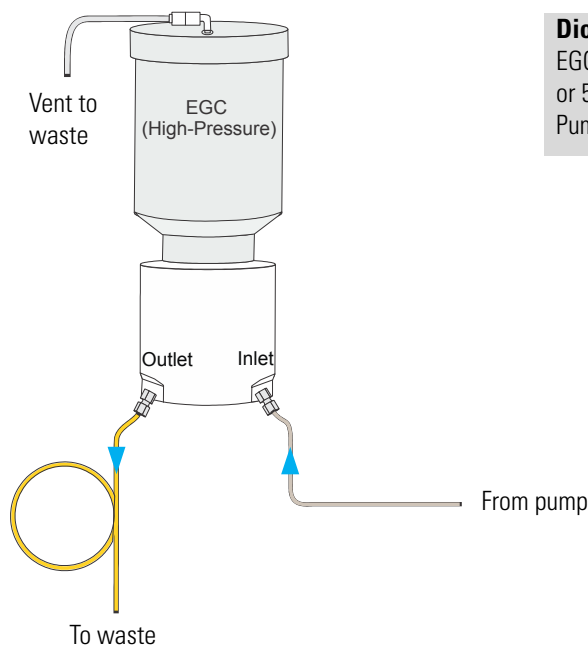

Dionex EGC conditioning:
EGC concentration at either 9 mM (for K_2CO_3)
or 50 mM (for all other cartridge types)
Pump flow 1 mL/min for 30 min

7. Remove the vent fitting or fitting plug and connect the vent line removed from the old cartridge to the vent opening. Save the vent fitting.

IMPORTANT To ensure proper ventilation, always connect the luer fitting and vent tubing to the Dionex EGC before operation. If you need to remove the Dionex EGC from the system, install the vent fitting or a fitting plug to prevent leaks.

8. Align the four pins inside the Dionex EGC cable connector with the holes in the **EGC** connector on the front tray. Push the cable firmly onto the front tray connector to secure it.



4-pin Dionex EGC cable connector

❖ To flush and condition the Dionex EGC

1. Verify that the suppressor and the Dionex CR-TC 600 are off.

IMPORTANT To avoid damaging the suppressor and Dionex CR-TC 600, always turn them off before flushing and conditioning the Dionex EGC. The pump flow is on during flushing; however, no flow reaches the suppressor or Dionex CR-TC 600.

2. Set the pump flow to 1.0 mL/min and turn on the flow.

3. Set the EG concentration to the value required for the cartridge type:

- For a Dionex EGC 500 K_2CO_3 , set the concentration to **9 mM**.
- For all other cartridge types, set the concentration to **50 mM**.

IMPORTANT To ensure proper ventilation, always install the luer fitting on the top of the Dionex EGC before operation. If you need to remove the Dionex EGC from the system, install the vent fitting or fitting plug to prevent leaks.

4. Turn on the Dionex EGC power. Condition the Dionex EGC for 30 minutes and then turn off the Dionex EGC and the pump flow.
5. Disconnect the backpressure coil from the Dionex EGC outlet port.
6. Reconnect the Dionex CR-TC 600 eluent inlet line to the Dionex EGC outlet port and connect the other end to the Dionex CR-TC 600 eluent inlet port.
7. Align the four pins inside the Dionex CR-TC 600 cable connector with the holes in the **CR-TC** connector on the front tray. Push the cable firmly onto the front tray connector to secure it.
8. Before beginning operation, check the Consumables Inventory window in Chromeleon to verify that all consumables installed in the system are compatible. Refer to the Chromeleon Help for details.

Replacing a Dionex CR-TC 600

Items needed

- Dionex CR-ATC 600 (P/N 088662) or Dionex CR-CTC 600 (P/N 088663)
- Tubing and fittings for hydrating the Dionex CR-TC 600; provided in the Dionex Integration Ship Kit (RFIC, P/N 22153-62003; non-RFIC, P/N 22153-62002)

See [Figure 89](#) for the Dionex Integriion EG flow schematic.

❖ To remove the old Dionex CR-TC 600

1. Turn off the pump flow. This turns off the Dionex EGC, Dionex CR-TC 600, and suppressor, also.
2. Pull open the display door to access the Dionex CR-TC 600.
3. Unplug the Dionex CR-TC 600 cable (pull it straight out of the connector).
4. Disconnect the liquid lines from the four ports on the Dionex CR-TC 600.
5. Pull the Dionex CR-TC 600 straight off of its mounting location and remove it from the system.

❖ To flush the new Dionex CR-TC 600

1. Remove the plugs from the ports on the new Dionex CR-TC 600.
2. Connect the Dionex EGC eluent outlet line to the Dionex CR-TC 600 eluent inlet port (see Figure 92).
3. Connect the Dionex CR-TC 600 hydration tubing between the Dionex CR-TC 600 eluent out port and regen in port as shown in Figure 92.
4. Connect a waste line to the Dionex CR-TC 600 regen out port and direct the tubing to waste.

Figure 92. Flow schematic for flushing the Dionex CR-TC 600

Dionex CR-TC 600 flushing:

Pump flow at application rate for 10 min

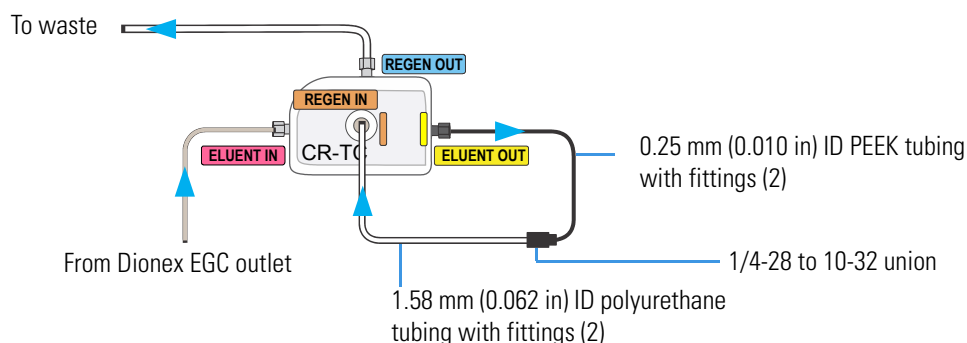

5. Verify that the suppressor current, Dionex EGC current, and Dionex CR-TC 600 voltage are off.

IMPORTANT To avoid damaging the suppressor, always turn off the suppressor before flushing the Dionex CR-TC 600. The pump flow is on during conditioning; however, no flow reaches the suppressor.

6. Set the pump flow rate to 1 mL/min and turn on the pump flow.
7. Flush the Dionex CR-TC 600 for 10 minutes.
8. Turn off the pump.

❖ To complete the new Dionex CR-TC 600 plumbing

1. Disconnect the lines from the Dionex CR-TC 600 eluent out, regen out, and regen in ports.
2. Align the two mounting holes on the Dionex CR-TC 600 back plate with the ball studs on the mounting plate, check that no liquid lines are caught under the Dionex CR-TC 600, and then push the Dionex CR-TC 600 firmly onto the mounting ball studs. The CR-TC clicks into place when properly installed.

3. Reconnect the liquid lines to the Dionex CR-TC 600 eluent out, regen out, and regen in ports (see [Figure 93](#)).

Figure 93. Flow schematic for operating the Dionex CR-TC 600

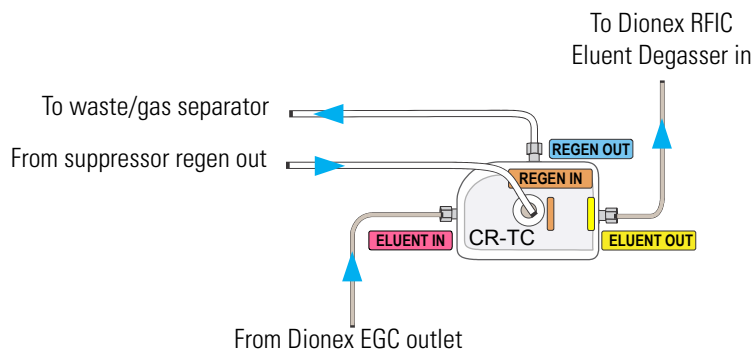

4. Align the four pins inside the cable connector with the holes in the CR-TC connector on the front tray. Push the cable firmly onto the front tray connector to secure it.
- 

4-pin Dionex
CR-TC 600
cable connector
5. Before beginning operation, check the Consumables Inventory window in Chromeleon to verify that all consumables installed in the system are compatible. Refer to the Chromeleon Help for details.

Servicing High-Pressure (Injection) Valves

This section includes the following procedures:

- “[Rebuilding a High-Pressure Valve](#)” on [page 199](#)
- “[Replacing a High-Pressure Valve Pod](#)” on [page 200](#)

Rebuilding a High-Pressure Valve

Thermo Fisher Scientific recommends rebuilding the high-pressure injection valve annually.

Items needed

To obtain the required replacement parts, order the appropriate High-Pressure Valve Maintenance Kit:

- 0.4 μ L Internal Loop High-Pressure Valve Maintenance Kit (P/N 075040)
- 6-Port High-Pressure Valve Maintenance Kit (P/N 075974)
- 10-Port High-Pressure Valve Maintenance Kit (P/N 079053)

Note Substitution of non-Dionex/Thermo Fisher Scientific parts may impair valve performance and void the product warranty.

Note If you prefer, you can replace the high-pressure valve “pod,” instead of rebuilding the valve. Replacing the pod is easier and faster than rebuilding the valve.

❖ **To rebuild a high-pressure valve**

1. Turn off the pump flow.
2. Flip the power switch on the rear panel to turn off the system power.
3. Open the column compartment door.
4. Disconnect each liquid line connected to the valve.
5. Follow the instructions provided with the Maintenance Kit to rebuild the valve.
6. Reconnect all liquid lines to the injection valve.
7. Turn on the system power.
8. Turn on the pump flow. Check for leaks from the valve. For tightening guidelines for high-pressure fittings, see [page 180](#).
9. Close the door.

Replacing a High-Pressure Valve Pod

This procedure describes how to replace the mechanical parts (the “pod”) of a high-pressure valve.

Note If the valve electronics require service, contact Thermo Fisher Scientific. Electronics-related repair procedures must be performed by Thermo Fisher Scientific personnel.

Note Substitution of non-Dionex/Thermo Fisher Scientific parts may impair valve performance and void the product warranty.

Items needed

4-port pod (P/N 074699), 6-port pod (P/N 075971), or 10-port pod (P/N 075972)

❖ **To replace a high-pressure valve pod**

1. Turn off the pump flow.
2. Flip the power switch on the rear panel to turn off the system power.
3. Open the column compartment door.
4. Disconnect each liquid line connected to the valve.
5. Grasp the front of the valve pod and pull out firmly to remove it from the system.

6. Align the slots in the new pod with the runner in the valve holder on the compartment (see [Figure 94](#)). Valve pods are keyed to fit only one way (one slot is narrower than the other). Verify that the slots are aligned with their matching runners.
7. Also verify that the two splines on the pod align with the matching splines inside the valve holder (see [Figure 94](#)). If necessary, twist the end of the pod to adjust the position of the splines.

Figure 94. High-pressure valve pod and pod holder

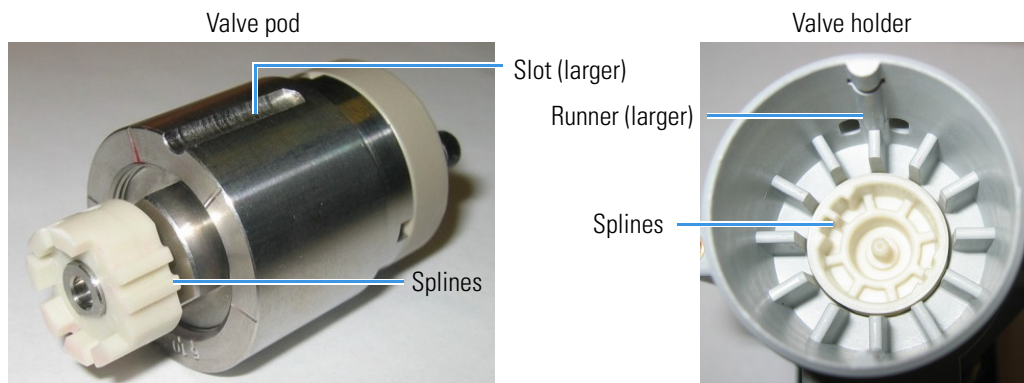

8. Push the pod into the holder until it clicks into place.
9. Reconnect all liquid lines to the valve.
10. Turn on the system power and start the pump flow. Check for leaks from the valve. Tighten fittings as required. For tightening guidelines for high-pressure fittings, see [page 180](#).
11. Close the door.

Servicing a Dionex Integrion Conductivity Detector

This section includes the following procedures:

- “[Calibrating a CD Cell](#)” on [page 202](#)
- “[Replacing a CD](#)” on [page 203](#)
- “[Replacing a Suppressor](#)” on [page 204](#)

Calibrating a CD Cell

CD cell calibration consists of two steps: calibrating the offset with the total conductivity at or near 0.0 μS , followed by calibrating the slope with the total conductivity at $147.00 \pm 2 \mu\text{S}$.

Note New cells are calibrated at the factory. Do not calibrate a new cell.

Items needed

- 1.0 mM KCl solution (prepare by dissolving 0.07456 g of reagent-grade KCl in 1 liter of 18 megohm-cm deionized water)
- A source of He or N₂ gas

Preparation

1. Fill a reservoir with the 1.0 mM KCl solution and connect it to the pump inlet.
2. Direct the pump outlet to waste. Set the flow rate to 1.0 mL/min and turn on the pump.
3. Set the cell heater to 35 °C and allow the temperature to equilibrate.

❖ To calibrate the CD cell

1. You can perform the calibration from either Chromeleon or the mobile app.
 - For Chromeleon operation: Click the **CD** tab in the ePanel Set and click **Detector Calibration**.
 - For mobile app operation: First, disconnect the Dionex Integrion from Chromeleon. Then, on the mobile app quick access toolbar, tap the Service  icon and select **Calibration**.
2. Follow the instructions on the Calibration ePanel or mobile app to complete the calibration.
3. After calibration, flush the KCl solution from the system by pumping ASTM Type I (18 megohm-cm) filtered and deionized water through the cell. When the conductivity drops to less than 1 $\mu\text{S}/\text{cm}$, stop the pump.
4. Reconnect the system plumbing for routine operation.

Replacing a CD

Items needed

- Dionex Integrion Conductivity Detector (P/N 22153-60036)

❖ To replace a CD

1. Stop the pump flow.
2. Flip the power switch on the rear panel to turn off the system power.

IMPORTANT Always turn off the Dionex Integrion system power before removing or installing a detector.

3. Open the detector compartment door and disconnect the tubing from the inlet and outlet ports on the CD cell.
4. Follow the steps below to remove the suppressor:
 - a. Disconnect the liquid lines from the suppressor.
 - b. Unplug the suppressor cable.
 - c. Slide the suppressor down a few millimeters to detach it from its mounting tabs, and then pull the suppressor toward you to remove it from the detector.
5. Loosen the two thumbscrews on the CD and pull the detector straight out to remove it from the compartment.
6. Note the electrical plug on the back of the new detector and the receptacle inside the detector compartment.
7. Push the new CD (P/N 22153-60036) into the opening and press firmly to ensure the electrical connection is secure. Tighten the thumbscrews.
8. Reinstall the suppressor and reconnect the liquid lines to the suppressor and CD cell.
9. Close the compartment door, turn on the system power, and restart the pump flow.

Removing Trapped Air from a CD Cell

Air bubbles in the cell can cause pulsations of the baseline, random noise, and low readings. Air may result from outgassing of the eluent.

Items needed

- Standard disposable laboratory gloves (powder-free, particle-free, and oil-free)
- Protective eyewear

❖ To remove trapped air from a CD cell

1. Turn off the suppressor (leaving the pump flow on).
2. Disconnect the fitting at the suppressor **Regen In** port.
3. With the pump on, apply pressure by placing your thumb over the open end of the tubing for 3 seconds. Remove your thumb, and then repeat the procedure two more times.
4. Reconnect the fitting to the **Regen In** port and turn on the suppressor current.

Replacing a Suppressor

Refer to the suppressor manual for guidance about when to replace a suppressor and for instructions on how to prepare a new suppressor before initial use. Suppressor manuals are provided on the Thermo Scientific Reference Library DVD (P/N 60-053891).

Items needed

- A suppressor compatible with the Dionex Integrion. For a list of compatible suppressors, see [“Suppressors, CRD, and SRN”](#) on page 31.

Preparation

- All new suppressors require hydration or other preparation steps before initial use. For instructions, refer to the manual for your suppressor type.

❖ To replace the suppressor

1. Stop the pump flow.
2. Flip the power switch on the rear panel to turn off the system power.

IMPORTANT Always turn off the system power before removing or installing a suppressor.

3. Open the detector compartment door and disconnect the liquid lines from the suppressor.
4. Unplug the suppressor cable.
5. Slide the suppressor down a few millimeters to detach it from its mounting tabs, and then pull the suppressor toward you to remove it from the detector.
6. Orient the new suppressor with the **Eluent Out** port on the top and press it onto the mounting tabs. Slide the suppressor down to secure it onto the tabs.
7. Pull slightly on the suppressor to verify that it is securely fastened.
8. Reconnect the liquid lines to the new suppressor and plug in the cable.
9. Close the compartment door, turn on the system power, and restart the pump flow.

10. If the new suppressor is a different type than the previous, configure it in the Chromeleon Instrument Configuration Manager.
11. Before beginning operation, check the Consumables Inventory window in Chromeleon to verify that all consumables installed in the system are compatible. Refer to the Chromeleon Help for details.

Servicing a Dionex Integrion Electrochemical Detector

This section includes the following procedures:

- “[Disconnecting an ED Cell](#)” on [page 205](#)
- “[Replacing a Disposable Working Electrode Gasket](#)” on [page 206](#)
- “[Replacing a Disposable Working Electrode Gasket](#)” on [page 206](#)
- “[Replacing a Conventional Working Electrode Gasket](#)” on [page 207](#)
- “[Polishing a Conventional Working Electrode](#)” on [page 209](#)
- “[Replacing a pH-Ag/AgCl Reference Electrode](#)” on [page 211](#)
- “[Replacing a PdH Reference Electrode](#)” on [page 214](#)

Note To prevent contamination, wear standard disposable laboratory gloves (powder-free, particle-free, and oil-free) when handling the ED cell.

Disconnecting an ED Cell

Before performing an ED cell service procedure, follow these instructions to disconnect the cell.

Note To prevent contamination, wear standard disposable laboratory gloves (powder-free, particle-free, and oil-free) when handling the ED cell. Never touch the electrode surface.

❖ To disconnect an ED cell

1. Turn off the cell voltage from the Chromeleon ePanel or the mobile app Detector page (see “[Electrochemical Detector \(ED\)](#)” on [page 90](#)).
2. Stop the pump flow.
3. Flip the power switch on the rear panel to turn off the system power and then open the detector compartment door.
4. Disconnect the cell outlet and inlet lines from the ED cell and disconnect the two electrical cables.
5. Grasp the cell by the cell body and pull straight out to remove it from the detector.

Replacing an ED

Items needed

- Dionex Integrion Electrochemical Detector (P/N 22153-60037)
- Standard disposable laboratory gloves (powder-free, particle-free, and oil-free)

❖ To replace an ED

1. Follow the instructions in “[Replacing a Disposable Working Electrode Gasket](#)” on [page 206](#) to turn off the cell voltage, stop the pump flow, and disconnect the cell from the detector.
2. Verify that the system power is off.

IMPORTANT Always turn off the system power before removing or installing a detector.

3. Loosen the two thumbscrews on the ED and pull the detector straight out to remove it from the compartment.
4. Note the electrical plug on the back of the new detector and the receptacle inside the Dionex Integrion.
5. Push the new ED (P/N 22153-60037) into the opening and press firmly to ensure the electrical connection is secure. Tighten the thumbscrews.
6. Reinstall the cell and reconnect the cell inlet and outlet lines and the cables.
7. Close the compartment door. Turn on the system power, and restart the pump flow.

Replacing a Disposable Working Electrode Gasket

For installation instructions for disposable working electrodes, refer to the installation guide shipped with the electrodes (listed below) or to *Product Manual for Disposable Electrodes* (Document No. 065040), which is provided on the Thermo Scientific Reference Library DVD (P/N 60-053891).

- *Disposable Silver Electrode Installation Guide for ED* (Document No. 065137)
- *Disposable Platinum Electrode Installation Guide for ED* (Document No. 065139)
- *Disposable Gold Electrode Installation Guide* (Document No. 065191)

IMPORTANT When installing a disposable electrode, be sure to install the correct gasket for your system:

- For a gold, silver, or platinum disposable electrode, use a 0.002 in PTFE gasket (P/N 060141, Pkg. of 4).
- For a carbon disposable electrode, use a 0.001 in Ultem gasket (P/N 069339).

Replacing a Conventional Working Electrode Gasket

Replace the ED cell gasket for conventional working electrodes if there is a leak between the gasket and electrode, or between the gasket and cell body.

Items needed

- ED cell gasket for conventional working electrodes (P/N 045972)
- Standard disposable laboratory gloves (powder-free, particle-free, and oil-free)
- Blunt-end tweezers

❖ To replace the gasket

1. Follow the instructions in “[Replacing a Disposable Working Electrode Gasket](#)” on [page 206](#) to turn off the cell voltage, stop the pump flow, and disconnect the cell from the detector.
2. Unscrew the yoke knob on the yoke block two to three turns to loosen it (see [Figure 95](#)).

Figure 95. ED cell (shown with a pH-Ag/AgCl reference electrode)

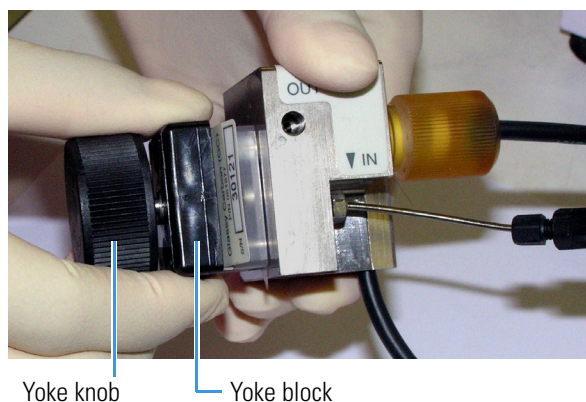

Note Handle the cell gasket and the inside surfaces of the cell carefully to prevent scratches, which may subsequently cause leaks.

3. Squeeze the tabs on the sides of the yoke block and pull the block and knob off the working electrode (see [Figure 95](#)).

- Carefully separate the parts (see [Figure 96](#)).

Figure 96. ED cell components

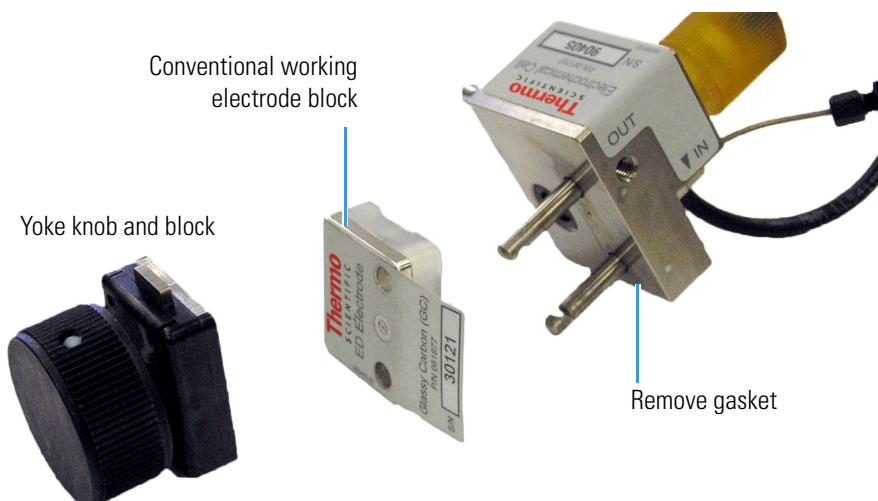

- Use tweezers to remove the old cell gasket from the cell body.
- Rinse the surface of the cell with ASTM Type I (18 megohm-cm) filtered and deionized water that meets the specifications listed in [“Deionized Water Requirements for IC”](#) on [page 3](#).
- Clean the polished surface of the cell with a clean, damp, lint-free tissue.
- Install the new gasket over the alignment pins on the cell body. When correctly installed, one end of the gasket extends beyond the cell body. This facilitates gasket installation and removal. See [“ED cell components”](#) on [page 208](#)
- Verify that the gasket is flat against the cell body and is not wrinkled.
- Reinstall the working electrode block and the yoke knob and block. Fingertighten the yoke knob by turning it a full 360 degrees.

Note It is not possible to over tighten the yoke knob. Once the knob clicks into place, it does not tighten any further. The yoke knob ensures that constant pressure is applied to the cell.

❖ **To reinstall the cell and reconnect tubing**

- Orient the cell assembly with the yoke knob on the left and then push the cell onto its mounting location on the ED.
- Reconnect the cell inlet and outlet lines.
- Reconnect the two electrical cables.
- Start the pump flow.

5. Wait until the pump pressure has stabilized (30 to 60 seconds), and then turn on the cell voltage.

Polishing a Conventional Working Electrode

These instructions are for conventional (nondisposable) working electrodes only. **Do not polish disposable electrodes.**

Guidelines for Polishing a Conventional Working Electrode

- **Do not polish new conventional working electrodes before installation.**
- After an electrode has been used for a period of time, a layer of contamination may build up. When this occurs, the electrode must be polished.
- After the working electrode is polished and installed, background signal and analyte sensitivity require several hours to stabilize. Once stabilized, do not polish the electrode unless you observe a loss of signal or severe electrode recession.

Items needed

- Polishing kit (P/N 036313) shipped with the electrode. The kit contains polishing pads (P/N 036321), a bottle of fine polishing compound (P/N 036318), and a bottle of coarse polishing compound (P/N 036319).
- Standard disposable laboratory gloves (powder-free, particle-free, and oil-free)
- Tweezers

Note To prevent contamination, wear standard disposable laboratory gloves (powder-free, particle-free, and oil-free) when handling when handling the working electrode. Never touch the electrode surface.

❖ To polish a conventional working electrode

1. Remove the working electrode from the cell. See the instructions in [“Replacing a Conventional Working Electrode Gasket,” Step 1 through Step 4.](#)
2. Prepare the polishing pads:
 - a. Designate a pad for use with the coarse polishing compound.
 - b. Designate another pad for fine polishing compound; also designate the working electrode type with which it will be used.

Note Do not use the same fine polishing pad to polish more than one type of working electrode; this can contaminate the electrode surface with microparticles from the other working electrodes.

- c. Designate a pad that will not be used with polishing compound. This pad is for removal of particles after polishing (see [Step 5](#)).

- d. Moisten the suede side of the polishing pad slightly with water and place the pad on a smooth, flat surface, with the suede side facing up.
3. Polish the electrode:

Note

- If you are polishing the electrode before initial installation, use only the fine polishing compound.
- If you are polishing the electrode because of degradation of performance, such as increased baseline noise or tailing peaks, first use the coarse polishing compound. Then, repeat with the fine compound.

- a. Sprinkle about one-half gram of polishing compound in the center of the suede side of the polishing pad. Add enough ASTM Type I (18 megohm-cm) filtered and deionized water to make a thick paste.
 - b. Using the working electrode block, spread the paste evenly over the pad. Then, applying firm pressure in a figure eight motion, polish the surface of the electrode block for about 1 minute. If the pad dries out while polishing, add water sparingly. However, never allow the polishing compound to dry on the electrode.
 - c. Use ASTM Type I (18 megohm-cm) filtered and deionized water to rinse off all traces of polishing compound from the electrode block. An ultrasonic cleaner is effective for thoroughly cleaning the electrode block. Carefully rinse the surface of the block with ASTM Type I (18 megohm-cm) filtered and deionized water.
4. If you used the coarse polishing compound in [Step 3](#), repeat the step with the fine compound.
 5. Using a moist piece of polishing cloth (with no polishing compound added), rub the polished surface free of residual polishing compound particles.
 6. Inspect the surface of the working electrode to make sure that it is clean. Repeat [Step 5](#), if necessary.

Note The polishing pads are reusable. Do not rinse the polishing compound from the pads. After initial use, add only enough polishing compound to maintain the coating on the pad.

7. Replace the working electrode block and yoke knob. Fingertighten the knob by turning it a full 360 degrees.

Note It is not possible to over tighten the yoke knob. Once the knob clicks into place, it does not tighten any further. The yoke knob ensures constant pressure is applied to the cell.

❖ **To reinstall the cell and reconnect tubing**

1. Orient the cell assembly with the yoke knob on the left and then push the cell onto its mounting location on the ED.
2. Reconnect the cell inlet and outlet lines.
3. Reconnect the two electrical cables.
4. Start the pump flow.
5. Wait until the pump pressure has stabilized (30 to 60 seconds), and then turn on the cell voltage.
6. Reapply the electrode potential. The baseline will drift for more than 1 hour as the cell re-equilibrates. Peak area values may require up to 12 hours to stabilize.

Replacing a pH-Ag/AgCl Reference Electrode

When to Replace a pH-Ag/AgCl Reference Electrode

Replace the pH-Ag/AgCl reference electrode if performance problems occur that are not corrected by regenerating the electrode. Performance problems can include no pH readouts, a shift in Ag/AgCl reference potential or incorrect readouts, baseline spikes, or a decreased response even with a freshly polished working electrode. The pH-Ag/AgCl reference electrode typically lasts from 3 months to 1 year, depending on use.

Note To regenerate a pH-Ag/AgCl reference electrode, soak it in a solution of 1 M KCl and 1 M HCl.

Items Needed

- pH-Ag/AgCl reference electrode (P/N 061879)
- Standard disposable laboratory gloves (powder-free, particle-free, and oil-free)
- Make or purchase two buffer solutions for the reference electrode calibration procedure:
 - A pH 7 buffer solution
 - A buffer solution that matches the pH of the eluent used in your application (for example, pH 4 or pH 10)

See [Table 34](#) for a list of recommended buffer solutions and their part numbers.

Table 34. Recommended pH buffer solutions

Product	Quantity	Fisher Scientific P/N
pH 4 Calibration and Check Standard	500 mL	SB101-500
pH 7 Calibration and Check Standard	500 mL	SB107-500
pH 10 Calibration and Check Standard	500 mL	SB141-500

❖ **To remove the old pH-Ag/AgCl reference electrode**

1. Follow the instructions in “Replacing a Disposable Working Electrode Gasket” on page 206 to turn off the cell voltage, stop the pump flow, and disconnect the cell from the detector.
2. To prevent contamination, put on standard disposable laboratory gloves (powder-free, particle-free, and oil-free) before handling the ED cell.
3. Unscrew the pH-Ag/AgCl reference electrode and remove it from the cell body (see Figure 97).

Figure 97. ED cell with pH-Ag/AgCl reference electrode

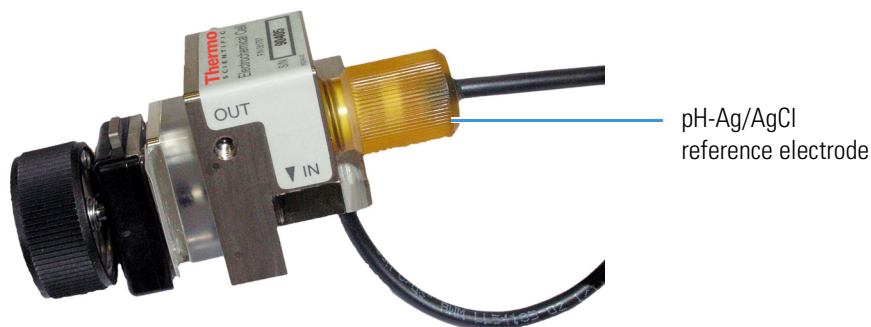

❖ **To prepare the new pH-Ag/AgCl reference electrode**

1. Remove the pH-Ag/AgCl reference electrode (P/N 061879) from its box (see Figure 98).

Figure 98. pH-Ag/AgCl reference electrode in storage cap



IMPORTANT The ED pH-Ag/AgCl reference electrode (P/N 061879) is similar in appearance to the Dionex AS-AP pH electrode (P/N 075529). However, these two electrodes are not interchangeable. Before continuing, check the label on the electrode to verify that you have the correct type.

2. Hold the electrode vertically, with the cable up and the storage cap down, to prevent spilling the storage fluid in the cap. Unscrew the storage cap from the electrode. Be careful not to spill the contents. Save the cap.

IMPORTANT Always store the pH-Ag/AgCl reference electrode in the storage cap filled with saturated KCl solution when the cell is not in use. This prevents the pH-Ag/AgCl reference electrode membrane from drying out and damaging the electrode.

3. Rinse the pH-Ag/AgCl reference electrode thoroughly in ASTM Type I (18 megohm-cm) filtered and deionized water to remove any precipitated salt.
4. Calibrate the pH-Ag/AgCl reference electrode.

❖ **To calibrate the pH-Ag/AgCl reference electrode**

1. Connect the cell and electrode electrical cables to the detector. Do not install the electrode in the cell yet.
2. You can perform the calibration from either Chromeleon or the mobile app.
 - For Chromeleon operation: Click the **ED** tab on the ePanel Set and click **pH Calibration**.
 - For mobile app operation: First, disconnect the Dionex Integrion from Chromeleon. Then, on the toolbar, tap the Service  icon and select **Calibration**.
3. Follow the instructions on the Calibration ePanel or mobile app to calibrate the offset and then the slope.
4. After calibration, disconnect the electrode cable and the cell cable.
5. Grasp the cell body and pull straight out to remove the cell from the detector.

❖ **To install the pH-Ag/AgCl reference electrode in the cell**

1. To avoid any hydraulic pressure buildup when inserting the reference electrode into the cell, verify that fitting plugs are not installed on the cell inlet and outlet fittings.
2. Verify that the O-ring is present on the pH-Ag/AgCl reference electrode (see [Figure 99](#)).

Figure 99. pH-Ag/AgCl reference electrode O-ring



7 Service

Servicing a Dionex Integrion Electrochemical Detector

3. Screw the pH-Ag/AgCl reference electrode into the reference electrode well and tighten it fingertight (see [Figure 100](#)).

Figure 100. Installation of the pH-Ag/AgCl reference electrode in the reference electrode well



4. Orient the cell assembly with the yoke knob on the bottom, and then push the cell onto its mounting location on the ED.
5. Reconnect the cell inlet and outlet ports and reconnect the two electrical cables.
6. Start the pump flow and turn on the Dionex Integrion power.
7. Wait until the pump pressure has stabilized (30 to 60 seconds) and then turn on the cell voltage.

Replacing a PdH Reference Electrode

When to Replace a PdH Reference Electrode

- Replace the PdH reference electrode if its sensing surface is damaged or if the electrode no longer seals properly. Replace the PdH electrode if performance has degraded (for example, you observe a lower response, higher background, or spikes).
- The PdH reference electrode typically lasts several years, depending on use.

Items Needed

- PdH reference electrode (P/N 072075)
- O-ring (P/N 030839)
- Wrench
- Tweezers
- Standard disposable laboratory gloves (powder-free, particle-free, and oil-free)

❖ To replace a PdH reference electrode

1. Follow the instructions in “Replacing a Disposable Working Electrode Gasket” on [page 206](#) to turn off the cell voltage, stop the pump flow, and disconnect the cell from the detector.
2. Use a wrench to unscrew the PdH reference electrode nut and then remove the nut from the reference electrode well (see [Figure 101](#)).

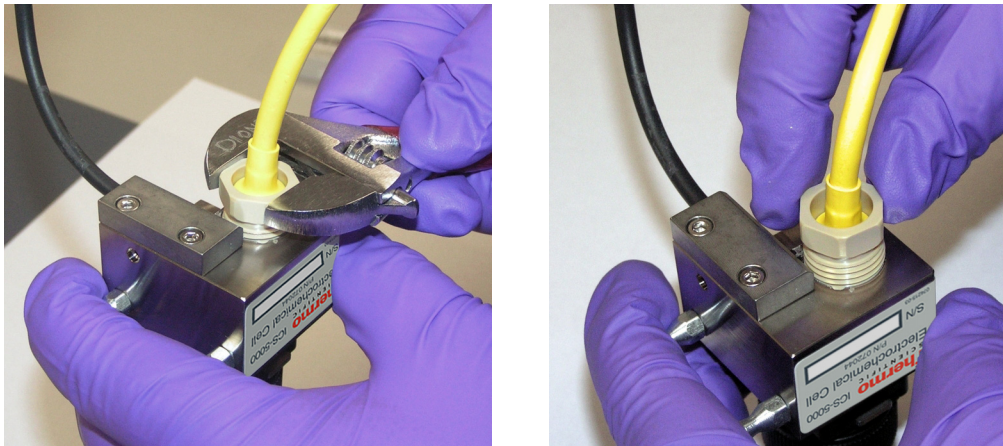
Figure 101. Removal of the PdH reference electrode nut

3. Pull the reference electrode out of the well (see [Figure 102](#)).

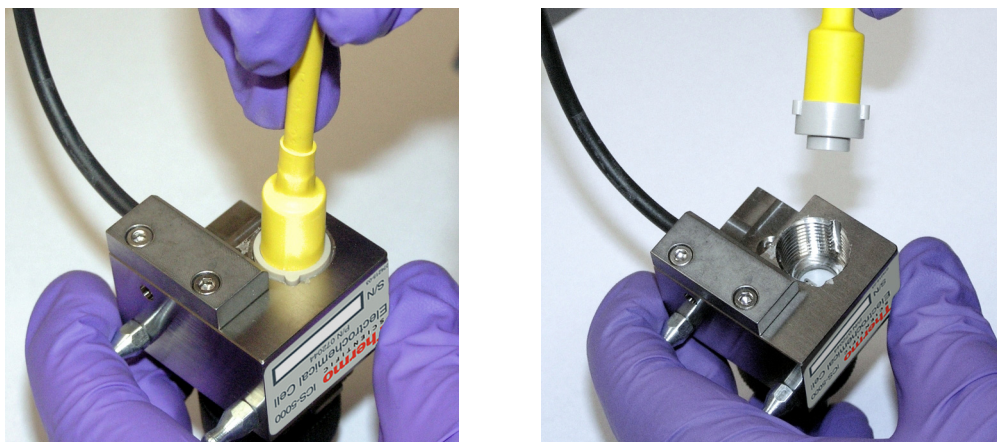
Figure 102. Removal of the PdH reference electrode

- Using tweezers, remove the PdH reference electrode gasket from the well (see [Figure 103](#)).

Figure 103. PdH reference electrode gasket installed in the reference electrode well

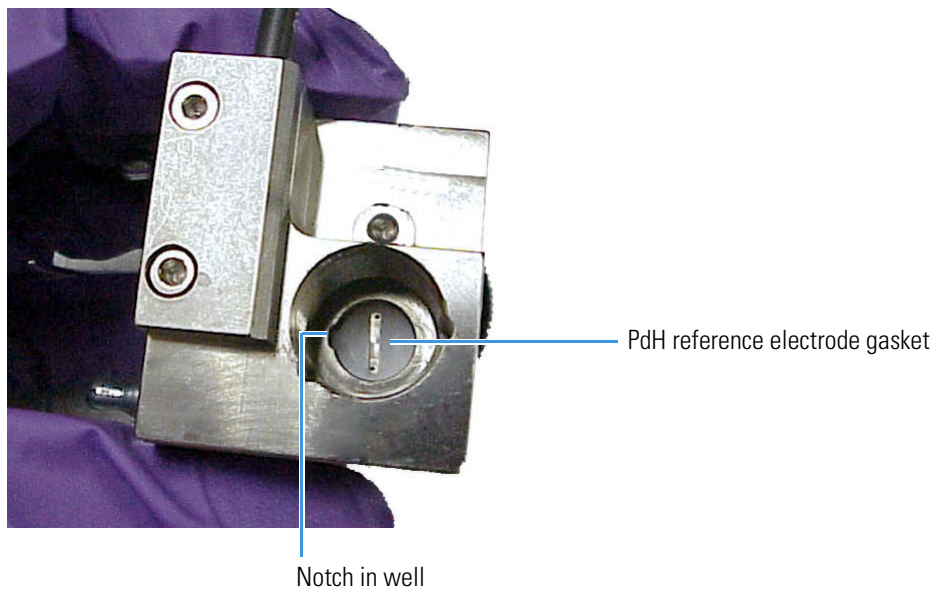

- Using tweezers, grasp the new PdH reference electrode gasket (P/N 072214) on its edge (see [Figure 104](#)). To avoid deforming the gasket cutout, do not place the tweezer tips on the cutout.

Figure 104. Installation of the PdH reference electrode gasket

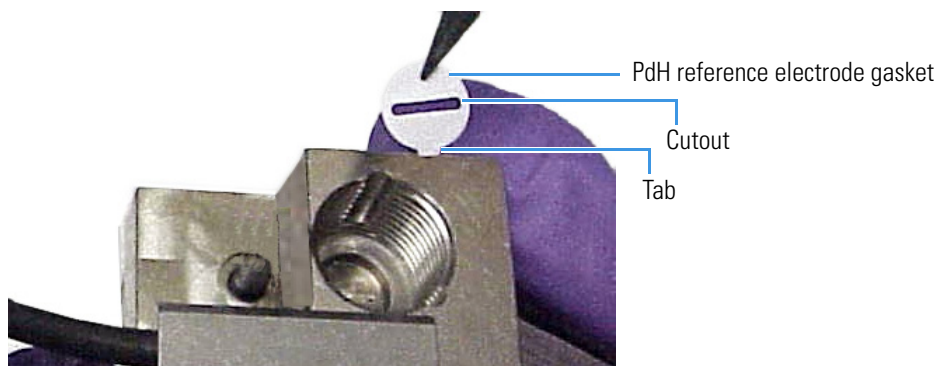

- Align the tabbed edge of the gasket with the corresponding notch in the reference electrode well, and then press the gasket into the well.
- Install the O-ring (P/N 030839) on the end of the reference electrode.
- To avoid any hydraulic pressure buildup when inserting the reference electrode into the cell, verify that fitting plugs are not installed on the cell inlet and outlet fittings.
- A fitting with knobs is installed on the end of the PdH reference electrode. Align the knobs on the fitting with the grooves in the reference electrode well (see [Figure 105](#)).

Figure 105. Installation of the PdH reference electrode

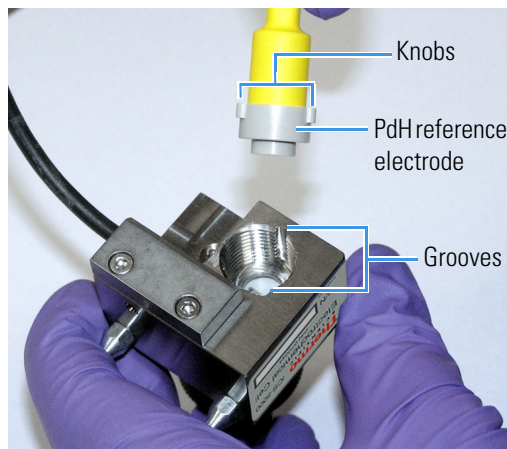

10. Insert the fitting into the well.
11. Screw the nut on the PdH reference electrode into the reference electrode well and tighten it fingertight. After fingertightening, use a wrench to tighten the nut an additional 20 to 30 degrees.
12. Orient the cell assembly with the yoke knob on the bottom and then push the cell onto its mounting location on the ED.
13. Reconnect the cell inlet and outlet ports and reconnect the two electrical cables.
14. Start the pump flow and turn on the Dionex Integrion power.
15. Wait until the pump pressure has stabilized (30 to 60 seconds), and then turn on the cell voltage.

Go on to the next section to condition the PdH reference electrode.

Conditioning the PdH Reference Electrode

Condition the PdH reference electrode after plumbing the cell.

❖ To condition the PdH reference electrode

1. Set the pump flow rate to **1 μ L/min** and turn on the pump flow.
2. Set the concentration to **100 mM** and turn on the Dionex EGC.
3. Verify that eluent is exiting the cell.
4. Set the ED reference electrode type to **PdH** and turn on the PdH power.
5. Select **DC Amperometry** mode, set the DC voltage to **0.000 V**, and turn on the cell voltage. Switch to **Integrated Amperometry** mode, click **Set Integrated Amperometry**, and select the **Gold, PdH RE, Carbo, Quad** waveform.
6. Condition the electrode for 1 hour at these settings.

7. Turn off the pump flow. This turns off the Dionex EGC power and the cell voltage.

Changing the Main Power Fuses

1. If the pump flow is currently on:
 - a. Turn off the flow.
 - b. Begin monitoring the current pressure reading. When the system pressure reaches zero, disconnect the system from the software by clicking **Connected** on the ePanel.
2. Flip the power switch on the rear panel to turn off the system power.
3. Disconnect the main power cord from both its source and from the rear panel.



WARNING HIGH VOLTAGE—Disconnect the main power cord from its source and also from the rear panel of the Dionex Integrion.



CAUTION The power supply cord is used as the main disconnect device. Make sure the socket-outlet is located near the IC system and is easily accessible.



CAUTION Operation at AC input levels outside of the specified operating voltage range may damage the IC system.



AVERTISSEMENT HAUTE TENSION—Débranchez le cordon d'alimentation principal de sa source et du panneau arrière du Dionex Integrion.



MISE EN GARDE Le cordon d'alimentation principal est utilisé comme dispositif principal de débranchement. Veillez à ce que la prise de base soit située/installée près du module et facilement accessible.



WARNUNG STROMSCHLAGGEFAHR—Zur Vermeidung von elektrischen Schlägen ist eine geerdete Steckdose zu verwenden. Das Gerät darf nicht ohne Erdung betrieben bzw. an Wechselstrom angeschlossen werden.



VORSICHT HOCHSPANNUNG—Ziehen Sie das Netzkabel aus der Steckdose und der Netzbuchse auf der Rückseite des Dionex Integrion.

4. The fuse holder is located below the power switch on the rear panel (see [Figure 106](#)). Use a small screwdriver to remove the fuse holder.

Figure 106. Power switch, fuse holder, and power receptacle

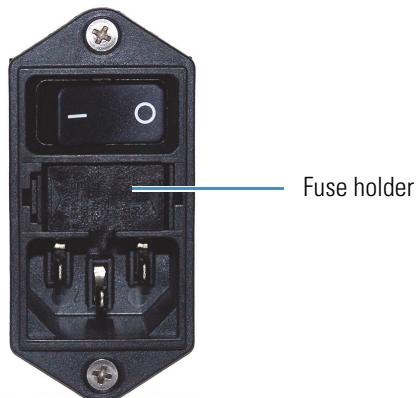

5. Replace the two fuses with new 5 A, 250 V, 5 x 20 mm IEC 60127-2 fast-blow fuses (P/N 00006-03-00016). Thermo Fisher Scientific recommends always replacing *both* fuses.
6. Reinstall the fuse holder. Reconnect the power cord and turn on the power.

7 Service

Changing the Main Power Fuses

Specifications

Pump	
Type	Isocratic, dual-piston (in series), microprocessor-controlled, constant-stroke, variable-speed, patented Isokinetic Eluent Precompression
Construction	Chemically inert, metal-free PEEK pump heads and flow path; compatible with aqueous eluents from pH 0–14 and reversed-phase solvents
Pressure Range	0–41 MPa (0–6000 psi)
Flow Rate Range	Flow Rate Range: 0.001–22.4* mL/min with settable flow increments at 0.001 mL/min *Flow rates above 10 mL/min require optional high flow rate pump heads
Flow Rate Precision	< 0.1%
Flow Rate Accuracy	≤0.1%
Pressure Ripple	<1.00% at 1.0 mL/min
Reservoir Pressure	None required; optional regulator assembly available
Vacuum Degasser	Option, low-pressure
Pump Seal Wash	Option, automatic operation
RFIC-EG Gradients	Electrolytic eluent generation at high pressure 0.1–100 mM
Gradient Profiles	Any combination of an unlimited number of linear, convex, and concave positive and negative gradient profiles
Eluent Shutoff Valve	Electrically-actuated
Leak Sensor	Built-in, optical

Eluent Generator	
Eluent Concentration Range	0.1–100 mM Concentration increments are 0.01 mM
Flow Rates	0.1–3.0 mL/min 1.0 mL/min eluent concentration is limited
Eluent Types (Standard Pressure)	Potassium hydroxide, lithium hydroxide, sodium hydroxide, potassium carbonate, carbonate/bicarbonate, methanesulfonic acid
Eluent Types (High Pressure)	Potassium hydroxide, potassium carbonate, carbonate/bicarbonate, methanesulfonic acid
Maximum Operating Pressure	35 MPa (5000 psi)
Maximum Solvent Concentration	Cations: None Anions: 25% methanol
Gradient Profiles	Any combination of an unlimited number of linear, convex, and concave positive and negative gradient profiles
Number of Cartridges Supported	Two
Heated Column Compartment	
Temperature Range	30–80 °C Minimum temperature: 5 °C above ambient) Equilibration time (ambient to ambient plus 20 °C): 20 min
Temperature Accuracy	±0.5 °C (at 30°C)
Temperature Stability	±0.2 °C (at 30°C)
Temperature-Controlled Detector Compartment	
Temperature Range	15–40 °C Minimum temperature: 15 °C or 20 °C below ambient (whichever is higher) Equilibration time (ambient to ambient minus 20 °C): 30 min
Temperature Accuracy	±0.5 °C (at 15 °C)
Temperature Stability	±0.2 °C (at 15 °C)
Suppression Modes	
Electrolytic Suppression, Self-Regenerating, Recycle Mode	
Electrolytic Suppression, Self-Regenerating, External Water Mode	
Non-Suppressed Conductivity	Supported (both anion and cation)

Suppression Modes, continued

Chemical Suppression	2 mm and 4 mm anion and cation, membrane suppression bed type
Displacement Chemical Regeneration	2 mm and 4 mm anion and cation, membrane suppression bed type

Conductivity Detector

Electronics Type	Microprocessor-controlled digital signal processing, autoranging
Cell Drive	8 kHz square wave
Linearity	1%
Resolution	0.00238 nS/cm
Output Range	Digital signal range: 0–15,000 μ S/cm Analog signal range: 0–15,000 μ S/cm
Noise, Wet	< 0.2 nS at 23 μ S/cm background < 0.1 nS at 1 μ S/cm background
Filter	Rise times 0 to 10 s, programmable
Sampling Rate	1 to 100 Hz, user-settable or automatic
Cell Temperature	7 °C above ambient to 60 °C maximum; user-settable working range is identical to settable range
Cell Temperature Stability	< 0.001 °C
Cell Temperature Compensation	Default 1.7% per °C; programmable from 0–3% per °C
Flow Cell Maximum Pressure	10 MPa (1500 psi)
Flow Cell Volume	0.7 μ L
Cell Electrodes	Passivated 316 stainless steel, compatible with MSA
Cell Body	Chemically inert polymer
Heat Exchanger	Inert, tortuous-path for low axial dispersion

Electrochemical Detector

Electronics Type	Microprocessor-controlled digital signal processing
Electronic Noise (Wet Noise)	IPAD (Au electrode) < 50 pC at 10 mM KOH DC Amperometry (GC) < 10 pA at catecholamine eluent
Potential Range	-2.0 to 2.0 V in 0.001 V increments

Electrochemical Detector, continued

Signal Range (Digital and Analog)	Integrated Amperometry: 50 pC to 200 μ C DC Amperometry: 5 pA to 74 μ A
Filter	0–10 s response time, user-settable
Control Mode	Local or remote control using relay closures or TTL, or control using Chromeleon software
Cell Body	Titanium body with titanium inlet tubing Compatible with 2–7 mm ID columns
Working Electrodes	Conventional: Gold, glassy carbon, platinum, and silver Disposable: Gold, platinum, carbon, and silver
Reference Electrodes	pH-Ag/AgCl combination, one-piece design PdH, one-piece design
Autoranging	Yes
Analog Output	User-selectable full scale of 10, 100, or 1000 mV
Cell Volume at Working Electrode	< 0.2 μ L
Maximum Cell Operating Pressure	0.7 MPa (100 psi)

System Software

Chromeleon Chromatography Data System

Physical Specifications

Power Requirements	100–240 Vac, 5 A, 50–60 Hz autoranging
Operating Temperature	4–40 °C (40–104 °F); cold-room compatible (4 °C) as long as system power remains on
Operating Humidity Range	20–80% relative, noncondensing
Control Modes	Full control through Chromeleon software and optional Dionex Integrion Mobile App; alternative control through TTL or relay closures; two relay outputs, two TTL outputs, four programmable inputs
USB Communication Protocol	One USB input; one built-in two-output USB hub
Dimensions (h x w x d)	62.5 x 30 x 55.9 cm (24.6 x 11.8 x 22 in)
Weight	41 kg (90 lb)

Reordering Information

Part Number	Item
Pump Head Components	
075047	Primary pump head
083482	Secondary pump head
045722	Inlet check valve assembly (for primary pump head) (includes inlet nut and 1/8 in cartridge)
045721	Outlet check valve assembly (for primary pump head) (includes outlet nut and 1/8 in cartridge)
075768	Main seal
074370	Backup ring
040695	O-ring
075767	Seal wash body
063382	Seal wash seal
062092	Retainer for seal wash seal
079857	Piston
063968	Priming valve
063382	Priming valve seal
N/A	Pressure transducer assembly (Part cannot be replaced by user)
N/A	Membrane (Part cannot be replaced by user)
60-078499	Seal wash seal insertion tool
Seal Wash System	
22153-62010	Seal Wash Pump Kit
Eluent Reservoirs and Accessories	
062510	Eluent reservoir, 2 liter
063292	Eluent reservoir, 4 liter
078520	Regulator Kit

Part Number	Item
045987	Filter, end-line
074505	Filter, high-pressure inline
Eluent Generator Consumables	
075778	Dionex EGC 500 KOH
074532	Dionex EGC III KOH
074534	Dionex EGC III LiOH
074533	Dionex EGC III NaOH
075779	Dionex EGC 500 MSA
074535	Dionex EGC III MSA
088453	Dionex EGC 500 K ₂ CO ₃
088471	Dionex EPM 500 Electrolytic pH Modifier
088467	Carbonate mixer, 2 mm
088468	Carbonate mixer, 4 mm
22153-62033	Carbonate Mixer Mounting Bracket Kit
088662	Dionex CR-ATC 600
088663	Dionex CR-CTC 600
075522	Dionex RFIC Eluent Degasser
Valves and Accessories	
22153-60016	High-pressure injection valve, 4-port
22153-60014	High-pressure injection or switching valve, 6-port
22153-60015	High-pressure injection or switching valve, 10-port
074699	High-pressure injection valve pod, 4-port
075971	High-pressure injection or switching valve pod, 6-port
075972	High-pressure injection or switching valve pod, 10-port
074698	High-pressure valve rebuild kit, 4-port
075973	High-pressure valve rebuild kit, 6-port
079054	High-pressure valve rebuild kit, 10-port
042949	Sample loop, 10 µL
042857	Sample loop, 25 µL
079848	Low-pressure valve, 2-way
061971	Low-pressure valve, 3-way
Detectors and Detector Cells	
22153-62034	Dionex Integrion Conductivity Detector (with shipping container)

Part Number	Item
22153-62035	Dionex Integriion Electrochemical Detector (without cell; with shipping container)
072044	ED cell
ED Detector Consumables and Accessories	
061879	pH-Ag/AgCl reference electrode
045972	Gasket for pH-Ag/AgCl reference electrode
014067	O-ring for pH-Ag/AgCl reference electrode
085324	High Concentration Carbohydrate Analysis Kit (includes one 62 mil PTFE gasket and modified spacer block)
075499	62 mil PTFE gasket, Pkg. of 2
072075	PdH reference electrode
072214	Gasket for PdH reference electrode
030839	O-ring for PdH reference electrode
061749	ED gold conventional working electrode, with gasket and polishing kit
061751	ED platinum conventional working electrode, with gasket and polishing kit
061753	ED glassy carbon conventional working electrode, with gasket and polishing kit
061755	ED silver conventional working electrode, with gasket and polishing kit
045972	Gasket, PTFE, 0.001 in (for conventional working electrode)
063722	ED AAA gold working electrode, with gasket and polishing kit
060082	Gold AAA-Direct disposable working electrodes (6 electrodes and 2 gaskets)
060139	Gold carbohydrate disposable working electrodes (polyester substrate) (6 electrodes and 2 gaskets)
066480	Gold carbohydrate disposable working electrodes (PTFE substrate) (6 electrodes and 2 gaskets)
064440	Platinum disposable working electrodes (6 electrodes and 2 gaskets)
063003	Silver disposable working electrodes (6 electrodes and 2 gaskets)
069336	Carbon disposable working electrodes (6 electrodes and 2 gaskets)
072117	Gasket for disposable working electrodes, PTFE, 0.001 in (2 gaskets)
062158	ED cell polypropylene support block (for use with disposable electrodes)
036313	Polishing kit for conventional working electrodes
036319	Coarse polishing compound
036318	Fine polishing compound

Part Number	Item
036321	Polishing pads
078498	pH-Ag/AgCl reference electrode cup holder
Fittings	
22000-98001	Fitting bolt, 10-32, for double-cone ferrule fitting
043276	Ferrule fitting, 10-32 double-cone
048949	Ferrule fitting, 1/8 in
052276	Fitting nut, flangeless, 1/8 in
057934	Fitting bolt, flangeless, 1/8 in (short)
062511	Ferrule fitting, flangeless, 2-piece, 1/16 in
052230	Fitting bolt, flangeless, 1/16 in
042772	Fitting plug, 10-32
042806	Fitting coupler, 1/4-28 to 10-32
042627	Fitting coupler, 10-32
039056	Fitting, coupler, 1/4-28
024305	Luer adapter fitting, 1/4-28
Tubing	
014157 (1 in length)	PTFE, 1.58 mm (0.062 in) ID
22153-40110	Pre-bent PEEK, black, 0.25 mm (0.010 in) ID (for RFIC systems) Mixer to column compartment connection
22153-40111	Pre-bent PEEK, black, 0.25 mm (0.010 in) ID (for non-RFIC systems) Mixer to column compartment connection
042690 (4 in length)	PEEK, black, 0.25 mm (0.010 in) ID
054410 (4.81 in length)	PEEK, tan, 1.02 mm (0.040 in) ID
Viper Fittings and Tubing Assemblies	
088805	Viper assembly, 0.18 mm (0.007 in), 102 mm (4.0 in)
088806	Viper assembly, 0.18 mm (0.007 in) ID, 140 mm (5.5 in)
088807	Viper assembly, 0.18 mm (0.007 in), 165 mm (6.5 in)
088808	Viper assembly (CD systems), 0.18 mm (0.007 in), 178 mm (7.0 in)
088809	Viper assembly (RFIC systems), 0.18 mm (0.007 in), 178 mm (7.0 in)
088810	Viper assembly, 0.18 mm (0.007 in), 229 mm (9.0 in)
088811	Viper assembly, 0.18 mm (0.007 in), 241 mm (9.5 in)

Part Number	Item
088813	Viper assembly, 0.18 mm (0.007 in), 114 mm (4.5 in)
Analog Output/Relay/TTL Accessories	
043598	Twisted pair of wires
924133	Connector plug, 8-position
923686	Connector plug, 12-position
Maintenance Kit	
22153-62041	Dionex Integrion HPIC System Preventive Maintenance Kit
Miscellaneous Items	
960777	USB cable (for PC), 1.8 m (6 ft)
00302-99-00119	USB cable (for mobile device), 16.5 cm (6.5 in)
22153-40107	Magnet for mobile device
923686	Connector plug, 12-position
00006-03-00016	Fuse, 5 A, 250 V, 5 x 20 mm IEC 60127-2 fast-blow
079803	Syringe, 10 mL
016388	Syringe, 1 mL
22153-62043	Dionex Integrion Temperature Calibration Kit

B Reordering Information



Index

Symbols

- % Offset (analog out) 74
- +5V output 37

Numerics

- 4-port high-pressure valve 27

A

- ACES 300 135
- Acetonitrile 32
- Ag/AgCl half-cell 33
- Air particulate samples 54
- Air pressure requirements 46
- Ambient humidity 34
- Ambient temperature 34
- Amperometry cell
 - See ED cell
- Analog output 37
 - Connection instructions 67
 - Connectors 37
 - Description 37
 - Full-scale 74
 - Mark 74
 - Offset level 74
 - Polarity 74
 - Range 74
 - Selecting settings 73
- Analog-to-digital converter 37
- Analyses 56
- Audit trail 110
 - Icons 110
- Autosampler
 - Injecting samples 55
 - Loading samples 55
- Autozero 52

B

- Background conductivity
 - High 174
 - Offsetting 52
- Background signal 52
- Backpressure, excessive
 - Causes of 142
- Backpressure, low
 - Causes of 141
- Baseline
 - Noisy or drifting 171–172
- Baseline, monitoring 52

C

- Calibration
 - CD cell 202
 - pH-Ag/AgCl reference electrode 213
- Check valve replacement 183
- Chromatogram 2
 - Dips instead of peaks 74
 - Water dip in 54
- Chromeleon 12
 - Audit trail 110
 - Command window 13
 - Connecting to 49
 - Creating sequences 56
 - Instrument method 56
 - Troubleshooting communication problems 138
 - USB connections 37
 - Virtual Column Separation Simulator 52
- Column, trap 25
- Command window 13
- Commands
 - Creating a program 56
- Compartment temperature control 34
- compliance
 - WEEE vii
- Concentration of eluent 58

Index: D

Conductivity Detector (CD) 29–30
Cell calibration 202
Replacement procedure 203
Temperature control 30
Consumable tracking 15
Consumables
Storage of 57
Contacting Technical Support 109
Continuously Regenerated Trap Column (CR-TC 600) 22, 25
Continuously Regenerated Trap Column (CR-TC)
Contamination 174
Replacement procedure 197–198
Counter electrode 32
CR-ATC 600 25
CR-CTC 600 25

D

Daily maintenance 107
Data analysis description 2
Degasser 20
Detection description 2
Detector output
Low 164
Detectors 29
Conductivity Detector (CD) 30
Electrochemical Detector (ED) 32
Disposable working electrodes 32
Drifting baseline 171–172

E

ED cell
Cell design 32
Description 32
Electrodes 32
Monitoring the pH readout 33
Operating precautions 60
Solvent compatibility 32
Storage of 57
EG degas cartridge 23
EGC
See Eluent generator cartridges
Electrochemical Detector (ED) 29
Detection modes 32
ED cell description 32
ED replacement procedure 206
Operating 60
Operating modes 62
Palladium hydrogen (PdH) reference electrode 33
pH-Ag/AgCl reference electrode 33
Waveforms 65

Working electrode gasket replacement 207
Working electrodes 32
See also ED cell
Electrodes 32
Reference 32
Working 32
Electrolysis gases 23
Electrolytics 59
Eluent Generator (EG) 22
Component description 24–25
Concentration selection 58
Operating 58
Eluent generator cartridges 24
Concentration ranges allowed 58
Entering the concentration 59
Leaks 141
Replacement procedure 193–195
Eluents
Aqueous 107
Delivery process 2
KOH 58
Monitoring pH 33
MSA 58–59
Vacuum degasser 20
EMC compliance iii
End-line filters 46
Equilibration 52
Error messages 109

F

Ferrule fittings
Tightening 181
Filter, end-line 46
Bacterial contamination 107
Dirty or clogged 107
Fittings 178
Tightening 181
Flow schematics
Electrochemical detection 43
Injection valves 28
Low-pressure valves 28, 38
Full-scale analog output 74
Response range 74
Fuses 37
Replacement procedure 218

G

Gas regulator 35, 47
Glassy carbon electrodes 32
Gold electrodes 32

H

- Half-cells 33
- High-pressure valve
 - Rebuilding 199
 - See also* Valves
- Humidity 34

I

- I/O connectors
 - Installation instructions 67–68
- Injection valve 27
 - Flow schematics 28
 - Rebuilding 199
 - Replacing mechanical parts (pod) 200
- Instrument method (Chromeleon) 56
- Integrated and pulsed amperometric detection (IPAD) 63
- Ion chromatography overview 1
- Ion exchange 2
- IPAD 63

K

- KOH eluent 24, 58

L

- Leak sensor 29
- Loading samples
 - With a syringe 55–56
 - With an autosampler 55
- Low detector output 164
- Low pressure limit tripped 141
- Low-pressure valves 35, 37–38
 - Flow schematic 28, 38

M

- Main power receptacle 37
- Main power switch 37
- Maintenance
 - Daily 107
 - Weekly 107, 171
 - Yearly 108
- Manual injections 55–56
- Mark (analog output) 74
- Methanesulfonic acid eluent (MSA) 24, 58–59
- Methanol 32
- Mobile app operation 77
 - Using with Chromeleon 80
- Monitoring background 52

N

- Nitrite in samples 53
- Noisy baseline 171–172

O

- Offset percentage (analog out) 74
- Offsetting background conductivity 52
- Operation 45
 - Creating sequences 56
 - Equilibrating the system 52
 - Performing analyses 56
 - Priming the pump 50
 - Reservoir setup 46
 - Sample preparation 53
 - Selecting eluent concentration 58
 - Setting operating parameters 52
 - Shutting down 57
- Organic solvent 32

P

- PAD 64
- Palladium hydrogen (PdH) reference electrode 33
 - Replacement procedure 214
- Parameters
 - Chromeleon commands 56
- Peaks
 - Reversed 74
 - Tailing 150, 153, 161
- pH gradient 33
- pH half-cell 33
- pH reading
 - Monitoring 33
 - Setting pH limits 62
- pH-Ag/AgCl reference electrode 32–33
 - Calibration procedure 213
 - Monitoring the pH 61
 - Preventing from drying out 33
 - Replacement procedure 211
 - See also* Reference electrodes
- Piston replacement 190
- Piston seal wash 22, 49
- Platinum working electrodes 32
- Polarity
 - Analog output 74
- Potassium hydroxide eluent 24
- Power output 37
- Power receptacle 37
- Power switch (rear panel) 37
- Powering up the system 49
- Pressure limit tripped 141

Index: Q

Pressurizing reservoirs 47
Priming the pump 50
Priming valve seal replacement 192
Problems
 See Troubleshooting
Processing samples 56
Product warranty, voiding 177
Pulsed amperometric detection (PAD) 64
Pump 20
 Low pressure limit tripped 141
 Priming 50
 Seal wash 22, 49
 Troubleshooting 145
Pump check valve replacement 183
Pump piston replacement 190
Pump priming valve seal replacement 192
Pump seal replacement 185

Q

Queue (Chromeleon 7) 57

R

Rear panel 35
 Analog outputs 37
 I/O connectors 67
 Power switch 37
 TTL and relay connectors 37
 USB connections 37
 Waste lines 36
Recorder
 Analog output setting 74
Reference electrodes
 Palladium hydrogen (PdH) 33
 pH-Ag/AgCl 32–33
Reference potential shift 33
Relay connectors 37
 Installation instructions 67–68
Relay outputs 37
 Connections for normally open/normally closed 68
 Controlling 72
Reproducibility
 Affected by amperometry cell pH 33
Reproducibility is poor 174
Reservoirs
 Cleaning 159, 161, 165, 168
 End-line filters 46
 Pressurizing 47
 Setting up 46
Reversed-phase solvents 32
RFID 15

Running samples 56

S

Sample analyses 56
Sample loop 27
 Injecting 27
Sample processing 56
Samples
 Collecting and storing 53
 Diluting 54
 Filtering 53
 Pretreating 54
Seal replacement 185
Seal wash pump 22
 Setting up 49
Separation process 2
Sequences 56
Service procedures 177
 CD cell calibration 202
 CD replacement 203
 CR-TC replacement 197–198
 ED replacement 206
 EGC replacement 193–195
 Fuse replacement 218
 Injection valve pod replacement 200
 Palladium hydrogen (PdH) reference electrode replacement 214
 pH-Ag/AgCl reference electrode replacement 211
 Pump check valve replacement 183
 Pump piston replacement 190
 Pump priming valve seal replacement 192
 Pump seal replacement 185
Ship Kit 37
Short-term storage
 ED cell 57
Shutdown 57
Silver electrodes 32
Solvent compatibility (ED) 32
Start-up procedures
 Offsetting the background 52
Sulfite in samples 53
Support 109
Syringe
 Manual injections 55–56
 Using to prime pump 50
System flow descriptions 39
System power-up 49
System shutdown 57

T

Technical Support 109, 177

- Temperature control 34
 - Compartment 34
 - Conductivity cell 30
- Tightening fittings 181
- Trap column 25
- Troubleshooting 109
 - Chromatographic reproducibility 174
 - EG stops operation 146
 - Error message 109
 - High background 174
 - Low detector output 164
 - Noisy baseline 171–172
 - Pump stops unexpectedly 145
 - Tailing peaks 150, 153, 161
 - USB connections 138
 - Vacuum degasser low vacuum 145
- Troubleshooting Chromatogram Symptoms 109
- TTL and relay connectors 37
 - Installation instructions 67–68
- TTL and relay control 37
- TTL inputs
 - Assigning functions to 69
 - Control types 71
 - Functions available 37
- TTL outputs
 - Controlling 37, 72
- Tubing and fittings
 - Replacing 178

U

- USB cable 37
- USB connections 37
 - Troubleshooting 138

V

- Vacuum degasser 20
 - Vacuum is low 145
- Valves
 - 4-port high-pressure (injection) 27
 - Injection 27
 - Low-pressure 35, 38
 - Rebuilding high-pressure valves 199
 - Replacing a high-pressure valve pod 200
- Virtual Column Separation Simulator 52

W

- Waste lines 36
- Water dip 54
- Water samples 54
- Waveforms 65

- WEEE compliance vii
- Weekly maintenance 107
- Working electrode gasket
 - Replacement procedure 206–207
- Working electrodes 32
 - Materials 32
 - Polishing conventional electrodes 209

Y

- Yearly maintenance 108

Z

- Zero position (analog out) 74

