

ACCU-CHEK® Inform II

Roche



Accu-Chek® Inform II

BLOOD GLUCOSE MONITORING SYSTEM

Operator's Manual

ACCU-CHEK®

Revision History

Manual versions 1, 2, 3 and 3.x are for Accu-Chek Inform II meters with serial number versions UU13000000 to less than UU14000000. Manual versions 4, 5, 6 and 7.x are for Accu-Chek Inform II meters with serial number versions greater than or equal to UU14000000.

Manual version	Revision date	Changes
Version 1.0	2012-10	New document
Version 2.0	2013-02	Upgrade to FW 03.04; Revise critically ill statement
Version 3.0	2013-03	Update cleaning and disinfecting chapter
Version 3.1	2017-04	Add "Rx only" to Version 3.0 Operator's Manual.
Version 3.2	2020-08	Upgrade to FW 03.07; Revise critically ill statement.
Version 4.0	2014-02	Transition to new meter hardware; 2D barcode scanner; modifications to wireless LAN option (separate insertable RF card replaced by integrated WLAN component); new battery pack. Update to SW 04.00; misc. editorial revisions.
Version 5.0	2015-03	Correct two typographical errors in chapter 1, Introduction, Overview of the Accu-Chek Inform II Base Unit Hub section.
Version 6.0	2017-04	SW 04.01 and low power icons implemented; update to SW 04.02; new Base Unit in "System overview"; new section "What is new..."; new Appendix E for legacy Base Unit; misc. editorial revisions.
Version 7.0	2020-02	Update text for CLIA Waiver and modified Intended Use statement; implementation of supplements for SW 04.03
Version 7.1	2020-08	Update, new SW version 04.04
Version 7.2	2021-05	Updated information on WLAN regulatory registration.
Version 7.3	2021-09	Added information on open test strip vials.

ACCU-CHEK[®] Inform II System

Operator's Manual

Version 7.3

© 2012-2021, Roche Diagnostics. All rights reserved.

The contents of this document, including all graphics, are the property of Roche Diagnostics. No part of this document may be reproduced or transmitted in any form or by any means, electronic or mechanical, for any purpose, without the express written permission of Roche Diagnostics. Roche Diagnostics has made every reasonable effort to ensure that all the information contained in this manual is correct at the time of printing. However, Roche Diagnostics reserves the right to make any changes necessary without notice as part of ongoing product development.

Please send questions or comments about this document to your local Roche representative.

ACCU-CHEK, ACCU-CHEK INFORM and COBAS are trademarks of Roche.

All other trademarks are the property of their respective owners.



The Wi-Fi CERTIFIED Logo is a certification mark of the Wi-Fi Alliance.

On the packaging, on the identification plate of the meter, the battery pack, the base unit, or the code key reader you may encounter the following symbols, shown here with their meaning:



Caution, consult accompanying documents. Refer to safety-related notes in the instructions for use accompanying this product.



Temperature limitation (Store at)



Admissible humidity range (Store at)



Manufacturer



Date of manufacture



Catalog number



In vitro diagnostic medical device



Global Trade Item Number



Serial Number



The system fulfills the Canadian and U.S. safety requirements (UL LISTED, in accordance with UL 61010-1 and CAN/CSA-C22.2 No. 61010-1).

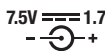

Power supply connection (Base Unit and Base Unit Light, legacy version)



Power supply connection (Base Unit and Base Unit Light)

Rx only

Caution: Federal law restricts this device to sale by or on the order of a physician

On meters with WLAN capability:



This device complies with Part 15 of the FCC Rules and with Industry Canada RSS standard(s).



The compliance mark indicates that the product complies with the applicable standard and establishes a traceable link between the equipment and the manufacturer, importer or their agent responsible for compliance and for placing it on the Australian and New Zealand market.

For other WLAN certifications, see label on bottom of battery compartment.

What is new in publication version 7.3?

- Added information on open test strip vials (see page 70)

What is new in publication version 7.2?

	6
1 Introduction	13
1.1 Before you start	13
CLIA Categorization	13
Intended use	14
Important information regarding use	15
If you need help	16
Note on the use of "base unit" in this manual	16
Note on illustrations in this manual	16
What can the system do for you?	17
Test principle	17
1.2 Important safety instructions and additional information	18
Important information regarding safety	19
Disposal of the system	20
Product safety	20
General care	21
Accessory box	21
Meter	21
Power off meter	21
Automatic power-off	21
Shut down meter	22
Automatic shutdown	23
Battery Pack	23
Touchscreen	26
Electromagnetic compatibility (EMC)	26
Electrostatic discharge (ESD)	27
Wireless connectivity	28
Radiofrequency radiation exposure information	28
Local Area Network: protection from unauthorized access	30
Wired network connection	30
1.3 System components	32
1.4 Overview of the meter	33
1.5 Overview of the code key reader	35
1.6 Overview of the Accu-Chek Inform II Base Unit	36
1.7 Overview of the Accu-Chek Inform II Base Unit Hub	38
1.8 Overview of the accessory box	39
1.9 Reagents and consumables	39
1.10 Instructions for initial setup	40

2	Powering Up and Entering an Operator ID	41
2.1	Powering up the meter.....	41
	Adjusting the display	42
	Enabling/disabling wireless connectivity	42
	Closing startup	44
2.2	Entering the operator ID.....	44
	Entering an operator ID with barcode scanner	45
	Entering the operator ID manually.....	46
	Entering a password	46
3	Patient Glucose Testing	47
3.1	Information regarding blood glucose testing	47
	Preparing to test	48
3.2	Performing a patient glucose test.....	50
	Overview of test procedure	50
	Entering or selecting the patient ID	51
	Entering the patient ID manually.....	53
	Selecting the patient ID from a list.....	54
	Entering a patient ID with barcode scanner.....	55
	Confirming or selecting the test strip lot.....	56
	Patient identification information	58
	Inserting test strips	59
	Obtaining a blood sample.....	60
	Applying a blood sample.....	61
	Results screen	62
	Adding comments.....	65
	Add barcode content to a result.....	67
	Additional Patient Test	68
4	Glucose Control Testing	69
4.1	Information regarding glucose control tests.....	69
	Glucose control testing intervals	70
	Information stored during glucose control testing.....	71
	Control solutions.....	72
	Preparing to run a glucose control test.....	72
4.2	Performing glucose control tests	73
	Overview of test procedure	73
	Starting a glucose control test.....	74
	Confirming or selecting the lot number for control solutions	75
	Confirming or selecting the test strip lot.....	76
	Inserting test strips	77
	Applying the control solution.....	78
	Results screen	79
	Performing a STAT test.....	81

5	Review Results	83
5.1	Displaying test results from the memory	83
	Information stored in data records for test results.....	83
	List of results stored in the memory	84
6	Storing Test Strip, Control Solution, and Linearity Solution Information in the Meter	87
6.1	Storing information about test strips	87
	Transferring code key information to the meter	88
	Editing test strip data.....	91
	Order test strips	93
6.2	Storing control solution information	94
	Entering the lot number of the control solution	94
	Selecting a stored lot number as the current lot number	97
6.3	Storing linearity test information	99
	Entering the lot number of the linearity test.....	99
	Selecting a stored lot number as the current lot number	101
7	Linearity Testing	103
7.1	Information regarding linearity tests.....	103
	Linearity testing intervals	104
	Information stored during linearity testing	104
	Linearity test kit	105
	Preparing to run a linearity test.....	105
7.2	Performing a linearity test.....	106
	Overview of test procedure	106
	Starting a linearity test	106
	Confirming or selecting the lot number for linearity test kits.....	107
	Confirming or selecting the test strip lot.....	107
	Inserting test strips.....	108
	Applying a linearity test sample	109
	Results screen	110
8	Proficiency Testing	111
8.1	Information regarding proficiency tests	111
	Information stored during proficiency testing.....	112
	Preparing a proficiency test.....	112
8.2	Performing a proficiency test.....	113
	Overview of test procedure	113
	Starting a proficiency test.....	113
	Entering the proficiency sample ID	114
	Confirming or selecting the test strip lot.....	114
	Inserting test strips.....	115
	Applying a proficiency sample	116
	Results screen	117

9	Initial Startup	119
9.1	Connecting the base unit	119
9.2	Installing or replacing the battery pack.....	121
	Removing the battery pack.....	122
	Installing the battery pack	124
9.3	Docking the meter.....	126
	Docked screen - battery status	126
	Improved charging performance.....	127
	Docked screen - meter status.....	128
9.4	Initial setup on the meter	130
	Menu overview.....	131
9.5	Opening the Setup Menu.....	135
9.6	Date and time format.....	136
9.7	Display options and optional tests.....	137
9.8	Options for test strips	138
9.9	Options for glucose control tests	140
9.10	Value ranges (normal, critical, reportable)	142
9.11	Options for Operator ID Entry.....	143
9.12	Patient ID options.....	144
9.13	Creating a setup password.....	145
9.14	Setting the date and time.....	146
9.15	Beeper options.....	147
10	Maintenance and Care	149
10.1	Conditions for storage and shipping	149
	General operating conditions	149
	Shipping	150
	Storage.....	151
10.2	Cleaning/disinfecting the Accu-Chek Inform II system.....	151
	Guide to cleaning and disinfecting the Accu-Chek Inform II system	152
	Cleaning and disinfecting the meter.....	152
	Acceptable cleaning/disinfecting agents.....	153
	What to clean/disinfect	154
	Technical assistance.....	154
10.3	How to clean and disinfect the Accu-Chek Inform II system.....	155
	Cleaning the meter	156
	Disinfecting the meter	157
10.4	Logging maintenance activities	158
10.5	Diagnostics view.....	159
10.6	Unlocking a Download Lockout	161
10.7	Service menu	163
	Deleting patient information.....	163
	Manual deletion.....	164
	Automatic deletion.....	165

11	Troubleshooting	167
	Errors and unusual behavior without error messages	167
	Low power icons	171
	Pop-up messages	172
	Table of Information, Warning, and Error messages	174
	Meter reset	181
12	General Product Information	183
12.1	Technical data	183
12.2	Further Information	188
	Ordering	188
	Accu-Chek Inform II Operator's Manual and Quick Reference Guide.....	190
	Reagents and Solutions.....	190
	Product Limitations	190
	Information about software licenses.....	191
	Contact Roche.....	192
A	Appendix	193
A.1	Table of configuration options.....	193
A.2	Example of barcode symbologies	209
B	Appendix	213
B.1	Option: Wireless network (WLAN)	213
	Preliminary note.....	213
	Background.....	213
	Technical implementation.....	214
	RF specific functionalities and effective performance claims.....	216
C	Supplement for Other Test Entry	219
C.1	Before you start.....	219
	Description	219
C.2	Overview of Other Test Entry (OTE)	220
	Introduction.....	220
C.3	Recording Other Patient Tests	223
C.4	Recording Other Control Tests	230
	Introduction.....	230
	Other Control Testing Intervals.....	230
	Stored Control Information.....	230
	Warning messages	236
C.5	Reviewing Other Test Results.....	237
C.6	Other Test Entry Configuration Options	240
D	Supplement for Observed Test Sequence	241
	Observed Test Sequence (OTS).....	241
	Using the OTS function.....	242

E	Supplement for Enhanced Workflows	245
E.1	Configurable workflows.....	245
	Blood sample type selection	246
	Isolation Room Workflow	248
	Test procedure for patients in an isolation room	248
F	Appendix for Accu-Chek Inform II Base Unit (legacy version)	251
F.1	Overview of the base unit with older hardware.....	251
F.2	Connecting the base unit (legacy version)	253
F.3	Technical data	254
G	Limited Warranty	255
	Accu-Chek [®] Inform II meter LIMITED WARRANTY	255
	Index	257

1 Introduction

1.1 Before you start

CLIA Categorization

This is a CLIA Waived system. A Certificate of CLIA Waiver (or higher) is required to perform the test. Information on obtaining CLIA certificates can be found at www.cms.hhs.gov/clia. Facilities performing testing must have a CLIA Certificate of Waiver. 42 USC 263a(c)(2).

Laboratories with a certificate of waiver must follow the manufacturer's instructions for performing the test. 42 CFR 493.15(e)(1). Any modifications and/or failure to follow test system instructions, including those for limitations/intended use and performance of QC testing as a failure alert mechanism, results in use that is considered high complexity and subject to all applicable CLIA requirements. All applicable state and local laws must be met.

Any adverse reactions experienced with the use of this product, and/or quality problems should also be reported to the FDA's MedWatch Adverse Event Reporting program online (at www.fda.gov/MedWatch/report.htm), by phone (1-800-FDA-1088), or by returning the postage-paid FDA form 3500 (which may be downloaded from www.fda.gov/MedWatch/getforms.htm) by mail to (MedWatch, 5600 Fishers Lane, Rockville, MD 20852-9787) or fax (1-800-FDA-0178).

If there are any problems with the Accu-Chek Inform II System, notify CMS at <http://www.cms.hhs.gov/clia/ro-map.asp>

Intended use

The Accu-Chek Inform II test strips are for use with the Accu-Chek Inform II meter to quantitatively measure glucose (sugar) in venous whole blood, arterial whole blood, neonatal heel stick, or fresh capillary whole blood samples drawn from the fingertip as an aid in monitoring the effectiveness of glucose control.

The system is not for use in diagnosis or screening of diabetes mellitus, nor for testing neonate cord blood samples.

The Accu-Chek Inform II Blood Glucose Monitoring System is intended for testing outside the body (in vitro diagnostic use) and is intended for multiple-patient use in professional healthcare settings. This system should only be used with single-use, auto-disabling lancing devices.

The multiple-patient use Accu-Chek Inform II Blood Glucose Monitoring System will consist of:

- Meter: Accu-Chek Inform II Meter
- Test Strip: Accu-Chek Inform II Test Strip
- Controls: Accu-Chek Inform II Control Solutions
- Linearity: Accu-Chek Linearity Kit

Important information regarding use

Read this operator's manual, as well as the package inserts for all relevant consumables, before using the system for the first test.

You must configure the Accu-Chek Inform II system according to your needs **before** initial use. You can configure the system either directly on the meter or by using a suitable data management system. Refer to Chapter 9 "Initial setup on the meter" for on-meter configuration. Refer to Appendix A for configuration via a data management system.



Be sure to read the "Important safety instructions and additional information" section in this chapter before operating the system.



The FDA, CDC, and CMS recommend that Point of Care blood testing devices such as the Accu-Chek Inform II meter should be used only on one patient and not shared. If dedicating blood glucose meters to a single patient is not possible, the meters must be properly cleaned and disinfected after every use following the guidelines provided in this manual (see section "Maintenance and Care").

If you need help

Information about using the system, the screen menus and performing a test can be found in this operator's manual.

Error messages that appear on screen include information or instructions on how to correct the error.

For all questions about the Accu-Chek Inform II system that are not answered in this manual, contact the Roche Customer Support Center at 1-800-440-3638 24 hours a day, 365 days a year. In order to expedite troubleshooting, please have ready your Accu-Chek Inform II meter, its serial number, this manual, and all related consumables when you call. If you suspect a communication error beyond the meter, also have your Accu-Chek Inform II Base Unit serial number ready to help assist our customer care group in troubleshooting.

Note on the use of “base unit” in this manual

Unless otherwise specified, the term “base unit” refers to both the Accu-Chek Inform II Base Unit and the Accu-Chek Inform II Base Unit Light.

Note on illustrations in this manual

Illustrations in this manual show two different kinds of hands:

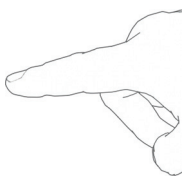

Hand without glove

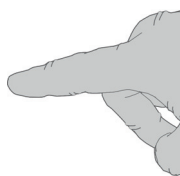

Hand with glove



A dashed arrow between screen illustrations indicates that some screens have been skipped in these illustrations.

What can the system do for you?

The Accu-Chek Inform II system has the following features and properties:

- Perform patient blood glucose tests and glucose control tests with control solution.
- Automatically record all relevant data for the application, which includes:
 - Time and date of test
 - IDs for operator, patient, and samples
 - Information about control solutions, test strips, and linearity
 - Test results and comments
 - Patient sample type based on configuration.
- Record patient test results, quality control test results and reagent information for certain off-meter manual tests.
- For purposes of quality assurance, information on the following areas can be collected, stored, and transferred:
 - Meters
 - Test strips
 - Glucose control solutions
 - Linearity solutions
 - Test results

Test principle

An enzyme on the test strip converts the glucose in the blood sample to gluconolactone. This reaction creates a harmless DC electrical current that the meter interprets and converts into a blood glucose result. The sample and environmental conditions are also evaluated using AC and DC signals.

For more details, refer to the test strip package insert.

1.2 Important safety instructions and additional information

This section explains how safety-related messages and information related to the proper handling of the system are presented in the Accu-Chek Inform II manual. Please read these passages carefully.



The safety alert symbol alone (without a signal word) promotes awareness to hazards which are generic or directs the reader to related safety information.

These symbols and signal words are used for specific hazards:



WARNING

Indicates a hazardous situation which, if not avoided, could result in death or serious injury.



CAUTION

Indicates a hazardous situation which, if not avoided, could result in minor or moderate injury.

NOTICE

Indicates a hazardous situation which, if not avoided, may result in damage to the system.

Important information that is not safety relevant is presented against a colored background (without a symbol). Here you will find additional information on correct use of the meter or useful tips.

Important information regarding safety



Operator qualification

Only trained healthcare professionals may operate the Accu-Chek Inform II system. Operators must also have received comprehensive instruction in the operation, quality control, and care of the Accu-Chek Inform II system.



WARNING

Protection against infection and blood-borne pathogens

Healthcare professionals using the Accu-Chek Inform II system to perform tests must be aware that any object coming into contact with human blood is a potential source of infection. Operators need to adhere to Standard Precautions when handling or using the Accu-Chek Inform II system. All parts of this system should be considered potentially infectious and are capable of transmitting blood-borne pathogens between patients and between patients and healthcare professionals.

- Use gloves. Wear a new pair of clean gloves for testing each patient.
- Wash hands thoroughly with soap and water before putting on a new pair of gloves and performing the next patient test.
- Use an auto-disabling single-use lancing device for each patient.
- Dispose of used lancets in a sturdy sharps container with lid.
- Dispose of used test strips from patient and proficiency tests according to your institution's infection control policy.
- Follow all health and safety regulations in force locally.
- For more information, refer to the following practice guidelines:
 - “Guideline for Isolation Precautions: Preventing Transmission of Infectious Agents in Healthcare Settings 2007”, <http://www.cdc.gov/hicpac/2007ip/2007isolationprecautions.html>.
 - “Biosafety in Microbiological and Biomedical Laboratories (BMBL)” found at <http://www.cdc.gov/biosafety/publications/bmb15/>
 - “CLSI. Protection of Laboratory Workers From Occupationally Acquired Infections”; Approved Guideline - Fourth Edition. CLSI document M29-A4. Wayne, PA: Clinical and Laboratory Standards Institute; 2014.

**WARNING****Avoidance of electrical shock, fire, and explosions**

- Only use Roche original accessories (cables, power supply units, battery packs, and spare parts). Third-party cables, power supply units, and battery packs can cause the battery pack to explode or the meter to become damaged.
- Do not use loose power sockets or damaged power supply units, cables, plugs, or battery packs.
- Do not short circuit the power supply unit, the base unit charging contacts, or the battery pack.
- Do not drop the Accu-Chek Inform II meter, the power supply unit, or the battery pack and protect these against shaking and vibrations.

Disposal of the system**WARNING****Infection by a potentially biohazardous instrument**

The Accu-Chek Inform II system or its components must be treated as potentially biohazardous waste. Decontamination (i.e., a combination of processes including cleaning, disinfection and/or sterilization) is required before reuse, recycling, or disposal.

Dispose of the system or its components according to the appropriate local regulations or your facility policy. For more information, contact Roche Customer Support Center.

Product safety

Observe the following information to ensure product safety:

- The system is suitable for continuous operation.
- The system is not protected against the harmful ingress of fluids (IP X0 rating according to IEC 60529).

General care

NOTICE

To avoid damaging the system, use only solutions recommended to clean and disinfect the system. Using other solutions may result in incorrect operation and possible failure of the system.

Accessory box

NOTICE

Carry the accessory box carefully by the handle for easy transport. Dropping or hitting the box may damage it.

Meter

Dispose of the meter in accordance with applicable laws and regulations. See “Disposal of the system” on page 20.

Power off meter

When you power off the meter by pressing the On/Off button  briefly (less than a second) or the meter powers off automatically (see below), the screen goes blank. However, the meter is in standby mode and continues to draw power from the battery pack to maintain date/time and run various functions in the background such as wireless communication.

Automatic power-off

- Unless otherwise configured, the system automatically powers off and goes into standby mode to save power after 5 minutes of inactivity (e.g., no screen touches, strip insertions).
- In measurement mode only: If you are performing a test (patient, control, proficiency, or linearity), the meter will power off after 10 minutes of inactivity (no screen touches), independently of configured automatic power-off time. If a result is already present, the meter will emit three warning beeps every minute after 5 minutes of inactivity and will save the result before powering off after 10 minutes of inactivity. The result will be flagged with a standard comment (“Result not confirmed”) when it is transmitted to the DMS.

Shut down meter

In standby mode (“Automatic power off”), energy continues to be drawn from the battery and it depletes within a day if not docked. Shutting down the meter shuts down wireless communication and all other functionalities. Date and time, however, are maintained. Powering up the meter will take slightly longer than from power-off (standby) mode.

To shut down the meter, press the On/Off button  for about 5 seconds and release the button as soon as the Roche logo is displayed and the meter beeps. The screen goes blank and the meter is shut down.

Use meter shutdown when you want to remove or replace the battery pack (see page 122).

If you press the On/Off button for too long, a meter reset will be triggered after about 12 seconds (see page 181) and date and time will be lost.

Automatic shutdown

In case of a *Download Lockout* (see page 161) or if the battery pack is critically low (see page 171), wireless communication and all other functionalities are shut down (although date and time are maintained).

The meter can be configured to automatically shut down 30 minutes after power-off when it is NOT docked. This feature is enabled by default. However, with this configurable automatic shutdown feature, the meter will automatically wake up on a regular basis for wireless communication. The setting for this wake-up timer is configurable (see Appendix A.1, "Table of configuration options").

If you configure the meter to wake up more often from shutdown for wireless communication (if WLAN is enabled and the meter is not docked), more power will be drawn from the battery pack and the meter will need to be recharged more frequently. If you choose to leave the meter in shutdown until you power it up manually or opt for longer time intervals between waking up for wireless communication, the battery will last longer but synchronization with the DMS may also take longer. In this case however, the meter's database will probably need to be synchronized before you can start testing.

Which option you choose will be determined by the workflow needs of your institution.

Battery Pack

The meter contains a rechargeable battery pack that begins charging as soon as it is placed in an active base unit (i.e., one connected to a power supply).

NOTICE

Use only the specially designed battery pack provided by Roche Diagnostics. Using any other type of battery may damage the system.

 **WARNING****Possible hazards posed by the battery pack**

Damaged or swollen battery packs can overheat, catch fire, or leak. Immediately cease use of Accu-Chek Inform II meters with damaged or swollen battery packs and under no circumstances recharge them (do not place in the base unit).

Overheating can cause the battery pack to catch fire or explode.

- Never throw the battery pack or the meters onto a fire. Do not dismantle, compress, or pierce the battery pack as this could cause an internal short circuit that leads to overheating.
- Do not place either the battery pack or the Accu-Chek Inform II meter on or in heating appliances, such as a microwave, conventional oven, or radiator.
- Avoid prolonged exposure to direct sunlight, e.g., when the meter is docked in the base unit. Keep this in mind when positioning the base unit.

Battery fluid or materials leaking from damaged battery packs can irritate your skin or cause burns due to high temperatures.

- Avoid contact with leaking battery fluid. In the event of accidental contact with the skin, rinse with water. If you get battery fluid in your eye(s), you should also seek medical attention.

Handle and dispose of battery packs with care.

Extreme temperatures reduce the charging capacity and usage period of the meter and the battery pack.

Observe the following general safety instructions for handling batteries:



Disposal of used batteries

Do not dispose of the battery pack with normal domestic waste. As a component of the Accu-Chek Inform II system, it must be deemed as potentially biohazardous. Treat it accordingly. See “Disposal of the system” on page 20.

- When storing or disposing of the battery pack, use the manufacturer's original packaging.

Save or download data from the meter prior to replacing the battery pack to prevent loss of data (see Chapter 9).

- Always **shut down** the meter before removing the battery pack (see page 122).
- When the *Battery Low* warning is displayed, the meter must be returned **as soon as possible** to the base unit for recharging.
- The *Battery Critically Low* warning indicates that the meter must be returned **immediately** to the base unit for recharging. No more tests can be performed.

If the meter displays a large red battery icon  instead of powering up when you press the On/Off button, this indicates that the battery is empty. Return the meter to the base unit immediately for recharging. See Troubleshooting, “Low power icons” on page 171.

Touchscreen

NOTICE

- Use only your finger to touch the screen elements. Using a sharp-edged object (e.g., tip of a pen) can damage the touchscreen.
- Do not use the system in direct sunlight. Direct sunlight may reduce the life expectancy and functionality of the display, as well as the integrity of test strips.

Electromagnetic compatibility (EMC)

The Accu-Chek Inform II system complies with the emission and immunity requirements described in IEC 61326-2-6. It has been designed and tested to CISPR 11 Class B.

In a domestic environment it may cause radio interference, in which case, you may need to take measures to mitigate the interference.

The electromagnetic environment in which the Accu-Chek Inform II device will be operated should be thoroughly evaluated prior to operation of the device.

This equipment has been tested and found to comply with the limits for a Class B digital device, pursuant to Part 15 of the FCC Rules. These limits are designed to provide reasonable protection against harmful interference in a residential installation. This equipment generates, uses and can radiate radio frequency energy and, if not installed and used in accordance with the instructions, may cause harmful interference to radio communications. However, there is no guarantee that interference will not occur in a particular installation. If this equipment does cause harmful interference to radio or television reception, which can be determined by powering the equipment off and on, the user is encouraged to try to correct the interference by one or more of the following measures:

- Reorient or relocate the receiving antenna.
- Increase the separation between the equipment and receiver.
- Connect the equipment into an outlet on a circuit different from that to which the receiver is connected.
- Consult the dealer or an experienced radio/TV technician for help.

This Class B digital apparatus complies with Canadian ICES-003.

The Accu-Chek Inform II system complies with both the electromagnetic immunity requirements and radio interference immunity requirements at the frequency and test levels according to ISO 15197.

Electrostatic discharge (ESD)

The Accu-Chek Inform II system complies with the electrostatic discharge (ESD) immunity requirements as specified in IEC 61326-2-6. Electrostatic discharge (ESD) is an electrical charge at rest, most commonly known as static electricity. If the meter experiences ESD during a blood glucose test, an error message is displayed and no blood glucose result is displayed by the meter or stored in the meter's memory. The blood glucose test will need to be repeated.

To avoid ESD, do not use the meter in a very dry environment, particularly one in which synthetic materials (e.g., carpets) are present that might cause damaging static discharges.

If the Accu-Chek Inform II meter experiences a form of ESD before or after running a blood glucose test, the test result will be stored in the meter memory and transmitted when the meter is docked in a connected base unit or when a wireless connection is established.

Wireless connectivity

If the meter is equipped with WLAN functionality:

Wireless connectivity allows the meter to send data (test results, patient IDs, operator IDs, etc.) to the data management system without the need to return the meter to the base unit. This feature must be configured by the system administrator. Observe the guidelines of your facility for using wireless local area network connections. For information about how to temporarily enable or disable this function, see page 42. For a description of the Accu-Chek Inform II meter's ability to connect to Wireless Local Area Networks (WLAN, Wi-Fi), see appendix B.

Radiofrequency radiation exposure information

Glossary:

- "FCC" stands for "Federal Communications Commission" (USA).
- "RF" stands for "radio frequency"
- "RSS" stands for "Radio Standards Specification" (Canada).
- "WLAN" stands for "Wireless Local Area Network"

The Industrial, Scientific and Medical (ISM) radio frequencies may contain emissions from microwave ovens, heaters, and other noncommunication devices. While these types of devices usually pose no threat of interference as they are low-powered devices, the possibility exists that some industrial high power systems may wipe out any attempted communication use of a WLAN. Therefore, perform a site survey and interference analysis with a spectrum analyzer to view the entire spectrum, looking for signals that might not only be within the frequency range of the intended WLAN but also could be near or at the same frequency and cause interference.



Roche supports industry wireless standards and recommends using products that have Wi-Fi certification. This certification tests products to the 802.11 industry standards for basic connectivity, security, authentication, Quality of Service (QoS), interoperability and reliability. The Wi-Fi CERTIFIED logo is an assurance that the Wi-Fi Alliance has tested a product in numerous configurations and with a diverse sampling of other devices to ensure compatibility with other Wi-Fi CERTIFIED equipment that operates in the same frequency band. The Wi-Fi Alliance network of independent test labs conducts interoperability testing programs to ensure that wireless devices work together and support secure connections.

This equipment has been tested and found to comply with the limits for a Class B digital device, pursuant to Part 15 of the FCC Rules. These limits are designed to provide reasonable protection against harmful interference in a residential installation. This equipment generates, uses and can radiate radio frequency energy and, if not installed and used in accordance with the instructions, may cause harmful interference to radio communications. However, there is no guarantee that interference will not occur in a particular installation. If this equipment does cause harmful interference to radio or television reception, which can be determined by turning the equipment off and on, the user is encouraged to try to correct the interference by one or more of the following measures:

- Reorient or relocate the receiving antenna.
- Increase the separation between the equipment and receiver.
- Connect the equipment into an outlet on a circuit different from that to which the receiver is connected.
- Consult the dealer or an experienced radio/TV technician for help.

NOTICE

This device complies with Part 15 of the FCC Rules and with Industry Canada licence-exempt RSS standard(s).

Operation is subject to the following two conditions:

- (1) this device may not cause harmful interference, and
- (2) this device must accept any interference received, including interference that may cause undesired operation.

NOTICE

Changes or modifications made to this equipment not expressly approved by (Roche Diagnostics GmbH) may void the FCC authorization to operate this equipment.

Radiofrequency radiation exposure Information: This device has been tested and meets the FCC/ISED RF exposure guidelines. Nevertheless, the device should be used in such a manner that the potential for human contact during normal operation is minimized.



CAUTION

The UNII-1 band (5150-5250 MHz) is only allowed for indoor use in Canada.

Local Area Network: protection from unauthorized access

If this product is connected to a local area network, this network must be protected against unauthorized access. In particular, it must not be linked directly to any other network or the Internet. Customers are responsible for the security of their local area network, especially in protecting it against malicious software and attacks. This protection might include measures, such as a firewall, to separate the device from uncontrolled networks as well as measures that ensure that the connected network is free of malicious code.

Wired network connection

If connected to a local area network, the Accu-Chek Inform II Base Unit or Accu-Chek Inform II Base Unit Hub must be protected against unauthorized access by means of a **strong password management**. For additional information about the Accu-Chek Inform II Base Unit or Accu-Chek Inform II Base Unit Hub, refer to the Accu-Chek Inform II Base Unit Hub Operator's Manual or the "Technical Note" stored on the Accu-Chek Inform II Base Unit as a PDF file (see page 191 of this manual). Or contact Roche Customer Support Center for technical assistance.

Observe your own facility guidelines on password management where available, or apply the following rules:

Characteristics of strong passwords

- Passwords must not contain the user's account name or parts of the user's full name that exceed two consecutive characters.
- Passwords must be at least eight characters in length.
- Passwords must contain characters from at least three of the following four categories:
 - English **uppercase alphabetic** characters (A through Z)
 - English **lowercase alphabetic** characters (a through z)
 - **Numeric** characters (0 through 9)
 - **Non-alphabetic** characters (for example, !, \$, #, %)

Examples of weak passwords

- **uhxwze11** contains no upper case letter.
- **UHXW13SF** contains no lower case letter.
- **uxxxx7F** contains the same character more than four times.
- **x12useridF** contains a substring of the user ID longer than four characters.

1.3 System components

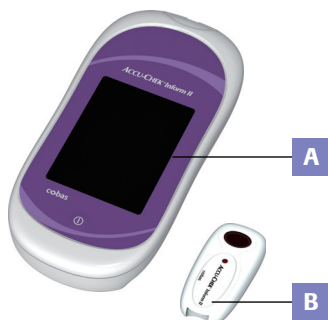

The Accu-Chek Inform II system includes the following components and accessories:

- A** Meter
- B** Code key reader
- C** Base Unit/Base Unit Light (power supply units not shown)
- D** Base Unit Hub
- E** Accessory box



The meter can be configured by two different methods:

- 1 Configuration by the Setup function on the meter (see Chapter 9)
- 2 Configuration via data management system

Note: Not all options can be configured using the Setup function on the meter.

The meter performs the following tasks within the system:

- Serves as the primary operator interface through the touchscreen and on/off button
- Performs glucose tests
- Scans barcodes (test strip lots, controls, patient and operator IDs) in a variety of supported formats
- Displays test results from patient tests and control tests
- Transfers stored data to the data management system via wireless communication (WLAN, optional) or the Accu-Chek Inform II Base Unit (LAN)



1.4 Overview of the meter

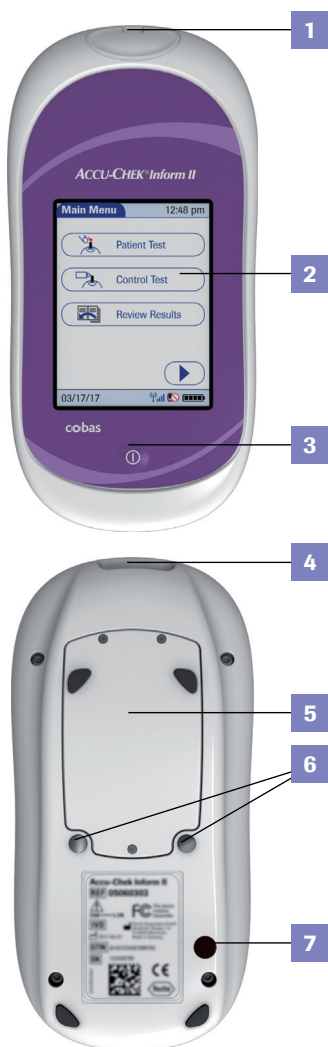

The meter has the following elements:

- 1 Test strip port**
Insert the test strip here.
- 2 Touchscreen (touch-sensitive display)**
This screen allows you to perform patient tests, perform controls tests, and review results. To select any of these functions, simply touch the button on the screen.
- 3 On/Off button**
Press this button to power the meter on or off.
- 4 Barcode scanner**
The integrated barcode scanner can be used to read operator and patient IDs, and patient information.
- 5 Battery compartment cover**
Remove to insert the battery pack.
- 6 Charging contacts**
These contacts are used to charge the battery pack when the meter is in the base unit.
- 7 Infrared window**
Facilitates data communication with code key reader and base unit.



8 Battery pack
Powers the device.

9 Wireless LAN label
If the meter supports wireless connectivity: This label displays registration numbers that are specific to the meter RF hardware.

10 Interface
(For manufacturer's use only.)

11 Battery pack connector socket
Connect battery pack here.

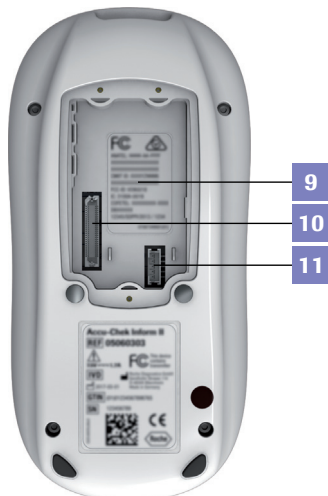

1.5 Overview of the code key reader

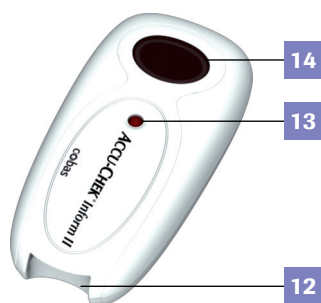

Test strip vials include a code key.¹ This code key is read by the code key reader and the data is sent to the meter. For additional information about the code key reader, see Chapter 6.

The code key reader has the following elements:

- 12 Code key slot
- 13 LED (green) for displaying status
- 14 Infrared window for transmitting the code file to the meter

Do not replace code keys while the code key reader is still flashing. If the green LED status light is still flashing, the code key reader will continue to transmit the previously loaded code file and ignore the code file on the newly inserted code key. You may get an error message on the meter.

1. The *code key* is also frequently referred to as a *code chip*. The terms are synonymous.

1.6 Overview of the Accu-Chek Inform II Base Unit

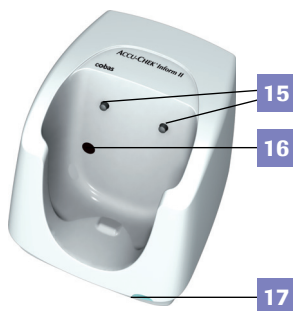

To provide flexibility in line with customer requirements, two versions of the base unit are available.

- The Accu-Chek Inform II Base Unit
- The Accu-Chek Inform II Base Unit Light

Both versions of the base unit can:

- charge the meter battery pack.

In addition, the Accu-Chek Inform II Base Unit supports:

- communication with a data management system.¹
- communication with a computer.

Both versions of the base unit have the following elements:

- 15** Charging contacts
- 16** Infrared window for communication with the meter
- 17** Status LED (lights up when power is connected):
 - Lights up red: Power supply is connected, application is starting up (Accu-Chek Inform II Base Unit only)
 - Lights up green: Ready
 - Flashes red: Error
 - Lights up blue: Configuration mode (Accu-Chek Inform II Base Unit only)

1. The Accu-Chek Inform II Base Unit Light can support communication with a data management system only when used together with the Accu-Chek Inform II Base Unit Hub.

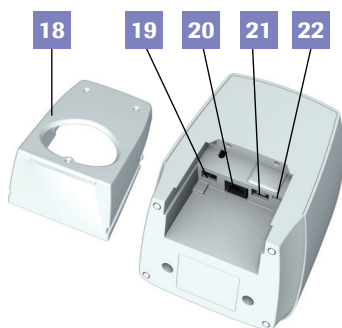

Electrical connections are located on the back of the Accu-Chek Inform II Base Unit and the Base Unit Light.

Illustration on the left shows the Accu-Chek Inform II Base Unit above, the Accu-Chek Inform II Base Unit Light below.

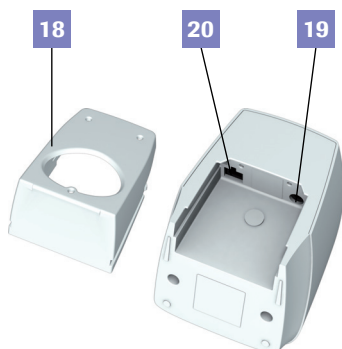

- 18** Removable mount for wall installation
- 19** Power input jack for the power supply unit
- 20** Network connection
 - Base Unit: Ethernet/RJ45 port
 - Base Unit Light: RJ25 port (communication via Base Unit Hub)
- 21** USB port (Base Unit)
- 22** USB configuration switch (Base Unit, for System Administrator use only)

The following additional elements are provided with the base units:



- 23** Power supply unit for
 - Base Unit: 12V \equiv 1,25A
 - Base Unit Light: 7.5V \equiv 1.7A (not shown here)
- 24** USB cable for
 - Base Unit: USB A to USB micro B

For instructions on connecting the base unit, see Chapter 9.



For an overview of the Base Unit with older hardware (REF 05060290001), see Appendix F, "Appendix for Accu-Chek Inform II Base Unit (legacy version)".

1.7 Overview of the Accu-Chek Inform II Base Unit Hub

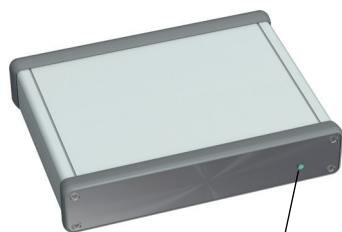

17



21

20

24

19



25

The Accu-Chek Inform II Base Unit Hub is able to connect up to 4 Accu-Chek Inform II Base Units Light (RJ25) and supports communication to a data management system via Ethernet (RJ45).

The hub also provides power for the Accu-Chek Inform II Base Unit Light. When connected to a hub an Accu-Chek Inform II Base Unit Light does not require a separate power supply. The LED colors of the hub are the same as for the Accu-Chek Inform II Base Unit Light.

- 17 Status LED (lights up when power is connected)
- 19 Power input jack for the power supply unit
- 20 Network connection — Ethernet/RJ45 port
- 21 USB port
- 24 Connections for up to 4 Accu-Chek Inform II Base Units Light (RJ25, data transfer, and power)
- 25 RJ25 cable — connects the hub to an Accu-Chek Inform II Base Unit Light

NOTICE

Cable mismatch

Do not insert the RJ25 cable used to connect an Accu-Chek Inform II Base Unit Light to the hub into the network connection (Ethernet/RJ45 port) of an Accu-Chek Inform II Base Unit (new or legacy version). Inserting the wrong cable into the Ethernet/RJ45 port may cause severe damage to the Accu-Chek Inform II Base Unit.

For additional information about the Accu-Chek Inform II Base Unit or Accu-Chek Inform II Base Unit Hub, refer to the Accu-Chek Inform II Base Unit Hub Operator's Manual or the "Technical Note" stored on the Accu-Chek Inform II Base Unit as a PDF file (see page 191 of this manual). Or contact Roche Customer Support Center for technical assistance.

1.8 Overview of the accessory box



The accessory box provides an area for storing and transporting consumables needed for performing point-of-care blood glucose tests.

1.9 Reagents and consumables

You need the following reagents to perform patient tests and glucose control tests:

- Accu-Chek Inform II Test Strips
- Accu-Chek Inform II Control Solutions: Available for purchase separately, consists of two 2.5 mL bottles. One bottle contains the Level 1 (Lo) control, while the other bottle contains the Level 2 (Hi) control.
- Accu-Chek Linearity Kit (if required by your facility guidelines): Available for purchase separately, contains six 2.5 mL bottles. These bottles span the glucose range in six levels (L1 to L6).

Your facility provides additional consumables such as blood collection supplies. Observe the current rules and safety guidelines for collecting and handling blood samples.

1.10 Instructions for initial setup

The meter must be configured prior to initial use. During this setup, the following parameters are configured:

- Date and time format
- Input mode for Patient ID
- Input mode for Operator ID
- Glucose controls: Type and schedule
- Results screen for glucose control
- Comments for entry after a test
- Settings for data transfer

You can perform these settings on a limited basis directly in the *Setup Menu* of the meter. For more information about configuration using the *Setup Menu*, see Chapter 9, as well as Appendix A. In addition to this option, the meter can be configured using a data management system. Suitable data management systems provide a range of functions for configuring the meter that go beyond what is possible with the meter-based configuration feature.

For questions about using data management systems, contact Roche Customer Support Center (see Chapter 12).

To ensure standardized configuration within a facility, the meter-based *Setup Menu* may be disabled.



2 Powering Up and Entering an Operator ID

2.1 Powering up the meter

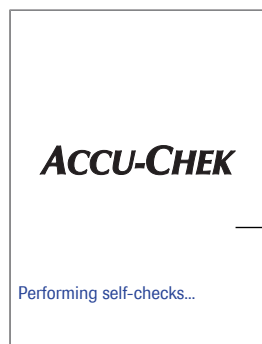

- 1 Press and release the On/Off button . The meter is now on.
- 2 The *Power Up* screen appears.
- 3 Check in the *Power Up* screen whether the date (lower left) and time (upper right) are displayed correctly. If necessary, refer to the instructions for updating these settings in Chapter 9.



- If during self-check an error is detected, the appropriate error message appears on screen.
- If the *QC Lockout* feature is enabled and glucose control is required, a corresponding message is displayed.
- The battery icon shows the current battery level. A completely filled icon  indicates a fully charged battery, and a partial charge is displayed as a partially filled battery icon . If the battery is nearly empty, the battery icon turns red .

Adjusting the display

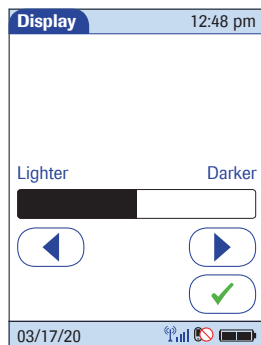

Using the *Display* options, you can adjust the display contrast to the ambient light conditions.

- 1 In the *Power Up* screen, touch *Contrast*. The *Display* screen appears.
- 2 Touch ◀ or ▶ to make the display lighter or darker.
- 3 Touch ✓ to confirm the setting.

After 30 seconds without any activity (e.g., without a screen touch) the meter automatically dims the display backlight to conserve energy (“Low Power Mode”).

Enabling/disabling wireless connectivity

If the meter supports wireless connectivity, you can temporarily enable or disable this functionality as required.



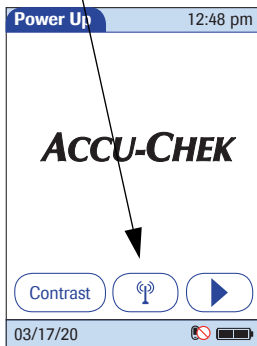

Wireless connectivity is automatically reactivated the next time you power on the meter. You can then disable it again temporarily, if required.

WARNING





If you suspect that the RF emissions of wireless communication are harming the patient or affecting other devices, you should carefully reassess the appropriateness of continued use of the WLAN functionality of the Accu-Chek Inform II system using the guidelines of your facility.





If wireless connectivity is activated, the  (*RF OFF*) icon is displayed as a button in the *Power Up* screen.

- To temporarily **disable** the wireless network connection, touch  (*RF OFF*) in the *Power Up* screen. The icon then changes to  (*RF ON*).
- To temporarily **enable** the wireless network connection, touch  (*RF ON*) in the *Power Up* screen. The icon then changes to  (*RF OFF*).

The *RF ON/RF OFF* button always displays the **option** you currently have. The current communication **status** is displayed in the status bar (bottom line) of the display in all menus and screens.

- The  icon is displayed, if wireless connectivity is enabled. Signal strength is shown by 4 bars next to the  icon in the status bar. Signal strength can range from “poor”  to “excellent” .

The signal strength bars are only displayed when wireless communication is actually taking place. For example, since wireless communication never takes place when a test is being run on the meter, no status bars will be displayed.

- The  icon is displayed if the last attempt to communicate with the data management system was successful and was terminated according to the communication protocol.
- The  icon is displayed if the last attempt to communicate with the data management system was not successful or was unintentionally terminated. If this icon persists, contact your system administrator. Ignoring this information may lead to a *Download Lockout* (if configured, see page 48).

Closing startup

Once you have completed all the necessary changes,

- touch  to proceed to the screen used to enter the operator ID, or
- wait 5 seconds and the meter automatically proceeds to the screen used to enter the operator ID.

2.2 Entering the operator ID

How and when an operator ID is entered and if a password is required, depends on the configuration of the system. It is also, for example, possible to require the operator ID only when starting control tests. In general, the system can manage and check operator IDs as well as make additional functions ID-dependent.

Every successful operator login will be logged as a meter event in an audit trail (ID, date and time).

If an operator name matching the entered operator ID is available on the meter, this name will be displayed in the *Main Menu* (shown here as “Maria S.”).

There are a number of options for entering operator IDs and these depend on the configuration of the system:

- Via barcode scanner only (a list of supported barcode symbologies can be found in Appendix A.2)
- Manually or optionally via barcode scanner

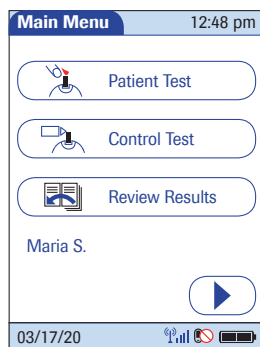

Operator IDs can consist of up to 20 alphanumeric characters.

Alphanumeric characters are any combination of A - Z and 0 - 9, additionally “.” (period), or “-” (hyphen) may be used. See also page 46.

Barcode masking can be used to eliminate any characters not belonging to the Operator ID. See information on “Operator and patient ID barcode masks” on page 206.

Entering an operator ID with barcode scanner

When the screen for entering the operator ID is displayed:

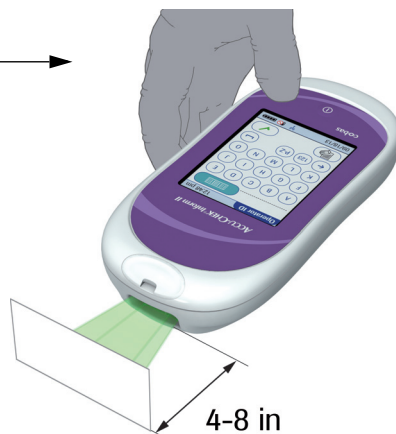
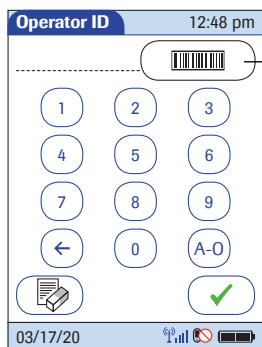

- 1 Press and release the barcode scanner button . The button now appears with a black background (during the scan).
- 2 Hold the meter so that the window of the barcode scanner is approx. 4-8 inches above the barcode you wish to read.

The meter beeps once the barcode has been read successfully. The barcode information appears in the operator ID field. The barcode scanner turns off after 10 seconds, if a barcode is not scanned.

The meter can be configured so that there is a small delay between activating the barcode scanner (green beam) and reading the barcode (red beam). The delay is adjustable and can range from 0 - 10 seconds. (See also table "Barcode Configuration" on page 204.)

This delay gives the operator time to position the barcode scanner and/or the barcode properly, e.g., in case several different barcodes are located very close to each other such as in a list.

Entering the operator ID manually

When the screen for entering the operator ID is displayed:

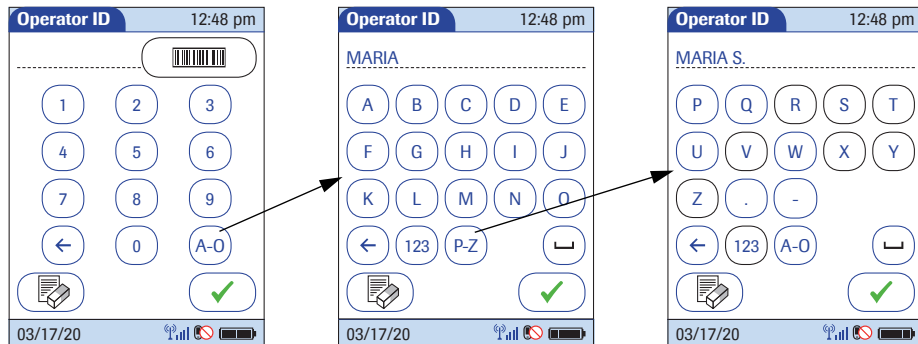

- 1 Touch the letters or numbers to enter the ID.
- 2 Use the following buttons to toggle between ranges of characters:
 - **A-O** for letters A-O
 - **P-Z** for letters P-Z, period and hyphen
 - **123** for numbers 0-9
- 3 Touch **←** to backspace and delete a character entered incorrectly. Touch **↵** to delete the whole entry. Touch **␣** to enter a space.
- 4 Touch **✓** to confirm.

If the operator ID you have entered is not valid (or the operator is not stored in the meter), an error message is displayed. Confirming the message allows you to enter the ID again.

Entering a password

Once the operator ID has been entered correctly, a screen for entering a password may appear (if configured). Enter the password manually in the same manner as described above for the operator ID.

Once all entries are complete, the *Main Menu* appears.

3 Patient Glucose Testing

3.1 Information regarding blood glucose testing



Before performing a blood glucose test, observe the following safety precautions:

- Observe the applicable regulations and directives for hygiene and safety when collecting blood samples.
 - Observe the applicable regulations and directives for disposing of potentially infectious samples and materials.
 - Refer to the section “Important information regarding safety” starting on page 19 of this manual, in particular: “Protection against infection and blood-borne pathogens”
 - Use gloves. Wear a new pair of clean gloves for testing each patient.
 - Wash hands thoroughly with soap and water before putting on a new pair of gloves and performing the next patient test.
 - Use an auto-disabling single-use lancing device for each patient
-

Preparing to test

For more detailed information regarding the Accu-Chek Inform II test strip, refer to the package insert for instructions for use, performance characteristics, and limitations of the system.

The following requirements must be met before you can perform a test:

- The Accu-Chek Inform II test strips are available.
- At least one code file for test strips must be stored in the meter and match the lot number of the test strips used (see Chapter 6).
- An operator ID must be entered (with password, if required), if the meter is configured for login.
- Glucose control tests specified in the system configuration must be run and completed successfully before running patient tests. Information whether glucose control tests are necessary is displayed in the *Power Up* screen.
- If configured, the meter may require downloading stored data to the data management system within defined time intervals. If such a download (either via WLAN or by docking the meter in a base unit) does not happen within the specified time, the meter is locked (*Download Lockout*) and cannot be used for testing.

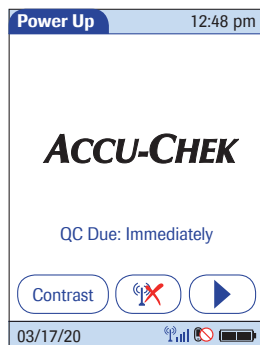

If a glucose control test is shown as required, patient glucose testing cannot be performed until the controls are run successfully.

Depending on how your meter is configured (see page 140), QC Lockout occurs when

- patient testing is attempted and controls have not been run in the time interval or frequency established by your facility.
- controls have been run but the control values were not in range.
- new software has been installed.
- a test strip lot other than the “current” lot is selected (default setting).
- you use a new test strip lot for the first time

For emergencies, STAT (**Short TurnAround Time**) tests can be configured in the meter by the system administrator based on your facility policies. This option allows the meter to perform a limited number of patient glucose tests, if circumstances require, despite the meter being in QC Lockout or Download Lockout (see page 81).



- Observe the applicable regulations and directives for hygiene and safety when collecting blood samples.
 - Observe the applicable regulations and directives for disposing of potentially infectious samples and materials.
-

3.2 Performing a patient glucose test

Overview of test procedure

A patient glucose test comprises the following steps:

- Enter the patient ID. This can be done either manually or by using the barcode scanner.
- Confirm that the test strip lot matches the test strips in use (if configured).
- Perform the test.
- Optionally a test may be categorized as an *Observed Test Sequence* (see page 241).

Entering or selecting the patient ID

After preparing the meter as described, you can proceed to the steps directly related to testing:

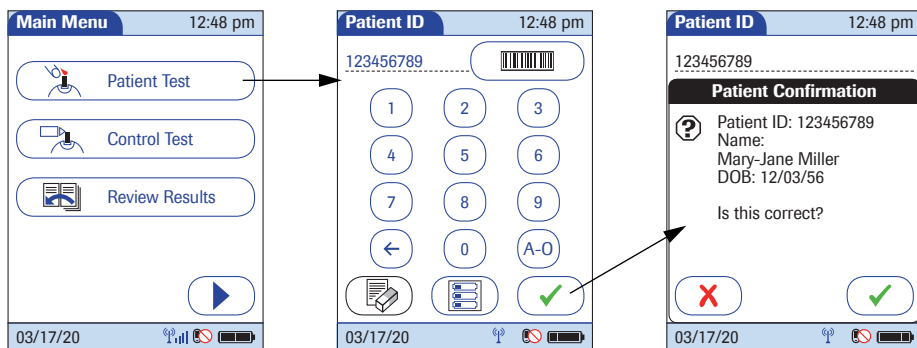

- 1 From the *Main Menu* screen touch *Patient Test*.
- 2 Enter or select the *Patient ID* as described on the following pages.
- 3 If the function *Patient Confirmation* is enabled, verify and confirm the displayed patient information, after you entered or selected the ID.

You now have three different options, depending on setup, for assigning the subsequent test to a patient.

The patient ID function can be configured by your system administrator to:

- Enter any combination of up to 20 alphanumeric characters, with specified minimum and maximum lengths.

Alphanumeric characters are any combination of A - Z and 0 - 9, additionally "." (period), or "-" (hyphen) may be used.

- Enter patient ID via barcode scanner.¹
- Select a patient from a list.²

The following options are available for validating patient IDs:

- Manual entries can be validated based on an downloaded list.
- Confirmation of patient name, date of birth, and ID can be required.²
- Barcode masking can be used to eliminate any characters not belonging to the Patient ID. See information on "Operator and patient ID barcode masks" on page 206.

1. A list of supported barcode symbologies can be found in Appendix A.2.
2. Depending on the DMS you are using, this feature may be disabled.

Entering the patient ID manually

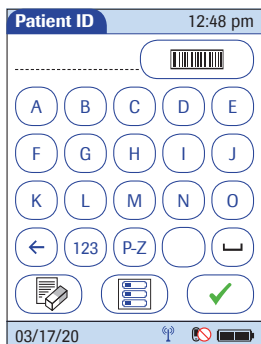

Use the displayed keypad to enter the patient ID. You can select characters in the same manner as when entering an operator ID.



- 1 Touch the letters or numbers to enter the ID.
- 2 Use the following buttons to toggle between ranges of characters:
 - (A-O) for letters A-O
 - (P-Z) for letters P-Z
 - (123) for numbers 0-9
- 3 Touch ← to backspace and delete a character entered incorrectly. Touch (X) to delete the whole entry. Touch () to enter a space.
- 4 Touch (✓) to confirm, or touch (☰) to cancel this procedure and return to the *Main Menu*.

- If the patient ID you have entered is **not valid** (does not match configured max/min length) an **error message** is displayed. Confirming the error message allows you to enter the ID again.
- If the patient is **not found** in the downloaded list, a **decision message** may be displayed (depending on configuration, see Appendix A.1). Cancelling the decision message also allows you to enter the ID again.
- Confirming the decision message allows you to perform a test on the patient if the ID complies with the configured maximum/minimum length. However, the patient ID will not be automatically added to the list.

Selecting the patient ID from a list



Choose the patient ID from a list¹, if a list has been downloaded to the meter (from the data management system).

- 1 Touch  or  to scroll up or down in the list. If one of the buttons is hidden, you have reached the top or bottom of the list.
- 2 Touch the desired entry to select a patient, or touch  to cancel this procedure and return to the *Main Menu*.

1. Depending on the DMS you are using, this feature may be disabled.

Entering a patient ID with barcode scanner

When the screen for entering the patient ID is displayed:

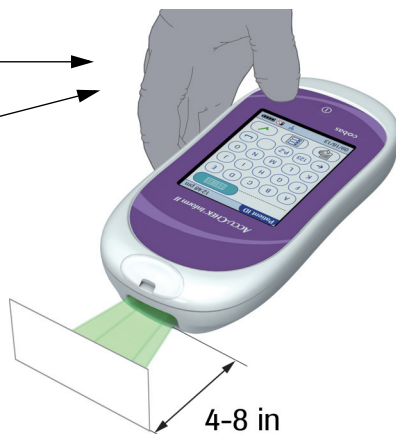
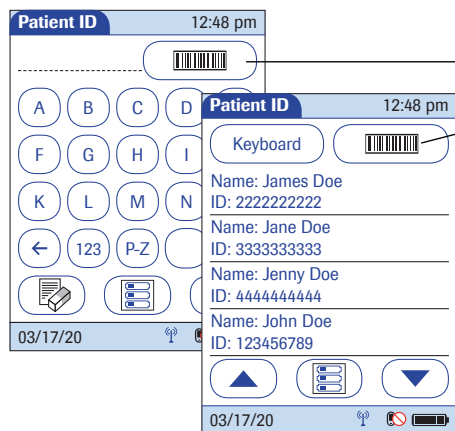

- 1 Press and release . The button now appears with a black background (during the scan).
- 2 Hold the meter so that the window of the barcode scanner is approx. 4-8 inches above the barcode you wish to read.

The meter beeps once the barcode has been read successfully.

- 3 If the function *Barcode Confirmation* is enabled, verify and confirm the barcode information.

If the *Barcode Confirmation* screen appears (before or without the *Patient Confirmation* screen), the function to add barcode content to a test result is enabled. See page 67.

The extracted patient ID¹ appears in the patient ID field of the succeeding screens. The barcode scanner turns off after 10 seconds if a barcode is not scanned.

1. See also section "Operator and patient ID barcode masks" starting on page 206.

Confirming or selecting the test strip lot

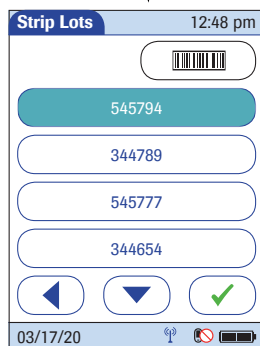

Once you have entered and confirmed the patient ID, you are asked to choose the lot number for the test strips. Compare the number displayed by the meter to the number on the label of the test strip vial.

- 1 Select the lot number as follows:
 - To read the lot number from the test strip vial via barcode scanner, press and release . Follow the instructions for scanning IDs (see note below).
 - If you want to use the preselected lot number displayed by the meter, touch to confirm.
 - To use a different lot number than the one displayed, touch to display a list of stored lot numbers. Select the desired lot number from the list.

The meter can be configured so that no QC lockout occurs when you switch **between** stored test strip lots. However, the selected test strip lot must already have passed a glucose control test.

A QC Lockout will still occur if a test strip lot is stored in the meter but no glucose control test has been run. A glucose control test must always be performed before using a lot for the first time.

- 2 Touch to confirm the selected or scanned lot number.

If the meter is configured to use the “Isolation Room Workflow” (see Appendix A.1) the strip lot will be confirmed before a patient ID is entered or selected.

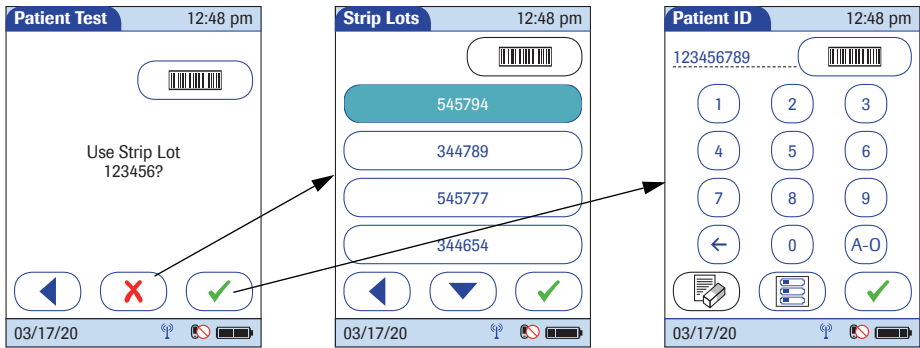

The meter can be configured so that manual confirmation is not necessary. In this setup, only the lot number is displayed. Additional options are not available.

The meter can be configured so that lot numbers are entered via barcode scanner only (see note below).

For additional information about storing lot numbers for test strips, see page 87.

Note: Barcodes on control solutions may not be available in all countries. In this case either

- manually enter the lot number each time (recommended),
- pick a previously entered lot number from the list, or
- configure the meter to only display the lot number (without confirmation by the operator).

Patient identification information

All available patient ID information for the selected patient is displayed on the *Patient Test* screen. Additional patient identifiers such as name and date of birth help verify patient identity. When performing a test, the operator can easily check whether the gender and age of the patient match the patient details shown on the screen. The display cycles (every second) between displaying patient ID and (if available) patient name. In a second line the date of birth (DOB) is displayed. If no DOB is available, a dash (-) is shown instead. See illustrations below.

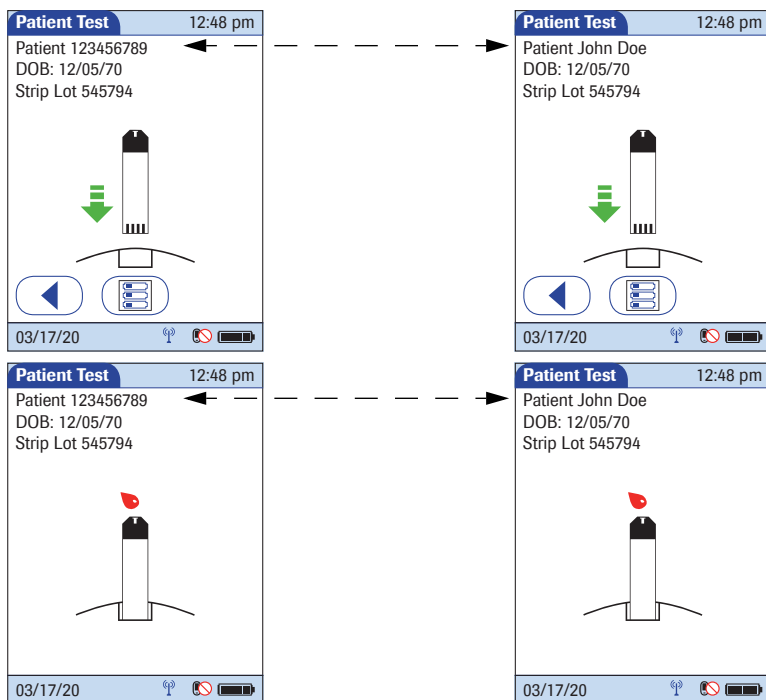

The DOB is not displayed on the patient test result screens, stored test results, or OTE test screens.

Inserting test strips

After confirming the test strip lot, a flashing green arrow appears on screen and prompts you to insert the test strip.

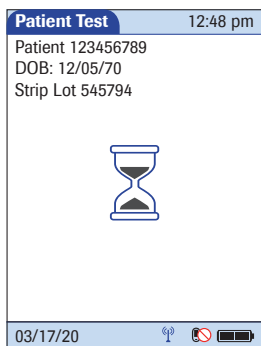
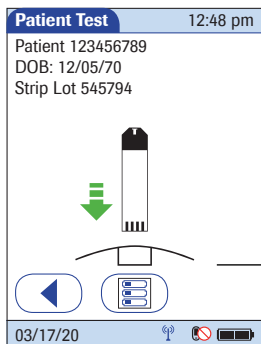

- 1 Remove the test strip from the test strip vial and close the vial with the cap.
- 2 Hold the test strip so the lettering "ACCU-CHEK" is facing upward.
- 3 Slide the test strip into the test strip port as far as it goes in the direction indicated by the arrows on the test strip.

The meter beeps. The hourglass icon appears and indicates that the meter is checking the test strip. Do not apply blood while it is displayed.

Obtaining a blood sample

Prepare the selected blood collection site and obtain blood from the patient per facility policy.

Recommendations for the collection of capillary blood

If no facility policy exists for obtaining capillary blood, the patient's hands (or heel in the case of small children) should be washed with warm water and soap, and then dried thoroughly. If you are using alcohol wipes or other disinfectants when obtaining capillary blood, the patient's skin must be completely dry before you lance the site to obtain blood.

We recommend obtaining the capillary blood sample from the side of the fingertip as this part is the least sensitive to pain.



WARNING

Potential risk of incorrect results due to residues on skin

- Traces of food on the fingers or fatty residues from hand cremes or soap products may contaminate the sample and lead to incorrect results. Wash the puncture site thoroughly and rinse with plenty of water.
- Residues of water or disinfectant on the skin can dilute the drop of blood and lead to incorrect results. After you have washed and disinfected the site, ensure that the patient's skin is completely dry before lancing the site to obtain a capillary blood sample.

Use an auto-disabling single-use lancing device for each patient. The lancing device must be intended for use by healthcare professionals in a multiple patient setting. Follow the manufacturer's instructions for use.

Applying a blood sample

Once the meter has checked the test strip, the hourglass icon disappears and you are prompted to apply a blood sample.

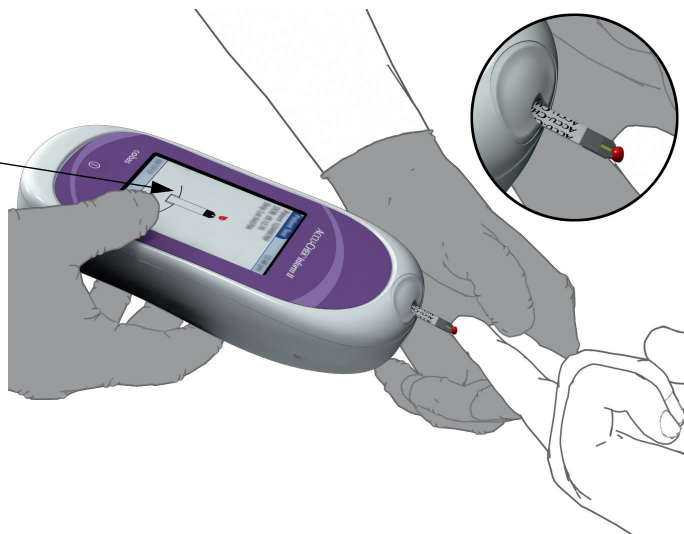
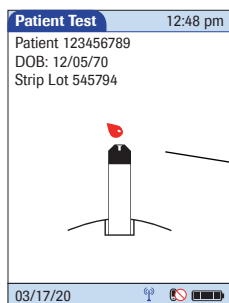

When applying the sample, position the meter so that the test strip port is always higher or on the same level as the blood drop. This prevents any excess blood from flowing down the strip and entering the meter.

- 1 Wait until the flashing drop appears in the display before applying the blood. The meter beeps.
- 2 Apply the **drop of blood** to the **front edge** (yellow dosing area) of the test strip. Blood is pulled into the test strip by capillary action.
Do **not** apply the blood to the top of the strip. Blood on top of the test strip is not available for testing because it will not be pulled into the strip.

Once a sufficient blood sample has been detected, the meter beeps and the measurement begins. Do not touch test strip once the meter beeps. Wait for the glucose test result to show on screen.

Results screen

The hourglass icon indicates the test is running. When the test is completed and the result is ready, the meter beeps again.

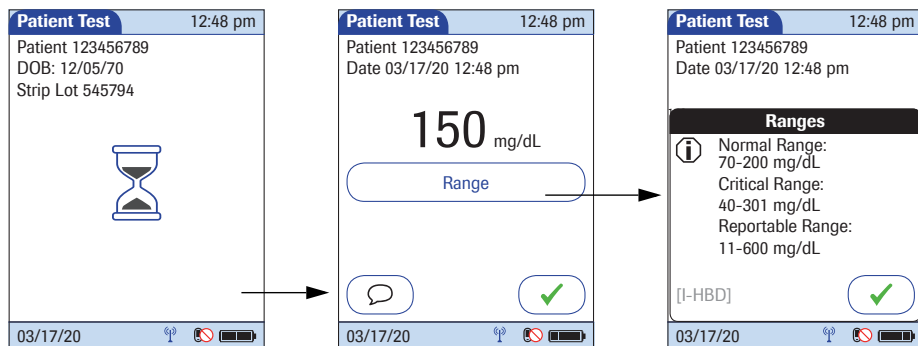

When the result is displayed, a message or warning may also appear (depending on system configuration) notifying you if the result exceeds the specified limit values. Additionally, a **red flashing arrow** next to the test result indicates that a result is out of range.

↑: the value is **above** the normal/critical upper range.

↓: the value is **below** the normal/critical lower range.

Example: For the ranges shown above, a value between 40 and 69 mg/dL would be rated as “below normal range” but “within critical range”.

These limit values define ranges that can either be configured individually by the system administrator in line with facility guidelines, or are the (technical) limits of the system. The characteristics of these ranges are explained on the following page.

The results screen contains a button that changes its name based on the result (*Range* or *Out of ... Range*). Touch this button to display the configured limit values.



- The System Measuring Range refers to the measurement range of the system itself (strips and meter) and is the only range which cannot be configured. With Accu-Chek Inform II test strips this fixed range is 10 to 600 mg/dL (0.6 to 33.3 mmol/L). If a result falls outside this range, the message HI or LO appears, i.e., the result cannot be quantified.
- Glucose results above or below the Reportable Range, as defined by the institution or local regulatory body, are above the highest or below the lowest numerical results to be reported. Results outside this range must not be used for intervention decisions.
- Glucose results above or below the Critical Range, as defined by the institution, require immediate action as defined by hospital policy.
- Glucose results within the Normal Range, as defined by the institution, are considered normal and require no therapeutic action.

The following messages¹ may appear in instead of a numeric test result:

- **CR LO** (below the Critical Range threshold, but within the Reportable Range)
- **CR HI** (above the Critical Range threshold, but within the Reportable Range)
- **RR LO** (below the Reportable Range threshold, but within the System Measurement Range)
- **RR HI** (above the Reportable Range threshold, but within the System Measurement Range)
- **LO** (below the System Measurement Range)
- **HI** (above the System Measurement Range)

For test results that lie outside the critical or reportable range, a message (up to 100 characters in length) can be configured during setup. This message is then displayed with the corresponding test results.

Instructions on how to add comments are provided in the following section.

1. Results that are below or above the Critical Range threshold, but within the Reportable Range can be configured to display as either numeric results or as CR LO or CR HI. All other results exceeding specified limit values will always be displayed as RR LO, RR HI, LO, or HI.

If comments are not set as required and you do not wish to add a comment to the test result, touch  to return to the *Main Menu*.

Test results are saved automatically if the meter is powered off or if it powers itself off after 10 minutes of inactivity/no screen touches (see “Automatic power-off” on page 21).

Remove the test strip and dispose of it in accordance with applicable regulations and directives for disposal of potentially infectious samples and materials.

Adding comments



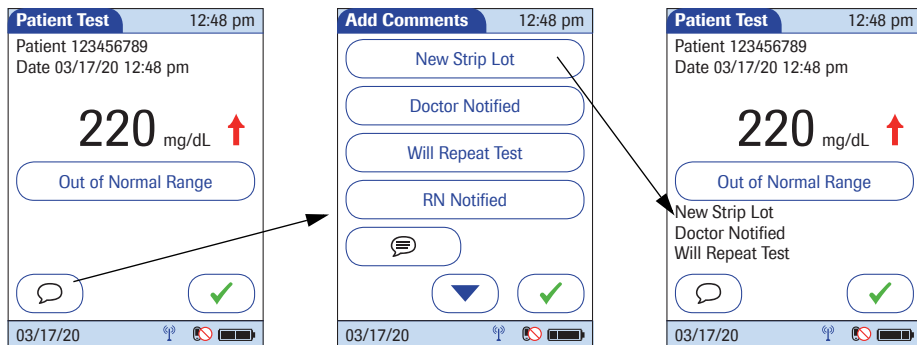

You can add up to three comments to a test result. Comments can provide, for example, additional information about the test conditions or the patient.

Of these three comments only one can be a custom comment; the others can be selected from the predefined comments list.

The meter can be configured so that comments are always required, required depending on the result range, optional, or disabled. You can call up the function for adding comments directly in the results screen. If comments are set as required, the meter will not accept an empty comment field.



To add comments:

- 1 In the *Patient Test* screen, touch .
- 2 Select up to three desired predefined comment(s) from the display list (if configured) or touch  to enter up to one custom comment (if custom commenting is enabled). Use the keypad (as with login) to enter your comment(s).
- 3 Once you have selected the desired comment(s), touch  to return to the results screen.
- 4 Touch  to return to the *Main Menu*.

Add barcode content to a result

It is possible to read and display the complete content of a barcode (not only the extracted ID) and add it as a comment to the test result, to be further processed by the DMS. This option can only be configured via a DMS. The following options can be set:

- Barcode content will not be added to the result
- Barcode content will be added to the result
- Barcode content will be displayed for confirmation after scanning and then added to the result

If the meter is set to the last option (enabled with confirmation), you can choose to display the complete barcode content in the confirmation screen as follows:

- The barcode is displayed as a continuous string of characters without any formatting. The separator characters (“~%\$+?”) are shown. See example in top screen in the illustration on the left.
- The barcode is divided into separate lines for easier reading. The separator characters (“~%\$+?”) are replaced by line breaks. See example in the bottom screen in the illustration on the left.

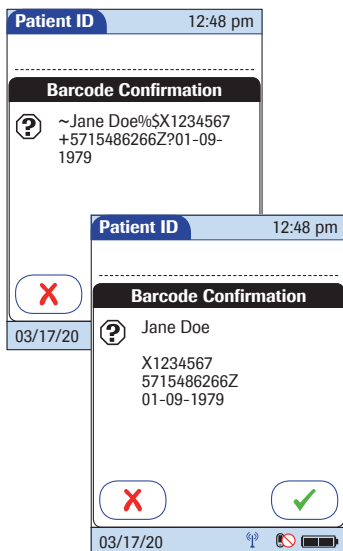

The replacement of separator characters by line breaks is only applied temporarily for display in the *Barcode Confirmation* screen. The barcode information stored with the test result contains the original separator characters.

During a patient test, the *Barcode Confirmation* screen appears before the *Patient Confirmation* screen, if both are enabled.

Additional Patient Test

The screenshot shows a patient test result screen. At the top, it displays "Patient Test" and the time "12:48 pm". Below this, the patient ID "123456789" and the date "03/17/20 12:48 pm" are shown. The main result is "150 mg/dL". A pop-up dialog titled "Additional Patient Test" is overlaid on the screen, asking "Perform additional Patient Test for Patient ID 123456789?". The dialog has two buttons: a red "X" button and a green checkmark button. At the bottom of the screen, the date "03/17/20" and various status icons (signal strength, Wi-Fi, battery) are visible.

It is possible to enable a patient test series (e.g. for plausibility checks). If this function is enabled (only possible via DMS), a pop-up dialog allows the operator to perform another test for the same patient immediately after the first test result is displayed. This function is also available for OTS and OTE workflows.

4 Glucose Control Testing

4.1 Information regarding glucose control tests

Observe the applicable regulations and directives of the responsible regulatory agencies when performing glucose control tests.

Accurately testing known levels of glucose ensures that the system and your technique used in testing give accurate results on patient tests. Glucose control solutions have defined (known) values. The results for these solutions must first fall within a certain acceptable range in order to allow valid patient testing.

The system may be configured to require in-range glucose control testing before patient testing is allowed. This is called *QC Lockout*, and the system actually prevents patient and proficiency testing when the control results are not within the accepted range.

Glucose control testing intervals

Intervals between running glucose control tests are determined by your facility. These intervals are entered when the system is configured. At the end of the specified interval (or after a specific event such as starting to test with a new test strip lot), a warning is displayed when the meter is powered on and when the *Glucose Test* function is selected.

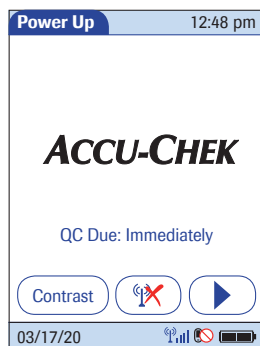

Glucose control tests should be run in the following circumstances:

- Before using the meter for patient testing the first time
- At the glucose control intervals established by your facility
- When using a new test strip vial for the first time
- When using a new test strip lot for the first time (and as a result a new test strip code)
- If questionable test results are displayed repeatedly
- If you wish to test the performance of the system

In addition, the following events can be specified during setup as a reason for a glucose control test:

- If a previous control test is out of range
- If glucose control tests were not run at the proper intervals



WARNING

If the container is open or damaged before using the test strips for the first time, if the cap is not fully closed, if you see any damage to the cap or container, or if anything prevents the cap from closing properly, do not use the test strips. Do not perform a control test. Contact Roche.

If a glucose control test is required (as shown in the illustration on the left), you will not be able to test blood glucose until the controls have been run successfully. For emergencies, STAT tests can be configured in the meter. This option allows the meter to perform a limited number of blood glucose tests, if circumstances require, despite the meter being in QC Lockout (see page 81).

Information stored during glucose control testing

The following information is stored for every glucose control test using control solution:

- Glucose control test result
- Lot number of the control solution
- Operator ID (if configured)
- Level of control solution (L1 or L2)
- Lot number of the test strips
- Time and date of test
- Comments (if applicable)
- Out of range measurements

Control solutions

For blood glucose test strips, control solutions have two levels:

- Level 1 (L1): Lo (low values in test results)
- Level 2 (L2): Hi (high values in test results)

Preparing to run a glucose control test

Aside from special preparations (see the following section), a glucose control test is run in the same manner as a patient test:

- At least one code file for test strips must be stored in the meter and match the lot number of the test strips used (see Chapter 6).
- The proper test strips must be available.
- An operator ID must be entered (with password, if applicable), if the meter is configured for login.

4.2 Performing glucose control tests

Overview of test procedure

A glucose control test using control solution comprises the following steps:

- Select the desired level of control solution for the test.
- Check the lot number of the control solution.
- Check the lot number of the test strips.
- Perform the test with the control solution.

The result must fall within the specified range (as shown on the label of the test strip vial or defined per configuration) for the control test to be completed successfully. Patient tests can now be performed (again).

Starting a glucose control test

After preparing the meter as described, you can proceed to the steps directly related to control testing:



- 1 From the *Main Menu* screen touch *Control Test*.
In the *Control Test* screen, the levels available for the control solution are displayed. To the right of the buttons, the word *Required* identifies the level at which a glucose control test must be run to remove QC Lockout.
- 2 Touch *Level 1 (Lo)* or *Level 2 (Hi)* to select the level for the following test. In the example above, *Level 2 (Hi)* is marked.

Confirming or selecting the lot number for control solutions

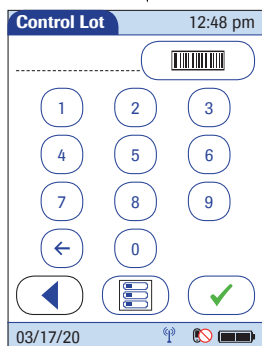
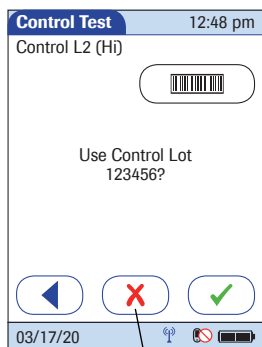

Once you have selected the level, you are asked to confirm or enter the lot number of the control solution. Compare the number displayed by the meter to the number on the label of the control solution.

- 1 Select the lot number as follows:
 - To read the lot number from the control solution bottle via barcode scanner, press and release . Follow the instructions for scanning IDs (see page 45).
 - If you want to use the preselected number displayed by the meter, touch to confirm.
 - If you want to use a different number than the lot number displayed, touch to open the keypad and enter the number manually, or
- 2 Touch to confirm the selected test strip lot number.

The meter can be configured so that manual confirmation is not necessary. In this setup, only the lot number is displayed. Additional options are not available.

The meter can be configured so that lot numbers are entered via barcode scanner only.

For additional information about storing lot numbers for control solutions, see page 94.

Confirming or selecting the test strip lot

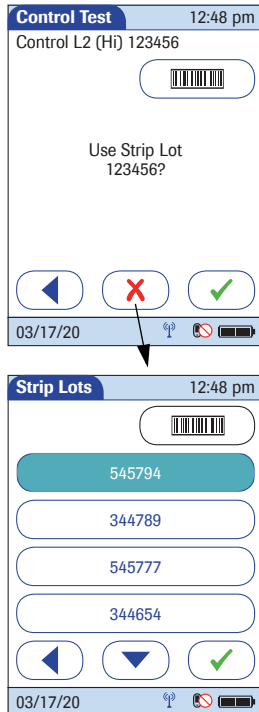

Once you have entered and confirmed the lot number of the control solution, you are asked to choose the lot number for the test strips. Compare the number displayed by the meter to the number on the label of the test strip vial.

- 1 Select the lot number as follows:
 - To read the lot number from the test strip vial via barcode scanner, press and release . Follow the instructions for scanning IDs.
 - If you want to use the preselected lot number displayed by the meter, touch to confirm.
 - To use a different lot number than the one displayed, touch to open the keypad and enter the number manually, **or** to display a list of stored lot numbers and then select the desired lot number from the list.
- 2 Touch to confirm the selected test strip lot number.

The meter can be configured so that manual confirmation is not necessary. In this setup, only the lot number is displayed. Additional options are not available.

The meter can be configured so that lot numbers are entered via barcode scanner only.

The meter can be configured so that lot numbers can only be selected from a list.

For additional information about storing lot numbers for test strips, see page 87.

Inserting test strips

After confirming the test strip lot, a flashing green arrow appears on screen and prompts you to insert the test strip.

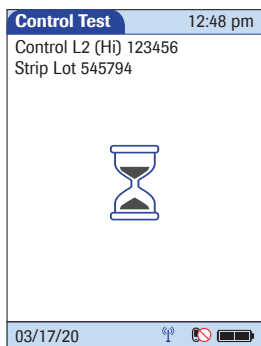
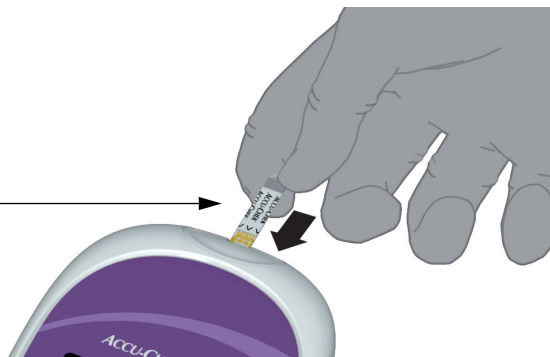
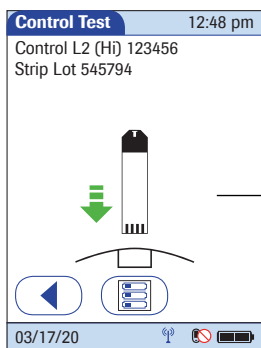

- 1 Remove the test strip from the test strip vial and close the vial with the cap.
- 2 Hold the test strip so the lettering "ACCU-CHEK" is facing upward.
- 3 Slide the test strip into the test strip port as far as it goes in the direction indicated by the arrows on the test strip.

The meter beeps. The hourglass icon appears and indicates that the meter is checking the test strip. Do not apply control solution while it is displayed.

Applying the control solution

Once the meter has checked the test strip, the hourglass icon disappears and you are prompted to apply control solution.

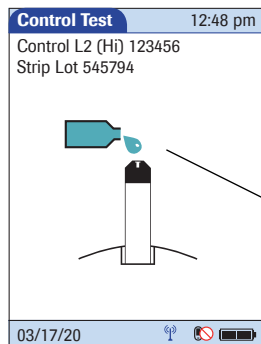

When applying the control solution, position the meter so that the test strip port is always higher or on the same level as the control solution. This prevents any excess solution from flowing down the strip and entering the meter.

- 1 Wait until the flashing drop appears in the display before applying the control solution. The meter beeps.
- 2 Apply a drop of glucose control solution to the **front edge** of the test strip. Do **not** apply the control solution to the top of the strip. The control solution is pulled into the test strip by capillary action.

Once sufficient control solution has been detected, the meter beeps and the measurement begins. Do not touch test strip once the meter beeps. Wait for the control test result to show on screen.

Results screen

The hourglass icon indicates the test is running. When the test is completed and the result is ready, the meter beeps again.

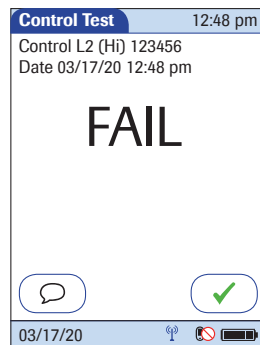
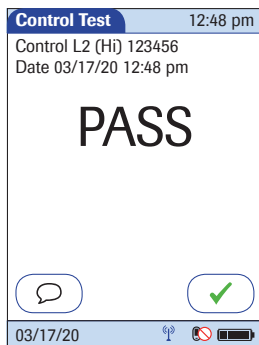
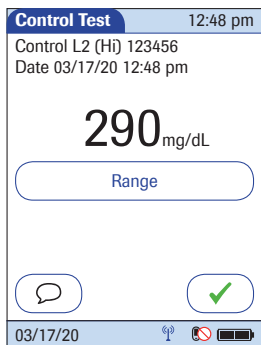

Depending on configuration, the result is displayed either as a value or only as a qualitative result *Pass* or *Fail*. Your system may be configured to disallow further testing until all the required glucose control levels are successfully run (QC Lockout).

When the results are displayed as a value, the results screen contains a button that changes its name based on the result (*Range* or *Out of ... Range*). Touch this button to display the minimum and maximum target values for the control levels.

You can add comments to a control test result (as with blood glucose tests) (see page 65).

For control tests, comments are only required if the result is outside the specified range (whether this is displayed as a value or as FAIL). If the result is within the specified range (displayed as a value or as PASS), comments are optional.

If you do not wish to add a comment to the test result, touch  to continue to the next level of the control test, if necessary, or to return to the *Main Menu*.

Test results are saved automatically if the meter is powered off or if it powers itself off after 10 minutes of inactivity/no screen touches (see “Automatic power-off” on page 21).

Remove the test strip and dispose of it in accordance with applicable regulations and directives.

Performing a STAT test

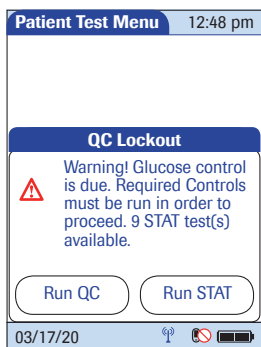

The meter can be configured to allow a STAT patient glucose test to be run even if the meter is in QC Lockout or Download Lockout. This option is to be used in situations with critical patients. The system administrator can allow control tests to be delayed one to nine times.

Run STAT appears in the *QC Lockout* warning box under the following conditions:

- You are successfully logged in and have selected *Patient Test* from the *Main Menu*.
- A glucose control test is required (due to specified control intervals or other conditions).
- The administrator has enabled the *STAT test* option during setup.
- The number of STAT tests available has not been exceeded.

If these conditions are fulfilled, two buttons appear in the warning message that allow you to choose the next step:

- Touch *Run QC* to run the required control test instead of a patient test.
- Touch *Run STAT* to perform a patient test even if a glucose control test is required. The status as STAT test is stored with the data record for the test.

If the meter is in a *Download Lockout* status, and no STAT test is available, the meter can be unlocked by a system administrator (see page 161).

This page intentionally left blank.

5 Review Results

5.1 Displaying test results from the memory

Information stored in data records for test results

When you retrieve the data record for stored test results, the following information is displayed.



- Patient ID, glucose control, or sample ID
- The test result
- The lot numbers of the reagents used for glucose control and linearity tests
- Date and time of the test
- Comments entered at the time the test was performed

Maintenance results (for documentation of maintenance activities) are stored and displayed with date and time only if comments were added.

List of results stored in the memory

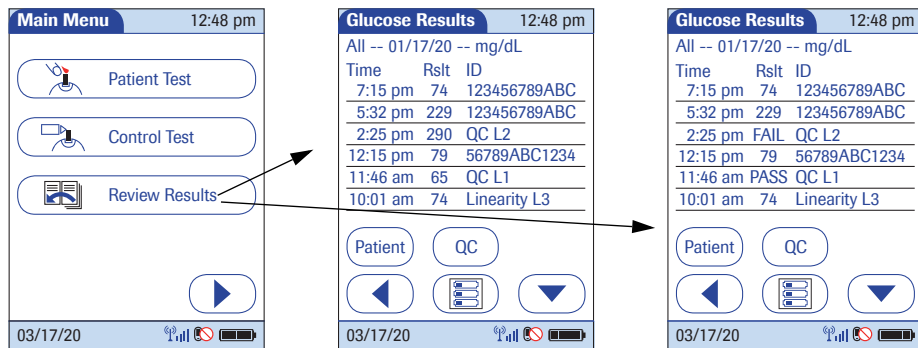
To display the results from the memory as a list:





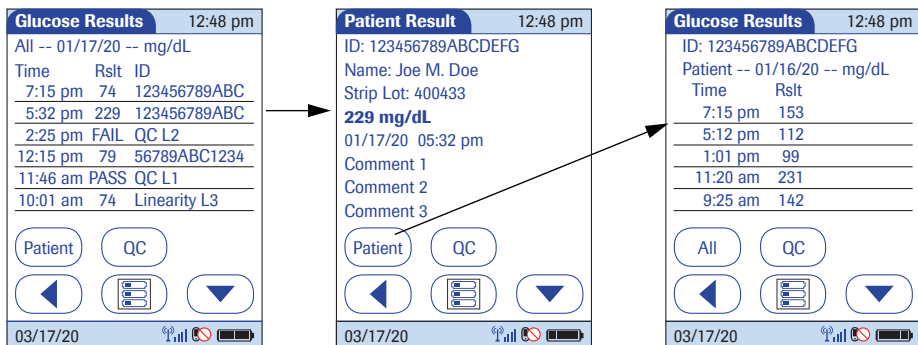

- 1 From the *Main Menu* screen touch *Review Results*. All stored test results are displayed in a sequential list.
- 2 Touch  or  to scroll up or down in the list. The results are grouped by date.



- 3 Touch an entry in the list to display the related details.
- 4 Touch *Patient*, if you wish to display results for a specific patient only.
 - If you touch *Patient* from the full list view, you will be asked to enter the patient ID manually or via barcode scanner. The list now contains only the results for the selected patient.
 - If you touch *Patient* in the *Patient Result* view (middle screen above), the list of test results for this patient will be displayed.

Glucose Results		12:48 pm
All -- 01/17/20 -- mg/dL		
Time	Rslt	ID
7:15 pm	74	123456789ABC
5:32 pm	229	123456789ABC
2:25 pm	FAIL	QC L2
12:15 pm	79	56789ABC1234
11:46 am	PASS	QC L1
10:01 am	74	Linearity L3

03/17/20    

- 5 Touch *QC*, if you wish to display a list of glucose control tests.

If the meter is configured to show PASS/FAIL instead of a numerical QC result, you can use the list to check whether a meter lockout is due to a failed or overdue control test.

- 6 Touch *All* in the *Glucose Results* screen to remove the *Patient* or *QC* selection and display all results.
- 7 Touch to return to the previous menu screen, or touch to return to the *Main Menu*.

6 Storing Test Strip, Control Solution, and Linearity Solution Information in the Meter

6.1 Storing information about test strips

Each box of test strips contains a code key.¹ Each code key belongs to a single lot number and provides important information about the lot-specific properties of the test strip. The properties of the test strips are downloaded (as a code file) from the code key using the code key reader and sent to the meter. The code file is stored in the meter.

This procedure also allows the code key information to be stored centrally in the data management system, from where it can be sent to all the meters used in your facility.

Make sure with each test that the code stored (and selected by you) matches the lot number of the test strips in use.

Aside from the unchangeable data directly linked to the lot-specific properties, some of the information from the code key can be modified (depending on your meter setup). This information includes:

- Expiration date (can be set to a date **before** the date stored in the key)
- Parameters for control solutions (minimum and maximum values for levels L1/Lo and L2/Hi)

When using a data management system for configuration, it is possible to partially or fully disable the functions described in this chapter. In this case, the respective buttons in *Main Menu 2* do not appear. See also Appendix A.

1. The *code key* is also frequently referred to as a *code chip*. The terms are synonymous.

Transferring code key information to the meter

The following description assumes that the meter is powered on and the *Main Menu* is displayed.

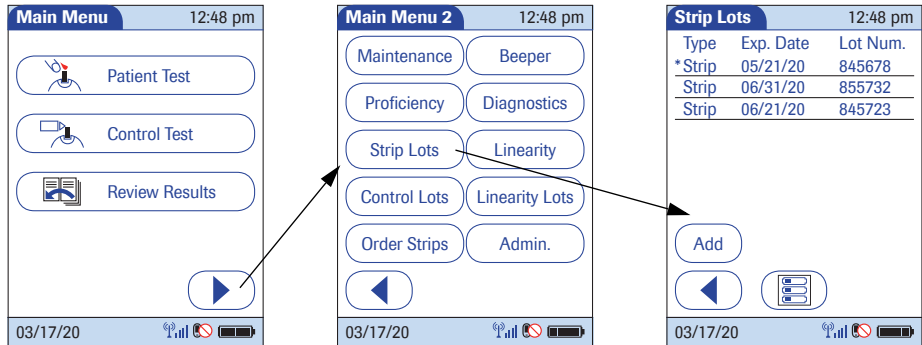

- 1 Touch  to open the *Main Menu 2* screen.
- 2 Touch *Strip Lots* to open the related menu.
- 3 Touch *Add* if you want to add the information for a new test strip lot from a new code key. The *Add Strip Lot* screen opens.
- 4 Insert the new code key into the opening of the code key reader. The LED starts flashing green and signals that the reader is ready to transfer data.



The code key reader remains ready to send for a few seconds after it has transmitted data. As a result, you can perform the following procedure on multiple meters without having to reinsert the code key.



- 5 Place the code key reader on a level surface such as a bench. Hold the meter 4-6 inches above the code key reader so that a connection can be made between the two infrared windows.
- 6 Touch  to begin downloading data.

- The code file is ready for transmission as long as the LED on the code key reader is flashing, even if the code key is removed.
 - After the LED stops flashing, remove the code key and insert a new code key for download, if required.
 - If you get an error message that the download was not successful, re-insert the same code key and try again.
- Do not replace code keys while the code key reader is still flashing. If the code key reader is still flashing, it will continue to transmit the previously loaded code file and ignore the code file on the newly inserted code key. You may get an error message on the meter.

Once the connection is made, the meter provides you with status information on the download.

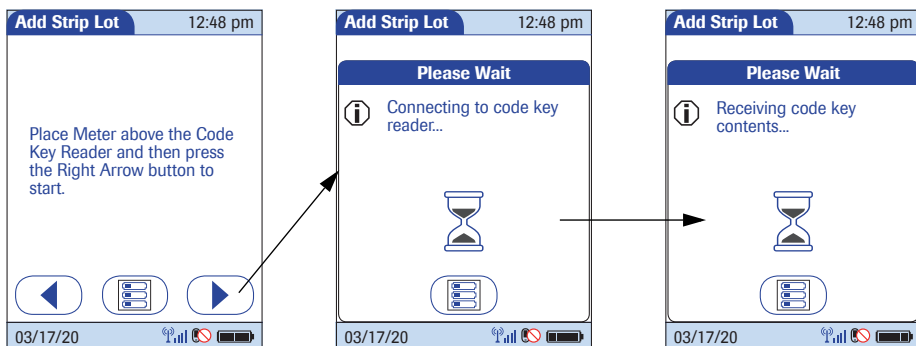

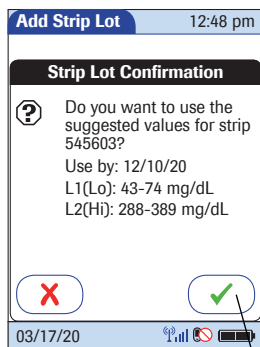

Information about the expiration date and parameters for control solutions is subsequently displayed.

- 1 Touch to store the data for this lot number in the meter without changes, or touch to modify the data for this lot number before storing it in the meter.

If you accept the suggested values the following screen appears. You can use this screen to select the lot number you have just transmitted as the current lot number.

The current lot number is provided automatically for use with subsequent tests.

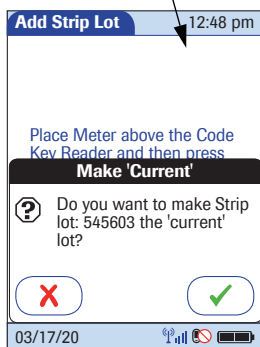

- 2 Touch to confirm that you want this lot number to be the lot number currently in use, or touch to store the entries without making the lot number the current lot number.
- 3 Continue entering additional lot numbers, or touch to return to the *Main Menu*.

Editing test strip data

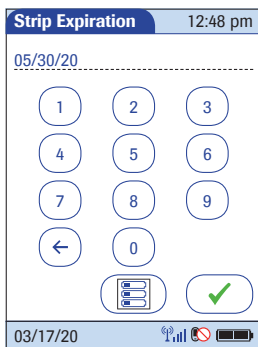
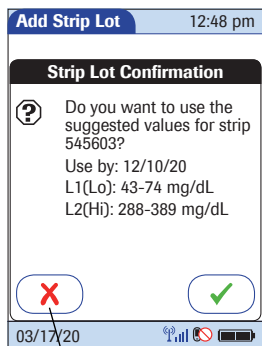

As mentioned at the beginning of this chapter, you can edit several parameters for test strips, the expiration date and the value ranges for control solutions.

- 1 Use the keypad to enter the desired expiration date (use two digits and leading zero, if necessary). It is **not** possible to enter a date beyond the expiration date stored in the key.
- 2 Touch  to accept the modified date and continue to the value ranges.

The parameters for control solutions consist of four separate values.

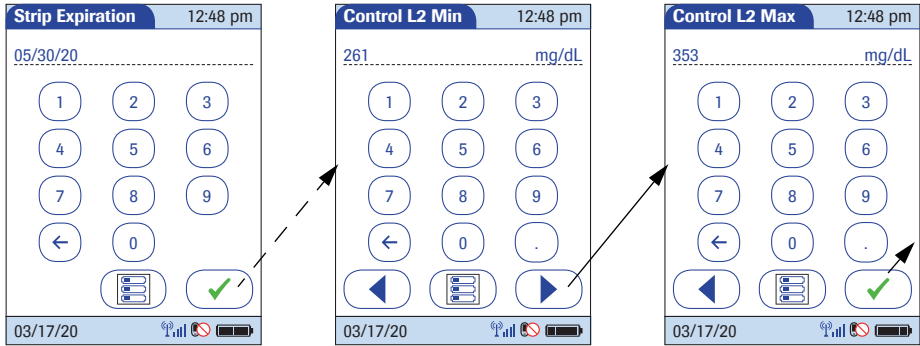

- 3 Use the keypad to enter the desired values one after another:
 - Minimum limit value for Level 1
 - Maximum limit value for Level 1
 - Minimum limit value for Level 2
 - Maximum limit value for Level 2
- 4 Touch  to confirm each separate entry and continue to the next entry.



Once you have finished updating the test strip information, you can use the next screen to select the lot number you are currently editing as the current lot number.

The current lot number is provided automatically for use with subsequent tests.

- 5 Touch to confirm that you want this lot number to be the lot number currently in use, or touch to store the entries without making the lot number the current lot number.
- 6 Continue entering additional lot numbers, or touch  to return to the *Main Menu*.

Order test strips

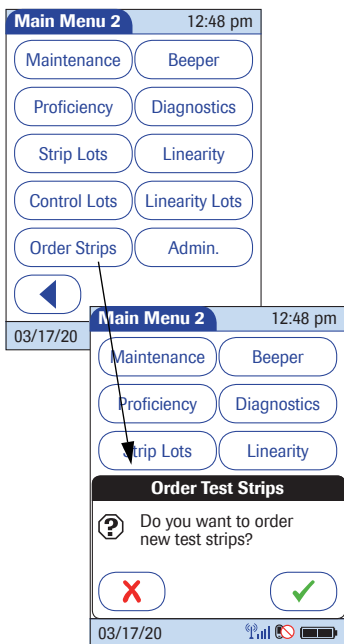

If you notice that strip lots are running empty or the expiration date is approaching soon, you can inform your system administrator to reorder new test strips.

- 1 Touch *Order Strips* to open the related menu.
- 2 Touch to confirm that you want to inform your system administrator about the order, or touch to close this dialog without sending the order request.

Confirming the *Order Test Strips* dialog creates and sends an order event to the DMS. This does not automatically lead to an order of new test strips. The administrator is informed via the DMS and has to place the order accordingly.

6.2 Storing control solution information

Glucose control solution lot information can be entered before testing, if lot editing has been allowed at the meter level in the setup, and appears in a list for operators to refer to. Use the following procedure to add glucose control lot numbers to the Control Lot list.

Entering the lot number of the control solution

The following description assumes that the meter is powered on and the *Main Menu* is displayed.

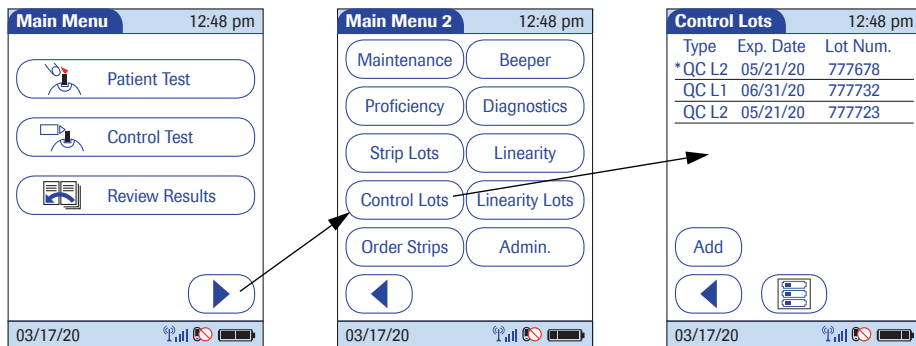

- 1 Touch  to open the *Main Menu 2* screen.
- 2 Touch *Control Lots* to open the related menu.
- 3 Touch *Add* to enter a new lot number.

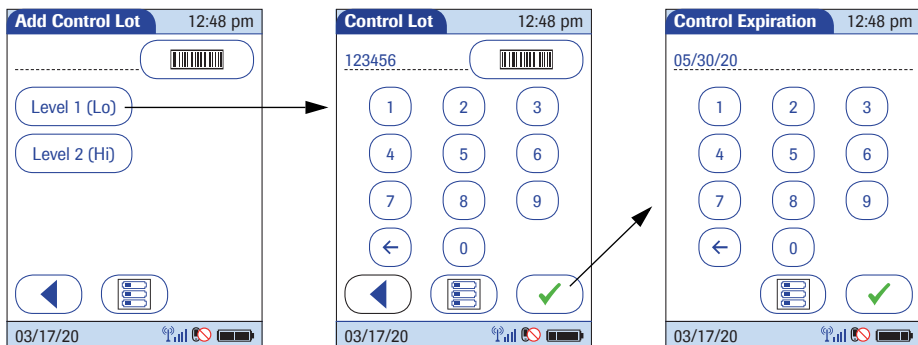

- 4 Select the level (L1/Lo or L2/Hi).
- 5 Use the keypad to enter the lot number. Touch to confirm the entered lot number,
or
 press and release  to read the lot number from the control solution bottle via barcode scanner. Follow the instructions for scanning IDs (see page 45).
- 6 Use the keypad to enter the expiration date as stated on the control solution bottle.
- 7 Touch to confirm the entered expiration date.

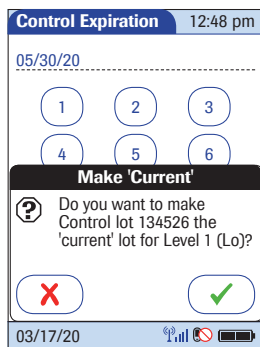

Once you have finished updating the control solution information, you can use the next screen to select the lot number you are currently editing as the current lot number.

The current lot number is provided automatically for use with subsequent tests.

- 8 Touch to confirm that you want this lot number to be the lot number currently in use, **or** touch to store the entries without making the lot number the current lot number.
- 9 Continue entering additional lot numbers, or touch  to return to the *Main Menu*.

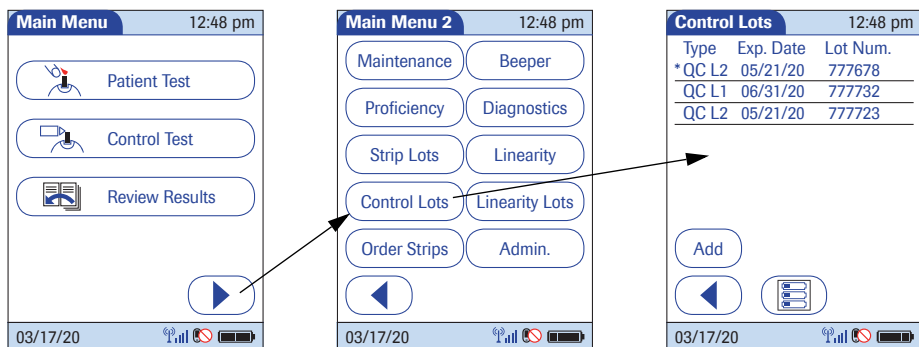

Selecting a stored lot number as the current lot number

You can select any stored lot number as the current lot number.

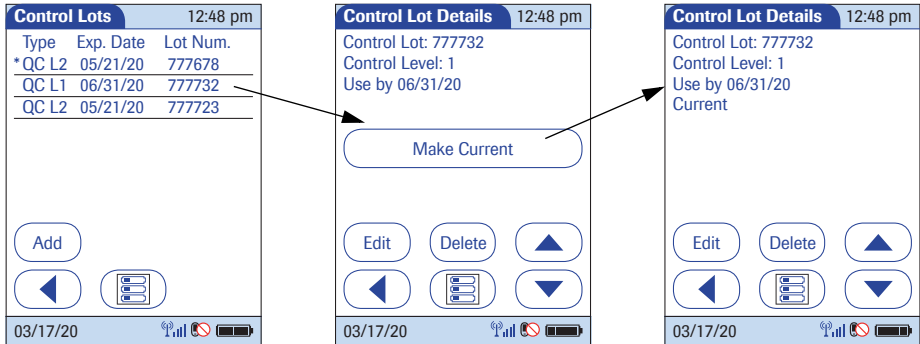

- 1 Touch  in the *Main Menu* to open the *Main Menu 2* screen.
- 2 Touch *Control Lots* to open the related menu. The current lot number is indicated by an asterisk (*).



- 3 Touch the lot number you wish to select as the current lot number. This opens the related detail view.
- 4 Touch *Make Current* to make the lot number the current lot number. The information *Current* is then also displayed in the detail view.
- 5 Touch  to return to the list of lot numbers, **or** touch  to return to the *Main Menu*.

6.3 Storing linearity test information

Observe the applicable regulations and directives of the responsible regulatory agencies when performing linearity tests.

Entering the lot number of the linearity test

The following description assumes that the meter is powered on and the *Main Menu* is displayed.

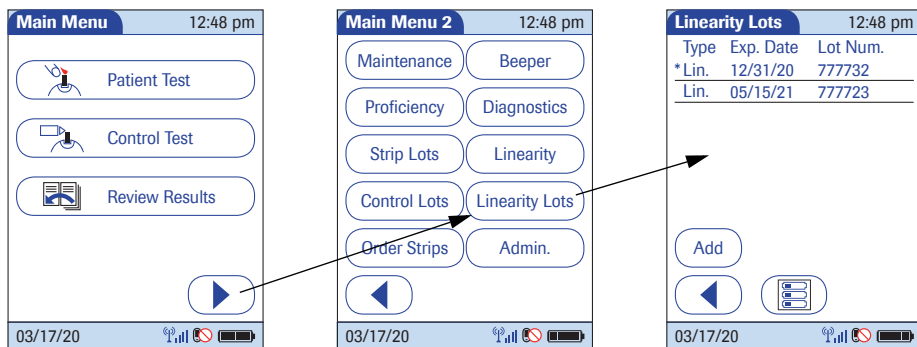

- 1 Touch  to open the *Main Menu 2* screen.
- 2 Touch *Linearity Lots* to open the related menu.
- 3 Touch *Add* to enter a new lot number.

Linearity Lot 12:48 pm

777678

1	2	3
4	5	6
7	8	9
←	0	A-0

03/17/20

Linearity Expiration 12:48 pm

03/31/20

1	2	3
4	5	6
7	8	9
←	0	

03/17/20

- 4 Use the keypad to enter the lot number.
- 5 Touch to confirm the entered lot number.
- 6 Enter the expiration date (use two digits and leading zero, if necessary) and touch to confirm the expiration date you have entered.

Once you have finished updating the linearity test information, you can use the next screen to select the lot number you are currently editing as the current lot number.

Linearity Lots 12:48 pm

Type	Exp. Date	Lot Num.
*Lin.	12/31/20	777732
Lin.	05/15/21	777723

Make 'Current'

? Do you want to make Linearity lot 777678 the 'current' lot?

03/17/20

The current lot number is provided automatically for use with subsequent tests.

- 7 Touch to confirm that you want this lot number to be the lot number currently in use, **or** touch to store the entries without making the lot number the current lot number.
- 8 Continue entering additional lot numbers, **or** touch to return to the *Main Menu*.

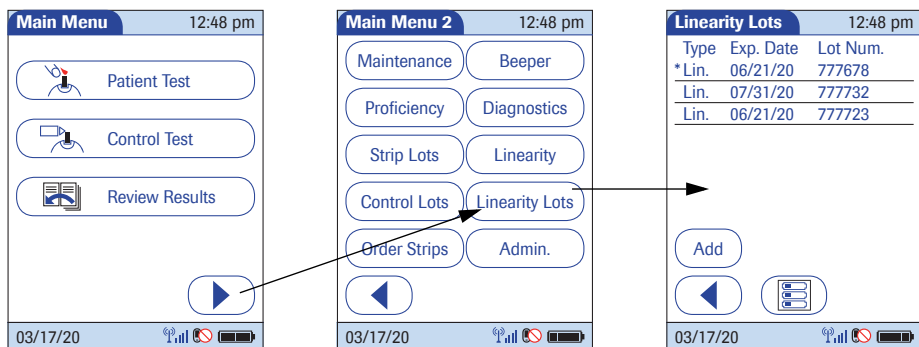

Selecting a stored lot number as the current lot number

You can select any stored lot number as the current lot number.

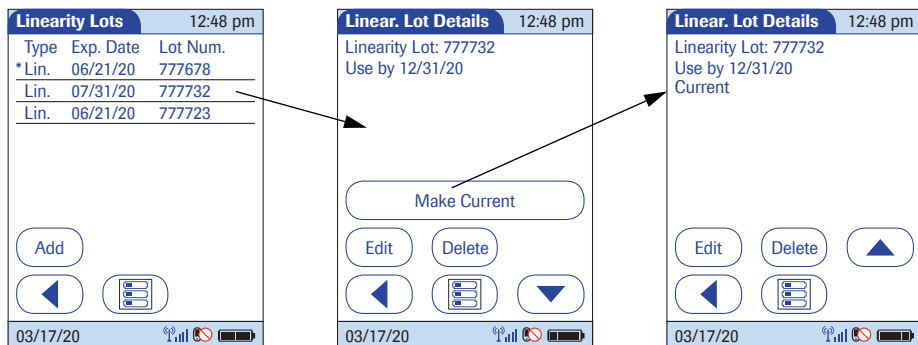

- 1 Touch  in the *Main Menu* to open the *Main Menu 2* screen.
- 2 Touch *Linearity Lots* to open the related menu. The current lot number is indicated by an asterisk (*).



- 3 Touch the lot number you wish to select as the current lot number. This opens the related detail view.
- 4 Touch *Make Current* to make this lot number the current lot number. The *Current* information is then also displayed in the detail view.
- 5 Touch  to return to the list of lot numbers, **or** touch  to return to the *Main Menu*.

7 Linearity Testing

7.1 Information regarding linearity tests

Observe the applicable regulations and directives of the responsible regulatory agencies when performing linearity tests. For information about sources for products required during linearity testing or for technical assistance, contact Roche Customer Support Center.

Linearity tests can help you to check the function and accuracy of the entire system over the full range of specified values. Linearity samples should be treated in exactly the same manner as previously described for control solutions used in glucose control testing.

The term “Linearity” describes the ability of the system to maintain a constant accuracy over the full range of specified values. If test results were plotted against reference values as a curve over the full range of these values, the ideal (high linearity) would be a straight line. Linearity is the range of values from the lowest to the highest for which an instrument is proven capable of giving accurate results.

When using a data management system for configuration, it is possible to partially or fully disable the functions described in this chapter. In this case, the respective buttons in *Main Menu 2* do not appear. See also Appendix A.

Linearity testing intervals

The linearity of the system should be checked before it is used the first time for patient testing. The intervals for subsequent linearity tests are determined by the facility that operates the system. Linearity testing can also be run when you want to check the overall performance of the system.

Information stored during linearity testing

The following information is stored for every linearity test:

- Test result
- Lot number of the linearity solution
- Level of linearity solution (L1 to L6)
- Operator ID (if configured)
- Lot number of the test strips
- Time and date of test
- Comments (if applicable)

Linearity test kit

The linearity test kit contains glucose solutions in six levels (6 vials, 2.5 mL each). For additional information about the contents and handling of the kit, refer to the package insert.

Preparing to run a linearity test

Aside from special preparations (see the following section), a linearity test is run the same as a patient test. Please check the following:

- At least one code file for test strips must be stored in the meter and match the lot number of the test strips used (see Chapter 6).
- The proper test strips must be available.
- An operator ID must be entered (with password, if applicable), if the meter is configured for login.

7.2 Performing a linearity test

Overview of test procedure

A linearity test comprises the following steps:

- Check the lot number of the linearity solutions.
- Check the lot number of the test strips.
- Perform the test with a minimum of three linearity solutions.

Starting a linearity test

The following description assumes that the meter is powered on and the *Main Menu* is displayed.

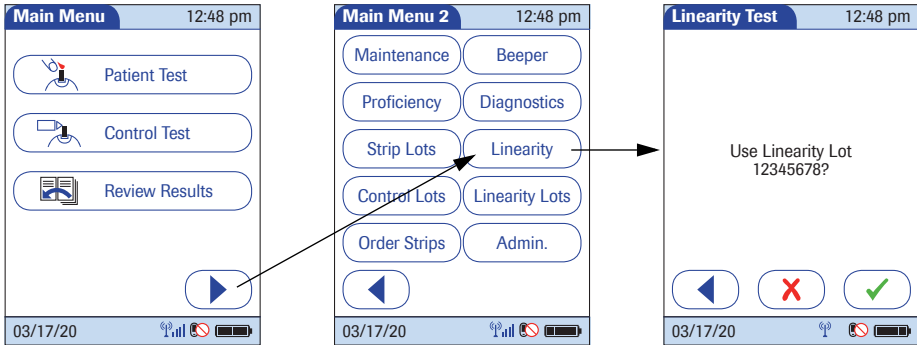

- 1 Touch  in the *Main Menu* to open the *Main Menu 2* screen.
- 2 Touch *Linearity* to start the linearity test. The *Linearity Test* screen opens.

Confirming or selecting the lot number for linearity test kits

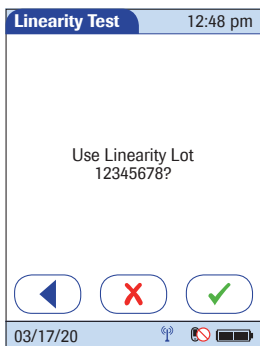

Confirming or selecting the test strip lot



You are now prompted to confirm or enter the lot number of the linearity test kit. Compare the number displayed by the meter to the number on the label of the linearity test kit.

- 3 If you want to use the preselected number displayed by the meter, touch to confirm.

To use a different number than the lot number displayed, touch to open the keypad and enter the number manually (see page 99).

Once you have entered and confirmed the lot number of the linearity test kit, you are asked to choose the lot number of the test strips. Compare the number displayed by the meter to the number on the label of the test strip vial.

- 4 Select the test strip lot number as follows:

To read the test strip lot number from the test strip vial via barcode scanner, press and release . Follow the instructions for scanning IDs.

To use the preselected number displayed by the meter, touch to confirm.

To use a different number than the lot number displayed, touch to select the number from a list, enter the number manually via keypad, or use the barcode scanner to enter the lot number (see page 87).

Touch to confirm the selected test strip lot number.

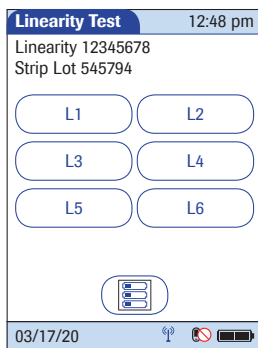

Inserting test strips

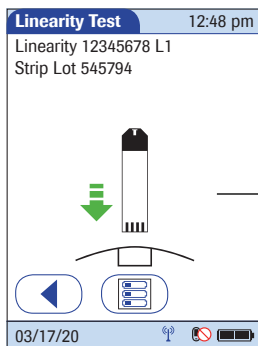

In the *Linearity Test* menu, the levels available for the linearity test are displayed.

- 5 Touch *L1* to start the subsequent test with this (first) level.

After selecting the level, a flashing green arrow appears on screen and prompts you to insert the test strip.

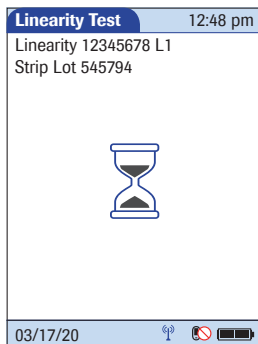
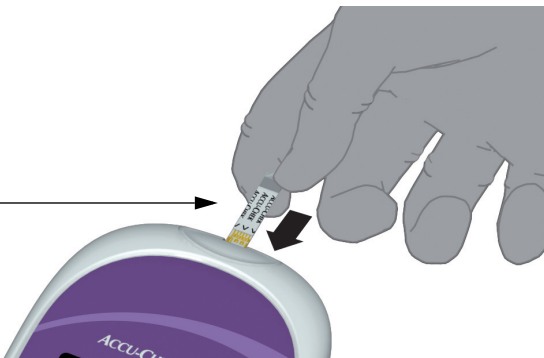

- 1 Remove the test strip from the test strip vial and close the vial again with the cap.
- 2 Hold the test strip so the lettering "ACCU-CHEK" is facing upward.
- 3 Slide the test strip into the test strip port as far as it will go in the direction indicated by the arrows on the test strip.

The meter beeps. The hourglass icon appears and indicates that the meter is checking the test strip. Do not apply linearity solution while it is displayed.

Applying a linearity test sample

Once the meter has checked the test strip, the hourglass icon disappears and you are prompted to apply linearity solution.

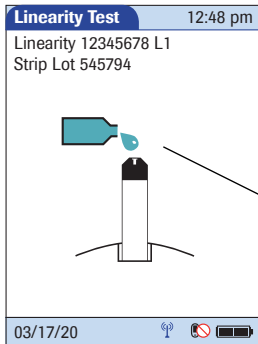

When applying the linearity solution, position the meter so that the test strip port is always higher or on the same level as the linearity solution. This prevents any excess solution from flowing down the strip and entering the meter.

- 1 Wait until the flashing drop appears in the display before applying the solution. The meter beeps.
- 2 Apply a drop of the linearity solution to the **front edge** of the test strip. Do **not** apply the solution to the top of the strip.
The linearity solution is pulled into the test strip area by capillary action.

Once sufficient linearity solution has been detected, the meter beeps and the measurement begins. Do not touch test strip once the meter beeps. Wait for the linearity solution result to show on screen.

Results screen

The hourglass icon indicates the test is running. When the test is completed and the result is ready, the meter beeps again.

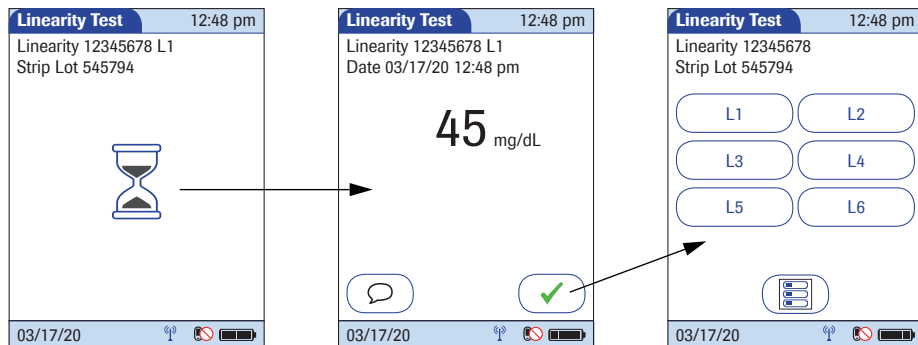

You can add comments to a test result (as with blood glucose tests, see page 65).

If you do not wish to add a comment to the test result, touch to continue to the next level of the linearity test.

Remove the test strip and dispose of it in accordance with applicable regulations and directives. Repeat the above steps for all levels of the linearity test.

Test results are saved automatically if the meter is powered off or if it powers itself off after 10 minutes of inactivity/no screen touches (see “Automatic power-off” on page 21).

8 Proficiency Testing

8.1 Information regarding proficiency tests

Observe the applicable regulations and directives of the responsible regulatory agencies when performing proficiency tests.

Blood glucose proficiency tests are run on samples whose values are unknown to the operator performing the test. These samples are provided by an outside source, and the results should be forwarded to the appropriate source after completing the test. The supplied samples are treated in the same manner as regular patient samples.

Blood glucose proficiency testing provides another means to verify that your technique, reagents, system, and testing performance are as they should be. Some regulatory agencies require that these proficiency samples be tested as part of an institution's quality assurance program before certification of the institution is allowed.

When using a data management system for configuration, it is possible to partially or fully disable the functions described in this chapter. In this case, the respective buttons in *Main Menu 2* do not appear. See also Appendix A.

Information stored during proficiency testing

The following information is stored for every proficiency test:

- Test result
- Sample ID
- Lot number of the test strips
- Time and date of test
- Comments (if applicable)
- Operator ID (if configured)

For blood glucose proficiency tests, the sample ID (instead of patient ID) must be stored as identification. Sample IDs with up to 20 characters can be entered.

Preparing a proficiency test

To perform a proficiency test you need the following:

- At least one code file for test strips must be stored in the meter and match the lot number of the test strips used (see Chapter 6).
- The proper test strips must be available.
- An operator ID must be entered (with password, if applicable), if the meter is configured for login.

8.2 Performing a proficiency test

Overview of test procedure

A proficiency test comprises the following steps:

- Enter a sample ID for the proficiency sample.
- Check the lot number of the test strips.
- Perform the actual test with the proficiency sample.

Starting a proficiency test

The following description assumes that the meter is powered on and the *Main Menu* is displayed.

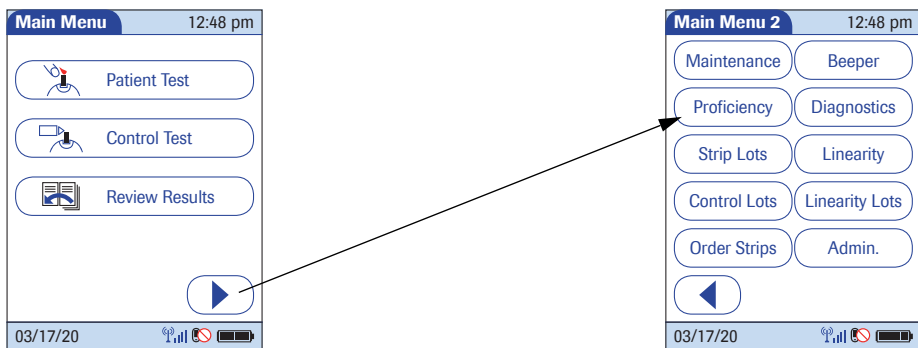

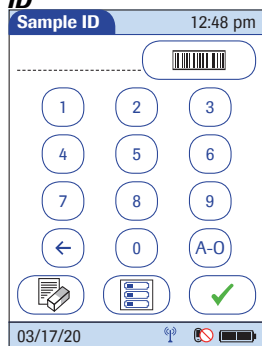

- 1 Touch  in the *Main Menu* to open the *Main Menu 2* screen.
- 2 Touch *Proficiency* to start the proficiency test.

Entering the proficiency sample ID



You will now be asked to enter the sample ID.

- 1 Use the keypad to manually enter the sample ID, or press and release  to read the sample ID from the sample vial via barcode scanner (see page 45). Make sure in this case that the proficiency sample has a compatible barcode (see Appendix A).
- 2 Touch  to confirm the selected or scanned sample ID.

Confirming or selecting the test strip lot



Once you have entered and confirmed the sample ID, you will be asked to choose the test strip lot number. Compare the number displayed by the meter to the number on the label of the test strip vial.

- 3 If you want to use the preselected number displayed by the meter, touch  to confirm.

To use a different number than the lot number displayed, touch  to select the number from a list, enter the number manually via keypad, or use the barcode scanner to enter the lot number (see page 87).

Inserting test strips

After confirming the test strip lot, a flashing green arrow appears on screen and prompts you to insert the test strip.

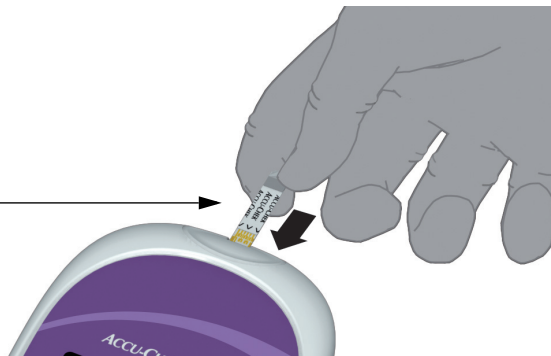
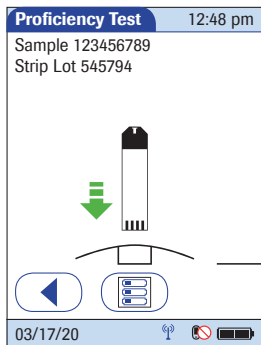

- 1 Remove the test strip from the test strip vial and close the vial with the cap.
- 2 Hold the test strip so the lettering "ACCUCHEK" is facing upward.
- 3 Slide the test strip into the test strip port as far as it will go in the direction indicated by the arrows on the test strip.

The meter beeps. The hourglass icon appears and indicates that the meter is checking the test strip. Do not apply the proficiency sample while it is displayed.

Applying a proficiency sample

Once the meter has checked the test strip, the hourglass icon disappears and you are prompted to apply the proficiency sample.

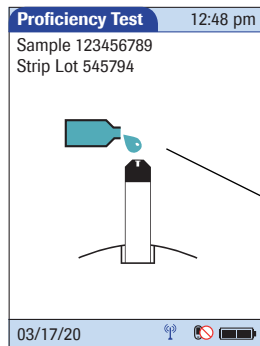

When applying the proficiency sample, position the meter so that the test strip port is always higher or on the same level as the sample. This prevents any excess sample from flowing down the strip and entering the meter.

- 1 Wait until the flashing drop appears in the display before applying the sample. The meter beeps.
- 2 Apply a drop of sample to the **front edge** of the test strip. Do **not** apply the sample to the top of the strip. The sample is pulled into the test strip area by capillary action.

Once sufficient sample has been detected, the meter beeps and the measurement begins. Do not touch test strip once the meter beeps. Wait for the proficiency test result to show on screen.

Results screen

The hourglass icon indicates the test is running. When the test is completed and the result is ready, the meter beeps again.

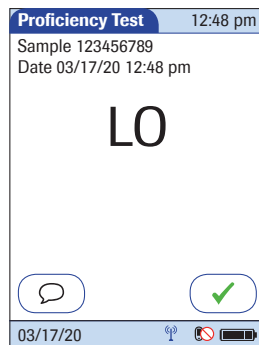
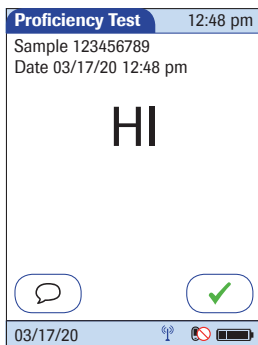
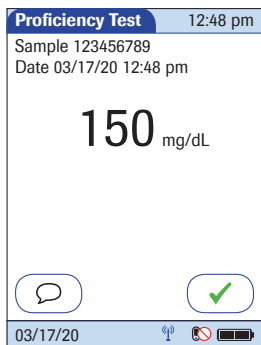

The result is displayed as a numerical value, unless it falls outside the system measurement range. In this case, the message *Hi* or *Lo* is displayed.

You can add comments to a test result (as with blood glucose tests) (see page 65).

If you do not wish to add a comment to the test results, touch  to complete the test and store the result.

Test results are saved automatically if the meter is powered off or if it powers itself off after 10 minutes of inactivity/no screen touches (see "Automatic power-off" on page 21).

Remove the test strip and dispose of it in accordance with applicable regulations and directives for disposal of potentially infectious samples and materials.

This page intentionally left blank.

9 Initial Startup

9.1 Connecting the base unit

NOTICE

To ensure continuous safe and reliable operation, use only the power supply unit provided for the Accu-Chek Inform II system (for ordering information see page 188).

Accu-Chek Inform II Base Unit:

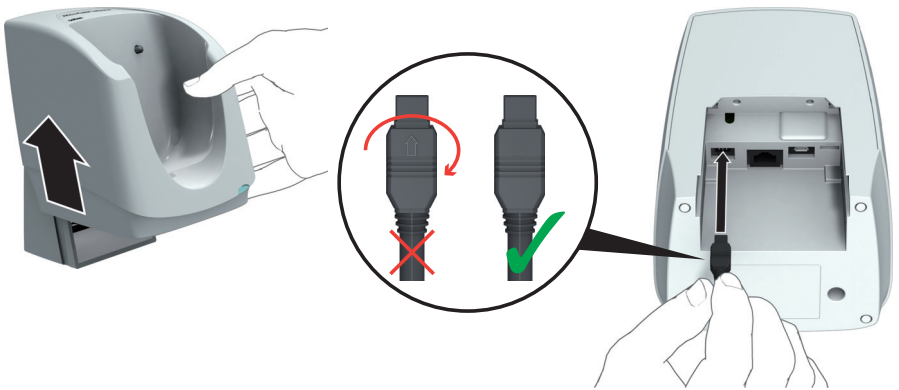

Accu-Chek Inform II Base Unit Light:

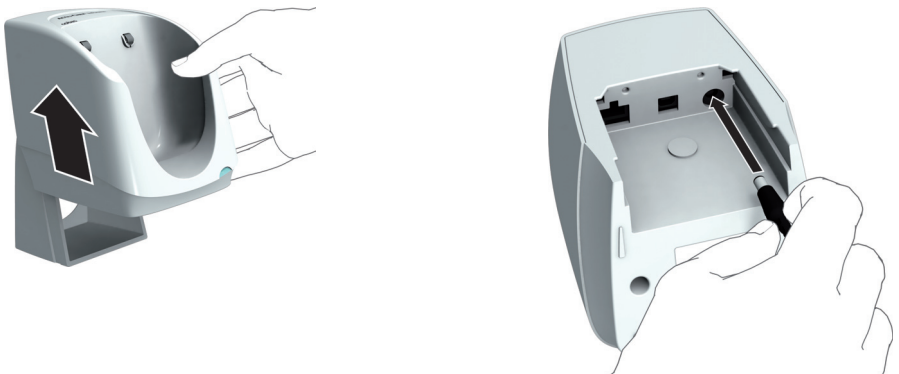

- 1 Slide the base unit upward and remove it from the wall mount (if in use).
- 2 Connect the power supply to the power input jack.
- 3 **If you want to connect the Accu-Chek Inform II Base Unit in a wired environment:**
Connect the Ethernet (RJ45) cable or the USB cable to the respective port. Use only the USB cable provided with the Accu-Chek Inform II system.
- 4 Slide the base unit back onto the wall mount (if in use).

For details on configuring the Accu-Chek Inform II Base Unit, contact Roche Customer Support Center for technical assistance.

Note for System Administrator: For further technical information on setting up and configuring the Accu-Chek Inform II Base Unit, consult the package insert accompanying the device and the “Technical Note” stored on the Accu-Chek Inform II Base Unit as a PDF file. You can access this file by connecting the base unit to a PC with the USB cable.

For connecting the Base Unit with older hardware (REF 05060290001), see Appendix F, “Appendix for Accu-Chek Inform II Base Unit (legacy version)”.

9.2 Installing or replacing the battery pack

When shipped, the battery pack is not installed in the Accu-Chek Inform II meter.

Unused battery packs lose their charge over time and have to be recharged before they can be used. After installing a **new battery pack**, the meter **should be charged for at least 8 hours (e.g., overnight)** in the base unit before testing.

Whenever the meter is in the base unit, the  icon is displayed. This icon shows that power is available and the meter can charge, if necessary.

Make sure that the allowable temperature range for charging the battery pack (37-108 °F or 3-42 °C) is maintained during installation and initial setup.

Replace the battery pack within approximately 10 minutes to retain the date and time settings. Beyond this period of time, you may have to re-enter date and time, or you may return the meter to the base unit to obtain the correct date and time. Replace the battery pack only in shutdown mode, see page 122.

Data stored in the memory (see section 12.1) is kept when replacing the battery pack even if no battery is inserted. All settings (other than date/time - see above) are also retained.

Removing the battery pack

If a battery pack is already installed, make sure that the meter is shut down to prevent damage to the meter or potential data loss.

- 1 To shut down the meter, press the the On/Off button  **for about 5 seconds** and release the On/Off button as soon as the Roche logo is displayed and the meter beeps.

If you press the On/Off button for too long, a meter reset will be triggered after about 12 seconds (see section “Meter reset” on page 181.)

- 2 Place the meter face down on a level surface.

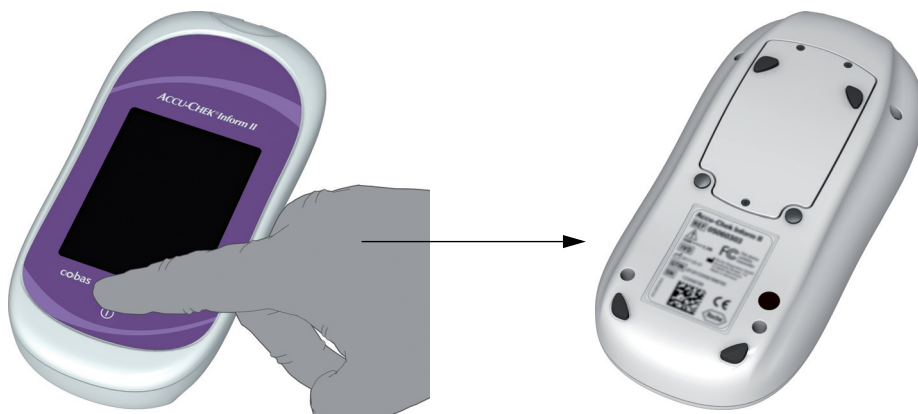



- 3 Using a Torx screwdriver size T5, remove the three screws holding the battery compartment cover in place.
- 4 Remove the battery compartment cover from the meter. The battery pack now visible is connected to the meter by a plug.
- 5 Carefully lift the battery pack and remove the plug connector.



Disposal of used batteries

Do not dispose of the batteries with normal domestic waste. Dispose of used batteries in accordance with applicable local regulations and directives and your facility's guidelines on the disposal of electronic waste equipment.

Installing the battery pack

- 1 Loosen the screws on the battery compartment cover until they are protruding about 2/10 inch.



- 2 Hold the battery pack in your hand, with the wires and the plug pinched between your thumb and index finger.

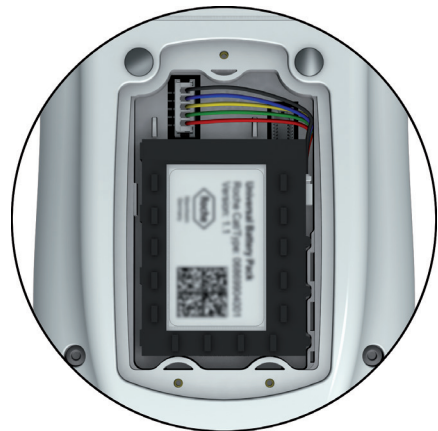

- 3 Plug the connector plug into the socket.
- 4 Place the battery pack inside the battery compartment as shown above.

To position the battery pack correctly, always align the ridges on the side of the battery pack with the ridges on the inside of the battery compartment.



- 5 Close the battery compartment with the cover. Make sure that the plug connector wires do not get pinched between meter and cover.
- 6 Tighten all three screws until snug (do not over-tighten).

After inserting a new battery pack, the meter powers on automatically.

- The Roche logo is displayed. If the meter does not power on automatically, the battery pack may be nearly empty. Place the meter in a base unit for a minimum of 15 minutes, then remove the meter and try to power it on. If it powers on, the battery pack is charging properly.
 - Within a short period of time, the start screen should appear.
 - If the meter has been without power for too long, a message may appear informing you that the date and time settings have been lost due to power loss.
 - The screens for entering the date and the time appear.
- 7 Enter the date and time. After you have entered the correct information, confirm each screen with .
 - Unless your QC configuration is *Always OK* (see page 140), the meter will now be in QC Lockout due to the manually entered date/time.
 - 8 Synchronize the meter's date/time with the date/time of your facility via base unit or, if working wirelessly, wait at least ten minutes for the next WLAN synchronization before performing any further tests.

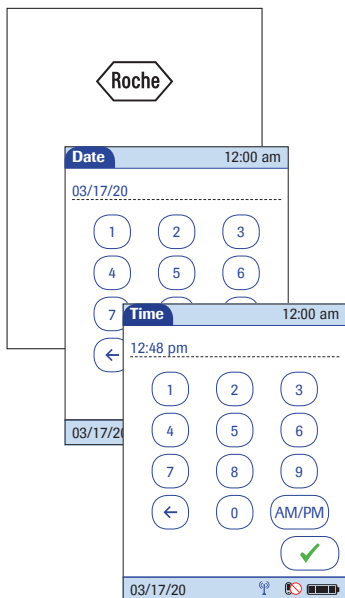

After installing a new battery pack, the meter should be charged for at least 8 hours (e.g., overnight) in the base unit before testing.

9.3 Docking the meter

Docked screen - battery status

Docking the meter in the base unit allows you to charge the battery pack. The *Docked* screen displays a large battery icon showing the current charging status of the battery. This information enables you to choose the meter with the best battery status for the next test.

Battery status is displayed as follows:

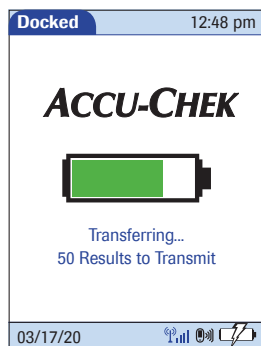

Icon	Description
	Battery is empty and device cannot be used.
	Software updates and WLAN disabled.
	Software updates are disabled.
	All functions available

Improved charging performance

After 2 minutes in the base unit, the meter powers off and goes into standby mode. The screen goes blank and the charging process starts. Charging the battery pack in standby mode improves charging performance.

When the screen is blank during the charging process, you can power on the meter at any time **to check** the battery charging status or that the meter is properly docked by touching the screen or pressing the On/Off button . The screen lights up for 2 minutes and displays the *Docked* screen with the colored battery icon best showing the current battery status.

If the meter is **NOT** properly docked, a short “humming” noise sporadically occurs and the battery charging icon  flashes in the status bar.

- Remove the meter from the base unit.
- Redock it by gently pushing it into the base unit to ensure proper contact.

Once the meter is properly docked and charging, the battery charging icon stops flashing. See section “Low power icons” on page 171.

When the battery pack is fully charged, the meter powers on automatically and stays on. The screen displays the green battery icon to show that the battery is fully charged.

Docked screen - meter status

When docked, the meter shows different messages according to the current meter status.

The following displays appear on the meter when it is **docked** in an Accu-Chek Inform II Base Unit or an Accu-Chek Inform II Base Unit Light **and communicating**. The same displays appear whether the meter is transferring data via base unit or via wireless connection.

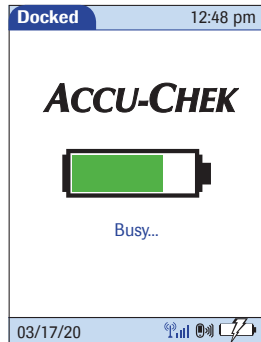
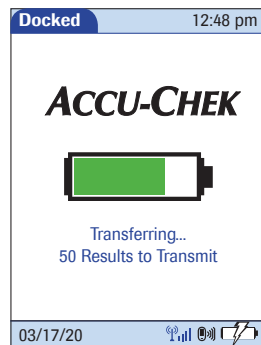
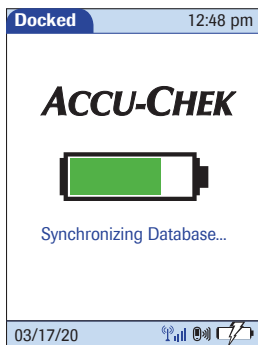
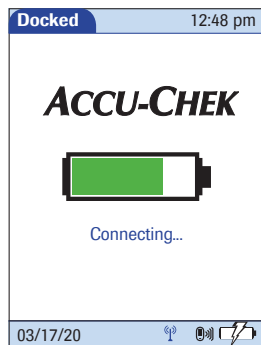

This display is visible when communication is still active but the meter is busy processing the data received or waiting for the next data message from the Data Management System (DMS).

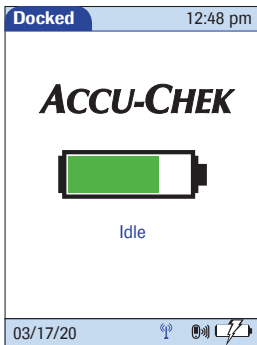

This display is visible when no communication is taking place.



This display is visible when software updates are being transferred to the meter.

- If the meter transfers data wirelessly immediately after a test, this **communication is not visible** on the display. The display remains unchanged (usually in the *Main Menu* view after a test).
- If a meter is in standby (but not docked) and communicating wirelessly, this **communication is not visible** on the display. The display remains blank.

9.4 Initial setup on the meter

There are two ways to customize the setup of the meter: directly on the meter (see the following menu overview) or via the data management system (see Appendix A). The two methods differ according to the range of options available.

If the meter is configured by a system administrator using a data management system, the configuration options on the meter may be disabled to avoid conflicts in the settings. These options then appear grayed out on the display.

The meter is delivered with preconfigured default settings. The following settings can be configured on the meter:

- Date and time format
- Date and time editing enabled
- Units
- Test types
- Lot information editing enabled
- Methods for verifying lot information
- Enable barcode scanner
- Normal, critical, and reportable ranges
- Operator ID options
- Patient ID options
- Settings for glucose controls and QC Lockout
- Beeper

The option *Service Menu* (see section 10.7) with the feature “Delete Patient Information” is not available in the preconfigured default setting. The *Service Menu* can only be activated via DMS.

Menu overview

The following tables contain a brief overview of the menu structure. The menus can be used to operate the meter fully and enter the most important basic settings.

Main Menu		
Patient Test	Observer Login	<ul style="list-style-type: none"> - Enter Observer ID - Enter Observer Password
	Glucose Test	<ul style="list-style-type: none"> - Enter Patient ID - Verify Test Strip Lot - Insert Test Strip - Apply Sample - View Test Results - Add Comments
	Other Test	<ul style="list-style-type: none"> - Pregnancy - Visual Urinalysis (UA) - Rapid Streptococcus - Rapid Drugs of Abuse Tests (DAT) - Fecal Occult - Gastric Occult - Ketones - Rapid-Acting Insulin - Regular Insulin - Intermediate-Acting Insulin - Long-Acting Insulin - Insulin Mixtures
Control Test	Glucose Control Test	<ul style="list-style-type: none"> - Select Level - Verify Control Lot - Verify Test Strip Lot - Insert Test Strip - Apply Control Solution - View Test Results - Add Comments
	Other Control Tests	<ul style="list-style-type: none"> - Select Type of Control - Enter Date/Time tested - Enter/Confirm Kit or Test Strip Lot Number - Enter Kit or Test Strip Expiration Date - Enter/Confirm Control Lot Number - Enter Control Lot Expiration Date - Select Control Result(s).
Review Results	Review Glucose Test	<ul style="list-style-type: none"> - Review All Test Results
	Review Other Test	<ul style="list-style-type: none"> - Review All OTE Results

Main Menu 2	
Maintenance	<ul style="list-style-type: none"> - Add Comment - Maintenance Result
Proficiency	<ul style="list-style-type: none"> - Enter Sample ID - Verify Test Strip Lot - Insert Test Strip - Apply Sample - View Test Results - Add Comments
Strip Lots	<ul style="list-style-type: none"> - View Lot List - Add Lot - Enter Expiration Date - Set Control Ranges - View Lot Details - Make Lot Current - Edit/Delete Lot
Control Lots	<ul style="list-style-type: none"> - View Lot List - Select Control Level - Add Lot - Enter Expiration Date - Make Lot Current - Edit/Delete Lot
Order Strips	<ul style="list-style-type: none"> - Trigger ordering of test strips
Beeper	<ul style="list-style-type: none"> - Set Beeper Volume
Diagnostics	<ul style="list-style-type: none"> - List Software Versions - Test Barcode Scanner - Meter Events Log - Statistics - Configuration - Ranges - Wireless Setup - Wireless Status - Wireless Test

Main Menu 2	
Linearity	<ul style="list-style-type: none"> - Verify Linearity Lot - Verify Strip Lot - Select Linearity Level - Insert Test Strip - Apply Linearity Solution - View Test Results - Add Comments
Linearity Lots	<ul style="list-style-type: none"> - View Lot List - Add Lot - Enter Expiration Date - Make Lot Current - Edit/Delete Lot

Admin Menu		
Language	<ul style="list-style-type: none"> - German, French, Spanish, Italian, Dutch, Swedish, English, Danish, Portuguese - Additional installable languages 	
Date/Time	<ul style="list-style-type: none"> - Enter Current Date - Enter Current Time 	
Setup Menu	Date/Time Options	<ul style="list-style-type: none"> - Date/Time Editing - Time Format - Date Format
	Test Display Options	<ul style="list-style-type: none"> - Result Unit - Enable Tests - Number of STAT Tests (if enabled)
	Reagent Options	<ul style="list-style-type: none"> - Reagent Editing - Lot Verification Mode
	QC Frequency	<ul style="list-style-type: none"> - Control Frequency
	Test Ranges	<ul style="list-style-type: none"> - Normal - Critical - Reportable
	Operator ID Entry	<ul style="list-style-type: none"> - Operator Entry - Operator Validation - Barcode
	Patient ID	<ul style="list-style-type: none"> - Patient Entry - Patient Validation - Barcode
	Setup Password	<ul style="list-style-type: none"> - Change Setup Password

Admin Menu

Service Menu¹	Delete Patient Information	- Delete all patient-related data (patient list and results)
---------------------------------	-----------------------------------	--

Touch to confirm and save any changes to the settings.

1. Only if activated via DMS

9.5 Opening the Setup Menu

All settings described here are configured via the *Setup Menu*. To open the *Setup Menu*, proceed as follows:

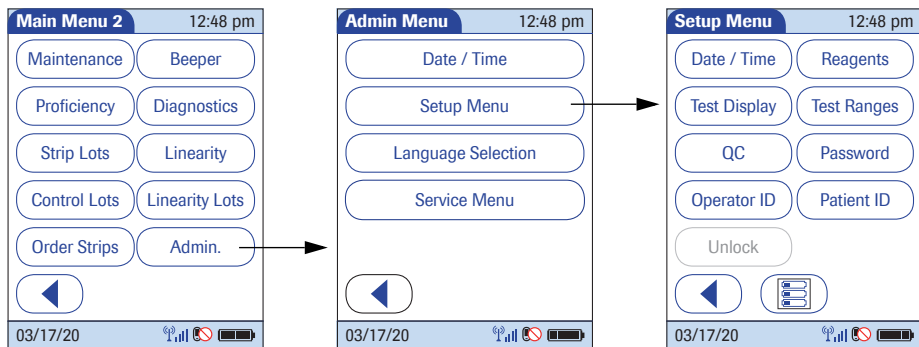

- 1 Touch  in the *Main Menu* to open the *Main Menu 2* screen.
- 2 Touch *Admin.* to open the *Admin Menu*.
- 3 Touch *Setup Menu* to open the *Setup Menu*.
- 4 Enter the *Setup* password if requested (see “Creating a setup password” on page 145).

9.6 Date and time format

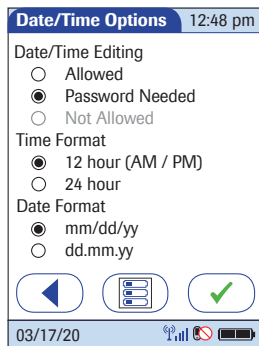

Use this menu to select the date and time format for the display. You can also choose whether the operator is allowed to edit date and time (optionally with password required, see “Creating a setup password” on page 145).

1 Touch the desired option to enable it:

■ Date/Time Editing

- *Allowed*: Enables the operator to edit the date and time.
- *Password Needed*: Enables the operator to edit the date and time only after entering a password.
- *Not Allowed*: The operator cannot edit date or time.

When using a data management system for configuration, it is possible to fully disable the *Date/Time Editing* option.

■ Time Format

- *12 hour (AM/PM)*
- *24 hour*

■ Date Format

- *mm/dd/yy*: The date is displayed in two-digit month/day/year format
- *dd.mm.yy*: The date is displayed in two-digit day/month/year format

2 Touch  to save the settings,

or

touch  to exit this menu without saving any changes.

The display returns in both cases to the *Setup Menu*.

9.7 Display options and optional tests

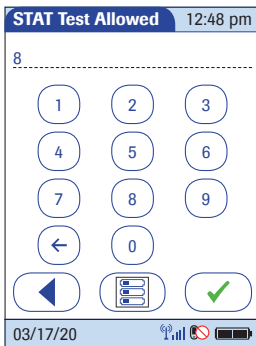
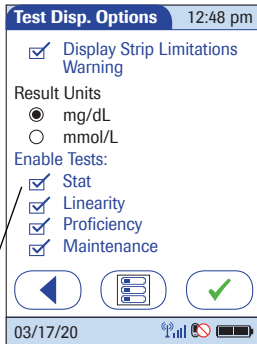

Use this menu to select the unit of measure for test results and enable or disable optional tests.



1 Touch the desired option to enable it:

■ Result Units

- *mg/dL*
- *mmol/L*

■ Enable Tests

- *STAT*: STAT tests may be performed. When this option is enabled, you must enter the number of STAT tests allowed (after confirming the settings).
- *Linearity* is displayed in the *Main Menu 2* screen
- *Proficiency* is displayed in the *Main Menu 2* screen
- *Maintenance* is displayed in the *Main Menu 2* screen

2 Touch  to save the settings. If the *STAT* option is enabled, enter the number of STAT tests allowed, **or** touch  to exit this menu without saving any changes.

The display returns in both cases to the *Setup Menu* (after entering the number of STAT tests allowed).

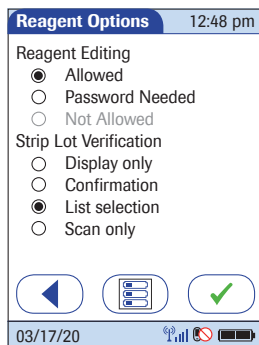

9.8 Options for test strips



This menu allows you to select options for handling lot numbers and specify whether the operator is allowed to add or delete reagent lots, edit the expiration date and limit values on the meter (see “Creating a setup password” on page 145).



- 1 Touch the desired option to enable it:
 - **Reagent Editing**
 - *Allowed*: Enables the operator to edit the reagent information without needing a password.
 - *Password Needed*: Enables the operator to edit the reagent information only after entering a password.
 - *Not Allowed*: The operator cannot edit reagent information.

When using a data management system for configuration, it is possible to fully disable the *Reagent Editing* option.

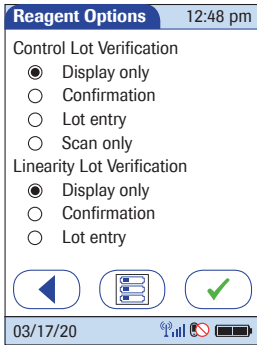
- **Strip Lot Verification**
 - *Display only*: The lot number is shown on screen but the operator cannot confirm it or select a different lot number.
 - *Confirmation*: The operator must confirm the lot number displayed and can enter alternative lot numbers manually or via barcode scanner.
 - *List selection*: The operator can also select from a list of stored lot numbers.
 - *Scan only*: Lot numbers can be verified via barcode scanner only.
- 2 Touch  to change to the second screen of options,
or
 touch  to exit this menu without saving any changes.



On the second settings screen, you can select options for handling lot numbers with glucose control and linearity tests.

- 1 Touch the desired option to enable it:
 - **Control Lot Verification**
 - *Display only*: The lot number is shown on screen but the operator cannot confirm it or select a different lot number.
 - *Confirmation*: The operator must confirm the lot number displayed and can enter alternative lot numbers manually or via barcode scanner.
 - *Lot entry*: The operator must enter the lot number.
 - *Scan only*: Lot numbers can be verified via barcode scanner only.
 - **Linearity Lot Verification**
 - *Display only*: The lot number is shown on screen but the operator cannot confirm it or select a different lot number.
 - *Confirmation*: The operator must confirm the lot number displayed and can enter alternative lot numbers manually.
 - *Lot entry*: The operator must enter the lot number.
- 2 Touch  to save the settings (for both settings screens),
or
 touch  to return to the first settings screen.

9.9 Options for glucose control tests

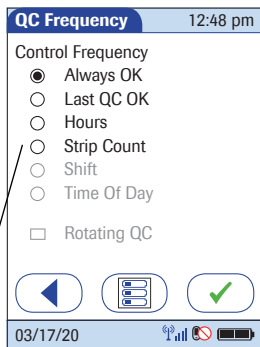



This menu contains options that allow you to specify whether and at what intervals glucose control tests are performed. If you require control tests, check your settings for STAT tests (see page 137).

1 Touch the desired option to enable it:

■ Control Frequency

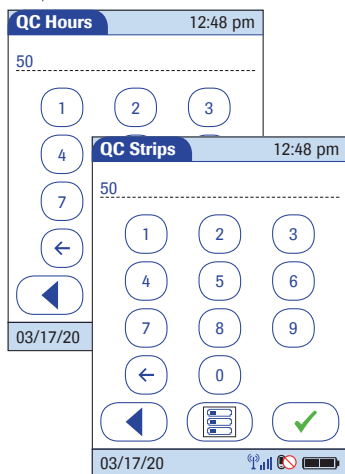
- *Always OK*: QC Lockout is disabled, patient tests can be performed at any time. This applies regardless of the result of running glucose control tests.
- *Last QC OK*: QC Lockout is activated only when the last glucose control test is out of range or a control test is not available (e.g., when changing the test strip lot).
- *Hours*: QC Lockout is activated after the specified time. When a glucose control test is run successfully, the counter is reset to “0”.
- *Strip Count*: QC Lockout is activated after reaching the specified number of tests. When a glucose control test is run successfully, the test strip counter is reset to “0”.



- *Shift*: QC Lockout is activated per shift.
 - *Time Of Day*: QC Lockout is activated at the specified time of day. (Up to six times per day can be configured.)
 - *Rotating QC*: QC tests require alternating use of L1 and L2 controls, instead of requiring both controls when performing a QC test.
- 2 Touch  to save the settings. If the *Hours* or *Strip Count* option is enabled, enter the desired number, **or** touch  to exit this menu without saving any changes.



The display returns in both cases to the *Setup Menu*.

9.10 Value ranges (normal, critical, reportable)

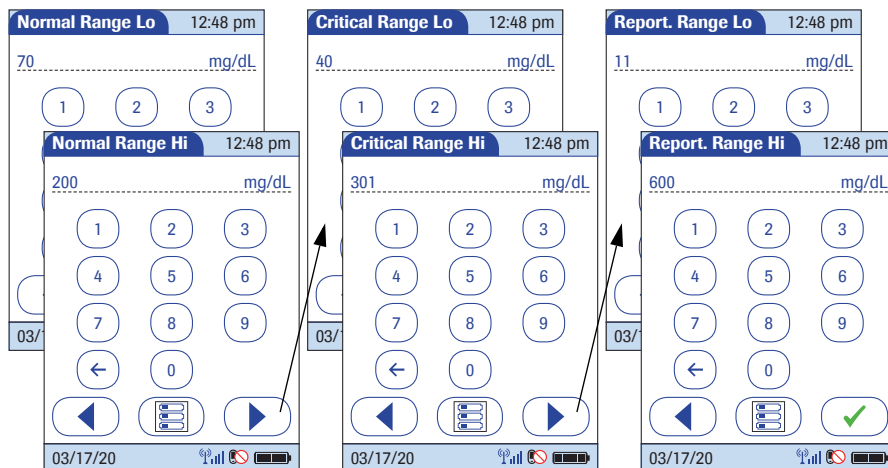
This menu allows you to set limit values for results as *Normal*, *Critical*, or *Reportable*. Results outside these limits will be flagged to alert you of this event. The *Reportable Range* allows the system administrator to set an institution defined range for reporting patient results.



Values for range limits are entered one directly after the other in the following order:

- Normal (low/high limit value)
 - Critical (low/high limit value)
 - Reportable (low/high limit value)
- 1 Use the keypad to enter the first value.
 - 2 Touch  to enter the following value,
or
touch  to return to the previous view.
 - 3 After entering the last value, touch  to save all the previous settings.

9.11 Options for Operator ID Entry

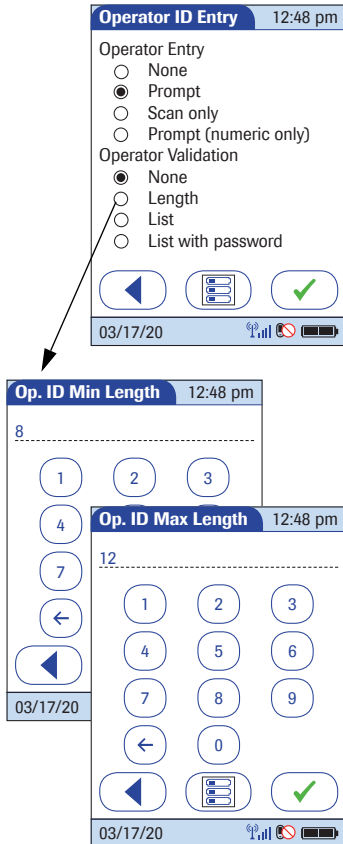

This menu allows you to specify if and how operator login is performed.

1 Touch the desired option to enable it:

■ Operator Entry

- *None*: The meter can be used without operator login.
- *Prompt* or *Prompt (numeric only)*: Operator login is required. The Operator ID can be entered manually via keypad or via barcode scanner.
- *Scan only*: Operator login is required. Entry of ID via barcode scanner only.

■ Operator Validation

- *None*: The operator ID can have any length (up to 20 characters).
- *Length*: The operator ID must be a specified length (up to 20 characters). Enter the minimum and maximum lengths after selecting this option.
- *List*: The operator ID must be on a list received from the data management system (DMS).
- *List with password*: The operator ID must be on a list received from the data management system (DMS). Additionally, a password must be entered.

2 Touch to save the settings. If the *Length* option is enabled, enter the desired numbers, **or** touch to exit this menu without saving any changes.

The display returns in both cases to the *Setup Menu*.

9.12 Patient ID options

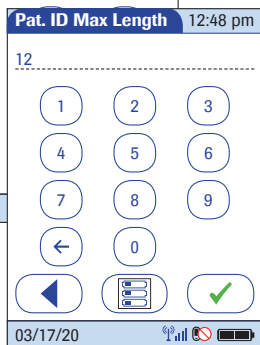
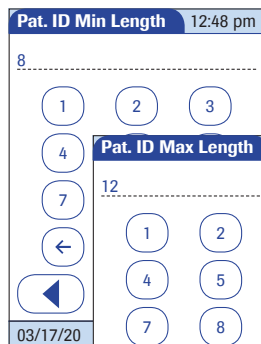
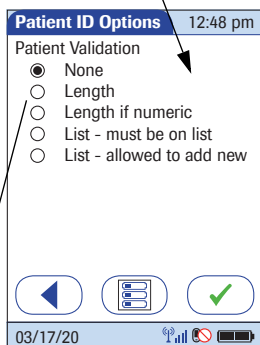
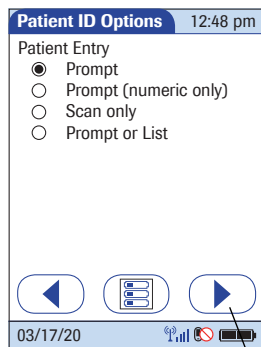

This menu allows you to specify the criteria for entering a patient ID.

1 Touch the desired option to enable it:

■ Patient Entry

- *Prompt* or *Prompt (numeric only)*: The Patient ID can be entered manually via keypad or via barcode scanner.
- *Scan only*: Entry of ID via barcode scanner only.
- *Prompt or List*: The Patient ID can be entered manually via keypad or via barcode scanner, or can be picked from a list received from the DMS.

■ Patient Validation

- *None*: The patient ID can have any length (up to 20 characters).
- *Length*: The patient ID must be a specified length (up to 20 characters). Enter the minimum and maximum lengths after selecting this option.
- *Length if numeric*: Only numeric patient IDs are validated for their length. Alphabetic patient IDs are not validated.
- *List - must be on list*: The patient ID must be on a list received from the DMS.
- *List - allowed to add new*: The patient ID will be checked against a list received from the DMS. However, it is allowed to create a new patient ID using the meter.

2 Touch to save the settings. If the *Length* option is enabled, enter the desired numbers, **or** touch to exit this menu without saving any changes.

The display always returns to the *Setup Menu* (after entering the desired numbers).

9.13 Creating a setup password

This screen allows you to create a password for all the settings described in this chapter as well as for editing date/time and lot information (if password protected). The setup password ensures that only authorized persons can make changes to the setup.

Please note that password protection can only be reset or modified after entering the current password. Proper authentication is required to access the *Setup Menu*. Store your password in a safe place.



- 1 Use the keypad to enter the password.
- 2 Touch to save the password and enable password protection
or
 touch to exit this screen without saving any changes. The display returns to the *Main Menu*. Password protection will take effect only after the next power on.

To disable password protection:

- 1 Open the *Setup Menu* (you must enter the current password).
- 2 Touch *Password*.
- 3 Delete the current password by touching .
- 4 Touch to disable password protection.

9.14 Setting the date and time

This setting can be hidden or require entry of the setup password, based on configuration.

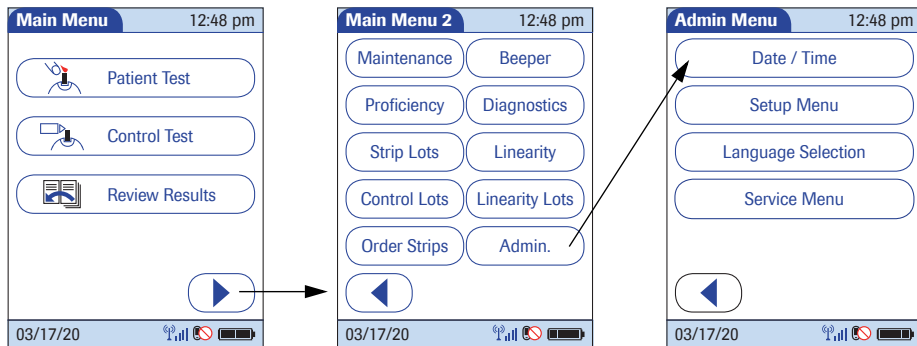

- 1 Touch  in the *Main Menu* to open the *Main Menu 2* screen.
- 2 Touch *Admin.* to open the *Admin Menu*.
- 3 Touch *Date/Time* to begin entering the date.

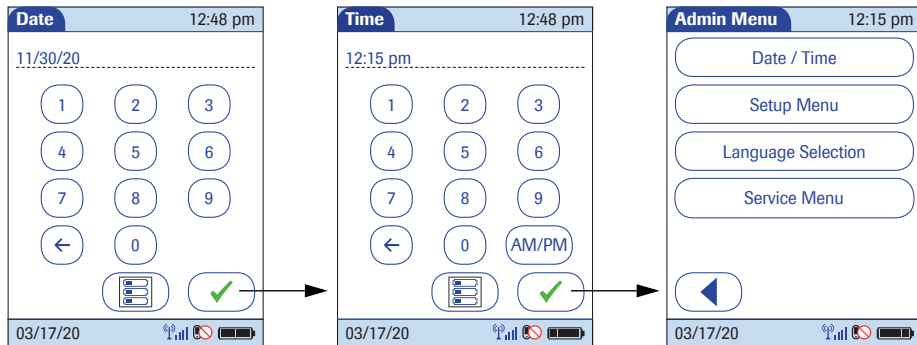



- 4 Enter the date first, then time (all values are two-digit with a leading zero, if necessary) by touching .

If the time format is "12h", touch *am/pm* to select the correct time.

9.15 Beeper options

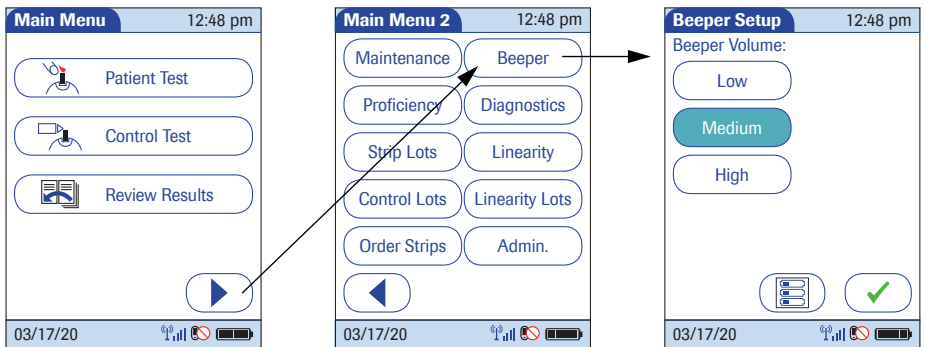
This setting can be used to set the volume of the beeper.



- 1 Touch  in the *Main Menu* to open the *Main Menu 2* screen.
- 2 Touch *Beeper* to set the volume.
- 3 Touch the button with the desired volume. When you touch a button, the meter will beep at the corresponding volume.
- 4 Touch  to save the setting and return to the *Main Menu 2* screen.

10 Maintenance and Care

10.1 Conditions for storage and shipping

All information given on maintenance and care of the “base unit” in this chapter applies to both the Accu-Chek Inform II Base Unit and the Accu-Chek Inform II Base Unit Light.

General operating conditions

Please observe the following points to ensure the reliable operation of your system over the long term:

- Handle the meter and its system components with care. Avoid dropping it or banging it.
- Protect the base unit from dripping liquid.
- Do **not** immerse the meter or base unit in any liquid.
- Following cleaning or disinfection, **ensure the meter is dry** before placing in base unit.
- Follow the instructions for cleaning, beginning on page 151.



Observe the following safety information to ensure the system functions properly. Improper handling can lead to erroneous test results.

- Do not expose the meter to excessive sources of heat for prolonged periods of time when performing a test. Potential sources of heat can be, but are not limited to:
 - Leaving the meter under a bilirubin light or photo therapy light
 - Leaving the meter on a bed warmer
 - Leaving the meter in an isolette

See Chapter 12 for operating and storage temperature ranges.

Shipping



Observe the following safety information when shipping the meter and battery pack. Failure to do so may result in injury to persons or damage to the meter or battery pack.

- If the meter has to be shipped or transported over long distances, always remove the battery pack from the meter. This eliminates the possibility of the battery pack overheating due to a short circuit. It also prevents deep discharge and other damage to the battery pack or meter.
- Only ship undamaged battery packs. Damaged battery packs must be disposed of locally. See page 24 for the risks associated with damaged battery packs and disposal information.
- Package the battery pack for shipping so that it cannot move around in the packaging. Also observe any other applicable national regulations.
- When shipping via third parties (e.g., by air or parcel service), work with the carrier to check whether specific requirements need to be met in relation to the lithium-ion battery packs on the basis of national or international laws on hazardous goods and, where applicable, if special packaging and labeling requirements apply.

For short distances - example between a facility's sites - users may transport the battery packs (either installed in the meter or separately) by road without having to meet further requirements.

Storage

- Store the system and test strips in the same environment in which they are used.
- Do not store the meter in direct sunlight or under extreme temperature conditions.
- Observe the limits for temperature and humidity when storing and using the meter (see Chapter 12).

10.2 Cleaning/disinfecting the Accu-Chek Inform II system

Cleaning and disinfecting the exterior surface of the meter is, at minimum, recommended daily for dedicated patient devices. Meters used with multiple patients may require more frequent cleaning and disinfecting. Follow recommendations from the FDA, CDC, and CMC and your facility's policies and procedures for infection control.^{1, 2}

The FDA recommends that Point of Care testing devices, such as blood glucose meters, should be used only on one patient and not shared. If dedicating blood glucose meters to a single patient is not possible, the meters must be properly cleaned and disinfected after every use following the guidelines given in this section.³

For technical assistance or questions on cleaning and disinfecting, please contact Roche Customer Support Center at 1-800-440-3638.

1. FDA Public Health Notification: Use of Fingertick Devices on More than One Person Poses Risk for Transmitting Bloodborne Pathogens: Initial Communication, (2010). <http://www.fda.gov/MedicalDevices/Safety/AlertsandNotices/ucm224025.htm>
2. CDC Clinical Reminder: Use of Fingertick Devices on More than One Person Poses Risk for Transmitting Bloodborne Pathogens, (2010). <http://www.cdc.gov/injectionsafety/FingertickDevicesBGM.html>
3. Healthcare Infection Control Practices Advisory Committee (HICPAC), William A. Rutala, Ph.D., M.P.H., and David J. Weber, M.D., M.P.H. Centers for Disease Control and Prevention, 2008. Guideline for Disinfection and Sterilization in Healthcare Facilities. Atlanta, GA.

Guide to cleaning and disinfecting the Accu-Chek Inform II system

Prior to cleaning and disinfecting a blood glucose testing equipment:

- 1 Follow the infection control procedures of your institution when handling blood glucose testing equipment
- 2 Wear gloves
- 3 The gloves worn during cleaning and disinfecting should be removed and hands washed thoroughly with soap and water before performing the next patient test

Cleaning and disinfecting the meter

- Clean the meter to remove visible soil and organic material prior to disinfecting.¹
- Disinfect the meter to destroy pathogenic and other types of microorganisms. Disinfection destroys most recognized pathogenic microorganisms but not necessarily all microbial forms (e.g., bacterial spores).¹

NOTE: The meter should be cleaned and disinfected between each patient use.

1. Healthcare Infection Control Practices Advisory Committee (HICPAC), William A. Rutala, Ph.D., M.P.H., and David J. Weber, M.D., M.P.H. Centers for Disease Control and Prevention, 2008. Guideline for Disinfection and Sterilization in Healthcare Facilities. Atlanta, GA.

Acceptable cleaning/ disinfecting agents

- To purchase approved disinfecting products, please refer to your facility's guidelines, which may include instructions on direct purchase from the agent manufacturer or through an approved distributor. For additional information on product availability for purchase, refer to manufacturer's website: <http://www.cloroxprofessional.com> for Clorox[®] Germicidal Wipes or <http://www.pdipdi.com/> for Super Sani-Cloth[®] Germicidal Disposable Wipes.
- Dispose of acceptable cleaning and disinfection solutions per facility guidelines.

Acceptable active ingredients and products for cleaning and disinfecting are:

- Clorox[®] Germicidal Wipes (Environmental Protection Agency (EPA) reg. no. 67619-12) Pre-moistened disinfecting cloths (active ingredient 1% (or less) solution of sodium hypochlorite in water)
- Super Sani-Cloth[®] Germicidal Disposable Wipes (EPA reg. no. 9480-4) Pre-moistened disinfecting cloths (active ingredient 0.5% quaternary ammonium chlorides and up to 60% isopropanol)
- Cleaners and disinfectants were validated separately and only one cleaning/disinfecting solution should be used on the device as the effect of using more than one cleaner/disinfectant interchangeably has not been evaluated.

NOTE: Always use Clorox Germicidal Wipes (EPA reg. no. 67619-12) or Super Sani-Cloth Germicidal Disposable Wipes (EPA reg. no. 9480-4) to clean and disinfect the meter. Do not use any other cleaning or disinfecting solution. Using solutions other than Clorox Germicidal Wipes (EPA reg. no. 67619-12) or Super Sani-Cloth Germicidal Disposable Wipes (EPA reg. no. 9480-4) could result in damage to the system components.

NOTE: Roche has tested the approved cleaning and disinfecting product for a total of 12,045 cycles, which is equal to cleaning and disinfecting after each patient use simulating 3 years of device use.

What to clean/disinfect

The following parts of the meter and system components may be cleaned and disinfected:

- The area around the test strip port
- The meter display (touchscreen)
- The meter housing (entire meter surface)

Technical assistance

If you notice any of the following signs of deterioration after cleaning or disinfecting of your meter system, stop using the system component and contact Roche Customer Support Center at 1-800-440-3638 for assistance:

- clouding of the touchscreen display
- on/off button malfunction
- clouding of the infrared data port and/or barcode scanner
- quality control results outside of the specified range

10.3 How to clean and disinfect the Accu-Chek Inform II system

WARNING

Avoid getting liquid into the test strip port!

Failure to follow these instructions may damage the meter and stop it from working properly.

- **Do Not** clean or disinfect the meter while performing a blood glucose or control test.
- **Do Not** get any moisture in the test strip port.
- **Do Not** spray anything onto the meter.
- **Do Not** immerse the meter in liquid.

If you suspect that moisture may have entered the test strip port, perform a glucose control test.

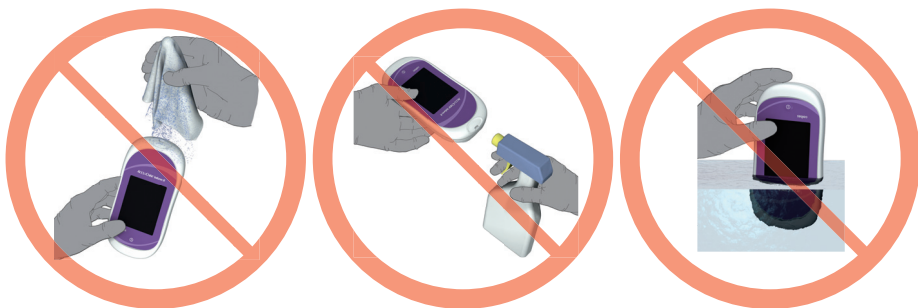

NOTICE

Do not allow liquid to enter the test strip port or allow pooling of liquid on the touchscreen. If liquid does get into the test strip port, immediately dry the components with a dry cloth or gauze. **If solution is allowed to collect in any meter opening, severe damage to the system can occur.**

Cleaning the meter



- 1 Place the meter on a level surface prior to cleaning.
- 2 Power off the meter.

Be certain that solutions contain acceptable active ingredients for cleaning the system. When using commercially available pre-moistened cleaning cloths, **squeeze off excess cleaning solution** or blot on a dry paper towel to remove any excess cleaning solution before cleaning the surface of the meter.



- 3 Use a Clorox Germicidal Wipe or Super Sani-Cloth Germicidal Disposable Wipe to clean by gently wiping the outside of the meter and carefully wipe around the test strip port area, making sure that no liquid enters the test strip port and then wipe dry with a tissue.



- 4 Dry the meter thoroughly with a dry cloth or gauze. Visually verify that no solution is seen anywhere on the meter at the completion of cleaning and disinfecting. **Ensure that the meter is thoroughly dried after cleaning** (see safety message "Avoid getting liquid into the test strip port!" and NOTICE in this section).

Disinfecting the meter



NOTE: The meter should be cleaned prior to each disinfection step.

Remember to keep the meter on a level surface prior to disinfecting and powered off. Be certain that solutions contain acceptable active ingredients for disinfecting the system. When using commercially available pre-moistened disinfecting cloths, **squeeze off excess disinfecting solution** or blot on a dry paper towel to remove any excess disinfecting solution before disinfecting the surface of the meter.

- 1 Use a fresh Clorox Germicidal Wipe or Super Sani-Cloth Germicidal Disposable Wipe to disinfect by gently wiping the outside of the meter three times horizontally and three times vertically and carefully wipe around the test strip port area, making sure that no liquid enters the test strip port.
- 2 Allow the surface of the meter to remain damp with the recommended disinfecting solution. The recommended contact times are as follows: Clorox Germicidal Wipes, a 1-minute contact time, and Super Sani-Cloth Germicidal Disposable Wipe, a 2-minute contact time.

NOTE: Meter surface should stay moist for the entire contact time.

- 3 Dry the meter thoroughly with a dry cloth or gauze. Visually verify that no solution is seen anywhere on the meter at the completion of cleaning and disinfecting. **Ensure that the meter is thoroughly dried after cleaning** (see safety message "Avoid getting liquid into the test strip port!" and NOTICE in this section).
- 4 If further testing is not needed, return the meter to the base unit to charge the battery.





10.4 Logging maintenance activities

Cleaning, disinfecting, and other maintenance activities can be logged in the meter. Make sure that all cleaning activities are complete and the system is thoroughly dry before powering on the meter.

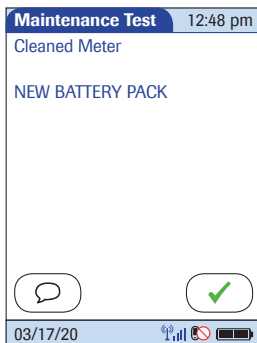
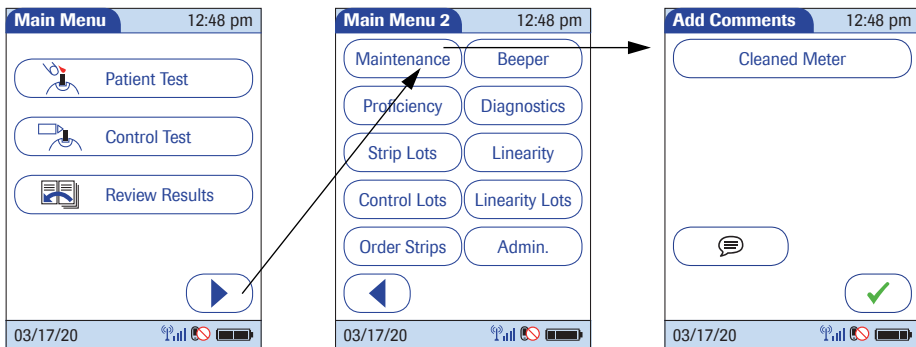
All logged maintenance comments can be reviewed later using the *Review Results* function of the meter (see page 83ff).

To store cleaning information in the meter, proceed as follows:







- 1 Touch  in the *Main Menu* to open the *Main Menu 2* screen.
- 2 Touch *Maintenance* to open the screen for adding comments.
- 3 Select the desired comment(s) from the list or touch  to enter your own comment via keypad.
- 4 Once you have entered your comments, touch  to save the maintenance comments. The *Maintenance Test* screen opens up.
- 5 Touch  to return to *Main Menu 2*.

You can add up to three comments. For details see section "Adding comments" on page 65.

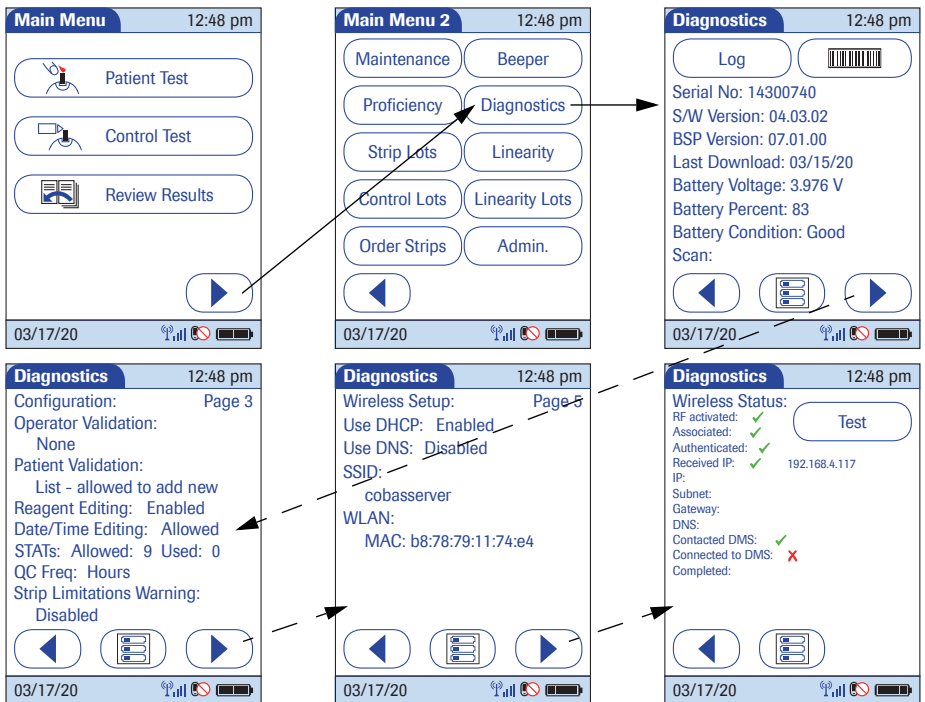

10.5 Diagnostics view

Under *Diagnostics* you can find information about the system, such as software version, number of data records stored, and configuration details. Use this menu to display stored error messages and test the barcode scanner and the wireless status (if your meter is equipped with the WLAN option). The *Diagnostics* screens shown here are for illustration purposes only. Information shown on your meter may differ.

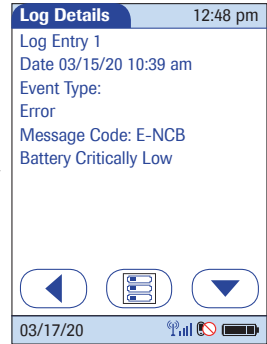
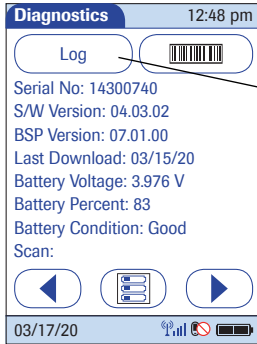

- 1 Touch  in the *Main Menu* to open the *Main Menu 2* screen.
- 2 Touch *Diagnostics* to call up the main screen for this menu.
- 3 Touch  or  to scroll between screens.



- 4 Touch *Log* to display stored error messages.
- 5 Touch  to test the barcode scanner.
- 6 Touch  to return to the *Main Menu*.

10.6 Unlocking a Download Lockout

When using a data management system for configuration, a *Download Lockout* can be configured. This lockout prevents a meter from being used for testing, if the meter data have not been downloaded for a defined period of time. If a download lockout occurs, the operator may use a STAT test to temporarily override the lockout. If no STAT test is configured or left, the meter cannot be used until the stored data is downloaded via network (either wireless or by docking the meter).

In cases of e.g., network failures (which make a download impossible), or other emergencies, it may be necessary to unlock a meter without access to the data management system. Since unlocking is a function of the *Setup Menu*, it is restricted to persons who know the setup password.

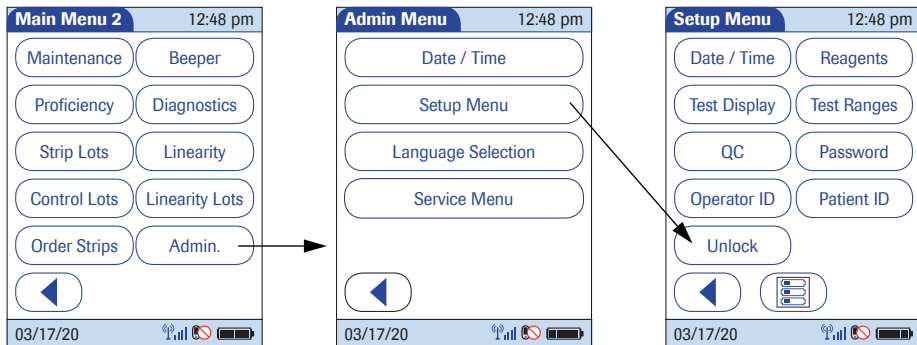

To unlock a meter:

- 1 Touch  in the *Main Menu* to open the *Main Menu 2* screen.
- 2 Touch *Admin.* to open the *Admin Menu*.
- 3 Touch *Setup Menu* to open the *Setup Menu*.
- 4 Enter the *Setup* password if requested.
- 5 Touch *Unlock* to reset the lockout timer.

The meter shuts down, and is ready for testing after powering up again.

10.7 Service menu

The option *Service Menu* with the feature “Delete Patient Information” is not available in the preconfigured default setting. The *Service Menu* can only be activated via DMS.

Deleting patient information

Deletion of data stored on the meter is not only a maintenance measure to conserve or restore meter memory. It may become necessary to comply with data protection and privacy policies when sending a meter back to the manufacturer or passing it on to another facility. You can delete data manually and/or automatically.

Manual deletion

This feature allows you to delete all patient-related data (patient lists and results) manually.

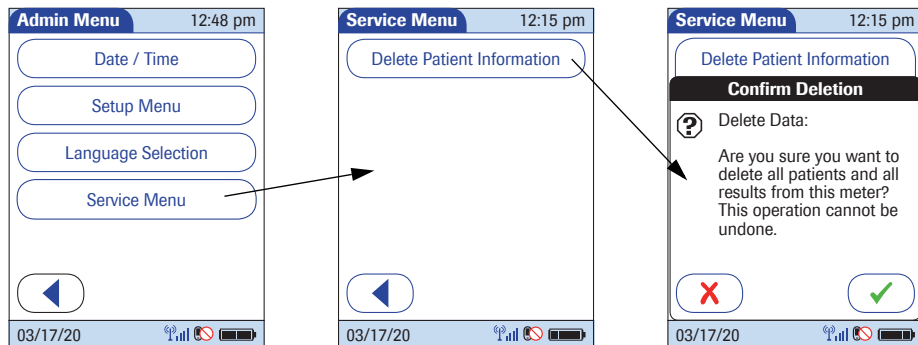

To ensure deleted data is not transferred back through an unwanted automatic synchronization with the DMS, remove the battery pack immediately after deleting patient data.

Be aware that the function *Delete Patient Information* irrevocably deletes all data once you touch  to confirm. The system will delete any patient results regardless of whether they have been synchronized with a data management system or not. Therefore, always ensure that you have downloaded all relevant patient results before you use this function.

Automatic deletion

By configuring a retention time (only via DMS) you can enable an automatic deletion of outdated results. Results will only be automatically deleted, if they meet both the following criteria:

- The result has already been transmitted to the DMS
- The result is older than the configured retention time

These results will be deleted automatically when powering up the meter and before each test.

Automatic deletion of patient data is not sufficient when sending a meter back to the manufacturer or passing it on to another facility. Make sure to manually delete **all** data stored in the meter for that purpose.

This page intentionally left blank.

11 Troubleshooting

The Accu-Chek Inform II meter continually checks its systems for unexpected and unwanted conditions.

A troubleshooting table follows that will help you when the system is not performing as expected. Most concerns can be resolved quickly by referring to this table for help. Take the following steps when an unexpected condition arises:

- Find the displayed message or condition in the Troubleshooting Table.
- Take the action suggested under the column header *Possible Solution*.

If further assistance is required, contact Roche Customer Support Center.

Errors and unusual behavior without error messages

Some conditions may arise that have no associated error message. Refer to the following table, if such a condition arises on the Accu-Chek Inform II system.

Display/symptom	Possible solution
No message or unusual behavior	
If you notice any issues with the display functionality (e.g. unexpected lines/marks on the meter display) stop using the system and contact the Roche Customer Support Center.	
Meter display does not power on	<ul style="list-style-type: none"> - Wait 10 seconds and try powering on the unit again. - Place the meter in the base unit and confirm that it is charging. - Check that the battery pack is correctly installed and connected.
	Follow the instructions in Chapter 9 to avoid data loss when replacing the battery pack.
Meter displays an unexpected result	Refer to the package insert for the test strips.





Display/symptom	Possible solution
Test result LO/HI	<p>The glucose result may be below (LO) or above (HI) the measurement range of the system.</p> <ul style="list-style-type: none"> - Refer to the package insert for the test strips. - Check that you are performing the test correctly (see Chapter 3). - Run a glucose control test with a new test strip (see Chapter 4). - Repeat the test or proceed according to the requirements of your facility.
Test result RR LO/RR HI	<p>The glucose result may be below/above the reportable range set by system administrator.</p> <ul style="list-style-type: none"> - Run a glucose control test with a new test strip (see Chapter 4). - Repeat the test or proceed according to the requirements of your facility.
Test result CR LO/CR HI	<p>The glucose result may be below/above the critical range set by system administrator.</p> <ul style="list-style-type: none"> - Run a glucose control test with a new test strip (see Chapter 4). - Repeat the test or proceed according to the requirements of your facility.
Meter displays Strip defect Error	<p>The test strip is defective.</p> <ul style="list-style-type: none"> - Refer to the package insert for the test strips. - Check that you are performing the test correctly (see Chapter 3). - Run a glucose control test with a new test strip (see Chapter 4). - Repeat the test or proceed according to the requirements of your facility. - If the error persists, contact Roche Customer Support Center.
Meter displays an error Type Bad Dose	<p>Insufficient amount of blood on the test strip.</p> <ul style="list-style-type: none"> - Refer to the package insert for the test strips. - Review proper testing procedure. - Repeat the test using a new test strip, ensuring proper sample application. - If the error persists, contact Roche Customer Support Center.
Meter displays (QC) FAIL or Out of Range	<ul style="list-style-type: none"> - Refer to the package insert for the test strips. - Check that you are performing the test correctly (see Chapter 4). - Repeat the glucose control test with a new test strip. - If the error persists, contact Roche Customer Support Center.

Display/symptom	Possible solution
Meter displays Glucose Error	<p>Detection of an unexpected hardware error</p> <ul style="list-style-type: none"> - Repeat the test or proceed according to the requirements of your facility. - Run a glucose control test with a new test strip (see Chapter 4). - Power the meter off and on. - Reset the meter by pressing the On/Off button for 12 seconds (see page 181). - If the error persists, contact Roche Customer Support Center.
Meter displays Unexpected SW Error	<p>Detection of an unexpected software error</p> <ul style="list-style-type: none"> - Repeat the test or proceed according to the requirements of your facility. - Place meter into a connected base unit to synchronize configurations with the data management system. - If the error persists, contact Roche Customer Support Center.
Communication Problems with the Data Management System via Wireless	
The Accu-Chek Inform II Meter is unable to communicate with the Data Management System	<ul style="list-style-type: none"> - Check whether WLAN is activated on the meter (see Chapter 2). - Check whether the data transfer icon shows that the last attempt at data transfer was successful (see Chapter 2). - Dock the wireless enabled meter into a hard-wired base unit to transfer the data (see Chapter 9). - Check the meter WLAN performance in Diagnostic Screen #7 on the meter. See page 159. - Reset the meter by pressing the On/Off button for 12 seconds (see page 181). - If the error persists, contact Roche Customer Support Center.
Base unit	
LED is not illuminated	<p>Not connected to power supply unit or power supply unit is defective, base unit is defective, or mains power outlet not active.</p> <ul style="list-style-type: none"> - Disconnect and connect the power supply again. - If the error persists, contact Roche Customer Support Center.
LED flashes red	<p>Communication or configuration error.</p> <ul style="list-style-type: none"> - Check the configuration and/or the connection to the Data Management System (DMS). Contact the DMS or IT administrator of your institution. - If the error persists, contact Roche Customer Support Center.

Display/symptom	Possible solution
Automatic power-off	
	<p>The meter powers off after a configurable time without activity (e.g., pressing a key, touching the screen) and goes into standby mode to save power. In addition, the meter may power off automatically for the reasons listed below. Reactivate the meter/screen as described in the following:</p>
Power-off after time specified by system administrator (default is 5 minutes, configurable by system administrator)	<ul style="list-style-type: none"> - Press the On/Off button on the meter.
Battery Low	<ul style="list-style-type: none"> - Charge the battery by placing the meter in the base unit.
Battery Critically Low	<ul style="list-style-type: none"> - Charge the battery by placing the meter in the base unit. - Check that the battery pack is correctly installed and connected. - Replace the defective battery pack.
	<p>Follow the instructions in Chapter 9 to avoid data loss when replacing the battery pack.</p>

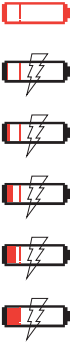
Low power icons

If the battery pack is running low or not charging properly, the meter will display a series of low power icons. Refer to the following table for their meaning.

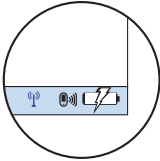





Display/symptom	What it means/Remedy
	<p>Meter displays  when you try to power on:</p> <ul style="list-style-type: none"> - Battery is empty. Dock the meter. <p>When docked, meter displays :</p> <ul style="list-style-type: none"> - Charging status is indicated by a single red segment that grows gradually until the required threshold for booting the meter is reached.
<p>Avoid using the meter in case of low power to guarantee full functionality. The On/Off button cannot be used. If not docked, the meter will shut down automatically after 1 minute.</p>	
<p>Flashing  icon in status bar</p> 	<p>If the meter is not properly docked, a short “humming” noise sporadically occurs and the battery charging icon flashes.</p> <ul style="list-style-type: none"> - Remove the meter from the base unit. - Redock it by gently pushing it into the base unit to ensure proper contact. <p>Once the meter is properly docked and charging, the battery charging icon stops flashing.</p>











Pop-up messages

There are different message types displayed by the meter, namely decision, information, warning, and error messages. All except the decision messages contain a letter code on the lower left side of the screen. The first letter of this code identifies the message type (**I**nformation, **W**arning, **E**rror).

All information, warning, and error messages displayed by the system are accompanied by a description and, if necessary, a possible solution. Take the action suggested on screen to resolve the problem.

The different message types are illustrated in the following table.

Sample message type	Description									
<p>Linearity Lots 12:48 pm</p> <table border="1"> <thead> <tr> <th>Type</th> <th>Exp. Date</th> <th>Lot Num.</th> </tr> </thead> <tbody> <tr> <td>*Lin.</td> <td>12/31/20</td> <td>777732</td> </tr> <tr> <td>Lin.</td> <td>05/15/21</td> <td>777723</td> </tr> </tbody> </table> <p>Make 'Current'</p> <p>? Do you want to make Linearity lot 777678 the 'current' lot?</p> <p><input type="checkbox"/> <input checked="" type="checkbox"/></p> <p>03/17/20   </p>	Type	Exp. Date	Lot Num.	*Lin.	12/31/20	777732	Lin.	05/15/21	777723	<p>- Decision; To confirm, touch <input checked="" type="checkbox"/>. To reject, touch <input type="checkbox"/>.</p>
Type	Exp. Date	Lot Num.								
*Lin.	12/31/20	777732								
Lin.	05/15/21	777723								
<p>Patient Test 12:48 pm</p> <p>Patient 123456789 Date 03/17/20 12:48 pm</p> <p>Ranges</p> <p>i Normal Range: 70-200 mg/dL Critical Range: 40-301 mg/dL Reportable Range: 11-600 mg/dL</p> <p>[I-HBD] <input checked="" type="checkbox"/></p> <p>03/17/20   </p>	<p>- Information; touch <input checked="" type="checkbox"/> to confirm.</p>									

Sample message type	Description
<div data-bbox="129 169 384 248" style="border: 1px solid black; height: 50px;"></div> <div data-bbox="129 248 384 531" style="border: 1px solid black; padding: 5px;"> <p style="text-align: center;">Loss of Date/Time</p> <p> D/T settings lost due to meter reset or loss of power. Before performing further tests: Enter D/T manually and synchronize meter. OR: Ask System Admin. for help.</p> <p>[W-SBD] </p> </div>	<p>- Warning; touch  to confirm.</p>
<div data-bbox="129 531 384 893" style="border: 1px solid black; padding: 5px;"> <p style="text-align: center;">Operator ID 12:48 pm</p> <div style="border: 1px solid black; padding: 2px; text-align: center; width: fit-content; margin: 0 auto;">  </div> <p style="text-align: center;"> 1 2 3 </p> <p style="text-align: center;">Invalid Scan</p> <p> Invalid Scan. The scan returned an entry > 20 characters. Please see your System Administrator.</p> <p>[E-FCG] </p> <p style="font-size: small;">03/17/20    </p> </div>	<p>- Error; touch  to confirm. To resolve the problem, take the actions suggested.</p>

**Table of Information, Warning,
and Error messages**

Information Messages	
Code	Text
I-FBB	Login Message: <Message can be configured to the current operator. Free configurable, up to 120 characters.>
I-FBC	Observer Login: Observer *, please log in to proceed. Otherwise the OTS test will not be complete. <* is the observer operator name or ID>
I-FBG	Please Wait: Performing code key checks...
I-FBL	Code Key Reader: The code key reader is low on power. Replace code key reader.
I-HBD	Ranges: Normal Range: <values> Critical Range: <values> Reportable Range: <values> <values are determined by the institution>
I-HBF	Controls: L1 (Lo) <values> L2 (Hi) <values> <values are determined by the institution>
N/A ¹	Please Wait: Connecting to code key reader...
N/A ¹	Please Wait: Receiving code key contents...

1. N/A = not applicable, no code is displayed on the screen.

Warning Messages	
Code	Text
W-HBG	QC Lockout: Warning! Glucose control is due. Required Controls must be run in order to proceed.
W-HBK	Invalid Patient Result: This patient result is invalid due to unacceptable control bar result. Please repeat test on new card.
W-HBL	Invalid Patient Result: The patient result is invalid due to unacceptable control result. Please repeat test on new card.
W-HBM	The entered lot * has expired. Do not use an expired lot. <This is only for Other Test Entry, and not for blood glucose test strip lots. * is the lot number>
W-HCB	Out of Reportable Range: * <* is the institution defined reportable range>
W-HCC	Out of Critical Range: * <* is the institution defined critical range>
W-HDK	Invalid Control Result: This control result is invalid due to unacceptable control bar result. Please repeat test on new card.
W-NBC	Battery Low: The battery is getting low. Return this meter to the base unit for charging as soon as possible.
W-SBB	Download Warning: The meter needs to be downloaded soon. Last download occurred at *. Please dock meter. If the problem persists, see your System Administrator. <* is the date and time>
W-SBD	Loss of Date/Time: D/T settings lost due to meter reset or loss of power. Before performing further tests: Enter D/T manually and synchronize meter. OR: Ask System Admin. for help.
W-YBB	Unexpected Warning: Unexpected warning. See log file for details. If the problem persists, see your System Administrator.

Error Messages	
Code	Text
E-CBC	Invalid Operator ID: Operator ID is invalid. ID entered was not found in the list of valid operator IDs. Please see your System Administrator.
E-CBD	Invalid Operator ID: Operator ID length is invalid. ID must be between * characters long. <* is the minimum and maximum character length defined at the institution >
E-CBF	Invalid Operator ID: Operator ID length is invalid. ID must be * characters long. <* is the minimum character length defined at the institution >
E-CBG	Invalid Password: Invalid operator password. Please enter a valid password or see your System Administrator.
E-CBH	Password Format: Invalid operator password format. The operator password must be at least four characters.

Error Messages	
Code	Text
E-CBK	Invalid Password: Invalid Setup password. Please enter valid password or see your System Administrator.
E-CBL	No Operators Loaded: There are no operators loaded in this meter. In order to continue, operators must be downloaded. Please see your System Administrator.
E-CBM	QC not allowed: The Operator ID entered was not found in the list of valid operator IDs for QC. Please see your System Administrator.
E-CBN	Invalid Observer ID: Observer ID is invalid. ID entered was not found in the list of valid observer IDs. Please see your System Administrator.
E-CCB	Invalid Observer ID: Invalid Observer ID: The observer ID is invalid. The observer supervising the current OTS test must log in again.
E-DNL	Invalid Time: Time entered is in the future. Please enter the time in HH:MM AM/PM format. (If in 24 hr mode the AM/PM is removed.)
E-DNM	Invalid Date: Date entered is beyond the code key expiration date. Please re-enter date.
E-DNN	Invalid Date: Date entered is in the future. Please enter the date in MM/DD/YY format.
E-FBB	Invalid Date: Date entered is expired. Please check the package and re-enter date. <i><for control and linearity lots expiry dates></i>
E-FBC	Invalid Time: Time entered is invalid. Please enter the time in HH:MM AM/PM format.
E-FBD	Invalid Date: Date entered is invalid. Please enter the date in MM/DD/YY format.
E-FBF	Invalid Patient ID: Patient ID is invalid. ID entered was not found in the list of valid patient IDs. Please see your System Administrator.
E-FBG	Invalid Patient ID: Patient ID length is invalid. ID must be between * characters long. <i><* is the minimum and maximum character length defined at the institution ></i>
E-FBH	Invalid Patient ID: Patient ID length is invalid. ID must be * characters long. <i><* is the minimum character length defined at the institution ></i>
E-FBL	Comment required: A comment is required for this result. Please enter at least one comment.
E-FBM	Invalid Lot Number: A valid lot number must be provided. Please enter a lot number.
E-FCB	Invalid Control Range: Level 1 (Lo) Max must be greater than Level 1 (Lo) Min (currently *). Please re-enter. <i><* is the L1 Control Range minimum value defined by the Control Lot information on the device></i>
E-FCC	Invalid Control Range: Level 2 (Hi) Max must be greater than Level 2 (Hi) Min (currently *). Please re-enter. <i><* is the L2 Control Range minimum value defined by the Control Lot information on the device></i>
E-FCD	Invalid Control Range: Level 2 (Hi) Min must be greater than Level 1 (Lo) Max (currently *). Please re-enter. <i><* is the L1 Control Range maximum value defined by the Control Lot information on the device></i>
E-FCF	Invalid Sample ID: Invalid sample ID, length is invalid. ID must be at least one character. Please re-enter.

Error Messages	
Code	Text
E-FCG	Invalid Scan: Invalid Scan. The scan returned an entry > 20 characters. Please see your System Administrator.
E-FCH	Invalid Range: The range entered must be between 10 and 600 mg/dl. Please re-enter.
E-FCK	Invalid Range: The Normal Range Hi value must be greater than the Normal Range Lo value (currently *). Please re-enter. < * is the Normal Range value defined by the institution on the device >
E-FCL	Invalid Range: The Critical Range Hi value must be greater than the Critical Range Lo value (currently *). Please re-enter. < * is the Critical Range value defined by the institution on the device >
E-FCM	Invalid Range: The Reportable Range Hi value must be greater than the Reportable Range Lo value (currently *). Please re-enter. < * is the Reportable Range value defined by the institution on the device >
E-FCN	Invalid Range: The Reportable Range Lo value must be less than or equal to the Critical Range Lo value (currently *). Please re-enter. < * is the Critical Range value defined by the institution on the device >
E-FDB	Invalid Range: The Reportable Range Hi value must be greater than or equal to the Critical Range Hi value (currently *). Please re-enter. < * is the Critical Range value defined by the institution on the device >
E-FDC	Invalid Range: The Critical Range Hi value must be greater than or equal to the Normal Range Hi value (currently *). Please re-enter. < * is the Normal Range value defined by the institution on the device >
E-FDD	Invalid QC Hours: QC Hours must be greater than 0 and less than 10,000. Please re-enter.
E-FDF	Invalid Strip Limit: QC Strips must be greater than 0 and less than 1,000. Please re-enter.
E-FDH	Invalid Strip Lot Barcode: The scanned in barcode is invalid for a Strip lot barcode. Please scan in a valid barcode, or see your System Administrator
E-FDK	Undefined Strip Lot: The barcode scanned strip lot: * is not defined on this meter. Please see your System Administrator. < * is the test strip lot number >
E-FDL	Invalid Limit: The length entered must be between 0 and 20. Please enter a valid length.
E-FDM	Invalid Limit: The Operator ID Max length must be greater than or equal to the Operator ID Min length (currently *). Please re-enter. < * is the Operator ID minimum length defined by the institution >
E-FDN	Invalid Limit: The Patient ID Max length must be greater than or equal to the Patient ID Min length (currently *). Please re-enter. < * is the Patient ID minimum length defined by the institution >
E-FFB	Invalid Operator Barcode: The barcode scanned is not a valid operator barcode. Please scan a valid operator barcode or see your System Administrator.

Error Messages	
Code	Text
E-FFC	Invalid Patient Barcode: The barcode scanned is not a valid patient barcode. Please scan a valid patient barcode or see your System Administrator.
E-FFD	Invalid Control Lot Barcode: The scanned in barcode is invalid for a Control lot barcode. Please scan in a valid barcode, or see your System Administrator.
E-FFF	Control Level Mismatch: The control level on the barcode does not match the level already selected. Please select the correct level or rescan at the control level screen.
E-FFG	Invalid Range: The Critical Range Lo value must be less than or equal to the Normal Range Lo value (currently *). Please re-enter. <i><* is the Normal Range value defined by the institution on the device></i>
E-HBC	Too Many Comments: A maximum of three comments can be added to a result. De-select a comment in order to replace it with another one.
E-HBF	Control Lot Not Found: Control lot not found. Please enter an existing control lot or see your System Administrator.
E-HBG	Strip Lot Expired: The Strip lot * has expired. Please use a non-expired Strip lot. <i><* is the test strip lot number></i>
E-HBH	Strip Lot Not Present: The meter does not have a valid Strip lot. Please see your System Administrator.
E-HCB	Control Lot Expired: The control lot has expired. Please enter a non-expired control lot.
E-HCK	Linearity Lot Expired: The linearity lot has expired. Please enter a non-expired linearity lot.
E-HCL	Linearity Lot Not Found: Linearity lot not found. Please enter an existing linearity lot or see your System Administrator.
E-HHB	Connection Error: Could not connect to the code key reader. Check code key Reader and try again.
E-HHC	Communication Error: Communication error while receiving code key contents. Check code key reader and try again.
E-HHF	Duplicate Code Key: The code key received is already contained in this meter. Please use the existing code key data.
E-HHG	Duplicate Control Lot: The Control Lot received is already contained in this meter. Please use the existing Control Lot.
E-HHH	Duplicate Linearity Lot: The Linearity Lot received is already contained in this meter. Please use the existing Linearity Lot.
E-KBC	Temperature Lockout: The meter has detected a temperature error. Meter will shut itself down. Let meter rest in room temperature, then restart.
E-KHB	OTE Initialization: Initialization failed. No OTE Test is available on the meter. Please see your System Administrator.
E-KHC	OTE Configuration: OTE test configuration is not valid. Please see your System Administrator.
E-LBB	Hardware Error: This meter has reported an error. Please see your System Administrator.
E-LBG	Battery Error: This meter has reported a Battery Pack error. See your System Administrator.

Error Messages

Code	Text
E-LVL	Internal Communication: Communication error with barcode scanner module. Power meter off and on, and repeat last procedure. If problem persists, see your System Administrator.
E-NCB	Battery Critically Low: Battery is critically low. Return meter immediately to the base unit for charging before further use.
E-QBB	Reagent Database Full: Reagent database is full. Please see your System Administrator.
E-QBC	Database Full: No further test can be performed until a download occurs. Please synchronize the meter or see your System Administrator.
E-QBD	Database Failure: The meter has detected a result database error. Please see your System Administrator.
E-QBF	Database Failure: The meter has detected a reagent database error. Please see your System Administrator.
E-QBG	Database Failure: The meter has detected an operator database error. Please see your System Administrator.
E-QBH	Database Failure: The meter has detected a patient database error. Please see your System Administrator.
E-QBK	Database Failure: The meter has detected a comments database error. Please see your System Administrator.
E-QBL	Database Failure: The meter has detected a strip lot database error. Please see your System Administrator.
E-QBN	Database Failure: The meter has detected a config database error. Please see your System Administrator.
E-QCC	Database Failure: The meter has detected an event database error. Please see your System Administrator.
E-SBC	Download Lockout: The meter needs to be downloaded soon. Last download occurred at *. Please dock meter. If the problem persists, see your System Administrator
E-SBD	Download Lockout: The meter has detected a config database error and needs to be downloaded. Please dock meter. If the problem persists, see your System Administrator.
E-VBB	Glucose Error: An unexpected internal error has occurred. If problem persists, see your System Administrator.
E-VBC	Strip defect Error: This strip is defective. Please insert a new strip and only apply sample when prompted.
E-VBD	Code Key Error: The meter has reported an error. Restart the test procedure with the correct code key. If the problem persists, see your System Administrator.
E-VBF	Glucose Error: Error detected. Repeat bG test with new strip. If this error shows twice for the same patient, perform QC and repeat bG test. If problem still persists, use another method.
E-VBG	Glucose Error: This strip is defective. Please insert a new strip and only apply sample when prompted.
E-VBH	Glucose Error: Strip removed during test. Repeat test with new strip.
E-VBK	Glucose Error: Strip lot expired. Use new strip lot.

Error Messages	
Code	Text
E-VBL	Hardware Error: A hardware or electronic error has occurred. If problem persists, see your System Administrator.
E-VBM	Glucose Error: Place meter immediately in base unit to recharge. If problem persists, see your System Administrator.
E-VBN	Glucose Error: Place meter in base unit to recharge. If problem persists, see your System Administrator.
E-VCB	Glucose Error: A real time clock error has occurred. Set date and time or dock meter. If problem persists, see your System Administrator.
E-VCC	Glucose Error: An internal communication error has occurred. If problem persists, see your System Administrator.
E-VCD	Glucose Error: An unexpected internal error has occurred. If problem persists, see your System Administrator.
E-VCF	Glucose Error: A SW error has occurred. If problem persists, see your System Administrator.
E-VCG	Glucose Error: The meter has reported an error. Type Unknown Command. Please see your System Administrator.
E-VCH	Temperature Lockout: The meter has detected a temperature error. Let meter rest in room temperature and repeat the test. If problem persists, see your System Administrator.
E-VCK	Code key changed error: An unexpected internal error has occurred. If problem persists, see your System Administrator.
E-VCL	Sample Detection Error: The meter detected an incorrect sample during the test. Repeat the test using a new strip.
E-VCM	Sample Detection Error: The meter detected an incorrect control sample during the test. Repeat the test using a new strip.
E-VCN	Sample Detection Error: The meter detected an incorrect linearity sample during the test. Repeat the test using a new strip.
E-VDB	Software Error: A software error has occurred. Repeat the test, using a new test strip. If problem persists, see your System Administrator.
E-VDC	Date/Time Setting Mismatch: The meter is set to an earlier date than current code file production date. Set date and time properly or dock meter. If problem persists, see your Admin.
E-YBB	Unexpected SW Error: An application SW-error has occurred. The meter will be turned off. If problem persists, see your System Administrator.

Meter reset

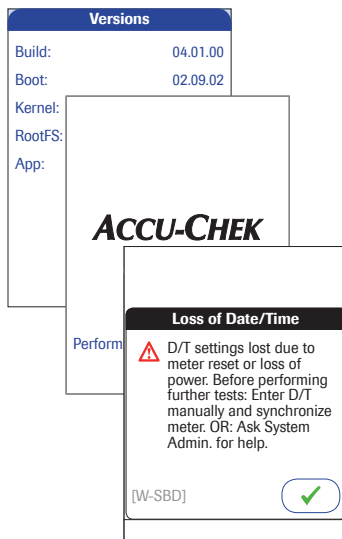
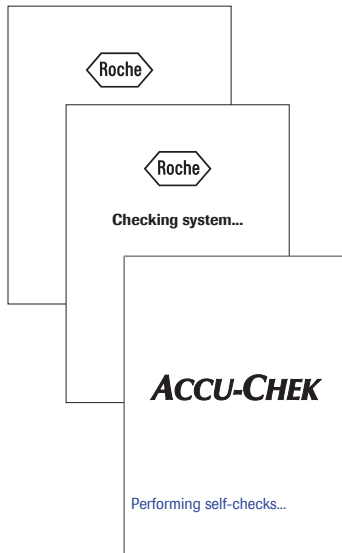

A meter reset should only be performed if all other remedies have failed.

- 1 Place the meter on a level surface.
- 2 Press the On/Off button for at least 12 seconds and release the button.
 - The meter powers off and on again.
 - The Roche logo is displayed. If the Roche logo does not appear within 15 seconds, place the meter in a base unit for a minimum of 15 minutes to recharge the battery.
 - The meter performs a system check. During the system check, the *Versions* screen appears for a few seconds, then disappears. The *Versions* screen shows the version numbers of the meter components. (The *Versions* screen shown here is for illustration purposes only. Version numbers on your meter may differ.)
 - A message appears informing you that the date and time settings have been lost due to the meter reset.
- 3 Confirm the message *Loss of Date/Time*.

Before performing any further tests, you must now **either** enter date/time manually and then synchronize the meter, **or** contact your system administrator for help.

To enter date/time manually and synchronize the meter, follow the instructions on the next page.

Date 12:00 am
03/17/20
1 2 3
4 5 6
7 8 9
← 0
✓
03/17/20

Time 12:00 am
12:48 pm
1 2 3
4 5 6
7 8 9
← 0 AM/PM
✓
03/17/20

- Once you have confirmed the message *Loss of Date/Time*, the screens for entering the date and the time appear.
- 4 Enter the date and time. After you have entered the correct information, confirm each screen with .
- Unless your QC configuration is *Always OK* (see page 140), the meter will now be in QC Lockout due to the manually entered date/time.
- 5 Synchronize the meter's date/time with the date/time of your facility via base unit or, if working wirelessly, wait at least ten minutes for the next WLAN synchronization before performing any further tests.

Even if your configuration does not require it, we recommend always performing a QC test after a meter reset.

12 General Product Information

12.1 Technical data

Specification	Meter	Base unit	Power supply unit
Height	1.73 in / 44 mm (max.)	Base Unit: 4.84 in / 123 mm (max.) Base Unit Light: 4.33 in / 110 mm (max.)	1.38 in / 35 mm + AC plug (1.1-1.6 in / 28-40 mm)
Width	3.74 in / 95 mm (max.)	Base Unit: 5.12 in / 130 mm (max.) Base Unit Light: 4.65 in / 118 mm (max.)	2.01 in / 51 mm
Length	7.60 in / 193 mm (max.)	Base Unit: 5.12 in / 130 mm (max.) Base Unit Light: 4.06 in / 103 mm (max.)	3.43 in / 87 mm
Weight	approx. 347 g (with rechargeable battery)	Base Unit: 671 g with wall mount Base Unit Light: 573 g with wall mount	170 g
User interface	Touchscreen and barcode scanner	Base Unit: LED (tricolor: red, green, blue) Base Unit Light: LED (bicolor: red, green)	LED: green
Display resolution (touchscreen)	320 x 240 pixel	N/A	N/A
Memory	<ul style="list-style-type: none"> - 1,000 Results - 5,000 Operator ID records - 4,000 Patient ID records - 300 Predefined comments - 20 Code Files (test strip lots) - 100 Reagent Lots (control, linearity, OTE) - 250 Events 	N/A	N/A

Specification	Meter	Base unit	Power supply unit
Operating temperature	37 to 108 °F 3 to 42 °C	37 to 122 °F 3 to 50 °C	32 to 104 °F 0 to 40 °C
Measurement temperature	Test strip dependent: Refer to the test strip package insert		
Storage conditions (long-term storage)	41 to 104 °F / 5 to 40 °C at 10 - 85% RH (non-condensing) (Remove battery pack from meter for long-term storage.)		
Humidity (operating)	10 - 90 % RH (non-condensing)		
Air pressure	0.7 to 1.06 bar 70 to 106 kPa	0.7 to 1.06 bar 70 to 106 kPa	N/A

Specification	Meter	Base unit	Power supply unit
Battery voltage/type	3.7 volt rechargeable (lithium technology)	N/A	N/A
Input voltage	+7.5 V DC	Base Unit: +12 V DC legacy Base Unit Light: +7.5 V DC NEW Base Unit Light: +12V DC	100 to 240 V AC
Input frequency	DC	DC	50 to 60 Hz
Input current	1.7 A (max)	Base Unit: 1.25 A (max) legacy Base Unit Light: 1.7 A (max) NEW Base Unit Light: 1.25 A (max)	350 to 150 mA (REF 07006098001, 07455976190) 400 to 200 mA (REF 08692432001, 08692432160)
Battery capacity	30 (subsequent) measurements possible after 90 min of charging ¹	N/A	N/A
Interfaces	Charging contacts IR port Barcode scanner WLAN (Channel 1-11 only)	Charging contacts IR port RJ45 Ethernet (Base Unit) RJ25 (Base Unit Light) USB type B *	DC connector Replaceable AC input contacts

1. A fully charged battery pack will provide sufficient power for at least 100 tests within 5 hours including wireless communication (WLAN, if available and enabled).

Specification	Meter	Base unit	Power supply unit
Data transfer rate	WLAN: up to 54 Mbps	IR: 9.6K - 115K bps ¹ Ethernet: 10/100 Mbps (auto-negotiate) full-duplex ¹ USB: 12 Mbps ¹ In combination with the Base Unit Hub: IR: 9.6K - 115K bps ² Ethernet: 10 Mbps half-duplex ³	N/A
Supported barcodes	Code 128, Code 39, Code 93, EAN 13, ⁴ Interleaved 2 of 5 (with or without checksum), Codabar, GS1 DataBar Limited, Aztec, QR Code, DataMatrix, PDF417	N/A	N/A

1. Accu-Chek Inform II Base Unit
2. Accu-Chek Inform II Base Unit Light (NEW and legacy versions)
3. Accu-Chek Inform II Base Unit Hub
4. EAN 13 barcodes are not recommended for identification of operators and patients

Specification	Accessory box	Code key reader	Base unit hub
Height	3.35 in / 85 mm	0.72 in / 18.4 mm	1.38 in / 35 mm
Width	11.02 in / 280 mm	1.37 in / 34.8 mm	6.65 in / 169 mm
Length	10.71 in / 272 mm	2.78 in / 70.7 mm	5 in / 127 mm
Weight	approx. 1100 g	approx. 28 g	approx. 470 g
Operating temperature	N/A	37 to 122 °F 3 to 50 °C	37 to 122 °F 3 to 50 °C
Storage temperature (short-term)	-13 to 158 °F -25 to 70 °C	37 to 122 °F 3 to 50 °C	-13 to 158 °F -25 to 70 °C
Relative humidity (short-term storage)	< 93%	< 93%	< 93%
Battery voltage/type	N/A	Not replaceable	N/A
Interfaces	N/A	IR port Code key socket	LED (red, green, blue)
Input voltage	N/A	N/A	+12 V DC
Input current	N/A	N/A	2.0 A

Specification	Accu-Chek Inform II Test Strip
System measurement range	10-600 mg/dL
Hematocrit	10-65 %
Altitude	up to 10,000 feet
Measurement temperature	61 to 95 °F (16 to 35 °C)
Operating humidity	10-80 %
Acceptable samples:	Whole Blood: capillary, venous, arterial, and neonate heelstick
Sample size	0.6 µL

The system has not received FDA clearance for use with patients receiving intensive medical intervention or therapy. For more information about the Accu-Chek Inform II test strip, refer to the package insert for instructions for use, performance characteristics, and limitations of the system.

12.2 Further Information

Ordering

Item	Description	REF/Catalog Number
Accu-Chek Inform II Meter	Meter, equipped with built-in WLAN functionality	05060303001
Accu-Chek Inform II Battery Pack	Rechargeable battery pack (for meters with serial no. above UU14000000)	06869904001
Accu-Chek Inform II Battery Compartment Cover	Replacement cover for meter battery compartment (for meters with serial no. above UU14000000)	06869823001
Accu-Chek Inform II Base Unit (NEW)	Equipped with charging and connectivity functionality	07671717190
Accu-Chek Inform II Base Unit Light (NEW)	Equipped with charging functionality	08376824190
Power Supply*	Power supply (international edition) for Base Unit Light (NEW) REF 08376824190/ Base Unit (NEW) REF 07671717190	08692432001
Power Supply*	Power supply (North America) for Base Unit Light (NEW) REF 08376824190/ Base Unit (NEW) REF 07671717190	08692432160

* Important note

Power supply REF 07006098001, (International edition) and Power supply REF 07455976190, (North America), Type: FW7555M/12, Input: 100-240V/50-60Hz/350-150 mA, Output: 12V === 1.25A have been discontinued and replaced by:

Power supply REF 08692432001, (International edition) and Power supply REF 08692432160, (North America), Type: FW8001M/12, Input: 100-240V/50-60Hz/400-150 mA, Output: 12V === 1.50A

The change in power supply has no effect on product performance. Type: FW7555M/12 and Type: FW8001M/12 can be used in parallel.

Item	Description	REF/Catalog Number
Accu-Chek Inform II Base Unit Light (legacy version)	Equipped with charging functionality (discontinued)	05920353001
Power Supply	Power supply (North America) for legacy Base Unit Light REF 05920353001/ legacy Base Unit REF 05060290001	05388805001
Accu-Chek Inform II Base Unit Wall Mount	Wall Mount for Base Unit/Base Unit Light (fits legacy and new versions)	05404878001
Accu-Chek Inform II Base Unit Hub	Equipped with power and connectivity functionality for the Accu-Chek Inform II Base Unit Light	05888760001
Power Cord	Required to power the Base Unit Hub (North America)	03868133001
Accu-Chek Inform II Code Key Reader		04884671001
Accu-Chek Inform II Accessory Box		05060281001
Accu-Chek Inform II Battery Pack	Rechargeable battery pack (for meters with older hardware and serial no. below UU14000000)	04882326001
Accu-Chek Inform II RF Card Kit	Wi-Fi card replacement (for meters with older hardware and serial no. below UU14000000)	05112699001

Accu-Chek Inform II Operator's Manual and Quick Reference Guide

The Accu-Chek Inform II Operator's Manual and the Accu-Chek Inform II Quick Reference Guide are available on the Roche Diagnostics USA website at diagnostics.roche.com

Reagents and Solutions

Supplies are available through Roche Diagnostics. Contact Roche Customer Support Center.

Product Limitations

Read the information in the package insert supplied with the reagents and solutions for detailed product data and limitations.

Information about software licenses

This product incorporates software modules developed under open source licenses. The source code of this software can be requested on a standard data exchange medium from the manufacturer at the following address:

Roche Diagnostics GmbH
Sandhofer Str. 116
68305 Mannheim
Germany

The complete license agreements are stored as a text file (file name "license.pdf") on the Accu-Chek Inform II Base Unit of the Accu-Chek Inform II system. The file "license.pdf" is located in the same folder as the PDF file "ROCHE BU Technical Note UDS5".¹

You can access these files by connecting the Accu-Chek Inform II Base Unit to a PC with the USB cable. For detailed instructions on how to do this, see the instruction sheet "Setting Up the Base Unit" included in the Accu-Chek Inform II Base Unit Kit.

Everyone is permitted to copy and distribute verbatim copies of this license document, but changing it is not allowed.

1. On legacy base units the respective PDF file is called "ROCHE HBU-BU-BUH Technical Note".

Contact Roche

For all questions about the Accu-Chek Inform II system that are not answered in this manual, contact Roche Customer Support Center. If you do not already have contact details, visit our website at www.roche.com. Click on “Menu”, then select “Worldwide” to find the appropriate local office contact information.

The Accu-Chek Inform II system is manufactured for and distributed by:

In the United States:

Roche Diagnostics
9115 Hague Road
Indianapolis, IN 46256

A Appendix

A.1 Table of configuration options

This section provides an overview of all the settings available.

The two rightmost columns describe the accessibility of a configuration parameter on the device (*Setup Menu*) and via the data management system (DMS).

“Y” (Yes) means, that this parameter is available, “N” (No) means, that this parameter is not available using the respective configuration method.

DEVICE: If the meter is configured by a system administrator using a data management system, the configuration options on the meter may be disabled to avoid conflicts in the settings. This option is indicated by the use of parentheses e.g., (Y).

DMS: Configuration options may vary depending on available DMS settings.

Configuration options

Subject/Attribute	Range	Default	Device	DMS
Timer				
Power-off timeout (meter powers off automatically if no activity)*	30 – 3,600 s	300	N	Y
Shut down (meter automatically shuts down 30 minutes after powering off)	0: disabled 1: enabled	1	N	Y
Time Interval reconnect (0 = disabled)	0: disabled 10 – 1440 minutes (24 hrs)	30	N	Y
* Not applicable in measurement mode (see “Automatic power-off” on page 21).				

Subject/Attribute	Range	Default	Device	DMS
Beeper				
Beeper volume	0: low 1: medium 2: high	2	Y	Y
Measurement Flow				
Comments required*	0: optional 1: out of range 2: required 3: disabled	0	N	Y
Comments requirement level: if out of ... (only valid if <i>Comments required</i> = 1)*	0: normal range 1: critical range 2: reportable range 3: measurement range	0	N	Y
Custom comments*	0: disabled 1: enabled	1	N	Y
* Does not apply to QC measurement workflow				
Control lot verification	0: display only 1: yes / no confirmation 2: prompt for entry 3: scan only	1	Y	Y
Control result display	0: value (numeric) 1: PASS / FAIL	0	N	Y
Critical range display	0: value (numeric) 1: HI / LO	0	N	Y
Critical range HI limit	10 – 600 mg/dL 0.6 – 33.3 mmol/L	600 mg/dL 33.3 mmol/L	Y	Y
Critical range LO limit	10 – 600 mg/dL 0.6 – 33.3 mmol/L	10mg/dL 0.6 mmol/L	Y	Y
Critical range message enabled	Whether to display the out-of-critical range warning message (1) or not (0)	1	N	Y
Critical range text	0 – 100 characters	“Out of Critical Range”	N	Y
Normal range HI limit	10 – 600 mg/dL 0.6 – 33.3 mmol/L	600 mg/dL 33.3 mmol/L	Y	Y
Normal range LO limit	10 – 600 mg/dL 0.6 – 33.3 mmol/L	10mg/dL 0.6 mmol/L	Y	Y
STAT tests allowed	0: no 1: yes	0	Y	Y
Number of STAT tests allowed	0 – 9	9	Y	Y
Reportable range HI limit	10 – 600 mg/dL 0.6 – 33.3 mmol/L	600 mg/dL 33.3 mmol/L	Y	Y

Subject/Attribute	Range	Default	Device	DMS
Reportable range LO limit	10 – 600 mg/dL 0.6 – 33.3 mmol/L	10mg/dL 0.6 mmol/L	Y	Y
Reportable range message	Whether to display a reportable range message (1) or not (0)	1	N	Y
Reportable range message text	0 – 100 characters	“Out of Reportable Range”	N	Y
Strip limitations warning	Configuration, whether to display the strip limitations warning (1) or not (0).	0	Y	Y
Strip lot verification	0: display only 1: yes/no confirmation 2: list selection 3: scan only	1	Y	Y
Linearity lot verification	0: display only 1: yes/no confirmation 2: prompt for lot entry	1	Y	Y
Additional Patient Test: enables consecutive tests on the same patient (creating a patient test series)	0: disabled 1: enabled	0	N	Y
Blood sample type selection	0: disabled 1: enabled	0	N	Y
Isolation Room	0: disable (select patient ID before strip lot selection) 1: enable (select strip lot before patient ID selection)	0	N	Y

Subject/Attribute	Range	Default	Device	DMS
Display				
Contrast	0 - 15	7	Y	Y
Formats and Language				
Date format	1: MM/DD/YY 2: DD.MM.YY	1	Y	Y
Time format	1: 24 hours 2: 12 hours	2	Y	Y
Language setting *	1: German 3: French 4: Spanish 5: Italian 6: Dutch 7: Swedish 8: English (USA) 9: Danish 11: Portuguese	8	Y	Y
* Other languages: For the availability of languages not listed above, contact Roche.				
Glucose result units	0: mg/dL 1: mmol/L	0	Y	Y
Power Up				
Location (a string to show where a certain meter ought to be located); to be shown on the Power Up screen.	0 - 20 characters	""	N	Y

Subject/Attribute	Range	Default	Device	DMS
Meter Functionality				
Date and time editing allowed	0: electronically only (only the DMS can set date and time) 1: anyone (anyone can set date and time) 2: password required (the setup password is required to set date and time)	1	N	Y
Main menu 2 "Linearity" (if enabled, linearity tests are allowed)	0: disabled 1: enable	1	Y	Y
Main menu 2 "Maintenance" (if enabled, maintenance comments are allowed)	0: disabled 1: enable	1	Y	Y
Main menu 2 "Proficiency" allowed (if enabled, proficiency tests are allowed)	0: disabled 1: enable	0	Y	Y
Admin menu "Setup" (if enabled, access to setup screens is possible)	0: disabled 1: enable	1	Y	Y
Setup password	0 – 20 characters	""	Y	Y
Reagent editing allowed	1: Allowed 2: Password needed 0: Not allowed	1	(Y)	Y

Subject/Attribute	Range	Default	Device	DMS
Operator ID				
Operator ID entry control	0: None 1: Prompt 2: Scan only 3: Prompt (numeric only)	1	Y	Y
Operator ID entry control on Glucose control only	0: yes (on controls only) 1: no (always)	1	Y	Y
Operator ID validation (Any character allowed [except non-printable ones, represented as hexadecimal ASCII values by 0x01 - 0x1F and 0x7F]. Via the meter keyboard only A-Z/a-z, 0-9, ".", "[period], "-" [hyphen] can be entered.) Remark: leading and trailing spaces are truncated.	0: none 1: length 2: list 3: list & password	0	Y	Y
Operator ID maximum length (used to validate an operator ID if operator ID validation mode is set to "Length")	0 - 20	20	Y	Y
Operator ID minimum length (used to validate an operator ID if operator ID validation mode is set to "Length")	0 - 20	0	Y	Y
Operator ID timeout (determines the time in sec. before the operator is logged out after power-off). 0 = immediately logged out.	0 - 3,600sec	0	N	Y
Operator password length	4-20 characters (only a-z, 0-9 allowed)	N/A	N	N
Operator certification expiry warning	0-90 days	0 (=off)	N	Y
Operator Name length	0-25 characters	N/A	N	N
Operator ID and patient ID barcode masks				
Operator ID barcode mask (see separate table at the end of this chapter)	0 - 300 characters*	""	N	Y
Patient ID barcode mask (see separate table at the end of this chapter)	0 - 300 characters*	""	N	Y
* The number of characters in the unmasked barcode may not exceed 20.				

Subject/Attribute	Range	Default	Device	DMS
Patient ID				
Patient ID confirmation	0: disabled 1: name 2: date of birth (DOB)* 3: name/DOB*	0	N	Y
* Depends on available DMS settings.				
Patient ID entry mode	0: Keyboard / Scan 1: List / Keyboard / Scan 2: Scan only 3: Prompt (numeric)	0	Y	Y
Patient ID validation (Any character allowed [except non-printable ones, represented as hexadecimal ASCII values by 0x01 - 0x1F and 0x7F]. Via the meter keyboard only A-Z/a-z, 0-9, ".", "[period], "-" [hyphen] can be entered.) Remark: leading and trailing spaces are truncated.	0: none 1: length 2: list 3: list allowing entry if not on list 4: length if numeric	0	Y	Y
Patient ID maximum length (used to validate a patient ID if patient ID validation mode is set to "Length" or "List - allowed to add new")	0-20	20	Y	Y
Patient ID minimum length (used to validate a patient ID if patient ID validation mode is set to "Length" or "List - allowed to add new")	0-20	0	Y	Y
Patient name length	0-25 characters	N/A	N	N

Subject/Attribute	Range	Default	Device	DMS
QC algorithm				
QC Algorithm	0: None (always OK) 1: Last result OK 2: Time of day (DMS only) 3: Shift (DMS only) 4: Hours 5: Strip count 6: Time of day rotate (DMS only) 7: Shift rotate (DMS only) 8: Hours rotate (DMS only) 9: Strip count rotate (DMS only)	0	(Y)	Y
QC hours (Number of hours between required control measurements if QC algorithm is set to "Hours" or "hours rotate")	1 - 9,999 hours	24	Y	Y
QC shift length (a PASS control remains valid for twice this amount in time after shift start if the QC algorithm is set to "Shift" or "Shift rotate")	1, 2, 3, 4, 6, 8, 12, 24 hours	8	N	Y
QC shift start (time of the shift start if the QC algorithm is set to "Shift" or "Shift rotate")	0 - 23 hours	6	N	Y
QC strip count (number of tests a PASS control remains valid)	1 - 999	50	Y	Y
QC time of day	6 POCT1-A data fields 00:00 - 23:59	06:00 09:00 12:00 15:00 18:00 22:00	N	Y
QC time of day set	6 POCT1-A data fields 0 or 1	1 0 0 0 0 0	N	Y

Subject/Attribute	Range	Default	Device	DMS
Result deletion				
Result deletion algorithm. Automatic or First in First out.	0: automatic 1: FIFO	1	N	Y
Result retention time: Number of days since a result was measured before it will be deleted automatically if result deletion algorithm is set to "automatic". Results are then deleted when powering up the meter or performing a test.	1 – 1,000 d	30	N	Y
Result download required	0: disabled 1: enabled	0	N	Y
Electronic communication				
Download warning	0 – 999 h	0: disabled	N	Y
Download Lockout	0 – 999 h	0: disabled	N	Y
Maximum number of list items transferred in one POCT1-A message	1 – 500	75	N	Y
Application timeout (within this time the application expects a response by the DMS to any POCT1-A command)	30 – 3,600 s	60	N	Y
TLS Encryption of communication	0: disabled 1: enabled	0	N	Y
Compression of data communication	0: disabled 1: enabled	0	N	Y

Subject/Attribute	Range	Default	Device	DMS
WLAN settings (general)				
WLAN enabled	0: disabled 1: enabled	0	N	Y
Use DHCP	0: disabled 1: enabled	0	N	Y
IP (the meter's static IP-address if no DHCP is used)	0.0.0.0 – 255.255.255.255	0.0.0.0	N	Y
Subnet Mask (subnet mask to be used by the meter if static IP is used. Note: if DHCP is used; the DHCP-subnet mask will be used.)	0.0.0.0 – 255.255.255.255	0.0.0.0	N	Y
Use DNS	0: disabled 1: enabled	0	N	Y
DMS host (the host's DNS name if DNS is used)	0 – 60 characters	""	N	Y
DMS IP address (the host's IP address if no DNS is used)	0.0.0.0 – 255.255.255.255	0.0.0.0	N	Y
DMS port (the port number to request open socket from the DMS. Roche recommends use of port numbers ≥ 1024 .)	0 – 65,535	0	N	Y
DNS IP (IP address of the DNS-server if DHCP is not used and DNS is configured)	0.0.0.0 – 255.255.255.255	0.0.0.0	N	Y
Gate IP (static gateway IP address)	0.0.0.0 – 255.255.255.255	0.0.0.0	N	Y

Subject/Attribute	Range	Default	Device	DMS
WLAN settings (security)				
Cipher Type (encryption method)	0: None (no cipher type) 1: AES (symmetric key cryptography) 2: TKIP (using dynamic keys) 3: AES TKIP (AES and TKIP together) 4: WEP40 (WEP with 64 bit key length) 5: WEP104 (WEP with 128 bit key length)	0: disabled	N	Y
Security Type *	0: open (no security/encryption) 1: WEP 2: WPA_PSK (WPA with pre-shared key) 3: - 4: EAP**	0	N	Y
* Note: Only those combinations of cipher type and security type are allowed that are listed below, see table "Allowed combinations of cipher and security type".				
**Note: When using option 4 ensure that an appropriate WLAN EAP package has already been downloaded from the DMS to the meter. Within this EAP container, the appropriate EAP type (TLS, PEAP or TTLS) and the diverse EAP configuration settings have to be configured.)				
SSID	0 – 32 characters	""	N	Y
WEP-key (40 or 104 bits)	NUL-terminated string of 10 or 26chs (HEX)	""	N	Y
WEP-authentication	0: open system authentication 1: shared key authentication	0	N	Y
WPA Key Type	0: Passphrase 1: Key	0	N	Y
WPA Key	string of 64 characters (HEX)	""	N	Y
WPA pass phrase (Un-encrypted text used to generate the 256-bit preshared key.)	8 – 63 characters	""	N	Y

Subject/Attribute	Range	Default	Device	DMS
Other Test Entry (OTE)				
OTE functionality *	0: disabled 1: enabled	0	N	Y
* Depends on available DMS settings.				
Barcode Configuration				
Code 128	0: disabled 1: enabled	1	N	Y
Code 39	0: disabled 1: enabled	1	N	Y
Code 93	0: disabled 1: enabled	1	N	Y
EAN 13	0: disabled 1: enabled	1	N	Y
Interleaved 2 of 5	0: disabled 1: enabled	1	N	Y
Codabar	0: disabled 1: enabled	1	N	Y
GS1 DataBar Limited	0: disabled 1: enabled	1	N	Y
QR Code	0: disabled 1: enabled	1	N	Y
DataMatrix	0: disabled 1: enabled	1	N	Y
PDF417	0: disabled 1: enabled	1	N	Y
Aztec	0: disabled 1: enabled	1	N	Y
PreAimer Delay (in milliseconds)	0 - 9,999	500	N	Y
Interleaved 2 of 5 checksum validation	0: disabled 1: enabled	0	N	Y
Add barcode to patient test result	0: disabled 1: enabled 2: enabled and confirm	0	N	Y
Barcode Separators: List of separator characters (readable characters, or hexadecimal ASCII values* preceded by a backslash) to be replaced by line breaks on the confirmation screen. Only valid if <i>Add barcode to patient test result=2</i> .	0-30 characters	""	N	Y
* See the table of ASCII characters on page 208.				

Allowed combinations of cipher and security type

security_type	cipher_type	wep_auth_type	wep_key	wpa_key_type	wpa_key	wpa_passphrase
0 - open	0 - none	-	-	-	-	-
1 - WEP	4 - WEP40	0 - open / 1 - shared	10 characters HEX	-	-	-
1 - WEP	5 - WEP104	0 - open / 1 - shared	26 characters HEX	-	-	-
2 - WPA_PSK	1 - AES (WPA2)	-	-	0 - passphrase	-	8-63 characters
2 - WPA_PSK	1 - AES (WPA2)	-	-	1 - key	64 characters HEX	-
2 - WPA_PSK	2 - TKIP (WPA)	-	-	0 - passphrase	-	8-63 characters
2 - WPA_PSK	2 - TKIP (WPA)	-	-	1 - key	64 characters HEX	-
2 - WPA_PSK	3 - AES/TKIP (WPA2/WPA)	-	-	0 - passphrase	-	8-63 characters
2 - WPA_PSK	3 - AES/TKIP (WPA2/WPA)	-	-	1 - key	64 characters HEX	-
3 -	-	-	-	-	-	-
4 - EAP	-	-	-	-	-	-

Operator and patient ID barcode masks

Barcode mask character	Definition
A-Z, 0-9	If not preceded by the Caret (“^”), the scan data character must be the same as the mask character. This character is not saved as part of the ID. If the characters are not the same, the scan data is not a valid ID.
Dollar (“\$”)	The scan data character in this position is kept as part of the ID.
Asterisk (“*”)	The scan data character in this position is not kept as part of the ID.
Tilde (“~”)	The scan data character in this position must be a number, 0-9, and it is not kept as part of the ID. If the scan data character is not a number, the scan data is not a valid ID.
Plus (“+”)	The scan data character in this position must be an alpha character, A – Z, and it is not kept as part of the ID. If the scan data character is not an alpha character, the scan data is not a valid ID.
Caret (“^”)	This mask character denotes that the scan data character must be equal to the next character in the barcode mask after the “^”, and that the scan data character is kept as part of the ID. If the scan data character is not equal to the mask character following the “^”, the barcode reading is invalid as an ID.
Caret Plus (“^+”)	The “^” can be combined with the plus (“+”). This denotes that the scan data character in this position must be an alpha character, A – Z/a-z, and that it is kept as part of the ID. If the scan data character is not an alpha character, the scan data is not a valid ID.
Caret Tilde (“^~”)	The “^” can be combined with the tilde (“~”). This denotes that the scan data character in this position must be a number, 0-9, and that it is kept as part of the ID. If the scan data character is not a number, the scan data is not a valid ID.

The barcode mask can be preceded by optional square brackets containing the separator characters - [nC₁mC₂] - to extract the ID from any position within the barcode. The ID to be extracted must start after the nth occurrence of the starting character C₁ and must end after the mth occurrence of the ending character C₂. The extracted string of characters will be processed by the succeeding mask (see page 206) to identify the patient ID.

C₁ and C₂ can be represented by any readable characters, or by any hexadecimal ASCII values if marked by a preceding backslash (“\”). See the table of ASCII characters on page 208.

Example 1:

```
[1$1+]^+^~^~^~^~^~^~^~
```

Extract the ID between first occurrence of “\$” and first occurrence of “+”. The ID must start with one alpha character (A-Z/a-z), followed by seven numbers (0-9). This mask will extract the ID **X1234567** from the following barcode example:

```
~Jane Doe%$X1234567+5715486266Z?01-09-1979
```

Example 2:

```
[3\3b1\3b]^+^~^~^~^~^~^~^~
```

Extract the ID between 3rd and 4th semicolon (; = 0x3b). This mask will extract the ID **X1234321** from the following barcode example:

```
;Mary Miller;;X1234321;5715486266Z;01-09-1982
```

Table of ASCII characters

Dec	Hex	Char	Dec	Hex	Char	Dec	Hex	Char	Dec	Hex	Char
0	0	[NULL]	32	20	[SPACE]	64	40	@	96	60	`
1	1	[START OF HEADING]	33	21	!	65	41	A	97	61	a
2	2	[START OF TEXT]	34	22	"	66	42	B	98	62	b
3	3	[END OF TEXT]	35	23	#	67	43	C	99	63	c
4	4	[END OF TRANSMISSION]	36	24	\$	68	44	D	100	64	d
5	5	[ENQUIRY]	37	25	%	69	45	E	101	65	e
6	6	[ACKNOWLEDGE]	38	26	&	70	46	F	102	66	f
7	7	[BELL]	39	27	'	71	47	G	103	67	g
8	8	[BACKSPACE]	40	28	(72	48	H	104	68	h
9	9	[HORIZONTAL TAB]	41	29)	73	49	I	105	69	i
10	A	[LINE FEED]	42	2A	*	74	4A	J	106	6A	j
11	B	[VERTICAL TAB]	43	2B	+	75	4B	K	107	6B	k
12	C	[FORM FEED]	44	2C	,	76	4C	L	108	6C	l
13	D	[CARRIAGE RETURN]	45	2D	-	77	4D	M	109	6D	m
14	E	[SHIFT OUT]	46	2E	.	78	4E	N	110	6E	n
15	F	[SHIFT IN]	47	2F	/	79	4F	O	111	6F	o
16	10	[DATA LINK EXCAPE]	48	30	0	80	50	P	112	70	p
17	11	[DEVICE CONTROL 1]	49	31	1	81	51	Q	113	71	q
18	12	[DEVICE CONTROL 2]	50	32	2	82	52	R	114	72	r
19	13	[DEVICE CONTROL 3]	51	33	3	83	53	S	115	73	s
20	14	[DEVICE CONTROL 4]	52	34	4	84	54	T	116	74	t
21	15	[NEGATIVE ACKNOWLEDGE]	53	35	5	85	55	U	117	75	u
22	16	[SYNCHRONOUS IDLE]	54	36	6	86	56	V	118	76	v
23	17	[ENG OF TRANS. BLOCK]	55	37	7	87	57	W	119	77	w
24	18	[CANCEL]	56	38	8	88	58	X	120	78	x
25	19	[END OF MEDIUM]	57	39	9	89	59	Y	121	79	y
26	1A	[SUBSTITUTE]	58	3A	:	90	5A	Z	122	7A	z
27	1B	[ESCAPE]	59	3B	;	91	5B	[123	7B	{
28	1C	[FILE SEPARATOR]	60	3C	<	92	5C	\	124	7C	
29	1D	[GROUP SEPARATOR]	61	3D	=	93	5D]	125	7D	}
30	1E	[RECORD SEPARATOR]	62	3E	>	94	5E	^	126	7E	~
31	1F	[UNIT SEPARATOR]	63	3F	?	95	5F	_	127	7F	[DEL]

A.2 Example of barcode symbologies



WARNING

Risk of barcode read errors

If a barcode is read incorrectly, this may lead to patient misidentification and therefore to inappropriate therapy decisions.

When creating patient or operator barcodes, always adhere to the applicable international IEC/ISO standards for the respective barcode symbology. In particular, ensure that barcode size and print quality (as defined in ISO/IEC 15416 and 15415) are adequate. Inadequate print size and/or quality may lead to erroneous decoding. In addition every user must carry out a plausibility check on all data scanned into and displayed by the instrument.

To reduce the probability of the barcode being misread, it is strongly recommended that you use the configuration options for patient and/or operator ID validation as applicable to your specific workflow. These options are:

- check ID against list or
- check ID for length¹
- use barcodes with check digits

In combination with the above options or as a single measure, use an appropriate barcode mask if this is compatible with the structure of your barcode content.

1. If no operator/patient list can be used, it is recommended that you at least set a minimum length for the respective ID, even if your facility uses IDs of varying length.

Always make sure that the entire barcode is covered by the green light beam when scanning.

EAN 13 barcodes, although widely used in retail, are less recommendable for patient/operator barcodes. If used, they demand the very highest quality standards of barcode creation and reproduction.

It is possible to **selectively enable or disable the barcode types used for scanning Patient IDs or Operator IDs**. Barcode types that are not used can be disabled (see “Barcode Configuration” on page 204). This feature is only available via a Data Management System (DMS).

For questions about working with barcodes that are not answered in this manual and for best practice guidelines on creating and reading barcodes, contact Roche Customer Support Center (see Chapter 12).

The barcode samples shown on page 212 are for illustration purposes only. If printed out, they can be used to check the barcode scanner. However, they are not meant to be used as a reference for size or resolution of real patient or operator ID barcodes. When creating patient or operator barcodes always refer to the relevant standard ISO/IEC 15416 and 15415 for size and resolution requirements and to the specification listed below. Successful barcode scanning results from optimizing a number of variables including barcode printer method and configuration, the substrate material on which the barcode is printed, and the resulting print quality.

	Recommended Specification	Remarks
Print resolution	300 dpi preferred 200 dpi minimum	At 200 dpi issues with the wide-to-narrow ratio may exist.
Reflective contrast	70% or greater	Matte finish is preferred over gloss finish.
Symbol grade	Grade C or above Grade B is preferred Symbol grades are A-F based on analysis of several quality elements.	Depending on quality grade parameters for a specific bar code, grade C may not be sufficient when motion, reflection, or poor lighting occur.
Module width (minimum)	0.16 mm (linear barcodes) 0.20 mm (2D barcodes)	

Ensure that your printer can print the module width of the barcode with the required resolution, i.e., that there is no mismatch between print resolution and module width.



Codabar

1234567890



Code 39

1234567890



Code 93

ABC123-/+



Code 128

1234567890



EAN 13

1 112223 334448



GS1 DataBar Limited

(01)01234567890128



Interleaved 2/5 without checksum

1234567890



Interleaved 2/5 with checksum

012345678905



PDF417

Roche Professional Diagnostics



Aztec

Roche Professional Diagnostics



DataMatrix

Roche Professional Diagnostics



QR Code

Roche Professional Diagnostics

B Appendix

B.1 Option: Wireless network (WLAN)

Preliminary note

Appendix B has been developed to explain the wireless communication principles of the Accu-Chek Inform II system¹ and to help your facility's information technology/management team(s) in effectively deploying the Accu-Chek Inform II system on your wireless network.

Whether your meter has wireless capability or not depends on the system configuration that you purchased.

Background

The Accu-Chek Inform II meter can only be configured through a data management system to communicate wirelessly. The data management system is also used to set-up and configure the meter to connect to one hospital specific Wireless Local Area Network (WLAN²). WLANs use electromagnetic waves in the 2.45 GHz and/or 5.15 - 5.25 GHz and/or 5.725 - 5.850 GHz frequency range to wirelessly transmit data³. The Accu-Chek Inform II system adheres to IEEE Standard 802.11g (2.45 GHz range)⁴. The system is backwards compatible to 802.11b. During wireless communication to an Access Point (AP), the Accu-Chek Inform II meter recognizes the existent AP WLAN protocol configuration (802.11b or 802.11g) and automatically transmits data using the appropriate communication protocol⁵.

1. The Accu-Chek Inform II system is certified by the Wi-Fi Alliance.
2. WLAN is also commonly referred to as wireless LAN or Wi-Fi.
3. For the wireless functionality to work properly, the wireless module must first be configured by your system administrator.
4. While the Accu-Chek Inform II system adheres to the 802.11g standard, it uses only channels 1-11. Channels 12-14 are not used by the system.
5. WLANs are organized in cells. A typical WLAN cell consists of Access Point(s) that are connected to the (wired) Local Area Network and one or more clients, e.g., Accu-Chek Inform II meters along with other clients such as portable computers.

The loss of signal or access to bandwidth of one particular client may vary depending on one or more of the following situations: the type and number of other clients, the performance of the Access Point, the presence of electromagnetic disturbances, and other potential interfering factors, e.g., concrete walls.

The Accu-Chek Inform II meter uses a burst-like communication protocol that will only consume bandwidth if there is actually data to be transferred. Compared to other applications, such as Voice over Internet Protocol (VoIP) or multi-media applications, the meter's bandwidth consumption is minimal. If the WLAN that the Accu-Chek Inform II meter seeks to connect to is degraded, the meter design minimizes the impact on functionality.

Technical implementation

Prior to connecting any wireless device to a wireless network, it is recommended that a WLAN site survey be performed. The goal of a WLAN site survey is to ensure that Access Points will provide enough coverage and performance to support any new radio frequency (RF) application or device. The survey will also detail RF signals, including all existing WLANs along with any competing RF signals and interferences (building structure related and other wireless equipment / devices).

As part of an RF implementation of the Accu-Chek Inform II system, it is recommended that at minimum one base unit be hard wired per floor. A networked base unit provides redundancy if a wireless network malfunctions or loses service. If the Accu-Chek Inform II meter with RF is used in an area with low signal or interferences, it is recommended to install a connected base unit for redundancy. The redundancy of the connected base unit allows immediate transmission of patient results when the meter is docked.

The facility wireless network infrastructure (hardware and software) is integral in maintaining wireless communication. Prior to changing or upgrading the facility wireless network infrastructure, contact Roche Customer Support Center for technical assessment and assistance.

The current RF system consists of an antenna and a WLAN system-on-chip (SoC) along with other components. The WLAN system-on-chip is the core of the WLAN system. The RF system used in the Accu-Chek Inform II meter specifically adheres to the following specifications:

- Its WLAN system-on-chip supports IEEE 802.11b and 802.11g. It works seamlessly together with other Wi-Fi certified transceivers. It also implements the Wi-Fi Protected Access (WPA™ - Enterprise and WPA™ - Personal), Wi-Fi Protected Access 2 (WPA2™ - Enterprise and WPA2™ - Personal), and Wired Equivalent Privacy (WEP) security mechanisms with Temporal Key Integrity Protocol (TKIP) and Advanced Encryption Standard (AES). In addition, the system supports the extensible authentication protocol (EAP) with EAP-TLS, EAP-TTLS/MSCHAPv2 and PEAPv0/EAP-MSCHAPv2. The Accu-Chek Inform II meter interoperability Wi-Fi certificate can be accessed at http://certifications.wi-fi.org/search_products.php. Further information including a glossary of terms, frequently asked questions, and other topics related to Wi-Fi technology can be found on the Wi-Fi Alliance site (<http://www.wi-fi.org/>).
- The used channels in the 2.4 GHz-band are channels 1-11, which are the legally allowed channels in the USA. (Channels 12-14 are not used by the Accu-Chek Inform II meter.)
- RF output power is approximately 15 dBm at a data rate of 54 MBPS.

Note: For technical reasons, only client certificates in a *.pem file format are acceptable for EAP-TLS authentication. In a Windows-based network environment, *.pfx files need to be converted to *.pem format. It is in the responsibility of the customer / customer's IT department to convert *.pfx certificates to the required *.pem format.

RF specific functionalities and effective performance claims

The Accu-Chek Inform II system offers the option of wireless network connectivity (WLAN/Wi-Fi). If you purchase a system with this option, the WLAN function is enabled during production.

This module can only be configured by a data management system (DMS), which activates the meter's wireless communication and data transfer capabilities. Wireless connectivity can help to ensure that updates to information in the DMS are sent immediately to all networked meters.

Meters with an integrated and activated wireless option use the base unit for recharging and/or as a redundant communication option to exchange data with the DMS.

The meter also has to be docked if the hospital changes security protocols. When this change occurs, it may lock out all meters until docked and reconfigured with the new protocol.

As described above, the Accu-Chek Inform II meter supports the 802.11g standard. This translates into the following RF specific performance claims:

- The Accu-Chek Inform II meter is capable of transferring to a suitable DMS, via WLAN, a data set of up to 1000 result records, 100 reagent records, and 500 operator ID records in less than 15 minutes, when operated in a typical WLAN environment (correct WLAN administration, typical population of other clients present, any of the supported security models enabled).
- Immediately after the operator has initiated the sending of a blood glucose result, the Accu-Chek Inform II meter will attempt to connect to the DMS. In line with the industry communication standard POCT1-A, the DMS must acknowledge the meter's request for connection and actively query for the result. Only upon receipt of this DMS query, the meter will send the result. Hence the effective time for transmitting results depends on infrastructure, DMS workload, etc. Once the DMS sends a query, however, the meter will respond within a few seconds.
- An Accu-Chek Inform II meter with wireless connectivity enabled will communicate results after every test¹ or, when the meter is idle; it will automatically attempt to communicate with the DMS every 10 minutes.

1. The meter will attempt to transmit the result after touching . If the meter is left to power off automatically (see page 21) or powered off manually using the On/Off button the result will be transmitted only after another 10 minutes in the next communication cycle.

A typical range for direct connection between the Accu-Chek Inform II meter and the access point (air, direct view, low disturbances) is up to 49 to 66 feet (15 to 20 meters). The actual range depends on the positioning of the access point's antennas and other topological properties of the space between WLAN device and AP. Additionally, dynamic control of the transmitting power of the access point may reduce the maximum distance between WLAN device and AP within which communication can be guaranteed.

The Accu-Chek Inform II system is designed such that it coexists with other wirelessly communicating devices. The Accu-Chek Inform II system does NOT include any real-time or even time critical wireless functionality. It communicates exclusively single, digital data fields. It does NOT communicate continuous waveform data.

Note: The Accu-Chek Inform II meter monitors the Quality of Service (QoS) of the WLAN communication connection. Should the last attempt to communicate have failed, an icon appears on the screen (see page 42). A degraded QoS will not impact the functionality of the meter but may delay the communication of results to the DMS. Users should be aware that **real-time communication** of blood glucose readings **cannot be guaranteed** by the Accu-Chek Inform II meter.

C Supplement for Other Test Entry

C.1 Before you start

Description

The *Other Test Entry (OTE)* feature is designed to allow the professional user to document patient test results from certain off-meter tests or other related information (e.g., prescribed insulin type, number of units).

External controls are entered in the *Control Test* section. The meter facilitates the transfer of this information to a data management system (DMS).

The activation of this feature is only possible via a suitable DMS.

Activating this feature permanently adds an additional step to the *Patient Test* or a *Control Test* sequence. Once this feature is activated, you will have to select the type of test (*Glucose Test/Other Test* or *Glucose Control Test/Other Control Tests*) each time.

The examples in this manual are for illustration purposes only. Consult the instructions that come with the DMS for details and configuration options.

C.2 Overview of Other Test Entry (OTE)

Introduction

The *Other Test Entry (OTE)* feature allows you to enter patient results for the following tests:

- Pregnancy
- Visual Urinalysis (UA)
- Rapid Streptococcus
- Rapid Drugs of Abuse Tests (DAT)
- Fecal Occult
- Gastric Occult
- Ketones

The *Other Test Entry* feature also allows you to add information about prescribed insulin type and number of units:

- Rapid-Acting Insulin
- Regular Insulin
- Intermediate-Acting Insulin
- Long-Acting Insulin
- Insulin Mixtures

In the *Review Results* listing, the test names for the above tests and insulin information will be abbreviated as follows:

- Pregnancy (Preg)
- Visual UA (VUA)
- Rapid Strep (Strep)
- Rapid DAT (DAT)
- Fecal Occult (F Occ)
- Gastric Occult (G Occ)
- Ketones (Ket)
- Rapid-Acting (Rap-I)
- Regular (Reg-I)
- Intermediate-Acting (Int-I)
- Long-Acting (Long-I)
- Insulin Mixtures (Mix-I)

Entering patient test results using the *Other Test Entry* feature comprises the following steps:

- Enter the patient ID.¹

This can be done either manually or by using the barcode scanner.

- Enter the date and time the test was performed.
- Enter or confirm the test strip, kit and/or other reagent lot numbers.

This can be done either manually or by using the barcode scanner (if a barcode is available).

- Enter the test strip, kit and/or other reagent expiration date the first time a lot number is entered.
- Enter the onboard control result(s) if available.
- Enter the test result(s).
- Select appropriate comments.

1. Note: The display of date of birth (DOB) is not available for OTE workflows.

C.3 Recording Other Patient Tests

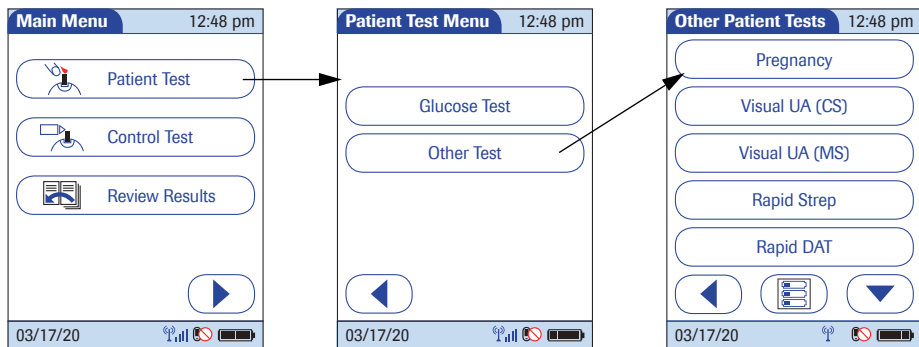

The following steps must be completed already:

- The meter is powered on.
- You have entered your operator ID.
- You have completed login by selecting and the *Main Menu* screen is displayed.



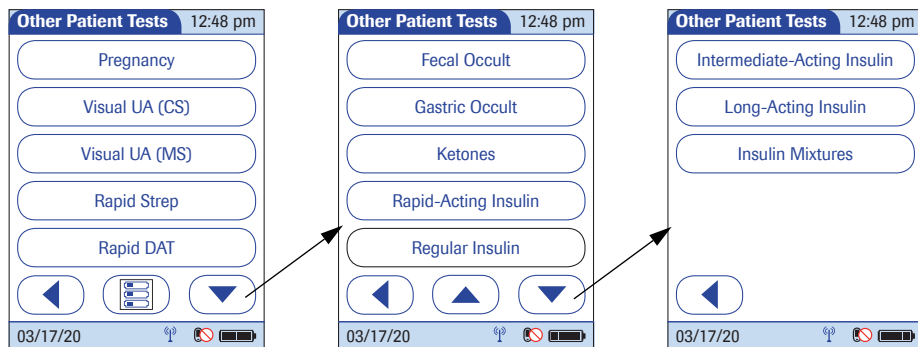

- 1 From the *Main Menu* screen touch *Patient Test*.
- 2 From the *Patient Test Menu* touch *Other Test*.
The *Other Patient Tests* menu list is displayed.



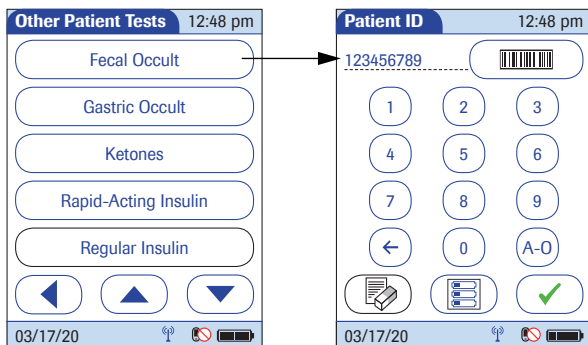

- 3 Touch  or  to scroll up or down in the list.
- 4 Select the desired test from the display list.

If you need to change an entry, touch  to return to the previous screen.

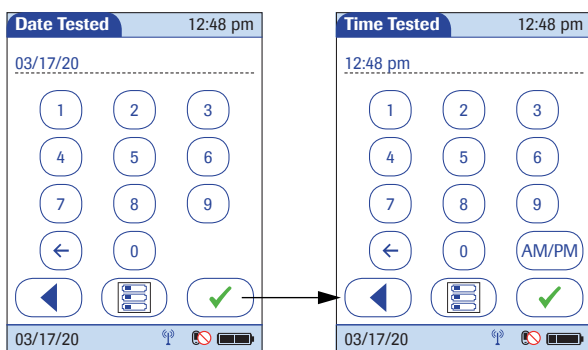

- 5 Enter or select the *Patient ID*. Touch  to proceed to the next screen¹.



- 6 Use the keypad to enter the date the test was performed. For single digit numbers, add a leading zero. Touch  to proceed to the next screen.
- 7 Use the keypad to enter the time the test was performed. For single digit numbers, add a leading zero. Touch  to proceed to the next screen.

1. See also section “Entering or selecting the patient ID” in Chapter 3.

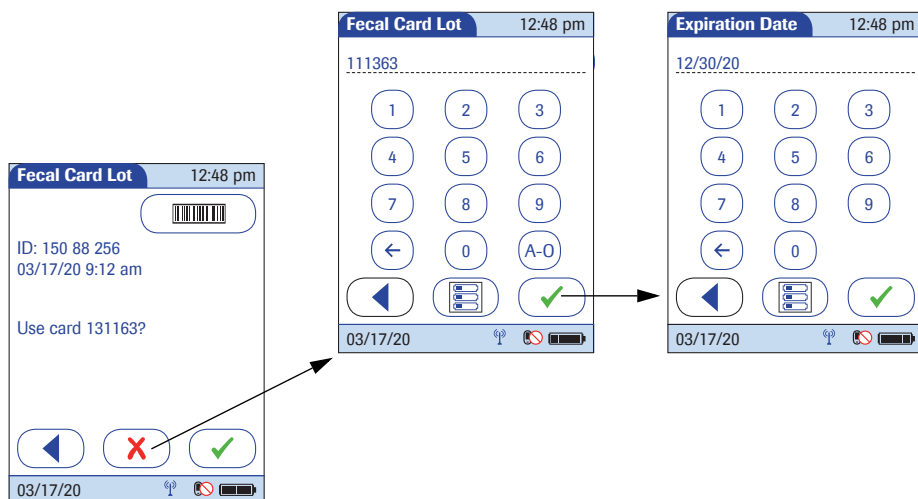

- 8 Use the keypad or barcode scanner to enter the *Fecal Card Lot* number, and touch to proceed to the next screen. OR, if configured:
 - Touch to confirm that you want to use the pre-selected lot number displayed by the meter.
 - Touch to enter a new lot number, if you want to use a different lot number than the one displayed.

If you touch to confirm the displayed lot number, the meter will not prompt for expiration date.

- 9 Use the keypad to enter the *Fecal Card Lot* expiration date. Touch to proceed to the next screen.

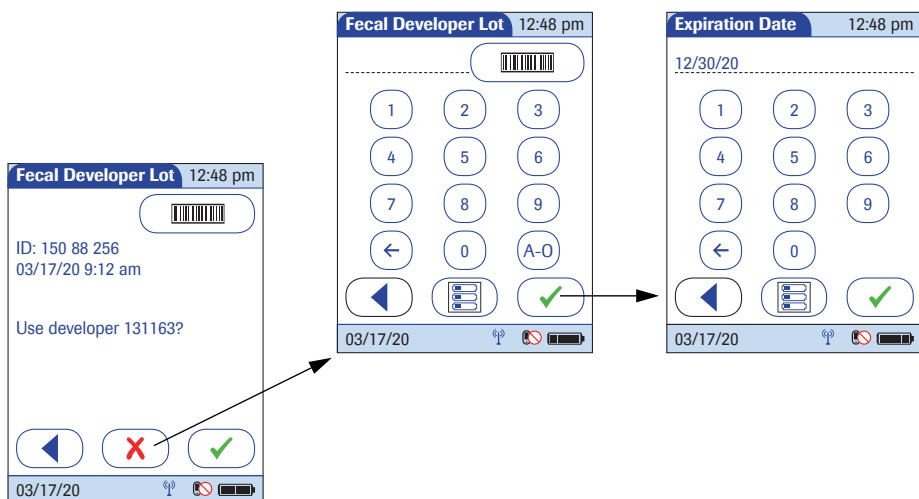

- 10 Use the keypad or the barcode scanner (if a barcode is available) to enter the *Fecal Developer Lot* number, and touch to proceed to the next screen. Or, if configured:
 - Touch to confirm that you want to use the pre-selected lot number displayed by the meter.
 - Touch to enter a new lot number, if you want to use a different lot number than the one displayed.

If you touch to confirm the displayed lot number, the meter will not prompt for expiration date.

- 11 Use the keypad to enter the *Fecal Developer Lot* expiration date. Touch to proceed to the next screen.

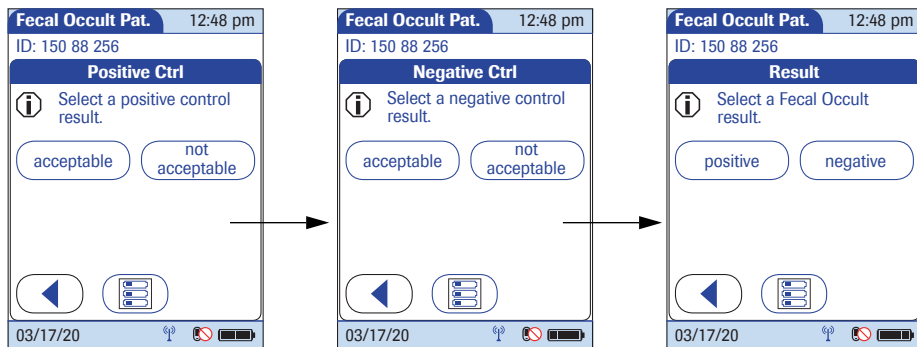



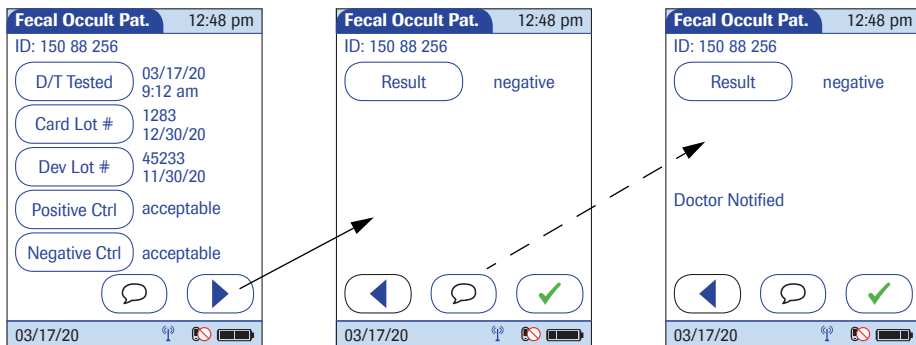

- 12 Select the result of the *Positive Control* as *acceptable* or *not acceptable* by touching the appropriate button.
- 13 Select the result of the *Negative Control* as *acceptable* or *not acceptable* by touching the appropriate button.
- 14 Select the patient test result as *positive* or *negative* by touching the appropriate button.



Once the result(s) are entered, the *Fecal Occult Pat.* result screen is displayed.

- 15 To change an entry or a result, touch the appropriate button.

To add comments¹:

- 16 In the result screen, touch .
- 17 Select the desired predefined comment from the display list (if configured)
or
touch  to enter your own custom comment. Use the keypad (as with login) to enter your comment.
- 18 Once you have selected the desired comment(s), touch  to return to the results screen.
- 19 Touch  to return to the *Main Menu*.

Test results are also saved when the meter is powered off in the results screen or automatically powers off.

1. See also section "Adding comments" in Chapter 3.

C.4 Recording Other Control Tests

Introduction

The *Other Control Tests* feature allows you to enter liquid control results for the following OTE tests:

- Pregnancy (Preg)
- Visual UA (VUA)
- Rapid Strep (Strep)
- Rapid DAT (DAT)

Running controls ensures that your technique used in testing will give accurate results on *Other Patient Tests*. Control solutions have defined (known) values. Commercially prepared control solutions should be used on a regular basis, as established by your institution's quality control protocols. The results for these solutions should be within a certain acceptable range in order to ensure valid OTE testing.

Other Control Testing Intervals

Intervals between running control tests are determined by your institution. Quality control lockout is not available for *Other Test Entry*.

Stored Control Information

The meter can record the following information about *Other Control Tests*:

- Operator ID
- Type of control
- Date tested
- Time tested
- Kit lot number
- Control lot number
- Control test result(s)
- Comment (if applicable)

Entering control test results using the *Other Control Tests* menu comprises the following steps:

- Select the type of control to be recorded.
- Enter the date tested (if required).
- Enter the time tested (if required).
- Enter or confirm the kit or test strip lot number.

This can be done either manually or by using the barcode scanner (if a barcode is available).

- Enter the kit or test strip expiration date.
- Enter or confirm the control lot number.
- Enter the control lot expiration date.
- Select the control result(s).

The control solution results must fall into the acceptable range indicated on the test kit or reagent packaging, or as defined by your institution, before being considered successful.

The following steps must be completed already:

- 1 The meter is powered on.
- 2 You have entered your operator ID.
- 3 You have completed login by selecting and the *Main Menu* screen is displayed.

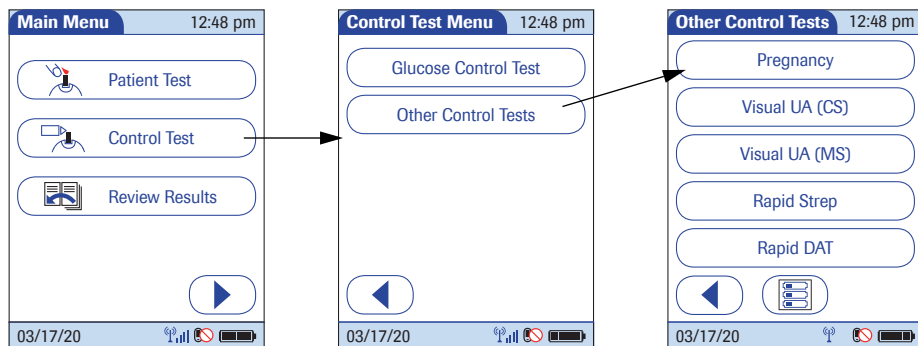

- 1 From the *Main Menu* screen touch *Control Test*.
- 2 From the *Control Test Menu* touch *Other Control Tests*.

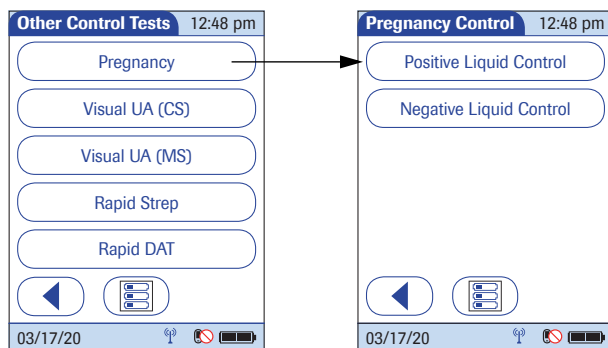

- 3 Select the desired test from the display list. (*Pregnancy* control will be used as an example.)
- 4 Select the type (level) of control being used.

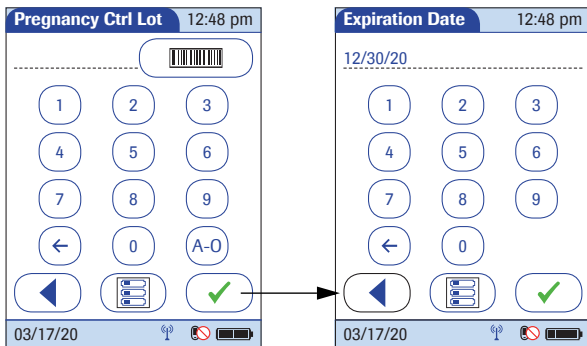

- 5 Use the keypad or the barcode scanner (if a barcode is available) to enter the *Pregnancy Ctrl Lot* number. Touch to proceed to the next screen.
- 6 Use the keypad to enter the *Pregnancy Ctrl Lot* expiration date. Touch to proceed to the next screen.

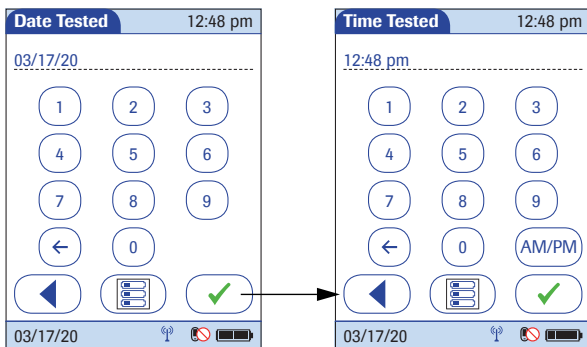

- 7 Use the keypad to enter the date the test was performed. For single digit numbers, add a leading zero. Touch to proceed to the next screen.
- 8 Use the keypad to enter the time the test was performed. For single digit numbers, add a leading zero. Touch to proceed to the next screen.

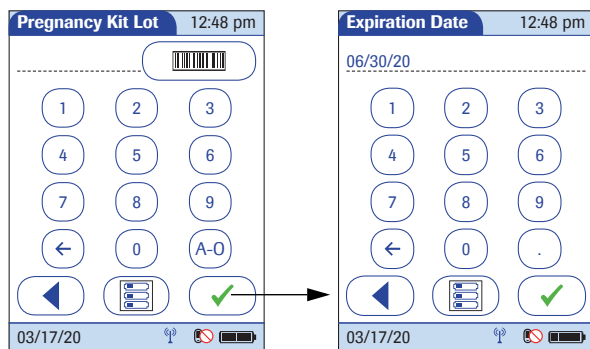

- 9 Use the keypad or the barcode scanner (if a barcode is available) to enter the *Pregnancy Kit Lot* number. Touch to proceed to the next screen.
- 10 Use the keypad to enter the *Pregnancy Kit Lot* expiration date. Touch to proceed to the next screen.

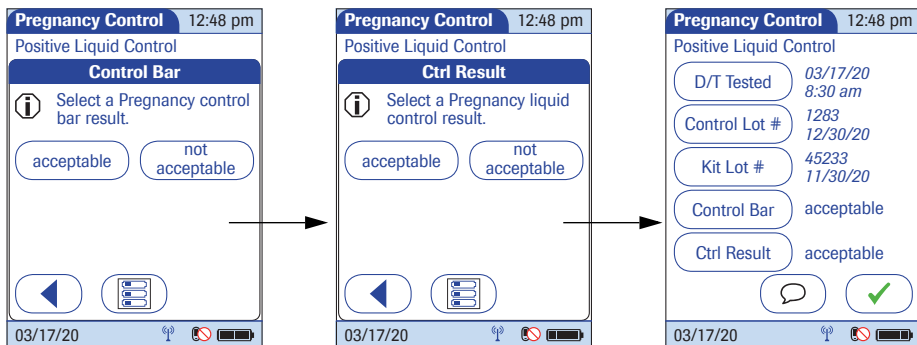





- 11 Select the result of the *Control bar* test as *acceptable* or *not acceptable* by touching the appropriate button.
- 12 Select the result of the liquid control test (*Ctrl Result*) as *acceptable* or *not acceptable* by touching the appropriate button.

Once the results are entered, the *Pregnancy Control* result screen is displayed.

- 13 To change an entry or a result, touch the appropriate button.

To add comments¹:

- 14 In the result screen, touch .
- 15 Select the desired predefined comment(s) from the display list (if configured)
or
touch  to enter your own custom comment(s).
Use the keypad (as with login) to enter your comment.
- 16 Once you have selected the desired comment(s), touch  to return to the results screen.
- 17 Touch  to return to the *Main Menu*.

Test results are also saved when the meter is powered off in the results screen or automatically powers off.

Warning messages

The meter may display error or warning messages when you enter *Other Patient Tests* and *Other Control Tests*. These error or warning messages occur when the validity of the recorded result is questionable. These messages caution that test information may not be valid or accurate. (See also “Pop-up messages” in Chapter 11)

When entering other patient and other control test results, the user may be prompted to enter a control test (control bar) result as either acceptable or not acceptable. If the result is entered as not acceptable, subsequent patient results may not be valid due to the invalid control bar result.

1. See also section “Adding comments” in Chapter 3.

C.5 Reviewing Other Test Results

The *Other Test Results* screen displays all stored OTE results. Results can be viewed in three ways: *All*, *Patient*, or *QC*.

The following steps must be completed already:

- 1 The meter is powered on.
- 2 You have entered your operator ID.
- 3 You have completed login by selecting and the *Main Menu* screen is displayed.



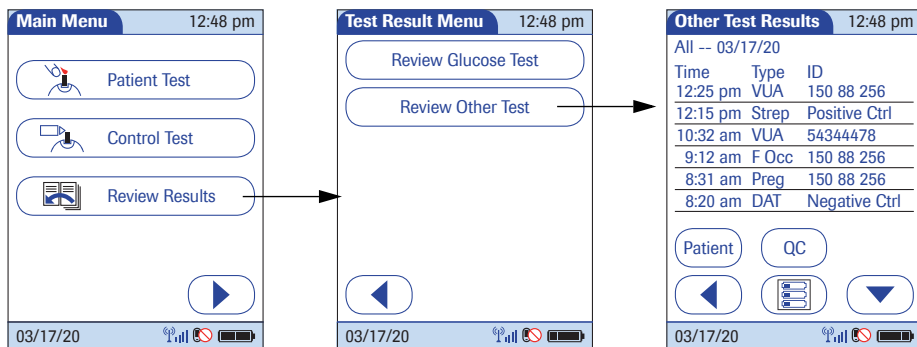

Perform the following steps to *Review Other Test* result(s):

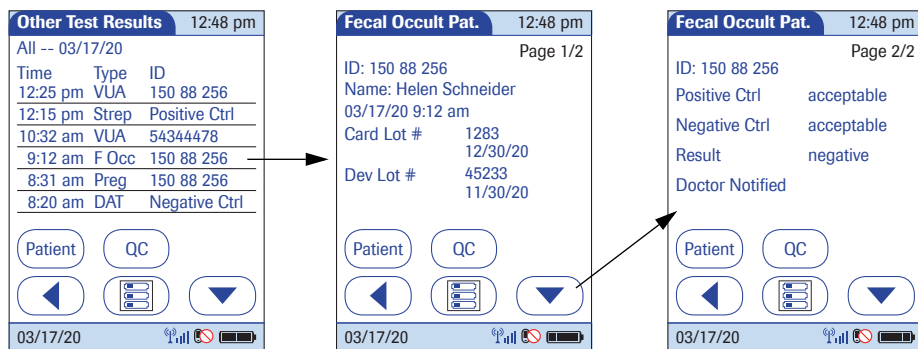

- 1 From the *Main Menu* screen touch *Review Results*.
- 2 From the *Test Result Menu* touch *Review Other Test*.

All stored OTE test results are displayed in a sequential list.



- 3 Touch  or  to scroll up or down in the list. The results are grouped by date.
- 4 Touch an entry in the list to display the related details.
- 5 Touch  or  to display all available pages of a test result.

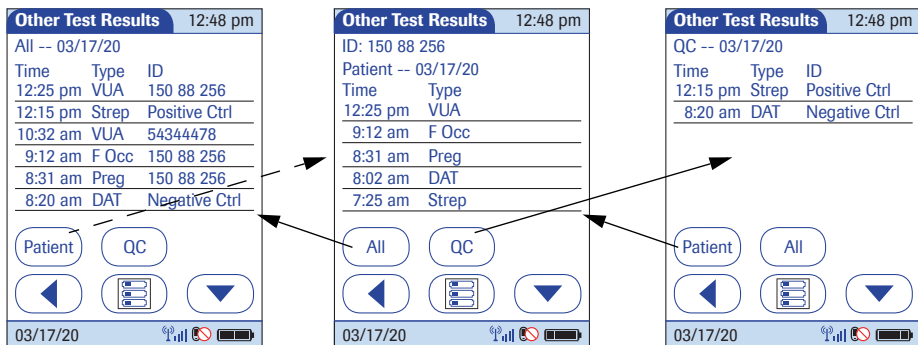

- 6 Touch *Patient*, if you wish to display results for a specific patient only.
 - If you touch *Patient* from the full list view, you will be asked to enter the patient ID manually or via bar-code scanner. The list now contains only the results for the selected patient.
- 7 Touch *QC*, if you wish to display a list of other control tests.
- 8 Touch *All* in the *Other Test Results* screen to remove the *Patient* or *QC* selection and display all results.
- 9 Touch ◀ to return to the previous menu screen, **or** touch ☰ to return to the *Main Menu*.

C.6 Other Test Entry Configuration Options

Other Test Entry options can only be configured using a DMS. The availability of configuration options will thus vary according to the data management software utilized by your institution. Consult your system administrator.

D Supplement for Observed Test Sequence

Observed Test Sequence (OTS)

The *Observed Test Sequence* (OTS) function allows an observer (supervisor) to assess and record an operator's performance (e.g., for recertification purposes). The observer monitors an operator during a test to check that the test is being performed according to the recommended procedures. He/she then evaluates the performance and passes or fails the operator. This assessment is saved together with the glucose test result and any desired comments.

This function needs to be configured by the system administrator and depends on available DMS settings. Electronic configuration options will thus vary according to the data management software utilized by your institution.

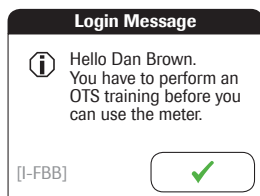

If so configured, the operator may receive a message from the DMS when he or she tries to log in to the meter. This message informs the operator that they have to renew their certification. The contents of the message is created on the DMS and may vary. The screen message shown here is for illustration purposes only.

Using the OTS function

A request for an Observed Test Sequence comes from the DMS.

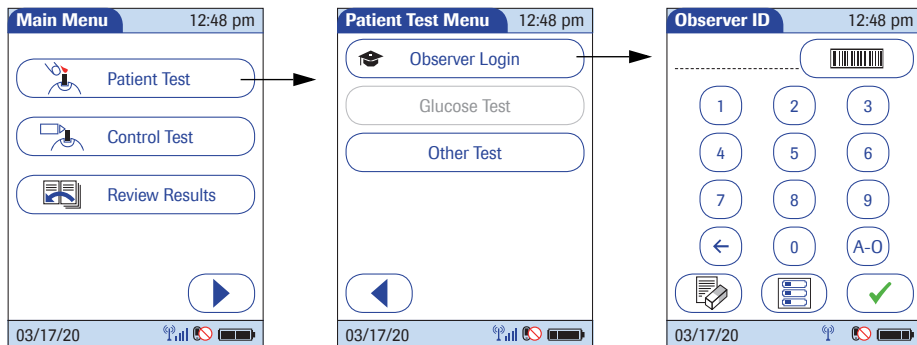

Observer:

- 1 Touch *Patient Test*.

In the *Patient Test Menu*, the *Glucose Test* button is grayed out (disabled) until the observer has logged in.

- 2 Touch *Observer Login*.
- 3 Wait until the *Observer ID* screen is displayed.
- 4 Enter your operator ID or scan your operator ID bar-code. Enter the (optional) password in the *Observer Password* screen, and touch  to log in.

The *Patient Test Menu* is displayed again. The *Glucose Test* button is now available.

- 5 Hand the meter to the operator who can now perform the patient test under supervision.

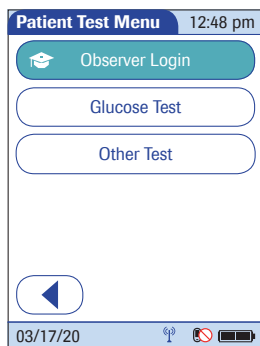

Operator:

6 Touch *Glucose Test*.

Perform the patient test as usual. Once the test is completed, the observer has to complete the next steps.

7 Hand the meter back to the observer.

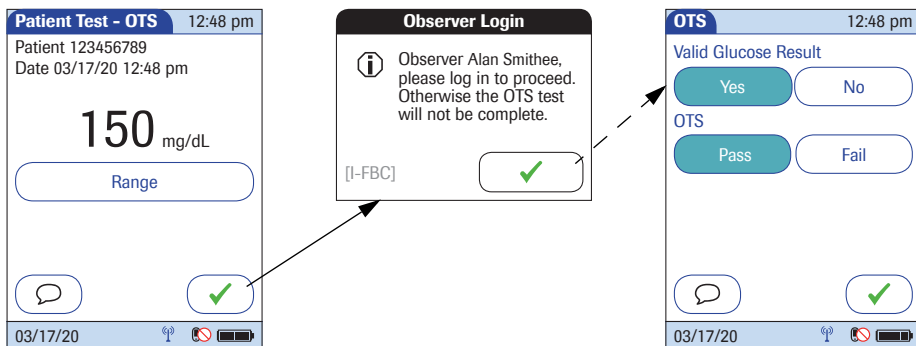
**Observer:**

8 Touch to log in again.

9 After you enter your password, touch to proceed with the assessment.

10 Assess the test result validity by touching *Yes* or *No*.

11 Assess the operator's performance by touching *Pass* or *Fail*.

12 Touch , if you want to add a comment.

13 Touch to return to the *Main Menu* screen.

The OTS information is saved together with the test result.

This page intentionally left blank.

E Supplement for Enhanced Workflows

E.1 Configurable workflows

The Accu-Chek Inform II system offers enhanced configuration options for adapting the default patient testing workflow described in chapter 3 “Patient Glucose Testing” to meet a facility’s specific requirements or needs. See Appendix A.1, “Table of configuration options”.

The activation of these features is only possible via a suitable data management System (DMS). See Appendix A.1, “Table of configuration options”.

Blood sample type selection

This feature allows you to select and document the blood sample type used for a patient test.

After you have confirmed or selected the test strip lot (see page 56) **or** Patient ID (in case of the Isolation Room Workflow described below), the blood sample type selection screen appears.

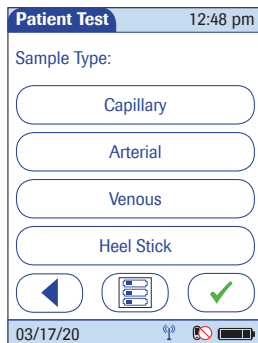

Or

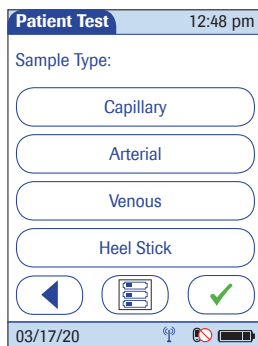

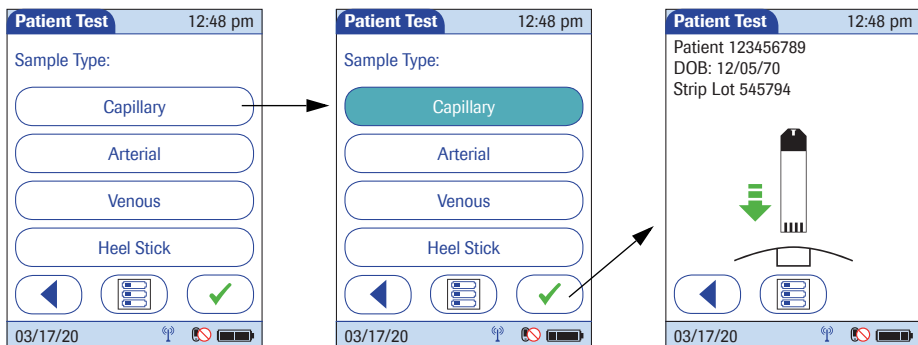

- 1 Select the blood sample type: *Capillary*, *Arterial*, *Venous*, or *Heel Stick*.
- 2 Touch to confirm the selected blood sample type.

After confirming the selected blood sample type, a flashing green arrow appears on screen and prompts you to insert the test strip.

- 3 Slide the test strip into the test strip port as far as it goes in the direction indicated by the arrows on the test strip.

Isolation Room Workflow

If configured, this feature allows you to reverse the order of the steps “Entering or selecting the patient ID” and “Confirming or selecting the test strip lot” to avoid contamination issues. This workflow allows you to test a patient in an isolation room without having to take the test strip vial to the patient.

Test procedure for patients in an isolation room

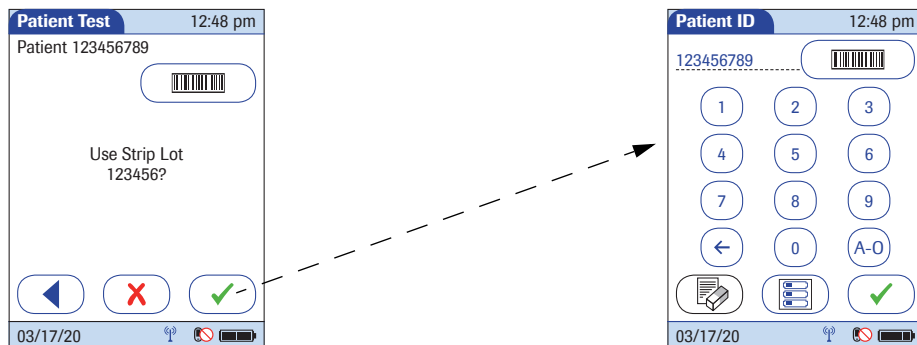

- 1 Confirm or select the test strip lot. For more details see page 56.

Once a test strip has been removed from the vial, **the blood sample must be applied within 3 minutes.**

- 2 Take the meter and the test strip to the isolation room.

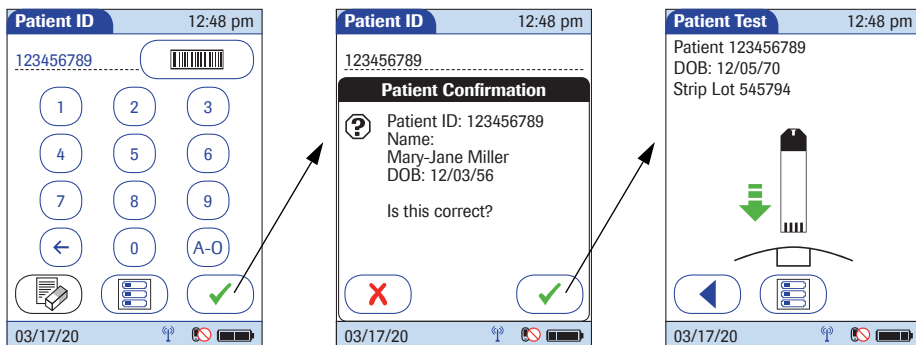

- 3 Enter or select the patient ID. For more details see pages 51 - 55.
- 4 Perform the test. For more details see pages 58 - 61.

The test strips should be used immediately after removing them from the test strip vial (see package insert). However, where this is not possible due to an altered workflow (example: Isolation Room Workflow), studies show that the test strips remain stable for 3 minutes between removing them from the vial and applying a blood sample.

This page intentionally left blank.

F Appendix for Accu-Chek Inform II Base Unit (legacy version)

The legacy version of the Accu-Chek Inform II Base Unit (REF 05060290001) differs in some technical aspects from the newer Accu-Chek Inform II Base Unit (REF 07671717190) that is described in section 1.6 “Overview of the Accu-Chek Inform II Base Unit”. This chapter describes the elements and technical data of the legacy base unit version with older hardware.

F.1 Overview of the base unit with older hardware

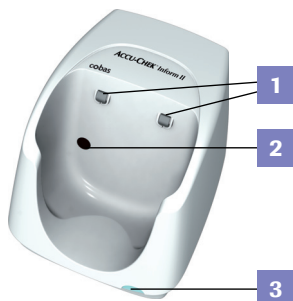

The Accu-Chek Inform II Base Unit (legacy version) can:

- charge the meter battery pack.
- communicate with a data management system.
- communicate with a computer.

The base unit has the following elements:

- 1 Charging contacts
- 2 Infrared window for communication with the meter
- 3 Status LED (lights up when power is connected):
 - Lights up red: Power supply is connected, application is starting up
 - Lights up green: Ready
 - Flashes red: Error
 - Lights up blue: Configuration mode

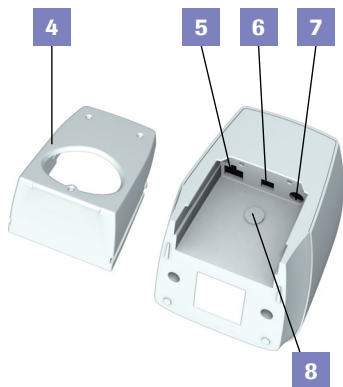

Electrical connections are located on the back of the base unit.

- 4** Removable mount for wall installation
- 5** Network connection — Ethernet/RJ45 port
- 6** USB port
- 7** Jack for the power supply unit provided
- 8** USB configuration switch (for System Administrator use only)

7.5V  1.7A

F.2 Connecting the base unit (legacy version)

NOTICE

To ensure continuous safe and reliable operation, use only the power supply unit provided for the Accu-Chek Inform II system (for ordering information see page 188).

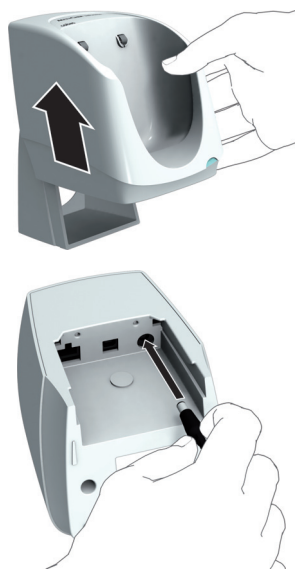

- 1 Slide the base unit upward and remove it from the wall mount (if in use).
- 2 Connect the power supply to the power input jack.
- 3 **If you want to connect the Accu-Chek Inform II Base Unit in a wired environment:** Connect the Ethernet (RJ45) cable or the USB cable to the respective outlet. Use only the USB cable provided with the Accu-Chek Inform II system.
- 4 Slide the base unit back onto the wall mount (if in use).

For details on configuring the Accu-Chek Inform II Base Unit, contact Roche Customer Support Center.

F.3 Technical data

Specification	Base unit (legacy version)	Power supply unit
Height	4.33 in / 110 mm (max.)	1.38 in / 35 mm + AC plug (1.1-1.6 in / 28-40 mm)
Width	4.65 in / 118 mm (max.)	2.01 in / 51 mm
Length	4.06 in / 103 mm (max.)	3.43 in / 87 mm
Weight	Accu-Chek Inform II Base Unit (legacy version) 615 g with wall mount	N/A
User interface	LED (tricolor: red, green, blue)	LED: green
Operating temperature	37 to 122 °F 3 to 50 °C	32 to 104 °F 0 to 40 °C
Storage conditions (long-term storage)	41 to 104 °F / 5 to 40 °C at 10 - 85% RH (non-condensing)	
Humidity (operating)	10 - 90 % RH (non-condensing)	
Air pressure	0.7 to 1.06 bar 70 to 106 kPa	N/A
Input voltage	+7.5 V DC	100 to 240 V AC
Input frequency	DC	50 to 60 Hz
Input current	1.7 A (max)	350 to 150 mA
Interfaces	Charge contacts IR port RJ45 Ethernet USB type B	DC connector Replaceable AC input contacts
Data transfer rate	IR: 9.6K - 115K bps Ethernet: 10 Mbps half-duplex USB: 12 Mbps	N/A

G Limited Warranty

Accu-Chek® Inform II meter LIMITED WARRANTY

Roche Diagnostics warrants to the original purchaser that the Accu-Chek® Inform II meter will be free from defects in materials and workmanship for 1 year from the date of purchase.

If, during the warranty period, the meter does not work properly because of a defect in materials or workmanship, Roche Diagnostics will repair it or replace it with a new or refurbished Accu-Chek® Inform II meter or equivalent product free of charge. The warranty of the repaired or replacement meter will expire on the date of the original warranty expiration or 90 days after shipment of a replacement meter, whichever period is longer. The purchaser's sole and exclusive remedy with respect to the Accu-Chek® Inform II meter shall be repair or replacement, in Roche Diagnostics sole discretion.

This warranty does not apply to the performance of an Accu-Chek® Inform II meter that has been damaged by accident or has been altered, misused, tampered with or abused in any way.

THE ABOVE WARRANTY IS EXCLUSIVE OF ALL OTHER WARRANTIES, AND ROCHE DIAGNOSTICS MAKES NO OTHER WARRANTIES, EXPRESS OR IMPLIED, INCLUDING WITHOUT LIMITATION THE IMPLIED WARRANTY OF MERCHANTABILITY OR FITNESS FOR A PARTICULAR PURPOSE.

IN NO EVENT SHALL ROCHE DIAGNOSTICS BE LIABLE TO THE PURCHASER OR ANY OTHER PERSON FOR ANY INCIDENTAL, CONSEQUENTIAL, INDIRECT, SPECIAL OR PUNITIVE DAMAGES ARISING FROM OR IN ANY WAY CONNECTED WITH THE PURCHASE OR USE OF THE ACCU-CHEK® INFORM II METER. NO WARRANTY OF MERCHANTABILITY OR FITNESS FOR A PARTICULAR PURPOSE, IF ANY IS IMPLIED FROM THE SALE OF THE METER, SHALL EXTEND FOR A LONGER DURATION THAN 1 YEAR FROM THE DATE OF PURCHASE.

Some states do not allow limitations on how long an implied warranty will last or the exclusion of incidental or consequential damages, so the above limitation and exclusion may not apply to you. This warranty gives you specific legal rights, which vary from state to state.

This page intentionally left blank.

Index

A

Accessory box	
Overview	39
Addresses (Roche)	192
Automatic power-off	21

B

Barcode	
Masks	206
Symbologies	212

Base Unit (legacy version)

Connecting	253
Overview	251

Base Unit Hub	38
---------------------	----

Base Unit, Base Unit Light

Connecting	119
Overview	36

Battery pack

Installing or replacing	121–125
-------------------------------	---------

Beeper	147
--------------	-----

C

Cipher	205
--------------	-----

Cleaning agents	153
-----------------------	-----

Code chip

 See code key

Code key	35, 87
----------------	--------

Code key reader

Downloading code key information	88
Overview	35

Comments

Adding	66
Maintenance log	158

Components	32
------------------	----

Configuration	130–147, 193–206
---------------------	------------------

Menu overview	131–134
---------------------	---------

Control frequency	140
-------------------------	-----

Control lots

Editing control lot data	94–98
Selecting	75
Storing information	87–102

Control solution

Lot number	75
------------------	----

CR LO/HI	64
----------------	----

Critical range	64, 142
----------------------	---------

D

Date and time	146
---------------------	-----

Date and time format	136
----------------------------	-----

Delete patient	164
----------------------	-----

Diagnostics	159
-------------------	-----

Display options	137
-----------------------	-----

Disposal	20
----------------	----

Docking the meter	128
-------------------------	-----

Download lockout	48, 81
------------------------	--------

Unlocking	161
-----------------	-----

E

Error messages	172
----------------------	-----

Errors (without error message)	167–170
--------------------------------------	---------

G

Glucose control

Control solutions	72
-------------------------	----

Intervals	70
-----------------	----

Performing a test	73–80
-------------------------	-------

Preparing	72
-----------------	----

STAT test	81
-----------------	----

Glucose control options	140
-------------------------------	-----

Glucose control testing	69–81
-------------------------------	-------

Results	79
---------------	----

H

HI	64
----------	----

I

Icons

Identification plate	5
----------------------------	---

Packaging	5
-----------------	---

Information service	192
---------------------------	-----

Initial startup	120–160
-----------------------	---------

Isolation Room Workflow	248
-------------------------------	-----

L

License (GPL)	191
---------------------	-----

Linearity lots

Editing linearity lot data	99–102
----------------------------------	--------

Storing information	87–102
---------------------------	--------

Linearity testing	103–110	Patient ID	51–55
Intervals	104	Barcode scanner	55
Performing a test	106–110	Entering manually	53
Preparing	105	Options	144
Results	110	Powering off	21
LO	64	Powering up	41
Lots	87–102	Power-off (automatic)	21
M		Product information	183–191
Maintenance	149–165	Proficiency test	
Log	158	Preparing	112
Meter		Proficiency testing	111–117
cleaning	156	Performing a test	113–117
Diagnostics	159	Results	117
disinfecting	157	Q	
Overview	33	QC lockout	69
Powering off	21	R	
Powering up	41	Ranges (results)	63
Reset	181	Reagent options	139
Setup	193–206	Reagents	39
Shut down	22	Records (Patient ID, Operator ID)	183, 217
Meter setup	130–147	REF (catalog numbers)	188
Menu overview	131–134	Reportable range	64, 142
N		Reset	181
Normal range	64, 142	Result memory	83–86
O		Results screen	63, 79, 110, 117
Observed Test Sequence (OTS)	242	RF (radio frequency)	28, 214
Operating conditions (general)	149	RR LO/HI	64
Operator ID	44–46	S	
Barcode Scanner	45	Safety	
Entering manually	46	Protection against infection	19
Options	143	User qualification	19
Password	46	Safety information	20–31
Ordering	188	Sample	
Other Test Entry (OTE)	219–239	Applying	61, 78, 109, 116
P		Select type	246
Password	145	Service menu	163
Patient glucose testing	48–68		
Performing a test	50–65		
Preparing	48		
Results	63		

Setup	130–147, 193–206	T	
Beeper	147	Technical data	183, 254
Date and time	146	Telephone number (information service) ...	192
Date and time format	136	Test strip lots	
Display options	137	Storing information	87–102
Glucose control options	140	Test strip options	138
Menu overview	131–134	Test strips	
Operator ID entry	143	Applying blood sample	61
Password	145	Applying control solution	78
Patient ID entry	144	Applying linearity sample	109
Reagent options	139	Applying proficiency sample	116
Setup menu	135, 162	Editing data	91–93
Test strip options	138	Inserting	59, 77, 108, 115
Value ranges	142	Setup options	138
Shut down meter	22	Troubleshooting	167–182
Specifications	183, 254	U	
STAT test	81	Unit (results)	137
Storage	151	W	
Strip lot		Wi-Fi	28, 29
Selecting	56, 76	Wireless connectivity	
System		Disabling temporarily	42
Components	32	WLAN	28, 213
General information	183–191	WLAN security	205
Initial startup	120–160		
Maintenance	149–165		
Overview (accessory box)	39		
Overview (base unit hub)	38		
Overview (base unit)	36		
Overview (code key reader)	35		
Overview (meter)	33		
Technical data	183, 254		
Troubleshooting	167–182		

This page intentionally left blank.

Notes

Notes







ACCU-CHEK, ACCU-CHEK INFORM,
and COBAS are trademarks of Roche.



Roche Diagnostics GmbH
Sandhofer Strasse 116
68305 Mannheim, Germany

Manufactured for and distributed in the U.S.A. by:
Roche Diagnostics
9115 Hague Road
Indianapolis, IN 46256

Rx only

dialog.roche.com

05-01306-04

08424705001 (05) 2021-09 USA

ACCU-CHEK®