

# **OLYMPUS<sup>®</sup>**

---

DIGITAL CAMERA

*TG-2*

## **Instruction Manual**

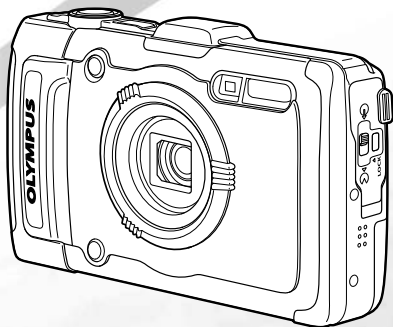

- Thank you for purchasing an Olympus digital camera. Before you start to use your new camera, please read these instructions carefully to enjoy optimum performance and a longer service life. Keep this manual in a safe place for future reference.
- We recommend that you take test shots to get accustomed to your camera before taking important photographs.
- In the interest of continually improving products, Olympus reserves the right to update or modify information contained in this manual.

## Checking the contents of the box



Digital camera



Strap



Lithium Ion  
Battery  
(LI-90B)



or



USB-AC adapter  
(F-2AC)



USB cable  
(CB-USB8)



OLYMPUS Setup  
CD-ROM



Lens ring





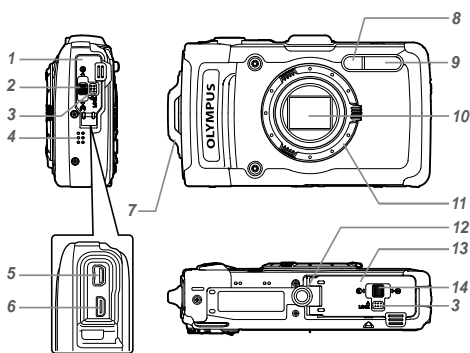

Other accessories not shown: Warranty card  
Contents may vary depending on purchase location.

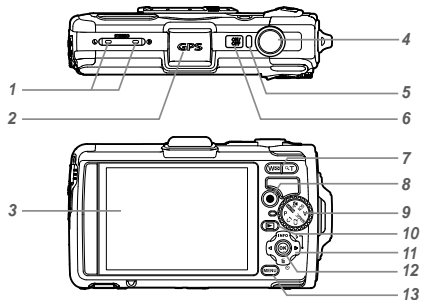
## Names of Parts





- 1 Connector cover
- 2 Connector cover lock
- 3 LOCK knob
- 4 Speaker
- 5 Multi-connector
- 6 HDMI micro connector
- 7 Strap eyelet
- 8 Self-timer lamp/LED Illuminator/  
AF illuminator
- 9 Flash
- 10 Lens
- 11 Lens ring
- 12 Tripod socket
- 13 Battery/card cover
- 14 Battery/card cover lock

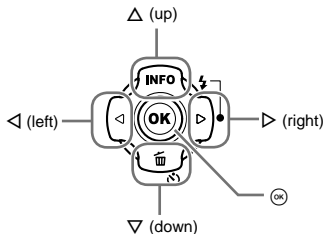

- 1 Stereo microphone
- 2 GPS antenna
- 3 Monitor
- 4 Shutter button
- 5 Indicator lamp
- 6 ON/OFF button
- 7 Zoom buttons
- 8  button (shooting movies)
- 9 Mode dial
- 10  button (switching between shooting and playback)
- 11 Arrow pad
- INFO (changing information display)
-  (flash)
-  (self-timer)
-  (erase)
- 12  button (OK)
- 13 MENU button

### Arrow pad



  $\Delta \nabla \triangleleft \triangleright$  instruct to press the up/down/left/right arrow pad.

### Attaching the camera strap



 Pull the strap tight so that it does not come loose.

## Inserting and removing the battery and card (commercially available)

### 1 Follow Steps ①, ② and ③ to open the battery/card cover.

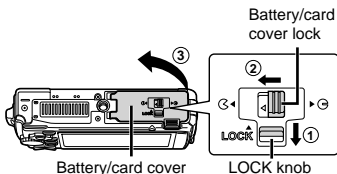

- ❗ Turn off the camera before opening the battery/card cover.

### 2 Insert the battery while sliding the battery lock knob in the direction of the arrow.

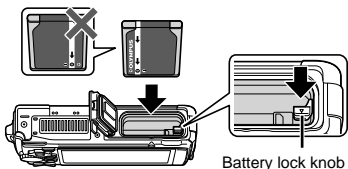

- ❗ Insert the battery as illustrated with the **-** mark toward the battery lock knob. Damage to the battery exterior (scratches, etc.) may produce heat or an explosion.

- ❗ Slide the battery lock knob in the direction of the arrow to unlock, and then remove the battery.

### 3 Insert the card straight until it clicks into place.

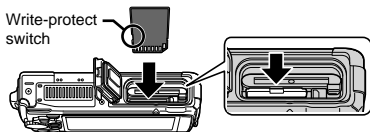

- ❗ Always use SD/SDHC/SDXC/Eye-Fi/FlashAir (with Wireless LAN function) card with this camera. Do not insert other types of memory cards. "Using the card" (p. 79)
- Do not touch the metallic parts of the card directly.

### To remove the card

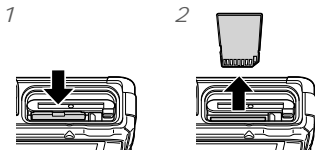

- Press the card in until it clicks and comes out slightly, then remove the card.

#### 4 Follow Steps ①, ② and ③ to close the battery/card cover.

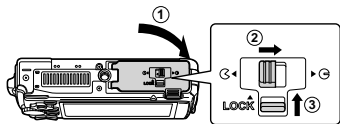

- ⚠ When using the camera, be sure to close and lock the battery/card cover.

### *Charging the battery*

Connect the USB cable and USB-AC adapter to the camera and charge the battery.

For charging the battery abroad, see "Using your charger and USB-AC adapter abroad" (p. 79).

- The battery is not fully charged at shipment. Before use, be sure to charge the battery until the indicator lamp turns off (up to 4 hours).

### Connecting the camera

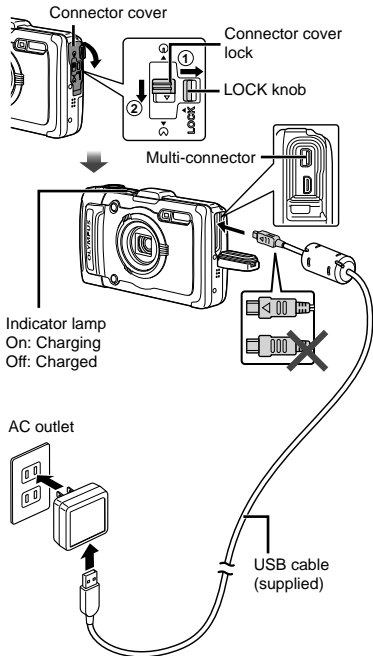

## When to charge the batteries

Charge the battery when the error message shown below appears.

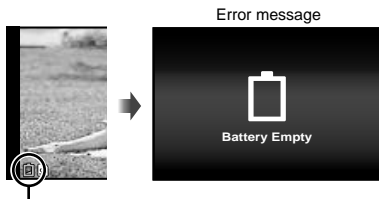

Flashes in red

- ❗ Never use any cable other than supplied or Olympus-designated USB cable. This may cause smoking or burning.
  - ❗ The included F-2AC USB-AC adapter (hereafter referred to as USB-AC adapter) differs depending on the region where you purchased the camera. If you received a plug-in type USB-AC adapter, plug it directly into AC outlet.
  - ❗ The included USB-AC adapter has been designed to be used for charging and playback. Do not take pictures while the USB-AC adapter is connected to the camera.
  - ❗ Be sure to unplug the power plug of the USB-AC adapter from the wall outlet when the charging is complete or the playback ends.
  - ❗ For details on the battery, see "Battery Handling Precautions" (p. 98). For details on the USB-AC adapter, see "USB-AC adapter" (p. 99).
  - If the indicator lamp does not light, check the USB cable and USB-AC adapter connections.
- The battery can be charged while the camera is connected to the computer via USB. The charging time varies depending on the performance of the computer. (There may be cases in which it takes approx. 10 hours.)

## Turning on the camera and making the initial settings

When you turn on the camera for the first time, a screen appears enabling to set the language for the menus and messages displayed in the monitor, and the date and time.

To change the selected date and time, see "Setting the date and time" (p. 49).

**1 Press the ON/OFF button to turn on the camera, press  $\Delta \nabla \triangleleft \triangleright$  of the arrow pad to select your language and press the  $\text{OK}$  button.**

**2 Press  $\Delta \nabla$  of the arrow pad to select the year for [Y].**

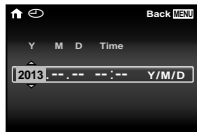

Date and time setting screen

**3 Press  $\triangleright$  of the arrow pad to save the setting for [Y].**

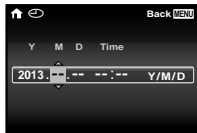

**4 As in Steps 2 and 3, press  $\Delta \nabla \triangleleft \triangleright$  of the arrow pad to set [M] (month), [D] (day), [Time] (hours and minutes), and [Y/M/D] (date order), and then press the  $\text{OK}$  button.**

For precise time setting, press the  $\text{OK}$  button as the time signal strikes 00 seconds.

**5 Press  $\triangleleft \triangleright$  of the arrow pad to select time zone and then press the  $\text{OK}$  button.**

- Use  $\Delta \nabla$  to turn daylight saving time ([Summer]) on or off.



## Before Using GPS

---

The camera's GPS (Global Positioning System) feature determines your position (latitude and longitude) and stores this information with pictures taken with the camera.

The camera uses supplementary orbital data (assisted GPS or A-GPS) for improved signal acquisition.

A-GPS data must be updated every 14 days.

Before using GPS, you will need to set the camera clock to the correct date and time. (p. 49)

### Updating A-GPS Data

---

#### 1 Install the update software (OLYMPUS A-GPS Utility).

- Download the update software from the following website and install it on your computer.  
<http://sdl.olympus-imaging.com/agps/>  
The update software can also be installed from the supplied PC software.

#### 2 Connect the camera to the computer and launch the update software.

##### “Connecting with a computer” (p. 56)

- Once the software has started, follow the on-screen instructions.

## Using GPS

---

#### 1 Select [On] for [GPS Settings] > [GPS] in the $\bar{f}$ (Settings Menu 3) tab. (p. 55)

- Once the camera has determined the position,  $\bar{G}$ PS and location coordinates will appear in the display.



---

$\bar{G}$ PS	Blink: Searching GPS signal
--------------	-----------------------------

---

$\bar{G}$ PS	Light: Receiving GPS signal
--------------	-----------------------------

---

- The camera may take a few minutes to determine position after a period of disuse. If the icon is still flashing after several minutes, the camera is probably having difficulty detecting a signal. Move to an unobstructed outdoor area or otherwise change your location.



## 2 Press INFO button in the shooting display.

- The display changes in the order of Normal → Detailed → No info. → Measurement position information each time **Δ (INFO)** is pressed.
- Nearby landmarks in the GPS database will be displayed.



- |                                 |                                  |
|---------------------------------|----------------------------------|
| ① Landmark name                 | ⑥ Latitude                       |
| ② Landmark information position | ⑦ Longitude                      |
| ③ Electronic compass            | ⑧ Atmospheric/Hydraulic pressure |
| ④ Update status                 | ⑨ Altitude/Water depth           |
| ⑤ GPS tracking active           | ⑩ Current date and time          |

	Select a landmark.
	Update GPS data.

- Some countries or regions may regulate the use of GPS devices. Follow all local regulations.
- Turn GPS off when on board aircraft and in other locations in which the use of GPS devices is prohibited.
- The provision of A-GPS data may be terminated without prior notice.
- Position data may be unavailable or contain errors in the following locations:
  - Locations without a clear view of the sky (indoors, underground or underwater, or near trees or tall buildings)

- Locations subject to strong magnetic or radio interference (near high-voltage power lines, magnets, electronic devices, or cell phones operating in the 1.5 GHz band)
- GPS data may take more time to acquire or be unavailable in some locations or at certain times of day.
- Do not cover the GPS antenna with your hands or metal objects.
- If the battery is low, the camera cannot acquire GPS data while the camera turns off.
- The camera is not equipped for GPS navigation.
- While [Track] is [On], the GPS receiver will continue to draw power from the battery when the camera is off.
- GPS data are not recorded with movies.
- Press the **INFO** button while the camera is turned off. The current time and the shooting location are displayed for approx. 30 seconds.

## Learning how to use the camera

- Press the **ON/OFF** button to turn on the camera and enter the standby mode. (Press the **ON/OFF** button again to turn off the camera.)
  - Select the shooting mode, and press the shutter button to shoot a still image.
  - To shoot a movie, press the **Ⓢ** button.
  - Set the shooting functions using the function menu or the setup menu.
- To view images, press the **▶** button to switch to playback mode.
  - To return to standby mode, press the **▶** button again, or press the shutter button halfway down and then release it.
- Press and hold the **▶** button while the camera is turned off to start up the camera in the playback mode.
  - In this case, pressing the **▶** button again sets the camera to the standby mode.

## Shooting still images

- 1 Press the **ON/OFF** button to turn on the camera.
- 2 Select the shooting mode. (p. 14)
- 3 Hold the camera and compose the shot.

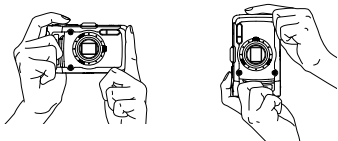

- ⚠ When holding the camera, take care not to cover the flash, microphone or other important parts with your fingers, etc.
- ⚠ Take care so that the flash window is not exposed to fingerprints or dirt.
- ⚠ Press and hold **Ⓢ** button to brighten the monitor when there is difficulty in seeing the monitor. The monitor brightness returns to the default setting if no operations are performed for 10 seconds.

#### 4 Press the shutter button halfway down to focus.

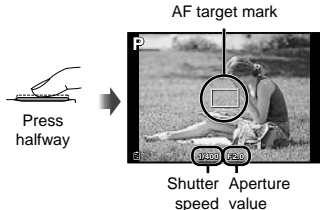

- The camera was unable to focus if the AF target mark flashes red. Try focusing again.

#### 5 To take the picture, gently press the shutter button all the way down while being careful not to shake the camera.

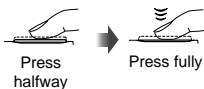

### Using the zoom

Pressing the zoom buttons adjusts the shooting range.

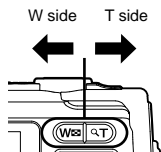

Image size	Zoom bar
12M	 Optical zoom Super-resolution zoom*1
Other	 *2

\*1 For Super-resolution zoom, see [Super-Res Zoom] (p. 36).

\*2 Due to increased processing of the pixel counts, the image quality will not degrade. The magnification ratio changes depending on the image size setting.

## Using the flash

The flash functions can be selected to best match the shooting conditions.

### 1 Press $\triangleright$ .



### 2 Use $\triangleleft$ and $\triangleright$ to select the setting option, and press the $\text{OK}$ button to set.

Option	Description
Flash Auto	The flash fires automatically in low-light or backlight conditions.
Redeye	Pre-flashes are emitted to reduce the occurrence of red eye in your photos.
Fill In	The flash fires regardless of the available light.
Flash Off	The flash does not fire.
LED On	The LED turns on when a picture is taken. This is effective for taking close up pictures.
Remote Control	For details, see "Taking pictures with the Olympus Wireless RC Flash System" (p. 82).
Slave	

## Using the self-timer

After the shutter button is pressed all the way down, the picture is taken after a short delay.

### 1 Press $\nabla$ .

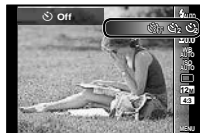

### 2 Use $\triangleleft$ and $\triangleright$ to select the setting option, and press the $\text{OK}$ button to set.

Option	Description
$\text{Off}$	The self-timer is deactivated.
$\text{12 sec}$	The self-timer lamp turns on for approx. 10 seconds, then blinks for approx. 2 seconds, and then the picture is taken.
$\text{2 sec}$	The self-timer lamp blinks for approx. 2 seconds, then the picture is taken.
$\text{Auto Release}^{*1}$	When your pet (cat or dog) turns its head towards the camera, its face is recognized and the picture is taken automatically.

<sup>\*1</sup> [Auto Release] is displayed only when the **SCN** mode is [ $\text{[G]}$ ] or [ $\text{[A]}$ ].

### To cancel the self-timer after it starts

Press the **MENU** button.

## Shooting screen displays

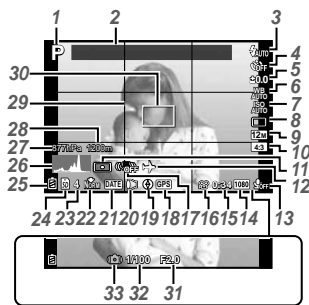

When the shutter button is pressed halfway down

### Reading a histogram

If the peak fills too much of the frame, the image will appear mostly white.

If the peak fills too much of the frame, the image will appear mostly black.

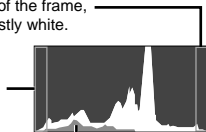

The green section shows luminance distribution within the screen's center.



### Switching the displays























The displays change in the order of Normal → Detailed → No info. → Measurement position information each time  $\Delta$  (INFO) is pressed.

No.	Name	Normal	Detailed	No info.
1	Shooting mode	✓	✓	-
2	Landmark	✓	✓	-
3	Flash	✓	✓	-
4	Self-timer	✓	✓	✓
5	Exposure compensation	✓	✓	-
6	White balance	✓	✓	-
7	ISO sensitivity	✓	✓	-
8	Drive	✓	✓	-
9	Image size (still images)	✓	✓	-
10	Aspect	✓	✓	-
11	Metering	-	✓	-
12	World time	-	✓	-
13	Recording with sound/ wind noise reduction	✓	✓	-
14	Image size (movies)	✓	✓	-
15	Movie recording length	✓	✓	-
16	Movie recording icon	✓	✓	-
17	Image stabilization	-	✓	-

18	GPS icon	✓	✓	-
19	Direction information	✓	✓	-
20	Conversion Lens	✓	✓	-
21	Date stamp	✓	✓	-
22	Compression	✓	✓	-
23	Number of storable still pictures	✓	✓	-
24	Current memory	✓	✓	-
25	Battery check	✓	✓	-
26	Histogram	-	✓	-
27	Atmospheric/ Hydraulic pressure	-	✓	-
28	Altitude/Water depth	-	✓	-
29	Grid Guide	-	✓	-
30	AF target mark	✓	✓	✓
31	Aperture value	✓	✓	✓
32	Shutter speed	✓	✓	✓
33	Camera shake warning	✓	✓	✓

## Selecting the shooting mode

 The default settings of the function are highlighted in .

Shooting mode	Submode
<b>P (P mode)</b>	–
<b>iAUTO (iAUTO mode)</b>	–
 (Super Macro mode)	Filter Effect Off/ <b>1</b> Pop Art/ <b>2</b> Pin Hole/ <b>3</b> Fish Eye/ <b>4</b> Soft Focus/ <b>5</b> Punk/ <b>6</b> Sparkle/ <b>7</b> Watercolor/ <b>8</b> Reflection/ <b>9</b> Miniature/ <b>10</b> Fragmented/ <b>11</b> Dramatic
<b>SCN (SCN mode)</b>	 Portrait/ <b>B</b> Beauty/  Landscape/  Hand-Held Starlight/  Night Scene/  Night+Portrait/  Sport/  Indoor/  Self Portrait/  Sunset/  Fireworks/  Cuisine/  Documents/  Beach & Snow/  Snapshot/  Wide1/  Wide2/  Macro/  Pet Mode - Cat/  Pet Mode - Dog/  Snow/  Panorama/  Backlight HDR
<b>A (A mode)</b>	–
<b>MAGIC (MAGIC mode)</b>	Pop Art/Pin Hole/Fish Eye/Soft Focus/Punk/Sparkle/Watercolor/Reflection/ Miniature/Fragmented/Dramatic
<b>C1, C2 (Custom mode)</b>	–

- “List of settings available in each shooting mode” (p. 73), “List of **SCN** settings” (p. 74), “List of **MAGIC** settings” (p. 77)
- In certain shooting modes, the camera may take a few moments for image processing after taking a picture.

## 1 Use the mode dial to select the shooting mode.

- ! In **SCN** or **MAGIC**, press  $\triangleleft$  of the arrow pad for the function menu, then press  $\triangleleft \triangleright$  of the arrow pad for the sub menu, and press the  $\odot$  button.



### To select a submode



Icon indicating the submode that is set

## Learning about the shooting modes

### *P (P mode)*

The camera will select the appropriate aperture value and shutter speed for the subject. Changes can also be made to various shooting settings, such as exposure compensation, as needed.

### *IAUTO (IAUTO mode)*

The camera will automatically select the optimal shooting mode for the scene. The shooting condition is decided by the camera and settings cannot be changed, excepting some functions.

### *MS (Super Macro mode)*

Images can be taken from up to 1cm away from the subject.

- You can press the  $\odot$  button to fix the focus distance (AF lock). Press the  $\odot$  button again to cancel the AF lock.

## SCN (SCN mode)

You can shoot with the best mode for the subject and shooting scene. The best shooting settings for various scenes are pre-programmed as submodes. Note that functions may be limited in some modes.

Refer to the descriptions displayed on the submode selection screen, and select the desired submode.

### To take photos with the **B**\* (Beauty) setting

- 1 Select [**B**\* Beauty].
- 2 Press  $\nabla$  to go to the submenu.



- 3 Use  $\triangleleft$  to select the retouching setting, and press the  $\odot$  button to set.

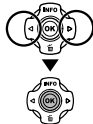

Retouching setting

- 4 Point the camera toward the subject. Check the frame appearing around the face detected by the camera, and then press the shutter button to take the picture.
- 5 To save the image, select [OK] on the review screen and press the  $\odot$  button. To retouch the image additionally, select [Beauty Fix].



### Beauty Fix

- 1 Use  $\triangle$   $\nabla$   $\triangleleft$  to select a retouching item, and press the  $\odot$  button.



- 2 Check the retouched effects on the review screen, then press the  $\odot$  button to start the retouch process and save.
- Settings for Beauty Fix can be registered.
  - Depending on the picture, the editing may not be effective.





## To take underwater photos

The [Snapshot], [Wide1], [Wide2]<sup>1</sup>, [Macro] submode is recommended for shooting underwater.

<sup>1</sup> When set to [Wide2], the focus distance is automatically fixed to approx. 5.0 m (16.4 ft.).



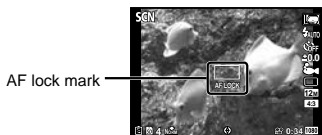

## To lock the focus distance for underwater shoots (AF lock)

In the [Snapshot], [Wide1], or, [Macro] submode, you can press the  button to fix the focus distance (AF lock).

Press the  button again to cancel the AF lock.



## To take panoramic photos ( Panorama)

- 1 Select .
- 2 Press  to go to the submenu.
- 3 Use  to select [Auto], [Manual] or [PC], and press the  button to set.

Submenu	Application
Auto	Panorama images are automatically combined just by swinging the camera in the shooting direction.
Manual	Three frames are taken and combined by the camera. The user composes the shots using the guide frame and manually releases the shutter.
PC	The frames that were taken are combined into a panorama image using the PC software.

- Move the camera as if rotating it around a vertical axis through the center of the lens to take better panorama images.

## Taking pictures with [Auto]

- 1 Press the shutter button to take the first frame.
- 2 Move the camera slightly in the direction of the second frame.



Screen when combining images from left to right

- 3 Move the camera slowly so that the pointer and the target mark overlap. The camera releases the shutter automatically when the pointer and the target overlap.
- To combine only two frames, press the **(C)** button.
  - 4 Repeat step 3 to take a third frame. The camera automatically combines the frames into a single panorama image.
- To cancel the panorama function, press the **MENU** button.
  - If the shutter does not automatically release, try [Manual] or [PC].

## Taking pictures with [Manual]

- 1 Use  $\Delta$   $\nabla$   $\triangleleft$   $\triangleright$  to specify at which edge the next picture is to be connected.

Direction for combining frames

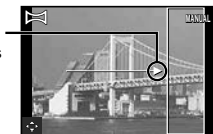

- 2 Press the shutter button to take the first frame.
  - 3 Compose the next shot so that the edge of the first frame displayed faintly on the screen overlaps the subject of the second frame, and press the shutter button.
- To combine only two frames, press the **(C)** button.
  - 4 Repeat step 3 to take a third frame. The camera automatically combines the frames into a single panorama image.

## Taking pictures with [PC]

- 1 Use  $\Delta \nabla \triangleleft \triangleright$  to select the direction that the frames are combined.
- 2 Press the shutter button to take the first frame. The edge of the first frame is displayed faintly on the screen.
- 3 Compose the next shot so that the edge of the first frame displayed faintly on the screen overlaps the subject of the second frame, and press the shutter button.
- 4 Repeat step 3 until the desired number of frames are taken, and then press the  $\odot$  button or **MENU** button when finished.  
Panorama shooting is possible for up to 10 frames.

The shot images are combined into a single panorama image by the PC software.

- For details on installing the PC software, refer to (p. 56). In addition, refer to the PC software help guide for details on how to make panorama images.

## **A** (*A mode*)

When an aperture value is set, the camera automatically sets an appropriate shutter speed. After pressing  $\triangleleft$ , you can change the aperture value using  $\Delta \nabla$ .

## **MAGIC** (*MAGIC mode*)

You can shoot with special effects.

Refer to the sample images displayed on the submode selection screen, and select the desired submode.

The best shooting settings for each effect are pre-programmed, so some function settings cannot be changed.

- Note that some effects may not be applied to movies.

## *C1, C2 (Custom mode)*

In **C1** and **C2** mode, you can call up shooting settings that you have stored in advance.

## Viewing images

### 1 Press the button.

Number of frames/  
Total number of images



Playback image

- Pictures taken using **B<sup>\*</sup>** mode or sequential shooting function are displayed as a group. Press the **T** button to play back the image in the group.

### 2 Use to select an image.



- Hold **>** to fast forward and hold **<** to reverse.
- Press the  button again to return to the shooting screen.

### To play sound recordings

To play sound recorded with an image, select the image and press the  button.

- Press **Δ ▽** to adjust volume.

## Index view and close-up view

Index view enables quick selection of a desired image. Close-up view (up to 10x magnification) allows checking of image details.

### 1 Press the zoom buttons.

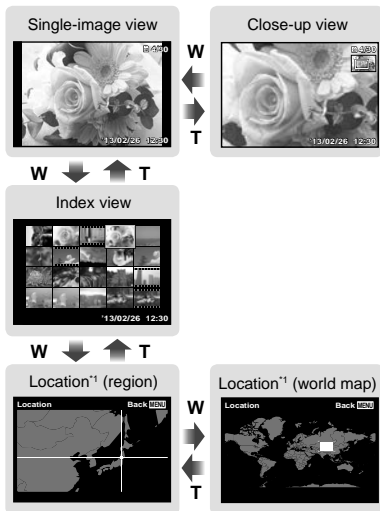
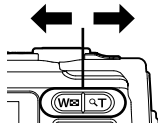

\*\* Location information will be displayed if present.

### To select an image in index view

Use  $\Delta \nabla \langle \rangle$  to select an image, and press the  $\text{OK}$  button to display the selected image in single-image view.

### To scroll an image in close-up view

Use  $\Delta \nabla \langle \rangle$  to move the viewing area.

## *Playing back panorama images*

Panorama images that were combined together using [Auto] or [Manual] can be scrolled for viewing.

### 1 Select a panorama image during playback.



### 2 Press the $\text{OK}$ button.



Viewing area

### To control panorama image playback

**Stop playback:** Press the **MENU** button.

**Pause:** Press the  $\text{OK}$  button.

#### Control while paused

Press  $\Delta \nabla \langle \rangle$  to scroll the image in the direction of the pressed button.

Press the zoom buttons to enlarge/shrink the image.

Press the  $\text{OK}$  button to restart scrolling.

## *Playing back grouped images*

With **B\*** or Sequential, the taken images are displayed as a group during playback.

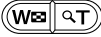
T side  	Expands. • Select the image and press the $\text{OK}$ button to display the images respectively. • Use $\langle \rangle$ to view the previous/next frame.
$\text{OK}$ button	Playback/pauses playback.

## Playback mode display

### • Normal



Still image

### • Detailed

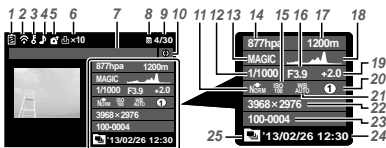

### • No information



## Switching the displays

The displays change in the order of Normal → Detailed → No info. each time **Δ (INFO)** is pressed.

No.	Name	Normal	Detailed	No info.
1	Battery check	-	✓	-
2	Eye-Fi transfer data	✓	✓	-
3	Protect	✓	✓	-
4	Adding sound	✓	✓	-
5	Upload order	✓	✓	-
6	Print reservation/ number of prints	✓	✓	-
7	Landmark	-	✓	-
8	Current memory	✓	✓	-
9	Frame number/ total number of images	✓	✓	-
10	Direction information	-	✓	-
11	Compression	-	✓	-
12	Shutter speed	-	✓	-
13	Shooting mode	-	✓	-
14	Atmospheric/ Hydraulic pressure	-	✓	-
15	ISO sensitivity	-	✓	-
16	Aperture value	-	✓	-
17	Altitude/Water depth	-	✓	-
18	Histogram	-	✓	-
19	Exposure compensation	-	✓	-
20	Shooting submode	-	✓	-
21	White balance	-	✓	-
22	Image size	-	✓	-
23	File name	-	✓	-
24	Recording date and time	✓	✓	-
25	Grouped images	✓	✓	✓

### 1 Display the image you want to erase and press $\nabla$ (🗑️).



### 2 Press $\Delta$ $\nabla$ to select [Erase], and press the $\odot$ button.

- Grouped images are erased as a group. If you want to delete images from the grouped images, you can expand the group and delete the images individually.
- Multiple images or all images can be erased at a time (p. 41).

### 1 Press the $\odot$ button to start recording.

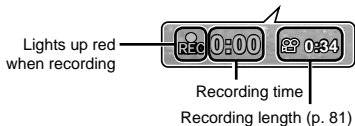
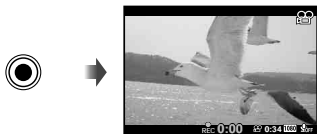

- The movie is shot in the set shooting mode. Note that the shooting mode effects may not be obtained for some shooting modes.
- Sound is also recorded.
- When using a camera with a CMOS image sensor, moving objects may appear distorted due to the rolling shutter phenomenon. This is a physical phenomenon whereby distortion occurs in the filmed image when shooting a fast-moving subject or due to camera shaking. In particular, this phenomenon becomes more noticeable when using a long focal length.

### 2 Press the $\odot$ button again to stop recording.

## Playing back movies

Select a movie, and press the **OK** button.



Movie



During playback

<b>Pausing and restarting playback</b>	Press the <b>OK</b> button to pause playback. During pause, fast forward or reverse, press the <b>OK</b> button to restart playback.
<b>Fast forward</b>	Press <b>▶</b> to fast forward. Press <b>▶</b> again to increase the fast forward speed.
<b>Rewind</b>	Press <b>◀</b> to rewind. Press <b>◀</b> again to increase the rewind speed.
<b>Adjusting the volume</b>	Use <b>▲▼</b> to adjust the volume.

## Operations while playback is paused

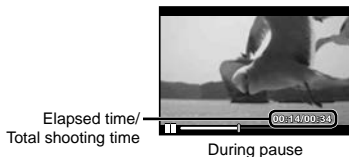

<b>Cueing</b>	Use <b>▲</b> to display the first frame and press <b>▼</b> to display the last frame.
<b>Advancing and rewinding one frame at a time</b>	Press <b>▶</b> or <b>◀</b> to advance or rewind one frame at a time. Hold <b>▶</b> or <b>◀</b> pressed for continuous advance or rewind.
<b>Resuming playback</b>	Press the <b>OK</b> button to resume playback.

## To stop movie playback

Press the **MENU** button.

- To play back movies on the computer, the supplied PC software is recommended. For the first use of the PC software, connect the camera to the computer, then launch the software.



## Menu settings

For details, refer to “List of settings available in each shooting mode” (p. 73).

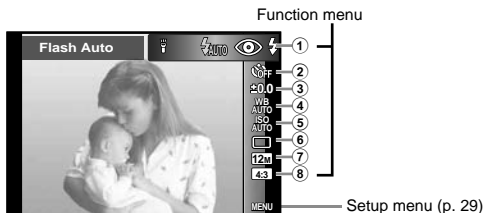

### Function menu











① Flash	⑤ ISO sensitivity
② Self-timer	⑥ Drive
③ Exposure compensation	⑦ Image Size
④ White balance	⑧ Aspect



















## Using the function menu





- 1 Use  $\blacktriangleleft$  of the arrow pad to display the function menu.
- 2 Use  $\blacktriangle$   $\blacktriangledown$  of the arrow pad to select the function to be set.
- 3 Use  $\blacktriangleleft$   $\blacktriangleright$  of the arrow pad to select the setting value, and then press the  $\text{OK}$  button to enter the setting.

Example: Exposure compensation





<b>Flash</b>		<b>Sets the flash firing method.</b>
 Flash Auto		The flash fires automatically in low-light or backlight conditions.
 Redeye		Pre-flashes are emitted to reduce the occurrence of red eye in your photos.
 Fill In		The flash fires regardless of the available light.
 Flash Off		The flash does not fire.
 LED On		The LED turns on when a picture is taken. This is effective for taking close up pictures.
 RC Remote Control		For details, see "Taking pictures with the Olympus Wireless RC Flash System" (p. 82).
 SLV Slave		
<b>Self-timer</b>		<b>Sets the time after the shutter button is pressed until the picture is taken.</b>
 Off		The self-timer is deactivated.
 12 sec		The self-timer lamp turns on for approx. 10 seconds, then blinks for approx. 2 seconds, and then the picture is taken.
 2 sec		The self-timer lamp blinks for approx. 2 seconds, then the picture is taken.
 Auto Release		When your pet (cat or dog) turns its head towards the camera, its face is recognized and the picture is taken automatically.
<b>Exposure compensation</b>		<b>Compensates the brightness (appropriate exposure) adjusted by the camera.</b>
-2.0 to +2.0 Value		Set a larger negative (-) value to adjust darker, or a larger positive (+) value to adjust brighter.

<b>White balance</b>		<b>Sets an appropriate color scheme for the light of the shooting scene.</b>
 WB AUTO	WB Auto	The camera automatically adjusts the white balance.
	Sunny	Suitable for shooting outdoors under a clear sky.
	Cloudy	Suitable for shooting outdoors under a cloudy sky.
	Incandescent	Suitable for shooting under tungsten lighting.
	Fluorescent	Suitable for shooting under white fluorescent lighting.
	Underwater	Suitable for underwater shooting.
	One Touch 1	For manually adjusting the white balance according to the light when shooting. Set a piece of white paper or other white object so that it fills the entire screen, and press the <b>MENU</b> button to set the white balance. For how to register one touch white balance, see “Registering one touch white balance” (p. 28).
	One Touch 2	
<b>ISO sensitivity</b>		<b>Sets the ISO sensitivity.</b>
 ISO AUTO	ISO Auto	The camera automatically sets the sensitivity with priority on image quality.
 ISO HIGH	High ISO Auto	The camera automatically sets the sensitivity with priority on minimizing blur caused by a moving subject or by camera shake.
 ISO 100 to ISO 6400	Value	Set a smaller value to reduce noise in the picture, or a larger value to reduce blur.
<b>Drive</b>		<b>Sets the sequential shooting function.</b>
	Single	One frame is shot each time the shutter button is pressed.
	Sequential	The images are taken sequentially while holding down the shutter for up to 100 frames.
 Hi 12	High-Speed1	The camera takes sequential shots at approximately 15 frames/sec.
 Hi 24	High-Speed2	The camera takes sequential shots at approximately 60 frames/sec.
<b>Image size</b>		<b>Sets the number of recording pixels.</b>
 12M	3968x2976	Suitable for printing pictures over A3 (11x17 in.).
 8M	3200x2400	Suitable for printing pictures up to A3 (11x17 in.).
 3M	1920x1440	Suitable for printing pictures up to A4 size (8.5x11 in.).
 VGA	640x480	Suitable for using pictures on emails.

Aspect		Sets the horizontal-to-vertical ratio of images.
 4:3	Change the horizontal-to-vertical ratio when taking pictures.	
 16:9		
 3:2		
 1:1		

- In certain shooting modes, some functions cannot be set. Refer to "List of settings available in each shooting mode" (p. 73).
- Examples of image size when the aspect ratio is 4:3.

### Registering one touch white balance

Select [ One Touch 1] or [ One Touch 2], face the camera toward a piece of white paper or other white object, and press the **MENU** button.

- The camera releases the shutter and the white balance is registered. When the white balance was previously registered, the registered data is updated.
- The registered white balance data will not be cleared by turning off the power.
- Perform this procedure under the light where the pictures will be actually taken.
- When the camera settings are changed, the white balance must be registered again.
- When the white balance cannot be registered, check that the white paper fills the screen, and then perform the procedure again.

## Setup menu

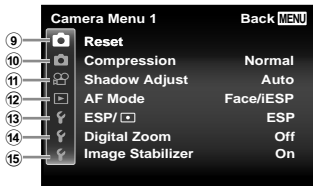

9	Camera Menu 1	p. 31
	<ul style="list-style-type: none"> <li>Reset</li> <li>Compression</li> <li>Shadow Adjust</li> <li>AF Mode</li> <li>ESP/</li> <li>Digital Zoom</li> <li>Image Stabilizer (Still images)</li> </ul>	
10	Camera Menu 2	p. 33
	<ul style="list-style-type: none"> <li>Accessory Settings</li> <li>AF Illuminat.</li> <li>Rec View</li> <li>Pic Orientation</li> <li>Icon Guide</li> <li>Date Stamp</li> <li>Super-Res Zoom</li> </ul>	
11	Movie Menu	p. 37
	<ul style="list-style-type: none"> <li>Image Size</li> <li>IS Movie Mode</li> <li>(Movie sound recording)</li> <li>Wind Noise Setting</li> <li>Recording Volume</li> </ul>	

12	Playback Menu	p. 38
	<ul style="list-style-type: none"> <li>Slideshow</li> <li>Edit</li> <li>Erase</li> <li>Print Order</li> <li>(Protect)</li> <li>Upload Order</li> <li>FlashAir</li> </ul>	
13	Settings Menu 1	p. 43
	<ul style="list-style-type: none"> <li>Memory Format/Format</li> <li>Backup</li> <li>Eye-Fi</li> <li>Custom Mode Setup</li> <li>USB Connection</li> <li>Power On</li> <li>Sound Settings</li> </ul>	
14	Settings Menu 2	p. 45
	<ul style="list-style-type: none"> <li>File Name</li> <li>Pixel Mapping</li> <li>(Monitor)</li> <li>Info Off</li> <li>TV Out</li> <li>Power Save</li> <li>(Language)</li> </ul>	
15	Settings Menu 3	p. 49
	<ul style="list-style-type: none"> <li>(Date/time)</li> <li>World Time</li> <li>Beauty Settings</li> <li>Tough Settings</li> <li>GPS Settings</li> </ul>	

## Using the setup menu

Press the **MENU** button during shooting or playback to display the setup menu.

The setup menu provides access to a variety of camera settings, such as shooting and playback functions, time and date settings, and display options.

### 1 Press the MENU button.

- The setup menu is displayed.

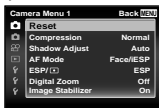

### 2 Press $\triangleleft$ to select the page tabs. Use $\triangle\triangledown$ to select the desired page tab and press $\triangleright$ .

Page tab

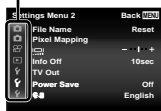

Submenu 1

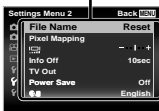

### 3 Use $\triangle\triangledown$ to select the desired submenu 1 and then press the $\text{OK}$ button.

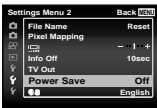

Submenu 2



### 4 Use $\triangle\triangledown$ to select the desired submenu 2 and then press the $\text{OK}$ button.

- Once a setting is selected, the display returns to the Submenu 1.
- There may be additional operations.

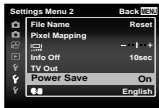

### 5 Press the MENU button to complete the setting.

- The default settings of the function are highlighted in   .
- For the operation method, refer to "Using the setup menu" (p. 30).

## Camera Menu 1

### Restoring the shooting functions to the default settings [Reset]

Submenu 2	Application
Yes	Restores the following menu functions to the default settings. <ul style="list-style-type: none"> <li>• Aperture value</li> <li>• Flash</li> <li>• Self-timer</li> <li>• Exposure compensation</li> <li>• White balance</li> <li>• ISO sensitivity</li> <li>• Drive</li> <li>• Image Size (still images)</li> <li>• Aspect</li> <li>• Filter Effect</li> <li>• Camera Menu 1, Camera Menu 2 and Movie Menu Functions</li> </ul>
No	The settings will not be changed.



### Selecting the image quality for still images [Compression]

Submenu 2	Application
Fine	Shooting at high quality.
Normal	Shooting at normal quality.

- "Number of storable pictures (still images)/ Recording length (movies) in the internal memory and cards" (p. 81)

### Brightening the subject against backlight [Shadow Adjust]

Submenu 2	Application
Auto	Automatically On when a compatible shooting mode is selected.
Off	The effect is not applied.
On	Shoot with automatic adjustment to brighten an area that has become darker.

- When [ESP/, ], [Shadow Adjust] is automatically fixed to [Off].

## Selecting the focusing area

### [AF Mode]



Submenu 2	Application
Face/ESP	The camera focuses automatically. (If a face is detected, it is shown by a white frame <sup>1</sup> ; when the shutter button is pressed halfway and the camera focuses, the frame turns to green <sup>2</sup> . If no face is detected, the camera chooses a subject in the frame and focuses automatically.)
Spot	The camera focuses on the subject located within the AF target mark.
AF Tracking	The camera tracks the subject movement automatically to focus on it continuously.

<sup>1</sup> For some subjects, the frame may not appear or may take some time to appear.

<sup>2</sup> If the frame blinks in red, the camera cannot focus. Try refocusing on the subject.

- [AF Tracking] is enabled in the optical zoom area.

## To focus on a moving subject continuously (AF Tracking)

- ① Hold the camera to align the AF target mark on the subject and press the  button.
  - ② When the camera recognizes the subject, the AF target mark automatically tracks the subject movement to focus on it continuously.
  - ③ To cancel the tracking, press the  button.
- Depending on the subjects or the shooting conditions, the camera may be unable to lock the focus or fail to track the subject movement.
  - When the camera fails to track the subject movement, the AF target mark changes to red.

## Selecting the method for measuring the brightness

### [ESP/

Submenu 2	Application
ESP	Shoots to obtain a balanced brightness over the entire screen (Meters the brightness at the center and surrounding areas of the screen separately).
 (spot)	Shoots the subject at the center during backlighting (Meters the brightness at the center of the screen).

- When set to [ESP], the center may appear dark when shooting against strong backlighting.



## Shooting at higher magnifications than optical zoom

### [Digital Zoom]

Submenu 2	Application
Off	Disable digital zoom.
On	Enable digital zoom.

- The option selected for [Digital Zoom] affects the appearance of the zoom bar. (p. 36)

## Reducing the blur caused by the camera shake when shooting

### [Image Stabilizer]

Submenu 2	Application
Off	The image stabilizer is deactivated. This is recommended for shooting when the camera is fixed in place on a tripod or other stable surface.
On	The image stabilizer is activated.

- There may be a noise coming from inside the camera when the shutter button is pressed with [Image Stabilizer] set to [On].
- Images may not be stabilized if camera shake is too severe.
- When the shutter speed is extremely slow, such as when taking pictures at night, [Image Stabilizer] may not be as effective.

## Camera Menu 2

### Using separately sold accessories

#### [Accessory Settings]

Submenu 2	Submenu 3	Application
Remote Flash	Off	The external flash is not available.
	RC	An Olympus Wireless RC Flash System compatible flash is used for taking pictures. (Channel: CH1, Group: A)
	Slave	The commercially-available slave flash that is synchronized with the camera flash is used for taking pictures. The flash intensity setting can be adjusted.
Conversion Lens	Off	Select when taking pictures without a conversion lens.
	PTWC-01	Select depending on designated optional conversion lenses.
	FCON-T01	
	TCON-T01	

- "Taking pictures with the Olympus Wireless RC Flash System" (p. 82)
- "Use the conversion lens (sold separately)" (p. 83)

## Using the assist lamp for shooting a dark subject [AF Illuminat.]

Submenu 2	Application
Off	The AF illuminator is not used.
On	When the shutter button is pressed halfway down, the AF illuminator turns on to aid focusing.

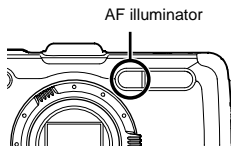

## Viewing the image immediately after shooting [Rec View]

Submenu 2	Application
Off	The image being recorded is not displayed. This allows the user to prepare for the next shot while following the subject in the monitor after shooting.
On	The image being recorded is displayed. This allows the user to make a brief check of the image that was just taken.

## Automatically rotating images shot with the camera in a vertical position during playback

### [Pic Orientation]

- During shooting, the  (p. 41) setting on the playback menu is set automatically.
- This function may not work properly if the camera is facing up or down during shooting.

Submenu 2	Application
Off	Information about the vertical/horizontal orientation of the camera during shooting is not recorded with images. Images shot with the camera in a vertical position are not rotated during playback.
On	Information about the vertical/horizontal orientation of the camera during shooting is recorded with images. Images are automatically rotated during playback.

## Displaying icon guides

### [Icon Guide]

Submenu 2	Application
Off	No icon guide is displayed.
On	The explanation of the selected icon will be displayed when a shooting mode or function menu icon is selected (position the cursor on the icon for a while to display the explanation).

Icon guide



## Imprinting the date of recording

### [Date Stamp]



Submenu 2	Application
Off	Do not imprint the date.
On	Stamp new photographs with the date of recording.

- When the date and time are not set, [Date Stamp] cannot be set. "Turning on the camera and making the initial settings" (p. 7)
- The date stamp can not be deleted.
- When drive settings are set to other than [□], [Date Stamp] cannot be set.

## Shooting larger pictures than when using optical zoom with low degrading of image quality [Super-Res Zoom]

Submenu 2	Application
Off	Disable super-resolution zoom.
On	Enable super-resolution zoom.

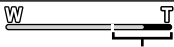
- [Super-Res Zoom] is available only when [Image Size] is set to [12M].

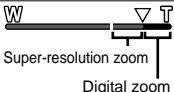
Super-resolution zoom	Digital zoom	Image size	Zoom bar
On	Off	12M	 Super-resolution zoom
Off	On	12M	 Digital zoom
		Other	
On	On	12M	 Super-resolution zoom Digital zoom

\*1 Due to increased processing of the pixel counts, the image quality will not degrade. The magnification ratio changes depending on the image size setting.

- Photographs taken with the zoom bar displayed in red may appear "grainy".

## Selecting the image size for movies [Image Size]

Submenu 2	Application
1080p 720p VGA (640×480) HS 120fps <sup>1</sup> (640×480) HS 240fps <sup>1</sup> (320×240)	Select the image quality based on the image size and frame rate.

<sup>1</sup> HS: Film quickly moving subjects for slow-motion playback.  
Only available in **P** mode.

- “Number of storable pictures (still images)/ Recording length (movies) in the internal memory and cards” (p. 81)

## Reducing the blur caused by the camera shake when shooting [IS Movie Mode]

Submenu 2	Application
Off	The image stabilizer is deactivated. This is recommended for shooting when the camera is fixed in place on a tripod or other stable surface.
On	The image stabilizer is activated.

- Images may not be stabilized if camera shake is too severe.
- In HS movie mode, this setting is fixed to [Off].

## Recording sound when shooting movies [🔊]

Submenu 2	Application
Off	No sound is recorded.
On	Sound is recorded.

- Sound is not recorded when an HS movie mode is selected.

## Reduce wind noise in the recorded sound when recording movie [Wind Noise Setting]

Submenu 2	Application
Off	Disable Wind Noise Reduction.
On	Uses Wind Noise Reduction.

## Adjusting the microphone volume [Recording Volume]

Submenu 2	Application
Normal	Set the microphone level to Normal for general use.
Low	Set the microphone level to Low not to produce clipping sound when the microphone level is high.

## Playing back images automatically

### [Slideshow]

Submenu 2	Submenu 3	Application
BGM	Off/Cosmic/ Breeze/ Mellow/ Dreamy/ Urban	Selects the background music options.
Type	Normal/ Fader/ Zoom	Selects the type of transition effect used between slides.
Start	—	Starts the slideshow.

- During a slideshow, press  $\triangleright$  to advance one frame,  $\triangleleft$  to go back one frame.
- Press the **MENU** button or the  $\odot$  button to stop the slideshow.

## Changing the image size

This saves a high-resolution image as a separate image with a smaller size for use in e-mail attachments and other applications.

Submenu 1	Submenu 2	Submenu 3
Edit		3M VGA

- ① Use  $\triangleleft$  to select an image.
- ② Use  $\triangleup$   $\triangledown$  to select an image size and press the  $\odot$  button.
  - The resized image is saved as a separate image.

## Cropping image

Submenu 1	Submenu 2
Edit	

- ① Use  $\triangleleft$  to select an image, and press the  $\odot$  button.
- ② Use the zoom buttons to select the size of the cropping frame, and use  $\triangleup$   $\triangledown$   $\triangleleft$   $\triangleright$  to move the frame.

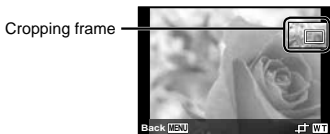

- ③ Press the  $\odot$  button after you have selected the area to trim.
  - The edited image is saved as a separate image.

## Adding sound to still images



Submenu 1	Submenu 2
Edit	

- ① Use  $\triangleleft \triangleright$  to select an image.
- ② Aim the microphone toward the sound source.

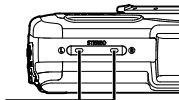

Microphone

- ③ Press the  $\text{OK}$  button.
  - Recording starts.
  - The camera adds (records) sound for approx. 4 seconds while playing back the image.

## Retouching faces on still images



Submenu 1	Submenu 2
Edit	Beauty Fix

- Depending on the picture, the editing may not be effective.
- ① Use  $\triangleleft \triangleright$  to select an image, and press the  $\text{OK}$  button.
  - ② Use  $\triangle \nabla$  to select a retouching item, and press the  $\text{OK}$  button.
  - ③ To save the image, select [OK] on the review screen and press the  $\text{OK}$  button. To retouch the image additionally, select [Beauty Fix].
    - The retouched image is saved as a separate image.



- The [Image Size] of the retouched image is limited to **[3M]** or lower.

## Beauty Fix

- 1 Select a retouching item and retouching level, and press the **OK** button.



- 2 Press the **OK** button on the review screen.

## Brightening areas that are dark due to backlight or other reasons ▶ [Shadow Adj]

Submenu 1	Submenu 2
Edit	Shadow Adj

- 1 Use **<D>** to select an image, and press the **OK** button.
  - The edited image is saved as a separate image.
- Depending on the picture, the editing may not be effective.
- The retouching process may lower the image resolution.

## Retouching red eyes in flash shooting ▶ [Redeye Fix]

Submenu 1	Submenu 2
Edit	Redeye Fix

- 1 Use **<D>** to select an image, and press the **OK** button.
  - The edited image is saved as a separate image.
- Depending on the picture, the editing may not be effective.
- The retouching process may lower the image resolution.

## Changing the landmark information recorded on the images ▶ [Landmark]

You can change the landmark information (such as place names and names of buildings) recorded on the images when they were shot using the GPS function to different landmark information registered near the place where you shot the images.

Submenu 1	Submenu 2
Edit	Landmark

- Refer to "Recording the shooting location and time information on the images shot **Y** [GPS Settings]" (p. 55).
- 1 Select the image using **<D>**, and press the **OK** button.
    - If the target landmark is at a distance from the position recorded on the images, it may not be displayed.
    - A list of the landmarks registered near the position recorded on the images are displayed.



- ② Select the new landmark to be recorded on the image using  $\Delta \nabla$ , and press the  $\text{OK}$  button.
- ③ Select [OK] using  $\Delta \nabla$ , and press the  $\text{OK}$  button.

## Rotating images

Submenu 1	Submenu 2
Edit	

- ① Use  $\triangleleft \triangleright$  to select an image.
  - ② Press the  $\text{OK}$  button to rotate the image.
  - ③ If necessary, repeat Steps ① and ② to make settings for other images, and press the **MENU** button.
- The new picture orientations will be saved even after the power is turned off.

## Erasing images [Erase]

Submenu 2	Application
All Erase	All images in the internal memory or card will be erased.
Sel. Image 	Images are individually selected and erased.
Erase	Deletes the image displayed.
Erase Group	All images in the group are erased.

- When erasing pictures in the internal memory, do not insert the card into the camera.
- Protected images cannot be erased.

### To individually select and erase images [Sel. Image]

- ① Use  $\Delta \nabla$  to select [Sel. Image], and press the  $\text{OK}$  button.
- ② Use  $\Delta \nabla \triangleleft \triangleright$  to select the image to be erased, and press the  $\text{OK}$  button to add a  $\checkmark$  mark to the image.
  - Press the T button to the single frame display.

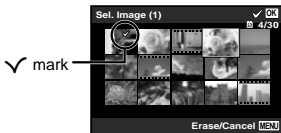

- ③ Repeat Step ② to select the images to be erased, and then press the **MENU** button to erase the selected images.
- ④ Use  $\Delta \nabla$  to select [Yes], and press the  $\odot$  button.
  - The images with a  $\checkmark$  mark are erased.

### To erase all images [All Erase]

- ① Use  $\Delta \nabla$  to select [All Erase], and press the  $\odot$  button.
- ② Use  $\Delta \nabla$  to select [Yes], and press the  $\odot$  button.

### Saving print settings to the image data [Print Order]

- "Print Reservations" (p. 63)
- Print reservation can be set only for still images that are recorded to the card.

### Protecting images [6]

- Protected images cannot be erased by [Erase] (p. 23, 41), [Sel. Image] (p. 41), [Erase Group] (p. 41), or [All Erase] (p. 41), but all images are erased by [Memory Format]/[Format] (p. 43).
- ① Use  $\triangleleft \triangleright$  to select an image.
  - ② Press the  $\odot$  button.
    - Press the  $\odot$  button again to cancel the settings.
  - ③ If necessary, repeat Steps ① and ② to protect other images, and press the **MENU** button.
- If you protect the grouped images, all images in the group will be protected at once.

### Setting images to upload to Internet using OLYMPUS Viewer 3 [Upload Order]

- ① Use  $\triangleleft \triangleright$  to select an image.
  - ② Press the  $\odot$  button.
    - Press the  $\odot$  button again to cancel the settings.
  - ③ If necessary, repeat Steps ① and ② to make settings for other images, and press the **MENU** button.
- Only JPEG files can be ordered.
  - For details on OLYMPUS Viewer 3, refer to "Installing the PC software and registering user" (p. 57).
  - For details on uploading images, refer to OLYMPUS Viewer 3 "Help".

## Connecting to Smartphone

### [FlashAir]

- Using the FlashAir (with Wireless LAN function) card (commercially available), you can connect the camera to a Wi-Fi enabled smartphone or PC and view or import images from the FlashAir card.
- When using a FlashAir card, read the FlashAir card instruction manual carefully, and comply with the instructions.

Submenu 2	Application
Start/Stop	Connect to or disconnect from Wi-Fi.
Starting option	[Manual Start] or [Auto Start] can be selected.

- The camera will not go into sleep mode while connected to Wi-Fi.
- Smartphone application is available.  
<http://olympuspen.com/OIShare/>
- Before use, refer to "FlashAir/Eye-Fi card" (p. 79).

## *Ÿ Settings Menu 1*

### *Erasing data completely*

#### *Ÿ [Memory Format]/ Ÿ [Format]*

- Before formatting, check that no important data is left in the internal memory or card.
- Cards must be formatted with this camera before first use or after being used with other cameras or computers.
- Be sure to remove the card before formatting the internal memory.

Submenu 2	Application
Yes	Completely erases the image data in the internal memory or card (including protected images).
No	Cancels formatting.

### *Copying images in the internal memory to the card Ÿ [Backup]*

Submenu 2	Application
Yes	Backs up image data in the internal memory to the card.
No	Cancels the backup.

## Using an Eye-Fi card ¶ [Eye-Fi]

Submenu 2	Application
All	Transfers all images.
Sel. Image	Transfers only selected image.
Off	Disable Eye-Fi communication.

- When using an Eye-Fi card, read the Eye-Fi card instruction manual carefully, and comply with the instructions.
- This camera does not support the Eye-Fi card's Endless mode.
- Before use, refer to "FlashAir/Eye-Fi card" (p. 79).

## Saving custom settings ¶ [Custom Mode Setup]

The screen to select the Custom Mode 1 or Custom Mode 2 is displayed.

Submenu 2	Application
Set	Save current settings.
Reset	Return to the default setting.

## Selecting a method for connecting the camera to other devices ¶ [USB Connection]

Submenu 2	Application
Auto	Set to select the connection method each time the camera is connected to another device.
Storage	Connect camera as a card reader.
MTP	For Windows Vista/Windows 7/Windows 8, connect camera as a portable device.
Print	Select when connecting to a PictBridge-compatible printer.

- When using the supplied software, select [Storage].
- Refer to "Connecting with a computer" (p. 56) for the connection method with a computer.

## Turning on the camera with the button $\Psi$ [ Power On]

Submenu 2	Application
No	The camera is not turned on. To turn on the camera, press the <b>ON/OFF</b> button.
Yes	Press and hold the  button to turn the camera on in the playback mode.

## Selecting the camera sound and its volume $\Psi$ [Sound Settings]

Submenu 2	Submenu 3	Application
Sound Type	1/2/3	Selects the camera sounds (operation sounds, shutter sound, and warning sound).
Volume	0/1/2/3/4/5	Selects the operation volume of camera buttons.
 Volume	0/1/2/3/4/5	Selects the image playback volume.

## $\Psi$ Settings Menu 2

### Resetting the file names of pictures $\Psi$ [File Name]

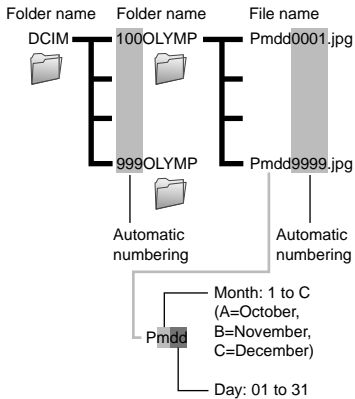

Submenu 2	Application
Reset	This resets the sequential number for the folder name and file name whenever a new card is inserted. <sup>*1</sup> This is useful when grouping images on separate cards.
Auto	Even when a new card is inserted, this continues the numbering for the folder name and file name from the previous card. This is useful for managing all image folder names and files names with sequential numbers.

<sup>\*1</sup> The number for the folder name is reset to 100, and the one for the file name is reset to 0001.

## Adjusting the image processing function *ƒ* [Pixel Mapping]

- This function has already been adjusted at factory shipping, and no adjustment is needed right after purchase. Approximately once a year is recommended.
- For best results, wait at least one minute after taking or viewing pictures before performing pixel mapping. If the camera is turned off during pixel mapping, be sure to perform it again.

### To adjust the image processing function

Press the **OK** button when [Start] (Submenu 2) is displayed.

- The check and adjustment of the image processing function starts.

## Adjusting the brightness of the monitor *ƒ* [!☰]

### To adjust the monitor brightness

- ① Use **Δ** **∇** to adjust the brightness while viewing the screen, and then press the **OK** button.

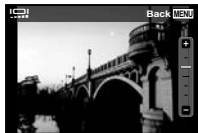

## Displaying indicators *ƒ* [Info Off]

Submenu 2	Application
10sec	Indicators automatically clear from the display if no operations are performed for 10 seconds.
Hold	Indicators are always displayed during shooting.

- Indicators that are always displayed may “burn in” to the monitor. “Monitor” (p. 99)

## Playing back images on a TV ¶ [TV Out]

- ! The TV video signal system varies depending on the countries and regions. Before viewing camera images on your TV, select the video output according to your TV's video signal type.

Submenu 2	Submenu 3	Application
NTSC/PAL	NTSC	Connecting the camera to a TV in North America, Taiwan, Korea, Japan, and so on.
	PAL	Connecting the camera to a TV in European countries, China, and so on.
HDMI Out	480p/576p 720p 1080i	Set the signal format to be given priority. If the TV setting does not match, it is changed automatically.
HDMI Control	Off	Operate with the camera.
	On	Operate with the TV remote control.

- ! The factory default settings differ according to the region where the camera is sold.

### To play back camera images on a TV

- Connection via AV cable
  - ① Use the camera to select the same video signal system as the one of connected TV ([NTSC]/[PAL]).
  - ② Connect the TV and camera.
- Connection via HDMI cable
  - ① On the camera, select the digital signal format that will be connected ([480p/576p]/[720p]/[1080i]).
  - ② Connect the TV and camera.
  - ③ Turn on the TV, and change "INPUT" to "VIDEO (an input jack connected to the camera)".
  - ④ Turn on the camera, and use  $\Delta \nabla \langle \rangle$  to select the image for playback.
- When the camera is connected to the computer by the USB cable, do not connect the HDMI cable to the camera.

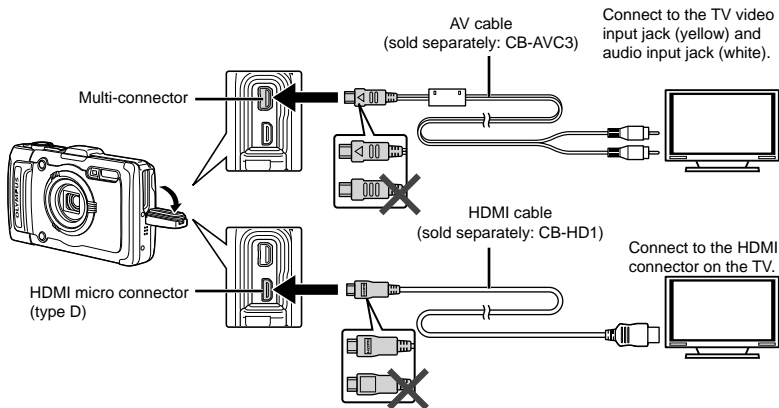

- For details on changing the input source of the TV, refer to the TV's instruction manual.
- When the camera and TV are connected by both an AV cable and an HDMI cable, the HDMI cable will take priority.
- Depending on the TV's settings, the displayed images and information may become cropped.

### To operate images with the TV remote control

- ① Set [HDMI Control] to [On], and turn off the camera.
  - ② Connect the camera and TV with an HDMI cable. "Connection via HDMI cable" (p. 47)
  - ③ First turn on the TV, and then turn on the camera.
    - Operate by following the operation guide that is displayed on the TV.
- With some TVs, operations cannot be performed with the TV remote control even though the operation guide is displayed on the screen.
  - If operations cannot be performed with the TV remote control, set [HDMI Control] to [Off] and operate using the camera.



## Saving battery power between shots [Power Save]

Submenu 2	Application
Off	Cancels [Power Save].
On	When the camera is not being used for approx. 10 seconds, the monitor automatically turns off to save battery power.

### To resume standby mode

Press any button.

## Changing the display language

Submenu 2	Application
Languages	The language for the menus and error messages displayed on the monitor is selected.

## Settings Menu 3

### Setting the date and time

- ① Press  $\Delta \nabla$  of the arrow pad to select the year for [Y].
  - ② Press  $\triangleright$  of the arrow pad to save the setting for [Y].
  - ③ As in Steps ① and ②, press  $\Delta \nabla \triangleleft \triangleright$  of the arrow pad to set [M] (month), [D] (day), [Time] (hours and minutes), and [Y/M/D] (date order), and then press the  $\text{OK}$  button.
- For precise time setting, press the  $\text{OK}$  button as the time signal strikes 00 seconds.

### To check the date and time

Press the **INFO** button while the camera is turned off. The current time is displayed for approx. 30 seconds.

## Choosing home and alternate time zones ¶ [World Time]

- You will not be able to select a time zone using [World Time] if the camera clock has not first been set using [⌚].

Submenu 2	Submenu 3	Application
Home/ Alternate	🏠	The time in the home time zone (the time zone selected for 🏠 in submenu 2).
	➔	The time in the travel destination time zone (the time zone selected for ➔ in submenu 2).
🏠 <sup>*1</sup>	—	Select the home time zone (🏠).
➔ <sup>*1,2</sup>	—	Select the travel destination time zone (➔).

<sup>\*1</sup> In areas where daylight saving time is in effect, use  $\Delta \nabla$  to turn daylight saving time ([Summer]) on.

<sup>\*2</sup> When you select a time zone, the camera automatically calculates the time difference between the selected zone and the home time zone (🏠) to display the time in the travel destination time zone (➔).

## Registering the settings for Beauty Fix ¶ [Beauty Settings]

- Depending on the picture, the editing may not be effective.
- Use  $\Delta \nabla$  to select a retouching setting, and press the  $\odot$  button.
  - Press the shutter button to take a portrait picture.



- The image is not saved.
- Select a retouching item and retouching level, and press the  $\odot$  button.



- Press the  $\odot$  button on the review screen to save the image.
  - Registration is complete.

## Displaying the current altitude/water depth (atmospheric/hydraulic pressure) $\bar{y}$ [Manometer]

- The readings may have a margin of error depending on meteorological conditions. Use the readings only for your reference.

Submenu 1	Submenu 2	Submenu 3	Application
Tough Settings	Manometer	Off	Cancels the manometer display.
		On	Displays the current altitude/water depth (atmospheric/hydraulic pressure) in the shooting standby mode screen. (–20 m to 5,000 m)
		Calibrate	Proceed to the setting screen. See below.

- When set to [On], a cautionary message appears if the water depth reaches 12 m (39.4 ft), followed by a warning if the depth exceeds 15 m (49.2 ft).

### To adjust the altitude/water depth display

- Use  $\Delta \nabla$  to select [Calibrate], and press the  $\odot$  button.
- Use  $\Delta \nabla$  to select the current altitude/water depth, and press the  $\odot$  button to set.

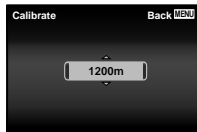

## Setting the units of elevation, depth, etc. $\bar{y}$ [m/ft]

Submenu 1	Submenu 2	Submenu 3	Application
Tough Settings	m/ft	m	This displays in meters.
		ft	This displays in feet.



## Operating during playback mode

When switched to playback mode by tapping the top of the camera body twice, the operations below can be used.

Display next image: Tap the right side of the camera once.

Display previous image: Tap the left side of the camera once.

Fast forward and reverse: Tilt the camera to the right or the left.

Return to the shooting mode: Tap the top side of the camera twice.



When tapping the camera's top

## To adjust the tap control

- 1 Select [Calibrate] in Submenu 3 and press the **OK** button.
- 2 Select the part to adjust with  $\Delta$   $\nabla$  and press the **OK** button.
- 3 Select the [Str] setting with  $\Delta$   $\nabla$  and press  $\blacktriangleright$ .
- 4 Select the [Intvl] setting with  $\Delta$   $\nabla$  and press the **OK** button.



- Check the operation of the camera by tapping on the camera after making the settings.

## Using the LED illuminator as an auxiliary light ♪ [LED Illuminator]

Submenu 1	Submenu 2	Submenu 3	Application
Tough Settings	LED Illuminator	Off	Disables the LED illuminator.
		On	Enables the LED illuminator.

### To use the LED illuminator

Press and hold the **INFO** button down until the LED illuminator lights up.

- If you perform an operation when the LED illuminator is on, it will illuminate up to approx. 90 seconds.

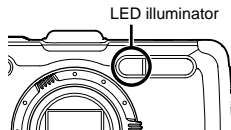

- The LED illuminator turns off if no operation is performed for approx. 30 seconds.
- Even when the camera's power is turned off, if the **INFO** button is pressed until the LED illuminator lights up, it lights for 30 seconds.

### To turn the LED illuminator off

Press and hold the **INFO** button down, until the LED illuminator turns off.

## Recording the shooting location and time information on the images shot *f* [GPS Settings]

The [Track] option records GPS data to create a GPS track log.

Submenu 2	Submenu 3	Application
GPS	Off	When the GPS function is not going to be used.
	On	When the GPS function is going to be used.
Auto Time Adjust	Off	Do not adjust the clock.
	On	Adjust the clock using GPS UTC data.
Track	Off	Turn GPS tracking off.
	On	The camera records the log automatically.
	Save	Create a track log manually.
Country/Region	Off	When the country or region is not to be displayed.
	On	When the country or region is to be displayed.
State/Province	Off	When the state or province is not to be displayed.
	On	When the state or province is to be displayed.
City	Off	When the city is not to be displayed.
	On	When the city is to be displayed.
Landmark	Off	When the landmark is not to be displayed.
	On	When the landmark is to be displayed.

- [Auto Time Adjust] applies only when  (home time zone) is selected for [World Time].
  - Track logs are stored automatically at regular intervals in the GPSLOG folder on the memory card. A new file is created each time you select [Save] if there is unsaved data present. Multiple files will be created if:
    - The date changes during tracking
    - You set [Track]
- Tracking ends automatically when:
- The battery is exhausted
  - The camera is left off for more than 24 hours

You can view the track logs using OLYMPUS Viewer 3. For information on such topics as viewing GPS tracks using software other than OLYMPUS Viewer 3, see the manual for your GPS tracking software.

## Connecting with a computer

Set [USB Connection] in the setup menu of the camera beforehand. (p. 44)

### Connecting the camera

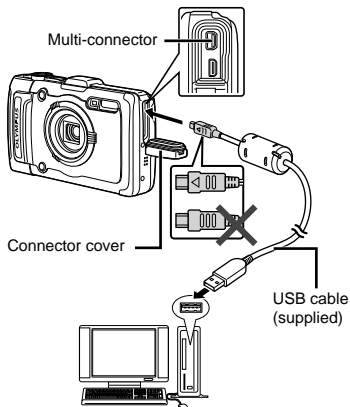

When [USB Connection] is set to [Auto], connect the camera and the computer, select [Storage] or [MTP] at the screen for selecting the connection method, and then press the **OK** button.

### System requirements

Windows : Windows XP Home Edition/  
Professional (SP1 or later)/  
Windows Vista/Windows 7/  
Windows 8

Macintosh : Mac OS X v10.3 or later

- Even if a computer has USB ports, proper operation is not guaranteed in the following cases:
  - Computers with USB ports installed using an expansion card, etc.
  - Computers without a factory-installed OS and home-built computers
- When the computer does not support SDXC cards, a message may appear urging to format the internal memory or card. (Formatting will completely erase all images, so do not format.)



## *Installing the PC software and registering user*

---

### Windows

---

#### 1 Insert the supplied CD in a CD-ROM drive.

##### Windows XP

- A "Setup" dialog will be displayed.

##### Windows Vista/Windows 7/Windows 8

- An Autorun dialog will be displayed. Click "OLYMPUS Setup" to display the "Setup" dialog.



- If the "Setup" dialog is not displayed, select "My Computer" (Windows XP) or "Computer" (Windows Vista/Windows 7) from the start menu. Double-click the CD-ROM (OLYMPUS Setup) icon to open the "OLYMPUS Setup" window and then double-click "Launcher.exe".

- ! If a "User Account Control" dialog is displayed, click "Yes" or "Continue".

---

#### 2 Register your Olympus product.

- Click the "Registration" button and follow the on-screen instructions.
- To register the camera must be connected to the computer. "Connecting the camera" (p. 56)
- If nothing is displayed on the camera screen even after connecting the camera to the computer, the battery may be exhausted. Charge the battery and then connect the camera again.

---

#### 3 Install OLYMPUS Viewer 3.

- Check the system requirements before beginning installation.
- Click the "OLYMPUS Viewer 3" button and follow the on-screen instructions to install the software.

## OLYMPUS Viewer 3

Operating System	Windows XP (Service Pack 2 or later) / Windows Vista / Windows 7 / Windows 8
Processor	Pentium 4 1.3 GHz or better (Core 2 Duo 2.13 GHz or better required for movies)
RAM	1GB or more (2GB or more recommended)
Free Hard Drive Space	3GB or more
Monitor Settings	1024 x 768 pixels or more Minimum 65,536 colors (16,770,000 colors recommended)

- See online help for information on using the software.

## 4 Install the camera manual.

- Click the “Camera Instruction Manual” button and follow the on-screen instructions.

## Macintosh

### 1 Insert the supplied CD in a CD-ROM drive.

- Double-click the CD (OLYMPUS Setup) icon on the desktop.
- Double-click the “Setup” icon to display the “Setup” dialog.



### 2 Install OLYMPUS Viewer 3.

- Check the system requirements before beginning installation.
- Click the “OLYMPUS Viewer 3” button and follow the on-screen instructions to install the software.
- You can register via “Registration” in OLYMPUS Viewer 3 “Help”.

---

**OLYMPUS Viewer 3**

---

Operating System	Mac OS X v10.5–v10.8
Processor	Intel Core Solo/Duo 1.5 GHz or better (Core 2 Duo 2 GHz or better required for movies)
RAM	1GB or more (2GB or more recommended)
Free Hard Drive Space	3GB or more
Monitor Settings	1024 × 768 pixels or more Minimum 32,000 colors (16,770,000 colors recommended)

- Other languages can be selected from the language combo box. For information on using the software, see online help.

---

### 3 Copy the camera manual.

- Click the “Camera Instruction Manual” button to open the folder containing the camera manuals. Copy the manual for your language to the computer.

## Direct printing (PictBridge)

By connecting the camera to a PictBridge-compatible printer, you can print images directly without using a computer.

To find out if your printer supports PictBridge, refer to the printer's instruction manual.

- The printing modes, paper sizes, and other parameters that can be set with the camera vary depending on the printer that is used. For details, refer to the printer's instruction manual.
- For details on the available paper types, loading paper, and installing ink cassettes, refer to the printer's instruction manual.
- In the setup menu, set [USB Connection] to [Print]. [USB Connection] (p. 44)

## Printing images at the printer's standard settings [Easy Print]

### 1 Display the image to be printed on the monitor.

- "Viewing images" (p. 20)

### 2 Turn on the printer, and then connect the printer and camera.

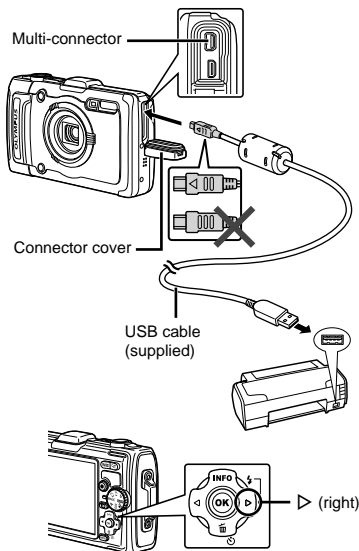

### 3 Press ▶ to start printing.

### 4 To print another image, use ◀▶ to select another image, and press the button.

## To exit printing

After a selected image is displayed on the screen, disconnect the USB cable from the camera and printer.

## Changing the printer's settings for printing [Custom Print]

### 1 Display the image to be printed on the monitor.

- "Viewing images" (p. 20)

### 2 Turn on the printer, and then connect the printer and camera.

### 3 Press the **OK** button.

### 4 Use **Δ**/**∇** to select the print mode, and press the **OK** button.

Submenu 2	Application
Print	This prints the image selected in Step 8.
All Print	This prints all images stored in the internal memory or card.
Multi Print	This prints one image in a multiple layout format.
All Index	This prints an index of all images stored in the internal memory or card.
Print Order <sup>*1</sup>	This prints images based on the print reservation data on the card.

<sup>\*1</sup> [Print Order] is available only when print reservations have been made. "Print Reservations" (p. 63)

### 5 Use **Δ**/**∇** to select [Size] (Submenu 3), and press **▷**.

- If the [Printpaper] screen is not displayed, the [Size], [Borderless], and [Pics/Sheet] are set to the printer's standard.

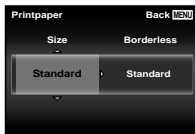

### 6 Use **Δ**/**∇** to select the [Borderless] or [Pics/Sheet] settings, and press the **OK** button.

Submenu 4	Application
Off/ On <sup>*1</sup>	The image is printed with a border around it ([Off]). The image is printed to fill the entire paper ([On]).
(The number of images per sheet varies depending on the printer.)	The number of images per sheet ([Pics/Sheet]) is selectable only when [Multi Print] is selected in Step 4.

<sup>\*1</sup> The available settings for [Borderless] vary depending on the printer.



**!** If [Standard] is selected in Steps 5 and 6, the image is printed at the printer's standard settings.

7 Use **<|>** to select an image.

8 Press **△** to make a print reservation for the current image. Press **▽** to make the detailed printer settings for the current image.

To make the detailed printer settings

- ① Use **△ ▽ <|>** to select the setting, and press the **OK** button.

Submenu 5	Submenu 6	Application
 X	0 to 10	This selects the number of prints.
Date	With/ Without	Selecting [With] prints the images with the date. Selecting [Without] prints the images without the date.
File Name	With/ Without	Selecting [With] prints the file name on the image. Selecting [Without] does not print any file name on the image.
	(Proceeds to the setting screen.)	This selects a portion of the image for printing.

To crop an image []

- ① Use the zoom buttons to select the size of the cropping frame, use **△ ▽ <|>** to move the frame, and then press the **OK** button.

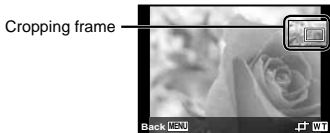

- ② Use **△ ▽** to select [OK], and press the **OK** button.

9 If necessary, repeat Steps 7 and 8 to select the image to be printed, make the detailed settings, and set [Single Print].

10 Press the **OK** button.

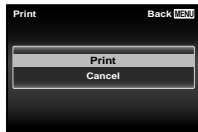

---

## 11 Use $\Delta$ / $\nabla$ to select [Print], and press the $\text{\textcircled{OK}}$ button.

- Printing starts.
- When [Option Set] is selected in [All Print] mode, [Print Info] screen is displayed.
- When printing is finished, the [Print Mode Select] screen is displayed.

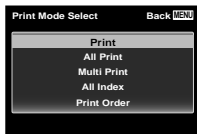

### To cancel printing

- 1 Press the **MENU** button while [Do Not Remove USB Cable] is displayed.
- 2 Select [Cancel] using  $\Delta$ / $\nabla$  and then press the  $\text{\textcircled{OK}}$  button.

---

## 12 Press the MENU button.

---

## 13 When the message [Remove USB Cable] is displayed, disconnect the USB cable from the camera and printer.

---

## Print Reservations

In print reservations, the number of prints and date imprint option are saved in the image on the card. This enables easy printing at a printer or print shop supporting DPOF by using only the print reservations on the card without a computer or a camera.

- Print reservations can be set only for the images stored on the card.
- DPOF reservations set by another DPOF device cannot be changed by this camera. Make changes using the original device. Making new DPOF reservations with this camera will erase the reservations made by the other device.
- DPOF print reservations can be made for up to 999 images per card.

---

## Single-frame print reservations



---

### 1 Display the setup menu.

- "Using the setup menu" (p. 30)

---

### 2 From the playback menu , select [Print Order] and then press the $\text{\textcircled{OK}}$ button.

- 
- 3 Use  $\Delta \nabla$  to select [ $\square$ ], and press the  $\text{OK}$  button.

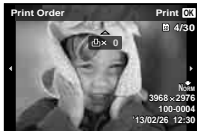

- 
- 4 Use  $\triangleleft \triangleright$  to select the image for print reservation. Use  $\Delta \nabla$  to select the quantity. Press the  $\text{OK}$  button.

- 
- 5 Use  $\Delta \nabla$  to select the [ $\text{Date}$ ] (date print) screen option, and press the  $\text{OK}$  button.

Submenu 2	Application
No	This prints the image only.
Date	This prints the image with the shooting date.
Time	This prints the image with the shooting time.

- 
- 6 Use  $\Delta \nabla$  to select [Set], and press the  $\text{OK}$  button.

*Reserving one print each of all images on the card [ $\square$ ]*

---

- 1 Follow Steps 1 and 2 in [ $\square$ ] (p. 63).
- 2 Use  $\Delta \nabla$  to select [ $\square$ ], and press the  $\text{OK}$  button.
- 3 Follow Steps 5 and 6 in [ $\square$ ].

*Resetting all print reservation data*





---

- 1 Follow Steps 1 and 2 in [ $\square$ ] (p. 63).
- 2 Select either [ $\square$ ] or [ $\square$ ], and press the  $\text{OK}$  button.
- 3 Use  $\Delta \nabla$  to select [Reset], and press the  $\text{OK}$  button.



## *Resetting the print reservation data for selected images*

---

- 1 Follow Steps 1 and 2 in [ ] (p. 63).**
- 2 Use  $\Delta \nabla$  to select [ ], and press the  button.**
- 3 Use  $\Delta \nabla$  to select [Keep] and press the  button.**
- 4 Use  $\triangleleft \triangleright$  to select the image with the print reservation you want to cancel. Use  $\Delta \nabla$  to set the print quantity to “0”.**
- 5 If necessary, repeat Step 4, and then press the  button when finished.**
- 6 Use  $\Delta \nabla$  to select the [ ] (date print) screen option, and press the  button.**
  - The settings are applied to the remaining images with the print reservation data.
- 7 Use  $\Delta \nabla$  to select [Set], and press the  button.**

## Usage Tips

---

If the camera does not work as intended, or if an error message is displayed on the screen, and you are unsure of what to do, refer to the information below to fix the problem(s).

### Troubleshooting

---

#### Battery

**“The camera does not work even when batteries are installed”.**

- Insert recharged batteries in the correct direction.  
“Inserting and removing the battery and card (commercially available)” (p. 4), “Charging the battery” (p. 5)
- Battery performance may have been reduced temporarily due to low temperature. Take the batteries out of the camera, and warm them by putting them in your pocket for a while.

#### Card/Internal memory

**“An error message is displayed”.**

“Error message” (p. 68)



#### Lens

**“The lens has fogged up from the inside”.**

- It is likely that there is a high level of moisture inside the camera. Before using the camera again, remove the battery and memory card and dry fully with the battery/card cover open.

#### Shutter button

**“No picture is taken when the shutter button is pressed”.**

- Cancel sleep mode.  
To save battery power, the camera automatically goes into sleep mode and the monitor turns off if there is no operation for 3 minutes when the camera is turned on. No picture is taken even if the shutter button is fully pressed in this mode. Operate the zoom buttons or other buttons to restore the camera from sleep mode before taking a picture. If the camera is left for another 5 minutes, it automatically turns off. Press the **ON/OFF** button to turn the camera on.
- Press the  button to switch to the shooting mode.
- Wait until  (flash charge) stops blinking before taking pictures.
- With prolonged camera use, the internal temperature may increase, resulting in automatic shutdown. If this occurs, wait until the camera has sufficiently cooled. The camera's external temperature may also increase during use, however this is normal and does not indicate malfunction.

## **Monitor**

### **“Difficult to see”.**

- Condensation may have occurred. Turn off the power, and wait for the camera body to become acclimated to the surrounding temperature and dry out before taking pictures.

### **“The light is caught in the picture”.**

- Shooting with flash in dark situations results in an image with many flash reflections on dust in the air.

## **Date and time function**

### **“Date and time settings return to the default setting”.**

- If the batteries are removed and left out of the camera for about 3 days<sup>1</sup>, the date and time settings return to the default setting, and must be reset.  
<sup>1</sup> The time until the date and time settings return to the default setting varies depending on how long the batteries have been loaded.  
“Turning on the camera and making the initial settings” (p. 7)

## **Miscellaneous**

### **“The camera makes a noise when taking pictures”.**







- The camera may activate the lens and make a noise even if no operation is performed. This is because the camera automatically performs actions of auto focus as far as it is ready to shoot.







### **“The compass heading is not correct or the compass needle flashes”.**

- The compass does not function as expected in the vicinity of strong electromagnetic fields such as those produced by televisions, microwaves, large electric motors, radio transmitters, and high-voltage power lines. Normal function can sometimes be restored by moving the camera through a figure eight while rotating your wrist.

## Error message





- When one of the messages below is displayed on the monitor, check the corrective action.

Error message	Corrective action
 <b>Card Error</b>	<b>Card problem</b> Insert a new card.
 <b>Write Protect</b>	<b>Card problem</b> The card write-protect switch is set to the "LOCK" side. Release the switch.
 <b>Memory Full</b>	<b>Internal memory problem</b> <ul style="list-style-type: none"> <li>Insert a card.</li> <li>Erase unwanted images.<sup>1</sup></li> </ul>
 <b>Card Full</b>	<b>Card problem</b> <ul style="list-style-type: none"> <li>Replace the card.</li> <li>Erase unwanted images.<sup>1</sup></li> </ul>
	<b>Card problem</b> Use $\Delta$ $\nabla$ to select [Format], and press the $\text{OK}$ button. Next, use $\Delta$ $\nabla$ to select [Yes], and press the $\text{OK}$ button. <sup>2</sup>
	<b>Internal memory problem</b> Use $\Delta$ $\nabla$ to select [Memory Format], and press the $\text{OK}$ button. Next, use $\Delta$ $\nabla$ to select [Yes], and press the $\text{OK}$ button. <sup>2</sup>

Error message	Corrective action
 <b>No Picture</b>	<b>Internal memory/Card problem</b> Take pictures before viewing them.
 <b>Picture Error</b>	<b>Problem with selected image</b> Use photo retouch software, etc. to view the image on a computer. If the image still cannot be viewed, the image file is corrupted.
 <b>The Image Cannot Be Edited</b>	<b>Problem with selected image</b> Use photo retouch software, etc. to edit the image on a computer.
 <b>Battery Empty</b>	<b>Battery problem</b> Charge the battery.
 <b>No Connection</b>	<b>Connection problem</b> Connect the camera and computer or printer correctly.
 <b>No Paper</b>	<b>Printer problem</b> Load paper into the printer.
 <b>No Ink</b>	<b>Printer problem</b> Refill the ink in the printer.

<sup>1</sup> Before erasing important images, download them to a computer.

<sup>2</sup> All data will be erased.

Error message	Corrective action
 <b>Jammed</b>	<b>Printer problem</b> Remove the jammed paper.
<b>Settings Changed<sup>3</sup></b>	<b>Printer problem</b> Return to the status where the printer can be used.
 <b>Print Error</b>	<b>Printer problem</b> Turn off the camera and printer, check the printer for any problems, and then turn the power on again.
 <b>Cannot Print<sup>4</sup></b>	<b>Problem with selected image</b> Use a computer to print.
 <b>Caution: Depth</b>	<b>Depth problem</b> The depth exceeds 15m. Please use at depths of 15m or less.

<sup>3</sup> This is displayed, for instance, when the printer's paper tray has been removed. Do not operate the printer while making the print settings on the camera.

<sup>4</sup> This camera may be unable to print images taken by other cameras.

## Shooting tips

When you are unsure of how to take a picture that you envision, refer to the information below.

### Focusing



#### "Focusing on the subject"

- **Taking a picture of a subject not in the center of the monitor**

After focusing on an object at the same distance as the subject, compose the shot, and take the picture.

Pressing the shutter button halfway (p. 11)

- **Set [AF Mode] (p. 32) to [Face/iESP]**
- **Taking a picture in [AF Tracking] mode (p. 32)**

The camera tracks the subject movement automatically to focus on it continuously.

- **Taking a picture of a shadowy subject**

Using the AF illuminator makes focusing easier. [AF Illuminat.] (p. 34)

- **Taking a picture of subjects where autofocus is difficult**

In the following cases, after focusing on an object (by pressing the shutter button halfway down) with high contrast at the same distance as the subject, compose the shot, and take the picture.

Subjects with low contrast

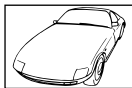

When extremely bright objects appear in the center of the monitor



Object with no vertical lines<sup>\*\*</sup>

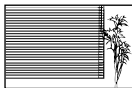

When objects are at different distances



Fast-moving object

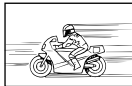

The subject is not in the center of the frame





<sup>\*\*</sup> It is also effective to compose the shot by holding the camera vertically to focus, and then returning to the horizontal position to take the picture.

## Camera shake



### “Taking pictures without camera shake”

- **Taking pictures using [Image Stabilizer] (p. 33)**  
The image pickup device<sup>1)</sup> shifts to correct for camera shake even if the ISO sensitivity is not increased. This function is also effective when taking pictures at a high zoom magnification.  
<sup>1)</sup> A device that takes light received through the lens and converts it into electric signals.
- **Shooting movies using [IS Movie Mode] (p. 37)**
- **Select [ Sport] in the scene mode (p. 14)**  
The [ Sport] mode uses a fast shutter speed and can reduce the blur incurred by a moving subject.
- **Taking pictures at a high ISO sensitivity**  
If a high ISO sensitivity is selected, pictures can be taken at a high shutter speed even at locations where a flash cannot be used.  
“ISO sensitivity” (p. 27)



## Exposure (brightness)



### “Taking pictures with the right brightness”



- **Taking pictures of a subject against a backlight**  
Faces or backgrounds are bright even when shot against backlight.  
[Shadow Adjust] (p. 31)  
[ Backlight HDR] (p. 14)

- **Taking pictures using [Face/IESP] (p. 32)**  
Appropriate exposure is obtained for a face against backlight, and the face is brightened.

- **Taking pictures using [] for [ESP/] (p. 32)**

Brightness is matched with a subject in the center of the screen and the image is not affected by background light.

- **Taking pictures using [Fill In] (p. 26) flash**  
A subject against backlight is brightened.
- **Taking pictures of a white beach or snow scene**

Select [ Beach & Snow], [ Snow] in the scene mode (p. 14).

- **Taking pictures using exposure compensation (p. 26)**

Adjust the brightness while viewing the screen for taking the picture. Normally, taking pictures of white subjects (such as snow) results in images that are darker than the actual subject. Use the exposure compensation to adjust in the positive (+) direction to express whites as they appear. When taking pictures of black subjects, on the other hand, it is effective to adjust in the negative (-) direction.

## Color hue

## WB

“Taking pictures with colors at the same shade as they appear”

- **Taking pictures by selecting white balance (p. 27)**

Best results in most environments can normally be obtained with the [WB Auto] setting, but for some subjects, you should try experimenting with different settings. (This is especially true for sunshade under a clear sky, mixed natural and artificial light settings, and so on.)

## Image quality



“Taking sharper pictures”

- **Taking pictures with the optical zoom or super-resolution zoom**

Avoid using digital zoom (p. 33) to take pictures.

- **Taking pictures at a low ISO sensitivity**

If the picture is taken with a high ISO sensitivity, noise (small colored spots and color unevenness that were not in the original image) can occur, and the image can appear grainy.

“ISO sensitivity” (p. 27)

## Batteries



“Making batteries last longer”

- **Set [Power Save] (p. 49) to [On]**

## Playback/Editing tips

### Playback



“Playing images in the internal memory and card”

- **Remove the card and display the images in internal memory**
  - “Inserting and removing the battery and card (commercially available)” (p. 4)

“Viewing images with high picture quality on a high-definition TV”

- **Connect the camera to the TV using an HDMI cable (sold separately)**
  - “Playing back images on a TV † [TV Out]” (p. 47)

### Editing



“Erasing the sound recorded to a still image”

- **Record over the sound with silence when playing back the image**

“Adding sound to still images  [⏮]” (p. 39)



## List of settings available in each shooting mode

For details on **SCN**, refer to "List of **SCN** settings" (p. 74).

For details on shaded areas, refer to "List of **MAGIC** settings" (p. 77).

	<b>P</b>	<b>IAUTO</b>		<b>A</b>	<b>MAGIC</b>
Zoom	✓	✓	*1	✓	✓
Flash	✓	*1	*1	✓	✓
Self-timer	*1	*1	*1	*1	*1
Exposure Compensation	✓	–	✓	✓	
White balance	✓	–	✓	✓	
ISO sensitivity	✓	–	✓	✓	–
Drive	✓	–	✓	–	–
Image Size	✓	✓	✓	✓	✓
Aspect	✓	✓	✓	✓	✓
Filter Effect	–	–	✓	–	–
Reset	✓	✓	✓	✓	✓
Compression	✓	✓	✓	✓	✓
Shadow Adjust	✓	–	✓	✓	–
AF Mode	✓	–	–	✓	–
ESP/ 	✓	–	✓	✓	✓
Digital Zoom	✓	–	✓	✓	–
Image Stabilizer	✓	✓	✓	✓	✓
Accessory Settings	✓	*1	*1	✓	✓
AF Illuminat.	✓	✓	✓	✓	✓
Rec View	✓	✓	✓	✓	✓
Pic Orientation	✓	✓	✓	✓	✓
Icon Guide	✓	✓	✓	✓	✓
Date Stamp	✓	✓	✓	✓	–
Super-Res Zoom	✓	–	✓	✓	–

\*1 Some functions cannot be set.





## List of **SCN** settings

Zoom	✓	✓	✓	✓	✓	✓	✓	✓	✓	✓	✓
Flash	*1	*1	–	–	–	*1	*1	*1	*1	–	–
Self-timer	*1	*1	*1	*1	*1	*1	*1	*1	*1	*1	*1
Exposure compensation	–	–	–	–	–	–	–	–	–	–	–
White balance	–	–	–	–	–	–	–	–	–	–	–
ISO sensitivity	–	–	–	–	–	–	–	–	–	–	–
Drive	–	–	–	–	–	–	*1	–	–	–	–
Image Size	✓	*1	✓	*1	✓	✓	✓	✓	✓	✓	✓
Aspect	✓	✓	✓	✓	✓	✓	✓	✓	✓	✓	✓
Filter Effect	–	–	–	–	–	–	–	–	–	–	–
Reset	✓	✓	✓	✓	✓	✓	✓	✓	✓	✓	✓
Compression	✓	✓	✓	✓	✓	✓	✓	✓	✓	✓	✓
Shadow Adjust	✓	✓	✓	–	–	–	✓	✓	✓	✓	✓
AF Mode	✓	–	✓	✓	✓	✓	✓	✓	✓	–	✓
ESP/	✓	–	✓	✓	✓	✓	✓	✓	✓	–	✓
Digital Zoom	✓	✓	✓	–	✓	✓	✓	✓	✓	–	✓
Image Stabilizer	✓	✓	✓	✓	✓	✓	✓	✓	✓	✓	✓
Accessory Settings	✓	*1	✓	✓	✓	✓	✓	✓	✓	*1	✓
AF Illuminat.	✓	✓	✓	✓	✓	✓	✓	✓	✓	✓	✓
Rec View	✓	✓	✓	✓	✓	✓	✓	✓	✓	✓	✓
Pic Orientation	✓	✓	✓	✓	✓	✓	✓	✓	✓	✓	✓
Icon Guide	✓	✓	✓	✓	✓	✓	✓	✓	✓	✓	✓
Date Stamp	✓	–	✓	✓	✓	✓	✓	✓	✓	✓	✓
Super-Res Zoom	–	–	–	–	–	–	–	–	–	–	–

\*1 Some functions cannot be set.

Zoom	✓	✓	✓	✓	✓	✓	–	✓	✓	✓	✓	✓	–	✓	✓	–	✓	✓	–	✓	✓	✓	✓	✓
Flash	–	*1	*1	*1	*1	*1	*1	*1	*1	*1	*1	*1	*1	*1	*1	*1	*1	*1	*1	*1	*1	*1	*1	–
Self-timer	*1	*1	*1	*1	*1	*1	*1	*1	*1	*1	*1	*1	*1	*1	*1	*1	*1	*1	*1	*1	*1	*1	*1	✓
Exposure compensation	–	–	–	–	✓	✓	✓	✓	✓	✓	✓	✓	✓	✓	✓	✓	✓	✓	✓	✓	✓	✓	✓	–
White balance	–	–	–	–	*1	*1	*1	*1	*1	*1	*1	*1	*1	*1	*1	*1	*1	*1	*1	*1	*1	*1	*1	–
ISO sensitivity	–	–	–	–	–	–	–	–	–	–	–	–	–	–	–	–	–	–	–	–	–	–	–	–
Drive	–	–	–	–	–	*1	*1	*1	*1	*1	*1	*1	*1	*1	*1	*1	*1	*1	*1	*1	*1	*1	*1	–
Image Size	✓	✓	✓	✓	✓	✓	✓	✓	✓	✓	✓	✓	✓	✓	✓	✓	✓	✓	✓	✓	✓	✓	✓	✓
Aspect	✓	✓	✓	✓	✓	✓	✓	✓	✓	✓	✓	✓	✓	✓	✓	✓	✓	✓	✓	✓	✓	✓	✓	✓
Filter Effect	–	–	–	–	–	–	–	–	–	–	–	–	–	–	–	–	–	–	–	–	–	–	–	–
Reset	✓	✓	✓	✓	✓	✓	✓	✓	✓	✓	✓	✓	✓	✓	✓	✓	✓	✓	✓	✓	✓	✓	✓	✓
Compression	✓	✓	✓	✓	✓	✓	✓	✓	✓	✓	✓	✓	✓	✓	✓	✓	✓	✓	✓	✓	✓	✓	✓	✓
Shadow Adjust	–	✓	✓	✓	✓	✓	✓	✓	✓	✓	✓	✓	✓	✓	✓	✓	✓	✓	✓	✓	✓	✓	✓	✓
AF Mode	–	✓	✓	✓	✓	*1	*1	–	–	–	–	–	–	*1	*1	–	–	–	–	–	–	–	–	–
ESP/	✓	✓	✓	✓	✓	✓	✓	✓	✓	✓	✓	✓	✓	✓	✓	✓	✓	✓	✓	✓	✓	✓	✓	✓
Digital Zoom	✓	✓	✓	✓	✓	✓	✓	✓	✓	✓	✓	✓	✓	✓	✓	✓	✓	✓	✓	✓	✓	✓	✓	✓
Image Stabilizer	✓	✓	✓	✓	✓	✓	✓	✓	✓	✓	✓	✓	✓	✓	✓	✓	✓	✓	✓	✓	✓	✓	✓	✓
Accessory Settings	✓	✓	✓	✓	✓	✓	✓	✓	✓	✓	✓	✓	✓	✓	✓	*1	*1	*1	*1	*1	*1	*1	*1	*1
AF Illuminat.	–	✓	✓	✓	✓	✓	✓	✓	✓	✓	✓	✓	✓	✓	✓	✓	✓	✓	✓	✓	✓	✓	✓	–
Rec View	✓	✓	✓	✓	✓	✓	✓	✓	✓	✓	✓	✓	✓	✓	✓	✓	✓	✓	✓	✓	✓	✓	✓	✓
Pic Orientation	✓	✓	✓	✓	✓	✓	✓	✓	✓	✓	✓	✓	✓	✓	✓	✓	✓	✓	✓	✓	✓	✓	✓	✓
Icon Guide	✓	✓	✓	✓	✓	✓	✓	✓	✓	✓	✓	✓	✓	✓	✓	✓	✓	✓	✓	✓	✓	✓	✓	✓
Date Stamp	✓	✓	✓	✓	✓	✓	✓	✓	✓	✓	✓	✓	✓	✓	✓	✓	✓	✓	✓	✓	✓	✓	✓	✓
Super-Res Zoom	–	–	–	–	–	–	–	–	–	–	–	–	–	–	–	–	–	–	–	–	–	–	–	–

\*1 Some functions cannot be set.

				
Zoom	✓	✓	✓	✓
Flash	-	*1	-	-
Self-timer	✓	-	*1	*1
Exposure compensation	-	-	✓	-
White balance	-	-	✓	-
ISO sensitivity	-	-	-	-
Drive	-	-	-	-
Image Size	✓	✓	*1	*1
Aspect	✓	✓	-	✓
Filter Effect	-	-	-	-
Reset	✓	✓	✓	✓
Compression	✓	✓	✓	✓
Shadow Adjust	✓	✓	-	-
AF Mode	-	✓	*1	✓
ESP/ 	✓	✓	✓	✓
Digital Zoom	✓	✓	-	-
Image Stabilizer	✓	✓	✓	✓
Accessory Settings	*1	✓	✓	✓
AF Illuminat.	-	✓	-	✓
Rec View	✓	✓	✓	✓
Pic Orientation	✓	✓	✓	✓
Icon Guide	✓	✓	✓	✓
Date Stamp	✓	✓	-	✓
Super-Res Zoom	-	-	-	-

\*1 Some functions cannot be set.

## List of **MAGIC** settings

---

	<b>Pop Art</b>	<b>Pin Hole</b>	<b>Fish Eye</b>	<b>Soft Focus</b>	<b>Punk</b>	<b>Sparkle</b>
Exposure compensation	✓	✓	-	✓	✓	✓
White balance	✓	✓	-	✓	-	✓

	<b>Watercolor</b>	<b>Reflection</b>	<b>Miniature</b>	<b>Fragmented</b>	<b>Dramatic</b>
Exposure compensation	✓	✓	✓	✓	✓
White balance	✓	✓	✓	✓	✓

## Appendix

### Camera care

#### Exterior

- Wipe gently with a soft cloth. If the camera is very dirty, soak the cloth in mild soapy water and wring well. Wipe the camera with the damp cloth and then dry it with a dry cloth. If you have used the camera at the beach, use a cloth soaked in clean water and wrung well.
- Foreign materials may be attached to the camera when using the camera in conditions with foreign materials such as dirt, dust or sand. If you continue to use the camera in such conditions, it could cause damage to the camera. To avoid such damage, wash the camera using the following method.

- ① Close and lock the battery/card cover and connector cover firmly. (p. 5)
- ② Fill a bucket or other container with fresh water, immerse the camera facing downward in the bucket and shake the camera thoroughly. And rinse the camera by placing it directly under a strong stream of tap water with pressing the button.

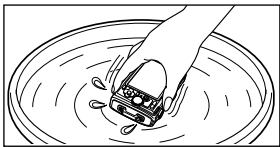

#### Monitor

- Wipe gently with a soft cloth.

#### Lens

- Blow dust off the lens with a commercial blower, then wipe gently with a lens cleaner.
- ⚠ Do not use strong solvents such as benzene or alcohol, or chemically treated cloth.
- ⚠ Mold may form on the lens surface if the lens is left dirty.

#### Battery/USB-AC adapter

- Wipe gently with a soft, dry cloth.

### Storage

- When storing the camera for extended periods, remove the battery, USB-AC adapter and card, and keep in a cool, dry place that is well ventilated.
- Periodically insert the battery and test the camera functions.
- ⚠ Avoid leaving the camera in places where chemical products are handled since this may result in corrosion.

### Using a separately sold USB-AC adapter

The USB-AC adapter F-3AC (sold separately) can be used with this camera. Do not use any USB-AC adapter other than the dedicated one. When using F-3AC, be sure to use the USB cable included with this camera.

Do not use any other USB-AC adapter with this camera.

## Using a separately sold charger

A charger (UC-90: sold separately) can be used to charge the battery.

## Using your charger and USB-AC adapter abroad

- The charger and USB-AC adapter can be used in most home electrical sources within the range of 100 V to 240 V AC (50/60Hz) around the world. However, depending on the country or area you are in, the AC wall outlet may be shaped differently and the charger and USB-AC adapter may require a plug adapter to match the wall outlet. For details, ask at your local electrical shop or travel agent.
- Do not use travel voltage converters as they could damage your charger and USB-AC adapter.

## Using the card

### Cards compatible with this camera

SD/SDHC/SDXC/Eye-Fi/FlashAir (with Wireless LAN function) card (commercially available) (for compatibility card details, visit the Olympus website.)

- This camera can be used without a card by storing images in its internal memory.



## FlashAir/Eye-Fi card

- “FlashAir” SD cards have built-in wireless LAN and cannot be formatted. Use the software supplied with the FlashAir card to format the card.
- Use the FlashAir or Eye-Fi card in compliance with the laws and regulations of the country where the camera is used. Remove the FlashAir or Eye-Fi card from the camera or disable the card functions in airplanes and other locations where use is prohibited.
- The FlashAir/Eye-Fi card may become hot during use.
- When using a FlashAir/Eye-Fi card, the battery may run out faster.
- When using a FlashAir/Eye-Fi card, the camera may function more slowly.

### SD/SDHC/SDXC card write-protect switch

The SD/SDHC/SDXC card body has a write-protect switch.

If you set the switch to the “LOCK” side, you will not be able to write to the card, delete data or format. Return the switch to enable writing.



### Format

Cards must be formatted with this camera before first use or after being used with other cameras or computers.



## Checking the image saving location

The memory indicator shows whether the internal memory or card is being used during shooting and playback.

### Current memory indicator

: Internal memory is being used

: Card is being used

-  Even if [Memory Format]/[Format], [Erase], [Sel. Image], or [All Erase] is performed, the data in the card is not completely erased. When disposing of the card, damage the card to prevent the disclosure of personal data.
-  Switching between a card and internal memory is not available.  
When using the internal memory, remove the card first.

### Readout/recording process of the card

During shooting, the current memory indicator lights up in red while the camera is writing data. Never open the battery/card cover or unplug the USB cable. This can not only damage the image data but also render the internal memory or card unusable.



## Number of storable pictures (still images)/Recording length (movies) in the internal memory and cards

! The figures for the number of storable still pictures and recording length are approximate. The actual capacity varies with shooting conditions and the card used.

### Still pictures<sup>\*1</sup>

Image Size	Compression	Number of storable pictures	
		Internal memory	SD/SDHC/SDXC card (4GB)
<b>12M</b> 3968x2976	FINE	3	600
	NORM	6	1,080
<b>8M</b> 3200x2400	FINE	5	870
	NORM	8	1,500
<b>3M</b> 1920x1440	FINE	16	2,770
	NORM	31	5,300
VGA 640x480	FINE	117	20,340
	NORM	194	30,510

\*1 Examples of image size when the aspect ratio is 4:3.

### Movies

Image Size	Recording length	
	Internal memory	SD/SDHC/SDXC card (4GB)
<b>1080</b> 1920x1080 <sup>*1</sup>	8 sec.	24 min.
<b>720</b> 1280x720 <sup>*1</sup>	12 sec.	36 min.
VGA 640x480	31 sec.	96 min.
<b>HS</b> 1920x1080 640 x 480 <sup>*2</sup>	2 sec.	7 min.
<b>HS</b> 1280x720 320 x 240 <sup>*2</sup>	3 sec.	10 min.

\*1 The recording length is up to 29 minutes in the HD quality specified.

\*2 The recording length is up to 20 sec. in the HS quality specified.

- The maximum file size of a single movie is 4GB, regardless of the capacity of the card.

### Increasing the number of pictures that can be taken

Either erase unwanted images, or connect the camera to a computer or other device to save the images, and then erase the images in the internal memory or card.

[Erase] (p. 23, 41), [Sel. Image] (p. 41), [All Erase] (p. 41), [Erase Group] (p. 41), [Memory Format]/[Format] (p. 43)

## Taking pictures with the Olympus Wireless RC Flash System

You can take pictures with a wireless flash when using a flash compatible with the Olympus Wireless RC Flash System. The camera's built-in flash is used for communication between the camera and flash.

- For details about operation of a wireless flash, refer to the instruction manual for the special external flash.

### 1 Set the wireless flash based on the guidelines below.

#### Wireless flash setup range guidelines

- The setup range varies depending on the ambient environment.

Point the remote sensor toward the camera

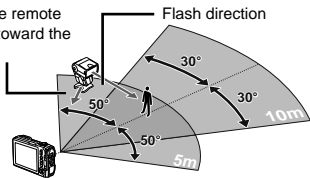

### 2 Turn on the wireless flash.

### 3 Use the MODE button on the wireless flash to set to RC mode, and make the channel and group settings. (Channel: CH1, Group: A)

### 4 Set [Remote Flash] (p. 41) on the camera to [⚡RC].

### 5 Select the flash option in the function menu, and then select the remote control.

- "Using the flash" (p. 12)

### 6 Take a test shot to check the operation of the flash and the resulting image.

- Be sure to check the charge level of the camera and wireless flash before taking pictures.
- Although there is no limit on the number of wireless flash units that are set up, usage of a maximum of three units is recommended to prevent malfunction due to interference with each other.
- When the camera flash is set to [⚡RC], the camera built-in flash is used for communication with the wireless flash. It cannot be used for taking pictures.

## Use the conversion lens (sold separately)

Conversion lens	Converter adapter
Fish Eye converter (FCON-T01)	CLA-T01
Teleconverter (TCON-T01)	

- To use the conversion lens (sold separately), remove the lens ring which has been attached to the camera and then attach the converter adapter (sold separately) to the camera.

### To attach/remove the lens ring

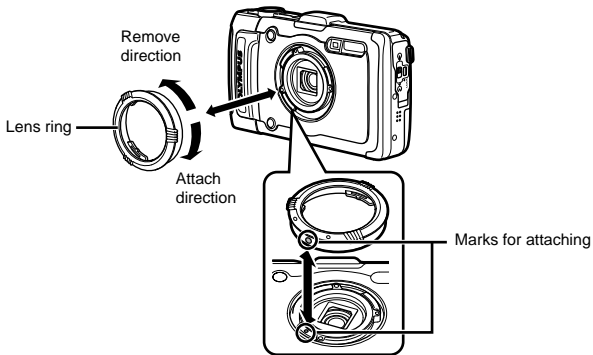

## To attach/remove the conversion lens/filter

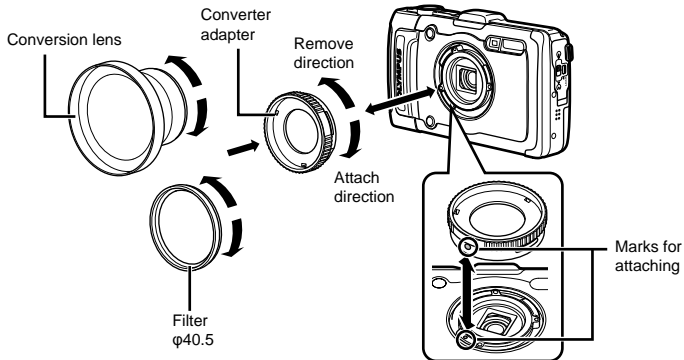

- To attach the lens ring or converter adapter to the camera, align the marks and screw it in the direction of attaching until it clicks into place.
- For details, please visit the Olympus website for your local area.

## Important information about water and shock resistant features

**Water resistance:** The waterproof feature is warranted<sup>\*1</sup> to operate at depths up to 15 m (49.2 feet) for up to one hour.

The waterproof feature may be compromised if the camera is subject to substantial or excessive impact.

**Shock resistance:** The anti-shock feature warrants<sup>\*2</sup> the operation of the camera against accidental impact incurred from everyday use of your digital compact camera. The anti-shock feature does not unconditionally warrant all defective operation or cosmetic damage. Cosmetic damage, such as scratches and dents, are not covered under the warranty.

As with any electronic device, proper care and maintenance are required to preserve the integrity and operation of your camera. To maintain camera performance, please take your camera to the nearest Olympus Authorized Service Center to have it inspected after any major impact. In the event the camera is damaged as a result of negligence or misuse, the warranty will not cover costs associated with the service or repair of your camera. For additional information on our warranty, please visit to the Olympus website for your local area.

Please observe the following care instructions for your camera.

<sup>\*1</sup> As determined by Olympus pressure testing equipment in accordance with IEC Standard Publication 529 IPX8 - This means that the camera can be used normally under water at a specified water pressure.

<sup>\*2</sup> This anti-shock performance is confirmed by Olympus' testing conditions in accordance with MIL-STD-810F, Method 516.5, Procedure IV (Transit Drop Test). For more details of Olympus' testing conditions, please refer to the Olympus website for your local area.

### Before Use:

- Check the camera for foreign material including dirt, dust or sand.
- Firmly close the battery/card cover lock, connector cover lock and LOCK knob.
- Do not open the battery/card cover and connector cover with wet hands, while under water, or in a damp or dusty environment (e.g. beach).

### After Use:

- Be sure to wipe off any excess water or debris after using the camera under water.
- **After the camera is used under seawater, immerse the camera in a bucket containing fresh water for about 10 minutes (with the battery/card cover and connector cover firmly closed, the lock in place and the lens ring removed). After that, let the camera dry in a shaded location with good ventilation.**
- **When opening the battery/card cover or connector cover, open slowly with the camera orientated as shown in the following illustration to prevent water drops entering the camera. If any water drops are found on the inner side of the cover, be sure to wipe them off before using the camera.**

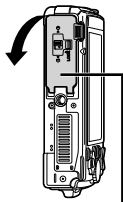

Battery/card cover

## Storage and Maintenance

- Do not leave the camera in an environment at high temperature (40°C (104°F) or more) or at low temperature (-10°C (14°F) or less). Failure to do so may break down water resistance.
  - Do not use chemicals for cleaning, rust prevention, anti-fogging, repairing, etc. Failure to do so may break down water resistance.
  - **Do not leave the camera in water for a long time. Prolonged exposure to water will cause damage to the camera's appearance and/or deteriorate water resistance.**
  - **In order to preserve the water resistant feature, as with any underwater housing, it is recommended that the waterproof packing (and seals) are replaced annually.**
- For the Olympus distributors or service stations where the waterproof packing can be replaced, visit Olympus website for your local area.**

- ⚠ The included accessories (e.g. USB-AC adapter) do not offer shock or water resistance.

## Trademarks

- Microsoft and Windows are registered trademarks of Microsoft Corporation.
- Macintosh is a trademark of Apple Inc.
- SDXC Logo is a trademark of SD-3C, LLC.
- Eye-Fi is a registered trademark of Eye-Fi, Inc.
- FlashAir is a trademark of Toshiba Corporation.
- Powered by ARCSOFT.
- "Shadow Adjustment Technology" function contains patented technologies from Apical Limited.



- All other company and product names are registered trademarks and/or trademarks of their respective owners.

HDMI, the HDMI Logo and High-Definition Multimedia Interface are trademarks or registered trademarks of HDMI Licensing, LLC.

THIS PRODUCT IS LICENSED UNDER THE AVC PATENT PORTFOLIO LICENSE FOR THE PERSONAL AND NONCOMMERCIAL USE OF A CONSUMER TO (i) ENCODE VIDEO IN COMPLIANCE WITH THE AVC STANDARD ("AVC VIDEO") AND/OR (ii) DECODE AVC VIDEO THAT WAS ENCODED BY A CONSUMER ENGAGED IN A PERSONAL AND NON-COMMERCIAL ACTIVITY AND/OR WAS OBTAINED FROM A VIDEO PROVIDER LICENSED TO PROVIDE AVC VIDEO. NO LICENSE IS GRANTED OR SHALL BE IMPLIED FOR ANY OTHER USE. ADDITIONAL INFORMATION MAY BE OBTAINED FROM MPEG LA, L.L.C. SEE [HTTP://WWW.MPEGLA.COM](http://www.MPEGLA.COM)

The software in this camera may include third party software. Any third party software is subject to the terms and conditions, imposed by the owners or licensors of that software, under which software is provided to you.

Those terms and other third party software notices, if any, may be found in the software notice PDF file stored within the accompanying CD-ROM or at <http://www.olympus.co.jp/en/support/msgs/digicamera/download/notice/notice.cfm>

- The standards for camera file systems referred to in this manual are the "Design rule for Camera File system/ DCF" standards stipulated by the Japan Electronics and Information Technology Industries Association (JEITA).

**HDMI**™  
HIGH-DEFINITION MULTIMEDIA INTERFACE

## Concerning GPS

### Place Names for Locations Outside Japan

#### Terms and Conditions

##### Personal Use Only

You agree to use this Data together with this digital camera for the solely personal, non-commercial purposes for which you were licensed, and not for service bureau, time-sharing or other similar purposes. Accordingly, but subject to the restrictions set forth in the following paragraphs, you may copy this Data only as necessary for your personal use to (i) view it, and (ii) save it, provided that you do not remove any copyright notices that appear and do not modify the Data in any way. You agree not to otherwise reproduce, copy, modify, decompile, disassemble or reverse engineer any portion of this Data, and may not transfer or distribute it in any form, for any purpose, except to the extent permitted by mandatory laws. Multi-disc sets may only be transferred or sold as a complete set as provided by OLYMPUS IMAGING CORPORATION and not as a subset thereof.

##### Restrictions

Except where you have been specifically licensed to do so by OLYMPUS IMAGING CORPORATION, and without limiting the preceding paragraph, you may not use this Data (a) with any products, systems, or applications installed or otherwise connected to or in communication with vehicles, capable of vehicle navigation, positioning, dispatch, real time route guidance, fleet management or similar applications; or (b) with or in communication with any positioning devices or any mobile or wireless-connected electronic or computer devices, including without limitation cellular phones, palmtop and handheld computers, pagers, and personal digital assistants or PDAs.

##### Warning

The Data may contain inaccurate or incomplete information due to the passage of time, changing circumstances, sources used and the nature of collecting comprehensive geographic data, any of which may lead to incorrect results.

##### No Warranty

This Data is provided to you "as is," and you agree to use it at your own risk. OLYMPUS IMAGING CORPORATION and its licensors (and their licensors and suppliers) make no guarantees, representations or warranties of any kind, express or implied, arising by law or otherwise, including but not limited to, content, quality, accuracy, completeness, effectiveness, reliability, fitness for a particular purpose, usefulness, use or results to be obtained from this Data, or that the Data or server will be uninterrupted or error-free.

##### Disclaimer of Warranty:

OLYMPUS IMAGING CORPORATION AND ITS LICENSORS (INCLUDING THEIR LICENSORS AND SUPPLIERS) DISCLAIM ANY WARRANTIES, EXPRESS OR IMPLIED, OF QUALITY, PERFORMANCE, MERCHANTABILITY, FITNESS FOR A PARTICULAR PURPOSE OR NON-INFRINGEMENT. Some States, Territories and Countries do not allow certain warranty exclusions, so to that extent the above exclusion may not apply to you.

### **Disclaimer of Liability:**

OLYMPUS IMAGING CORPORATION AND ITS LICENSORS (INCLUDING THEIR LICENSORS AND SUPPLIERS) SHALL NOT BE LIABLE TO YOU: IN RESPECT OF ANY CLAIM, DEMAND OR ACTION, IRRESPECTIVE OF THE NATURE OF THE CAUSE OF THE CLAIM, DEMAND OR ACTION ALLEGING ANY LOSS, INJURY OR DAMAGES, DIRECT OR INDIRECT, WHICH MAY RESULT FROM THE USE OR POSSESSION OF THE INFORMATION; OR FOR ANY LOSS OF PROFIT, REVENUE, CONTRACTS OR SAVINGS, OR ANY OTHER DIRECT, INDIRECT, INCIDENTAL, SPECIAL OR CONSEQUENTIAL DAMAGES ARISING OUT OF YOUR USE OF OR INABILITY TO USE THIS INFORMATION, ANY DEFECT IN THE INFORMATION, OR THE BREACH OF THESE TERMS OR CONDITIONS, WHETHER IN AN ACTION IN CONTRACT OR TORT OR BASED ON A WARRANTY, EVEN IF OLYMPUS IMAGING CORPORATION OR ITS LICENSORS HAVE BEEN ADVISED OF THE POSSIBILITY OF SUCH DAMAGES. Some States, Territories and Countries do not allow certain liability exclusions or damages limitations, so to that extent the above may not apply to you.

### **Export Control**

You agree not to export from anywhere any part of the Data provided to you or any direct product thereof except in compliance with, and with all licenses and approvals required under, applicable export laws, rules and regulations.

### **Entire Agreement**

These terms and conditions constitute the entire agreement between OLYMPUS IMAGING CORPORATION (and its licensors, including their licensors and suppliers) and you pertaining to the subject matter hereof, and supersedes in their entirety any and all written or oral agreements previously existing between us with respect to such subject matter.

### **Governing Law**

The above terms and conditions shall be governed by the laws of the State of Illinois, without giving effect to (i) its conflict of laws provisions, or (ii) the United Nations Convention for Contracts for the International Sale of Goods, which is explicitly excluded. You agree to submit to the jurisdiction of the State of Illinois for any and all disputes, claims and actions arising from or in connection with the Data provided to you hereunder.

### **United States Government End Users**

If the Data is being acquired by or on behalf of the United States government or any other entity seeking or applying rights similar to those customarily claimed by the United States government, the Data is a "commercial item" as that term is defined at 48 C.F.R. ("FAR") 2.101, is licensed in accordance with the End-User Terms under which this Data was provided, and each copy of the Data delivered or otherwise furnished shall be marked and embedded as appropriate with the following "Notice of Use," and shall be treated in accordance with such Notice:

#### **NOTICE OF USE**

CONTRACTOR (MANUFACTURER/ SUPPLIER) NAME:

NAVTEQ

CONTRACTOR (MANUFACTURER/SUPPLIER) ADDRESS:

425 West Randolph Street, Chicago, Illinois 60606

This Data is a commercial item as defined in FAR 2.101 and is subject to the End-User Terms under which this Data was provided.

© 1993-2012 NAVTEQ. All rights reserved.

If the Contracting Officer, federal government agency, or any federal official refuses to use the legend provided herein, the Contracting Officer, federal government agency, or any federal official must notify NAVTEQ prior to seeking additional or alternative rights in the Data.

### **Place Names for Locations in Japan**

- The extraction by any means of all or part of these data (with the exception of landmark data) from image data files in which they are included is forbidden.
- Neither you nor any third party shall, by any means, reproduce, copy, modify, disassemble, decompile, reverse engineer, or in any other way attempt to analyze or determine the nature of the data incorporated in this camera.



## Countries and regions where landmarks can be displayed and recorded

Country or regions	Screen display
Canada	CANADA
United States of America	USA
Barbados	BARBADOS
Jamaica	JAMAICA
Argentine Republic	ARGENTINA
Bolivarian Republic of Venezuela	VENEZUELA
Commonwealth of The Bahamas	BAHAMAS
Dominican Republic	DOMINICAN REPUBLIC
Federative Republic of Brazil	BRAZIL
Republic of Chile	CHILE
Republic of Colombia	COLOMBIA
Republic of Costa Rica	COSTA RICA
Republic of Ecuador	ECUADOR
Republic of El Salvador	EL SALVADOR
Republic of Honduras	HONDURAS
Republic of Panama	PANAMA
Republic of Peru	PERU
The Oriental Republic of Uruguay	URUGUAY
United Mexican States	MEXICO
Ireland	IRELAND
Federal Republic of Germany	GERMANY
French Republic	FRANCE
Grand Duchy of Luxembourg	LUXEMBOURG
Hellenic Republic	GREECE
Kingdom of Belgium	BELGIUM
Kingdom of Denmark	DENMARK
Kingdom of Norway	NORWAY
Kingdom of Spain	SPAIN
Kingdom of Sweden	SWEDEN
Kingdom of the Netherlands	NETHERLANDS
Portuguese Republic	PORTUGAL
Principality of Andorra	ANDORRA
Principality of Liechtenstein	LIECHTENSTEIN
Principality of Monaco	MONACO
Republic of Finland	FINLAND
Republic of Iceland	ICELAND
Republic of Italy	ITALY

Country or regions	Screen display
Republic of Malta	MALTA
Republic of San Marino	SAN MARINO
State of the City of Vatican	VATICAN CITY STATE
Swiss Confederation	SWITZERLAND
England	ENGLAND
Bosnia and Herzegovina	BOSNIA AND HERZEGOVINA
Montenegro	MONTENEGRO
Romania	ROMANIA
Ukraine	UKRAINE
Czech Republic	CZECH REPUBLIC
Former Yugoslav Republic of Macedonia	MACEDONIA
Republic of Albania	ALBANIA
Republic of Austria	AUSTRIA
Republic of Belarus	BELARUS
Republic of Bulgaria	BULGARIA
Republic of Croatia	CROATIA
Republic of Estonia	ESTONIA
Republic of Hungary	HUNGARY
Republic of Kazakhstan	KAZAKHSTAN
Republic of Latvia	LATVIA
Republic of Lithuania	LITHUANIA
Republic of Poland	POLAND
Republic of Serbia	SERBIA
Republic of Slovenia	SLOVENIA
Republic of Uzbekistan	UZBEKISTAN
Russian Federation	RUSSIA
Slovak Republic	SLOVAK REPUBLIC
Arab Republic of Egypt	EGYPT
Kingdom of Bahrain	BAHRAIN
Kingdom of Saudi Arabia	SAUDI ARABIA
Republic of Turkey	TURKEY
State of Kuwait	KUWAIT
State of Qatar	QATAR
Sultanate of Oman	OMAN
United Arab Emirates	UAE
Federal Republic of Nigeria	NIGERIA
Kingdom of Lesotho	LESOTHO
Kingdom of Morocco	MOROCCO
Republic of Angola	ANGOLA

Country or regions	Screen display
Republic of Ghana	GHANA
Republic of Mozambique	MOZAMBIQUE
Republic of Namibia	NAMIBIA
Republic of South Africa	SOUTH AFRICA
Republic of Kenya	KENYA
New Zealand	NEW ZEALAND
Commonwealth of Australia	AUSTRALIA
Hong Kong Special Administrative Region	HONG KONG
Macao Special Administrative Region	MACAU
Taiwan	TAIWAN
Japan	JAPAN
Malaysia	MALAYSIA
Brunei Darussalam	BRUNEI
Kingdom of Thailand	THAILAND
Republic of Indonesia	INDONESIA
Republic of Singapore	SINGAPORE
Republic of the Philippines	PHILIPPINES
Socialist Republic of Viet Nam	VIETNAM
Republic of India	INDIA
Cayman Islands	CAYMAN ISLANDS
Guadeloupe	GADELOUPE-FRANCE
Martinique	MARTINIQUE-FRANCE
Puerto Rico	PUERTO RICO
US Virgin Islands	US VIRGIN ISLANDS
Réunion	REUNION-FRANCE
French Guiana	GUYANE-FRANCE
Gibraltar	GIBRALTAR
Channel Islands	CHANNEL ISLANDS
Isle of Man	ISLE OF MAN
Northern Ireland	NORTHERN IRELAND
Scotland	SCOTLAND
Wales	WALES
Republic of Bolivia	BOLIVIA
Republic of Guatemala	GUATEMALA
Republic of Nicaragua	NICARAGUA
Republic of Paraguay	PARAGUAY
Republic of Trinidad and Tobago	TRINIDAD AND TOBAGO
Republic of Burundi	BURUNDI

Country or regions	Screen display
Belize	BELIZE
Co-operative Republic of Guyana	GUYANA
Republic of Cuba	CUBA
Republic of Suriname	SURINAME
Republic of Cote d'Ivoire	COTE D'IVOIRE
Republic of Rwanda	RWANDA
Republic of Maldives	MALDIVES
Republic of Nepal	NEPAL
Falkland Islands	FALKLAND ISLANDS

### Countries and regions with no landmark information

Country or regions	Screen display
Antigua and Barbuda	ANTIGUA AND BARBUDA
Grenada	GRENADA
Saint Lucia	SAINT LUCIA
St. Vincent and the Grenadines	SAINT VINCENT AND THE GRENADINES
Commonwealth of Dominica	DOMINICA
Federation of Saint Kitts and Nevis	SAINT KITTS AND NEVIS
Republic of Haiti	HAITI
Republic of Cyprus	CYPRUS
Turkmenistan	TURKMENISTAN
Burkina Faso	BURKINA FASO
Central African Republic	CENTRAL AFRICAN REPUBLIC
Democratic Republic of Congo	CONGO, DEMOCRATIC REPUBLIC
Democratic Republic of Sao Tome and Principe	SAO TOME AND PRINCIPE
Federal Islamic Republic of the Comoros	COMOROS
Gabonese Republic	GABON
Republic of Benin	BENIN
Republic of Cameroon	CAMEROON
Republic of Cape Verde	CAPE VERDE
Republic of Chad	CHAD

Country or regions	Screen display
Republic of Congo	CONGO, REPUBLIC OF THE
Republic of Equatorial Guinea	EQUATORIAL GUINEA
Republic of Guinea	GUINEA
Republic of Guinea - Bissau	GUINEA-BISSAU
Republic of Liberia	LIBERIA
Republic of Madagascar	MADAGASCAR
Republic of Mali	MALI
Republic of Mauritius	MAURITIUS
Republic of Niger	NIGER
Republic of Senegal	SENEGAL
Republic of Seychelles	SEYCHELLES
Republic of Sierra Leone	SIERRA LEONE
Republic of Togo	TOGO
Republic of Tunisia	TUNISIA
Solomon Islands	SOLOMON ISLANDS
Tuvalu	TUVALU
Federated States of Micronesia	MICRONESIA
French Polynesia	FRENCH POLYNESIA
Kingdom of Tonga	TONGA
Papua New Guinea	PAPUA NEW GUINEA
Republic of Kiribati	KIRIBATI
Republic of Nauru	NAURU
Republic of Palau	PALAU
Republic of the Fiji Islands	FIJI
Republic of the Marshall Islands	MARSHALL ISLANDS
Republic of Vanuatu	VANUATU
Mongolia	MONGOLIA
Republic of Korea	SOUTH KOREA
Kingdom of Cambodia	CAMBODIA
Lao People's Democratic Republic	LAOS
Union of Myanmar	BURMA (MYANMAR)
Democratic Socialist Republic of Sri Lanka	SRI LANKA
Kingdom of Bhutan	BHUTAN
People's Republic of Bangladesh	BANGLADESH
New Caledonia	NEW CALEDONIA

Country or regions	Screen display
Saint Helena	SAINT HELENA
Mayotte	MAYOTTE
Bermuda	BERMUDA
Turks and Caicos	TURKS AND CAICOS ISLANDS
Saint Pierre and Miquelon	SAINT PIERRE AND MIQUELON
Anguilla	ANGUILLA
Aruba	ARUBA
Netherlands Antilles	NETHERLANDS ANTILLES
Montserrat	MONTSERRAT
Greenland	GREENLAND
Guam	GUAM
Norfolk Island	NORFOLK ISLAND
American Samoa	AMERICAN SAMOA
Cook Islands	COOK ISLANDS
Wallis and Futuna	WALLIS AND FUTUNA
Niue	NIUE
Northern Mariana islands	NORTHERN MARIANA ISLANDS
Tokelau	TOKELAU

### Types of lands marks

Natural landmarks	Natural topography
	Ports and harbors
Government and public offices	Prefectural government offices
	Town halls and city halls
	Town and village offices
	Embassies and consulates
Transportation facilities	Government agencies
	Railway stations
	Airports and airstrips
	Ferry terminal buildings
Sports facilities	Sport facilities (stadiums, sports grounds, gymnasiums)
	Golf courses

Amusement parks	Museums
	Art museums, art galleries
	Zoos
	Botanical gardens
	Aquariums
	Recreation grounds
Places of interest	Leisure parks
	Places of interest, tourist destinations, scenic spots
Institutions, etc.	Theaters
	Towers
	Churches
	Marinas

- In some countries or regions, there may be few landmarks or their names may differ from what they are officially called.
- The landmark information is current as of July 2012, and it cannot be updated.



© 1993-2012 NAVTEQ. All rights reserved.

© Her Majesty, © Queen's Printer for Ontario, © Canada Post, GeoBase®, ©Department of Natural Resources Canada. All rights reserved.

©United States Postal Service® 2012. Prices are not established, controlled or approved by the United States Postal Service®. The following trademarks and registrations are owned by the USPS: United States Postal Service, USPS, and ZIP+4.



© Shobunsha Publications, Inc.  
 "MAPPLE" is a registered trademark of Shobunsha Publications, Inc. in Japan.  
 Landmark data for Japan is provided by Shobunsha Publications, Inc.

Australia	Copyright. Based on data provided under license from PSMA Australia Limited (www.pasma.com.au). Product incorporates data which is © 2012 Telstra Corporation Limited, GM Holden Limited, Intelmatics Australia Pty Ltd, and Continental Pty Ltd.
Austria	© Bundesamt für Eich- und Vermessungswesen
Canada	This data includes information taken with permission from Canadian authorities, including © Her Majesty, © Queen's Printer for Ontario, © Canada Post, GeoBase®, © Department of Natural Resources Canada. All rights reserved.
Croatia, Cyprus, Estonia, Latvia, Lithuania, Poland, Slovenia, Ukraine	© EuroGeographics
Ecuador	INSTITUTO GEOGRAFICO MILITAR DEL ECUADRO AUTORIZACION N° IGM-2011-01- PCO-01 DEL 25 DE ENERO DE 2011
France, French Guiana, Guadeloupe, Martinique, Réunion	source: © IGN 2009 – BD TOPO ®
Germany	Die Grundlagendaten wurden mit Genehmigung der zuständigen Behörden entnommen.
Great Britain	Contains Ordnance Survey data © Crown copyright and database right 2010 Contains Royal Mail data © Royal Mail copyright and database right 2010
Greece	Copyright Geomatics Ltd.
Guatemala	Aprobado por el INSTITUTO GEOGRAFICO NACIONAL – Resolución del IGN No 186-2011
Hungary	Copyright © 2003; Top-Map Ltd.

Italy	La Banca Dati Italiana è stata prodotta usando quale riferimento anche cartografia numerica ed al tratto prodotta e fornita dalla Regione Toscana.
Mexico	Fuente: INEGI (Instituto Nacional de Estadística y Geografía.)
Mozambique	Certain Data for Mozambique provided by Cenacarta © 2012 by Cenacarta
Norway	Copyright © 2000; Norwegian Mapping Authority
Portugal	Source: IgeoE – Portugal
Spain	Información geográfica propiedad del CNIG
Sweden	Based upon electronic data © National Land Survey Sweden.
Switzerland	Topografische Grundlage: © Bundesamt für Landestopographie
United States	©United States Postal Service® 2012. Prices are not established, controlled or approved by the United States Postal Service®. The following trademarks and registrations are owned by the USPS: United States Postal Service, USPS, and ZIP+4.
Nepal	Copyright © Survey Department, Government of Nepal.
Sri Lanka	This product incorporates original source digital data obtained from the Survey Department of Sri Lanka © 2009 Survey Department of Sri Lanka The data has been used with the permission of the Survey Department of Sri Lanka

## SPECIFICATIONS

---

### Camera

**Product type** : Digital camera (for shooting and displaying)

---

### Recording system

**Still pictures** : Digital recording, JPEG (in accordance with Design rule for Camera File system (DCF))

---

**Applicable standards** : Exif 2.3, Digital Print Order Format (DPOF), PRINT Image Matching III, PictBridge

---

**Sound with still pictures** : Wave format

---

**Movie** : MOV H.264 linear PCM/AVI Motion JPEG (HSVGA 120fps or HSQVGA 240fps)

---

**Memory** : Internal memory, SD/SDHC/SDXC/Eye-Fi/FlashAir (with Wireless LAN function) card

---

**No. of effective pixels** : 12,000,000 pixels

---

**Image pickup device** : 1/2.3" CMOS (primary color filter)

---

**Lens** : Olympus lens 4.5 to 18.0 mm, f2.0 to 4.9 (Equivalent to 25 to 100 mm on a 35 mm film)

---

**Photometric system** : Digital ESP metering, spot metering system

---

**Shutter speed** : 4 to 1/2000 sec.

---

### Shooting range

**Normal** : 0.1 m (0.3 ft.) to  $\infty$  (W/T)

---

**Super macro mode** : 0.01 m (0.3 ft.) to 0.1 m (0.3 ft.) (f=5.5 to 18.0 mm (fixed))

---

**Monitor** : 3.0" organic EL display, 614,000 dots

---

**Connector** : Multi-connector (DC-IN jack, USB connector, A/V OUT jack)/HDMI micro connector (type D)

---

**Automatic calendar system** : 2000 up to 2099

---

### Water resistance

**Type** : Equivalent to IEC Standard publication 529 IPX8 (under OLYMPUS test conditions), available in 15 m (49.2 ft.) deep water

---

**Meaning** : Camera can normally be used under water at a specified water pressure.

---

**Dust resistance** : IEC Standard publication 529 IP6X (under OLYMPUS test conditions)

---

<b>GPS</b>	: Reception frequency: 1575.42 MHz (C/A code)
<b>Geodetic system</b>	: WGS84
<b>Operating environment</b>	
<b>Temperature</b>	: -10 °C to 40 °C (14 °F to 104 °F) (operation)/ -20 °C to 60 °C (-4 °F to 140 °F) (storage)
<b>Humidity</b>	: 30 % to 90 % (operation)/10 % to 90 % (storage)
<b>Power supply</b>	: One Olympus lithium ion battery (LI-90B) or separately sold USB-AC adapter
<b>Dimensions</b>	: 111.5 mm (W) × 66.5 mm (H) × 29.1 mm (D) (4.4 × 2.6 × 1.1 in.) (excluding protrusions)
<b>Weight</b>	: 230 g (8.1 oz) (including battery and card)

### Lithium ion battery (LI-90B)



<b>Product type</b>	: Lithium ion rechargeable battery
<b>Model No.</b>	: LI-90B
<b>Standard voltage</b>	: DC 3.6 V
<b>Standard capacity</b>	: 1270 mAh
<b>Battery life</b>	: Approx. 300 full charges (varies on usage)
<b>Operating environment</b>	
<b>Temperature</b>	: 0 °C to 40 °C (32 °F to 104 °F) (charging)





### USB-AC adapter (F-2AC)

<b>Model No.</b>	: F-2AC-1B/F-2AC-2B
<b>Power requirements</b>	: AC 100 to 240 V (50/60 Hz)
<b>Output</b>	: DC 5 V, 500 mA
<b>Operating environment</b>	
<b>Temperature</b>	: 0 °C to 40 °C (32 °F to 104 °F) (operation)/ -20 °C to 60 °C (-4 °F to 140 °F) (storage)

Design and specifications subject to change without notice.

## SAFETY PRECAUTIONS

	<b>CAUTION</b> <b>RISK OF ELECTRIC SHOCK</b> <b>DO NOT OPEN</b>	
CAUTION: TO REDUCE THE RISK OF ELECTRICAL SHOCK, DO NOT REMOVE COVER (OR BACK). NO USER-SERVICEABLE PARTS INSIDE. REFER SERVICING TO QUALIFIED OLYMPUS SERVICE PERSONNEL.		

-  An exclamation mark enclosed in a triangle alerts you to important operating and maintenance instructions in the documentation provided with the product.
-  **DANGER** If the product is used without observing the information given under this symbol, serious injury or death may result.
-  **WARNING** If the product is used without observing the information given under this symbol, injury or death may result.
-  **CAUTION** If the product is used without observing the information given under this symbol, minor personal injury, damage to the equipment, or loss of valuable data may result.

**WARNING!**  
**TO AVOID THE RISK OF FIRE OR ELECTRICAL SHOCK, NEVER DISASSEMBLE, EXPOSE THIS PRODUCT TO WATER OR OPERATE IN A HIGH HUMIDITY ENVIRONMENT.**

### General Precautions

**Read All Instructions** — Before you use the product, read all operating instructions. Save all manuals and documentation for future reference.

**Cleaning** — Always unplug this product from the wall outlet before cleaning. Use only a damp cloth for cleaning. Never use any type of liquid or aerosol cleaner, or any type of organic solvent to clean this product.

**Attachments** — For your safety, and to avoid damaging the product, use only accessories recommended by Olympus.

**Water and Moisture** — For precautions on products with weatherproof designs, read the weatherproofing sections.

**Location** — To avoid damage to the product, mount the product securely on a stable tripod, stand, or bracket.

**Power Source** — Connect this product only to the power source described on the product label.

**Lightning** — If a lightning storm occurs while using a USB-AC adapter, remove it from the wall outlet immediately.

**Foreign Objects** — To avoid personal injury, never insert a metal object into the product.

**Heat** — Never use or store this product near any heat source such as a radiator, heat register, stove, or any type of equipment or appliance that generates heat, including stereo amplifiers.

### Handling the Camera

#### **WARNING**

- Do not use the camera near flammable or explosive gases.
- Do not use the flash and LED (including AF illuminator) on people (infants, small children, etc.) at close range.
- You must be at least 1 m (3 ft.) away from the faces of your subjects. Firing the flash too close to the subject's eyes could cause a momentary loss of vision.



• **Keep young children, infants, and animals such as pets away from the camera.**

- Always use and store the camera out of the reach of young children and infants to prevent the following dangerous situations which could cause serious injury:
  - Becoming entangled in the camera strap, causing strangulation.
  - Accidentally swallowing the battery, cards or other small parts.
  - Accidentally firing the flash into their own eyes or those of another child.
  - Accidentally being injured by the moving parts of the camera.

• **Do not look at the sun or strong lights with the camera.**

• **Do not use or store the camera in dusty or humid places.**

• **Do not cover the flash with a hand while firing.**

• **Use SD/SDHC/SDXC memory cards, Eye-Fi cards or FlashAir cards only. Never use other types of cards.**

If you accidentally insert another type of card into the camera, contact an authorized distributor or service center. Do not try to remove the card by force.

• **If you find that the USB-AC adapter is extremely hot or notice any unusual odors, noise, or smoke around it, unplug the power plug from wall outlet immediately and stop using it. Then, contact an authorized distributor or service center.**



**CAUTION**

• **Stop using the camera immediately if you notice any unusual odors, noise, or smoke around it.**

- Never remove the batteries with bare hands, which may cause a fire or burn your hands.
- **Do not leave the camera in places where it may be subject to extremely high temperatures.**
  - Doing so may cause parts to deteriorate and, in some circumstances, cause the camera to catch fire. Do not use the charger or USB-AC adapter if it is covered (such as a blanket). This could cause overheating, resulting in fire.

• **Handle the camera with care to avoid getting a low-temperature burn.**

- When the camera contains metal parts, overheating can result in a low-temperature burn. Pay attention to the following:
  - When used for a long period, the camera will get hot. If you hold on to the camera in this state, a low-temperature burn may be caused.
  - In places subject to extremely cold temperatures, the temperature of the camera's body may be lower than the environmental temperature. If possible, wear gloves when handling the camera in cold temperatures.

• **Be careful with the strap.**

- Be careful with the strap when you carry the camera. It could easily catch on stray objects and cause serious damage.

• **Do not touch the metallic parts of the camera for a long period of time at low temperatures.**

- This may damage your skin. At low temperatures, handle the camera while wearing gloves.
- To protect the high-precision technology contained in this product, never leave the camera in the places listed below, no matter if in use or storage:
  - Places where temperatures and/or humidity are high or go through extreme changes. Direct sunlight, beaches, locked cars, or near other heat sources (stove, radiator, etc.) or humidifiers.
  - In sandy or dusty environments.
  - Near flammable items or explosives.
  - In wet places, such as bathrooms or in the rain. When using products with weatherproof designs, read their manuals as well.
  - In places prone to strong vibrations.
- Never drop the camera or subject it to severe shocks or vibrations.
- When attaching the camera to or removing it from a tripod, rotate the tripod screw, not the camera.
- Before transporting the camera, remove a tripod and all other non-OLYMPUS accessories.
- Do not touch electric contacts on cameras.
- Do not leave the camera pointed directly at the sun. This may cause lens or shutter curtain damage, color failure, ghosting on the image pickup device, or may possibly cause fires.
- Do not push or pull severely on the lens.

- Before storing the camera for a long period, remove the batteries. Select a cool, dry location for storage to prevent condensation or mold from forming inside the camera. After storage, test the camera by turning it on and pressing the shutter button to make sure that it is operating normally.
- The camera may malfunction if it is used in a location where it is subject to a magnetic/electromagnetic field, radio waves, or high voltage, such as near a TV set, microwave, video game, loud speakers, large monitor unit, TV/radio tower, or transmission towers. In such cases, turn the camera off and on again before further operation.
- Always observe the operating environment restrictions described in the camera's manual.

## Battery Handling Precautions

**Follow these important guidelines to prevent batteries from leaking, overheating, burning, exploding, or causing electrical shocks or burns.**

### DANGER

- The camera uses a lithium ion battery specified by Olympus. Charge the battery with the specified USB-AC adapter or charger. Do not use any other USB-AC adapters or chargers.
- Never incinerate or heat batteries in microwaves, on hot plates, or in pressure vessels, etc.
- Never leave the camera on or near electromagnetic devices. This may cause overheating, burning, or exploding.
- Do not connect terminals with any metallic objects.
- Take precautions when carrying or storing batteries to prevent them from coming into contact with any metal objects such as jewelry, pins, fasteners, keys, etc.  
The short circuit may cause overheating, exploding, or burning, which burn or damage you.
- Never store batteries where they will be exposed to direct sunlight, or subjected to high temperatures in a hot vehicle, near a heat source, etc.
- To prevent causing battery leaks or damaging their terminals, carefully follow all instructions regarding the use of batteries. Never attempt to disassemble a battery or modify it in any way, solder, etc.

- If battery fluid gets into your eyes, flush your eyes immediately with clear, cold running water and seek medical attention immediately.
- Always store batteries out of the reach of small children. If a child accidentally swallows a battery, seek medical attention immediately.
- If you cannot remove the battery from the camera, contact an authorized distributor or service center. Do not try to remove the battery by force.  
Damage to the battery exterior (scratches, etc.) may produce heat or an explosion.

### WARNING

- Do not wet batteries with fluid such as water or seawater.
- To prevent batteries from leaking, overheating, or causing a fire or explosion, use only batteries recommended for use with this product.
- Insert the battery carefully as described in the operating instructions.
- If rechargeable batteries have not been recharged within the specified time, stop charging them and do not use them.
- Do not use a battery if it is cracked or broken.
- If a battery leaks, has unusual odor, becomes discolored or deformed, or becomes abnormal in any other way during operation, stop using the camera, and keep away from fire immediately.
- If a battery leaks fluid onto your clothing or skin, remove the clothing and flush the affected area with clean, running cold water immediately. If the fluid burns your skin, seek medical attention immediately.
- Never subject batteries to strong shocks or continuous vibration by dropping or hitting.  
This may cause exploding, overheating, or burning.

### CAUTION

- Before loading, always inspect the battery carefully for leaks, discoloration, warping, or any other abnormality.
- The battery may become hot during prolonged use. To avoid minor burns, do not remove it immediately after using the camera.

- Always unload the battery from the camera before storing the camera for a long period.  
Leaking and overheating may cause fire, injury, or malfunction.
- When storing the battery for a long period, select a cool location for storage.
- This camera uses one Olympus lithium ion battery. Use the designated battery. There is a risk of explosion if the battery is replaced with the incorrect battery type.
- Power consumption by the camera varies depending on which functions are used.
- During the conditions described below, power is consumed continuously and the battery becomes exhausted quickly.
  - The zoom is used repeatedly.
  - The shutter button is pressed halfway repeatedly in shooting mode, activating the auto focus.
- A picture is displayed on the monitor for an extended period of time.
  - The camera is connected to a printer.
- Using an exhausted battery may cause the camera to turn off without displaying the battery level warning.
- The Olympus lithium ion battery is designed to be used only for the Olympus digital camera.  
Do not use the battery to other devices.
- If the battery's terminals get wet or greasy, camera contact failure may result. Wipe the battery well with a dry cloth before use.
- Always charge a battery when using it for the first time, or if it has not been used for a long period.
- When operating the camera with battery power at low temperatures, try to keep the camera and spare battery as warm as possible. A battery that has run down at low temperatures may be restored after it is warmed at room temperature.
- Before going on a long trip, and especially before traveling abroad, purchase extra batteries. A recommended battery may be difficult to obtain while traveling.
- Please recycle batteries to help save our planet's resources. When you throw away dead batteries, be sure to cover their terminals and always observe local laws and regulations.

## USB-AC adapter

- The included USB-AC adapter F-2AC is designed to be used only with this camera. Other cameras cannot be charged with this USB-AC adapter.
- Do not connect the included USB-AC adapter F-2AC to equipment other than this camera.
- For plug-in type USB-AC adapter:  
The included USB-AC adapter F-2AC is intended to be correctly orientated in a vertical or floor mount position.

## Use Only Dedicated Rechargeable Battery, Battery Charger and USB-AC adapter

We strongly recommend that you use only the genuine Olympus dedicated rechargeable battery, battery charger and USB-AC adapter with this camera. Using a non-genuine rechargeable battery, battery charger and/or USB-AC adapter may result in fire or personal injury due to leakage, heating, ignition or damage to the battery. Olympus does not assume any liability for accidents or damage that may result from the use of a battery, battery charger and/or USB-AC adapter that are not genuine Olympus accessories.

## Monitor

- Do not push the monitor forcibly; otherwise the image may become vague, resulting in a playback mode failure or damage to the monitor.
- A strip of light may appear on the top/bottom of the monitor, but this is not a malfunction.
- When a subject is viewed diagonally in the camera, the edges may appear zigzagged on the monitor. This is not a malfunction; it will be less noticeable in playback mode.
- Static images displayed on organic EL monitors for extended periods of time may "burn in", causing a drop in brightness or discoloration in some areas of the display, which may be permanent in some cases. This phenomenon has no effect on images recorded with the camera.

- The monitor of this product is manufactured with high-quality accuracy, however, there may be a stuck or dead pixel on the monitor. These pixels do not have any influence on the image to be saved. Because of the characteristics, the unevenness of the color or brightness may also be found depending on the angle, but this is due to the structure of the monitor. This is not a malfunction.

## Legal and Other Notices

- Olympus makes no representations or warranties regarding any damages, or benefit expected by using this unit lawfully, or any request from a third person, which are caused by the inappropriate use of this product.
- Olympus makes no representations or warranties regarding any damages or any benefit expected by using this unit lawfully which are caused by erasing picture data.

## Disclaimer of Warranty

- Olympus makes no representations or warranties, either expressed or implied, by or concerning any content of these written materials or software, and in no event shall be liable for any implied warranty of merchantability or fitness for any particular purpose or for any consequential, incidental or indirect damages (including but not limited to damages for loss of business profits, business interruption and loss of business information) arising from the use or inability to use these written materials or software or equipment. Some countries do not allow the exclusion or limitation of liability for consequential or incidental damages or of the implied warranty, so the above limitations may not apply to you.
- Olympus reserves all rights to this manual.

## Warning

Unauthorized photographing or use of copyrighted material may violate applicable copyright laws. Olympus assumes no responsibility for unauthorized photographing, use or other acts that infringe upon the rights of copyright owners.

## Copyright Notice

All rights reserved. No part of these written materials or this software may be reproduced or used in any form or by any means, electronic or mechanical, including photocopying and recording or the use of any type of information storage and retrieval system, without the prior written permission of Olympus. No liability is assumed with respect to the use of the information contained in these written materials or software, or for damages resulting from the use of the information contained therein. Olympus reserves the right to alter the features and contents of this publication or software without obligation or advance notice.

## FCC Notice

- Radio and Television Interference
- Changes or modifications not expressly approved by the manufacturer may void the user's authority to operate this equipment. This equipment has been tested and found to comply with the limits for a Class B digital device, pursuant to Part 15 of the FCC Rules. These limits are designed to provide reasonable protection against harmful interference in a residential installation.
- This equipment generates, uses, and can radiate radio frequency energy and, if not installed and used in accordance with the instructions, may cause harmful interference to radio communications.
- However, there is no guarantee that interference will not occur in a particular installation. If this equipment does cause harmful interference to radio or television reception, which can be determined by turning the equipment off and on, the user is encouraged to try to correct the interference by one or more of the following measures:
  - Adjust or relocate the receiving antenna.
  - Increase the distance between the camera and receiver.
  - Connect the equipment to an outlet on a circuit different from that to which the receiver is connected.
  - Consult your dealer or an experienced radio/TV technician for help. Only the OLYMPUS-supplied USB cable should be used to connect the camera to USB enabled personal computers (PC).

Any unauthorized changes or modifications to this equipment would void the user's authority to operate it.

## For customers in North and South America

### For customers in USA

Declaration of Conformity  
Model Number: TG-2  
Trade Name: OLYMPUS  
Responsible Party:

#### OLYMPUS IMAGING AMERICA INC.

Address: 3500 Corporate Parkway, P.O. Box 610,  
Center Valley, PA 18034-0610, U.S.A.  
Telephone Number: 484-896-5000

Tested To Comply With FCC Standards  
FOR HOME OR OFFICE USE

This device complies with Part 15 of the FCC rules. Operation is subject to the following two conditions:

- (1) This device may not cause harmful interference.
- (2) This device must accept any interference received, including interference that may cause undesired operation.

### For customers in CANADA

This Class B digital apparatus complies with Canadian ICES-003.

## OLYMPUS WORLDWIDE LIMITED WARRANTY - IMAGING PRODUCTS

Olympus warrants that the enclosed Olympus® imaging product(s) and related Olympus® accessories (individually a "Product" and collectively the "Products") will be free from defects in materials and workmanship under normal use and service for a period of one (1) year from the date of purchase. If any Product proves to be defective within the one-year warranty period, the customer must return the defective Product to any of Olympus Service Centers, following the procedure set forth below (See "WHAT TO DO WHEN SERVICE IS NEEDED").

Olympus, at its sole discretion, will repair, replace, or adjust the defective Product, provided that Olympus investigation and factory inspection disclose that (a) such defect developed under normal and proper use and (b) the Product is covered under this limited warranty.

Repair, replacement, or adjustment of defective Products shall be Olympus's sole obligation and the customer's sole remedy hereunder.

The customer is liable and shall pay for shipment of the Products to the Olympus Service Center.

Olympus shall not be obligated to perform preventive maintenance, installation, deinstallation, or maintenance. Olympus reserves the right to (i) use reconditioned, refurbished, and/or serviceable used parts (that meet Olympus's quality assurance standards) for warranty or any other repairs and (ii) make any internal or external design and/or feature changes on or to its products without any liability to incorporate such changes on or to the Products.

## WHAT IS NOT COVERED BY THIS LIMITED WARRANTY

Excluded from this limited warranty and not warranted by Olympus in any fashion, either express, implied, or by statute, are:

- (a) products and accessories not manufactured by Olympus and/or not bearing the "OLYMPUS" brand label (the warranty coverage for products and accessories of other manufacturers, which may be distributed by Olympus, is the responsibility of the manufacturers of such products and accessories in accordance with the terms and duration of such manufacturers' warranties);
- (b) any Product which has been disassembled, repaired, tampered with, altered, changed, or modified by persons other than Olympus's own authorized service personnel unless repair by others is made with the written consent of Olympus;
- (c) defects or damage to the Products resulting from wear, tear, misuse, abuse, negligence, sand, liquids, impact, improper storage, nonperformance of scheduled operator and maintenance items, battery leakage, use of non-"OLYMPUS" brand accessories, consumables, or supplies, or use of the Products in combination with non-compatible devices;
- (d) software programs;
- (e) supplies and consumables (including but not limited to lamps, ink, paper, film, prints, negatives, cables and batteries); and/or
- (f) Products which do not contain a validly placed and recorded Olympus serial number, unless they are a model on which Olympus does not place and record serial numbers.

EXCEPT FOR THE LIMITED WARRANTY SET FORTH ABOVE, OLYMPUS MAKES NO AND DISCLAIMS ALL OTHER REPRESENTATIONS, GUARANTIES, CONDITIONS, AND WARRANTIES CONCERNING THE PRODUCTS, WHETHER DIRECT OR INDIRECT, EXPRESS OR IMPLIED, OR ARISING UNDER ANY STATUTE, ORDINANCE, COMMERCIAL USAGE OR OTHERWISE, INCLUDING BUT NOT LIMITED TO ANY WARRANTY OR REPRESENTATION AS TO THE SUITABILITY, DURABILITY, DESIGN, OPERATION, OR CONDITION OF THE PRODUCTS (OR ANY PART THEREOF) OR THE MERCHANTABILITY OF THE PRODUCTS OR THEIR FITNESS FOR A PARTICULAR PURPOSE, OR RELATING TO THE INFRINGEMENT OF ANY PATENT, COPYRIGHT, OR OTHER PROPRIETARY RIGHT USED OR INCLUDED THEREIN.

IF ANY IMPLIED WARRANTIES APPLY AS A MATTER OF LAW, THEY ARE LIMITED IN DURATION TO THE LENGTH OF THIS LIMITED WARRANTY.

SOME STATES MAY NOT RECOGNIZE A DISCLAIMER OR LIMITATION OF WARRANTIES AND/OR LIMITATION OF LIABILITY SO THE ABOVE DISCLAIMERS AND EXCLUSIONS MAY NOT APPLY.

THE CUSTOMER MAY ALSO HAVE DIFFERENT AND/OR ADDITIONAL RIGHTS AND REMEDIES THAT VARY FROM STATE TO STATE.

THE CUSTOMER ACKNOWLEDGES AND AGREES THAT OLYMPUS SHALL NOT BE RESPONSIBLE FOR ANY DAMAGES THAT THE CUSTOMER MAY INCUR FROM DELAYED SHIPMENT, PRODUCT FAILURE, PRODUCT DESIGN, SELECTION, OR PRODUCTION, IMAGE OR DATA LOSS OR IMPAIRMENT OR FROM ANY OTHER CAUSE, WHETHER LIABILITY IS ASSERTED IN CONTRACT, TORT (INCLUDING NEGLIGENCE AND STRICT PRODUCT LIABILITY) OR OTHERWISE. IN NO EVENT SHALL OLYMPUS BE LIABLE FOR ANY INDIRECT, INCIDENTAL, CONSEQUENTIAL OR SPECIAL DAMAGES OF ANY KIND (INCLUDING WITHOUT LIMITATION LOSS OF PROFITS OR LOSS OF USE), WHETHER OR NOT OLYMPUS SHALL BE OR SHOULD BE AWARE OF THE POSSIBILITY OF SUCH POTENTIAL LOSS OR DAMAGE.

Representations and warranties made by any person, including but not limited to dealers, representatives, salespersons, or agents of Olympus, which are inconsistent or in conflict with or in addition to the terms of this limited warranty, shall not be binding upon Olympus unless reduced to writing and approved by an expressly authorized officer of Olympus.

This limited warranty is the complete and exclusive statement of warranty which Olympus agrees to provide with respect to the Products and it shall supersede all prior and contemporaneous oral or written agreements, understandings, proposals, and communications pertaining to the subject matter hereof. This limited warranty is exclusively for the benefit of the original customer and cannot be transferred or assigned.

### WHAT TO DO WHEN SERVICE IS NEEDED

The customer must transfer any image or other data saved on a Product to another image or data storage medium and/or remove any film from the Product prior to sending the Product to Olympus for service.

IN NO EVENT SHALL OLYMPUS BE RESPONSIBLE FOR SAVING, KEEPING OR MAINTAINING ANY IMAGE OR DATA SAVED ON A PRODUCT RECEIVED BY IT FOR SERVICE, OR ON ANY FILM CONTAINED WITHIN A PRODUCT RECEIVED BY IT FOR SERVICE, NOR SHALL OLYMPUS BE RESPONSIBLE FOR ANY DAMAGES IN THE EVENT ANY IMAGE OR DATA IS LOST OR IMPAIRED WHILE SERVICE IS BEING PERFORMED (INCLUDING, WITHOUT LIMITATION, DIRECT, INDIRECT, INCIDENTAL, CONSEQUENTIAL OR SPECIAL DAMAGES, LOSS OF PROFITS OR LOSS OF USE), WHETHER OR NOT OLYMPUS SHALL BE OR SHOULD BE AWARE OF THE POSSIBILITY OF SUCH POTENTIAL LOSS OR IMPAIRMENT.

Package the Product carefully using ample padding material to prevent damage in transit and either deliver it to the Authorized Olympus Dealer that sold you the Product or ship it postage prepaid and insured to any of our Olympus Service Centers. When returning Products for service, your package should include the following:

- 1 Sales receipt showing date and place of purchase.
- 2 Copy of this limited warranty **bearing the Product serial number corresponding to the serial number on the Product** (unless it is a model on which Olympus does not place and record serial numbers).
- 3 A detailed description of the problem.
- 4 Sample prints, negatives, digital prints (or files on disk) if available and related to the problem.

When service is completed, the Product will be returned to you postage prepaid.

### WHERE TO SEND PRODUCT FOR SERVICE

See "WORLDWIDE WARRANTY" for the nearest service center.

### INTERNATIONAL WARRANTY SERVICE

International warranty service is available under this warranty.

#### For customers in Europe



"CE" mark indicates that this product complies with the European requirements for safety, health, environment and customer protection. "CE" mark cameras are intended for sales in Europe.

For customers in the EU: Hereby, Olympus Imaging Corp. and Olympus Europa Holding GmbH declare that this TG-2 is in compliance with the essential requirements and other relevant provisions of Directive 1999/5/EC. For details visit: <http://olympus-europa.com/>



This symbol [crossed-out wheeled bin WEEE Annex IV] indicates separate collection of waste electrical and electronic equipment in the EU countries.

Please do not throw the equipment into the domestic refuse.

Please use the return and collection systems available in your country for the disposal of this product.



This symbol [crossed-out wheeled bin Directive 2006/66/EC Annex II] indicates separate collection of waste batteries in the EU countries.

Please do not throw the batteries into the domestic refuse. Please use the return and collection systems available in your country for the disposal of the waste batteries.

## Provisions of warranty

- 1 If this product proves to be defective, although it has been used properly (in accordance with the written Handling Care and Operating instructions supplied with it), during the applicable national warranty period and has been purchased from an authorized Olympus distributor within the business area of Olympus Europa Holding GmbH as stipulated on the website: <http://www.olympus.com> this product will be repaired, or at Olympus's option replaced, free of charge. To claim under this warranty the customer must take the product before the end of the applicable national warranty period to the dealer where the product was purchased or any other Olympus service station within the business area of Olympus Europa Holding GmbH as stipulated on the website: <http://www.olympus.com>. During the one year period of the World Wide Guarantee the customer may turn the product in at any Olympus service station. Please notice that not in all countries such Olympus service station exists.
- 2 The customer shall transport the product to the dealer or Olympus authorized service station at his own risk and shall be responsible for any costs incurred in transporting the product.

## Provisions of Guarantee

- 1 \*OLYMPUS IMAGING CORP., 2951 Ishikawa-machi, Hachioji-shi, Tokyo 192-8507, Japan grants a one year World Wide Guarantee. This worldwide Guarantee must be presented at an Olympus authorized repair service station before any repair can be made under conditions of this Guarantee. This Guarantee is valid only if the Guarantee Certificate and proof of purchase are presented at the Olympus repair service station. Please note that this Guarantee is in addition to and does not affect the customer's legal warranty rights under the applicable national legislation governing the sale of consumer goods mentioned above.
- 2 This Guarantee does not cover the following and the customer will be required to pay repair charge, even for defects occurring within the Guarantee period referred to above.
  - a. Any defect that occurs due to mishandling (such as an operation performed that is not mentioned in the Handling Care or other sections of the instructions, etc.)
  - b. Any defect that occurs due to repair, modification, cleaning, etc. performed by anyone other than Olympus or an Olympus authorized service station.
  - c. Any defect or damage that occurs due to transport, a fall, shock, etc. after purchase of the product.
  - d. Any defect or damage that occurs due to fire, earthquake, flood damage, thunderbolt, other natural disasters, environmental pollution and irregular voltage sources.

- e. Any defect that occurs due to careless or improper storage (such as keeping the product under conditions of high temperature and humidity, near insect repellents such as naphthalene or harmful drugs, etc.), improper maintenance, etc.
  - f. Any defect that occurs due to exhausted batteries, etc.
  - g. Any defect that occurs due to sand, mud, etc. entering the inside of the product casing.
  - h. When the Guarantee Certificate is not returned with the product.
  - i. When any alterations whatsoever are made to the Guarantee Certificate regarding the year, month and date of purchase, the customer's name, the dealer's name, and the serial number.
  - j. When proof of purchase is not presented with this Guarantee Certificate.
- 3 This Guarantee applies to the product only; the Guarantee does not apply to any other accessory equipment, such as the case, strap, lens cap and batteries.
  - 4 Olympus's sole liability under this Guarantee shall be limited to repairing or replacing the product. Any liability under the Guarantee for indirect or consequential loss or damage of any kind incurred or suffered by the customer due to a defect of the product, and in particular any loss or damage caused to any lenses, films, other equipment or accessories used with the product or for any loss resulting from a delay in repair or loss of data, is excluded. Compelling regulations by law remain unaffected by this.

## Notes regarding Guarantee maintenance

- 1 This Guarantee will only be valid if the Guarantee Certificate is duly completed by Olympus or an authorized dealer or other documents contain sufficient proof. Therefore, please make sure that your name, the name of the dealer, the serial number and the year, month and date of purchase are all completed or the original invoice or the sales receipt (indicating the dealer's name, the date of purchase and product type) is attached to this Guarantee Certificate. Olympus reserves the right to refuse free-of-charge service if neither Guarantee Certificate is completed nor the above document is attached or if the information contained in it is incomplete or illegible.
  - 2 Since this Guarantee Certificate will not be re-issued, keep it in a safe place.
- \* Please refer to the list on the web site: <http://www.olympus.com> for the authorized international Olympus service network.



## For customers in Asia

### Provisions of warranty

- 1 If this product proves to be defective, although it has been used properly (in accordance with the written Handling Care and Operating instructions supplied with it), during a period of up to one year from the date of purchase this product will be repaired, or at Olympus's option replaced, free of charge. To claim under warranty the customer must take the product and this Warranty certificate before the end of the one year warranty period to the dealer where the product was purchased or any Olympus authorized service station listed in the instructions and request the necessary repairs.
- 2 The customer shall transport the product to the dealer or Olympus authorized service station at his own risk and shall be responsible for any costs incurred in transporting the product.
- 3 This warranty does not cover the following and the customer will be required to pay repair charge, even for defects occurring within the one year period referred to above.
  - a. Any defect that occurs due to mishandling (such as an operation performed that is not mentioned in the Handling Care or other sections of the instructions, etc.)
  - b. Any defect that occurs due to repair, modification, cleaning, etc. performed by anyone other than Olympus or an Olympus authorized service station.
  - c. Any defect or damage that occurs due to transport, a fall, shock, etc. after purchase of the product.
  - d. Any defect or damage that occurs due to fire, earthquake, flood damage, thunderbolt, other natural disasters, environmental pollution and irregular voltage sources.
  - e. Any defect that occurs due to careless or improper storage (such as keeping the product under conditions of high temperature and humidity, near insect repellents such as naphthalene or harmful drugs, etc.), improper maintenance, etc.
  - f. Any defect that occurs due to exhausted batteries, etc.
  - g. Any defect that occurs due to sand, mud, etc. entering the inside of the product casing.
  - h. When this Warranty Certificate is not returned with the product.
  - i. When any alterations whatsoever are made to the Warranty Certificate regarding the year, month and date of purchase, the customer's name, the dealer's name, and the serial number.
  - j. When proof of purchase is not presented with this Warranty Certificate.
- 4 This Warranty applies to the product only; the Warranty does not apply to any other accessory equipment, such as the case, strap, lens cap and batteries.

- 5 Olympus' sole liability under this warranty shall be limited to repairing or replacing the product and any liability for indirect or consequential loss or damage of any kind incurred or suffered by the customer due to a defect in the product, and in particular any loss or damage caused to any film or lenses or other equipment or accessories used with the product or for any loss resulting from delay in repair, is excluded.

### Notes;

- 1 This Warranty is in addition to and does not affect the customer's statutory right.
- 2 If you have any queries regarding this Warranty, call any of the Olympus authorized service stations listed in the instructions.

### Notes regarding warranty maintenance

- 1 This Warranty will only be valid if the Warranty Certificate is duly completed by Olympus or the dealer. Make sure that your name, the name of the dealer, the serial number and the year, month and date of purchase are all completed.
- 2 Since this Warranty Certificate will not be re-issued, keep it in a safe place.
- 3 Any request for repair by a customer in same country where the product was purchased shall be subject to the terms of the warranty issued by the Olympus distributor in that country. Where the local Olympus distributor does not issue a separate warranty or where the customer is not in the country where the product was purchased the terms of this worldwide warranty shall apply.
- 4 Where applicable, this Warranty is valid worldwide. The Olympus authorized service stations listed in this Warranty will gladly honor it.
  - \* Please refer to the appended list for the authorized international Olympus service network.

### Disclaimer of Warranty

Olympus makes no representations or warranties, either expressed or implied, by or concerning any content if these written materials or software, and in no event shall be liable for any implied warranty of merchantability or fitness for any particular purpose or for any consequential, incidental or indirect damages (including but not limited to damages for loss of business profits, business interruption and loss of business information) arising from the use of inability to use these written materials or software. Some states do not allow the exclusion or limitation of liability for consequential or incidental damages, so the above limitations may not apply to you.

## For customer in Thailand

This telecommunication equipment conforms to NTC technical requirement.

## **OLYMPUS KOREA CO., LTD.**

10F, Olympus Tower A, 114-9, Samsung-dong, Gangnam-gu, Seoul, Korea. 135-090  
<http://www.olympus.co.kr> Tel. 1544-3200

## **OLYMPUS (MALAYSIA) Sdn Bhd**

10-8, Menara 1 MK, Kompleks '1 Mont Kiara', No.1, Jalan Kiara, Mont Kiara, 50480  
Kuala Lumpur, Malaysia.

Tel:+603-6411 0000/Fax:+603-6411 0003

### **BRANCHES:**

#### **PENANG OFFICE**

Suite 3A-6, Level 3A, Wisma Great Eastern  
No.25, Lebu Light, 10200 Penang  
Tel:+604 262 2832/ Fax:+604 262 5832

#### **KUCHING OFFICE**

Level 6-5A, 6th Floor Menara MAA,  
Lot 86, Section 53,  
Jalan Central Timur,  
93300 Kuching, Sarawak  
Tel:+6082 253 885/ Fax:+6082 256 885

<http://www.olympus.com.my>

# OLYMPUS

<http://www.olympus.com/>

## OLYMPUS IMAGING CORP.

2951 Ishikawa-machi, Hachioji-shi, Tokyo, Japan

## OLYMPUS IMAGING AMERICA INC.

3500 Corporate Parkway, P.O. Box 610, Center Valley, PA 18034-0610, U.S.A. Tel. 484-896-5000

### Technical Support (USA)

24/7 online automated help:

<http://www.olympusamerica.com/support>

Phone customer support: Tel. 1-888-553-4448 (Toll-free)

Our phone customer support is available from 9 am to 9 pm  
(Monday to Friday) ET

<http://olympusamerica.com/contactus>

Olympus software updates can be obtained at:

<http://www.olympusamerica.com/digital>

## OLYMPUS EUROPA HOLDING GMBH

Premises: Wendenstrasse 14-18, 20097 Hamburg, Germany  
Tel: +49 40-23 77 3-0 / Fax: +49 40-23 07 61

Goods delivery: Modul H, Willy-Beicher Str. 36, 52353 Düren, Germany  
Letters: Postfach 10 49 08, 20034 Hamburg, Germany

### European Technical Customer Support:

Please visit our homepage <http://www.olympus-europa.com> or call our TOLL FREE NUMBER\* : **00800 - 67 10 83 00**  
for Austria, Belgium, Denmark, Finland, France, Germany, Italy, Luxembourg, Netherlands, Norway, Portugal, Spain, Sweden, Switzerland, United Kingdom  
\* Please note some (mobile) phone services providers do not permit access or request an additional prefix to +800 numbers.

For all European Countries not listed and in case that you can't get connected to the above mentioned number, please make use of the following  
CHARGED NUMBERS: **+49 180 5 - 67 10 83** or **+49 40 - 237 73 4899**

Our Technical Customer Support is available from 9 am to 6 pm MET (Monday to Friday)

## OLYMPUS IMAGING CHINA CO.,LTD.

Customer Support: 400-650-0303 Home page: <http://www.olympus.com.cn>

### Customer Service Center:

A8F, Ping An International Financial Center, No. 1-3,  
Xinyuan South Road, Chaoyang District, Beijing  
Tel: +86-10-58199199 Fax: +86-10-59761360 Zip: 100027

A,32F Shanghai Industrial Investment Building 18  
Cao Xi Road(N), Xuhui District, Shanghai  
Tel: +86-21-60823500 Fax: +86-21-60823100 Zip: 200030

Rm.1605-1608, Guangzhou International Electronic tower, No403,  
Huan Shi East Road, Guang Zhou  
Tel: +86-20-61227111 Fax: +86-20-61227120 Zip: 510095

16F Huamin Hanzun Internation Plaza, No.1, Fuxing Street,  
Chengdu  
Tel: +86-28-86703531 Fax: +86-28-86703532 Zip: 610016

## OLYMPUS HONG KONG AND CHINA LIMITED

Digital Camera Repair Centre

L4207, Office Tower, Langham Place, 8 Argyle Street, Mongkok, Kowloon, Hong Kong

Customer Hotline: +852-2376-2150 Fax: +852-2375-0630

<http://www.olympus.com.hk>