

Model 3901V/3902V/3903V

Installation Guide

NOTE: This product is intended for installation by a professional installer only! Any attempt to install this product by any person other than a trained professional may result in severe damage to a vehicle's electrical system and components.

Directed[®]
E L E C T R O N I C S

Bitwriter®, *Code Hopping™*, *Doubleguard®*, *ESP™*, *FailSafe®*, *Ghost Switch™*, *Learn Routine™*, *Nite-Lite®*, *Nuisance Prevention® Circuitry*, *Revenger®*, *Silent Mode™*, *Soft Chirp®*, *Stinger®*, *Valet®*, *Vehicle Recovery System®*, *VRS®*, and *Warn Away®* are all Trademarks or Registered Trademarks of Directed Electronics.



The Bitwriter® (p/n 998T)
requires chip version 2.5 or
newer to program this unit.

Table of contents

What is included.....	5	Integrated LED/Valet®.....	16
Control module diagram.....	5	Data port - Bitwriter®.....	16
Installation points to remember.....	6	Data port - Bootloader.....	16
Before beginning the installation.....	6	Four-pin optional sensor harness.....	17
After the installation.....	7	On-board dual stage shock sensor.....	18
Tools required.....	7	Zones.....	18
Deciding on component locations.....	8	Longterm event history.....	19
Control module.....	8	Rapid resume logic.....	19
Integrated LED/Valet® switch.....	9	Multi-level security arming.....	20
Starter kill relay.....	9	Feature programming.....	21
Connecting your wires.....	10	To access feature programming.....	21
Obtaining constant 12V.....	10	Feature menus.....	22-23
Finding a light wire.....	11	Bitwriter® features.....	23
Main harness wire connection guide.....	12	Features description.....	24-26
CAN harness.....	15	Special features.....	28
CAN harness wiring guide.....	15	Vehicle Application Charts.....	29-33
Plug-in harness.....	16	Wiring quick reference guide.....	34

What Is Included

- The control module
- 9-pin main harness
- 4-pin sensor harness
- LED/VALET switch
- 3-pin CAN(control area network) harness

Control Module

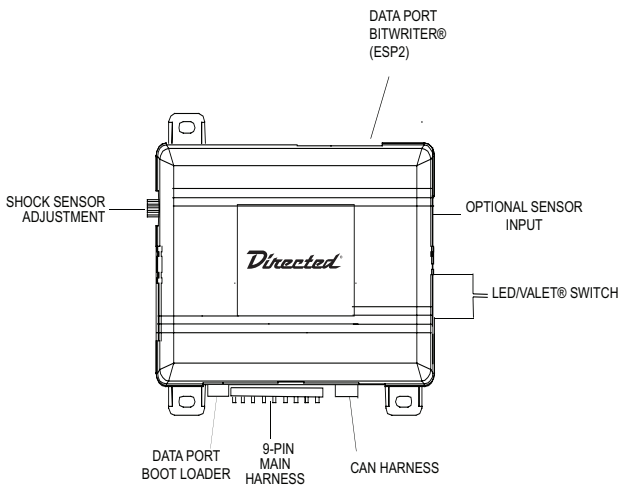

WARNING: Before beginning your install go to www.XPRESSVIP.com and be sure to print the LATEST corresponding installation manual for the firmware that is flashed to the platform you are using.

IMPORTANT! Before you begin the install process ensure the hardware matches the vehicle and verify the wires needed.

Installation points to remember

This product represents many years of research and development. It is very sophisticated and should be installed by experienced security installers only. Please do not attempt installation of this product without reading this guide.

This product is not intended for consumer installation and will have NO WARRANTY unless it is installed by an authorized dealer. Do not disconnect the battery if the vehicle has an anti-theft coded radio. If equipped with an airbag, avoid disconnecting the battery if possible.

IMPORTANT! Please read this entire installation guide before beginning the installation. The installation of this security system requires interfacing with many of the vehicle's systems. Many new vehicles use low-voltage or multiplexed systems which can be damaged by low resistance testing devices, such as test lights or logic probes. Test all circuits with a high-quality digital multi-meter before making the connections.

IMPORTANT! Many airbag systems will display a diagnostic code through their warning light after they lose power. Disconnecting the battery requires this code to be erased, a procedure that can require a trip to the dealer.

Before beginning the installation

- Check with the customer to determine the LED and Valet switch locations.
- Roll down a window to avoid being locked out of the car.

After the installation

- Test all functions. The “Using Your System” section of the Owner’s Guide is very helpful when testing.
- When testing, don’t forget that this system is equipped with Nuisance Prevention® Circuitry (NPC). NPC can bypass both sensor zones, making them appear to stop working.
- Carefully reassemble the under-dash trim panels.
- Inspect the engine compartment for tools that may have been left behind.

Tools required

This is a general list of tools required to complete the installation of this security system for most vehicles. Some vehicles may require additional tools.

- Digital multi-meter
- Nutdriver and/or socket set
- Wire cutters/strippers
- Panel removal tool
- Solderless terminal crimpers
- Drill bit set
- Cordless power drill
- Phillips head screwdriver
- Torx driver set - Work light

Deciding on component locations

Control module

Some things to remember about where to mount the control module

- Never put the control module in the engine compartment!
- The first step in wiring a vehicle is removing the driver's side under-dash panel to access the starter and ignition wires. If the control module is placed just behind the driver's side dash it can easily be disconnected.
- When mounting the control module, try to find a secure location that will not require you to extend the harnesses' wires (they are 1.5 meters long). Keep it away from the heater core (or any other heat sources) and any obvious leaks.
- Some good control module locations are: Above the glove box, inside the center console, above the under-dash fuse box, or above the radio.

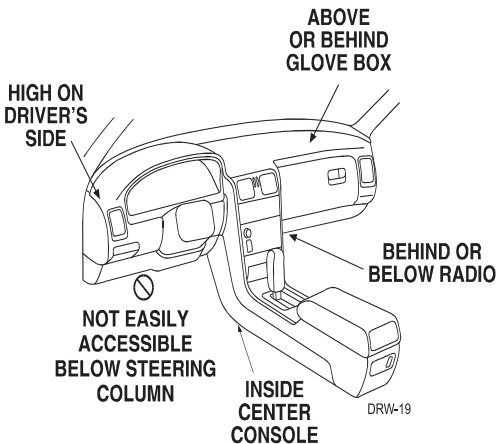

Integrated LED/Valet switch

Things to remember when positioning the integrated LED/Valet switch:

- It should be visible from both sides and the rear of the vehicle, if possible.
- It needs at least 1-1/2 inch clearance to the rear.
- It is easiest to remove a small panel, such as a switch blank or a dash bezel, before drilling a 5/16 inch hole.

Starter kill relay

If the Starter kill relay or its connections are immediately visible when removing the underdash panel, they can easily be bypassed. Always make the relay and its connections difficult to discern from the factory wiring! Exposed yellow butt connectors do not look like factory parts, and will not fool anyone! For this reason, routing the starter kill wires away from the steering column is recommended.

Connecting your wires

Now that you have decided where each component will be located, you're going to find the wires in the car that the security system connects to.

IMPORTANT! Do not use a 12V test light to find these wires! Use a digital multimeter for all testing described in this manual.

Obtaining constant 12V

We recommend two possible sources for 12V constant: the (+) 12v terminal of the battery, or the constant supply to the ignition switch. If you connect the module to the CAN bus wire at the OBD II plug, you can use the +12 v wire existent in the plug. Always install a fuse within 12 inches of this connection.

IMPORTANT! Do not remove the fuse holder on the red (N1/3) wire. It ensures that the control module has its own fuse, of the proper value, regardless of how many accessories are added to the main power feed.

Find a (-) parking light wire

Use the following procedure to find a (-) parking light flash wire with your multimeter:

1. Set to DCV or DV voltage (12V or 20V).
2. Attach the (+) probe of the meter to a fused (+) source.
3. Probe the wire you suspect of being the parking light wire. Usually, the area near the headlight/parking light switch is an excellent area to start, as is the kick panel. Refer to the directechs.com for specific vehicle information.
4. Turn on the parking lights. If your meter shows 12V, turn off the parking lights and make sure it goes back to zero.
5. If it does return to zero, turn the parking lights back on and, using the dash light dimmer control, turn the brightness of the dash lights up and down. If the meter changes more than a volt when using the dimmer, look for another wire. If it stays relatively close to 12V, you have found your parking light wire.

Main harness wire connection guide

N1/1	RED	(+) 12V Constant Power
N1/2	BLACK	(-) Chassis Ground Input
N1/3	RED/WHITE	(-) 200mA Auxillary Channel Output
N1/4	BLUE	(-) Instant Trigger Input
N1/5	ORANGE	(-) Ground While Armed Output
N1/6	WHITE	(-) Light Flash Output
N1/7	BROWN	(+) Siren Output
N1/8	BLUE/WHITE	(-) Status/shunt Input
N1/9	BROWN/WHITE	(-) 200 mA Horn Output

N1/1 RED – (+) 12V constant power input: Before connecting this wire, remove the supplied fuse. Connect to the battery positive terminal or the constant 12V supply to the ignition switch.

NOTE: Always use a fuse within 12 inches of the point you obtain(+)12V. Do not use the supplied fuse in the harness for this purpose. This fuse protects the module itself.

N1/2 BLACK - (-) chassis ground connection: Attach this wire to the kick panel or firewall. There should be no paint, and no factory grounds. Do not use under dash bracing or steering columns as ground points.

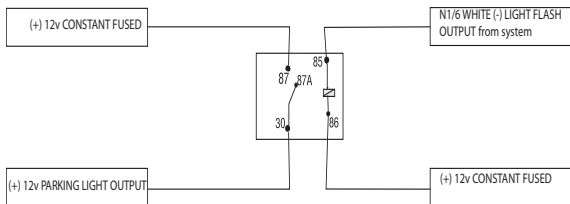

10-4

(+) Parking light relay - Wiring instructions if a positive parking light output is needed

N1/7 BROWN – (+) siren output: Connect this wire to the RED one from the siren. Connect the BLACK wire from the siren to (-) chassis ground, preferably at the same point you connect the control module's BLACK ground wire.

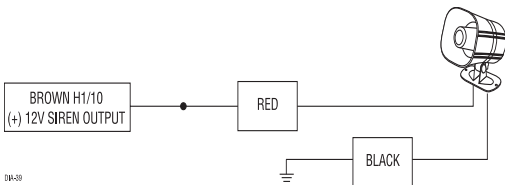

10-50

N1/8 BLUE/WHITE– (-) Status/shunt input: Remote Start Input - Connect this input to the Remote Start Status Output of a remote start module (if used) when the ignition and sensors need to be bypassed during remote start active status.

N1/9 BROWN/WHITE – 200mA (-) Horn honk output: This wire supplies a 200mA (-) output that can be used to honk the vehicle's horn. It provides a pulsed output when the security system is armed/disarmed and in trigger sequence or in panic mode. In most vehicles with (-) horn circuits this wire can control the vehicle's horn without adding a relay. If the vehicle has a (+) horn circuit, an optional relay must be used to interface with the vehicle's horn circuit.

IMPORTANT! Never use this wire to drive anything but a relay or a low-current input! This transistorized output can only supply (-) 200mA and connecting directly to a solenoid, motor or other high current device will cause the module to fall.

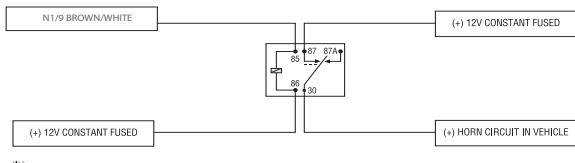

CAN harness

CAN Harness connection diagram

N7/1	LIGHT GREEN	SW CAN BUS
N7/2	ORANGE/GREEN (BROWN/RED)	CAN BUS (high) FT (HS)
N7/3	ORANGE/BROWN (BROWN/BLACK)	CAN BUS (low) FT (HS)

N7/1 LT GREEN – SW CAN bus (present only in Single Wire CAN Security Systems 3902V)

Connect this wire to the vehicle CAN wire. (Check for color and location on the vehicle application list or on the website).

N7/2 - ORANGE/GREEN or BROWN/RED – FT CAN Bus High or HS CAN bus High (present only in Fault Tolerant/High Speed CAN Security Systems such as 3901V for FT and 3903V for HS, respectively.)

Connect this wire to the vehicle CAN High wire. (Check for color and location on the vehicle application list or on the website).

N7/3 ORANGE/BROWN or BROWN/BLACK – FT CAN Bus Low or HS CAN bus Low (present only in Fault Tolerant or High Speed CAN Security Systems such as 3901V for FT and 3903V for HS, respectively.)
Connect this wire to the vehicle CAN Low wire. (Check for color and location on the vehicle application list or on the website).

Plug-in harnesses

Integrated LED/VALET®/switch, 2-pin BLUE and 2-pin White plugs

The integrated LED VALET®/switch should be accessible from the driver's seat. The VALET® part of the switch plugs into the BLUE port on the side of the unit. Check for rear clearance before drilling a 5/16 -inch hole and mounting the switch. The LED part of the switch operates a 2V DC and plugs into the white port on the side of the unit. Make sure the LED wires are not shorted to ground as the LED will be damaged.

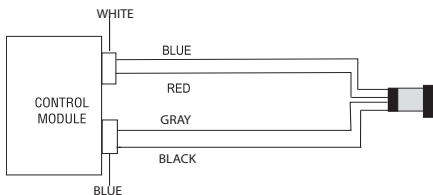

Data port-Bitwriter

The black three-pin port can be used for programming the unit using the Directed Bitwriter, a hand held programming tool. The Bitwriter also allows programming of the features that are not available in the features menus.

Data port – Bootloader

The white four-pin port is used to connect USB Bootloader adaptor and computer to download and flash vehicle specific firmware. A dedicated software has to be installed on your computer that can be downloaded free of charge from the Directed Accessories web site www.expresskit.com.

Four-pin optional sensor harness

RED wire

The red wire supplies constant power to the optional sensor.

BLACK wire

The black wire supplies ground to the optional sensor.

BLUE, GREEN wires

The blue and green wires are multiplex inputs. They are both tied to the same zone. If an input of less than 0.8 seconds is supplied to either wire the Warn-Away response will occur. An input longer than 0.8 seconds to either wire will initiate the triggered sequence and report zone 4. This port can be used for optional sensors such as: the 506T – glass breakage sensor, or the 504D – field disturbance sensor.

On-board dual stage shock sensor

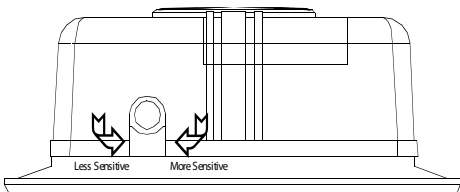

There is a dual-stage shock sensor inside the control module. Adjustments are made via the rotary control as indicated above. Since the shock sensor does not work well when mounted firmly to metal, we recommend against screwing down the control module. The full trigger of the on-board shock sensor reports zone 2. See Table of Zones.

NOTE: When adjusting the sensor, it must be in the same mounting location that it will be after the install is completed. Adjusting the sensor and then relocating the module requires readjustment.

Zones

Zone number	Trigger Type	Input Description
1	Instant Trigger	Hood and/or trunk switches (detected on the vehicle's CAN bus).
2	Multiplex Input	Heavy impact from on-board Doubleguard shock sensor.
3	Two-Stage, progressing from warning to full alarm	Door switch (detected on the vehicle's CAN bus)
4	Multiplex	Optional sensor port. Inputs shorter than 0.8 seconds will trigger Warn Away® response, while inputs longer than 0.8 seconds will instantly trigger full alarm sequence
5	Instant Trigger	Ignition input (detected on the vehicle's CAN bus)
6	Instant Trigger	BLUE N1/4 (-) input

Note: The Warn Away® response does not report on the LED

Long-term event history

The control module will store the last two triggers in memory that are not erased when the ignition is turned on. This can be helpful for troubleshooting false alarm reports. To access the event history use the following procedure:

1. Turn the ignition switch off and press and hold the integrated LED/VALET® button.
2. While holding the integrated LED/VALET® button turn the ignition On.
3. Release the integrated LED/VALET® button.
4. Within 5 seconds press and release the integrated LED/VALET® button.

The LED will flash in groups indicating the last two zones reported triggered. For example, if zone 2 and 3 were the last two zones to be triggered the LED will flash two times followed by a pause and then flash three times followed by a pause.

NOTE: The Warn-Away response does not report on the LED.

The Long Term Event History will exit if the ignition is turned off or there is no activity for 60 seconds.

Rapid resume logic

The current state of the alarm will be stored in non-volatile memory. If power is lost and then reconnected, the system will recall the stored state from memory. This applies to all states of the system including arm, disarm, and VALET® mode. If the unit was powered down while triggered, the control unit will continue to sound the siren (honk the horn) after power up until the unit is recognizing the vehicle again. If at least one zone is still active after this, the unit will sound the siren/horn cycle three times, if not disarmed in the meantime. If no zone is active after the vehicle was recognized, the siren will stop after one siren/horn cycle, if not disarmed in the meantime.

NOTE: The unit will not sound the siren (honk the horn) after power up, if the panic mode was active when powered down.

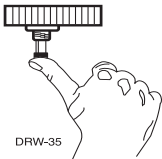

Multi-level security arming

Multi-Level Security Arming allows the user to select sensors to be active or bypassed when the system is armed. Multi-Level Security Arming can only be accessed if the function is set ON (option 3-2)

By pressing the LOCK button more than once within 3 and 7 seconds of arming the system activates Multi-Level Security Arming. If the LOCK button is pressed again the unit cancels the bypass of the sensors. There are different security levels which can be selected, as follows:

Step	Lock Button pressed	Number of Siren/Horn Chirps	Armed State with Zone Bypassed
1	Once	1 Chirp	No Zone Bypassed
2	Twice	3 Chirps, 3 flashses	Zone 2 & 4 Bypassed
3	If the Lock button is pressed again anytime, the system will return to step 1. The user can repeat the steps provided the LOCK button is pressed between 3 and 7 seconds and no other buttons are pressed.		

Disarming without the original vehicle remote (system override)

This feature allows you to override the system without the transmitter should it be lost, damaged or disabled. To do this, you must have the vehicle's ignition key and know where the integrated LED/VALET® switch is located.

Turn the ignition to the "run" position. Press and release the integrated LED/VALET® switch the programmed number of time (1-5), within 10 seconds. After a few seconds the LED will stop flashing and the vehicle should start. If it does not, you may have waited too long. Turn the ignition off and try again.



DRW-94

Note: On some vehicles, the security system can be armed using the ignition key for the driver's door cylinder but can not be disarmed in the same way. The system can only be disarmed using the ignition key for the driver's door cylinder only if remote start status is active.

Note: The setting for the number of times the Valet switch must be pressed is set in the Feature Programming section of this guide.

Feature programming

The feature programming procedure is used to access and change any of the feature settings in the three menus below. The feature settings can be accessed and changed by using one of the following:

- The integrated LED/VALET® button to enter the feature programming procedure.
- Use of Directed Electronics Bitwriter® is recommended. Expanded programming options are only available when using the Directed Electronics Bitwriter®.

NOTE: If Feature Programming Lockout is set to ON, all features will be locked and can ONLY be accessed by using a Bitwriter®.

To enter feature programming procedure:

1. Open a door.
2. Turn the ignition on and then off.
3. Within 5-seconds, press and HOLD the Valet® button. After 3-seconds, the siren/horn will sound once and the LED will flash once to indicate entry into the Menu 1 "Basic User's Features".
To select the Menu 2 "Advanced User's Features", continue to hold the Valet® button until the siren/horn sounds twice and the LED flashes twice. Repeat these steps to select Menu 3 "Installer Features". Once the desired menu is selected, the user releases the integrated LED/VALET® button and then proceeds to the next step.
4. Within 25-seconds, press and release the VALET button the number of times corresponding to the desired feature listed below. Then press the Valet® once more time and hold. The siren/horn will sound the number of times equal to the feature number selected and the LED will continuously flash the same number with 2 seconds pause until you move further to the next step.
5. While holding the integrated LED/VALET® button, assign the selected feature to a factory button by either pressing: Lock or unlock for 1 chirp setting (LED ON) or pressing Lock/Unlock again for 2 chirps setting (LED OFF).

NOTE: For features with more than 2 options pressing Unlock multiple times will toggle through all the rest of the settings and emit the corresponding number of chirps.

Once a feature is programmed:

- Another feature(s) can be programmed.
- The other feature menu can be selected.
- The feature programming procedure can be exited.

Accessing another feature:

- Release, then press and release the integrated LED/VALET® button the number of times to advance from the feature just programmed to the next feature desired.
- Press and **hold** the integrated LED/VALET® button once more.
- The siren/horn will chirp to confirm the feature selected.

Accessing another menu:

- Release, then press and hold the Valet® button.
- After 3-seconds, the unit will advance to the next menu and the siren/horn will sound a number of times equal to the number of the selected menu.

Exiting feature programming :

- Close the opened door
- Turns the ignition On.
- No activity for 15 seconds except when selecting the settings.
- Press and release the VALET® button too many times.

Menu 1 – Basic user's features

Factory default settings are shown in bold.

Feature Step	One chirp	Two chirps
1-1	ZAP (reset default settings)	-
1-2	Chirps ON	OFF
1-3	Horn function(full trigger only)	Siren function - chirp length (20mS, 30mS, 40mS, 50mS)
1-4	Siren duration - 30 seconds	Siren duration - 60 seconds

Menu 2 – Advanced user's features

Factory default settings are shown in bold

Feature Step	One chirp	Two chirps
2-1	Light confirmation ON	OFF
2-2	Parking light supervision ON	Parking light supervision OFF
2-3	Light Output (parking lights)	Light Output (turn signal)
2-4	Automatic re-arming On (60S)	Automatic re-arming OFF

Menu 3 - Installer features

Factory default settings are shown in bold

Feature Step	One chirp	Two chirps
3-1	Nuisance Prevention® Circuity (ON)	Nuisance Prevention® Circuity OFF
3-2	Arm function (Arm Only)	Arm function (Grouped Multi-level Arming- zones 2 & 4, Panic, AUX Ch)
3-3	Progressive door trigger	Instant door trigger
3-4	One-time VALET® ON	One-time VALET® OFF
3-5	Ground When Armed in VALET® (On)	Ground When Armed in VALET® (Off)

Bitwriter features

Factory default settings are shown in bold

Feature	Description
Siren duration	1-180 seconds (30 seconds)
Feature programming (unlocked)	Feature programming (locked)
VALET® Code	1 to 5 (Default 1)
ZAP	Reset all to default

Features description

Menu 1 – Basic User's Features

1-1 ZAP (Reset all features to default): This setting will reset all the features to factory default.

1-2 CHIRPS **ON/OFF**: This setting controls the systems arming & disarming chirps.

- Chirps ON (default): the system will emit chirps when arming and disarming.
- Chirps OFF: the system will NOT emit chirps when arming and disarming.

1-3 HORN FUNCTION (FULL ALARM ONLY)/**SIREN FUNCTION (20mS, 30mS, 40mS, and 50mS)**: This setting controls if the output used by the alarm when fully triggered is the horn or the siren (in the last case different timing options for chirps can be selected).

1-4 SIREN DURATION **30/60 SECONDS**: This setting changes the siren output from 30 seconds to 60 seconds duration when in the panic mode and when the system is fully triggered. The siren duration can also be programmed from 1-180 seconds in 1 second increments using the Bitwriter®.

Menu 2 – Advanced user's features

2-1 LIGHT FLASH CONFIRMATION **ON/ OFF**: This setting control the light flash confirmation of the security system on arming or disarming. When set ON, the security system will control the light confirmation of arming/disarming of the vehicle. When set OFF, the security system will not control the lights confirmation when arming/disarming the vehicle (the original confirmation light of the vehicles will be the only one present on arming/disarming). Note: When (-) input blue/white status shunt is active, the parking lights flash in case it is used for remote start.

2-2 PARKING LIGHT SUPERVISION **ON/OFF**: When set ON the parking lights will illuminate for 30-seconds after disarming the system, or turning off the ignition. The parking lights will be switch OFF during this time if the system is armed again or the ignition becomes ON.

2-3 LIGHT OUTPUT (**PARKING LIGHTS/TURN SIGNAL**): This settings control whether the parking lights or turn signal will be used while the system is triggered or as confirmation lights.

2-4 AUTOMATIC RE-ARMING **OFF/ON (60S)**: This settings control whether the system will re-arm if no door was opened after 60 seconds or not. This will not include locking of the doors or arming the original security system (if present). When set ON, the system will arm only if Lock button is pressed. This option is ignored if the vehicle has automatic rearming feature ON from the factory.

Menu #3 – Installer features

3-1 NUISANCE PREVENTION® CIRCUITRY (NPC®) ON/OFF: These settings control the number of times a sensor can trigger the system within a given time period.

•NPC ON (Default): In this setting any source (sensor or trunk switch) that triggers more than 3 times within 1 hour period will be bypassed for a minimum of 1 hour. If within that 1 hour the systems see's the same source (sensor or trunk switch) trigger again it will not activate the siren/horn and will restart the 1 hour timer.

NOTE: Door switches and the ignition switch are exempt to the description above.

•NPC OFF: In this setting the sensors will trigger repeatedly until the system is disarmed.

3-2 ARM FUNCTION **OFF-ARM ONLY**/ (Grouped MULTI-LEVEL ARMING/PANIC/AUX CH): These settings change the system ability to activate multi-level arming, panic or auxiliary channel while pressing the Lock button.

•When set ARM ONLY, the system will be re-armed at successive presses on lock button.

•When set PANIC, the system will switch on panic function while the user press lock button for the second time. Panic will cease when arming/disarming with original remote.

•When programmed on AUX CH, the system will activate the auxiliary channel when pressing the Lock button for the second time.

•When programmed on Multi-level Arming, the system will activate the Multi-level Arming function when pressing the Lock button for the second time.

NOTE: The second press must be between 3 to 7 seconds from first press.

Grouped multi-level arming

After arming, press the LOCK button again. The parking lights or turn signal will flash 3 times, the siren/horn will chirp 3 times and all sensor warn-away and full alarm zones will be bypassed. All remaining zones are still active (door, hood, trunk, and ignition).

Aux channel

After arming, press the LOCK button again. The security system will activate the auxiliary output (N1/3) and will start bypass all sensor zones for 30 seconds. During the first 3 seconds the security system will monitor the trunk status and/or N1/8 Blue/White- (-) Status input: If either input is active, the security system will bypass all sensors and the trunk when open, and flash the parking lights. After the trunk is closed the sensors will be bypassed for another 20 seconds.

WARNING! If the AUX CHANNEL option is used for Remote Start activation the following must be taken into consideration:

- The Remote start status output of the remote start module has to be connected to the N1/8 Blue/White - (-) Status input in order for ignition and sensors to be bypassed during remote start.

After the Status input is deactivated, the system will bypass sensors for another 20 seconds and the ignition for 5 seconds.

- During the remote start the module will flash the lights.
- During the remote start, the unit will ignore any activation of the OEM remote start (if present) from the OEM transmitter.
- In some vehicles such as Honda and Acura, the keyless entry remotes are inactive while the vehicle is running. You have to use the key to enter the running vehicle if the system is install one of those vehicle. Turning the key in the key cylinder will disarm the system. You can not shut down the remote start with the OEM transmitter either.

3-3 PROGRESSIVE DOOR TRIGGER **ON/OFF**: These settings control the siren/horn output when the system is set off by the door trigger input.

- PROGRESIVE DOOR TRIGGER ON** (default): In this setting if the door is opened while the system is armed the siren will chirp (the horn will honk) 10 times prior to the constant siren/horn output. This is still an instant trigger and closing the door quickly will not stop the trigger sequence.
- PROGRESIVE DOOR TRIGGER OFF**: In this setting if the door is opened while the system is armed the siren/horn will emit a constant siren/horn output immediately.

3-4 ONE TIME VALET® **ON/OFF**: These settings allows the system to be switched to VALET® mode but only until the next time the ignition is turned on.

- ON**: VALET® mode is exit every time the ignition is turned on.
- OFF** (default): VALET® mode is exit only by using the VALET® switch

3-5 GROUND WHEN ARMED IN VALET® **ON/OFF**: Provides On/Off programming for the Ground When Armed wire output when locking the vehicle in VALET® mode.

Bitwriter Features

SIREN DURATION (1-180S): The Bitwriter® can adjust the siren duration setting anywhere from 1 second to 180 seconds in length.

FEATURE PROGRAMMING (UNLOCKED/LOCKED):

- UNLOCKED** (default): In this setting the features can be changed using the Valet switch and the vehicle OEM transmitter.
- LOCKED**: In this setting the features can not be changed using the Valet switch and the vehicle OEM transmitter. If LOCKED, the unit will emit 1 long chirp when trying to enter feature programming.

VALET® CODE: These settings change the number of times the Valet switch must be pressed to disarm the system without the transmitter.

•**1 pulse** (default): Setting is 1 pulse

•**2-5 pulses:** These settings will make it more difficult for a thief to defeat the system.

ZAP FUNCTION This button will reset all the features to default.

VALET® Mode

To prevent the system from arming, the system can be determined to enter in VALET® mode. To enter or exit VALET® mode, use the integrated LED/VALET® switch as follows:

Turn the Ignition On, then OFF.



Within 10 seconds, press and release the integrated LED/VALET® button. The LED will come on if you have entered VALET® mode. To exit VALET® mode, repeat the steps above. The LED will turn Off when VALET® mode is exited.

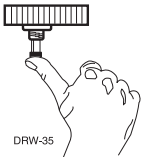

Special Features

Initialization:

The Unit has an initialization procedure that verifies that the unit is properly connected to the CAN bus. You have to connect the unit to the CAN bus and than power it up. It has to pass the initialization procedure to function normally. After connecting the CAN bus and powering up, you have to switch on the ignition for the procedure to be completed. Each time power is disconnected the initialization procedure starts again.

The LED will visually report the status of the initialization procedure.

LED Flashes	Description
LED blinks three digits with 2 seconds break between digits	Firmware revision
LED ON for 5 seconds and stops	Initialization failed. Remove power and retry
LED blinks shortly every 3 seconds	Hardware initialization passed, waiting for ignition to be turned ON
LED blinking rapidly	Power up initialization in process
LED ON for 2.5 seconds, then OFF for 2.5 seconds, then blinks shortly a number and stops	- error 1 = vehicle not recognized - error 2= newest firmware for the vehicle software (check the website for downloading new firmware)
LED OFF immediately after blinking rapidly	Initialization passed and it enter normal operation

Vehicle application charts

The following charts lists all of the vehicles covered by each of the platforms as of 10-2007. Firmware versions for various vehicle platforms are available through the Directed Vehicle Interface Program (VIP) & Bootloader.

Note: Please visit www.xpresskit.com for online VIP detailed installation instructions and troubleshooting guide.

3901V Vehicle Application Chart - Fault Tolerant (a)

Make	Brand	Year	Operates Parking Lights	Hood Switch available through CAN-BUS	VIN Code (Note*1)
VW	Caddy	2005 -2007	•	•	2K
	Touran	2003 -2007	•	•	1T
	Passat	1996 -2005		•	3B
	New Passat	2005 -2007	•	•	3C
	Jetta	2005 -2007	•	•	1K
	Touareg	2003 -2007	•	•	7L
	EOS	2006 -2007	•	•	1F
	Polo Mark IV	2002 -2005	•	•	9N
	Polo Mark IVF	2005 -2007	• (only Turn Signal)	•	9N3
Transporter	2004 -2007	• (only Turn Signal)	•	N/A	
Porsche	Cayenne	2003 -2007	•	•	9P
Seat	Ibitza		• (only Turn Signal)		
	Altea	2004 -2007	•	•	5P
	Toledo	2004 -2007	•	•	5P
	Leon	1999 -2007		•	1M
	New Leon	?	•	•	1P
	Cordoba	2002 -2007	• (only Turn Signal)	•	N/A
Skoda	Octavia Tour	1996 -2007		•	1U
	Octavia II	2004 -2007	•	•	1Z
	Superb	2002-2007		•	3U
	Fabia	1999 -2007		•	N/A
	New Fabia	2007	• (only Turn Signal)	•	N/A
	Roomster	2006 -2007	• (only Turn Signal)	•	N/A
Audi	A3	2004 -2007	•	•	8P
	A4	2002 -2007	•	•	8E
	A4 Cabrio	2007	•	•	8H
	A6	2004 -2007	•	•	4F
	A6 Allroad	2007	•	•	4F
	Q7	2006 -2007	•	•	4L
	TT	2007	•	•	8J
BMW	1 Series	2004 -2007			E81/E87
	3 Series				
	5 Series	2004 -2007			E60/E61

3901V Vehicle Application Chart - Fault Tolerant (b)

Fiat	Grande Punto	2005 -2007			N/A
	Punto	2003 -2007			N/A
	Stilo	2001 -2007			N/A
	Croma	2005 -2007			N/A
	Ducato	2006 -2007			N/A
	Doblo	2001 -2007			N/A
Alfa	159	2005 -2007			N/A
	Brera	2005 -2007			N/A
	147	2000 -2007			N/A
Lancia	Ypsilon	2003 -2007			N/A
	Musa	2004 -2007			N/A
Peugeot	307	2001 -2007			N/A
	407	2004 -2007			N/A
Chrysler	300C	2005 -2007	•		C3K/C3J
	Sebring	2006 -2008	•		C3L
	Aspen	2007	•		A8H
	Pt Cruiser	2001 -2007			A4F
Dodge	Charger	2006 -2007	•		B3K
	Magnum	2005 -2007	•		D4F
	Durango	2004 -2007	•		D4H
	Dakota	2006 -2007			D7H
	RAM	2006 -2007			D7H
	Avenger	2006-2008			B3L
	Caliber	2006 -2007			N/A
Jeep	Commander	2006 -2007	•		J8H
	Grand Cherokee	2005 -2007	•		J4H
	Compass	2006 -2007			J8F
Mercedes	A Classe	2004 -2007	•		W169
	B Classe	2005 -2007	•		W245
	C Classe	2000 -2007	•		W203
	E Classe	2003 -2007	•		W211

NOTE*1

For Audi/Seat/Skoda/Porsche/VW the two digits are the 7th and the 8th. For example: Audi A6 has xxxxxx4F.

For Chrysler/Dodge/Jeep the digits are the 2nd, the 3rd and the 4th. For example: Dodge Charger has xB3K.

For Mercedes the digits are the 2nd, the 5th, 6th and 7th. For example: Mercedes C Classe has Wxx203.

3902V Vehicle Application Chart - Single Wire

Make	Brand	Year	Operates Parking Lights	Blind Switch available through CAN-HUS	VIN Code (Note*3)	
Honda	Accord	2004 -2007	-	-	N/A	
	Civic	2006 -2007	-	- note 1	N/A	
	CR-V	2006 -2007	-	-	N/A	
	Ridgeline	2006 -2007	-	-	N/A	
	Odyssey	2006 -2007	-	-	N/A	
Acura	TL	2006 -2007	-	-	N/A	
	TSX	2006 -2007	-	-	N/A	
	CSX	2006 -2007	-	-	N/A	
	RSX	2006 -2007	-	-	N/A	
	Chevrolet	Impala	2006 -2007	-	-	1W
		Monte Carlo	2006 -2007	-	-	
Tahoe		2006 -2007	-	-	1W	
Avanuche		2006 -2007	-	-	NP	
Equinox		2006 -2007	-	-	ND	
Saturn		2006 -2007	-	-	NP	
Malibu		2006 -2007	-	- note 3	1Z	
HR		2006 -2007	-	- note 3	ND	
Cobalt		2006 -2007	-	- note 3	1A	
Silverado		2006 -2007	-	-	CB	
GMC	Captiva	2006 -2007	-	-	1C	
	Sierra	2006 -2007	-	-	1B	
Cadillac	Yukon	2006 -2007	-	-	KF	
	Escalade	2006 -2007	-	-	YF	
	STS	2006 -2007	-	-	6D	
	DTS	2006 -2007	-	-	6K	
Buick	SRX	2007	-	-	YB	
	Lucerne	2006 -2007	-	-	4H	
Poniac	G6	2006 -2007	-	- note 3	1Z	
	Solstice	2006 -2007	-	- note 3	2M	
	Tonant	2006 -2007	-	- note 3	N/A	
Saturn	Aura	2006 -2007	-	- note 3	1Z	
	Sky	2006 -2007	-	- note 3	EM	
	Outlook	2006 -2007	-	- note 3	2H	
Opel	Astra H	2006 -2007	-	-		
	Zafira	2006 -2007	-	-		
	Vectra C	2004 -2007	-	-		
	Corsa D	2006 -2007	-	-		

NOTE*1 Only for cars having OEM security system

NOTE*2 Only for cars having OEM remote start

NOTE*3 For GM the digits are the 3rd and the 4th. For example Chevrolet Malibu has xx1Z.

3903V Vehicle Application Chart - High Speed

Make	Brand	Year	Operates Parking Lights	Head Switch available through CAN BUS	VIN Code (Note*1)
Renault	Clao III	2005 -2007	.		N/A
Nissan	Pathfinder	2005 -2007	.		N/A
	Nissan	2005 -2007	.		N/A
	Micra	2002 -2007			N/A
Infiniti	EX35s	2008 -2007		-	N/A
	EX35s	2006 -2007		-	N/A
Ford (EU)	Fiesta	2006 -2007			N/A
	Mondeo				
	Focus	2006 -2007			N/A
Mazda	3	2006 -2007			N/A
Dodge	Nitro	2007 -2008			?
Jeep	Wrangler	2007 -2008			

NOTE*1 For Chrysler/Dodge/Jeep the digits are the 2nd, the 3rd and the 4th. For example: Dodge Charger has nBSE.

Wiring quick reference guide

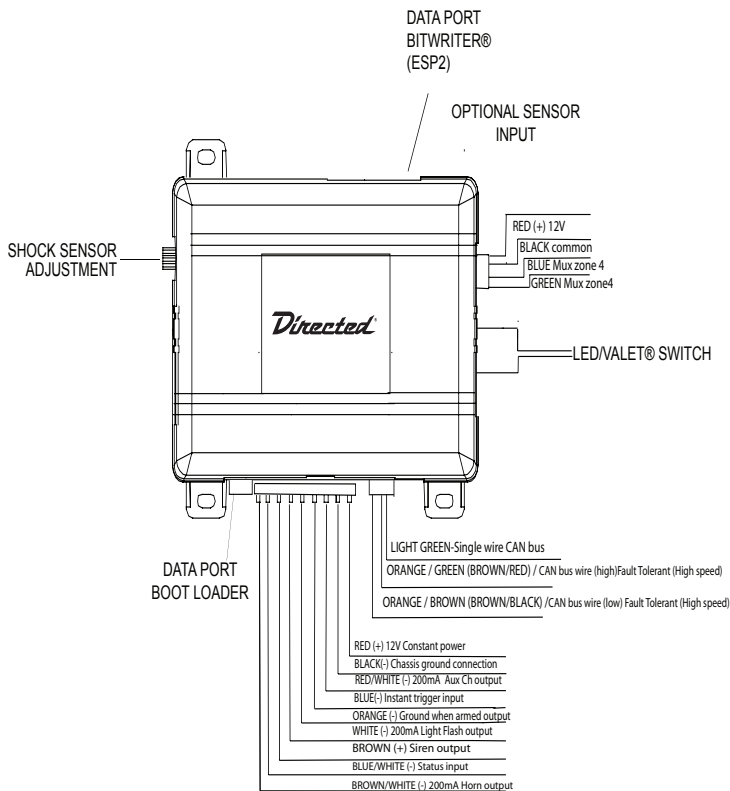

Directed[®]
E L E C T R O N I C S

Directed Electronics, Inc.

Vista, CA 92081

www.directed.com

© 2007 Directed Electronics, Inc. - All rights reserved

N3901V 2007-09