



StudioRack

User Guide



Introduction	3
Quick Start	5
Getting Around StudioRack.....	7
Selecting a View	7
Floating Plugin Panels	8
StudioRack Windows	9
Using StudioRack	13
Adding Plugins	13
<i>Components and Racks</i>	13
<i>Managing, Moving, and Copying Plugins</i>	14
Parallel Split Insert	16
<i>Parallel Split Signal Flow</i>	17
Multiband Split	18
<i>Multiband Split Rack Signal Flow</i>	19
Internal Sidechain	20
Input, Output, and Imaging Controls	21
<i>Main Chainer</i>	21
<i>Parallel and Multiband Split Racks Input</i>	21
<i>Panning, Rotation, and Rack Output Level</i>	22
Track Name	23
Latency	24
Using Macros	25
<i>Editing Macros</i>	28
<i>About Automation</i>	30
Using StudioRack with SoundGrid.....	31
SoundGrid Essentials.....	32
Offloading Processing from the Host Computer to the Server	35
Low-Latency Monitoring During Recording	37
<i>StudioRack Monitor Setup</i>	38
<i>Mixer StudioRack Layer</i>	40
<i>Linking StudioRacks to the Mixer</i>	41
<i>Automatically Linking to DAW Playback/Input and Auto Monitor Status</i>	42
Set Up a Mackie HUI in a DAW	44



Introduction

StudioRack is a plugin chainer that helps you to create and mix sounds more efficiently. It lets you do complex things in a simple way. StudioRack flexibly chains up to eight plugins per DAW instance, and it provides far more than simple plugin chaining.

- Using **Parallel Split**, you can split a rack at any point in the signal flow and send the signal to up to eight supplemental racks for parallel processing. This lets you quickly create processing chains that are independent of each other and of the rest of the main chainer. Very specific effects can be created and then inserted back into the signal flow at the same insert point. And since everything can be controlled by Macros, you can use different parallel racks for different sections of a song or scene.
- In the **Multiband Split** mode, you can split the signal from the main rack and isolate the processing based on frequency. Up to five frequency bands can be processed with different racks of plugins, so you can treat the highs, lows, and midrange of an instrument in entirely different ways.
- Stereo Parallel Split input can be set to L/R stereo, M/S, M, or S. This allows for targeted processing of specific parts of the stereo image. This, combined with Multiband Split processing, provides detailed control of *what* you are processing.
- Parallel Split rack and Multiband Split rack processing do not tie up extra DAW channels or plugin instances.
- A **Macros** section lets you group the controls of any of the plugins in the racks of the StudioRack instance. You can adjust complex groupings of controls—all from one Macro. Since Macros can span several plugins, you can create personal Macros for things you might call “shine,” or “bottom,” or whatever else. Turn one control and you’ll adjust all the settings together. This leaves you free to create, rather than bother with controls while you mix.

All of these features are available in both Native CPU processing and SoundGrid processing modes.



SOUNDGRID PROCESSING

StudioRack can also operate within a SoundGrid network. This opens up two more important functions:

- Plugin processing is offloaded from the host processor (your local DSP) to a high-speed SoundGrid server. This provides much more CPU power than the local host can, which enables a significantly higher plugin count.
- When part of a SoundGrid network, StudioRack is integrated with SoundGrid Studio. This enables low-latency monitoring and recording. This means that when the DAW is in record, monitoring switches from the DAW to the server, which makes possible very low-latency record monitoring—an option that is not possible within the host. Switching between DAW to server and back to DAW follows the host's commands, in most popular DAWs.

PORTABILITY

Move a StudioRack from one track to another or from one DAW session to another, and rack organization, plugins and all presets will follow. Move a session from one studio to another, and the StudioRack—with all its properties—will follow. You will, of course, need the same plugins and licenses installed and activated in both systems, but you don't need the same hardware. The same StudioRacks will work when using your local CPU or a SoundGrid server.



Quick Start

FOLLOW THESE STEPS TO SET UP AND USE STUDIO RACK:

1. Instantiate StudioRack on a DAW track. The plugin will open with the main chainer rack.
2. To insert a plugin into a rack slot, click on the slot's plus sign (+). This opens the Plugins menu. Search for a plugin by name or navigate to it by category. The plugin will open in a floating window.
3. Once plugins are set up, adjust the rack input and output levels.
4. Rack signal flow is from top to bottom. Drag a plugin up or down the rack to change its position in the signal flow.

Use the buttons on the left side to select a view: Rack, Macro, or All.

FOR PARALLEL PROCESSING:

1. Select "Rack" or "All" view.
2. Open the Plugins menu and select "Parallel Split." Since the position of the Parallel Split insert determines its place in the signal flow, move the Parallel Split insert point to where you want it in the signal.
3. Use the plus sign (+) to add up to eight parallel processing racks.
4. Add plugins to the processing racks, just as you did in the main chainer rack. We suggest that you organize the plugins so that each rack represents a single type of process. You might, for example, want to design a set of parallel processing racks to process a drum track. On the first rack, add a bit of distortion and power to a drum track. Start, for example with distortion. Try Abbey Road Saturator and Schepps Omni Channel, then add PSR SuperModels for amp trash. On another parallel rack, take care of dynamics. And on yet a third rack, create your space. All of these parallel racks take the same input signal that their signals all return to the Parallel Split insert slot. Adjust the input and output levels and panning of the rack as needed.

FOR MULTIBAND SPLIT PROCESSING:

1. Open the Plugins menu and select "Multiband Split." Place the insert where you want the rack to fall in the signal flow. Use the plus sign (+) to open up to five crossover processing bands.
2. Control the crossover frequency between two bands by sliding up and down on the crossover value box. This defines what frequencies will be processed by each band.



TO LINK CONTROLS

There are three ways to assign plugin controls to a Macro, but (for now) we will describe only one method. [Macro assignment](#) is discussed in detail later in this user guide.

1. Select “Macro” or “All” view.
2. Open the plugins whose controls you want to assign to Macros.
3. One at a time, right-click on a plugin control. On the Add Macro sub menu, select the Macro you want to assign the control to. Once the control has been assigned, it will have a red trim on the plugin interface. Assign as many controls as you like to a Macro.
4. To edit the offset, direction, or limit of a control, select “Edit Macro” from the drop-down menu. This opens the Macros Edit Window, where you can set the range, direction, and offset of any control that’s assigned to a Macro.

Other ways to [assign and edit Macros](#) are described later in this user guide.

USING STUDIO RACK WITH SOUNDGRID

StudioRack can be used in conjunction with the SoundGrid Studio application to enhance performance. Using a basic SoundGrid Studio configuration and a server, plugin processing can be offloaded to the DSP server to greatly increase plugin processing. Adding an I/O and a server can enable low-latency monitoring while recording. This is carried out with the eMotion ST mixer, which is a key element of SoundGrid Studio. There are several SoundGrid Studio configurations—larger configurations offer more mixer channels, auxes, and groups, but all configurations allow DSP offloading.

SoundGrid Studio must be installed and configured for StudioRack to work in the SoundGrid processing mode.

[Using StudioRack with SoundGrid Studio](#) is described later in this user guide.



Getting Around StudioRack

Selecting a View

StudioRack has four basic sections: Racks, Macros controls, Macros editing, and floating Plugin windows. Use the buttons on the left side to select a view.

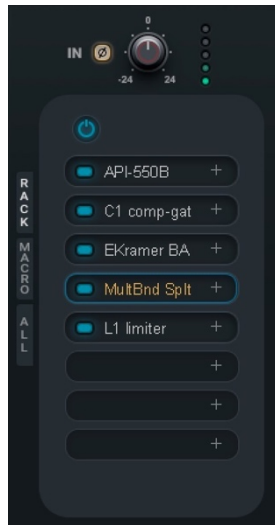

RACKS

There is one main plugin chainer rack that accepts up to eight plugins. From here you can also insert Parallel Split racks and Multiband Split racks.



MACROS

Macros let you link controls of one or more plugins. Right-click on any control to open the Macro assignment drop-down menu and assign the control to one of eight Macros.

MACROS EDITOR

The Macros Edit Window is where the range, start and stop points, and direction are set for Macro-assigned controls.

Macro	Plugin	Control Name	Slot	Control Range	Macro Range
1	C1 comp-gate	#S2:C1 comp-gate:Gate Attack	2	Min: 0.01ms, Max: 1000.00ms	0 - 1000
2	Main Rack	Input Gain	-	Min: -24.0, Max: 24.0	328 - 1000
3	EKramer BA	#S3:EKramer BA:Sensitivity	3	Min: -50.0, Max: 50.0	261 - 539
Drum Middle	MultiBand Split	#S4:MultiBand Split:Rack 4 Inp	4	Min: -24.0, Max: 24.0	305 - 1000
5	EKramer BA	#S3:EKramer BA:Output 2	3	Min: -50.0, Max: 50.0	0 - 1000
6	API-550B	#S1:API-550B:In	1	Min: Out, Max: In	133 - 533
AIR	MultiBand Split	#S4:MultiBand Split:Rack 4 Out	4	Min: -Inf, Max: 12.0	261 - 722
8	API-550B	#S1:API-550B:Low Gain	1	Min: -12 dB, Max: +12 dB	183 - 833



Floating Plugin Panels

Click on a plugin name in a rack slot to open the plugin in a floating window.

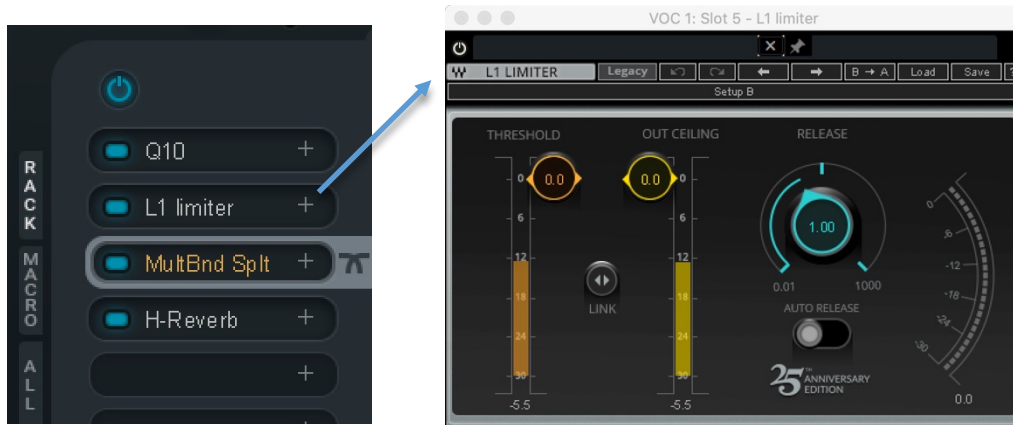

Floating windows can be positioned anywhere and will remain visible until closed. If a plugin interface is hidden by another object, it remains open and can be brought to the front by clicking on its rack icon. Pin a window and it will remain in front in any view or application.



Floating plugin panels are controlled in the area above the WaveSystem Toolbar.

- 1 Plugin channel and plugin name.
- 2 In/Out button bypasses the plugin.
- 3 Pin window. When the pin is active, this window will remain in the front.
- 4 Close all plugin windows.
- 5 WaveSystem Toolbar. Used by all Waves plugins for presets management, undo/redo, and other functions. Appearance and tools vary slightly by plugin. To learn more, read the [WaveSystem Toolbar user guide](#).
- 6 Hide this floating plugin window.



StudioRack Windows

Main Insert View

The main page has eight plugin slots and input and output sections. From any slot, you can insert additional processing racks for parallel processing and Multiband Split racks to process by frequency band.

The screenshot shows the StudioRack Main Insert View interface. At the top is the WaveSystem Toolbar with icons for undo, redo, and navigation, along with buttons for 'A → B', 'Load', 'Save', and a help icon. Below this is the SoundGrid Studio Control Bar showing '79%' usage, '10 / 128' slots, 'SG' logo, and channel information 'emoST Channel 3 L'. The main interface features an Input Section with a phase reverse button (1), an input gain knob (2), and a main rack on/off button (3). A central rack contains a list of plugins: Q10, PgTc MEQ5, H-Reverb, and a limiter (4). To the right is the Output Section with an output fader (5), a full-scale meter (6), a fader position indicator (7), and two peak value meters (8). At the bottom, the total gain reduction of the main chainer is shown (9) and the DAW Track Name 'CHR 1' is displayed. Labels on the left side identify the SoundGrid Studio Control Bar, Input Section, Processing View Selector, and Main Plugins Rack. Labels on the right side identify the WaveSystem Toolbar, Output Section, and DAW Track Name.

WaveSystem Toolbar

SoundGrid Studio Control Bar

Input Section

Processing View Selector

Main Plugins Rack

Output Section

DAW Track Name

- 1 Input Phase Reverse
- 2 Input Gain
- 3 Main Rack On/Off
- 4 Plugin Bypass
- 5 Output Fader
- 6 Full-scale Meter
- 7 Fader Position
- 8 Left and Right Peak Values
- 9 Total Gain Reduction of Main Chainer



Parallel Split View

A Parallel Split is an insert on the plugin rack that splits the signal and sends it to up to eight more racks for additional processing. This is similar to copying the DAW source track several times, sending each copy to an aux track for processing, and returning each signal to the DAW; except that in StudioRack all of this happens on one track. This way, the different processes are parallel to each other, not in a series (like a chainer rack). One parallel rack is not influenced by the others.

Each processing rack has gain and phase reverse controls, and stereo racks can be panned and rotated individually.

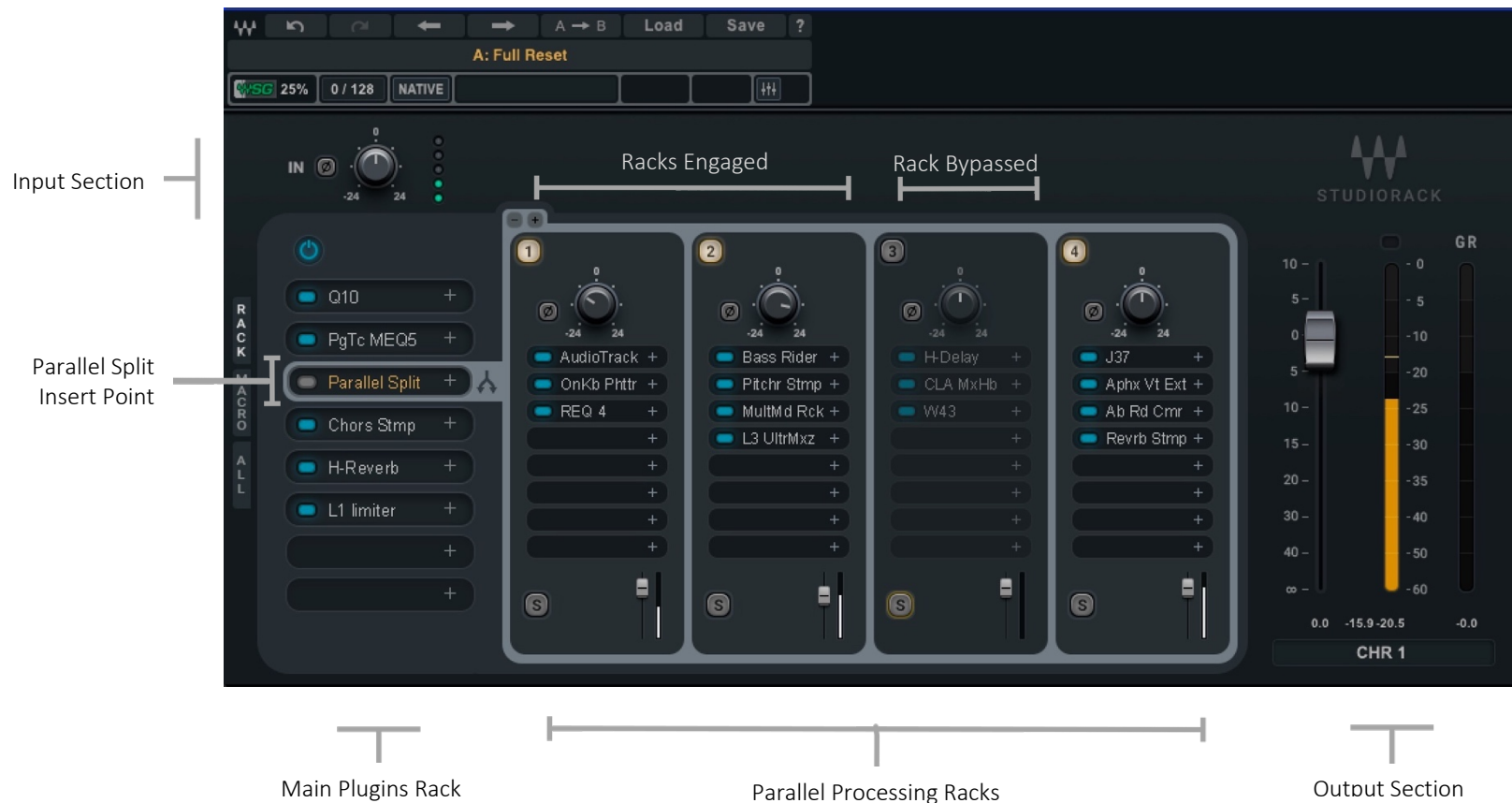

Macros View

There are eight Macro Controllers, to each of which you can assign plugin controls or other StudioRack controls. This lets you group controls and adjust them together. Macro assignments can span several plugins, and once you create a group, you can name the Macro.



Multiband Split View

A Multiband Split Rack, like a Parallel Split, is an insert in the plugin rack from which you can send and return a signal for processing. In the Multiband Split mode, there is an adjustable crossover between the processing racks, so each rack can process different parts of the frequency spectrum. There can be up to five processing racks per Multiband Split Rack insert.

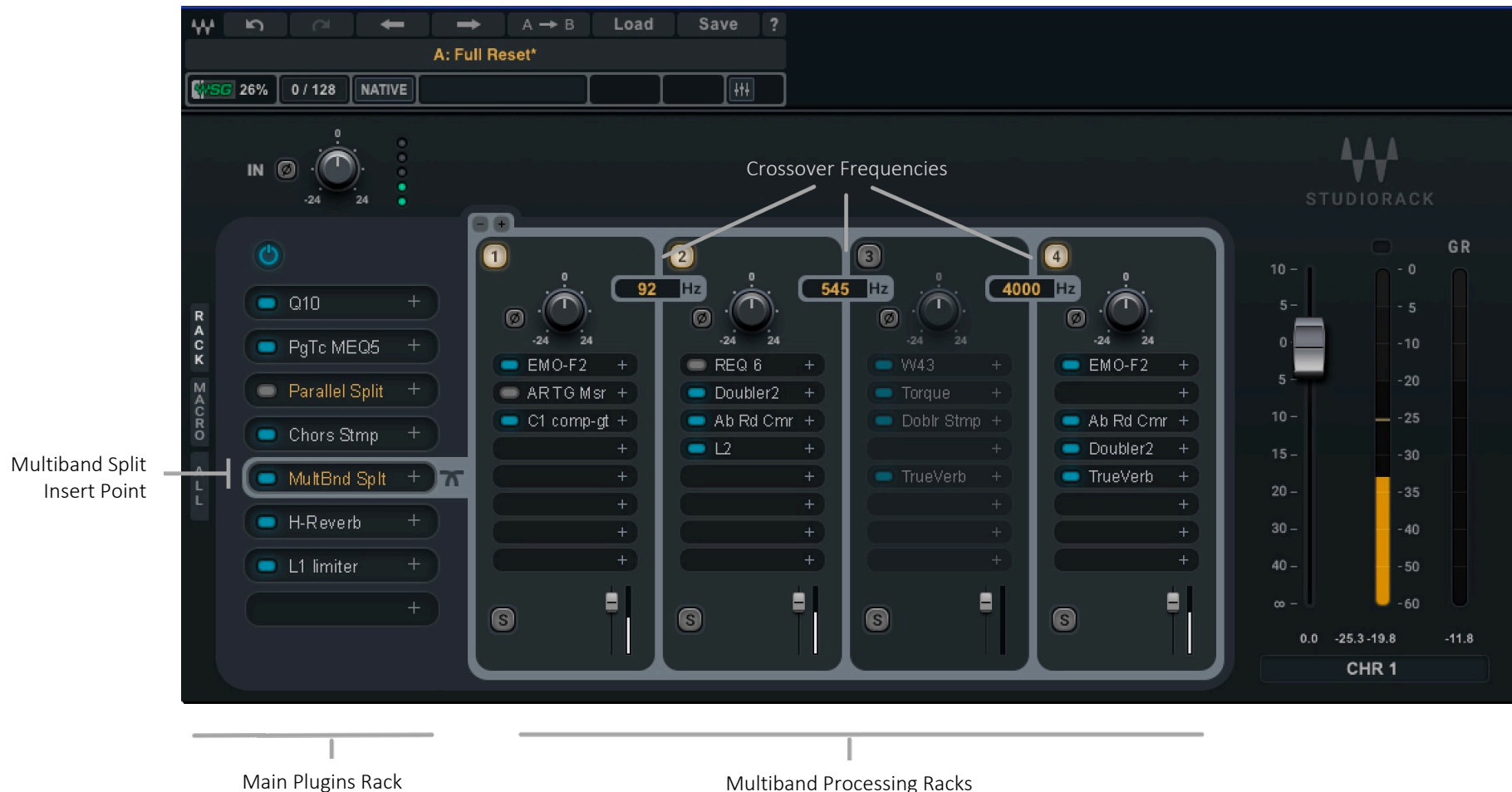

Using StudioRack

Adding Plugins

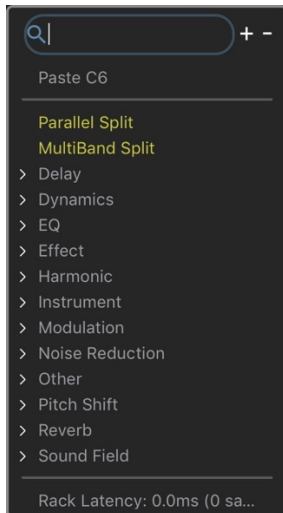

- To add plugins to a rack slot, click anywhere in a slot and choose from the list of plugins. This is the Plugins menu.
- You can search for the plugin's name or browse by category.
- The new plugin will open as a floating widow that you can position anywhere on your displays. Double-click on a plugin name to close or reopen its floating window. Up to five plugin floating windows can be open at the same time. Close a floating window with the OS close window.
- You can show/hide a plugin by clicking on its rack slot.

Components and Racks

Mono

Instantiated on a mono DAW track. Only mono plugins can be inserted in a StudioRack.

Stereo

Instantiated on a stereo DAW track. Only stereo plugins can be inserted in a StudioRack.

Mono-to-Stereo

When mono components are inserted, the rack is mono. If you insert a mono-to-stereo plugin, that plugin will be stereo, as will all rack slots later in the signal flow (lower in the rack). Plugins earlier in the signal flow (above) will remain mono.

This enables you to apply mono processing to a signal (e.g., EQ, Dynamics) in order to keep the image tight, and then add stereo delay and reverb to create a stereo image.

A mono StudioRack can be converted to a stereo StudioRack by changing the component in the host DAW. All plugin settings will be preserved. This is useful if you build a complex mono processing chain, and then decide to add a stereo reverb, for example, at the end of the chain.



Managing, Moving, and Copying Plugins

Tools for managing a plugin are at the top of the Plugin Menu.

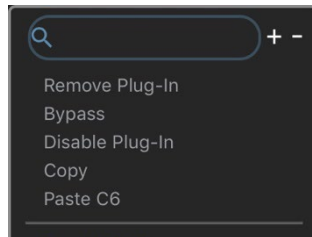

Remove Plugin deletes the plugin from the rack slot. All parameter settings and control assignments are lost.

Bypass bypasses the plugin while keeping it in the processing chain. It does not reduce latency or CPU. Click on the small blue light next to the plugin name to bypass/un-bypass the plugin. You can also bypass/un-bypass the plugin with the power button at the top of the frame.

Disable Plugin removes the plugin from the processing chain without deleting it from the rack. Disabling a plugin removes its latency from the rack. It also frees up processing power. You can re-enable a disabled plugin without losing its settings, controls, or automation assignments.

Copy copies the plugin and its parameters. Please refer to the next page.

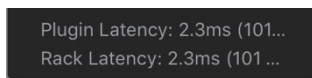

Latency indicates the delay introduced by the plugin.

Rack Latency shows the total latency of all plugins in the StudioRack, including Parallel Splits and Multiband Split racks. If no latency is declared by any of the plugins in the rack, both latency sections will be grayed out.

MOVING PLUGINS

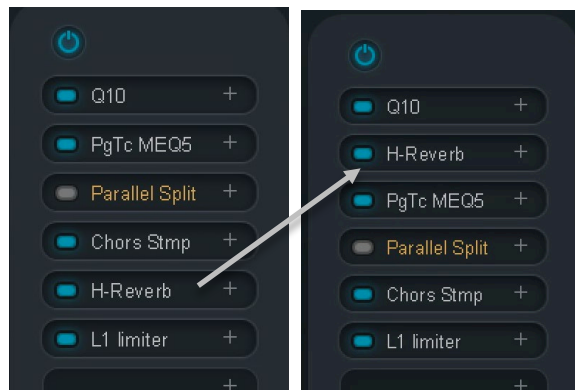

You can change the order of the plugins in the rack simply by dragging them up and down. This changes the plugin's place in the signal flow, which affects the plugins lower in the rack. Changing a plugin's position in the rack may alter the gain structure of the rack, so you may need to rebalance some plugin levels.

You may choose to keep the first slot in a Parallel Split rack or a Multiband Split rack empty. This enables you to later propagate a plugin at the top of each rack's signal flow without repositioning all of the other plugins in the rack.



COPYING PLUGINS AND PLUGIN PRESETS

Any plugin and its settings can be copied to an empty rack slot or pasted into a currently populated slot.

Copy Plugin

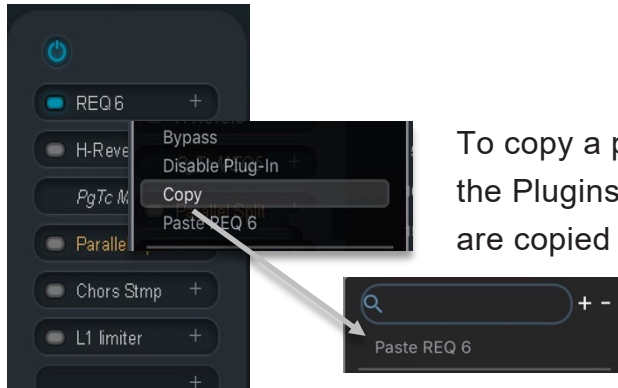

To copy a plugin and its preset (settings), select the plugin and choose “Copy” from the Plugins menu. In this example, Renaissance 6 EQ (REQ6) and its current preset are copied to the clipboard

The copied plugin and its preset can be pasted into an empty slot or a slot that already has a plugin. If the slot is populated, then *Paste [plugin name]* will replace the existing plugin. The preset for the replaced plugin is lost unless it has been saved with the WaveSystem Toolbar.

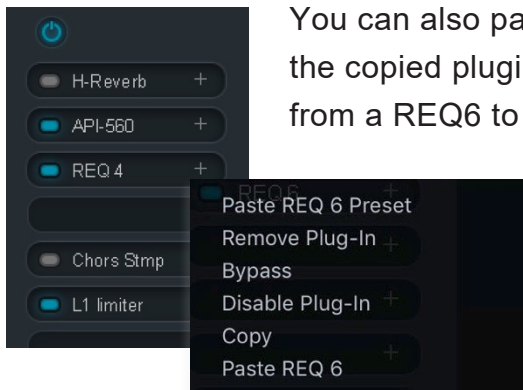

You can also paste only a plugin’s preset. Select *Paste [plugin name] Preset*. This requires that the copied plugin is of the same plugin family as the target. You can, for example, paste a preset from a REQ6 to a REQ4. You cannot, however, paste a preset from a REQ6 to a Q6.

When you cannot paste presets only, then your only option is *Paste [plugin name]*, which replaces the plugin and its preset.

Plugins and plugin presets can be copied to and from the Main chainer rack, Parallel Splits, and Multiband Split Rack. In the Parallel Split or Multiband Split Rack views you can *move* plugins between racks. To *copy* a plugin to another rack, Opt/Alt + drag the plugin.



Parallel Split Insert

A plugin chainer is, by its nature, serial. The output of a plugin becomes the input of the next one, so each plugin's processing is influenced by its predecessor. Normally, this is what you want to do in a DAW insert. There are, however, times when you want to process one signal in several different ways with several racks working in parallel. All the racks have the same input and are not influenced serially by each other's processing.

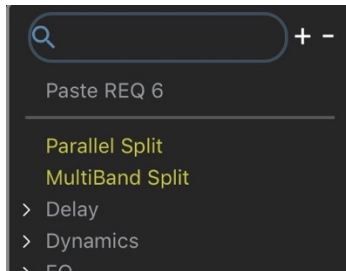

To process several racks in parallel, choose a plugin slot and select “Parallel Split” from the top of the plugin menu. A Parallel Split's position in the rack determines the place of all of its hosted racks in the signal flow.

Each Parallel Split can host up to eight parallel processing racks.

Add and manage plugins in the same manner as in the Main Chainer. The processed signals from each parallel rack are delay compensated and returned to the same Parallel Split slot in the Main Chainer.

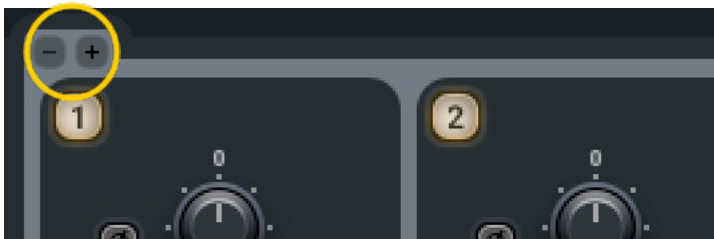

To add or remove processing racks, click on the plus (+) or minus (-) symbols at the top of the racks. When a rack is removed, all of its contents and presets are lost. You will be prompted to confirm this choice.

[Parallel Rack input and output](#) controls are described later in this user guide.



Parallel Split Signal Flow

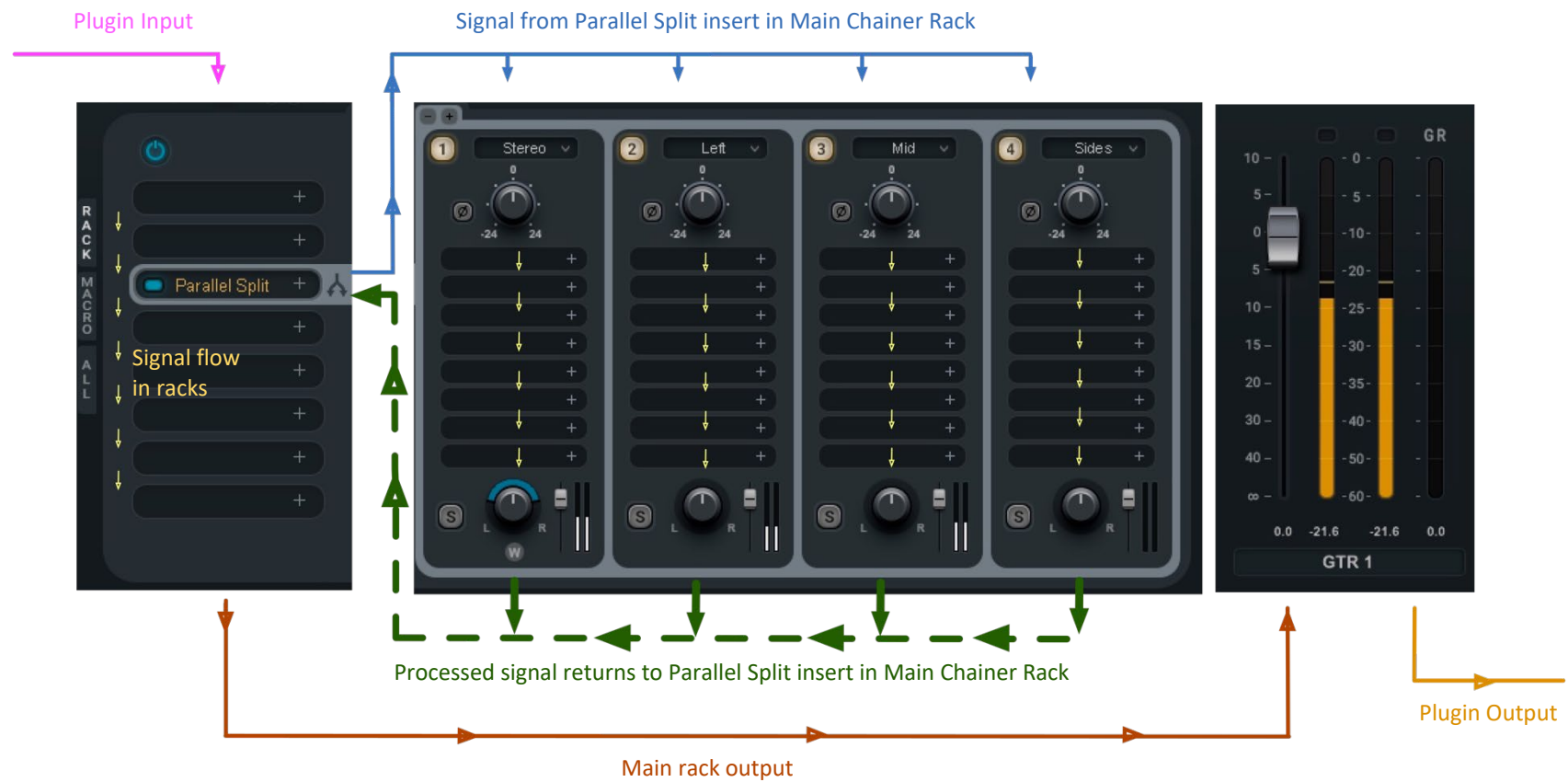

Multiband Split

Multiband processing enables you to split a signal into adjustable frequency bands and process each band separately. There can be up to five processing bands with four crossovers.



- 1 To adjust the crossover between processing bands, drag the crossover value up or down.
- 2 Add or remove processing bands with the +/- symbol on the left.

CROSSOVER RANGES

Crossover 1	92 Hz to 545 Hz
Crossover 2	545 Hz to 4000 Hz
Crossover 3	4000 Hz to 11,071 Hz
Crossover 4	11,071 Hz to 20,000 Hz



Multiband Split Rack Signal Flow

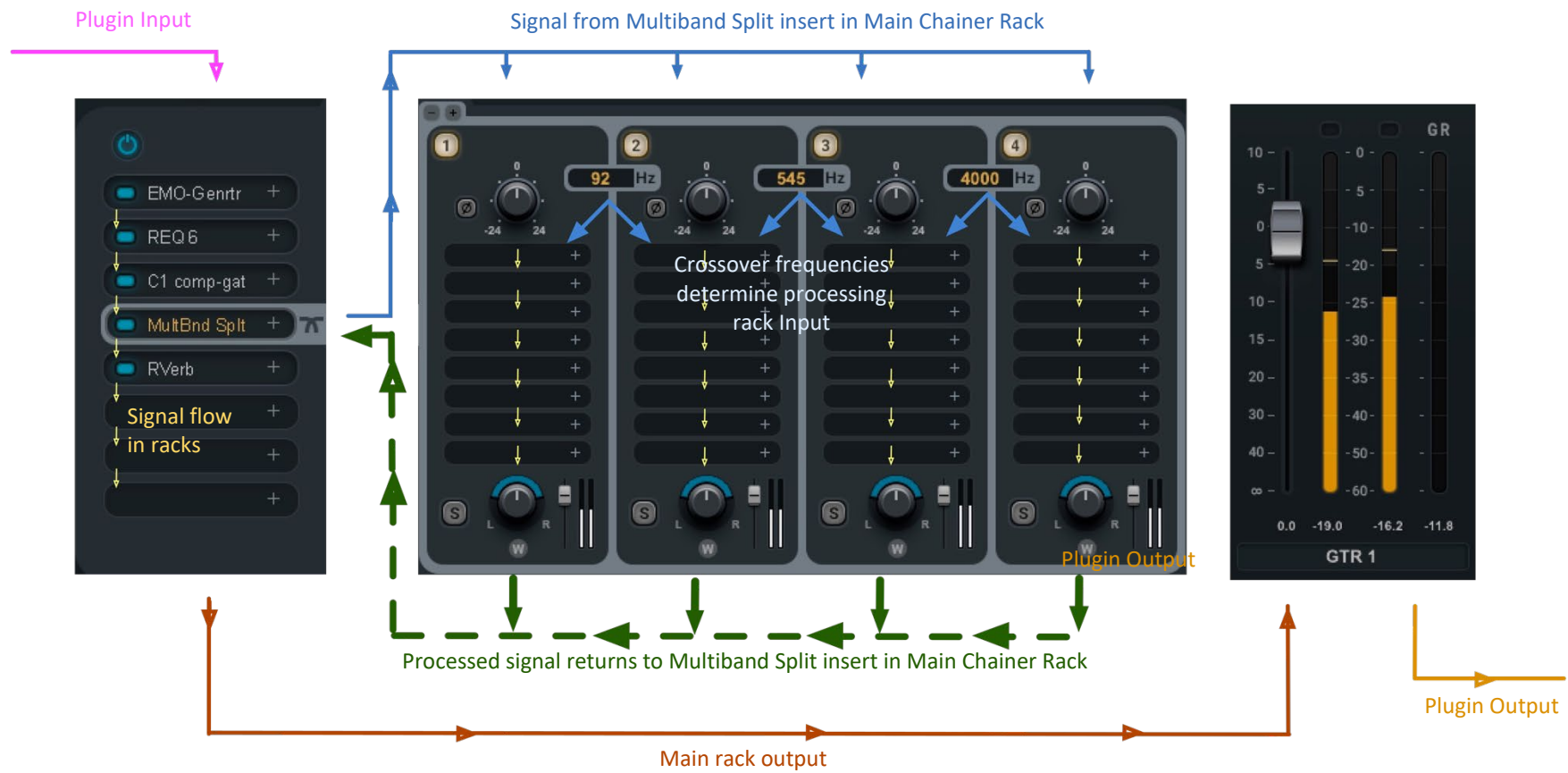

Internal Sidechain

There are four sideband sources for Parallel Split and Multiband Split racks. Click the SC button on the upper left corner of a sidechain-enabled plugin and choose from the menu. This selection affects the entire rack, not just the plugin.

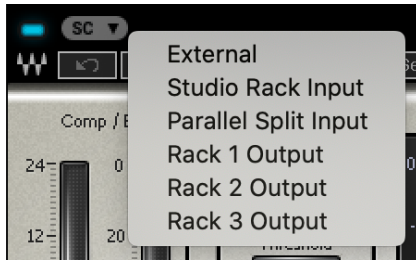

External	Sidechain signal is from the internal patch of the host DAW.
StudioRack Input	Sidechain is from plugin input, before input gain control, before main rack processing.
Parallel or Multiband Split Input	The Split insert in the main rack is the sidechain source.
Rack # Output	A specified Multiband Split or Parallel Split rack is used to create the sidechain for a plugin in a later split rack. Before rack gain control, before mute control, after panner.

USING THE MAIN RACK AS A SIDECHAIN



In this example, we want to drastically compress a drum while adding distortion from a stomp. We don't want the compressor to be triggered by the stomp action, so it is placed after the stomp and is triggered by a sidechain from the parallel insert split in the main rack. When the split insert is the sidechain source, any plugins above the split (in this case, an SSL Channel) will influence the sidechain.

USING A SPLIT RACK AS A SIDECHAIN



A PuigTec EQ in Parallel Rack 1 is shaping the sidechain used by HComp in rack 3. Note that Parallel Rack 1 is muted—it is used only for sidechain, so we do not want to hear it in the mix.

Sidechain signal flows from left to right. Split rack 2, for example, can provide a sidechain for racks 3 and higher, but not for rack 1.



Input, Output, and Imaging Controls

Main Chainer

The main input and output sections are visible in all views.



The rack input level is adjustable from -24 dB to +24 dB. A small, full-scale meter with a clip indicator shows post-fader input gain. Click on the meter to reset the clip light. There is also a phase invert switch.

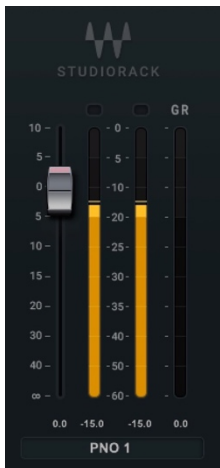

The main output section consists of a full-scale meter and a fader (range: -infinity to +12 dB). Fader position is shown beneath the fader. Meter peak level (L/R) is shown beneath the meter. Click on the peak light to reset the peak level and clip indicators.

The host DAW track name is displayed at the bottom of the output section.

Parallel and Multiband Split Racks Input



Main Rack: Stereo

Stereo Parallel Split
Stereo Source

Stereo Parallel Split:
Mono Source

The Parallel racks and Multiband Split racks have input controls and phase reverse buttons at the top of each rack. Click on the rack's number to turn the rack on or off.

Select the rack input source with the drop-down menu.

Note: A stereo StudioRack output is always two channels, even if the input source is mono (e.g., left, right, mid, or sides).



Panning, Rotation, and Rack Output Level



A stereo rack with a stereo source (image on the left) can be panned and rotated. A stereo rack (right) with a mono source can be panned but not rotated.

1 Pan/Balance Control Knob

A mono StudioRack has a mono input and output. A mono signal (i.e., left, right, mid, or sides) in a stereo rack can be panned between left and right channels. Turning the knob causes a gain decrease in one channel and a corresponding increase in the other. The sound image moves left and right, but the internal balance may be affected.

2 Stereo Rotator

When working with a stereo component, the S1 stereo rotator lets you move an entire stereo image, to change its size asymmetrically and to change the width of the image. The colored area around the panner indicates the width and orientation of the stereo image. Drag this area to rotate the image. This moves the entire stereo image, so the internal balance is unchanged.

3 Stereo Width Adjust

Drag up and down on the “W” button to change the width of the stereo image. When you drag the width value to less than zero, the sides of the stereo image will reverse. The colored ring will turn brown to indicate this condition.



OTHER RACK OUTPUT CONTROLS AND DISPLAYS

4 Rack Output Fader

Range: -infinity to +12 dB

5 Rack Output Meter

Range: -infinity to 0 dB

6 Solo

Solos the rack with respect to the other Parallel Split or Multiband Split racks in this insert. It does not mute other plugins in the main rack.

There is no Mute button on a Parallel Split or Multiband Split rack. Use, instead, the Rack On/Off button at the top of the rack.

Track Name

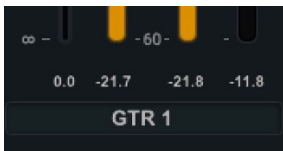

The name of the DAW track on which this StudioRack is instantiated is displayed in the box below the meters. If you change the track name in the DAW, this name will change accordingly. Some DAWs do not support track naming, in which case you can fill in the Track Name manually.



Latency

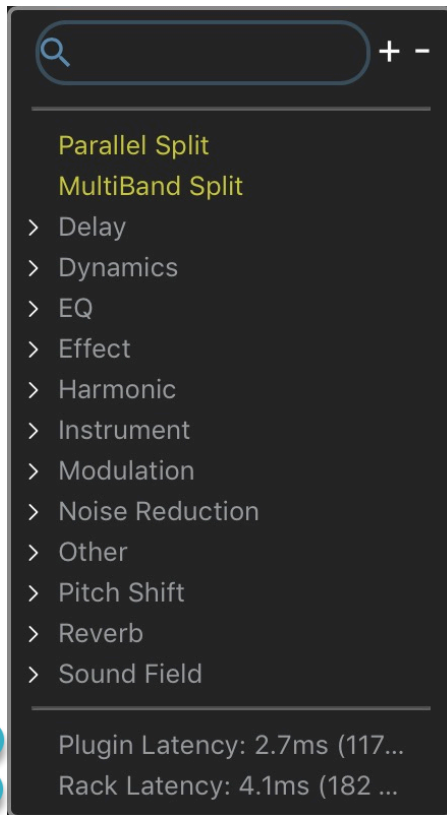

Latency is the delay imposed on a signal as it passes through a buss. The most common source of latency is plugin processing, but buss summing can also increase delay. It's likely that different racks will have different latencies, since each has its own plugins. When these racks are summed, they must be time-aligned. Otherwise, their signals may not be in sync.

StudioRack measures the total latency of all of the plugins in the main rack, which includes the latency of any Multiband Split racks and Parallel Splits and their plugins. Once calculated, this latency is reported to the DAW's latency compensation engine.

The latency of a specific plugin as well as the total latency of the StudioRack are shown at the bottom of the plugin menu. There are two latency indicators:

- 1 Latency of the selected plugin: 117 samples
- 2 Latency for all busses and plugins in the StudioRack instance: 182 samples.

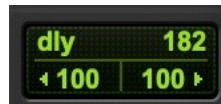

This value is reported to the Host.

In native StudioRack, buss latency and the maximum number of plugins in the DAW session is determined by the speed and power of the host computer. The faster its CPU, the more plugins it can process simultaneously.

When a StudioRack is connected to a SoundGrid network with a SoundGrid server, all plugin processing is offloaded to the server. This greatly increases the number of plugin instances, and can reduce system latency.



Using Macros

One instance of StudioRack can hold many, many plugins. It's likely that from time to time you will want to adjust several controls on one or more of these plugins simultaneously. You may want, for example, to simultaneously control a number of parameters to adjust a type of effect you named "Sparkle" so that you can dynamically control whatever it takes to add or reduce the "sparkle" of that instance.



StudioRack lets you do this easily. Each instance of StudioRack has eight Macro control knobs that let you link controls on any of its hosted plugins in the Main chainer rack, the Multiband Split racks or the Parallel Split racks. You can assign controls to a Macro knob, then adjust the range, scope, and direction of each control.

ASSIGNING PARAMETER CONTROLS

There are three ways to assign parameter controls to a Macro:

1. Assign from Macro knob.
2. Assign from a plugin control.
3. Assign with the Assign button at the bottom of the Macros panel.



ASSIGN MACROS FROM THE MACRO KNOB



1. Right-click on an unused Macro knob. You will see a list of all the inserted plugins in the main plugin slot, including Parallel Split and Multiband Split racks. In Parallel Split and Multiband Split racks, the letter “S” followed by a number identifies the rack slot number.
2. Click on a plugin name to open a drop-down menu of the controls that can be assigned to the Macro.

3. Select a control to assign. Repeat for as many controls as needed. The plugin input gain and output gain can also be assigned.
4. Double-click on the Macro name box to give it a descriptive name.

Assigning Macros to Parallel Split and Multiband Split Racks from the Macro Knob



Controls for all rack slots are listed sequentially by slot:

S1–S8 Rack 1; S9–S16 Rack 2; S17–S24 Rack 3, etc.



Assign Macros from the Plugin Controls



1. Right-click on a plugin control that you want to assign to a Macro. This opens the Macro Assignment menu.
 2. Select the Macro to which you want to assign the control. Variable controls (e.g., knobs, faders) and switches can be assigned.
 3. In addition to plugin controls, Parallel Split and Multiband Split Rack chainer controls can be assigned to a Macro.
- Any number of controls can be assigned to a Macro, but a single control can be assigned to only one Macro.

Assign Macros with the Assign Selector

1. Click the Assign button. All Macros will flash.
2. Select a Macro. It alone will continue to flash.
3. Click on the controls that you want to assign to the Macro. You can assign controls in any plugin, in any rack, in any number, within this instance of StudioRack.
4. Click Assign to save and exit the assignment.



A plugin control that has been assigned to a Macro is outlined in red.

To remove a control from a Macro, or to assign it to another Macro, right-click on the control and choose from the menu.



Editing Macros

Use the Macros Edit Window to adjust how the assigned controls behave when the Macro is moved. There are three ways to access the window:

1. Right-click on a Macro knob. Select “Edit Macro.”
2. Right-click on any assigned control.
3. Click the “Edit” button at the bottom of the Macro panel.

MACROS EDIT WINDOW

Macro	Plugin	Control Name	Slot	Control Range	Macro Range
1	C1 comp-gate	#S2:C1 comp-gate:Gate Attack	2	Min: 0.01ms Max: 1000.00ms	0 to 1000
2	2a Main Rack	Input Gain	-	Min: -24.0 Max: 24.0	328 to 1000
3	2b EKramer BA	#S3:EKramer BA:Sensitivity	3	Min: -50.0 Max: 50.0	261 to 539
Drm Middle	2c MultiBand Split	#S4:MultiBand Split:Rack 4 Inp	4	Min: -24.0 Max: 24.0	305 to 1000
5	EKramer BA	#S3:EKramer BA:Output 2	3	Min: -50.0 Max: 50.0	0 to 1000
6	API-550B	#S1:API-550B:In	1	Min: Out Max: In	133 to 533
AIR	MultiBand Split	#S4:MultiBand Split:Rack 4 Out	4	Min: -Inf Max: 12.0	261 to 722
8	API-550B	#S1:API-550B:Low Gain	1	Min: -12 dB Max: +12 dB	183 to 833



1	Macro Number	Identifies the Macro Control knob.
2	Plugin Name	Defines what populates this slot: (2a) Main rack controls (not plugins) are identified with "Main Rack." (2b) A plugin in the Main rack is identified by its name. (2c) Parallel Splits and Multiband Split Racks do not identify their hosted plugins here.
3	Control Name	Identifies a control within the Plugin (Plugin Name) that is controlled by the Macro. Parallel Splits and Multiband Split Racks identify controls first by processing slot number (#S), then by plugin name, and then by the name of the control.
4	Slot Number	Identifies the rack slot number.
5	Control Range	Limits how much a control can be changed by a Macro. Also sets the direction of the control (i.e., high-to-low or low-to-high).
6	Macro Scale	Sets which part of a Macro knob's rotation will affect the control.

Control Range sets the minimum and maximum values of the plugin or rack control that is assigned to a Macro.



At its default setting, the assigned control will move through its complete range, directly linked to the Macro knob.

When the range is reduced, the control will be limited to a narrower range, even when the Macro knob turns entirely. In this example, the control will move only between 50% and 70% of its range. Drag up or down over a value box to change its setting.

The arrows in the middle reverse the direction of the control.

Macro Range sets the points in the movement of the Macro at which the control will begin and end its movement.

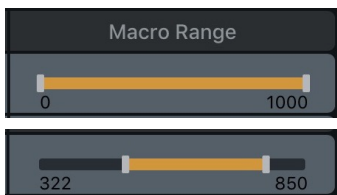

At its default setting, the assigned control will begin and end its movement with the full range of the Macro.

Limiting the Range means that the assigned control will begin and end its movement only when the Macro is within your defined limited range.



About Automation

If you are automating a very large number of plugins in the Main rack and Parallel Split and Multiband Split racks, we suggest that rather than assigning controls with the DAW's plugin automation panel, you assign directly from the controls themselves. This prevents running out of automation lanes and thus not seeing the control when automating. Select a control and then Ctrl+Opt+Cmd+Click (Mac), Ctrl+Alt+Win+Click (PC) *Pro Tools only*.



Using StudioRack with SoundGrid

Using StudioRack together with SoundGrid Studio opens new processing capabilities. SoundGrid is the Waves networking protocol that connects and controls devices on an Ethernet network, and SoundGrid Studio is the application that controls this network.

- When StudioRack is used as part of a Waves SoundGrid network, plugin processing is offloaded from the host computer to a dedicated SoundGrid server. This results in a significant increase in the total number of plugins that can be used simultaneously.
- A StudioRack can become an integral part of SoundGrid Studio's eMotion ST mixer. This enables low-latency monitoring and recording, and it lets you control up to 16 StudioRacks at once.
 - When a StudioRack is in **Playback** mode, the signal plays through the DAW's StudioRack plugin, with its inserted plugins. This is normal DAW playback. But when you switch the StudioRack to **Input** mode, DAW playback is bypassed from the DAW, and all processing—with the same plugins—takes place inside the mixer. Monitoring from the Mixer eliminates system latency and lets the artist hear an uninterrupted input signal while recording.
 - Switch back to Playback mode and you will once again hear playback from the DAW. Several grouped StudioRacks can automatically punch in or out together, triggered by the DAW transport.

A StudioRack (in SG mode) that has been assigned to a SoundGrid Studio input channel will appear in the eMotion ST StudioRack layer with the same functionality as other mixer channels.



SoundGrid Essentials

This is an overview of using StudioRack with SoundGrid Studio. For information about setting up, configuring and using SoundGrid Studio, please refer to the SoundGrid Studio user guide.

To use StudioRack in the SoundGrid mode, the host computer must be running SoundGrid Studio and the SoundGrid network must include a server and at least one I/O device. A non-SoundGrid I/O device can be integrated into the network using SG Connect, but offload processing will not occur in real time. To enable real time offload processing, a SoundGrid I/O must be used (this is described later).

When you first set up SoundGrid Studio, you will be prompted about how you want to configure your I/O devices and server, as well as your monitor I/O channel. Once SoundGrid Studio is installed and configured, SoundGrid processing will be available to all instances of StudioRack in the DAW session.

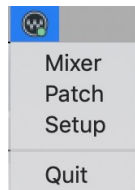

A small SoundGrid Studio icon on the Menu Bar (Mac OS) or Task Bar (PC) shows that SoundGrid Studio is running.

Use the drop-down menu to move directly to a window or to quit the application. SoundGrid Studio will launch automatically the next time you start the computer or if you choose to launch it manually.

A SoundGrid network includes these components:

HOST COMPUTER: CONTROL SOUNDGRID STUDIO AND THE DAW



The host computer controls the mixer and the SoundGrid network that connects all devices and streams audio. Applications, plugins, and preset files are located here. With Native systems, plugins processing is carried out on the host. When a SoundGrid server is assigned to the system, processing is done on the high-speed server.



SOUNDGRID SERVER AND I/O

OFFLOAD PLUGIN PROCESSING AND ENABLE LOW-LATENCY MONITORING

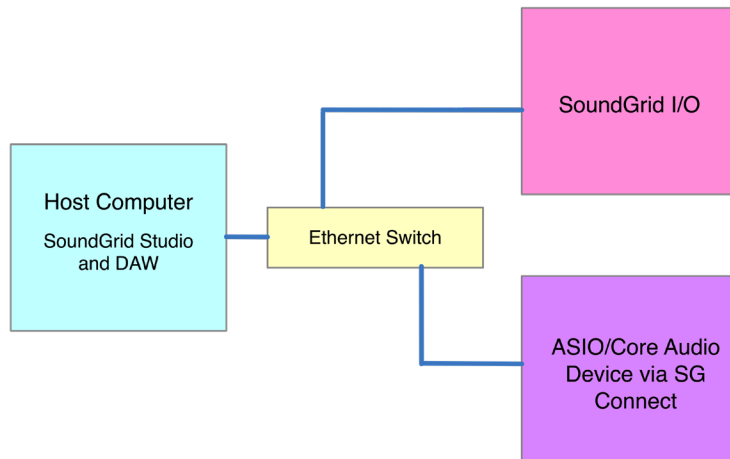

To offload processing, add a SoundGrid server and at least one SoundGrid I/O. The StudioRacks in the DAW session control the connections to the mixer and the DAW. For offload processing alone, you can use SG Connect, a feature of the SoundGrid driver, assign an ASIO/Core Audio device driver to SoundGrid Studio. This replaces a SoundGrid I/O for offload processing.

Use a SoundGrid I/O and you can also use the SoundGrid Studio eMotion ST mixer. This is a full-feature studio mixer that enables low-latency monitoring during recording. This feature is not possible with non-SoundGrid I/O devices.

The speed of the server has a direct impact on the number of SoundGrid channels and plugin instances. There are a number of server configuration options. Visit www.waves.com/hardware for up-to-date specifications and requirements about servers and other hardware components.

When there is more than one device in the network, you must use a 1 Gb Ethernet switch to connect all devices. We advise against “daisy chaining” from one device to another.

TO SET UP SOUNDGRID STUDIO, FOLLOW THESE STEPS:

1. Install the SoundGrid Studio app from Waves Central.
2. Connect the server, I/O devices, and the host to the Ethernet switch using Cat. 5e or better Ethernet cable.
3. Launch SoundGrid Studio.

Please refer to the [SoundGrid Studio user guide](#) for setup details.



SETUP WINDOW OVERVIEW



When you first launch SoundGrid Studio, it will configure itself based on your inventory and your needs. If StudioRack encounters problems communicating with SoundGrid Studio, you will be prompted as to what action to take. You can then set up the link between the StudioRacks in the DAW session and the SoundGrid Studio eMotion ST mixer.

- 1 Quit application
- 2 System controlling SoundGrid Studio
- 3 Start auto-configuration
- 4 Host network port select
- 5 Re-scan network ports
- 6 Network link up/down
- 7 Network speed
- 8 Sample rate selector
- 9 I/O racks (hardware + software I/Os)
- 10 SoundGrid driver assignment
- 11 SG Connect assignment
- 12 Server Racks
- 13 Control racks
- 14 Mixer config settings
- 15 Interface preferences



Offloading Processing from the Host Computer to the Server

Offloading requires a server and at least one I/O. You can use a SoundGrid I/O device or a third-party device with an ASIO/Core Audio driver. Each DAW channel for which you want to offload processing must have an instance of StudioRack.

Adding a Server

Configuring the server is just a matter of connecting it to the Ethernet switch and powering it up. SoundGrid Studio will detect the server, ask if you want to assign it, and then add it to your inventory. If the server requires a firmware update, the “FW” button on the server icon will be lit. Click on the button and the firmware will be brought up to date.

Assigning an I/O Device

USING A SOUNDGRID I/O DEVICE

1. *Launch SoundGrid Studio.* If this is the first time you have opened SoundGrid Studio, you will need to Auto-configure.
2. *Configure the DAW for Offload Processing:*
 - a. Launch your DAW.
 - b. Select “Waves SoundGrid” as the playback engine.
 - c. Insert StudioRack on all channels that will be offloaded to the SoundGrid server for DSP processing.
 - d. Open each StudioRack and set the StudioRack Processing mode to “SG.”

USING A NON-SOUNDGRID I/O DEVICE

SG Connect is a feature of the SG Driver that enables an ASIO/Core Audio device to appear in the SoundGrid Studio inventory as a SoundGrid I/O. This lets you incorporate a non-SoundGrid device in a SoundGrid network for high-speed offload processing. When you run Auto Config and if no SoundGrid I/Os are present in the network, you



will be asked if you want to assign the SG Connect driver. If so, it will be assigned its dedicated slot. It can be assigned only to this slot.

An assigned ASIO/Core Audio device (e.g., RME, MOTU) appears in the Local Devices assignment submenu.



Once assigned, the device will appear in the assignment menus and the Patch just like any other device.

CONFIGURE THE DAW FOR OFFLOAD PROCESSING

- a. Launch your DAW.
- b. Select your audio interface's driver as the playback engine ("Windows built-in" must use ASIO4ALL).
- c. Insert StudioRack on all channels that will be offloaded to the SoundGrid server for DSP processing.
- d. Open each StudioRack and set the StudioRack Processing mode to "SG."

There's nothing else to set. All DAW channels with a StudioRack in the SoundGrid processing mode will offload processing to the server.



The SoundGrid Connect feature is designed primarily for the studio, to help you offload CPU from your computer to a SoundGrid server. It is not recommended for live sound or low-latency monitoring while recording.



Low-Latency Monitoring During Recording

Low-latency monitoring while recording is accomplished by sending the input signal from the I/O directly to a SoundGrid DSP server (see diagram). When StudioRack is in playback mode, the monitor signal passes through the DAW, as is expected. When the StudioRack monitor status switches to input, the I/O input signal is split to two paths. One path goes to the DAW and the second—for low-latency monitoring—goes directly to the inserted StudioRack, bypassing the DAW buffering latency.

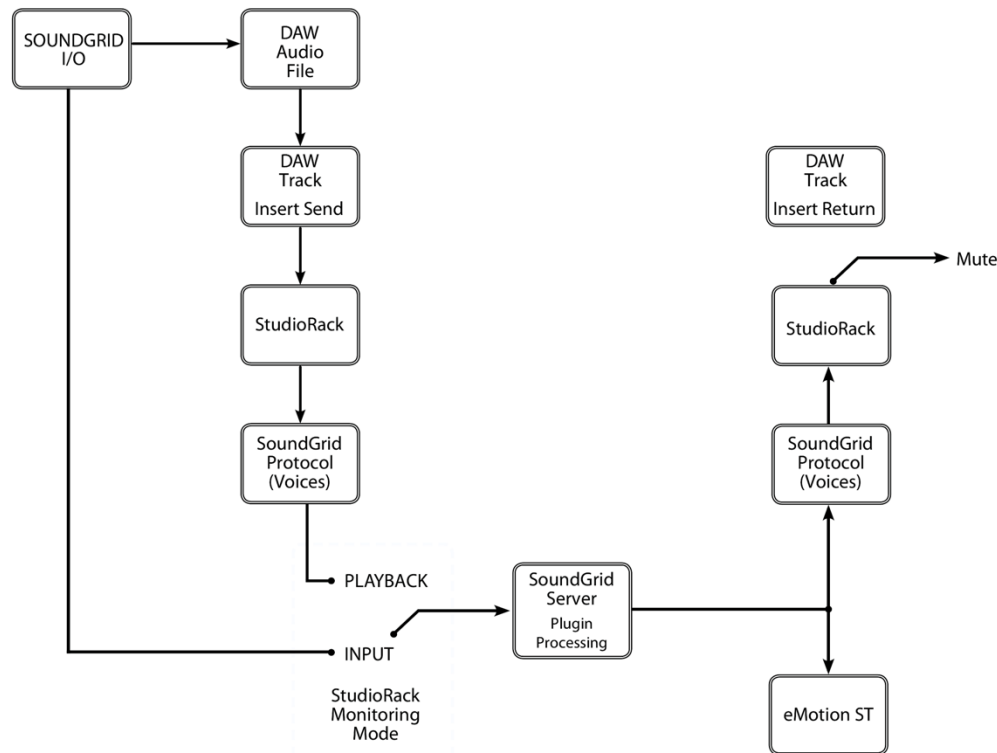

During recording, the DAW output is muted and only the direct sound from the SoundGrid DSP server is heard in the control room or headphone monitor mixes. This prevents “double monitoring,” the phase error of audible doubling that would result from combining both signals due to the greater latency of the DAW output.

When recording is finished, the monitor path switches back to the output of the DAW—with StudioRacks in playback mode—for normal playback. You hear the same processing during recording and playback without having to commit to specific mixes or processing.

Low-latency monitoring requires at least one SoundGrid DSP server and one I/O. It requires no special setup. StudioRack must be in SoundGrid DSP Processing mode.



StudioRack Monitor Setup

The SoundGrid Connection panel is used to establish a link between each StudioRack and the mixer.

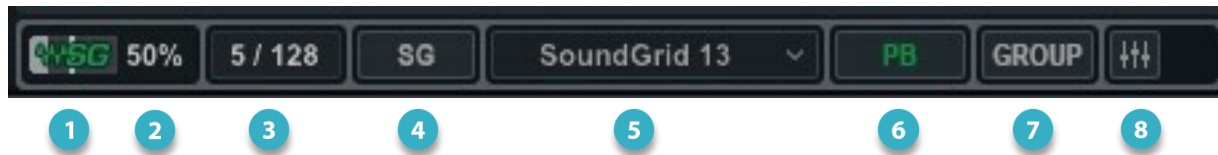

1	SoundGrid Status (WSG)	Indicates SoundGrid server status. When green, the server is working properly. Red indicates an error in the configuration. Clicking the WSG button will display the error and show the SoundGrid Setup window so that you can address the problem. All StudioRacks will mute when the server is missing. The shaded indicator bar and the numeric displays show average CPU of all cores. Click on the WSG button to access the SoundGrid Studio Setup window.
2	DSP Percent	Shows the peak DSP load of the core with the highest CPU.
3	Voices	Displays the number of SoundGrid Studio channels being used between the StudioRack and the eMotion mixer. This is independent of the voices used in the DAW. A mono StudioRack takes one voice, a stereo StudioRack requires two, and a side chain requires one more.
4	SoundGrid/Native	Switches between SoundGrid and Native modes. This must be set to SG to link the StudioRack with the mixer.
5	Monitor Source Selector	Sets the I/O that will serve as input to the server when the StudioRack is in Input. The StudioRack will not appear in the mixer if an I/O channel is not selected.
6	PB/Input/Auto	Controls the monitor status of the StudioRack. When set to <i>PB</i> , audio is played from the DAW. When set to <i>Input</i> , such as during recording, the signal is “hijacked” and sent to the server for faster processing. <i>Auto</i> switches between Input and Output, following commands from the DAW.
7	Group	Assigns several StudioRacks to a group for switching between Input, Playback, and Auto modes. When <i>Group</i> is selected in a StudioRack, it is a member of the switching group. Change the mode of any StudioRack and the others will follow.
8	Mixer Access	Click to open the StudioRack layer of the mixer.



FOLLOW THESE STEPS TO CONNECT

- a) Open the DAW session and set the Playback Engine to “Waves SoundGrid.”
- b) Insert a StudioRack on each track where you want to perform low-latency monitoring while recording.
- c) Confirm that the WSG logo is green. If it’s not green, click to access the SoundGrid Studio Setup window to address the problem.
- d) Assign the StudioRack input I/O channel used for low-latency monitoring during recording.
- e) Switch monitor signal between input and play. Monitoring can also switch automatically based on the host’s record/play status. This is explained later in this section.
- f) Group together several StudioRack instances so that they change status simultaneously.

Establishing a Link Between StudioRack and eMotion ST

Each channel in the StudioRack layer of eMotion ST is one StudioRack instance in the DAW, so there must be a way of establishing a link between the two. There are two links that must be established: one between StudioRack and eMotion ST, another between StudioRack and the input channel of the DAW.

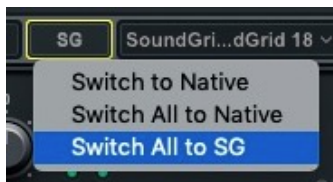

Set StudioRack to the SG processing mode. This moves StudioRack processing to the SoundGrid DSP server and establishes an initial connection between the mixer and the StudioRack. “Switch All to SG” or “Switch All to Native” simultaneously switches all StudioRack instances in the host session to SoundGrid or Native respectively. eMotion ST will not recognize StudioRack channels that are set to Native CPU.



Mixer StudioRack Layer



The StudioRack mixer layer is made up of the StudioRack instances in the Host DAW session. Each StudioRack channel is one StudioRack instance. If there are no StudioRack instances linked with the mixer, this layer will be blank.

The SuperRack layer includes the Input, Route, Aux, and Monitor 1–16.

When part of a SoundGrid network that includes a SoundGrid server and at least one SoundGrid I/O, a StudioRack plugin is integrated with the eMotion ST mixer. This enables low-latency monitoring and recording, and it lets you control up to 16 StudioRacks at once.

If the StudioRack layer button is active but some StudioRacks do not appear in the mixer, it probably means that those StudioRacks are not assigned to I/Os.



Linking StudioRacks to the Mixer



- 1 To populate channels in the eMotion ST StudioRack layer, set the StudioRack input channel to match the driver input channel in the DAW track where the StudioRack is inserted.
- 2 This StudioRack instance will appear as a channel strip in the StudioRack layer of the mixer. The channel input will match the Input assignment in the StudioRack plugin.
- 3 By setting the StudioRack input to the same source, switching from Input to Playback will match.
- 4 Track Name: Each instance of the plugin will show the track name it is instantiated on. Please note that some DAWs do not support track naming. When working with such DAWs, you can fill in the Track Name manually.

- 5 Switch between Playback, Input or Auto in the mixer or on the StudioRack plugin. When a StudioRack is in Playback mode, it and all members of the group are muted, since StudioRack is not active and does not stream audio in the mixer during playback
- 6 You can assign a StudioRack to the switching group either on the StudioRack plugin instance or on the mixer. Switch any member of the group to Playback, Input or Auto, and all other members of the group will switch.



A StudioRack's placement in the mixer is directly related to the position of its device in the rack (Setup window). If, for example, you select IOS channel 5 in StudioRack A and IOX channel 2 in StudioRack B, the placement of these channels in the mixer will be determined by which device slot the IOS and IOX are assigned to in the Setup inventory. Within a device, track order in the mixer is determined by input channel number, with lower channels placed to the left of higher ones.

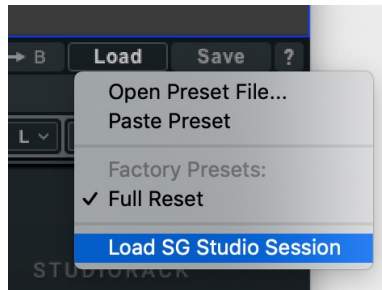

You can load the SoundGrid Studio session that is associated with the current StudioRack. Go to the Load menu at the top of the plugin and select “Load SG Studio Session.”

Automatically Linking to DAW Playback/Input and Auto Monitor Status

StudioRack can be set to follow a DAW's input channel selection and its monitor switching. This means that, with certain DAWs, you need to set the channel input source only once, in the DAW channel.

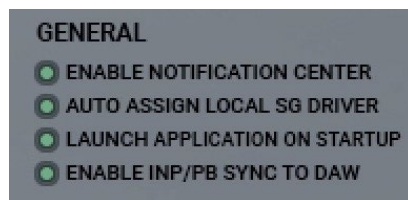

To enable monitor syncing with the DAW, select “Enable INP/PB Sync to DAW,” in the SoundGrid Studio Setup window.



Once Sync to DAW is enabled, the StudioRack input channel selection will mirror input channel selected in the DAW.

In addition, Sync to DAW enables automatic monitor switching.





In this example, a section has been selected for a punch-in recording in the DAW (the small bar at the top, between “2” and “3.”) The play head is on the left, indicated by the arrow. As it approaches the punch-in, the DAW is in playback. The StudioRack follows this command and displays (A)PB.



When the DAW goes into record, the StudioRack switches to input.

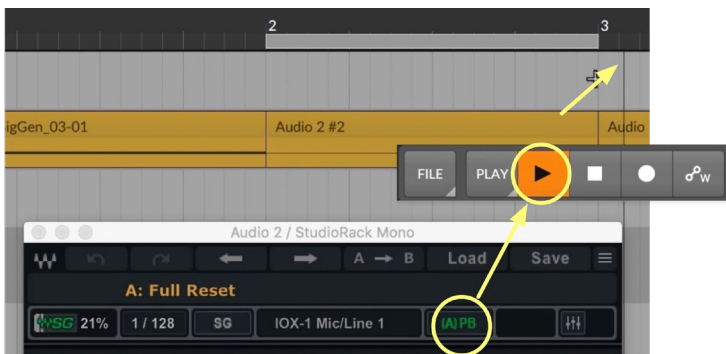

At the end of the punch-in, the DAW and the StudioRack return to playback.



Set Up a Mackie HUI in a DAW

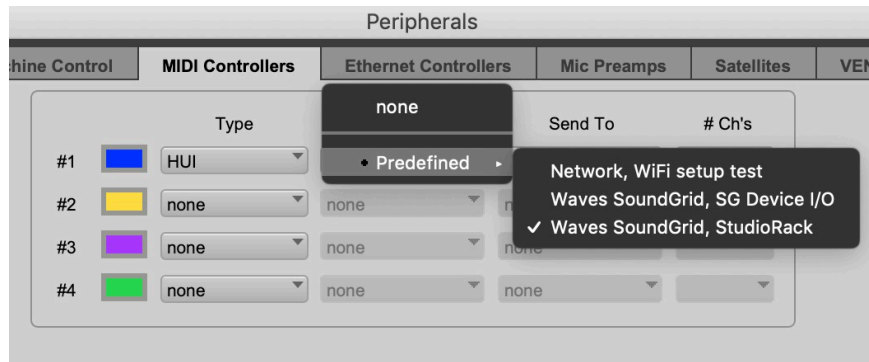

Setting up a MIDI controller using HUI protocol varies from one DAW manufacturer to another. It consists of selecting a HUI protocol virtual controller and then assigning Waves SoundGrid and StudioRack to “Receive From” and “Send To.” SuperRack does not need additional configuration.

Controller configuration varies by DAW manufacturer.

The following are examples of how to set up a Mackie HUI in the most popular DAWs. If you cannot find the information you’re looking for, refer to the user manual or website for your DAW.



Logic Pro X

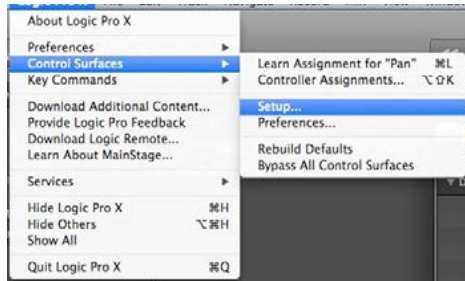

1. Go to Logic Pro X menu > Control Surfaces > Set Up.

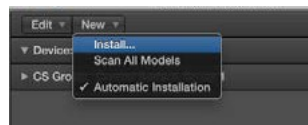

2. On the upper left side of the window, click on “New” and choose “Install.”

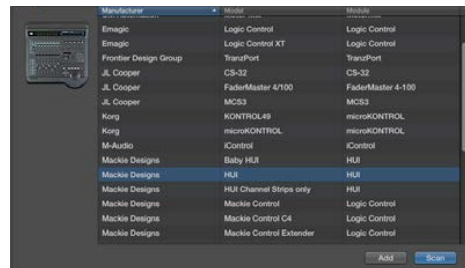

3. Choose “Mackie Designs. Then select “HUI” and then click on “Scan.”

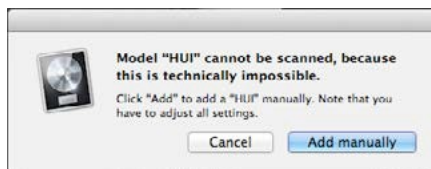

4. A pop-up window will appear. Click on “Add Manually.”



5. In the HUI Device window, set “Output Port” and “Input Port” to “StudioRack.”



Pro Tools 11

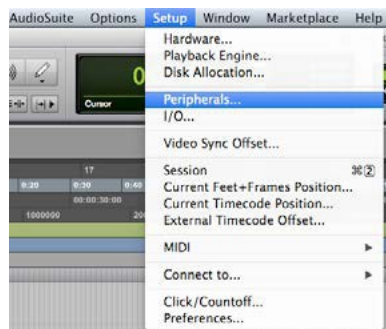

1. Go to Setup.
2. Choose Peripherals.



3. Click on the MIDI Controllers tab and set one of the slots to "HUI."

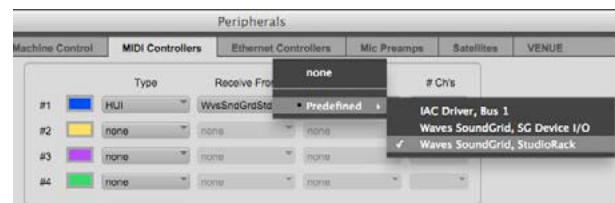

4. Set "Receive From" and "Send To" as "Waves SoundGrid StudioRack."



Cubase

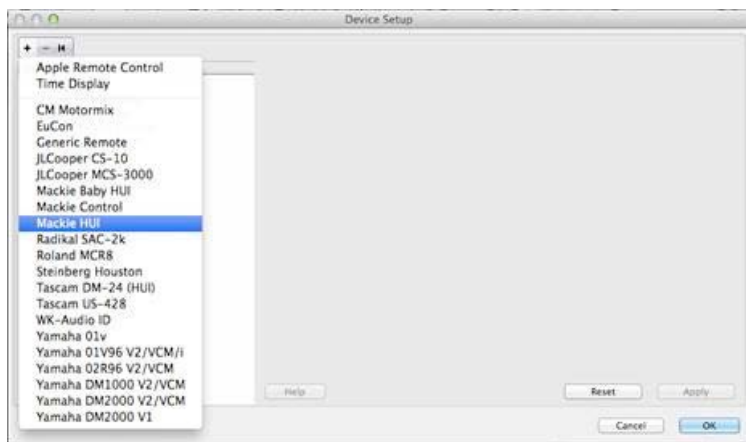

1. Go to Studio > Studio Setup.

2. On the top left corner of the window, click on the “+” icon to add a device.

3. Choose “Mackie HUI.”



4. In the Mackie HUI window, assign “MIDI Input” and “MIDI Output” to “Waves StudioRack.”



Studio One

1. In the Studio One upper menu, go to Studio One > Preferences.
2. Click on the “External Devices” tab.
3. Click on “Add” to add a device.
4. Open the Mackie folder and Choose “HUI.”
5. Set “Send and Receive From” to “Waves SoundGrid StudioRack.”

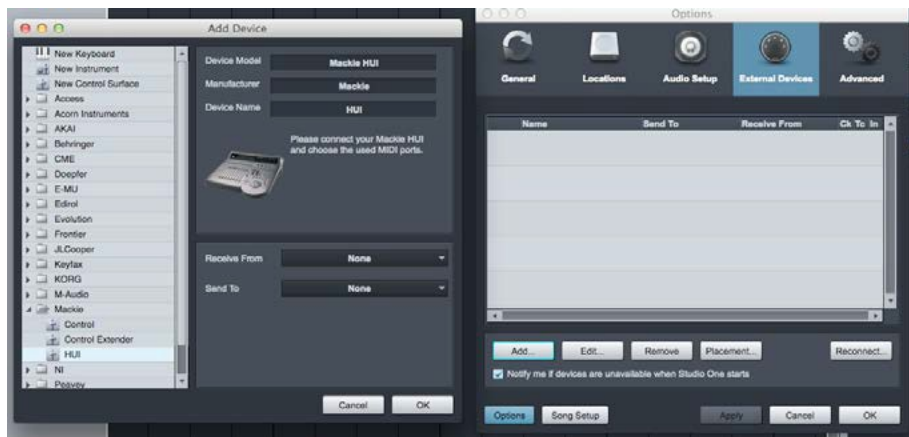

Digital Performer

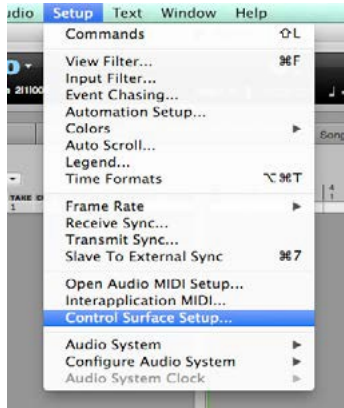

1. In the Digital Performer top menu, go to Setup > Control Surfaces Setup.



2. In the small window that opens, click on “+” to add a device and choose “HUI” from the list.



3. Set “Input and Output” ports to “Waves SoundGrid StudioRack.”



Reaper

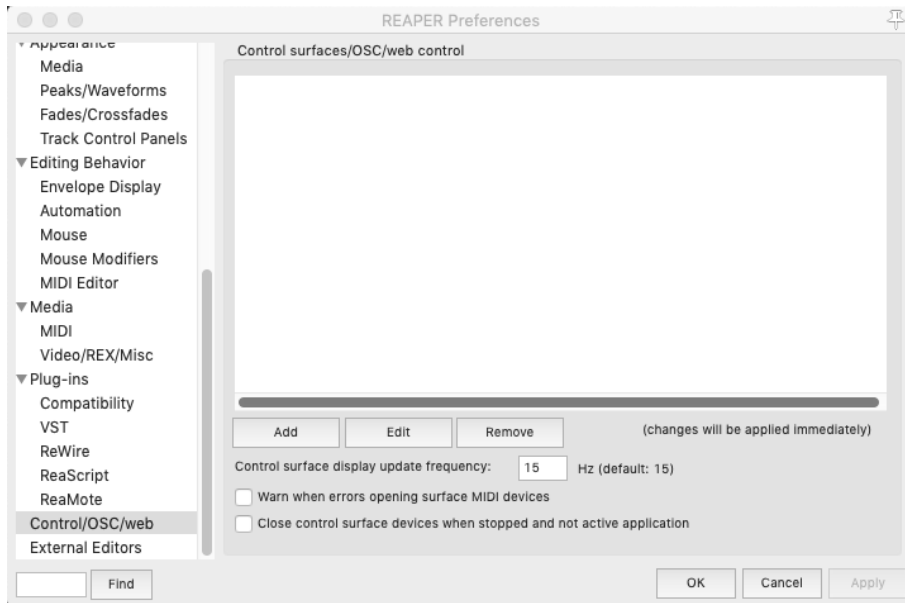

Go to the Options menu > Preferences.

Select “Control/OSC/web” at the bottom of the list.

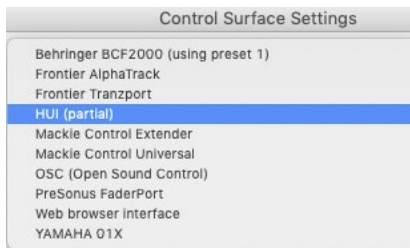

Click on “Add,” then select “HUI (partial).”

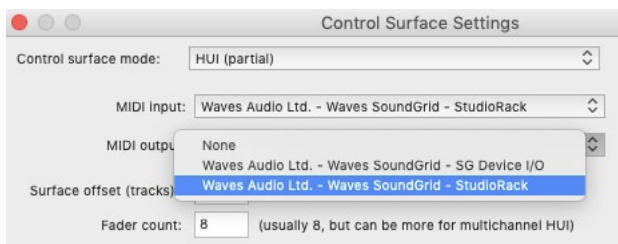

In “MIDI Input” and “MIDI Output” select “Waves Audio Ltd. – Waves SoundGrid – StudioRack.”

Click “OK.”

