



# Escort Stair Lift

## Installation Manual



# escort



Read and understand this manual thoroughly before attempting to install or operate the lift. If you have any questions, please contact your Authorized AmeriGlide Dealer or AmeriGlide's Technical Service Department at 866-294-4460.

# Table of Contents

<b>INSTALLATION &amp; APPLICATION NOTES</b>	<b>3</b>
<b>PREPARATION</b>	<b>4-11</b>
Tool Checklist.....	4
What's In the Box .....	5
Getting to Know the Rail .....	6
Preparing the Rail.....	7-11
<b>INSTALLATION</b>	<b>12-21</b>
Installing the Rail .....	12
Installing the Chassis.....	13-15
Installing the Chair.....	16-17
Re-installing the Charging Strips .....	18
Installing the Upper Limit Cam .....	19
Installing the End Cap/Bracket Cap Option	20
Charging System .....	21
Completion Checklist .....	22
<b>VERIFYING OPERATION</b>	<b>23</b>
<b>REQUIRED MAINTENANCE</b>	<b>24-25</b>
<b>AUDIO ALERT</b>	<b>26</b>
<b>REMOTE CONTROL PROGRAMMING</b>	<b>27</b>
<b>MANUAL LOWERING TOOL</b>	<b>28</b>
<b>APPENDIX I</b>	<b>29</b>
Measuring the Rail.....	30
Flight Angle Charts .....	31
Cutting the Rail.....	32-34
<b>APPENDIX II</b>	<b>35-38</b>
Cutting the Gear Rack.....	36
Adjusting the Gear Rack.....	37-38
<b>SERVICE NOTES</b>	<b>39</b>



## READ AND UNDERSTAND THIS MANUAL PRIOR TO INSTALLATION OR OPERATION.

Please read, follow, and fully understand the installation section of this manual before beginning. Knowing the lift's adjustments and becoming familiar with tips for proper installation will not only save you time and energy, but also help you avoid possible injury. If you do not understand any portion of installation or operation, please consult our technical service department at 866-294-4460.

### SYMBOLS USED IN THIS MANUAL



**READ MANUAL** - Pay close attention to the instructions in the manual.



**CAUTION** - Hazardous situation. If not avoided, could result in serious damage to property.



**WARNING** - Hazardous situation. If not avoided, could result in serious injury to installer or user.



**SHOCK HAZARD** - Disconnect from power source to avoid personal injury.



**HEAVY** - Be sure to have help available to avoid back injury.



**TIP** - Helpful tips that will facilitate ease of installation.



**CHECK** - Reminder to check certain portions of installation before continuing.

### INDICATIONS OF USE STATEMENT

The Escort Stair Lift assists with the transfer of patients or mobility impaired persons, up and down between levels of a residential or private facility.

## INSTALLATION AND APPLICATION NOTES

### INCLINE

The maximum inclination (angle) the Escort lift can be installed is 45 degrees.

The minimum inclination (angle) the Escort lift can be installed is 25 degrees.

### MAXIMUM RAIL LENGTH

32 Feet

### LOAD CAPACITY

The maximum load capacity is 300 lbs.

The lift is not to be used to transport cargo.

### ELECTRICAL POWER SUPPLY REQUIREMENTS

A dedicated 120 VAC 15A 60Hz, 3-wire grounded outlet. NEC requirement.

Electrical equipment shall be certified to the requirements of CAN/CSA B44.1/ASME A17.5.

### ASME 18.1 REQUIREMENTS INSTALLATION REGULATIONS

The Escort lift is an incline stairway chair lift for private residence use only.

Installation of this lift must comply to the following American Society of Mechanical Engineers ASME 18.1 – 2011 "safety standard for platform lifts and stairway chair lifts".

- 7.1.1 The structure on which the equipment is installed shall be capable of safely supporting the loads imposed.
- 7.1.2 The installation of all electrical equipment and wiring shall conform to the requirements ANSI/NFPA 70.
- 7.6.4 At no point in its travel shall the edge of the footrest facing the upper landing be more than 24 in. above the step or landing as measured vertically.

## PREPARATION

### TOOL CHECKLIST

- 1/2 inch Combination Wrench
- 3/8" Ratchet with 1/4, 3/8, 1/2, 9/16 inch and 7mm hex sockets
- 3/8" Drive torque Wrench
- 6 inch long Ratchet extension
- Stub Screwdriver - #2 size phillips tip
- Slotted Screwdriver - #1 or 2 size
- Set of Hex Wrenches
- Measuring tape or ruler
- Level
- 3/8" power drill
- Metal cutting saw (hacksaw)
- Square
- Safety Glasses
- Volt meter
- Hammer
- Utility knife



## WHAT'S IN THE BOX

### Box 1

1.  Stair Lift Chassis (1)
2.  Remote Controls with Batteries (2)
3.  Installation Manual (1)
4.  Owner's Manual / Warranty (1)
5.  Rail Mounting Brackets (2 per rail)
6.  Lag Bolts (6 per rail)
7.  Power Supply (1)
8.  Power Cord (1)
9.  Limit Cams (2)
10.  Limit Cam bolts and square nuts (4)
11.  7 mm Manual Lowering Device (1)
12.  Timing Gear Rack (1)
13.  9/64" Hex Wrench (1)
14.  End Stop (1)
15.  Tube of Calcium Base Lubricant (1)
16.  End Covers (2)
17.  End Cover Screws (4)
18.  Flat Washers (2)
19.  Thrust Roller Bearing (1)
20.  Copper Based Antisieze Lubricant (1)

### Box 2

21.  Seat Assembly (1) (Escort shown)

### Box 3 (not shown)

22.  2 Aluminum Rails - Installations over 16 feet will be shipped with 3 or 4 rails, depending on installation requirements
23.  2 Splice Bars - Installations over 16 feet will be shipped with 4 or 6 splice bars, depending on installation requirements (Installed on rails)
24.  2 sets charging strips (Installed in rails)
25.  Gear Rack (Installed in rail)

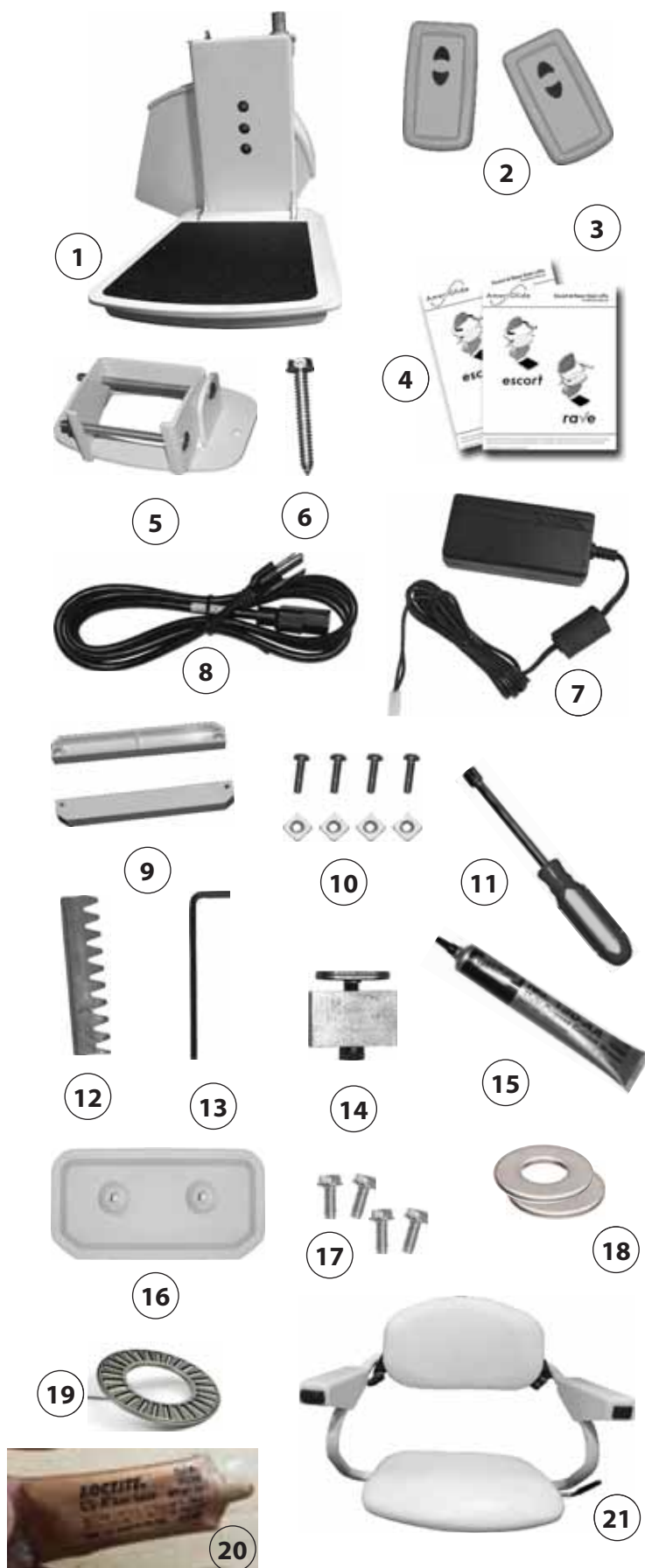

## GETTING TO KNOW THE RAIL

### 1. Gear Rack Fastener Channel

The gear rack is fastened using a 9/64" hex wrench to tighten the set screws to the plate. The plate slides into the channel. The gear rack will sit inside channel 2" in order to allow for contact with the pinion gear.

### 2. Pinion Gear Channels

These channels allow for the gear rack and pinion gear to interact.

### 3. Guide Wheel Channel

The lower portion is where the Guide wheels will ride in this channel.

### 4. Limit Cam Fastener Channel

The limit cams are attached to the rail by screwing the supplied 10-24 screws and square nuts. The square nut will slide into this channel and tightened.

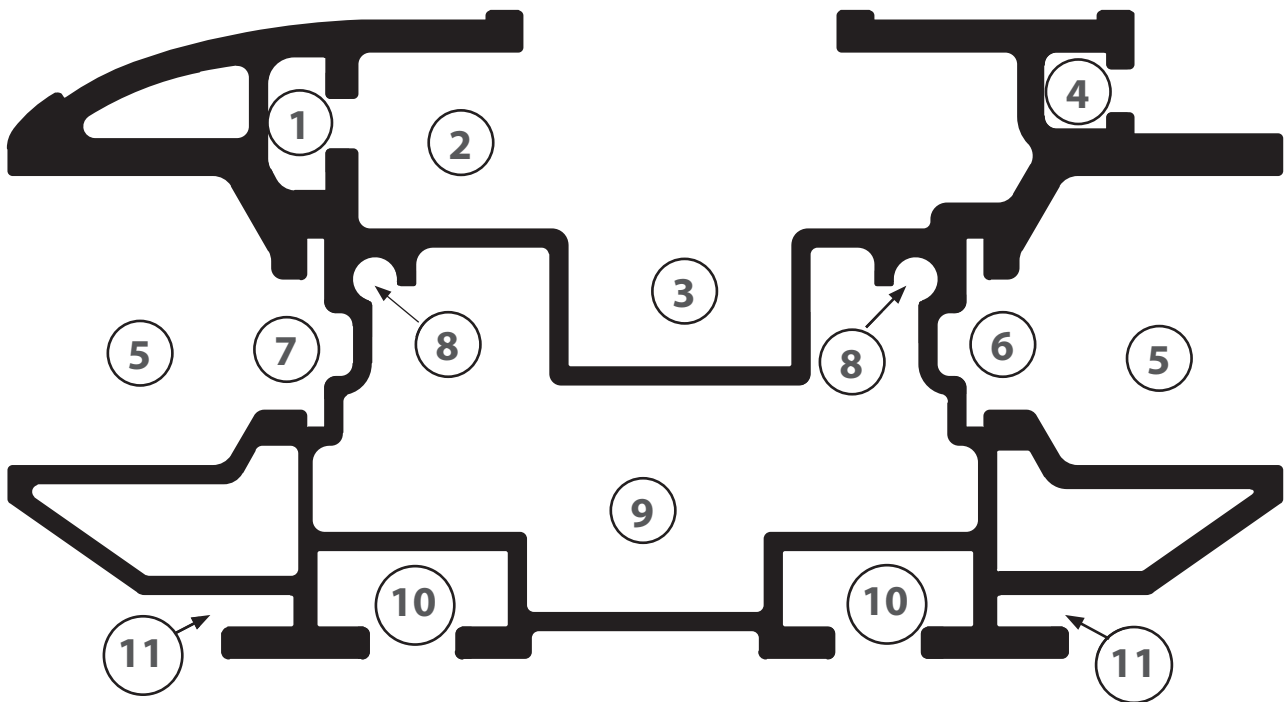

### 5. Chassis Wheel Channels

The chassis wheels will ride up and down the rail in these channels.

### 6. Positive Charging Strip Channel

Positive charging strip will rest inside these channels.

### 7. Negative Charging Strip Channel

Negative charging strip will rest inside these channels.

### 8. End Cap Screw Channels

Use these to fasten the end caps onto the rail.

### 9. Main Interior Wire Channel

Used for running wiring up and down the rail.

### 10. Splice Bar Channels

Slide splice bars into these channels when connecting two or more sections of rail.

### 11. Rail Bracket Channels

Rail brackets attach to the rail using these channels.

## PREPARING THE RAIL

The following sections are instructions for installing the rail and adjusting the gear rack for lifts that have been shipped with pre-cut rails and gear rack. If your rail and gear rack require customization, you **MUST** read and follow the instructions in Appendix I and II before continuing.

### IMPORTANT!

Each section of rail must be mounted with two mounting brackets.

A mounting bracket must be placed on the next step directly above and below the rail splice joint.

The teeth of the gear rack must face toward the wall nearest to where the lift will be installed.

The rail should be installed 5 in. away from walls or obstructions.

**NOTE:** These steps are for connecting two rails. If you have more than two rails, follow steps 1-4 for each rail before moving onto step 5.

The top piece of rail has the gear rack protruding out of the lower end. The gear rack is protected by a three (3) inch piece of rail. This rail can be removed and discarded.



### TIP

*It is easiest to prepare the rail in an open environment such as a room or outdoors unless maneuverability of the full rail will be cumbersome.*

## INSTALLING THE LOWER LIMIT CAM

1. Assemble the limit cams by placing the supplied screws into the open side of the cam and loosely screwing the square nuts onto the screws.  
[Figure 8-1]

[Figure 8-1]

**NOTE:** Both cams may be prepared at this time. Save one for later.

2. Slide the lower limit cam square nuts into the limit cam fastener channel and onto rail.[Figure 8-2]

3. Position the end of the cam at 1-3/4" within the end of the rail [Figure 8-3]. Secure the limit cams with (2) 10-24 screws and square nuts (provided).



**TIP**

*The position of the limit cam can be adjusted later if needed.*

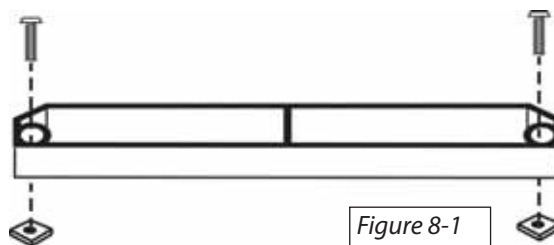

Figure 8-1

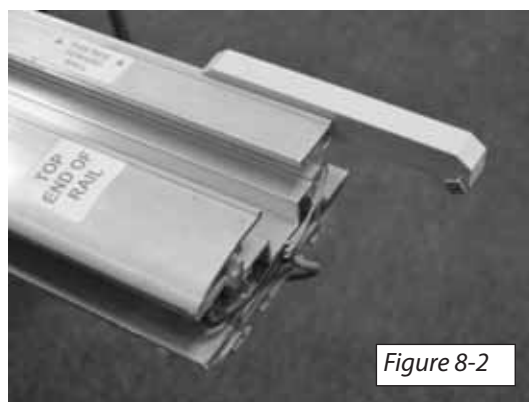

Figure 8-2

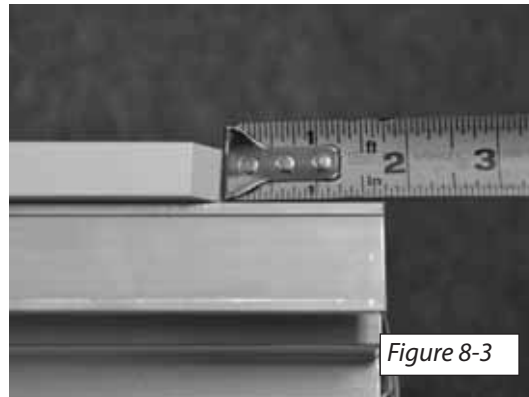
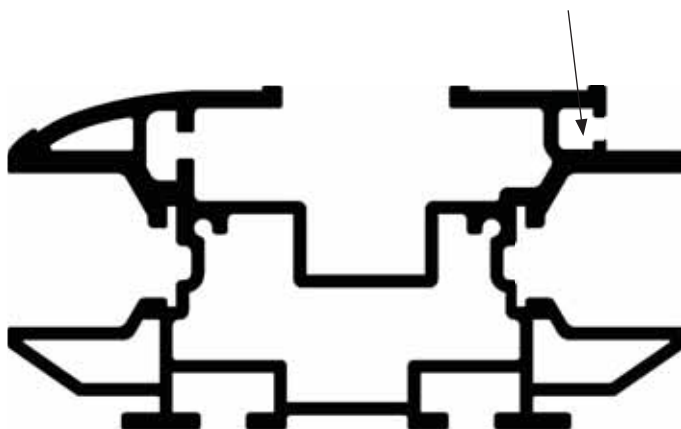

Figure 8-3

LIMIT CAM CHANNEL





## INSTALLING THE END CAP

1. Move the end stop to the end of the gear rack and tighten with a 9/64" hex wrench.



2. Install the rail end cap onto the top end of the rail. The wire with the connector should be routed out of the end cap on the wall side if charging from the top. Otherwise, excess wire can be tucked into the inside of the rail. [Figure 9-1]

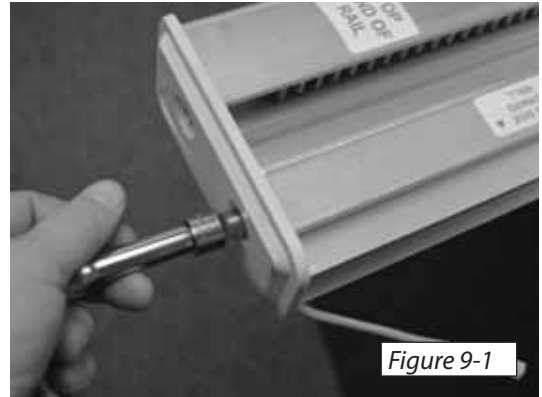
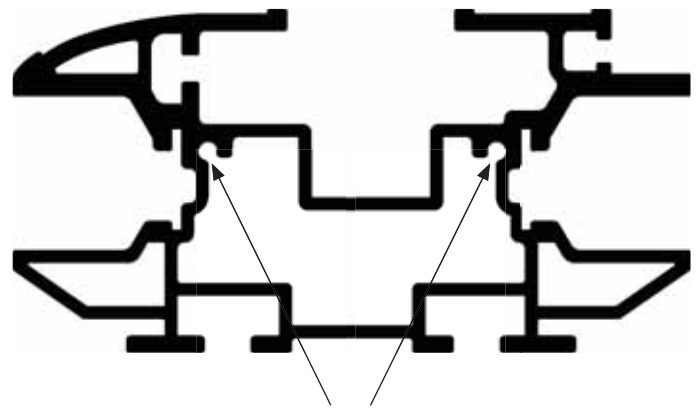

Figure 9-1



**CAUTION**

*Align end cap screw holes precisely.  
Do not overtighten.*



END CAP SCREW CHANNELS

## CONNECTING THE RAILS

1. Each section of rail is shipped with the gear rack and the charging strips installed with a short piece of rail covering the protruding rail for protection. With the rail turned upside down, loosen the four (4) allen screws attaching the two sections of rail with the splice bars on the bottom of the protective section of rail. [Figure 10-1]

2. Pull the protective section apart from the rail. This can be cast away. [Figure 10-1]

**NOTE:** The rails are labeled top and bottom and which side goes toward the wall.



3. Position the two ends of the rails close together. Connect the plugs on each end of the two power supply wires inside the rail pieces. [Figure 10-2 and 10-3]

4. Tuck the wire back into the rail channel.

5. Slide the rail onto the splice bars and tighten all splice bar screws. [Figure 10-4]

6. Tighten the one loose gear rack screw with the provided 9/64" hex wrench.

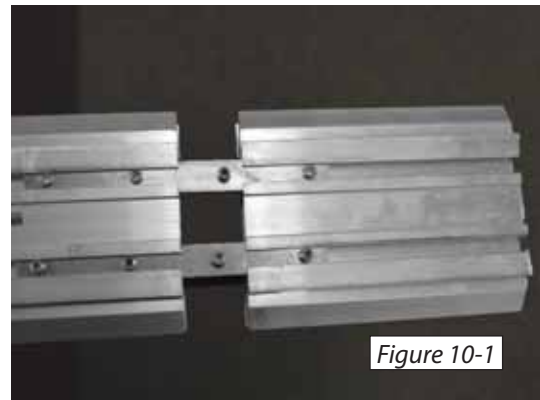

Figure 10-1

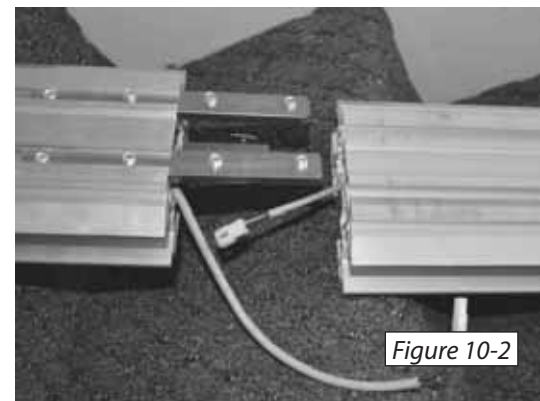

Figure 10-2

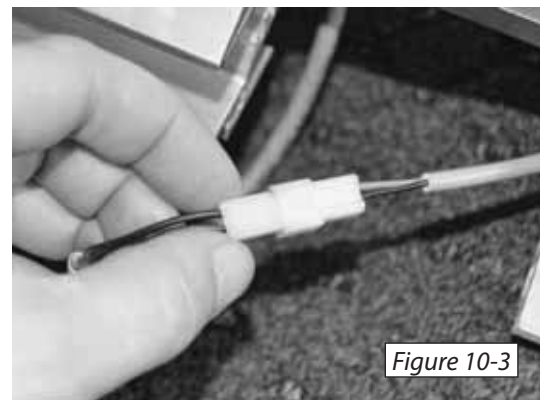

Figure 10-3



*Be careful not to pinch wires when sliding rails together.*

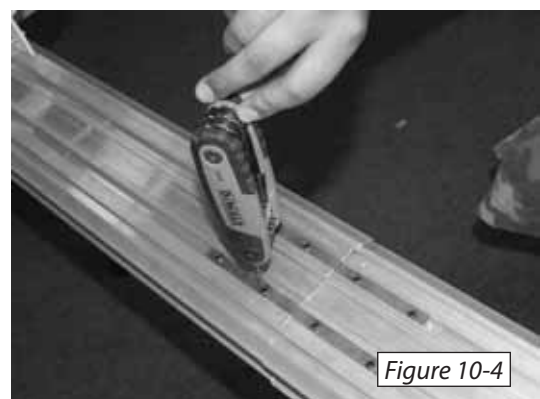
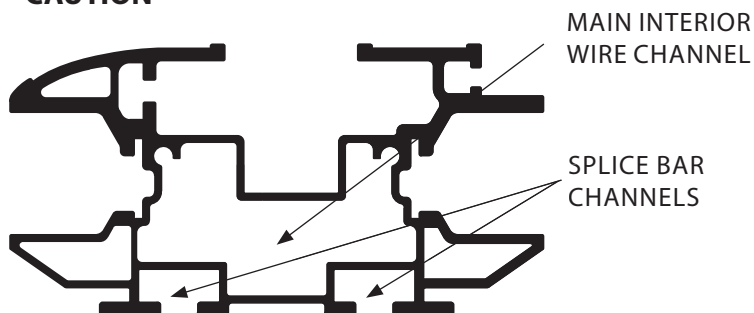

Figure 10-4

**INSTALLING THE BRACKETS**

1. Carefully remove the charging strips from the top end of the rail. [Figure 11-1]

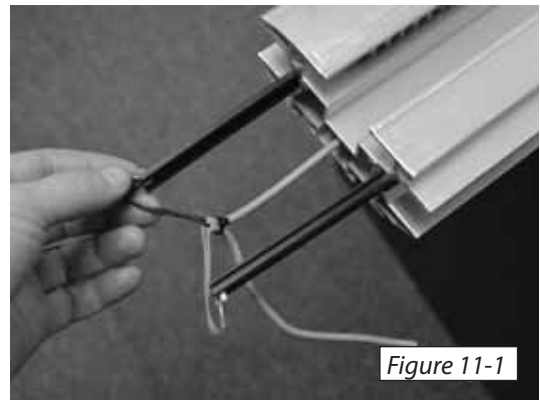

Figure 11-1



**CAUTION** Do not attempt to remove the attached center wire from the rail as it is attached at the other end to the bottom rail. Pull the wire out only far enough to remove the charging strips

2. Slide rail mounting brackets onto rail to the approximate locations shown [Figure 11-2 and 11-3]. Exact positions of brackets will be determined later.

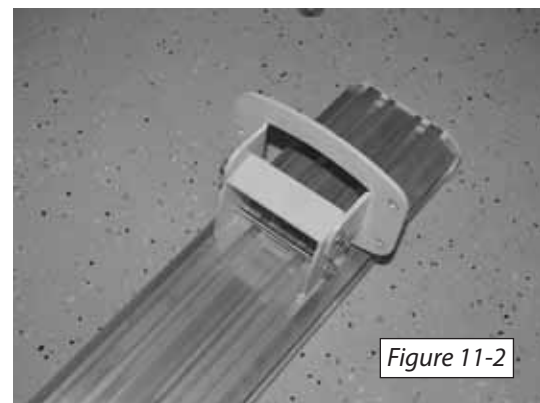
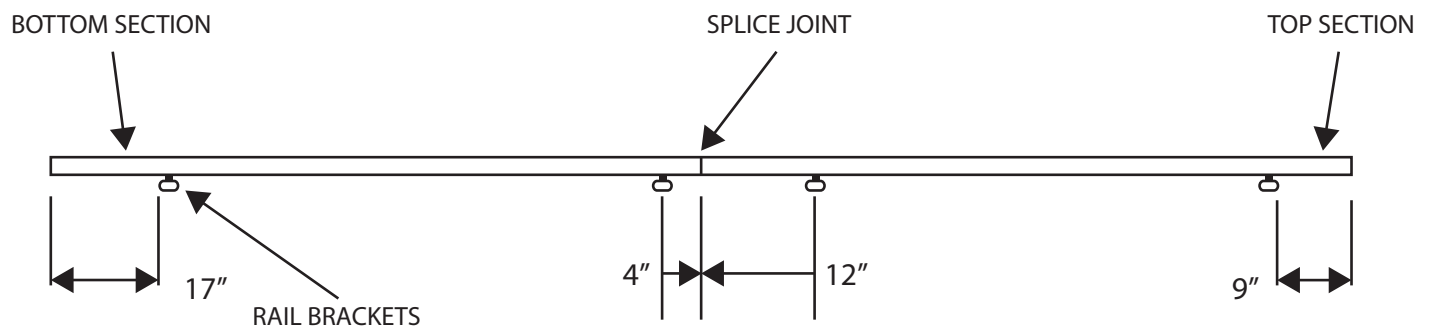
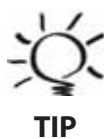

Figure 11-2

**NOTE:** The nut side of bracket goes toward the wall.



[Figure 11-3]



**TIP** The brackets will fit tightly on the rail. Loosening the bracket bolts will help them slide easier. A short piece of 2 x 4 may also be used to gently tap the brackets into place.

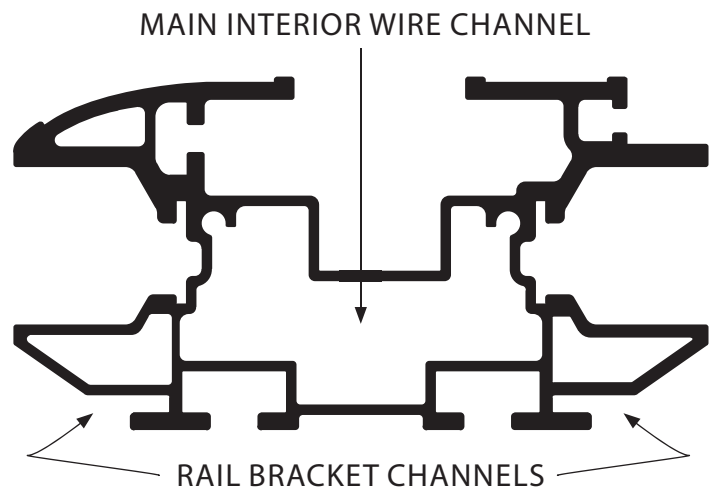

### INSTALLING THE RAIL

1. Set the lower section of rail onto the steps. The bottom of the rail should be resting on the stair nosings and the bottom end should be 1/4" off of the floor at the bottom landing [Figure 12-1].

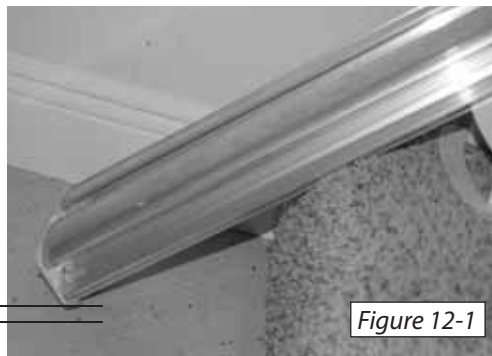
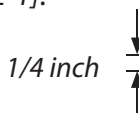

Figure 12-1

#### For The Escort

Position the rail 5" [Figure 12-2] from the wall or any protruding object.

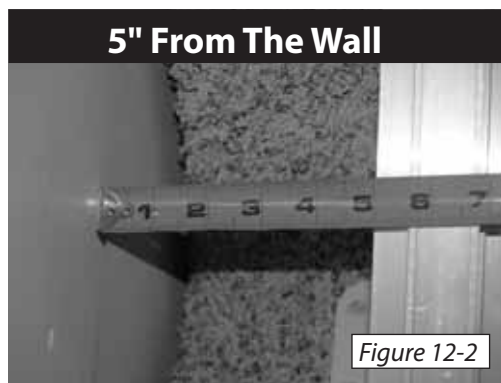

Figure 12-2

2. Secure the rail by positioning one lag bolt in the lower rail bracket and tightening to step. [Figure 12-4]. The side of the bracket with two holes should be towards the wall.

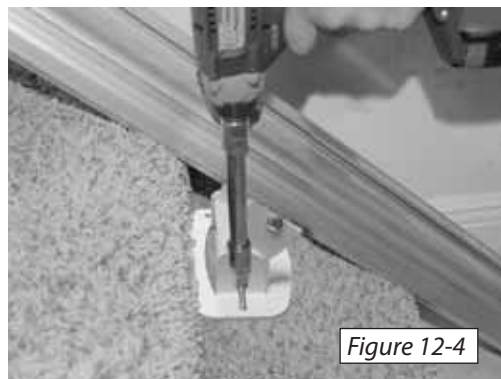

Figure 12-4

#### For The Escort

3. Verify each segment of rail is 5" from the wall or any protruding obstruction and secure the remaining rail brackets to the staircase steps with the remaining lag bolts (three (3) per bracket).

#### For The Escort Plus

Position the rail 6" [Figure 12-3] from the wall or any protruding object.

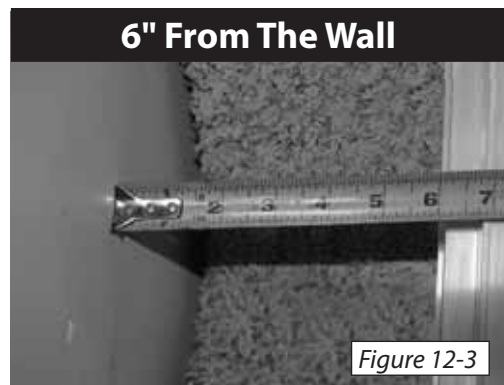

Figure 12-3

2. Secure the rail by positioning one lag bolt in the lower rail bracket and tightening to step. [Figure 12-4]. The side of the bracket with two holes should be towards the wall.



If a pilot hole is required use a 7/32" diameter drill bit.

TIP



q ALL RAIL MOUNTING SCREWS ARE SECURE

q ALL SPLICE BAR SCREWS ARE SECURE

#### For The Escort Plus

3. Verify each segment of rail is 6" from the wall or any protruding obstruction and secure the remaining rail brackets to the staircase steps with the remaining lag bolts (three (3) per bracket).

## INSTALLING THE CHASSIS



**HEAVY**

*The chassis is quite heavy and can be difficult to install on the rail by one person.*

**1.** The chassis slides onto the top of the rail. Carefully pick up the chassis and align the pinion and guide wheels with the rail channels. Insert the chassis onto the rail. [Figure 13-1 and 13-2] Let it slide down until it stops (the pinion gear will make contact with the gear rack, allowing it to stop). [Figure 13-3]



**CAUTION**

*Be sure the charging strips are NOT in the rail and ensure that the charging strip wires extruding from the top of the rail are not pinched when installing the chassis.*

**NOTE** - The chassis may not slide into the rail far enough to allow for the wheels to be fully inside the rail. If this is the case, follow the instructions in this section to lower the chassis further.

1. Using a flat head screwdriver, pry out the white plastic plug located on the left side of the chassis where it is marked for Manual Operation. This will allow for access to the end of the motor shaft.
2. Using the provided tool or a 7mm socket attached to your drill and extension, turn the end of the motor shaft until the wheels are within the rail.

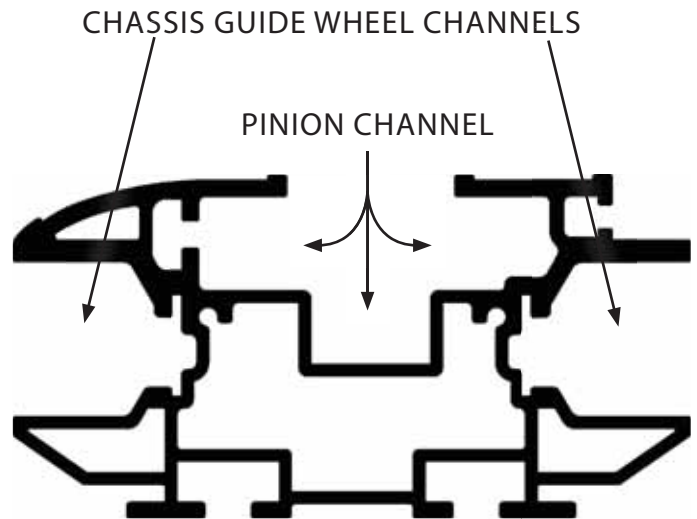

Figure 13-1

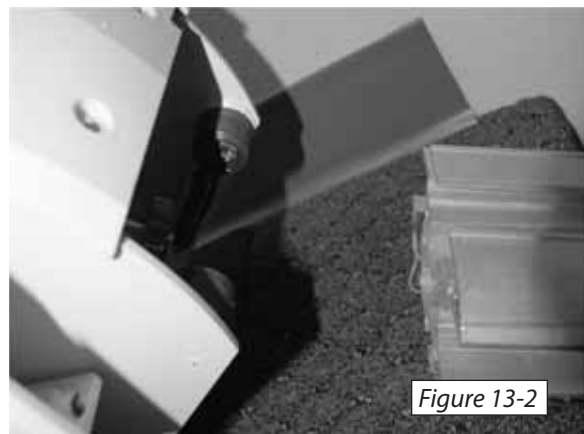

Figure 13-2

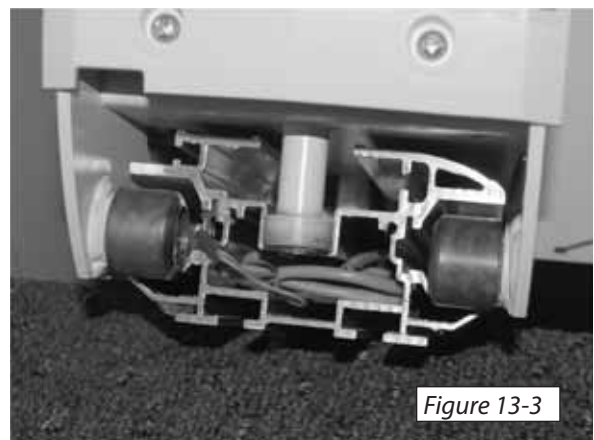

Figure 13-3

## INSTALLING THE CHASSIS (CON" T)

**2.** On the front side of the chassis, loosen the three (3) bolts on the seat support using a 9/16" socket.

[Figure 14-1]



Figure 14-2



Figure 14-1

The top bolt goes through the chassis and has a nut on the back which may need to be held for loosening. [Figure 14-2]

**3.** Rotate the seat support until the top plate is level and tighten the bolts with ratchet. [Figure 14-2]

**4.** With a torque wrench and 9/16" socket tighten each bolt to between 35 and 50 ft-lb of torque.



**q SUPPORT MOUNTING SCREWS ARE SECURE**



**WARNING**

*Three star washers must be located between chassis and seat support and bolts must be torqued as specified to prevent serious bodily injury. [Figure 15-1]*

**Star Washers**

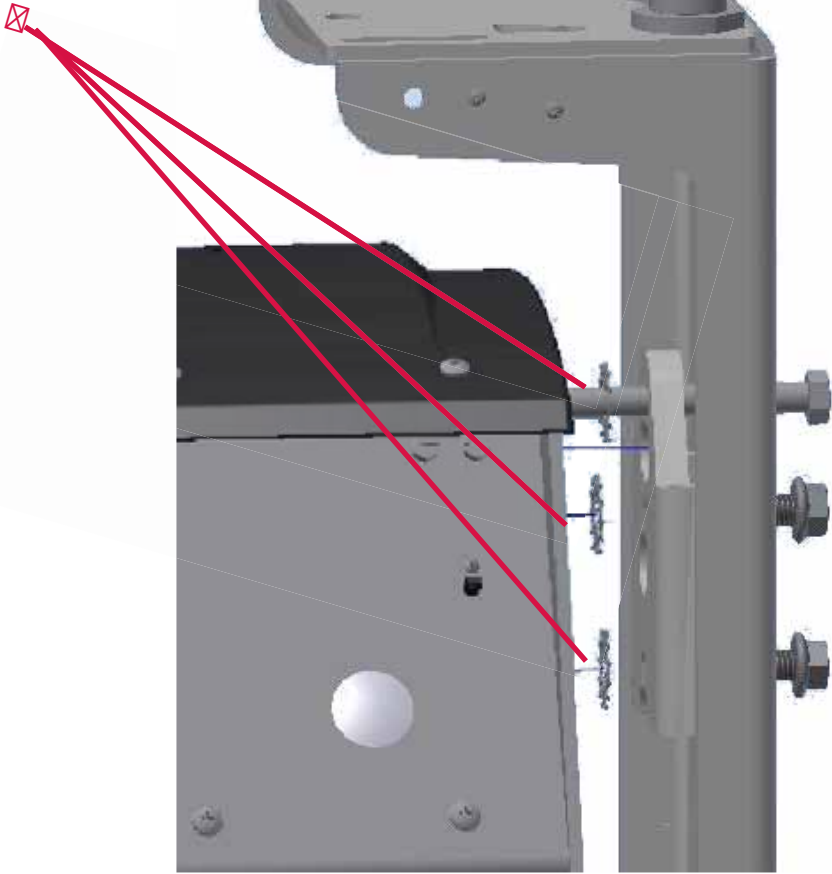

[Figure 15-1]

## INSTALLING THE CHAIR



**WARNING**

*Escort stair lifts are configured as a left or right handed unit and cannot be changed. Contact Ameriglide's technical service department at 866-294-4460 to change configuration*

**1.** Verify the latch spring loop is wrapped around the latch screw. [Figure 16-1]

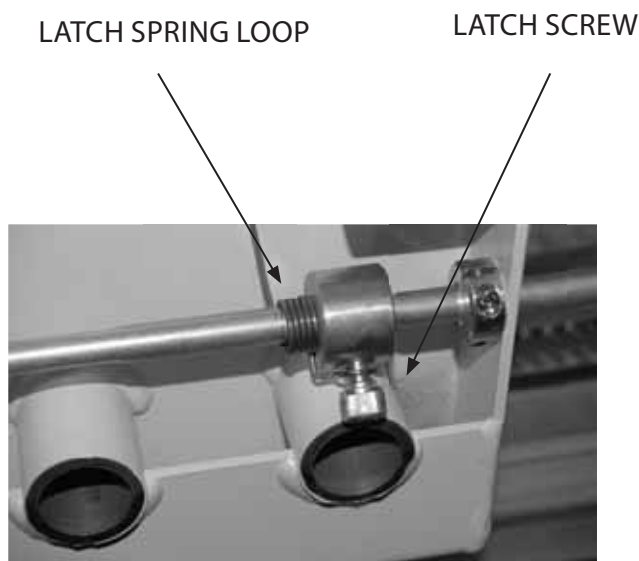

Figure 16-1

**2.** Add bearing and lubricant to the seat post:  
Apply a small amount of Copper Anti-Seize lube (provided) to the thrust roller bearings and sandwich the bearing between the washers. The lube will help to keep the parts together and aligned. Apply a moderate amount of lube to the top and sides of the post. Center the bearing assembly on the top of the post again using the lube to hold the parts in place. [Figure 16-2a, 16-2b, 16-2c, 16-2d]



Figure 16-2a



Figure 16-2b

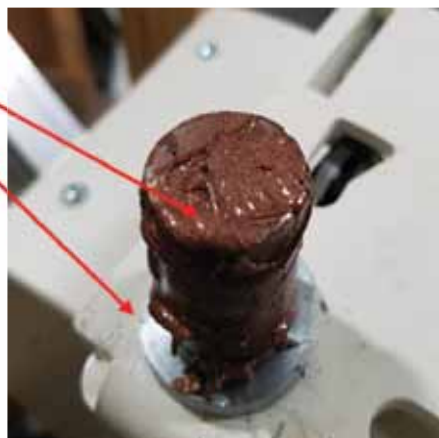

Figure 16-2c



Figure 16-2d



**INSTALLING THE CHAIR (CON'T)**

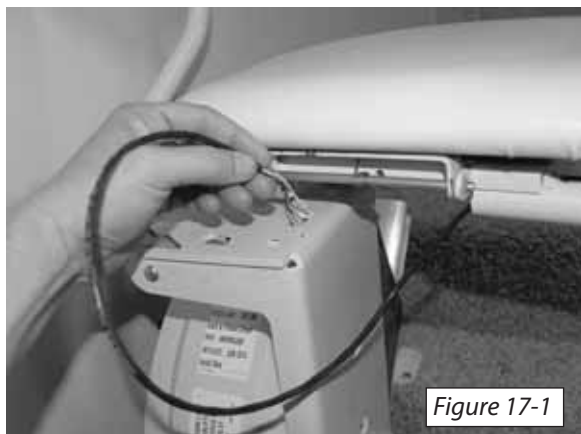

Figure 17-1

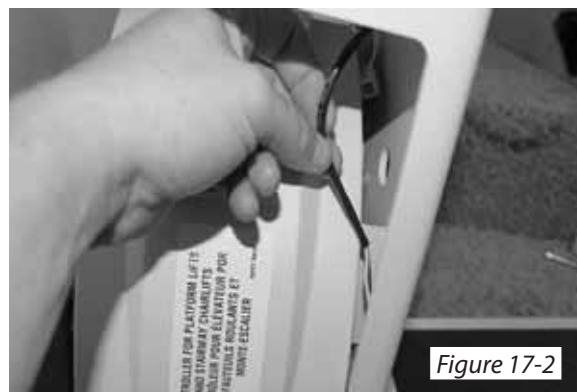

Figure 17-2

**3.** Route the 3 pin wire connector through the hole in the top of the seat chassis and down the left side. *[Figure 17-1 and Figure 17-2]*

**4.** Reinstall seat assembly: While holding the swivel handle in the down position, set the seat onto the seat post on top of the seat support. Ensure the bearings are present atop the seat post.

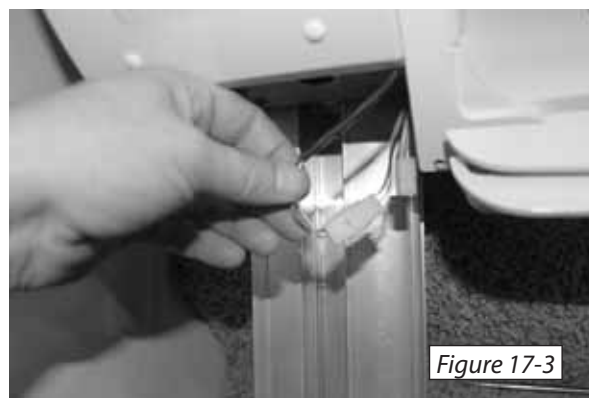

Figure 17-3

**5.** Plug the 3-pin wire connector from the seat into the mating connector from the chassis. *[Figure 17-3]*

**6.** On the backside of the chassis, there is an on/off switch. Cut off and discard the shipping tie on the switch. *[Figure 17-4]*

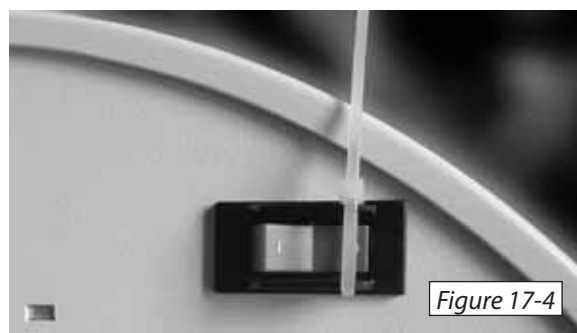

Figure 17-4

**7.** Turn the switch to the on position. The unit should beep once when it has completed booting.

**8.** Use the armrest control switch to run the lift down the rail approximately 30". *[Figure 17-5]*

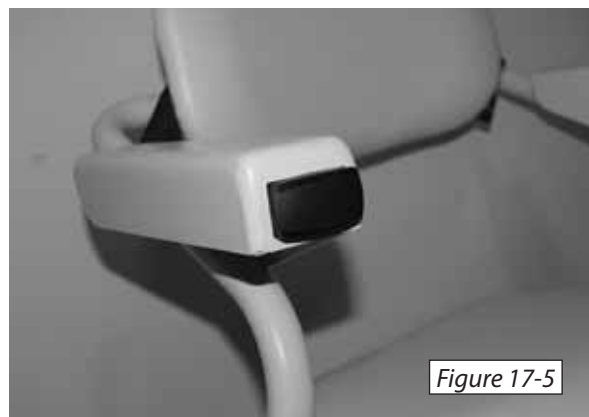

Figure 17-5

**NOTE:** Refer to page 26 if the unit does not beep.



- LATCH SCREW ENGAGES LATCH SLOTS WHEN SEAT IS ROTATED
- UNIT DOES NOT OPERATE WHEN SEAT IS ROTATED
- LATCH SPRING APPLYS PRESSURE TO LATCH SCREW

## RE-INSTALLING THE CHARGING STRIPS

**1.** Carefully re-insert the charging strips back into the rail. [Figure 18-1]

**2.** Slide the charging strips all the way into the rail. Tucking extra charging wire into the Main Interior Wire Channel as you go. Be sure the wire is all the way in leaving only the end piece with the 2-pin connector outside the rail. [Figure 18-2]

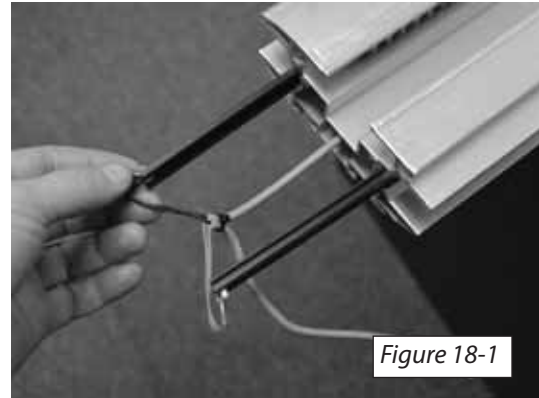

Figure 18-1

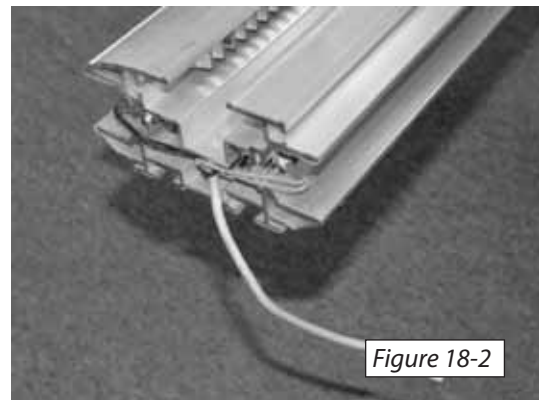
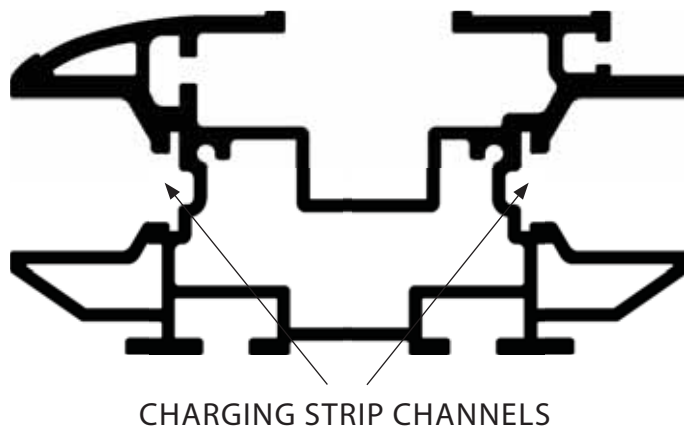

Figure 18-2

## INSTALLING THE UPPER LIMIT CAM

1. Gather the limit cam you assembled from page 8.
2. Insert the upper limit cam into the end of the rail. *[Figure 19-1 and 19-2]*
3. Position the end of the cam at 1-3/4" from the top of the rail. Secure the limit cams with (2) 10-24 screws and square nuts (provided). *[Figure 19-3]*



**CAUTION**

*Align end cap screw holes precisely.  
Do not overtighten.*

**IMPORTANT!**

**LUBRICATE THE GEAR RACK.**

**A tube of lubricant is provided in the chassis box.**

**Lightly lubricate the entire gear rack by squeezing the tube onto the gear rack.**

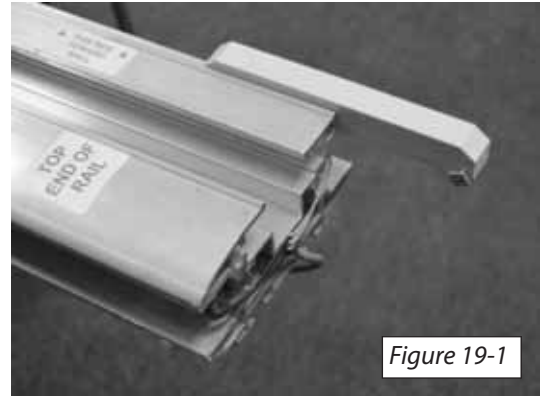

Figure 19-1

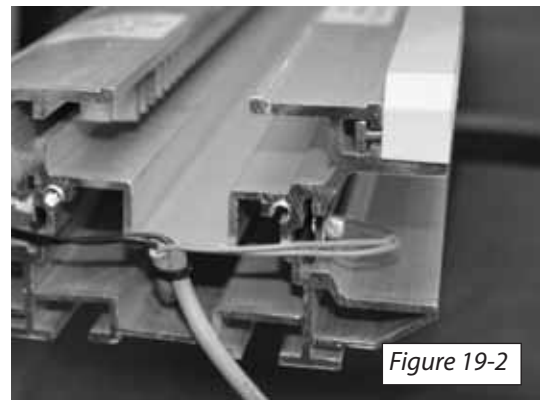

Figure 19-2

LIMIT CAM CHANNEL

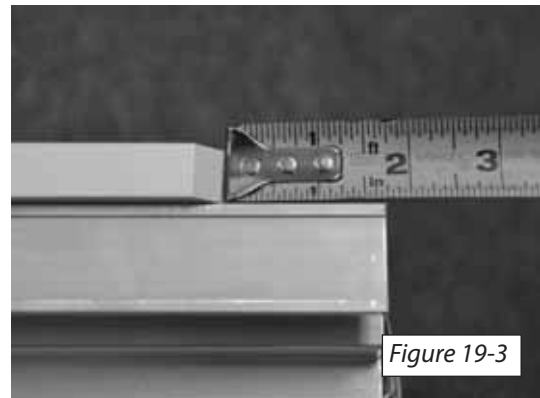
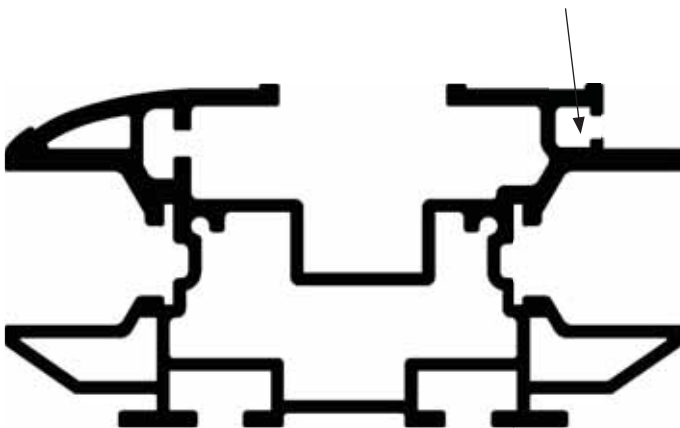
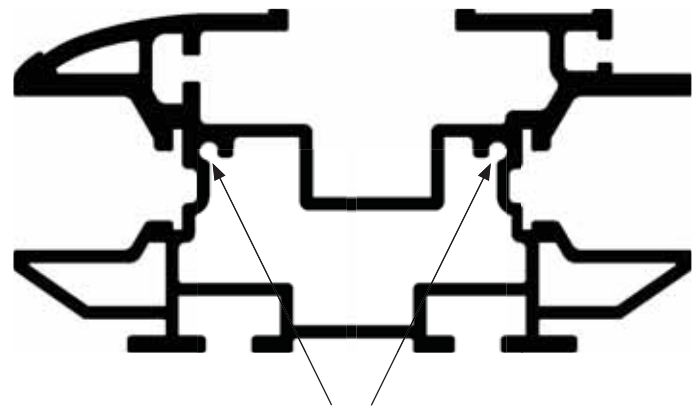
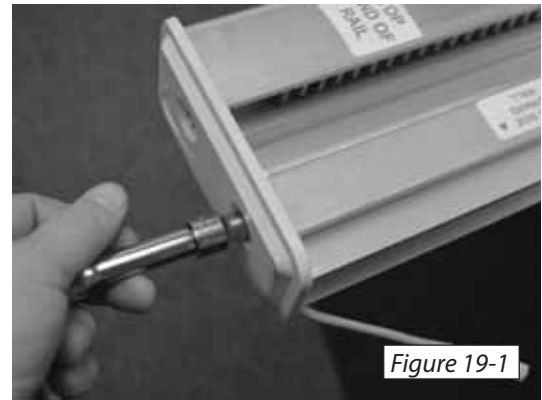

Figure 19-3

### INSTALLING THE END CAP

**1.** Install the rail end cap onto the top end of the rail. The wire with the connector should be routed out of the end cap on the wall side if charging from the top. Otherwise, excess wire can be tucked into the inside of the rail. [Figure 20-1]



END CAP SCREW CHANNELS

### INSTALLING THE BRACKET CAPS (OPTION)

- 1.** The bracket covers will cover the outside of the bottom piece of the brackets in order to hide the lag bolt and swivel assembly.
- 2.** Place the bracket cover over the outside of the bottom piece of the bracket and slide it down until it snaps into place.
- 3.** Repeat on all brackets.



## CHARGING THE BATTERIES

1. The power supply has a cord with a 2-pin connector that mates to a cable from the charging strips. Connect the power supply at either the top or bottom end of the rail.
2. Plug the power supply into a dedicated 120VAC 15A outlet.

**NOTE:** The power supply should be connected to an outlet at all times and the switch on the back of the chassis must remain on for the batteries to charge.

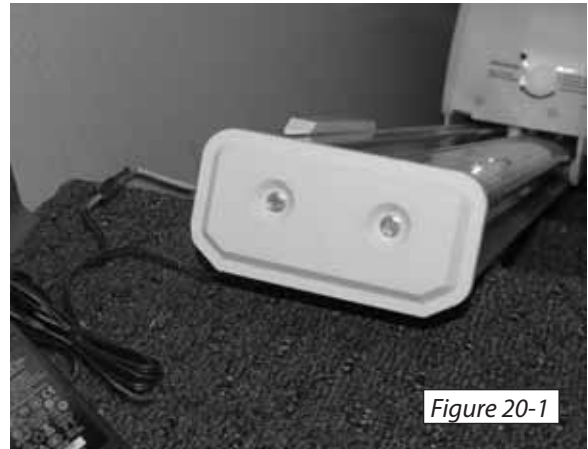

### COMPLETION CHECKLIST

#### Complete Checklist before riding the lift.

- Three star washer are located between the chassis and the seat support.
- Chair mounting bolts are secure and torqued to specified value.
- The chair locks in all positions when rotated.
- Lift does not operate when chair is rotated from the normal ride position.
- Rail mounting bracket and mounting feet bolts and nuts are secure.
- The spacing of the gear rack at each end of the rail is correct.
- The footrest safety pan stops lift when obstructed in each direction.
- The lift stops when it comes in contact with the limit cams.
- All electrical wires are clear of moving parts.

## VERIFYING LIFT OPERATION

### Observe the following rules when operating the lift.

- Never stand on the footrest when the lift is moving.
- Never exceed the weight capacity of the lift.
- Never use the lift to transport cargo.
- Always place your feet in the center of the footrest.
- Always lock the seat in the ride position when using the lift.
- Always use the seat belt and remain seated in the center of the seat.

## DIRECTION CONTROLS

The Escort Stair Lift is equipped with an armrest mounted control and two wireless remote controls. All controls are constant pressure.

To prevent accidental movement, the lift has a programmed delay before moving.

When using the remote control, aim the remote toward the lift's receiver eye located on side of the lift.

## FOOTREST SAFETY PAN

The lift is equipped with a safety pan mounted on the bottom of the footrest. Should the safety pan encounter an obstruction, the lift will stop abruptly. The lift can be backed away from the obstruction.

## CHAIR LOCK

The lift will not operate if the chair is not locked in the ride position.

When using the lift at the top of the staircase, always verify that the seat is securely locked in the load (rotated) position before attempting to sit in the chair.

## SEAT BELT RESTRAINT

Always use the seat belt.

# Maintenance

## REQUIRED MAINTENANCE

The rail gear should be cleaned **once a year** or more frequently if exposed to contaminants such as pet hair, excessive dust, etc. Wipe debris from the gear teeth. Apply a small amount of lubricant onto a clean cloth and wipe across the gear teeth. Do not apply too much lubricant. Over lubrication will attract dirt and debris.

Ensure all rail, footrest and seat support fasteners are tight.

The seat post and thrust roller bearings should be lubricated **once a year** or sooner if used frequently.



**TIP**

*Gear rack should be lubricated with a multi-purpose calcium grease. **DO NOT USE** any type of light weight penetrating oil (WD-40, GUNK, Kroil, Liquid Wrench etc.)*



**TIP**

*The seat post and thrust roller bearing should be lubricated with a copper based antisieze lubricant. **DO NOT** use any type of light weight penetrating oil (WD-40, GUNK, Kroil, Liquid Wrench etc.)*



**TIP**

*The lift and aluminum rail can be cleaned with any commercial window cleaner. **DO NOT USE** abrasive cleaners.*



**SHOCK  
HAZARD**

*To prevent electrical shock or damage to the lift, disconnect the 120 VAC power when cleaning the lift. Never apply cleaning liquids directly on the rail mounted charging stations or electrical safety switches.*



## SEAT REMOVAL FOR LUBRICATION

1. Lower stair lift to bottom of staircase.
2. Turn lift off at switch on backside of chassis.
3. Remove the seat:
  - a. Rotate the seat 90 degrees. *[Figure 25-1]*



*[Figure 25-1]*

- b. Unplug three pin wire connector from the seat out of the mating connector from the chassis. *[Figure 25-2]*

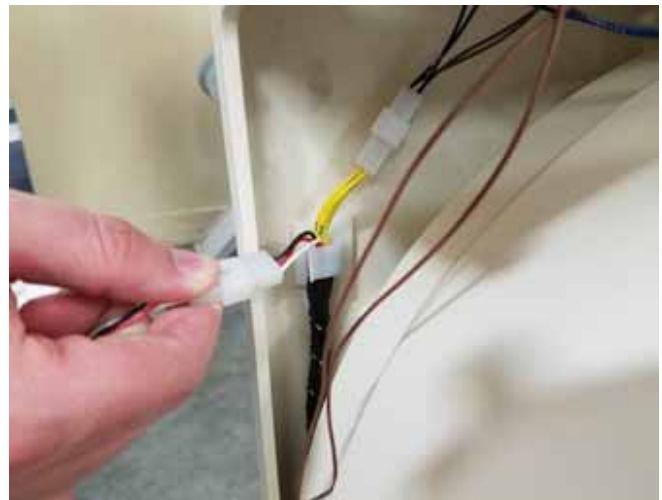

*[Figure 25-2]*

- c. Return seat to normal position.

- d. While depressing swivel lever, lift seat vertically off the seat post. Rotating the seat back and forth while lifting may be helpful in removal of the seat. *[Figure 25-3]*

4. Refer back to the INSTALLING THE CHAIR section (page 16) for applying the lubrication and reinstalling the seat.



*[Figure 25-3]*



### CAUTION

*Never touch the circuit board chips or circuits. Static electricity will damage the circuit board. When handling the circuit board always disconnect the 120 VAC power and use a static discharge wrist band.*

## AUDIO ALERTS

**If your lift does not operate, diagnose the problem by listening to the beeps emitted:**

- No beeps means either the lift is not turned on or the battery has no charge.
- A long beep when the control switch is pressed indicates the lift is touching an obstruction.
- One beep per second for 30 seconds (after a 30 second delay) indicates the lift has been stopped off the charging station. It is recommended that the lift be immediately moved to a charging station (located either end of the rail).
- Two beeps every 60 seconds indicates a major fault with the circuit board. Turn unit off and back on to reset.
- Three beeps every 60 seconds indicate a major fault with the footrest sensor. Turn unit off and back on to reset.
- Seven beeps every 60 Seconds indicate a major fault with the slow down switches. Turn unit off and back on to reset.
- Eight beeps every 60 seconds indicate a major fault with the limit switch. Turn unit off and back on to reset.

If your lift fails to reset, contact your dealer for service.

**NOTE:** A fault is defined as major any time it requires the unit to be turned off and back on to reset.

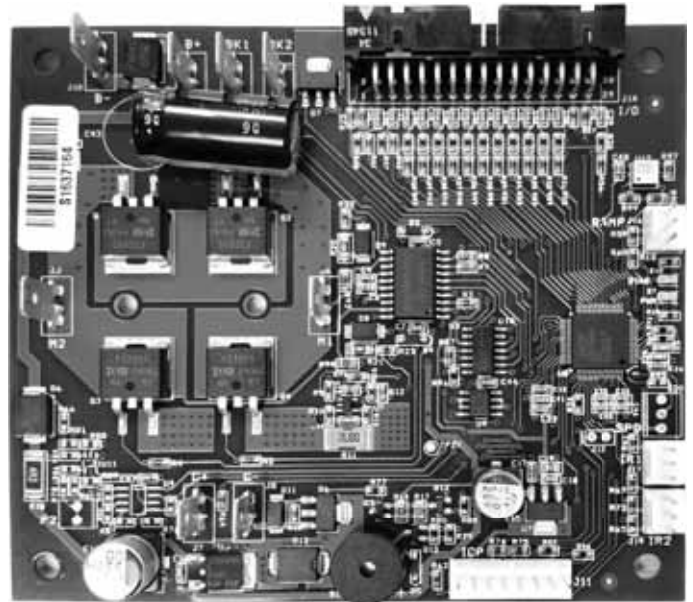

## REMOTE CONTROL PROGRAMMING

If there are multiple lifts in the home, the infra-red remote controls can be programmed to work with individual lifts.

1. Remove the battery door on each IR remote.
2. Move the dip switches to a different code. The two remotes must be set to the same code.
3. Replace the battery doors.
4. Use the seat control switch to move the lift so that it is not on a limit switch.
5. Turn the ON/OFF switch to OFF.
6. Swivel the seat toward the upper landing.
7. Press and hold the footrest safety pan to simulate an obstruction.
8. Turn the ON/OFF switch to ON. Fast beeping should occur indicating the circuit board is in the IR learning mode.
9. Release the footrest safety pan and swivel the seat back to the normal, riding position.
10. Aim the first IR remote at the chassis, press and release the UP or DOWN button. The fast beeping should end with a single beep, indicating that the first remote is programmed.
11. Aim the second IR remote at the chassis, press and release the UP or Down button. Two beeps should sound indicating the second remote is programmed.

# Manual Lowering Tool

## MANUAL LOWERING TOOL



*If the lift is inoperable because it has driven onto the final limit switch or has run out of power, it has to be manually moved off the final limit*

1. Turn the lift off at the power switch.

**NOTE:** Disconnecting the power supply does not turn the lift off. The power supply only charges the batteries.

2. Remove the round plastic plug on the end of the chassis to access the end of the motor shaft.  
*[Figure 28-1]*
3. Place the manual lowering tool onto the end of the motor shaft and rotate until the final limit switch becomes disengaged.
4. Re-install the plastic plug and turn the lift "ON".



# **APPENDIX I**

---

## Measuring and Cutting the Rail

The following section is for installations where the rail has not been ordered pre-cut.

## MEASURING THE RAIL

1. Measure from the nose of the top step to the point on the landing where the rail will rest [Figure 30-1]. Enter this measurement into BOX 1 of the Rail Length Worksheet below.

2. To figure the overall length of the rail you must know the flight angle of your stairway. Measure your rise and run as shown in Figure 30-2. Use the chart on page 31 and its key to figure the flight angle and the corresponding overrun. Enter the overrun into BOX 2 of the Rail Length Worksheet below

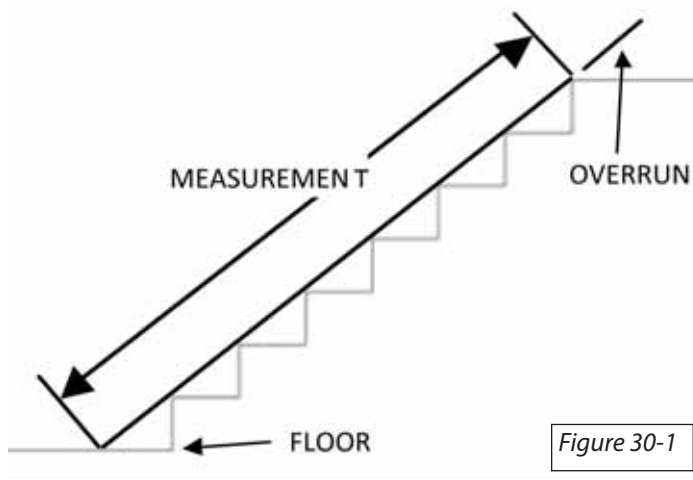

Figure 30-1

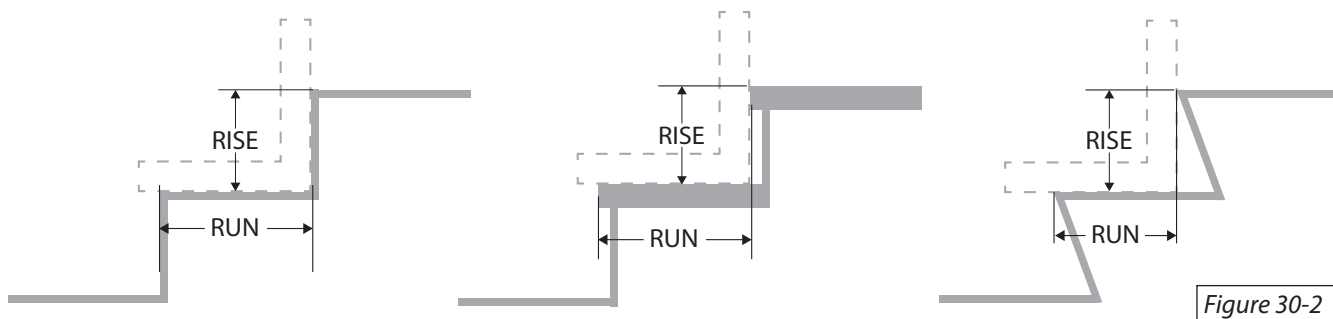

Figure 30-2

3. Add BOX 1 and BOX 2. Enter the value into BOX 3. This is the overall length of the rail.

### Rail Length Worksheet

	BOX 1
	BOX 2
	BOX 3

#### NOTE: Seat Height Compensation

- The Rail length shown in BOX 3 of the **Rail Length Worksheet** will position the footrest level with the upper floor.
- The seat height will be 18 inches. To raise the seat height, additional rail length must be added.
- The length shown in the **Overrun to Raise Seat** column of the **Rise and Run Chart Key** is the length of rail that must be added for each additional inch of seat height.
- The maximum allowable overrun is 12 inches.

# FLIGHT ANGLE CHART

		Average Rise												
		6"	6.25"	6.5"	6.75"	7"	7.25"	7.5"	7.75"	8"	8.25"	8.5"	8.75"	9"
Average Run	9.5"	32.3	33.3	34.4	35.4	36.4	37.3	38.3	39.2	40.1	41.0	41.8	42.6	43.5
	9.75"	31.6	32.7	33.7	34.7	35.7	36.6	37.6	38.5	39.4	40.2	41.1	41.9	42.7
	10"	31.0	32.0	33.0	34.0	35.0	35.9	36.9	37.8	38.7	39.5	40.4	41.2	42.0
	10.25"	30.3	31.4	32.4	33.4	34.3	35.3	36.2	37.1	38.0	38.8	39.7	40.5	41.3
	10.5"	29.7	30.8	31.8	32.7	33.7	34.6	35.5	36.4	37.3	38.2	39.0	39.8	40.6
	10.75"	29.2	30.2	31.2	32.1	33.1	34.0	34.9	35.8	36.7	37.5	38.3	39.1	39.9
	11"	28.6	29.6	30.6	31.5	32.5	33.4	34.3	35.2	36.0	36.9	37.7	38.5	39.3
	11.25"	28.1	29.1	30.0	31.0	31.9	32.8	33.7	34.6	35.4	36.3	37.1	37.9	38.7
	11.5"	27.6	28.5	29.5	30.4	31.3	32.2	33.1	34.0	34.8	35.7	36.5	37.3	38.0
	11.75"	27.1	28.0	29.0	29.9	30.8	31.7	32.6	33.4	34.2	35.1	35.9	36.7	37.5
	12"	26.6	27.5	28.4	29.4	30.3	31.1	32.0	32.9	33.7	34.5	35.3	36.1	36.9
	12.25"	26.1	27.0	28.0	28.9	29.7	30.6	31.5	32.3	33.1	34.0	34.8	35.5	36.3
	12.5"	25.6	26.6	27.5	28.4	29.2	30.1	31.0	31.8	32.6	33.4	34.2	35.0	35.8
	12.75"	25.2	26.1	27.0	27.9	28.8	29.6	30.5	31.3	32.1	32.9	33.7	34.5	35.2
	13"	24.8	25.7	26.6	27.4	28.3	29.1	30.0	30.8	31.6	32.4	33.2	33.9	34.7

**Flight Angle (degrees)**

### Flight Angle Chart Key

Chart Color	Overrun	Overrun to Raise Seat
41-45°	6 1/2 Inches	1 1/2 Inches
36<41°	6 inches	1 3/4 inches
30<36°	5 inches	2 inches
25<30°	4 inches	2 1/4 inches

**NOTE:** If steps are carpeted, compress carpet to obtain measurement

**IMPORTANT!**  
**Always cut at the bottom or top of the rail, not where splice joints are located, to ensure a smooth transition between rails. Rail length cannot be cut to less than 36 inches.**

## CUTTING THE ALUMINUM RAIL

### One Rail Installation (96 Inches or less)

1. Determine if the lift will be installed on the right or left side of the staircase. [Figure 32-1]

When deciding on which side of the staircase to install the lift, consider:

- Which side offers access to an electrical outlet?
- Which side has protruding obstructions such as handrails or wall or window trim?
- Is there a doorway at the top or bottom?

2. Determine top and bottom of rail. The teeth of the gear rack must face toward the wall nearest to where the lift will be installed.

3. Remove the charging strip, gear rack and wiring from the rail.

4. Cut the rail to length.

5. Replace charging strip in both ends of the rail routing the wire through the main interior channel.

[Figure 32-2]

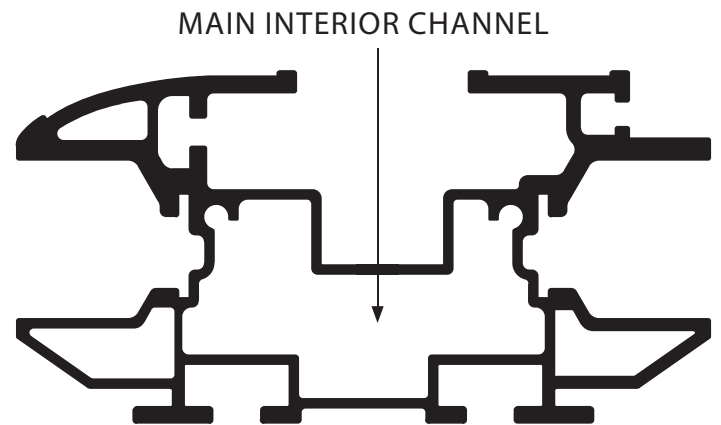
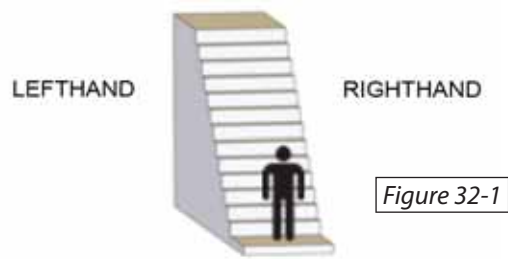

Figure 32-2



*Before cutting the rail, remove the gear rack, charging strip and wire from the rail.*



*When removing the gear rack DO NOT remove the screws from the gear rack. If you do, the fastening plate will become lost within the channel and the gear rack will need to be removed.*



## Two Rail Installation (96¼ -192 inches)

1. Determine if the lift will be installed on the right or left side of the staircase. [Figure 33-1]

When deciding on which side of the staircase to install the lift, consider:

- Which side offers access to an electrical outlet?
- Which side has protruding obstructions such as handrails or wall or window trim?
- Is there a doorway at the top or bottom?

2. Determine top and bottom of rail. The teeth of the gear rack must face toward the wall nearest to where the lift will be installed.

3. Remove the charging strip, gear rack and wiring from the rail.

4. Cut the rail to length at the top end.

5. Replace charging strip in the top end of the rail routing the wire through the main interior channel. [Figure 33-2]

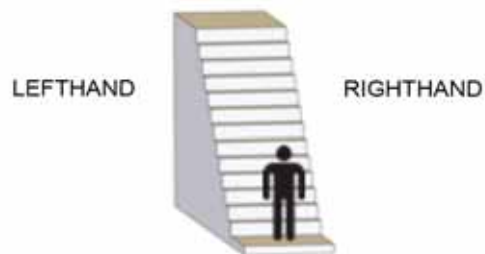

Figure 33-1



Before cutting the rail, remove the gear rack, charging strip and wire from the rail that will be cut.



When removing the gear rack DO NOT remove the screws from the gear rack. If you do, the fastening plate will become lost within the channel and the gear rack will need to be removed.

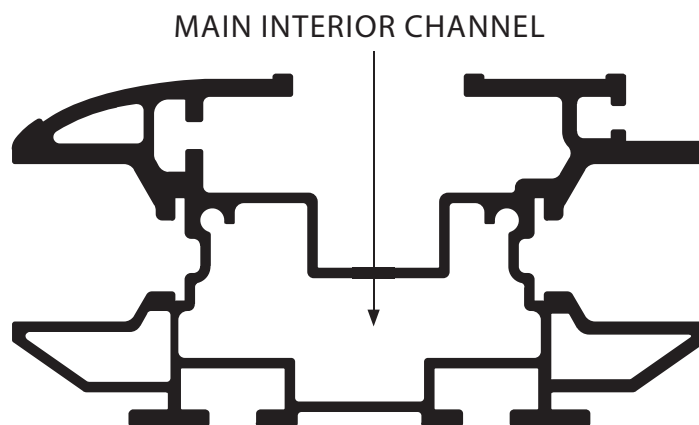
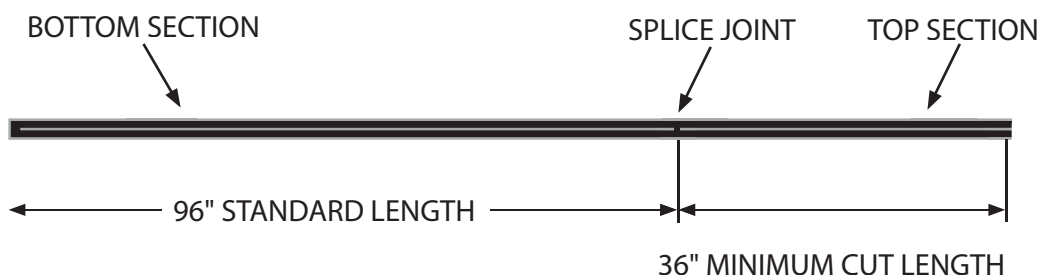

Figure 33-2

### Two Rail Configuration



Remember to keep the factory cuts together at the splice joint to assure the smoothest transition.

## Three Rail Installation (192¼ -288 inches)

1. Determine if the lift will be installed on the right or left side of the staircase. [Figure 34-1]

When deciding on which side of the staircase to install the lift, consider:

- Which side offers access to an electrical outlet?
- Which side has protruding obstructions such as handrails or wall or window trim?
- Is there a doorway at the top or bottom?

2. Determine top and bottom of rail. The teeth of the gear rack must face toward the wall nearest to where the lift will be installed.

3. Remove the charging strip, gear rack and wiring from the rail.

4. Cut the rail to length at the top and bottom ends.

5. Replace charging strips into both ends of the rail routing the wire through the main interior channel.

[Figure 34-2]

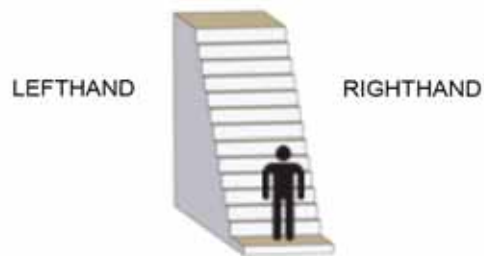

Figure 34-1



Before cutting the rail, remove the gear rack, charging strip and wire from the rails that are to be cut.



When removing the gear rack DO NOT remove the screws from the gear rack. If you do, the fastening plate will become lost within the channel and the gear rack will need to be removed.

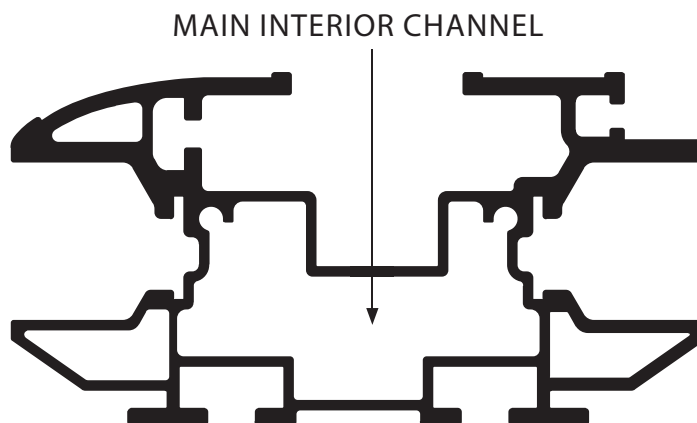
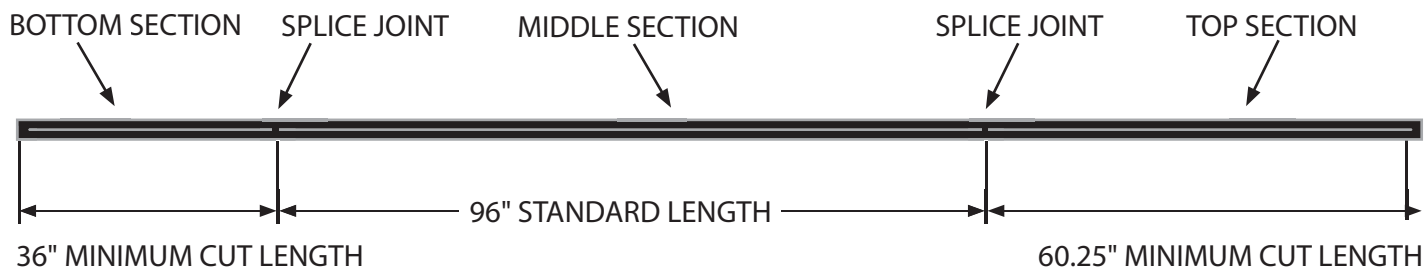

Figure 34-2

### Three Rail Configuration



Remember to keep the factory cuts together at the splice joints to assure the smoothest transition.

# APPENDIX II

---

## Cutting and Adjusting the Gear Rack

The following section is for installations where the rail has not been ordered pre-cut.

## CUTTING THE GEAR RACK



**READ  
MANUAL**

*Pay close attention to the instructions and guidelines below to ensure a proper cut on the gear rack. If you have any questions please consult our technical service department at 866-294-4460.*

### Gear Rack Cutting Rules

Total length of gear rack equals total rail length minus 10.5 inches.

The shortest length a section of gear rack can be cut is 22 inches long due to the spacing of the screws.

Each section of gear rack must have at least two mounting screws.

If the required length measures to the middle of a gear tooth, make the cut at the nearest tooth root (the thinnest part of the gear teeth).

If the cut falls on a screw hole, increase the length by one tooth.

**Each section of gear rack is 46" long.**

1. Use the Gear Rack Configuration Form to determine the length of the gear racks.



**TIP**

*Depending on the length of your rail you will need to cut either one or two pieces of gear rack.*

2. Cut either one or two pieces of gear rack depending on your configuration.

3. Insert the gear rack pieces into the top of the rail.

4. Lightly tighten the rack with the hex screws.

### GEAR RACK CONFIGURATION FORM

**Total Rail Length =**

**minus 10.5 inches**

**(Total gear Rack Needed) =**

**(Smallest Possible Length) minus 22 inches**

**(working inches) =**

**divided by 46**

**number of full gear rack pieces**

**Remainder**

**If remainder is < or = 24 inches, add this to the 22 inch cut. You will only need to make one cut.**

**If remainder is > 24 inches, cut one piece at remainder and one piece at 22 inches. You will be making two cuts.**

## ADJUSTING THE GEAR RACK

1. Loosen the splice bars just enough to allow for some play between the rails.
2. Loosen all of the screws in the gear rack using the 9/64" hex wrench included with the lift [Figure 37-1]. (Do not remove the screws)



### TIP

*DO NOT remove the screws from the gear rack. If you do, the fastening plate will become lost within the channel and the gear rack will need to be removed.*

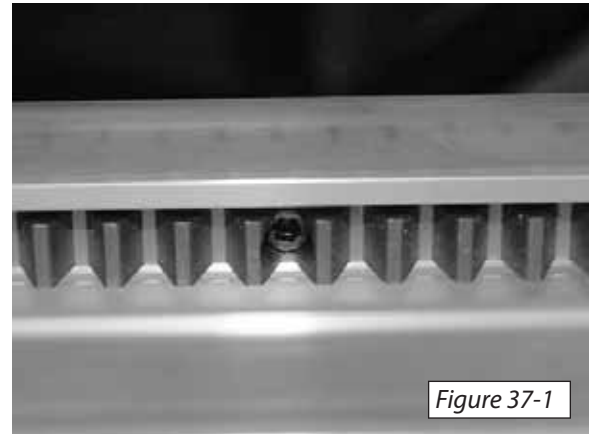

Figure 37-1

3. Position the lower gear rack to the correct end of rail spacing dimension (shown below). [Figure 37-2 and 37-3]

### BOTTOM GEAR SPACING

Left hand installation = 9 in. Maximum  
Right hand installation = 1-1/2 in. Maximum

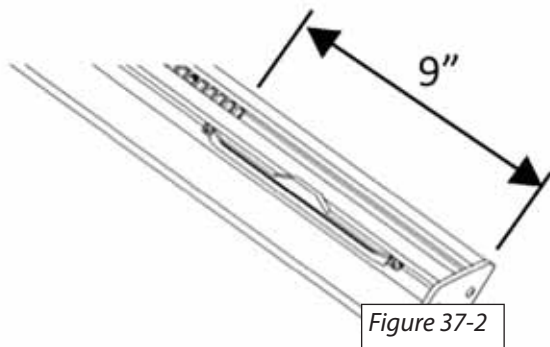

Figure 37-2

Left Hand Install Shown

### TOP GEAR SPACING

Left hand installation = 1-1/2 in. Maximum  
Right hand installation = 9 in. Maximum

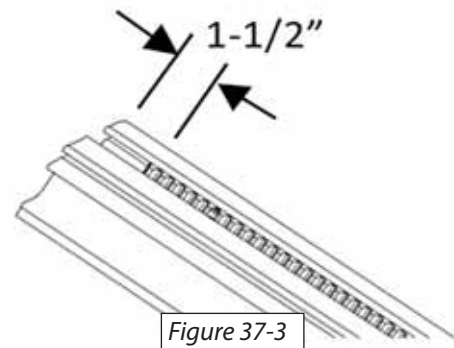

Figure 37-3

Left Hand Install Shown

### ADJUSTING THE GEAR RACK (CON'T)

4. Tighten all screws in the gear rack
5. After securing the lower gear rack, slide the next gear rack against the lower gear rack. Bridge the mating ends of each gear with the timing tool.
6. With the timing tool engaged in teeth of both gear sections, tighten the upper gear rack to the rail.  
*[Figure 38-1 and 38-2]*
7. Repeat with remaining gear rack pieces.
8. Retighten all the splice bars screws.
9. Move the end stop to the end of the gear rack and tighten in place with a 9/64" hex wrench. *[Figure 38-3]*

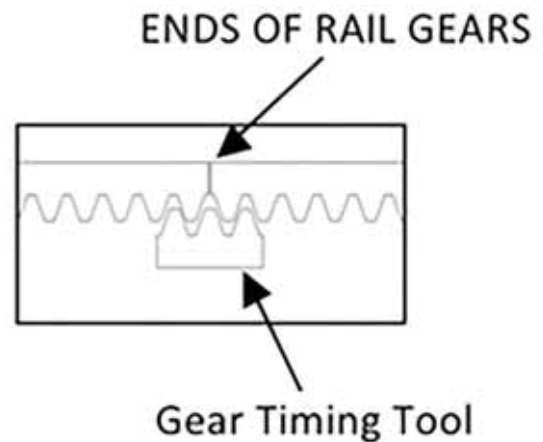
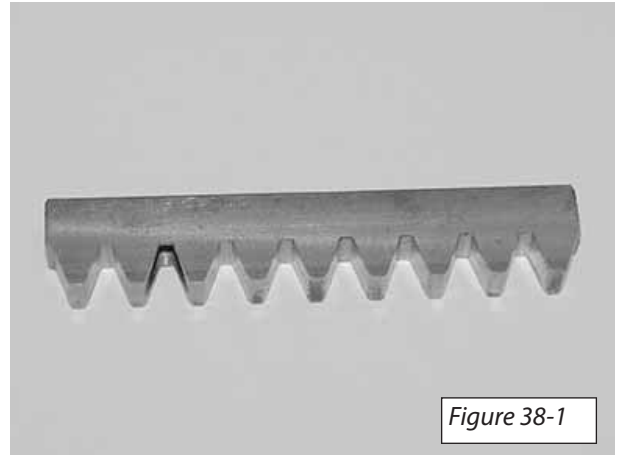
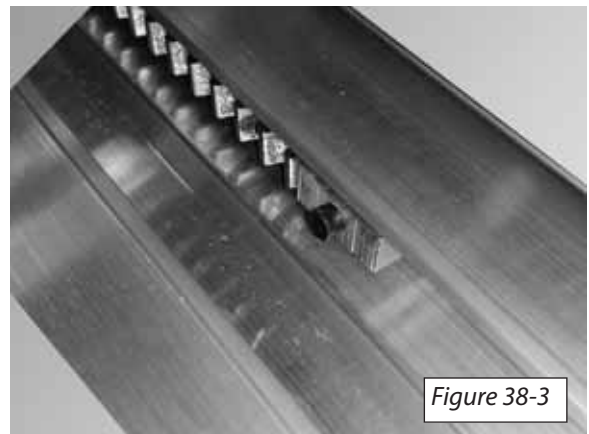

Figure 38-2



- ALL GEAR RACK MOUNTING SCREWS ARE SECURE
- TOP AND BOTTOM GEAR RACK SPACING IS CORRECT

---

Service Description:

Service Date:

Performed By:

---

Service Description:

Service Date:

Performed By:

---

Service Description:

Service Date:

Performed By:



---

**Escort Stair Lift**  
**Installation Manual**