



TESLA

# MODEL S OWNER'S MANUAL



The Model S Owners Manual is available on the touchscreen.  
To view it, touch **CONTROLS > SETTINGS > MANUAL**  
(located in the lower left corner).

More information about your Model S is available at  
**[www.teslamotors.com/mytesla](http://www.teslamotors.com/mytesla)**.

To contact Tesla, call **1-877-79TESLA (1-877-798-3752)**.

#### DOCUMENT APPLICABILITY

Features released in the most recent versions of software may not be described in this document but are described in Release Notes. Display Release Notes on the touchscreen by touching the Tesla "T" at the top center of the touchscreen, then touching the Release Notes link. If information provided in this document conflicts with information in the Release Notes, the Release Notes take precedence.

#### ILLUSTRATIONS

The illustrations provided in this document are for demonstration purposes only. Depending on vehicle options, software version and market region, the information displayed on the touchscreen in your Model S may appear slightly different.

#### PRODUCT SPECIFICATIONS

All specifications and descriptions contained in this document are verified to be accurate at the time of printing. However, because continuous improvement is a goal at Tesla, we reserve the right to make product modifications at any time.

#### ERRORS OR OMISSIONS

To communicate any inaccuracies or omissions in this document, please send an email to: [ownersmanualfeedback@teslamotors.com](mailto:ownersmanualfeedback@teslamotors.com).

©2012-2014 TESLA MOTORS, INC. All rights reserved.

All information in this document and all MODEL S® software is subject to copyright and other intellectual property rights of Tesla Motors, Inc. and its licensors. This material may not be modified, reproduced or copied, in whole or in part, without the prior written permission of Tesla Motors, Inc. and its licensors. Additional information is available upon request. The following are trademarks or registered trademarks of Tesla Motors, Inc. in the United States and other countries:

TESLA

TESLA MOTORS

TESLA  
ROADSTER

TESLA



MODEL S

HOMELINK® and the HOMELINK® house icon are registered trademarks of Johnson Controls, Inc. Bluetooth® is a registered trademark of Bluetooth SIG, Inc. iPhone® is a registered trademark of Apple, Inc. Android™ and Google Maps™ are trademarks of Google, Inc. Sirius, XM and all related marks and logos are trademarks of Sirius XM Radio Inc. Pandora is a registered trademark of Pandora Media, Inc. Spotify is a registered trademark of the Spotify Group. All other trademarks contained in this document are the property of their respective owners and their use herein does not imply sponsorship or endorsement of their products or services. The unauthorized use of any trademark displayed in this document or on the vehicle is strictly prohibited.



<b>Overview.....</b>	<b>2</b>	<b>Charging.....</b>	<b>86</b>
Interior Overview.....	2	Electric Vehicle Components.....	86
Exterior Overview.....	3	Battery Information.....	88
		Charging Model S.....	89
<b>Opening and Closing.....</b>	<b>4</b>	<b>Maintenance.....</b>	<b>93</b>
Doors.....	4	Maintenance Schedule.....	93
Windows.....	8	Tire Care and Maintenance.....	94
Rear Trunk.....	9	Temporary Tire Repair.....	99
Front Trunk.....	11	Cleaning.....	103
Glove Box.....	13	Wiper Blades and Washer Jets.....	106
Sunroof.....	14	Fluid Reservoirs.....	108
Cup Holders.....	15	Fuses.....	111
		Jacking and Lifting.....	118
		Parts and Accessories.....	119
<b>Seating and Safety</b>		<b>Specifications.....</b>	<b>120</b>
<b>Restraints.....</b>	<b>16</b>	Identification Labels.....	120
Front and Rear Seats.....	16	Vehicle Loading.....	121
Seat Belts.....	18	Dimensions and Weights.....	124
Child Safety Seats.....	21	Subsystems.....	125
Tesla Built In Rear Facing Child Seats.....	27	Wheels and Tires.....	128
Airbags.....	31		
		<b>Roadside Assistance.....</b>	<b>134</b>
<b>Driving.....</b>	<b>35</b>	About Roadside Assistance.....	134
Driver Profiles.....	35	Instructions for Transporters.....	135
Steering Wheel.....	36		
Mirrors.....	39	<b>Consumer Information.....</b>	<b>138</b>
Starting and Powering Off.....	40	Disclaimers.....	138
Gears.....	41	Reporting Concerns.....	140
Instrument Panel.....	42	Declarations of Conformity.....	141
Lights.....	47		
Wipers and Washers.....	51		
Park Assist.....	52		
Trip Information.....	54		
Getting Maximum Range.....	55		
Brakes.....	56		
Traction Control.....	58		
Cruise Control.....	59		
Hill Start Assist.....	61		
Rear View Camera.....	62		
<b>Using the Touchscreen.....</b>	<b>63</b>		
Touchscreen Overview.....	63		
Controls.....	65		
Settings.....	67		
Climate Controls.....	70		
Smart Air Suspension.....	73		
Media and Audio.....	74		
Phone.....	77		
Maps and Navigation.....	79		
Security Settings.....	81		
HomeLink Universal Transceiver.....	82		
Connecting to Wi-Fi.....	83		
Software Updates.....	84		
Mobile App.....	85		

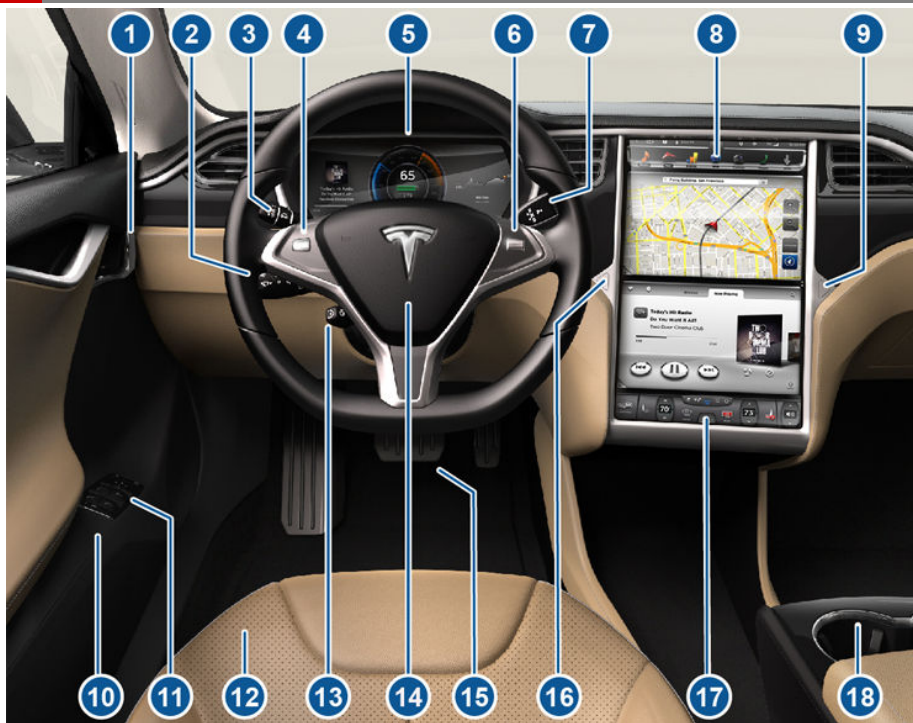

1. Interior doors ([Using Interior Door Handles](#) on page 6)
2. High beams ([Headlight High Beams](#) on page 49), Turn signals ([Turn Signals](#) on page 50), Wipers and washers ([Wipers and Washers](#) on page 51).
3. Cruise control ([Cruise Control](#) on page 59)
4. Steering wheel buttons - left ([Using Left Steering Wheel Buttons](#) on page 36)
5. Instrument panel ([Instrument Panel Overview](#) on page 42)
6. Steering wheel buttons - right ([Using Right Steering Wheel Buttons](#) on page 37)
7. Gear selector ([Shifting Gears](#) on page 41)
8. Touchscreen ([Touchscreen Overview](#) on page 63)
9. Glove box button ([Glove Box](#) on page 13)
10. Power window switches ([Opening and Closing](#) on page 8)
11. Exterior mirror adjustment switches ([Mirrors](#) on page 39)
12. Seats ([Front and Rear Seats](#) on page 16)
13. Steering column adjuster ([Steering Wheel](#) on page 36)
14. Horn ([Horn](#) on page 38)
15. Brakes ([Brakes](#) on page 56)
16. Hazard warning lights ([Hazard Warning Flashers](#) on page 50)
17. Cabin climate control ([Climate Controls](#) on page 70)
18. Cup holders ([Cup Holders](#) on page 15)

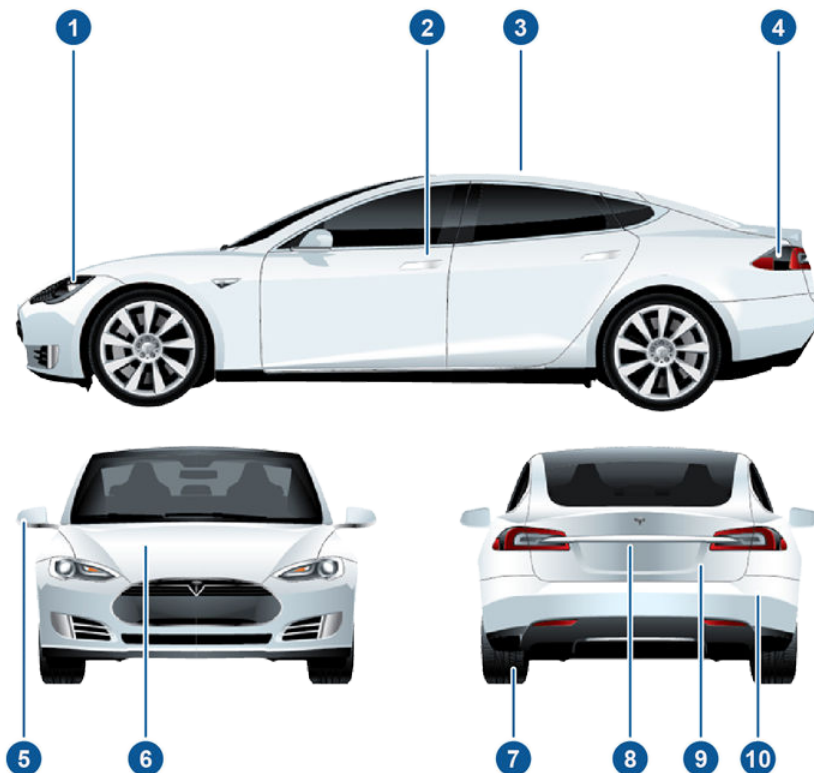

1. Exterior lights ([Lights](#) on page 47)
2. Door handles ([Using Exterior Door Handles](#) on page 5)
3. Sunroof ([Sunroof](#) on page 14)
4. Charge port ([Charging Model S](#) on page 89)
5. Exterior mirrors ([Mirrors](#) on page 39)
6. Front trunk ([Front Trunk](#) on page 11)
7. Wheels and tires ([Wheels and Tires](#) on page 128)
8. Rear view camera ([Rear View Camera](#) on page 62)
9. Rear trunk/liftgate ([Rear Trunk](#) on page 9)
10. Parking sensors ([Park Assist](#) on page 52)



## Keyless Locking and Unlocking

Model S has sensors that can recognize the presence of a key. The sensors have a range of approximately three feet (one meter).

If Model S is equipped with the optional tech package, walking up to Model S when you have your key with you automatically unlocks the doors. Similarly, open the trunk by just walking up to the Model S with your key, then pressing the switch located under the trunk's exterior handle.

Press a door handle, and it extends. Or, if the AUTO-PRESENT HANDLES setting is turned on (see [Using Exterior Door Handles](#) on page 5), door handles extend automatically.

If you turn on the walk-away locking setting using the touchscreen, Model S locks when you walk away carrying your key with you (see [Walk-away Locking](#) on page 6).

**Warning:** To avoid any possibility of interference between a pacemaker and the keyless system's antennas, people with implanted pacemakers should ensure their pacemaker is kept at least nine inches (22 cm) away from any keyless drive antenna mounted in Model S. Antenna locations are shown below:

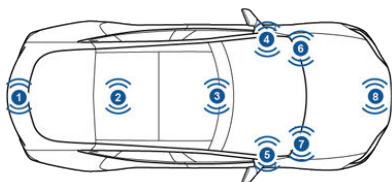

1. Center of the rear bumper.
2. Under the rear seats.
3. Center console.
4. Leftmost side of the dashboard.
5. Rightmost side of the dashboard.
6. Right Hand Drive vehicles only - at the base of the left (passenger side) windshield wiper.
7. Left Hand Drive vehicles only - at the base of the right (passenger side) windshield wiper.
8. Center of the front trunk.

## Using the Key

To quickly familiarize yourself with the key, think of the key as a miniature version of Model S, with the Tesla badge representing

the front. The key has three buttons that feel like softer areas on the surface.

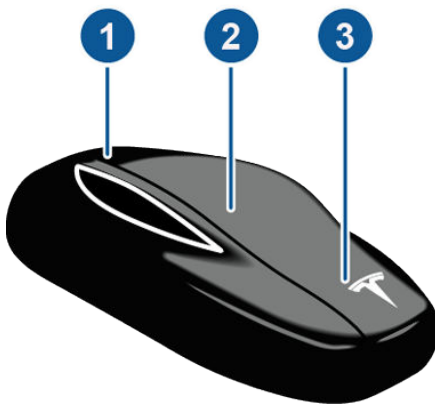

1. Trunk
  - Double-click to open the rear trunk.
  - If Model S is equipped with a powered liftgate, double-click to close the rear trunk. You can also single-click to stop the liftgate when it is moving.
2. Lock/Unlock All
  - Double-click to unlock doors and the rear trunk. Hazard warning lights flash twice and door handles extend.
  - Single-click to lock doors and trunks (all doors and trunks must be closed). Hazard warning lights flash once and door handles retract.
3. Front trunk (also called the "frunk")
  - Double-click to open the front trunk.

You do not need to point the key at Model S, but you must be within operating range (which varies depending on the strength of the key's battery). If Model S is unable to detect the key, the touchscreen displays a message indicating that a key is not inside. Place the key where Model S can best detect it, which is below the 12V power socket (see [Key Not Inside](#) on page 40).

Radio equipment on a similar frequency can affect the key. If this happens, move the key at least one foot (30 cm) away from other electronic devices (phone, laptop, etc). If the key does not work, you may need to change its battery. If the key's battery is discharged, you can open Model S by following the unlocking procedure. See [Unlocking When the Key Doesn't Work](#) on page 7.



- ⚠ **Caution:** Remember to bring the key with you when you drive. Although you can drive Model S away from its key, you will be unable to power it back on after it powers off.
- ⚠ **Caution:** Protect the key from impact, high temperatures, and damage from liquids. Avoid contact with solvents, waxes and abrasive cleaners.

### Replacing the Key Battery

The key's battery lasts for approximately a year. When the battery is low, a message displays on the instrument panel. Follow these steps to replace it:

1. Place the key, button side down, on a soft surface.

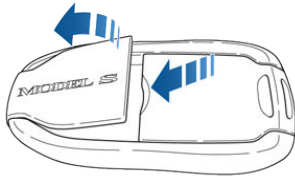

2. Release the battery using a small flat bladed tool.

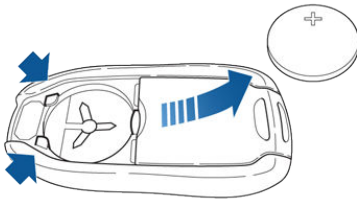

3. Remove the battery by pushing it toward the center of the key to release it from the front retaining clips.
4. Insert the new battery (type CR2032) with the '+' side facing up. Avoid touching the flat surfaces of the battery, and wipe the battery clean before fitting. Finger marks can reduce battery life.
5. Align the battery, then press the key and battery together until they snap into place.

### Getting More Keys

If you lose a key or require an additional one, contact Tesla. Model S can recognize up to three keys.

When ordering a new key for Model S, take all available keys with you for reprogramming.

### Using Exterior Door Handles

A light press on a door handle extends it, provided Model S detects a valid key nearby.

If Model S is equipped with the optional tech package, you can set the door handles to extend automatically whenever you approach the driver's side carrying the key. On the touchscreen, touch **Controls > Settings > Vehicle > Auto-Present Handles > On**.

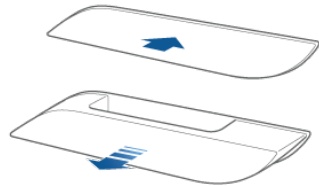

Insert your hand into the handle and pull to open the door.

Door handles retract if you do not use them within one minute after they extend. Just press a handle to extend it again. Door handles also retract a minute after the last door closes, when Model S begins moving, and when you lock Model S.

**Note:** To preserve battery life, Model S is designed to temporarily disable the Auto-Present Handles feature when:

- The key has been out of range for more than 48 hours.
- The key remains within range for five minutes after all doors have been closed.

In these cases, extend the handles by touching the driver's door handle or pressing the unlock button on the key. There is no need to reset the setting. The next time you approach Model S, provided the above conditions do not apply, handles automatically extend.



Whenever a door is open, the Door Open indicator displays on the instrument panel. The image of the Model S on the touchscreen Controls window also shows which door or trunk is open.



## Using Interior Door Handles

Pull the interior door handle toward you to open the door.

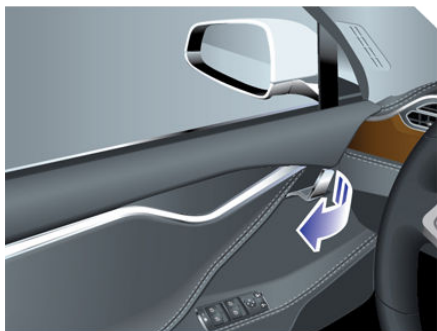

**Note:** To prevent children from opening rear doors using the interior handles, use the touchscreen, **Controls > Settings > Vehicle > Child Protection Lock**, to turn on the child-protection locks (see [Child-protection Lock](#) on page 6).

## Interior Locking and Unlocking

From inside Model S, you can use the touchscreen to lock or unlock doors and trunks, provided a valid key is inside the vehicle. Touch **Controls > Lock/Unlock**. The current lock status displays on the bottom left of the instrument panel.

**Note:** If a door or trunk is still open when you lock Model S, it locks when you close it.

## Child-protection Lock

Model S has child-protection locks on the rear doors and liftgate to prevent them from being opened using interior handles. Use the touchscreen to turn child protection locks on or off. Touch **Controls > Settings > Vehicle > Child Protection Lock**.

**Note:** It is recommended that you turn child-protection locks on whenever children are seated in the rear seats.

## Drive-away Locking

Model S can automatically lock all doors (including the trunks) whenever your driving speed exceeds 5 mph (8 km/h). To turn this feature on or off, touch **Controls > Settings > Vehicle > Drive-Away Door Lock**.

## Walk-away Locking

If Model S is equipped with the optional tech package, Model S doors and trunks can automatically lock whenever you walk away carrying the key.

To turn this feature on or off, touch **Controls > Settings > Vehicle > Walk-Away Door Lock**.

**Note:** If all doors are closed and you double-click the key to unlock Model S, walk-away locking is temporarily suspended until the next time you use the key to lock Model S. This allows you to keep Model S unlocked in your garage.





## Unlocking When the Key Doesn't Work

If Model S does not unlock when you walk up to it, or when you press the unlock button on your key, the key's battery may be dead. If this is the case, you can still unlock and drive Model S.

To unlock Model S (and disable the security alarm), first position the key near the base of the passenger side windshield wiper, as shown. Then press the passenger door handle.

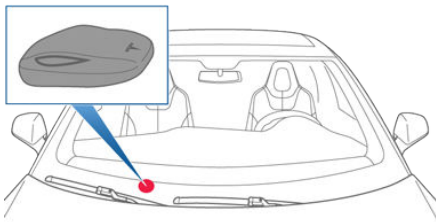

To drive Model S, place the key against the center console, immediately below the 12V power outlet, then press and hold the brake pedal to turn Model S on.

For instructions on how to replace the key's battery, see [Replacing the Key Battery](#) on page 5.

**Note:** It is important to position the key in the correct position. If Model S doesn't unlock, try adjusting the position of the key.

**Note:** Unlocking Model S using this method disables walk-away locking. You must manually re-enable walk-away locking after replacing the key's battery.

## Opening Interior Doors with No Power

If Model S has no electrical power, front doors open as usual using the interior door handles. To open the rear doors, fold back the edge of the carpet below the rear seats to expose the mechanical release cable. Pull the mechanical release cable toward the center.

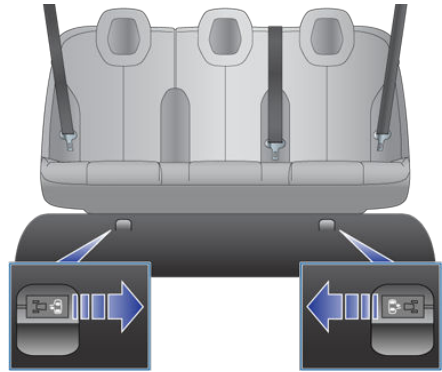



## Opening and Closing

Press down on a switch to lower the associated window all the way down. Window switches operate at two levels. To lower a window partially, hold the switch and release when the window is at the desired position.

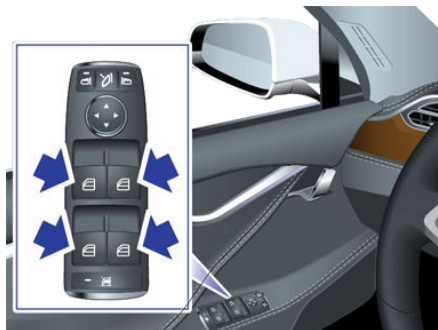

Similarly, pull a switch to raise the associated window. This also operates at two levels—when raising, hold the switch and release when the window is at the desired position.

**Warning:** Before closing a power window, it is the driver's responsibility to ensure that all occupants, especially children, do not have any body parts extended through the window's opening. Failure to do so can cause serious injury.

**Warning:** When leaving Model S, always take your key with you. Leaving the key in Model S allows all doors, windows, and controls to be fully operational and can cause hazardous, unauthorized or unintentional use of Model S.

## Locking Rear Windows

To prevent passengers from using the rear window switches, press the rear window lock switch. The switch light turns on. To unlock rear windows, press the switch again.



**Warning:** To ensure safety, it is recommended that you lock the rear windows whenever children are seated in the rear seats.

**Warning:** Never leave children unattended in Model S.

## Opening

To open the rear trunk, do one of the following:

- Touch **Controls** > **Trunk** on the touchscreen.
- Double-click the Trunk button on the key.
- Press the switch located under the exterior handle (if not equipped with the optional tech package, you must first unlock Model S).



When the liftgate is open, the instrument panel displays the Door Open indicator light. The image of the Model S on the touchscreen Controls window also displays the open trunk.

To stop a powered liftgate while it is moving, single-click the Trunk button on the key. Then, when you double-click the Trunk button, it moves again, but in the opposite direction (provided it was not almost entirely open or closed when you stopped it). For example, if you single-click to stop the liftgate while it is opening, when you double-click, it closes.

To open the trunk in the unlikely situation in which Model S has no electrical power, see [Opening with No Power](#) on page 10.

## Closing

To close the trunk, pull down on the liftgate and push firmly, ensuring it is fully closed.

If Model S is equipped with the optional tech package, you can close the powered liftgate by:

- Double-clicking the trunk button on the key.
- Touch **Controls** > **Trunk** on the touchscreen.
- Pressing the switch located on the underside of the liftgate (see [Adjusting the Opening Height](#) on page 9).

If a powered liftgate senses an obstruction when closing, it automatically opens and sounds two chimes. Remove the obstruction and try closing it again. If it cannot close the second time, powered operation is temporarily disabled. Manually closing it restores powered operation.

**Note:** The power closing feature is also temporarily disabled if you leave the powered liftgate open for more than an hour.

## Adjusting the Opening Height

If Model S is equipped with a powered liftgate, you can adjust its opening height to make it easier to reach:

1. Open the liftgate, then lower it to the desired opening height.



2. Press and hold the button on the underside of the liftgate for two seconds until you hear a confirmation beep.
3. Confirm that you have set it to the desired height by closing the liftgate, then reopening it.



## Interior Release

To open the trunk from inside Model S, press the interior release switch and push the liftgate up.



If Model S is equipped with the optional tech package, you do not need to push it up. When you press the release switch, it opens, and when you pull the switch, it closes.

**Note:** The interior release switch is disabled if the child-protection locks are turned on (see [Child-protection Lock](#) on page 6), or if Model S is moving.

## Opening with No Power

If Model S has no electrical power, you can open the rear trunk from inside. Use the mechanical release cable located on the underside of the liftgate, next to the interior light.

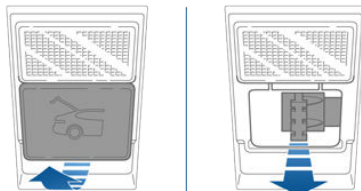

1. Remove the cover by pulling its lower edge very firmly toward you.
2. Pull the cable to release the latch.
3. Push the liftgate open.



## Opening

To open the front trunk:

- Touch **Controls** > **Front Trunk** on the touchscreen, or double-click the front trunk button on the key.
- Pull the hood up.

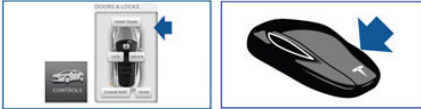

The door open indicator displays on the instrument panel when the front trunk is open. The image of the Model S on the touchscreen Controls window also displays the open trunk.

To open the front trunk in the unlikely situation in which Model S has no electrical power, see [Opening with No Power](#) on page 12.

## Closing

The Model S body is made of lightweight aluminum. Therefore, the hood is not heavy enough to latch under its own weight and applying pressure on the front edge or center of the hood can cause damage. To close the hood:

- Lower the hood fully until it touches the latch.
- Placing both hands on the front of the hood in the areas shown, press down firmly to engage the latches.
- Lift the front edge of the hood to ensure it is fully closed.

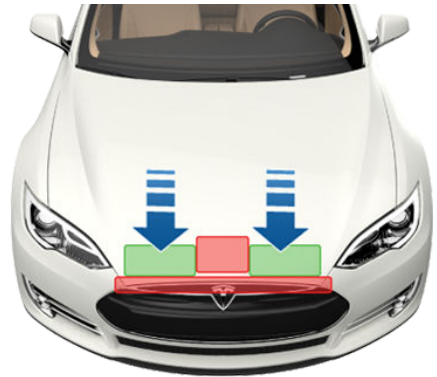

**⚠ Caution:** To prevent damage:

- Apply pressure only to the green areas illustrated above. Applying pressure to the red areas can cause damage.
- Do not close the hood with one hand - this applies concentrated force in one area and can result in a dent or crease.
- Do not apply pressure to the leading edge of the hood - this can crease the edge.
- Do not slam or drop the hood.

**⚠ Warning:** Do not drive with the hood secured by the secondary catch alone.



## Interior Emergency Release

An interior release button inside the front trunk allows a person locked inside to get out. This release button is active whenever Model S is stationary.

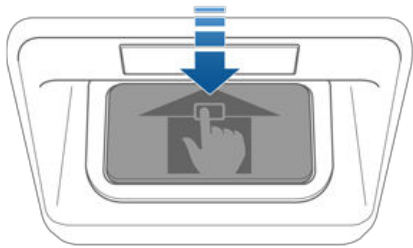

Press the interior release button to open the front trunk, then push up on the hood.

**Note:** The button glows for several hours after a brief exposure to ambient light.

## Opening with No Power

If Model S has no electrical power, or if you are unable to open the front trunk using the touchscreen or key, pull the mechanical release lever located below the glove box. This releases the primary catch.



Then push down on the secondary catch lever and lift the hood. You may need to push the hood down slightly to release the pressure against the secondary catch.

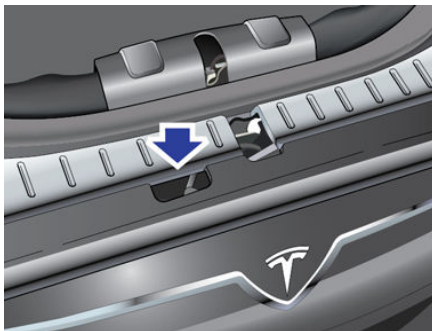



## Opening and Closing

To open the glove box, press the switch located to the right of the touchscreen. If you leave the glove box open for five minutes, its light automatically turns off.

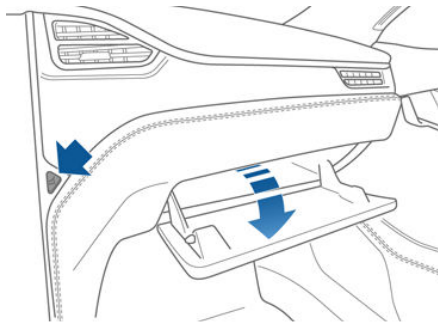

**Note:** The glove box locks whenever Model S is locked externally, using the key or walk-away locking. It does not lock when Model S is locked using the touchscreen.

**Warning:** When driving, keep the glove box closed to prevent injury to a passenger if a collision or sudden stop occurs.



## Opening and Closing

If your Model S is equipped with a sunroof, touch **Controls** > **Sunroof** on the touchscreen to operate it. Drag, or tap on, the sunroof slider bar, or touch the image of the sunroof and drag it. The sunroof moves to the selected position.



Touch **OPEN** once to open the sunroof to its comfort position (80% open to minimize wind noise). Or, move the sunroof to the comfort position by dragging the slider bar to the indent position. If you find wind noise (which varies depending on driving speed) excessive, even with the sunroof in the comfort position, open a window slightly.

Touch **OPEN** twice to open the sunroof fully.

Touch **CLOSE** to fully close the sunroof.

If the sunroof's safety mechanism detects any obstruction, it does not close. If, after removing the obstruction, it still does not close, touch and hold **CLOSE** to override the sunroof's anti-trap mechanism.

Touch **VENT** to open the sunroof slightly.

To stop the sunroof from moving at any time, touch the image of the sunroof.

**Warning:** Do not allow occupants to extend any part of their body through the sunroof. Doing so can cause serious injury from flying debris, tree branches, or other obstructions.

**Warning:** Before closing the sunroof, ensure that occupants, especially children, do not have any body part extended through the sunroof opening. Failure to do so can cause serious injury.

**Caution:** Remove snow and ice before opening the sunroof. Opening a sunroof covered in snow and ice can cause damage.

**Caution:** Do not carry objects in Model S that protrude through the sunroof. Doing so can damage the sunroof's seals and anti-trap mechanism.





## Opening and Closing

To expose a cup holder, slide back the armrest.

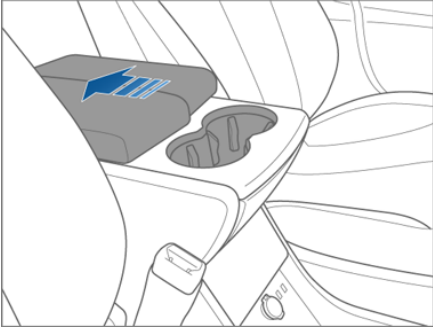



## Correct Driving Position

The seat, head support, seat belt and airbags work together to maximize your safety. Using these correctly ensures greater protection.



Position the seat so you can wear the seat belt correctly, while being as far away from the front airbag as possible:

1. Sit upright with both feet on the floor and the seat back reclined no more than 30 degrees.
2. Make sure you can easily reach the pedals and that your arms are slightly bent when holding the steering wheel. Your chest should be at least 10" inch (25 cm) from the center of the airbag cover.
3. Place the shoulder section of the seat belt mid-way between your neck and your shoulder. Fit the lap section of the belt tightly across your hips, not across your stomach.

Model S seats include integrated head supports that cannot be adjusted or removed.

## Adjusting the Driver's Seat

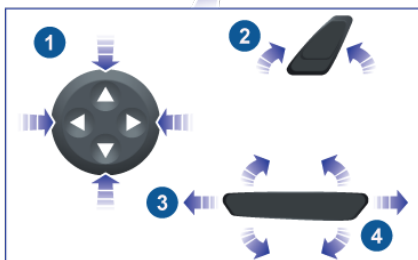

1. Adjust lumbar support.
2. Adjust backrest.
3. Move seat forward/backward.
4. Adjust the seat's height and tilt angle.

**Warning:** Do not adjust seats while driving. Doing so increases the risk of a collision.

**Warning:** Riding in a moving vehicle with the seat back reclined can result in serious injuries in a collision, as you could slide under the lap belt or be propelled into the seat belt. Ensure your seat back is reclined no more than 30 degrees when the vehicle is moving.



## Folding Rear Seats

Model S has a split rear seat that can fold forward.

Before folding, remove items from the seats and the rear foot well. To allow the rear seat backs to fold completely flat, you may need to move the front seats forward.

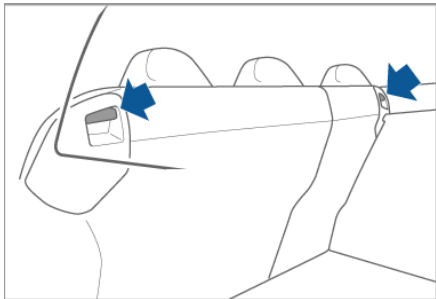

To fold a rear seat, press the corresponding lever and fold the seat forward.

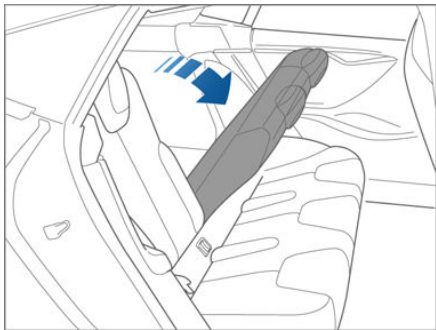

## Raising Rear Seats

Before raising a rear seat, make sure that the seat belts are not trapped behind the backrest.

Pull the seat back upward until it locks into place.

To confirm that the seat back is locked in the upright position, try pulling it forward.

**⚠ Warning:** Always ensure the seat backs are locked in their upright position. Failure to do so increases the risk of injury.

## Head Supports

Seats include integrated head supports that cannot be adjusted or removed.

## Seat Covers

Do not use seat covers on Model S. Doing so could restrict deployment of the side air bags if an accident occurs. It can also reduce the accuracy of the occupant detection system.



## Wearing Seat Belts

Using seat belts and child safety seats is the most effective way to protect occupants if a collision occurs. Therefore, wearing a seat belt is required by law in most jurisdictions.

Both the driver and passenger seats are equipped with three-point inertia reel seat belts. Inertia reel belts are automatically tensioned to allow occupants to move comfortably during normal driving conditions.

The seat belt reel automatically locks to prevent movement of occupants if Model S experiences a force associated with hard acceleration, braking, cornering, or an impact in a collision.



The seat belt reminder on the instrument panel alerts you if a seat belt for an occupied front seat is not fastened. If the belt remains unfastened, the reminder flashes and an intermittent chime sounds. If all occupants are buckled up and the reminder stays on, re-fasten seat belts to ensure they are correctly latched. Also remove any heavy objects (such as a briefcase) from an unoccupied seat. If the reminder light continues to stay on, contact Tesla.

## To Fasten a Belt

1. Ensure correct positioning of the seat (see [Correct Driving Position](#) on page 16).

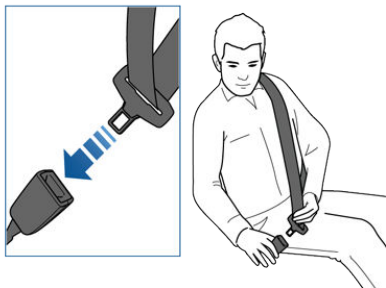

2. Draw the belt out smoothly, ensuring the belt lays flat across the pelvis, chest and mid-point of your collar bone, between the neck and shoulder.
3. Insert the latch plate into the buckle and press together until you hear a click indicating it is locked in place.

4. Pull the belt to check that it is securely fastened.
5. Pull the diagonal part of the belt toward the reel to remove excess slack.

## To Release a Belt

Hold the belt near the buckle to prevent the belt from retracting too quickly, then press the button on the buckle. The belt retracts automatically. Ensure there is no obstruction that prevents the belt from fully retracting. The belt should not hang loose. If a seat belt does not fully retract, contact Tesla.

## Wearing Seat Belts When Pregnant

Do not put the lap or shoulder sections of the seat belt over the abdominal area. Wear the lap section of the belt as low as possible across the hips, not the waist. Position the shoulder portion of the belt between the breasts and to the side of the abdomen. Consult your doctor for specific guidance.



**Warning:** Never place anything between you and the seat belt to cushion the impact in the event of an accident.

## Seat Belt Pre-tensioners

The front seat belts are equipped with pre-tensioners that work in conjunction with the airbags in a severe frontal collision. The pre-tensioners automatically retract both the seat belt anchor and the seat belt webbing, reducing slack in both the lap and diagonal portions of the belts, resulting in reduced forward movement of the occupant.

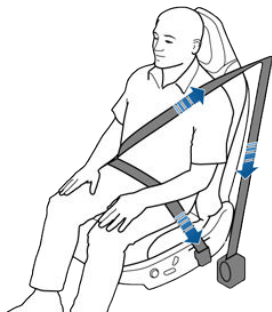

If the pre-tensioners and airbags did not activate in an impact, this does not mean they malfunctioned. It usually means that the strength or type of force needed to activate them was not present.

**Warning:** Once the seat belt pre-tensioners have been activated, they must be replaced. After any accident, have the airbags, seat belt pre-tensioners and any associated components checked and, if necessary, replaced.

## Testing Seat Belts

To confirm that seat belts are operating correctly, perform these three simple checks on each seat belt.













1. With the seat belt fastened, give the webbing nearest the buckle a quick pull. The buckle should remain securely locked.
2. With the belt unfastened, unreel the webbing to its limit. Check that unreeling is free from snags, and visually check the webbing for wear. Allow the webbing to retract, checking that retraction is smooth and complete.
3. With the webbing half unreeled, hold the tongue plate and pull forward quickly. The mechanism should lock automatically and prevent further unreeling.

If a seat belt fails any of these tests, contact Tesla immediately.

For information about cleaning seat belts, see [Seat Belts](#) on page 104.



## Seat Belt Warnings

-  **Warning:** Seat belts should be worn by all occupants at all times, even if driving for a very short distance. Failure to do so increases the risk of injury or death if an accident occurs.
-  **Warning:** Secure small children in a suitable child safety seat (see [Choosing a Child Safety Seat](#) on page 21). Always follow the child safety seat manufacturer's instructions when installing.
-  **Warning:** Ensure that all seat belts are worn correctly. An improperly worn seat belt increases the risk of injury or death if an accident occurs.
-  **Warning:** Do not wear seat belts over hard, fragile or sharp items in clothing, such as pens, keys, eyeglasses, etc. The pressure from the seat belt on such items can cause injury.
-  **Warning:** Seat belts should not be worn with any part of the strap twisted.
-  **Warning:** Each seat belt assembly must be used by one occupant only. It is dangerous to put a seat belt around a child being carried on an occupant's lap.
-  **Warning:** Seat belts that have been worn in an accident must be inspected or replaced by Tesla, even if damage to the assembly is not obvious.
-  **Warning:** Seat belts that show signs of wear (such as fraying), or have been cut or damaged in any way, must be replaced by Tesla.
-  **Warning:** Avoid contaminating a seat belt's components with any chemicals, liquids, grit, dirt or cleaning products. If a seat belt fails to retract or latch into the buckle, it must be replaced immediately. Contact Tesla.
-  **Warning:** Do not make modifications or additions that can prevent a seat belt mechanism from taking up slack, or that can prevent a seat belt from being adjusted to remove slack. A slack belt greatly reduces occupant protection.
-  **Warning:** Do not make modifications that can interfere with the operation of a seat belt, or that can cause a seat belt to become inoperable.
-  **Warning:** When seat belts are not in use, they should be fully retracted and not

hanging loose. If a seat belt does not fully retract, contact Tesla.



## Guidelines for Seating Children

Your Model S seat belts in the front and second row seats are designed for adults and larger children. You must restrain infants and small children in the second row seats only, and you must use a suitable child safety seat appropriate for the child's age, weight, and size. Never use child safety seats in the front row passenger seat. Carefully follow the instructions provided by the manufacturer of the child safety seat.

If your Model S is equipped with the optional Tesla built-in rear facing child seats, these seats are child safety seats and are designed only for children within a specific height and weight range (see [Tesla Built In Rear Facing Child Seats](#) on page 27).

## Choosing a Child Safety Seat

All children age 12 and under should ride in the rear (second row) seats. Always use a child safety seat suitable for a young child's age and weight.

	Infants	Toddlers	Young children
Age	Birth to 1 year*	Over 1 year*	4 years and older, and less than 57 in. (145 cm) tall
Weight	Up to at least 20 lbs (9 kg)*	Over 20 lbs (9 kg) (minimum) and up to 40 lbs (18 kg)*	Over 40 lbs (18 kg)
Type of child safety seat	Rear facing (or convertible)	Forward facing (or convertible)*	Seat belt retained booster seat
Seat position	Rear facing only*	Forward facing*	Forward facing
Recommended attachment method	If combined weight of child and safety seat is up to 65 lbs (29 kg), attach the safety seat using either LATCH (lower anchor only) or the seat belt only.** If combined weight of child and safety seat is over 65 lbs (29 kg), attach the safety seat using the seat belt only.**	If combined weight of child and safety seat is up to 65 lbs (29 kg), attach the safety seat using either LATCH (both lower anchors and top tether anchor), or the seat belt and upper tether strap.** If combined weight of child and safety seat is over 65 lbs (29 kg), attach the safety seat using the seat belt and upper tether strap.**	Attach booster seats using the seat belt only.

**\* Many child safety seats currently available allow children to ride rear-facing using the child safety seat's integrated 5-point harness for a longer period of time BASED UPON SPECIFIC HEIGHT AND WEIGHT LIMITS. Keep your child in a rear facing seat for as long as possible. CHECK THE CHILD SAFETY SEAT MANUFACTURER'S INSTRUCTIONS AND CAREFULLY FOLLOW ALL INSTRUCTIONS**

**\*\* Subject to instructions provided by the child safety seat manufacturer.**



**Warning:** Laws that govern how and where children should be carried when traveling in a vehicle are subject to change. It is the driver's responsibility to keep up to date on, and comply with, all current regulations in the region(s) where Model S is driven. To check the child passenger safety laws for your state, go to: [http://www.ghsa.org/html/stateinfo/laws/childsafety\\_laws.html](http://www.ghsa.org/html/stateinfo/laws/childsafety_laws.html).





## Seating Larger Children

If a child is too large to fit into a child safety seat, but too small to safely fit into the standard seat belts, use a booster seat appropriate for the child's age and size. Carefully follow the manufacturer's instructions to secure the booster seat using the seat belts. Do not use the LATCH system to secure booster seats, even in situations where the booster seat is equipped with the LATCH system.

## Installing Child Safety Seats

There are two general methods used to install child safety seats:

- Seat belt retained - these seats are secured using the vehicle's seat belts (see [Installing Seat Belt Retained Child Seats](#) on page 23).
- LATCH\* retained - these seats can attach to anchor bars built into the vehicle's rear seats (see [Installing LATCH Child Seats](#) on page 24).

Check the child safety seat manufacturer's instructions and the table on [Choosing a Child Safety Seat](#) on page 21 to determine which installation method to use. Some child safety seats can be installed using either method. Always follow the child safety seat manufacturer's instructions.

\*LATCH - Lower Anchors and Tethers for Children

## Installing Seat Belt Retained Child Seats

First, make sure that the child falls into the correct weight range for the seat.

Avoid dressing the child in bulky clothing and do not place any objects between the child and the restraint system.

Adjust harnesses for every child, every trip.

To securely hold child safety seats, all passenger seating positions are equipped with an automatic locking retractor (ALR) that, by pulling the seat belt beyond the length needed for a typical adult occupant, locks the belt into place until the seat belt is unbuckled and the webbing is fully retracted. The ALR mechanism operates as a ratchet, winding in slack and preventing the seat belt from extending any further until it has been completely rewound. When installing a child safety seat, engage the belt's automatic locking retractor by pulling the seat belt webbing until it is **fully** extended. The ALR system engages only when the seat belt is at its maximum extension point.

**Note:** An automatic locking retractor disengages only when the seat belt is unbuckled and fully retracted. The belt can then be worn as a normal belt, sliding freely in and out and locking tight only in an emergency. Once disengaged, the belt must be fully extended to re-engage the locking mechanism whenever you install a child safety seat.

Always follow the detailed instructions provided by the child safety seat manufacturer. General guidelines are provided below.

1. Place the child safety seat in Model S, and fully extend the seat belt. Route and buckle the seat belt in accordance with the child safety seat manufacturer's instructions.

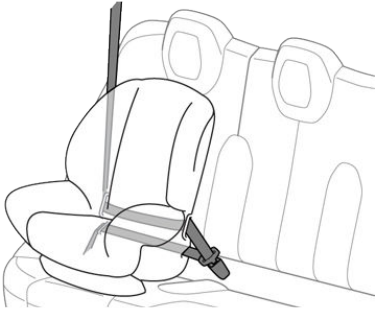

2. Allow the seat belt to retract, and remove all slack in the seat belt while firmly pushing the child safety seat into the Model S seat.
3. If the seat belt retained child safety seat has an upper tether, attach it to the back of the seat (see [Attaching Upper Tether Straps](#) on page 25).

## Installing LATCH Child Seats

Lower LATCH anchor positions are provided in the second-row seats and are located between the seat's back rest and rear cushion. The exact location of each anchor is identified by a child safety seat identification button, illustrated below. The button is located on the seat back, directly above its associated anchor. Some Model S vehicles have two LATCH seating positions (outboard seating positions only) whereas others have three.

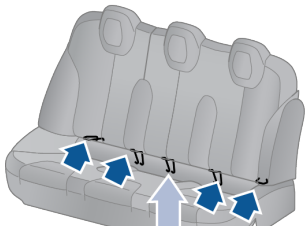

NOTE: SOME VEHICLES DO NOT HAVE THE CENTER LATCH (ISOFIX) POSITION, AS INDICATED BY THE LACK OF AN IDENTIFICATION BUTTON LOCATED ON THE SEAT BACK IN THE CENTER POSITION. IF THIS IS THE CASE, DO NOT INSTALL A LATCH (ISOFIX) CHILD SEAT IN THE CENTER POSITION.

children, use a seat belt retained seat in the center position.

On vehicles without the center LATCH position, install LATCH seats in the outboard seating positions only and always use a seat belt retained seat in the center position.



NOTE: SOME VEHICLES DO NOT HAVE THE CENTER LATCH (ISOFIX) POSITION, AS INDICATED BY THE LACK OF AN IDENTIFICATION BUTTON LOCATED ON THE SEAT BACK IN THE CENTER POSITION. IF THIS IS THE CASE, DO NOT INSTALL A LATCH (ISOFIX) CHILD SEAT IN THE CENTER POSITION.



On vehicles with the center LATCH position, you can install two LATCH seats adjacent to each other only if you install one of the seats on the right (passenger side) and the other in the center, as illustrated below. To seat three



To install a LATCH retained child safety seat, slide the safety seat latches onto the anchor bars until they click into place. Carefully read and follow the instructions provided by the child safety seat manufacturer.

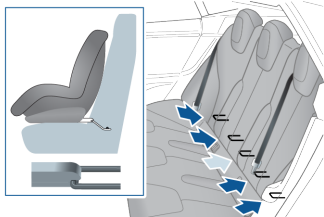

NOTE: SOME VEHICLES DO NOT HAVE THE CENTER LATCH (ISOFIX) POSITION, AS INDICATED BY THE LACK OF AN IDENTIFICATION BUTTON LOCATED ON THE SEAT BACK IN THE CENTER POSITION. IF THIS IS THE CASE, DO NOT INSTALL A LATCH (ISOFIX) CHILD SEAT IN THE CENTER POSITION.

Once installed, test the security of the installation before seating a child. Attempt to twist the child safety seat from side to side and try to pull it away from the seat, then check that the anchors are still securely in place.

## Attaching Upper Tether Straps

If an upper tether strap is provided, attach its hook to the anchor point located on the back of the rear seats. Always position the strap so that it runs over the center of the Model S head support, except in cases where you are installing a LATCH retained child safety seat in the center position—in this case, run the strap over the left hand side of the head support, as shown. Tighten according to the child safety seat manufacturer's instructions.

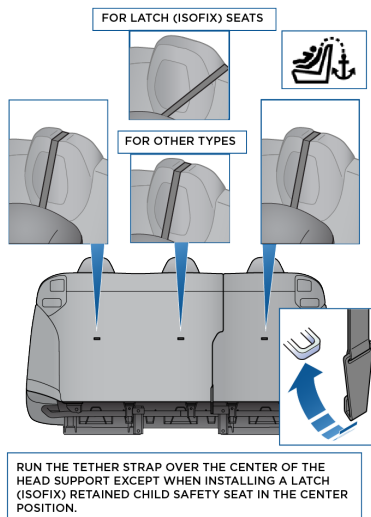

**Note:** To prevent the strap from moving from side to side, the top of the head support deforms.













## Testing a Child Safety Seat

Before seating a child, always make sure the child safety seat is not loose:

1. Hold the child safety seat by the belt path and try to slide the safety seat from side to side and front to back.
2. If the seat moves more than one inch (2.5 cm), it is too loose. Tighten the belt or reconnect the LATCH retained child safety seat.
3. If you are unable to reduce slack, try a different seat location or try another child safety seat.



## Warnings - Child Safety Seats

-  **Warning:** Extreme hazard! Do not seat a child on the front passenger seat even if you are using a child safety seat. This seat has an airbag in front of it. Although this airbag is disabled when Model S detects a lightweight passenger, do not rely on technology to protect your child.
-  **Warning:** Do not use a forward facing child safety seat until your child weighs over 20 lbs (9 kg) and can sit independently. Up to the age of two, a child's spine and neck are not sufficiently developed to avoid injury in a frontal impact.
-  **Warning:** Do not allow a baby or infant to be held on a lap. All children should be restrained in an appropriate child safety seat at all times.
-  **Warning:** To ensure children are safely seated, follow all instructions provided in this document and by the manufacturer of the child safety seat.
-  **Warning:** Children should ride in a rear facing child safety seat using the seat's integrated 5-point harness for as long as possible.
-  **Warning:** Do not use seat belt extenders when installing a child safety seat or booster seat.
-  **Warning:** When seating larger children, make sure the child's head is supported and the child's seat belt is properly adjusted and fastened. The shoulder portion of the belt must be away from the face and neck, and the lap portion must not be over the stomach.
-  **Warning:** Never attach two child safety seats to one anchor point. In a collision, one anchor point may be incapable of securing both seats.
-  **Warning:** Child restraint anchorages are designed to withstand only those loads imposed by correctly fitted child restraints. Under no circumstances are they to be used for adult seatbelts, harnesses, or for attaching other items or equipment to the vehicle.
-  **Warning:** Always check harnesses and tether straps for damage and wear.
-  **Warning:** Do not use seat belt extenders on a seat belt that is being used to install a child safety seat or booster seat.
-  **Warning:** Never leave a child unattended, even if the child is secured in a child safety seat.
-  **Warning:** Never use a child safety seat that has been involved in an accident. Have the seat inspected or replaced as a described in the child safety seat manufacturer's instructions.

## Usage Restrictions

The Tesla built-in rear facing child seats are child restraint systems and must only be used for children over 37" (94 cm) tall and weighing between 35 and 77 lbs (16.2 to 35.2 kg).

Always ensure the top of the child's head cannot contact the vehicle and that the child is seated comfortably with the seat belts positioned and latched correctly. The child's pelvis must be held securely in place by the lap belt. Follow all instructions provided and **do not use supplemental child safety seats in these seats.**

**Note:** Whenever a child is seated in the Tesla built-in rear facing child seats, it is recommended that you set the climate control system to draw outside air into Model S instead of recirculating the air. This draws more air into the rear seating areas. See [Customizing Climate Control](#) on page 71.

## Opening

1. Remove the cover from the trunk floor and pull the strap attached to the seat to lift the seat assembly upward.

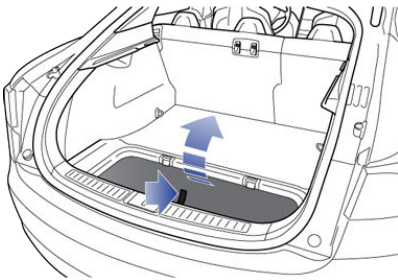

2. Push the seat assembly into position.

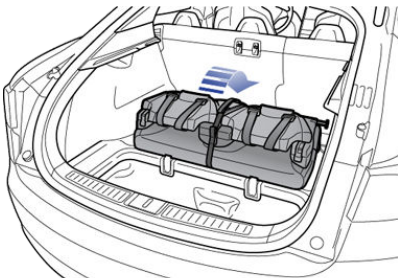

3. Undo the Velcro strap.

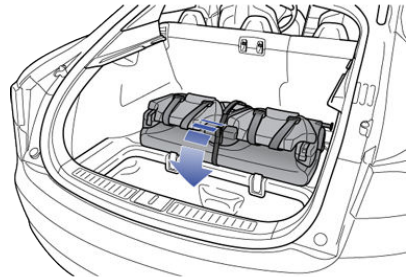

4. Pull the handle to release the head supports from the seat back, then pull the head supports toward you to unfold them.

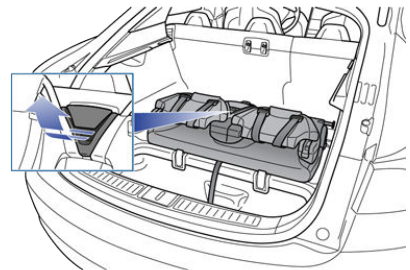

5. Raise the seat back to the upright position and push until it locks into position. Visually check to ensure that the retaining catches are engaged.

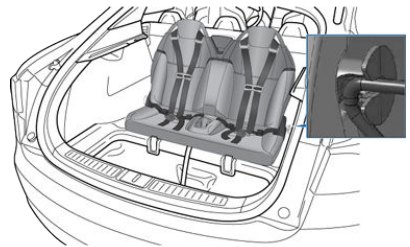

6. Check that the seat back and seat base are securely retained in the upright position by trying to pull the seat back toward you.



## Storing

**⚠ Caution:** Before folding the seats, fasten the seat belts to prevent them from getting trapped in the seat mechanism and being damaged.

1. Pull the handle to release the seat back and pull the seat back fully forward.

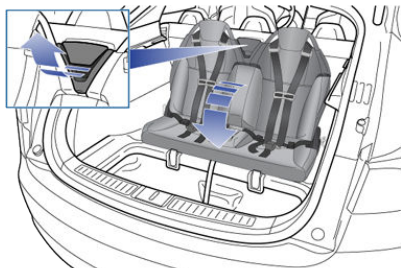

2. Push the lever to release the head supports from the seat back, then fold back onto the seat.

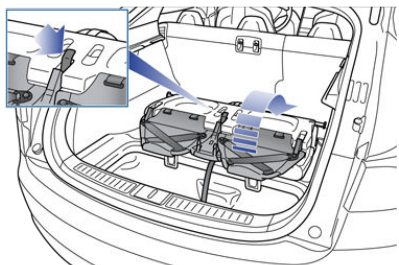

3. Secure the Velcro strap.

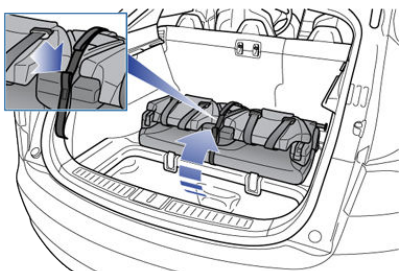

4. Pull the strap at the rear of the seat to fold the seat assembly into the trunk floor.

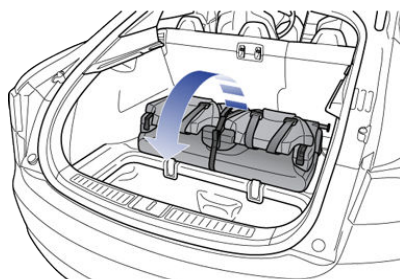

5. Replace the cover on the trunk floor.

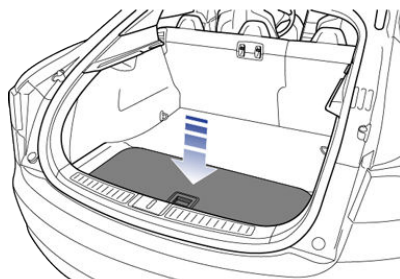



## Seating a Child

The Tesla built-in rear facing child seats are child restraint systems and must only be used for children over 37" (94 cm) tall and weighing between 35 and 77 lbs (16.2 to 35.2 kg).

Always ensure the top of the child's head cannot contact the vehicle and that the child is seated comfortably with the seat belts positioned and latched correctly. The child's pelvis must be held securely in place by the lap belt. Follow all instructions provided and **do not use supplemental child safety seats in these seats.**

**Note:** Whenever a child is seated in the Tesla built-in rear facing child seats, it is recommended that you set the climate control system to draw outside air into Model S instead of recirculating the air. This draws more air into the rear seating areas. See [Customizing Climate Control](#) on page 71.

1. Position the child in the seat with arms through the loops of the seat belts.
2. Connect the two halves of the seat belt tongue.
3. Insert the seat belt tongue into the buckle and ensure it is securely fastened.

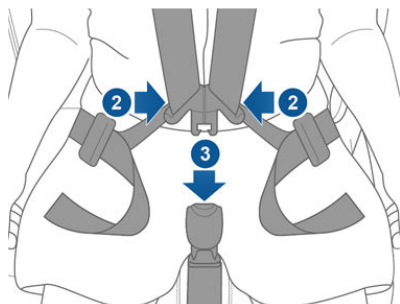

4. Adjust the shoulder belts so they run over the top of the child's shoulders and away from the face.
5. Connect the chest clip and adjust it to be as high as possible without causing the shoulder belts to touch the child's neck.
6. Pull the lower straps until the child is securely held in the seat.



7. Slide the shoulder clips into place to ensure the upper portion of the belts remain positioned over the child's shoulders.

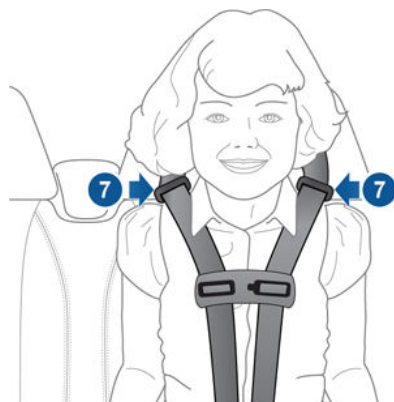

To release, press the button on the buckle, release the chest clip, and separate the two halves of the seat restraint.



## Warnings - Tesla Child Seats

**Warning:** The Tesla built-in rear facing seats are child restraint systems and must only be used for children over 37" (94 cm) tall and weighing between 35 and 77 lbs (16.2 to 35.2 kg).

**Warning:** Do not use supplemental child restraint systems, including booster seats, in the Tesla built-in rear facing child seats.

**Warning:** Always ensure that the top of the child's head cannot touch the vehicle and that the child is seated comfortably with the seat belts correctly fastened.

**Warning:** Follow all instructions and heed all warnings related to the rear facing child seats. Failure to do so can compromise occupant safety.

**Warning:** Read all safety warnings and labels attached to the seats.

**Warning:** Do not leave children unattended in Model S, even if the child is secured in a child safety seat or a Tesla built-in rear facing child seat. In hot weather, the interior temperature can reach dangerous levels that can result in dehydration, serious injury or death.

**Warning:** Do not remove or replace the fabric on a Tesla built-in rear facing child seat. The covers are an integral part of the restraint's performance and should not be removed or replaced with any other type than those supplied by Tesla.

**Warning:** If the Tesla built-in rear facing child seats have been worn in an accident, they must be inspected or replaced by Tesla, even if damage is not obvious.

**Warning:** Before allowing a child to ride in the Tesla built-in rear facing child seats, check that the seat is securely held in the upright position by trying to pull the seat back toward you.

**Warning:** Do not remove the built-in rear facing child seats for any reason, including cleaning. To ensure safety of occupants, removal and installation must be performed by qualified Tesla service technicians.

**Warning:** Do not make modifications or additions that can interfere with the operation of the Tesla built-in rear facing child seats.

**Warning:** To prevent injury, ensure all loose items (bags, luggage, etc.) are secured. In an accident, or during hard braking and sharp turns, loose items could cause injury.



## Location of Airbags

Airbags are located in the approximate areas shown here. Airbag warning information is printed on the sun visors.

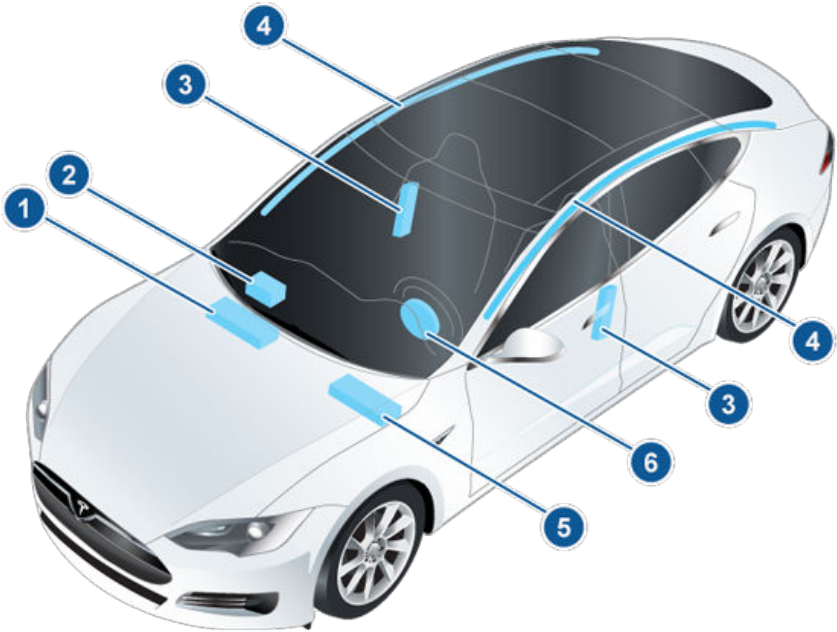

1. Passenger knee airbag
2. Passenger front airbag
3. Side airbags
4. Curtain airbags
5. Driver's knee airbag
6. Driver's front airbag



## How the Airbags Work

Inflation of airbags depends on the rate at which the vehicle's cabin changes speed in a collision. The rate of deceleration determines whether airbags inflate.

Airbags inflate instantly with considerable force accompanied by a loud noise. The inflated bag, together with the seat belts, limits movement of occupants to reduce the risk of injury.

Front airbags are not ordinarily designed to inflate in rear collisions, rollovers, minor front or side collisions, heavy braking, or driving over bumps and potholes. Therefore, significant superficial damage can occur to the vehicle without the airbags inflating or, conversely, a relatively small amount of structural damage can cause airbags to inflate.

If you are planning to modify your vehicle for a person with disabilities in a way that may affect the airbag system, contact Tesla.

## Types of Airbags

Advanced front airbags	The front airbags are advanced airbags designed to reduce airbag related injuries to children or small adults who ride in the front seats. On the driver's side, the front airbag works with a seat position sensor that adjusts the inflation level based on the seating position of the occupant. On the passenger's side, the airbag responds to a sensing system in the seat that determines whether or not the passenger side front airbag inflates, and optimizes the inflation level based on the weight of the occupant (described below).
Knee airbags	Knee airbags and the front airbags work together. The knee airbags limit the forward motion of the front seat occupants by restricting leg movement, thereby positioning the occupants so that the front airbags work more effectively.
Side airbags	Side airbags protect the thorax region of the torso and the pelvis. They inflate only if a severe side impact occurs. Side airbags on the non-impacted side do not inflate.
Curtain airbags	Curtain airbags help protect the head and typically inflate only if a severe side impact occurs, or if the vehicle rolls over. Curtain airbags on the non-impacted side do not inflate.



## Passenger Front Airbag

Model S has an occupancy sensor in the front passenger seat that controls the status of the airbags based on the weight of the occupant. Passenger airbag status displays in the top right corner of the touchscreen to indicate whether the airbag will inflate (on) or not inflate (off) if a collision occurs.



**Note:** The occupancy sensor system meets the regulatory requirement of FMVSS 208 and automatically detects when inflating the passenger front airbag would be unnecessary or potentially harmful.

Front passenger seat occupancy*	Passenger airbag status
Empty	OFF
Infant in child safety seat (up to 20 lbs/ 9kg)	OFF
Child or small occupant (20-100 lbs/9-45 kg)	ON or OFF
Heavy object/ occupant	ON
*Values are approximate. Occupants whose weight is close to the low weight threshold can cause the status to occasionally turn on and off depending on seating position and physique.	

If the status shows the airbag as permanently on, even when the seat is empty and the seat belt is unbuckled, contact Tesla immediately.

To make sure the sensing system can correctly detect occupancy status, eliminate the following:

- Objects lodged under the seat.
- Heavy objects sitting on the seat (briefcase, large purse).

- Objects wedged between the seat back and seat cushion.
- Cargo interfering with the seat.
- After market items attached to, or sitting on, the seat (covers, mats, blankets, etc.).

These conditions can interfere with the occupancy sensor. If you have eliminated the above possibilities, and the airbag status is still incorrect, ask passengers to ride in the rear seats and contact Tesla to have the airbag system checked.

**Note:** The front passenger seat's sensing system affects the operation of the passenger front airbag only. Other passenger airbags (side airbag and curtain airbag) are not affected.

**Warning:** Never seat a child in a child safety seat or a booster seat on the front passenger seat when the airbag is activated.

**Warning:** Do not use seat covers on Model S. Doing so could restrict deployment of the side air bags if an accident occurs. It can also reduce the accuracy of the occupant detection system.



## Inflation Effects

When airbags inflate, a fine powder is released. This powder can irritate the skin and should be thoroughly flushed from the eyes and from any cuts or abrasions.

After inflation, the airbags deflate to provide a gradual cushioning effect for the occupants and to ensure the driver's forward vision is not obscured.

If airbags have inflated, or if your vehicle has been in an accident, always have the airbags, seat belt pre-tensioners and any associated components checked and, if necessary, replaced by Tesla.

In a collision, in addition to the airbags inflating:

- Doors unlock and the door handles extend.
- Hazard warning lights turn on.
- Interior lights turn on.
- High voltage is disabled.

To restore Battery power, use the touchscreen to manually power off Model S (see [Powering Off](#) on page 40), then press the brake to power it back on again.

## Airbag Warning Indicator



The airbag indicator on the instrument panel remains lit if the airbag system is malfunctioning. The only time this indicator should light up is briefly when Model S first starts up, in which case it turns off within a few seconds. If it remains lit, contact Tesla immediately and do not drive.

## Airbag Warnings

- Warning:** All occupants, including the driver, should always wear their seat belts, whether or not an airbag is also provided at their seating position, to minimize the risk of severe injury or death in the event of a collision.
- Warning:** Front seat occupants should not place their arms over the airbag module, as an inflating bag can cause fractures or other injuries.
- Warning:** Do not use seat covers on Model S. Doing so could restrict deployment of the side air bags if an accident occurs. It can also reduce the accuracy of the occupant detection system.
- Warning:** Airbags inflate with considerable speed and force, which can cause injury. To limit injuries, ensure that occupants are wearing seat belts and are correctly seated, with the seat positioned as far back as possible. The National Highway Traffic Safety Administration (NHTSA) recommends a minimum distance of 10" (25 cm) between an occupant's chest and an airbag.
- Warning:** Do not use a child safety seat or seat young children on a seat with an operational airbag in front of it. Doing so can cause injury or death if the airbag inflates.
- Warning:** To ensure correct inflation of the side airbags, maintain an unobstructed gap between an occupant's torso and the side of Model S.
- Warning:** Passengers should not lean their heads against the doors. Doing so can cause injury if a curtain airbag inflates.
- Warning:** Do not allow passengers to obstruct the operation of an airbag by placing feet, knees or any other part of the body on or near an airbag.
- Warning:** Do not attach or place objects on or near the front airbags, the side of the front seats, the headliner at the side of the vehicle, or any other airbag cover that could interfere with inflation of an airbag. Objects can cause serious injury if the vehicle is in a collision severe enough to cause the airbag to inflate.
- Warning:** Following inflation, some airbag components are hot. Do not touch until they have cooled.

## Creating a Driver Profile

If Model S is equipped with the optional tech package, you only need to adjust Model S once. When you first adjust the driver's seat, steering wheel, or driver's side mirror, the touchscreen prompts you to create a driver profile to save these adjustments. Your profile also saves several other preferences you make using the touchscreen's Settings window.

A new driver can also add a driver profile by touching **Controls > Settings > Driver Profiles** (or by touching the driver icon on the touchscreen's status bar, and touching **Create Driver Profile**). Enter the driver name and touch Create Profile.

If you change the position of the steering wheel, driver's seat, or driver's side mirror after you have saved a profile, the touchscreen prompts you to save the new position or restore the previously saved position (other preferences are automatically saved). To use a setting without saving or restoring, just ignore the prompt.

## Restoring a Driver's Profile



To adjust Model S based on a driver's profile, touch the driver profile icon, located to the left side of the Tesla "T" on the touchscreen's status bar. Then choose the driver and the saved adjustments are automatically made.

## Saved Driver Settings

To see what settings are associated with your driver profile, touch **Controls > Settings > Driver Profiles**. Then touch **See what's saved**. A popup window lists the settings that are associated with a driver profile. These settings vary depending on the version of software currently running in Model S.



## Adjusting Position

Adjust the steering wheel to the desired driving position by moving the control on the left side of the steering column.

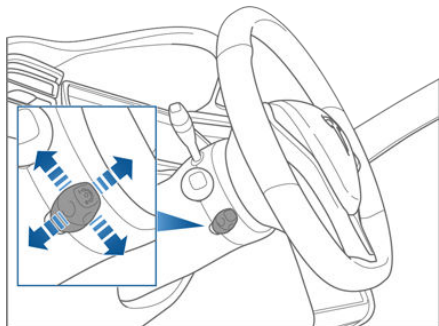

**Warning:** Do not make adjustments while driving.

## Adjusting Sensitivity

You can adjust the feel and sensitivity of the steering system to suit your personal preference:

1. On the touchscreen, touch **Controls**.
2. Choose a steering option:
  - **Comfort** - reduces the effort required to turn the wheel. In town, Model S feels easier to drive and park.
  - **Standard** - Tesla believes that this setting offers the best handling and response in all conditions.
  - **Sport** - Increases the effort required to turn the wheel. When driving at higher speeds, Model S feels more responsive.

The only way to really know which option you like best is to try them.

## Using Left Steering Wheel Buttons

Use the buttons on the left side of the steering wheel to change radio stations, control the media player's volume, and control what displays on the left side of the instrument panel (whenever the Navigation app is not displaying instructions).

**Note:** The volume control on the steering wheel does not adjust spoken navigation instructions. To control the volume of navigation instructions, use the navigation

window on the touchscreen (see [Using Maps](#) on page 79).

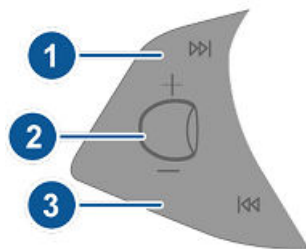

### 1. Next

If you are listening to local or satellite radio and you have defined more than one radio preset, press to play the next preset in the radio band that is currently playing. If you have not defined more than one preset, press to go to the next available frequency.

If you are listening to Internet radio, or to an audio file on a connected Bluetooth or USB device, press to skip to the next song or station.

### 2. Scroll Wheel

- To adjust the media volume, roll up or down.
- To mute the media volume, or to pause/play an audio file, tap the wheel.
- To choose what displays on the left side of the instrument panel, press and hold the scroll wheel to display the available options. Then roll the scroll wheel to browse through the options. Tap the scroll wheel when the option you want is selected.

### 3. Previous

Same as described above for Next, except it skips to the previous song or station.

**Note:** Regardless of how you customize the left side of the instrument panel, it automatically changes to display navigation instructions (if applicable), or to let you know if a door or trunk is open when Model S is in a driving gear.



## Using Right Steering Wheel Buttons

Use the buttons on the right side of the steering wheel to control the phone, to choose and control a Model S feature by tapping the scroll wheel, to use voice commands, and to choose what displays on the right side of the instrument panel.

**Note:** Regardless of how you customize the right side of the instrument panel, it automatically displays the phone menu to help you easily handle phone calls on your Bluetooth connected phone.

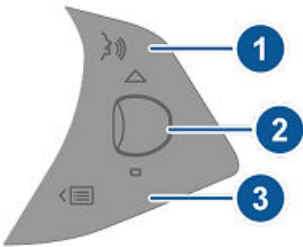

### 1. Phone Menu or Voice Commands

During a phone call, press to display the phone menu, which gives you the option to mute, hold, or end the call.

Press and hold to use voice commands to call a contact, navigate, or listen to Internet music. When you hear the tone, speak your command. Release the button when you finish speaking. For details, see [Using Voice Commands](#) on page 37.

### 2. Scroll Wheel

- To choose what displays on the right side of the instrument panel, press and hold the scroll wheel to display the available options. Then roll the scroll wheel to browse through the options. Tap the scroll wheel when the option you want is selected.
- When the right side of the instrument panel displays a menu, rolling the wheel highlights the next item in a menu and tapping the wheel selects the highlighted item. When a menu is not displayed, rolling the wheel adjusts your chosen controllable feature (see Item 3 below).

### 3. Customize the Scroll Wheel/Exit a Menu

Press, then use the scroll wheel to select Phone to browse through and select contacts and recent calls.

Press, then use the scroll wheel to select Customize to choose the Model S feature that you want to control whenever you roll the wheel when a menu is not displayed. You can choose from:

- All - allows you to roll the wheel and choose from all available functions (listed next).
- Climate Temps - roll the wheel to change the temperature, or press the wheel to turn the climate control system on and off.
- Fan Speed - roll the wheel to adjust the speed of the fan used to cool or heat the cabin.
- Display Brightness - roll the wheel to change the brightness level of the displays, or press the wheel to restore default settings.
- Sunroof (if equipped) - roll the wheel to adjust the position of the sunroof.
- Media Source - roll the wheel to control what Media Player is playing, or press the wheel to add/remove the currently playing station or audio track as a Favorite.

Press the lower right button at any time to either exit a menu, or go back one level in the menu structure.

## Using Voice Commands

You can use voice commands to call a contact, navigate, or listen to Internet music. Press and hold the voice button on the upper right side of the steering wheel. When you hear the tone, speak your command while continuing to hold down the voice button. Release the button when you finish speaking.

- To call a contact on your Bluetooth-connected phone, say “Call” or “Dial,” followed by the contact’s first and/or last name(s). For example, “Call Eric” or “Call Mike Phillips.”
- To search for, or navigate to, a location, say “Where is,” “Drive,” or “Navigate,” followed by an address, business name, business category, or landmark. For example, “Drive to Tesla in Menlo Park,” “Drive to Starbucks on Homestead in Cupertino,” or “Where is Stanford University?” If you have defined a navigation address for your home or work locations, you can use a voice command to “Navigate home” or “Navigate to work.”
- To listen to an Internet music service, say “Listen to,” or “Play,” followed by the



name of the song, album, artist or combination. To improve voice recognition accuracy, provide multiple cues in your command, such as artist plus song (for example, “Play Honky Chateau by Elton John” or “Listen to Boogie Wonderland”).

## Horn

To sound the horn, press the center pad on the steering wheel.





## Adjusting Exterior Side Mirrors

Press the button associated with the mirror you want to adjust (left or right). The button's light turns on and you can then press the dial to move the mirror to the desired position. Repeat for the other side mirror. If Model S is equipped with the optional tech package, you may need to touch **SAVE** on the touchscreen to save the mirror adjustment in your driver profile.



To fold exterior mirrors, press the center button.

If Model S is equipped with the optional tech package, the driver's side mirror automatically dims at night, in proportion to the level of glare from the headlights of a vehicle behind you (except when in Reverse gear). Also, both exterior side mirrors have heaters that turn on and off with the rear window heater.

### Mirror Auto-tilt When Reversing

If Model S is equipped with the optional tech package, both exterior mirrors can automatically tilt downward when backing up. To adjust the auto-tilt position, shift into Reverse, then adjust the mirrors as described above (press the button associated with the mirror you want to adjust, then press the dial to move the mirror to the desired position). Touch **SAVE** on the touchscreen to save the mirror adjustment in your driver profile.

When you shift back into Drive, the mirrors tilt back to their normal (upward) position. But now that you have adjusted them for backing up, they automatically tilt to the selected downward position whenever you shift into Reverse.

You can turn the auto-tilt feature on or off using the touchscreen, Touch **Controls** > **Settings** > **Vehicle** > **Mirror Auto-Tilt**.

## Rear View Mirror

Except when in Reverse gear, the rear view mirror automatically dims in proportion to the level of glare from the headlights of a vehicle behind you.

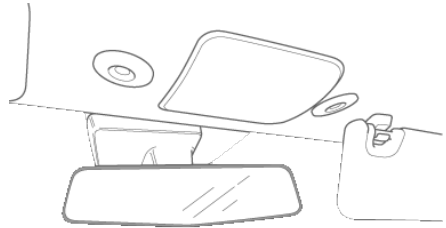



## Starting Model S

When you open a door, Model S powers on the instrument panel and touchscreen. The center circle on the instrument panel displays the status of doors and the charge level, and you can operate all controls.

To drive:

- **PRESS THE BRAKE** - the center circle on the instrument panel changes to display the speedometer, power meter, charge level, and selected gear (P, R, N, or D).
- **SELECT A GEAR** - all the way down for Drive and all the way up for Reverse.

Everything you need to know when driving Model S displays on the instrument panel.

### Key Not Inside

If Model S does not detect a key when you press the brake, the instrument panel displays a message telling you that a key was not detected.

Place the key in the center console cup holder where Model S can best detect it.

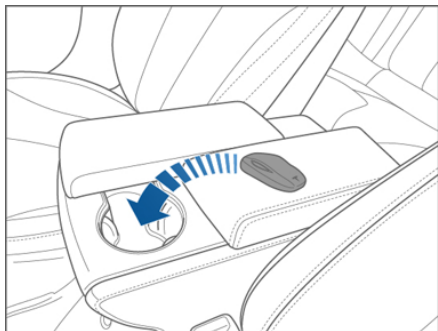

If Model S still does not detect the key, try holding it against the center console, immediately below the 12V power socket (see [12V Power Socket](#) on page 76 ). Or try using another key. If another key does not work, contact Tesla.

A number of factors can affect whether Model S can detect the key. These include a low battery in the key, interference from other devices using radio signals, and objects between the key and receiver.

Always keep the key with you. After driving, you need it to restart Model S after it powers off. And when you leave Model S, you must bring it with you to lock Model S, either

manually or automatically (see [Walk-away Locking](#) on page 6).

## Powering Off

When you finish driving, shift into Park by pressing the button on the end of the gear selector. The parking brake automatically engages and all systems keep operating. When you leave Model S with the key, it powers off automatically, turning off the touchscreen and instrument panel.

Model S also powers off automatically after being in Park for 15 minutes, even if you are sitting in the driver's seat.

Although usually not needed, you can power off Model S while you are still sitting in the driver's seat. Touch **Controls > E-Brake & Power Off > Power Off**. Model S automatically powers back on again if you press the brake or touch anywhere on the touchscreen.

**Note:** Model S automatically shifts into Park whenever you leave the vehicle, even if you shift into Neutral before exiting. To keep Model S in Neutral, see [Leaving Model S in Neutral - Tow Mode](#) on page 41.



## Shifting Gears

When Model S is in Park, you must press the brake to shift to another gear.

Move the lever up or down to change gears.

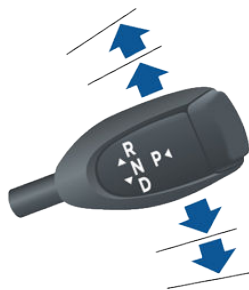

If you try to shift into a gear that the current driving speed prohibits, you will hear a chime and the gear does not change.

### Reverse

Push the lever all the way up and release. You can only shift into Reverse when Model S is stopped or moving less than 5 mph (8 km/h). If moving less than 1 mph (1.6 km/h), you must press the brake.

### Neutral

Push the lever up or down to the first position and release to shift into Neutral. Neutral allows Model S to roll freely.

If Model S is in Park and you use the touchscreen to release the parking brake (**Controls > E-Brake & Power Off**), Model S shifts into Neutral (see [Parking Brake](#) on page 57).

Model S automatically shifts into Park when you exit. To leave Model S in Neutral, use the touchscreen to engage Tow mode (see [Leaving Model S in Neutral - Tow Mode](#) on page 41).

### Drive

Push the lever all the way down and release. You can shift into Drive when Model S is stopped or moving less than 5 mph (8 km/h) in Reverse. If Model S is moving less than 1 mph (1.6 km/h), you must press the brake to shift into Drive.

## Park

With Model S stopped, press the end of the gear selector. Whenever Model S is in Park, the parking brake is applied.



Model S automatically shifts into Park whenever you:

- Leave the vehicle.
- Connect a charge cable.

## Leaving Model S in Neutral - Tow Mode

Model S automatically shifts into Park whenever you finish driving and leave Model S. To keep Model S in Neutral when you exit, allowing it to roll freely (for example, pulling onto a transporter, etc.), activate Tow mode:

1. Shift into Park.
2. Press the brake pedal.
3. Touch **Controls > E-Brake & Power Off > Tow Mode**.

Model S beeps, and shifts into Neutral (which releases the parking brake).



When Tow mode is active, Model S displays this indicator light on the instrument panel, along with a message telling you that Model S will remain free rolling.

**Note:** In Tow mode, Model S does not shift into a driving gear. To cancel Tow mode, shift into Park or touch Tow mode again. Tow mode also cancels if you use the touchscreen to apply the parking brake (**Controls > E-Brake & Power Off > Parking Brake**).



## Instrument Panel Overview

**Note:** The following illustration is provided for demonstration purposes only. Depending on vehicle options, software version, and market region, the information displayed may be slightly different.

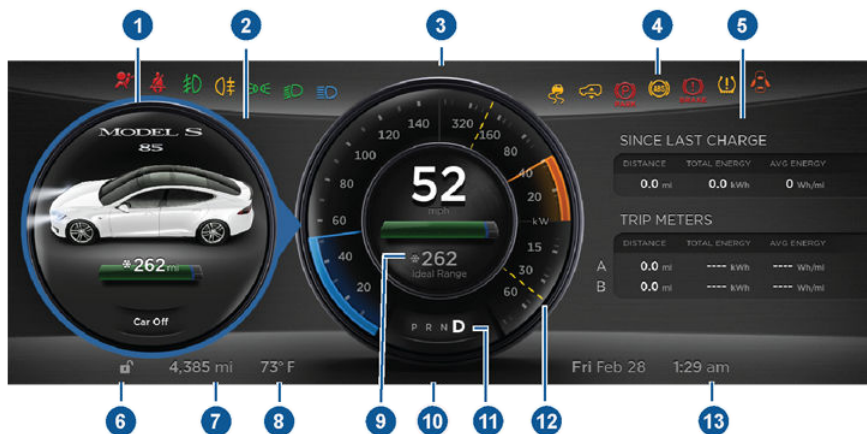

1. The center display changes depending on whether Model S is off or ready to drive. If Model S is off, the center display shows remaining estimated range and status of doors. Pressing the brake powers Model S on—the indicator lights flash on for a second and the center display shows speed, power, charge level, estimated range (see item 9), and active gear. When Model S is plugged in, the instrument panel displays charging status (see [Charging Status](#) on page 92).
2. Use the left steering wheel buttons to operate the audio system. You can also press and roll the scroll wheel to change what displays on the left side of the instrument panel (see [Steering Wheel](#) on page 36).
3. Pay attention to important status messages that display here.
4. All indicator lights flash on briefly when you press the brake to prepare to drive. They should then turn off, unless the light applies to a current situation (see [Indicator Lights](#) on page 43).
5. Use the right steering wheel buttons for voice commands, to handle telephone calls, and to control some features of Model S. You can customize what features the scroll wheel can control (see [Using Right Steering Wheel Buttons](#) on page 37).
6. Door lock status
7. Odometer
8. Outside temperature
9. Total estimated driving distance (or energy) available. Instead of driving distance as shown here, you can display the percentage of battery energy remaining. To do so, touch **Controls** > **Settings** > **Units & Format** > **Energy & Charging** (see [Settings](#) on page 67).

**Note:** When anticipating when you need to charge, use range estimates as a general guideline only.

**Note:** In cold weather, some of the stored energy in the Battery may not be available on your drive because the Battery is too cold. When this happens, a portion of the Battery meter is blue and the driving distance value has a snowflake image next to it. If Model S is plugged in, you can heat your Battery using wall power by turning on climate control using the mobile app. When the Battery warms up, the blue portion on the meter and the snowflake image are no longer displayed.







10. Pay attention to alert messages that appear at the bottom center of the instrument panel. If any alerts are in effect, you can view information about them by touching the alert icon (exclamation mark) on the touchscreen's status bar (the topmost area of the touchscreen).
11. Currently selected gear: Park, Reverse, Neutral, or Drive.
12. Dashed lines appear on the power meter if Model S is limiting power. The dashed lines appear on the top portion when power available for acceleration is being limited, and on the bottom portion when power that can be gained by regenerative braking is limited. Model S limits power for many reasons. Here are just a few examples:
  - Acceleration may be limited when the Battery is reaching a low state of charge or if the powertrain is hot.
  - Both acceleration and regenerative braking may be limited when the ambient temperature is either very high or very low.
  - Regenerative braking may be limited when the Battery is fully charged.
13. Date and time



## Indicator Lights

Indicator lights flash on briefly when you press the brake pedal to prepare for driving. Unless an indicator light applies to a current situation, they should turn off. If an indicator light fails to turn on or off, contact Tesla.







In addition to indicator lights, alerts display on the top or bottom center of the instrument panel. If alerts are in effect, an alert icon (exclamation mark) displays on the top of the touchscreen. Touch this icon to display a description of the alert.

Indicator	Description
	Airbag safety. If this indicator does not flash on briefly when Model S prepares to drive, or if it remains on, contact Tesla immediately. See <a href="#">Airbag Warning Indicator</a> on page 34.
	A driver or front passenger's seat belt is not fastened. See <a href="#">Seat Belts</a> on page 18.
	Front fog lights (optional). See <a href="#">Lights</a> on page 47..
	Parking lights (side marker lights, tail lights, and license plate lights) are on.



Indicator	Description
	Headlight low beams are on.
	Headlight high beams are on. See <a href="#">Headlight High Beams</a> on page 49.
	Electronic stability control systems are applying the brake to the relevant wheel to prevent slippage (light flashes).
	The traction control system has been disabled. See <a href="#">Traction Control</a> on page 58.
	A Smart Air Suspension fault is detected. Contact Tesla. See <a href="#">Smart Air Suspension</a> on page 73.
	Smart Air Suspension's automatic self-leveling is disabled. In other words, Model S is in Jack mode and is ready to be lifted or pulled onto a transporter. Jack mode cancels when Model S is driven over 4.5 mph (7 km/h). See <a href="#">Smart Air Suspension</a> on page 73.
	The parking brake is manually applied. See <a href="#">Parking Brake</a> on page 57.



Indicator	Description
	A parking brake fault is detected. Contact Tesla. See <a href="#">Parking Brake</a> on page 57.
	An ABS (Anti-lock Braking System) fault is detected. See <a href="#">Brakes</a> on page 56. Contact Tesla immediately.
	A brake system fault is detected or the brake fluid level is low. See <a href="#">Brakes</a> on page 56. Contact Tesla immediately.
	Tire pressure warning. The pressure of a tire is out of range. If a fault with the Tire Pressure Monitoring System (TPMS) is detected, the indicator flashes. For a TPMS fault, contact Tesla. See <a href="#">Tire Care and Maintenance</a> on page 94.
	A door or trunk is open. See <a href="#">Using Exterior Door Handles</a> on page 5.
	Flashes green when the left turn signal is operating. Both turn signal indicators flash green when the hazard warning flashers are operating.
	Flashes green when the right turn signal is operating. Both turn signal indicators flash green when the hazard warning flashers are operating.



Indicator	Description
	<p>Model S is in Tow mode and can roll freely. It does not automatically shift into Park when you exit. See <a href="#">Instructions for Transporters</a> on page 135.</p>







## Controlling Lights

Touch Controls on the bottom left corner of the touchscreen to control most of the lights.

In addition to the lights that you can control from the touchscreen, Model S has convenience lights that turn on and off automatically based on what you are doing. For example, you will notice interior lights, marker lights, tail lights, door handle lights, and puddle lights that turn on when you unlock Model S, when you open a door, and when you shift into Park. They turn off automatically after a minute or two or when you shift into a driving gear or lock Model S.

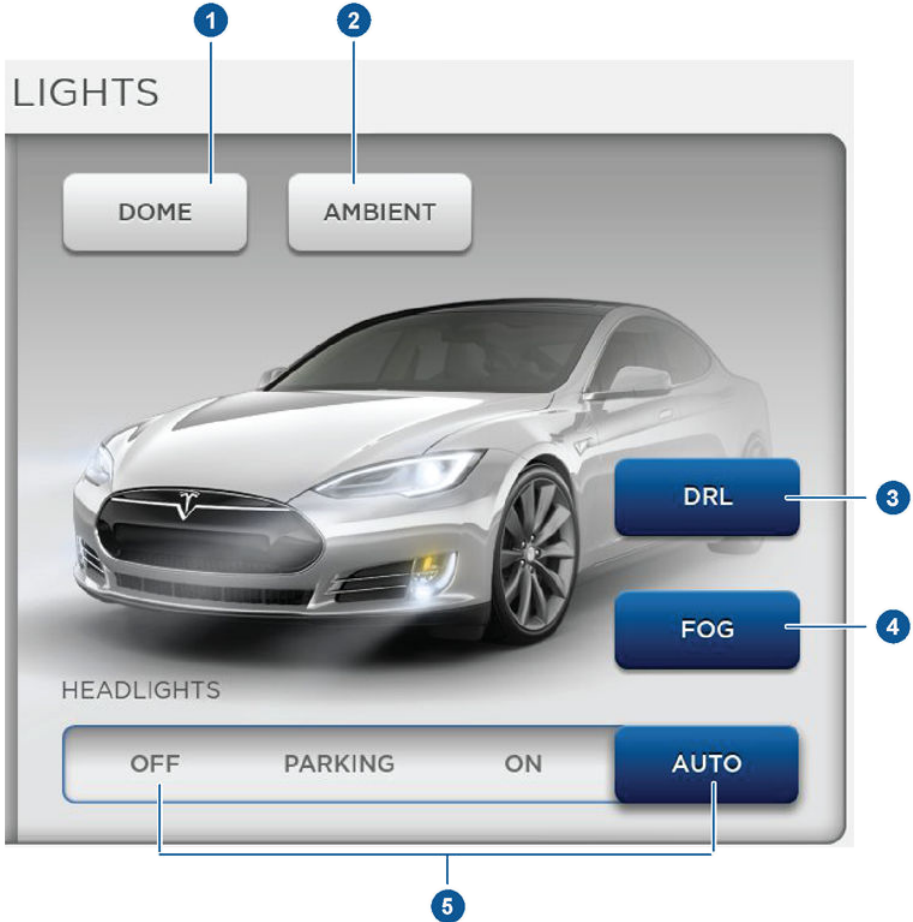



1. If DOME lights are set to AUTO, interior dome (map) lights turn on when you unlock Model S, open a door upon exiting, or shift into P (Park). They turn off after 60 seconds, when you lock Model S, or when you shift into a driving gear.

You can also turn an individual dome light on or off by pressing its lens. If you manually turn a dome light on, it turns off when Model S powers off. If Model S was already powered off when you manually turned the light on, it turns off after 60 minutes.

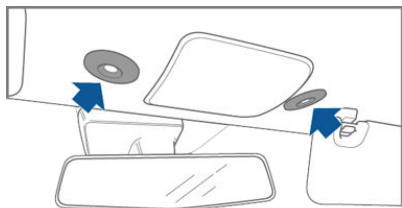

2. If you turn on AMBIENT lights, the lights on the door armrests turn on whenever the headlights are on.
3. DRL (Daytime Running Lights) operate only when driving with the headlights off. In jurisdictions where required by law (Canada), daytime running lights can not be turned off.
4. Exterior lights are set to AUTO each time you start Model S. Touch these options to temporarily change the exterior light setting:

**OFF** All exterior lights (headlights, tail lights, side marker lights, parking lights, and license plate lights) turn off until you manually turn them back on or until the next time you drive Model S.

**PARKING** Only the side marker lights, parking lights, tail lights and license plate lights turn on.

**ON** All exterior lights (headlights, tail lights, side marker lights, parking lights, and license plate lights) turn on.

**AUTO** All exterior lights (headlights, tail lights, side marker lights, parking lights, and license plate lights) turn on automatically when driving in low lighting conditions. If you change to a different setting, lights always revert to this AUTO setting on your next drive.

**Note:** Optional fog lights operate automatically whenever the headlights are on. When headlights are off, fog lights are also off.



## Headlight High Beams

Push the left-hand steering column lever away from you. To cancel, pull the lever toward you.



The high beam indicator lights up on the instrument panel whenever high beams are on.

To flash the headlight high beams, pull the lever fully toward you and release.

## Headlights After Exit

When you stop driving and park Model S in low lighting conditions, the exterior lights automatically turn on. They automatically turn off after two minutes or when you lock Model S.

You can turn this feature on and off using the touchscreen. Touch **Controls** > **Settings** > **Vehicle** > **Headlights After Exit**.

## Cornering Lights

If Model S is equipped with the optional tech package, LED cornering lights broaden the beam of the headlights whenever you drive through a corner.

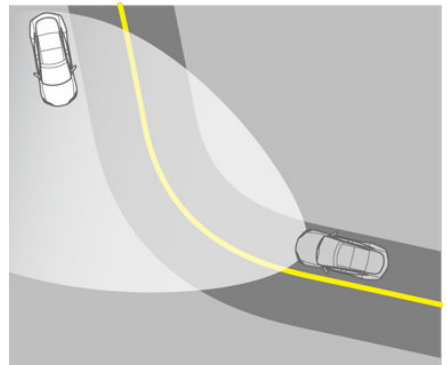
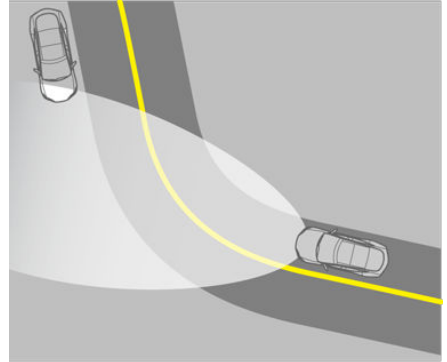



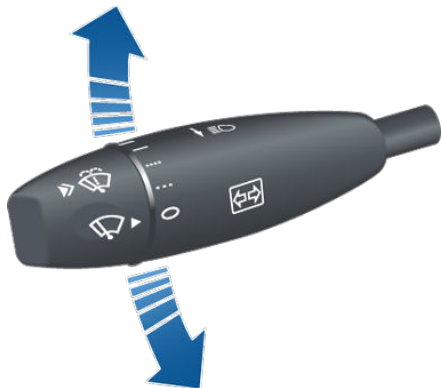

## Turn Signals

Move the left-hand steering column lever up (before turning right) or down (before turning left).



The turn signals stop operating when canceled by the steering wheel, or when you return the lever to the central position.

-  The corresponding Turn Signal indicator lights up on the instrument panel when a turn signal is operating. You also hear a clicking sound.
- 

## Lane Change Flash

To indicate a lane change, quickly press the lever up or down against the spring pressure, then release. The corresponding turn signal flashes three times.

## Hazard Warning Flashers

Press the switch located to the left of the touchscreen to turn on the hazard warning flashers. All turn signals flash. Press again to turn off.



**Note:** Hazard warning flashers operate even without a Model S key nearby.



## Wipers

To wipe the windshield, rotate the end of the left-hand steering column lever away from you. You can choose from four levels:

- 1st: Auto with low rain sensitivity.\*
- 2nd: Auto with high rain sensitivity.\*
- 3rd: Continuous, slow.
- 4th: Continuous, fast.



For a single wipe, press and release the end of the lever.

If the wipers are set to Auto and the sensor detects no water, the wipers do not wipe.

When you operate the wipers, headlights automatically turn on (if they are not on already).

\*Model S has a rain sensor located on the inside of the windshield at the base of the interior mirror. When wipers are set to Auto, the frequency at which they wipe depends on how much water the sensor detects. When wipers are set to the 2nd level, the sensor is more sensitive.

To extend the life of wiper blades, remove ice from the windshield before turning wipers on. Ice has sharp edges that can damage the rubber on the blades.

Periodically check and clean the edge of the wiper blade. If damaged, replace the blade immediately. For details on checking replacing wiper blades, see [Wiper Blades and Washer Jets](#) on page 106.

**⚠ Caution:** In harsh climates, ensure that the wiper blades are not frozen or adhered to the windshield.

### De-icing Wipers

To make wiper blades easy to access so you can remove any ice and snow, shift Model S into Park, then use the touchscreen to move them to the service position. Touch **Controls > Settings > Vehicle > Service Mode > ON**. When parking in cold outdoor climates, it is helpful to leave Model S with the wipers in the service position. In this position, they are

closer to the defrost vent, allowing you to thaw them by directing air from the climate control system towards the windshield.

If Model S is equipped with the cold weather option, you can de-ice wipers by touching **Controls > Cold Weather > Heated Wipers**. This control heats the wipers for 15 minutes and then automatically turns off.

**Note:** Wipers automatically return to their normal position when you shift Model S out of Park.

## Washers

Press the button on the end of the left steering column lever to spray washer fluid onto the windshield. You can press this button at two levels. Press partially for a single wipe, without any washer fluid. Press fully for both wipe and wash. When washing the windshield, the wipers will perform two wipes after you release the button, then a third wipe a few seconds later.



Periodically top up washer fluid (see [Topping Up Washer Fluid](#) on page 110).

### De-icing Washer Nozzles

If Model S is equipped with the cold weather option, washer nozzles have de-icers that turn on whenever the ambient temperature nears freezing, or when you turn on the heated wipers (**Controls > Cold Weather > Heated Wipers**). The washer de-icers turn off when the heated wipers turn off (after 15 minutes), provided the temperature is warm enough to prevent freezing.



## How Park Assist Works

If Model S is equipped with the Park Assist option, both the front and rear bumpers include four sensors. When moving slowly in Drive or Reverse, the sensors alert you if an object is detected close to the front or rear bumper, respectively.



When driving less than 3 mph (4.8 km/h), the sensors are activated.

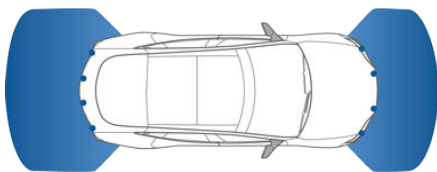

**Warning:** Never depend on Park Assist to inform you if an area you are approaching is free of objects and/or people. Several external factors can reduce the performance of Park Assist, causing either no readings or false readings (see [Limitations and False Warnings](#) on page 52). Therefore, depending on Park Assist to determine if Model S is approaching an obstruction can result in damage to the vehicle and/or objects, and can potentially cause serious injury. Always inspect the area with your own eyes. When reversing, perform shoulder checks and use all mirrors. Park assist does not

detect children, pedestrians, bicyclists, animals, or objects that are moving, protruding, located too far above or below the sensors, or too close or too far from the sensors. Park Assist is for guidance purposes only and is not intended to replace your own direct visual checks. It is not a substitute for careful driving.

## Visual and Audio Feedback

Whenever Model S is moving slowly in Reverse or Drive at a speed of less than 3 mph (4.8 km/h), the left side of the instrument panel provides feedback to alert you if an object is detected near the corresponding back or front bumper. When reversing, visual feedback also displays on the touchscreen, immediately below the camera view (see [Rear View Camera](#) on page 62).

If chimes are turned on (see [Controlling Audible Feedback](#) on page 52), an audible beep sounds as you approach an object. You can temporarily mute the chime by pressing the scroll wheel on the left side of the steering wheel.

**Note:** If a sensor is unable to provide feedback, the instrument panel displays an alert message.

- Caution:** Keep sensors clean from dirt, debris, snow, and ice. Avoid using a high pressure power washer on the sensors and do not clean a sensor with a sharp or abrasive object that can scratch or damage its surface.
- Caution:** Do not install accessories or stickers on or near the parking sensors.

## Controlling Audible Feedback

You can use Park Assist with or without audible feedback. To turn chimes on or off, touch **Controls > Settings > Safety & Security > Park Assist Chimes**.

You can also mute the chimes temporarily by pressing the scroll wheel on the left side of the steering wheel. The chimes are muted until you shift into a different gear or drive over 3 mph (4.8 km/h).

## Limitations and False Warnings

The parking sensors may not function correctly in these situations:



- One or more of the parking sensors is damaged, dirty, or covered (such as mud, ice, or snow).
- Object is located below approximately 8 inches (20 cm) (such as a curb or low barrier).
- Weather conditions (heavy rain, snow, or fog) are interfering with sensor operation.
- Object is thin (such as a sign post).
- A sensor's operating range has been exceeded.
- Object is sound-absorbing or soft (such as powder snow).
- Object is sloped (such as a sloped embankment).
- Model S has been parked in, or being driven in, extremely hot or cold temperatures.
- The sensors are affected by other electrical equipment or devices that generate ultrasonic waves.
- Object is located too close to the bumper.
- A bumper is misaligned or damaged.
- An object that is mounted to Model S is interfering with and/or obstructing the sensor (such as a bike rack or a bumper sticker).

## Other Parking Aids

In addition to Park Assist, when shifted into Reverse gear, the backup camera displays a view of the area behind Model S. See [Rear View Camera](#) on page 62.



## Displaying Trip Information

Trip information displays on the touchscreen when you touch **Controls > Trips**. There are two trip meters available, A and B. To reset a particular trip meter, touch its associated **RESET**.

**Note:** You can also display range and trip information on the instrument panel (see [Using Left Steering Wheel Buttons](#) on page 36).





## Driving Tips to Maximize Range

You can maximize your driving range using the same driving habits that you use to conserve fuel in a gasoline-powered vehicle. In addition to driving habits, energy consumption depends on environmental conditions (such as cold weather and hilly roads). To get the maximum mileage from a charge, you should:

- Avoid frequent and rapid acceleration.
- Instead of using the brake to slow down, move your foot off the accelerator. Whenever Model S is moving and your foot is off the accelerator, regenerative braking slows down Model S and feeds surplus energy back to the Battery (see [Regenerative Braking](#) on page 57).
- Keep tires at the recommended inflation pressures (see [Tire Care and Maintenance](#) on page 94).
- Lighten your load by removing any unnecessary cargo.
- Limit the use of resources such as heating and air conditioning. Using seat heaters to keep warm is more efficient than heating the cabin. You can turn on Range mode to automatically limit the power of the climate control system (see [Settings](#) on page 67).

The power meter on the instrument panel and the Energy app provide feedback on energy usage. With this feedback, you will soon become familiar with how driving habits and environmental conditions impact how much energy Model S is using.

## Saving Energy

Model S has an energy-saving feature that reduces the amount of energy being consumed when Model S is not being used. Touch **Controls > Displays > Energy Saving**. When energy saving is turned on, the start-up time of the instrument panel, Bluetooth, data connection, and mobile app is slower than usual.



## Braking Systems

Model S has an anti-lock braking system (ABS) that prevents the wheels from locking when you apply maximum brake pressure. This improves steering control during heavy braking in most road conditions.

During emergency braking conditions, the ABS constantly monitors the speed of each wheel and varies the brake pressure according to the grip available.

The alteration of brake pressure can be felt as a pulsing sensation through the brake pedal. This demonstrates that ABS is operating and is not a cause for concern. Keep firm and steady pressure on the brake pedal while experiencing the pulsing.



The ABS indicator flashes briefly on the instrument panel when you first start Model S. If this indicator lights up at any other time, an ABS fault has occurred and ABS is not operating. Contact Tesla. The braking system remains fully operational and is not affected by an ABS failure. However, braking distances may increase.



If the instrument panel displays this indicator at any time other than displaying briefly when you first start Model S, a brake system fault is detected or the brake fluid level is low. Contact Tesla immediately.

## Emergency Braking

In an emergency, fully press the brake pedal and maintain firm pressure, even on low traction surfaces. ABS varies the braking pressure to each wheel according to the amount of traction available. This prevents wheels from locking and ensures that you stop as safely as possible.

**Warning:** Do not pump the brake pedal. Doing so interrupts operation of the ABS and can increase braking distance.

**Warning:** Always maintain a safe distance from the vehicle in front of you and be aware of hazardous driving conditions. While ABS can improve stopping distance, it cannot overcome the laws of physics. It also does not prevent the danger of hydroplaning (where a layer of water prevents direct contact between the tires and the road).

## Brake Wear

Model S brake pads are equipped with wear indicators. A wear indicator is a thin metal strip attached to the brake pad that squeals as it rubs against the rotor when the pad wears down. This squealing sound indicates that the brake pads have reached the end of their service life and require replacement. To stop the squealing, contact Tesla Service.

**Warning:** Neglecting to replace worn brake pads will result in damage to the braking system and can create a braking hazard.



## Regenerative Braking

Whenever Model S is moving and your foot is off the accelerator, regenerative braking slows down Model S and feeds any surplus energy back to the Battery.

By anticipating your stops and simply removing your foot from the accelerator to slow down, you can take advantage of regenerative braking to increase driving range. Of course, this is no substitute for regular braking when needed for safety.

**Note:** If regenerative braking is aggressively slowing Model S, such as on a steep descent, brake lights turn on to alert other road users that you are slowing down.

The power meter on the instrument panel displays real-time feedback on the amount of energy being gained by regenerative braking.

The amount of energy fed back to the Battery using regenerative braking can depend on the current state of the Battery and the charge level setting that you are using. If regenerative braking is limited, a dashed yellow line displays on the power meter. For example, regenerative braking may be limited if the Battery is already fully charged or if the ambient temperature is low.



### To Set the Regenerative Braking Level

You can use the touchscreen to change the level of regenerative braking:

1. Touch **Controls**.
2. Choose from two levels:
  - Standard - provides the maximum amount of regenerative braking.

When you release the accelerator, Model S slows down faster, reducing the need to use the brakes.

- Low - limits the amount of regenerative braking. When you release the accelerator, Model S takes longer to slow down and coasts further.

## Parking Brake

The parking brake automatically engages whenever you shift Model S into Park, and releases whenever you shift into any other gear.



**Note:** The parking brake operates on the rear wheels only, and is independent of the foot-operated brake system.

Use the touchscreen to manually release the parking brake (which also shifts Model S into Neutral):

1. Touch **Controls > E-Brake & Power Off**.
2. Press the brake pedal, then touch Parking Brake. If Model S was previously in Park, it shifts into Neutral.



The parking brake indicator lights up on the instrument panel whenever you use the touchscreen to manually apply the parking brake.



If an electrical issue occurs with the parking brake, an amber parking brake fault message displays at the top center of the touchscreen.

- ⚠ Caution:** In the unlikely event that Model S loses electrical power, you cannot release the parking brake.



## How It Works

The traction control system constantly monitors the difference in speed between the front and rear wheels. If Model S experiences a loss of traction, the traction control system minimizes wheel spin by controlling brake pressure and motor power.



The electronic stability control indicator displays on the instrument panel whenever the traction control system is actively controlling brake pressure and motor power.



**Warning:** Traction control does not prevent accidents caused by driving dangerously or turning too sharply at high speeds.

## Turning Off

Under normal conditions, you should leave traction control on. Turn it off only in circumstances where you deliberately want the wheels to spin, such as:

- Starting on a loose surface, such as gravel or snow.
- Driving in deep snow, sand or mud.
- Rocking out of a hole or deep rut.

To turn traction control off, touch **Controls** > **Driving** > **Traction Control** > **Off**.



The Traction Control Off indicator displays at the top center of the touchscreen whenever the traction control system is turned off.

Although traction control turns on again automatically the next time you start Model S, turn it on using the touchscreen as soon as the circumstances that required you to turn it off have passed.



## Operating Cruise Control

Cruise control makes it easy for you to maintain a consistent speed without holding your foot on the accelerator. This is useful when driving at the same speed over a long distance.

You must be driving over 17 mph (27 km/h) to operate cruise control.

**Warning:** Do not use cruise control on winding or slippery road surfaces, or when traffic conditions make it unsafe to drive at a consistent speed.

To operate cruise control:

1. When driving over 17 mph (27 km/h), touch the end of the cruise control lever. The light on the lever turns on.



2. Accelerate until you reach your desired cruising speed.
3. Move the cruise control lever up or down, then release.



The instrument panel displays the Cruise On message above the speedometer and a white arrow on the speedometer shows your set speed.

You can accelerate at any time when driving at a set speed in cruise control. But when you release the accelerator, your speed returns to the set speed.

**Warning:** Driving downhill can increase driving speed, causing Model S to exceed your set speed.

## Changing the Cruising Speed

Move the cruise control lever up (increase) or down (decrease) until your desired speed is reached.



**Note:** It may take a few seconds for Model S to reach the new cruising speed. If you decrease the set speed to less than 17 mph (27 km/h), cruise control cancels and the set speed clears.



## Canceling and Resuming

Cruise control cancels automatically if you do either of the following:

- Press the brake.
- Drive below 17 mph (27 km/h).
- Shift out of Drive.

To cancel cruise control manually, briefly push the cruise control lever away from you. The message on the instrument panel turns off, but the set speed remains displayed until Model S powers off.



To resume cruising at the previously set speed, briefly pull the cruise control lever toward you. Cruise control resumes only if driving over 17 mph (27 km/h).





Hill Start Assist automatically engages the brakes for approximately one second when on a hill. This prevents Model S from rolling during the time it takes for you to move your foot from the brake pedal to the accelerator pedal. Hill Start Assist engages the brakes only if Model S is in Drive and facing uphill, or in Reverse and facing downhill.

**⚠ Warning:** After approximately one second, Hill Start Assist no longer brakes your vehicle and it could roll. Therefore, quickly move your foot from the brake pedal to the accelerator pedal. Never rely on Hill Start Assist to prevent Model S from rolling for more than one second. Failure to do so can result in a collision.



## Camera Location

Model S is equipped with a rear view camera located above the rear license plate.

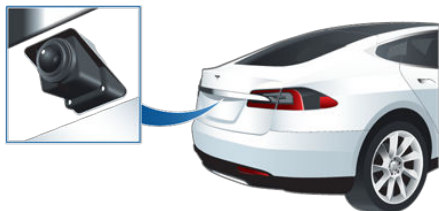

Whenever you shift into Reverse, the touchscreen displays the view from the camera.



**Note:** If Model S is equipped with the optional Park Assist feature, visual feedback from the parking sensors displays below the camera image. See [Park Assist](#) on page 52.

**Warning:** Never depend on the rear view camera to inform you if the area behind you is free of objects and/or people when reversing. The camera may not detect objects or barriers that can potentially cause damage or injury. In addition, several external factors can reduce the performance of the camera, including a dirty or obstructed lens. Therefore, depending on the rear view camera to determine if Model S is approaching an obstruction can result in damage to the vehicle and/or objects, and can potentially cause serious injury. Always inspect the area with your own eyes. When reversing, perform shoulder checks and use all mirrors. Use the camera for guidance purposes only. It is not intended to replace your own direct visual checks and is not a substitute for careful driving.

## Cleaning the Camera

To ensure a clear picture, keep the camera lens clean, and free of obstructions. Remove any buildup of dirt by occasionally wiping the camera lens with a soft damp cloth.

**Caution:** Do not use chemical-based or abrasive cleaners that can scour the surface of the camera lens.





## The Big Picture

The main components of the touchscreen are shown here. To manually control the brightness and contrast, touch **Controls** > **Displays**. When set to Auto, the touchscreen changes between Day and Night brightness depending on ambient lighting conditions.

**Note:** The following illustration is provided for demonstration purposes only. Depending on vehicle options, firmware version and market region, your touchscreen may appear slightly different.

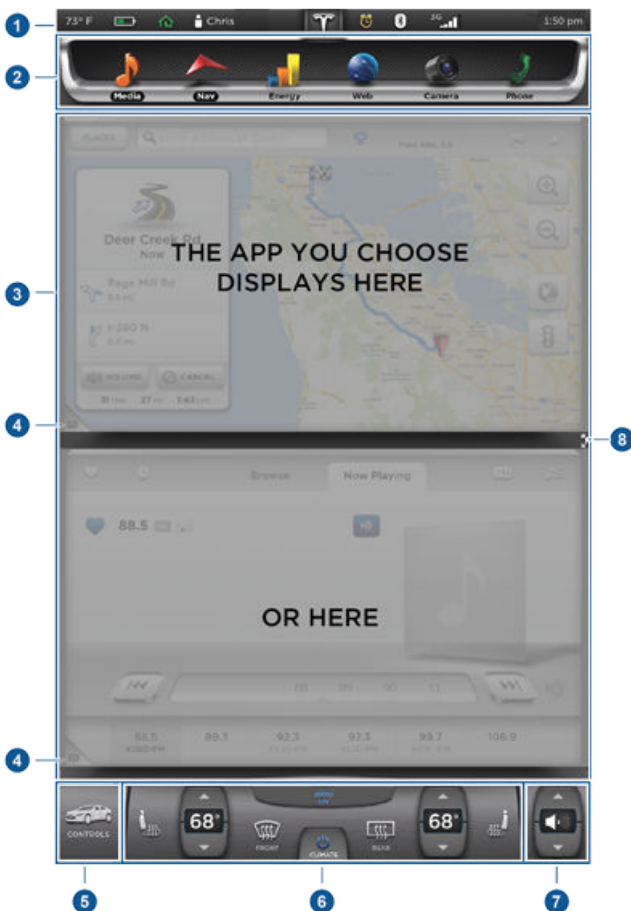



## 1. Status bar

The top line displays provides shortcuts to Charging, HomeLink, Driver Profiles, vehicle information (the Tesla "T"), firmware updates, Bluetooth, and Wi-Fi settings. The status symbols show current temperature, network signal strength, Bluetooth, Wi-Fi settings, passenger airbag status, and time. If an alert icon (exclamation mark) is displayed, touch it to see warning messages that are in effect.

**Note:** The airbag status symbol displays only when Model S is powered on.

## 2. Apps

There are several ways to display an app in the main viewing area:

- Tap the app's icon to display it in the top viewing area. If the app is already displayed, a second tap displays it in full-screen view (only some apps have a full-screen mode).
- Drag the app's icon directly onto the top or bottom viewing area.
- Touch and hold the app's icon to display a popup that lets you choose whether to display the app in the top or bottom of the main viewing area.



Media. See [Media and Audio](#) on page 74.



Maps/Navigation. See [Using Maps](#) on page 79.



Energy. See [Getting Maximum Range](#) on page 55.



Web. Access the Internet using the web browser.



Camera. Display the area behind Model S. This area also displays automatically whenever you shift into Reverse. See [Rear View Camera](#) on page 62.



Phone. See [Phone](#) on page 77.

## 3. Main viewing area

The main viewing area changes depending on the app you have chosen (in the example, the Nav and Media apps are displayed). For some apps (such as Nav and Web), you can zoom in and out

using standard touchscreen finger gestures.

## 4. Maximize/minimize app

Touch the small rectangle to expand the associated app to fill the entire main viewing area (some apps are not expandable). Touch again to display two apps in half-screen view.

## 5. Controls

Touch to access all Model S controls and settings (doors, locks, lights, etc).

## 6. Climate controls (see [Climate Controls](#) on page 70).

## 7. Volume control

Touch the up and down arrows to increase or decrease the volume of the speakers. You can also adjust the volume using the scroll wheel on the left side of the steering wheel.

## 8. Reverse the position of the two currently displayed apps.



**Warning:** Paying attention to road and traffic conditions must always be the driver's highest priority. To ensure the safety of vehicle occupants as well as other road users, using the touchscreen should be done only when road and traffic conditions permit.



## Controlling Model S Features

Touch **Controls** on the bottom corner of the touchscreen to control and customize all main features of Model S.

**Note:** The following illustration is provided for demonstration purposes only. Depending on vehicle options, software version and market region, the options available on the Controls screen may be different.

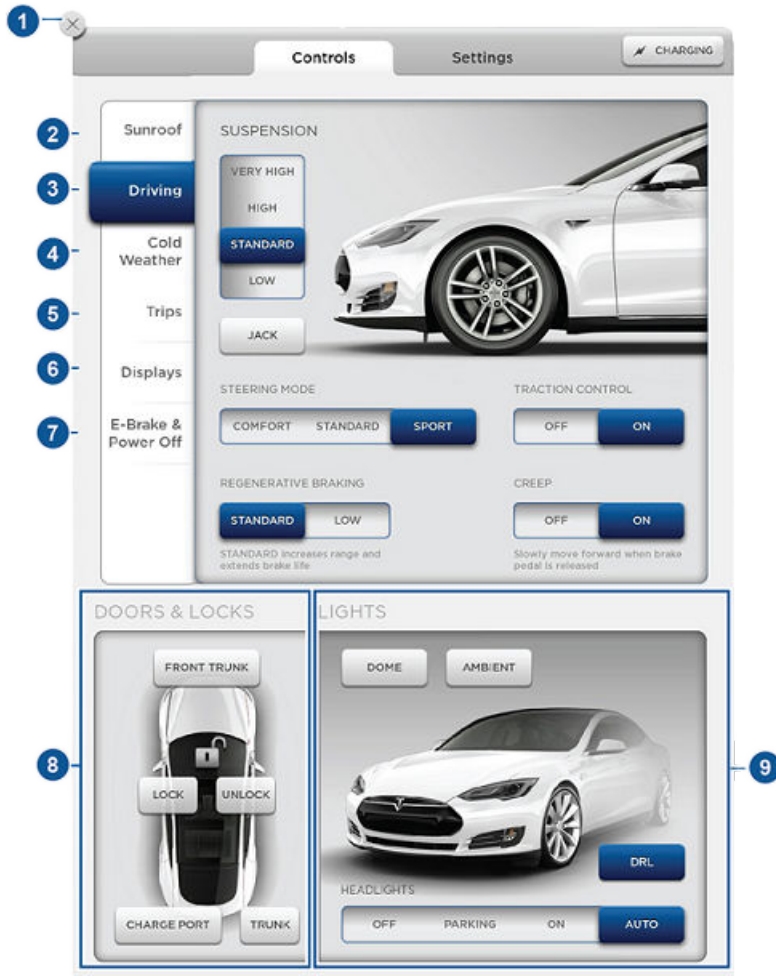



## 1. Close

Touch the circled **X** in the top left corner of a window to close it (or you can touch anywhere outside the window).

## 2. Sunroof

If Model S is equipped with a sunroof, touch to adjust its position (see [Sunroof](#) on page 14).

## 3. Driving

### • Suspension

If Model S is equipped with Smart Air Suspension, touch to manually raise or lower Model S (see [Smart Air Suspension](#) on page 73). Model S must be powered on, or you must press the brake pedal before you can change suspension settings. Smart Air Suspension causes Model S to self-level, even when powered off. Therefore, when lifting or towing, you must disable self-leveling (see [Jack Mode](#) on page 73 and [Jacking and Lifting](#) on page 118).

### • Steering mode

Adjust the amount of effort required to turn the steering wheel. Sport feels more responsive whereas Comfort feels easier to drive and park (see [Steering Wheel](#) on page 36).

### • Regenerative braking

When you release the accelerator when driving, regenerative braking slows Model S and feeds any surplus energy back to the Battery. If set to Low, Model S does not slow down as quickly, but you may experience less range (see [Regenerative Braking](#) on page 57).

**Note:** Regardless of the setting, the energy gained by regenerative braking is reduced if the Battery is full, or if it is extremely cold or hot (the surplus energy is used to heat or cool the Battery).

### • Traction Control

If you turn off Traction Control, a warning message displays on the instrument panel. The off setting stays in effect for the current drive only (see [Traction Control](#) on page 58).

### • Creep

When on, Model S slowly moves forward when in Drive and backward in Reverse when you release the brake

(similar to a conventional vehicle with an automatic transmission). You can adjust this setting only when Model S is in Park.

## 4. Cold Weather

If Model S is equipped with the cold weather option, you can control all seat heaters and the heated wipers. Note that you can also control the front driver and passenger seats using the main climate control panel located on the bottom of the touchscreen (see [Climate Controls](#) on page 70).

## 5. Trips

View and reset the trip meters that summarize how far you have driven (see [Trip Information](#) on page 54).

## 6. Displays

Manually control the touchscreen's brightness and control its day (light background) or night (dark background) setting. When set to Auto, the touchscreen automatically changes between Day and Night brightness depending on the ambient lighting conditions. You can also put Model S into an energy saving mode so it consumes less energy when not in use (see [Getting Maximum Range](#) on page 55).

## 7. E-Brake & Power Off

You can manually:

- Apply and release the parking brake (see [Parking Brake](#) on page 57).
- Power off (see [Powering Off](#) on page 40).
- Keep Model S in Neutral by activating Tow Mode (see [Leaving Model S in Neutral - Tow Mode](#) on page 41).

## 8. Doors & locks (see [Using Interior Door Handles](#) on page 6)

## 9. Lights (see [Lights](#) on page 47)

**Warning:** Do not read the touchscreen while driving. Doing so increases the likelihood of a collision. Everything you need to know when driving is displayed on the instrument panel.



## Customizing Model S

Touch the Settings tab on the Controls window to adjust Model S to suit your preferences.

**Note:** The following illustration is provided for demonstration purposes only. Depending on vehicle options, firmware version, and market region, the options available on the Settings screen may be different. For example, in many regions, the “Language & Units” tab is called “Units & Format.”





1. Adjust settings associated with installed apps (applications). Apps that have no settings that you can adjust at this time are grayed out.
2. Manage driver profiles (see [Driver Profiles](#) on page 35).
3. Units & Format

Adjust how Model S displays:

- Distance: Miles or km can be shown on the range display, speedometer, energy chart, trip meters, Google map searches and navigation routes.
- Time: 12 or 24 hour format.
- Temperature: °F or °C.
- Charging Units: Display charging units as either the percentage of battery energy remaining, or distance remaining.
- Range Display: Display estimated range as either:
  - Rated - based on EPA testing.
  - Ideal - assumes ideal driving conditions based on driving at a steady speed of 55 mph (89 km/h) on a flat road, and using no additional energy (seat heaters, air conditioning, etc).

**Note:** When anticipating when you need to charge, use range estimates as a general guideline only.

#### 4. Vehicle

- Drive-away Door Lock: If on, all doors automatically lock whenever you drive Model S over 5 mph (8 km/h) (see [Drive-away Locking](#) on page 6).
- Walk-away Door Lock: If on, all doors automatically lock when you walk away from Model S, carrying the key with you (see [Walk-away Locking](#) on page 6). Available only if Model S is equipped with the optional tech package.
- Child-Protection Lock: If on, safety locks prevent the rear doors and the liftgate from being opened from inside Model S.
- Auto-Present Handles: If on, door handles extend automatically whenever you approach Model S carrying a key, whether locked or unlocked (see [Using Exterior Door Handles](#) on page 5). Note that to preserve battery life, Model S is designed to temporarily disable the Auto-Present Handles feature when

the key has been out of range for more than 48 hours, or if the key remains within range for five minutes after all doors have been closed.

- Headlights After Exit: If on, headlights stay on for two minutes after you exit, or until you lock Model S (see [Headlights After Exit](#) on page 49).
- Tire Pressure Monitor: Touch **Reset Sensors** to reset the TPMS sensors after replacing a wheel (see [Resetting the TPMS Sensors](#) on page 97).
- Range Mode: If on, Model S conserves energy by limiting the power of the climate control system. Cabin heating and cooling may be less effective, but seat heaters turn on to compensate.
- Service Mode: If on, moves wiper blades to the service position to make them easier to access when replacing them. Model S must be in Park. See [Wiper Blades and Washer Jets](#) on page 106.
- Mirror Auto-Tilt: If on, exterior mirrors tilt downward when reversing (see [Mirrors](#) on page 39). Available only if Model S is equipped with the optional tech package.
- Mirror Auto-Fold: If on, exterior mirrors fold when you lock Model S with the key or walk-away locking. They extend automatically when you return to Model S. Available only if Model S is equipped with both folding mirrors (newer models) and the optional tech package. For newer Model S vehicles, you can also fold mirrors manually by touching the center mirror control button (see [Mirrors](#) on page 39).
- Automatic Lowering: If Model S is equipped with Smart Air Suspension, you can set the speed at which the suspension automatically transitions to a lower ride height (see [Smart Air Suspension](#) on page 73).

#### 5. Safety & Security

Turn various safety and security features on and off:

- Active safety devices Model S is equipped with, such as Park Assist Chimes (see [Park Assist](#) on page 52).
- Alarm, and security options Model S is equipped with (see [Security Settings](#) on page 81).



- Remote access by Tesla's mobile applications (see [Mobile App](#) on page 85).

## 6. HomeLink

If the HomeLink feature is available in your region, use it to control RF-enabled garage doors, lights, or security systems (see [HomeLink® Universal Transceiver](#) on page 82).

## 7. Manual

Display this owners manual.

-  **Warning:** Do not read the touchscreen while driving. Doing so increases the likelihood of a collision.



## Overview of Climate Controls

The climate controls are always available at the bottom of the touchscreen. By default, climate control is set to Auto On, which maintains optimum comfort in all but the most severe weather conditions. When you adjust the temperature, the system automatically adjusts the heating, air conditioning, air distribution, air circulation, and fan speed to maintain your selected temperature. To override these settings, touch **Auto On** (see [Customizing Climate Control](#) on page 71).

The fan, heating, and air conditioning systems are powered by the Battery. Therefore, prolonged use decreases driving range.

**Note:** The following illustration is provided for demonstration purposes only. Depending on vehicle options, software version, market region, and settings, the information displayed may be slightly different.



1. The front seats are equipped with heating pads that operate at three levels from 3 (highest) to 1 (lowest).

When operating, the indicator turns red and displays the setting number.

**Note:** If Model S is equipped with the optional cold weather package, you can also control seat heaters in the rear seats as well as heated wipers by touching **Controls > Cold Weather** (see [Controls](#) on page 65).

2. Touch the up or down arrow to set the cabin temperature (from LO, 63° F to HI, 90° F/LO, 17° C to HI, 32° C). To apply a temperature setting to both the driver and passenger side at the same time, touch SYNC TEMP on the temperature popup that appears when you touch an arrow.
3. Automatic/Manual climate control (see [Customizing Climate Control](#) on page 71).
4. The windshield defroster distributes air flow to the windshield and operates the heating and fan at their maximum level. Touch once for Normal Defrost and twice for Max Defrost. When on, touch again to turn off and restore the air distribution, heating, and fan to their previous settings.
5. Turn climate control system on/off.

6. The rear window defroster warms up the rear window\* for 15 minutes, then automatically shuts off.

\*If Model S is equipped with the optional tech package, exterior side mirrors are also heated.

**Warning:** To avoid burns resulting from prolonged use, individuals who have peripheral neuropathy, or whose capacity to feel pain is limited because of diabetes, age, neurological injury, or some other condition, should exercise caution when using the climate control system and seat heaters.





## Customizing Climate Control

The climate control system is designed to automatically provide optimum comfort in most situations. All you need to do is set the desired temperature, and the air conditioning, air recirculation, air distribution, and fan speed automatically maintain your selected temperature.

To override the automatic setting, touch **Auto On** to view the individual settings. Then touch the setting you want to change. When you change a setting, the Auto On icon turns from blue to gray and Reset Auto is displayed instead.



1. Touch **Reset Auto** to change all settings back to their default values.
2. Touch **A/C ON** or **A/C OFF** to turn the air conditioning on and off, respectively. Turning it off reduces cooling, but saves energy.



Because Model S runs much quieter than a gasoline-powered vehicle, you may notice the sound of the compressor as it is operating. To minimize noise, reduce the fan speed or recirculate the air.

3. Touch to specify how air is drawn into Model S:

 Outside air is drawn into Model S (see [Ventilation](#) on page 72). Although less efficient than recirculating the air in very hot or low climate conditions, this setting draws more air into the rear seating areas, and is recommended when occupants are seated in the Tesla built-in rear facing child seats.

 Air inside Model S is recirculated. This prevents outside air (traffic fumes) from entering but reduces dehumidifying and cooling performance. Recirculating the air is the most efficient way to cool the front cabin area but it is also the loudest. To prevent the windshield from fogging in some conditions, briefly change the setting every hour to draw in outside air.

4. Touch one of these icons to select where air flows. You can choose more than one location:

	Foot-level vents
	Face-level vents
	Windshield vents

5. Touch and drag the slider to set the speed of the fan.



## Ventilation

Outside air is drawn into Model S through the grill in front of the windshield. Keep the grill clear of obstructions such as leaves and snow.

To direct the flow of air inside Model S, move the interior vents up, down, or from side to side.

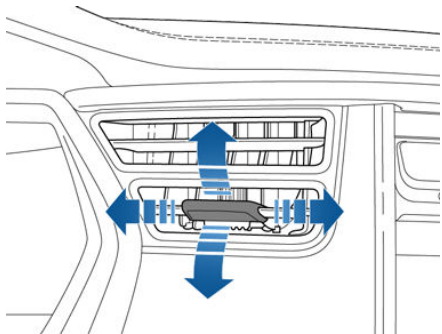

**Note:** You can direct the outer face level vents toward the side windows to help defrost or defog them.

## Cabin Air Filter

Model S has an air filter that prevents pollen, industrial fallout, road dust and other particles from entering through the vents. Tesla replaces the air filter every 24,000 miles (40,000 km).

## Climate Control Operating Tips

- To conserve energy, you can limit the power of the climate control system by turning on Range Mode. Cabin heating and cooling may be less effective, but seat heaters turn on to compensate. Touch **Controls > Settings > Vehicle > Range Mode**.
- If the climate control system operates more loudly than you prefer, reduce the fan speed or adjust the air flow to draw in outside air (instead of recirculating).
- In addition to cooling the interior, the air conditioning system also cools the Battery. Therefore, in hot weather, the air conditioning system can turn on even if you turned it off. This is normal because the system's priority is to cool the Battery to ensure it stays within an optimum temperature range to support long life and optimum performance.
- To ensure the climate control system operates efficiently, close all windows and ensure that the exterior grill in front of the windshield is free of ice, snow, leaves, and other debris.
- To reduce the time it takes to reach a comfortable temperature in hot weather, drive with the windows slightly open for a few minutes when you first start driving.
- In very humid conditions, it is normal for the windshield to fog slightly when you first turn on the air conditioning. This fog clears within a few seconds.
- It is normal for a small pool of water to form under Model S when parked. Extra water produced by the dehumidifying process is drained underneath.



**Note:** If Model S is equipped with Smart Air Suspension, you may hear the sound of the compressor when Model S starts, as the system's reservoir fills with air.

Smart Air Suspension has both manual and automatic modes of operation.

## Manual Height Adjustments

**⚠ Caution:** Before adjusting the suspension height, ensure Model S is clear of all obstacles, above and below.

Manually raising the height of Model S is useful when you need extra ground clearance, such as steep driveways or ramps, deep snow, speed bumps, etc.

With Model S powered on, or the brake pedal pressed, use the touchscreen to manually change the ride height. Touch **Controls** > **Driving**, then choose from:

- **Very High.** When set to Very High, the suspension will automatically lower to High when driving speed reaches 22 mph (35 km/h).
- **High.** When set to High, the suspension will automatically lower to Standard when driving speed reaches 34 mph (55 km/h).
- **Standard.** The Standard setting ensures optimum comfort and handling under all loading conditions.
- **Low.** Lowering the height can make it easier to load or unload cargo and passengers.

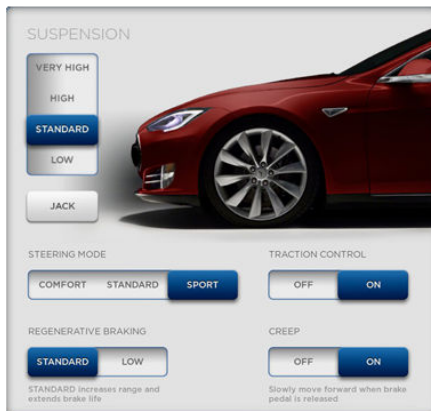

**Note:** Available settings depend on your driving speed and other conditions. For

example, the suspension does not lower if a door is open.

## Automatic Height Adjustments

When Model S is moving above typical driveway or parking lot speeds, Smart Air Suspension automatically lowers ride height to improve aerodynamics and handling. For most average speed driving, the suspension is automatically set to Standard. As described above, when you make manual height adjustments, the suspension automatically lowers at increased driving speeds.

When carrying loads, Smart Air Suspension also maintains a level height between the front and rear.

You can set the speed at which the Air Suspension automatically transitions to the LOW ride height by touching **Controls** > **Settings** > **Vehicle** > **Suspension** on the touchscreen. This setting is saved to your Driver Profile.

**Note:** You can temporarily override the ride height by touching an air suspension control in **Controls** > **Driving**, and manually choosing a ride height. Your suspension's automatic lowering setting is restored the next time you drive.



If a fault is detected with the air suspension system, a yellow indicator lights up on the instrument panel. If the problem persists, contact Tesla.

## Jack Mode

Before jacking or lifting, set the suspension to Jack mode to prevent the self-leveling that occurs even when Model S is powered off.

Press the brake pedal, then touch **Controls** > **Driving** > **Jack**.



When Model S is in Jack mode, a red air suspension indicator lights up on the instrument panel.

To deactivate, touch **Jack** again.

**Note:** Jack mode automatically cancels when you drive over 4.5 mph (7 km/h).



## Overview

Touch the **Media** icon to listen to the radio or play audio files. The touchscreen displays the Media Player. Media Player has two tabs. Use the Browse tab to select what you want to play and use the Now Playing tab to view and control what is currently playing. You can play AM, FM radio (including HD), and XM satellite radio (if Model S is equipped with the optional sound package). You can also play Internet radio, and audio files from a Bluetooth-connected device or a USB-connected flash drive.

## XM Radio

If Model S is equipped with the optional sound studio package, you can listen to XM radio, a subscription-based satellite radio service. To receive XM radio channels, you must provide the radio service provider with the radio ID for your touchscreen.

To view the radio ID:

1. Select the XM radio source.
2. Tune it to channel 0.
3. The Radio ID displays in the station information area.

To select an XM radio channel, you can either manually scroll through the channel numbers, or you can browse the channels by category.

To browse by category, touch **Browse > Radio > XM Satellite Radio**.

## Internet Radio

Internet radio services are accessed over a data connection. To use Internet radio, touch **Media > Browse > Internet**.

Choose your desired Internet radio service (for example, TuneIn or Slacker), then browse through the available categories and/or stations. When you select a specific station or episode, Media Player starts playing it and displays the Now Playing screen.

To play the next (and in some cases previous) available station, episode, or track being provided by the Internet radio service, touch the arrows on the Now Playing screen, or use the left steering wheel (see [Using Left Steering Wheel Buttons](#) on page 36). The exact function of these controls vary depending on the specific Internet service you are listening to.

You can also use voice commands to play a specific song, artist, or album from an Internet radio service. For details, see [Using Voice Commands](#) on page 37.

### Internet Radio Account Registration

Model S provides you with one or more Internet radio services. To enter your log in information, touch **Controls > Settings > Apps > Media Player**. Enter your user name and password, for the Internet radio account(s) you want to use, then touch Log In.

### Slacker

You can use your own Slacker account or the one that Tesla has already set up for you. To use your own account, log in as described above.

### TuneIn

TuneIn does not require an account for it to work. But if you have a TuneIn account (go to [www.tunein.com](http://www.tunein.com)), you can log in as described above.



## Favorites



To add a currently playing radio station or audio file to your Favorites list, touch the Favorites icon on the Now Playing screen. The icon turns blue to show that it is a favorite. To remove a favorite, touch the icon again.

**Note:** Adding a radio station to your Favorites list also assigns it to one of the six presets, if an empty preset is available.

**Note:** To select a favorite radio station or audio file, you can browse your list of Favorites by touching **Browse > Favorites**. As shown below, the Favorites are sorted by their source.

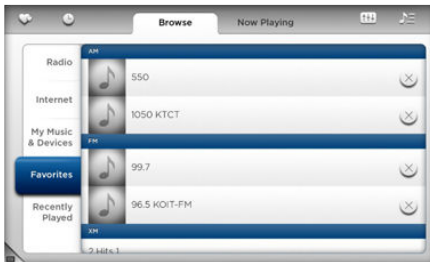

To play the previous or next song or station in your Favorites list, touch the previous or next icon on the Now Playing screen, or use the controls on the left side of the steering wheel (see [Using Left Steering Wheel Buttons](#) on page 36).

To remove a favorite from the list, touch the associated X.

**Note:** If you remove a favorite radio station or channel that is assigned to a preset, it is also removed from the preset.

## My Music & Devices

To play audio files from a USB-connected flash drive or a Bluetooth-connected device, touch **Media > Browse > My Music & Devices**. The name of the device will be displayed. Touch the song, album, or playlist you want to play and Media Player starts playing and displays the Now Playing screen.

To play the next song in the selected playlist or album, touch the previous or next arrows on the touchscreen, or use the left steering wheel (see [Using Left Steering Wheel Buttons](#) on page 36).

### USB Connected Flash Drives

Connect a flash drive to one of the USB connections (see [USB Connections](#) on page 76). Touch **Media > Browse > My Music & Devices**, then touch the name of the flash drive and the song you want to play.

**Note:** To play media from a USB connection, Model S recognizes flash drives only. To play media from other types of devices (such as an iPod), connect using Bluetooth (if supported by the device).

### Bluetooth<sup>®</sup> Connected Devices

If you have a Bluetooth-capable device such as a phone, that is paired and connected to Model S (see [Pairing a Bluetooth Phone](#) on page 77), you can play audio files stored on it, and you can stream a music service (for example, Pandora or Spotify). Touch **Media > Browse > My Music & Devices**, then touch the name of your Bluetooth-connected device.

Your Bluetooth device begins playing the audio file that was currently active on your device, and the touchscreen displays the Now Playing screen.

To change the track playing, touch the previous or next icons on the touchscreen, or use the left steering wheel controls.

**Note:** To play media from a Bluetooth-connected device, ensure that access to the device's media is turned on. See [Phone](#) on page 77.



## USB Connections

Your Model S has two USB connections located on the front of the center console. Use these connections to connect USB drives. You can also use these connections to charge USB devices.

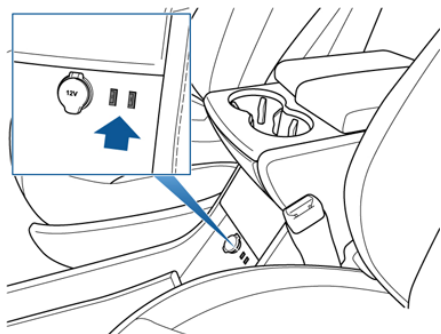

To play audio files stored on a connected USB drive, see [My Music & Devices](#) on page 75.

**Note:** Do not connect multiple devices using a USB hub. This can prevent connected devices from charging or from being recognized by the touchscreen.

## 12V Power Socket

Your Model S has a power socket located on the front of the center console. Power from the socket is available whenever the instrument panel and touchscreen are on.

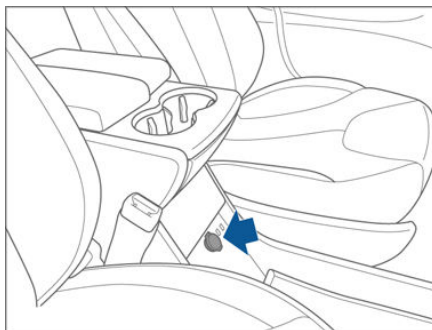

The 12V power socket is suitable for accessories requiring up to 15A or a maximum of 180 watts.

**Note:** In situations where Model S is unable to detect the key (low battery, interference, etc), place it immediately below the 12V power socket where Model S can best detect it.

**Warning:** The power socket and an accessory's connector can become hot.



## Bluetooth<sup>®</sup> Compatibility

You can use your Bluetooth-capable phone hands-free in Model S provided your phone is within operating range. Although Bluetooth typically supports wireless communication over distances of up to approximately 30 feet (9 meters), performance can vary based on the phone you are using.

Before using your phone with Model S, you must pair it. Pairing sets up Model S to work with your Bluetooth-capable phone (see [Pairing a Bluetooth Phone](#) on page 77).

You can pair up to ten Bluetooth phones. Model S always automatically connects to the last phone that was used (provided it is within range). If you want to connect to a different phone, see [Connecting to a Paired Phone](#) on page 78.

**Note:** On many phones, Bluetooth turns off if the phone's battery is low.

**Note:** In addition to phones, you can also pair Bluetooth-enabled devices with Model S. For example, you can pair an iPod Touch or an iPad or Android tablet to stream music.

## Pairing a Bluetooth Phone

Pairing sets up Model S to work with your Bluetooth-capable phone. Once a phone is paired, Model S can connect to it whenever the phone is within range.

To pair a phone, follow these steps while sitting inside Model S:

1. Ensure both the touchscreen and the phone are powered on.
2. On the touchscreen's status bar, touch the Bluetooth icon.
3. On your phone, enable Bluetooth and set it to discoverable.
4. On the Model S touchscreen, touch Start Search. The touchscreen searches then displays the list of all available Bluetooth devices within operating distance.
5. On the Model S touchscreen, touch the phone with which you want to pair. Within a few seconds, the touchscreen displays a randomly generated number, and your phone should display the same number.
6. Check that the number displayed on your phone matches the number displayed on the touchscreen. Then, on your phone, confirm that you want to pair.

When paired, Model S automatically connects to the phone, and the touchscreen displays

the Bluetooth symbol next to the phone's name to show that the connection is active.

## Importing Contacts

Once paired, you can use the Bluetooth settings screen to specify whether you want to allow access to your phone's contacts and recent calls.

If access is turned on, you can see your list of contacts on the Model S touchscreen. **Touch Phone > Contacts.** You can then touch a contact to dial its phone number or navigate to its address.

**Note:** Before contacts can be imported, you may need to either set your phone to allow syncing, or respond to a popup on your phone to confirm that it is OK to sync contacts. This varies depending on the type of phone you are using. For details, refer to the owner documentation provided with your phone.

If access is turned on, imported information is displayed when you touch the contacts tab on the Phone app.

## Unpairing a Bluetooth Phone

If you want to disconnect your phone and use it again later, simply touch Disconnect on the Bluetooth settings screen. If you do not want to use your phone with Model S again, touch Forget This Device. Once you forget a device, you need to pair it again if you want to use it with Model S (see [Pairing a Bluetooth Phone](#) on page 77).

**Note:** Your phone automatically disconnects whenever you leave Model S.



## Connecting to a Paired Phone

Model S automatically connects with the last phone to which it was connected, provided it is within operating range and has Bluetooth turned on. If the last phone is not within range, it attempts to connect with the next phone that it has been paired with.

To connect to a different phone, touch the Bluetooth icon on the touchscreen's status bar. The Bluetooth window displays a list of paired phones. Choose the phone you want to connect to, then touch **Connect**. If the phone you want to connect to is not listed, follow the instructions on [Pairing a Bluetooth Phone](#) on page 77.

When connected, the Model S touchscreen displays the Bluetooth symbol next to the phone name to show that the connection is active.

## Making a Phone Call

You can make a phone call by:

- speaking a voice command (for details, see [Using Voice Commands](#) on page 37)
- choosing a contact from your contact list (described above)
- using the Model S on-screen dialer

To make a phone call using the on-screen dialer:

1. Touch the Phone app on the touchscreen, then touch Dialer.
2. Enter the phone number on the dialer.
3. Touch Call. The touchscreen displays the call screen and the number you are calling.

To make a phone call by choosing a contact:

1. Touch the Phone app on the touchscreen, then touch Contacts.

**Note:** Ensure that access to the phone's contacts is turned on.

2. Touch the name of the contact you want to call to display details about the contact.
3. Touch the number you want to dial (there may be more than one). The touchscreen displays the call screen and the name of the contact you are calling.

**Note:** If it is safe and legal to do so, you can also initiate a call by dialing the number or selecting the contact directly from your phone.

## Receiving a Phone Call

When your phone receives an incoming call, both the instrument panel and the touchscreen display the caller's number or name (if the caller is in your phone's contact list and Model S has access to your contacts).

Touch one of the options on the touchscreen, or use the scroll wheel on the right side of the steering wheel to Answer or Ignore the call (see [Using Right Steering Wheel Buttons](#) on page 37).

## In Call Options

When a call is in progress, you can display the call menu on the instrument panel by pressing the top button on the right side of the steering wheel. Then use the scroll wheel to scroll through and choose an option (see [Using Right Steering Wheel Buttons](#) on page 37).





## Overview

Touch the **Map** (or **Nav**) icon to view and search for a location on Google Maps™. If Model S is equipped with the navigation option, the app is labeled **Nav** and onboard maps are available. Onboard maps allow you to navigate to any location, even if a data connection is not available. When you specify a location, the touchscreen displays the route and provides turn-by-turn instructions. If Model S is not equipped with the navigation option, onboard maps are not available, but you can find and display any location (provided you have a data connection).

## Using Maps

Touch the search field, or speak a voice command to specify a location (for details on how to use voice commands, see [Using Voice Commands](#) on page 37). You can enter or speak an address, landmark, business, etc. You can also touch **PLACES** and choose from a list of recent locations and searches, favorite destinations, Supercharger locations, and charging stations you've visited.

Touch the North/Heading Up icon to the right of the search bar to center the map on your car and have the map track your position as you drive. The icon is blue when the map is tracking your position and by touching the icon, you can change the orientation of the map:



North Up - North is always at the top of the screen.



Heading Up - The direction you are heading is always at the top of the screen. The map rotates when you change direction.

You can rotate the map in any direction. When you rotate the map you'll notice the icon turn gray, indicating the map is no longer tracking your position. Touch the icon again to track your position.



Whenever the map is in the Heading Up orientation (where North is not at the top), a compass appears on the map. The compass arrow points North and the text indicates the direction you are driving. You can touch the compass to switch to North Up (described above).

**Note:** To change the size of the font used to display the map's labels, touch **Controls** > **Settings** > **Apps** > **Maps & Navigation** > **Map Magnification**.

## Starting Navigation

1. Touch the **Nav** icon to display the map.
2. Touch the search bar to enter the destination, then touch **GO**. You can also use voice commands to specify the destination (for details, see [Using Voice Commands](#) on page 37). If you have a data connection, you can start entering the destination, then choose one of the auto-complete entries that appear. For example, you can enter just the street, business name, or category (such as hotels, coffee, etc). If you don't have a data connection, you must enter complete and exact location information.

A list of matching destinations appears on the left, and their corresponding pins (with letters A, B, C, etc) appear on the map.

**Note:** You can also touch **PLACES** and choose a location from the list of Recent locations and searches, Favorite locations, Supercharger locations, or Visited Chargers.

3. Touch any destination in the list to immediately start navigation, or touch the lettered pin on the map to view the destination popup, which also allows you to place a phone call to the destination (in situations where a phone number is available).

## During Navigation

During navigation, the touchscreen displays the navigation route on the map, and a turn-by-turn direction list that includes estimated driving time, mileage, and arrival time. Depending on the map's zoom level, you might not be able to see the entire route. But



as you drive, the map shows your location on the map.

During navigation, the instrument panel also displays directions to your destination and you hear spoken instructions.

## Favorite Destinations

If you frequently navigate to a destination, you may want to add it as a Favorite to avoid having to enter the location's name or address each time. When you add a destination as a Favorite, you can easily navigate to it by touching **PLACES**, then selecting it from the list of Favorites. The Favorites list has placeholders for your Home and Work locations. In fact, Model S may prompt you to save a current location as Home or Work based on your usage pattern.



Add any destination to your list of Favorites by either touching its flag while navigating to it, or by displaying it on the map then touching its pin. Then, in the popup dialog that appears, touch the Favorites icon. When a destination is on your Favorites list, the icon is blue. To remove a favorite destination, touch the Favorites icon again.



## About the Security System

If Model S does not detect a key nearby and a locked door or trunk is opened, an alarm sounds and headlights and turn signals flash. To deactivate the alarm, press any button on the key.

To manually enable or disable the alarm system, touch **Controls** > **Settings** > **Safety & Security** > **Alarm**. When set to on, Model S activates its alarm one minute after the doors lock and a recognized key is no longer detected nearby.

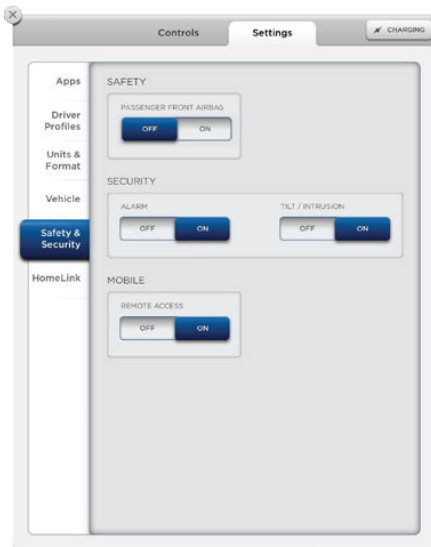

**Note:** If you plan to leave something that moves, such as a dog, inside your locked Model S, remember to turn off the tilt/intrusion system. Any type of motion detected inside Model S activates the siren.



## About HomeLink<sup>®</sup>

If Model S is equipped with the optional tech package, you can program the HomeLink<sup>®</sup> Universal Transceiver to operate up to three garage doors, gates, lights, and security systems that can transmit Radio Frequency (RF) signals.

## Programming HomeLink<sup>®</sup>

1. Park in front of the device you want to program, and have the device's remote control ready.
2. Touch **Controls** > **Settings** > **HomeLink** on the touchscreen.
3. Touch **Enter Name**, then use the onscreen keyboard to enter a name for your HomeLink device.
4. Touch **Create HomeLink**.
5. Follow the onscreen instructions.

Once programmed, you can operate the device by touching its corresponding HomeLink icon on the touchscreen's status bar. HomeLink remembers the location of your programmed devices. When you approach a known location, the HomeLink control on the touchscreen automatically drops down. When you drive away, it disappears.

**Note:** For security reasons, erase your HomeLink settings if you sell Model S.

 **Warning:** Your device might open or close during programming. Before programming, make sure that the device is clear of any people or objects.

 **Warning:** Do not use the HomeLink Universal Transceiver with a garage door that does not meet federal safety standards. A garage door opener that cannot detect an object in its path and then automatically stop and reverse, does not meet these standards. Using a garage door opener without these features increases the risk of injury or death.



Wi-Fi is available as a data connection method and is often faster than cellular data networks. Connecting to Wi-Fi is especially useful in areas with limited or no cellular connectivity. To ensure fast, reliable delivery of Model S software updates (see [Software Updates](#) on page 84), Tesla recommends leaving Wi-Fi turned on and connected to a Wi-Fi network. To connect to a Wi-Fi network:

1. Touch the **3G** icon in the touchscreen status bar. Model S will start scanning and display the Wi-Fi networks that are within range.
2. Select the Wi-Fi network you want to use, enter the password (if necessary), then touch **Connect**.

You can also connect to a hidden network that isn't shown on the list of scanned networks. Just touch **Wi-Fi Settings** and enter the name of the network in the resulting dialog box.

Once you have connected to a network, Model S auto-connects whenever the network is within range. If more than one previously connected network is within range, Model S connects to the one most recently used.

**Note:** You can also use a mobile hotspot or your phone's Internet connection via Wi-Fi tethering.

**Note:** At Tesla service centers, Model S automatically connects to a Tesla Service Wi-Fi access point.



## Loading New Software

Model S updates its software wirelessly, providing new features throughout your term of ownership. The first time you enter Model S after an update is made available, a scheduling window displays on the touchscreen.

**Note:** Some software updates can take from two to three hours to complete. Model S must be in P (Park) when the new software is being installed. To ensure the fastest and most reliable delivery of software updates, leave the Wi-Fi turned on and connected whenever possible (see [Connecting to Wi-Fi](#) on page 83).

When a software update is available, a yellow clock icon appears on the touchscreen's status bar.

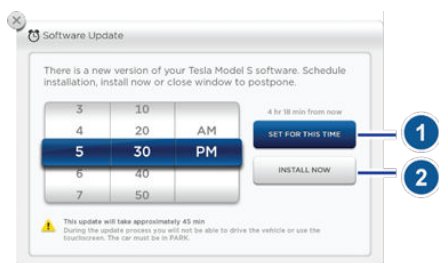

1. Touch the up and down arrows to change the time you want the update to begin (if necessary). Then touch **Set For This Time** to schedule the update. Once scheduled, the yellow clock icon on the touchscreen's status bar becomes white.
2. Touch **Install Now** to immediately start the update process.

You can reschedule the update any time before it begins. To do so, touch the clock icon on the touchscreen's status bar to display the update window.

If Model S is charging when the software update begins, charging stops. Charging resumes automatically when the update is complete. If you are driving Model S at the scheduled update time, the update is canceled and you need to reschedule.

If the touchscreen displays a message indicating that a software update was not successfully completed, contact Tesla.

## Viewing Release Notes

When a software update is complete, learn about the new features by displaying the release notes. To display release notes at any time touch the Tesla "T" at the top center of the touchscreen, then touch Release Notes.



## Model S Mobile App

The Tesla Model S mobile app allows you to communicate with Model S remotely using your iPhone<sup>®</sup> or Android<sup>™</sup> phone. With this app, you can check charging progress, start and stop charging, heat or cool Model S, locate Model S or track its movement, flash lights, honk the horn, lock and unlock, and more.

Simply download the app to your phone and enter your login credentials. You must also ensure that Model S is ready to communicate with the mobile app by turning on its remote access setting. Touch **Controls > Settings > Safety & Security > Remote Access > On** (see [Settings](#) on page 67).



## High Voltage Components

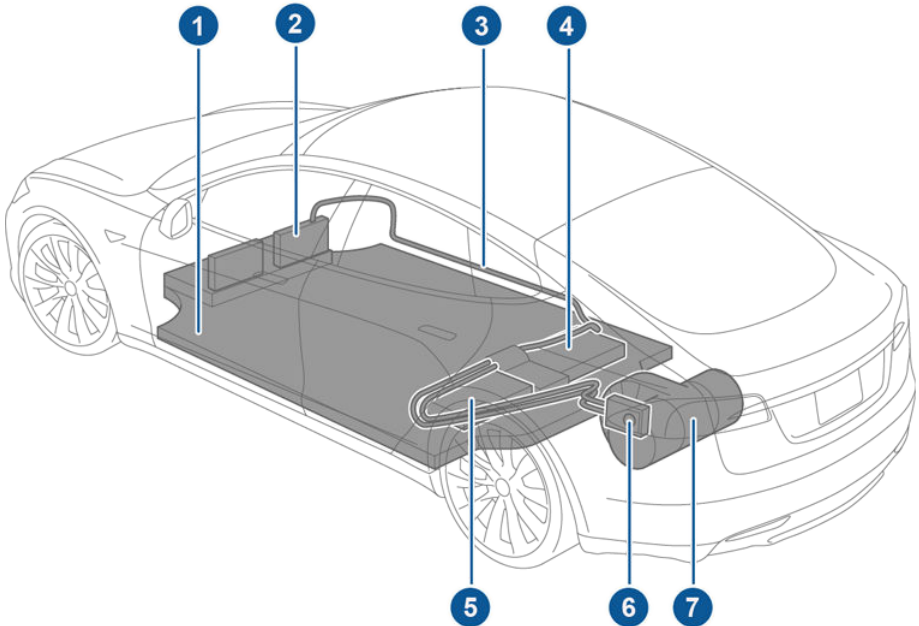

1. Battery
2. DC-DC converter and junction box
3. High voltage cabling (colored orange)
4. 10 kW on-board master charger
5. OPTIONAL: 10 kW on-board charger
6. Charge port
7. Drive unit

**⚠ Warning:** The high voltage system has no user serviceable parts. Do not disassemble, remove or replace high voltage components, cables or connectors. High voltage cables are colored orange for easy identification.

**⚠ Warning:** Read and follow all instructions provided on the labels that are attached to Model S. These labels are there for your safety

**⚠ Warning:** In the unlikely event that a fire occurs, immediately contact your local fire emergency responders.





## Charging Equipment

Charging equipment designed specifically to charge your Model S is available from Tesla. A Tesla Wall Connector, which installs in your garage, is the fastest way to charge Model S at home.

In several market regions, Model S is equipped with a Mobile Connector and the adapter(s) you need to plug into commonly used power outlets. When using the Mobile Connector, first plug the Mobile Connector into the power outlet, then plug in Model S. For more information about your Mobile Connector, see the Mobile Connector Owner's Manual. Additional adapters can be purchased from Tesla.

Tesla also provides various types of adapters (including J1772, Mennekes Type 2, and CHAdeMO) that allow you to plug Model S into the most commonly used public charging stations in your region. Connect the adapter to the charging station's charge cable, open the charge port door using the touchscreen (see [Charging Model S](#) on page 89), then plug in Model S.

For more information on the charging equipment available for your region, go to [www.teslamotors.com](http://www.teslamotors.com), choose your region, then view the available charging options.



## About the Battery

Model S has one of the most sophisticated battery systems in the world. The most important way to preserve the Battery is to **LEAVE YOUR MODEL S PLUGGED IN** when you are not using it. This is particularly important if you are not planning to drive Model S for several weeks. When plugged in, Model S wakes up when needed to automatically maintain a charge level that maximizes the lifetime of the Battery.

There is no advantage to waiting until the Battery's level is low before charging. In fact, the Battery performs best when charged regularly.

**Note:** If the Model S Battery becomes completely discharged in a situation in which towing is required, the owner is responsible for towing expenses. Discharge-related towing expenses are not covered under the Roadside Assistance policy.

## Battery Care

Never allow the Battery to fully discharge. Even when Model S is not being driven, its Battery discharges very slowly to power the onboard electronics. On average, the Battery discharges at a rate of 1% per day. Situations can arise in which you must leave Model S unplugged for an extended period of time (for example, at an airport when traveling). In these situations, keep the 1% in mind to ensure that you leave the Battery with a sufficient charge level. For example, over a two week period (14 days), the Battery discharges by approximately 14%.

Discharging the Battery to 0% may permanently damage the Battery. To protect against a complete discharge, Model S enters a low-power consumption mode when the charge level drops to 5%. In this mode, the Battery stops supporting the onboard electronics to slow the discharge rate to approximately 4% per month. Once this low-power consumption mode is active, it is important to plug in Model S within two months to avoid Battery damage.

**Note:** When the low-power consumption mode is active, the auxiliary 12V battery is no longer being charged and can completely discharge within 12 hours. In the unlikely event that this occurs, you may need to jump start or replace the 12V battery before you can charge. In this situation, contact Tesla.

## Temperature Limits

Do not expose Model S to ambient temperatures above 140° F (60° C) or below -22° F (-30° C) for more than 24 hours at a time.

## Energy Saving Feature

Model S has an energy-saving feature that reduces the amount of energy being consumed when Model S is not being used. Touch **Controls > Displays > Energy Saving**. When energy saving is turned on, the start-up time of the instrument panel, Bluetooth, data connection, and mobile app is slower than usual.

## Battery Warnings and Cautions

**Warning:** The Battery has no parts that an owner or a non-Tesla authorized service technician can service. Under no circumstances should you open or tamper with the Battery. Always contact Tesla to arrange for Battery servicing.

**Caution:** If the Battery's charge level falls to 0%, you must plug it in. If you leave it unplugged for an extended period, it may not be possible to charge Model S or use the vehicle without jump starting or replacing the 12V battery. Leaving Model S unplugged for an extended period can also result in permanent Battery damage. If you are unable to charge Model S, contact Tesla immediately.

**Caution:** The Battery requires no owner maintenance. Do not remove the filler cap and do not add fluid. If the instrument panel warns you that the fluid level is low, contact Tesla immediately.

## Opening the Charge Port

The charge port is located on the driver's side of Model S, behind a door that is part of the rear tail light assembly.

Park Model S so that the charge cable easily reaches the charge port.

With Model S unlocked, or a recognized key nearby, press and release the button on a Tesla charge cable.

If the cable you are using does not have this button, touch **Controls > Charge Port**. Or, you can touch the battery icon at the top of the touchscreen, then from the Charging screen, touch **Open Charge Port**.



To charge at a public charging station, attach an adapter to the station's charging connector. The most commonly used adapter(s) for each market region are supplied with Model S. Depending on the charging equipment you are using, you may need to start and stop charging using a control on the charging equipment.

**Note:** The charge port lights up white when you open the charge port door. If you do not connect a charge cable, the light eventually turns off.

**Note:** If you do not insert the charge cable into the charge port within a few minutes after opening the charge port door, the latch closes. If this happens, use the touchscreen to open the charge port door.

**⚠ Caution:** The connector end of the charge cable can damage the paint if dropped onto Model S.

**⚠ Caution:** Do not attempt to force the charge port door open. Doing so can damage the latch. A damaged latch cannot hold the door closed.

## Plugging In

If desired, use the touchscreen to change the charge limit and the charging current.

If you are using the Mobile Connector, plug it into the power outlet before plugging it into Model S.

Align the connector to the charge port and insert fully. When the connector is properly inserted, charging begins automatically after Model S:

- Engages a latch that holds the connector in place.
- Shifts into Park (if it was in any other gear).
- Heats or cools the Battery, if needed. If the Battery requires heating or cooling, you may notice a delay before charging begins.

**Note:** Whenever Model S is plugged in but not actively charging, it draws energy from the wall instead of using energy stored in the Battery. For example, if you are sitting in Model S and using the touchscreen while it's in parked and plugged in, the energy being used is drawn from the power outlet instead of the Battery.



## During Charging

During charging, the charge port pulses green and charging status displays on the instrument panel. The frequency at which the charge port's light pulses slows down as the charge level approaches full. When charging is complete, the light stops pulsing and is solid green.

**Note:** If Model S is locked, the light around the charge port does not light up.

If the light around the charge port lights up red while charging, a fault is detected. Check the instrument panel or touchscreen for a message describing the fault. A fault can occur due to something as common as a power outage. If a power outage occurs, charging resumes automatically when power is restored.

**Note:** When charging, particularly at high currents, the refrigerant compressor and the fan operate as needed to keep the Battery cool. Therefore, it is normal to hear sounds during charging.

## Stopping Charging

You can stop charging at any time by disconnecting the charge cable or touching Stop Charging on the touchscreen.

To disconnect the charge cable:

1. Press and hold the button on a Tesla connector to release the latch.
2. Pull the connector from the charge port.
3. Push the charge port door closed.

**Note:** To prevent unauthorized unplugging of the charge cable, Model S must be unlocked or able to recognize a key before you can disconnect the charge cable.

**Note:** Model S stops charging whenever you double-click the key. If you do not unplug within 60 seconds, charging resumes.

**⚠ Caution:** Tesla strongly recommends leaving Model S plugged in when not in use. This maintains the Battery at the optimum level of charge.

## Charge Port Light

White	The charge port door is open and charge mode is initiated.
Green - pulsing	Charging is in progress.
Green - solid	Charging is complete.
Red - flashing	A fault was detected and charging has stopped. Check the instrument panel or touchscreen for a message describing the fault.



## Changing Charge Settings

The charge settings screen displays on the touchscreen whenever the charge port door is open.

To display charge settings at any time, touch the Battery icon on the top of the touchscreen, or touch **Controls** > **Charging** (located in the upper right portion of the Controls screen).

The following illustration is provided for demonstration purposes only and may vary slightly depending on the firmware version and market region of your Model S.

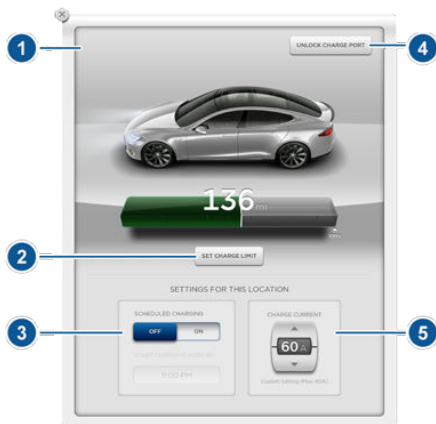

1. Charge status messages (such as Charging Scheduled, Charging In Progress) display here.
2. Adjust the charge limit based on your anticipated driving needs. Touch Set Charge Limit, then drag the slider bar to the desired charge level. You can charge to any level from 50% to 100%. For daily driving, charge between 50% and 90% to improve battery longevity. Charge above 90% for trips requiring maximum range. The setting you choose applies to both immediate and scheduled charging sessions.
3. Location-specific schedule

With Model S in Park, set a specific time when you want Model S to begin charging at the current location. If, at the scheduled time, Model S is not plugged in at the location, it will start charging as soon as you plug it in as long as you are plugging it in within six hours of the scheduled time. If you plug in after six hours, Model S does not start charging until the

scheduled time on the next day. To override this setting, touch Start Charging or Stop Charging (see item 4). When you set a scheduled charging time, Model S displays the set time on the instrument panel and the touchscreen.

4. Touch to open the charge port door or to start (or stop) charging.
5. The current automatically sets to the maximum current available from the attached charge cable, unless it was previously reduced to a lower level.

If needed, touch the up/down arrows to change the current (for example, you may want to reduce the current if you are concerned about overloading a domestic wiring circuit shared by other equipment). It is not possible to set the charging current to a level that exceeds the maximum available from the attached charge cable.

When you change the current, Model S remembers the location. So if you subsequently charge at the same location, you do not need to change it again.

**Note:** If Model S automatically reduced a charging location's current because of fluctuations in input power (see the note in [Charging Status](#) on page 92), Tesla recommends charging at the lower current until the underlying problem is resolved and the charging location can provide consistent power.



## Charging Status

The following illustration is provided for demonstration purposes only and may vary slightly depending on the software version and market region of your Model S.

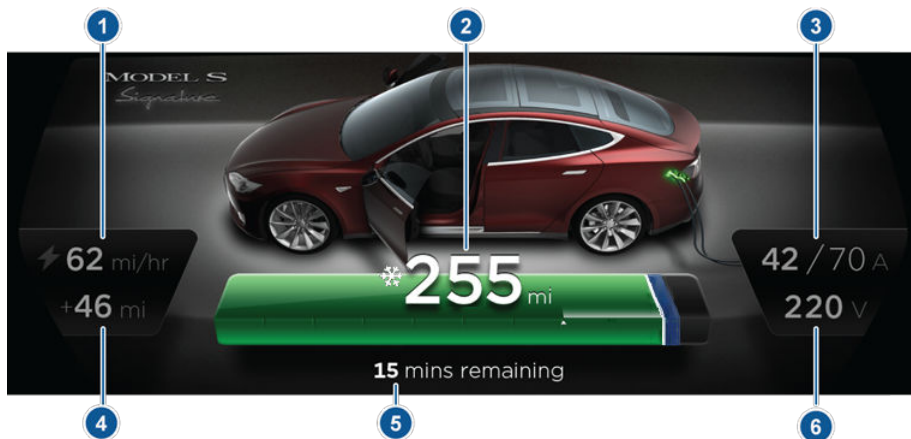

1. Charging rate per hour.
2. Total estimated driving distance (or energy) available. Instead of driving distance as shown here, you can display the percentage of battery energy remaining. To do so, touch **Controls > Settings > Units & Format > Energy & Charging**.  
**Note:** A portion of the battery image may appear blue. This indicates that a small portion of the energy stored in the battery is not available on your drive because the battery is cold. This is normal and no reason for concern. When the battery warms up, the blue portion is no longer displayed.
3. Current being supplied/Total current available from the connected power supply (see [Changing Charge Settings](#) on page 91).
4. Estimated increase in driving distance (or energy) achieved so far in this charging session. Instead of driving distance as illustrated above, you can change settings to display the amount of energy achieved. To do so, touch **Controls > Settings > Units & Format > Energy & Charging**.
5. Charging status information displays here. For example, if Model S is charging, it displays the time remaining until fully charged at the currently selected charge level. When scheduled charging is set for

a location, it displays when charging will start.

6. Voltage being supplied by the charge cable.

**Note:** If Model S is charging and detects unexpected fluctuations in the input power, it automatically reduces the charging current by 25%. For example, a 40 amp current is reduced to 30 amps. This automatic current reduction increases robustness and safety in situations when a problem exists outside of Model S or its charging electronics. For example, a home wiring system, receptacle, adapter or cord is unable to meet its rated current capacity. When Model S automatically reduces a location's charging current, it retains the reduced current for that location as a precaution. Although you can manually increase it, Tesla recommends charging at the lower current until the underlying problem is resolved and the charging location can provide consistent power.



## Service Intervals

Regular maintenance is the key to ensuring the continued reliability and efficiency of your Model S.

Rotate the tires every 5000 miles (8000 km) (except on Performance Plus models), maintain the correct tire pressures, and take Model S to Tesla at the regularly scheduled maintenance intervals of every 12 months, or every 12,500 miles (20,000 km), whichever comes first. It is also important to perform the daily and monthly checks described below.

Model S must be serviced by Tesla-certified technicians. Damages or failures caused by maintenance or repairs performed by non-Tesla certified technicians are not covered by the warranty.

## Daily Checks

- Check the Battery's charge level, displayed on the instrument panel.
- Check that all exterior lights, horn, turn signals, and wipers and washers are working.
- Check the operation of the brakes, including the parking brake.
- Check the operation of the seat belts (see [Seat Belts](#) on page 18).
- Look for fluid deposits underneath Model S that might indicate a leak. It is normal for a small pool of water to form (caused by the air conditioning system's dehumidifying process).

## Monthly Checks

- Check the mileage to determine if the tires need to be rotated (every 5000 miles/8000 km, except on Performance Plus models), and check the condition and pressure of each tire (see [Tire Care and Maintenance](#) on page 94).
- Check washer fluid level and top up if necessary (see [Topping Up Washer Fluid](#) on page 110).
- Check that the air conditioning system is operating (see [Climate Controls](#) on page 70).

**⚠ Warning:** Contact Tesla immediately if you notice any significant or sudden drop in fluid levels or uneven tire wear.

## Fluid Replacement Intervals

Do not change or top up Battery coolant and brake fluid yourself. Tesla service technicians replace fluids at the regularly scheduled service intervals:

- Brake fluid - every 2 years or 24,000 miles (40,000 km), whichever comes first.
- Battery coolant - every 4 years or 48,000 miles (80,000 km), whichever comes first.

**Note:** Any damage from opening the Battery coolant reservoir is excluded from the warranty.

## High Voltage Safety

Your Model S has been designed and built with safety as a priority. However, be aware of these precautions to protect yourself from the risk of injury inherent in all high-voltage systems:

- Read and follow all instructions provided on the labels that are attached to Model S. These labels are there for your safety.
- The high voltage system has no user-serviceable parts. Do not disassemble, remove or replace high voltage components, cables or connectors. High voltage cables are colored orange for easy identification.
- If an accident occurs, do not touch any high voltage wiring, connectors, or components connected to the wiring.
- In the unlikely event that a fire occurs, immediately contact your local fire emergency responders.

**⚠ Warning:** Always disconnect the charge cable before working underneath Model S, even if charging is not in progress.

**⚠ Warning:** Keep your hands and clothing away from cooling fans. Some fans operate even when Model S is powered off.

**⚠ Caution:** Some fluids (battery acid, Battery coolant, brake fluid, windshield washer additives, etc.) used in motor vehicles are poisonous and should not be inhaled, swallowed, or brought into contact with open wounds. For your safety, always read and follow instructions printed on fluid containers.



## Maintaining Tire Pressures

Keep tires inflated to the pressures shown on the Tire and Loading Information label, even if it differs from the pressure printed on the tire itself. The Tire and Loading Information label is located on the center door post and are visible when the driver's door is open.



The Tire Pressure indicator light on the instrument panel alerts you if one or more tires is under- or over-inflated.

The Tire Pressure indicator light does not immediately turn off when you adjust tire pressure. After inflating the tire to the recommended pressure, you must drive over 25 mph (40 km/h) for more than 10 minutes to activate the Tire Pressure Monitoring System (TPMS), which turns off the Tire Pressure indicator light.

If the indicator light flashes for one minute whenever you power on Model S, a fault with the Tire Pressure Monitoring System (TPMS) is detected (see [TPMS Malfunction](#) on page 98).

## Checking and Adjusting Tire Pressures

Follow these steps when tires are cold and Model S has been stationary for over three hours:

1. Remove the valve cap.
2. Firmly press an accurate tire pressure gauge onto the valve to measure pressure.
3. If required, add air to reach the recommended pressure.
4. Re-check pressure by removing and re-attaching the tire gauge.
5. If you added too much air, release air by pressing the metal stem in the center of the valve.
6. Recheck the pressure with the tire gauge and adjust if necessary.
7. Replace the valve cap to prevent dirt from entering. Periodically check the valve for damage and leaks.



**Warning:** Under-inflation is the most common cause of tire failures and can cause a tire to overheat, resulting in severe tire cracking, tread separation, or blowout, which causes unexpected loss of vehicle control and increased risk of injury. Under-inflation also reduces Battery range and tire tread life.



**Warning:** Check tire pressures using an accurate pressure gauge when tires are cold. It takes only one mile of driving to warm up the tires sufficiently to affect tire pressures. Parking the vehicle in direct sunlight or in hot weather can also affect tire pressures. If you must check warm tires, expect increased pressures. Do not let air out of warm tires in an attempt to match recommended cold tire pressures. A hot tire at or below the recommended cold tire inflation pressure is dangerously under-inflated.



**Warning:** Do not use any tire sealant other than the type provided in a Tesla tire repair kit. Other types can cause tire pressure sensors to malfunction. If your Model S did not include a tire repair kit, you can purchase one from Tesla Motors.





## Inspecting and Maintaining Tires

Regularly inspect the tread and side walls for any sign of distortion (bulges), cuts or wear.

**⚠ Warning:** Do not drive Model S if a tire is damaged, excessively worn, or inflated to an incorrect pressure. Check tires regularly for wear, and ensure there are no cuts, bulges or exposure of the ply/cord structure.

### Tire Wear

Model S is originally fitted with tires that have wear indicators molded into the tread pattern. When the tread has been worn down to 1/16" (1.6 mm), the indicators start to appear at the surface of the tread pattern, producing the effect of a continuous band of rubber across the width of the tire.

Replace a tire as soon as an indicator band becomes visible or the tread depth reaches the minimum permitted by law.

### Tire Rotation, Balance, and Wheel Alignment

Tesla recommends rotating the tires every 5000 miles (8000 km).

**Note:** Do not rotate tires on the Performance Plus models.

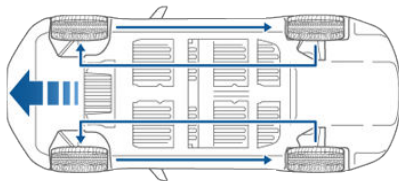

Unbalanced wheels (sometimes noticeable as vibration through the steering wheel) affect vehicle handling and tire life. Even with regular use, wheels can get out of balance. Therefore, they should be balanced as required.

If tire wear is uneven (on one side of the tire only) or becomes abnormally excessive, check the alignment of wheels.

### Punctured Tires

A puncture eventually causes the tire to lose pressure, which is why it is important to check tire pressures frequently. Permanently repair or replace punctured or damaged tires as soon as possible. Do not drive with a punctured tire, even if the puncture has not caused the tire to deflate. A punctured tire can deflate suddenly at any time.

Your tubeless tires may not leak when penetrated, provided the object remains in the tire. If, however, you feel a sudden vibration or ride disturbance while driving, or you suspect a tire is damaged, immediately reduce your speed. Drive slowly, while avoiding heavy braking or sharp steering and, when safe to do so, stop the vehicle. Arrange to have Model S transported to a Tesla service center, or to a nearby tire repair center.

**Note:** In some cases, you can temporarily repair small tire punctures (under 1/4"/6 mm) using an optional tire repair kit available from Tesla. This allows you to slowly drive Model S to Tesla or to a nearby tire repair facility (see [Temporary Tire Repair](#) on page 99).

**⚠ Warning:** Do not drive Model S with a punctured tire. Even if the punctured tire has not deflated, it can suddenly deflate at any time.

### Flat Spots

If Model S is stationary for a long period in high temperatures, tires can form flat spots. When Model S is driven, these flat spots cause a vibration which gradually disappears as the tires warm up and regain their original shape.

To minimize the flat spots during storage, inflate tires to the maximum pressure indicated on the tire wall. Then, before driving, release air to adjust tire pressure to the recommended levels.

### Driving in Low Ambient Temperatures

Tire performance is reduced in low ambient temperatures, resulting in reduced grip and an increased susceptibility to damage from impacts. Performance tires can temporarily harden when cold, causing you to hear rotational noise for the first few miles until the tires warm up. Contact Tesla for winter tire recommendations.



## Improving Tire Mileage

To improve the mileage you get from your tires, maintain tires at the recommended tire pressures, observe speed limits and advisory speeds, and avoid:

- Pulling away quickly, or hard acceleration.
- Fast turns and heavy braking.
- Potholes and objects in the road.
- Hitting curbs when parking.
- Contaminating tires with fluids that can cause damage.

## Replacing Tires and Wheels

Tires degrade over time due to the effects of ultraviolet light, extreme temperatures, high loads, and environmental conditions. It is recommended that tires are replaced every six years, or sooner if required.

Wheel rims and tires are matched to suit the handling characteristics of the vehicle. Replacement tires must comply with the original specification. If tires other than those specified are used, ensure that the load and speed ratings marked on the tire (see [Understanding Tire Markings](#) on page 130) equal or exceed those of the original specification.

Ideally, you should replace all four tires at the same time. If this is not possible, replace the tires in pairs (both front or both rear). When replacing tires, always re-balance and check the alignment of wheels.

If you replace a wheel, the TPMS (Tire Pressure Monitoring System) sensors need to be reset to ensure they provide accurate warnings when tires are under- or over-inflated (see [Resetting the TPMS Sensors](#) on page 97).

For the specification of the original wheels and tires installed on Model S, see [Wheel Specifications](#) on page 128.

**Warning:** For your safety, use only tires and wheels that match the original specification. Tires that do not match the original specification can affect the operation of the Tire Pressure Monitoring System (TPMS).

## Asymmetric Tires

Model S tires are asymmetric and must be mounted on the wheel with the correct sidewall facing outward. The sidewall of the tire is marked with the word **OUTSIDE**. When new tires are installed, make sure that the tires are correctly mounted on the wheels.



**Warning:** Road holding is seriously impaired if the tires are incorrectly installed on the wheels.

## Winter Tires

In snowy and icy conditions, consider installing winter tires. Winter tires must be the same size, brand, construction and tread pattern on all four wheels. For recommendations on winter tires, contact Tesla.

**Warning:** On dry roads, winter tires could have less traction than the originally installed tires.



## Using Tire Chains

Tesla has tested and approved Security Chain Company (SCC) Model Z-563 chains for use on the rear wheels. These chains must only be used if your Model S has 245/45R19 rear tires installed. Do not use chains on 21 inch tires.

When installing tire chains, follow the instructions provided by the tire chain manufacturer. Mount them as tightly as possible.

When using tire chains:

- Drive slowly—do not exceed 30 mph (48 km/h).
- Avoid heavily loading Model S (heavy loads can reduce the clearance between the tires and the body).
- Remove the tire chains as soon as conditions allow.

**Note:** Tire chains are prohibited in some jurisdictions. Check local laws before installing tire chains.

**⚠ Caution:** Using non-recommended tire chains, or using tire chains on other sized tires, can damage the suspension, body, wheels, and/or brake lines. Damage caused by using non-recommended tire chains is not covered by the warranty.

**⚠ Caution:** Ensure that tire chains cannot touch suspension components or brake lines. If you hear the chains making unusual noises that would indicate contact with Model S, stop and investigate immediately.

## Tire Pressure Monitoring

Each tire should be checked monthly when cold and inflated to the recommended pressures that are printed on the Tire and Loading Information label located on the driver's door pillar (see [Maintaining Tire Pressures](#) on page 94). If your vehicle has tires of a different size than the size indicated on the vehicle placard or tire inflation pressure label, determine the proper tire inflation pressure for those tires.

As an added safety feature, your vehicle has been equipped with a tire pressure monitoring system (TPMS) that displays a tire pressure telltale (Tire Pressure Warning) on the instrument panel when one or more of your tires is significantly under- or over-inflated. Accordingly, when the Tire Pressure indicator light displays on the instrument panel alerting of tire pressure, stop and check your tires as

soon as possible, and inflate them to the proper pressure (see [Maintaining Tire Pressures](#) on page 94). Driving on a significantly under-inflated tire causes the tire to overheat and can lead to tire failure. Under-inflation also reduces fuel efficiency and tire tread life, and may affect the vehicle's handling and stopping ability.



If Model S detects a fault with the Tire Pressure Monitoring System (TPMS), this indicator flashes for one minute whenever you power on Model S.

**Note:** Installing accessories that are not approved by Tesla can interfere with the TPMS system.

**⚠ Warning:** The TPMS is not a substitute for proper tire maintenance, including manually checking tire pressures and regularly inspecting the condition of tires. It is the driver's responsibility to maintain correct tire pressure, even if under- or over-inflation has not reached the level for the TPMS to trigger the Tire Pressure Warning on the instrument panel.

### Resetting the TPMS Sensors

To ensure accurate tire pressure warnings after replacing one or more wheels, the TPMS sensors must be reset.

**Note:** When changing to 21" wheels (Performance Plus models), the TPMS may generate false tire pressure warnings. Bring Model S to a Tesla Service center for further adjustment.

**Note:** The TPMS sensors do not need to be reset after replacing a tire or rotating wheels.

**Note:** Do not reset the TPMS sensors in an attempt to clear tire pressure warnings.

To reset the tire pressure sensors:

1. Inflate all tires to their recommend pressures, as indicated on the Tire and Loading Information label located on the driver's door pillar.
2. Get ready to drive for ten minutes, then, on the Model S touchscreen, touch **Controls > Settings > Vehicle > Tire Pressure Monitor > Reset Sensors**.
3. Follow the onscreen instructions.



## Replacing a Tire Sensor

If the Tire Pressure warning indicator displays frequently, contact Tesla to determine if a tire sensor needs to be replaced. Tire sensors must be replaced by a Tesla service technician who can perform a brief setup procedure. If a non-Tesla service center repairs or replaces a tire, the tire sensor will not work until Tesla performs the setup procedure.

## TPMS Malfunction

Model S has also been equipped with a TPMS malfunction indicator to indicate when the system is not operating properly.



The TPMS malfunction indicator is combined with the tire pressure indicator light. When the system detects a malfunction, the indicator flashes for approximately one minute after Model S powers on, and then remains continuously lit. This sequence continues upon subsequent vehicle start-ups as long as the malfunction exists. When the TPMS malfunction indicator is on, the system might not be able to detect or signal under- and over-inflated tires as intended.

TPMS malfunctions can occur for a variety of reasons, including installing replacement or alternate tires or wheels on the vehicle that prevent the TPMS from functioning properly. Always check the TPMS malfunction indicator light after replacing one or more tires or wheels on your vehicle to ensure that the replacement or alternate tires and wheels allow the TPMS to continue to function properly.

**Note:** If a tire has been replaced or repaired using a different tire sealant than the one available from Tesla, and a low tire pressure is detected, it is possible that the tire sensor has been damaged. Contact Tesla to have the fault repaired as soon as possible.



## Tire Repair Kit

Your Model S has no spare tire. Depending on the legislations that apply to the region in which you purchased Model S, a tire repair kit may or may not be included. If a tire repair kit was not provided in Model S upon delivery, you can purchase one from Tesla.

**Note:** Although Model S does not have a spare tire, in the event of a flat tire, Roadside Assistance provides towing coverage for up to 50 miles.

The tire repair kit consists of a compressor and a canister of tire sealant (enough to repair one tire). When injected into a tire, the sealant can penetrate a small puncture up to 1/4 in (6 mm) to form a temporary repair.

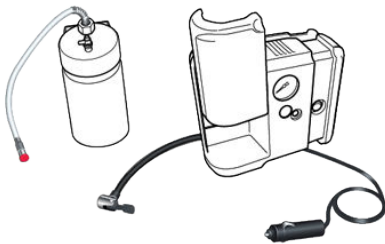

**Note:** For punctures larger than 1/4" (6 mm), severe tread damage, a damaged sidewall, ripped tires or tires that have come off the rim, call Roadside Assistance.

- Warning:** The tire repair kit is a temporary repair only. You must repair or replace a damaged tire as soon as possible.
- Warning:** Do not exceed 30 mph (48 km/h) when driving with a tire that has been temporarily repaired with sealant.
- Warning:** Follow all directions and warnings on the tire repair kit before starting a repair.
- Caution:** Do not drive on a deflated tire as this can cause serious damage.

## Tire Sealant Canister

The tire sealant provided in the Tesla tire repair kit is approved for use with Model S and is designed not to damage the TPMS (Tire Pressure Monitoring System) sensors. Therefore, you must replace it only with one of the same type and capacity (see [Replacing the Sealant Canister](#) on page 102). Tire sealant canisters can be purchased from Tesla.

The tire sealant has an expiration date printed on the outside of the canister. If the expiration date has passed, the sealant might not work as expected. Always replace an expired tire sealant canister.

- Warning:** Do not use any tire sealant other than the one available from Tesla. Doing so could cause tire pressure sensors to malfunction.
- Warning:** Always read and follow the safety and handling instructions printed on the sealant canister.
- Warning:** Keep tire sealant out of the reach of children.
- Warning:** Tire sealant can be harmful if it contacts the eyes or if swallowed or inhaled. If the sealant comes into contact with your eyes, immediately flush with water and seek medical attention if irritation persists. If swallowed, do not induce vomiting and seek medical assistance immediately. If inhaled, breathe fresh air. Inhalation can cause drowsiness and dizziness. If breathing is affected, seek medical assistance immediately.



## Inflating with Sealant and Air

If you have a Tesla tire repair kit, follow these steps to temporarily repair a small tire puncture (less than 1/4" (6 mm)).

1. Stop Model S in a safe place away from traffic and ask passengers to wait in a safe area.
2. Turn on the hazard warning flashers to alert other road users.
3. If possible, position the wheel with the puncture at the bottom.

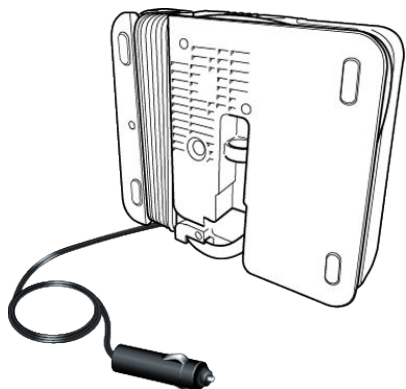

4. Detach the power supply connector from the back of the compressor and plug it into the 12V power socket located on the front of center console.
5. Release the clear plastic hose from the tire compressor.

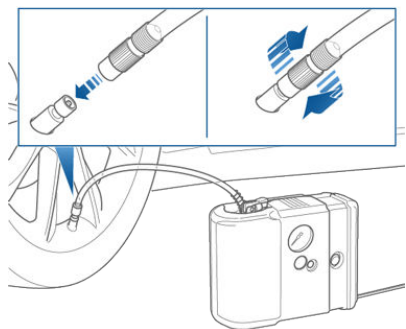

6. Remove the red cap and screw the end of the hose onto the tire's valve.

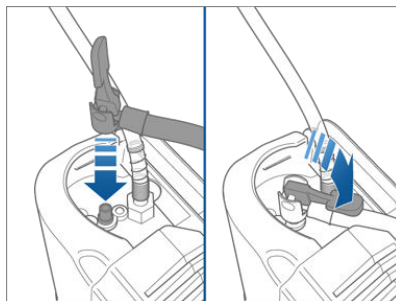

7. Attach the sealant kit's black air hose to the sealant valve and press the lever down to secure it in place.
8. Ensure the compressor is lying on a level surface with the pressure gauge facing to the side as shown in Step 5.
9. Turn on the compressor.
10. Inflate the tire to the recommended pressure.
11. Turn off the compressor and disconnect the hose from the tire's valve. Wipe any excess sealant from the tire valve and wheel rim.
12. Immediately drive for 5 miles (8 km) to distribute the sealant around the tire. Do not exceed 30 mph (48 km/h).
13. Stop and check the tire's pressure. If necessary, inflate using the black air hose.
14. Have the tire repaired or replaced as soon as possible.
15. Replace the tire repair sealant canister (see [Replacing the Sealant Canister](#) on page 102).



## Inflating with Air Only

If you have a Tesla tire repair kit, follow these steps to inflate a tire with air:

1. Detach the power supply connector from the rear of the compressor and plug it into the 12V power socket located in Model S on the front of center console.

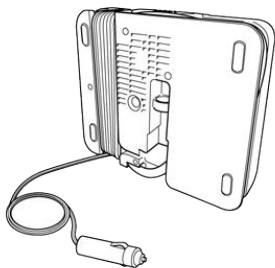

2. Release the black air hose from the compressor.
3. Attach the air hose to the valve and press the lever down to secure it in place.

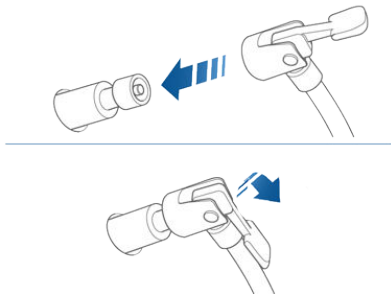

4. Ensure the compressor is lying on a level surface with the pressure gauge facing to the side where you can read it.
5. To add air, turn on the compressor and inflate until the desired pressure is reached.
6. To release air, turn off the compressor, then press and hold the red button until the desired pressure is reached.

**Note:** For your convenience, the tire repair kit includes a selection of adapters that allow you to inflate other items. These adapters are located in a compartment on the back of the compressor.

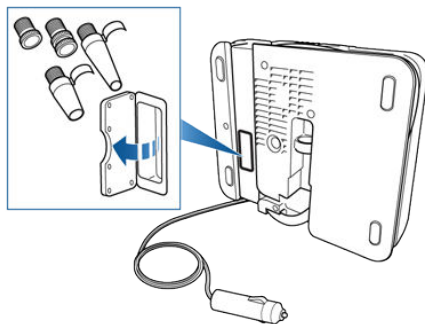

- ⚠ **Caution:** To avoid overheating, do not use the compressor continuously for more than eight minutes. Allow the compressor to cool for 15 minutes between uses.
- ⚠ **Caution:** The compressor runs slowly when overheated from excessive use. Turn it off and allow it to cool.



## Replacing the Sealant Canister

If you have a Tesla tire repair kit, you can purchase additional or replacement canisters of tire sealant from Tesla.

Follow these steps to replace the canister in your Tesla tire repair kit:

1. Unwrap the clear hose from the compressor. This hose is included with the tire repair sealant canister.
2. Remove the canister cover by sliding it upward to release it from the compressor.

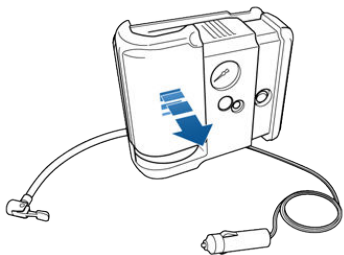

3. Remove the canister.

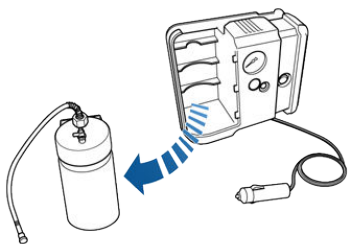

4. Insert the new canister and replace the cover.





## Cleaning the Exterior

To prevent damage to the paint, immediately remove corrosive substances (bird droppings, tree resin, dead insects, tar spots, road salt, industrial fallout, etc). Do not wait until Model S is due for a complete wash. If necessary, use denatured alcohol to remove tar spots and stubborn grease stains, then immediately wash the area with water and a mild, non-detergent soap to remove the alcohol.

Follow these steps when washing the exterior of Model S:

### 1. Rinse Thoroughly

Before washing, flush grime and grit from the bodywork using a hose. Flush away accumulations of mud in areas where debris easily collects (such as wheel arches and panel seams). If salt has been used on the highways (such as during winter months), thoroughly rinse all traces of road salt from the underside of the vehicle.

### 2. Hand Wash

Hand wash Model S using a soft cloth and cold or lukewarm water containing a mild, good quality car shampoo.

### 3. Rinse with Clean Water









After washing, rinse with clean water to prevent soap from drying on the surfaces.

### 4. Dry Thoroughly and Clean Exterior Glass

After washing and rinsing, dry thoroughly with a chamois.

Clean windows and mirrors using an automotive glass cleaner. Do not scrape, or use any abrasive cleaning fluid on glass or mirrored surfaces.

## Cautions for Exterior Cleaning

-  **Caution:** Do not use windshield treatment fluids. Doing so can interfere with wiper friction and cause a chattering sound.
-  **Caution:** Do not use hot water and detergents.
-  **Caution:** In hot weather, do not wash in direct sunlight.
-  **Caution:** If using a pressure washer, maintain a distance of at least 12" (30 cm) between the nozzle and the surface of Model S. Keep the nozzle moving and do not concentrate the water jet on any one area.
-  **Caution:** Do not aim water hoses directly at window, door or hood seals, or through wheel apertures onto brake components.
-  **Caution:** Avoid using tight-napped or rough cloths, such as washing mitts.
-  **Caution:** If washing in an automatic car wash, use Touchless car washes only. These car washes have no parts (brushes, etc.) that touch the surfaces of Model S. Using any other type of car wash could cause damage that is not covered by the warranty.
-  **Caution:** Do not use chemical based wheel cleaners. These can damage the finish on the wheels.
-  **Caution:** Avoid using a high pressure power washer on the rear view camera or parking sensors (if equipped) and do not clean a sensor or camera lens with a sharp or abrasive object that can scratch or damage its surface.



## Cleaning the Interior

Frequently inspect and clean the interior to maintain its appearance and to prevent premature wear. If possible, immediately wipe up spills and remove marks. For general cleaning, wipe interior surfaces using a soft cloth (such as micro fiber) dampened with a mixture of warm water and mild non-detergent cleaner (test all cleaners on a concealed area before use). To avoid streaks, dry immediately with a soft lint-free cloth.

### Interior Glass

Do not scrape, or use any abrasive cleaning fluid on glass or mirrored surfaces. This can damage the reflective surface of the mirror and the heating elements in the rear window.

### Airbags

Do not allow any substance to enter an airbag cover. This could affect correct operation.

### Dashboard and Plastic Surfaces

Do not polish the upper surfaces of the dashboard. Polished surfaces are reflective and could interfere with your driving view.

### Leather Seats

Leather is prone to dye-transfer which can cause discoloration, particularly on light colored leather. White and tan leather is coated with an anti-soiling treatment. Wipe spills as soon as possible using a soft cloth moistened with warm water and non-detergent soap. Wipe gently in a circular motion. Then wipe dry using a soft, lint-free cloth. Using detergents or commercially available leather cleaners and conditioners is not recommended because they can discolor or dry out the leather.

### Cloth Seats

Wipe spills as soon as possible using a soft cloth moistened with warm water and non-detergent soap. Wipe gently in a circular motion. Then wipe dry using a soft, lint-free cloth. Vacuum the seats as needed to remove any loose dirt.

### Carpets

Avoid over-wetting carpets. For heavily soiled areas, use a diluted upholstery cleaner.

## Seat Belts

Extend the belts to wipe. Do not use any type of detergent or chemical cleaning agent. Allow the belts to dry naturally while extended, preferably away from direct sunlight.

### Tesla Built-In Rear Facing Child Seats

Vacuum the seats to remove any loose dirt. Wipe the seats with a soft cloth dampened with warm water. You can also use an upholstery cleaner designed for automotive use. Extend the belts to wipe. Allow the belts to dry naturally, preferably away from direct sunlight.



### Touchscreen and Instrument Panel

Clean the touchscreen and instrument panel using a soft lint-free cloth specifically designed to clean monitors and displays. Do not use cleaners (such as a glass cleaner) and do not use a wet wipe or a dry statically-charged cloth (such as a recently washed microfiber). To wipe the touchscreen without activating buttons and changing settings, you can enter screen cleaning mode. Touch **Controls > Displays > Enter Screen Cleaning**. The display darkens to make it easy to see dust and smudges.

### Chrome and Metal Surfaces

Polish, abrasive cleaners or hard cloths can damage the finish on chrome and metal surfaces.

### Cautions for Interior Cleaning

-  **Warning:** If you notice any damage on an airbag or seat belt, contact Tesla immediately.
-  **Warning:** Do not allow any water, cleaners, or fabric to enter a seat belt mechanism.
-  **Caution:** Using solvents (including alcohol), bleach, citrus, naphtha, or silicone based products or additives on interior components can cause damage.



## Polishing, Touch Up, and Body Repair

To preserve the cosmetic appearance of the body, you can occasionally treat the paint surfaces with an approved polish containing:

- Very mild abrasive to remove surface contamination without removing or damaging the paint.
- Filling compounds that fill scratches and reduce their visibility.
- Wax to provide a protective coating between the paint and environmental elements.

Regularly inspect the exterior paint for damage. Treat minor chips and scratches using a paint touch up pen (available for purchase from Tesla). Use the touch-up pen after washing but before polishing or waxing.

Repair rock chips, fractures or scratches. Body repairs should be performed only by a Tesla approved body repair facility. Contact for a list of approved facilities.

**⚠ Caution:** Do not use cutting pastes, color restoration compounds, or polishes containing harsh abrasives. These can scour the surface and permanently damage the paint.

**⚠ Caution:** Do not use chrome polish or other abrasive cleaners.

## Using a Car Cover

To preserve the cosmetic appearance of the body when Model S is not being used, use a genuine Tesla car cover. Car covers can be purchased from Tesla.

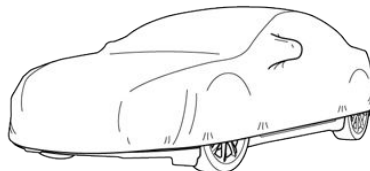

**⚠ Caution:** Use only a Tesla-approved car cover when Model S is plugged in. Using a non-Tesla car cover can prevent the Battery from being adequately cooled during charging.

## Floor Mats

To extend the life of your carpet and make them easier to clean, use genuine Tesla floor mats. Maintain mats by cleaning them regularly and replacing them if they become excessively worn.

**⚠ Warning:** To avoid potential interference with a foot pedal, ensure that the driver's floor mat is securely fastened, and never place an additional floor mat on top of it.



## Checking and Replacing Wiper Blades

To make wiper blades easy to access, turn off the wipers, shift Model S into Park, then use the touchscreen to move them to the service position. Touch **Controls > Settings > Vehicle > Service Mode > ON**.

**Note:** Wipers automatically return to their normal position when you shift Model S out of Park.

Periodically check and clean the edge of the wiper blade and check the rubber for cracks, splits and roughness. If damaged, replace the blade immediately to prevent damage to the glass.

Contaminants on the windshield, or on the wiper blades, can reduce the effectiveness of the wiper blades. Contaminants include ice, wax spray from car washes, washer fluid with bug and/or water repellent, bird droppings, tree sap, and other organic substances.

Follow these guidelines for cleaning:

- Clean the windshield using non-abrasive glass cleaner.
- Wipe the blades clean using isopropyl (rubbing) alcohol or washer fluid.

If the wipers remain ineffective after cleaning, replace the wiper blades.

For optimum performance, wiper blades should be replaced at least once a year.

To replace wiper blades:

1. Turn off the wipers, shift Model S into Park, then use the touchscreen to move the wipers to the service position. Touch **Controls > Settings > Vehicle > Service Mode > ON**.

**Note:** Wipers must be in the OFF position before turning on Service Mode.

2. Lift the wiper arm away from the windshield.
3. Press the locking tab while sliding the blade down the arm.
4. To install the new blade, align the new blade on the wiper arm and slide it toward the hooked end of the arm until it locks into place.
5. Place the wiper arms with the blades against the windshield.

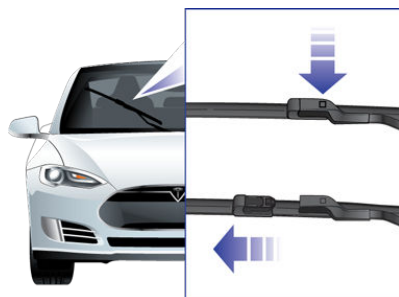

If the problem persists with new blades, clean the windshield and wiper blades using a soft cloth or sponge and warm water with non-detergent soap. Then, rinse the windshield and wiper blades with clean water. The windshield is clean when water beads do not form.

**⚠ Caution:** Only use cleaning products approved for use on automotive glass and rubber. Inappropriate products can cause damage or smears, and create glare on the windshield.

**⚠ Caution:** Only install replacement blades that are identical to the original blades. Using inappropriate blades can damage the wiper system and affect the operation of the rain sensor.



## Cleaning Washer Jets

The position of the windshield washers is set at the factory and should never need adjusting.

If a windshield washer becomes blocked, use a thin strand of wire to clear any blockages from the nozzle.

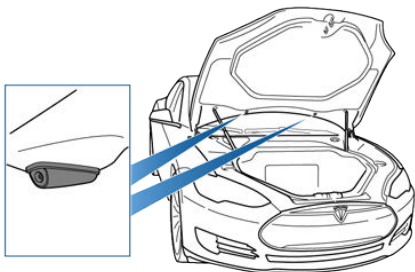

- ⚠ Warning:** Do not operate the washers while cleaning Model S. Windshield washer fluid can irritate eyes and skin. Read and observe the washer fluid manufacturer's instructions.



## Removing the Maintenance Panel

To access fuses and check fluid levels, remove the maintenance panel:

1. Pull the rear edge of the maintenance panel upward to release the five clips that hold the panel in place.
2. Maneuver the maintenance panel toward the windshield to remove.

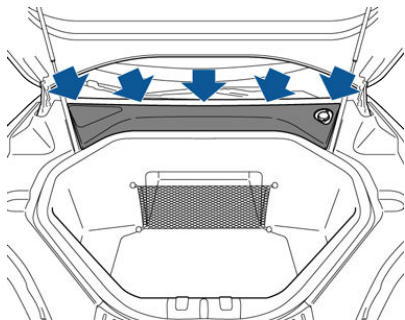

**Caution:** The maintenance panel protects the front trunk from water. When re-attaching, make sure it is fully seated.

## Checking Battery Coolant

If the quantity of fluid in the cooling system drops below the recommended level, the instrument panel displays a warning message. Stop Model S as soon as safety permits and contact Tesla .

### Fluid Level Check

Tesla checks the Battery coolant level at the regularly scheduled maintenance intervals. To check it yourself, park Model S on level ground. When Model S is cool, remove the maintenance panel (see [Removing the Maintenance Panel](#) on page 108).

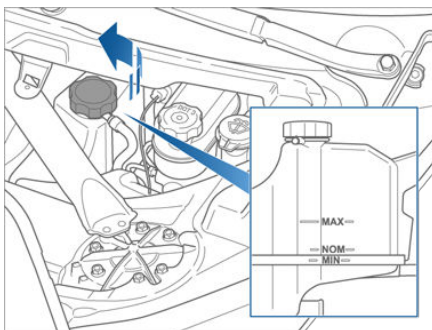

Check the fluid level visually by looking at the outside marks on the side of the reservoir. **DO NOT REMOVE THE FILLER CAP AND DO NOT ADD FLUID.** Doing so can result in damage not covered by the warranty.

The fluid level should be between the **MIN** and the **MAX** marks. If you notice that the fluid level has dropped significantly, contact Tesla before using Model S.

### Topping Up the Battery Coolant

Under no circumstances should you add coolant. If the instrument panel warns you that the fluid level is low, contact Tesla immediately.

To maximize the performance and life of the Battery, the cooling system uses a specific type of G-48 ethylene-glycol coolant (HOAT). Contact Tesla for more specific information about the coolant.



## Checking Brake Fluid

**Warning:** Contact Tesla immediately if you notice increased movement of the brake pedal or a significant loss of brake fluid. Driving under these conditions can result in extended stopping distances or complete brake failure.



The Brake indicator on the instrument panel alerts you if the quantity of fluid in the brake reservoir drops below the recommended level. If it displays while driving, stop as soon as safety permits by gently applying the brakes. Do not continue driving. Contact Tesla immediately for assistance.

### Fluid Level Check

Tesla checks the brake fluid level at the regularly scheduled maintenance intervals. To check it yourself, park Model S on level ground. When Model S is cool, remove the maintenance panel, as described above.

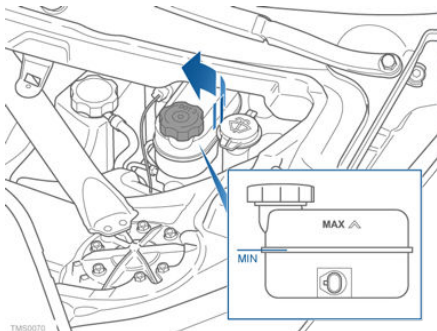

Check the fluid level visually by looking at the outside marks on the side of the reservoir without removing the filler cap.

The brake fluid level should be between the **MIN** and the **MAX** marks.

**Note:** The brake fluid level drops slightly during normal use, as a result of brake pad wear, but should not be allowed to drop below the MIN mark.

### Topping Up the Brake Fluid

Do not top up your brake fluid. Tesla service does this when you bring Model S in for regular servicing. The following instructions

are provided for information purposes and future reference only:

1. Clean the filler cap before removing to prevent dirt from entering the reservoir.
2. Unscrew the cap and remove.
3. Top up the reservoir to the **MAX** mark using brake fluid meeting DOT3 or DOT4 specifications.
4. Replace the filler cap.

**Warning:** Only use new fluid from a sealed air-tight container. Never use previously used fluid or fluid from a previously opened container—fluid absorbs moisture which decreases braking performance.

**Warning:** Brake fluid is highly toxic. Keep containers sealed and out of the reach of children. In the event of accidental consumption, seek medical attention immediately.

**Caution:** Brake fluid damages painted surfaces. Immediately soak up any spills with an absorbent cloth and wash the area with a mixture of car shampoo and water.



## Topping Up Washer Fluid

Model S has only one reservoir into which you can add fluid. This is the washer fluid reservoir under the front trunk. When the level is low, a message displays on the instrument panel. Fill until the fluid level is visible just below the filler neck.

Do not use formulated washer fluids that contain water repellent or bug wash. These fluids can cause streaking, smearing, and squeaking or other noises.

Operate the washers periodically to check that the nozzles are clear and properly directed.

To top up washer fluid:

1. Clean the filler cap before opening to prevent dirt from entering the reservoir.
2. Open the filler cap.

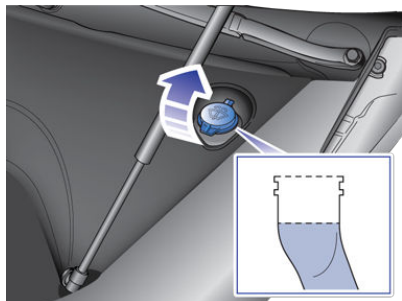

3. Fill the reservoir until the fluid is visible just below the filler neck.
4. Replace the filler cap.

**Note:** Some national or local regulations restrict the use of Volatile Organic Compounds (VOCs). VOCs are commonly used as antifreeze in washer fluid. Use a washer fluid with limited VOC content only if it provides adequate freeze resistance for all climates in which you drive Model S.

**⚠ Caution:** Under no circumstances do you need to inspect or top up other fluid reservoirs. Two additional fluid reservoirs are located next to the washer fluid, but underneath the maintenance panel. In the unlikely event that you see a message on the instrument panel that one of these fluid levels is low, stop Model S as soon as safe to do so, and contact Tesla.

**⚠ Caution:** Do not spill washer fluid on body panels. Doing so can cause damage. Wipe up spills immediately and wash the affected area with water.

**⚠ Warning:** In temperatures below 40°F (4°C), use a washer fluid with antifreeze. In cold weather, using a washer fluid without antifreeze can impair visibility through the windshield.





## Fuse Box Locations

Three fuse boxes are located under the maintenance panel, located in the front trunk. For instructions on how to remove this panel, see [Removing the Maintenance Panel](#) on page 108.

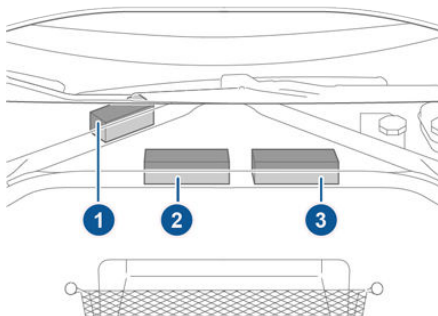

1. Fuse box 1 (see [Fuse Box 1](#) on page 112). DO NOT replace these fuses. If one of them fails, contact Tesla.
2. Fuse box 2. (see [Fuse Box 2](#) on page 114).
3. Fuse box 3 (see [Fuse Box 3](#) on page 116).

If Model S is equipped with the cold weather option, an additional fuse box (4) is located under the driver's side trim panel.

## Replacing a Fuse

To remove a fuse box cover, press the plastic tabs on either side.

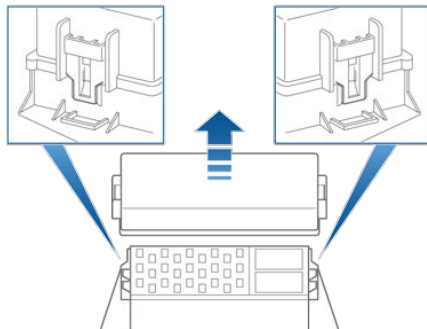

Identify the fuse protecting the affected circuit. Refer to the label on the inside of the fuse box cover or the fuse tables provided in this section.

Pull the fuse to remove it. A break in the wire inside the fuse indicates that the fuse has blown.

**Note:** Do not replace fuses in fuse boxes 1 and 4, and do not remove or replace any relays. If one of these fails, contact Tesla.

**Warning:** Always manually power Model S off before replacing a fuse (see [Powering Off](#) on page 40).

**Caution:** Only use Tesla-approved replacement fuses of the same rating and specification. Using an incorrect fuse can damage the electrical system and result in a fire.

**Caution:** If a replacement fuse blows after installation, contact Tesla to have the electrical system checked.



## Fuse Box 1

**Note:** Access to fuse box 1 requires removal of components that must be performed by a Tesla service technician. The following fuse list is provided only to assist you in determining if a fuse in this box needs to be replaced. Contact Tesla Service if one of these fuses needs to be replaced.

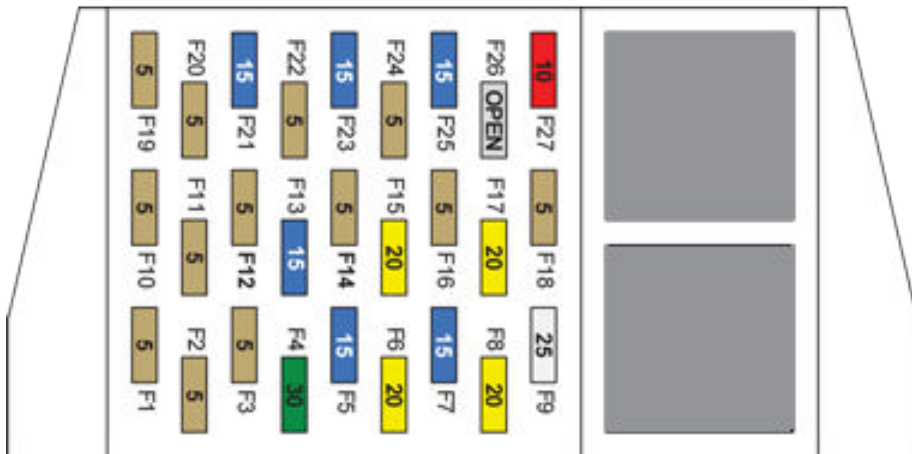

Fuse	Rating	Circuit Protected
1	5 A	Accessory sensor, radio, USB hub
2	5 A	Headlight leveling system (EU/China Coil Suspension vehicles only)
3	5 A	Vanity lights, rear view mirror
4	30 A	Outboard rear seat heaters (cold weather option)
5	15 A	Seat heater (driver's seat)
6	20 A	Base audio amplifier
7	15 A	Seat heater (front passenger seat)
8	20 A	Premium audio amplifier
9	25 A	Sunroof
10	5 A	Passive safety restraints
11	5 A	Steering wheel switches
12	5 A	Sensor for Drive mode and Yaw Rate (Stability/Traction Control)
13	15 A	Wiper park
14	5 A	Drive inverter
15	20 A	Electric parking brake
16	5 A	Parking sensors
17	20 A	Electric parking brake



Fuse	Rating	Circuit Protected
18	5 A	Not used
19	5 A	In-vehicle HVAC sensor
20	5 A	Cabin air heater logic
21	15 A	Coolant pump 1
22	5 A	Inlet actuators
23	15 A	Coolant pump 2
24	5 A	Cabin climate control
25	15 A	Coolant pump 3
26	-	Not used
27	10 A	Thermal controller



## Fuse Box 2

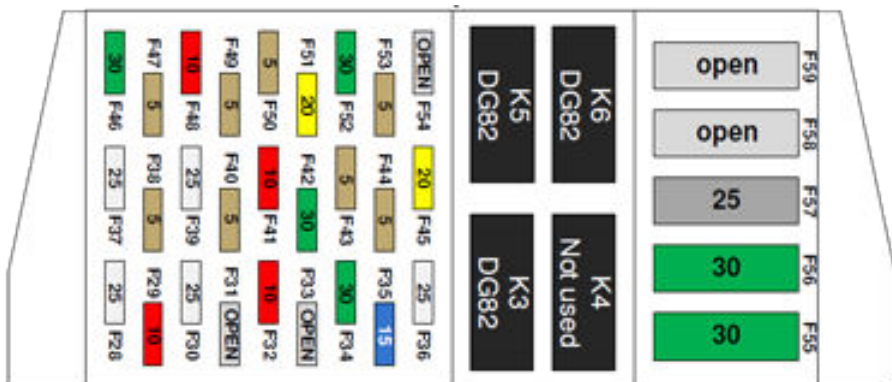

Fuse	Rating	Circuit Protected
28	25 A	Window lift motor (right rear)
29	10 A	Contact power
30	25 A	Window lift motor (right front)
31	-	Not used
32	10 A	Door controls (right side)
33	-	Not used
34	30 A	Rear center seat heaters, washer/wiper de-ice (cold weather option)
35	15 A	12V power socket
36	25 A	Air suspension
37	25 A	Window lift motor (left rear)
38	5 A	Driver's seat memory
39	25 A	Window lift motor (left front)
40	5 A	Rear door handles
41	10 A	Door controls (left side)
42	30 A	Powered liftgate
43	5 A	Perm. power sensor, brake switch
44	5 A	Charger (charge port)
45	20 A	Passive entry (horns)
46	30 A	Body controls (group 2)
47	5 A	Glove box light
48	10 A	Body controls (group 1)



Fuse	Rating	Circuit Protected
49	5 A	Instrument panel
50	5 A	Siren, intrusion/tilt sensor (Europe only)
51	20 A	Touchscreen
52	30 A	Heated rear window
53	5 A	Battery management system
54	-	Not used
55	30 A	Left front electric seat
56	30 A	Right front electric seat
57	25 A	Cabin fan
58	-	Not used
59	-	Not used



## Fuse Box 3

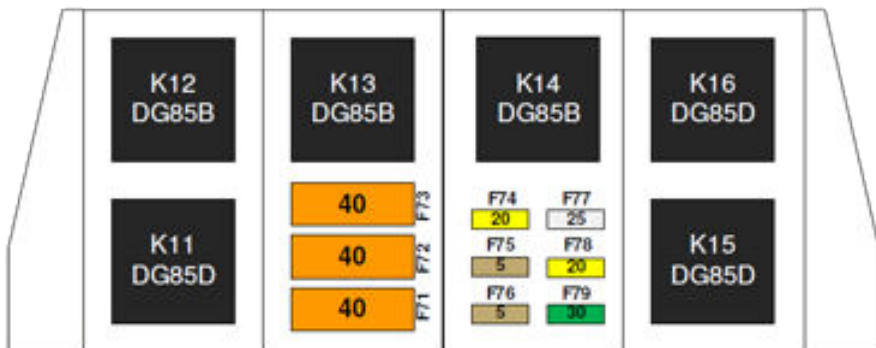

Fuse	Rating	Circuit Protected
71	40 A	Condenser fan (left)
72	40 A	Condenser fan (right)
73	40 A	Vacuum pump
74	20 A	12V drive rail (cabin)
75	5 A	Power steering
76	5 A	ABS
77	25 A	Stability control
78	20 A	Headlights - high/low beam
79	30 A	Light - exterior/interior



## Fuse Box 4

If Model S is equipped with the cold weather option, an additional fuse box (4) is located under the driver's side trim panel. Access to fuse box 4 requires removal of several components that must be performed by a Tesla service technician. The following fuse list is provided only to assist you in determining if a fuse in this box needs to be replaced. Contact Tesla Service if one of these fuses needs to be replaced.

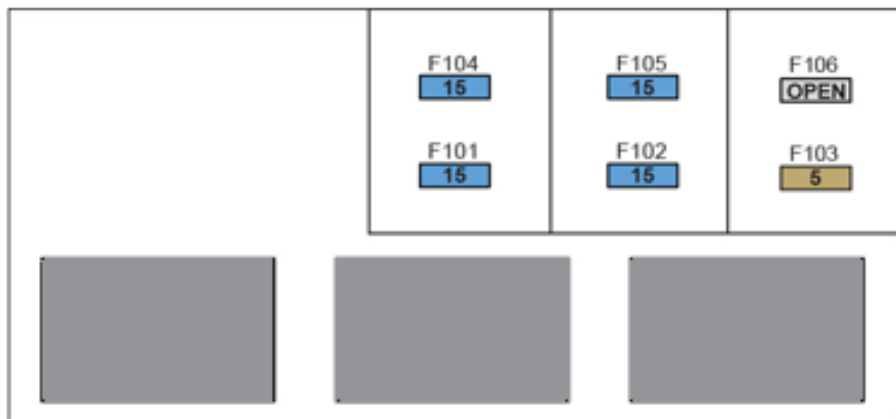

Fuse	Rating	Circuit Protected
101	15 A	Left rear seat heater
102	15 A	Right rear seat heater
103	5 A	Middle rear seat heater control
104	15 A	Middle rear seat heater
105	15 A	Wiper de-icer
106	-	Not used



## Jacking Procedure

Follow the steps below to lift Model S. Ensure that any non-Tesla repair facility is aware of these lifting points.

1. Position Model S centrally between the lift posts.
2. If your Model S is equipped with Smart Air Suspension, it automatically self-levels, even when power is off. Use the touchscreen to set the suspension as follows:
  - Touch **Controls > Driving**.
  - Press the brake pedal, then touch **Very High** to maximize the height of the suspension.
  - Touch **Jack** to disable self-leveling.



When Jack mode is active, Model S displays this indicator light on the instrument panel, along with a message telling you that active suspension is disabled.

3. Position the lift arm pads under the body rails at the locations illustrated. **DO NOT** position the lift arm pads under the Battery.
4. Adjust the height and position of the lift arm pads to ensure they are correctly located.
5. With assistance, raise the lift, ensuring the lift arm pads remain in their correct positions.

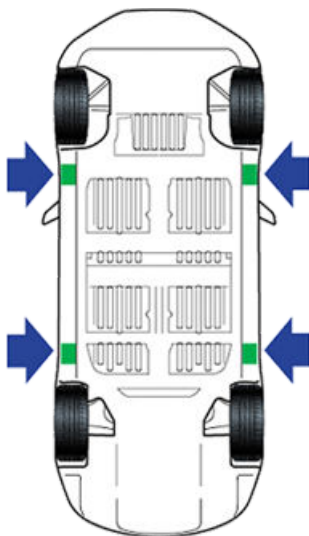

**Note:** Jack mode cancels when Model S is driven over 4.5 mph (7 km/h).

- Warning:** If your Model S is equipped with Smart Air Suspension, it automatically self-levels, even when power is off. You **MUST** disable this system by engaging Jack mode before lifting or jacking. If you do not disable Smart Air Suspension, Model S can attempt to self-level, causing serious damage, bodily injury, or death.
- Warning:** Never raise Model S when the charge cable is connected, even if charging is not in progress.
- Warning:** Do not work on an incorrectly support vehicle. Doing so can cause serious damage, bodily injury, or death.
- Caution:** **DO NOT** lift from under the Battery. Place the lift arm pads under the body rails only. The locations illustrated are the only approved lifting points for Model S. Lifting at any other points can cause damage. Damage caused by lifting Model S is not covered by the warranty.





## Parts, Accessories, and Modifications

Use only genuine Tesla parts and accessories. Tesla performs rigorous testing on parts to ensure their suitability, safety, and reliability. Purchase these parts from Tesla, where they are professionally installed and where you can receive expert advice about modifications to Model S.

Tesla is unable to assess parts manufactured by other distributors and therefore accepts no responsibility if you use non-Tesla parts on Model S.

**⚠ Warning:** Installing non-approved parts and accessories, or performing non-approved modifications, can affect the performance of Model S and the safety of its occupants. Any damage caused by using or installing non-approved parts, or by performing non-approved modifications, is not covered by the warranty.

**⚠ Warning:** Tesla does not accept liability for death, personal injury or damage that occurs if you use or install non-approved accessories or make non-approved modifications.

## Body Repairs

If Model S is in a collision, contact Tesla to ensure that it is repaired with genuine Tesla parts. Tesla has selected collision repair centers that meet strict requirements for training, equipment, quality, and customer satisfaction.

Some repair shops and insurance companies might suggest using non-original equipment or salvaged parts to save money. However, these parts do not meet Tesla's high standards for quality, fit and corrosion resistance. In addition, non-original equipment and salvaged parts (and any damage or failures they might cause) are not covered by the warranty.



## Vehicle Identification Number

You can find the VIN at the following locations:

- The top of the dashboard, stamped on a plate that can be seen by looking through the windshield.
- Stamped on the chassis. Can be seen by removing the maintenance panel (see [Removing the Maintenance Panel](#) on page 108).
- Printed on the vehicle certification label, located on the driver's side door pillar. Visible when the driver's door is open.

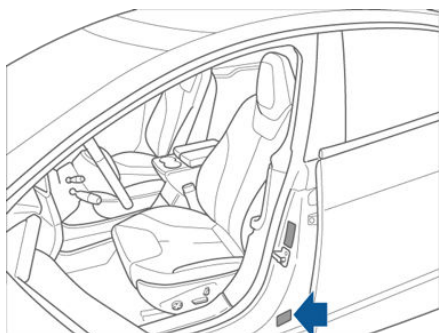

## Emission Control Label

The emission control label is located on the opening face of the liftgate.





## Load Capacity Labeling

It is important to understand how much weight your Model S can safely carry. This weight is called the vehicle capacity weight and includes the weight of all occupants, cargo and any additional equipment added to your Model S since it was manufactured.

There are two labels attached to Model S that state how much weight it can safely carry. These labels are located on the center door post and are visible when the driver's door is open:

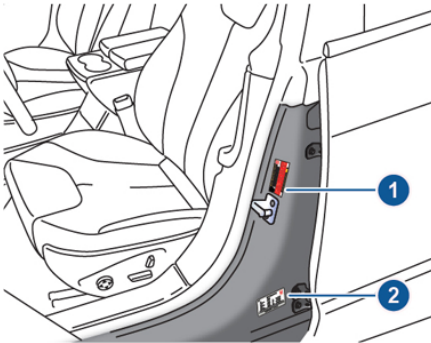

1. Tire and Loading Information label
2. Vehicle Certification label

**Warning:** Overloading Model S has an adverse effect on braking and handling, which can compromise your safety or damage Model S.

**Caution:** Never load more than 300 lbs (136 kg) in the front trunk. Doing so can cause damage.

**Caution:** Never store large amounts of liquid in Model S. Significant spillage of liquids can cause electrical components to malfunction.

## Tire and Loading Information Label

The Tire and Loading Information label provides:

- The maximum number of occupant seating positions.
- The maximum vehicle capacity weight.
- The size of the original tires.
- The cold inflation pressures for the original front and rear tires. These pressures are recommended to optimize ride and handling characteristics.

United States:

**TIRE AND LOADING INFORMATION**

SEATING CAPACITY - TOTAL 5 FRONT 2 REAR 3

THE COMBINED WEIGHT OF OCCUPANTS AND CARGO SHOULD NEVER EXCEED XXXX KG OR XXXXX LBS

TIRE	FRONT	REAR	SPARE
ORIGINAL TIRE SIZE	PXXX/RXX	PXXX/XXXXX	NONE
COLD TIRE INFLATION PRESSURE	XXX KPa, XX psi	XXX KPa, XX psi	NONE

SEE OWNER'S MANUAL FOR ADDITIONAL INFORMATION

Canada:

**TIRE AND LOADING INFORMATION**  
**RENSEIGNEMENTS SUR LES PNEUS ET LE CHARGEMENT**

SEATING CAPACITY/NOMBRE DE PLACES - TOTAL 5 FRONT/AVANT 2 REAR/ARRIÈRE 3

THE COMBINED WEIGHT OF OCCUPANTS AND CARGO SHOULD NEVER EXCEED  
LE POIDS TOTAL DES OCCUPANTS ET DU CHARGEMENT NE DOIT JAMAIS DÉPASSER

TIRE/PNEU	FRONT/AVANT	REAR/ARRIÈRE	SPARE/DE SECOURS
ORIGINAL TIRE SIZE/ TAILLE DES PNEUS D'ORIGINE	dépend de son véhicule model/	dépend de son véhicule model/	NONE/AUCUN
COLD TIRE PRESSURE/ PRESSION DES PNEUS À FROID	dépend de son véhicule model/	dépend de son véhicule model/	NONE/AUCUN

SEE OWNER'S MANUAL FOR ADDITIONAL INFORMATION. VOIR LE MANUEL DE L'USAGER POUR PLUS DE RENSEIGNEMENTS.

Never change this label, even if you use different tires in the future.

**Note:** If Model S is loaded to its full capacity, double check all tires to ensure they are inflated to their recommended pressure levels.



## Vehicle Certification Label

The Vehicle Certification Label provides:

- GVWR - Gross Vehicle Weight Rating. The maximum allowable total mass of Model S. This is calculated as the weight of Model S, all passengers, fluids, and cargo.
- GAWR FRT and GAWR RR - Gross Axle Weight Rating for the front and rear axles. The GAWR is the maximum distributed weight that each axle can support.

United States:

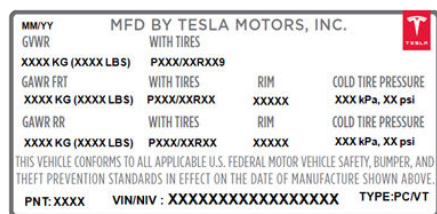

Canada:



- ⚠ **Caution:** To prevent damage, never load Model S so that it is heavier than GVWR or exceeds the individual GAWR weights.

## Calculating Load Limits

1. Locate the statement “The combined weight of occupants and cargo should never exceed XXX kg or XXX lbs” on your vehicle’s “Tire and Loading Information” label.
2. Determine the combined weight of the driver and passengers that will be riding in the vehicle.
3. Subtract the combined weight of the driver and passengers from XXX kg or XXX lbs (see Step 1).
4. The resulting figure equals the available amount of cargo and luggage load capacity. For example, if the “XXX” amount equals 1400 lbs (635 kg) and there will be five 150 lb (68 kg) passengers in the vehicle, the amount of

available cargo and luggage capacity is 650 lbs (1400 - 750 (5 x 150) = 650 lbs) or 295 kg (635 - 340 (5 x 68) = 295 kg).

5. Determine the combined weight of cargo and luggage being loaded on the vehicle. That weight must not exceed the available cargo and luggage load capacity calculated in Step 4.

- ⚠ **Warning:** The front and rear trunks are the preferred places to carry objects. In an accident, or during hard braking and sharp turns, loose items in the cabin could injure occupants.

## Example Load Limit Calculations

How much cargo you can carry in Model S depends on the number and weight of passengers. The following are typical examples of calculated load limits. These examples assume passengers weighing 150 lbs (68 kg). If the passengers weigh more or less, the available cargo and luggage load capacity decreases or increases respectively.

### Example 1: Driver and one passenger

Description	Total
Vehicle capacity weight	954 lbs (433 kg)
Subtract occupant weight (2 x 150 lbs/68 kg)	300 lbs (136 kg)
Available cargo weight	654 lbs (297 kg)

### Example 2: Driver and four passengers

Description	Total
Vehicle capacity weight	954 lbs (433 kg)
Subtract occupant weight (5 x 150 lbs/68 kg)	750 lbs (340 kg)
Available cargo weight	204 lbs (93 kg)

The available cargo or luggage weight should then be distributed between the front and rear trunks.

- ⚠ **Caution:** Do not exceed the maximum front trunk load weight of 300 lbs (136 kg).



## Towing a Trailer

-  **Warning:** Do not tow a trailer. Model S does not support a trailer hitch. Installing one could damage Model S and increase the risk of an accident.



## Exterior Dimensions

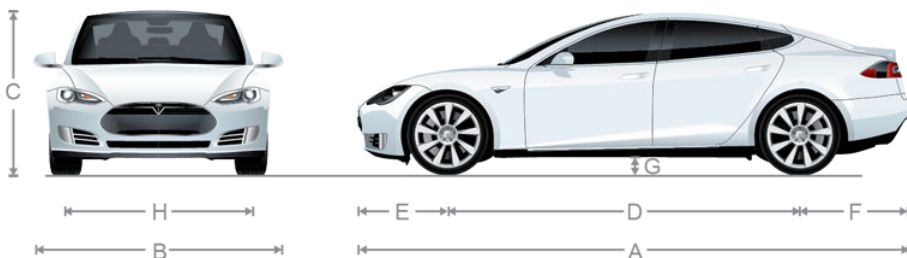

A	Overall Length	196 in	4,970 mm
B	Overall Width (including mirrors)	86.2 in	2,189 mm
	Overall Width (excluding mirrors)	77.3 in	1,963 mm
C	Overall Height	56.5 in	1,427 mm
D	Wheel Base	116.5 in	2,960 mm
E	Overhang - Front	37 in	929 mm
F	Overhang - Rear	42.5 in	1080 mm
G	Ground Clearance	6 in	155 mm
H	Track - Front	65.4 in	1,661 mm
	Track - Rear	66.9 in	1,699 mm

## Weights

Curb Weight* (85 kWh Battery)	4,630 lbs	2,100 kg
Curb Weight* (60 kWh Battery)	4,407 lbs	1,999 kg
Gross Vehicle Weight Rating	5,710 lbs	2,590 kg
Gross Vehicle Weight Distribution - 19" wheels	Front: 2,425 lbs (1,100 kg)	Rear: 3,285 lbs (1,490 kg)
Gross Vehicle Weight Distribution - 21" wheels	Front: 2,612 lbs (1,185 kg)	Rear: 3,097 lbs (1,405 kg)
Gross Axle Weight Rating- Front	2,813 lbs	1,276 kg
Gross Axle Weight Rating- Front (Performance Plus models)	2,723 lbs	1,235 kg
Gross Axle Weight Rating - Rear: 19" wheels	3,307 lbs	1,500 kg
Gross Axle Weight Rating - Rear: 21" wheels	3,131 lbs	1,420 kg
Trailer Towing	Not permissible	
*Curb Weight = weight of the vehicle with correct fluid levels, no occupants and no cargo		



## Motor

Type	AC induction motor, liquid-cooled, with variable frequency drive
Rating	375 Volts
Maximum Speed	16000 rpm

## Transmission

Type	Single speed fixed gear
Overall Final Drive Ratio	9.73:1
Reverse Gear	Reverse direction of motor, limited to 24 km/h

## Steering

Type	Rack and pinion with electronic power steering Variable ratio and speed sensitive
Number of turns lock to lock	2.45
Turning Circle (curb to curb)	11.3 metres



## Brakes

Type	4-wheel anti-lock braking system (ABS) with Electronic Brake Force Distribution, Integrated Advanced Stability Control and Electronic Accelerator pedal actuated regenerative braking system
Calipers	Four piston fixed
Rotor Diameters (ventilated)	Front: 13.98"/355 mm Rear: 14.37"/365 mm
Front Rotor thickness	New: 1.26"/32 mm Service limit: 1.18"/30 mm
Rear Rotor thickness	New: 1.10"/28 mm Service limit: 1.02"/26 mm
Front Brake Pad Thickness (excluding back plate)	New: 0.354"/9.0 mm Service limit: 0.078"/2 mm
Rear Brake Pad Thickness (excluding back plate)	New: 0.315"/8.0 mm Service limit: 0.078"/2 mm
Electronic Parking Brake (EPB) Pad Thickness (excluding back plate). Electronic calipers self-adjust for pad wear.	New: 0.216"/5.5 mm Service limit: 0.039"/1 mm
Parking brake	Electrically actuated parking brake calipers

## Suspension

Front	Independent, double wishbone, air spring or coil spring/telescopic damper, sway bar
Rear	Independent, multi-link, air spring or coil spring/telescopic damper, sway bar (air suspension vehicles only)
For alignment values, see <a href="#">Wheel Alignment Values</a> on page 128.	

## Battery - 12V

Rating	33 amp-hr or higher
Voltage and Polarity	12V negative (-) ground





## Battery - High Voltage

Type	Liquid-cooled lithium ion (Li-ion)
Rating	60 or 85 kWh (at beginning of life)
Voltage and Polarity	366V DC negative (-) ground
Temperature Range	Do not expose Model S to ambient temperatures above 140° F (60° C) or below -22° F (-30° C) for more than 24 hours at a time.



## Wheel Specifications

Wheel Type	Location	Size	Offset
19"	Front	8.0J x 19	1.575" 40 mm
	Rear	8.0J x 19	1.575" 40 mm
21" - Silver (standard)	Front	8.5J x 21	1.575" 40 mm
21" - Grey (standard)	Rear	8.5J x 21	1.575" 40 mm
21" - Silver and Grey (optional) Performance Plus vehicles	Rear	9.0J x 21	1.575" 40 mm

Road Wheel Nut Torque	129 lb. ft (175 Nm)
Requirements for dynamic wheel balance	.49 ounces (14 grams)
<b>Note:</b> For instructions on how to jack/lift Model S, see <a href="#">Jacking and Lifting</a> on page 118.	

## Wheel Alignment Values

Location	Air Suspension		Coil Suspension	
	Front	Rear	Front	Rear
Camber	-0.75 +/- 0.35	-1.75 +/- 0.35	-.53 +/- 0.35	-1.55 +/- 0.35
Camber Split	-0.00 +/- 0.20	-0.00 +/- 0.50	-0.00 +/- 0.20	-0.00 +/- 0.50
Caster	4.00 +/- 0.50	n/a	3.70 +/- 0.50	n/a
Caster Split	0.00 +/- 0.20	n/a	0.00 +/- 0.20	n/a
Single Wheel Toe	OUT 0.05 OUT 0.15 (limit) IN 0.05 (limit)	IN 0.20 +/- 0.05	IN 0.02 OUT 0.08 (limit) IN 0.12 (limit)	IN 0.185 +/- 0.05
Thrust Angle	n/a	0.00 +/- 0.30	n/a	0.00 +/- 0.30
Suspension Bolt Height (at design)	213.5 +/- 5 mm	Standard models: 144 +/- 5 mm Performance Plus: 151 +/- 5 mm	230 mm (nominal)	158 mm (nominal)



## Tire Specifications

Tire Type	Location	Size
19" wheels (85 kWh vehicles): Michelin	All	P245/45R19
19" wheels (60 kWh vehicles): Standard - Goodyear Optional - Michelin	All	P245/45R19
21" wheels: Continental	All	P245/35R21
21" wheels on Performance Plus vehicles: Michelin	Front Rear	P245/35R21 P265/35R21
Tire pressures vary depending on the type of tires fitted on Model S. Refer to the tire pressures printed on the Tire and Loading Information label. This label is located on the driver's door pillar and is visible when the driver's door is open (see <a href="#">Maintaining Tire Pressures</a> on page 94).		
Winter tires (Pirelli P245/45R19) can be purchased from a Tesla store.		



## Understanding Tire Markings

Laws require tire manufacturers to place standardized information on the sidewall of all tires. This information identifies and describes the fundamental characteristics of the tire. It also provides the tire identification number (TIN) for safety standard certification and in case of a recall.





1	Tire category. P indicates that the tire is for passenger vehicles.
2	Tire width. This 3-digit number is the width (in millimeters) of the tire from sidewall edge to sidewall edge.
3	Aspect ratio. This 2-digit number is the sidewall height as a percentage of the tread width. So, if the tread width is 205 mm, and the aspect ratio is 50, the sidewall height is 102 mm.
4	Tire construction. R indicates that the tire is of Radial ply construction.
5	Wheel diameter. This 2-digit number is the diameter of the wheel rim in inches.
6	Load index. This 2 or 3-digit number is the weight each tire can support. This number is not always shown.
7	Speed rating. When stated, indicates the maximum speed (in mph) at which the tire can be used for extended periods. Q=99 mph (160 km/h), R=106 mph (170 km/h), S=112 mph (180 km/h), T=118 mph (190 km/h), U=124 mph (200 km/h), H=130 mph (210 km/h), V=149 mph (240 km/h), W=168 mph (270 km/h), Y=186 mph (300 km/h).
8	Tire composition and materials. The number of plies in both the tread area and the sidewall area indicates how many layers of rubber coated material make up the structure of the tire. Information is also provided on the type of materials used.
9	Maximum tire load. The maximum load which can be carried by the tire.
10	Maximum permissible inflation pressure. This pressure should not be used for normal driving.
11	U.S. DOT Tire Identification Number (TIN). Begins with the letters DOT and indicates that the tire meets all federal standards. The next 2 digits/letters represent the plant code where it was manufactured, and the last 4 digits represent the week and year of manufacture. For example, the number 1712 is used to represent the 17th week of 2012. The other numbers are marketing codes used at the manufacturer's discretion. This information can be used to contact consumers if a tire defect requires a recall.
12	Treadwear grade. This number indicates the tire's wear rate. The higher the treadwear number is, the longer it should take for the tread to wear down. A tire rated at 400, for example, lasts twice as long as a tire rated at 200.
13	Traction grade. Indicates a tire's ability to stop on wet roads. A higher graded tire should allow you to stop your vehicle in a shorter distance than a tire with a lower grade. Traction is graded from highest to lowest as AA, A, B, and C.
14	Temperature grade. The tire's resistance to heat is grade A, B, or C, with A indicating the greatest resistance. This grading is provided for a correctly inflated tire, which is being used within its speed and loading limits.



## Uniform Tire Quality Grading

The following information relates to the tire grading system developed by the National Highway Traffic Safety Administration (NHTSA), which grades tires by tread wear, traction and temperature performance. Tires that have deep tread, and winter tires, are exempt from these marking requirements.

Where applicable, quality grades are found on the tire's sidewall between the tread shoulder and maximum section width. For example:

TREADWEAR R 180	TRACTION AA	TEMPERATURE RE A
--------------------	----------------	---------------------

In addition to the marking requirements, passenger car tires must conform to Federal Safety Requirements.

### Treadwear

The treadwear grade is a comparative rating based on the wear rate of the tire when tested under controlled conditions on a specified government test course.

For example, a tire graded 150 wears one and a half times better on a government test course than a tire graded 100. The relative performance of tires depends on the actual conditions of their use, however, and can depart significantly from the norm due to variations in driving habits, service practices, road characteristics, and climate.

### Traction

The traction grades, from highest to lowest, are: AA, A, B, and C. These grades represent a tire's ability to stop on wet pavement as measured under controlled conditions on test surfaces of asphalt and concrete. A tire marked C might have poor traction performance.

**Warning:** Defective tires are dangerous. Do not drive if a tire is damaged, excessively worn, or is inflated to an incorrect pressure. The safety of the vehicle and occupants can be adversely affected. Check tires regularly for wear and to ensure there are no cuts, bulges or exposure of the ply/cord structure.

**Warning:** The traction grade assigned to the tire is based on straight-ahead braking tests, and doesn't include: acceleration, cornering, hydroplaning or peak traction characteristics.

### Temperature

The temperature grades are A (the highest), B, and C, representing the tire's resistance to the generation of heat and its ability to dissipate heat when tested under controlled conditions on a specified indoor laboratory test wheel. Sustained high temperature can cause the tire to degenerate and reduce tire life, and excessive temperature can lead to sudden tire failure.

The grade C corresponds to the minimum level of performance that all passenger car tires must meet under the Federal Motor Safety Standard No. 109. Grades B and A represent levels of performance on the laboratory test wheel that exceed the minimum requirements.

**Warning:** A tire's temperature grade is established for a tire that is properly inflated and not overloaded. Excessive speed, under-inflation, or excessive loading, either separately or in combination, can cause heat buildup and possible tire failure.



## Wheels and Tires Glossary

Accessory Weight	The combined weight (in excess of those items replaced) of items available as factory installed equipment.
Bead	The inner edge of a tire that is shaped to fit to the rim and form an air tight seal. The bead is constructed of steel wires which are wrapped, or reinforced, by the ply cords.
Cold Tire Pressure	The air pressure in a tire that has been standing in excess of three hours, or driven for less than one mile.
Curb Weight	The weight of a standard vehicle, including any optional equipment fitted, and with the correct fluid levels.
Gross Vehicle Weight	The maximum permissible weight of a vehicle with driver, passengers, load, luggage, and equipment.
kPa (kilo pascal)	A metric unit used to measure pressure. One kilo pascal equals approximately 0.145 psi.
Maximum Inflation Pressure	The maximum pressure to which the tire should be inflated. This pressure is given on the tire side wall in psi (lbf/in). <b>⚠ Caution:</b> This pressure marked on the tire is the maximum allowed by the tire manufacturer. It is not the pressure Tesla recommends using for Model S.
Maximum Loaded Vehicle Weight	The sum of curb weight, accessory weight, vehicle capacity weight, and production options weight.
Production Options Weight	The combined weight of options installed which weigh in excess of 3 lb more than the standard items that they replaced, and are not already considered in curb or accessory weights.
PSI (lbf/in)	Pounds per square inch (the unit used to measure tire pressure).
Recommended Tire Inflation Pressure	Tire inflation pressure, established by Tesla, which is based on the type of tires that are mounted on the vehicle at the factory. This information can be found on the Tire and Loading Information label located on the door pillar.
Rim	The metal support for a tire, or tire and tube, upon which the tire beads are seated.
Vehicle Capacity Weight	The number of seats multiplied by 150 lbs plus the rated amount of load/luggage.



## Contacting Roadside Assistance

Tesla Roadside Assistance is available to you, 24 hours a day, 365 days a year, throughout the United States and Canada for the duration of your warranty period.

To contact Roadside Assistance, call:

**1-877-79TESLA (1-877-798-3752)**

Advise the representative of the vehicle identification number (VIN), license plate number, mileage, your location, and the nature of the problem. The VIN is on the upper dashboard on the driver's side of your vehicle and is visible through the windshield.

Roadside Assistance covers transportation of Model S for up to 50 miles in the event of a flat tire. However, owners are responsible for transportation expenses if the Battery is over-discharged. For a complete description of the terms and conditions of the Tesla Roadside Assistance Program, refer to the policy that was provided to you by Tesla when you purchased Model S.

It is your responsibility to provide vehicle transporters with instructions on how to transport Model S (see [Instructions for Transporters](#) on page 135).





## Use a Flatbed Only

Use a flatbed trailer only, unless otherwise specified by Tesla. Do not transport Model S with the tires directly on the ground.



**⚠ Caution:** Damage caused by transporting is not covered by the warranty.

**⚠ Caution:** To transport Model S, follow the instructions exactly as described next.

## Disable Self-Leveling (air suspension vehicles only)

If Model S is equipped with Smart Air Suspension, it automatically self-levels, even when power is off. To prevent damage, you must activate Jack mode to disable self-leveling:

1. Touch **Controls > Driving** on the bottom left of the touchscreen.
2. Press the brake pedal, then touch **Very High** to maximize height.
3. Touch **Jack**.



When Jack mode is active, Model S displays this indicator light on the instrument panel, along with a message telling you that active suspension is disabled.

**Note:** Jack mode cancels when Model S is driven over 4.5 mph (7 km/h).

**⚠ Warning:** Failure to activate Jack mode on a Model S equipped with Smart Air Suspension can result in the vehicle becoming loose during transport, which may cause significant damage.

## Activate Tow Mode

Model S may automatically shift into Park when it detects the driver leaving the vehicle, even if it has previously been shifted into Neutral. To keep Model S in Neutral (which disengages the parking brake), you must use the touchscreen to activate Tow mode:

1. Shift into Park.
2. Press the brake pedal, then on the touchscreen, touch **Controls > E-Brake & Power Off > Tow Mode**.



When Tow mode is active, Model S displays this indicator light on the instrument panel, along with a message telling you that Model S is free-rolling.

**Note:** Tow mode cancels when Model S is shifted into Park.

**⚠ Caution:** If the electrical system is not working, and you therefore cannot release the electric parking brake, attempt to quick start the 12V battery. For instructions, call Tesla. If a situation occurs where you cannot disengage the parking brake, use tire skids or transport Model S for the shortest possible distance using wheeled dollies. Before doing so, always check the dolly manufacturer's specifications and recommended load capacity.



## Connect the Tow Chain

The method used to connect the tow chain depends on whether Model S is equipped with a towing eye (located in the front trunk).

**If not equipped with a towing eye:**

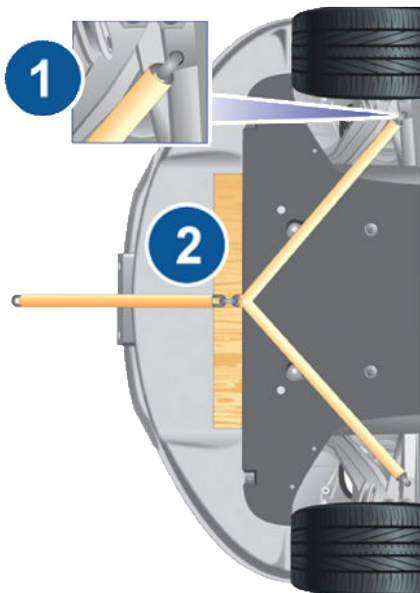

1. Connect the tow chains to the large hole on each of the rearmost lower suspension arms.
2. To protect the underbody from any damage that could be caused by the tow chains, place a 2" x 4" piece of wood between the tow chains and the underbody.

**⚠ Caution:** Before pulling, position the wood between the tow chain and the underbody to ensure the underbody is protected from any damage that could be caused by the tow chain.

**If equipped with a towing eye:**

1. Remove the nose cone.

Insert a plastic pry tool into the top right corner, and gently pry the nose cone toward you. When the clip releases, pull the nose cone toward you, without twisting or bending, to release the three remaining clips.

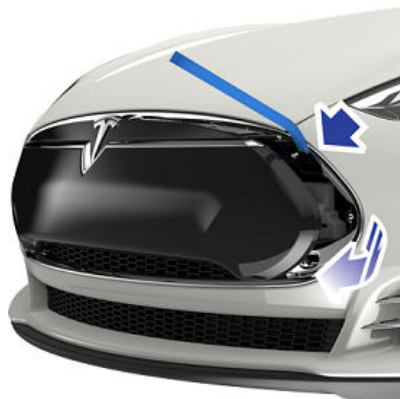

2. Insert the towing eye.

Fully insert the towing eye (found in the front trunk) into the opening on the right side, then turn it counter-clockwise until securely fastened.



3. Attach the tow chain to the towing eye.

**⚠ Caution:** Before pulling, make sure the towing eye is securely tightened.



## Pull Onto the Trailer and Secure the Wheels

Secure wheels using chocks and tie-down straps:

- Ensure any metal parts on the tie-down straps do not contact painted surfaces or the face of the wheels.
- Do not place straps over body panels or through the wheels.



**⚠ Caution:** Attaching straps to the chassis, suspension or other parts of the vehicle's body may cause damage.

**⚠ Caution:** To prevent damage, do not transport Model S with the tires directly on the ground.



## Vehicle Telematics/Data Recorders

This vehicle is equipped with electronic modules that monitor and record data from various vehicle systems, including the motor, Battery, braking and electrical systems. The electronic modules record information about various driving and vehicle conditions, including braking, acceleration, trip and other related information regarding your vehicle. These modules also record information about the vehicle's features such as charging events and status, the enabling/disabling of various systems, diagnostic trouble codes, VIN, speed, direction and location.

The data is stored by the vehicle and may be accessed, used and stored by Tesla service technicians during vehicle servicing or periodically transmitted to Tesla wirelessly through the vehicle's telematics system. This data may be used by Tesla for various purposes, including, but not limited to: providing you with Tesla telematics services; troubleshooting; evaluation of your vehicle's quality, functionality and performance; analysis and research by Tesla and its partners for the improvement and design of our vehicles and systems; and as otherwise may be required by law. In servicing your vehicle, we can potentially resolve issues remotely simply by reviewing your vehicle's data log.

Tesla's telematics system wirelessly transmits vehicle information to Tesla on a periodic basis. The data is used as described above and helps ensure the proper maintenance of your vehicle. Additional Model S features may use your vehicle's telematics system and the information provided, including features such as charging reminders, software updates, and remote access to, and control of, various systems of your vehicle.

Tesla does not disclose the data recorded in your vehicle to any third party except when:

- An agreement or consent from the vehicle's owner (or the leasing company for a leased vehicle) is obtained.
- Officially requested by the police or other authorities.
- Used as a defense for Tesla in a lawsuit.
- Ordered by a court of law.
- Used for research purposes without disclosing details of the vehicle owner or identification information.
- Disclosed to a Tesla affiliated company, including their successors or assigns, or our information systems and data management providers.

In addition, Tesla does not disclose the data recorded to an owner unless it pertains to a non-warranty repair service and in this case, will disclose only the data that is related to the repair.

## Quality Control

You might notice a few miles/km on the odometer when you take delivery of your Model S. This is a result of a comprehensive testing process that ensures the quality of your Model S.

The testing process includes extensive inspections during and after production. The final inspection takes place at Tesla Motors and includes a road test conducted by a technician.

## About this Owner Information

The illustrations provided are for demonstration purposes only. Depending on vehicle options, software versions, region of purchase, and specific vehicle settings, your Model S may appear slightly different. All specifications and descriptions are known to be accurate at time of publishing. However, because continuous improvement is a goal at Tesla, we reserve the right to make product modifications at any time. To communicate any inaccuracies or omissions, or to provide general feedback or suggestions regarding the quality of this owner information, send an email to [ownersmanualfeedback@teslamotors.com](mailto:ownersmanualfeedback@teslamotors.com).

## Document Applicability

This owner information is updated on a regular basis to reflect updates to your Model S. However, in some cases, recently released features may not be described. To display information about recently released features, view the Release Notes on the Model S touchscreen. Release Notes are displayed on the touchscreen after a software update, and can be displayed at any time by touching the Tesla "T" at the top center of the touchscreen, then touching the Release Notes link. If information related to how to use the Model S touchscreen conflicts with information in the Release Notes, the Release Notes take precedence.

## Copyrights and Trademarks

All information in this document and all Model S software is subject to copyright and





other intellectual property rights of Tesla Motors, Inc. and its licensors. This material may not be modified, reproduced or copied, in whole or in part, without the prior written permission of Tesla Motors, Inc. and its licensors. Additional information is available upon request. The following are trademarks or registered trademarks of Tesla Motors, Inc. in the United States and other countries:

- TESLA
- TESLA MOTORS
- TESLA ROADSTER
- 
- 
- 
- 
- 
- Model S
- MODEL X

All other trademarks contained in this document are the property of their respective owners and their use herein does not imply sponsorship or endorsement of their products or services. The unauthorized use of any trademark displayed in this document or on the vehicle is strictly prohibited.

## California Proposition 65

-  **Warning:** Certain vehicle components contain or emit chemicals known to the State of California to cause cancer and birth defects or other reproductive harm. In addition, certain fluids contained in vehicles and certain products of component wear contain or emit chemicals known to the State of California to cause cancer and birth defects or other reproductive harm.
-  **Warning:** Certain components of this vehicle such as airbag modules and seat belt pre-tensioners may contain Perchlorate Material. Special handling may be required for service or vehicle end of life disposal. See <http://www.dtsc.ca.gov/hazardouswaste/perchlorate>.

[www.dtsc.ca.gov/hazardouswaste/perchlorate](http://www.dtsc.ca.gov/hazardouswaste/perchlorate).

-  **Warning:** Battery posts, terminals, and related accessories contain lead and lead compounds. Wash hands after handling.



## Contacting Tesla

For detailed information about your Model S, go to [www.teslamotors.com](http://www.teslamotors.com), click the MY TESLA link, then enter your login credentials (or sign up to get these credentials).

If you have any questions or concerns about your Model S, call 1-877-79TESLA (1-877-798-3752).

## Reporting Safety Defects - US

If you believe that Model S has a defect which could cause a crash or could cause injury or death, you should immediately inform the National Highway Traffic Safety Administration (NHTSA) in addition to notifying Tesla Motors.

If NHTSA receives similar complaints, it may open an investigation. If it finds that a safety defect exists in a group of vehicles, it may order a recall and remedy campaign. However, NHTSA cannot become involved in individual problems between you, your dealer, or Tesla Motors.

To contact NHTSA, you may call the Vehicle Safety Hotline toll-free at 1-888-327-4236 (TTY: 1-800-424-9153); go to <http://www.safercar.gov>; or write to: Administrator, National Highway Traffic Safety, 1200 New Jersey Avenue SE., Washington, DC 20590. You can also obtain other information about motor vehicle safety from <http://www.safercar.gov>.

## Reporting Safety Defects - Canada

If you believe that your Model S has a defect which could cause a crash or could cause injury or death, you should immediately inform Transport Canada, in addition to notifying Tesla. To contact Transport Canada, call their toll-free number: 1-800-333-0510.



## Key and Passive Unlocking System

### FCC Certification

This device complies with Part 15 of the FCC rules. Operation is subject to the following two conditions:

1. This device may not cause harmful interference, and
2. This device must accept any interference received, including interference that may cause undesired operation.

Changes or modifications not expressly approved by Tesla could void the user's authority to operate the equipment.

### IC Certification

#### IC: 10176A-002 Model: 002

This device complies with Industry Canada licence-exempt RSS standard(s). Operation is subject to the following two conditions:

1. This device may not cause harmful interference, and
2. This device must accept any interference received, including interference that may cause undesired operation.

## Tire Pressure Monitoring System

The tire pressure monitoring system (TPMS) complies with Part 15 of the FCC rules and RSS-210 of Industry Canada. Operation is subject to the following two conditions:

1. This device may not cause harmful interference, and
2. This device must accept any interference received, including interference that may cause undesired operation.

Changes or modifications not expressly approved by Tesla could void the user's authority to operate the equipment.

## HomeLink

This device complies with Part 15 of the FCC rules and IC-RSS-210 Industry Canada. Operation is subject to the following conditions:

- This device may not cause harmful interference.
- This device must accept any interference received, including interference that may cause undesired operation.

Any changes or modifications to the device not expressly approved by the manufacturer or Tesla Motors could void the user's authority to operate the equipment.

## Radio Frequency Information

This equipment has been tested and found to comply with the limits for a Class B digital device, pursuant to Part 15 of the FCC Rules. These limits are designed to provide reasonable protection against harmful interference in a residential installation. This equipment generates, uses and can radiate radio frequency energy and, if not installed and used in accordance with the instructions, may cause harmful interference to radio communications. However, there is no guarantee that interference will not occur in a particular installation. If this equipment does cause harmful interference to radio or television reception, which can be determined by turning the equipment off and on, the user is encouraged to try to correct the interference by one or more of the following measures:

- Reorient or relocate the receiving antenna.
- Increase the separation between the equipment and receiver.
- Connect the equipment into an outlet on a circuit different from that to which the receiver is connected.
- Consult the dealer or an experienced radio/TV technician for help.



## A

- ABS (Anti-lock Braking System) [56](#)
- access panel, removing [108](#)
- accessories
  - installing [119](#)
  - plugging into power socket [76](#)
- air circulation [71](#)
- air conditioning [70](#)
- air distribution [71](#)
- air filter [72](#)
- air suspension [73](#)
- air vents [72](#)
- airbags [31](#)
- alarm [81](#)
- anti-lock braking (ABS) [56](#)
- audio
  - playing files [74](#)
  - steering wheel buttons [36](#)

## B

- backup camera [62](#)
- battery (12V)
  - complete discharge [88](#)
  - specifications [126](#)
- Battery (high voltage)
  - care of [88](#)
  - coolant [108](#)
  - specifications [127](#)
  - temperature limits [88](#)
- battery (key), replacing [5](#)
- Bluetooth
  - devices, playing audio files from [75](#)
  - general information [77](#)
  - phone, pairing and using [77](#)
- body repairs [119](#)
- body touch up [105](#)
- brake fluid replacement [93](#)
- brakes
  - fluid level [109](#)
  - overview of [56](#)
  - specifications [126](#)

## C

- cabin temperature control [70](#)
- California Proposition [65](#) [139](#)
- camera (rear view) [62](#)
- car cover [105](#)
- car washes [103](#)
- carpets, cleaning [104](#)
- CHAdEMO [87](#)
- chains [97](#)
- charge port [89](#)
- charging

- changing charge settings [91](#)
- components and equipment [86](#)
- instructions [89](#)
- public charging stations [87](#)
- status of [92](#)
- child protection
  - disabling liftgate and rear door handles [6](#)
  - disabling rear window switches [8](#)
- child seats
  - cleaning [104](#)
  - installing and using [21](#)
  - Tesla built-in rear facing [27](#)
- cleaning [103](#)
- climate controls [70](#)
- console
  - 12V power socket [76](#)
  - cup holders [15](#)
  - USB ports [76](#)
- contact information
  - roadside assistance [134](#)
  - Tesla [140](#)
- coolant
  - Battery, checking level of [108](#)
  - Battery, replacement interval [93](#)
- copyrights [138](#)
- cornering lights [49](#)
- cruise control [59](#)
- cup holders [15](#)
- customizing Model S [67](#)

## D

- dashboard overview [2](#)
- data recording [138](#)
- delivery mileage [138](#)
- devices
  - Bluetooth, playing audio files [75](#)
  - connecting [76](#)
  - playing audio files from [75](#)
- dimensions [124](#)
- dome (map) lights [47](#)
- door handles [5](#)
- door labels [121](#)
- doors [4](#)
- Drive gear [41](#)
- drive-away locking [6](#)
- driver
  - profiles [35](#)
  - seat adjustment [16](#)
- driving
  - seating position [16](#)
  - starting Model S [40](#)
  - tips to maximize range [55](#)





## E

- electric parking brake [57](#)
- emergency flashers [50](#)
- emergency rear door opening [7](#)
- emission label [120](#)
- energy
  - gained from regenerative braking [57](#)
  - range information [42](#)
  - tips to minimize usage of [55](#)
- energy saving mode [55](#)
- event data recording [138](#)
- exterior
  - car cover [105](#)
  - cleaning [103](#)
  - dimensions [124](#)
  - lights [47](#)
  - overview [3](#)
  - polishing, touch up, & repair [105](#)

## F

- fan speed, interior [71](#)
- favorites, adding and removing [75](#)
- FCC Certifications [141](#)
- features, downloading new [84](#)
- firmware (software) updates [84](#)
- flash drives, playing audio files from [75](#)
- flashers, warning [50](#)
- flat tire repair [99](#)
- floor mats [105](#)
- fluids
  - replacement intervals [93](#)
  - reservoirs, checking [108](#)
- fog lights [47](#)
- front passenger detection [33](#)
- front trunk [11](#)
- fuses
  - location of [111](#)
  - removing access panel [108](#)

## G

- garage doors, opening [82](#)
- gates, opening [82](#)
- GAWR [122](#)
- gears [41](#)
- glove box [13](#)
- Gross Axle Weight Rating [122](#)
- Gross Vehicle Weight Rating [122](#)
- ground clearance [124](#)
- GVWR [122](#)

## H

- hazard warning flashers [50](#)
- head supports [17](#)
- headlights
  - after exit [49](#)
  - cornering lights [49](#)
- heated wipers [51](#)
- heating [70](#)
- height adjustments (suspension)
  - automatic and manual settings [73](#)
  - disabling (Jack mode) [73](#)
- high voltage
  - Battery specifications [127](#)
  - components [86](#)
  - safety [93](#)
- Hill Start Assist [61](#)
- HomeLink
  - FCC certification [141](#)
  - programming and using [82](#)
- hood [11](#)
- horn [38](#)

## I

- IC certifications [141](#)
- Ideal range [42](#), [67](#)
- identification labels [120](#)
- indicator lights, summary of [43](#)
- instrument panel
  - charging status [92](#)
  - cleaning [104](#)
  - overview of [42](#)
- interior
  - cleaning [104](#)
  - lights [47](#)
  - overview [2](#)
  - temperature control [70](#)
- Internet radio [74](#)
- intrusion detection [81](#)

## J

- J1772 [87](#)
- Jack mode [73](#)
- jacking Model S [118](#)

## K

- key



- FCC and IC certifications 141
  - how to use 4
  - key not inside 40
  - ordering extras 5
  - replacing battery 5
- keyless entry 4

## L

- label
  - Tire and Loading Information 121
  - vehicle certification 122
- lane change flash 50
- LATCH child seats, installing 24
- liftgate
  - adjust opening height 9
  - opening 9
- lifting Model S 118
- lights
  - cornering lights 49
  - hazard warning 50
  - headlights after exit 49
  - turn signals 50
- load limits 121
- lock/unlock status 42
- locking and unlocking doors 4
- lumbar support 16

## M

- maintenance
  - brake fluid, checking 109
  - cleaning 103
  - daily and monthly checks 93
  - fluid replacement intervals 93
  - panel, removing 108
  - replacing fuses 111
  - replacing wiper blades 106
  - service intervals 93
  - tires 94
  - washer fluid, topping up 110
  - washer jets, cleaning 107
- maps 79
- mats 105
- media 74
- mileage upon delivery 138
- mirrors 39
- mobile app 85
- Mobile Connector
  - description 87
  - using 89
- modifications 119
- motor specifications 125

## N

- navigation 79
- Neutral gear 41
- NHTSA, contacting 140

## O

- occupancy sensor 33
- odometer
  - on instrument panel 42
  - resetting trip odometer 54
- overhang dimensions 124
- Owner Information, about 138

## P

- Park Assist 52
- Park gear 41
- parking brake 57
- parts replacement 119
- passenger detection 33
- passenger front airbag 33
- phone
  - steering wheel controls for 37
  - using 77
- power socket 76
- power windows 8
- powering on and off 40
- preferences, setting 67
- Proposition 65 139
- public charging stations 87

## R

- radio 74
- radio frequency, FCC information 141
- rain sensor 51
- range
  - displayed on instrument panel 42
  - driving tips to maximize 55
  - regenerative braking 57
- Rated range 42, 67
- rear seats, folding and raising 17
- rear view camera 62
- rear window switches, disabling 8
- regenerative braking 57
- release notes 84
- Reverse gear 41
- roadside assistance 134

## S

- safety defects



- reporting (Canada) 140
- reporting (U.S.) 140
- safety information
  - airbags 34
  - child seats 26
  - rear facing child seats 30
  - seat belts 20
- seat belts
  - cleaning 104
  - in a collision 19
  - overview of 18
  - pre-tensioners 19
  - wearing when pregnant 18
- seat covers 17
- seat heaters 70
- seating capacity 121
- seats
  - adjusting 16
  - heaters 70
  - Tesla built-in rear facing 27
- security settings 81
- service data recording 138
- service intervals 93
- Settings 67
- shifting gears 41
- Slacker 74
- software updates 84
- specifications
  - dimensions 124
  - exterior 124
  - subsystems 125
  - tires 129
  - weights 124
  - wheels 128
- stability control 58
- starting Model S 40
- steering specifications 125
- steering wheel 36
- sunroof 14
- suspension 73
- suspension specifications 126

## T

- telematics 138
- telephone
  - steering wheel controls for 37
  - using 77
- temperature
  - Battery (high voltage), limits 88
  - cabin, controls for 70
  - outside 42
  - tires 132
- tie-down straps 137
- tilt detection 81
- Tire and Loading Information label 121
- Tire Pressure Monitoring System

- FCC certification 141
- overview of 97
- tire pressures, checking 94
- tire repair kit
  - inflating with air only 101
  - inflating with sealant 100
  - replacing the sealant canister 102
- tires
  - balancing 95
  - chains 97
  - industry glossary of terms 133
  - inspecting and maintaining 95
  - pressures, how to check 94
  - quality grading 132
  - replacing 96
  - replacing a tire sensor 98
  - rotation 95
  - specification 129
  - temperature grades 132
  - tire markings 130
  - tire sealant 99
  - traction grade 132
  - treadwear grade 132
  - winter 96
- touch up body 105
- touchscreen
  - cleaning 104
  - Controls 65
  - overview 63
  - Settings 67
  - software updates 84
- tow chain, connecting 136
- Tow mode 135
- towing 135
- towing a trailer 123
- towing instructions 135
- TPMS
  - FCC certification 141
  - overview of 97
- traction control 58
- trademarks 138
- trailer hitches 123
- transmission specifications 125
- Transport Canada, contacting 140
- transporting 135
- trip information 54
- trunk, front 11
- trunk, rear
  - child protection lock 6
  - disabling interior handle 6
- Tuneln 74
- turn signals 50

## U

- uniform tire quality grading 132
- Units & Format 67
- unlocking



- trunk, front [11](#)
- trunk, rear [9](#)
- unlocking and locking doors [4](#)
- unlocking when key doesn't work [7](#)
- USB devices
  - connecting [76](#)
  - playing audio files from [75](#)
- USB ports [76](#)

## V

- vehicle certification label [122](#)
- Vehicle Identification Number (VIN) [120](#)
- vehicle loading [121](#)
- vent, sunroof [14](#)
- ventilation [72](#)
- VIN (Vehicle Identification Number) [120](#)
- volume control [63](#)

## W

- walk-away locking [6](#)
- Wall Connector [87](#)
- warning flashers [50](#)
- warning lights, summary of [43](#)
- washer fluid, topping up [110](#)
- washer jets, cleaning [107](#)
- washers, using [51](#)
- weight specifications [124](#)
- wheel chocks [137](#)
- wheels
  - alignment [95](#)
  - replacing [96](#)
  - specifications [128](#)
- Wi-Fi, connecting to [83](#)
- windshield washer fluid, topping up [110](#)
- winter tires [96](#)
- wiper blades, replacing [106](#)
- wipers and washers [51](#)
- wipers, de-icing [51](#)

## X

- XM radio [74](#)