

Digital Design

Computers • Peripherals • Systems

SHOWCASES

**Color Graphic
Terminals**

**Digitizers
Plotters**

DD44828
485
SERIALS LIBRARY
STATE TECHNICAL INST
5983 MACON COUN
MEMPHIS
134

Forth

Networking

Image Processing

Selecting Data Link Systems

Series 9000...
still the class act
in digital tape transports.



Being the best in your business is neither boring, tiresome or repetitive—it's challenging. Now that we have the most dependable and advanced tape transports in the world—what's left?

Delivering them. On time and on-line faster than anyone. That's what! They still have all the features:

- A position arm anticipatory sensing system. An exclusive Kennedy feature, the linear, non-contact (Mag Pot) position sensor requires no lamp source and assures performance for the life of the machine.
- Interchangeable electronics on all Series 9000 transports, reduce stocking costs and down time.
- Front-accessible off-line test panel; marginal skew check; threshold scanning which automatically compensates for drop-ins or drop-outs; Read-After-Write shortened skew

gate; simplified tape path and quick release hubs.

- All models are available with either 7 or 9 track, 800NRZ1, 1600 PE or 800/1600 NRZ1/PE.
- 7 and 9 track NRZ1 and PE format/control units to simplify customer electronics. Also, a variety of popular mini-computer mag tape controllers are available. Series 9000's performance is as impressive as its features, with data transfer rates to 72KHz, and tape speeds from 10 to 45 ips. Being best is nice. So is being fast. Kennedy is both.

KENNEDY

Subsidiary, Magnetics & Electronics, Inc.

1600 Shamrock Ave., Monrovia, CA. 91016
(213) 357-8831 TWX 910-585-3249

KENNEDY • QUALITY • COUNT ON IT

Circle 2 on Reader Inquiry Card

- Motorola MC68000 16-bit processor
- Multi-tasking operating system
- Languages supported include C, PASCAL and BASIC
- Mass storage devices up to 10MB
- 19" CRT
- 1024 x 768 high resolution color graphics
- 256 simultaneously displayable colors



- CAD/CAM
- Business Graphics
- Imaging
- Animation
- Process Control
- Scientific
- Graphic Arts
- Demography
- Cartography

- CGC 7900 prices start at \$19,995.
- Call toll-free 1-800-241-9467.

INTRODUCING THE WORLD'S MOST POWERFUL USE OF COLOR.

ChromaticsTM
The World's Most Colorful Computer Company.

Chromatics, Inc./2558 Mountain Industrial Boulevard/Tucker, GA 30084/Telephone: 404/493-7000/TWX: 810/766-8099

Circle 3 on Reader Inquiry Card

Image processing systems Modular graphic display systems Frame buffers—Television monitors

Grinnell has them all, for almost any application: from simple black and white line drawing to full color image processing. Select a packaged system, or configure one "your way."

GMR 270 Series: 512 × 512 frame buffers and full color pipeline image processing systems.

GMR 260 Series: 1024 × 1024 frame buffers for greyscale, black and white, pseudo color and full color.

GMR 27 Series: 256 × 512 to 1024 × 1024 high speed, modular graphic and image display systems.

All systems are available in both U.S. and European versions, with plug-compatible interfaces to most minicomputers (including DEC, Data General and PRIME). Proven system designs ensure reliability, and an expanded FORTRAN library and driver package makes operation easy.

So, whether you need a complete system, or just a card set to embed in a larger system, Grinnell has an optimum cost/performance solution. For complete specifications and/or a quotation, call or write today.

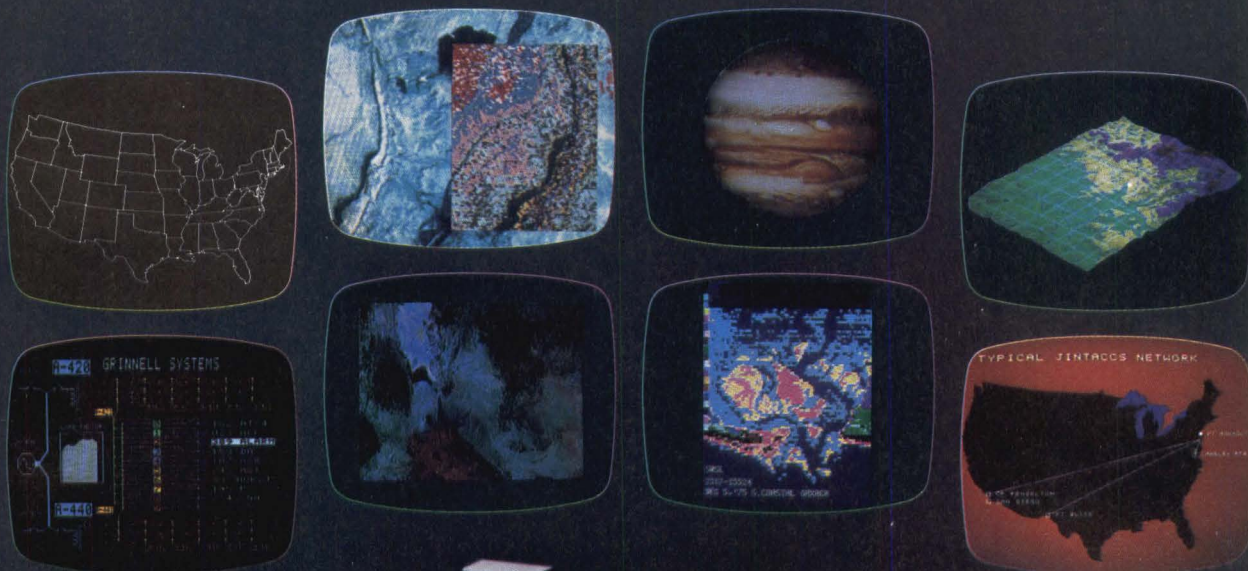

GRINNELL SYSTEMS

2159 Bering Drive, San Jose, California 95131 (408) 263-9920 TWX 910-338-2145

Circle 4 on Reader Inquiry Card

Digital Design

Computers • Peripherals • Systems

Copyright © 1981 Benwill Publishing Corporation, a Morgan-Grampian company

Publication Number: USPS 407-010

Features

23 Plotter Showcase

Whether you need graphic hard copy units for producing slick presentation graphics or for plotting life-size drawings of airplane components, you'll find the manufacturers you're looking for in this DD showcase.

30 Plotters: Charting A Course Through The '80s

An overview of pen plotters, as well as the newer technologies in graphic hard copy that threaten pen plotters' long-held market supremacy.

32 Digitizer Showcase

Nearly three dozen manufacturers offer digitizers to suit a wide spectrum of applications.

40 Digitizers Improve

Applications extend from mapping petroleum beds to cataloging bank account signatures; digitizers today fill a growing, diverse market.

43 Color Graphics Terminals

Some color graphic terminals are full-blown systems; others, rack-mountable monitors. Included is a graphics glossary update and lexicon.

46 Image Processing

A photo essay on how digitizing and processing can affect ordinary photographic images.

48 A Lexicon For Modern Day Graphics.

Color graphics system can be grouped in one of four distinct categories. And each of the four can operate in one of three basic technologies.

52 FORTH: Exaggeration Or Panacea?

This multi-level language has a powerful core of constructs, extensibility, interactivity and portability.

58 Designing Data Link Systems

This article examines throughput and reliability, benchmark program and figure of merit for average throughput/dollar.

Departments

6 Letters

9 Speakout:

Of FBEs And AAES: A Poll

10 Technology Trends

- Low-Cost Terminals Aid IRTs
- Removable Winchester Cartridge Protects R/W Heads
- Fiber Optic Costs Plummet

12 Remote Terminals

From: Taiwan, Scotland, London, Tokyo, South Africa, West Germany, South Wales, Israel, Ireland, France, Canada, etc.

14 Innovative Design

- Computer "Ears" Available for OEM Designers
- Image Processing Expands Into Low-End

64 New Products

74 Designers' Notebook

- Fiber Optics Scan Objects
- μ P-Interface "Jitter Switch Alarm" Foils Thieves
- Tilt Switch Inverts LED/LCD Displays
- Making Floating Measurements Easier

76 Advertisers' Index

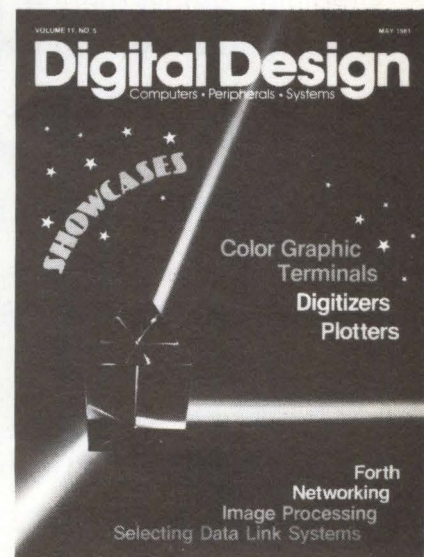

Chromatics, Inc., of Tucker, GA, uses prismatic colors like these to symbolically illustrate its color graphic terminals. Cover photo courtesy of Chromatics, Inc. Cover designed by Josh Randall

RGB MONITORS

for your

COLOR VIDEO GRAPHIC DISPLAY

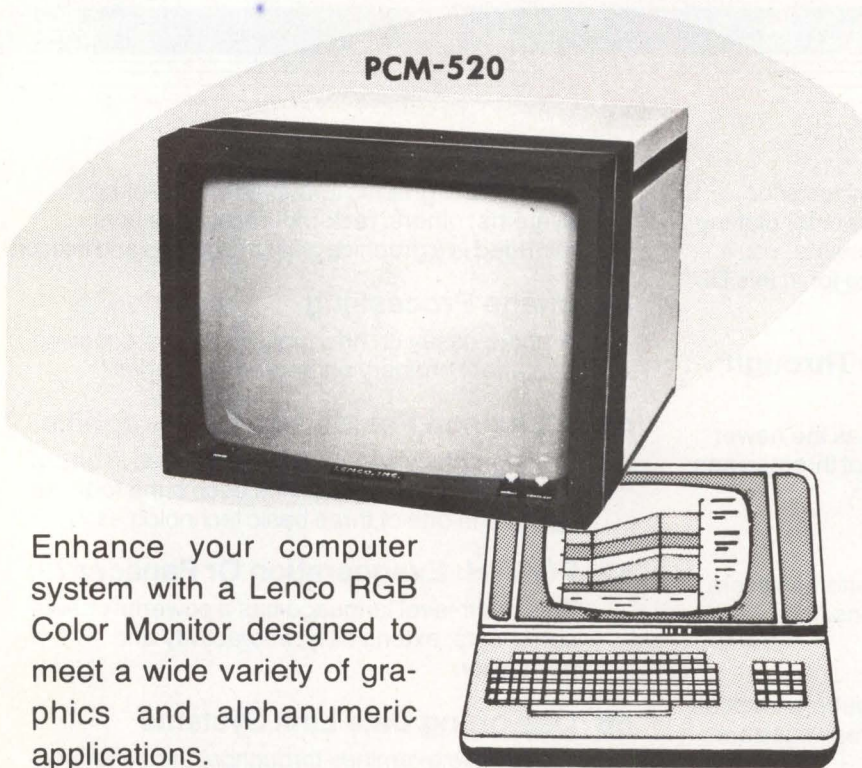

Enhance your computer system with a Lenco RGB Color Monitor designed to meet a wide variety of graphics and alphanumeric applications.

The PCM-520 RGB Color Monitors utilize the new Precision In-Line (PIL) black shadow mask CRT that simplifies convergence adjustment thus increasing reliability and reducing maintenance time.

Although the PCM-520 is a 20" RGB monitor, it only requires a 13 $\frac{7}{8}$ " vertical mounting space.

Check these outstanding features:

- 80 Characters Per Line
- 20" Black Matrix PIL CRT
- Resolution 512 X 483
- Underscan
- Simplified Convergence
- Internal/External Sync
- Automatic Degaussing
- Modular Design

Call or write today for detailed specifications and price.



LENCO, INC., ELECTRONICS DIVISION
300 N. Maryland St., Jackson, MO 63755. (314) 243-3147
The Professional's Choice

Circle 5 on Reader Inquiry Card

Digital Design

Computers • Peripherals • Systems

Group Publisher: Main Office
Harold G. Buchbinder (617) 232-5470

Editorial Director: Western Office
George King (714) 789-6688

Editor: Main Office
Paul Snigier (617) 232-5470

Managing Editor	Harry Shershow
Book Review Editor	William Belt
Assistant Editor	Bob Hirshon
Editorial Assistant	Martha Hawkins
Contributing Editor	Zachary Shpall
Art Director	Richard D. Sarno
Staff Artists	Jacky Brill, Stephen Fisher Laurie R. Guptill, Josh Randall Donni Richman
Production Manager	Erik W. Slickman
Production	Jon Buchbinder Florence L. Daniels
Research Director	Jackson Parker
Marketing Services Manager	C. King
Circulation	Hiro Irie Sarah Binder, Regina Harrington
Composition	M. Yva Doricent Robert Hildebrand, Claudia Majetich Harvey Sweat
General Administration	Joan Carey Lisa Finichel, Mal Rankin Heather Ryan, Esther Shershow

SUBSCRIPTION POLICY

DIGITAL DESIGN is circulated only to qualified research, development and design engineers in all branches of industry, government institutions and universities. To obtain a complimentary subscription, request (on company letterhead) a qualification card from Circulation Director. For change of address, attach old address label from recent issue to new company letterhead or note. Send this plus request for new qualification card to:

Circulation Department
DIGITAL DESIGN
1050 Commonwealth Ave.
Boston, MA 02215

Subscription rates: non-qualified subscribers (US and Canada) — \$35/yr.; non-qualified foreign — surface mail — \$45; air mail — \$70.

DIGITAL DESIGN solicits editorial material and articles from engineers and scientists. Contributors should submit duplicate manuscripts typed with two spaces between lines. All illustrations should be clear; components on all schematics and line drawings should be labeled. The editors assume no responsibility for the safety or return of any unsolicited manuscripts.



Published monthly by Benwill Publishing Corporation, a Morgan-Grampian Company, Harold G. Buchbinder, Chief Executive Officer; George Palken, President; Domenic A. Mucchetti, Treasurer; Executive, Editorial and Subscription Offices, 1050 Commonwealth Ave., Boston, MA 02215. Telephone: (617) 232-5470.

Morgan-Grampian also publishes American City & County • Circuits Manufacturing • Contractor • Design Engineering • Electronics Test • Government Buyer • Industrial Distribution • Industrial Product Bulletin • Mart • Municipal Index

For maximum cost-efficiency, design with the new MCE CMOS Monochip.[™]

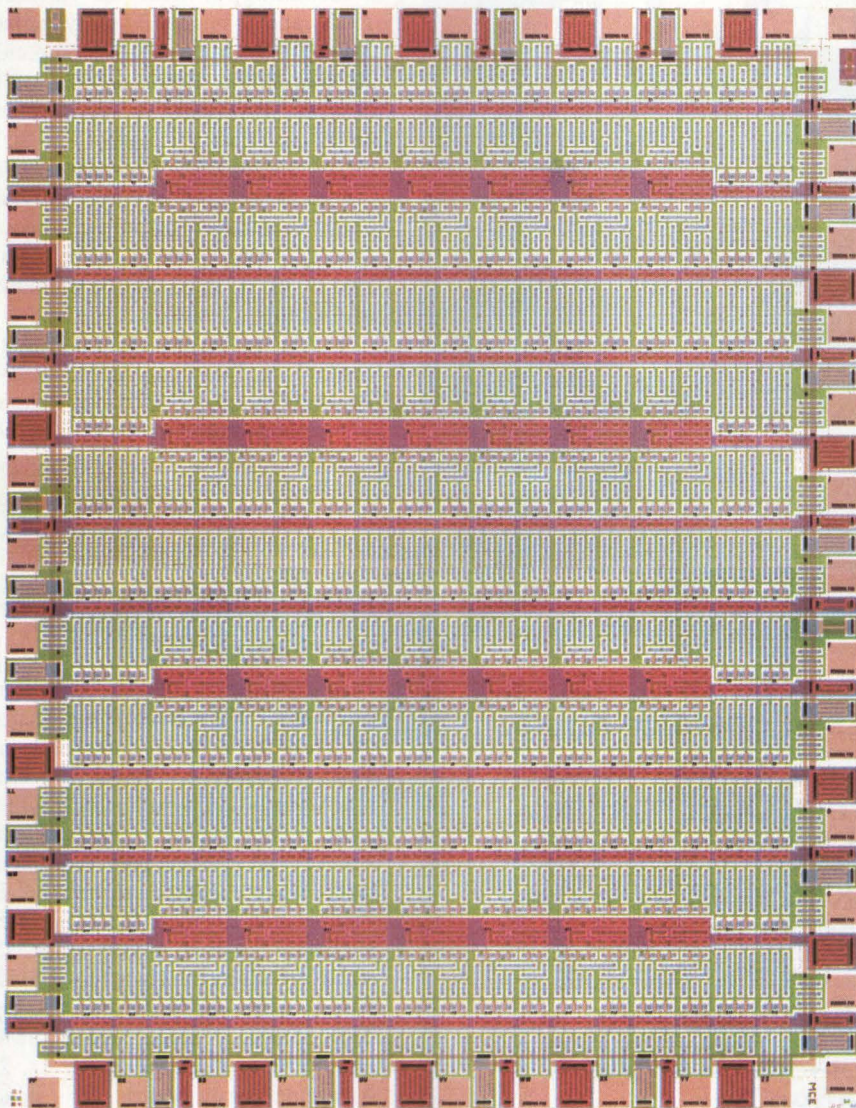

MCE Monochip[™] is the most cost-effective member of our CMOS digital gate array family. It's the same size as our MCC Monochip (23,500 square mils), but has 28 flip flops more—giving you the equivalent of 444 gates and boosting silicon usage efficiency by 37%. That means greater cost savings for you.

MCE Monochip[™] is ideal for applications such as counters or dividers, data latches, or shift registers where numerous flip flops are required. Plus MCE Monochip has many new features to make chip layouts simpler for you, including 22 buffers and 18 drivers evenly distributed on the chip's periphery, internal contacts for easier accommodation of bus structures, and underpasses for easy access to the four corner bonding pads.

Start designing your own MCE gate array today. Our CMOS Design Manual gives you all the materials and information you need for just \$25.

Because MCE Monochip's components are already in place, all you do is tell us how to connect them for the circuit you need. Working from your layout, we make your circuit and deliver 20 prototypes in 12 to 14 weeks for \$4,650. Once you've approved them, we'll produce 1,000 to 500,000 parts for you.

Start saving money on your designs today—with the MCE Monochip. To order your kit—or for more information—call or write us. Interdesign, 1255 Reamwood Avenue, Sunnyvale, CA 94086. (408) 734-8666.

Description

444 equivalent gates

28 dedicated D-type flip flops arranged in 4 rows of 7 each

160 array cells arranged in 8 rows of 18 each and 4 rows of 4 each

40 I/O/cells, 22 of which can be connected as three-state outputs

136 x 174 mils

44 pins max.

Specification at 25°C (5 volts)

3 to 5 volts supply

Average propagation delay of 13ns (FO = 2)

Toggle frequency up to 5 megahertz

Storage temperature range: -55 to +150°C

Operating temperature range: -55 to +125°C

Proven metal gate CMOS technology

Interdesign

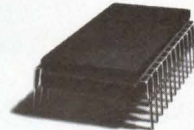

Monochip[™]
the semi-custom IC.

Interdesign is a Ferranti Company.

Circle 7 on Reader Inquiry Card

See the solution.



The Problem: Glare from CRT displays. Eye strain. Inefficiency. Loss of operator-hours. The ergonomic difficulties of interfacing man and CRT are growing. OCLI has the solution: HEA® – High Efficiency Antireflection Coating. HEA reduces glare by 94% while optimizing contrast. It improves the operator's visual efficiency and comfort. It's cost efficient. It's the solution. For more information write, phone, or TWX: OCLI, Dept. 109-DQ, 2789 Giffen Ave., P.O. Box 1599, Santa Rosa, CA. 95402. (707) 545-6440. TWX: (510) 744-2083.

OCLI The Anti-Glare Solution
Display Products

Circle 6 on Reader Inquiry Card

Letters

Projected \$1B In 1985

Dear Editor:

Digital Design has given some good coverage to Programmable Array Logic (PAL), and we appreciate your interest. PAL, a registered trademark, represents a technology which was patented in 1978; and it is an IC family replacing 5400/7400-series TTL components. By combining logic functions of TTL devices, PAL circuits reduce components on PCBs by up to 12 to 1. The projected market is \$1 billion in 1985.

Please keep Programmable Array Logic in mind as you prepare upcoming articles, and remember to identify PAL® as a registered trademark of Monolithic Memories.

If you would like more information, contact me, or call Roy Twitty or Andrea Gregg at TFB Public Relations. Their phone number is (415) 328-4745.

Ray Gouldsberry
Monolithic Memories
Sunnyvale, CA

Printer Controllers

Dear Editor:

In his article on Printer Controllers in the March 1981 issue, Stan Margullis of MDB Systems, pointed out that a serial interface equipped with buffer-ready (or busy) monitor logic will prevent printer buffer overrun. He then states, "At present only four such interfaces are available (all from MDB)." Andromeda Systems has been offering such a circuit as an option on our MSII1 series of serial interfaces for LSI11/Q-Bus systems for more than two years. The option, designated TI810/MOD, adds \$50 to the cost of our 1-, 2- or 4-channel serial boards. It is standard on the serial channel of our VDC11 video display controller for the LSI-11.

Les LaZar
President
Andromeda Systems, Inc.
9000 Eton Ave.
Canoga Park, CA 91304

Your letters are welcome.
Send to: Editor
Digital Design
1050 Commonwealth Ave.
Boston, MA 02215

Series 630

NEW



Quite frankly,
when it comes to OEM
terminals, TEC far exceeds competition.

designed with the OEM in mind

*A must for
your consideration
because the Series 630
starts where other terminals stop.*

The 630 is a smart state-of-the-art ergonomically designed terminal which incorporates quality, reliability, and the flexibility to adapt to your system at a price which helps keep your overall system cost down.

The 630 has many standard features to complement your system. A few of these are detached keyboard with the reliable reed switch technology, non glare screen, full editing capabilities, user programmable auxiliary I/O port and horizontal split screen, six user defined function keys, and upper and lower case characters.

TEC also offers an array of

options to make the 630 even more attractive to you, some of which are tilt/swivel terminal base, 96 character limited graphics set, composite video output, 2, 4, or 8 pages of memory with paging or scrolling.

TEC has been in business for over 23 years. We know how to make OEMs happy, we have built CRT terminals for them for over 15 years. That's a long time and we're proud of it. We believe in providing individual support to all of our customers, especially after the sale has taken place. TEC will also modify or completely redesign its terminals to meet your exact requirement.

For a detailed brochure on the 630 or other TEC terminals, or for applications assistance, contact TEC today.

TEC, Incorporated

DECADES OF SUPPORT

Corporate Headquarters
2727 N. Fairview Ave.
Tucson, Arizona USA 85705 (602) 792-2230
TWX 910-952-1377 Telex 16-5540

- Boston (617) 879-6886
- Chicago (312) 655-1060
- Cincinnati (513) 984-6620
- Los Angeles (714) 848-3111
- Minneapolis (612) 941-1120
- Philadelphia (201) 780-6700
- San Francisco (408) 374-2660
- Washington D.C. (703) 354-1222
- West Palm Beach (305) 684-1604

TEC International, Inc.
European Sales Office
Avenue Louise 148-Box 6
1050 Brussels, Belgium
(02) 649-81 54 Telex 846-63553



Made in U.S.A.



Circle 8 on Reader Inquiry Card

AMAZING!

ONE QUAD + ONE DUAL PROVIDES NRZI AND PE FOR LSI-11 AND PDP-11

ALSO FROM DATARAM
 WE'VE JUST ANNOUNCED
 PDP 11/44
 MEMORY

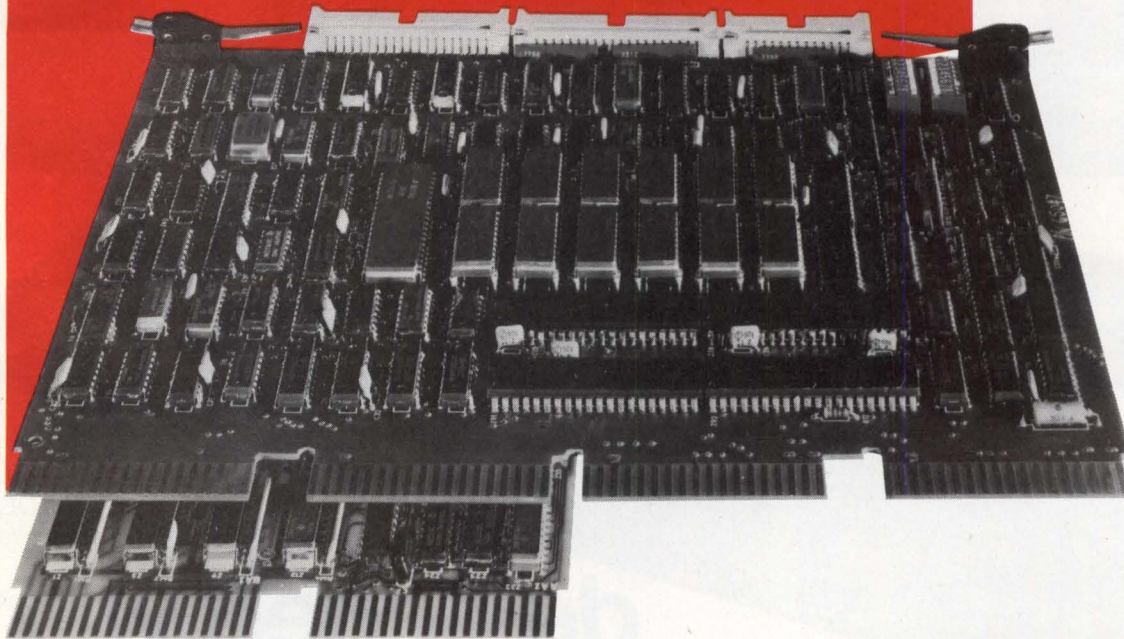

Get more from your LSI-11 and PDP-11 by putting less into it! It's possible, with Dataram's dual-density DEC®-compatible tape controllers that offer an amazingly efficient packaging approach.

For NRZI operation (LSI-11 or PDP-11), a single quad board from Dataram is all that's needed. For phase encoded mode, the simple addition of

the dual-size PE board, anywhere in the LSI-11 or PDP-11 backplane, makes it possible. Packaging flexibility that allows you to optimize your DEC configuration.

Dataram's T03/T04/T34 family, summarized in the chart below, offers the widest array of DEC-compatible tape controllers available today.

The T04/T34 controllers, utilizing an integral 16-bit bipolar microprocessor, provide speed capability to handle up to 1600 BPI at 125ips. And they require only +5.0VDC.

Less power. Less space. Less cost. That's a lot of less...and it adds up to more performance for your DEC-based system. From Dataram.

	NRZI	PE
LSI-11	T03 2 DUALS	T04 1 QUAD and 1 DUAL
	T04 1 QUAD	
PDP-11	T34 1 QUAD	T34 1 QUAD and 1 DUAL

DEC, LSI-11, and PDP are registered trademarks of Digital Equipment Corporation.

DATARAM CORPORATION

Princeton Road
 Cranbury, New Jersey 08512
 Tel: 609-799-0071 TWX: 510-685-2542

Canada: Ahearn & Soper Ltd., 416-245-4848 • Finland: Systek OY, (80) 73 72 33 • France: YREL, (01) 956 81 42 • Hungary/Poland/Romania: Unitronex Corporation, WARSAW 39 6218 • Italy: ESE s.r.l., 02/607 3626 • Netherlands: Technitron b.v., (020) 45 87 55 • Sweden: M. Stenhardt AB, (08) 739 00 50 • Switzerland: ADCOMP AG, 01/730 48 48 • United Kingdom: Sintrom Ellinor Ltd., (0734) 85464 • West Germany: O.E.M.-Elektronik GmbH, 07 11-79 80 47 • Yugoslavia: Institut "Jozef Stefan", 263-261 • Australia/New Zealand: Anderson Digital Equipment, (03) 543-2077 • India: Infosystems Private Limited, 79281 • Israel: Minix Computers & Systems Ltd., 03-298783 • Japan: Matsushita Electric Trading Co., Ltd., 06 (282) 5111

Circle 9 on Reader Inquiry Card

Of FBEs and AAES: A Poll

Paul Snigier, Editor

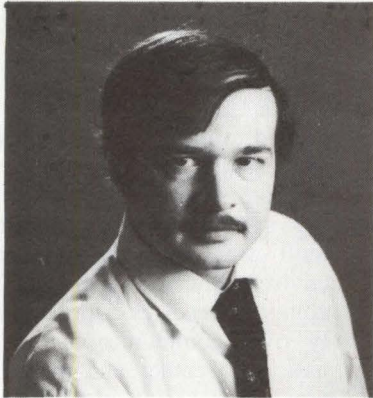

Numerous articles are appearing in the trade press on foreign-born engineers (FBEs) and the American Association of Engineering Societies (AAES). Judging from its coverage in other computer trade tabloids and magazines, the first issue, FBEs, is of great interest to engineering readers. Although we maintained a hands-off policy on taking a stand on this issue, from time to time we do wonder what our readers think about this issue.

Here, the way I see it, are the pros and cons:

AAES: Affirmative. IEEE is right: AAES can go after age discrimination, ethics violations, pension reform and wage busting. AAES has more time than IEEE in helping to prosecute violations of professional rights. IEEE officers can now get on with its business of setting standards and disseminating information.

AAES: Negative. AAES is a paper tiger, say its critics. IEEE's joining AAES at \$150,000/year is a tactic by officers to pass professional issues on

to AAES. This avoids bad PR for the IEEE.

FBEs: Affirmative. First, FBEs are not "flooding" the US engineering field. Our universities do train some. Most return to raise their nations' living standards, thus stabilizing a troubled world. Second, of those who stay here, by what right do we proclaim ourselves as the only true Americans, and turn away FBEs? (Isn't this selfish? Such individuals helped make America the country it is today.)

FBEs: Negative. Importing FBEs subsidizes universities and enables corporate executives to cut EE salaries. When they are graduated, FBEs are often offered lower salaries — which is also unfair to them — or are deported.

No matter how you feel on these two issues, how about a word to us? We'd like to hear from our entire readership, if possible, so we can get a reading of the EEs' temperatures on this subject. Please fill out this questionnaire (or a photocopy) and mail it to: **Speakout**, Digital Design, 1050 Commonwealth Ave., Boston, MA 02215. We will tabulate your responses and publish the results. **D**

Paul Snigier

Please circle one (or more, if appropriate) . . .

1. I am (1. in favor, 2. against, 3. don't care) about more new FBE students and FBEs permanently entering the U.S.
2. I (1. do, 2. do not, 3. don't care) feel that FBEs will be a job threat to U.S. EEs in the future.
3. Comparable FBEs hired in the U.S. are (1. paid less, 2. paid more, 3. paid the same) as their U.S. counterparts. If paid less, is this unfair? (1. yes, 2. no, 3. don't care).
4. I (1. am, 2. was, 3. am not) an FBE. If a resident of a different country, I (4. would, 5. would not, 6. don't care) like to become a U.S. citizen.
5. I feel those EEs against FBEs (1. are, 2. are not, 3. don't care) unfair.

What are your thoughts on FBEs (and of others' attitudes)? _____

6. I already know (1. a lot, 2. something, 3. nothing) about AAES.
7. I am (1. slightly, 2. a lot, 3. not at all) curious about AAES.
8. I (1. am, 2. am not, 3. don't care) in favor of IEEE membership in AAES.
9. AAES (1. can, 2. cannot, 3. maybe can) help professional issues.

What are your thoughts on AAES? _____

Low-Cost Terminals Aid IRTs

During this decade, low-cost information retrieval terminals (IRTs) will be available to consumers, professionals and small businessmen. Teletext and videotext information services are in Britain, France, Germany, Canada and Japan. Many in the test phase are jointly sponsored by government and industry. In the US, the first federally funded test is a videotext-style "farm information retrieval system" (FIRS), and is being tested in Kentucky to help farmers improve crop and livestock management. To overcome the problem of disseminating relevant information to farmers rapidly, Project Green Thumb or FIRS provides farmers with real-time weather, marketing, and agricultural information. It reduces risks due to weather, minimizes environmental contamination and helps farmers become more competitive in domestic and international markets. FIRS links together computers at the National, State and County levels. Farmers access local county computers using inexpensive home information terminals

(HIT). The test is in Shelby and Todd counties in Kentucky. There are 100 HITs in farm houses in each county. They communicate with county computers who, in turn, are linked to the University's computer equipment in Lexington.

The following account of this significant development was provided by Principal Staff Engineers William Pierce and S. James Reid and Senior Staff Engineer William Peterson, all from the Motorola Semiconductor Group in Phoenix, AZ.

state computer

Motorola designed the HIT and delivered 250 units. The actual assembly was subcontracted to Tandy.

Farm families are currently accessing weather reports, commodity prices, home economics tips, and hundreds of other useful items. As the test progresses, the university is fine-tuning the information to the farmer's needs. Test results are being monitored from both a technical and market viability

viewpoint.

The University's computer was upgraded to handle the FIRS application and existing time-sharing tasks. Other medium sized computers with operating systems capable of handling a multi-user, concurrent programming environment are also suitable. The state computer receives information remotely over communications links from national weather and marketing services. Local generation and editing of text items and data management by University personnel is provided via conventional CRT terminals. Composition and editing of graphics items, such as radar weather maps, is accomplished on an off-line graphics terminal and digitizer. The computer converts remote and local input information into item selections, consisting of pages formatted for storage in data base disk files.

The state computer has a dedicated 1200 baud telephone line for each of the two county computers. It can request observation input data, status, and log-

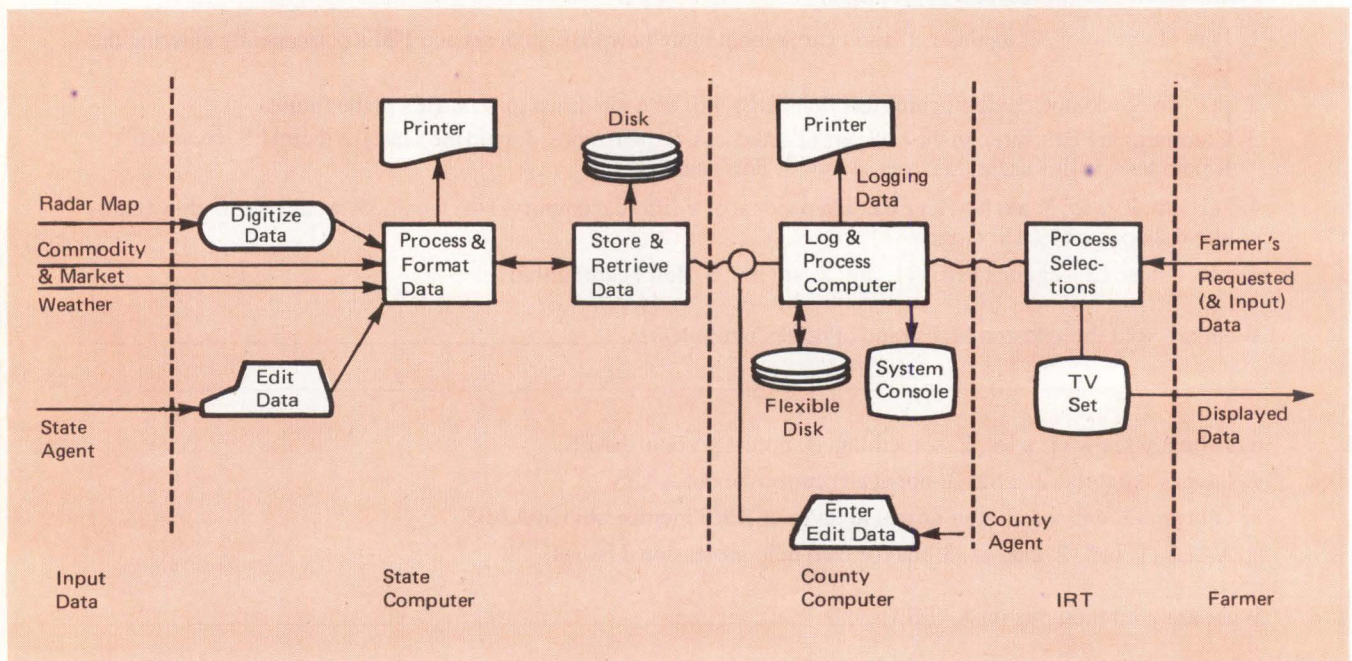

Figure 1: The FIRS system, illustrated in this simplified block diagram, is a former of information retrieval systems of the 1980s.

ging data and send updated menu items at regular intervals. This same telephone line also allows the county agricultural extension agent to enter information into the system via a conventional CRT terminal.

The county processors are essentially store and forward computer systems, with call accounting and logging functions. They are dual-processor configurations, using separate microcomputers for communications and disk operations. Menu items, observation input data and call record/management statistics are maintained on floppy disks. A CRT console provides initialization and diagnostic capability, while a printer logs a summary of state computer transactions. The county processors are essentially turn-key and unattended after initialization. Seven 300-baud phone lines on a rotary interface the 100 HIT users in each county.

HIT

The home information terminal or "Green Thumb Box," is an inexpensive intelligent terminal for entry and reception of information from a computer over standard dialup telephone lines. It connects to a readily available telephone jack for communications, to the antenna input terminals of an unmodified TV set for display, and to a calculator style power module for power. It may be easily installed by the home owner with simple hand tools.

The HIT is interactive to the degree that it provides a means for the farmer to request information items and enter weather observation data off-line. The HIT then communicates the farmer's inputs to the county computer, and automatically terminate the call at the end of the transaction. The off-line operation and automatic termination reduce the connect time and the possibility of bottlenecks at the county computer.

The user installs the unit much the same as an extension phone and video game. The unit is supplied with a cord that plugs into the existing telephone outlet and an antenna switch box which when connected to the television antenna terminals feeds the RF signal generated by the unit into the television on VHF channel 3 or 4. There is a 16 keypad on the face of the unit that is used to enter data that will instruct the county computer what data should be sent and also to allow some data to be sent to the county system if that option is active.

The HIT is designed to be somewhat foolproof in nature and utilizes a

prompting scheme for all user input. It does a cursory analysis on the data as it is entered and leads the operator through the necessary input steps right up to telling him when to place the call to the county computer. After the call is initiated the system becomes automatic and all handshaking between the county computer and the HIT is accomplished without further user intervention. The HIT also terminates the call when the data has been successfully received or there is some abnormal circumstance and informs the user in all cases of the

results of the transaction. The user is now capable of examining the data that was requested without incurring any additional telephone connect charges.

user level specification

Two major actions are performed for the user by this system. They include accessing prepared display files such as pricing information on crops or futures, weather data or any other community information, and the ability to send to the county computer specific data such as local temperature or humidity.

BASF has the 8" Winchester drive with the difference you can see.

Notice that our linear voice coil actuator and many of our electronics are positioned *outside* the basic package. It makes a big difference in reducing circuit-damaging heat, and cuts your risk of magnetic field-induced data loss. Our linear actuator is a far more accurate and higher performance design than the competition's rotary or stepper motor systems, and more appropriate to tomorrow's high track densities.

- Field-proven for more than two years.

- Available for immediate delivery.
- 8, 24, and 40 megabyte unformatted capacity.
- SMD, Disk Bus, and ANSI interface options.
- Competitive OEM prices.
- Incorporates BASF-manufactured disks... never a shortage.

Write for complete details, or call, in the East, (617) 271-4168; in the West, (714) 752-6126.



It looks different because it is different.

BASF Systems Corporation,
Crosby Drive, Bedford, MA 01730
ATTN: Marketing Services, Computer
Hardware Products.
Please send me complete details on the BASF
6170 Series 8" Winchester Drives:

Name _____ Title _____
Company _____
Address _____
City _____
State _____ Zip _____
Telephone _____



BASF

Circle 10 on Reader Inquiry Card

The prepared display files are organized in groups on related topics and each file is assigned a reference number. This number is used to access that data by the farmer. An index is published at regular intervals which contains the major categories available for display and this index is also available as a display file itself.

HIT system design

The overall HIT system has three major sections: the protocol, I/O control and display format descriptions. The protocol relates to the interactions between the HIT and county computer during the time that they are linked via phone lines for data transfer. The I/O control relates to the modem and video signals present and their associated timing constraints. The display format description relates to the actual screen formats presented on the user's TV screen.

future features

The results of the testing will be evaluated and be the basis for enhancements, including the following: auto dial capability for the HIT, auto answer mode for the HIT, data compression during transmission, full ASCII keyboard, write protected fields of the display, non printable input (password input), viewing of screens already in memory while data is being received, enhanced prompting and additional LSI for cost reduction.

Removable Winchester Cartridge Protects R/W Heads

A removable data cartridge for the Lynx Winchester disk drive from Data Peripherals of Sunnyvale, CA, protects R/W heads from damage and guards against improper cartridge insertion into the drive. The sealed cartridge has an interlock that prevents an operator from opening the head access door by pushing on it.

The sealed cartridge mates with mechanisms in the drive that guide it during insertion. During approximately the final inch of cartridge travel, a

(continued on page 13)

Taiwan. Multitech International Corporation has developed a "Dragon" Chinese character I/O computer and a terminal. There are 35,000 ideograms (complex Chinese characters) in the official "Kang Hsi Dictionary"

...**Scotland.** David Simpson, president of Gould, Inc., told an audience of electronic engineers, here, that manufacturing plants operating in Scotland could, by 1990, be earning half the income made by US electronics companies trading in the European market.

"Any American firm," said Simpson, "that does not set up overseas manufacturing operations within the next five years will have to watch as their friends gobble up the market" ...**London.**

"Components '81" has cancelled its June show. The sponsoring organization, English Industrial and Trade Fairs, said that the cancellation was due to lack of support. There is a trend now away from the traditionally large shows to the less costly hotel-based exhibitions

...**Tokyo.** Fujitsu executive, Michio Naruto, recently compared American workers with Japanese workers.

"When a person comes to work for a Japanese company he becomes part of a corporate family. Workers are never laid off. They are retrained for better jobs. We make them more intelligent workers." Japanese are meticulous workers and they feel that Americans, by contrast, are sloppy. The big trouble with Americans, say some Japanese, is that the Americans buy cheap clothes instead of looking for fine stitching

...**South Africa.** Looking ahead to the future when the gold mines will run dry, companies here are beginning to invest in high technology. A factory making PCBs has launched a multi-million dollar expansion program. Another company is establishing a silicon diode plant that will turn out 25 million diodes annually ...**West**

Germany. Manufacturers of electronic data processing equipment in this country have boosted last year's sales by almost 13% (to about \$3.5 Billion.)

...**South Wales.** Mitel, a leading electronics manufacturer, is building a \$72 million plant to manufacture advanced electronic switchboard equipment, thick film hybrid microcircuits and ICs ...**Israel.** Fibronics, Inc., in

Haiffa, is marketing a new fiber-optic component which is used to pipe data between computers and peripheral equipment ...**France.** 74 international computer and computer-component companies have established main offices in this country. The companies include such giants as IBM, Westinghouse, Arthur D. Little, and Apple Computer ...**Switzerland.**

"SWISSDATA '81," an international computer exhibition (aimed at the OEM market) will be held in Basel, Sept. 8-12, 1981

...**The Netherlands.** Three information centers are being set up in this country. The centers will limit itself to documentation, information, orientation and advice. The centers will inform and advise companies on possible uses of microelectronics. The three centers (at Delft, Eindhoven and Twente) all have technical universities which will participate in the government-sponsored program

...**Canada.** The government is spending \$22 million in expanding its viewdata system which is competing for the US market with Britain's Prestel and France's Antiope

...**United Arab Emirates.** Sperry Corp. has opened an office in the city of Dubai. The office will serve as the Middle East regional office for the company. "There has been marked increases in business activity in the Middle East during the past year," said Spencer Ross, VP for marketing of Sperry. The company makes communications equipment, combat systems, simulators, radar equipment, guidance and control systems, test equipment and commercial marine systems

...**Sweden.** Facit Data Products of Stockholm has begun deliveries of its new low-cost printer. The printer (with a Z-80 μ P) handles all common European languages as well as ASCII and Katakana. It has a noise level under 60 dBA ...**Ireland.**

The availability of highly qualified computer personnel was the key reason for the recent decision by the UK Post Office to establish a Systems Software Engineering Center near Belfast. The center will develop software for electronic exchanges and other modern telecommunications equipment. The company will employ 200 graduate engineers and computer scientists.

(continued from page 12)

probe in the drive enters the cartridge and activates a mechanical linkage that opens the head access door. Mechanical interlocks prevent the cartridge from being fully seated if drive or cartridge mechanisms work improperly. These interlocks also prevent improper cartridge insertion; cartridges inserted backwards or upside-down cannot fully enter the drive. Once heads are inside a properly inserted cartridge, closing the drive front door cams the cartridge down onto the spindle and locks it in place.

The drive uses a 3330-type cartridge/spindle interface. Instead of a mating cone design used in other cartridges, the Lynx uses a cylindrical spindle. The cartridge has nine flexures that slip down over the top of the spindle and evenly distribute pressure around the spindle. This design helps ensure cartridge interchangeability since holding spindle tolerances during manufacturing is easier with cylindrical spindles than with conical spindles. The cartridge, which provides 11-MB of storage unformatted, is 8.2" square by 1" thick and weighs about 1-1/4 lbs.

Fiber Optic Costs Plummet

Fiber optics continue dropping in price, approaching the point where low cost/performance ratios will trigger a massive switch among OEM designers. Positioned in the center of this activity is Spectronics, a division of Honeywell, which announced a price cut of over 50% for its low-cost "Sweet Spot" fiber optic component series. The components include the Spectronics low-cost Sweet Spot LED and three photodetectors. These components are compatible with four lines of AMP connectors, and with the HDC interface developed jointly by Honeywell, DuPont and ITT Cannon.

The four AMP lines able to incorporate the Spectronics components are: the new, low-cost Optimate/field applicable connector; the Active Device Module (ADM) series capable of taking fibers from 125 μm to 1140 μm , the duplex connector series; and the SMA (Subminiature type A) line designed to meet NATO and IBC requirements.

The Spectronics emitter and photodetectors have the same semiconductors and micro-optical elements as those announced last May, however,

now they are available at lower cost. The Sweet Spot LED and each photodetector are for \$4.00 (1-k qty.); \$2.50 (50k); \$1.50 of (100k).

The three photoconductors include the medium speed detector (DC to a Mb/s), high-sensitivity PIN detector for up to 10 Mb/s and Schmitt detector (including on-chip signal processing).

These components are for high-volume markets. With the introduction of the new AMP low-cost commercial connectors and the Eska (Mitsubishi) plastic fiber, a 3-m, \$5.00 link is pos-

sible; when used with the Sweet Spot series, 20-m links can be assembled.

Spectronics components provide adequate performance for medium-speed data links to 30-m long and data rates to 30 Mb/s when used with the HDC Interface, which uses DuPont plastic core fibers and ITT Cannon connectors. Longer links, up to 1.5 km and 30 Mb/s are possible with other connector and cable types. A components starter kit (\$39) complete with LEDs, connectors and cables was available last month at Electro.

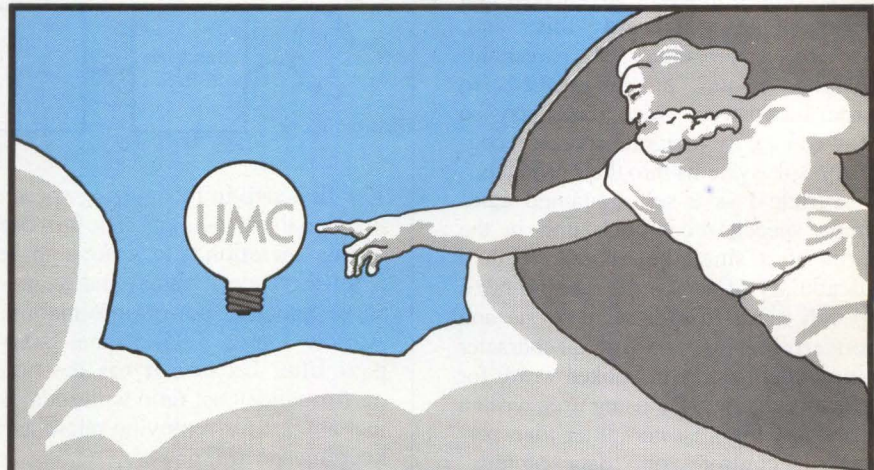

Want more zest in your PDP-11 ?

Plug a UMC into your PDP-11 and get a microprocessor system on your UNIBUS.

The UMC is a modular system of boards and support software. It plugs into your UNIBUS, shares work with your PDP-11 and gives you powerful independent processing.

Use the UMC system for terminal control or network attachment. Have it serve as an intelligent controller. Or use it for data acquisition, pre-processing or post-processing.

Since the UMC system is modular, it's flexible. It conforms and grows to meet your demands. Select only the UMC components that serve your specific needs:

UMC Processor Board. With Z80 microprocessor, 4K bytes static RAM, room for 16K bytes user PROM, 2 serial I/O lines and up to 3 DMA channels.

UMC Memory Board. Has up to 64K bytes RAM and space for 32K bytes PROM. Use multiple boards for extra memory.

UMC Serial I/O Board. Up to 16 full-duplex channels with independent microprocessors and programmable baud rates. Extra boards serve extra lines.

UMC Terminal I/O Board. Has 8 full-duplex RS-232C channels, a Z80 microprocessor, 32K bytes RAM and space for 16K bytes PROM.

UMC ProtoHex Board. For custom wirewrap work.

UMC Software Development System. Run it in your PDP-11 to support writing UMC programs.

UMC Software Application Packages. For various protocols 2770, 2780, X.25, HASP, 3270, ADCCP and others.

Now then, want to hear more about adding zest to the old PDP-11? Contact ACC right now.

ASSOCIATED COMPUTER CONSULTANTS

228 EAST COTA STREET, DEPT. N, SANTA BARBARA, CA 93101.
(805) 963-8801. TWX 910 334-4907.

Wire-Wrap is a registered trademark of Gardner-Denver Co. PDP and UNIBUS are registered trademarks of Digital Equipment Corp. Z80 is a registered trademark of Zilog, Inc.

Circle 11 on Reader Inquiry Card

Computer "Ears" Available For OEM Designers

Actually working with a voice data-entry unit is the best way for system designers to learn about speech recognition's inherent advantages and disadvantages. Toward this end, Auricle, a subsidiary of Threshold, designed a unit enabling OEMs to experiment with voice data-entry so they can easily integrate speech recognition sub-systems into their products.

Auricle-1 is a self-contained automatic speech recognition unit in the form of a single-board *mC*. With a vocabulary of 40 words, the unit takes speech input from a microphone and converts that input into digital character output identifying the spoken words for a host computer. By using user-written software, the host computer then performs "control" or "data capture" functions in response to verbal commands.

Auricle-1 accepts voice entries up to 1.2 secs long ("San Francisco" is about 1 sec) and compares them to entries stored on templates in RAM. Each user must create these templates by saying each utterance three times during a training session; these sessions need not be repeated, since they may be stored on magnetic media for future use.

During operation, users select how closely an utterance must match its template in order to be recognized. Auricle-1's recognition threshold must be set high enough to differentiate various sounds, but low enough so that it doesn't eliminate entries based on slight variations in speech quality. The unit cancels steady background noise automatically.

Auricle intends their first model, priced at \$2500, to be a tool for OEMs interested in incorporating speech recognition into their systems. For actual use in those systems, Auricle will offer a plug-in, single-board module consisting of 14 custom IC chips, onboard ROM and serial port, for less than \$500 in volume. The plug-in modules will be available in approximately ten months.

According to Ben Warren, Auricle

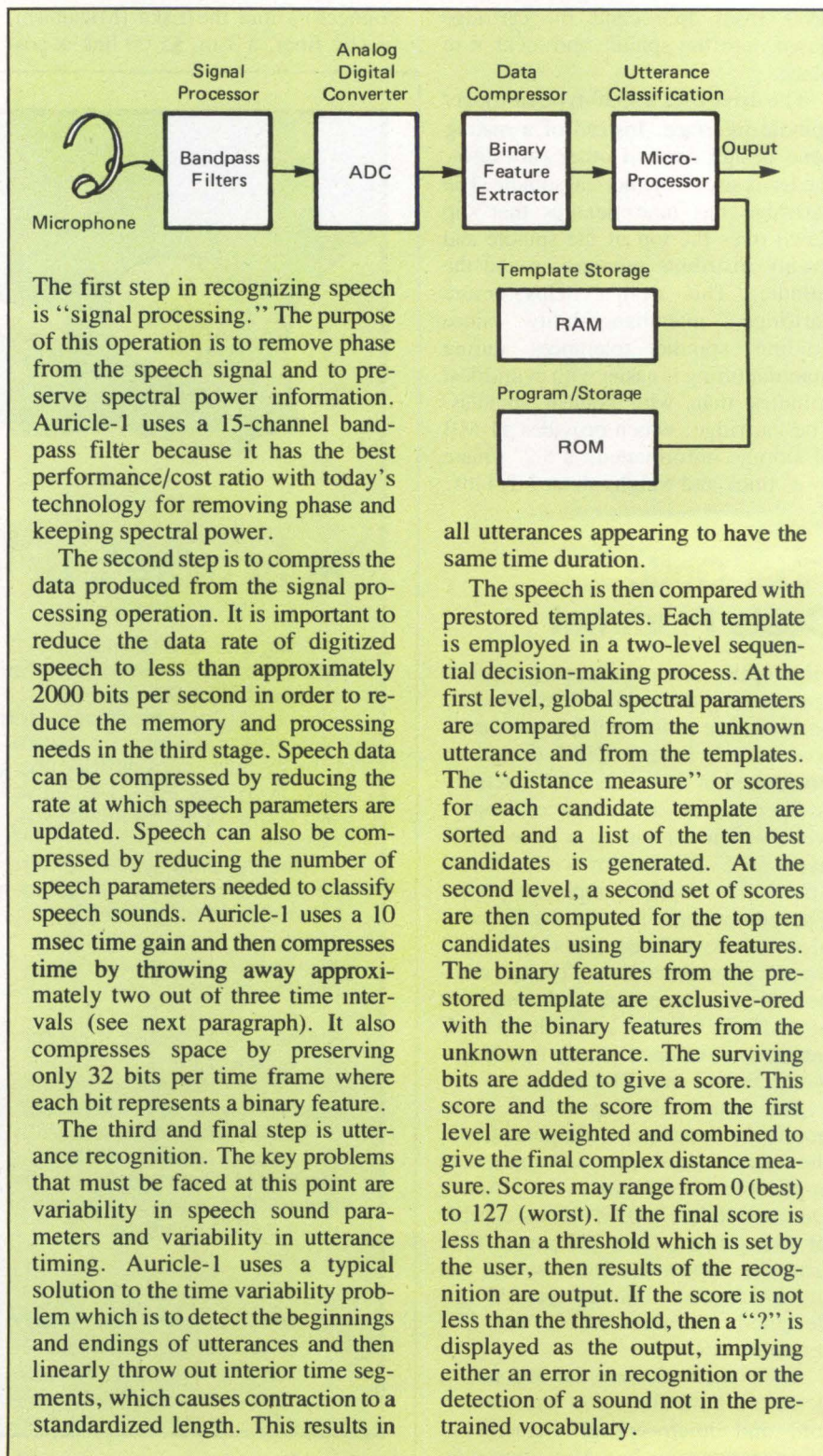

WE'VE ALWAYS OFFERED MORE GRAPHICS SOLUTIONS.



WITH ELECTROSTATICS, WE OFFER THEM ALL.

With the addition of electrostatics, CalComp has the broadest line of plotters available from any vendor. Whatever your application demands — flatbed, beltbed, continuous roll, computer output to microfilm or electrostatic — CalComp has a solution. And our sales representatives, graphics consultants with years of experience, will make sure it's the correct solution.

For plot previewing at an affordable price, our sales representative will introduce you to the new electrostatic printer/plotters. They're ideal for mapping, plot previewing, business charts and graphs and a host of other applications. And they function as a fast line printer as well.

Our representatives can help you select from a printer/plotter family that offers seven models, paper widths of 11" and 22" and plotting resolutions of 100 and 200 dots per inch. Plus, there's a wide range of operational and application software available.

When your plotter application requires a high degree of resolution or larger plots, our graphics professionals will still have the answer. Take our compact 1012 desk-top plotters for starters. You get crisp, clean 8½" x 11" or 11" x 17" size plots and the convenience of Z-fold paper.

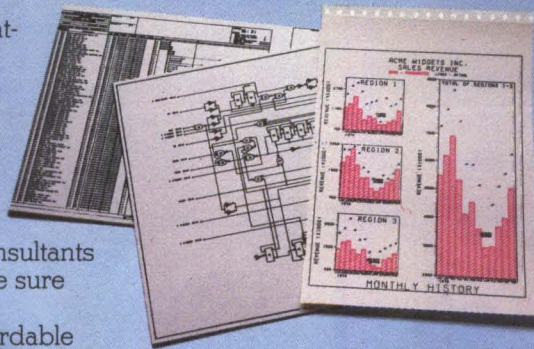

For bigger jobs, there are six other precision drum plotters to choose from. Including the industry's largest, our new 1065, with an extra-wide 72" drum that plots at 30 ips.

For the best of high-end performance, there's our 960 beltbed plotter. It delivers big 33" x 60" vertical plots. And nobody handles computer graphics on a grander scale. Our top-of-the-line

flatbed plotters — the 7000 System — literally draw away from the competition with a 43" x 59" plotting surface.

You also get a reliability guaranty you'd only expect from the graphics leader. All CalComp plotters are covered by our unique one year warranty on parts and labor. And our graphics consultants are backed by 22 systems analysts and over 100 service representatives in 35 cities — the most extensive service and support network in the plotter industry.

So, if you're looking for a solution to your graphic needs, call us today. We've got all the right answers.

CALCOMP
A Sanders Graphics Company

 **SANDERS**

California Computer Products, Inc., 2411 W. La Palma Ave., Anaheim, CA 92801 — Sales Offices: Tempe, AZ: (602) 894-9468, Orange, CA: (714) 978-7111, Santa Clara, CA: (408) 727 0936, Tarzana, CA: (213) 708-1093, Englewood, CO: (303) 770-1950, Altamonte Springs, FL: (305) 331-4615, Norcross, GA: (404) 448-4522, Schaumburg, IL: (312) 884-0300, Shawnee Mission, KS: (913) 362-0707, Metairie, LA: (504) 833-5155, Waltham, MA: (617) 890-0834, Southfield, MI: (313) 569-3123, Bloomington, MN: (612) 854-3448, St. Louis, MO: (314) 863-2711, Woodbridge, NJ: (201) 636-6500, Fairport, NY: (716) 223-3820, Cleveland, OH: (216) 362-7280, Dayton, OH: (513) 276-5247, Tulsa, OK: (918) 663-7392, Portland, OR: (503) 241-0974, Wayne, PA: (215) 688-3405, Pittsburgh, PA: (412) 922-3430, Dallas, TX: (214) 661-2326, Houston, TX: (713) 776-3276, McLean, VA: (703) 442-8404, Bellevue, WA: (206) 641-1925

Circle 12 on Reader Inquiry Card

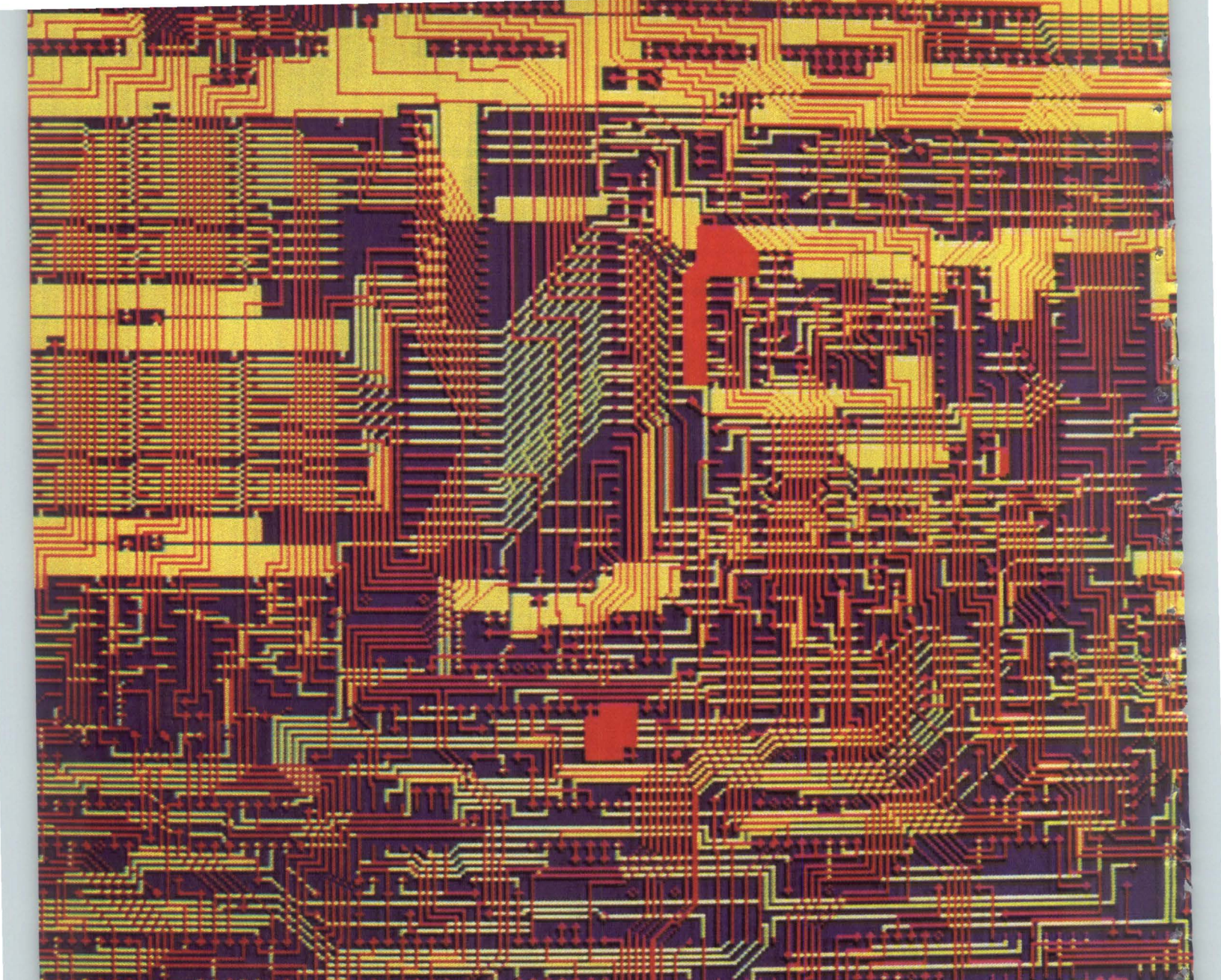

LEXIDATA

You're looking at a raster graphic* generated by the best family of high-speed, high-resolution processors, monitors, and peripherals available. *Dollar-for-dollar*, they'll outperform any systems you can buy.

Our System 3400 display processor, for example, updates at 2 μ Sec/pixel, draws vectors at 3 μ Sec/pixel, and generates 9 nSec pixels at 60 Hz

*Photo of actual CRT display.

refresh, for extremely fast, flicker-free displays at peak 1280 x 1024 raster resolutions.

Versatile Lexidata systems let you configure and program for your particular application...complex CAD/CAM or simple business graphics. Unique look-up tables give you the power to display 4096 colors (from 16.7 million hues) *simultaneously!* You'll create and manipulate graphics to the limits of your demands.

For details on a Lexidata raster display system, call (617) 663-8550 or write to us at 755 Middlesex Turnpike, Billerica, MA 01865.

 **LEXIDATA CORPORATION**

RASTER DISPLAYS...FOR THOSE WHO DEMAND PERFORMANCE

Circle 13 on Reader Inquiry Card

president, hardware design wasn't the limiting factor in designing their device, although procuring components did require some ingenuity: "There was, and is, a lot of difficulty getting switch capacitor filters with adequate performance commercially," he explains. "We additionally showed a different approach to the conversion process — we used a codec from the telephone industry, because it has a very good log characteristic and it has the A/D converter all on the same piece of silicone. And it was cheap, at \$6. So we get a good long converter, and a good A/D converter all for \$6, and we control that all from mP — there's no timing circuit."

Software design did pose some

obstacles, mainly in achieving the necessary accuracy required for the system within the unit's size and price constraints. "Originally, there was some hope we'd fit it into 2K bytes of ROM and 2K bytes of RAM," says Rick Parfitt, software design engineer, "and that was just not workable. The final product ended up at 6K bytes of ROM and 5K bytes of RAM. RAM is where the templates are stored, and we needed nearly three times as many bits in the templates to achieve the necessary accuracy."

That accuracy is greater than 99%. Auricle executives decided that anything less than 99% quickly discouraged users. Also, to compete against keyboard data-entry, Auricle had to develop comparable error rates.

Getting accustomed to using voice data-entry isn't as difficult as might be imagined, according to Warren. Apparently, just as typists learn not to

drum their fingers on their keyboard absently, Auricle-1 users soon learn not to make voice entries such as "er... hrrumph... thirty-nine."

Applications for speech recognition cover the entire realm of data entry, but seem most promising in "hands-busy" operations, such as testing and assembly. Auricle also sees applications in the office of the future, telecommunications, medicine (voice-controlled wheelchairs), and consumer products (cars, personal computers).

"People now ask 'why use speech recognition if you can just type it in?'" explains Warren. "We're hoping that soon people will ask 'why bother typing it in when it's so much easier to say it?'"

— Bob Hirshon

Auricle, Inc, subsidiary of Threshold Tech, Inc, 20823 Stevens Creek Blvd, Cupertino, CA 95014. **Circle 199.**

Image Processing Expands Into Low-End

Image digitizing and processing may be one of the smallest segments of the graphics industry (less than 4% of the total market), but it's one of the fastest growing. This is because new lower cost systems filtered down to low-end users, and innumerable new commercial applications shot up as a result.

Several companies supply this growing market; they include Colorado Video, DataCube, Digital Graphics, Matrox and Octek. Octek recently introduced a complete image processing sub-system on a PC board that comes supplied with software for under \$5K in OEM quantities. Their 15-inch x 15-inch board does video digitization and picture display, stores one to four pictures, performs image processing and communicates control and picture data to a Data General computer. Standard software includes fifty Fortran calls to aid operations; in addition, high level packages for inspection, robot vision and font digitizing are available.

Applications for Model 2000 blanket a previously untapped market of middle- to low-end users. For example, banks can use the 2000 to store pictures of their customers' faces and signatures with their account files for instant identification (**Figure 1**). According to Octek, a bank with 100K customers could store all of their signatures on a single 40-MB disk drive.

Inventory for a museum could be

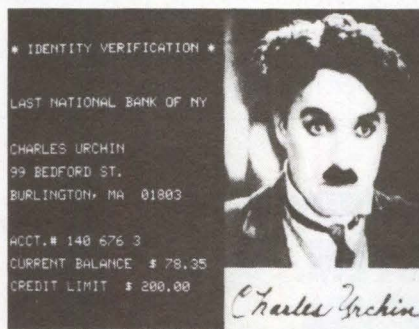

Figure 1: Bank accounting

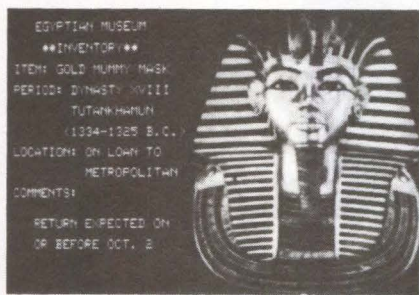

Figure 2: Museum cataloging

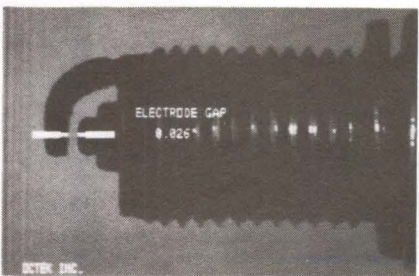

Figure 3: Automatic inspection

handled in a similar fashion, providing visual cues for researchers and staff cataloguers alike (**Figure 2**).

Automatic inspection is another application for Model 2000. By using a high quality television camera, or scanner, focused on a production line, the 2000 can analyze visual specifications of a product. An onboard 8X300 μ P can perform part of the processing, so measurements can be made in less than 0.5 secs on, for example, a spark plug gap (**Figure 3**).

Octek was founded by Arthur Fox and John Trombly, engineers working on a high-speed image processor. Out of that technology evolved the idea of digitizing and displaying an image simultaneously. Octek president John Trombly started the company with the intention of building a frame grabber. "After starting that project, we decided to do a market survey," explained Trombly. "We did a careful analysis of what was available on the market and what directions various companies were going in and at that point we redefined the product and added a lot of capabilities, such as the programmable μ P, that were not part of the original product."

Because Octek's unit (Model 2000) is EIA RS-170 compatible, it works with standard videotape cameras, recorders, monitors, etc. It converts incoming analog video into digital data, using a high-speed 4-bit A/D con-

verter. Digitized data then is channeled into a digital translation table for data transform functions. From one to four images can then be stored in image memory: if 16 grey levels are required, memory can store one picture, each pixel of the image becoming a 4-bit word representing one of the 16 grey levels. If fewer than 16 grey levels are required, a μ P can divide the memory into 3-, 2-, or 1-bit image planes, allowing storage of up to four images. Storage of one image field takes 1/60 of a second, since the memory and A/D converter are synchronized.

"The memory is a true dual-ported integration," says Trombly. "In other words, the μ P can access the memory at the same time as the video input is writing onto the memory."

Image memory is equipped with four video outputs. The primary output has a 16 grey level D/A converter, while the rest are binary, black and white video. When combined with a color monitor, these binary outputs allow display of 16 colors at a time from a software palette

of 64 colors. Or they can be used to operate multiple displays. A hardware character generator and graphics cursor are optional.

"Image data can be transmitted to or from the host computer by either Programmed I/O or Data Channel I/O (DMA)," says Trombly. "Under Programmed I/O, the onboard μ P handles all data exchanged. DMA transfers are processed by a separate onboard controller that controls the 2000's Image Memory directly."

Model 2000's onboard high-speed bipolar μ P, in addition to controlling the entire 2000 board, also performs data processing functions. It can, for example, sum large areas, read or load image data in blocks, and be programmed for special image-processing or analysis tasks.

Robot inspection requires an optional software package. Octek also sells a font-digitizing package for customers who want to generate fonts for dot matrix printers. These extra packages typically sell for several hundred dollars above the Model 2000 base price. Trombly says he plans to continue adding high level software packages for different customers.

Other future plans include possible

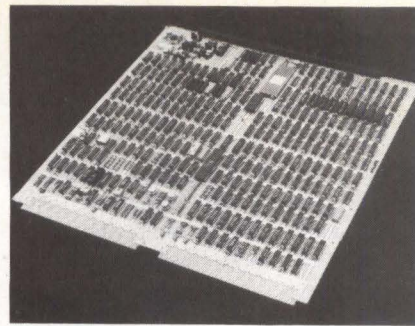

Model 2000, a single 15" x 15" board, plugs directly into the Data General host computer, providing video graphics/processing/analysis capabilities. Software provided with the 2000 makes the system immediately operational.

interfaces for computers other than Data General. Octek is currently beginning prototype shipments of a stand alone inspection system, including a low-end minicomputer, priced at approximately \$20K, user quantity one.

Model 2000 sells for under \$10K user quantity one, or under \$5K in volume quantities.

— Bob Hirshon

Octek, Inc, 7 Corporate Pl, South Bedford St, Burlington, MA 01803. **Circle 198.**

EXATRON'S RS-232C STRINGY/FLOPPY MASS STORAGE SYSTEM.



Mini-disk speed, capacity and reliability for only \$349.50.

- Standard RS-232C communications link
- Built-in operating system
- Two file management structures: ASCII and binary
- Three baud rates available: 300, 1200 and 9600
- Busy/ready handshaking supported

Call our **HOTLINE** ...
(800)-538-8559
In California,
Call **(408)-737-7111**



Exatron, Inc.
181 Commercial Street
Sunnyvale, California 94086
(408)-737-7111

Circle 25 on Reader Inquiry Card

IMPORTANT ANNOUNCEMENT

A red label on the cover of your magazine indicates that you must requalify at this time. This is your last chance to complete the qualification form, and return it to us before your name is removed from our free subscription list.

If you recently submitted a requalification form, we must ask that you do so again. Requalifying is necessary in order to conform to the standards of our new qualification form.

To avoid missing the next issue of **DIGITAL DESIGN** please return this form to us immediately. Make sure that ALL parts are filled in, as an incomplete form can not be processed.

Attention overseas subscribers: Due to the rising international postage and printing costs, overseas subscribers have to share the cost of postage. The charge for Surface Mail is \$15.00 per year, and the charge for Air Mail is \$35.00 per year. Please return completed form with your check to the Circulation Department. Your check must be payable in U.S. funds, drawn on a U.S. bank.

Before mailing your qualification form, please make sure that the red label is affixed to the address box on the form.

Thank you for your cooperation.

Electronics Test & Measurement Conference



October 5-8, 1981

Hyatt-Regency Chicago • Chicago, IL

**The Only Midwest Conference
and Exhibition Devoted Exclusively to
Test Instrument and ATE Technology**

Produced by *Electronics Test* and co-sponsored by *Circuits Manufacturing*, *Digital Design*, and *Design Engineering* Magazines.

Leaders in the ATE and test industry will focus on the technology and management involved with the

Electronics Test & Measurement Conference

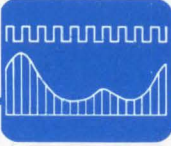

October 5-8, 1981

Hyatt-Regency Chicago • Chicago, IL

Technical Program

Four-day technical program of specialized courses, workshops and invited papers addressing the following problem areas:

Component Functional Testing

Functional testing of components is growing in importance at the same time that increasingly complex ICs are coming into wider use. This technical session together with companion workshops will focus on functional component testing problems as well as discussions of the latest developments in the technology. Topics include: methods for evaluating optimum economic levels of testing microprocessors and other VLSI components, and problems and solutions for testing op-amps, D/A and A/D converters and other analog devices.

Other problem areas this technical program track will address include: using component test data throughout the product design, acquisition, assembly and QA cycle; and recently developed methods using mini-computers to generate complex component functional test programs, where access to mainframe computers is limited or unavailable.

Leader: **John J. Theodore**, Senior Research Engineer, Lockheed Missile and Space Co., Sunnyvale, CA



• Responsible for managing test engineering for the SSD Microelectronics Center and Lockheed's Missile and Space facility • Directs and coordinates all test strategies, documentation and planning for optimum utilization of test engineering personnel resources • Responsible for the characterization of a wide variety of ICs, including GaAs logic and analog components, SOS gate arrays, and other silicon and microwave devices • Experience includes design, fabrication and testing of specialized circuits for spacecraft systems.

Effective Management of Test Resources

Because ATE has become a key productivity driver in factory production, implementation of ATE equipment must consider all other areas of production planning — for example, tie-ins to CAD and design for testability. Examples of how test data can be used most effectively to support QA functions will also be discussed.

In less than a decade, resources available to production floor test management have multiplied. In addition to computer-controlled test equipment, this technical program track will highlight software aids for generating effective test programs for various types of today's complex components and PCBs. This program will examine the two toughest problems facing corporate management: first, utilizing, developing and stimulating competent technical people and second, utilizing available equipment and capital resources effectively.

Specific topics include ways of increasing compatibility of test software destined for in-plant and field service use; top management's concerns regarding return-on-investment calculations for new ATE equipment, and the importance of test management making competent and orderly make-or-buy decisions and valid obsolescence projections.

Leader: **Paul J. Giordano**, Chief Executive Officer, Giordano Associates, Inc., Sparta, NJ



• 25 years experience in systems management and engineering • Consultant in product and program planning for major aerospace and commercial companies • Lecturer in ATE training programs for military managers • Former president of Instrumentation Engineering • Former head of advanced development for System Management Division of Sperry Rand • BSEE degree from City College of New York.

Understanding and Effectively Using Today's New Breed of Test Instruments

Recent rapid developments in IC technology have been accompanied by comparable developments in test instrumentation, and microprocessors have played a major role in these developments.

Thus, both workshops and session papers for this technical program track will emphasize how microprocessor-based (smart) instruments are changing the capabilities and application opportunities for test instrumentation. Compatibility problems with the IEEE 488 bus in production environments will be discussed in detail, as will experience with some of the instruments emerging as critical to test technology advancement, such as logic and waveform analyzers.

Other problem areas to be covered include waveform analysis, digital signal generation for testing charge-coupled devices and experience with mm-wavelength microwave measurement instrumentation.

Leader: **Stan Kubota**, Vice President, Interface Technology, San Dimas, CA

• Founder of Interface Technology, a Dynatech Co. • Involved in instrumentation providing stimuli for testing a wide range of digital systems • Responsible for design detail, product definition and product testing for Interface • Author of technical papers on microprocessor-based instrumentation and the use of the IEEE 488 bus interface • BSEE degree from the University of Hawaii.

Functional Burn-In Testing: Trade Offs and Solutions

Step-by-step descriptions of how to plan and operate computer-controlled burn-in and temperature cycling systems for typical industrial manufacturing operations will be detailed in this session and accompanying workshops. Topics include problems in setting up a small scale prototype operation for feasibility studies, and requirements for handling functional testing of boards and components during high-temperature burn-in. Engineering, manufacturing, QA, purchasing and management staffs who specify and evaluate burn-in materials, components or systems or who must assure quality based on burn-in procedures will benefit from this session and related workshops.

Leader: **Bob Scholl**, Engineering Manager, Eaton-Pacific Reliability, Sunnyvale, CA



•Managed burn-in and environmental testing responsibilities at National Semiconductor and at Microtest Systems • Experience includes all phases of burn-in from equipment specification to design and layout of systems • BS in Physics and MS in Scientific Instrumentation from the University of California.

Leader: **Jerry Koran**, Special Projects Manager, Eaton-Pacific Reliability, Sunnyvale, CA



•Nine years experience in ATE systems at Adar Associates and Eaton Macrodata • Test engineer and field service manager with Adar Associates • Developed high temperature burn-in facilities capable of parallel at-speed testing of memory boards • BS degree from University of Detroit.

Evaluating ATE to Achieve Cost Effective Testing

Trends and latest developments in both ATE hardware and software technology will be covered in this session and related workshops. Beginning with an introductory overview of current practices, a wide range of the key problems and opportunities facing ATE users will be detailed. Included are suggestions for optimizing make-or-buy decisions on ATE equipment and for evaluating options on investments in hardware vs. software.

Latest practices in digital, analog and hybrid testing, both at component and board levels will be covered, as well as continuity testing of large scale PCB interconnections.

Newcomers to the ATE field as well as managers responsible for new ATE systems will find particularly helpful the discussions of errors to avoid when getting ATE online. This track in the technical program will deal with specific problems in ATE testing of a wide range of different types of complex PCBs.

Leader: **Al Cota**, Department Chief, Circuit Pack Testing, Western Electric Co., Northern Illinois Works, Lisle, IL



•Manages production testing of a wide range of complex central circuit packs at Western Electric Northern Illinois Works • Formerly responsible for testing semiconductor storage memories for central office systems and central station switching systems circuit packs • Development engineer on magnetic memory testing and semiconductor memories at Western Electric's Hawthorne Works • BSEE degree from Milwaukee School of Engineering • MS Degree from Illinois Institute of Technology.

Exhibit

Comprehensive three-day exhibit of test and measurement equipment:

INSTRUMENTS: • Hand held Instruments — from DVM's to Logic Probes • Microprocessor Troubleshooting and Development Tools
• Automatic Measuring Instruments — meters, generators, analyzers, scopes, counters • Field, Depot and Maintenance Testers • Instrument Controllers • Calibration Instruments

ATE EQUIPMENT/SERVICES: • Handlers • IC Testers • Memory Testers • System Testers
• In-Circuit Testers • Bare Board Testers
• PCB Assembly Testers • Burn-In/ Temperature Cycling Systems • Cable/Wiring/ Harness Testers • Test Services • Interfaces

List of exhibitors as of April 1, 1981

ACDC ELECTRONICS
AEROTRONIC ASSOCIATES
AMERICAN ELECTRODATA
ANALOG DEVICES
ATE SYSTEMS
AUTEK SYSTEMS
CARLTON INDUSTRIES
CHATSWORTH DATA
COMPIC
COMPUTER AUTOMATION
CONTROL
DAYMARC
DIT-MCO INTERNATIONAL
EAGLE TEST SYSTEMS
ELECTRO-MECHANICAL
SYSTEMS

ELECTRONIC SYSTEMS and
PROGRAMMING
EVERETT/CHARLES TEST
EQUIPMENT
FAIRCHILD TEST SYSTEMS
GROUP
FLUKE AUTOMATED SYSTEMS
FTS SYSTEMS
GENRAD
HUNTRON INSTRUMENTS
INTERFACE TECHNOLOGY
INSTRUMENTATION
ENGINEERING
KEITHLEY INSTRUMENTS
LOGICAL SOLUTIONS
LUTHER & MAELZER

MARTIN MARIETTA AEROSPACE
MICRO COMPONENT
TECHNOLOGY
MICRO CONTROL
OSTBY & BARTON
PERCEPTION ELECTRONICS
PIER ELECTRONICS
PLANTRONICS/ZEHTEL
POINTMASTER
PRACTICAL TECHNOLOGY
PRAGMATIC DESIGNS
PYLON
Q CORP.
RACAL-DANA
RLG/SUBSIDIARY OF
COMPUTER CONSOLES

SENSITEK
SIEMENS
SOLARTRON INSTRUMENT
GROUP
SYSTRON-DONNER
T&B/CABLESCAN
TEST ENGINEERING SOLUTIONS
TEST SYSTEMS
THERMONICS
TRACE INSTRUMENTS
UTI
VIMTEK
VIRGINIA PANEL
ZIATECH

Short Courses

ATE: How to Select It—Apply It—Manage It

Faculty: **Arnold Greenspan**, *President*, AMG Associates
Ralph P. Anderson, *Product Line Manager*,
GenRad, Inc.

Description:

This course teaches the principles of automatic testing and their application to testing electronic assemblies. With emphasis on commercial ATE systems, the instructors provide an overview of all aspects of automatic testing, including hardware, system software, test application software and the tools used to develop, apply and manage a total ATE site or application. The course should prove of greatest value to engineers and managers who are newcomers to ATE, particularly those who are establishing and managing new applications. No prior experience in ATE is assumed, but attendees should have a basic understanding of electronics and the general capabilities of digital computers. The instructors encourage active participation by the attendees and will aid them in solving specific problems of interest to the class.

Introduction to Digital Testing

Faculty: **Lutz P. Henckels, Ph.D.**, *President*, HHB, Inc.
Rene Haas, *Executive Vice-President*, HHB, Inc.
Andrew Herman, *Director of Test Engineering Institute*, HHB, Inc.

Description:

This course provides a thorough treatment of all aspects of digital testing. It is intended for people who want to broaden their understanding of digital testing either as programmers or as supervisors of a test operation. The student is first introduced to the concepts of incircuit and functional digital testing. Following the presentation, the class will program, test and diagnose a board on paper thus applying the above concepts. Thereafter, the hardware and software elements of both functional and in-circuit ATE systems are discussed in detail.

The course concludes with a "how to test" discussion for microprocessor boards. This presentation includes a detailed discussion of design for testability rules, programming techniques, diagnostic considerations and interface adaptor design.

Advanced ATE Technology and Management

Faculty: **Philip C. Jackson**, *President*,
Giordano Associates, Inc.
Paul J. Giordano, *Chief Executive Officer*,
Giordano Associates, Inc.

Description:

Focusing primarily on commercial applications of automatic test systems to factory and depot testing, this 2-day course covers such topics as component test and the use of systems and subsystems for diagnostics and go/no-go screening. The course provides an overview of the state-of-the-art of ATE technology: description of ATE elements, ATE acquisition process, design for testability, testing requirements and test program set generation. It includes a review of ATE hardware/software, state-of-the-art ATE configurations and future trends in ATE design. Finally, it gives members of the commercial sector an overview of military ATE: the criteria employed by major military programs to evaluate investments in ATE R&D funding, how these initiatives will affect available technology for commercial ATE and the impact of new military ATE concepts on aerospace manufacturers supplying equipment to that market.

ATE Software Tutorial—Definitions, Strategies, Languages, Applications

Faculty: **Damon C. Hart**, *President*, Lexico Enterprises, Inc.
Roger L. Williams, *General Manager, Applications Support Division*, Lexico Enterprises, Inc.

Description:

Educating the attendee on all aspects of ATE software, this course starts with introductory material for the beginner and builds up to advanced material for software engineers already familiar with test programming and control software. Specifically, the instructors give useful definitions and nomenclature; discuss the history of software; describe software views of test strategies; thoroughly cover test languages; review test system architecture including support, control and test application software; carefully analyze all the stages required for test program development; analyze the effectiveness of various software development tools; talk about software procurement and predict future trends for ATE software.

For further information contact Dona Atwood,
Electronics Test & Measurement Conference, 1050 Commonwealth Ave., Boston, MA 02215 (617) 232-5470.



Please send me further information on the Electronics Test & Measurement Conference.

DD 5/81

Please send me details on:

- attending the Technical Program and Short Courses
- exhibiting at the Electronics Test & Measurement Conference

Name _____

Company _____

Address _____

City _____ State _____ Zip _____

Phone _____

Return coupon to : Dona Atwood, Registrar, Electronics Test & Measurement Conference,
1050 Commonwealth Ave., Boston, MA 02215 (617) 232-5470

Plotter Showcase

What is a plotter? The most restrictive sense of the term includes only pen plotters; the most liberal includes almost anything that makes any sort of a mark on paper. The problem is that all alphanumeric printers are capable of making crude graphics, and many now come with graphics packages enabling them to produce more sophisticated art. Yet there are so many more printer manufacturers than true plotter manufacturers, it would be counter-productive to include them all. Therefore, this showcase includes those manufacturers who produce, in the opinion of the editors, devices whose primary function is producing graphic hard copy. These devices use not only pen plotter technology, but electrostatic, thermal, photographic, laser-photographic, dot matrix impact, xerographic and ink jet techniques. Printers that plot graphics as a secondary function, as well as graphics software packages enabling them to do so, will be listed in our "Printer/Printer Components Showcase."

Although this showcase represents the most comprehensive listing of graphic hard copy manufacturers to date, some omissions may have occurred. For inclusion in future listings, write to Showcase Editor, **Digital Design**, 1050 Commonwealth Ave, Boston, MA 02215.

Color Ink-Jet Drum Plotter. The Satellite plotter employs ink jet raster drum plotting technology to produce high-quality color graphics on a choice of media at high speeds. Can produce plots for immediate use or color separated plots for offset printing plates. Resolution is 125 points per inch; paper size is 22" x 34". Thousands of colors are possible via COLOR software that automatically defines matrices of picture elements and varies the number of filled elements. Model CP5586 works off-line from 9-track magnetic tape and is used in seismic data analysis, printed circuit design, mapping, remote sensed data analysis, and graphic arts. Another type of graphics plotter, the AGS/AP53, is high-accuracy, high-speed dual-mode graphics output subsystem combining line plotting and photoplotting techniques. Typical applications include photoplotting onto film or photosensitive glass, and plotting ink line drawings onto vellum, Mylar, or other media. **Applicon, Inc**, 32 Second Ave, Burlington, MA 01803. **Circle 283**

Drafting and Digitizing Systems. Aristo produces high-quality precision drafting equipment for surveying, graphics arts, aerospace design, and electronics

development. MAZ 038 is a manual drafting machine, with dotting accuracy of ± 0.02 mm. Unit can draft with lead cartridges, ball-point pens, ink drafting units, and engraving and cutting devices for cutting on coated drafting media. Utilizing a circular, rotating drafting surface, this model is intended for creating artwork masters for integrated circuits, among other applications. Other models are available for manual, semi-automatic or fully-automatic drafting. **Aristo Graphics Corp**, 6 Emery Ave, Randolph, NJ 07869. **Circle 284.**

Precision Flatbed Plotter. High-Speed, precision plotting in wet ink characterizes the Mark 4 plotter line. These plotters accommodate four "D" size or two "E" size drawings. They use up to four ball-point or wet-ink pens on vellum or Mylar plastic. Drawing speeds range up to 28 inches/sec. Resolution is 0.001 in, accuracy is ± 0.003 in, and repeatability is ± 0.001 in. Designed for use with an Auto-trol graphics system, Mark 4 has a minicomputer controller providing flexibility in support of maintenance diagnostics, accuracy compensation, and speed control. **Auto-trol Technology Corp**, 12500 N. Washington St, Denver, CO 80233. **Circle 285**

High-Speed Drum Pen Plotters. Benson offers a large range of incremental drum plotters with plotting widths ranging from 13" to 36". Model 5342 is the only plotter that can use all popular sizes of drawing media, from "A" through "E". Unit also offers auto-adhesive

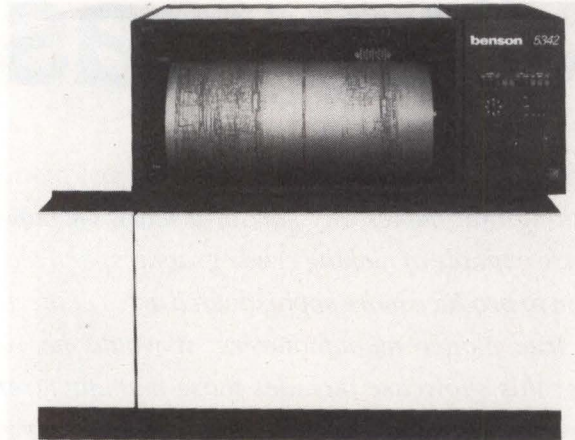

paper hold, manual or automatic selection of 4 pens, push-button selectable drawing speed and 0.0125mm resolution. A variety of fanfold-paper incremental drum plotters offer axial speeds ranging from 5 to 25 cm/sec. Liquid ink pens assure uniform line width; ball point and fiber-tip pens can be used for less exacting work. A line of electrostatic printer/plotters, Series 9000, is also available from this manufacturer, in widths from 11" to 36". Top of the line is the new Quadrascan, providing high-quality copy from four offset rows of writing styli, at a speed of up to 560 lines per minute. **Benson**, 385 Ravendale Dr, Mountain View, CA 94043. **Circle 286**

Incremental Single-Pen Plotters. These drum plotters plot on roll, fanfold, nine-inch wide paper. Resolution and repeatability is 0.004 inches. Two models are available, one with paper movement and pen speed specs of 667 steps/sec and another spec'd at 480 steps/sec. Both interface directly to most computers and offer optional systems processor and input digitizer. Models currently available are 600-500 and 600-501. **Broomall Industries**, 700 Abbott Dr, Broomall, PA 19008. **Circle 287**

Digital Incremental Drum Plotter. The Model 106X series is a wide format, high performance line. Model 1060 has a 54" wide drum, and Model 1065 has a 72" wide drum. Both have a maximum axial drawing speed of 30 ips, acceleration rate of 2G and resolutions of 0.0005 inches. Linear pen actuation allows fast up/down pen times. Four program-selectable pens plot on translucent, rag, vellum or Mylar media. Another product line is the Model 5000 series of electrostatic plotter/printers, for high speed hardcopy production.

Using 22" roll paper, these units plot at from 100 to 200 dots per inch and at speeds up to 2.9 ips. Plot speed and quality is independent of plot complexity with electrostatic technology. **CalComp, Inc**, 2411 W. La Palma Ave, Anaheim, CA 92801. **Circle 288**

Large Flat-Bed Plotters. Manufacturer claims these flat-beds compare favorably with units selling in the six-figure price range. The line uses open loop stepping motor design free of any servo-type adjustment. Manual controls provide for Auto Run, Auto Stop, Pen Up, Pen Down, Move Left, Right, Up Down and Rapid Travel. Surface is tiltable from horizontal to 70 degrees. Vacuum and backlit surfaces available. Standard step size is 0.001" at 0.005" accuracy. **Computer Talk, Inc**, PO Box 148, 2800 South Rooney Rd, Morrison, CO 80465. **Circle 289**

DG Incremental Digital Plotter. Specifically designed for computer graphics, Model 4017E operates on-line, off-line, or with time-sharing systems. Compatible with all Data General computers and fully software supported, the plotter makes reproducible ink plots of graphs, charts, and drawings, annotated with alphanumeric characters. Manufacturer claims the plotter's output is especially suited to engineering applications, since the plots require virtually no drafting to meet specifications. Speed is 300 increments per sec, with increment size of 0.01 inches, 0.005 inches, 0.25mm or 0.1mm. Fanfold paper can be 8-1/2" x 11" or 11" x 17". **Data General Corp**, Westboro, MA 01581. **Circle 290**

Automatic Design Drafting Plotter. Producing high resolution output (0.0025") at high throughput speeds (16 inches per sec), this plotter is aimed primarily at engineering applications. Overall plot area is 34"

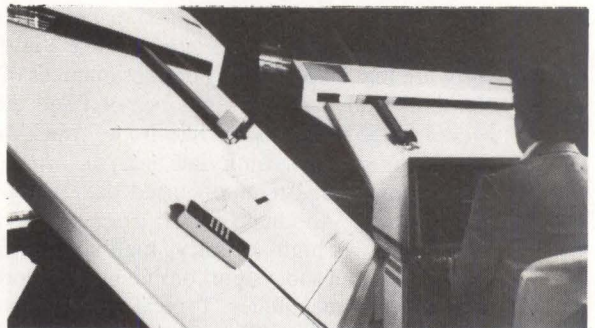

by 54" on "E" size paper. Model 3454 interfaces with most on-line and off-line devices, including all mini-computers. Unit's simple design is stressed by the manufacturer; the only moving mechanism is the drafting arm that holds the pens. During plotting, the drawing is always in full viewing position. **Data Technology, Inc**, 4 Gill St, Woburn, MA 01801. **Circle 291**

Color Camera Systems. The 630 Series comprises three highly automated, stand alone Color Camera Systems, providing a range of photographic and electronic options and accessories. All produce hard copy from raster scan graphic terminals. Model 632 is

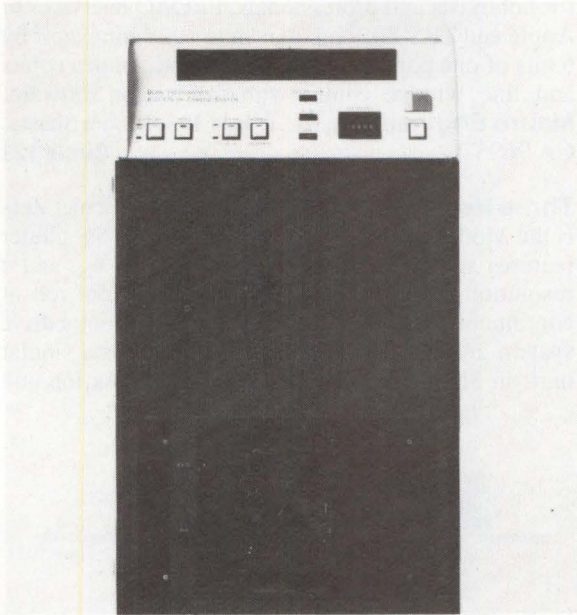

designed for those whose needs are limited to smaller formats. No standard output, but 2" x 2" slides, SX70 prints, 4" x 5" prints and transparencies, and 16mm or 35mm cine animation are all available formats. Model 631's standard format is 8" x 10" prints or transparencies, with other output optional. Model 633 provides multiple-image output. **Dunn Instruments, Inc.**, 544 Second St, San Francisco, CA 94107. **Circle 292**

Photographic Plotter. This large-format recorder handles 42 x 60 inch plots. Approximate plotting speed is 100 inches per second; resolution is from 0.001 to 0.005 inches. **Geo Space Corp.**, 5803 Glenmont Dr, Houston, TX 77036. **Circle 293**

High-speed Photoplotting System. New model 41 features a plotting speed of 275 inches per minute and 1 mil accuracy. Plotting area is 16 x 20 inches. Repeatability and resolution are both 0.5 mil. Model 41 can be used with Gerber's 6000, 6200, 4400 and 4300 controllers or with the turnkey PC 800 model 2 CAD system. **Gerber Scientific Instrument Company, Inc.**, PO Box 305, Hartford, CT 06101. **Circle 294**

Thermal Graphics Printer. Using fixed head, thick film linear array, Microplot-44 is designed for use with μ P-based systems where analytical or computational data has already been generated in digital form. Unit is

a hard copy output device for producing finished plots and graphs. Its μ P-based electronics provides a fully programmable graphics interface allowing mixing of a variety of printing and plotting capabilities. Resolution is 256 dots. Provides 96 character ASCII and 44-column printing. **Gulton Industries, Inc.**, Gulton Industrial Park, East Greenwich, RI 02818.

Circle 295

Low-Priced Drafting Plotter. Costing half as much as comparable plotters, according to the manufacturer, this device is neither a drum plotter nor a flat-bed. Instead, the 7580A grips media (paper, vellum, or double matte polyester film) with pinch wheels. The plotter automatically senses media size (from 8" x 10.5" to 24.5" x 46.85") and establishes border around the media edge to restrict pen motion. Unit uses roller ball, fiber tip, or liquid ink drafting pens. Resolution is 0.025mm and repeatability is 0.050mm. H-P also introduced a new line of 8-pen flat-bed plotters, allowing up to eight different colors on a single plot without operator intervention. Models 7220C, 7220T, 7221C, 7221T, 9872C and 9872T all feature air-cushioned pen mechanisms and increment size of 0.001 in. A wide variety of interfaces and options is available. **Hewlett-Packard**, 16399 W. Bernardo Dr, San Diego, CA 92127. **Circle 296**

Hi-Plot Flatbeds. This line of plotters includes desk-top units with and without μ Ps. Models DMP-2,3 and 4 use 8-1/2" x 11" paper, while models 5, 6 and 7 use

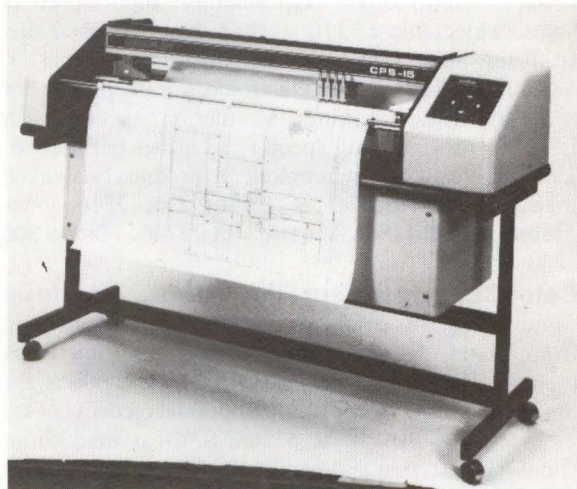

11" x 17". Models 6 and 7 can be mounted vertically as well as horizontally, to provide versatility for the system builder. Plot speeds range from 2.4 to 3.0 inches per sec. Use of Houston Instrument's DM/PL language permits minimum software burden on the host computer. A new option allows all plotters in the line to use six pens to produce multi-color graphs or charts.

Company also produces larger format Complot line. **Houston Instrument**, One Houston Sq, Austin, TX 78753. **Circle 297**

Color Dot-Matrix Graphic Printer. Uses four-color cartridge ribbon for printed copy of color display data. Color printed material can include reports, charts, graphs, symbols and designs. Model 3287 prints at a resolution of 64 dots per inch through an IBM 3274 control unit. Medium is plain fanfold paper; speed is 2 min./four-color plot. Models available with print speeds of 80- and 120 characters per sec. **IBM Corp.**, 1133 Westchester Ave, White Plains, NY 10604. **Circle 298**

Desk-top Color Camera. Produces small format color hard copy from NTSC video signals; interfaces with most raster color graphics terminals. Model 3000 works with personal computer systems, while model 5000 attaches to higher resolution graphics systems. Models also are compatible with videodisk, videotape and video camera systems with freeze frame capability. Film formats include 4" x 5", 3-1/4" x 4-1/4", SX70 and 35mm. RS232C interface is optional. **Image Resource Corp.**, 2260 Townsgate Rd, Westlake Village, CA 91361. **Circle 299**

Flatbed Drafting System. EDP-11/75 is a high-speed, standalone flatbed that can be augmented with hardware and software to build a complete interactive graphics system. Resolution of the three-pen system is 0.001", with ± 0.003 " repeatability. Input speed is switch-selectable at 110 to 9600 baud. Flatbed tilts from full horizontal to 55 degrees. Plot size is 54" x 48". The ETP/1 is an electronic terrain plotter for semi-automatic drafting. Resolution specs match EDP-11/75's; plotting speed is 35 inches per second. Unit couples with a stereoplotter to produce final inked manuscripts. **Keuffel & Esser Co.**, 7816 Jones Maltsberger Rd, San Antonio, TX 78216. **Circle 300**

Color Copy on Instant Film. Using standard instant camera film, this color camera line produces hard copy from raster display terminals. Standard interfaces include RS-170 and RS-330; RS-343 and others are optional. Media (some require optional camera backs) include 8" x 10", 4" x 5" and SX70 prints, 35mm slides, and 16 mm and 35mm cine. Basic model 2000 takes standard 8" x 10" prints; model 4007 allows multiple images on single film sheets. Print speed for an SX70 picture is about 1.5 mins. **Matrix Instruments**, 230 Pegasus Ave, Northvale, NJ 07647. **Circle 124**

Multi-Format Pen Plotter With Unique Paper Drive. According to the manufacturer, this inexpen-

sive plotter, called PROAC, has a multi-point paper drive that allows superior accuracy. The compact unit (6" x 6" x 17") uses standard 8-1/2" x 11", 11" x 17" or 11" wide continuous roll paper, and draws at 2.5 inches/sec with 0.005 inch resolution. Intended both for hobbyists and professionals, PROAC interfaces to Apple and TRS-80 computers or to other computers by 6 bits of one parallel output port. Choice of pen colors and line widths; comes with full vector software. **Mauro Engineering**, Rt. 1, Box 133, Mount Shasta, CA 96067. **Circle 123**

Three New Drum Plotters. New from Nicolet Zeta is the Model 5400 digital drum plotter. The 54" plotter features speeds of 35 ips, acceleration of 4g, and a resolution of 0.0125mm. It holds a 240 foot roll of continuous feed paper and features a servo-motor drive system and two 16-bit μ Ps. Model 3620 is a similar unit, in 36" form. Model 1453 is a 12" desk-top unit

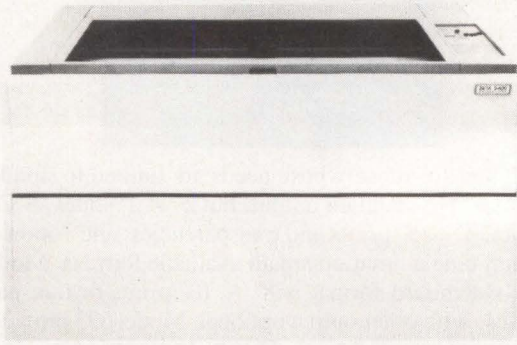

with speed and resolution manufacturer claims is comparable to other 36" plotters. Features hardware character generator that creates 214 characters; also, a microcomputer-based controller, 15 ips speed and 0.001 inch resolution. Zeta also produces plotter work stations and electrostatic printer/plotters, in addition to their digital drum plotter line. **Nicolet Zeta Corp.**, 2300 Stanwell Dr, Concord, CA 94520. **Circle 122**

High-Speed Digital Color. Series 4000 is a family of color image processing systems for scientific, industrial and graphic arts applications. These rotating drum, modulated light systems plot on photographic film, offering fine resolution (2000 lines per inch), geometric accuracy (.00008 inch), and continuous color fidelity. All models operate under normal lighting conditions and provide complete user control over color expression. Capable of 256 discrete and repeatable intensity levels per color. Direct interface to most minicomputers, or magnetic tape for off-line use. **Optronics International, Inc.**, 7 Stuart Rd, Chelmsford, MA 01824. **Circle 121**

Desk-Top Color Ink Jet. Using 12 ink-jet nozzles, IS 8001 produces color graphics on 11" × 15" continuous form plain paper. Features quiet operation (50dBa), low cost per page (10¢) and quick speed (2 minutes per page) all in a desk-top unit. Also has μ P with 8K ROM and 16K RAM and continuous copy feature. Applications include business graphics, process control, and inter-office reports and records. **PrintaColor Corp**, 5965 Peachtree Corners East, Box 52, Norcross, GA 30091. **Circle 120**

Drop-In Color Cartridge Printer/Plotter. Featuring separate cartridge ribbons and print heads for each of the four primary colors, manufacturer claims model 4100 eliminates muddy colors due to ribbon contamination. Interface is standard 8-bit parallel, Centronics compatible. Prints on standard fanfold paper at approximately 3 minutes per page at a resolution of 68 dots per inch. Controlled by Z-80 μ P, unit accepts input from a raster refresh graphic system. Designed for use in business systems, CAD/CAM, command and control, and graphic work station applications. **Ramtek Corp**, 2211 Lawson Ln, Santa Clara, CA 95050. **Circle 119**

Large-Format Precision Laser Film Recorder. These film recorders use argon-ion laser and rotating drum techniques, and handle formats up to 40 × 72 inches. Absolute accuracy is 20 microns, and incremental accuracy is 2.5 microns. Input is coded digital from any source. Although developed for graphic arts applications, these recorders, says the manufacturer, can easily be adapted to other applications, including many that now use X-Y film plotters. Applications are in publishing, printing preparation, cartography, seismography and remotely sensed data recording. **Sci-Tex North America**, 75-D Wiggins Ave, Bedford, MA 01730. **Circle 118**

Eight-Pen Intelligent Plotter. This Z-80 controlled pen-plotter offers a number of features unique to its price range, including programmable pen select of 8 pens — either nylon-tip or Koh-i-noor technical pens — with various line thicknesses and colors. Electrostatic paper hold grips paper up to 11.5" × 16". Accuracy is 0.1% of full scale and repeatability is ± 0.1 mm. Model 281 is available with three different interfaces, allowing nearly universal use with mini-computers, microcomputers, desk calculators, measuring systems and offline instruments. Digitizing function uses special digitizing "sight" to transfer point coordinates to a computer. Options include programmable paper advance, special character and/or user defined functions, and input buffer expansion. **Soltec Corp**, 11684 Pendleton St, Sun Valley, CA 91352. **Circle 117**

Low-Cost Drum Plotter. This desk-top unit uses four-phase stepping motors to provide drum rotation and linear pen motion. Step size is 0.004 inches along each axis. Drum is designed to accept 8-1/2" × 11" paper, and pen holder accepts a wide variety of commercially available pens. In addition, Model 100 features an interactive digitizing mode to enter X-Y coordinate data into the computer. Unit can be interfaced to any computer through two parallel 8-bit output ports and one 8-bit input port. Strobe provides assembly language vector software support for 8080/8085, Z80 and 6502 μ Ps. **Strobe, Inc**, 897 Independence Ave, Bldg. 5A, Mountain View, CA 94043. **Circle 116**

Interactive Digital Plotter. This flat bed plotter line includes models that plot on "B" size (11" × 17") and "C" size (17" × 22") paper or plastic. Both are μ P controlled and use a variety of pen types and colors. Interfaces include RS232, IEEE488, TTY, and Current Loop. Options include paper advance, circular interpolation, macros and expanded buffer. Applications cover business and science data analysis, computer-aided design and drafting, mapping, and architectural design. Recently introduced is an enhancement that allows Tektronix plotters to plot using eight pens. **Tektronix, Inc**, P.O. Box 500, Beaverton, OR 97077. **Circle 115**

Multicolor Ribbon Matrix Printer/Plotter. Offering the first multicolor matrix printer/plotter, Trilog now offers several models, with print resolutions of 60-, 100-, and 144-dots per inch. Interfaces include RS232 and Centronics compatible. Proprietary bidirectional paper drive system allows dot registration accuracy within $\pm .005$ inches, as well as plotting and printing on same line. Medium is plain, single-part, fanfold, edge-perforated paper, 4 to 16 inches wide. **Trilog, Inc**, 17391 Murphy Ave, Irvine, CA 92714 **Circle 114**

From Desk-Top to Six-Foot Electrostatic Plotters. Versatec's line of electrostatic plotters ranges from desk-top size all the way up to models like the 8272 that plot on paper six feet wide. Resolution for the 8272 is 200 dots per inch. Series V-80 also prints at 200 dots per inch, but on standard size paper. V-80 printer/plotters turn out 1000 lines of copy per minute, and are quiet and compact. Plots, regardless of complexity, take about seven seconds each. A simultaneous print/plot feature allows users to mix graphic and alphanumeric data. For on-line plotting, V-80s interface to a wide variety of computers. Versatec makes a number of other models of plotters, printer/plotters and display terminal copiers. **Versatec**,

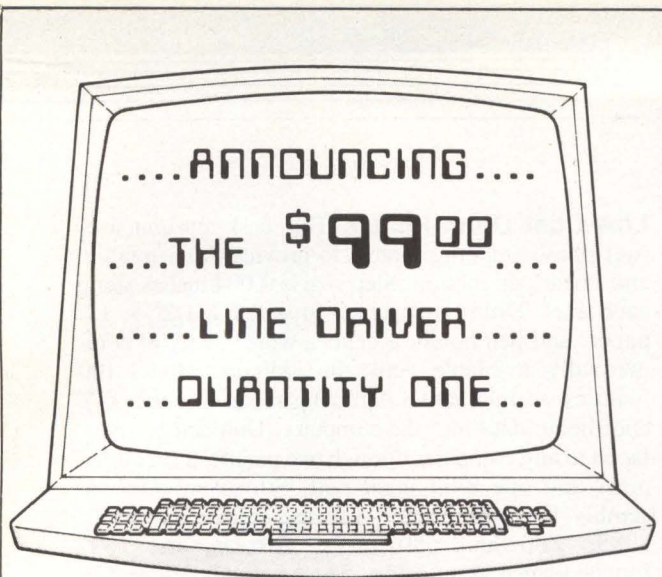

The bo-sherrel M-3 Asynchronous Line Driver provides full duplex data transmission over regular 4-wire lines. It is end-to-end compatible with bo-sherrel's M-1 Short Haul Modem, but requires power from the attached terminal.

bo-sherrel co.

6101 Jarvis Avenue
Newark, CA 94560
415 + 792-0354

Quantity:	Price:
10 - 99	\$83.00
100 - 999	\$67.00
1000 - UP	\$51.00

Circle 14 on Reader Inquiry Card

CORDLESS MATRIX BOARDS
SEAELECTROBOARD
FOR PROGRAMMING

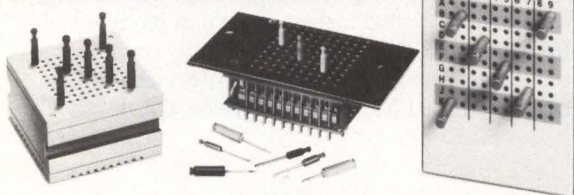

The reliable, common-sense way to switch and program any process or sequence of events. The ideal man-to-system interface providing instantaneous read-out or program changes anytime, anywhere. Multiple switching from any input to any output. Non-polarized or diode connections. Matrix available in .250", .100", or 4 mm spaced hole patterns. Boards can be supplied in 2, 3, 4, 5 or more switching planes. Standard or custom matrix patterns. Exclusive Seaelectro contact design for highest reliability, top performance and longest life. Write for complete Seaelectroboard data file.



PROGRAMMING DEVICES DIVISION
SEAELECTRO
CORPORATION
MAMARONECK, N.Y. 10543
PHONE: 914 698-5600 TWX: 710-566-1110
Seaelectro West:
14011 Ventura Blvd., Suite 215, Sherman Oaks, Ca. 91423, (213) 990-8131
1901 Old Middlefield Way, Suite 19, Mountain View, Ca. 94043 (415) 965-1212
Seaelectro Ltd., Portsmouth, Hants, England
Seaelectro S.A., Zone Industrielle Toulon Est, 83087 Toulon Cedex, France

CIRCUIT COMPONENTS ■ R. F. COMPONENTS ■ PROGRAMMING DEVICES

Circle 15 on Reader Inquiry Card

A Xerox Co, 2805 Bowers Ave, Santa Clara, CA 95051

Circle 113

Intelligent Microcomputer Plotter. Connecting to any microcomputer, this pen plotter produces graphs and drawings using any hard fiber-tip pen. Makes solid and broken lines and generates letters, numerals and symbols, which may be rotated to four orientations. Includes self test mode and printer mode. Plotting area is 360mm x 260mm; speed is 50mm/sec; step size is 0.1mm; and accuracy is within 1%. Features straight-forward single cable connection. **Watanabe Instruments Corp.**, 3186-D Airway Ave, Costa Mesa, CA 92626.

Circle 112

Xerographic Color Printer/Plotter. The 6500 CGP accepts digital input from color graphic terminals of those companies that supply interfaces (including Ramtek, Tektronix and Chromatics). Copy is quick (0.3 min/plot), sharp (100 dpi), and cheap (.06¢ per copy). Plots on plain paper or transparency material; option allows making paper or transparency material copies of 35mm slides. Method employs laser sensitization of photosensitive drum that picks up color toners one at a time and delivers them on paper or plastic material. **Xerox Corp.**, Xerox Sq, Rochester, NY 14644.

Circle 111

Automatic Drafting System. Model 1100 automated drafting system is a flatbed plotter for use in a variety of drafting applications. Featuring 0.001" resolution, ± 0.005" plotting accuracy, and ± 0.001"



repeatability, Model 1100 plots over an effective area of 43" x 56". Speed is 28 ips per axis and 40 ips diagonally. Acceleration is up to 3g on diagonal. Model 1100 creates, among other things, wiring board diagrams for machine tool control. **Xynetics Inc.**, 2901 Coronado Dr, Santa Clara, CA 95051.

Circle 110

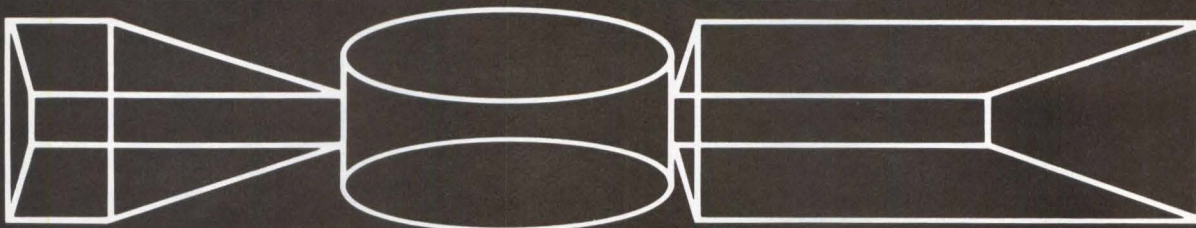

VGM

Great visual applications need a great graphics system

VGM® — The Virtual Graphics Machine

A truly great graphics system providing a rich set of operations, developed for flexibility and device independence. This will allow your own applications to drive any graphics device without software alteration. VGM is designed to support any output configuration based on any display technology, be it raster, vector, storage or hardcopy and any input device such as lightpen or joystick. With VGM you concentrate on what's important; the application, not the hardware.

Flexibility the Key

VGM provides a wide variety of selectable features to support a broad spectrum of graphics applications including engineering, architectural and business. Since this set of graphics functions implements and extends the 1979 ACM/SIGGRAPH Core System standards, program portability is guaranteed and significant reduction in programmer training is ensured. In addition, VGM is written in ANSI-FORTRAN and is compact enough to fit on most processors, including micros, making VGM machine independent — another key factor in VGM's flexibility!

The Basic Package

VGM lets you optimally use graphics by providing: a complete set of 2D primitives including lines, arcs, text polylines; choice of size, colour, orientation and intensity; an extensive debugging and error handling facility which speeds up application software development; introductory and user manuals; fully documented skeleton device driver; a user requested device driver from the current VGM library; Acceptance Package for system self-test; 90-day support. These are some of the key features now available.

For your Future Expansion

VGM's modular design allows you to expand your system capability by using VGM options. Increase productivity through the ability to interactively build quality charts with our Business Graphics option. Types handled include cartesian graphs, pie charts, polar plots, in any color, texture and font. Other enhancements include: additional device drivers; a 3D graphics package which resides on top of VGM, with optional hidden line removal. Extended support, on-site installation guidance and consultation are also available.

For more information on this versatile system which can provide a positive increase in performance please contact:

VGM Marketing
Dept. 8D01
Bell-Northern Research
P.O. Box 3511, Station C
Ottawa, Canada K1Y 4H7
(613) 226-5400

VGM

Bell-Northern Research is the largest privately owned research and development organization in Canada. It is widely recognized as a world leader in electronics and digital communications, VGM and many other quality software tools help maintain its prominence.

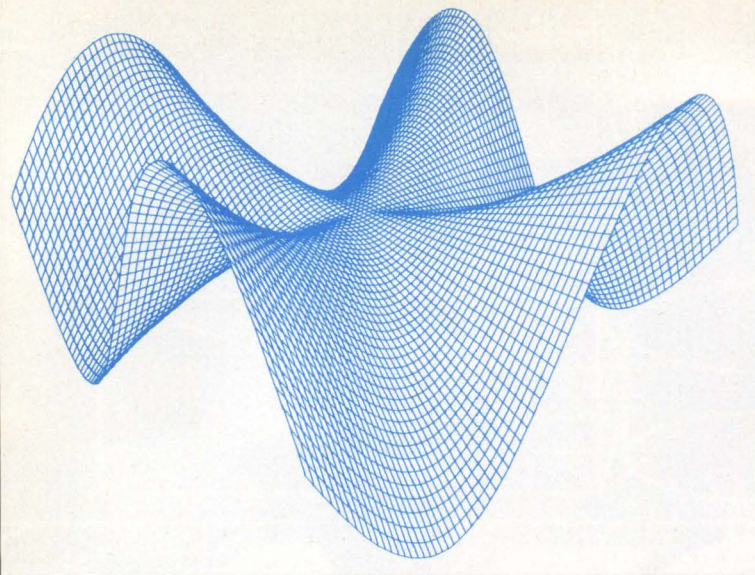

Illustration is an artist's impression.
VGM is a registered trademark
of Bell-Northern Research.

Circle 17 on Reader Inquiry Card

Bob Hirshon, Assistant Editor

Plotters:



Pen plotters have evolved little since arising out of the primordial electronics soup of the 1950's — although smarter and faster than ever before, incremental plotters bear a striking resemblance to their forebears. This is unique in the electronics world, where technological species become extinct on a regular basis. But plotters' slow evolution is due not to slow R&D departments, but to the nature of their task. Purely electronic devices develop at the speed of light, seemingly with a momentum of their own; electro-mechanical devices are slowed by the weight of that "-mechanical" suffix. No matter how sophisticated electronics get, you can only push a pen on paper so fast.

That interface between machine and paper is the point of developmental friction that faces all hard copy devices. And thanks to that design-drag, in nearly thirty years, no new technology has arisen to unseat pen plotters as the premier graphic hard copy devices. They're simple, reliable, software-efficient (especially with today's on-board μ Ps) and can produce graphics that rival those of a skilled draftsman.

Pen plotters are generally either drum or flatbed, although there are a few hybrids that attempt to combine the best qualities of each.

Flatbeds provide the greatest accuracy. They range in size from bread-box-sized units to huge table-size models big enough to ac-

comodate a dinner party. Users can remove drawings from flatbed plotters and then replace them for further work. The major disadvantage of flatbeds is that the larger units require a large outlay of floor space. Manufacturers include Applicon, Aristo-graphics, Auto-trol, Computer Talk, Data General, Data Technology, Gerber, Hewlett-Packard, Houston Instruments, Keuffel & Esser, Soltec, Tektronix and Watanabe.

Drum plotters can create drawings of almost unlimited length from relatively small units. They tend to be less accurate than flatbeds. Manufacturers include Benson, Broomall, CalComp, Mauro, Nicolet-Zeta, and Strobe.

Several new plotter types, which use a single sheet of paper on a drum writing surface, offer the accuracy of flatbeds with the space requirements of drum plotters. Manufacturers of hybrids include Benson, Gerber and Hewlett-Packard.

Pen plotters as a family boast reliability, accuracy, low initial cost, low material cost, ability to draw on paper or transparency plastic, and color capability. Disadvantages include slow speed and inability to easily color in large areas.

Electrostatic plotters are the only technology other than pen plotters with a sizeable share of the graphic hard copy market. Electrostatics are raster devices, requiring large amounts of memory. In fact, they are to pen plotters what raster graphic displays are to stroke/refresh displays, following the same market pattern. As memory became cheaper, raster devices became competitive with the less memory-hungry technologies.

Two factors would enable electrostatics to unseat pen plotters in many applications: continuation of rapid advances in cheap memory, and the advent of color capability. Plotter manufacturers have no control over the former, but they're actively working on the latter.

Meanwhile, electrostatics offer high-speed and the ability to quickly fill-in areas, the two capabilities pen plotters lack. Electrostatics are also adept at producing alphanumeric, allowing them to double as printers, another plus. Their quality can't match pen plotters', since they produce not continuous lines, but dot lines with resolutions of 100 to

Top: Pen plotter graphics courtesy Strobe

Bottom: Electrostatic plotting courtesy Tektronix

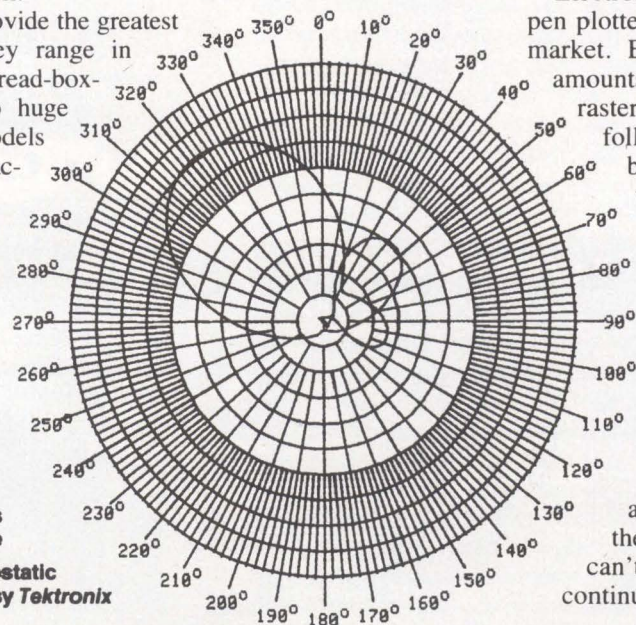

Charting A Course For The '80s

200 dots per inch. A disadvantage is their inability to plot on overhead transparency plastic.

Electrostatics, like pen plotters, range from table-top size to table size. Manufacturers include Benson, CalComp, Nicolet Zeta, Tektronix and Versatec.

Other technologies have small but rapidly increasing markets. Color cameras, produced by Dunn, Image Resource, and Matrix, make photographic prints and slides of color graphic display images. The high quality of these pictures makes them especially suitable for business presentations. High media cost is their chief disadvantage.

Film recorders, by Geo-Space, Gerber, Optronics and Sci-Tex, offer premium quality film plots — at a premium price. Units are used for geological and seismographic surveys, satellite pictures, graphic arts and any other application requiring very high resolution.

Ink jet plotters offer color capabilities as well as plain paper media. Applicon's Satellite Plotter serves the high end of this market, producing high resolution plots with thousands of colors on plain paper or Mylar plastic. PrintaColor makes a much less expensive, lower resolution desk-top ink jet plotter, to cover the market's lower end.

Xerox's 6500 Color Graphics Printer is a modified version of their color copier. It accepts color graphics display input, producing either paper or acetate copy quickly and cheaply. It doubles as a color copier, and even copies from 35mm slides (with an adapter). Chief disadvantage is the high acquisition cost; in addition, competing manufacturers claim (and accept this from whence it came) that units in the field deliver inconsistent color quality.

Finally, many printer companies now produce devices that double as plotters. Actually, any printer can produce graphics to at least some degree, but some printer companies now specialize in graphics. Gultron, for example, bills their thermal unit as a "thermal graphic printer"; thermal units offer the same advantages and disadvantages as electrostatic units, but are slightly slower and have slightly higher resolution.

Many impact matrix printers offer graphics software packages that provide for graphics with about 100 dots per inch resolution. IBM, Ramtek and Trilog offer line printers using multicolor ribbon systems for color graphics, providing printing and color plotting in one unit. **D**

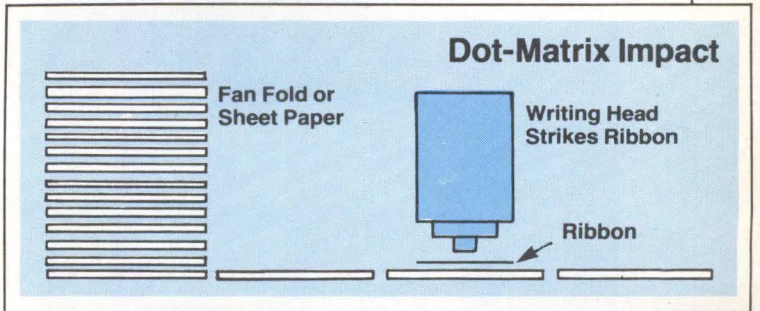
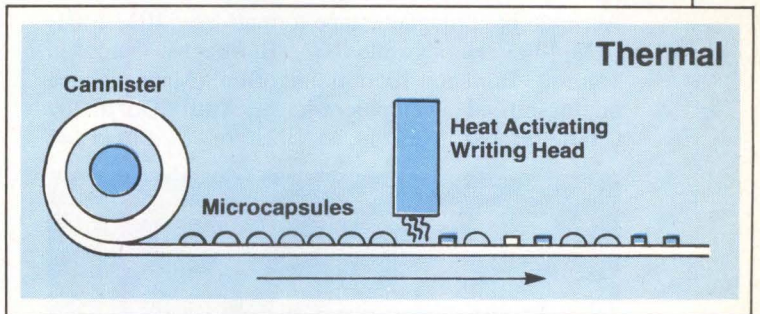
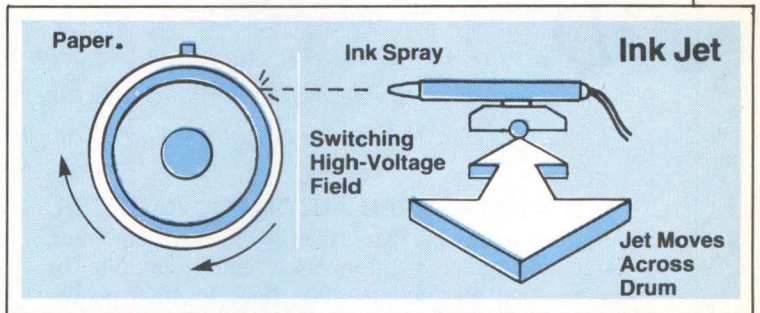
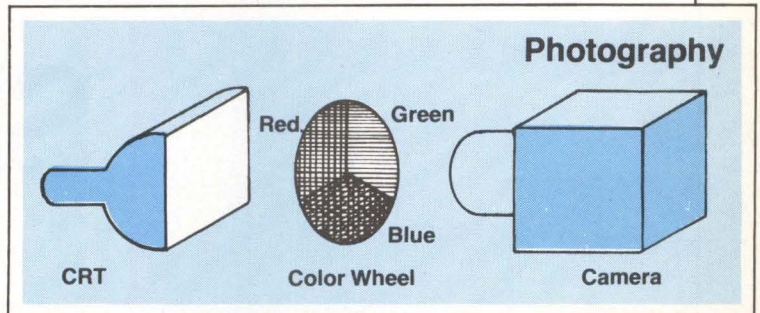
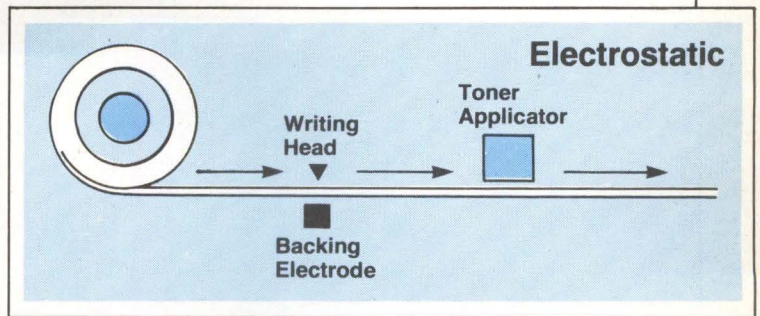

Digitizer Showcase

Digitizers are data entry devices which can scan images and transmit those images as digital impulses to a computer. As seen here, digitizers can take many forms. Additional information on these and other manufacturers' models can be obtained from the manufacturer. Use the Reader Inquiry Card for quick response.

AUDIX HIGH SPEED AUTOMATIC DIGITIZER.

Digitizes a drawing in less than 20 seconds, combining A/N and graphic information onto microfilm or microfiche. Resolution: 4000 lines \times 4000 pixels. Accepts drawings from 8 1/2" \times 11" to 22" \times 34". Accepts input magnetic tape formats from IBM 1401, IBM 1403, Honeywell, RCA, Burroughs. Output in 16mm, 35mm and 105mm microfilm. (Magnetic tape output in final development stage.) **Audix Corp.** 209 Charlemont St., Newton, MA 02159 **Circle 244**

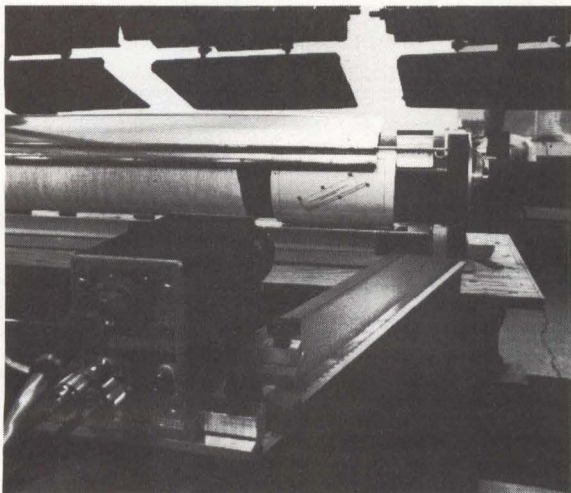

OPTEC 30. Highly accurate digitizer. Provides accuracy to 0.003". Keypad cursor assembly is equipped with interchangeable cross hairs and can be configured using a 3 \times magnifier cursor which intensifies the points to be digitized. Scaling area 48 \times 60 in. Resolution 0.001". Slew speed: 100" per second (maximum.) Options: larger screen size, variable intensity backlight, optical line pointer; grid lights. **Auto-trol Technology Corp.**, 12500 N. Washington St., Denver, CO 80233. **Circle 225**

LARGE ELECTRONIC TABLE. Digitizes and Edits Graphics Data. Part of Applicon Graphics System. Large stand-alone tablet has 2 electronic pens, one constructs new layouts, the other (non-marking) is for editing. Has transfer rate of 400 coordinate pairs per second. System used for 2D, 3D, printed circuit designs, schematics, CAD, CAM. **Applicon, Inc.**, 32 Second Ave., Burlington, MA 01803. **Circle 226**

AGD5-2 Automatic Graphics Design Station. Laser scanning digitizing system. Dual storage tube display, backlighted 2-axis manual digitizer table, menu tablet, cursor and keyboard (ASCII.) Continuous audible and visual feedback. Used to capture, manipulate, store and transmit graphic data. **Broomall Industries, Inc.**, 700 Abbott Dr, Broomall, PA. **Circle 227**

800 SERIES DIGITIZER. A Coordinate Measuring Device Translates graphical input data to a digital form suitable for computer application. Three main

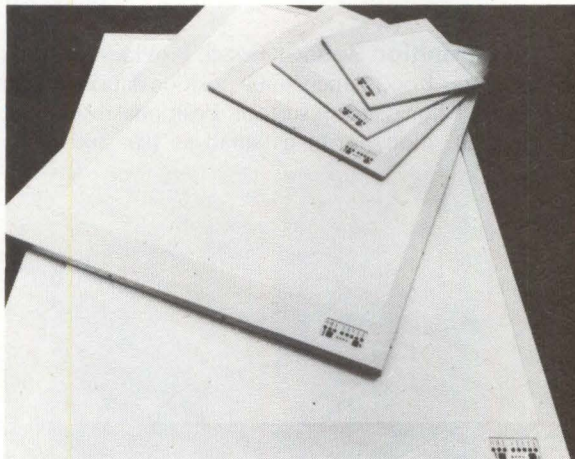

components: transducer (pen or cursor); a remote electronic unit; an active surface tablet. System can be expanded to two transducers and two tablets. Baud rates: 75 up to 19,200. Cursor with choice of 4, 12 or 16 buttons. **California Computer Products, Inc.**, 2411 West La Palma Ave., Anaheim, CA 92801.

Circle 228

274C VIDEO FRAME STORE. Solid State Card File. Allows user to "freeze" a single frame of TV information in an internal digital memory for computer processing, decision making and redisplay. Memory is

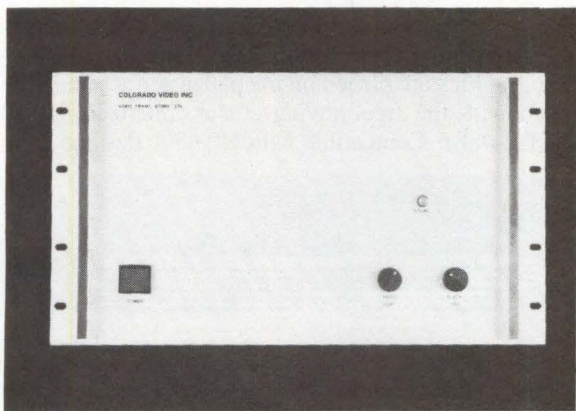

organized as 512x512 pixels with 8 bits of gray scale (256 levels). Mounts on standard 19" rack. **Colorado Video, Inc.**, Box 928, Boulder, CO 80306.

Circle 229

MIP-3/A. Data Spooler or Input Processor. Spools data continuously onto a PDP-11 system disk. Up to 100,000 samples per second. On-board, bit-sliced μC automatically switches between buffers in

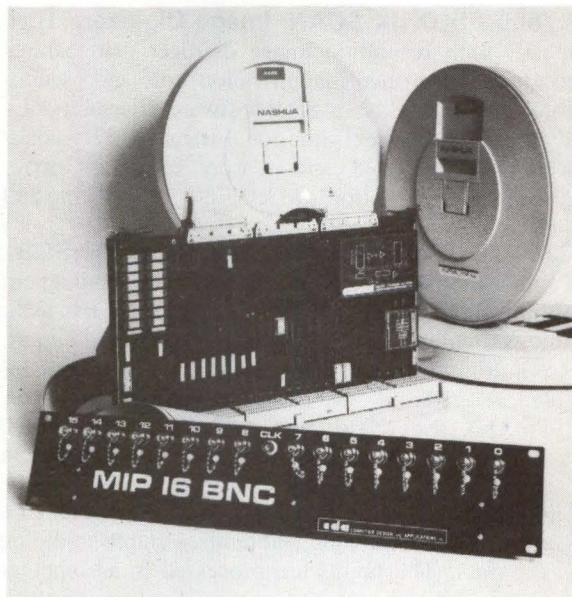

the dual-ported memory. Plugs directly into slots of Unibus and receives power from PDP-11. Runs continuously at 100 KHz. Other input processors can match this speed only in burst modes. **Computer Design & Applications, Inc.**, 377 Elliot St., Newton, MA 02164

Circle 230

VG-120 VIDEO DIGITIZER GRAPHICS BOARD. Multibus compatible single board graphics system. Digitizes and stores real time data from a TV camera. 320x240x6 bit memory. Displays on a TV monitor. 64 pseudo-color display. Average access time is 800 ns. Graphics generation, image processing, scan conversion, transmission (with modem) of TV image over voice-grade telephone lines. **Datacube Inc.**, 670 Main St., Reading, MA 01867.

Circle 231

LC600 LINE SCAN CAMERA. Makes possible rapid and accurate non-contact measurements. Film plane is an array of photodiodes. Arrays available from 64 to 1024 diodes per line. Camera field of view from fraction of an inch to many feet. Time to scan a line can be varied from 0.04 sec down to $N \times 10^{-6}$ sec. (N=no. of diodes in array.) **E G & G Reticon.** 345 Potrero Ave., Sunnyvale, CA 94096.

Circle 232

DATATAB. Precision Coordinate Digitizer. Makes highly accurate X, Y coordinate measurements. Bonded single compact unit with no moving parts or loose wires. 16-button crosshair or bullseye cursor. Choice of binary, BCD or RS232 output interfaces. OEM control electronics card. A complete pre-processor for on-line systems. **Altek Corp.**, 2150 Industrial Pkwy, Silver Spring, MD 20904.

Circle 214

#7800 EIKONIX SCAN. Image Digitizer. High speed, high resolution image digitizer that features computer-controlled magnification, true and pseudocolor capability, 12 or 8-bit software selectable grey level resolution, real time tonal transfer. 37 second/scan speed and 2048 element array. **Eikonix Corp.**, 23 Crosby Dr., Bedford, MA 01730 **Circle 233**

E230 TOUCH SENSITIVE POSITION SENSOR. Tablets are pressure activated by styli (ball point pen) or light finger-touch. Tablets based on a resistive technology which provides analog coordinate output. Resolutions 1/4000th of tablet dimensions are obtainable. 2" x 2" to 4' x 4' in size. **Elographics, Inc.** 1976 Oak Ridge Turnpike, Oak Ridge, TN 37830 **Circle 234**

DIGITIZING SERVICE. This service takes customer's graphs or a line drawing and reduces graphs to digital XY points. The points are processed in a computer which outputs a listing or mag tape of values. Applications in field of pollution, meteorology, oceanography, geography, power and land management. **Envirodata Corp.**, 26 Worthen Street, Chelmsford, MA 01824 **Circle 235**

VUE POINT Digitizing Panel. Only 2 3/4" thick. The flat panel can be hung on wall, attached to an industrial control panel or placed on stand for desktop use. Finger control to any of 240 discrete touch locations sends response to host computer. RS-232 inter-



face by baud rates from 300 to 19,200. Options: a 40 CPL hard copy printer; a 128 character ASCII keyboard. **General Digital Corp.** 700 Burnside Ave., East Hartford, CT., 06108 **Circle 236**

IGD-CAD Work Station. "Station" has 11 x 17 Micro-digi Pad with 120 VAC power supply, 16 button cursor, UPT Dual Z80A terminal, with 9" CRT disk drives (mini floppy), full ASCII keyboard; numeric or control keypad. Designed for entry, display editing, storage analysis, manipulation, zooming and

windowing. For education, mapping, manufacturing, aerospace, research, medical, architectural, etc. **GTCO Corp.**, 1055 First St., Rockville, MD 20850 **Circle 237**

C-1454 Position Sensor Head. Provides accurate, continuous, 1 or 2 dimensional position data on a light spot focused on detector surface. Positional resolution, 1/5000. Positional error as small as 1%. 300 Hz or

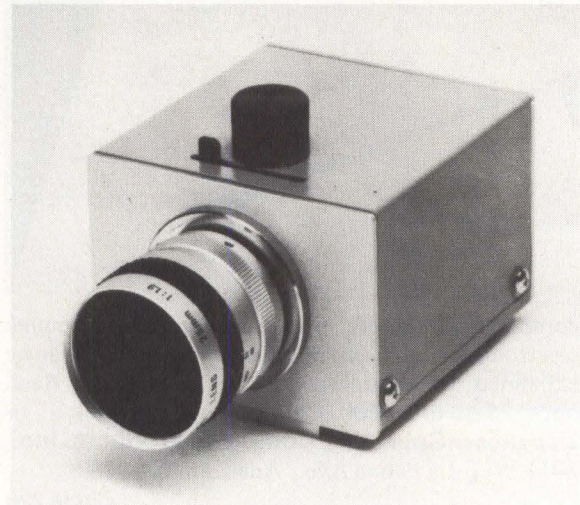

faster response time. C-mount thread allows use with all TV camera lenses. Converter for Nikon lenses is optional. **Hamamatsu Systems**, 332 Second Ave., Waltham, MA 02154 **Circle 238**

9874A Digitizer. A μ P-Controlled Workstation. Converts graphic information into digital form. Existing graphics are placed on the platen surface and digitized with the free-moving cursor. Interface: HP-IB (IEEE-488). Compatible with HP 9800 desktop com-

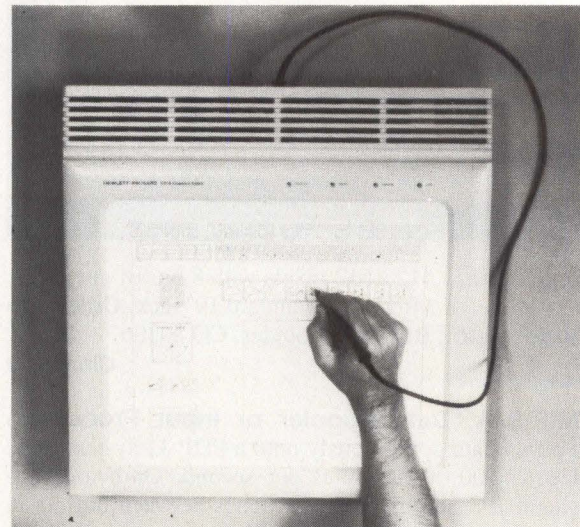

puters. Most popular use in: 1) Medical, 2) Mapping, 3) CAD, 4) Strip Chart, and 5) Test Analysis areas.

HP 9111A Graphics Input Tablet. 16-user definable, platen imbedded softkeys. Ceramic platen, lightweight stylus. Programmable data rate. Line drawings, charts, etc., can be traced then stored for future use. Data transfer rate = 1 to 60 points/sec. Audio feedback. Self-test. **Hewlett-Packard Co.**, 1507 Page Mill Rd., Palo Alto, CA 94304 **Circle 239**

DT-11A HI PAD. Digitizer for Apple II. Hardware and software supported. Has a slot interface for Apple II, floppy based software package, menu overlay, stylus. Functions: draw, line, area, background, pen color, separate, catalog, save, load, shape, etc. BASIC and PASCAL compatibility. **Houston Instruments**, One Houston Square, Austin, TX 78753. **Circle 240**

DATA TABLE. Digitizing Tablet. Recognizes many handprint characters and calculations. Digitizes shapes, processes data then stores or outputs same.

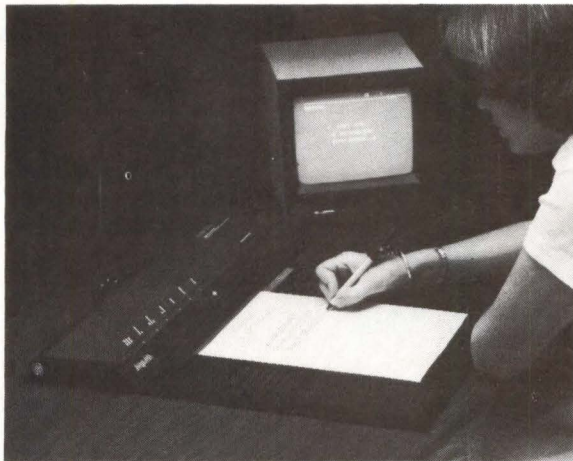

Touch keyboards imbedded on both sides of tablets. Ballpoint pen. Signals converted to ASCII code then transmitted to host computer via RS-232C at rates up to 9600 baud. **Image Data Products Ltd.**, 1-4 Portland Square, Bristol, England, B528RR **Circle 241**

LP 700 SOLID STATE LIGHT PEN. Pen uses custom, integrated circuit signal processor to provide a completely self-contained light pen. Operates from a single voltage power supply. Has an optional combination of push tip and touch actuation. Luminous sensitivity. 1-ft Lambert. Response time less than 300 ns. **Information Control Corp.**, 9610 Bellanca Ave., Los Angeles, CA 90045. **Circle 242**

1241 RUBY WAND. Bar Code Light Pen. Reads low density bar code labels, including dot matrix

labels. Scan velocity up to 30 ips. A low power LED above ball of pen irradiates the label. The LED provides a good signal-to-noise ratio when reading non-carbon based inks. **Interface Mechanisms, Inc.**, Box N, Lynwood, WA 98036. **Circle 243**

IEWS. Image Analysis System. Special color display processor. Composite images can be formed containing multiple data fields which can then be "visually comprehended." System based on three look-up tables of intensity, hue and saturation then transformed to red, green and blue display. **Interpretation Systems, Inc.**, 6322 College Blvd., Overland Park, KS 66211. **Circle 217**

FXM 202 HAAG-STREIT COORDINATOGRAPH. An XY motion instrument that is positioned manually. Used in photomask art work in circuitry and other applications requiring accurate layout construction. Can produce a resolution of 0.0001" measuring capability. Coordinatographs are high precision "drafting machines" that produce accurate plans and drawings. Complete electronics package provides interface for a printer, computer, etc. **F.X. McWilliam Co.**, (for Haag-Streit). PO 247 Bala-Cynwyd, PA 19004. **Circle 245**

DS-80 DIGISECTOR. High Resolution Video Digitizer. 256 × 256 picture element scan. 64 levels gray scale. Conversion as low as 4 μs/pixel. Uses one slot in microcomputer. For all S-100 microcomputers.

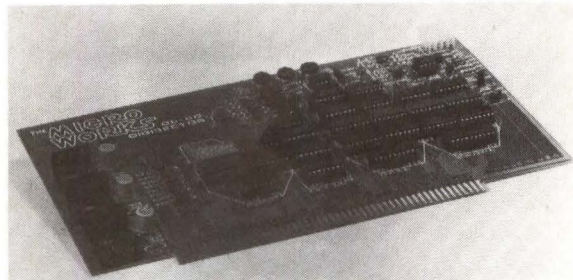

Software gives 128 × 128 resolution. Additional routines available to drive both graphics and ASCII printers. Available with TV camera FS11. **Micro Works Inc.**, PO Box 1110, Del Mar, CA 92014 **Circle 246**

2000 VIDEO IMAGE ANALYZER. Unit performs image processing while simultaneously digitizing and displaying the image. Fully contained 15" × 15" PC card, unit plugs directly into a host minicomputer (DG Nova and Eclipse.) Pixel matrix (320×240×4.) Provides more resolution than a 512 × 512 graphics display. A comprehensive software package of more than 50 Fortran callable subroutines is supplied. Has a

data transfer rate of 25 Mbits/sec. **Octek Inc.**, 7 Corporate Place, South Bedford St., Burlington, MA 01803 **Circle 247**

VERSAWRITER. An Apple Drawing Tablet.

Using a menu on Apple's screen, the user can select from 6 colors for lines, or 106 colors for fill-in areas. Images can be stored on disk and called up later for changes or incorporated into another picture. Versawriter has two disks which include a set of common electronic schematic and logic symbols. Requires a 32K Apple Computer. **Peripherals Plus**, 119 Maple Ave., Morristown, NJ 07960 **Circle 248**

GP 6-30 GRAF PEN. 3D Sonic Digitizer. Performs 3-dimensional digitizing. System times a passage of a sound wave, 60 KHz, from stylus cursor (sound emitter) to microphones mounted in L frame. Distance is computed by control system providing absolute cartesian coordinates. Useful in static or motion analysis. **Science Accessories Corp.**, 970 Kings Highway West, Southport, CT 06490. **Circle 249**

109 PT3 EYECOM II. Picture Digitizer. Unit samples a video signal 640 times per line for each of 480 lines. Grey scale image is stored as an array of $640 \times 480 \times 8$ bit numbers. (The 8 bit represents 256 shades of gray.) Applications: visual inspection measurement; analysis of microscopic images; radiographic enhancement; earth resource analysis. **Spatial Display Systems, Inc.**, 500 S. Fairview Ave., Goleta, CA 93017 **Circle 250**

GM ONE. Programmable Digitizer System. 9" CRT. 8085A Based μ C. 48K RAM, detachable 77-unit keyboard, 80K mini-floppy disk, (optional, a second disk.) Functions as a stand-alone system or as an intelligent terminal for preprocessing to a host



computer. A stylus, on contact with board, sends input to video board. Inputs then transmitted to μ C for processing. **Summagraphics Corp.**, 35 Brentwood Ave., Box 781, Fairfield, CT, 06430. **Circle 251**

7612D DUAL CHANNEL WAVEFORM DIGITIZER. Captures, digitizes and stores single-shot or repetitive signals for subsequent computer processing. Unit has two digitizers in one cabinet. Signals are converted to 8 bit words by a new AD converter before storage in memory. Memory capacity, 2048 words. **Tektronix Inc.**, PO Box 1700, Beaverton OR 97077. **Circle 252**

TSD-12 TOUCH SCREEN DIGITIZER. Uses Surface acoustic waves to measure touch position. A finger touching glass screen reflects acoustic waves back to piezoelectric transducers. The XY acoustical

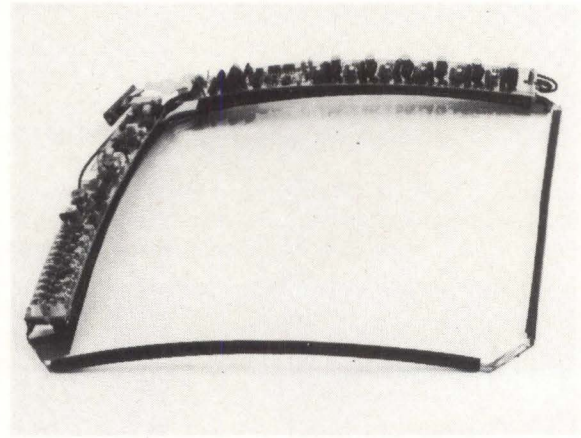

positions of moving fingers is measured. System enables untrained personnel to gain access to computer data by simply touching the screen with a finger. No keyboard or language needed. **TSD Display Products, Inc.**, 35 Orville Drive, Bohemia, NY 11716. **Circle 253**

75-2800 VIDEO DIGITIZER BOARD. Low cost unit which converts video analog signals into high resolution, 4-bit digitak code. Uses a TV camera or recorder for signal capture, using 4 bits to every XY point. Converts up to 700 points per line (480 lines per image) in about 2 seconds. Useful for stationary objects. Applications: printing of digitized TV images; quality control; in some manufacturing processes, security system. **Vector Graphic, Inc.**, 31364 Via Colinas, Westlake Village, CA 91367. **Circle 254**

IMAGE ANALYSIS SYSTEM. Analysis from photographs, negatives, projected images, drawings, X rays, video cameras, light microscopes. System has 64K user memory, 16K video memory, dual floppy disk drive, video monitor. The video monitor also functions as an aid for direct measurements. Acquired data can be evaluated immediately or stored for later analysis. **Carl Zeiss, Inc.**, 44 Fifth Ave., New York, NY 10018. **Circle 255**

SPECIAL OFFER TO PLOT 10 USERS. THE 'GREAT WALL OF CHINA' IN 256 COLORS. FREE!

美 The Great Wall of China is the largest man-made fortification in the world. To the Chinese, it is a vivid symbol of struggle and glory. The full impact of this historic rampart can now be displayed on our AED512 imaging and graphics terminal in 256 simultaneous colors. And because the '512' emulates Tektronix 4010-15 software, your Plot 10 application programs will run the image in any color (monochrome) selected from a total palette of 16.8 million hues (2^{24}), without alteration. This microprocessor-based terminal puts 256 Kbytes of video memory, plus joystick panning and the largest refresh memory of any model right on your desktop for about the same cost as a 'Green Machine'. That includes the price of the ASCII keyboard, two RS232 ports, parallel direct video access channel and Tektronix emulation firmware! So if you currently use Plot 10 software and would like to know more, just complete the coupon below. We'll send you all the information you need, plus a FREE 15" x 22½" color poster, suitable for framing, showing the AED512 raster image of the 'Great Wall'.

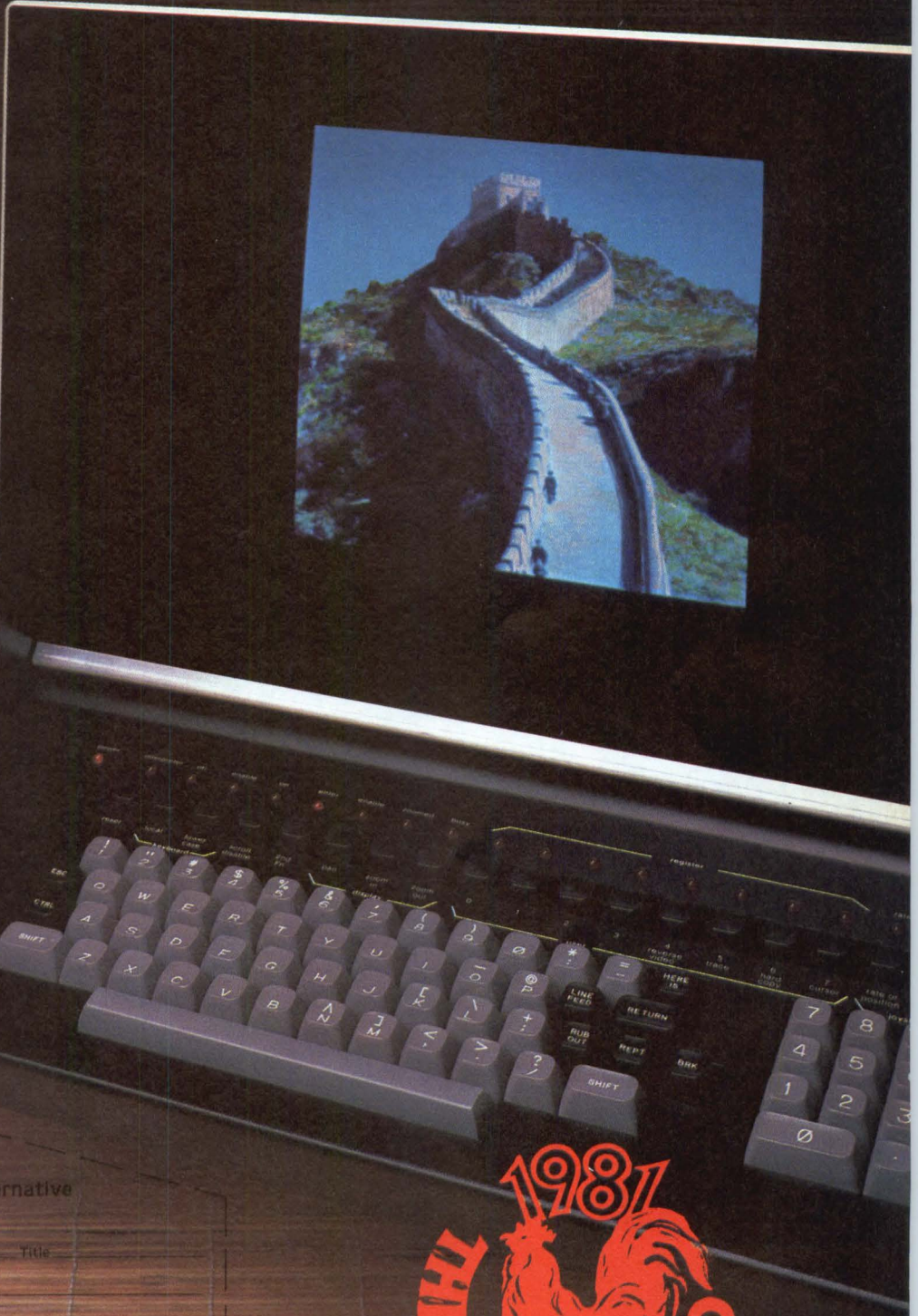

Advanced Electronics Design
 440 Potrero Avenue
 Sunnyvale, CA 94086
 408-733-3555

Boston, 617-256-1700
 Australia, (02) 449-4400
 Japan, 03-437-5471
 France, 1 724 19 54
 India, 79281
 New Zealand, 499 197
 Holland, 070-46-95-09
 Switzerland, 022-32-97-20
 West Germany, 021-6217081
 United Kingdom, 44-0296-61551

**SEND ME A
'GREAT WALL' POSTER**
 I am currently using Tektronix
 terminals and want information on alternative
 displays that are software compatible.

Name _____ Title _____
 Organization _____
 Address _____ Zip _____
 Area code and phone no. _____ Ext. _____
 No. of terminals in use _____ Host computer _____
 Current software _____
 Application (CAD etc) _____
 PLEASE COMPLETE AND MAIL THIS COUPON TO OUR SUNNYVALE ADDRESS.



* Digitized by MIT Architecture Machine Group
Circle 1 on Reader Inquiry Card

YOU ARE CORDIALLY INVITED TO

COMPAT '81

COMPATIBLE COMPUTER PRODUCTS EXPOSITION



SEPTEMBER 16 & 17, 1981 SAN FRANCISCO HOTEL

COMPAT '81 was conceived to:

- Enhance Computer Capabilities
- Provide Computers with Greater Flexibility
- Assure Availability of Peripherals, Accessories and Software for ALL Branches of the Computer Industry

THE COMPATIBLE COMPUTER EQUIPMENT MANUFACTURERS (CEMs), MEMBERS OF A SPECIALIZED INDUSTRY, WILL SHOW AND TELL ALL ABOUT THEIR PRODUCTS AND SERVICES

LISTEN TO authoritative speakers give you information on how CEMs (Compatible Equipment Manufacturers) help OEMs, systems integrators, turn-key houses and large volume sophisticated end users

SOLVE COMPUTER APPLICATION PROBLEMS



CIRCLE NO. 69 FOR YOUR EARLY
CIRCLE NO. 99 FOR YOUR

ANOTHER EXPOSITION ORGANIZED BY:

The Benwill Conference Group who also bring you the ATE Seminar/Exhibit, PC '81 — the International Printed Circuits Conference and the Electronics Test and Measurement Conference

THE FIRST NATIONAL EXPOSITION DEDICATED EXCLUSIVELY TO THE EXPANDING WORLD OF COMPATIBLE COMPUTER PRODUCTS

EL (Across the street from WESCON) **SAN FRANCISCO, CA**

A MARKETING FORUM for CEMs

This exposition is dedicated to the proposition that the unprecedented growth and expansion in the use of computers for all kinds of applications will continue at an exponential rate. No one company can solve everyone's applications problems; no one company can supply everyone's needs for complete systems, add-ons, peripherals and software.

Building around the central processing unit, the OEMs, the systems integrators, the turn-key houses and the sophisticated large volume end users will continue to use compatible computer equipment to devise special systems to solve applications problems with greater versatility and flexibility.

IF YOU ARE a buyer and specifier of plug-in electronics and appropriate software, you have a need to know about currently available products you can design into your systems as well as future trends in the state-of-the-art **THIS EXPOSITION GIVES IT TO YOU.**

BIRD ATTENDEE'S REGISTRATION FORM
EXHIBITOR'S APPLICATION FORM

PRODUCED BY:

Digital Design
Computers • Peripherals • Systems

co-sponsored by Circuits Manufacturing,
Design Engineering and Electronics Test magazines.



Digitizers Improve

Staff Report

The Digitizer, once considered a dumb terminal that did nothing more than obey a joystick, now has a twin brother, "the smart digitizer." With a display device of some sort and its own microprocessor in the system, the new smart digitizer has become a special purpose stand-alone device that even performs high speed calculations.

Some of the fields in which digitizers have already been put to use include the following:

Doctors use these devices to trace outlines of brain sections and to compute particle size density.

Geographers inventory huge forests from digitized Landsat data. In the Arctic they can detect, identify and track icebergs.

Geologists resolve seismic refraction data in a matter of hours. Once, such a task required weeks.

Widest use of the digitizer is in industry where it serves as a data input device in CAD.

Digitizers are still in their adolescent stage of growth. As they mature their talents will become more sophisticated. Some new characteristics will include a 10,000 lines/inch resolution; accuracy and linearity around two mils; a MULTIBUS μ P system; 64K memory; card slots to accommodate any peripheral controller.

Some common definitions:

POINT MODE — When a pen or cursor is activated a single conversion cycle is generated.

RUN MODE — A constant stream of data as the inactive pen passes across the digitizing surface.

TRACK MODE — A constant stream of data when the cursor or pen is "activated."

TRUE INCREMENT MODE — When pen or cursor remains in one place, only one pair of coordinates is sent.

RESOLUTION — Number of X and Y points per inch that can be distinguished. At 200 lines per inch, accuracy is 0.005 inch. At 1000 lines per inch, accuracy is 0.0001 inch.

REPEATABILITY: — Ability of digitizer to identify the same position on the surface repeatedly with the same coordinates.

NON-LINEARITY — Deviation obtained between moving a cursor on a straight line and moving it through plotted points to form a straight line.

RELATIVE ACCURACY — The distance across the entire surface of a digitizer measured by pen or cursor and compared to the same distance measured by exact instruments.

The new computer technology will even drastically change how and where computers are used. Computers in the past were big and expensive and accessible only to large companies employing computer professionals. Today, computers are relatively inexpensive and are appearing in many environments where the employees are never programmers nor

computer operators. The rapid proliferation of computers is creating a problem in the area of man-machine interface. The conventional input and output computer devices can intimidate and overwhelm the non-computer professional. New ways have to evolve that permit workers to interact with computers in a manner that is natural to the job at hand.

Classical computer input devices are acceptable to a data processing room environment, but they are totally out of place in a hospital laboratory, machine shop floor, warehouse, and retail store showroom. In order to achieve a workable relationship, the computer and its devices have to be made to conform to the human operator's needs and skills.

General Digital's work is indicative of the activity in this field. Recently, General Digital (of Hartford, Conn.) announced a new computer input/output device, (the "VuePoint") which was tailored to meet human operator needs. The device is a flat-panel display whose surface is touch sensitive. The computer shows choices on the face of the screen and the operator touches either the picture or the word he desires. The choice is then communicated back to the computer. This natural mode of operation (i.e. touch what you want, point to your object of interest) requires no special training and no special dexterity. Many computer professionals know how to use a typewriter - but a typewriter keyboard as used in conventional terminals could prove awkward to a factory worker, machine tool operator, laboratory technician, or sales clerk.

"VuePoint," says the company, is currently in use in factory environments, executive desktop terminal applications and machine tool control. One user of the panel has it stationed along a production line. Workers touch a small picture of the object selected, which notifies a computer inventory system of the identity of a removed object.

Several users of VuePoint are attracted to its compact size. The panel is only 2½ inches thick, 12 inches wide, and weighs only six pounds. This obviously is less cumbersome and requires less desktop space as an executive terminal than a CRT terminal and typewriter keyboard. Several users have literally hung the VuePoint on the side of a machine tool test stand and have thereby created a "buttonless" push-button system. The computer displays allowable action or warning messages. The operator points to the desired action. This creates a very flexible operator's console, helps guide and prompt the user, and limits the selection of buttons to only those which are meaningful.

Other users, says the company, include restaurants, the Stock Exchange, military installations, and CAD/CAM installations. The one key denominator in all applications has been the non-computer professional who finds he can now use a computer as part of his job. **D**



VIEWS is changing the way image processing sees the world

In just moments EARTHVIEWS, a new member of the VIEWS family, has enhanced the splendor of San Francisco at the touch of a few keys. And when you're up against a rock and a hard place, quick response counts because you need answers fast.

This ease of interaction helps you to examine vast surfaces or the most minute areas to help rescue our forests from disease, monitor ocean life, assess storm damage, locate precious metals, control pollution, or discover hidden energy resources.

The VIEWS family is a total hardware and software image

analysis and enhancement system able to meet your specific application needs and more. Non-computer people, from many nations, have already produced results after a minimum of training. In fact, VIEWS has set a new standard for "User Friendly" systems.

With our patented IHS hardware system, VIEWS reveals the world to you, as the human mind sees it, as no one else can. VIEWS gives you features that can make your work-world a lot easier to manage. A highly interactive turnkey VIEWS system, which is configured to your requirements, is ready for installation.

Unequaled in today's marketplace, there's no limit to how the proven VIEWS family can help you see image processing at its best. If you would like to know more about our patented IHS system, contact:

LogE/Interpretation Systems Inc.
7001 Loisdale Road
Springfield, Virginia 22150 U.S.A.
(703) 971-1400 Telex: 8-9455

LogE / Interpretation
Systems Incorporated

Circle 18 on Reader Inquiry Card

Say Ahh...

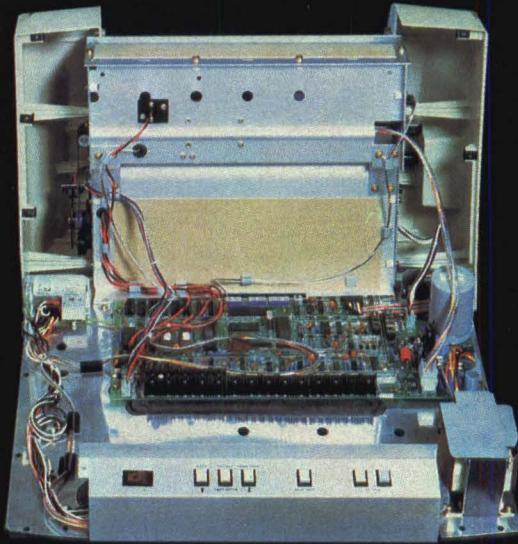

Our New grafixPLUS™ 80-column printer opens wide for easy servicing.

Introducing the newest members of our grafixPLUS™ family—the DP-9000 Series 80/132 column printers—built on the same tradition of quality printout, solid design and low cost of ownership established by our 132/220 column DP-9500 Series.

A Case for Serviceability

Not that it comes up often, but want to get inside? Simple. Just remove a few screws and the clam-shell case swings open exposing all major components. This easy access plus built-in self-test and minimum component count yields an MTTR of one-half hour. The 9-wire print head replacement's even simpler... two screws and it's out. Without opening the case. And without a service call.

Performance Plus

The DP-9000 Series prints the full ASCII 96 character set, including descenders and underlining, bi-directionally, at up to 200 CPS. Number of columns can go up to 80 or 132, depending on character density—switch or data source selectable from 10 to 16.7 characters per inch. And all characters can be printed double width. The print head produces razor-sharp characters and high-density graphics with dot resolutions of 72X75 dots/inch under direct data source control.

Interface Flexibility

The three ASCII compatible interfaces (parallel, RS-232-C and current loop) are standard, so connecting your computer is usually a matter of plug-

it-in and print. Also standard are: a sophisticated communications interface for printer control and full point-to-point communications, DEC PROTOCOL, and a 700 character FIFO buffer. An additional 2K buffer is optional.

When you're ready for a printer (or several thousand), look into the grafixPLUS DP-9000 Series from Anadex—you'll find an open and shut case for quality. Contact us today for details, discounts and demonstrations.

 **Anadex**
...the plus in printers

Circle 46 on Reader Inquiry Card

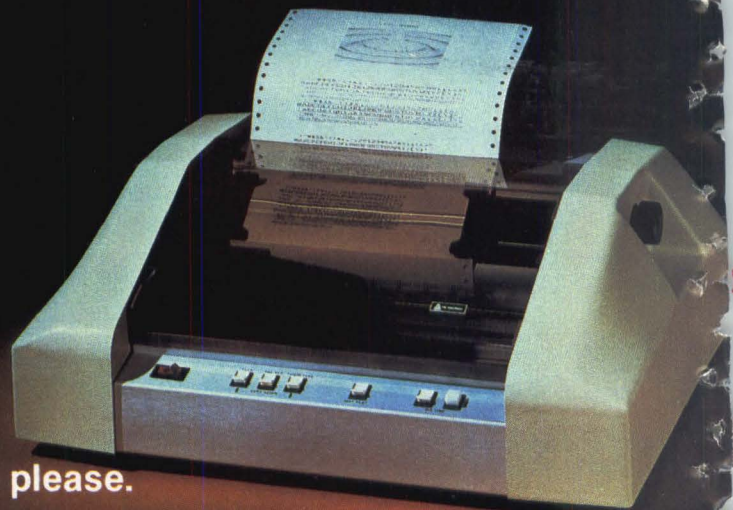

... close please.

SALES OFFICES: San Jose, CA (408) 247-3933
Fullerton, CA (714) 871-0501 • Wakefield, MA (617) 245-9160 • Austin, TX (512) 327-5250

ANADEx, INC. • 9825 DeSoto Avenue • Chatsworth, California 91311, U.S.A. • Telephone: (213) 998-8010 • TWX 910-494-2761
ANADEx, LTD. • Dorna House, Guildford Road • West End, Woking, Surrey GU24 9PW, England • Tel: Chobham (09905) 6333 • Telex: 858762 ANADEx G
See Us at NCC Booths 2908-2909

Graphics Terminals Showcase

Color graphics manufacturers offer a wide range of options for everything from single on-board processors to complete systems. Shown here are only one of companies' many products. Descriptions of other sophisticated models and other products can be obtained by writing to company via the Reader Inquiry Card.

AED 512. Full Color Graphics Terminal. 256 simultaneous colors. 512x483 pixel screen. Zoom,

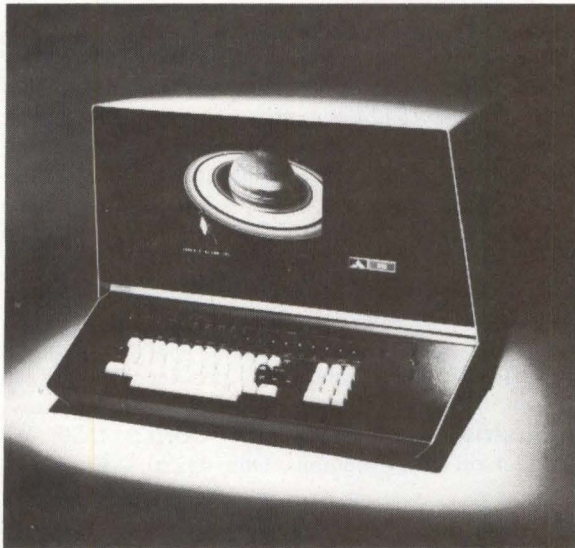

pan. DMA transfer in 0.5 sec. Super-roam expanded image of 1024 x 1024 pixels. **Advance Electronics Design**, 440 Potrero Ave., Sunnyvale, CA 94086
Circle 256

LIGHT 50. Color Graphics Generator. Multiple video outputs for RGB. Accommodates 4 independent image outputs with an image space up to 2KB of encoded information and 512 x 512 bytes. Windowing. Picture scale and scroll without repainting. Reverse display. Full color and features access from Fortran through "Plot 10" extensions. Optional:

a 512 x 512 x 8-bit refresh board that provides 256 color selections. **Applied Dynamics International**, 3800 Stone School Rd., Ann Arbor, MI 48104

Circle 257

COLOR VIDEO TERMINAL. Raster scan display. A/N keyboard. Choice of tablets with electronic pens. 19" display. 8 colors. Selective erase. **Applicon Inc.**, 32 Second Ave., Burlington, MA 01803 **Circle 258**

5217 CT. Color Terminal. Monitor plus keyboard. 256 A/N and special graphic symbols. Ten function keys. 80 x 48 characters per page. Two character



sizes. Eight colors, reverse background, blink, protect, intensity. Inline gun, RGB color monitor. **Aydin Controls**, 414 Commerce Drive, Fort Washington, PA 19034
Circle 259

IP 8500. Image Processing Display Station.

Four memory controllers handle four image memories each for up to 16, 512 × 512 × 8-bit image memories. Independent integer zoom. Special functions for histograms, rotation and warping; high speed vector generation. Four dual cursor generators; four special function generators. **DeAnza Systems**, 118 Charcot Ave., San Jose, CA 95131 **Circle 260**

CC 7900. 19" Color Graphic Computer.

Powerful 16-bit (MC 68000) processor. Can support 10 MB Winchester Drive and two double density disk drives. 1024 × 768 dot resolution. 30 Hz interlaced refresh rate. 256 colors displayed at one time including 256 shades of gray. **Chromatics, Inc.**, 2558 Mountain Industrial Blvd., Tucker, GA 30084 **Circle 261**

VISION ONE/20. Image Processing System.

48 MB refresh image memory and graphics. Options: expandable memory; video I/O; TV rates for videotaping; mag tape and disk storage. Up to 4 work-station



capability. Dual ported RAM from 512 × 512 pixels up to 4096 × 4096-24 bit pixels. 2× and 4× zooming. **Comtal Corp.** (Susiary of 3M) 505 W. Woodbury Rd., Altadena, CA 91001 **Circle 262**

COLOR GRAPHICS BOARD PROCESSOR.

13" or 19". With or without keyboard. Primarily used for graphics imaging. Raster technology. 484 × 512 Resolution. 5000 LPS scanning speed. 30 Hz refresh rate. Input sources; TV Camera; Light Pen; Bit Pad; Keyboard, S-100, PDP-11, LSI-11, Apple Compatible, 34 lines display. 80 CPL, 7×9 dot format. **Digital Graphics Systems, Inc.**, 407 California Ave., Palo Alto, CA 94306 **Circle 263**

MODEL 374. Flicker-Free Ultra High Resolution Color Display.

1024 × 512 pixel graphics displayed at non-flicker 60 Hz refresh rate. Ideal for the display of computer graphics. 1024 × 1024 @ 30

Hz refresh. **Systems Research Labs., Inc.**, 2800 Indian Ripple Rd., Dayton, Ohio 45400 **Circle 264**

GCT-3000. Computer Graphic Display System.

Display aspects; 256 × 256 to 1280 × 1024 pixels. 30 or 40 interlaced frames per second (60 noninterlaced.) Video lookup table — makes possible selection from over 16 million colors and 256 gray-scale shades. Long persistence CRT phosphors provide flicker-free viewing. DMA transfer rate: 300K words/sec. **Genisco Computers Corp.**, 3545 Cadillac Avenue, Costa Mesa, CA 92626 **Circle 265**

FULL COLOR GRAPHICS SYSTEM.

GMR 270 1024 × 1024 Resolution frame buffers. Full color imaging processing. B&W, pseudo color and full color. **Grinnell Systems**, 2159 Bering Dr., San Jose, CA 95131 **Circle 266**

RGB COLOR MONITOR.

Wide video bandwidth from 50 Hz to 25MHz 0.31 mm spacing between triad pairs for high tri-dot density. Single PCB configuration. Choice of screen sizes. **Hitachi America Ltd.**, 100 California St., San Francisco, CA 94111

Circle 267

4600 GRAPHICS DISPLAY SYSTEM.

High resolution color graphics for HP 21000/MX/XE/XF computers. Resides in host computer. Display channel format is 768×512 dot matrix with 2 to 8 channels per system. Standard functions: vectors, areas, perimeters, characters (multiple size), points and image readback. **Intermedia Systems**, 10601 S. Saratoga Sunnyvale Rd., Cupertino, CA 95014 **Circle 268**

LTD 2000. Color CRT Monitor.

512 × 512 pixels. 19" system. 8 colors and patterns. Normally sold with keyboard. A/N + graphics. Raster technology. Input: ASCII RS 232. 85 characters per line. 51 lines on screen. 7-pixel high characters. Readout color: Grey. **Industrial Data Terminal Corp.**, 1550 W. Henderson Rd., Columbus, Ohio 43220 **Circle 269**

MODEL 70. Image Computer and Display Terminal.

Full color graphics system. Resolution, 515×512. 19" screen. 1024 levels per primary colors. Compatible with VAX, PDP-11 DG Eclipse, HP1000, 3000. Raster technology. 256 gray levels per image plane. Real time arithmetic between images, point processing, zoom, pan, split screen, video frame digitizer, programmable pipeline image array processor. **International Imaging Systems**, (Div. of Stanford Technology) 650 North Mary Ave., Sunnyvale, CA, 94086 **Circle 270**

PCM-520. 20" RGB Color Monitor.

Requires only 13 3/8" vertical mounting space. For graphics and

A/N. Precision in-line black shadow mask CRT. 80 CPL. 512×483 resolution. Automatic degaussing. **Lenco Inc.**, Electronics Div., 300 N. Maryland St., Jackson, MO 63755. **Circle 271**

SYSTEM 3400. Image and Graphics Processor. 60 Hz Raster scan display. 10 bits of input pixel. Line drawing and tonal imaging using B&W gray scale and color displays. Resolution up to 1280 pixels × 1024 lines. Handles burst data transfers from host computer at 2 MB/sec. **Lexidata Corp.**, 37 North Ave., Burlington, MA 01803 **Circle 272**

WHIZZARD 6250. Color Graphics Work Station. High technology CAD/CAM line drawing capabilities in a new low-priced terminal configuration. Unit consists of a 13" color monitor and graphics

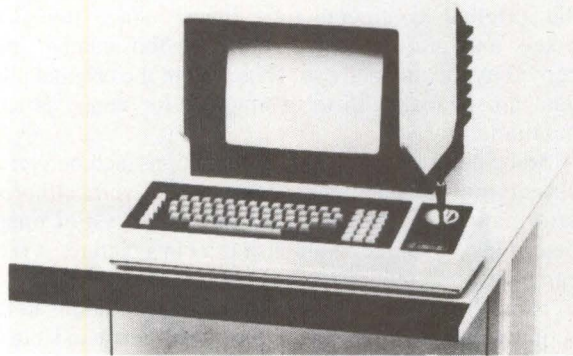

processor packaged with a keyboard and joystick control in a desk-style cabinet. **Megatek Corp.**, 3931 Sorrento Valley Blvd., San Diego, CA 92121 **Circle 273**

C-6911. Color Monitor. 19" diagonal. Rack mounting or free standing. 7000 character analog display capability. Scanning lines 1400 maximum, 1050 standard. Scanning frequency: horizontal 28-35 KHz; vertical, 50-60 Hz. Accurate differentiation of the full spectrum of colors is possible in the versions with RGB phosphors. Dynamic convergence circuits are easily adjusted with separate controls for each color. **Mitsubishi Electronics America, Inc.**, 2200 West Artesia Blvd., Compton, CA 90220 **Circle 274**

CVD 2. High Resolution Digital Video Processor. Low-cost real time animation display at 15 frames per second. 640×480 resolution with 64 selectable colors from a 32,768 color palette. Character generation in variable width. **3 Rivers Computer Corp.** Box 235, Schenley Park, Pittsburgh, PA 15213 **Circle 275**

6212 COLORGRAPHIC. Computer Terminal. 13" Diagonal screen. 16 displayable colors from a palette of 64. Optional keyboard. Refresh rate of 30 or 60 Hz. Video lookup table, optional high-speed vector generator, voltage controlled oscillator for RS170 compatibility. Interface: RS-232C, 24 or 48 display lines. 80 characters per line. 8×10 character cell. 5×7 character width, can have double height and width. **Ramtek Corp.**, 2211 Lawson Lane, Santa Clara, CA 95050 **Circle 276**

EYE COM II. Image Processing Terminal. Resolution: 640×480×24 bits maximum. Graphics overlay 640×480 resolution. Color look-up table. Joystick, cursor. A/N keyboard and display, 128 characters upper & lower case. Frame grabber, optional. Real time adder/processor optional. **Spatial Data Systems, Inc.**, 508 S. Fairview Ave., Goleta, CA 93017 **Circle 277**

GRAPHICS-8. Display System. Raster graphics. 256 simultaneous colors, high resolution, dynamic operation with double-buffered refresh memory. Built-in test. Fortran support. Remote or local operation. Interfaces to most computers. **Sanders Associates Inc.**, Daniel Webster Highway South, Nashua, NH 03061 **Circle 278**

8600 COLOR DISPLAY SYSTEM. Two 16-bit processors. Can receive external RGB signals or transmit such signals to external video monitor. Flexible character generator. Characters in English, Russian, Greek, Hebrew, or Arabic. DEC based hardware. **Terak Corp.**, 4151 North 76th Street, Scottsdale, AZ 85260 **Circle 279**

MA 512 MICROANGELO. High Resolution Color Graphics System. Graphics board offers 512 × 480 resolution and a choice of up to 256 on-screen colors for a palette of 16.8 million colors. Color look-up tables. S-100 bus. Uses "bit plane" approach allowing sophisticated overlays. Z-80 μ P. Included is a three-part CP/M compatible software package. **Scion Co.**, 8455-D Tyco Road, Vienna, VA 22180. **Circle 216**

4027 COLOR GRAPHICS TERMINAL. Palette of 64 available colors, 80 characters/line, 34 lines/display, 15 MHz video bandwidth, 525 line scan, standard 64/96 ULC ASCII. Optional character sets available. Compatible with any TTY supported computer. Raster scan display. Scrolls graphics and A/N in color. Colors vectors, characters, symbols and fills polygons with up to 120 different patterns or color combinations. **Tektronix, Inc.**, PO Box 500, Beaverton, OR 97077 **Circle 280**

Image Processing

Dave Rutland

Pres. Spatial Data Systems
Goleta, California

Modern technology utilizes all type of pictures, or images, as sources of information for interpretation and analysis. These may be portions of the earth's surface viewed from an orbiting satellite, the internal composition of a complex metallic or organic structure seen with the aid of X-rays, chromosomes viewed through a microscope, or schematic line drawings of electronic circuitry. The proliferation of these bases of pictorial data has created the need for a vision-based automation that can rapidly, accurately, and cost effectively extract the useful information contained in images. These requirements are being met through the new technology of "Image Processing."

Image Processing is based on the same fundamental principles as visual recognition in human beings. Although the actual visual process is physiologically complex, the basic mechanism of vision utilizes the eyes and the brain as an automatic information interpreting system. The eyes receive stimuli in the form of visual light, and the brain processes and interprets this input for the observer of the image. The human visual system can be simulated using an electronic scanner, (similar to a television camera) as the eyes, and a high-speed digital computer as the brain. This type of system can "see" images through the scanner, and by means of the programmed capabilities of the computer, it can manipulate the images.

A reconstructed scene of the United States Capitol Building demonstrates the unique capabilities of our "EyeCom System." **Figure 1** shows the Capitol on the EyeCom



Figure 1

Display. This picture has been digitized and stored in the Computer's memory as 307,200 pixels, (a 640×480 matrix) each represented by one of 256 gray levels ranging from black to white. This picture has the same appearance as the original continuous-tone image, since the sizes of pixels and gray level variations are too small to be discerned by the unaided eye. Hence all of the original pictorial data are available in the Computer for image processing manipulations.

Some other image processing functions include averaging, classifying, contrast enhancement and vertical/horizontal information. It is often useful for the analyst of images to determine "average" values of gray in a picture. Averaging can be used to reduce random variations caused by the grain in film, the texture of objects, or by scintillations in fluoroscopic images. Starting at the upper left-hand corner, a mathematical average is calculated for a 2 by 2 array of pixels. The average value then replaces each of the original four pixels. This operation can also be performed with pixel arrays arranged in square or rectangular shapes with any number of pixels on a side. **Figure 2** shows the original picture averaged with 2 by 2 arrays. Although there is a necessary loss of picture resolution when this operation is performed, the eye can barely distinguish any difference between **Figure 2** and the original scene in **Figure 1**.

However, when the original is averaged over 16 by 16 pixels (**Figure 3**), the structure of the average picture



Figure 2

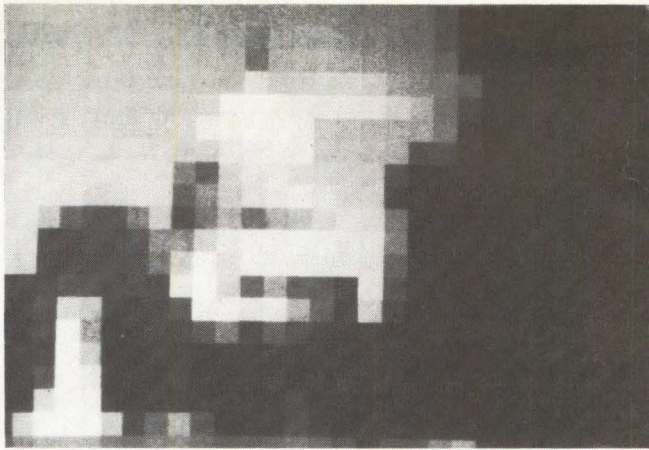

Figure 3

becomes increasingly apparent. The Computer can also reconstruct the picture in the following manner. The gray scale is divided into five unequal parts. Each part comprises a proportion of the scale based on the pixel values in its associated feature, i.e., trees, sky, clouds, Capitol, statue. The resulting picture is shown in **Figure 4**. With this basic classification of the pictorial data, each of the five features is clearly delineated, and may now be further analyzed, for example, to determine percentage of area, measure average brightness or enhance details. The Capitol building and foreground statue are now visually conspicuous against their darker backgrounds of trees and sky.

The contrast enhancement algorithm can be modified to display the image with greater degrees of contrast than demonstrated above. When the multiplier is increased to a value greater than two, the contrast is correspondingly increased as more pixels are forced into the white zone. Such is the case with the image in **Figure 5**. The enhancement algorithm is performed using a multiplier of eight, which creates an almost completely black and white image with only a few high-contrast gray areas in the clouds and foreground lawn.

An interesting ancillary operation is performed when picture is shifted in one direction. This operation allows the analyst to extract and enhance edge lines that appear along one axis, horizontal or vertical, and to simultaneously eliminate edge lines that appear along the opposite axis. This function can be useful as a type of filter for eliminating patterns of interference lines which appear vertically or horizontally on a picture.

Figure 6 shows an edge-enhanced version of the Capitol scene generated with only a single upward shift prior to the subtraction. Vertical edges have been eliminated from this picture. Similarly, **Figure 7** has been generated with a single shift to the right; now all horizontal edges are eliminated from the picture. Spatial Data's EyeCom is a new type of computer terminal for processing images through a digital computer. Shown here are just a few possibilities. Other functions include magnifications, gray-level adjustment, histogram plotting, reverse contrasting, low pass filtering, high pass filtering, negative imaging, rotate 45°, edge enhancement-Laplacian, pictorial voice filtering, and various print-outs. All the tools required for efficient image processing are provided within the EyeCom. Combining the EyeCom with a digital computer and image processing creates a stand-alone image processing system. The digital computer can be either a microprocessor contained within the EyeCom, or a separate minicomputer, depending on the amount of image processing required. **D**

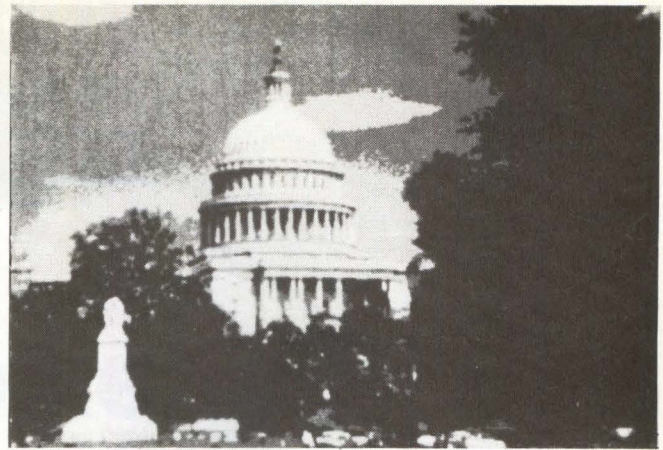

Figure 4

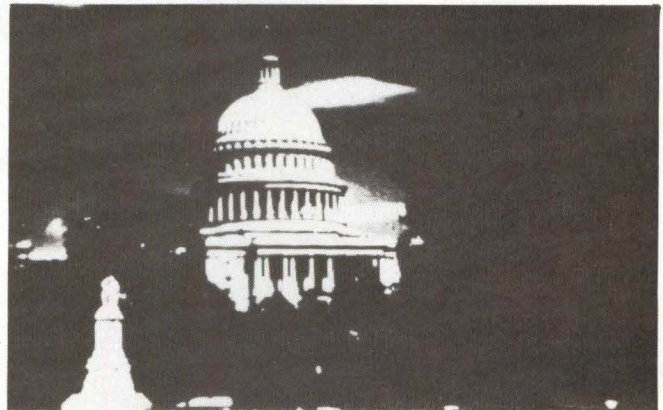

Figure 5

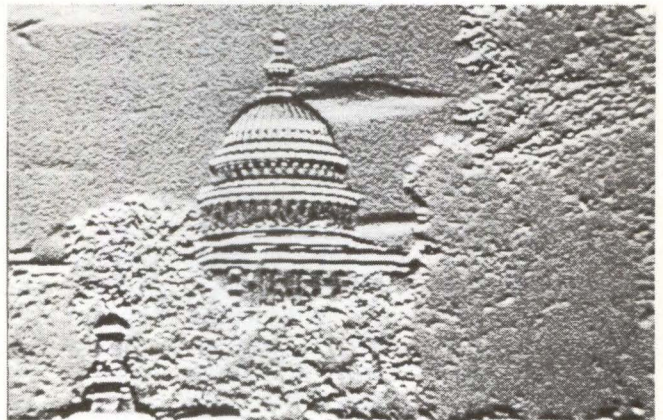

Figure 6

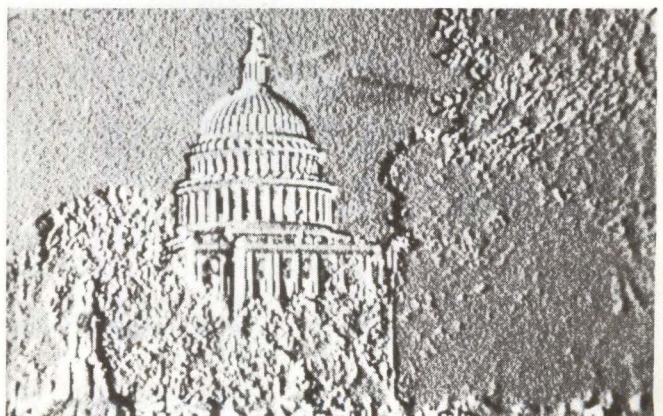

Figure 7

A Lexicon for Modern-day Graphics

Thomas W. Moxon

It is not as easy to talk about color graphics **systems** as it is to talk about mainframes. With mainframes you always know what you're getting for your money. With color graphics **systems** you can't be sure. To begin with, there are a number of different classes of display systems (based on overall function):

- I Terminal Displays
- II Graphic Displays
- III Graphic Imaging Displays
- IV Graphic and Image Processing Displays

And each of these four classes may be implemented by a manufacturer in one or more distinct technologies:

- 1 Directed Beam CRT
- 2 Direct View Storage CRT
- 3 Raster Scan (Digital Video)

As one might imagine, all possible combinations of the above accounts for the babble in the computer graphics market about whose hardware is doing exactly what. One good way to understand color graphics is to learn the meaning of the seven divisions listed above. These seven divisions are the ABC's of the Graphics Language.

terminal display.

A graphics terminal, either color or monochrome, is basically a character oriented display with several additional writing and coordinate positioning modes. These additional modes are generally invoked by sending special character sequences to the display. A typical example is the direct position point plotting of most graphics terminals. Generally, the user sends out a 'special' character perhaps an (escape), and then a command code, terminated by another 'special' character delimiter (usually carriage return). In response, the terminal performs a command. Basic commands allow user to specify any (X,Y) coordinate and place a character symbol or individual point at the coordinate. Color terminals, also, allow a color specification

Tom Moxon is Manager, New Products Development, Grinnell Systems Corp., 2159 Bering Drive, San Jose, CA 95131

at the coordinate (typically one of eight). Graphics terminals are usually low in cost (\$500 - \$10,000) and vary widely in technology and complexity.

graphics display.

A graphics display generates various alphanumerics, points, lines (vectors), curves, and other special patterns in response to commands from the host computer. Basic differentiation here is the level of command primitives recognized by display system. Several manufacturers have extensive software and firmware primitives. But it is sometimes difficult to determine from a manufacturer's literature if all 'features' are performed by the hardware, or by the host software routines. Capabilities of the majority of graphics displays include:

a) ALPHANUMERIC TEXT.

The graphics display should include all basic capabilities of the terminal display, for writing character-oriented data.

b) POINT PLOTTING.

The graphics display should be able to access any (X,Y) coordinate directly for reading or writing. Should also be able to specify a shade or color to write at that point.

c) LINE DRAWING.

The graphics display should be able to accept the endpoints of a line segment (X1, Y1, X2, Y2) and generate the segment in any desired shade or color.

d) CURVE DRAWING.

The display should be able to accept the coefficients of a curve and generate it on the display, in any desired shade or color.

$$aX^2 + bY^2 + cXY + dX + eY + K = 0$$

e) GRAPHIC PATTERN.

Specifying a starting (X,Y) coordinate, shape and dimensions, and shade or color data to plot in the shape. Generally a higher-level function used for symbol manipulation and polygon generation.

f) PLOT DRAWING.

User generally specifies a plot axis and dimension.

Data then determines dimensions of the other axis being plotted. Usually a shade or color can also be specified for each point plotted.

g) SPATIAL COORDINATE TRANSFORMATIONS.

Allows transformation function to be applied to coordinates before they are used in the command. Generally an offsetting, rotation, scaling, clipping, or masking of the screen (X,Y) address before being used. Feature is especially prevalent in Directed Beam Displays where the transformation process usually amounts to a 4×4 multiplication matrix, obtainable in real-time, or approximately 1/30 second.

h) DISPLAY LIST PROCESSING.

A display data formatting mode. The picture is represented by a list of coordinates and the spatial relationship functions between them. A typical display list is a polygon of some sort. The list defines a display entity. The (X,Y) coordinates refer to entities location on the screen. Some manufacturers provide area-fill functions along with this, allowing the polygon to be filled with a particular shade or color.

graphic imaging display.

A graphic imaging display can accept most commands of a graphics display system. Display has additional capabilities of accepting, storing, and displaying real-time image data, (from a digitizing camera for example.) This added capability enables user to intermix graphics-command-generated displays with real-world-image data to form composite images. Particularly useful in fields of science and medicine for annotating electronmicroscope images, radiotelescope images, CAT scanner images, X-ray images. Graphic

imaging display systems generally have limited processing capabilities, because most of the computation is performed in host computer. That is to say, the graphic imaging display system can accept and display real-time image data. For processing, however, that data must be read into the host's main memory, operated upon, then written back into the display system. There are some basic display manipulation functions provided in most graphic imaging display systems. These manipulation functions do not alter data stored in the display system, they merely perform various transformations on the visual representation of the data on the screen. Such manipulation functions often include:

a) INTENSITY MAPPING MEMORY.

This function has many trade names; such as, mapping memory, function memory, look-up table, transform table. Mathematical definition of the operation is "a linear transform operator." These are small memory arrays through which the picture data passes before going to the display. Memory arrays may contain various mathematical functions, (scaler multipliers, common log, natural log, inverse log, transcendental operators). Application of these functions can be employed for contrast enhancement, image scaling, density detection, and others. These tables are generally employed for pseudo-coloring images, a technique used primarily for image density detection. Pseudo-coloring the color rendition referring to specific monochrome density, or grey levels in the monochrome image.

b) IMAGE ZOOM AND PANNING.

This feature allows the user to enlarge and "home in" on areas of particular interest in the image.

LSI-11 SYSTEMS FROM ANDROMEDA

Any size you want.



No matter what your LSI-11 system needs are, Andromeda can satisfy them.

For example, the 11/M1 system shown on the right weighs only 14 pounds yet contains 102kb of mini disk storage

(expandable to 389kb), 64kb of RAM, space for up to 16kb of EPROM, 4 serial ports, and the LSI-11/2 CPU. All of this for less than \$4000. While the 11/M1 will run the RT-11 operating system, it is best suited for dedicated applications where its small size but large processing power are needed.

Near the other end of the scale is the 11/H23-DDF system shown at the left. The mobile enclosure includes the LSI-11/23 processor, 256kb main memory, 10mb of storage on the double density RK-05 cartridge disk and 1.2mb on the double density floppy disks. This system also has 4 serial ports and 7 empty dual width slots for additional interfaces. The \$22,500 price includes the video terminal shown, a 150 CPS matrix printer, and the RT-11 operating system.

These are just two examples of the many LSI-11 based systems available from Andromeda. And the standard systems are just starting points; we will provide any combination of pack-



age, processor, memory, interfaces, and peripherals to meet your requirements. In addition to general purpose systems, we also have turnkey packages for word processing, time-sharing, data acquisition, and graphics.

We also provide individual boards, software and accessories to support LSI-11 systems.

LSI-11, RT-11, and RK-05 are trademarks of the Digital Equipment Corp.

**ANDROMEDA
SYSTEMS**
INC. 

9000 Eton Ave.
Canoga Park, Calif. 91304
Phone: 213/709-7600
TWX: (910) 494-1248

Prices are domestic U.S.A. only.

Circle 33 on Reader Inquiry Card

"Panning" is the original displacement of a given image. "Zooming" refers to enlargement of the image based on several methods of replication of the original image data as it is sent to the display.

c) **SPLIT SCREENS AND IMAGE SEGMENTATION.**

This feature allows user to display more than one image at a time, by splitting the screen into several segments and displaying one image in each segment. Normally, there are horizontal, vertical, and quadrant splits that can display two or four images on the same screen.

graphics and image processing displays.

Graphics and image processing display systems have all capabilities of graphics terminals, graphics displays, and graphics imaging displays. In addition, the graphics and image processing display system performs high-speed computational operations on image data. Advantage of performing the arithmetic operations in the display system? The image data doesn't have to be transferred to and from the host's main memory to be processed. This has considerable merit. Most color images, in raster scan format, require upwards of a megabyte of memory to contain them and most minicomputers cannot even address this large a space. And the time overhead to transfer such large amounts of data is prohibitive to extended processing. Thus, display systems were designed with extremely high-speed computational abilities (7.86 megaoperations/second) and are usually programmable in themselves. This speed allows real-time acquisition and analysis or correction of image data.

The graphics and image processing machine is a relatively new development in image processing, (developed since the advent of inexpensive, fast semiconductor memory chips). These large (16K - 64K × 1 bit) dynamic memory chips, sometimes referred to as 'refresh memories' are used as bulk storage area for image data and computational results. Memory chips are read out at a rate that corresponds to the television scanning rate, and provide data for the screen display. At the same time, the data may be passed through a series of arithmetic and logic units to perform computations, in a read-modify-write type of memory cycle. This loop structure allows image data to be recursively, or iteratively processed by storing the processed data back into the refresh memories. The processed data can be recycled through the arithmetic units, as many times as is necessary for the particular algorithm in question. This process inherently refreshes volatile data inside the MOS dynamic memory chips, with no conflict for computational memory access.

The 'features' of this type of system might include:

a) **Programmable Microprocessor.**

A microprocessor can be used to sequence through various control functions or computations. Typical sequences: acquire an image; determine intensity distribution; calculate a normalization function; use Linear Transform Operator to normalize displayed image data; then acquire new image; etc.

b) **Image Intensity Distribution Analyzer.**

This unit forms a count of various picture elements and the intensity levels they achieve over the entire frame of image data. Data can then be employed to correct the distribution to some normalized curve, through application of the image processor. Uses of this device are many, such as film exposure correction, color matching from frame to frame, X-Ray and CAT scanner analysis, star field distributions, etc.

Of the four classes of display systems mentioned, only the

first two classes, terminal displays and graphics displays can be implemented in all three technologies. The only technology that can be effectively employed for all four classes of display systems is digital raster scan. A short comparison of all three technologies and their advantages:

Directed Beam CRT

This type of display uses a hardware controller to develop signals for the deflection amplifiers that drive the cathode ray tube. The controller periodically scans a display list to get its graphic data, then directs the electron beam accordingly. Such a system is very fast and very expensive. In addition, this system cannot accept real-time camera inputs and are used mainly for line drawing applications.

Direct View Storage Tube Display

The basic principle here is that the graphic image is retained on the phosphor of the CRT while the deflection of the electron beam is directed by the graphics controller. This system has very high resolution and is less expensive than the directed beam. However, due to the nature of the phosphor, the displays are relatively slow. They are also analog signals, and difficult to keep calibrated. As with directed beam, no real-time image data input is available. In addition, there are no means for selectively erasing portions of the screen.

Digital Raster Scan Television

In standard television, the electron beam moves as one's eyes read a page and scans an image on the face of the cathode ray tube. This deflection pattern occurs with a regular period of 1/30 second (NTSC standard), and the intensity of the electron beam at any point in time determines the brightness at that point. Digital Raster Scan employs semiconductor memories that are read out at the scanning rate. These supply data to one or more digital to analog converters that control the intensity of the electron beam scanning the phosphor screen. The scanning rate determines the screen resolution, (512 × 512, 640 × 480, 525 × 525) or the number of discrete picture elements (pixels) that the memory must address. The pixel resolution (bit — depth of each memory address) determines the grey scale, or color palette of the display system. Typical monochrome systems might be 1, 2, 4, 8 bits deep for graphics and imaging, corresponding to 1, 4, 16 and 256 grey scales respectively. Common color display systems might be 3, 12, and 24 bits deep for graphics and imaging corresponding to 8, 4096, and 16 million colors respectively. This technology is getting more inexpensive each day, as the prices of dynamic memory chips fall. In addition, it is flexible to use and allows real-time image acquisition and processing.

Display specifications and parameters, involve many types of specs for each display technology. Some parameters and specs that might apply to all display technologies are:

1) Display Screen Resolution

The number of discrete picture elements that can be viewed on the display.

Directed Beam typically — 1K × 1K, 4K × 4K
Raster Scan typically — 512 × 512, 1K × 1K

2) Picture Element Resolution

The number of discrete intensity changes that any picture element can obtain.

Directed Beam typically — on/off, to 256 levels

Raster Scan typically — on/off, to 256 levels,
to 2²⁴ colors

3) Display Writing Speed

The speed of any display is relative to the particular instruction being executed, however there are certain benchmark standards.

a) Single Random Picture Element

Directed Beam — 1-5 μ s

Raster Scan — 320 ns to 5 μ s

b) Diagonal Line of 50 Pixels

Directed Beam — 50 μ s to 250 μ s

Raster Scan — 20 μ s to 150 μ s

4) Output Device

The variety of output devices that may be used with the display system.

Directed Beam — CRT

Raster Scan — CRT, film printer, plotter Video recorder, Video disk

5) Graphic Input Devices

The variety of tactile devices that can control the display.

Directed Beam — Keyboard, Joystick, Trackball, Light Pencil, Digitizing Tablet

Raster Scan — Keyboard, Joystick, Trackball, Light Pencil, Digitizing Tablet, Video Camera

6) Richness of Instruction Set

The variety and types of data entities and screen addressing modes.

7) Software Support Packages

The level of programming support offered. Some machines may implement little in hardware, yet have

comprehensive 'soft' instructions; others offer little software yet achieve the same level of sophistication in their more complex hardware.

8) Internal Intelligence

This addresses the question of 'dumb' versus 'smart' and 'standalone' display systems. Generally, most display systems have some sort of microprocessor, either commercial or custom-designed as the heart of the graphics system. This micro typically decodes and executes display instructions from the host computer. If this micro can support peripherals, such as hard or floppy disk, tape cartridge, and keyboard, then the unit may be able to be used stand-alone'. That is to say, you no longer need a host to run the display, it can run by itself.

9) Host Interfaces

GPIB — IEEE Standard

Serial — Async, Sync, Baud Rate

Parallel —

General purpose 16-bit parallel

Commercial Interface Standard (DEC,

IBM,DG,etc.)

10) Our Products

Many manufacturers offer several lines of graphics and imaging displays, as well as image processing displays. For example, Grinnell Systems offers Graphics Display (Model GMR-37), Graphics Imaging Display (Model GMR-27, GMR-260), Graphics and Image Processing Display (Model GMR-270). Our software library implements FORTRAN subroutines to control instruction execution in the display systems, and allows transportability of software between different host computers. All Grinnell models execute the same instruction set. **D**

A Cost-Effective High-Speed Data Acquisition Network Micro-Link

LSI-11/2* and LSI-11/23* users can share resources, share loads and save money. Standard Engineering's new Micro-Link offers high-speed networking in a complete software/hardware package for only \$4,950.

Micro-Link software is simple to use. The RT-11* handler supports HDLC protocol. Micro-Link reconfigures whenever a failure occurs. Files up to 65K words can be transferred.

An intelligent DMA controller gives fast Q-bus interface. One MHz speed is noise immune. Two dual-height boards make up a station. A coaxial cable interconnect minimizes installation costs.

The Micro-Link is offered with one master and one slave. Additional stations are \$1,950 each. For more details, call Mary Mattel at 415-657-7555.

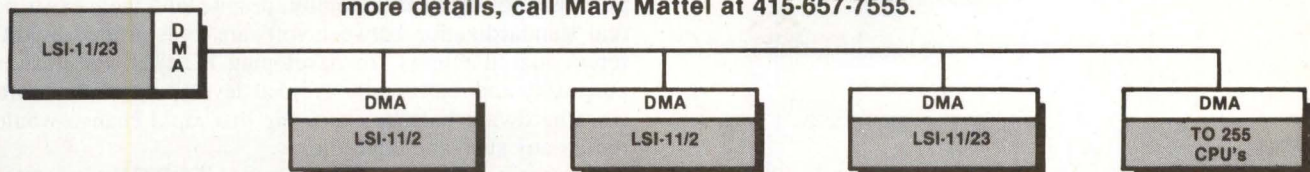

*LSI-11/2, LSI-11/23 and RT-11 are trademarks of Digital Equipment Corporation.



STANDARD ENGINEERING CORPORATION

44800 Industrial drive • fremont, calif. 94538 • 415 657-7555

Circle 21 on Reader Inquiry Card

FORTH: Exaggeration Or Panacea?

Paul Snigier
Editor

FORTH provides a general, compact and powerful core of constructs for arithmetic, logic, data structures, mass storage interface, editing and assembly. It offers extensibility to your specific problems, non-linking multi-level programming, interactivity, handling mass storage, and development simplicity.

You've seen the ads over the past couple of years for FORTH. Slash software development times up to 90%, slash memory requirements up to 90%, produce truly transportable programs, and cut run times by 60%. These utopian claims sound reminiscent of old-time claims that snake oil medicine men put forth for their wares. And if you haven't considered FORTH, you might be wondering: "Does FORTH really live up to the claims?" and "Should I try it?" We will try to answer your questions, attempt to be fair and will examine both sides.

old languages never die . . .

In its first two-and-a-half decades of existence, computer software was controlled by computer hardware; and, for a quarter century, hardware progressed rapidly. This certainly won't change for the foreseeable future. New developments in VLSI, VHSIC, MBM, Josephson junctions and mass memory, among other hardware changes to come, will guarantee quantum jumps in performance through the 1980s. Hardware progress will continue in spite of the "slowing" down of memory capacity per device. The demise of Moore's Law won't be as serious as some in the trade press have claimed. If memory doubles only every three or four years now, at these levels of capacity, the true impact of doubling of capacity per device is far greater than in the past. Computer capability is more than a mere linear function of memory capacity; i.e., more combinatorial than linear, as those working in AI well know (and those in CAD are learning).

But, has software kept up? Hardly. Although there is some shift from the von Neumann architecture (as in the 8048/49) — and although the late 1980s promises to see true software-driven architectures — the present reality is a far different matter. Program generators and user-friendly computers won't be enough. For now, the dichotomy between software and hardware has grown, and will continue to grow; and operating system software and language structures in use remain as they have been: based on qualities inherent in long obsolete hardware. This has led to software development problems, not to mention numerous languages that blossomed like weeds.

FORTH's history

Mini and micro software is complex, unwieldy and costly, resembling the Tower of Babel. Numerous attempts are being made to lower costs with "standard" packages and techniques, which are called up on a ready-made basis, program generators, user-friendly computers and even self-propagating software. In reality, despite talk, there exists no real standardization between software tools offered by different manufacturers. In developing FORTH, its creators purposely and realistically avoided developing an ideal software/hardware balance, knowing that rapid change would render any such attempt futile.

It was in this software jungle that FORTH's inventor, Charles Moore, was actively involved from 1968 through 1974. This earlier FORTH, implemented on older machines, was all that was available in the public domain until the Forth Implementation Team (FIT) implemented FORTH-78 with its standard language term definitions. Since then, the lang-

uage has expanded to several levels of documentation in the public domain.

Forth, Inc, founded in 1973 by Chuck Moore and Elizabeth Rather, licenses and supports the FORTH Operating Systems and Program Languages for minis and micros (first for mini and micro-FORTH and now replaced largely by polyFORTH), and also provides application programming services and complete turnkey systems. They contained disk-based operating systems, assembler, compiler, interpreters, editor, virtual memory and device drives. From a historical perspective, we will examine several versions of FORTH.

MiniFORTH, available for popular minis, contained its own monitor and disk-based operating system functions. Its completely integrated system included operating system, compiler, interpreters, assembler, virtual memory, text editor, multiprogrammer, and file management capability resident in less than 5 kB of memory. The multi-programmer included in the miniFORTH package allowed any number of terminal tasks to execute independently using private routines or re-entrant code, as desired. In addition, the multi-programmer provided for equipment control tasks with no terminals. In a demanding multi-task environment, it claimed the highest performance in the industry, and on modest equipment. It provided advanced file management features with keyed files, multiple-keyed files, and structured record definitions. This file management system could be the basis of sophisticated and powerful Data Base Management Systems. I/O drivers for standard disks and terminals were included; other peripheral drivers were available. Forth would install miniFORTH on your mini and give individualized on-site training classes.

MicroFORTH provided a completely integrated disk-based package which included compiler, interpreter, assembler, operating system, virtual memory, and text editor, all resident in less than 6 kB of memory. microFORTH also contained a cross-compiler for target CPU chips; the compiler generated a compressed version of the application, along with a 512-byte run-time microFORTH support nucleus. This code was suitable for target PROMs. If microFORTH and the application program required 8 kbytes on the development system, they usually needed a total of only 1 to 1.5 kB in the target device. Interactivity made programming easier.

When you ordered microFORTH, you received: a floppy disk containing microFORTH software, instructions for loading the system and adding equipment, "microFORTH Primer" to instruct first-time users, "Technical Manual" a reference source, any non-standard routines or additional capabilities that were ordered, and access to the microFORTH telephone Hotline which provided immediate service in answering questions. The microFORTH package was complete and self-contained.

PolyFORTH, combining both mini and microFORTH features, is for both minis and micros, and offers multiprogramming and target compiler. As this was written, polyFORTH operated out of PROM with disk as a peripheral for some systems. So, if your system is, say, SBC-86/12-based, and you want a developed system, you're all set in terms of CPU, lots of memory and a serial port for your CRT. With an SBC-204 disk controller, you can interactively test application software and hardware without onerous in-circuit emulation.

PolyFORTH offers a faster dictionary search algorithm, all 16-bit arithmetic, a more secure multiprogramming control, simplified vocabulary handling, a simpler target compiler and improved text editor.

The "target compiler" approach reduces development time. Software is developed on the same type of hardware it will run on, eliminating all conversion problems.

The more conventional cross-compiler approach enables the developer to work on a system that may be convenient — physically or in terms of its capabilities — but different from the target machine. (More on polyFORTH next month.)

the software development dilemma

High software development costs continue to plague equipment makers, particularly those newcomers just entering the μ P-based product market. Software development involves four processes: design, testing, determining if the software functions correctly (it usually doesn't), and if not, modifying it and then reentering the loop. After many times through the software development loop, the program eventually functions correctly and the designers can get on with building a hardware prototype. This may not be the end of it for the software development.

After system emulation and testing, performance may still be unsatisfactory. In that case it may be necessary to modify hardware, as well as reentering the software development loop to modify the software.

Unexpected software development costs are due to five culprits: (1) insufficient programming techniques (usually due to programmers with little experience on that particular μ P), (2) lack of language standardization between different μ P makers, (3) in-fighting, job protection tactics and staff turnover (4) poor documentation (when schedules are tight, good documentation is considered expendable) and (5) woes due to earlier structured programming given short shrift when an overemphasis on efficiency took precedence to meet deadlines.

Training and retraining programmers is costly and time-consuming, and, worse, retraining affects future projects. If your programmers are good at programming one μ P, guess what device they'll select for their next project? This could result in a choice that lowers profitability in the long run for mass-produced μ P-based products. This danger is one of software dictating hardware approaches that are not based on sound engineering judgment (component availability, cost, functional suitability and so on).

There is no easy solution to this software development problem, unless there is an easy-to-use, easy-to-learn development approach that permits a programmer to quickly understand what a previous programmer did.

In one partially successful approach, μ P makers introduced high-level languages for their specific machines. To this end, Zilog introduced its PL/Z; Intel, its PL/M; Motorola, its MPS. Did they succeed? Yes, but not without side effects. Although these languages certainly beat assembler language programming in terms of reducing program development time, the side effects were inefficient coding, larger program memory and higher hardware costs. And no one accused these language makers with standardization, as each language differed. So, if you wanted to competently use any of these or other languages, you spent time learning and using them first. But, this proved expensive when a new project comes along.

FORTH to the rescue

FORTH overcomes software development woes since its creators had no axe to grind, no chips to sell, and provided FORTH for software development on most devices. What does standardizing programming language and technique mean? With the proper development system, this frees

designers from making choices based on previous experience, rather than sound engineering judgment. If you program on one micro, you can use any FORTH package on another.

By standardizing programming languages, FORTH's creators minimized its users' future training costs. FORTH codes more efficiently than assembler language programming; modular program construction offers progressive program testing and debugging; and it's self-documenting, thus saving time normally spent in software documentation.

FORTH's creators point to these advantages, claiming faster software development and lower storage requirements, without saddling users to any specific μ Ps. This software transportability permits users to pursue parallel development on several hardware subsystems. This speeds up product development.

FORTH, an inherently-structured language, requires all its users to adopt a modular approach — one used by the best programmers with other languages — forcing even novices to apply a Top-Down software design and a Bottom-Up testing approach. A FORTH program is a linked program with modules. Each has an entry and exit point. With GO TO and JUMP commands unavailable, during debugging you won't be patching, that is, inserting corrected code into a routine to alter or correct it. Since in the final linked program, final code is a list of pointers to program blocks or modules,

that is, FORTH words, and thus proves more economical than conventional high-level languages.

the dark side of FORTH

FORTH has shortcomings. Knowing these shortcomings, potential users can be forewarned and make allowances. All languages have weaknesses, and relative to other languages, FORTH's benefits-to-shortcomings ratio is high. With this in mind, we can gain a more balanced picture by looking at FORTH's dark side.

FORTH trades program size for run-time. As for run-time, we make two criticisms. The linking process between high- and low-level modules to form the user's program creates time overhead that can reach 100% over one written directly in assembler language — certainly not a selling point. Then there's the matter of FORTH's dictionaries; they are like hedges: they must be pruned periodically or they get out of hand. FORTH has an inherent size overhead, and nothing can alter this; the trick is to prune words at frequent enough intervals and do it with care. Since FORTH's building block dictionary of words and the controller routine which sequences the program pointers must be resident, programmers must take care when adding new words to the dictionary. Since additions increase the dictionary size, at the start of each project, users should look for unwanted words and cut

FORTH DIRECTORY COMING UP

We will publish a FORTH Directory in a future issue. This is an excellent opportunity to be listed (for free) in a directory that will reach 65,000 direct (173,000) readers — leading computer system designers and integrators. So, if your firm produces FORTH or FORTH-related software, products, conventions, workshops, seminars, firmware operating systems, and so on, then fill out this question-

naire (use one questionnaire per item) and return it to us. Place one product or item per page (make photocopies as desired). Print legibly or type. Please, don't take the easy way out and write: "See spec sheet." (We cannot reprint spec sheets.) Include in your mail-back such material as press releases, photos, manuals, literature, articles, etc. Thanks. Paul Snigier, Editor

Product/item category: _____

Product/item name: _____

Description and specs: _____

Unit price _____ Quantity price (designate qty.): _____

Company Name/division: _____

Company contact (sales): _____

Street/Box #/MS: _____

City: _____

State/Zip: _____ Phone () _____

Mail completed form to: FORTH Directory Editor, Digital Design magazine, 1050 Commonwealth Ave., Boston, MA 02215. (617) 232-5470.

them from the dictionary. This can be an irritant.

FORTH ads claim a memory saving, but users say this saving applies to large and complicated programs. (Good programming in other high-level languages like LPZ, PL/M, abbreviated PL/1, Pascal, Ada, etc., all produce similar savings, don't they?)

As μ P users expand applications into new areas, μ Ps are pushed to their ultimate speeds to service interrupts and polling loops. But to reach these higher speeds, FORTH users use machine code. But this requires that users possess a good knowledge of the particular assembler language. In these cases, doesn't FORTH lose some of its claim to transportability between μ Ps?

FORTH's two-tier stack structure, its RPN features and unconventional data storage make it a bit unconventional. Users condemn the longer learning time. Other criticisms have antagonized users, such as a lack of defined I/O routines; floating point formats; and restrictions on 16-bit data. However, improvements have been (and are being) made. Then, FORTH's stack requires care when using DO loops and general program loops. Other users want a more powerful interpretive, high-level mode, since they must still edit and assemble programs prior to using the immediate mode.

Unlike minis, a very important part of μ C development often involves in-circuit testing, at which stage software and hardware changes may be made. This stage requires extra software.

Some of these criticisms are less important with poly-FORTH; and we say these things not as condemnations, but only to point out the weaknesses. Weaknesses afflict every language, and no language can ever come close to a theoretically ideal language. FORTH comes closer than many others.

defining words

Although some claim the language is difficult to learn, the rules are straightforward. FORTH, unlike other languages, is an extensible dictionary-based language consisting of a vocabulary of words — with no restraint on characters within words. Thus, any character may start or lie within a word. The dictionary, which occupies some of the memory used by the program, defines each vocabulary word and checks operations performed by verbs. FORTH adds new words to the dictionary, looks up correct words and spots contexts that select limited portions.

Entering CODE tells FORTH that you want the word following CODE to be placed in the dictionary and that it will be in machine code. This lets you perform all I/O functions, implement complex arithmetic operations (hyperbolic functions, etc.) and perform machine-dependent processing. You can thus write compact software for time- or memory-critical software for memory- or time-critical portions.

Can you move programs to a different μ C? In a time-saving feature, only words you define with "CODE" will be re-defined in the new μ P's machine code.

The third defining words, "VARIABLE", differs from CODE and the colon; it puts the word following it into the dictionary and assigns a word for its value. If you entered "8 VARIABLE MTBF", then FORTH defines the noun "MTBF" and sets its value at 8.

To communicate with words that you use, FORTH provides PRN operation and a pushdown stack. Suppose you enter items into the stack and next type a word that acts on the stack, thus producing a result. Let's say you typed "3 8 * 4 /". Since operation is RPN, the system will place 3 and 8 in

Quality Costs Less . . . with the Eaton 7000+ Printer

Costs less to buy.

Purchase price of the Eaton 7000+ Dot Matrix Impact Printer is less than most industrial stand-alone printers — but the built-in quality and reliability are what really make it a value investment.

Costs less to operate.

Prints on any regular roll paper with widths of .750 to 3.875 inches. No expense of special treated paper to buy and stock

Costs less to maintain.

Designed with a minimum of moving parts, the 7000+ requires little maintenance. Unique long life printhead boasts 100 million character life for dependable operation.

Designed for application in a wide variety of industrial and commercial fields — wherever hard copy information is needed. Ideal for printout of manufactur-



ing records, quality control test events, mailing lists, time-cost-quality information, or other data from a micro-processor or mini computer sources. Optional interface cables for serial RS 232, IEEE interface, current loop, or parallel interface. Capable of receiving

data at 110, 150, 300, 600 or 1200 BAUD.

High speed operation of 1.25 lines per second provided by unidirectional printing. Also available with a fast paper feed option for increased throughput.

Print versatility.

Single width font of 40 columns at 12 characters per inch or 20 columns at 6 characters per inch with a double wide font are standard, 64 columns at 19.2 characters per inch and 32 columns at 12 characters per inch optionally available.

For additional technical information, call or write: Eaton Corporation, Printer Products Operation, Riverton, WY 82501. Phone: 307/856-4821

EATON Printer Products

Circle 24 on Reader Inquiry Card

High-Speed MAXiRAM Storage System

Offers superior performance, throughput and reliability!

Compatible with:

- D.E.C.
- Data General
- Westinghouse

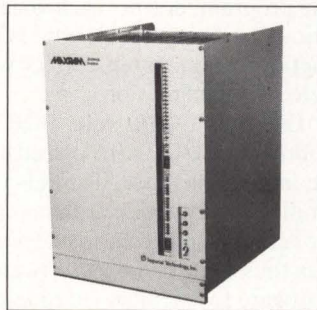

The non-rotating MaxiRam is a solid-state disc replacement storage system that operates at the speed of main memory. It is ideal for the following:

- ...if your processor is disc I/O bound.
- ...if your CPU spends too much time in the 'wait' state.
- ...if your present disc gives you reliability headaches.

Write or call to find out how *your* memory performance and reliability can be dramatically improved. Units available in both core and semiconductor.



Imperial Technology, Inc.

831 S. Douglas Street • El Segundo,
California 90245 • Telephone: (213) 679-9501

Circle 22 on Reader Inquiry Card

Brand New - Full 90 Day Warranty - Brand New - Full 90 Day Warranty

Scherer's Line of New DEC Terminals

"Serving the DEC Community since 1976"

New Special Price VT 100-AA \$1,495 EA.
(with advanced video option)

VT 100-AA	1,375 EA.*
VT 132-AA	1,595 EA.*
LA 34-DA	895 EA.*
LA 34-AA	995 EA.*
LA 38-GA	1,095 EA.*
LA 120-RA	1,795 EA.*
LA 120-AA	1,995 EA.*
LA 120-BA	2,075 EA.*
LA 180-EA	1,750 EA.*

Items are in stock - no limit

★ Quantity 1 cash prices

Call: Sonja at (614) 889-0810

SCHERER'S MINI COMPUTER MART
6145-F Dolan Place Dublin, OH 43017

Warranty Brand New - Full 90 Day Warranty

Circle 23 on Reader Inquiry Card

its stack, multiply the two and place the result (24) back in the stack. Next, it places 4 on the stack and divides it into the previous result to get 6, to get the final result, which (via the dot) is printed. To save program parameters, use a separate stack (Return Stack). Some programmers don't like RPN, but they do use it.

FORTH has two interpreter levels. With its High Level, it reads a word from the terminal, searches its dictionary and executes the entry it finds. The Low Level executes words you defined with the colon. In our earlier example, we entered "QUEUE" in the dictionary; and the words "WAITING" and "LINE" were looked up and their respective addresses stored under "QUEUE". When "QUEUE" is referenced, the interpreter picks up the associated addresses and then executes the required code. The text defining "QUEUE" is not stored.

examples make it clear

Let's assume you wanted the system to read an external clock's time (16 bits), put it on the stack ("GET") and also display on the terminal a number it removed from the stack ("PRINT"). This sequence could be performed by two words "GET" and "PRINT". To test "PRINT", manually place a number on the stack and type it out. As an example, "32 PRINT" prints it out. Once you test "PRINT", test "GET". Now, combining these two words gives "GET PRINT", which you may want to simplify by calling them "TIME". To do this, enter ":TIME GET PRINT;". After this is done, whenever "TIME" is typed in, FORTH's system prints the external clock's time.

Now, let's go one step further: How can we get the terminal to continuously display the time? We define "WAIT" by using "CODE" to mean "WAIT for one second". We enter ":SAMPLE WAIT TIME;" so that typing "SAMPLE" causes the terminal to display time after a one second delay. We can include "SAMPLE" in a loop called "CLOCK", where ":CLOCK 60 0 DO SAMPLE LOOP;" The DO statement, which is very powerful, is similar to its Fortran equivalent, and consists of a set of repeatedly-executed statements beginning with the one following the DO and continuing up to and including the one named in the DO. After this, whenever we type "CLOCK", the terminal displays every second for 60 seconds.

combining simple words yields complex operations

We can combine simple words, thus forming complex operations. Take care in choosing words and the program will document itself.

With FORTH's extreme modularity and self-documenting feature, users find debugging and making subsequent modifications easier. In addition, as we said earlier, FORTH forces its users to adopt a Top-Down approach when designing their program and a Bottom-Up implementation. This enables users to check each program module before rushing on to the next. Top-Down programming is more easily used by experienced programmers. In FORTH, a relative novice will find the language no more difficult than will experienced users. Certain languages, such as APL, do not lend themselves to structured programming; others, such as Pascal or Ada (which promises to be the language of the 1980s), do.

divide and conquer

Top-Down programming is a specific technique of algorithm development; complex problems are divided into smaller and more manageable sub-problems. Programmers in, say, For-

tran, develop a level-one outline of an algorithm and define this algorithm repeatedly, until sufficient detail lets them write the program. The main program that reflects the level-one algorithm is mostly made of calls to separate program modules ("remote blocks"), which specify details of each level-one program step.

Our goal in software problem solving is problem decomposition; that is, we break a complex problem into independent subroutines and solve these separately. This is done by drawing a first-level flow diagram to outline the sub-problems and then separately refining each, filling in algorithm details and even subdividing each sub-problem. This specifying of algorithms through such successive refinement is what we mean by "top-down" programming.

Just how is this implemented? To write such programs, we have a structure for designating statement sequences treated as remote blocks. For example, in the remote block structure, the header statement (REMOTE BLOCK) and terminator (END BLOCK) bracket a sequence of statements executed as a group when referenced by EXECUTE. In the EXECUTE statement, the remote block named after the statement is the operand and is executed, and control transferred to the first statement in the remote block. After executing all remote block statements, control is returned to the top-level program or remote block containing the EXECUTE, where it resumes with the next instruction.

Although you may use transfer instructions (GO TO, EXIT, AND NEXT) within a remote block, avoid transfers into remote blocks from outside (they are prohibited) and transfers out of a remote block to statements outside the block. Do not nest remote blocks within one another; list them separately. Although the remote block is not permitted

in many Fortran compilers, a more powerful technique is used in Top-Down programming, the subprogram. This can be a topic in itself. At any rate, getting back to FORTH, its interactive high-level code allows users to immediately conduct Bottom-Up testing of modules.

the bottom line . . .

When shopping, it's essential to consider more than just low prices in making your summary of cost-value comparisons. If lack of transportability delays a new product using a micro from reaching the market by several months, and this time enables competitors' products to gain a toehold, then the comparative merits of competitive software are academic.

Then, too, remember that as your firm gains software expertise, its software libraries will grow; thus it makes sense to re-use, salvage or adapt whatever already-developed software that you can in new projects. However, if your firm's next project might require a different micro, but your programmers lack experience in it, both they and management will be reluctant to switch.

let's hear it

Will FORTH's advantages enable it to standardize μ P programming? Only time will tell. In the meantime, if you're a FORTH user, write a letter to the editors and tell our readers about your good and bad experiences (how do you compare it to emulation, cross-assembling, cross-compiling, etc). Address your letters to: Letter to the Editor, Digital Design, 1050 Commonwealth Ave., Boston, MA 02215.

Want more information on FORTH? Write to: **FORTH, Inc.** at 2309 Pacific Coast Highway, Hermosa Beach, CA 90254. (213) 372-8493. **D**

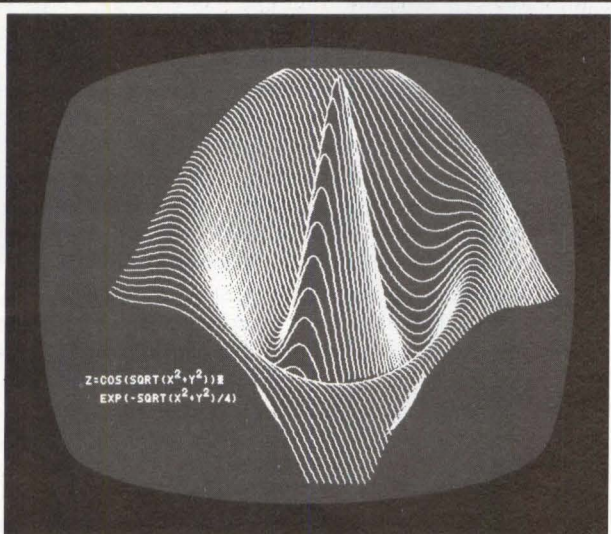

VIURAM video interfaces make your display I/O a natural extension of your computer software, not a choke point. Our direct-access display hardware, by avoiding cumbersome serial methods, provides maximum efficiency, fast character and pixel thruput, and extreme ease of software implementation.

LSI-II GRAPHICS

Model VRG-Q Add-In Graphics Memory for the Q-BUS

- 512 x 512 x 1 Frame Buffer
- Parallel Character Memory
- Dual-Height Card
- Line-By-Line or Direct Addressing
- TEK 4010 Emulation Software
- Low Cost, Available Now

Peritek
corporation

Contact Tom Birchell at:
3014 Lakeshore Avenue
Oakland, California 94610
(415) 465-9000
TWX: 910-366-2029

Computer Technology Division

Design/Selection Considerations for Local Area Data Link Systems

Donald Little, Tod Morcott and Gerald Budelman
 Standard Engineering Corp.
 Fremont, CA

Early work in networking, such as ARPANET, matured into several commercial products. DEC's DecNet, IBM's System Network Architecture (SNA) and Honeywell's Distributed Systems Environment (DSE) are a few examples of solutions to packet switching requirements. Packet switching implies a system to separate intercomputer messages into blocks or packets and route them individually over the best available transmission medium and then reassemble the packets into the original message at the receiver. These networking systems generally support long-haul, low-speed, common-carrier media; are expensive, software-intensive and require considerable sophistication on the part of the user. While packet networks are a major advance in the art, they do not relate well to the needs and the budget of the local area user wishing to link several mini- or μ Cs together for real time applications.

At the other end of the distance/speed spectrum is the requirement for connecting very high speed devices such as array processors, cache memory or high-speed discs to immediately adjacent multiple computers. Various bus extension schemes including multi-ported memories are effective solutions to these problems.

The area of greatest anticipated need for computer linking systems lies between these two extremes. In terms of speed and distance, total network length of from 50-25,000 feet supporting a throughput rate of $10^5 - 10^7$ bits per second represent conservative boundaries of an important range of systems most suitable for the local area multi-minicomputer user. While packet networks are dominated by software, and short high-speed bus extension systems are heavily hardware dependent, medium-distance/medium-speed links require an intermediate level of support in both areas. We present a decision-tree approach for either the designer or the user of local area data link systems and necessary attributes of such systems and alternatives.

advantages of linking computers

Reasons for linking computers and other devices together stem from five areas.

Resource sharing is best for cost savings and performance improvements in the local area data link network. Expensive, powerful peripherals, such as array processors, large disc drives, high speed printers and remote data base installations are available to each computer in the system. Data link requirements, however, are the most stringent. Data transfers are large and frequent and the link overloads easily if data cannot move quickly and efficiently. With large memory devices connected to the link, expensive disc-based software can be made available to individual minis at low cost. Downline loading of application programs permits

unattended operation — a particular advantage in the widely dispersed instrumentation or process control situation.

Load sharing. Where one of several local computers of equal status becomes overloaded, it is highly desirable to share the overage with a less busy unit; a linking system improves system response time during occasional overload and forestalls major system expansion if only a portion of the network is overburdened. Network response times need to be at most a few hundred ms. Data transfers are substantial but somewhat erratic.

Distributed data acquisition/process control. In these applications, remote computers and associated systems gather information and/or implement control routines and pass concentrated data or status information to a master computer for high level processing or decision making. These computers may be peer-group related but more frequently constitute a hierarchy and are specialized in function. Data flow in these applications is less frequent than in the preceding category and requires network response times of a few seconds at most. In some applications, particularly real time signal digitizing, data rates can soar but typically these systems are not bound by channel capacity.

Human message communication class of computer coupling is the "loosest" category; communication of human messages in real time systems occurs least frequently and is slowest. In the "office of the future," distributed minis pass memo information to a central printer or implement an electronic "mailbox" using CRT terminals. Most communications are at modest rates, and network response time requirements is measured in minutes.

selection/design considerations

Whether one approaches specification of a local area data link system from a user's or designer's standpoint, there are seven key areas listed below; the user/designer enters the tree at the top and evaluates his needs/market requirements in this order: service area geography, environmental constraints, network throughput, reliability requirements, network management architecture, protocol/software support requirements and cost performance tradeoffs.

Service area geography. The area over which computers are linked is defined in maximum overall length, maximum distance node to node, number of nodes connected and approximate position. If these distances are under 50 feet or over 25,000 feet, systems other than local area data links likely will prove more cost effective. With constant cost, distance and data rate capability are inversely related, so a sprawling network must either drive up costs or sacrifice speed.

Environmental constraints. In addition to temperature and humidity limits, a data link must operate in high interference environments as in high energy physics labs or heavy industry. For other than dp environments, immunize the system from substantial common and differential mode voltages. The use of transformers or OCIs helps provide protection. Long runs of cable, even underground, occasionally attract disastrous transients. Passive clamping is necessary to protect bus interface circuitry. If severe, use fiber optics.

Network throughput is the effective data rate minus overhead factors. In a dp environment, increased throughput represents increased system power; in a control or instrumentation situation, throughput threshold is achieved, beyond which speed loses importance. To determine throughput, an inexact calculation, beware of subtle topological differences. Let's consider only significant factors affect-

ing throughput: data link bit-rate, but sharing/replication, data formatting overhead, network management overhead and error rate. Throughput for different systems is optimum for different message sizes, so some information on the application category is useful.

Data link bit rate Most link systems are specified in bps transmitted over a given media of a specified maximum length. Many high-speed communications systems employ DMA front ends. Ignoring overhead factors, DMA transfers occur at R/N wps word rate where R is bit rate specified and N is bits/per word. How closely this limit is approached measures system efficiency. R/N rate represents an approachable upper bound; if the host computer cannot accept this data rate, particularly in an unbuffered link, overall system potential is degraded.

Bus sharing/replication. While a R/N wps peak DMA word rate is approachable point-to-point, inter-computer average word transfer rate can only approach R/NK , where K is number of computers linked to the network. This assumes each computer statistically produces equal traffic, otherwise timesharing factors must be introduced. In a response time critical application, these statistics must be carefully examined to insure that no one node can "hog" the bus thus preventing priority information from flowing. Usually a finite limit on the maximum size of uninterrupted data transfers is established. If the throughput becomes consistently unacceptable due to bus overload, system or channel capacity must be increased by one or more methods.

The only way to increase channel capacity is to increase the data rate which generally involves introducing different hardware while hopefully preserving the transmission media already in place. To increase system capacity, the bus can be replicated and thus a second network can be created with the nodes divided according to expected interaction. Usually some facility will have to be provided for communication between the two networks.

Another approach to creating additional system capacity involves multiplexing signals on the existing transmission media. Either Time (TDM) or frequency domain multiplexing (FDM) can be used. TDM has several problems: practically speaking, number of available channels must be specified at design time and is inflexible. Bandwidth requirement of the transmission system is constant regardless of the channels used; systems with fewer channels pay a data rate/distance penalty. FDM, while requiring a bit more circuit complexity, offers: a more flexible expansion of channels, capability of higher data rates at higher carrier frequencies (albeit covering shorter distances) and increased noise immunity/channel because of smaller percentage bandwidth.

Frequency Shift Keying (FSK) is generally the modulation method used for FDM systems. If a given node is provided with multiple modems, then access to all channels is permitted. Each layer of a hierarchy can be implemented at a different carrier frequency with interlayer communication occurring at a node provided with multiple modems.

Data formatting overhead. Data formatting establishes a procedure for identifying message body. Control characters and formatting indicate the transmission block's beginning and end, define certain link operating characteristics, provide for source and destination addressing, and enable error checking and recovery. Achieving data transparency may include bit or character stuffing to prevent confusion of data and control information and possible loss of clock synchronization. All of these supporting elements constitute an overhead which subtracts from the theoretical

B/NK DMA word rate. Average size of an individual message has a marked effect on efficiency. For example, if we assumed the use of HDLC (High Level Data Link Control) protocol, an internationally recognized standard, efficiency of data transmission for a block of 16 K bits is 97-99%, assuming no bit stuffing. For the transmission of a single byte of data, efficiency drops to about 5%. Opposing goals of efficiency and modest size messages must be carefully optimized.

In order to create modularity, most systems designers have come to recognize a number of hardware/software levels each of which may be formally recognized as a protocol. These levels are frequently denoted as the link level, the network level, and the higher operating system level. This article deals with various concepts of the link level only and divides its effects into 3 parts, i.e., data formatting, link management, and error detection.

Link management overhead. Any data link system must manage each node's access to the bus. This management responsibility can be either distributed or centralized. Choice of a link management system depends to some degree on the expected link use, and like protocol overhead, must be optimized for the expected message length. Important overhead elements are: time required to gain access to the bus (bus mastership), the time required to establish communication with the desired node (handshaking), and time required to acknowledge successful receipt of information.

Error rate. In any communication system, there are many non-destructive fault conditions. Line noise created by heavy machines, RF fields, static-discharge, and the like, garble transmission. Every system must detect and correct such errors. In most, synchronous protocol (HDLC, SDLC, etc.) errors are detected via a cyclic redundancy check method that treats a data block as a polynomial expression which is in turn divided by a fixed reference polynomial. The dividend is ignored, but the remainder is calculated and sent along with data. At the receiver, this is repeated and the locally calculated remainder is compared to the transmitted version. If they agree, data is assumed correct. If not, retransmission is requested. Due to low error and ease of retransmission on local area links, error correcting codes are used much.

reliability

System reliability in local area data links is more than an acceptable hardware MTBF. The system is a network of intelligent devices operating semi-independently: thus reliability is complex and involves message errors, immediacy of message transmission, complete or partial node failure, and complete or partial media failure, etc. Networks can be designed to degrade gracefully rather than abruptly. The way in which nodes are connected together is a major factor in designing and specifying failure tolerant systems and falls into the category of network topology.

Here are some of the more common approaches used in practical systems.

Redundant networks improve system reliability, either by data path replication or by complete meshing node. For example, if every node is connected to every other node independently, data can pass point-to-point via several paths. This interconnect scheme (meshing) is similar to packet switching systems where each node has access to other nodes through a variety of transmission channels. While practical and necessary in packet networks, such extensive meshing is rarely required for local area links. Conversely, redundancy is needed for installations unable to tolerate system down-

times of minutes to days.

Another major factor affecting reliability is the roll of each node as either a pass-through or bridging component in the link. A bridging node connects in parallel to transmission media via a high impedance buffer and takes appropriate action based on information addressed to it. When required to transmit, the node injects its signal upon the media and upon completion returns to the "listening" state. Such systems do not interrupt the data path and are designed so that failures in any given node do not impede the bus' data flow. In pass-through systems, information flowing on the bus passes through each node, where it is reconstructed (perhaps modified) and sent to the next station in the link. Such pass-through systems are often configured as uni-directional loops, beginning and ending with a master device. In specialized circumstances, pass-through systems exhibit some advantages. For example, transmission media such as fiber optics, which are yet impractical to "tap," are more suited to a pass through-system — as are applications involving small data blocks. Unfortunately multiple node pass-through-network has diminished reliability; the system fails if any node fails. This exposure has led to various loop collapse schemes whereby a given node is bypassed, usually by a relay, if the node fails. Unfortunately this adds to cost, complexity and shifts the reliability burden to the relay. IEEE Standard 595 (CAMAC Serial Highway) describes a pass-through system commercially available for several years. While this system has been used successfully in instrumentation, its failure to spread to the large data link field underscores its limitations.

Despite bridging system advantages, some method of providing redundancy is advisable. Media may fail due to outside events. The unwary contractor who installs a sprinkler system neatly severing a carefully-laid coax cable or the warehouse fire which shorts the cable serving the inventory control terminal are examples. One commonly used technique for increasing redundancy is to form the bus into a loop which is terminated at some arbitrary node. Under no-fault conditions, a signal generated at any given node would pass bidirectionally into the termination on each end of the loop. Should the loop be broken, communication beyond the break will cease. Communication anywhere on the bus will be questionable depending on the nature of the fault (open or short) and reflections caused by it. If communication is lost, it is possible for this system to reconfigure itself and use portions of the bus not damaged. To accomplish this, each node must implement the equivalent of the circuit shown in **Figure 1**. In absence of a fault, switches A and B are shown; the signal passes unimpeded. If communication is lost, the node attempts to establish contact by opening one side of the bus and inserting a Termination (**Figure 2**); if unsuccessful, the other side is opened and a termination provided (**Figure 3**). Depending on the link management system implemented, re-establishment of communication is a complex process and requires adaptive programming at each node.

Another redundancy approach we developed provides for 100% bus backup and simplifies fault detection and automatic reconfiguration. When both buses are operative, full duplex communication is supported degrading to half duplex if one fails.

network management

Local area network management system must prevent simultaneous transmissions by two or more nodes. Three schemes are common: Master/Slave, Token Pass and Carrier Sense

Multiple Access. In the first, one node assumes responsibility of polling the remaining nodes to establish bus access, and is good where the dominant data flow is to and from the Master and a number of secondary of Slave units. While one unit is designated primary master, another can be programmed to assume that roll in the event of a primary failure. The Master/Slave scheme, although possibly the most restrictive, offers significant benefits such as simple bus access prioritizing, simplified redundancy support, and a better capability for downline loading of application software. It is particularly well-adapted to hierarchy based industrial control applications.

In Token-Pass, the node currently selected as "bus master" polls the remaining nodes in cyclical order and upon finding one wishing to transmit passes the "token," thereby establishing a new "bus master." Token-Pass network management is a good choice where major amounts of traffic pass randomly between peer level nodes. Unfortunately, it complicates recovery from a failed transmission media in a redundant system.

In the Carrier Sense Multiple Access (CSMA) system, any node is permitted to transmit any time the bus is not being used (Carrier sense). Even with carrier sense, two nodes can decide to transmit simultaneously creating a "collision." Methodology for detecting and resolving collisions is not trivial and represents a complexity not generally warranted. CSMA is used when a system is exposed to constant reconfiguration since no access scheme (typically software) needs to be altered if a station is added or deleted. Under heavy loading, CSMA system efficiency can fall because of the time required to resolve excessively frequent collisions. A well-known commercially available system using CSMA is

the proprietary ETHERNET technique adopted by INTEL, DEC and Xerox. Further information on this system can be obtained from any of these companies.

protocol/software support

Earlier, the function and importance of the various levels of communication protocol were introduced. How a protocol is implemented has a direct bearing on the cost and efficiency of the system and the host CPU. Conceivably, almost any protocol could be handled as an I/O function of the host, but during that interval little else can be accomplished. It is feasible and practical to implement much of the protocol in hardware and in fact LSI chips are available to support a number of synchronous protocols at speeds of 64 kilobits per second up to 2 megabits per second. Typically, however, these chips only implement some of the lower level tasks such as flag recognition (beginning and end of message), destination address recognition, CRC generation and checking, and bit stuffing/unstuffing. A single LSI chip will recognize only one device address, but due to concurrent tasks at any host computer, several logical addresses may be implemented per node. All higher order elements — such as logical address handling, retransmission methodology, secondary control character recognition and stripping, error diagnostics and network management functions — must be serviced by the host computer or preferably local intelligence inside the link hardware. There are other benefits from designing both local intelligence and buffering into the link. If protocol handlers are in firmware, the system architect need not concern himself with rewriting the protocol handlers into his application program. Buffers enable the link to pass only verified, consolidated data to the host saving

EYECOM II the IMAGE PROCESSING PERIPHERAL

Add this image processing peripheral to your present PDP-11* or LSI-11* to measure variations in image brightness, separate image features, enhance edges and contrast, measure areas of interest, do real time image integration, and real time image differencing.

A basic software package is provided to apply the EyeCom System to your particular problem.

FEATURES:

- Real Time Digitizing, 640x480x8-bits
- Add, Subtract and Convolution of images at video frame rates
- Joystick Cursor, 640x480 Resolution
- Graphic & Alphanumeric Overlay
- Color & Gray Scale Mapping Tables
- Terminal or Rack Mount Configuration

Call or write for complete information:

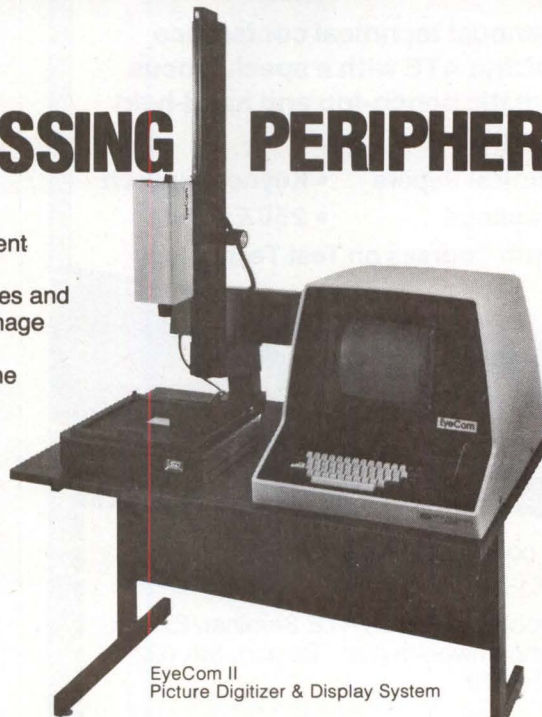

Spatial Data Systems, Inc.

P.O. Box 978, 508 So. Fairview Ave., Goleta, CA 93117 • Tel: (805) 967-2383

The Image Processing Company

*Trademarks of Digital Equipment Corporation

Circle 27 on Reader Inquiry Card

To keep up-to-date with the rapidly changing automatic test equipment industry, join us at the...

ATE *Ninth Semi-annual*
SEMINAR/EXHIBIT
 Automated Testing for Electronics Manufacturing

June 8-11, 1981

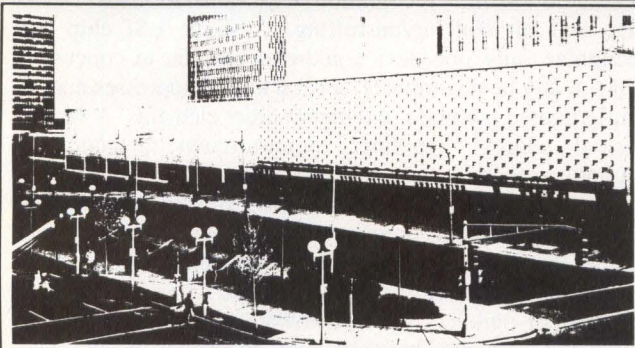

**John B. Hynes Veterans Auditorium
 Boston, MA**

A semi-annual technical conference emphasizing ATE with a special focus on automatic bench-top and hand-held instruments.

- 30 Technical Papers
- 35 Workshops
- 3 In-depth Courses on Test Technology
- Keynote Speech
- 250 Exhibits

Hear keynote address on
**"THE ROLE OF ATE IN THE
 FACTORY OF THE FUTURE"**

For more complete information return this coupon or call:

Sara Atwood, Registrar, ATE Seminar/Exhibit,
 1050 Commonwealth Ave., Boston, MA 02215
 (617) 232-5470

Name _____
 Title _____
 Company _____
 Address _____
 City/State/Zip _____

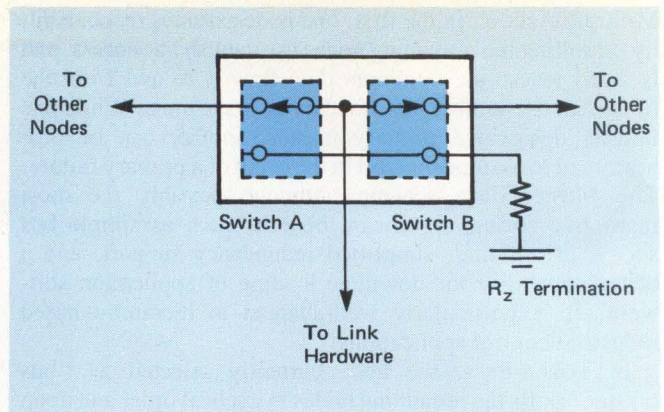

Figure 1: Loop Collapse Switches

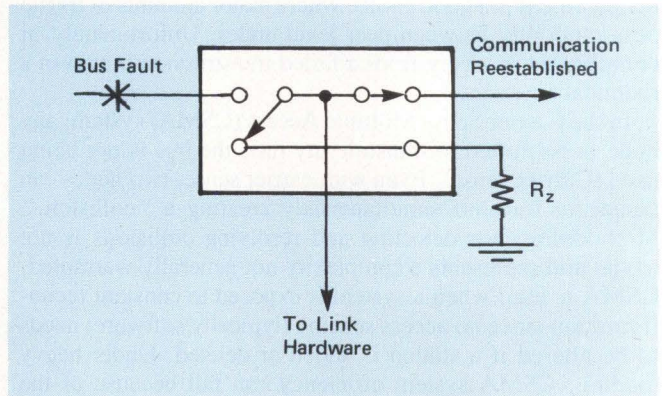

Figure 2: Fault Recovery- Situation 1

valuable RAM space. In simple systems the only link oriented software resident in the host mini-computer would be a modest device handler which allows the programmer to specify the logical address of the destination, the type of operation. After the transfer is complete the link should interrupt the host operating system. In the event of an unrecoverable error, the link should pass diagnostic information to the operating system to aid the operator in correcting the problem.

cost/performance tradeoffs

Whether designing or specifying a system, designers must sooner or later make a cost/performance decision. For some applications (home computers for example) cost considerations totally dominate the equation. Low speed communication for short distances is adequately handled by the cost-effective UART and RS-232C technology. At the other end, performance is the throttling parameter. In defense simulators, to pick one case, cost is a secondary consideration. For the large majority of situations, however, one can be traded against the other and it is useful to develop a simple figure of merit to evaluate performance as a function of cost.

The function of a linking system is the rapid data transfer, usually in DMA mode from memory space in one computer to memory space in another. The speed depends on channel capacity and indirectly to system usefulness. The calculation of "average" throughput is a valuable exercise and should include delays inherent in establishing the channel link between the subject nodes, servicing the protocol, transferring and verifying data, and acknowledging receipt. To make this calculation meaningful, a data block size should be estimated which fairly estimates that expected in practice. A physical separation distance equal to the worst case anticipated should be specified. A thorough analysis would also

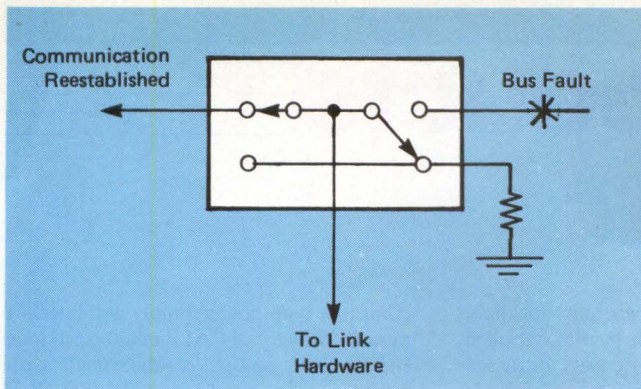

Figure 3: Fault Recovery - Situation 2

include effects of a heavily loaded channel; but for a first approximation, assume an idling channel. An objective evaluation of throughput requires a benchmark analysis similar to those for comparing μ Ps.

Once a throughput acceptable model is established, divide it by system cost to derive a "throughput per dollar" figure of merit. Elements comprising cost include: hardware acquisition cost of the hardware (for a given system), cost of purchasing and installing transmission media, and software cost developing the software necessary to support the system. It is also useful to calculate the marginal cost of adding nodes for system expansion. The significance of item 3 in the cost table — Software — should not be underestimated. For small systems, this developmental expense could easily overshadow the first two.

As for average throughput versus cost, at very modest bit rates, linking system expense is relatively constant due to

base line costs of packaging, power supplies, marketing, etc. The data rate these systems support relate more to the host computer or peripheral capacity than link technology. To increase speed, one technology yields to more expensive ones and transmission media often become more costly. As each sophistication layer is added the incremental cost of adding channel capacity increases, thus accounting for the general curve shape. Note that figure of merit represents the slope of a line drawn from the origin, intersecting the curve at any given point, which in turn is maximized at one place. While a convincing argument can be made for the general curve shape, scale factors are constantly changing as LSI advances. With current technology, a 1-Mbit/sec system can be implemented for about \$2,500/node, for a figure of merit of 400 bps/dollar. There is strong evidence that the larger IC houses are developing advanced LSI communications chips which promise to increase existing figures of merit by two- to three-fold.

conclusion

The explosive growth of decentralized computers has created a need for systems designed to link them together for load and resource sharing. As distinct from long-haul packet switching networks and high-speed short distance bus expanders, these local area data links are characterized by data rates in the $10^5 - 10^7$ bits per second range and network lengths of 50 to 25,000 feet. The seven key parameters for designing and selecting a data link system are: service area geography, environmental constraints, network throughput, reliability requirements, networks management architecture, protocol/software support requirements and cost/performance tradeoffs. **D**

COLOR GRAPHICS FROM TWO SMALL PLOTTERS WITH BIG IDEAS.



There's nothing small about Zeta's high-speed incremental plotters except their size and cost. Plot quality and throughput equal that of much larger machines.

Model 1453 gives you 4-pen, programmable multiple-color plotting. The 1553 is a one-pen plotter with low price but high-speed and high resolution. This inexpensive new plotter generates charts of unsurpassed plot quality. Both models plot with speeds of 10 inches per second. Both can give you multicolored graphics over a plotting area of 11 inches by 144 feet.

Color communicates better.

Our ZCHART II Interactive Business Graphics Program generates line charts, bar charts or pie charts with such relative ease that a secretary who's a novice to plotting can produce colored business graphics that communicate as only charts can. Prices start at less than \$6,000. We'd welcome an opportunity to tell you more. Write us. Or better yet, call.

ZETA PLOTTERS

NZC NICOLET ZETA CORPORATION 2300 Stanwell Drive, Concord, Ca. 94520 Call (415) 671-0600

Circle 29 on Reader Inquiry Card

New Products

WP/SMALL BUSINESS PRINTERS.

The WP-6000 is a dual mode printer capable of 150 cps in a near letter quality mode and over 250 cps in the data processing mode. It employs an 18-needle, dot-matrix print head. Graphics capability is provided with a 144 dots/in. resolution. Under \$1500 OEM. A 7x9 dot matrix print head is used in the DP-9600 receive only printer. It is capable of 200 cps at 10 char/in. and has compressed print capability from 10 to 16.7 char/in. Three serial and one parallel communications protocols are standard. Under \$1300 OEM. The DP-9600 KSR uses the same printing system as the DP-9600 RO. Other features include an 80-key alphanumeric keyboard, a separate 10-key numeric keyboard and editing keys for the insertion, deletion and scrolling of data as well as moving a cursor. Integral, non-volatile memory stores commands for tab, page width and length. Internal RAM stores up to 4600 characters. Under \$1500 OEM.

Anadex, Inc., 9825 DeSoto Ave., Chatsworth, CA 91311. **Circle 210**

SUPER-MICRO WINCHESTER. Model 10 is an intelligent 5-1/4" fixed Winchester disk drive that has an unformatted capacity of 12.06 MB and that accesses data 3-4 times faster than other similar-size Win-



chesters. Formatted capacity is 10 MB and average access time is 25 ms. Other members of the family will provide 24 MB and 48 MB of unformatted capacity. Each of the drives will fit in the same slot as an industry-standard 5-1/4" flexible disk drive. Track-to-track access time is only 3 ms. Under \$1000 OEM. **Micro Peripherals Inc.**, 9754 Deering Ave., Chatsworth, CA 91311.

Circle 211

Multiplexer Family. The 3 statistical multiplexers are designed to meet a broad variety of custom data network requirements. The Minimax will typically be used in point-to-point multiplexing, the Unimax as an async to sync converter with error correction, and the Multimux provides

statistical multiplexing capability for multipoint circuits. Each unit is μ P controlled, offers ARQ (Automatic Request for Repetition) data link error correction, and provides aggregate rates to 9600 bps and channel



rates up to 9600 bps. They also feature local echoplex, diagnostic indicators, and remote channel loopback. The units can be used modularly to increase capacity or to fit custom configurations. The Multimux starts at \$1650, the Minimax at \$1150, and the Unimax at \$895. **Prentice Corp.**, 266 Caspian Dr., Sunnyvale, CA 94086. **Circle 212**

CARD CAGE mounts standard 6.75" x 12" Series-80 boards from Intel and National, 5.3" x 10.0" S-100-type cards, and the 6.0" x 9.75" boards used in the Motorola Exorciser and Micromodule or Rockwell AIM65 and expansion systems. Space along the side can hold two muffin fans, power supplies or other equipment. The rear cross members accept either card-edge connectors or motherboards. A 1.5" setback along the front provides room for front-card I/O cable connectors and front-panel components. Fits any standard 19" RETMA standard rack. The 10-board CCK-80 cages are \$79. **Vector Electronic Co.**, 12460 Gladstone Ave., Sylmar, CA 91342. **Circle 206**

LSI-2 TAPE SYSTEM is a digital tape system for Computer, Automation LSI-2 minicomputer applications. The TDCA-100 System loads 4K words in 3 seconds and incorporates a 3M 140' DC-100A Data Cartridge with a capacity of 18 - 4K blocks. Dump/load/compare software program available. Can be used for auto load by specified PROM replacement. The system,

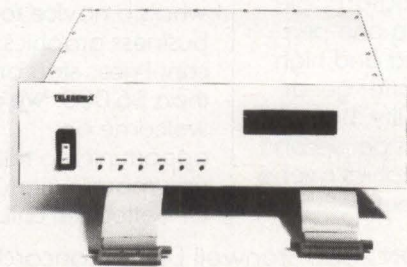

complete with power supply and interface, mounts directly to CAI motherboard. Panel LED's give power, rewind, read, write, ready and error indication. \$1,950 OEM, qty discounts. **Telegenix, Inc.**, 26 Olney Ave., Cherry Hill, NJ 08003. **Circle 166**

INSERTION/EXTRACTION TOOLS.

This series of DIP IC dispensers are available for MOS and CMOS as well as standard devices. Each channel accepts any standard IC shipping tube, and can accommodate any standard IC from 2-42 pins on .300, .400 or .600 centers. Adjustable guides position each IC individually for easy extraction, gravity feed assures deposit of next IC. Available in 1, 5 and 10-channel versions. The MDD-1 is \$21.85; MDD-5, \$83.43; MDD-10, \$160.45. **OK Machine & Tool Corp.**, 3455 Conner St., Bronx, NY 10475. **Circle 191**

550-W SWITCHERS. The HP 63312F is a 550-W 20-KHz model (up to 85A) with 2-24V output voltages. Uses include mainframes, peripherals, telecommunications and specialized equipment such as analyt-

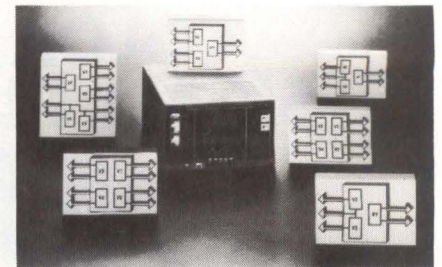

ical and diagnostic systems. Power supplies from this family are used in the HP 3000 Series III and Series 44. Extended operation range is from 87-127 VAC and 174-250 VAC to 47-63 Hz. This permits full power operation at any nominal line voltage from 100 to 120 V and 200 to 240 V. \$1125-\$1475. \$900-\$1180 (100). Inquiries Manager. **Hewlett-Packard Co.**, 1507 Page Mill Rd., Palo Alto, CA 94304. **Circle 150**

DISKETTE CONVERSION SOFTWARE

runs under the CP/M operating system and reads and writes floppy disks in the DEC RT-11 format. Users can transfer data files bidirectionally, and alter any of the fields in the DEC RT-11 directory. REFORMATTER also lists the DEC directory, and displays the unused areas of the disk. A squeeze function allows a fragmented DEC diskette to be packed into a continuous data area. A CP/M to IBM version is also available. \$195 per program. **MicroTech Exports**, 467 Hamilton Ave., Palo Alto, CA 94301. **Circle 134**

COLOR MATRIX PRINTER can print text, graphs, histograms and color VDU dumps in 7 different colors, with no restriction on mixing characters, dot-



addressed areas and color changes on the same line. The CX-80 uses plain white-edge perforated paper (4-10" wide). The character ROM contains 96 ASCII and 64 graphics characters. The 7-wire head produces a character format 5 x 7 plus graphics format 6 x 7. Print width is 80 columns, print speed is 125 chars/sec in a primary color. There are also 15 user-programmable characters. All characters may be printed in double length and/or reverse. Standard interface is Centronics; RS232C/V24 and IEEE488 are optional. (\$2000). **Integrex Inc.**, 233 N. Juniper St, Philadelphia, PA 19107. **Circle 151**

1000 W POWER SUPPLIES. Four multiple-output 1000 W switching regulated power supplies for large add-on memory systems, have a main output of 5 V dc @ 150 A. Up to 3 additional outputs are offered from 2 V dc to 28 V dc at 18 to 2 A. The SM Series offer a range of ac inputs to protect against brown-outs, from 85 to 130 V ac at 47 to 63 Hz and 166 to 260 V ac at 47 to 63 Hz. An optional 115 to 230 V ac input is also available. An IC control chip allows standard features of remote sense, power fail

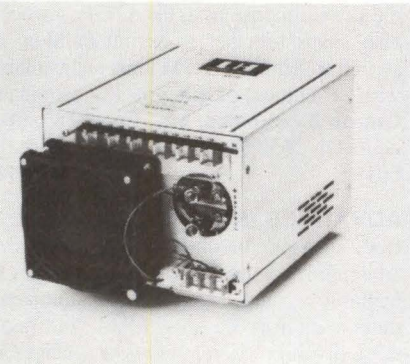

detection signal, remote On/Off circuit, plus the capability of monitored parallel operation with other units. From \$1,124 to \$1,177. **LH Research**, 14402 Franklin Ave, Tustin, CA 92680. **Circle 152**

LETTER-QUALITY PRINTER. The SELLUM I enhances the NEC Spinwriter print mechanism with an interface board containing on-board Z80 μ P, 16K RAM and 4K additional ROM capacity, multiple interface compatibility and full data handshaking signals. Features include automatic bi-directional printing, switch-

software selectable baud rate and logic seeking capabilities, for a maximum throughput of up to 700 wpm. The 650 character buffer and optional 16K buffer for printer spooling allow simultaneous data entry and printing. \$3495 including vertical forms tractor, ribbon, 128 character thimble and 6 months warranty. Custom applications, special protocols and qty. discounts available. **Intersell**, 465 Fairchild Dr, #214, Mountain View, CA 94043. **Circle 193**

OFF-LINE TEST UNIT for high-capacity disk drives with the storage module interface, and for Winchester 8" or 14" drives. The SX-530 Disk Memory Exerciser locates both permanent and intermittent errors. It can R/W data in 4 formatted modes using a selection of 3 fixed data patterns and one

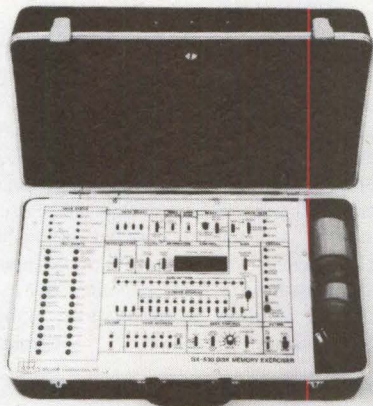

programmable pattern. Error indicators show the type and location of errors. Controls permit setting the SX-530 to override errors, or to stop on error. \$2250. **Wilson Laboratories, Inc.**, 2237 N. Batavia St, Orange CA 92655. **Circle 143**

LIGHT PEN features high EMI immunity with high scan rate response. A single 5 V dc power supply is required. Maximum scan rate responses up to 5000 cm/ms are typical. Light spot size, and optical field of view is 0.1" and .080" to .160". The LTP 105 A is activated by depressing the push tip against the CRT screen. For graphics application, the LTP 105 B features an optical push switch which can be activated up to 6" from the CRT. The LTP 105 A is \$325; LTP 105 B is \$349. **Ampower Instrument Co.**, 26 Just Rd, Fairfield, NJ 07006. **Circle 201**

LARGE FORMAT SCANNER/LASER generates images on photographic film for raster map scanning and digitizing. The X4040 digital Argon Laser recorder/scanner writes 1300 lines of data per minute, at all rasters on a variety of orthochromatic film types. Maximum resolution is 25 microns with up to 64 grey levels. The system handles reflective material in either B & W or color, line art or continuous tone. A 256 step grey scale modulation with 64 step repeatability over the entire 40x40" is standard depending on configuration. Output can be either continuous tone, line

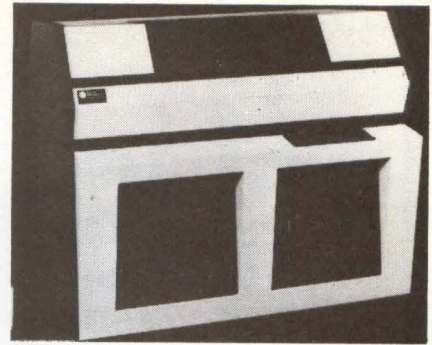

work or screened color separations, or line film with patterns or screened continuous tone. \$250,000, delivery is 9 months. **Optronics International, Inc.**, 7 Stuart Rd, Chelmsford, MA 01824. **Circle 157**

6801/6803 EMULATOR OPTION to operate, exercise and debug products using the Motorola 6801 and 6803 μ P family is available for the MicroSystem Analyzers. The Microsystem Analyzer is a low-cost functional board tester and fault isolator for μ P-based products. It features in-circuit emulation, signature analysis and count, and interval and frequency measurements. The 6801 and 6803 Emulator Option is completely transparent to the system under test. It includes 2 μ P's: a control processor that supervises system resources and executes system monitor commands; and a 6803NR μ P on the emulator board. The Emulator Option is \$2675. **Millennium Systems, Inc.**, 19050 Pruneridge Ave, Cupertino, CA 95014. **Circle 196**

LASER DATA TERMINAL. The MS123 LDT has a laser bar code scanner, 16-pad keyboard, 24-char. display, and 21-col matrix printer. It is a stand-alone, interactive data entry system with laser scanning for speed and reliability. Communicates through RS-232 with a computer. It scans



packages that fit under the hood (clearance of 150mm). In the portable mode, the terminal can scan objects of any size or shape at distances up to 20' from the terminal. The 21-col, dot matrix printer provides printout for tickets, receipts, data due slips, production tickets etc. The printer, keyboard and display are programmed through customer provided ROM of the 2716 type. \$3000 (100). **Metrologic Instruments Inc.**, 143 Harding Ave, Bellmawr, NJ 08031. **Circle 155**

DEC and DATA GENERAL

125 SYSTEMS

11/23, 11/34,
11/70, 11/44
VAX 11/750

UP TO 18% DISCOUNT ON
VAX 11/780

FREE CATALOG

SS13DD

NEWMAN COMPUTER EXCHANGE

1250 N. Main P.O. Box 8610 Ann Arbor, MI 48107

(313) 994-3200



Member
Computer Dealers
Association

Handy printer.

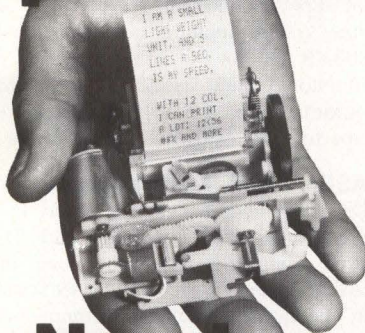

New low price.

The DC-1206B prints 12 characters/line nominal, but is capable of 15 columns. It is sized for portable hand-held applications with 1.7" H x 3.2" W x 3.7" D and 5.3 ounces. It prints 5 lines/sec on 1.4" paper and is \$35 in 1000 quantity. Other printers with interface electronics available.

Call or write HYCOM, 16841 Armstrong Ave., Irvine, CA 92714 — (714) 557-5252

HYCOM

Circle 30 on Reader Inquiry Card

URGENT!

The red label on the cover indicates that this is the last issue of your free subscription UNLESS you fill in the requalification form completely and return it to us IMMEDIATELY. See page 18 for details.

New Products

400 kB MASS STORAGE UNIT. This dual diskette Mass Storage Unit can trap, record, and play back over 400 kB of communications data and control sequences for fault analysis, network testing, and operator

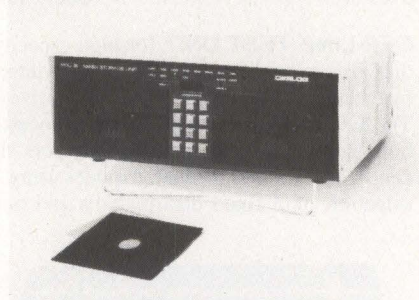

training. When used with the DLM III Data Line Monitor, MSU III provides unattended monitoring of full duplex communications data at line speeds up to 19.2K baud. Any DLM III feature for fault isolation, search, character suppression, or trap can be used to analyze information recorded on the MSU III diskettes. MSU III with double-density, double-sided 5-1/4" diskette drives is \$3,575. **Digilog Systems, Inc.**, Babylon Rd, Horsham, PA 19044. **Circle 130**

INTELLIGENT TERMINALS can be used as a stand-alone micro-NOVA system, a cluster controller, or a remote intelligent subsystem with downline loading, local disc or diskette storage. The 5100 is a user-



programmable display terminal compatible with standard DG hardware and software products, and uses a microNOVA MP/100 backplane. There are 9 models of the 5100 in two basic versions. The 5100B is based on the microNOVA Board Computer (MBC) line and has 4 expansion slots, while the 5100M is based on the MP/100 with 3 expansion slots. The models have 8- to 64-kB RAM, and sockets for up to 32-kB EPROM. From \$4,710 to \$6,750 with OEM discounts available, 90-120 days ARO. **Data General**, Rte. 9, Westboro, MA 01581. **Circle 129**

DATA ENTRY ERROR SOLUTION. Entry Error Elimination, E³, that eliminates high-speed data entry errors while reducing overall keyboard costs, is incorporated in the Full Travel Membrane (FTM) Keyboard. The E³ feature consists of a μ P-based

n-key rollover with "phantom key" lock-out. Entry error when an operator strikes more than one key simultaneously is eliminated. The FTM Keyboard with the E³ feature, combines the human-engineered feel and touch of full travel key design with highly reliable membrane switch technology; and offers a price/performance breakthrough. **Oak Switch Systems Inc.**, Box 517, Crystal Lake, IL 60014.

Circle 163

ULTRA SMALL PUSHWHEEL Measuring 18 mm. H x 17 mm. D x 6 mm. modular unit width, the A7C Pushwheel offers separate sets of plus and minus push-buttons for easier forward and reverse setting without time-consuming recycling. Rated switching capacity ranges from 1mA to 100mA at 50 VAC or 28 VDC (resistive), with a current capacity of 1A max. Switching capacity for the standard A7PH ranges from 10 uA to 0.15A at 125 VAC (resistive).

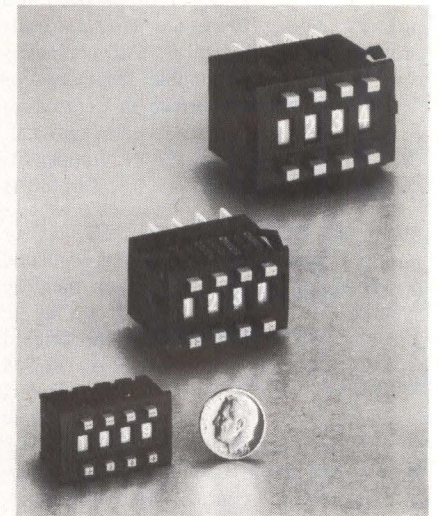

The Series A7M Thumbwheel Switch, with the same dimensions as the A7C Pushwheel, also snaps together to permit build-up of switch assemblies. A7M units are available with a choice of plug-in PC terminals. **Omron Electronics, Inc.**, Control Components Div, 650 Woodfield, Schaumburg, IL 60195. **Circle 137**

ADVANCES IN GRAPHICS systems. A free, 6-page brochure, by Walter M. Anderson, focuses on the rapid changes in technology and economics of minicomputers, microprocessors, RAM, and raster scan displays. It relates these changes to advances in graphic system design. **Lexidata Corp.**, 755 Middlesex Tpke, Billerica, MA 01865. **Circle 208**

PAPER/MYLAR TAPE PUNCH. This stand-alone tape punch has standard TTL compatible parallel ports suitable for data from tape readers, μ P's, data loaders and keyboards. An optional RS232C serial port is available. The Model 600 can punch 5 to 8 level paper and/or mylar tape, accommodates an 8" reel and an optional attachment for fanfold tape. \$1099. **Addmaster Corp.**, 416 Junipero Serra Dr, San Gabriel, CA 91776. **Circle 144**

FLEXIBLE BREADBOARD SYSTEM

accommodates several standard μ P boards and can tailor connector and plug sizes within a greater range. The Scotchflex system is solderless so boards are easily altered as necessary, and offer space and

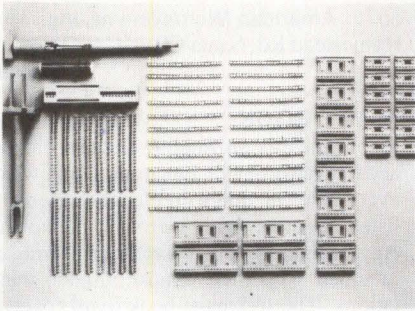

time saving. Accommodates sockets sized from 8 to 40 conductors. Plug strips and solder strips come in 24-contact sizes, and can be snapped off to suit a specific need. Any number can be stacked end-to-end or side-by-side. Standard kits are \$80; kits with μ P boards from \$110 to \$135. **3M**, Dept. EP81-5, Box 33600, St. Paul, MN 55133. **Circle 140**

IMAGE SYSTEM. This low cost, stand-alone digital image processing system operates in real-time 1/30 sec. Its memory has a capacity of up to four 512x512-8 bit images and up to four 512x512-1 bit graphic planes. There is additional RAM space for user code. An in-line, real-time pipeline processor provides brightness enhancement and color modification. Features include a pseudo-color processor and a zoom providing image enlargement by 1x, 2x, and 4x. Options include a monochrome high resolution vidicon camera, a real-time (10MHz) A to D converter, small area brightness or color control and image combination hardware to add, subtract, multiply or divide two 512² images in real-time. The Vision One/10 is under \$55,000.

Comtal/3M, 505 W. Woodbury Rd, Altadena, CA 91001. **Circle 160**

GRAPHIC DISPLAY SYSTEM, with dual processor architecture, combines the performance of a high-speed (112 ns) raster display processor with a powerful 16/32-bit microcomputer, Motorola's MC68000. It allows a greatly reduced graphics software development effort and improves host software efficiency by offloading the burden of high-precision graphics processing to the terminal. The system uses a 31-bit world coordinate system for a virtual resolution of 4 billion points per axis. The GS8000 accepts graphics primitives, including lines, circles, filled polygon areas and text, and retains them in a database in the graphics processor memory. The system has extensive windowing capabilities and is available in resolutions of 640x512 or 1280x1024, B&W or color, with a hardware cursor. Hardware pan and zoom, blink and bitmap overlays are available. \$26,200 to \$40,000.

Lexidata Corp., 755 Middlesex Tpke, Billerica, MA 01865. **Circle 184**

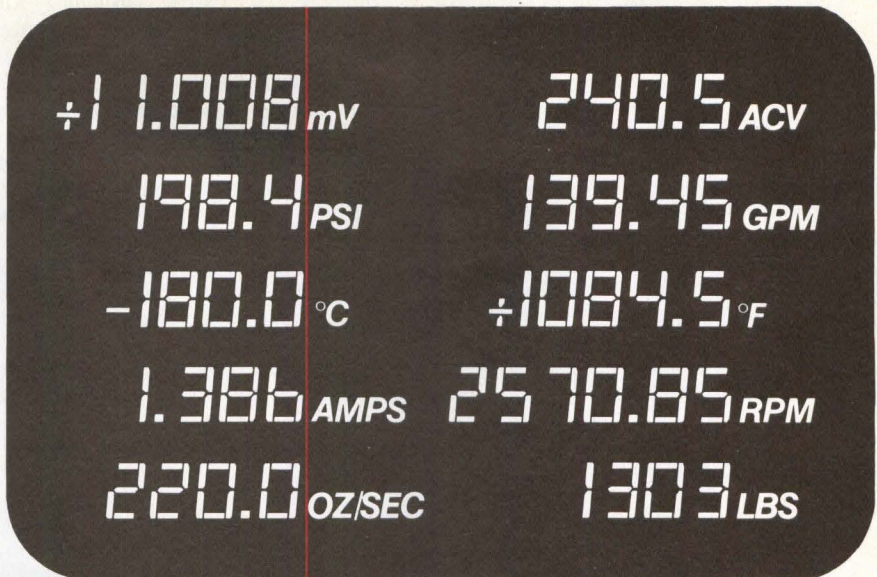

United Systems' Indicators Will:

- MEASURE voltage and current; ac, true rms or dc.
- CONVERT the output of any transducer/transmitter to display in engineering units.
- DISPLAY temperature (C or F) directly from thermocouple, RTD, or thermistor sensors.
- INTERFACE readily into your system by optional "single line enable" parallel BCD output.
- INDICATE when a predetermined limit is exceeded, through relay closure or logic level output from optional internal comparator alarm.

And with United Systems' exclusive adaptors these indicators change, in the field, to perform any measurement listed above and more!

For additional information contact your United Systems Representative or call the factory (513) 254-6251.

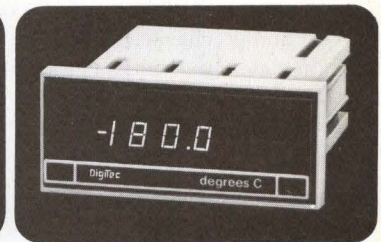

DigiTec. **UNITED SYSTEMS CORPORATION**

918 Woodley Road, Dayton, Ohio 45403
(513) 254-6251, TWX (810) 459-1728

United Systems Corp: Precision measurements to count on

Information only: Circle 31 on Reader Inquiry Card
Demonstration only: Circle 89 on Reader Inquiry Card

New Products

PASCAL BOOKS. The Pascal Handbook, by Jacques Tiberghien, contains every symbol, reserved word, identifier and operator for: UCSD, Jensen-Wirth, OMSI, Pascal Z, HP1000, ISO and CDC Pascals. Each of the over 180 entries contains the definition, syntax diagram, semantic description, implementation details, and program examples in a format structured for ease in accessibility and application. 500 pgs, \$14.95. The second edition of Intro-

duction To Pascal (Including UCSD Pascal), by Rodney Zaks, includes step-by-step instructions and practice exercises for beginners as well as more complex concepts for experienced programmers. Extensive appendices make it an important reference tool for all Pascal users. 440 pgs, \$14.95. **Sybox, Inc.**, 2344 Sixth St., Berkeley, CA 94710. **Inquire Direct**

CROSS SUPPORT SOFTWARE for the Intel MDS Model 230 μ P development system allows programmers to develop products using the 6800 μ P family. To speed editing, the cross support offers a screen-oriented editor with menu select.

Programmers can scan through 23 lines of code displayed on the screen, and edit by overwriting the existing code or selecting commands from the menu. Error recovery is included. Four macro assemblers are offered to support the 6800 family. The cross support package and one assembler is \$675. **American Microsystems, Inc.**, 3800 Homestead Rd, Santa Clara, CA 95051.

Circle 164

NEW BOOK. "Wörterbuch der Elektronik" is an English-German dictionary ("Dictionary of Electronics") in which every known English electronic term is listed together with German translations. Approximately 100,000 electronic terms are included with their almost 300,000 translations. The 692 page book (hard cover) is indispensable when dealing in English-German translations of technical subjects. Published by K.G. Saur. Distributed in the Western Hemisphere by **Gale Research Co.**, Book Tower, Detroit, MI 48226.

Circle 149

50W SWITCHING POWER SUPPLY. These single output supplies, Series 1050, are true-off-the-line switchers which feature four model types of 5VDC @10A, 12VDC @4A, 15VDC @3.4A and 24VDC @2A.

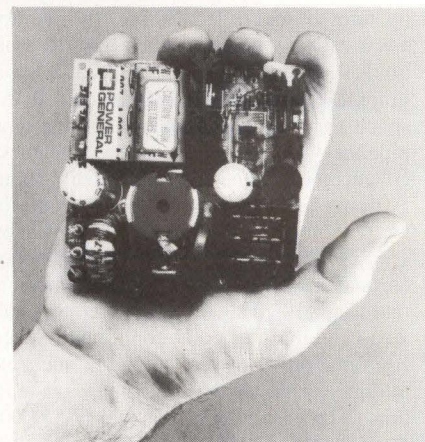

Specifications include: 80% efficiency, 90-130 VAC input voltage range or 180-260 VAC jumper selectable; 20 KHz internal clock oscillator; $\pm 0.1\%$ line regulation; $\pm 0.1\%$ load regulation; 16 ms holdup time; 1500 VAC I/O isolation; 0° to $+70^\circ$ C operating temperature range; $4"W \times 4"L \times 1.7"H$; and 14 oz total weight. \$75 (1-9). **Power General**, 152 Will Dr, Canton, MA 02021. **Circle 189**

LSI-11/Q-BUS CONTROLLER. This μ P controlled interface card replaces virtually all of the electronics associated with two serial ports, an alpha-numeric video terminal, and a medium resolution graphics display. When plugged into a standard Q-Bus backplane, the VDC11 appears as two serial ports. One port drives the video controller logic, the other port is an independent serial interface that can be used with another terminal, a printer, a modem, or any other RS232 serial device. **Andromeda Systems, Inc.**, 9000 Eton Ave., Canoga Park, CA 91304. **Circle 168**

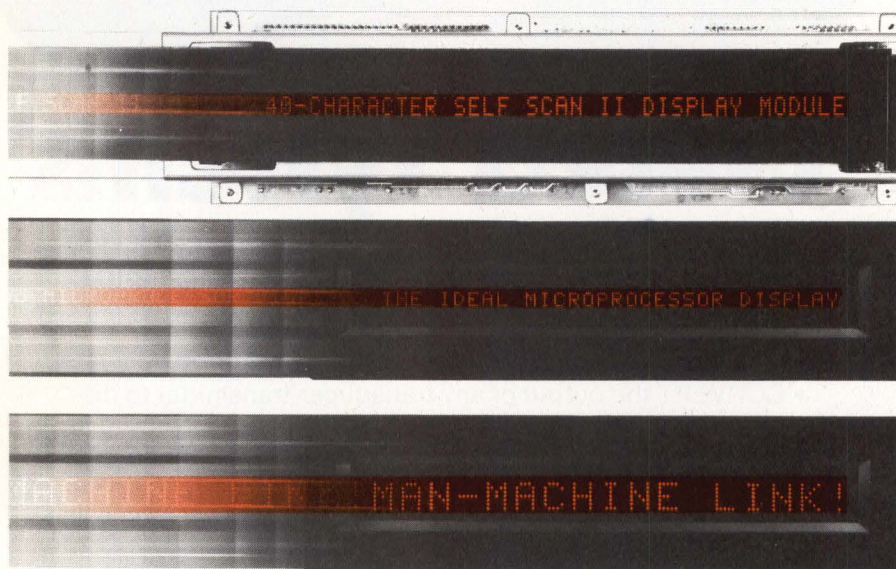

Fastest delivery ever. Self-Scan® displays.

Burroughs announces increased production availability on its best-selling 16, 32 and 40 character displays. Now, you can get 30-day delivery on most panel displays in this line. Bright, easy-to-read and microprocessor-compatible. Perfect for word processing and office-of-the-future applications. Get the full story. Call or write for the name of your nearest representative.



Burroughs OEM Marketing, Burroughs Place, Detroit, MI 48232. (313) 972-8031. East Coast: (201) 757-5000. Central U.S.: (612) 932-3800. West Coast: (714) 835-7335. In Europe, Langwood House, High Street, Rickmansworth, Hertfordshire, England. Telephone Rickmansworth (09237) 70545.

Burroughs

Circle 20 on Reader Inquiry Card

SEMICUSTOM GATE ARRAYS. A complete range of semicustom CMOS silicon gate and metal gate arrays is described in this 6-pg., color brochure. It describes the gate array approach to IC's allowing whole circuit boards of TTL or CMOS random logic to be condensed into an IC with savings in weight, power, size and cost. Includes graphs of the average gate cost compared with cumulative volume, propagation delay versus temperature and voltage, and toggle frequency versus voltage. **California Devices, Inc.**, 282 Kinney Dr, San Jose, CA 95112. **Circle 170**

DISCOUNT PRODUCTS CATALOG. Save up to 50% on name brand computer supplies. Retail prices are listed against discounted prices to show the amount saved per item. Features 3M Scotch Brand, Wabash, Rink King and many other accessories and furniture. **Executive Computer Supplies**, 1437 Belcher Rd S., #114, Clearwater, FL 33516. **Circle 148**

SWITCHER POWER SUPPLY. These wall plug-in power supplies deliver up to 25 W of regulated DC power. Two versions are offered for μ P-based systems: a single output +5 V at 5 A, and a triple output +5 V at 2.5 A, and ± 12 V at 0.2 A. For phone applications there is a single-output unit giving 48 V at 0.5 A. They weigh only 11 ounces and meet all requirements of UL standards 1012 and 1310. Units are available with output terminals or an output cable. **Ault, Inc.**, 1600H Freeway Blvd, Minneapolis, MN 55430. **Circle 203**

20MB CARTRIDGE DISK DRIVE has a 10 MB removable disk and a 10 MB fixed disk with high-speed built-in backup. Designed for low cost mini- and micro-computer applications to increase their on-line storage and retain the advantage of removable media storage. A μ P controlled

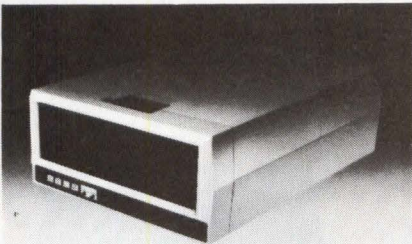

supervisory system monitors and controls all drive functions including digital control of all servo electronics, velocity profiled look-up tables for optimum positioner control and seek times, digitally controlled brushless DC motor/drive, and crystal controlled sectoring with switch selectable sector formats for the fixed disk. All variable functions are either preset or self-adjusting under μ P control. Non-interactive modular construction. The Series 8000 drive is available for 19" rack or table-top mounting. Comprehensive documentation and a 1 year mechanical, 90 day electronics warranty is

standard. \$2300. **Western Dynex Corp.**, 3536 West Osborn Rd, Phoenix, AZ 85019. **Circle 207**

SMALL BUSINESS COMPUTER offers 1.2 MB Storage and Automatic Error Correction. Central unit is a Vector 3 console with 12" VDT and keyboard, a Z80-based SBC and 64K memory. Mass storage units are dual, double-sided, quad-density,

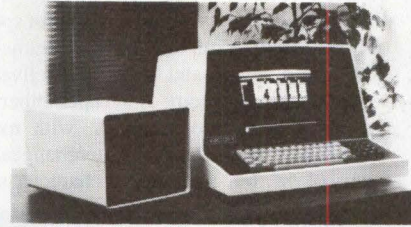

5 1/4" floppy disks storing a total of 1.2 MB. The DualMode controller board automatically corrects up to 5 erroneous bits in every 256 bytes transferred from disk to CPU and features a 256-byte sector buffering. The 2600 is under \$6000. **Vector Graphic Inc.**, 31364 Via Colinas, Westlake Village, CA 91362. **Circle 142**

16K EDITING BUFFER OPTION for the AJ 880 terminal, allows remote job entry, data logging, program loading and debugging, data inquiry, text editing, store and forward and transaction processing. Designed as a storage unit with send/receive buffer, the EBO permits offline storage,

editing and data formatting with block or line-at-a-time transmission at up to 1200 bits/sec. The non-volatile terminal attribute memory is supported by a nicad rechargeable battery, for storage of 128 bytes of set-up information for up to two months' protection with the power off. Included in this protected memory is a 26-character keyboard entered answerback message. The option may be leased for \$50/mo. or purchased at \$995. **Anderson Jacobson, Inc.**, 521 Charcot Ave, San Jose, CA 95131. **Circle 126**

RASTER GRAPHICS HANDBOOK. This handbook presents the broadest possible overview of the current state-of-the-art and points to developments that will influence the design of graphics systems. Obtain copies by writing on company letterhead to **Conrac Corp.**, 600 N. Rimsdale Ave, Covina, CA 91722.

SEMI-CUSTOM IC ARRAYS. Twenty basic arrays are available including 13 analog, 5 digital and 2 analog/digital designs. Engineers need only define the interconnection paths of these standard components to achieve a custom circuit function. UNIRAYs allow for maximum layout flexibility and design refinements incorporated with a minimum of both time and money. **Micro-Circuit Engineering, Inc.**, 1111 Fairfield Dr, West Palm Beach, FL 33407. **Circle 154**

Our new, slower, cheaper array processor.

Our new MSP-3X is only about half as fast as our MSP-3. But at \$4950 its price is also less than half that of any other array processor on the market.

"Slower," of course, is relative: MSP-3X lets your PDP-11 computer perform arithmetic and signal analyses 20 to 50 times faster than it can alone. A 1024-point real Fast Fourier Transform in 14.3 milliseconds, for example.

That's plenty of speed for most analyses of vibration, sonar, communications, radar, medical image, and dozens of other kinds of data.

And you needn't sacrifice convenience, either. Operation is simple and reliable, based on straightforward execution of an extensive library of functions, accessed through Fortran calls. And MSP-3X's two hex boards simply plug into your PDP-11.

All in all, MSP-3X is a most intelligent trade-off. Write us for detailed specifications.

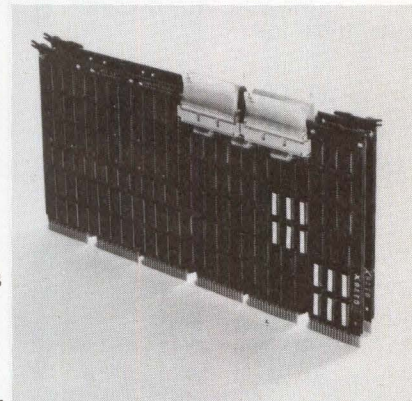

MSP-3X array processor

Computer Design & Applications, Inc.

377 Elliot Street
Newton, MA 02164 (617) 964-4320

Circle 32 on Reader Inquiry Card



SMALL, PRECISION MACHINED COMPONENTS

LaVeZZi provides fast, economical services for manufacturing ratchets, sprockets, shafts, clutches, and other precision components that require uncommonly close specs.

Blanking, CNC turning capable of 1/4-micron resolution, CNC 4-axis milling to one micron resolution. Hole sizing to .0001" tolerances and OD concentricity. Grinding to 4 RMS. Hobbing. Injection molding. Burr-free parts. For small-lot and large-scale production runs. All under one roof for single responsibility. Our brochure tells nearly all. Write for it! And call LaVeZZi before you "buy outside" on your next job.

LaVeZZi

LaVeZZi Machine Works, Inc.

900 N. Larch Avenue
Elmhurst, Illinois 60126
(312) 832-8990

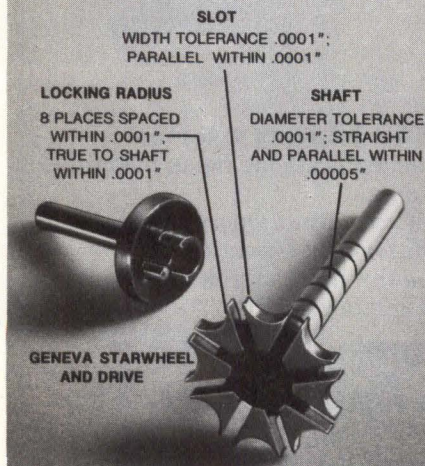

Circle 34 on Reader Inquiry Card

New Products

1200 LPM BAND PRINTER is priced 40% below industry-competitive band or drum models available. An optional switch selectable speed feature allows the printer to produce draft-quality WP output at 600 lpm. The 132-column Model 3121 includes over 40 digital display symbols, a low-cost spool ribbon system, a full line buffer, a below 65 dBA noise level, and a gravity activated paper stacking system. It accepts either of two print band specifications, with more available as an option. The interchangeable bands of 48, 64, 94 and 128 character sets

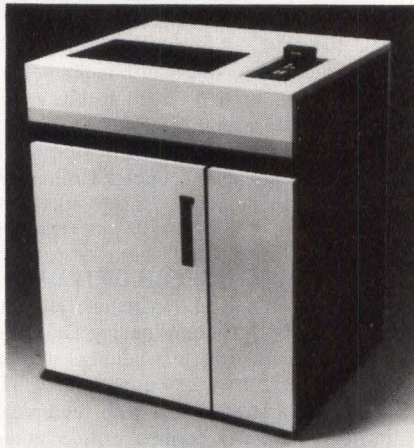

offer lpm throughput of 1350, 1200, 900 and 690, respectively. \$7800 in OEM qty. **Data Printer Corp.**, 99 Middlesex St, Malden, MA 02148. **Circle 131**

DUAL DISK DRIVE SUBSYSTEMS frees the CPU to the user while processing commands. Manufactured by Remex, the

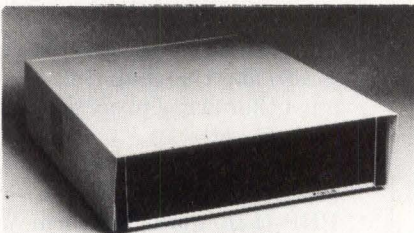

24/48 contains its own dc power supply in either two single-headed intelligent drives or two dual-headed drives. Drives are sold separately, in rack mountable/desk top enclosure or other configurations. Track to track access time is less than 3 ms due to head tunnel erase structures that are positioned by a split band/stepper motor systems. **Data Compass Peripherals Group**, 2550 Mira Loma Way, Anaheim, CA 92806. **Circle 147**

TRS-80 LINE PRINTER V. Suited to heavy business use, this printer has a bi-directional, logic-seeking dot-matrix head that prints high-quality 7x9 u & l case char. (with descenders) 132-col. wide, and software-selectable 5, 7.5, 10 or 15 cpi, 26

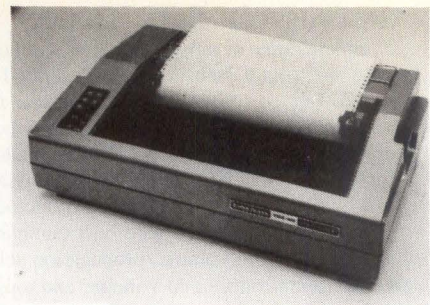

European char. and 30 graphics patterns. Print speed is 160 cps, 60 lpm. The tractor feed mechanism is adjustable to handle any fanfold computer paper up to 15" wide and to 5 sheets. It is adjustable in 1/8-line increments for accurate positioning of preprinted forms. The printer has indicators for Ready, Power and Alert (paper out), plus 5 pushbutton controls (including self-test). \$1860. **Tandy Corp/Radio Shack**, 1800 One Tandy Center, Fort Worth, TX 76102. **Circle 158**

FIXED DISK MEMORY POWER supplies. Seven open-frame power supplies for Winchester, Shugart, Micropolis and other fixed disk memories are available. Three models in the new line have 5 outputs (+5V, +24V, +12V, -5V and -12V) and four models have 3 outputs (+5V, +24V and -5V or -12V). These are the only fixed disk memory power supplies with an international transformer as standard. The line includes standard industry case styles of DBB, NBB and CBB. From \$130 to \$169 ea. for 5 output models; from \$110 to \$149 ea. for 3 output models, (both in 1-9 qty). **Condor, Inc.**, 4880 Adohr Lane, Camarillo, CA 93010. **Circle 146**

5 1/4" DRIVES offer an unformatted capacity of 6.91 MB, average access time of 96 ms, and a max access time of 288 ms. Data transfer rate is 960 kB/sec. The first within the 5000 series, the 5007, includes data separation built into the drive which provides compatibility with IMI's 8" units. Future drives will offer built-in controllers, and units without data separation. \$800 in

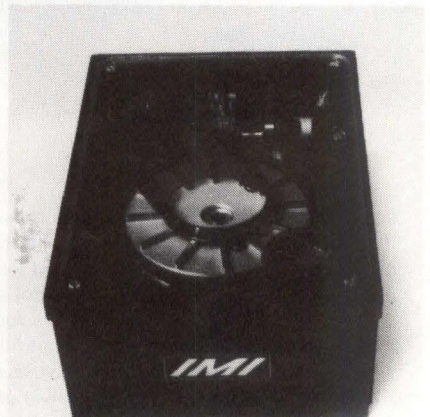

OEM qty, 90 days ARO. **International Memories Inc.**, 10381 Bandlely Dr, Cupertino, CA 94014. **Circle 133**

CLUSTER NETWORK offers high speed — 1000 times faster — for such steps as compiling, assembling, linking and slave emulation, and offers eventual use with GRNet local communications link to provide a long-term growth path. A typical cluster can include up to 8 separate stations, with access to network mass storage and printer made via an Information Control Processor (ICP). The ICP can support one printer, up to four 35MB hard disks or up to 8 floppy disk units. A memory expansion unit (MEU) for the 2300/2301 series puts up to 1/2MB of high speed RAM at each system or station. The MEU is a 5-board set which plugs 512 kB of RAM into the system console. This is in addition of 64 kB of execution memory already in each station. The operating system treats this as an additional floppy disk. Transfer speed to execution memory is 100 kB/sec. — about 100 times faster than transfers made via a local floppy disk. A unified operating system (UDOS) will support all combinations of station and network mass storage devices without modification. UDOS also offers 126 system file directories which can accommodate 154 user created files up to a max of 5800 files. Each user directory can be public or protected by a password. **Gen-Rad Development Systems Div.**, 5730 Buckingham Pkwy, Culver City, CA 90230. **Circle 132**

LOW COST GRAPHIC PRINTER features 7 x 7 or 14 x 7 dot matrix, 6 character sizes, 100 cps bidirectional print speed, selectable tractor or friction paper feed, and a long-life ribbon cartridge loading. It has

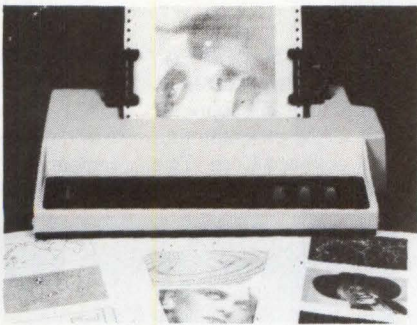

variable line density and continuous form length controls and can be operated at 100% duty cycle continuously without overheating. Provides plotting, printing CRT screen graphics, drawing illustrations and producing special effect symbols. With full 96 character ASCII set, it prints upper and lower case at 40, 48, 66, 80, 96 or 132 char/line. Model DIP-84G is \$575 in OEM qty 100. **Dip, Inc.**, 745 Atlantic Ave, Boston, MA 02111.

Circle 174

IMAGE PROCESSING SYSTEM. This family of image processing systems and components allows customized configurations for small image analysis stations to large multi-user distributed processing systems. The EIKONIXSCAN EC-1000 Series may contain combinations of host CPU, image digitizer, array processor, mass storage and displays, as well as compatible

options such as I/O devices, keyboards, digital tablet and track ball. Options include color and B&W display, interactive controls, graphic and measurement routines, statistical analysis, and real-time data

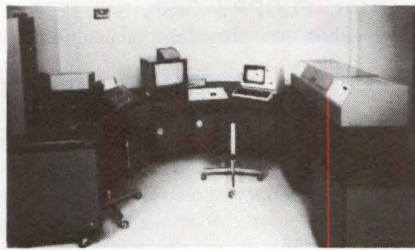

manipulation. From \$75,000, 120 days ARO. **Eikonix Corp.**, 23 Crosby Dr, Bedford, MA 01730. **Circle 178**

KEYBOARD CATALOG includes data on standard keyboards, plus a variety of models ranging from 10 to 98 keys. Featured are the Process Control Keyboard with serial I/O for industrial control system applications, full complement of keyboard enclosures and accessories. Ruggedized versions for heavy-duty industrial and military applications are offered. **George Risk Industries Inc.**, GRI Plaza, Kimball, NE 69145.

Circle 190

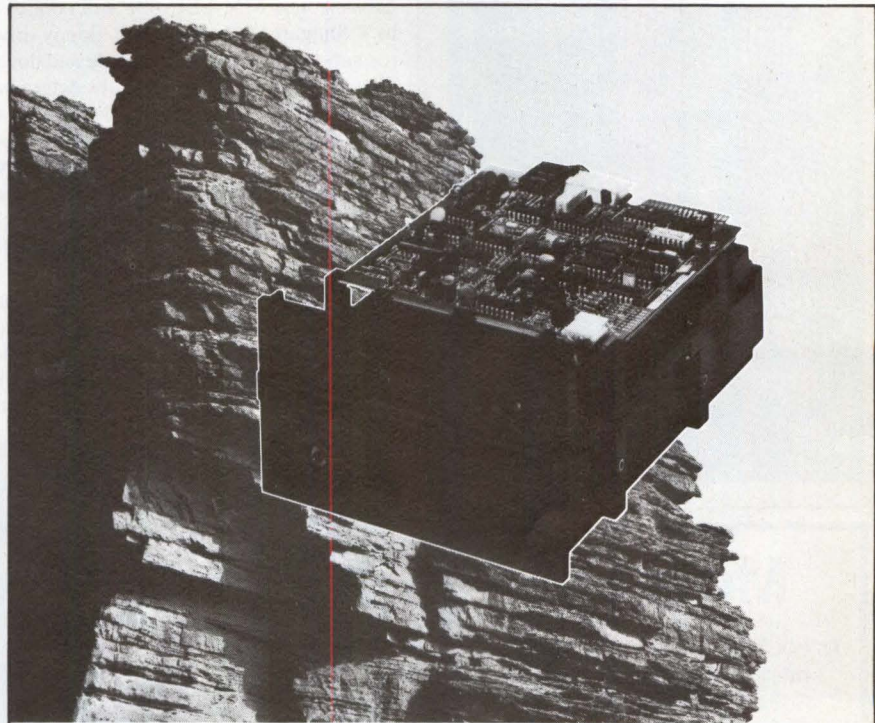

ROCK-SOLID FLOPPY DISK DRIVES FROM TEAC

Unique DC Spindle Drives feature our continuously-running brushless DC motor whose typical life expectancy is over 10,000 hours. Rock-stable, no electrical noise will interfere with the integrity of your data.

Superior Chassis features fiberglass reinforced polyester (FRP) which, unlike aluminum, won't stretch with heat. Extra-rugged and precision molded, the unit also has a shield to insulate the head from outside interference.

25 Years of Leadership in all magnetic recording technologies is your assurance of a quality product you can rely on. For complete information on all TEAC Rock-Solid Floppy Disk Drives (FD-50 Series) — including our one-year warranty and full technical support and service — just write:



TEAC Corporation of America
Industrial Products Division
7733 Telegraph Road, Montebello, CA 90640
(213) 726-8417

Circle 35 on Reader Inquiry Card

ATTENTION!

A red label on the cover of this issue indicates that your name will be dropped from our mailing list as of the next issue UNLESS you take immediate action.

Requalify NOW! Fill out the qualification form completely, affix the red mailing label, and return it to the Circulation Department immediately.

Before mailing your qualification form, please make sure that the red label is affixed to the address box on the form.

Thank you.

Moving?

1. For FASTEST service attach old mailing label in space below.

If mailing label is not available print your old Company name and address in this box

Please allow
6 weeks for
change to
take effect

2. Print your NEW business address here

NAME _____
TITLE _____
COMPANY _____
ADDRESS _____
CITY _____ STATE _____ ZIP _____

3. Mail to: Circulation Manager
Digital Design
1050 Commonwealth Ave.
Boston, MA 02215

New Products

DUAL FLOPPY DISK SYSTEM. The Megabox now provides total Multibus compatibility and runs all Intel software including ISIS II, plus CP/M and MP/M. The MM-SBC-80 Multibus floppy disk controller will support the Intel iSBC-201 and 202 single and double density formats at a lower cost, and support the IBM 3740 single density soft sectored format and the IBM System 3 double density format. It fully supports the ISIS II DOS allowing users to upgrade operations to both single and double density. The MM-SBC-80F will control up to 4 Shugart 800/850 type 8" floppy drives (or similar drives) in both single and double density mode. It automatically determines the density of the inserted diskette, with no user input. The total MM-SBC-80 Megabox system is \$3195; the MM-SBC-80 controller is available separately for \$995. **Micro-mation**, 1620 Montgomery St, San Francisco, CA 94111. **Circle 167**

FIBER-OPTIC CABLE. This series of partially graded-index optical fiber cables have a 100 μm core diameter and attenuation ratings of 9 dB max at 850 nm. The Series 2260 utilizes a glass-clad core that offers the

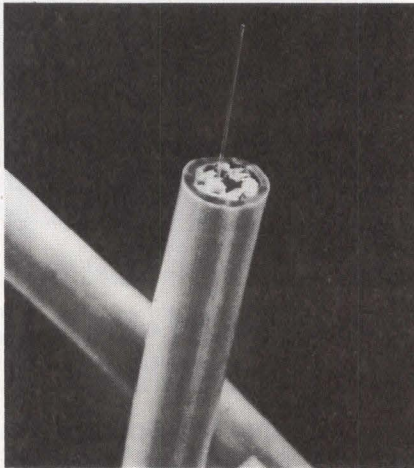

installation advantages of step-index fibers along with the stability of all-glass graded-index fibers. Outer diameter is 140 μm including the cladding; overall diameter, including the acrylate coating, is 250 μm . Numerical aperture is 0.3, and nominal bandwidth is 20 MHz-km. Available cabled with 1, 2, 6, 12, and 18 fibers. Single fiber design is \$1.68/meter in 1-5 km lengths. **Belden Corp**, 2000 S. Batavia Ave., Geneva, IL 60134. **Circle 169**

1/4" TAPE DRIVES. This series of 1/4" streaming cartridge tape drives have an integral controller/formatter. The intelligent SIDEWINDER drives can store up to 20MB of formatted data in about 4 minutes, but only occupy the space of an 8" floppy disk drive. \$995 in OEM qty. **Archive Corp**, 3540 Cadillac Ave, Costa Mesa, CA 92626. **Circle 204**

5 1/4" MICRO-WINCHESTER. With thin film R/W heads, the ST512 offers 12.76MB unformatted, 10MB formatted on two disks

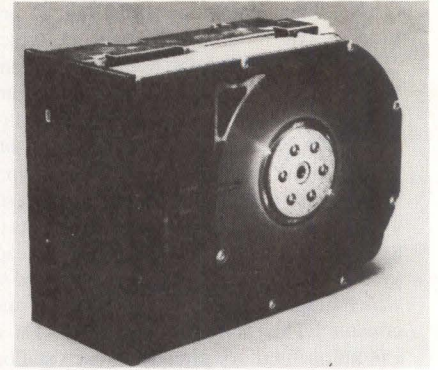

— twice the storage of current-generation ferrite head drives. This increased storage capacity is provided in the same 5 1/4" Minifloppy and ST506 compatible form factor. It uses the same recording format as the ST506 and operates with the same interface and 5 MHz data transfer rate. \$1450 (100). **Seagate Technology**, 360 El Pueblo Rd, Scotts Valley, CA 95066. **Circle 138**

STD BUS CARD RACKS. The MSI-CR Series of racks with motherboards feature a wider card spacing of 0.694". The additional width (approx. 0.2") provides space to house most STD cards in a single slot. Well ventilated, economical design. Provides 3, 6, 12, and 24 card racks in standard rack widths. **Microcomputer Systems, Inc.**, 1814 Ryder Dr, Baton Rouge, LA 70808. **Circle 187**

GRAPHICS DISPLAY SYSTEM emulates the IBM 3250 class of graphics display equipment and supports CADAM, a CAD and CAM programming system developed by Lockheed Corp. Twelve remote display station sites may be located as far as 3 miles

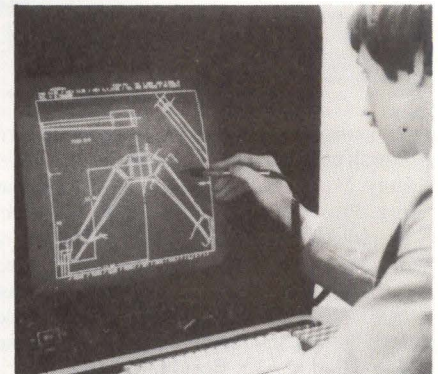

from the host computer. The VG 8250 channel speed of 1.2MB/sec and the operation of the selector, block multiplexor or byte multiplexor in its real mode allows support of 32 terminals. Other enhancements include a hand-held tablet/digitizer, a maintenance/data management supervisor, continuous rotation and scaling of characters, and an electrostatic plotter option. **Vector General**, 21300 Oxnard St., Woodland Hills, CA 91367. **Circle 205**

LSI-11 ANALYZER is a portable, self-contained test instrument that can realtime troubleshoot a complete LSI-11 computer-based system in as little as 15 minutes, in-



cluding peripherals. The CAS-11 is actually 3 instruments in one: a minicomputer front panel; a μ P analyzer; and a substitute program memory. It can debug and solve many problems as they relate to total malfunction, random errors, software development or peripherals interaction, including those incapable of isolation by self-test diagnostics. **Electro-Design, Inc.**, 7364 Convoy Court, San Diego, CA 92111. **Circle 177**

1K AND 2K PROMS use reliable titanium-tungsten (TiW) fuses and require only 70 mA of power, about $\frac{1}{2}$ the power required by their NiCr counterparts. Access time for the 1K TiW PROM is 55ns; 60ns for the 2K version. Pin-compatible with standard

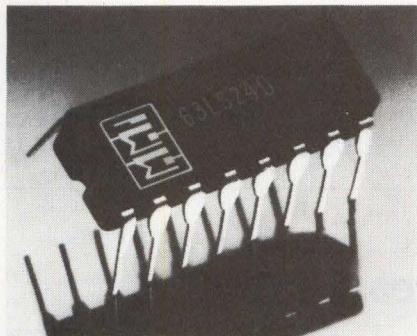

Schottky PROMs, they are organized as 256 by 4 bit (1K) and 512 by 4 bit (2K) configurations. All devices have full Schottky clamping, 3-state or open collector outputs, and PNP inputs for low input current. Available in plastic or ceramic 16-pin DIPs from \$2.50 to \$11.25 in 100 qty. **Monolithic Memories, Inc.**, 1165 E. Argus Ave, Sunnyvale, CA 94086. **Circle 186**

μ P FUNDAMENTALS BOOK. A balance of hardware and software and examples in "Microprocessing Fundamentals: Hardware and Software," by Edward Ramirez and Melvyn Weiss, has ten chapters covering μ Ps, programming and application fundamentals, with a generic instruction set. Most previous "generic instruction texts" were terrible. Aside from the first 30 pages (out of 300), this one isn't bad at all. Recommended for Students and EEs still struggling with μ Ps. Instructor's manual available. \$13.95. **Gregg/McGraw-Hill**, 1221 Ave. of the Americas, New York, NY 10020.

Inquire Direct

Unibus* repeater for PDP11 series systems.

Do you need to add peripherals or additional cable lengths to an overloaded bus? Do you have unknown system crashes such as caused by a type 4 trap — delayed response from a slave sync? Is your current repeater too slow for your current system?

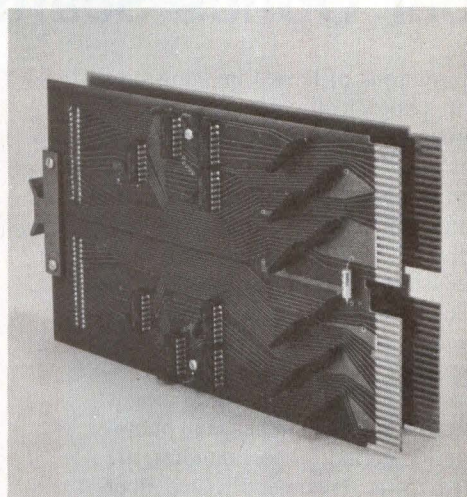

If these questions are relevant, then Datafusion Corporation has a device that can answer your needs, the OSB11-A Bus Repeater. It is a functional equivalent of DEC's* DB11-A, and is designed to drive at least 19 bus loads and 50 foot of bus cables.

Ultra Fast: 80 nanoseconds MSYNC to return SSYNC maximum (40 nsec one way). This is due, primarily, to the specially designed patented integrated circuit employed by the OSB11-A.

Reliable: Only 34 operational circuit components. Tested in environments from 0° to 70°C with virtually no degradation of signal quality.

Easy to Install: Remove a M920 Jumper and replace it with a OSB11-A. No extra system unit is needed; no wires or plugs to connect (or disconnect); no lost time in reconfiguration.

Available: Off-the-shelf. And, it's fully supported and warranted.

Cost: About 25% below DEC.* Quantity discounts are available.

Other PDP11 products available are a Busrouter (a Unibus* Switch) to reconnect multiple peripherals to one or more PDP11 cpu's, a Unibus* Cable Tester, and an Associative File Processor for high speed text search — a hardware approach.

We also have some ideas for the application of our products which might not have occurred to you. If you can't get the performance that you would like from your PDP11 system, maybe we can help. Please telephone our Marketing Manager at (213) 887-9523 or write to Datafusion Corporation, 5115 Douglas Fir Road, Calabasas, California 91302.



*TRADEMARK OF DIGITAL EQUIPMENT CORPORATION

Circle 36 on Reader Inquiry Card

Fiber Optics Scans Objects

The limitations of lensed imaging systems in photoelectric sensing, optical instrumentation and illumination applications has necessitated a different method of controlling light. The development of finely drawn optical quality glass has enabled us to detect objects in inaccessible places, gather light in ways lenses cannot, and remove almost all the heat from a high intensity light source.

One of the primary industrial usages of glass fiber optic bundles is in photoelectric detection: these bundles are referred to as "scanners". One fiber optic guides the light from the source to the sensing point and another fiber optic brings the light back.

Another common technique is to split one end of the fiber bundle into two legs. Scanning light is passed down one leg, exits the common bundle, is reflected

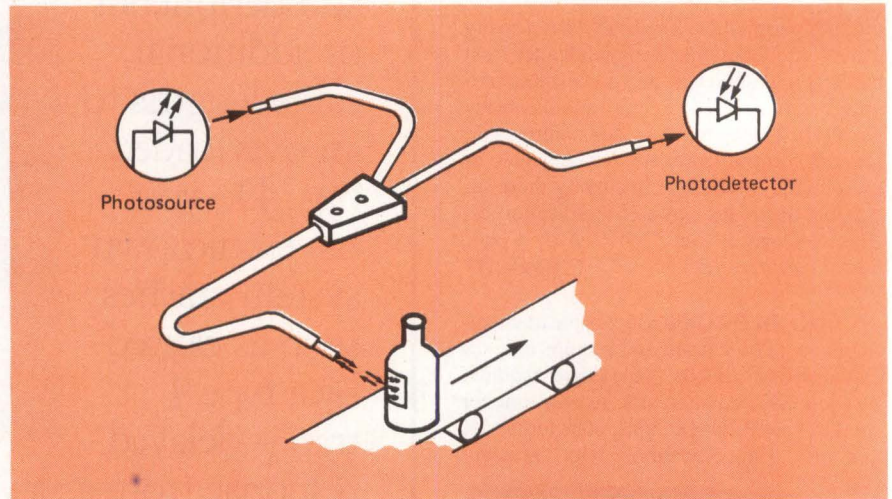

off an object and back into the same fiber optic. A photo detector on the other leg reads the signal. This is known as "Reflective" scanning.

Staff,

*Dolan-Jenner Industries, Inc.,
Box 1020, Woburn, MA 01801.*

μ P-Interface "Jitter Switch Alarm" Foils Thieves

Some coin operated lockers are a pushover for pry bar artists and vandals unless an alarm is used. You may construct one based on Fifth Dimension's TS7K jitter switch. Any attempt to force open a locker protected by this system sets off an ear-splitting siren discouraging further attempts at break-in.

TS7K need not be tipped to make momentary closure: even small amounts of vibration or oscillation cause the mercury ball within to move, completing the circuit. The only circuit components necessary to build an alarm system are the switch, latching device (SCR, TRIAC or relay), horn,

siren or other noisemaker, two resistors and power source which can be momentarily interrupted to kill the alarm.

Staff,

*Fifth Dimension, Inc.,
801 New York Ave., Trenton, NJ.*

Tilt Switch Inverts LED/LCD Displays

A telephone company manufactures a piece of equipment with a display which may be either desk-mounted or wall-mounted. When wall-mounted, however, the displayed numbers and letters would be inverted without corrective action. Rather than build and stock two separate systems, the company hit on a novel scheme to invert the readout when wall-mounted.

It depends on the action of a Fifth Dimension position sensor and a few additional components to do the job.

When the tilt switch signals that the display is "upside down", logic within the equipment reverses the direction of horizontal scan (clocked counters count down instead of up) and also reverses the row assignments for the display. This has the effect of a 180° rotation of

the entire display.

This concept may be extended to more sophisticated applications by recording logic or μ P subroutines to respond uniquely to a certain number(s) of inversions.

Staff,

*Fifth Dimension, Inc.,
801 New York Ave., Trenton, NJ.*

Making Floating Measurements Easier

Floating measurements (measurements made without reference to ground) are required in many situations, typically when signal voltage exceeds the test instruments' input rating or when the signal range is very small in proportion to the offsetting voltage. Floating measurements can be hazardous to the test equipment operator who has disconnected protective ground of the equipment (or is unaware of a component failure in the equipment). In either case, the result could be an injurious or lethal shock.

These measurements can also damage or destroy the test equipment or the circuit under test through voltage or current overload; some firms will not repair or calibrate an instrument whose protective ground lead and connection have been removed to make floating measurements.

Measurements can be difficult to perform because probes or connectors can introduce unwanted circulating currents (ground loops) into the circuit under test, thus imposing noise on the desired signal; and, they can interfere

with system operation through the connection of the probe ground.

Floating measurements can be made in several ways. Each method has limitations, and some are safer and more reliable than others. One method isolates the test equipment from ground by introducing a device that provides ground isolation. This approach to disconnecting the ground lead maintains the integrity of the test equipments' protective ground path.

CAUTION!

Floating measurements can be hazardous to your health.

Another often-used method isolates the signal and the common connection from the test equipment typically by placing transformers or capacitors in the signal and common paths. This approach allows the test instrument to remain grounded, but means that only ac measurements can be made, and these only at lower frequencies. Also, it can be very difficult to maintain system bandwidth at high voltages.

A third method uses an optically coupled isolator IC or circuit (OCI), which provides good isolation at high

voltages and low signal interference. This approach is limited since it is non-linear and temperature dependent.

A fourth method isolates the system under test from ground with an isolation transformer. System performance is maintained, but the operator must be protected as excessive voltage may be present in its chassis. This approach is not always viable, and isn't capable of high-voltage isolation.

A fifth method uses a differential amplifier. This method requires two matched probes and imposes voltage and bandwidth limitations at high frequencies.

A sixth method uses a battery-operated test instrument to avoid the necessity of grounding the test instrument chassis. Instruments are double insulated, but caution should be observed when connecting the probe to test points. This is well-suited to CMOS ICs, which are increasing in speed. Or, as a hybrid approach, permanently install a dedicated circuit for floating measurements in the device under test.

Staff Report,
Tektronix,
Beaverton, OR.

INSTANT REAL-TIME CONTROL

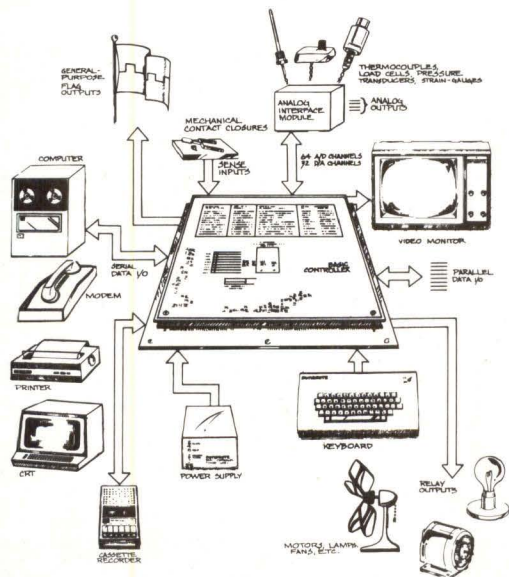

Dynabyte's BASIC CONTROLLER is a versatile measurement and control computer that can:

- Directly sense mechanical contact closures and/or digital logic levels
- Measure and generate analog signals
- Perform arithmetic computations, detect limits and manipulate data
- Directly control electronic and electromechanical devices
- Communicate with computer peripherals

All this and more in a single-board system that includes ZIBL™, an easy-to-use BASIC programming language which features special commands for direct input/output control. This unique combination of hardware and resident software makes the BASIC CONTROLLER the best solution for all your application requirements.

DYNABYTE

Industrial Control Products Division
115 Independence Drive
Menlo Park, California 94025
(415) 329-8021

■ Built-in CRT terminal circuitry ■ 24-hour clock ■ Serial and parallel data I/O ports
■ Cassette interface ■ EPROM programmer ■ 96 single-wire I/O lines ■ 8 on-board relays
■ Up to 64 analog inputs and 32 analog outputs with optional interface modules.

ATTENTION BARGAIN HUNTERS!

Buy, sell or trade all types of computer equipment and software (pre-owned and new) among 20,000 readers nationwide in the BIG (11x14") pages of **COMPUTER SHOPPER**.
 Subscription: \$10 yr./12 issues. Money back guarantee. P.O. Box F11, Titusville, FL 32780. (305) 269-3211. **MC & VISA only, 1-800-528-6050 Ex. 184.**
EQUIPMENT & SOFTWARE BARGAINS

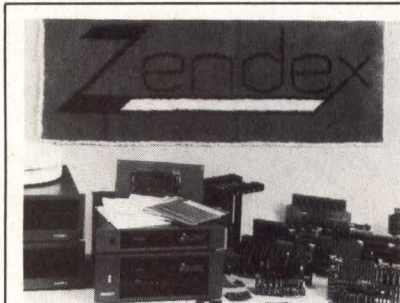

Zendex designs and manufactures a complete line of MULTIBUS compatible boards and MDS compatible systems.

- SBC CPU 8085A-2, 8088
- RAM 128K Dynamic
- FDC ISIS-II Compatible, RMX Compatible
- PROM Programmer 2716, 2732, 2732A
- Disk Systems
- Chassis ZX-660, ZX-655
- SBX-Modules Analog, IEEE, Digital
- MDS Systems CP/M, ISIS-II Compatible

Zendex 6680 Sierra Lane, Dublin, CA 94566
 (415) 829-1284

Circle 39 on Reader Inquiry Card

ATTENTION!

A red label on the cover of this issue indicates that your name will be dropped from our mailing list as of the next issue UNLESS you take immediate action.

Requalify NOW! Fill out the qualification form completely, affix the red mailing label, and return it to the Circulation Department immediately.

Before mailing your qualification form, please make sure that the red label is affixed to the address box on the form.

Thank you.

Moving?

1. For FASTEST service attach old mailing label in space below.

Please allow 6 weeks for change to take effect

If mailing label is not available print your old Company name and address in this box

2. Print your NEW business address here

NAME _____

TITLE _____

COMPANY _____

ADDRESS _____

CITY _____ STATE _____ ZIP _____

3. Mail to: Circulation Manager
 Digital Design
 1050 Commonwealth Ave.
 Boston, MA 02215

Advertisers' Index

Advanced Electronics Design	37	Grinnell	2
Anadex	42	Hycom	66
Andromeda Systems	49	Imperial Technology	56
Associated Computer Consultants .	13	Interdesign	5
Aydin Controls	C-3	Kennedy	C-2
BASF Systems	11	La Vezzi Machine Works	70
Bell Northern Research	29	Lenco	4
Bo-Sherrel	28	Lexidata	16
Burroughs OEM Marketing	68	LogEtronics	41
CalComp	15	Nicolet Zeta	63
Chromatics	1	Optical Coating Laboratories	6
Compat '81	38, 39	Peritek	57
Computer Design & Applications	69	Scherer's Mini Computer Mart	56
Datafusion	73	Seaelectro	28
Dataram	8	Spatial Data Systems	61
Dolch Logic Instruments	C-4	Standard Engineering	51
Dynabyte	75	TEAC	71
Eaton	55	TEC	7
Electronics Test & Measurement Conference	19-22	United Systems	67
Exatron	18	Zendex	76

Sales Offices

- MA, ME, NH, RI, & VT:** Jeffrey C. Hoopes, National Sales Manager, (617) 232-5470, 1050 Commonwealth Ave., Boston, MA 02215
- CT, L.I. & NY CITY:** Jack Flynn, (203) 673-0300, The Flynn Group, P.O. Box 675, Avon, CT 06001
- MID-ATLANTIC STATES:** Warren Smith, (201) 221-0184, P.O. Box 754, Bernardsville, NJ 07924
- SOUTHEASTERN STATES:** E. Harold Mitchell, (404) 634-7070, P.O. Box 13611, Atlanta, GA 30324
- OHIO VALLEY:** Doug Horst, (313) 476-3757, Horst Assocs., 27333 Bramwell, Farmington Hills, MI 48018
- MID-WESTERN STATES:** David Kingwill, Ed Krukowski, (312) 774-9660, The Kingwill Co., 5526 N. Elston Ave., Chicago, IL 60630
- SOUTHWESTERN STATES:** Jerry Ambroze, (713) 780-3326, Ambroze & Assocs., 2168 Augusta, Houston, TX 77057
- SOUTHERN CA:** Lindy Dolan, (213) 981-3300, Suite 1215, 15910 Ventura Blvd., Encino, CA 91436
- NORTHWESTERN STATES:** Neal W. Manning, Western Sales Manager, Charlotte King, Vernon D. Swart, Jr., (408) 371-9620, Suite 1005, 1901 S. Bascom, Campbell, CA 95008
- JAPAN:** K. Yanagihara., (03) 350-0272, 10-10 Shinjuku 3-chome, Shinjuku, Tokyo, 160 Cable Address: Yanacour Tokyo