

ACCU-CHEK[®]

Compact Plus

BLOOD GLUCOSE MONITORING SYSTEM

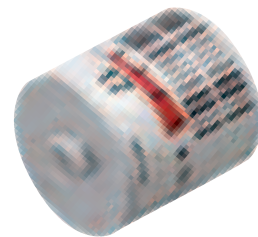

User's Manual



On the packaging, on the type plate of the meter and on the lancing device you may encounter the following symbols shown below. They have the following meanings:



Consult instructions for use



Caution (refer to accompanying documents). Please refer to safety-related notes in the instructions for use accompanying this instrument.



Store at



Use by / Expiry date



For single use only



Sterilized through irradiation



Manufacturer



Catalogue number



Lot number



For in vitro diagnostic use



Blood glucose meter: This product fulfils the requirements of Directive 98/79/EC on in vitro diagnostic medical devices.

Lancing device and lancets: These products fulfil the requirements of Directive 93/42/EEC on medical devices.



AST cap: This product fulfils the requirements of Directive 93/42/EEC on medical devices.

The explanation of any other symbols can be found in the instructions/ inserts, accompanying components within the packaging.



WARNING: Patients receiving peritoneal dialysis using solutions containing Icodextrin (e.g. Extraneal, Icodial) should not use the Accu-Chek Compact test strip. It could cause an overestimation of glucose results.

Last update: 2008-07

Intended use

Accu-Chek Compact Plus Blood Glucose Meter

Meter for quantitative determination of blood glucose values in fresh capillary blood using Accu-Chek Compact test strips.

Suitable for self-testing.

The Accu-Chek Compact Plus blood glucose meter may be used by people with diabetes to test their own blood glucose as well as for blood glucose determination by healthcare practitioners in a professional setting.

 Healthcare professionals must observe additionally the directions in Chapter 10 “Blood glucose testing in a multi-patient setting – Information for healthcare professionals”.

 Any object coming into contact with human blood is a potential source of infection (see: Clinical and Laboratory Standards Institute: Protection of Laboratory Workers from Occupationally Acquired Infections; Approved Guideline – Third Edition; CLSI document M29-A3, 2005).

Accu-Chek Softclix Plus Lancing Device

Lancing device with adjustable depth setting for obtaining capillary blood from a fingertip or earlobe and, when a special AST cap is used, from alternate sites such as the ball of the thumb.

 The lancing device is intended only for patient self-monitoring by a single person. It must not be used to collect blood in a multi-patient setting as it does not incorporate any features to guard against cross-infections.

About this User's Manual

Please read this User's Manual carefully and completely before testing blood glucose for the first time. If you have any questions, please call Accu-Chek Customer Care at 1-800-363-7949 (see Chapter 17).

This User's Manual will help you get to know your meter and lancing device step by step. It will provide you with all the information you need to operate and care for your meter and lancing device and to deal with any errors that might occur. Remember that, in order to keep your meter and lancing device in good working condition, you need to follow the correct operating procedures and also observe certain other instructions. The meter and lancing device are precision instruments and improper handling can impair their operation.

This User's Manual features three symbols to draw your attention to important information. Please read these points with special care.

 This symbol indicates **a possible risk of injury or of damage to your own health or to the health of others.**

 This symbol draws attention to actions that could result in **damage to meter or to the lancing device.**

 This symbol draws your attention to important information.

Other symbols are used, too. They have the following meaning:

- ▶ This symbol is a prompt for you to do something, such as turn the meter on.
- This symbol signifies a list.
 - This symbol signifies a list within a list.

We recommend that you start by getting to know all of the features of your meter and lancing device (see Chapter 1.1 and 1.2). Try out all of the steps described in this manual, and also practice using the meter and lancing device.

Contents

1 Introduction	12
1.1 The Accu-Chek Compact Plus blood glucose meter at a glance.....	12
1.2 The Accu-Chek Softclix Plus lancing device at a glance.....	15
1.3 Main features.....	16
1.4 Display illustrations.....	19
2 Initial steps before testing	20
2.1 Checking the contents	20
2.2 Checking the blood glucose unit.....	20
2.2.1 Type plate	21
2.2.2 Display check.....	21
2.3 Inserting or replacing the test strip drum.....	24
2.3.1 Test strip drum use-by period.....	33
2.3.2 Indication of the number of test strips remaining.....	36
3 Settings	38
3.1 Changing settings – General rules.....	41
3.2 Turning the meter on.....	44
3.3 Setting the beep tone or Acoustic Mode	45
3.4 Setting the brightness of the display	48
3.5 Setting the year.....	50
3.6 Setting the time/date format	52
3.7 Setting the time	54
3.8 Setting the date	56
3.9 Setting the alarm clock function.....	59
3.10 Setting the hypo indicator	67
4 Testing blood glucose	70
4.1 Preparing to test blood glucose	70
4.2 Preparing the lancing device	70
4.2.1 Undocking the lancing device from the meter	73
4.2.2 Docking the lancing device onto the meter	74
4.2.3 Inserting the lancet	75
4.3 Performing a blood glucose test	78
4.3.1 Turning the meter on.....	78
4.3.2 Obtaining blood	80
4.3.3 Drawing up blood with the test strip	84
4.4 Ejecting the test strip	90
4.5 Ejecting the used lancet.....	92
4.6 Symbols you see before, during or after testing and what they mean	95
4.7 Flagging special results.....	96
4.8 Evaluating results.....	97
4.8.1 Measuring range	98
4.8.2 Implausible results – possible causes of error	99
5 Using the meter as an electronic notebook	101
5.1 Memory	101
5.2 Retrieving results from memory	102
5.3 Average, highest value and lowest value for 7, 14 and 30 days.....	107
5.4 Downloading test results to a PC, handheld computer or a special evaluation system	114

6 Acoustic Mode	120
6.1 Beep tones at power-on.....	122
6.2 Beep tones during testing.....	123
6.3 Announcement of the result following a test.....	123
6.4 Announcement of results and average values from memory.....	126
6.5 Announcement of warnings and error messages.....	128
7 Checking your meter	129
7.1 What you need.....	130
7.2 Performing a performance check.....	131
7.3 Possible causes of error during the performance of performance checks.....	137
8 Cleaning the meter and lancing device	140
8.1 Cleaning the meter.....	140
8.2 Cleaning the lancing device.....	144
9 Changing the batteries	145
10 Blood glucose testing in a multi-patient setting – Information for healthcare professionals	150
10.1 Replacing the lancing device with a blanking plate.....	152
10.2 Performing a blood glucose test.....	154
10.3 Disinfecting the meter.....	158
10.4 Suitable disinfectants.....	162
11 Measurement and storage conditions	163
11.1 Temperature range.....	163
11.2 Light conditions.....	165

11.3 Humidity.....	166
11.4 Local sources of interference.....	166
12 Symbols, error messages and troubleshooting	167
12.1 Symbols shown in the display.....	168
12.1.1 Single symbols.....	170
12.1.2 Combinations of symbols.....	176
12.1.3 Symbols appearing in the numeric field.....	179
12.2 Interferences and error messages – causes and troubleshooting recommendations.....	181
13 Technical data	196
14 Alternate site testing	200
14.1 Choosing the right moment.....	202
14.2 Obtaining blood and testing blood glucose.....	204
14.3 Cleaning the AST cap.....	207
15 Disposing of the meter	208
16 System components	209
17 Patents	210
18 Accu-Chek Customer Care Line	211
18.1 Advice and troubleshooting.....	211
18.2 Addresses.....	212
19 Alphabetical index	213

1 Introduction

The meter is supplied with batteries already inserted. The time and date are already set. You may need to adjust these settings to your own time zone (see Chapter 3).

1.1 The Accu-Chek Compact Plus blood glucose meter at a glance

Front

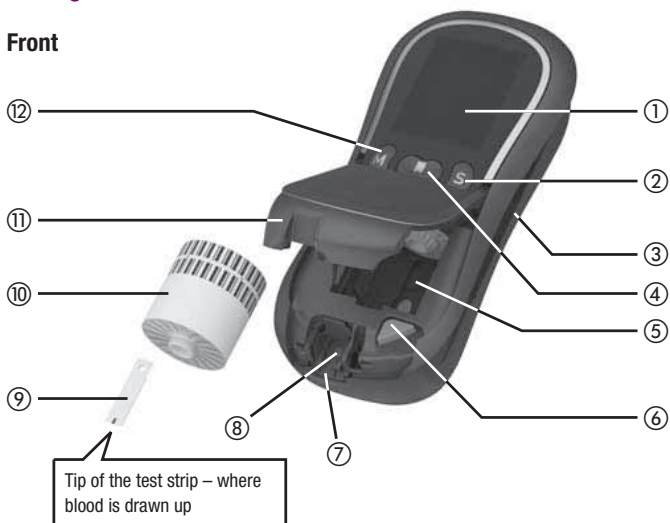

- ① Display window
- ② S button
Press this button to change settings.
- ③ Recess for docking the lancing device
- ④ Test button
*Use this button **only** if you want to test your blood glucose or perform a performance check, or wish to turn the meter off. Pull the button downwards towards the drum compartment cover. The button tips downwards and the meter turns on. This pull-tip mechanism stops the meter from turning on inadvertently.*
- ⑤ Drum compartment
- ⑥ Drum release button
- ⑦ Test strip guide
- ⑧ Measuring window
- ⑨ Test strip
- ⑩ Test strip drum
- ⑪ Drum compartment cover*
- ⑫ M Button
Press this button to retrieve results stored in the meter's memory.

* available as replacement part

Back

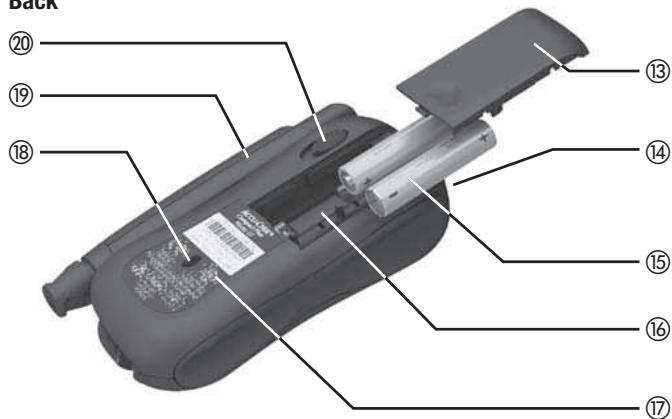

- ⑬ Battery compartment cover*
- ⑭ Infrared window for sending results to a PC, for instance
- ⑮ Batteries: type AAA, LR 03, AM 4, Micro
- ⑯ Battery compartment
- ⑰ Type plate
- ⑱ Control window (shows the number of strips remaining)
- ⑲ Lancing device*
- ⑳ Slide button for undocking the lancing device

* available as replacement part

1.2 The Accu-Chek Softclix Plus lancing device at a glance

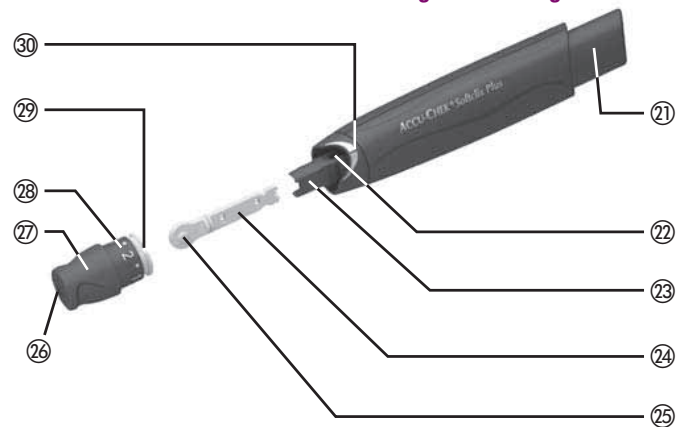

- ⑲ Plunger
The plunger is a multifunction button used to prime, trigger and eject the lancet.
- ⑳ Window showing the penetration depth setting
- ㉑ Lancet holder
- ㉒ Lancet
- ㉓ Protective cap on lancet
- ㉔ Pin-hole opening for lancet
- ㉕ Cap
- ㉖ Comfort Dial for depth selection (you change the depth by rotating the cap)
- ㉗ Locating notch
- ㉘ Locating line

1.3 Main features

Docked lancing device

The meter comes with an attached Accu-Chek Softclix Plus lancing device. You can leave it docked onto the meter to collect blood or, if you prefer, you can undock it.

Test strip drum instead of individual test strips

You never need to touch a test strip. Simply insert a drum with 17 test strips into the meter.

Easy to operate

Turn the meter on, apply blood, read the result, press the button to eject the test strip.

Automatic coding

Every test strip drum has its own bar code. The meter is automatically coded whenever you insert a new drum, a process which provides the meter with information on the specific characteristics of the test strips.

Indication of the number of test strips remaining

Each time you turn the meter off, it shows you the number of test strips remaining in the drum.

Reliability

The meter checks each test strip. If it finds a defective strip, it lets you know before you apply blood.

Blood volume checking

The meter can tell when you have applied sufficient blood (approximately 1.5 μL (1 microlitre = 1 thousandth of a millilitre)). It waits until then before starting the test. If the test does not start, you may apply more blood.

Alarm clock function

The meter can remind you to test your blood glucose. You can set an acoustic signal to remind you at three different times.

Hypo indicator function

In order to look out for unusually low results you can set a hypo indicator level (hypo threshold). If a result is below the level you have set, a symbol in the display and an acoustic signal (provided it is set to on) prompt you to check your result carefully to see if you are heading towards a possible hypo (low blood glucose).

Downloading data to a computer

The meter has an infrared window. You can download results to a computer running the appropriate software or to special analysis systems.

Acoustic Mode

Acoustic Mode is intended for persons who are visually impaired. When Acoustic Mode is turned on, the meter guides the user through the blood glucose test using beep tones; it also outputs the result as a series of beeps. For more information see Chapter 6.



Visually impaired persons need a sighted person to instruct them in the use of the meter and to assist them with all aspects of its operation. Visually impaired persons must not test their blood glucose without assistance from a sighted person.

1.4 Display illustrations

Throughout this User's Manual you will see examples of what the display looks like. Any elements that are shown surrounded by a halo in these examples flash in the display.

Example:

You have turned on the meter to perform a blood glucose test. In the display you see the time and date plus the test strip symbol and the drop symbol. The test strip symbol and drop symbol are flashing.



The time, date and blood glucose results shown in the display illustrations are intended only as examples. The numbers will not necessarily be the same as those shown by your own meter. The meter that is used for illustration in this manual displays blood glucose results in mmol/L (see Chapter 2.2) and has been set to 24-hour format (see Chapter 3.6). Your meter, on the other hand, may display the time in 12-hour format.

2 Initial steps before testing

2.1 Checking the contents

Check that your meter kit is complete. The package contents are listed on the box.

If anything is missing, please call Accu-Chek Customer Care at 1-800-363-7949. Details are given at the end of this User's Manual.

2.2 Checking the blood glucose unit

Blood glucose results can be displayed in two different units of measurement (mmol/L or mg/dL). Consequently, Roche sells two different versions of the same meter. If you do not know which is the right unit for you, ask your doctor.

- ▶ Check that your meter displays the unit that is right for you, in Canada mmol/L.

Check the unit by referring to the type plate and to the display window during a display check (see the following pages).

Note

- ⚠ The unit that your meter displays cannot be changed. If the wrong unit is printed on the type plate, please consult your dealer or pharmacy or the Accu-Chek Customer Care Line. Using the wrong unit can cause you to misinterpret the test results.

2.2.1 Type plate

The type plate on the back of your meter indicates which unit of measurement your meter uses.

2.2.2 Display check

You can check the unit of measurement your meter uses by performing a display check.

- ▶ Press and hold down the M button.

The meter turns on. While you hold down the M button, you first see the display check.

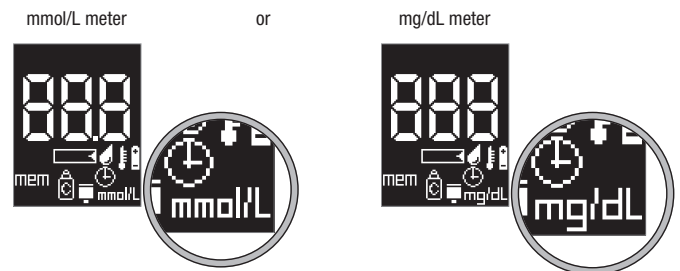

The unit of measurement is shown in the bottom right corner of the display.

If you continue to hold down the M button, you then see the following display after approximately 2 seconds.

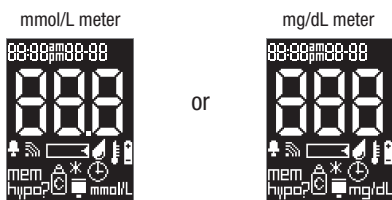

When you release the M button, your meter is in memory mode. As long as no results have yet been saved, three bars are displayed.

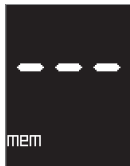

► Press the Test button to turn the meter off.

Notes

- i If additional lines appear during the display test or parts of the numeric field or of a symbol are missing, please call Accu-Chek Customer Care at 1-800-363-7949. If the numeric field **88.8** (mmol/L meter) or **888** (mg/dL meter) is affected, the meter may not show your test results correctly.
- i The meter automatically turns off after 60 seconds even if you keep the M button pressed.
- i You can perform a display check whenever you wish. If there are results already saved in memory, the most recently saved result is displayed when you release the M button.

2.3 Inserting or replacing the test strip drum

- ▶ Read the package insert that came with the test strip drums.
- ▶ If the meter is on, press the Test button to turn it off.
- ▶ Wait for the motor to stop.

Set into the bottom of the meter to the left of the lancing device is a recess. The upper part of this recess belongs to the drum compartment cover.



- ▶ Hold the meter in your right hand and place the thumb of your left hand into this recess. Then pull the drum compartment cover with your fingers slightly to the front and lift it up.

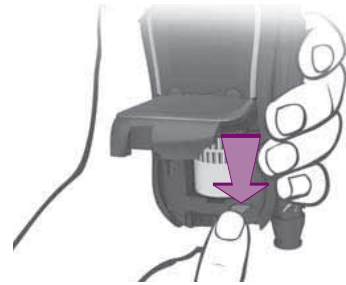

Irrespective of whether a test strip drum is inserted or not:

- ▶ Press the red drum release button.

The pin holding the test strip drum in position retracts with an audible CLICK.



If there is a test strip drum in the meter:

- ▶ Tip the meter forwards.

The test strip drum drops out.



- ▶ Insert a new test strip drum in the meter as illustrated (the two rows of bar code must be nearest the display window).
- ▶ Close the drum compartment cover and push it shut. There will be an audible CLICK.

The meter turns on and rotates the test strip drum until the first test strip is in the correct position. At the same time the meter reads the bar code that provides it with information on the specific characteristics of the test strips. After that, the meter turns off.

A dot appears in the small control window on the back of the meter. This indicates that you have just inserted a test strip drum. When you perform a blood glucose test, the meter counts the number of test strips that you have used. The number of strips remaining is displayed in the control window.



When all the test strips in a drum have been used up, the dot reappears in the small control window.

- ▶ Insert a new test strip drum.

If you do not insert a new drum, the following message appears the next time you turn on the meter:

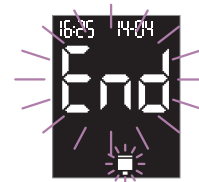

Error and the drum symbol are flashing to indicate that the test strip drum is empty.

Product Limitations

- ⓘ Please read the literature packaged with your test strip drum to find the latest information on product specifications and limitations.

Notes

- ⚠ Use only test strips that are not beyond their expiry date. Test strips that have expired can produce incorrect results. Incorrect results can cause the wrong therapeutic decision to be taken and so produce serious adverse health effects. The expiry date is printed on the pack and on the peel-off label on the drum container next to the ⏳ symbol.

 New test strip drums where the aluminium foil (the silver ends) is damaged cannot be used. Your blood glucose results may be incorrect if you use a damaged drum. Incorrect results can cause the wrong therapeutic decision to be taken and so produce adverse health effects.

 Only open the drum compartment cover when the meter is turned off and the motor is not running. Opening the drum compartment cover when the meter is turned on may result in damage to the meter.

 Handle the test strip drums with care! Only remove a test strip drum from its container when you intend to use it. The container protects the aluminium foil on the drum from damage.

 There is a label on every drum container. The left portion may be peeled off. On it is the concentration table for the Accu-Chek Compact Autocontrol control solutions. The stated concentrations are valid only for the test strips contained in this drum. You need this table for the performance check of your meter (see Chapter 7). You may, for instance, wish to stick the peel-off label in your notebook or diary. When conducting a performance check, always check that the peel-off label with the concentration table belongs to the test strip drum that is currently in the meter.

 If you insert a partly used drum in the meter, the meter rotates the drum so the dot appears in the control window on the back.

When you subsequently turn on the meter to perform a test and ...

- ... you have re-inserted a same drum you previously removed:
The meter immediately rotates the drum to the first chamber that contains a test strip, and ejects the strip.
- ... you have used up the previous drum or have replaced one partly used drum with another partly used one:
The meter may search all chambers until it finds the first one that contains a test strip. The fewer test strips the drum contains, the longer the process takes.
If the meter immediately rotates the drum to one of the chambers near the end (you can tell by the noise of the motor that rotates the drum), the drum may ultimately still contain test strips even though the meter regards it as empty. You can still use the test strips by inserting the drum again.

- i If you insert a partly used test strip drum into the meter, the meter cannot calculate the use-by period for that drum. Consequently, the next time you perform a test, the drum symbol and flashing bottle symbol are displayed to highlight the fact (see Chapter 2.3.1).
- i Use only Accu-Chek Compact test strip drums. Other test strips cannot be used to perform tests. If you insert a different test strip drum, error message E22 is displayed (see Chapter 12.2).
- i Make sure that the drum compartment cover is tightly closed. If it is not properly closed, the meter will not turn on when you press the Test button. All you see is the display check briefly.
- i You can dispose of used test strip drums with your regular household waste.

2.3.1 Test strip drum use-by period

When you insert a new drum into the meter, the meter starts to count the number of days the drum is in the meter. Each drum must be used within a 90-day use-by period.

Once a drum has been in the meter for 90 days, its use-by period has expired. The next time you turn the meter on to perform a test, the drum symbol, bottle symbol and clock symbol are displayed to highlight the fact.



- ▶ Insert a new test strip drum.

Note

- ! The test strips in this drum cannot be used. You must not use these test strips as they may produce incorrect results. Incorrect results can cause the wrong therapeutic decision to be taken and so produce serious adverse health effects.

The meter is unable to calculate the 90-day use-by period if

- you insert a partly used drum in the meter, even if it is the same one you have just removed,
- the year, date and time settings are lost when you replace the batteries (see Chapter 9), and a partly used drum remains in the meter.

The meter has no way of telling you in these cases when the drum was first inserted or how long the partly used drum has already been in the meter.

If the meter cannot calculate the use-by period and you turn the meter on to perform a test, the following symbols appear in the display:



- Flashing test strip and flashing drop, indicating that you may now apply blood or control solution
- Drum, indicating that the use-by period cannot be calculated
- Flashing bottle, prompting you to perform a performance check in order to check the test strips

► Perform a performance check (see Chapter 7).

If the result from the performance check is within the stated concentration range, you can still use the test strips remaining in the drum. If the result is outside the range, you need to insert a new drum.

Following the performance check, the bottle symbol disappears from the display. If you do not perform a performance check, the flashing bottle symbol appears with every test until you insert a new drum. The drum symbol continues to be displayed with each test in order to draw your attention to the fact that the meter cannot calculate the use-by period. All results are saved along with the drum symbol. The drum symbol only disappears when you insert a new drum.

2.3.2 Indication of the number of test strips remaining

Each time you turn the meter off with the Test button, it shows you the number of test strips remaining in the drum. The number of remaining strips continues to be displayed as long as you hold down the Test button.

In this example there are still 12 test strips in the drum.



When you release the Test button, the meter turns off.

Notes

- i If the test strip drum contains three or fewer test strips following a test, the number, the test strip symbol and drum symbol flash in the display window.
- i If you press the Test button only briefly when turning the meter off, the number of test strips remaining is displayed only briefly or not at all.

- i If you have not performed a test since last replacing the drum, the meter cannot tell how many test strips there are left in the drum. This is e.g. the case when, after you have changed the drum, you start by changing settings or retrieve results from memory. If you then press the Test button to turn the meter off, only three horizontal bars — — — are displayed instead of the number of test strips remaining. Only when you have performed a test with the newly inserted drum does the meter display the number of test strips remaining each time you turn the meter off with the Test button.

3 Settings

You can change the settings of your meter to turn the beep tone or Acoustic Mode on or off, to set the brightness of the display, to select the time-and-date format, to set the year, the time and the date, and to activate the alarm clock function and the hypo indicator.

Beep tone: When the beep tone is set to on, it provides user support during testing by marking the start of each step acoustically.

Acoustic Mode: When Acoustic Mode is turned on, the meter guides you through the blood glucose test using beep tones; it also outputs the result as a series of beeps.

Alarm clock function: You can set the meter to remind you to test your blood glucose.

Hypo indicator: You can set a personal hypo indicator level. If your result is below this level, the meter alerts you to the fact that you are possibly heading towards a hypo.

The meter is supplied with batteries already inserted. The time and date are already set. You may need to adjust these settings to your own time zone.

You can perform blood glucose tests without adjusting any of the settings. All settings are the default factory settings (see next page).

When you turn the meter on for the first time, it has the following pre-settings. These are factory defaults that you can change.

- Beep tone on, Acoustic Mode off
- Brightness of the display: medium
- Year: current year, e.g. 2007
- Time-and-date format: 12-hour or 24-hour format;
12-hour format is associated with the date format month-day (MM-DD)
24-hour format is associated with the date format day-month (DD-MM)
- Time: current time based on Eastern Standard Time (EST)
- Date: current date based on Eastern Standard Time (EST)
- Alarm clock function: off
- Hypo indicator: off

Notes

-  If the year, time and date settings were lost as a result of a battery replacement (see Chapter 9) and you fail to reset these, the meter displays the time as 0:00 and the date as 0-00 (in 24-hour format as well as in 12-hour format) when you perform a test. In memory the results are saved not with the time and date but with their memory location number (see Chapter 5.2). Without the

time and date the meter is not able to calculate averages, nor the lowest and the highest values (see Chapter 5.3). Results sent to a PC, for instance, without the time and date (see Chapter 5.4) cannot be statistically analyzed or, if they can, then only to a limited extent.

i If the year, date and time settings are lost as a result of a battery replacement, the meter displays the following settings:

- Year: year of manufacture 20XX, e.g. 2007
- Time: 0:00 or 12:00 am, depending on the time-and-date format you selected previously
- Date: 1-01 as day-month (D-MM) or month-day (M-DD), depending on the time-and-date format you selected previously

In the sections set out below you will find

- a description of the general rules for changing settings,
- descriptions of individual settings and how to change them.

The descriptions of settings proceed in the order in which they appear in the meter.

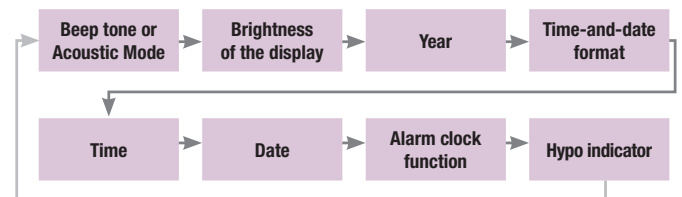

3.1 Changing settings – General rules

The appearance of **Set** in the display window indicates that the meter is in settings mode and that you can change these.





The procedure for changing the settings is as follows:

- The settings have a fixed sequence and are displayed consecutively, see illustration on the previous page.
- Press the S button to call up the settings.
A test strip is not advanced.
- Press the M button to change the setting that is currently flashing.
 - Numbers such as the year are incremented by one. Pressing and holding down the button increments the number quickly.
 - From the highest selectable number, pressing the M button automatically takes you to the lowest one.
 - In the case of settings where there are a number of options, such as the beep tone setting, pressing the M button presents each option in turn.
- Press the S button to save the chosen setting and move on to the next setting.
- You can change any setting at any time. Press the S button repeatedly until the setting you wish to change is displayed flashing.

- From the last setting “Hypo indicator” pressing the S button takes you back to the first setting “Beep tone/Acoustic Mode”.
- You can close the settings at any time by pressing the Test button. All settings you have entered up to that point are saved.

Notes

-  **Always** turn the meter on with the S button when you intend to change the settings.
Instead, if you turn the meter on with the Test button and there is a drum in the meter, a test strip will be advanced.
-  If you turn the meter off with the Test button, it shows you the number of test strips remaining in the drum (see Chapter 2.3.2).
-  The meter turns off automatically after approximately 60 seconds if you do not press a button. All settings you have confirmed up to that point with the S button are retained. Settings that you have not confirmed with the S button are lost and the original setting remains.

3.2 Turning the meter on



► With the meter turned off, press the S button.

The meter turns on without advancing a test strip.

Following the display check (see Chapter 2.2.2) the current beep tone setting (symbol ) is flashing.

3.3 Setting the beep tone or Acoustic Mode

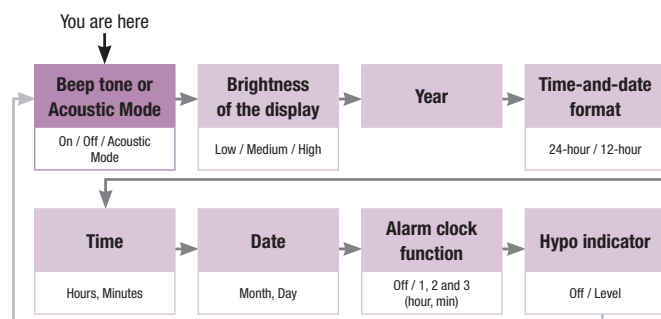

This setting enables you to turn the beep tone on or off and to activate Acoustic Mode.

When the beep tone is turned on, you hear a beep during testing

- when the meter is ready to test so you can draw up blood or control solution with the test strip,
- when the test strip has drawn up sufficient blood or control solution and test has started,
- when the result is displayed,
- when the hypo indicator is turned on and the result is below the level you have set,
- when the meter displays an error message.

There are two types of beep tone, differing in pitch. The pitch for a hypo indicator or an error message is higher than that heard in the other cases listed above.

When Acoustic Mode is turned on, the meter guides you through the blood glucose test using the beep tones mentioned above; it also announces the result as a series of beeps (see Chapter 6).

The beep tone is factory-set to on (ON).

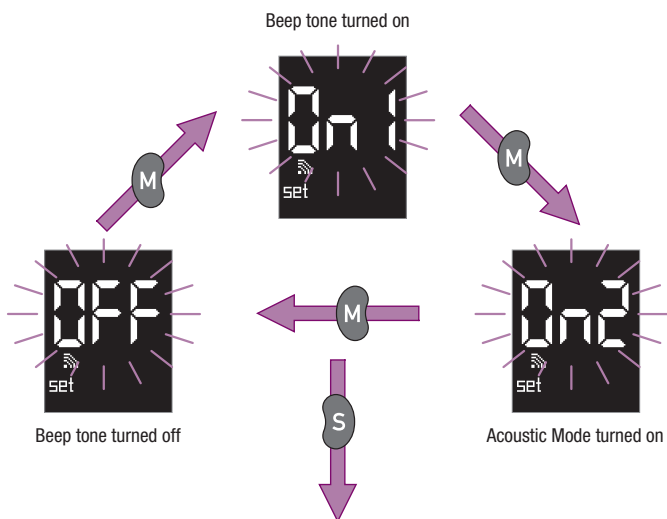

- ▶ Press the M button to move to the next option.
- ▶ Press the S button to save the chosen setting.

The brightness setting comes next.

Notes

- i** When you select Acoustic Mode ON, you hear a beep.
- i** The beep tone setting has no influence on the alarm clock function. If you have turned the alarm clock function on (see Chapter 3.9), the meter will always beep to remind you to test your blood glucose even if the beep tone itself is turned off.

3.4 Setting the brightness of the display

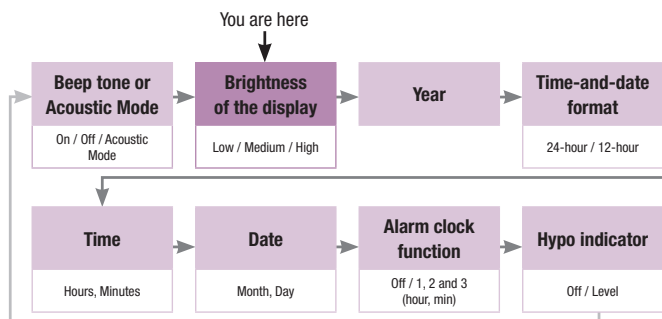

You can use this setting to adjust how bright you wish the displayed symbols and numbers to be. There are three brightness levels: low, medium and high.

The brightness is factory-set to medium (shown by the 2 at top right of the display window).

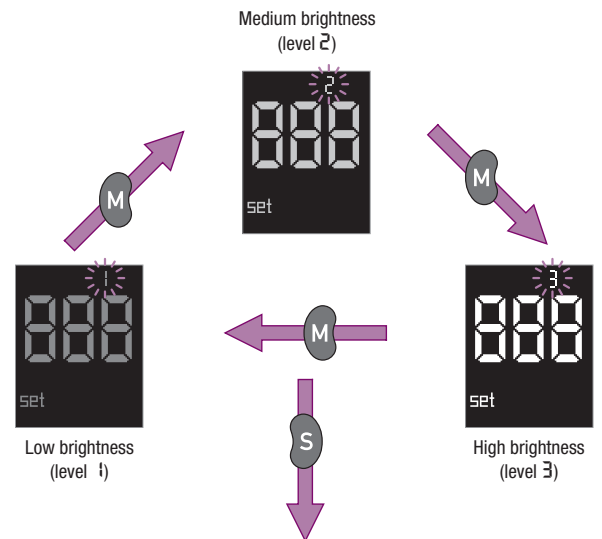

- Press the M button to move to the next option.

The brightness of the display window changes to the setting you have selected.

- Press the S button to save the chosen setting.

The year setting comes next.

3.5 Setting the year

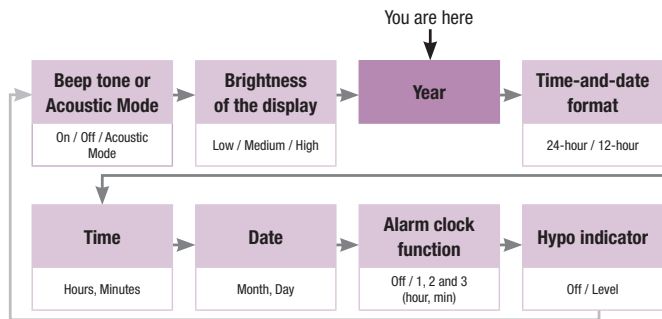

The year that is currently set flashes at top right of the display.

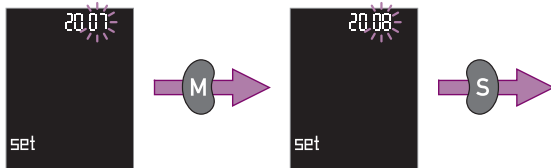

- ▶ Press the M button repeatedly, or press and hold it down, until the required year is displayed.
- ▶ Press the S button to save the chosen setting.

The time-and-date format setting comes next.

Notes

- i** The year you have set is not displayed during testing, nor together with the result, nor when you look at saved results in memory. It is only displayed when you are in the settings. However, having the correct year setting is still important because without it the meter will not be able to recognize February 29th in a leap year. The correct year setting is also needed to unambiguously identify your blood glucose test results when you download them to a computer for analysis or further processing.
- i** The year can be set from the year of production to the year of production plus 32.

3.6 Setting the time/date format

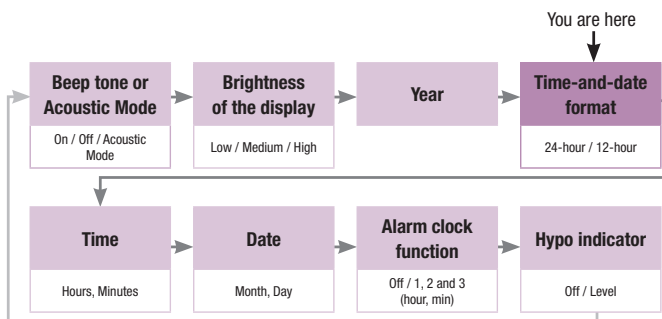

You can choose between two formats. In 24-hour format the time is displayed from 0:00 to 23:59. If you select this format, the date is displayed in the format DD-MM (day-month, no year). In 12-hour format the time is displayed from 12:00 to 11:59 with am or pm. If you choose this format, the date format changes to MM-DD (month-day, no year).

The time-and-date format is shown together with the current time and the current date setting. If the format is changed, the way the time and date are displayed also changes.

The time-and-date format that is currently set flashes in the display. If 12-hour format is the current setting, 12h will flash in the display. If 24-hour format is the current setting, 24h will flash in the display.

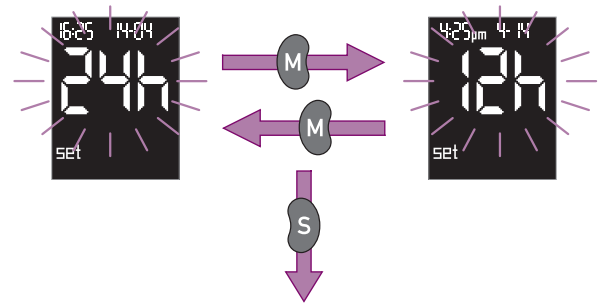

- ▶ Press the M button to change the time-and-date format.

If you press the M button again, the original time-and-date format reappears.

- ▶ Press the S button to save the chosen setting.

The time setting comes next.

3.7 Setting the time

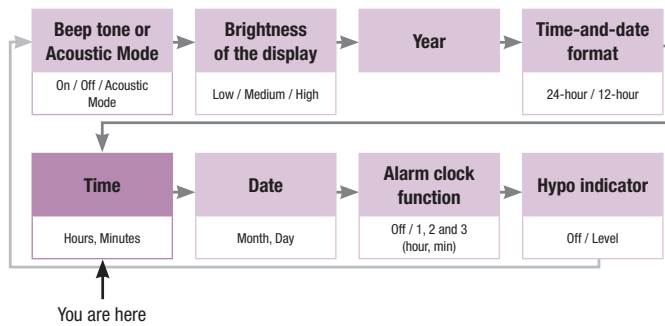

The time and the date that are currently set are displayed.

The **hour** flashes at top left of the display.

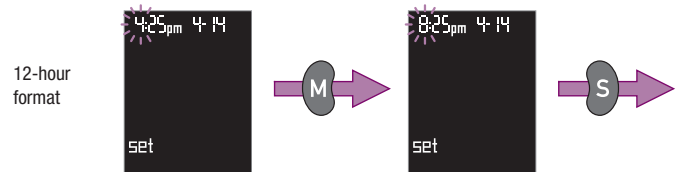
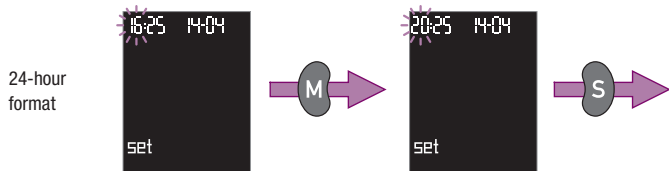

- ▶ Press the M button repeatedly, or press and hold it down, until the required hour is displayed.
- ▶ Press the S button to save the chosen setting.

The minute setting comes next.

The **minutes** flash at top left of the display.

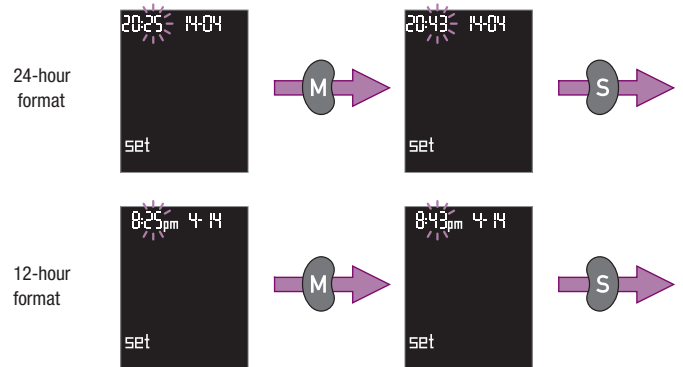

- ▶ Press the M button repeatedly, or press and hold it down, until the required minutes are displayed.
- ▶ Press the S button to save the chosen setting.

The date setting comes next.

3.8 Setting the date

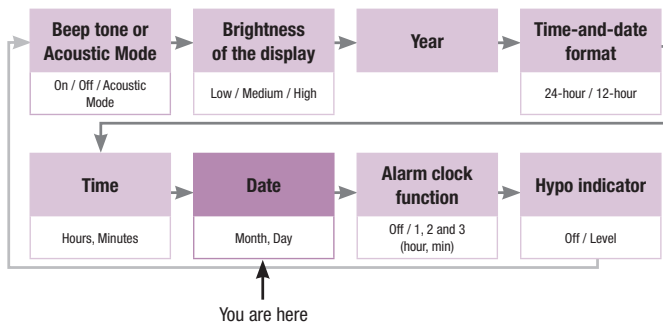

The **month** flashes at top right of the display.

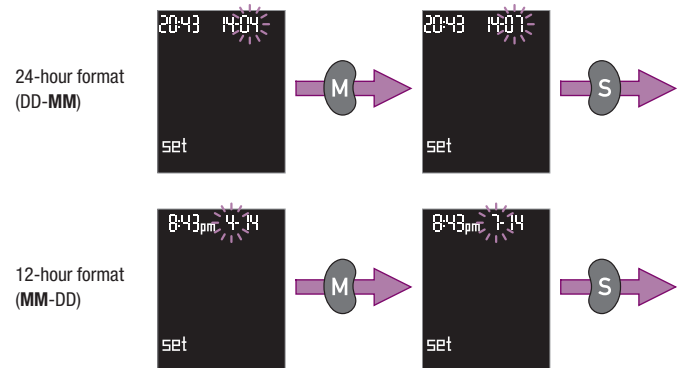

- ▶ Press the M button repeatedly, or press and hold it down, until the required month is displayed.
- ▶ Press the S button to save the chosen setting.

The day setting comes next.

The **day** flashes at top right of the display.

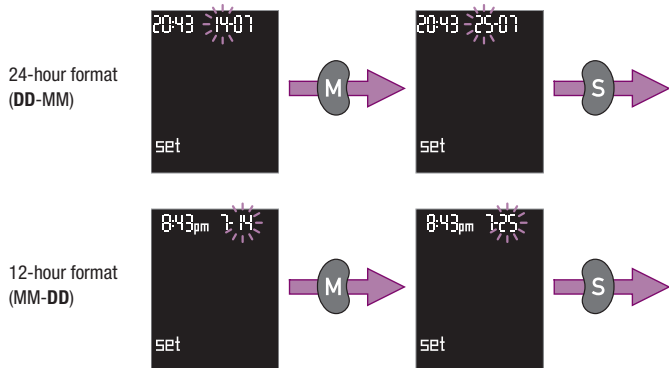

- ▶ Press the M button repeatedly, or press and hold it down, until the required day is displayed.
- ▶ Press the S button to save the chosen setting.

The alarm clock settings come next.

3.9 Setting the alarm clock function

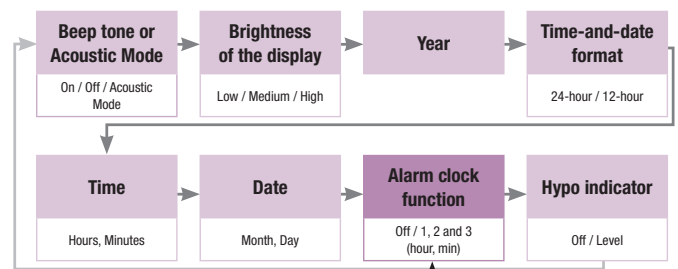

You are here

You can use the meter's alarm clock function to remind you to test your blood glucose. You can set three alarms.

The meter beeps for 20 seconds at the appointed time every day. The meter then turns off again. You can turn the beep tone off earlier. Do this by pressing any of the three buttons. The meter then turns off. A test strip is not advanced.

While it is beeping, the meter displays the following:

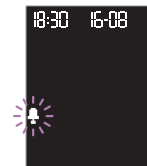

Two steps are involved in entering the setting. First you define whether the alarm clock function is basically to be turned on (ON) or off (OFF). When it is on, you can enter or change the alarm times.

The alarm clock function (🔔 symbol) is factory-set to off. OFF flashes in the display.

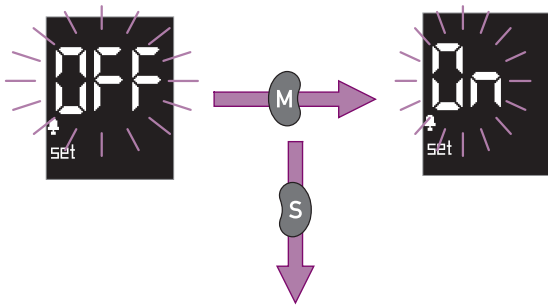

- ▶ Press the M button to turn the alarm clock function on. ON is displayed.

If you press the M button again, OFF reappears and the alarm clock function is turned off.

- ▶ Press the S button to save the chosen setting.

If you have turned the alarm clock function on, the setting for the first alarm time comes next. The following is displayed:



24-hour format



12-hour format

If you have turned the alarm clock function off, the setting for the hypo indicator comes next. The following is displayed (see Chapter 3.10):



Setting alarm times

The procedure for setting the alarm time is the same for each alarm. Alarm 1 is used below for illustrative purposes. The number 1 and subsequently 2 and 3 in the display stand for Alarms 1, 2 and 3.

The factory setting is 0:00 (24-hour format) or 12:00 am (12-hour format). This time means that alarm 1 is turned off. Only when you set a different alarm time is Alarm 1 turned on.

First the hour is set, and then the minutes.

The **hour** flashes at top left of the display.

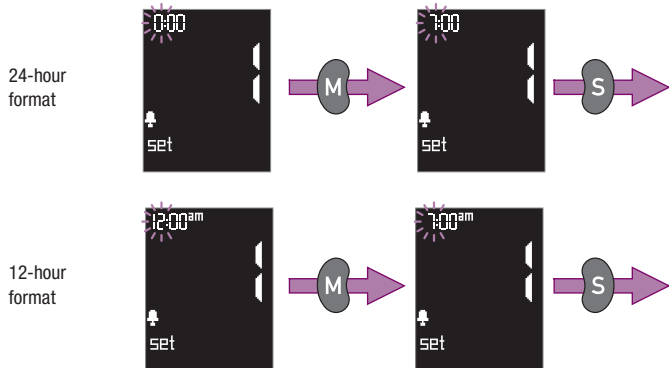

- ▶ Press the M button repeatedly, or press and hold it down, until the required hour is displayed.

- ▶ Press the S button to save the chosen setting.

The minute setting comes next.

The **minutes** flash at top left of the display.

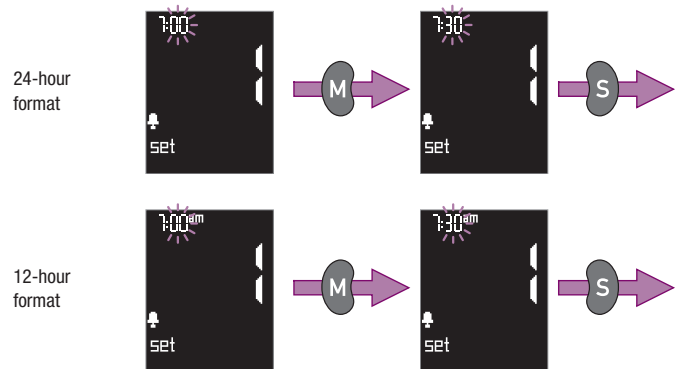

- ▶ Press the M button repeatedly, or press and hold it down, until the required minutes are displayed.

- ▶ Press the S button to save the chosen setting.

The setting for Alarm 2 comes next, and then for Alarm 3.



To set the alarm times for Alarm 2 and Alarm 3, proceed as described for Alarm 1.

The hypo indicator setting comes next.

Notes

- i** You do not have to set all three alarm times; you can set just one or two times. When you have set your alarm times and the hour for the next alarm flashes:

 - press the S button repeatedly until you reach the hypo indicator setting (see Chapter 3.10),

or

 - If you do not wish to set a hypo indicator, press the Test button to turn the meter off.
- i** You can turn off individual alarms by setting their time to 0:00 (24-hour format) or 12:00 am (12-hour format). Any other time means that the alarm clock function is turned on for this time. To set the alarm clock function for midnight you must therefore set the time to one minute to midnight (23:59 or 11:59 pm) or to one minute after midnight (0:01 or 12:01 am).

- i** The meter can only remind you to perform a blood glucose test when the year, time and date have been set in the meter. If you lose the year, time and date settings while replacing the batteries (see Chapter 9), you must re-enter these in order for the alarms to be active. The settings for the alarms themselves will not have been lost.
- i** If you have turned the alarm clock function on, the meter will always beep to remind you to test your blood glucose even if the beep tone itself is turned off. The beep tone setting has no influence on the alarm clock function.
- i** If you turn the alarm clock function off entirely (OFF), the alarm times you have set remain saved nevertheless.
- i** If the meter is already on when an alarm is due, whether for a blood glucose test or some other reason, the alarm is suppressed. The alarm sounds as soon as you turn the meter off or it turns off automatically. The alarm does not sound until then.

3.10 Setting the hypo indicator

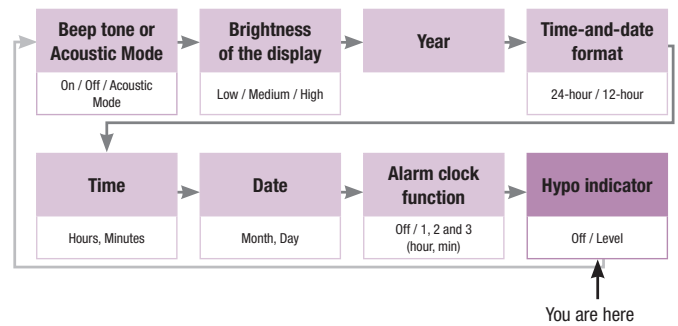

To help you to recognize a possible hypo, you can set the meter to let you know when your test result indicates a low blood glucose. You can select what blood glucose level you want this indicator to have.

As soon as a test result is below the level you have set, you see the flashing HYP symbol displayed along with the result. If the beep tone (ON) is turned on, you hear 5 short double beeps (after to the beep you hear when the result is displayed). The 5 short double beeps are not heard when the beep tone is set to off or Acoustic Mode (OFF) is set to on.

You can choose between the following hypo indicator levels:

- 3.3 mmol/L
- 3.9 mmol/L
- 4.4 mmol/L

The hypo indicator (hypo symbol) is factory set to off. OFF flashes in the display.

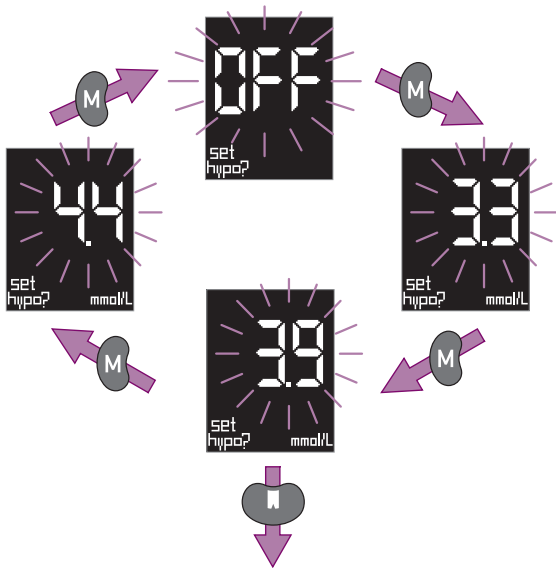

- ▶ Press the M button to move to the next option.
- ▶ When your chosen level is displayed, press the Test button to turn the meter off. The hypo indicator is then set to this level.

Notes

 The hypo indicator is only reliable if your hypo indicator level has been properly selected. Therefore we strongly recommend that you talk to your healthcare professional about what blood glucose level is your hypo level before you set the indicator. This function is **no** substitute for hypoglycemia training by your doctor or diabetes team.

 The hypo indicator level may vary from person to person. Therefore we recommend leaving the hypo indicator function turned **off** when using the meter in a professional setting.

4 Testing blood glucose

4.1 Preparing to test blood glucose

You will need the following items to carry out the test:

- the meter with a test strip drum inserted
 - the lancing device to obtain blood
 - a lancet for the lancing device
- Wash your hands with warm water and soap, and dry well. This stimulates blood flow and ensures that the puncture site is clean.

4.2 Preparing the lancing device

You use the lancing device to obtain blood from a fingertip or earlobe, or from other (alternate) sites. If you wish to obtain blood from alternate sites (such as the base of the thumb, forearm, upper arm, calf or thigh), you must replace the normal black cap on the lancing device with a special, transparent AST cap (which is included in the pack or is available through the Accu-Chek Customer Care Line). Please read the instructions for use that come with the AST cap before you use blood from alternate sites to test blood glucose.

You can choose one of 11 different penetration depth settings to suit your own skin type. You can use the lancing device either docked with the meter, or undocked.

The lancing device has a plunger at the top (see illustration in Chapter 1.2). This plunger has three functions:

- priming the lancing device
- triggering the lancet to obtain blood
- ejecting the used lancet

You can perform all of these functions using just one hand, as to activate a function you only have to press the plunger down.

To obtain blood you first need to insert a lancet and then set the penetration depth.

Notes

 The Accu-Chek Softclix Plus lancing device is intended only for patient self-monitoring by a single person. The lancing device must not be used on more than one patient due to the risk of infection.

Healthcare professionals testing blood glucose in a multi-patient setting must not use the Accu-Chek Softclix Plus lancing device to collect blood and should therefore remove the lancing device from the meter. The lancing device may be replaced with a blanking plate (see Chapter 10.1).

 Only use Accu-Chek Softclix lancets in your Accu-Chek Softclix Plus lancing device. Using any other lancets may damage the lancing device or impair its function. This may result in injury.

4.2.1 Undocking the lancing device from the meter

If you wish to use the lancing device undocked from the meter, detach it as follows:

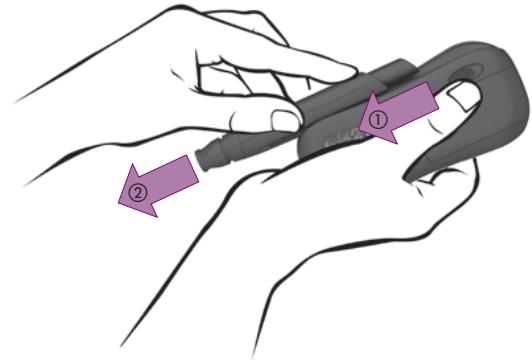

- ▶ Push the slide button in the direction indicated by the arrow (1) and hold it there.
- ▶ Withdraw the lancing device in the direction indicated by the arrow (2).

4.2.2 Docking the lancing device onto the meter

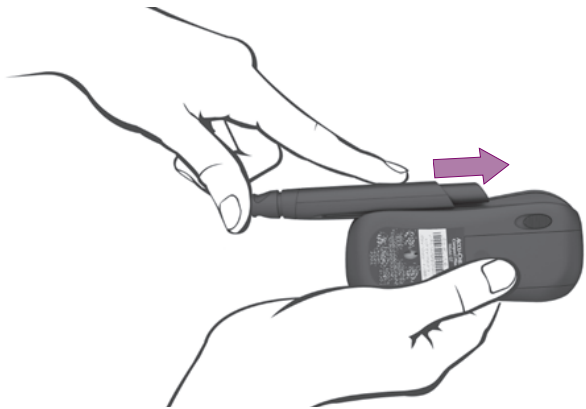

- ▶ Hold the meter so it is horizontal, with the recess for docking the lancing device pointing upwards.
- ▶ Place the flat face of the lancing device on the lower end of the recess, with the plunger facing towards the slide button.
- ▶ Slide the lancing device forward along the meter in the direction indicated by the arrow, until it locks with an audible CLICK. The guides along the inside of the recess must engage with the grooves along the lancing device.

4.2.3 Inserting the lancet



- ▶ Remove the cap from the lancing device.



- ▶ Slide a new lancet into the lancet holder, and push it in until you hear it CLICK into place.



- ▶ Remove the protective cap from the lancet with a twisting motion.

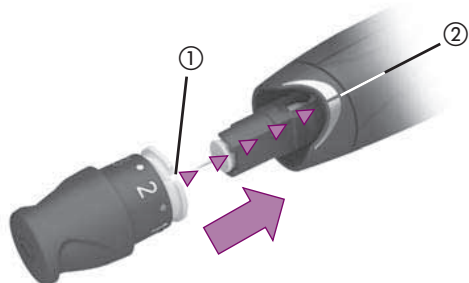

- ▶ Press the cap back on the lancing device. The locating notch in the cap (1) must be directly aligned with the locating line on the lancing device (2). The cap snaps into place with an audible CLICK.

Notes

! Dropping the lancing device with a lancet inserted may loosen the lancet in its holder. In that case the lancet is no longer properly lodged and cannot be used to obtain blood.

In rare cases the lancet may even protrude from the cap. In a case such as this you might injure yourself on the lancet. Therefore take great care not to touch the front of the cap.

Should you drop the lancing device, please pick it up with care. Remove the cap from the lancing device. Take care to avoid the lancet so as not to injure yourself. Always eject and dispose of the lancet if the lancing device has been dropped (see Chapter 4.5). Afterwards, re-attach the cap without inserting a lancet. Press the plunger all the way down twice. Only then insert a lancet again.

i For blood collection, the cap must be on the lancing device. Without this cap, the lancing device cannot be primed, nor can the lancet be triggered. Instead, the lancet is ejected when you press the plunger.

4.3 Performing a blood glucose test

4.3.1 Turning the meter on

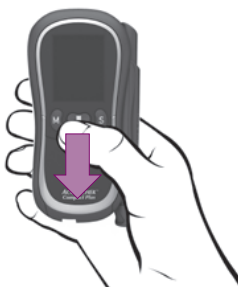

► Press the Test button to turn the meter on.

Following the display check (see Chapter 2.2.2) a test strip is automatically advanced and the test strip symbol and drop symbol flash in the display.



You now have about 5 minutes in which to draw up blood with the test strip.

Notes

- i** While the display test is running, you may press the Test button to turn the meter off again. If you do, a test strip is not advanced.
- i** If additional lines appear during the display test or parts of symbols are missing, please call Accu-Chek Customer Care at 1-800-363-7949. If the numeric field **88.8** (mmol/L meter) or **888** (mg/dL meter) is affected, the meter may not show your test results correctly.

4.3.2 Obtaining blood

All the fingertips and both the earlobes are suitable for obtaining blood. We recommend obtaining capillary blood from the side of the fingertip, as this causes the least amount of pain.

You can choose the penetration depth from a possible 11 settings ranging from 0.5 to 5.5. Your chosen penetration depth is visible in the window, e.g.:



The larger the number, the greater the penetration depth.

The half-settings – e.g. 2.5 – are identified by a dot. The setting 2.5 is set when the dot is between 2 and 3 in the window. For technical reasons the setting 5.5 is not identified by a dot. Setting 5.5 is set when you rotate the cap beyond setting 5 and the cap snaps into place.

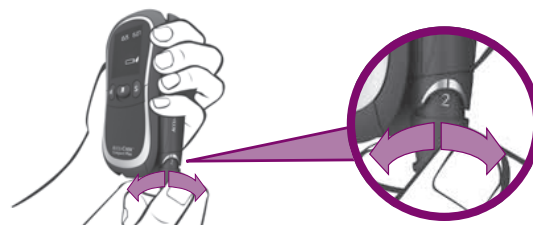

- ▶ Rotate the Comfort Dial (cap) until you reach your chosen setting. The cap snaps into place at each penetration depth setting.

We recommend a low setting (e.g. 2) if you are using the lancing device for the first time.

To obtain blood you first need to prime the lancing device.

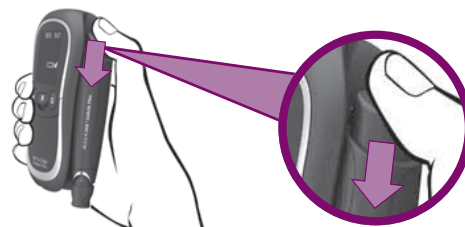

- ▶ Press the plunger all the way down.

The plunger returns about a third of the way. The lancing device is now primed.



- ▶ Firmly press the lancing device against the chosen puncture site.

You will feel the slightly raised ring against your skin. This is the pinhole through which the tip of the lancet emerges.

- ▶ Press the plunger all the way down.

This triggers the lancet, which penetrates the skin.

- ▶ Using gentle pressure, massage the finger towards the fingertip to encourage a drop of blood to form.

Notes

- ⚠ Use a new lancet each time you obtain blood. This not only reduces the risk of infection but also helps ensure virtually pain-free blood sampling.
- ✋ Do not prime the lancing device until you are ready to collect blood. Keeping the lancing device in this primed state can cause parts to become misshapen through tension, impairing its operation.
- ℹ The amount of blood that emerges at the puncture site depends on the penetration setting and the pressure used to hold the lancing device against the skin. If the amount of blood you obtain is too small, try again, applying more pressure this time. If you still obtain insufficient blood, repeat the procedure with progressively deeper settings. If too much blood emerges, reduce the penetration depth.

4.3.3 Drawing up blood with the test strip

- ▶ Wait until the test strip symbol and drop symbol flash in the display and the meter beeps (only when the beep tone is turned on).



- ▶ Hold the meter so the test strip is pointing downwards (see illustration).



- ▶ Immediately after the drop of blood has formed: Hold the tip of the test strip against the drop of blood so the black notch is touching the drop of blood.

The test strip draws up blood.

- ▶ Move the finger away from the test strip as soon as the hourglass symbol ⌚ is displayed and the meter beeps (only when the beep tone is turned on).

The test strip has then drawn up enough blood, and test starts. The hourglass symbol  indicates that the meter is busy performing a test.

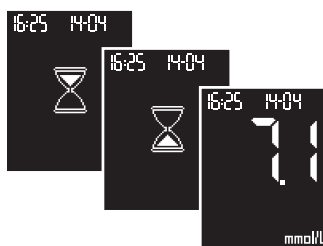





Testing is complete after approx. 5 seconds. The result is displayed and the meter beeps (only when the beep tone is turned on). At the same time the meter automatically saves the result to memory.

► Wipe the puncture site with a clean, dry tissue.

We recommend covering the puncture site to keep dirt out.

Notes

-  Do not touch the test strip unless you are drawing up blood with it. Residues (e.g. of food, drinks, or skin cream) on the skin can find their way onto the strip and may produce incorrect results. Incorrect results can cause the wrong therapeutic decision to be taken and so produce adverse health effects.
-  Take care not to bend the test strip either before or while you draw up blood. Do not bend or move the test strip while the test is in progress. Bending or moving the test strip can produce an incorrect result or cause error message E-5 (see Chapter 12.2) to be displayed.
-  Allowing the test strip to draw up blood too early, i.e. before the test strip symbol and drop symbol flash, can produce an incorrect result or cause error message E-5 (see Chapter 12.2) to be displayed.
Turn the meter off with the Test button so as to eject the test strip (see Chapter 4.4), and dispose of the test strip. Repeat the blood glucose test with a new test strip.

 Always hold the meter so the test strip is pointing downwards when you are drawing up blood with the test strip. If you hold it so the test strip is pointing upwards or sideways or you put the meter down on a surface with the test strip still in it, blood can enter the meter and contaminate it.



 As soon as the test strip symbol and drop symbol flash in the display, you have approx. 5 minutes to draw up blood with the test strip. If you have not drawn up blood within this time, i.e. testing has not started, the meter turns off automatically. In this case, press the Test button so as to eject the test strip (see Chapter 4.4), and dispose of the test strip. Start the blood glucose test again with a new test strip.

 If the test does not start despite the fact that you have held the drop of blood against the test strip, the test strip drew up too little blood. In this case you can, within a certain period, draw up more blood with the test strip (see the package insert that came with the test strip drums).

 If the meter beeps not once but several times when displaying the result, either the hypo indicator is turned on and the result is below the limit (see Chapter 3.10) or Acoustic Mode is turned on (see Chapters 3.3 and 6).

4.4 Ejecting the test strip

- ▶ Hold the meter over a waste bin with the test strip pointing downwards.

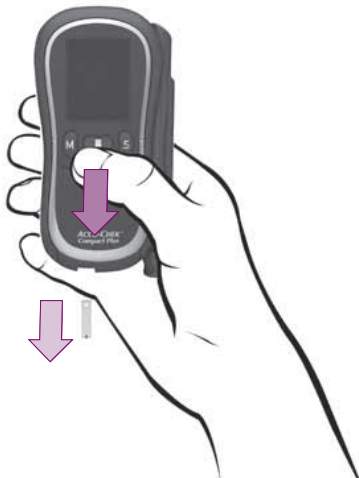

- ▶ Press the Test button to turn the meter off.

The used test strip drops out.

Before the meter turns off, it shows you the number of test strips remaining in the drum (see Chapter 2.3.2).

Notes



Always turn the meter off by pressing the Test button, so as to eject the test strip. Do not pull the test strip out. If you do pull the used test strip out, blood can enter the meter and contaminate it.



Do not push an ejected test strip back into the test strip drum. This includes any unused test strips that you have ejected by accident. These test strips can produce incorrect results. Incorrect results can cause the wrong therapeutic decision to be taken and so produce serious adverse health effects.



If you do not turn the meter off, it turns off automatically after approximately 60 seconds. The test strip then remains in the meter. The next time you turn the meter on, it ejects this test strip and automatically turns off again.



You can dispose of used test strips with your regular household waste.

4.5 Ejecting the used lancet



- ▶ Remove the cap from the lancet device.
- ▶ Hold the lancet device upright above a waste bin.



- ▶ Press in the plunger until it **CLICKS**.

The lancet drops out.

- ▶ Press the cap back on the lancet device.

If the lancet does not drop out:

- ▶ Keep the plunger pressed down.





- ▶ Hook the edge of the white "collar" of the cap behind the platform of the lancet.

A cut-out area on the inside of the lancet holder makes it easy to hook the lancet platform (see illustration).









- ▶ Use the white collar to pull the lancet out.

Notes

-  Make sure the lancet has dropped out. Inadvertently leaving the lancet in the lancing device may result in personal injury.
-  Carefully dispose of used lancets so that the needles cannot cause injury.
-  You must remove the cap to eject the lancet. If you leave the cap in place, pressing the plunger will prime the lancing device.

4.6 Symbols you see before, during or after testing and what they mean

You may see the following symbols displayed before, during or after a test. For further information please see Chapter 12.1.

-  The beep tone (🔊) or Acoustic Mode (🔊) is set to on.
-  You have turned on at least one alarm.
-  While the result is displayed:
You have turned the hypo indicator on. The result is below the indicator level you set. If the beep tone (🔊) is turned on, you hear 5 short double beeps (after the beep you hear when the result is displayed).
-  The batteries are running low.
-  The use-by period for the test strip drum has expired.
-  You inserted a partly used test strip drum.
-  The temperature is outside the permitted range of +10 °C to +40 °C.
-  The meter is prompting you to perform a performance check.
-  The test strip has drawn up control solution and the meter has flagged the result as a performance check.

H Instead of a result:
The result is above 33.3 mmol/L

LO Instead of a result:
The result is below 0.6 mmol/L

4.7 Flagging special results

You can flag special results, e.g. results obtained from alternate site testing or after exercise, with an asterisk *.

You can only do this while the result is displayed and as long as you have not yet turned the meter off.

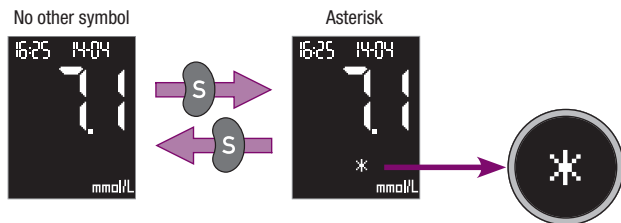

While the result is displayed:

- ▶ Press the S button. The asterisk appears in the display.

If you press the S button again, the asterisk disappears again.

The result is saved together with the asterisk as long as the asterisk is displayed and you press the Test button to turn the meter off.

4.8 Evaluating results

⚠ If the displayed test result agrees with the way you feel, follow your doctor's advice. If the displayed test result does not agree with the way you feel, please perform a performance check with an Accu-Chek Compact Autocontrol control solution and a new test strip (see Chapter 7). Then perform another blood glucose test. If the new test result still does not agree with the way you feel, please contact your doctor.

⚠ Do not change your treatment based on just one result.

4.8.1 Measuring range

Your meter measures blood glucose within a defined range (0.6–33.3 mmol/L).

Values below this range are displayed as:



The result is less than 0.6 mmol/L.

Values above this range are displayed as:





The result is greater than 33.3 mmol/L.

These results are not used to calculate averages (see Chapter 5.3).

4.8.2 Implausible results – possible causes of error

If your meter repeatedly displays implausible results or error messages, please check the following points:

Did you perform the blood glucose test according to the User's Manual (see Chapter 4.3)?	yes
Did you wash your hands with warm water and soap to improve blood flow and to remove any residues (e.g. of food, drinks, or skin cream)? Did you dry your hands well?	yes
Did you massage your finger only gently in the direction of the fingertip?	yes
Did you bend the test strip either before or while you were drawing up blood with it?	no
Did you wait for the test strip symbol and drop symbol to flash in the display before drawing up blood with the test strip?	yes
Did you draw up blood with the test strip immediately after the drop of blood formed?	yes
Did you bend or move the test strip while the test was in progress?	no

Did you perform the test within the correct temperature range (+10 °C to +40 °C)?	yes
Has the test strips' use-by date expired (see label on the container of the test strip drum next to the  symbol)?	no
Has the 90-day use by period for the test strip drum expired (see Chapter 2.3.1 and possibly the clock symbol  in the meter's display)?	no
Are the test strip guide and measuring window clean?	yes
Have you observed the proper storage conditions for the meter and test strip drums (see Chapter 11 and the package insert that came with the test strip drums)?	yes
Have you paid attention to the sources of error stated in the package insert that came with the test strip drums?	yes



If you give the responses as specified to all these questions and still receive implausible results or error messages, please call Accu-Chek Customer Care at 1-800-363-7949.

If your meter has been dropped, that can also lead to implausible results or error messages. If it has, again please call Accu-Chek Customer Care at 1-800-363-7949.

5 Using the meter as an electronic notebook

5.1 Memory

Your meter has a 500-value memory for saving results together with the time and date (only when you have set the time and date). You do not need to save the results manually. The meter automatically saves and numbers the results. The most recent result always occupies memory location 1, the preceding one location 2, etc. up to location 500. When all of the locations are occupied and a new test is performed, the result in location 500 is erased, the other results are shifted one place back in time, and the most recent result is saved in memory location 1.

In addition to the result, the time and the date, your meter also saves all other information that is relevant to that test. For example, results flagged as performance checks (see Chapter 7) are displayed together with the bottle symbol . Results obtained at a temperature outside the permitted range are displayed with the thermometer symbol . Please refer to Chapter 12.1 for a complete list of symbols which may be displayed.

5.2 Retrieving results from memory



- ▶ With the meter turned off, press the M button.

The meter turns on without advancing a test strip.

Following the display check (see Chapter 2.2.2), the most recently saved result is displayed together with the time, date and mem.



Retrieving older results from memory:

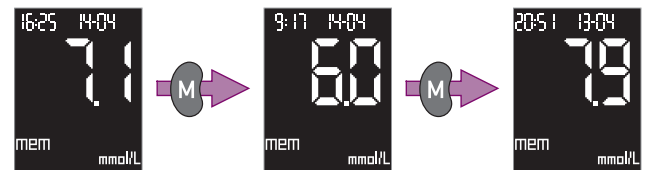

- ▶ Press the M button once to move towards the next older result saved.

With the M button you can move back until you reach the oldest result (max. 500 results). If you press and hold down the M button, the results are fast-scrolled, starting slowly and then speeding up.

To move back again towards the most recently saved results:

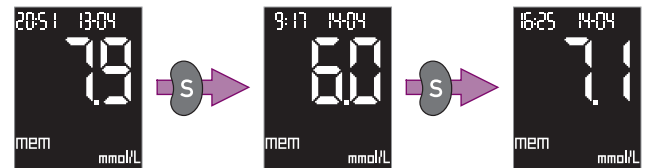

- ▶ Press the S button. To fast-scroll, press and hold down the S button.

By pressing the S button you can scroll back to the most recent result.

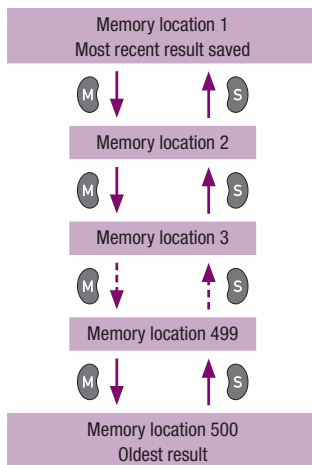

If the beep tone (🔔 1) or Acoustic Mode (🔔 2) is turned on, a beep sounds each time

- when you reach the oldest result (i.e. the memory location with the highest memory location number, see Chapter 5.1), and you press the M button,
- when you reach the most recently saved result again and you press the S button.

You can exit memory at any time:

- ▶ To do this, press the Test button.

The meter turns off.

Notes

- ❗ **Always** turn the meter on with the M button if you intend to review results held in memory. If you turn the meter on with the Test button and there is a drum in the meter, a test strip will be advanced.
- ❗ If no result has been saved in the meter, just three horizontal bars are displayed.



- i** If the time and date were not set at the time of testing, then the memory location number is displayed instead of the time and date.



If the memory contains both results that were saved together with the time and date and results that were not saved with this information, then you will see results shown together with their time and date as well as results shown only with their memory location number.

- i** If you turn the meter off with the Test button, it shows you the number of test strips remaining in the drum (see Chapter 2.3.2).
- i** The meter turns off automatically if you have not pressed a button for 60 seconds.

5.3 Average, highest value and lowest value for 7, 14 and 30 days

The meter can display the average values of results from the last 7, 14 or 30 days. Also, you can request that the lowest and highest values be displayed for these 3 periods. All results falling within the relevant period are included in the calculation. The current day is always included in the calculation. If more than 500 test results were saved during this period, the calculation will be based on the last 500 test results.

- ▶ With the meter turned off, press the M button.

The meter turns on without advancing a test strip.

Following the display check (see Chapter 2.2.2), the most recently saved result is displayed together with the time, date and mem. mem is short for memory.



- ▶ Press the M and S buttons at the same time.

The average of the results from the last 7 days is displayed.

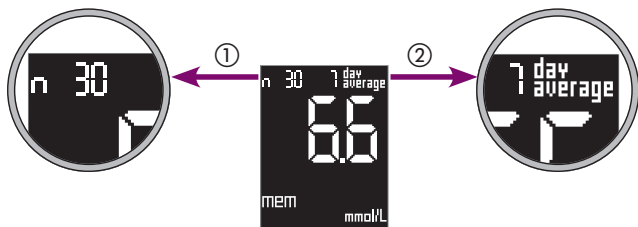

- ① The number of results n used in the calculation is displayed at top left (in this example: 30).
- ② The number of days for which the average was calculated is displayed at top right (in this example: 7).

- ▶ Again press the M and S buttons together to move to the other averages.

The 7-day average is followed by the 14-day and 30-day averages, and then again by the 7-day average.

For each of these three periods you can ask the meter to display the lowest and the highest values.

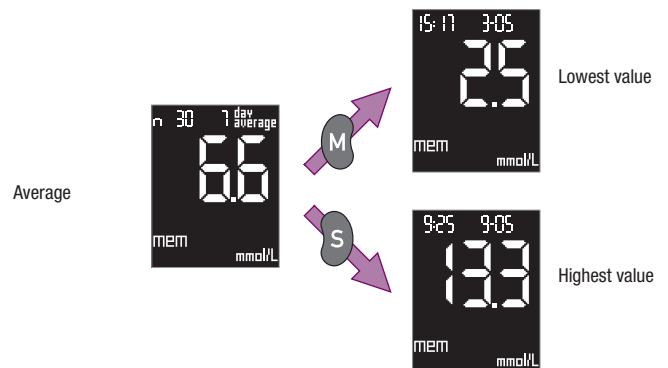

When one of the three averages is displayed:

- ▶ Press and hold down the M button to view the lowest value.
- ▶ Press and hold down the S button to view the highest value.

As long as you hold the M button or S button down, the lowest blood glucose value (and the highest blood glucose value, respectively) which you obtained within the period in question is displayed along with its time and date. If, for instance, the 7-day average was shown, then the lowest or highest value relates to the last 7 days.

When you release the button, the display reverts to the average.

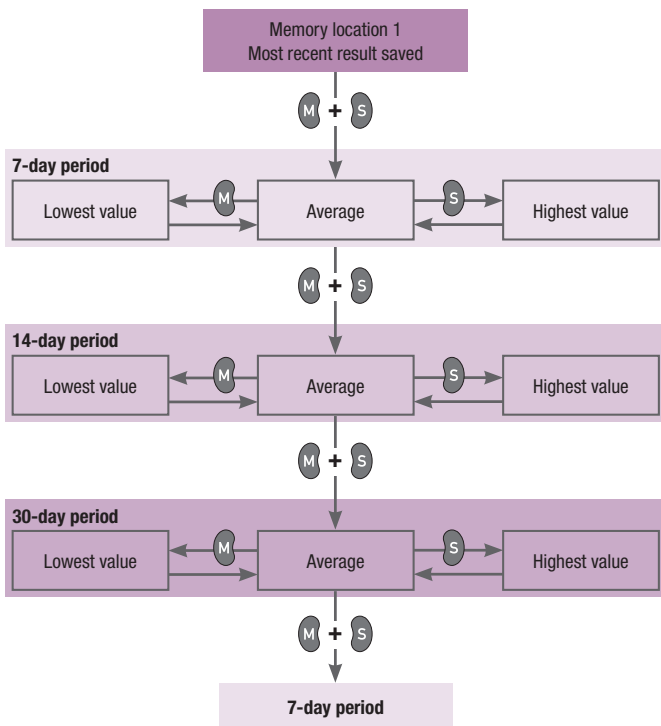







You can exit from the average value display at any time:



- To do this, press the Test button.

The meter turns off.

Notes

- ⓘ Results flagged as performance checks with the bottle symbol  are not included in the calculations.
- ⓘ Results shown as being  or  are not included in the average calculations, but are displayed as the lowest and highest values, respectively.
- ⓘ The meter calculates the average value, the lowest value and the highest value for a period even when the saved results cover a shorter period. Example: tests were only performed in the last 5 days. In addition, either no other results were saved or the results that were saved are more than 30 days old. Consequently the results for the last 5 days are used for calculating the average, the lowest value and the highest value for all three periods (7, 14 and 30 days).

-  If a large number of results were saved within one period, calculation of the average may take a while. mem flashes in the display while the calculation is in progress.
-  If no results were saved in memory for the period in question, three horizontal bars — — — are displayed instead of a numerical value. If, for example, the results are more than 7 days old, the average, lowest value and highest value cannot be calculated for 7 days.
-  The meter can only perform the necessary calculations as long as the results were stored together with the time and date. If you have not entered the time and date, three horizontal bars — — — are displayed instead of the numerical values.
-  In the event that you changed the date or time, then performed a test and afterwards re-set the date/time, the meter only includes results it saved in uninterrupted chronological order. If the chronological order was interrupted, the earlier results are ignored. If you have not performed any tests since you made the change, three horizontal bars — — — are displayed instead of a numerical value.

-  If the memory contains both results that were saved together with the time and date and results that were saved without this information, the averages and respective lowest and highest values will only be calculated from results saved with the time and date that come chronologically before the first result without the time and date. Example: The meter saved 150 results over a period of 50 days. The result in memory location 51 was saved without the time and date. The results in memory locations 1 to 50, which were saved together with the time and date, cover a 20-day period. For calculation of the 7- and 14-day averages, those results are included that are within the period in question. The 30-day average is calculated from all 50 results, even if these only covered a 20-day period. The results after the result without the time and date (memory location 52 and higher) are no longer available for calculation of averages, even if they were saved with the time and date.
-  If you turn the meter off with the Test button, it shows you the number of test strips remaining in the drum (see Chapter 2.3.2).
-  The meter turns off automatically if you have not pressed a button for 60 seconds.

5.4 Downloading test results to a PC, handheld computer or a special evaluation system

The meter has an inbuilt infrared window permitting wireless data downloading to a suitably equipped PC, handheld computer (PDA), or special evaluation systems.

Roche Diagnostics offers a variety of special hardware and software that extend the integrated notebook functions of your meter. These products enable you and your doctor to manage your data more effectively and, through their graph and table views, make it easier for you to understand your results.

Depending on the type of analysis you intend to perform, you will require a special software product and/or special hardware products. For further information please call Accu-Chek Customer Care at 1-800-363-7949.

The infrared window is located at the front end of the meter.



- ▶ Be sure to read the operating instructions supplied with the software and hardware you are using. These will include instructions on how to download your data.
- ▶ Make the receiving end (software product or hardware) ready to download the results.



- ▶ With the meter turned off, press the M and S buttons at the same time.

The meter turns on. Following the display check (see chapter 2.2.2), the following appears:



- ▶ Position the meter 5-20 cm away from the infrared window of the receiving end. Point the two infrared windows towards one another.
- ▶ If necessary, start the results download at the receiving end (software product or hardware).



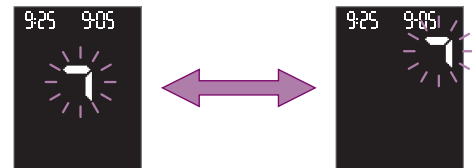

During the download both arrows flashed alternately. During the download only those results that are new to the receiving end, i.e. those have not yet been downloaded, are sent.





Once downloading has finished, the arrows stop flashing and the meter is automatically turned off by the receiving end.

If the meter is not turned off, press the Test button to turn it off.

Notes

-  Your results can only be fully analysed if all of the results have been saved together with the date and time, i.e. as long as you have set the date and time.
-  The results remain in the meter's memory following downloading.
-  You cannot perform a test while results are being downloaded.
-  If the results download does not occur (the  arrows do not start to flash) or was incomplete, the meter turns itself off automatically after approximately 5 minutes. This is what might have happened:

 - A download error occurred.
Start the results download again.
 - The infrared windows are too far apart or not properly facing one another.
Reduce the distance between the two infrared windows to 5-20 cm and position them so they are pointing towards one another. Start the results download again.
- Another device with an infrared source turned on or a strong light source is too close to the two infrared windows.
Remove the device or light source and start the download again.
 - An object, for instance, is blocking communication between the two infrared windows.
Remove the object and start the download again.
 - An error occurred at the receiving end.
Read the relevant manual(s).
-  If you already have a hardware or software product from Roche Diagnostics to enable you to transfer and evaluate results, it may not recognize more recent meters, so the results will not be downloaded. You may need a more recent software version for your hardware or software product. In this case please call Accu-Chek Customer Care at 1-800-363-7949.
-  Data transfer does not follow the IrDA standard (IrDA stands for Infrared Data Association).

6 Acoustic Mode

Acoustic Mode is intended for persons who are visually impaired. When Acoustic Mode is turned on, the meter guides you through the blood glucose test using beep tones; it also outputs the result as a series of beeps. The meter beeps additionally when the batteries are almost exhausted, the test strip drum is empty, or an error message is displayed.

Chapter 3.3 describes how to turn Acoustic Mode on.





Visually impaired persons need a sighted person to instruct them in the use of the meter and to assist them with all aspects of its operation. Visually impaired persons must not test their blood glucose without assistance from a sighted person.

An intimate knowledge of how results are represented as beeps and how to distinguish results from other beeps is crucial to reliably recognizing the result.

The chapters that now follow explain the beep tones in detail. In addition, training software (the BeepLearn-Programm) to help you interpret results announced in the form of beeps is available on CD from Accu-Chek Customer Care. Practice listening to beeps from actual tests or from the training software together with a sighted person until you can clearly recognize and interpret the results and other beeps you will hear.

If you have problems determining the results from the beeps, you should not use Acoustic Mode.

There are two types of beep tone, differing in pitch. Warnings have a higher tone (Tone 2, represented below as ) than the other beep tones (Tone 1, represented below as ). The following table shows which tone sounds for which event.

Turning on	Chapter 6.1	Tone 1 
Meter ready to test	Chapter 6.2	
Start of test	Chapter 6.2	
Announcement of the result	Chapters 6.3 and 6.4	

Signal that results are due to be announced	Chapters 6.3 and 6.4	Tone 2  (warning)
Announcement of an error message	Chapters 6.2 and 6.5	
Notification that the batteries are almost exhausted	Chapter 6.5	
Notification that the drum is empty	Chapter 6.5	

6.1 Beep tones at power-on

When Acoustic Mode is set to on, you hear a long beep (—) when you turn on the meter.

This is irrespective of which button you use to turn the meter on:

- the Test button in order to perform a test (see Chapter 4.3.1)
- the S button in order to change settings (see Chapter 3)
- the M button in order to retrieve results from memory (see Chapter 5)
- the M and S button in order to send results (see Chapter 5.4)

If you press the Test button or M button to turn the meter on, you first hear the long power-on beep followed by 6 further beeps spaced as 1 – 2 – 3 (– – – – –).

6.2 Beep tones during testing

Following the power-on beep and the 1 – 2 – 3 sequence of beeps, you will hear the following while you test:

- a single beep when the meter is ready to test so you can let the test strip draw up blood or control solution,
- a single beep when the test strip has drawn up sufficient blood or control solution and the test is starting,
- several beeps each time the meter displays an error message (see Chapter 6.5).

6.3 Announcement of the result following a test

In Acoustic Mode, whenever your meter displays a result following a blood glucose test, it also announces the result as a series of beeps. The result is not treated as an entity, but is broken down into individual digits.

Examples:

- The result 7.6 mmol/L is announced as 0 – 7 – decimal point – 6.
- The result 138 mg/dL is announced as 1 – 3 – 8.

Each digit is represented by the corresponding number of beeps; e.g. 4 beeps for the number 4 (- - - -). Zero is represented by a long beep (—).

The result is announced three times in succession. Each result is preceded by two short beeps (- -). Altogether, therefore, you hear: - - result - - result - - result.

mmol/L meters

First the tens are announced, then the units, then the decimal point and finally the tenths. There is a short pause between each group of beeps. The tens are always announced, even when the result is below 10. The tens in this case are represented by 1 long beep, signifying zero. The decimal point is represented by 1 very short beep (▪).

Examples:

- The result 13.8 mmol/L is announced as follows:
1 beep – pause – 3 beeps – pause – 1 very short beep – pause – 8 beeps
(- - - - ▪ - - - - -)
- The result 4.0 mmol/L is announced as follows:
1 long beep (for 0 tens) – pause – 4 beeps – pause – 1 very short beep – pause – 1 long beep
(— - - - - ▪ —)

mg/dL meters

First the hundreds are announced, then the tens, and finally the units. There is a short pause between each group of beeps. The hundreds are always announced, even when the result is below 100. The hundreds in this case are represented by 1 long beep, signifying zero.



Examples:

- The result 180 mg/dL is announced as follows:
1 beep – pause – 8 beeps – pause – 1 long beep
(- - - - - - - - —)
- The result 72 mg/dL is announced as follows:
1 long beep (for 0 hundreds) – pause – 7 beeps – pause – 2 beeps
(— - - - - - - - -)

Results that are lower than 0.6 mmol/L or 10 mg/dL and are displayed as $\frac{L}{U}$ are announced acoustically as 0 – decimal point – 0 and 0 – 0 – 0, respectively.

Results that are higher than 33.3 mmol/L or 600 mg/dL and are displayed as $\frac{H}{U}$ are announced acoustically as 9 – 9 – decimal point – 9 and 9 – 9 – 9, respectively.

Note

-  Information or warnings in the form of symbols (e.g. drum symbol or  symbol, see Chapter 12.1) that are displayed together with the result are not announced acoustically.

6.4 Announcement of results and average values from memory









Only the last (most recent) result that was saved can be announced acoustically.

If you press the M button to turn the meter on, you first hear the long power-on beep followed by the beep sequence 1 – 2 – 3 and then the most recent result.

Only the average for the last 7 days is announced acoustically. The lowest and highest results within this period are not announced acoustically.

The announcement follows the same pattern as any result that is announced directly following a test.

Notes

-  If the 7-day average cannot be calculated, three horizontal bars  are displayed. This is signalled acoustically with 3 long beeps representing 3 zeroes ().
-  If the result that was most recently saved is flagged by the bottle symbol  as being a performance check result (see Chapter 7), it is announced in the same way as any blood glucose test result. There is no acoustic signal to identify it as a performance check result. Likewise, there is no acoustic signal to identify a result flagged by an asterisk as being a special result (see Chapter 4.7).
-  The 14 and 30-day averages and the lowest and highest results within these two periods (see Chapter 5.3) are not announced acoustically in Acoustic Mode, but only displayed.
-  If no result has been saved, just three horizontal bars  are displayed. There is no acoustic announcement.

6.5 Announcement of warnings and error messages

When the batteries will soon be exhausted or the last test strip in a drum has been used, the meter issues an acoustic warning. This consists of two short beeps sounded three times in succession (- - - - -).

The warning is given at different times.

- Batteries are almost exhausted (the battery symbol  is displayed, see Chapter 9):
This acoustic warning is sounded when you turn the meter on.
- You have used the last test strip in the drum (End and drum symbol flash, see Chapters 2.3 and 12.2):
The acoustic warning is given after you have pressed the Test button to turn the meter off.

If error messages (E with a number or the EEE, see Chapter 12.2) are displayed, these are announced by two short beeps sounded four times in succession (- - - - -). This sequence is sounded only once and is not repeated. The same sequence of beeps is sounded for all error messages, i.e. they are not differentiated acoustically.

7 Checking your meter

To ensure your results are always dependable, you should periodically check the performance of your meter.

Do this by performing a performance check using the Accu-Chek Compact Autocontrol control solutions, each time

- after you have opened a new pack of test strip drums,
- after you have replaced the batteries.
- after your meter has displayed the bottle symbol  prompting you to perform a performance check,
- after you have cleaned the measuring window of the meter,
- if your result does not agree with how you feel.

Please call Accu-Chek Customer Care at 1-800-363-7949 to obtain the control solutions.

7.1 What you need

To perform a performance check you need the following items:

- meter with a test strip drum inserted
- Accu-Chek Compact Autocontrol G1 control solution (low glucose concentration) or Autocontrol G2 control solution (high glucose concentration)
- Concentration table for the control solutions (see label on the container the test strip drum came in).



Note

- i** The concentration table for the control solutions can be found on the peel-off label attached to the drum container. When conducting the performance check, always make sure that the peel-off label with the concentration table belongs to the test strip drum that is currently in the meter.

7.2 Performing a performance check

- ▶ Read the package insert that came with the control solutions.



- ▶ Press the Test button to turn the meter on.

Following the display check (see Chapter 2.2.2) a test strip is automatically advanced, and the test strip symbol and the drop symbol flash in the display.



You now have about 5 minutes in which to draw up control solution with the test strip.

- ▶ Take a bottle of control solution.
- ▶ Open it and wipe the tip of the dropper with a clean, dry paper towel in order to remove any dried-on residues.
- ▶ Invert the vial and hold it downwards at an angle. Squeeze it gently until a small drop is suspended from the tip.



- ▶ Apply the drop to the surface of a clean, easily washable object made of glass, porcelain or stainless steel (e.g. a plate or spoon).



- ▶ Hold the meter so the test strip is pointing downwards (see illustration).



- ▶ Hold the tip of the test strip to the drop of control solution.

The test strip draws up the control solution through the black notch.

- Move the test strip away from the control solution as soon as the hourglass symbol ⏳ is displayed and the meter beeps (provided the beep tone is turned on).

The test strip has then drawn up enough control solution, and testing starts. The hourglass symbol ⏳ indicates that the meter is busy performing a test. The meter automatically detects that the test strip has drawn up control solution. The bottle symbol 🍷 appears additionally in the display when the test starts.

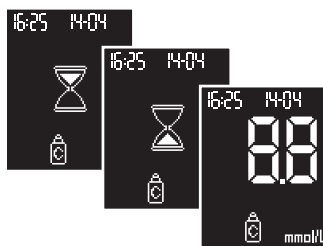

Testing is complete after approx. 5 seconds. The result is displayed and the meter beeps (provided the beep tone is turned on). The meter at the same time saves the result together with the bottle symbol 🍷. The saved result is thus recognizable as being a performance check result.

Immediately after the result is displayed:

- Compare the result with the concentration table printed on the peel-off label attached to the drum container.

The result must be within the concentration range stated.

The concentration table has two rows and two columns. Rows 1 and 2 contain concentration data for the two different control solutions, G1 and G2; the columns are for the two different units of measurement, mmol/L and mg/dL.

Make sure you compare the result with the concentration data stated for the control solution you used and the unit of measurement your meter displays.

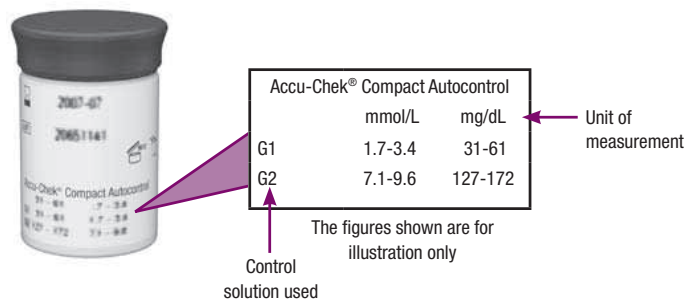





- ▶ Subsequently hold the meter directly above a waste bin with the test strip pointing downwards.
- ▶ Press the Test button to turn the meter off.

The used test strip drops out.

Before the meter turns off, it shows you the number of test strips remaining in the drum (see Chapter 2.3.2).

- ▶ Wipe the tip of the dropper with a clean, dry paper towel and close the bottle tightly.

Notes

-  The control solution you apply to a washable object must come from a suspended drop. Do not use the drop if it has run down the outside of the tip of the dropper. This may lead to results that are too high.
-  Control solution that is to be drawn up by the test strip must just have been freshly applied to the object. The control solution must not be left exposed on the surface for any length of time, or it may give results that are too high.
-  Results flagged as performance checks with the bottle symbol  are not included in the calculation of averages and lowest and highest results.



-  You can dispose of empty or only partly used bottles of control solution together with your regular household waste.

Please refer also to the notes in Chapters 4.3 and 4.4.

7.3 Possible causes of error during the performance of performance checks

If the result is outside the stated concentration range, perform a second performance check. If the result of this second check is outside the concentration range as well, please check the following points:

Did you perform the performance check as described above?	yes
Did you wipe the tip of the dropper before you applied control solution to the surface of the washable object?	yes
Did you use a suspended drop of control solution?	yes
Was there prolonged contact between the control solution and the washable object?	no
Did you bend the test strip either before or while you were drawing up control solution?	no
Did you wait for the test strip symbol and drop symbol to flash in the display before drawing up control solution with the test strip?	yes

Did you bend or move the test strip while the test was in progress?	no
Did you compare the result with the concentration data specifically relating to the control solution you used?	yes
Does the concentration table belong to the test strips that are currently in the meter?	yes
Did you perform the test within the correct temperature range (+10 °C to +40 °C)?	yes
Has the use-by date for the control solution or the test strips expired (see label on the bottle and the test strip drum next to the  symbol)?	no
Has the 90-day use-by period for the test strip drum expired (see Chapter 2.3.1 and possibly the clock symbol  in the meter's display)?	no
Are the test strip guide and measuring window clean?	yes
Have you observed the proper storage conditions for the meter, test strips and control solutions (see Chapter 11 and the package inserts that came with the test strips and control solutions)?	yes
Has the control solution been open for less than three months? Once opened, control solutions are only stable for three months and must not be used after this period.	yes

If your answers match those indicated on the previous pages, and your results are still outside the stated concentration range, please contact Accu-Chek Customer Care at 1-800-363-7949.

Note: If your meter has been dropped this can also lead to implausible results or error messages. If this is the case, again please contact Accu-Chek Customer Care.

Note



If a performance check produces results that are outside the stated concentration range, it is no longer certain that the meter and test strips are functioning properly. Blood glucose tests may then deliver incorrect results. Incorrect results can cause the wrong therapeutic decision to be taken and so produce serious adverse health effects.

8 Cleaning the meter and lancing device

8.1 Cleaning the meter

Your meter uses an optical measuring method that relies heavily on all of its components being clean. Owing to the way the test strip works, the meter does not normally come into direct contact with blood or control solution. Regular cleaning is therefore largely unnecessary. In the event of the meter becoming soiled through improper use, cleaning it may become necessary.

Wipe away any soiling from the housing or display with a cloth lightly moistened with cold water or 70 % ethanol.

Clean the test strip guide and measuring window thoroughly if

- the test strip guide has become visibly soiled,
- error message E-5 is displayed (see Chapter 12.2) and the soiled measuring window is the cause.

Do this as follows:

- ▶ If the meter is on, press the Test button to turn it off.
- ▶ Wait for the motor to stop.



- ▶ Wipe the test strip guide with a cotton swab lightly moistened with cold water or 70 % ethanol.



- ▶ Hold the meter in your right hand and place the thumb of your left hand into the recess below the drum compartment cover. Then pull the drum compartment cover with your fingers slightly to the front and lift it up.



- ▶ Wipe the measuring window and the area surrounding it with a cotton swab lightly moistened with cold water or 70 % ethanol.
- ▶ Remove any fluff or lint that may remain.
- ▶ Allow areas you have wiped time to dry thoroughly.
- ▶ Fold the drum compartment cover down and press it shut. There will be an audible CLICK.
- ▶ Perform a performance check (see Chapter 7).

Notes



Use only cold water or 70 % ethanol to clean the meter. Any other cleaning agents may damage the meter or impair its measuring function.

Use a lightly moistened cloth or a lightly moistened cotton swab. Do not spray anything onto the meter and do not immerse it in the cleaning liquid. Doing so may damage the meter's internal components and stop it from working properly.



Make sure that no liquid enters the meter. Avoid scratching the measuring window, as doing so could impair its measuring function.



Make sure that the drum compartment cover is tightly closed. If it is not properly closed, the meter will not turn on when you press the Test button.



Healthcare professionals using the meter to test several patients' blood glucose must also read the directions in Chapter 10.3 relating to disinfection.

8.2 Cleaning the lancing device

Clean your lancing device regularly to keep it in good working condition. If any blood gets on it, always wipe this away immediately. Clean the outside of the lancing device only. Wipe it once a week with a cloth lightly moistened with 70 % ethanol or 70 % isopropanol (available from your pharmacist).

In addition, thoroughly wipe the inside of the cap using a cotton bud lightly moistened with one of the two cleaning fluids.

Notes



After cleaning, allow the lancing device time to dry thoroughly. Never dip the lancing device in cleaning liquid. Doing so may damage the internal parts of the lancing device so affecting its operation.



Use only 70 % ethanol or 70 % isopropanol to clean the lancing device. Other cleaning agents may attack the plastic and stop the lancing device from operating properly.

9 Changing the batteries

When the battery symbol  first appears in the display, the batteries are running low. With these batteries you can perform about 50 more tests. However, we recommend that you replace the batteries as soon as possible. By then the batteries will have been heavily drained, and changeable conditions (e.g. cold surroundings) can affect their performance even further.

- ▶ If the meter is on, press the Test button to turn it off.



- ▶ Press lightly on the battery compartment cover and slide it in the direction of the arrow.
- ▶ Lift off the cover.
- ▶ Remove the used batteries.



- ▶ Insert two new batteries (type AAA, LR 03, AM 4 or micro).

The minus (-) ends of the batteries must match up with the minus marks in the battery compartment.

- ▶ Re-attach the battery compartment cover.

The three hooks on the underside of the cover must engage with the slots along the edge of the battery compartment. The cover is then just loosely held in position.

- ▶ Slide the battery compartment cover back into place.

It locks with an audible CLICK.

Notes

- i** A fresh pair of batteries has enough power either for about 1000 tests or for one year's worth of tests. If you have changed the brightness of the display to level 3 (high) or set Acoustic Mode to on, the battery life will be shorter.
- i** When you replace the batteries, your results always remain saved.
- i** The year, time and date settings only remain saved as long as
 - you do not take longer than two minutes to change the batteries,
 - you do not press any button while the batteries are not inserted,
 - you do not open the drum compartment while there are no batteries inserted.
 - you turn the meter off before removing the batteries.

If one of the above conditions is not met you will need to re-enter the year, time and date.

If you do not enter the year, time and date, all future results will be displayed and saved without the time and date. In that case

the test results saved in memory will be numbered consecutively so you can still recognize the order in which they were saved (see Chapter 5.2).

If the year, time and date have been lost, the meter rotates the drum in order to re-read the bar code.

 You can also use rechargeable NiMH batteries. If you do, please note the following:

- The number of tests you can perform with recharged batteries is considerably less than with ordinary batteries.
- To be ready to test at any time, you need to keep two rechargeable batteries in reserve which you can charge while the first pair are in the meter.
- Recharged batteries lose their charge during storage.
- When the battery symbol first appears, you can perform significantly fewer than 50 further tests. With old and exhausted rechargeable batteries you may not be able to perform even one more test.
- The performance and useful life of rechargeable batteries depends to a large extent on the quality of the battery charger you are using.
- Owing to the higher power consumption, we advise against using rechargeable batteries if the brightness of the display is set to level 3 (high) or if Acoustic Mode is set to on.

 Never throw batteries into a fire. This is dangerous because they may explode.

 Remove the batteries if you will not be using your meter for any length of time. When you insert the batteries again, remember to set the year, time and date.

 Think of the environment. Dispose of used batteries sensibly.

10 Blood glucose testing in a multi-patient setting – Information for healthcare professionals

Only professionals working in doctors' practices, hospitals and diabetes training centres as well as in-patient and ambulant nursing staff are allowed to perform blood glucose tests on more than one patient using the same Accu-Chek Compact Plus meter.

When using the meter always follow the recognized procedures for handling objects that are potentially contaminated with human material. Practice the hygiene and safety policy of your laboratory or institution.

Also, to stop your meter becoming contaminated, please follow the directions printed on the next few pages.

Notes

 Patients and healthcare workers are potentially at risk of becoming infected when the same Accu-Chek Compact Plus meter is used to test blood glucose in several patients. Any object coming into contact with human blood is a potential source of infection (see: Clinical and Laboratory Standards Institute: Protection of Laboratory Workers from Occupationally Acquired Infections; Approved Guideline – Third Edition; CLSI document M29-A3, 2005).

 **Any patient with an infection or suffering from an infectious disease and any patient who is a carrier of a multiresistant organism must be assigned his/her own meter. This applies also if a patient is suspected of being one of the above. For as long as the suspicion exists, the meter must not be used to test any other patient.**

 The lancing device is intended only for patient self-monitoring by a single person. It must not be used to collect blood in a multi-patient setting as it does not incorporate any features to guard against cross-infections.

Healthcare professionals testing blood glucose in a multi-patient setting must not use the Accu-Chek Softclix Plus lancing device to collect blood and should therefore remove the lancing device from the meter. The lancing device may be replaced with a blanking plate (see Chapter 10.1).

 The hypo indicator level may vary from person to person. Therefore we recommend leaving the hypo indicator function turned **off** when using the meter in a professional setting.

10.1 Replacing the lancing device with a blanking plate

Undock the lancing device from the meter as follows.

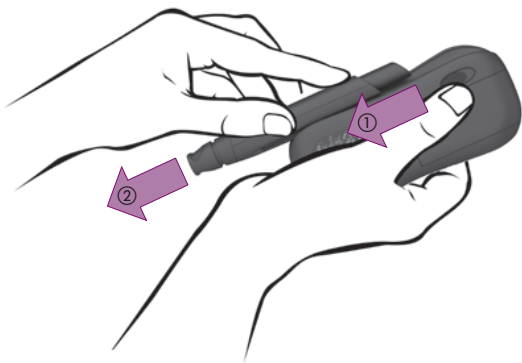

- ▶ Push the slide button in the direction indicated by the arrow (1) and hold it there.
- ▶ Slide the lancing device out in the direction indicated by the arrow (2).

Instead of the lancing device you can use a blanking plate which is available from Accu-Chek Customer Care at 1-800-363-7949.

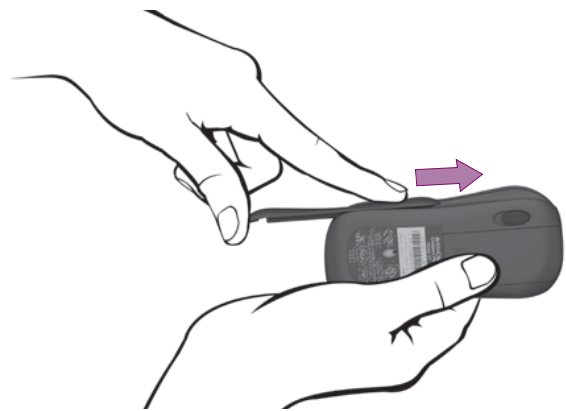



- ▶ Hold the meter so it is horizontal, with the recess for docking the lancing device pointing upwards.
- ▶ Slide the blanking plate over the recess from the left along the meter in the direction indicated by the arrow.

The guides along the inside of the recess must engage with the grooves along the blanking plate. The blanking plate is properly attached when it locks into place with an audible **CLICK**.

10.2 Performing a blood glucose test

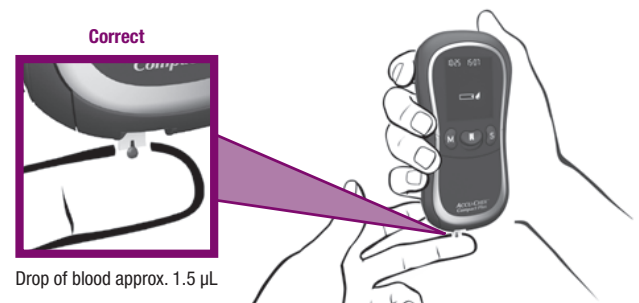
- ▶ Wear protective gloves.
- ▶ Wash or disinfect the patient's finger and allow it to dry thoroughly. The drop of blood does not spread so easily over dry skin.
- ▶ Use only a lancing device that is approved for use by healthcare professionals.
- ▶ Use a lancing device with adjustable penetration depth settings.
- ▶ Select a penetration depth to suit the patient's skin type. Start with a shallow depth setting.
- ▶ Select a puncture site along the side of a fingertip.
- ▶ Turn the finger so the chosen puncture site is facing upwards, and keep it facing upwards. The drop of blood cannot then spread so easily.
- ▶ Lance the side of the fingertip.
- ▶ Using gentle pressure, massage the finger towards the fingertip to encourage a drop of blood to form. A proper but nevertheless small drop of blood (approx. 1.5 μL) must form.



- ▶ Hold the meter with the test strip pointing downwards (see illustration).
- ▶ Immediately after the drop of blood has formed: Hold the tip of the test strip against the drop of blood so the black notch is touching the drop of blood. The test strip draws up blood.
- ▶ Move the test strip away from the drop of blood as soon as the hourglass symbol  is displayed and the meter beeps (only when the beep tone is turned on). The test strip has then drawn up enough blood, and test starts.
- ▶ When the result is displayed, hold the meter upright over a waste bin and press the Test button to turn it off. The used test strip drops out.

Notes

-  **Always** hold the meter so the **test strip is pointing downwards** when you are drawing up blood with the test strip. If you hold it so the test strip is pointing upwards or sideways or you lay the meter down with the test strip still in, blood can enter the meter and contaminate it. Hold the meter with the test strip pointing downwards until the result is displayed (measuring time approx. 5 seconds) and you have ejected the test strip.

Wrong

Test strip pointing upwards





-  To test blood glucose you require approximately 1.5 µL of blood. Avoid producing large drops of blood on the patient's finger. Where the drops of blood are too large, the meter may come into contact with the blood. Wipe off any large drops of blood. Test using the drop of blood that forms again at the puncture site.

Wrong

Drop of blood too large



-  Residues of water or disinfectant on the skin can dilute the drop of blood and so produce false results.

-  Always turn the meter off by pressing the Test button, so as to eject the test strip. Do not pull the test strip out. If you do pull the used test strip out, blood can enter the meter and contaminate it.

-  Dispose of used lancets or disposable lancing devices and used test strips according to local hygiene and safety regulations.

-  The test strip cannot properly draw up blood that has spread over the skin.

Wrong

Drop of blood that has spread



-  If you collect blood from an earlobe, be sure that the blood is on top and not hanging from the earlobe. Hold the earlobe or position the patient so the puncture site is on top.

10.3 Disinfecting the meter

The Accu-Chek Compact Plus meter may be disinfected. Disinfection is performed according to the degree of soiling (see “When to disinfect”).

What to disinfect

The following parts of the meter may become contaminated:

- the area around the test strip guide



- the lower edge of the drum compartment cover
- the measuring window
- the housing

In order to disinfect the lower edge of the drum compartment cover and measuring window, you need to open the drum compartment cover.

First make sure the meter is turned off.

- ▶ Hold the meter in your right hand and place the thumb of your left hand into the recess below the drum compartment cover. Then pull the drum compartment cover with your fingers slightly to the front and lift it up.

Once you have opened the drum compartment cover, you will see beneath it the small measuring window ① and have access to the lower edge of the drum compartment cover ②.

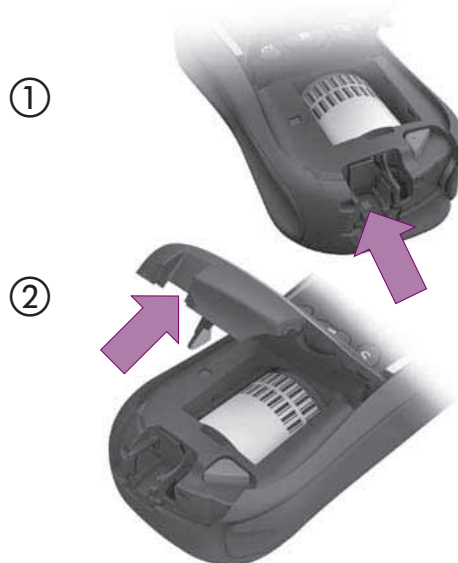

Cotton buds, wipes and cloths lightly moistened with disinfectant are all suitable for disinfecting the meter.

- ▶ Allow areas you have wiped time to dry thoroughly.
- ▶ Remove any fluff or lint that may remain.
- ▶ Fold the drum compartment cover down and press until it closes. It locks with an audible CLICK.
- ▶ Ensure that the drum compartment cover is properly closed.

Notes



The test strip guide and measuring window must always be kept clean. When you turn the meter on to perform a test, the test strip is advanced over the measuring window and out through the test strip guide. Any residues of blood remaining on the measuring window or in the test strip guide may get onto the test strip and contaminate it.



Make sure that no liquid enters the meter. Avoid scratching the measuring window, as scratches could impair its measuring function.



Do not spray anything onto the meter and do not immerse it in liquid. Doing so may damage the meter's internal components and stop it from working properly.

When to disinfect

- Each time after you have tested a patient's blood glucose:
 - ▶ wipe the area around the test strip guide.If you find blood on the cloth, wipe also the test strip guide itself and the measuring window.
- If there is blood on the meter:
 - ▶ wipe the meter.
- If blood has entered the meter:
 - ▶ wipe the area around the test strip guide, the lower edge of the drum compartment cover and the measuring window.
- ▶ Allow areas you have wiped time to dry thoroughly.

The meter, test strip guide and measuring window must be thoroughly cleaned and disinfected at least once a day after use. Carefully check all recesses, grooves and gaps, as well as the blanking plate.

10.4 Suitable disinfectants

Use only disinfectants of proven effectiveness quoted in official guidelines (e.g. Clinical and Laboratory Standards Institute: Protection of Laboratory Workers from Occupationally Acquired Infections; Approved Guideline – Third Edition; CLSI document M29-A3, 2005).

Use alcohol-based surface disinfectants with virucidal activity. Suitable agents are those, for instance, based on alcohols, aldehyde cleavers and quaternary compounds*. Use them according to manufacturer's instructions.

* List of disinfection methods that have been tested in accordance with the "Richtlinien für die Prüfung chemischer Desinfektionsmittel" [Guidelines for testing chemical disinfectants] and the "Anforderungskatalog" [Requirements catalogue] of the DGHM (Deutsche Gesellschaft für Hygiene und Mikrobiologie e.V.) [=German Society for Hygiene and Microbiology] based on the DGHM standard methods for testing chemical disinfection methods and have been found to be efficacious by the Desinfektionsmittel-Kommission [=Disinfectants Commission] of the DGHM in collaboration with representatives of the following professional associations: DGKH (Deutsche Gesellschaft für Krankenhaushygiene e.V.) [=German Society for Hospital Hygiene], GHU (Gesellschaft für Hygiene und Umweltmedizin e.V.) [=German Society for Hygiene and Environmental Medicine], DVV (Deutsche Vereinigung zur Bekämpfung der Viruskrankheiten e.V.) [=German Association for the Control of Viral Diseases] and DVG (Deutsche Veterinärmedizinische Gesellschaft e.V.) [=German Veterinary Society]

11 Measurement and storage conditions

The reliability of your meter and lancing device as well as the accuracy of your results is influenced by a number of factors. Pay close attention to the following points.

A meter that has been dropped can produce false results.

11.1 Temperature range

- **Without the batteries and without the test strip drum** the meter may be stored at between -25 °C and +70 °C.
- **With the batteries and without the test strip drum** the meter may be stored at between -10 °C and +50 °C.



At temperatures above +50 °C the batteries could leak and damage the meter.



At temperatures below -10 °C the batteries do not have enough power to keep the internal clock functioning.

- **With the batteries and with the test strip drum** the meter may be stored at between +2 °C and +30 °C.
- For blood glucose tests and performance checks the permitted range is from +10 °C to +40 °C.

- Blood glucose tests may be performed at the limit of the permitted range (between +6 °C and +10 °C or between +40 °C and +44 °C). When the temperature is at the limit of the permitted range, the thermometer symbol flashes in the display.

 Do not use results obtained at the limits of the permitted temperature range as a basis for making therapeutic decisions. The results may be incorrect. Incorrect results can cause the wrong therapeutic decision to be taken and so produce serious adverse health effects.

- Tests cannot be performed at temperatures below +6 °C and above +44 °C.

In this event the following message is displayed:



- Keep the lancing device at temperatures between -25 °C and +70 °C.

 Never try to speed up warming or cooling of your meter, e.g. by placing it on a radiator or in a refrigerator. Doing so can damage the meter and cause it to give incorrect results. Incorrect results can cause the wrong therapeutic decision to be taken and so produce serious adverse health effects.

 Keep the lancing device without a lancet inserted.

 Never expose the lancing device to high temperatures (e.g. in a hot car). High temperatures can cause parts of the lancing device to become warped, so impairing its operation.

11.2 Light conditions

All displayed numbers and symbols appear yellow. Bright light shining on the display may make them difficult to read. Shield the meter if necessary using your body, for instance.

 Keep the meter away from very strong light sources (e.g. direct sunlight, studio lighting, spot lights, etc.). These may interfere with the proper functioning of the meter and cause error messages to be displayed.

11.3 Humidity

Only test blood glucose at a relative humidity of between 20 % and 85 %.

Keep the meter and lancing device at a relative humidity of between 20 % and 85 %.

 Sudden changes in temperature cause condensation to form in or on the meter. If this happens, do not turn the meter on. Make sure that it returns to ambient temperature slowly. Never keep it in a room that is likely to harbour condensation (e.g. a bathroom).

11.4 Local sources of interference

 Strong electromagnetic fields may interfere with the proper operation of the meter. Do not use the meter in close to sources of strong electromagnetic radiation.

 To avoid electrostatic discharge, do not use the meter in a very dry environment, especially one in which synthetic materials are present.

12 Symbols, error messages and troubleshooting

In addition to test results, the time and the date, your meter also displays other symbols and error messages. Some of these routine display messages have already been explained in earlier chapters. Following is a complete summary of all symbols and messages, what they mean and what actions you should take when they appear.

When you use your meter, please watch out for any symbols and error messages that are displayed. They provide you with important information. If you do not recognize a symbol or do not understand an error message, please refer immediately to this chapter for an explanation. Otherwise you run the risk of wrongly interpreting your results.

On some of the pages that follow you will see a double arrow . It signifies the following:

- when it appears on the right at the bottom of the page – the description continues on the next page
- when it appears on the left at the top of the page – this is the continuation of the description from the last page

12.1 Symbols shown in the display

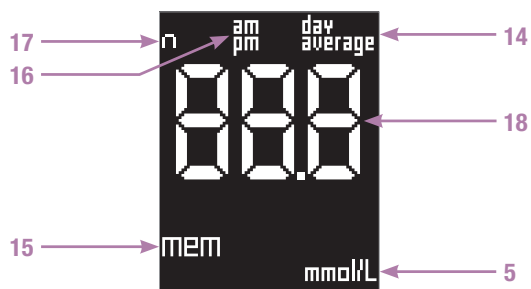
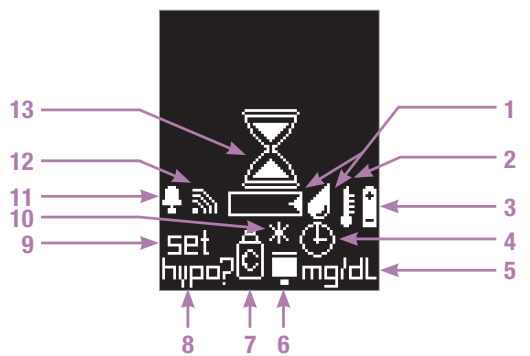





Symbols may be displayed singly or several at once. When several symbols are displayed, each symbol can have its own meaning. Alternatively, the combination of symbols may mean something.

In the following example you see a display with several symbols. This display appears when you have turned on the meter to perform a blood glucose test.





Here each symbol has its own meaning. The symbols shown along with the time and date mean:



-  You can draw up blood or control solution with the test strip now.
-  The batteries are running low.
-  You inserted a partly used test strip drum.
-  The beep tone or Acoustic Mode is set to on.





In the tables presented below you will first see the meanings of symbols that appear singly or have the same meaning when they appear together with other symbols. These are followed by the meanings of combinations of symbols and of symbols that appear in the numeric field.





12.1.1 Single symbols

Symbol	Meaning
1 	Draw up blood or control solution with the test strip now.
2 	<p>During a test and when the result is being displayed: the temperature is outside the permitted range of +10 °C to +40 °C.</p> <p>Do not use this result as a basis for therapeutic decisions.</p> <p>Move to a place where the temperature is between +10 °C and +40 °C and wait for the temperature of the meter to adjust to this temperature. Repeat the test with a new test strip. ▶▶</p>

Symbol	Meaning
▶▶	In memory: at the time of testing the temperature was outside the permitted range.
3 	<p>The batteries are running low.</p> <p>When the symbol first appears in the display, you can perform about 50 more tests.</p> <p>If you use NiMH rechargeable batteries instead of normal batteries, fewer than 50 more tests can be performed. If the rechargeable batteries are old and exhausted, it may not be possible to perform even one more test.</p> <p>When the batteries are so low that no more tests can be performed, just the battery symbol appears briefly for 3 seconds in the display. Then the meter turns off. Insert two batteries (new or recharged).</p>

Symbol	Meaning
4 	See under Combinations of symbols
5 mmol/L mg/dL	The unit your meter uses to display the blood glucose result, either mmol/L or mg/dL (depending on the meter).
6 	<p>The meter cannot calculate the use-by period for this test strip drum</p> <ul style="list-style-type: none"> because you inserted a partly used test strip drum, because you opened the drum compartment cover, because the year, time and date settings were lost when you changed the batteries and at this time the drum was partly used (see Chapter 9).



Symbol	Meaning
▶▶ 	Only in a new meter that has not yet been used to perform tests: There is no test strip drum in the meter or the mock drum has been left inserted. Insert a new test strip drum (see Chapter 2.3).
7 	This result is a performance check result.
	See under Combinations of symbols
8  hypo?	<p>After testing: You have turned on the hypo indicator and the displayed result is below the level you set.</p> <p>You are in the hypo indicator setting.</p> <p>In memory: The result is below the limit that was set at the time of testing.</p>

	Symbol	Meaning
9	set	You are in the settings.
10	✱	Flag for a special result, e.g. obtained from alternate site testing.
11		You have turned on at least one alarm or you are in the alarm clock setting.
		Optical warning while the alarm sounds for 20 seconds.
12		The beep tone (🔊) or Acoustic Mode (🔊) is set to on.
13		The test strip has drawn up enough blood or control solution, and test is running.
14	day average	When an average is displayed (from memory): the symbol is preceded by the number of days covered.

	Symbol	Meaning
15	MEM	You are in memory. Either the saved result or one of the averages, highest or lowest results is being displayed.
		During averaging, when the calculation is taking a while.
16	am pm	Displayed additionally when 12-hour time format is selected.
17	n	When an average is displayed (from memory): the symbol is followed by the number of tests n included in the calculation.



12.1.2 Combinations of symbols

The following combinations of symbols have meanings of their own.

Symbols	Meaning
4 + 6 + 7 	<p>The 90-day use-by period for the test strip drum has expired (see Chapter 2.3.1). The test strips cannot be used.</p> <p>Insert a new test strip drum.</p> <p> You must not use these test strips, as they may produce incorrect results. Incorrect results can cause the wrong therapeutic decision to be taken and so produce serious adverse health effects.</p>
4 + 6 	<p>See symbol combination 4 + 6 + 7</p> <p>After the symbol combination 4 + 6 + 7 appeared, you performed a performance check, so the bottle symbol is no longer displayed.</p>

Symbols

Meaning

▶▶	<p>In memory: The test strip you used for this test was unusable (the 90-day use-by period had expired, see Chapter 2.3.1).</p> <p> The result in memory may be incorrect. Incorrect results can cause the wrong therapeutic decision to be taken and so produce serious adverse health effects.</p>
6 + 7 	<p>The meter is unable to calculate the use-by period for the test strip drum and is prompting you to perform a performance check,</p> <ul style="list-style-type: none">because you have just changed the batteries, the year, time and date settings have been lost (see Chapter 9) and, at the same time, a partly used drum remains in the meter,

Symbols

Meaning



- because you have just inserted a partly used test strip drum,
- because you have just opened the drum compartment cover.

Perform a performance check (see Chapter 7). If the test produces a correct result, you may continue to use the test strips. If the result is incorrect, you need to insert a new drum. Following the performance check, the bottle symbol disappears from the display. The drum symbol continues to be displayed in order to draw your attention to the fact that the meter cannot calculate the use-by period. The symbol only disappears when you insert a new test strip drum. All results are saved along with the drum symbol. If you do not perform a performance check, the flashing bottle symbol appears with every test until you insert a new drum.

12.1.3 Symbols appearing in the numeric field

In the numeric field: **888** (mmol/L meter) or **888** (mg/dL meter) the following symbols may appear:

Symbol

Meaning



18



In memory:

- No results present in memory.
- Averaging is not possible because
 - you have not set the time and date,
 - memory only contains results without a time and date,
 - memory only contains results that are not included in the calculation, e.g. performance results,
 - no results were saved in the period in question, e.g. all results in memory are more than 7 days old,



Symbol	Meaning
▶▶	<ul style="list-style-type: none"> the date that it is set is in the past, you changed the time and date, then performed a test and afterwards re-set the time and date, but have not performed any more tests since then.
LO	The result is lower than 0.6 mmol/L.
HI	The result is greater than 33.3 mmol/L.
	You have turned the meter on in order to download the results.
	The meter is downloading results.
■	Decimal point displayed by mmol/L meters and is part of the result (e.g. 8.2 mmol/L is displayed as 8.2)

12.2 Interferences and error messages – causes and troubleshooting recommendations

If you receive frequent error messages, please call Accu-Chek Customer Care at 1-800-363-7949.

If this happens ...

The meter will not turn on.

it means:

- The batteries (normal or rechargeable) are empty or none are inserted. Insert batteries (new or recharged).
- You inserted the batteries the wrong way round.

Remove the batteries and re-insert them as shown in the battery compartment. If the batteries were in the meter the wrong way round for longer than two minutes, the year, time and date are now lost. Re-enter them (see Chapter 3).



If this happens ...**it means:**

- The drum compartment cover is not properly closed.
Close the drum compartment cover. It must close with an audible CLICK.
- The ambient temperature is low and the batteries are almost empty.
Move to a place where the temperature is between +10 °C and +40 °C and wait for the temperature of the meter to adjust to this temperature. Insert batteries (new or recharged).
- Condensation has affected the electronics.
Allow the meter to dry slowly.
- The meter is defective.
Please contact the Accu-Chek Customer Care Line.

If this happens ...

The meter is turned on, but the display is blank.

it means:

The display is defective.

Please call Accu-Chek Customer Care at 1-800-363-7949.

The clock has stopped or the clock is slow.

The meter was exposed to a temperature below -10 °C and the batteries are beginning to freeze.

Turn the meter off. Move to a place where the temperature is between +10 °C and +40 °C and wait for the temperature of the meter to adjust to this temperature.

When the meter is turned on, the date is shown as 0-00 and the time is shown as 0:00.

- The meter was exposed to a temperature below -10 °C and the batteries are beginning to freeze.

Press the Test button to turn the meter off. Move to a place where the temperature is between +10 °C and +40 °C and wait for the temperature of the meter to adjust to this temperature.



Error message

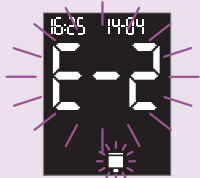
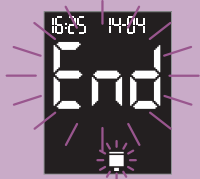

Meaning

- The year, time and date have not been set.
Set these as described in Chapter 3.
- The test strip drum in the meter is empty.
Insert a new test strip drum.

- The bar code information from the test strip drum has been lost.
Press the Test button to turn the meter off. Open and close the drum compartment cover. The meter rotates the drum and reads the bar code. When you next turn on the meter to perform a test, the drum symbol and flashing bottle symbol are displayed.



Error message

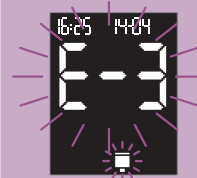

Meaning

Perform a performance check. You may use up all the test strips remaining in the drum. The 90-day use-by period will no longer be calculated for this drum. The drum symbol will therefore be displayed each time you perform a test until you insert a new test strip drum.

- The bar code on the test strip drum is damaged.
You can no longer perform tests with test strips from this drum. Insert a new drum.
- The test strip drum does not rotate.
Press the Test button to turn the meter off. Open the drum compartment cover and press the red drum release button. Close the drum compartment cover again.



Error message



Meaning

The meter rotates the drum and reads the bar code. When you next turn on the meter to perform a test, the drum symbol and flashing bottle symbol are displayed. Perform a performance check. You may use all the test strips remaining in the drum. The 90-day use-by period will no longer be calculated for this drum. The drum symbol will therefore be displayed each time you perform a test until you insert a new test strip drum.

- The bar code on the test strip drum is damaged.

You can no longer perform tests with test strips from this drum. Insert a new drum.

Error message

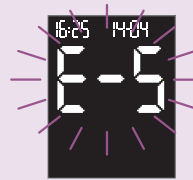

Meaning

- The measuring window is dirty.
Press the Test button to turn the meter off. Clean the measuring window (see Chapter 8.1) and repeat the test with a new test strip.
- A test strip is stuck in the meter.
Hold the meter upright so the test strip is pointing downwards. Press the Test button to turn the meter off and allow the test strip to drop out. If the test strip does not drop out, remove it manually, even if you feel some resistance.
- The test strip drew up too little blood or control solution.
Turn the meter off and then on again by pressing the Test button. Repeat the test with a new test strip and a larger amount of blood or control solution.



Error message



Meaning

- You drew up blood or control solution too soon with the test strip, i.e. before the test strip symbol and drop symbol were flashing in the display.

Turn the meter off and then on again by pressing the Test button. Repeat the test with a new test strip. Only draw up blood or control solution with the test strip when the test strip symbol and drop symbol are flashing in the display.

- You bent or moved the test strip during the test either while you were drawing up blood or control solution with it or during the test.

Turn the meter off and then on again by pressing the Test button. Repeat the test with a new test strip.



Error message



Meaning

- The test strip that was advanced is defective.

Hold the meter upright so the test strip is pointing downwards. Press the Test button to turn the meter off and allow the test strip to drop out. Press the Test button to turn the meter on again and repeat the test.

- You pulled the test strip out of the meter.

Press the Test button to turn the meter off. Only remove the test strip from the meter by pressing the Test button to turn the meter off.

- There is condensation in the meter.

Press the Test button to turn the meter off. Leave it to dry at room temperature.

Error message

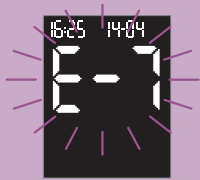

Meaning

- The batteries (regular or rechargeable) are empty or a meter error has occurred.

Turn the meter off and then on again by pressing the Test button. If the error message appears again, the batteries may be empty. Insert new batteries (new or recharged). If the error message is again repeated when the meter turns on, please contact Accu-Chek Customer Care Line.

- The meter was exposed to a strong electromagnetic field.

Press the Test button to turn the meter off. Move somewhere else or turn off the source of the field.

- You bent or moved the test strip during the test either while you were drawing up blood or control solution with it or during the test.



Error message



Meaning

Turn the meter off and then on again by pressing the Test button. Repeat the test with a new test strip.

- You drew up blood or control solution too soon with the test strip, i.e. before the test strip symbol and drop symbol were flashing in the display.

Turn the meter off and then on again by pressing the Test button. Repeat the test with a new test strip. Only draw up blood or control solution with the test strip when the test strip symbol and drop symbol are flashing in the display.

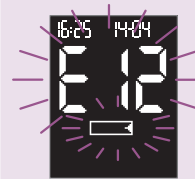

You pulled the test strip out of the meter during testing.

Turn the meter off and then on again by pressing the Test button. Repeat the test with a new test strip. Only remove the test strip from the meter by pressing the Test button to turn the meter off.

Error message

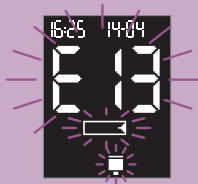

Meaning

The test strip is stuck or the test strip drum does not rotate.

Press the Test button to turn the meter off. Open the drum compartment cover and (if applicable) pull out the test strip. Press the red drum release button and remove the test strip drum. Insert the test strip drum again and close the drum compartment cover. The meter rotates the drum and reads the bar code. When you next turn on the meter to perform a test, the drum symbol and flashing bottle symbol are displayed. Perform a performance check. You may use all the test strips remaining in the drum. The 90-day use-by period will no longer be calculated for this drum. The drum symbol will therefore be displayed each time you perform a test until you insert a new test strip drum.

Error message



Meaning

- The meter has been exposed to severe differences in temperature.
- The ambient temperature or the temperature within the meter is too low (below +6 °C) or too high (above +44 °C) for a test.

Press the Test button to turn the meter off. Move to a place where the temperature is between +10 °C and +40 °C and wait for the temperature of the meter to adjust to this temperature.

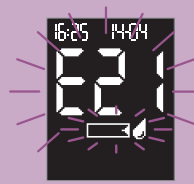

The test strip drew up too little blood or control solution.

Turn the meter off and then on again by pressing the Test button. Repeat the test with a new test strip and a larger amount of blood or control solution.

Error message

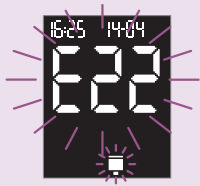

Meaning

- There is no test strip drum in the meter.
Press the Test button to turn the meter off. Insert a new test strip drum (see Chapter 2.3).
- The bar code on the test strip drum is damaged.
You can no longer perform tests with test strips from this drum. Insert a new drum.
- You inserted a test strip drum from a different blood glucose measuring system.
Press the Test button to turn the meter off. Insert an Accu-Chek Compact test strip drum (see Chapter 2.3).

Error message

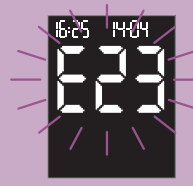

Meaning

In memory: the result in memory cannot be displayed.
All other results in memory can continue to be retrieved with the M or S button.

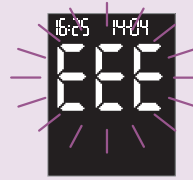

A meter error has occurred.

Turn the meter off and then on again by pressing the Test button. If the error message persists, please contact Accu-Chek Customer Care Line.

13 Technical data

Meter type	Accu-Chek Compact Plus (Model GT)
Catalogue No./Serial No.	See type plate on the back of the meter
Test principle	<p>Determination of glucose in fresh capillary blood by reflectance photometry. When using different specimen material please refer to the package insert that came with the Accu-Chek Compact test strips.</p> <p>Blood glucose concentrations may be measured in whole blood or in plasma. Although you always draw up whole blood with the test strip, your meter displays blood glucose results that relate either to whole blood or to plasma. To see whether your blood glucose meter displays results relating to whole blood or to plasma, please read the package insert that came with your test strips. There you will also find information on how the system works, on the test principle and on reference methods.</p>
Measuring range	0.6–33.3 mmol/L (10–600 mg/dL)
Sample size	approx. 1.5 µL (1 µL (microlitre) = 1 thousandth of a millilitre)

Measuring time	approx. 5 seconds (depending on concentration)
System operating temperature	+10 °C to +40 °C
Storage temperature	
Meter	without batteries and without a test strip drum: -25 °C to +70 °C
	with batteries and without a test strip drum: -10 °C to +50 °C
	with batteries and with a test strip drum: +2 °C to +30 °C
Lancing device	-25 °C to +70 °C
Humidity	
during testing	20 % to 85 % relative humidity
during storage	20 % to 85 % relative humidity
Altitude	Sea level to 4000 m
Memory	500 results together with time and date, averages, highest and lowest value for 7, 14 and 30 days
Dimensions	
without lancing device	121 × 57 × 32 mm
with lancing device	125 × 64 × 32 mm

Weight	approx. 147 g with lancing device, batteries and test strip drum
Display window	OLED (Organic Light Emitting Diode) display
Automatic power-off	after 60 seconds or 5 minutes depending on operating status
Power supply	2 batteries (type AAA, LR 03, AM 4 or Micro) or 2 NiMH rechargeable batteries (type AAA)
Battery life	approx. 1000 results or approx. 1 year (less when the brightness of the display is set to level 3 (high), or in Acoustic Mode owing to the higher power consumption, or when rechargeable batteries are used)
Interface	Infrared interface
Safety class	III
LED/IRED	Class 1
Electromagnetic compatibility	This device meets the electromagnetic immunity requirements according to EN ISO 15197 Annex A. The chosen basis for the immunity tests (on electrostatic discharge) was basic standard IEC 61000-4-2.

In addition it meets the electromagnetic emissions requirements according to EN 61326. Its electromagnetic emission is thus low. Interference from other electrically powered equipment is not to be anticipated.

Performance evaluation The performance data for the Accu-Chek Compact Plus system (Accu-Chek Compact Plus meter together with Accu-Chek Compact Plus test strips) were determined using capillary blood from patients with diabetes (method comparison, accuracy), venous blood (repeatability) and control solutions (reproducibility). The system is calibrated with venous blood containing various levels of glucose. The reference values are obtained using the hexokinase method. The method comparison was conducted by comparing the results from the system with those of the hexokinase method with deproteination using an automatic analyzer. The hexokinase method is traceable to a NIST standard (traceability).

The Accu-Chek Compact Plus system complies with the requirements of EN ISO 15197.

14 Alternate sites testing

Capillary blood for blood glucose testing can be obtained, not only from the fingertips, but also from other sites (the palm, the forearm, the upper arm, the calf or the thigh), which is referred to as Alternate Site Testing (AST).

The Accu-Chek Softclix Plus AST cap is a special cap that is used in conjunction with the Accu-Chek Softclix Plus lancing device and enables you to collect blood from these alternate sites.

 Blood obtained from a fingertip and the palm – both below the thumb and below the little finger – can be used at any time to test blood glucose. If blood from any of the other alternate sites – **the forearm, the upper arm, the calf and the thigh** – is used, there are certain times when testing is **not appropriate** (see the chapter “The right moment”). The results may differ from the results taken from the fingertips at these times. These differences can cause the wrong therapeutic decision to be taken and so produce adverse health effects.

 The AST cap is intended for patient self-monitoring by a single person. This cap must not be used for obtaining blood on more than one person owing to the risk of infection.

 Please read these instructions for use before you use blood from alternate sites to test blood glucose. Only in this way can you choose the right blood collection method. Before you decide to practice alternate site blood glucose testing, please consult your healthcare professional.

 Before using the AST cap, please carefully read the instructions for use of the Accu-Chek Compact Plus meter and the package insert of the Accu-Chek Compact test strip drums. Use the AST cap to obtain blood from alternate sites only.

 If you use this AST cap to collect blood from a fingertip, the lancet penetrates too deeply into the finger and could possibly cause unnecessary discomfort or pain.

 In rare instances bruising may occur following collection of blood from alternate sites.

 If the result using blood taken from the forearm, the upper arm, the calf or the thigh produces a result that does not agree with the way you feel, test again with blood collected from a fingertip or the palm. If the test result still does not agree with the way you feel, please contact your healthcare professional.

 Do not change your treatment based only on a single result.

 Only use the AST cap in conjunction with the Accu-Chek Softclix Plus lancing device. Using a different lancing device or using a different AST cap with the Accu-Chek Softclix Plus lancing device can prevent the lancing device and/or the AST cap from functioning properly or may result in damage to the lancing device and/or AST cap.

 The success of obtaining a suitably sized drop of blood from alternate sites may differ from person to person and from site to site.

14.1 Choosing the right moment

Before you test with blood collected from the forearm, the upper arm, the calf or the thigh, be aware of the following limitations:

Capillary blood in the fingertip and the palm responds more quickly to changes in blood glucose levels than blood in the forearm, the upper arm, the calf and the thigh. Blood glucose values tested in blood taken from these sites may therefore differ from values tested in blood taken from the fingertip and palm.

The difference in the blood glucose values is partly because the fingertips and the palm contain more blood vessels than other sites.

Do **not** test blood from the forearm, the upper arm, the calf and the thigh:

- up to two hours following a meal, when blood glucose values can change quickly
- after exercise
- if you have a temperature or if a medical condition is limiting your mobility, e.g. after breaking a leg or being confined to bed
- if you suspect that your blood glucose is extremely low (hypoglycemia)
- if you know that you sometimes do not notice when you are hypoglycemic
- during peak action time of short-acting insulin (up to approximately 4 hours after the injection) or rapid-acting insulin analogues (up to approximately 2 hours after the injection)

Alternate Sites for Testing

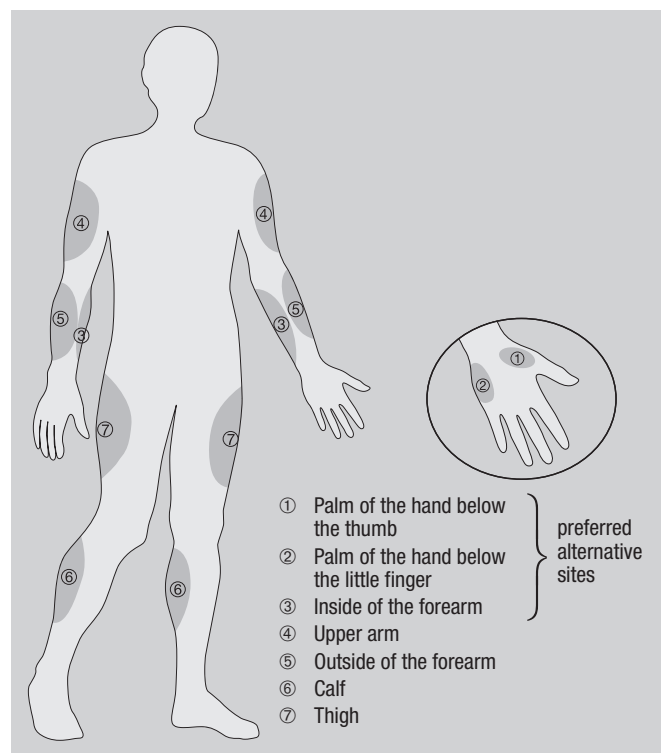

14.2 Obtaining blood and testing blood glucose

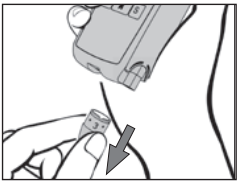

1. Remove the coloured cap from the lancing device.

2. Insert a new lancet into the lancing device as described in the instructions for use of the Accu-Chek Compact Plus meter.

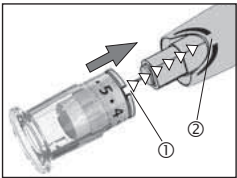

3. Attach the clear plastic AST cap. As with the coloured cap, the locating notch in the cap (1) must be directly aligned with the locating line on the lancing device (2). The AST cap must click into place.

i For blood collection, the AST cap must be on the lancing device. Without this cap, the lancing device cannot be primed, nor can the lancet be triggered. Instead, the lancet is ejected when you press the plunger.

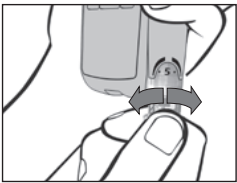

4. Rotate the cap until you reach your chosen penetration depth.

i To obtain a sufficiently large drop of blood from alternate sites, lancing must be deeper than on the fingertips. However, these sites are usually less painful.

5. Choose a fleshy area of the alternate site for blood collection and wash it with warm, soapy water. This ensures that the puncture site is clean. Allow the skin to dry thoroughly.

6. Prime the lancing device.

7. Press the AST cap firmly against the selected puncture site.

8. Press the plunger all the way down. This triggers the lancet, which penetrates the skin.

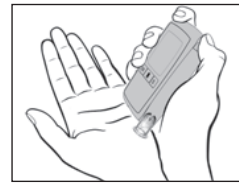

9. Keep the lancing device pressed against the puncture site for a few seconds.

You can watch the drop of blood form through the AST cap. The drop of blood should be approximately this size: ●

If the drop is smaller, release the pressure for a few seconds, without removing the lancing device from the puncture site. Then re-apply pressure on the lancing device until you get a sufficiently large drop of blood.

! Too much blood emerging can contaminate the AST cap. For hygienic reasons, the AST cap should be cleaned immediately after testing your blood glucose (see chapter "Cleaning the AST cap").

10. Press the Test button to turn the meter on.

11. Wait until the test strip symbol and drop symbol flash in the display.
12. Hold the meter so the test strip is pointing downwards.
13. Hold the tip of the test strip against the drop of blood so the black notch is touching the drop of blood.



The test strip draws up blood.

The test starts when the test strip has drawn up sufficient blood. The result is displayed as soon as the test is complete. At the same time the meter automatically saves the result to memory.

You can flag results obtained from alternate site testing as special results with an asterisk *. Please consult the instructions for use of the meter for information on how to flag results.

14. Hold the meter over a waste bin with the test strip pointing downwards.
15. Press the Test button to turn the meter off. The used test strip drops out.
16. Remove the AST cap from the lancing device and dispose of the used lancet.



Carefully dispose of used lancets so that the needles cannot cause injury.

17. Place the coloured cap back on the lancing device.

14.3 Cleaning the AST cap

Follow a weekly cleaning regime using a cloth moistened with 70 % ethanol or 70 % isopropanol (available in pharmacies). In addition, thoroughly wipe the inside of the AST cap using a cotton bud moistened with one of the two cleaning fluids mentioned.

Allow the AST cap time to dry thoroughly.



Never dip the AST cap in the cleaning fluid.

Cleaning fluid left in contact with the AST cap for too long can attack the material from which it is made, stopping it from functioning properly.



Use only 70 % ethanol or 70 % isopropanol to clean the AST cap. Other substances used for cleaning may attack the plastic and stop the cap from functioning properly.

15 Disposing of the meter

During blood glucose testing the meter itself may come into contact with blood. Used meters therefore carry a risk of infection. Please dispose of your used meter - after removing the batteries - according to the regulations applicable in your country. For information about correct disposal please contact your local council or authority.

The meter falls outside the scope of the European Directive 2002/96/EC (Directive on waste electrical and electronic equipment).

16 System components

Use only Accu-Chek Compact test strips for testing with the Accu-Chek Compact Plus meter. These are available from your pharmacist.

Use only Accu-Chek Compact Autocontrol control solutions to perform performance checks on your Accu-Chek Compact Plus meter.

Only use Accu-Chek Softclix lancets in your Accu-Chek Softclix Plus lancing device. The lancets are available in various pack sizes.

If you wish to use blood from alternate sites (such as the base of the thumb, forearm, upper arm, calf or thigh), you need a special, transparent AST cap to obtain blood using the Accu-Chek Softclix Plus lancing device. It is available through Accu-Chek Customer Care at 1-800-363-7949.

For healthcare professionals we recommend the Accu-Chek Softclix Pro lancing device (with special Accu-Chek Softclix Pro lancets), or the Accu-Chek Safe-T-Pro Plus or Accu-Chek Safe-T-Pro Uno disposable lancing devices.

17 Patents

Accu-Chek Compact Plus Meter

EP 732 590; EP 738 666; EP 742 436; EP 1 189 064; US 5,463,467; US 5,720,924; US 5,863,800; US 6,707,554; US 6,475,436; WO 2004/003549

Accu-Chek Softclix Plus Lancing Device

US 4,924,879; US-2004-0092996; US 2005-00908580; US Re. 35,803

Patent information

Roche has been granted patent protection in the USA for the Accu-Chek Softclix Plus lancing device and its use in combination with Accu-Chek Softclix and Accu-Chek Softclix XL lancets (US Patents 4,924,879 and Re. 35,803). Similar patent protection also exists in other countries, especially through European Patents 0565970, 0782838 and Japanese Patent 2702374. Your purchase entitles you to use your Accu-Chek Softclix Plus lancing device in combination with Accu-Chek Softclix and Accu-Chek Softclix XL lancets. As required by statute, Roche will refrain from pursuing its patent rights against private persons using the Accu-Chek Softclix Plus lancing device in combination with lancets from other manufacturers for non-commercial purposes. Acquisition of the Accu-Chek Softclix Plus lancing device is not associated, other than through the aforementioned statutory limitation on the effect of the patent, with any entitlement and in particular with any tacit permission for the acquirer to use third-party lancets. Roche reserves the right to assert its patent rights against any manufacturer offering lancets for the Accu-Chek Softclix Plus lancing device.

Accu-Chek Softclix Plus AST Accessory

US 5,951,493; US 6,071,250; US 6,464,649

210

Patents

18 Accu-Chek Customer Care

18.1 Advice and troubleshooting

Information service

If you have any questions on how to use your Accu-Chek Compact Plus meter or Accu-Chek Softclix Plus lancing device, if any of the results you obtain seem implausible, or if you suspect that the meter or lancing device may have a fault, please contact the Accu-Chek Customer Care. Refer to Chapter 18.2 "Addresses" for details.

Repair service

Please note that any repair, adjustment or other change to the meter or lancing device must only be performed by qualified persons who have been authorized by Roche Diagnostics. If you suspect that the meter or lancing device may have a fault, please start by contacting the Accu-Chek Customer Care. Our staff will attempt to identify and solve the problem with you over the phone.

Accu-Chek Customer Care

211

18

18.2 Addresses

Montreal area: (450) 686-7100

Outside Montreal (toll free): 1-800-363-7949

www.accu-chek.ca

Made in Ireland for export to:

Roche Diagnostics

201 Boul. Armand-Frappier

Laval, Quebec, Canada, H7V 4A2

19 Alphabetical index

A

Accu-Chek Customer Care 211

Acoustic Mode 120

setting 45

Alarm clock function

beep tone 59

setting alarms 59

symbol 60, 174

turning off individual alarms
65

Alternate sites 70, 200

AST cap 70, 200

Asterisk symbol 96, 174

At a glance

lancing device 15

meter 12

symbols 167

average (symbol) 108, 174

Averages 107

B

Bar code 16

Batteries

changing 145

disposal of ~ 149

life 147, 198

symbol 145, 171

types 14, 146, 198

Batteries, rechargeable 148

Battery compartment 14

Battery compartment cover 14

Beep tone

alarm clock function 59

announcement of results

using ~ 123, 126

during testing 45, 123

in Acoustic Mode 121

pitch 46, 121

setting 45

symbol 44, 174

Bell symbol 60, 174

Blanking plate 152

Blood

drawing up with test strip

84

obtaining 80

too little drawn up 89

volume 17, 196

Bottle symbol 35, 134, 173, 176

Brightness, display 48

C

Causes of error

downloading of results 118

performance check 137

test 99

Checking, meter 129
Cleaning
 AST cap 207
 lancing device 144
 meter 140
Clock symbol 33, 176
Control solution 129
 concentration table 130,
 135
 disposal of ~ 137
 drawing up with test strip
 133
 use-by date 138
Control window, test strip drum
14, 28
Customer Care line see
 Accu-Chek Customer Care 203

D

Data downloading 114
day (symbol) 108, 174
Disinfectants 162
Disinfecting, meter 158
Display 12
 illustrations 19, 169
 number of strips remaining
 36
 setting the brightness 48

 symbols in the ~ 168
Display check 21, 44, 78, 102
Disposal
 batteries 149
 control solution 137
 lancet 94
 meter 208
 test strip drum 32
 test strips 91
Downloading, results 114
 causes of error 118
Drop symbol 84, 170
Drum compartment 12
Drum compartment cover 12
Drum release button 12, 25
Drum symbol 172, 176

E

E and number (symbol) 184
EEE (symbol) 195
Electromagnetic compatibility
198
End (symbol) 29, 184
Error messages 181
 in Acoustic Mode 128

F

Flagging, result 96

H

HI (symbol) 98, 180
Highest value 107
Hourglass symbol 86, 174
Humidity 166, 197
Hypo indicator
 setting 67
 symbol 67, 173
hypo? (symbol) 67, 173

I

Infection risk 4, 150
Infrared window 14, 115
Intended use
 lancing device 5
 meter 4

L

Lancet 15
 disposal of ~ 94
 ejecting 92
 inserting 75

Lancing device
 at a glance 15
 cleaning 144
 docking 74
 obtaining blood using the ~
 80
 priming 81
 replacing with a blanking
 plate 152
 undocking 73
Light conditions 165
Light source, interfering 165
Liquids for cleaning
 lancing device 144
 meter 140
LO (symbol) 98, 180
Lowest value 107

M

M button 12, 42, 102
Measurement conditions 163
Measuring range 98, 196
Measuring time 86, 197
Measuring window 12
mem (symbol) 102, 175

Memory 101, 197
Memory location number 101, 106
Memory, results 101
Meter
 at a glance 12
 checking 129
 cleaning 140
 disinfecting 158
 disposal of ~ 208
 storage 163
 turning off 43, 90, 105
 turning on 44, 78, 102
mg/dL (symbol) 20, 172
mmol/L (symbol) 20, 172

N

n (symbol) 108, 175
NiMH batteries 148

P

Patents 210
Performance check 129
 causes of error 137
Performance evaluation 199
Penetration depth 80
 setting 81

Penetration depth setting 15
 window 15, 80
Plunger, lancing device 15, 71
Problems 181

R

Release button
 lancing device 14, 73
 test strip drum 12, 25
Result
 average 107
 downloading to e.g. a PC 114
 flagging 96
 highest value 107
 lowest value 107
 retrieving from memory 102

S

S button 12, 42, 103
set (symbol) 41, 174
Settings 38
 Acoustic Mode 45
 alarm clock function 59
 beep tone 45
 brightness of the display 48
 changing, rules 41
 closing 43

date 56
factory defaults 39
following battery replacement 39, 40, 147
hypo indicator 67
order 41
time 54
time-and-date format 52
turning the meter on 44
year 50
Setting the date 56
Setting the time 54
Setting the time-and-date format 52
Setting the year 50
Sources of electromagnetic interference 166
Sources of interference
 electromagnetic ~ 166
 light 165
Storage conditions 163
Symbols 167
 during testing 95
System components 209

T

Technical data 196
Temperature 163, 197
Test button 12
Test principle 196
Test strip guide 12
Test strip drum 12
 disposal of ~ 32
 inserting or replacing 24
 partly used ~ 31
 use-by period 33
Test strips 12
 disposal of ~ 91
 ejecting 90
 indication of the number remaining 36
 symbol 84, 170
 use-by date 29
Testing
 causes of error 99
 healthcare professionals 150
 procedure 78
Thermometer symbol 164, 170

Troubleshooting 181
Turning off, meter
 after testing 90
 automatic ~ 23, 43, 88, 91,
 106, 117, 198
 closing settings 43
 exiting memory 105
Turning on, meter
 retrieving results 102
 settings 42, 44
 testing 78
Type plate 14

U

Unit of measurement (mmol/L
and mg/dL) 20
Use-by date
 control solution 138
 test strips 29
Use-by period, test strip drum 33
 cannot be calculated 34
 expired 33



ACCU-CHEK, SOFTCLIX and SAFE-T-PRO
are trademarks of Roche.

Roche Diagnostics
201, boul. Armand-Frappier
Laval, Québec (CANADA) H7V 4A2
www.accu-chek.ca
Accu-Chek Customer Care: 1-800-363-7949



Roche Diagnostics GmbH
68298 Mannheim, Germany
www.accu-chek.com

DE 0 5125626001 (03) 2008-07 US 0 5125626002