

PIONEERING SINCE 1903

OWNER'S MANUAL 2018

VITPILEN 401

Art. no. 3402207en



<https://www.motorcycle-manual.com/>



<https://www.motorcycle-manual.com/>

DEAR HUSQVARNA MOTORCYCLES CUSTOMER

Congratulations on your decision to purchase a Husqvarna motorcycle. You are now the owner of a state-of-the-art sports motorcycle that will give you enormous pleasure if you service and maintain it properly.

We hope you enjoy riding this motorcycle!

Enter the serial numbers of your vehicle below.

Chassis number (📖 p. 32)	Dealer's stamp
Engine number (📖 p. 33)	
Key number (📖 p. 34)	

The Owner's Manual contained the latest information for this model series at the time of going to print. However, minor differences due to further developments in design cannot be ruled out completely.

All specifications are non-binding. Husqvarna Motorcycles GmbH specifically reserves the right to modify or delete technical specifications, prices, colors, forms, materials, services, designs, equipment, etc., without prior notice and without specifying reasons, to adapt these to local conditions, as well as to stop production of a particular model without prior notice. Husqvarna Motorcycles accepts no liability for delivery options, deviations from illustrations and descriptions, as well as misprints and other errors. The models portrayed partly contain special equipment that does not belong to the regular scope of supply.

© 2018 Husqvarna Motorcycles GmbH, Mattighofen Austria
All rights reserved



DEAR HUSQVARNA MOTORCYCLES CUSTOMER

Reproduction, even in part, as well as copying of all kinds, is permitted only with the express written permission of the copyright owner.



ISO 9001(12 100 6061)

Husqvarna Motorcycles applies quality assurance processes that lead to the highest possible product quality as defined in the ISO 9001 international quality management standard.

Issued by: TÜV Management Service

Husqvarna Motorcycles GmbH
Stallhofnerstraße 3
5230 Mattighofen, Austria

This document is valid for the following models:

VITPILEN 401 US (F2375R1)

1	MEANS OF REPRESENTATION.....	9	3.3	Spare parts, accessories	24	
	1.1	Symbols used	9	3.4	Service	25
	1.2	Formats used	10	3.5	Figures	25
2	SAFETY ADVICE	11	3.6	Customer service.....	25	
	2.1	Use definition	11	4	VIEW OF VEHICLE	28
	2.2	Misuse.....	11	4.1	View of vehicle, front left (example)	28
	2.3	Safety advice	11	4.2	View of vehicle, rear right (example).....	30
	2.4	Degrees of risk and symbols	12	5	SERIAL NUMBERS.....	32
	2.5	Overview of labels.....	14	5.1	Chassis number	32
	2.6	Consumer rights	18	5.2	Type label.....	32
	2.7	Operating noise warning.....	19	5.3	Engine number.....	33
	2.8	Noise emission warranty.....	19	5.4	Key number.....	34
	2.9	Reporting safety defects.....	19	6	CONTROLS	35
	2.10	Tampering warning	20	6.1	Clutch lever	35
	2.11	Safe operation.....	21	6.2	Hand brake lever.....	35
	2.12	Protective clothing	22	6.3	Throttle grip.....	36
	2.13	Work rules	22	6.4	Switches on the left side of the handlebar	36
	2.14	Environment.....	23	6.4.1	High beam flasher button.....	36
	2.15	Owner's Manual	23	6.4.2	Light switch	37
3	IMPORTANT NOTES	24	6.4.3	Turn signal switch	37	
	3.1	Manufacturer and implied warranty	24			
	3.2	Operating and auxiliary substances ...	24			

TABLE OF CONTENTS

6.4.4	Horn button	38	8	COMBINATION INSTRUMENT	52
6.5	Switches on the right side of the handlebar	38	8.1	Combination instrument	52
6.5.1	Emergency OFF switch	38	8.2	Activation and test	53
6.5.2	Electric starter button	39	8.3	Warning notes	54
6.6	Ignition/steering lock	39	8.4	Indicator lamps	59
6.7	Locking the steering	40	8.5	Shift warning light	61
6.8	Unlocking the steering	41	8.6	Display	63
6.9	Opening the filler cap	41	8.7	Fuel level display	64
6.10	Closing the filler cap	43	8.8	Coolant temperature indicator	65
6.11	Seat lock	44	8.9	Function buttons	66
6.12	Tool set	44	8.10	Info display	67
6.13	Grab handle	45	8.11	ODO display	68
6.14	Passenger foot pegs	45	8.11.1	Fuel Range	68
6.15	Shift lever	46	8.11.2	Service	69
6.16	Foot brake lever	47	8.12	TRIP 1 display	70
6.17	Side stand	47	8.12.1	Time Trip 1	71
7	ERGONOMICS	49	8.12.2	Average Speed Trip1	72
7.1	Adjusting the basic position of the hand brake lever	49	8.12.3	Avg F.C. Trip 1	73
7.2	Adjusting the basic position of the clutch lever	49	8.13	TRIP 2 display	74
7.3	Adjusting the shift lever	50	8.13.1	Time Trip 2	74
			8.13.2	Average Speed Trip2	75
			8.13.3	Avg F.C. Trip 2	76
			8.14	Setting the units	77
			8.15	Setting the clock	78





8.16	Adjusting the shift speed RPM1	79	12	TUNING THE CHASSIS.....	107
8.17	Adjusting the shift speed RPM2	80	12.1	Adjusting the spring preload of the shock absorber 	107
9	PREPARING FOR USE.....	82	13	SERVICE WORK ON THE CHASSIS	108
9.1	Advice on preparing for first use.....	82	13.1	Raising the motorcycle with the rear lifting gear	108
9.2	Running in the engine	84	13.2	Removing the rear of the motorcycle from the lifting gear	110
9.3	Loading the vehicle.....	84	13.3	Lifting the motorcycle with the front lifting gear.....	112
10	RIDING INSTRUCTIONS	87	13.4	Taking the motorcycle off the front lifting gear	113
10.1	Checks and maintenance measures when preparing for use.....	87	13.5	Cleaning the dust boots of the fork legs	114
10.2	Starting	88	13.6	Removing the seat	115
10.3	Starting off	90	13.7	Mounting the seat	116
10.4	Shifting, riding.....	91	13.8	Removing the left side cover 	116
10.5	Applying the brakes	96	13.9	Installing the left side cover 	119
10.6	Stopping, parking	98	13.10	Removing the right side cover 	121
10.7	Transport.....	100	13.11	Installing the right side cover 	124
10.8	Refueling	101	13.12	Removing the license plate holder....	127
11	SERVICE SCHEDULE.....	103	13.13	Installing the license plate holder	131
11.1	Additional information.....	103	13.14	Checking for chain dirt accumulation	136
11.2	Required work.....	103			
11.3	Recommended work.....	106			

TABLE OF CONTENTS

13.15	Cleaning the chain	136	15.4	Installing the rear wheel 🛠️.....	167
13.16	Checking the chain tension	138	15.5	Checking the rear hub rubber dampers 🛠️.....	170
13.17	Adjusting the chain tension.....	139	15.6	Checking the tire condition.....	171
13.18	Checking the chain, rear sprocket, and engine sprocket	141	15.7	Checking the tire air pressure.....	174
14	BRAKE SYSTEM	144	15.8	Checking spoke tension	175
14.1	Antilock brake system (ABS).....	144	16	ELECTRICAL SYSTEM.....	176
14.2	Checking the brake discs	146	16.1	Removing the battery 🛠️.....	176
14.3	Checking the front brake fluid level.....	148	16.2	Installing the battery 🛠️.....	179
14.4	Adding front brake fluid 🛠️.....	149	16.3	Recharging the battery 🛠️	181
14.5	Checking the front brake linings	152	16.4	Changing the ABS fuses.....	184
14.6	Checking the rear brake fluid level ...	153	16.5	Changing the fuses of individual power consumers	187
14.7	Adding rear brake fluid 🛠️.....	154	16.6	Changing the turn signal bulb.....	190
14.8	Checking the rear brake linings	156	16.7	Checking the headlight setting	191
14.9	Checking the free travel of the foot brake lever	158	16.8	Adjusting the headlight range	192
14.10	Adjusting the free travel of the foot brake lever 🛠️.....	159	16.9	Diagnostics connector	193
15	WHEELS, TIRES	161	16.10	Front ACC1 and ACC2	194
15.1	Removing the front wheel 🛠️.....	161	16.11	ACC2 rear	194
15.2	Installing the front wheel 🛠️.....	162	17	COOLING SYSTEM.....	195
15.3	Removing the rear wheel 🛠️.....	165	17.1	Cooling system	195
			17.2	Checking the antifreeze and coolant level.....	196

17.3	Checking the coolant level.....	199	22	TROUBLESHOOTING	226
17.4	Draining the coolant 🛠.....	201	23	TECHNICAL DATA	229
17.5	Filling/bleeding the cooling system 🛠.....	202	23.1	Engine	229
17.6	Changing the coolant 🛠.....	205	23.2	Engine tightening torques.....	230
18	TUNING THE ENGINE.....	209	23.3	Capacities	235
18.1	Checking the clutch lever play.....	209	23.3.1	Engine oil.....	235
18.2	Adjusting play in the clutch lever 🛠.....	210	23.3.2	Coolant.....	235
19	SERVICE WORK ON THE ENGINE	211	23.3.3	Fuel.....	235
19.1	Checking the engine oil level	211	23.4	Chassis	235
19.2	Changing the engine oil and oil filter, cleaning the oil screens 🛠.....	212	23.5	Electrical system.....	237
19.3	Adding engine oil	216	23.6	Tires	238
20	CLEANING, CARE	218	23.7	Fork.....	238
20.1	Cleaning the motorcycle.....	218	23.8	Shock absorber	239
20.2	Checks and maintenance steps for winter operation	221	23.9	Chassis tightening torques	239
21	STORAGE.....	223	24	SUBSTANCES.....	246
21.1	Storage	223	25	AUXILIARY SUBSTANCES.....	249
21.2	Preparing for use after storage.....	225	26	STANDARDS	251
			27	INDEX OF SPECIAL TERMS	252
			28	LIST OF ABBREVIATIONS	253
			29	LIST OF SYMBOLS	254
			29.1	Yellow and orange symbols.....	254

TABLE OF CONTENTS

29.2	Green and blue symbols.....	254
INDEX		255

1.1 Symbols used

The meaning of specific symbols is described below.



Indicates an expected reaction (e.g. of a work step or a function).



Indicates an unexpected reaction (e.g. of a work step or a function).



All work marked with this symbol requires specialist knowledge and technical understanding. In the interests of your own safety, have these jobs performed by an authorized Husqvarna Motorcycles workshop. There, your motorcycle will be optimally cared for by specially trained experts using the specialist tools required.



Indicates a page reference (more information is provided on the specified page).



Indicates information with more details or tips.



Indicates the result of a testing step.

1 MEANS OF REPRESENTATION



Indicates a voltage measurement.



Indicates a current measurement.



Indicates the end of an activity, including potential rework.

1.2 Formats used

The typographical formats used in this document are explained below.

Proprietary name	Indicates a proprietary name.
Name®	Indicates a protected name.
Brand™	Indicates a brand available on the open market.
<u>Underlined terms</u>	Refer to technical details of the vehicle or indicate technical terms, which are explained in the glossary.

2.1 Use definition

This vehicle has been designed and built to withstand the normal stresses and strains of road use. This vehicle is not suitable for use on race tracks or offroad.



Info

This vehicle is only authorized for operation on public roads in its homologated version.

2.2 Misuse

The vehicle must only be used as intended.

Dangers can arise for people, property and the environment through use not as intended.

Any use of the vehicle beyond the intended and defined use constitutes misuse.

Misuse also includes the use of operating and auxiliary fluids which do not meet the required specification for the respective use.

2.3 Safety advice

A number of safety instructions need to be followed to operate the product described safely. Therefore read this instruction and all further instructions included carefully. The safety instructions are highlighted in the text and are referred to at the relevant passages.



Info

Various information and warning labels are attached in prominent locations on the product described. Do not remove any information or warning labels. If they are missing, you or others may not recognize dangers and may therefore be injured.

2.4 Degrees of risk and symbols



Danger

Identifies a danger that will immediately and invariably lead to fatal or serious permanent injury if the appropriate measures are not taken.



Warning

Identifies a danger that is likely to lead to fatal or serious injury if the appropriate measures are not taken.



Caution

Identifies a danger that may lead to minor injuries if the appropriate measures are not taken.

Note

Identifies a danger that will lead to considerable machine and material damage if the appropriate measures are not taken.



Note

Indicates a danger that will lead to environmental damage if the appropriate measures are not taken.

2 SAFETY ADVICE

2.5 Overview of labels



- | | |
|---|-------------------------------------|
| 1 | Type label for Canada |
| 2 | Information on emissions control |
| 3 | Information on chain tension |
| 4 | Information on preparations for use |
| 5 | Information on noise emissions |
| 6 | Type label for USA |

MANUFACTURED BY/FABRIQUE PAR		KTM AG	
GVWR/PNDV	335 KG	DATE	XXXX
V.I.N./R.V.	VBKXXXXXXXXXXXX		
TYPE	MC		
GAAR/YNDE	TIRE/PNEU-DIMENSION-RIMJANTE		COLD INFL. PRESS PRESS. DE GONFL. A FROID
			PSI/LPC KPA
1H	130 KG	118/70R17 3.00x17	39 300
2H	230 KG	150/60R17 4.00x17	29 200
THIS VEHICLE CONFORMS TO ALL APPLICABLE STANDARDS PRESCRIBED UNDER THE CANADIAN MOTOR-VEHICLE SAFETY REGULATIONS IN EFFECT ON THE DATE OF MANUFACTURE - CE VÉHICULE EST CONFORME À TOUTES LES NORMES QUI LUI SONT APPLICABLES EN VERTU DU RÈGLEMENT SUR LA SÉCURITÉ DES VÉHICULES AUTOMOBILES DU CANADA EN VIGUEUR À LA DATE DE SA FABRICATION.			

F01415-01

Type label for Canada

2 SAFETY ADVICE

VEHICLE EMISSION CONTROL INFORMATION	
HUSQVARN	MANUFACTURER: KTM AG, Mattighofen, Austria
	IMPORTER: KTM NORTH AMERICA, INC.
ENGINE DISPLACEMENT	373 cc
ENGINE FAMILY	JKTRC.373PIL
EVAPORATIVE FAMILY	JKTED0014PL
PERMADATION FAMILY	JKTXPP1048ST
	ENGINE EXHAUST EMISSION CONTROL SYSTEM
	TWC, TBI, HD29
	MODEL NAME
	Viper® 401
THIS VEHICLE CONFORMS WITH US EPA AND CALIFORNIA REGULATIONS APPLICABLE TO 2018 MODEL YEAR NEW MOTORCYCLES AND IS CERTIFIED TO 2.0 GPM HC+NOX, 12.0 GPM CO EXHAUST EMISSION STANDARDS IN CALIFORNIA.	
ENGINE TUNEUP SPECIFICATIONS	
IGNITION TIMING:	NON-ADJUSTABLE
IDLE SPEED:	1100 ± 50 RPM IN NEUTRAL
IDLE MATURE:	NON-ADJUSTABLE
VALVE CLEARANCE:	0.08 - 0.12 mm INTAKE 0.13 - 0.17 mm EXHAUST
SPARK PLUG:	BOSSCH V18HR4
SPARK PLUG GAP:	1.0 mm
FUEL:	UNLEADED GASOLINE ONLY - 87 (89-92) OCTANE OR HIGHER
Oil:	SAE 15W-50

E01145-01

Information on emissions control

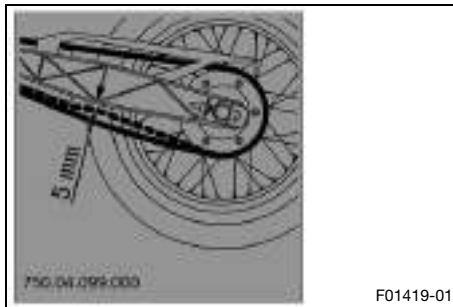

F01419-01

Information on chain tension

Information on preparations for use

ACHTUNG:
Lesen Sie vor dem ersten Inbetriebnahme des Fahrzeuges die gesamte Bedienungsanleitung aufmerksam durch!

IMPORTANT:
Please read the entire owner's manual carefully before putting the vehicle into operation for the first time.

ATTENZIONE:
Prima della messa in funzione leggere attentamente l'intero manuale d'uso!

ATTENTION:
Lire attentivement l'ensemble du manuel d'utilisation avant de mettre le véhicule en service!

ATENCIÓN:
Leer cuidadosamente y atentamente el manual de instrucciones antes de poner el vehículo por primera vez en servicio!

F00491-01

MOTORCYCLE NOISE EMISSION CONTROL INFORMATION
KTM AG, AUSTRIA

THIS 2018 HQV9080373 MOTORCYCLE, 285.05.082.033 MEETS EPA NOISE EMISSION REQUIREMENTS OF 80 dBA AT 7100 RPM BY THE FEDERAL TEST PROCEDURE. MODIFICATIONS WHICH CAUSE THIS MOTORCYCLE TO EXCEED FEDERAL NOISE STANDARDS ARE PROHIBITED BY U.S. FEDERAL LAW. SEE OWNER'S MANUAL.

Motorcycle Type : Vitpilen 401

E01147-01

Information on noise emissions

2 SAFETY ADVICE

		MFD BY KTM AG AUSTRIA		DATE xxxx	
		MOTORCYCLE			
GWR	732 lbs	355 kg			
GAWR FRONT	298 lbs	135 kg WITH	150/70R17 TIRE	54H TYPE	
	3.00x17 RIM AT	29 psi 2.0	bar COLD		
GAWR REAR	597 lbs	270 kg WITH	150/60R17 TIRE	66H TYPE	
	4.00x17 RIM AT	29 psi 2.0	bar COLD		
THIS VEHICLE CONFORMS TO ALL APPLICABLE U.S. FEDERAL MOTOR VEHICLE SAFETY STANDARDS IN EFFECT ON THE DATE OF MANUFACTURE SHOWN ABOVE.					
VBKxxxxxxxMxxxxxx					

F01416-01

Type label for USA

2.6 Consumer rights

Warranty claims should be submitted to a Husqvarna Motorcycles workshop. If you are not satisfied, please contact:

Husqvarna Motorcycles North America, Inc., c/o KTM North America, Inc., Customer Support, 1119 Milan Ave., Amherst, OH 44001, USA

Phone: (440) 985-3553

www.husqvarna-motorcycles.com

Husqvarna Motorcycles North America, 1375-3 Marie-Victorin, Saint-Bruno, QC J3V-6B7, Canada

Phone: (450) 441-9222

www.husqvarna-motorcycles.com

Different rights may apply, according to national or regional legislation.

2.7 Operating noise warning

This product should be checked for necessary repair or replacement parts if the motorcycle noise has increased significantly through use. Otherwise, the owner may become subject to penalties under the applicable ordinances.

2.8 Noise emission warranty

Husqvarna Motorcycles North America, Inc. guarantees that this exhaust system satisfies all U.S. EPA Federal noise emission standards applicable at the time of sale.

This warranty extends to the first person who buys this exhaust system for purposes other than resale, and to all subsequent buyers.

Warranty claims should be directed to:

Husqvarna Motorcycles North America, Inc., c/o KTM North America, Inc., Customer Support, 1119 Milan Ave., Amherst, OH 44001, USA

Phone: (440) 985-3553

www.husqvarna-motorcycles.com

Husqvarna Motorcycles North America, 1375-3 Marie-Victorin, Saint-Bruno, QC J3V-6B7, Canada

Phone: (450) 441-9222

www.husqvarna-motorcycles.com

2.9 Reporting safety defects

If you believe that your vehicle has a defect which could cause an accident resulting in injury or death, you should immediately inform the National Highway Traffic Safety Administration (NHTSA) in addition to notifying Husqvarna Motorcycles North America, Inc.

2 SAFETY ADVICE

If the NHTSA receives multiple similar complaints, it may open an investigation. and if it finds that a safety defect exists in a group of vehicles, it may order a recall and remedy campaign. However, NHTSA cannot become involved in individual problems between you, your dealer, or Husqvarna Motorcycles North America, Inc.

You can contact the NHTSA via the toll-free “Auto Safety Hotline” on 1–888–327–4236, visit the www.nhtsa.dot.gov website, or write to: NHTSA Headquarters, 1200 New Jersey Avenue, SE, West Building, Washington, DC 20590. You can also obtain other information about motor vehicle safety from the hotline.

2.10 Tampering warning

Tampering with the noise control system is prohibited. Federal law prohibits the following acts or the causing thereof:

- 1 The removal or rendering inoperative by any person other than for purposes of maintenance, repair, or replacement, of any device or element of design incorporated into any new vehicle for the purpose of noise control prior to its sale or delivery to the ultimate purchaser or while it is in use, or
- 2 the use of the vehicle after such device or element of design has been removed or rendered inoperative by any person.

Among those acts presumed to constitute tampering are the acts listed below:

- 1 Removal or puncturing of the main silencer, baffles, header pipes or any other components which conduct exhaust gases.
- 2 Removal or puncturing of parts of the intake system.
- 3 Lack of proper maintenance.
- 4 Replacing moving part of the vehicle, or parts of the exhaust or intake system, with parts other than those specified by the manufacturer.

2.11 Safe operation



Danger

Danger of accidents A rider who is not fit to ride poses a danger to him or herself and others.

- Do not operate the vehicle if you are not fit to ride due to alcohol, drugs or medication.
- Do not operate the vehicle if you are physically or mentally impaired.



Danger

Danger of poisoning Exhaust gases are toxic and inhaling them may result in unconsciousness and death.

- Always make sure there is sufficient ventilation when running the engine.
- Use an effective exhaust extraction system when starting or running the engine in an enclosed space.



Warning

Danger of burns Some vehicle components become very hot when the vehicle is operated.

- Do not touch any parts such as the exhaust system, radiator, engine, shock absorber, or brake system before the vehicle parts have cooled down.
- Let the vehicle parts cool down before you perform any work on the vehicle.

Only operate the vehicle when it is in perfect technical condition, in accordance with its intended use, and in a safe and environmentally compatible manner.

An appropriate driver's license is needed to ride the vehicle on public roads.

2 SAFETY ADVICE

Have malfunctions that impair safety immediately eliminated by an authorized Husqvarna Motorcycles workshop.

Adhere to the information and warning labels on the vehicle.

2.12 Protective clothing



Warning

Risk of injury Missing or poor protective clothing presents an increased safety risk.

- Wear appropriate protective clothing such as helmet, boots, gloves as well as trousers and a jacket with protectors on all rides.
- Always wear protective clothing that is in good condition and meets the legal regulations.

In the interest of your own safety, Husqvarna Motorcycles recommends that you only operate the vehicle while wearing protective clothing.

2.13 Work rules

Special tools are necessary for certain tasks. The tools are not a component of the vehicle, but can be ordered using the number in parentheses. Example: bearing puller (15112017000)

During assembly, use new parts to replace parts which cannot be reused (e.g. self-locking screws and nuts, seals, sealing rings, O-rings, pins, and lock washers).

In the case of certain screws, a thread locker (e.g. **Loctite**®) is required. Apply according to the manufacturer's instructions.

After disassembly, clean the parts that are to be reused and check them for damage and wear. Change damaged or worn parts.

After completing a repair or service work, check the operating safety of the vehicle.

2.14 Environment

If you use your motorcycle responsibly, you can ensure that problems and conflicts do not occur. To protect the future of the motorcycle sport, make sure that you use your motorcycle legally, be environmentally aware, and respect the rights of others.

When disposing of used oil, other operating and auxiliary fluids, and used components, comply with the laws and regulations of the respective country.

Because motorcycles are not subject to the EU regulations governing the disposal of used vehicles, there are no legal regulations that pertain to the disposal of an end-of-life motorcycle. Your authorized Husqvarna Motorcycles dealer will be glad to advise you.

2.15 Owner's Manual

It is important that you read this Owner's Manual carefully and completely before making your first trip. The Owner's Manual contains useful information and many tips on how to operate, handle, and maintain your motorcycle. Only then will you find out how to customize the vehicle ideally for your own use and how you can protect yourself from injury.

Keep the Owner's Manual in an accessible place to enable you to refer to it as needed.

If you would like to know more about the vehicle or have questions on the material you read, please contact an authorized Husqvarna dealer.

The Owner's Manual is an important component of the vehicle and must be handed over to the new owner if the vehicle is sold.

The Owner's Manual is also available for download from your authorized Husqvarna Motorcycles dealer and on the Husqvarna Motorcycles website.

International Husqvarna Motorcycles website: www.husqvarna-motorcycles.com

3 IMPORTANT NOTES

3.1 Manufacturer and implied warranty

The work prescribed in the service schedule must be carried out by an authorized Husqvarna Motorcycles workshop only and confirmed both in the customer's Service & Warranty Booklet and in the **Husqvarna Motorcycles Dealer.net**; otherwise, all warranty claims will be void. Damage or secondary damage caused by tampering with and/or conversions on the vehicle are not covered by the warranty. Additional information on the manufacturer or implied warranty and the procedures involved can be found in the Service & Warranty Booklet.

3.2 Operating and auxiliary substances



Note

Environmental hazard Improper handling of fuel is a danger to the environment.

- Do not allow fuel to enter the groundwater, the soil, or the sewage system.

Use operating and auxiliary substances in accordance with the Owner's Manual and specification.

3.3 Spare parts, accessories

For your own safety, only use spare parts and accessory products that are approved and/or recommended by Husqvarna Motorcycles and have them installed by an authorized Husqvarna Motorcycles workshop. Husqvarna Motorcycles accepts no liability for other products and any resulting damage or loss. Certain spare parts and accessory products are specified in parentheses in the descriptions. Your authorized Husqvarna Motorcycles dealer will be glad to advise you.

The current Husqvarna Motorcycles accessories for your vehicle can be found on the Husqvarna Motorcycles website.

International Husqvarna Motorcycles website: www.husqvarna-motorcycles.com

3.4 Service

A prerequisite for perfect operation and prevention of premature wear is that the service, care, and tuning work on the engine and chassis is properly carried out as described in the Owner's Manual. Incorrect adjustment and tuning of the engine and chassis can lead to damage and breakage of components.

Use of the vehicle under difficult conditions, such as in rain, high heat or with a heavy load, can lead to considerably more rapid wear of components such as the drive train, brake system, or suspension components. For this reason, it may be necessary to inspect or replace parts before the next scheduled service.

It is imperative that you adhere to the stipulated run-in times and service intervals. If you observe these exactly, you will ensure a much longer service life for your motorcycle.

3.5 Figures

The figures contained in the manual may depict special equipment.

In the interest of clarity, some components may be shown disassembled or may not be shown at all. It is not always necessary to disassemble the component to perform the activity in question. Please follow the instructions in the text.

3.6 Customer service

Your authorized Husqvarna Motorcycles dealer will be happy to answer any questions you may have regarding your vehicle and Husqvarna Motorcycles.

3 IMPORTANT NOTES

A list of authorized Husqvarna Motorcycles dealers can be found on the Husqvarna Motorcycles website.
International Husqvarna Motorcycles website: www.husqvarna-motorcycles.com

4 VIEW OF VEHICLE

4.1 View of vehicle, front left (example)



- ① Combination instrument (📖 p. 52)
- ② Clutch lever (📖 p. 35)
- ③ High beam flasher button (📖 p. 36)
- ③ Light switch (📖 p. 37)
- ③ Turn signal switch (📖 p. 37)
- ③ Horn button (📖 p. 38)
- ④ Filler cap
- ⑤ Seat
- ⑥ Grab handle (📖 p. 45)
- ⑦ Passenger foot pegs (📖 p. 45)
- ⑧ Shift lever (📖 p. 46)
- ⑨ Side stand (📖 p. 47)
- ⑩ Engine number (📖 p. 33)
- ⑪ Seat lock (📖 p. 44)

4 VIEW OF VEHICLE

4.2 View of vehicle, rear right (example)



- ① Tool set (📖 p. 44)
- ② Ignition/steering lock (📖 p. 39)
- ③ Emergency OFF switch (📖 p. 38)
- ③ Electric starter button (📖 p. 39)
- ④ Throttle grip (📖 p. 36)
- ⑤ Hand brake lever (📖 p. 35)
- ⑥ Level viewer, engine oil
- ⑦ Foot brake lever (📖 p. 47)
- ⑧ Compensating tank for coolant

5 SERIAL NUMBERS

5.1 Chassis number

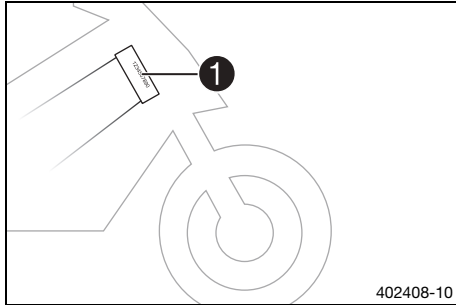

The chassis number ❶ is stamped on the right side of the steering head.

5.2 Type label

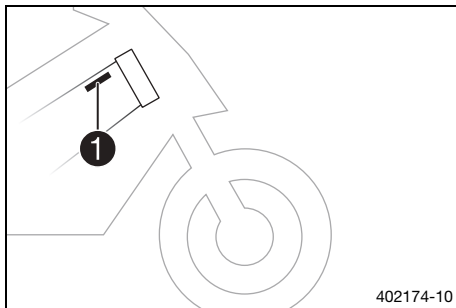

The USA type label ❶ is on the right of the frame behind the steering head.

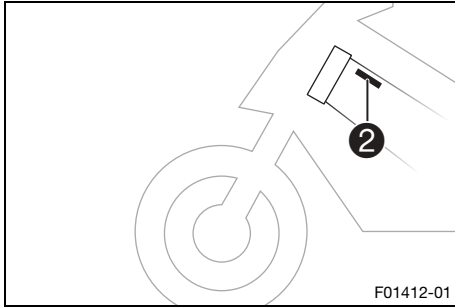

The Canada type label **2** is on the left of the frame behind the steering head.

5.3 Engine number

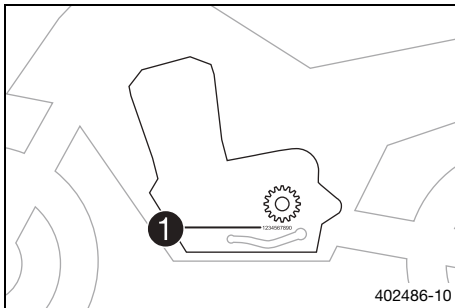

The engine number **1** is stamped on the left side of the engine under the engine sprocket.

5 SERIAL NUMBERS

5.4 Key number

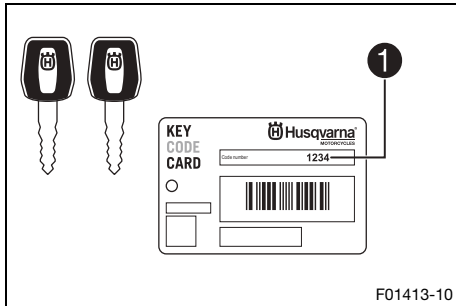

The key number **1** can be found on the **KEYCODECARD**.



Info

You need the key number to order a spare key. Keep the **KEYCODECARD** in a safe place.

6.1 Clutch lever

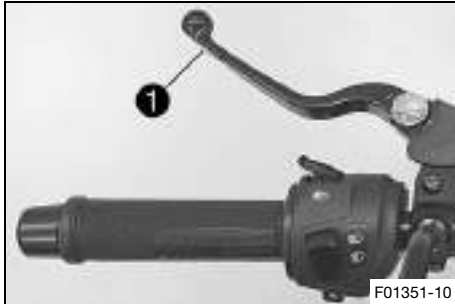

The clutch lever ❶ is fitted on the left side of the handlebar.

6.2 Hand brake lever

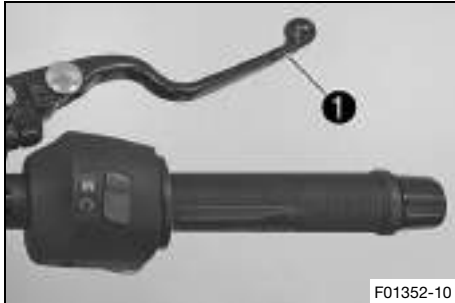

The hand brake lever ❶ is fitted on the right side of the handlebar.

The front brake is engaged using the hand brake lever.

6 CONTROLS

6.3 Throttle grip

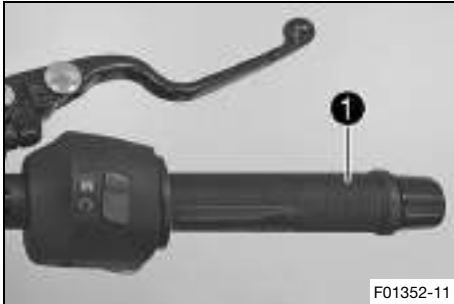

The throttle grip ❶ is fitted on the right side of the handlebar.

6.4 Switches on the left side of the handlebar

6.4.1 High beam flasher button

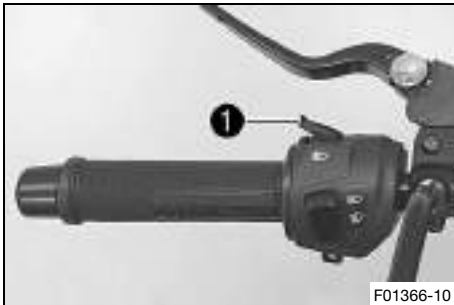

The high beam flasher button ❶ is fitted on the left side of the handlebar.

Possible states

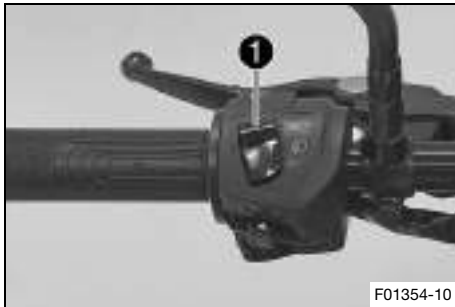

- High beam flasher button in neutral position
- High beam flasher button pressed – In this position, the headlight flasher (high beam) is actuated.

6.4.2 Light switch



Light switch ❶ is fitted on the left side of the handlebar.

Possible states



	Low beam on – The light switch is turned downward. In this position, the low beam and tail light are switched on.
	High beam on – The light switch is turned upwards. In this position, the low beam, the high beam and the tail light are switched on.

6.4.3 Turn signal switch



Turn signal switch ❶ is fitted on the left side of the handlebar.

Possible states

	Turn signal off
	Left turn signal, on – Turn signal switch pressed to the left. The turn signal switch returns automatically to the central position after use.
	Right turn signal, on – Turn signal switch pressed to the right. The turn signal switch returns automatically to the central position after use.

To switch off the turn signal, press the turn signal switch towards the switch case.

6 CONTROLS

6.4.4 Horn button



The horn button ❶ is fitted on the left side of the handlebar.

Possible states

- Horn button ❶ in neutral position
- Horn button ❶ pressed – The horn is operated in this position.

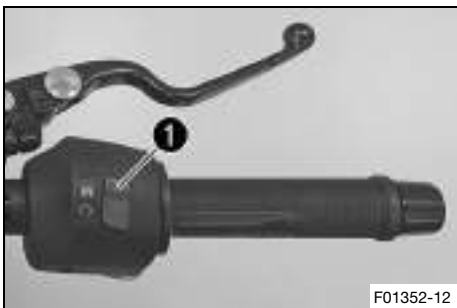

6.5 Switches on the right side of the handlebar

6.5.1 Emergency OFF switch



The emergency OFF switch ❶ is fitted on the right side of the handlebar.

Possible states

	Emergency OFF switch off – In this position, the ignition circuit is interrupted, a running engine stops, and a non-running engine cannot be started.
	Emergency OFF switch on – This position is required for operation; the ignition circuit is closed.

6.5.2 Electric starter button



The electric starter button ❶ is fitted on the right side of the handlebar.

Possible states

- Electric starter button ❷ in basic position
- Electric starter button ❷ pressed – In this position, the electric starter is actuated.

6.6 Ignition/steering lock



The ignition/steering lock is in front of the upper triple clamp.

Possible states

	<p>Ignition off OFF – In this position, the ignition circuit is interrupted, a running engine stops, and a non-running engine will not start. The ignition key can be removed.</p>
	<p>Ignition on – In this position, the ignition circuit is closed and the engine can be started.</p>
	<p>Steering locked – In this position, the ignition circuit is interrupted and the steering locked. The ignition key can be removed.</p>

6.7 Locking the steering

Note

Danger of damage The parked vehicle can roll away or fall over.

- Park the vehicle on a firm and level surface.

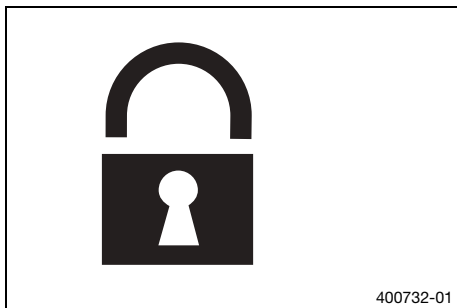

- Park the vehicle.
- Turn the handlebar all the way to the left.

Info

The steering can also be locked by turning it fully to the right. With the steering turned to the right, the vehicle is in a less slanted position.

- Insert the key into the ignition/steering lock, press in, and turn to the left. Remove the key.
 - ✓ Steering is no longer possible.

6.8 Unlocking the steering

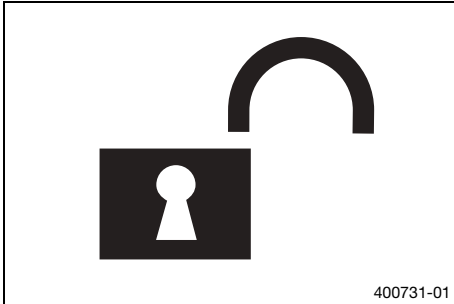

- Insert the key into the ignition/handlebar lock, press in, and turn to the right. Remove the key.
- ✓ You can now steer the bike again.

6.9 Opening the filler cap



Danger

Fire hazard Fuel is highly flammable.

The fuel in the fuel tank expands when warm and can escape if overfilled.

- Do not refuel the vehicle in the vicinity of open flames or lit cigarettes.
- Switch off the engine for refueling.
- Make sure that no fuel is spilled; particularly not on hot parts of the vehicle.
- If any fuel is spilled, wipe it off immediately.
- Observe the specifications for refueling.



Warning

Danger of poisoning Fuel is poisonous and a health hazard.

- Avoid skin, eye and clothing contact with fuel.
- Immediately consult a doctor if you swallow fuel.
- Do not inhale fuel vapors.
- In case of skin contact, rinse the affected area with plenty of water.
- Rinse the eyes thoroughly with water, and consult a doctor in case of fuel contact with the eyes.
- Change your clothing in case of fuel spills on them.
- Keep fuels correctly in a suitable canister, and out of the reach of children.



Note

Environmental hazard Improper handling of fuel is a danger to the environment.

- Do not allow fuel to enter the groundwater, the soil, or the sewage system.

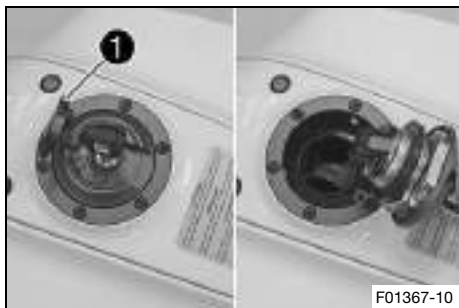

- Lift cover **1** of the filler cap and insert the ignition key in the lock.

Note

Danger of damage The ignition key may break if overloaded.

Damaged ignition keys must be replaced.

- Push down on the filler cap to take pressure off the ignition key.
-
- Turn the ignition key 90° clockwise.

- Open the filler cap.



6.10 Closing the filler cap

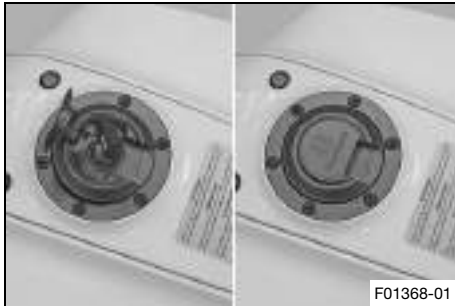

Warning

Fire hazard Fuel is highly flammable, toxic and a health hazard.

- Check the filler cap is locked correctly after closing.
- Change your clothing in case of fuel spills on them.
- Rinse the affected area immediately with plenty of water in the event of contact with the skin.

- Fold down the filler cap.
- Turn the ignition key 90° clockwise.
- Push down the filler cap and turn the ignition key counter-clockwise until the tank lock engages.
- Remove the ignition key and close the cover.



6 CONTROLS

6.11 Seat lock



The seat lock ❶ is located at the front left below the fuel tank. The seat lock can be unlocked using the ignition key.

6.12 Tool set



The tool set ❶ is located under the seat.

6.13 Grab handle



The grab handle ❶ is used for maneuvering the motorcycle. If you carry a passenger, the passenger can hold onto the grab handles during the trip.

6.14 Passenger foot pegs

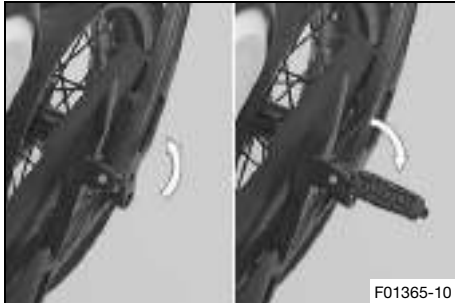

The passenger foot pegs can be folded up and down.

Possible states

- Passenger foot pegs folded up – For operation without a passenger.
- Passenger foot pegs folded down – For operation with a passenger.

6 CONTROLS

6.15 Shift lever

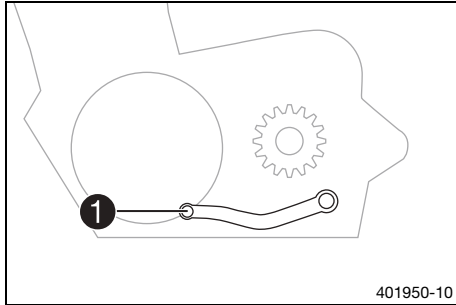

Shift lever **1** is mounted on the left side of the engine.

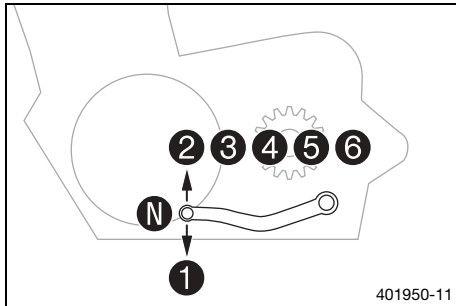

The gear positions can be seen in the photograph.
The neutral or idle position is between the first and second gears.

6.16 Foot brake lever

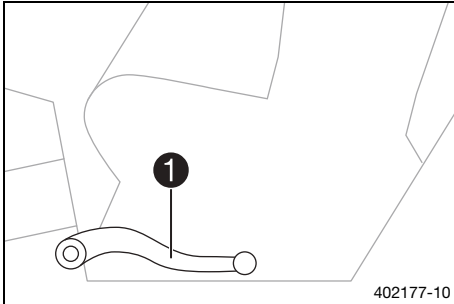

Foot brake lever **1** is located in front of the right footrest. The foot brake lever is used to activate the rear brake.

6.17 Side stand

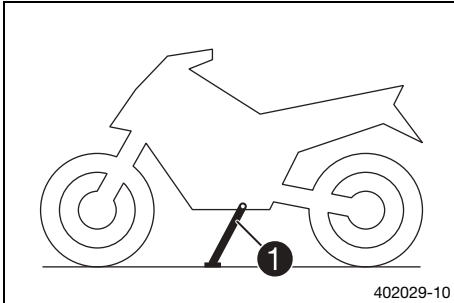

Side stand **1** is located on the left of the vehicle. The side stand is used for parking the motorcycle.

i Info

The side stand must be folded up during motorcycle use. Side stand is coupled with the safety start system; follow the riding instructions.

Possible states

- Side stand folded out – The vehicle can be supported on the side stand. The safety start system is enabled.

6 CONTROLS

- Side stand folded in – This position is mandatory when riding the motorcycle. The safety start system is disabled.

7.1 Adjusting the basic position of the hand brake lever



- Adjust the basic position of the hand brake lever to your hand size by turning adjusting wheel **1**.



Info

Push the hand brake lever forward and turn the adjusting wheel.
Do not make any adjustments while riding.



7.2 Adjusting the basic position of the clutch lever



- Adjust the basic position of the clutch lever to your hand size by turning adjusting wheel **1**.



Info

Push the clutch lever forward and turn the adjusting wheel.
Do not make any adjustments while riding.



7.3 Adjusting the shift lever

i Info

The adjustment range of the shift lever is limited.

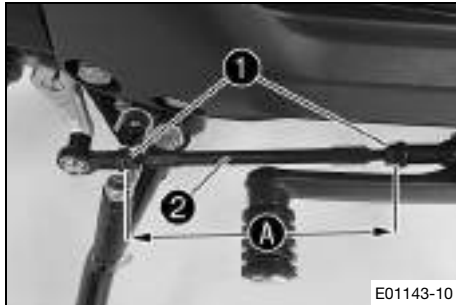

- Loosen nuts ①.
- Adjust the shift lever by turning shift rod ②.

Guideline

Shift rod adjustment range A	128 ... 142 mm (5.04 ... 5.59 in)
---------------------------------	--------------------------------------

i Info

Make the same adjustments on both sides.
At least five screw threads must be screwed into the seating.

- Tighten nuts ①.

i Info

After the nuts have been tightened, the bearings of the shift rod must be central and aligned identically to each other in order to ensure freedom of movement in the bearing shells.

- Check the shift lever to ensure it is functioning properly and can move freely.



8 COMBINATION INSTRUMENT

8.1 Combination instrument



The combination instrument is attached in front of the handlebar.

- ① Indicator lamps (📖 p. 59)
- ② Display (📖 p. 63)
- ③ Function buttons (📖 p. 66)

F01369-10

8.2 Activation and test



Activation

The combination instrument is activated when the ignition is switched on.

Info

The brightness of the displays is controlled by a brightness sensor in the combination instrument.

Test

When the ignition is switched on, all indicator lamps light up briefly except for the turn signal indicator lamp and immobilizer indicator lamp.

The segments of the tachometer and the gear display light up and switch off in sequence.

The speedometer counts from 0 to 299 and back.

The remaining display segments of the display light up briefly.

The **PIONEERING SINCE 1903** logo appears on the display.

The display then changes to the last selected mode.



Info

The malfunction indicator lamp always lights up as long as the engine is not running. If the engine is running and the malfunction indicator lamp lights up, stop (taking care not to endanger yourself or other road users in the process) and contact an authorized Husqvarna Motorcycles workshop.

The ABS warning lamp lights up so long as a speed of approx. 6 km/h (approx. 4 mph) or more has been reached.

8.3 Warning notes



Info

All existing warning notes are displayed on the **Info** display until these are no longer active.

As soon as an error occurs, the relevant indicator lamps light up to signal that an indication/warning note for the operating safety has been detected.

As soon as several warnings have been detected, the general warning symbol flashes additionally on the display.

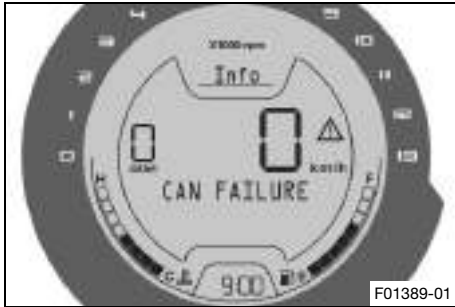

F01389-01

If an error has occurred in the CAN bus, various warning notes appear on the display:

CAN FAILURE, **CAN ABS FAILURE**, **CAN EMS FAILURE** and **CAN HLU FAILURE** can occur.



F01404-01

Transport Lock appears on the display if transport mode is activated.

SideStand Down appears on the display if the side stand is folded down.

8 COMBINATION INSTRUMENT

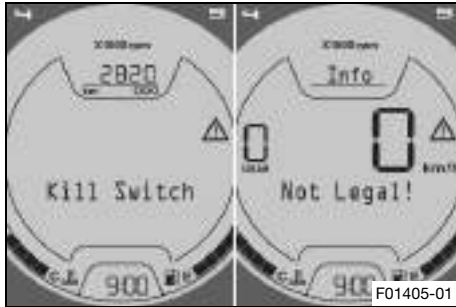

Kill Switch appears on the display if the emergency off switch is pressed.

Not Legal! appears on the display if the approval for road use is invalidated by modifications.



ABS Failure appears on the display if the **ABS** is no longer active.

Clutch Switch Failure appears on the display if the clutch switch is faulty.

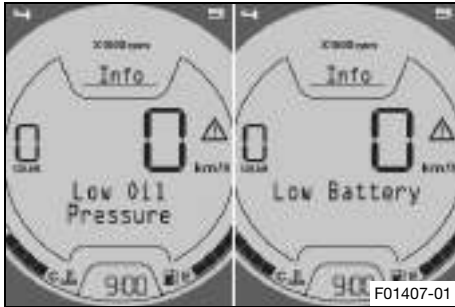

F01407-01

Low Oil Pressure appears on the display if the oil pressure is too low.

Low Battery appears on the display if the battery voltage falls below the specified value.

Battery voltage	$\leq 10.5 \text{ V}$
-----------------	-----------------------

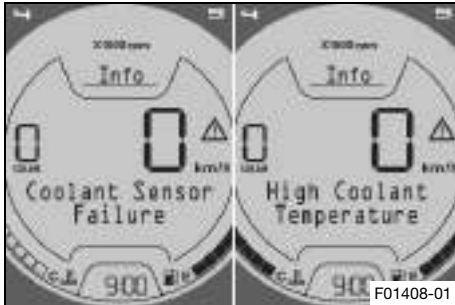

F01408-01

Coolant Sensor Failure appears on the display if the coolant temperature sensor is faulty.

High Coolant Temperature appears on the display if the coolant temperature rises above the specified value.

Coolant temperature	$> 115 \text{ }^{\circ}\text{C} (> 239 \text{ }^{\circ}\text{F})$
---------------------	---

8 COMBINATION INSTRUMENT

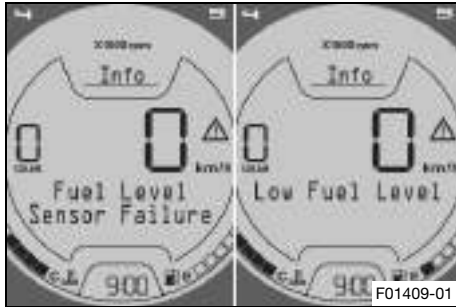

Fuel Level Sensor Failure appears on the display if the fuel level indicator is faulty.

Low Fuel Level appears on the display if the fuel level reaches the reserve mark.

8.4 Indicator lamps



F01372-01

The indicator lamps offer additional information about the operating state of the motorcycle.

When the ignition is switched on, all indicator lamps light up briefly except for the turn signal indicator lamp and immobilizer indicator lamp.

As soon as several warnings have been detected, the general warning symbol flashes additionally on the display.

i Info

The malfunction indicator lamp always lights up as long as the engine is not running. If the engine is running and the malfunction indicator lamp lights up, stop (taking care not to endanger yourself or other road users in the process) and contact an authorized Husqvarna Motorcycles workshop.







The ABS warning lamp lights up so long as a speed of approx. 6 km/h (approx. 4 mph) or more has been reached.

Possible states



The turn signal indicator lamp flashes green simultaneously with the turn signal – The turn signal is switched on.

8 COMBINATION INSTRUMENT

	Malfunction indicator lamp lights up yellow – The <u>OBD</u> has detected an error in the vehicle electronics. Come safely to a halt, and contact an authorized Husqvarna Motorcycles workshop.
	The shift warning lights up/flashes red – The shift warning light flashes red when the set shift speed RPM1 is reached. The shift warning light lights up red when the set shift speed RPM2 is reached.
	The idle indicator lamp lights up green – The transmission is in idle.
	The high beam indicator lamp lights up blue – The high beam is switched on.
	ABS warning lamp lights up yellow – Status or error messages relating to <u>ABS</u> .
	The immobilizer indicator lamp lights up red – Status or error message for immobilizer.

8.5 Shift warning light



F01411-10

The shift warning light ❶ is located in the center above the display.

i Info

The shift warning light can be configured in the **Trip 1** display and **Trip 2** display by keeping the **MODE** button pressed.

The shift warning light is always active during the running-in phase (up to 1,000 km / 621 miles). The shift warning light can only be deactivated, and the values for **RPM1** and **RPM2** can only be adjusted after this. The shift warning light flashes red at **RPM1** and the shift warning light lights up red at **RPM2**.

i Info

In sixth-gear, the shift warning light is deactivated when the engine is warm after the first service.

Coolant temperature	≤ 35 °C (≤ 95 °F)
ODO	< 1,000 km (< 620 mi)
The shift warning light always lights up at	6,500 rpm

8 COMBINATION INSTRUMENT

Coolant temperature	> 35 °C (> 95 °F)
ODO	> 1,000 km (> 620 mi)
RPM1 shift warning light	flashes
RPM2 shift warning light	lights up

8.6 Display



F01373-10

The tachometer ① shows the engine speed in revolutions per minute.

The gear display ② shows the engaged gear.

Speed ③ is shown in kilometers per hour **km/h** or in miles per hour **mph**.

The fuel level display is displayed in the ④ area.

The display ⑤ shows additional information.

The time appears in area ⑥.

The coolant temperature display appears in area ⑦.

i Info

The time must be reset if the battery was disconnected from the vehicle or the fuse was removed.

The brightness of the displays is controlled by a brightness sensor in the combination instrument.

8 COMBINATION INSTRUMENT

8.7 Fuel level display



F01374-10

The fuel tank contents are shown in area ❶ of the display. The fuel level indicator consists of bars. The more bars are lit, the more fuel is in the fuel tank.

i Info

If the fuel level is getting low, the warning note **Low Fuel Level** will also appear on the display. The fuel level is displayed with a slight delay to prevent the indicator from constantly moving while riding. The fuel level display is not updated while the side stand is folded out or the emergency off switch is switched off. Once the side stand is folded up and emergency OFF switch is switched on, the fuel level display is next updated after 2 minutes. The fuel level display flashes if the combination instrument does not receive a signal from the fuel level sensor.

8.8 Coolant temperature indicator



The coolant temperature display is shown in segment **1** of the display.

The coolant temperature indicator consists of bars. The more bars that light up, the hotter the coolant.

Note

Engine failure Overheating damages the engine.

- If the coolant temperature warning is displayed, stop immediately and take care not to endanger yourself or other traffic participants in the process.
- Allow the engine and cooling system to cool down.
- Check and, if necessary, correct the coolant level on the cooling system while it is in a cooled state.

Info

When all bars light up, the warning note **High Coolant Temperature** appears on the display. If the cooling system overheats, the maximum engine speed is limited.

Possible states

- The engine is cold – Up to three bars light up.
- Engine warm – Four bars light up.

8 COMBINATION INSTRUMENT

- Engine hot – Five to eight bars light up.
- Engine very hot – All eight bars light up.

8.9 Function buttons



Press the **MODE** button **1** to change display modes. Possible display modes are **Info**, total distance traveled (**ODO**), distance 1 (**TRIP 1**) and distance 2 (**TRIP 2**). Press the **SET** button **2** to change menus within a display mode. Keeping the **3** button and **MODE** button **1** pressed simultaneously enables the ABS to be activated.

8.10 Info display

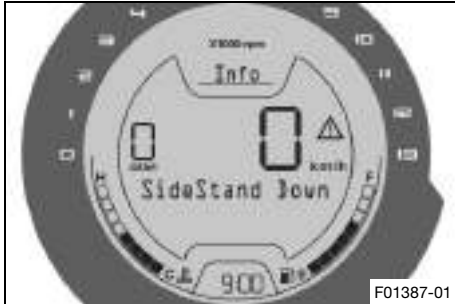

- Press the **MODE** button briefly and repeatedly until **Info** appears on the display.

Info shows messages or warnings that have occurred.

i Info

The **Info** display is only shown if a message or warning is pending.

The warnings that have occurred are saved in the

Info display until these are no longer active.

All warnings that have occurred are shown automatically in succession on the **Info** display.

Press the **SET** button briefly to change to the next warning note in the display.

Press the **MODE** button briefly to change to the next display mode in the display.

8 COMBINATION INSTRUMENT

8.11 ODO display



Press the **MODE** button briefly and repeatedly until **ODO** appears on the display.



Info

ODO shows the total distance covered.

This value is retained, even if the battery is disconnected from the vehicle or the fuse blows.

Press the **SET** button briefly to change to the next menu in the display.

Press the **MODE** button briefly to change to the next display mode in the display.

8.11.1 Fuel Range



- Press the **MODE** button briefly and repeatedly until **ODO** appears on the display.
- Press the **SET** button briefly and repeatedly until the desired menu appears.

The **Fuel Range** menu is identical on the **ODO** display, the **Trip 1** display and the **Trip 2** display.

The range is shown in this menu.

i Info

The range depends on the average fuel consumption and the fuel quantity in the fuel tank.
The range is displayed after several 100 meters of travel after the ignition is switched on.

Press the SET button briefly.	Next menu on the display
Press the MODE button briefly.	Next display mode on the display

8.11.2 Service



- Press the **MODE** button briefly and repeatedly until **ODO** appears on the display.
- Press the **SET** button briefly and repeatedly until the desired menu appears.

This menu shows the distance to the next service.

Press the SET button briefly.	Next menu on the display
--------------------------------------	--------------------------

8 COMBINATION INSTRUMENT

Press the **MODE** button briefly.

Next display mode on the display

8.12 TRIP 1 display



Press the **MODE** button briefly and repeatedly until **TRIP 1** appears on the display.

i Info

TRIP 1 shows the distance since the last reset, such as between two refueling stops. **TRIP 1** is always running and counts up to **9999.9**.

Press the **SET** button briefly to change to the next menu in the display.

Press the **MODE** button briefly to change to the next display mode in the display.

8.12.1 Time Trip 1



- Press the **MODE** button briefly and repeatedly until **TRIP 1** appears on the display.
- Press the **SET** button briefly and repeatedly until the desired menu appears.

Riding time 1 based on **TRIP 1** is shown in this menu.

Press the SET button briefly.	Next menu on the display
Press the SET button for 3 seconds.	Display of TRIP 1 is reset
Press the MODE button briefly.	Next display mode on the display

8 COMBINATION INSTRUMENT

8.12.2 Average Speed Trip1



- Press the **MODE** button briefly and repeatedly until **TRIP 1** appears on the display.
- Press the **SET** button briefly and repeatedly until the desired menu appears.

Average speed 1 based on **TRIP 1** is shown in this menu.

Press the SET button briefly.	Next menu on the display
Press the SET button for 3 seconds.	Display of TRIP 1 is reset
Press the MODE button briefly.	Next display mode on the display

8.12.3 Avg F.C. Trip 1

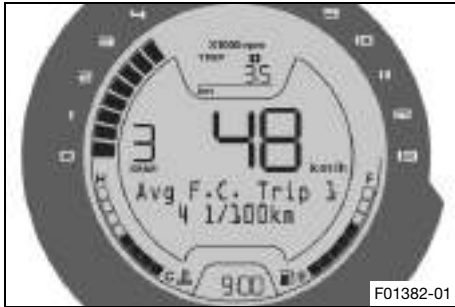

- Press the **MODE** button briefly and repeatedly until **TRIP 1** appears on the display.
- Press the **SET** button briefly and repeatedly until the desired menu appears.

Average fuel consumption 1 based on **TRIP 1** is shown in this menu.

Press the SET button briefly.	Next menu on the display
Press the SET button for 3 seconds.	Display of TRIP 1 is reset
Press the MODE button briefly.	Next display mode on the display

8 COMBINATION INSTRUMENT

8.13 TRIP 2 display



Press the **MODE** button briefly and repeatedly until **TRIP 2** appears on the display.



Info

TRIP 2 shows the distance since the last reset, such as between two refueling stops. **TRIP 2** is always running and counts up to **9999.9**.

Press the **SET** button briefly to change to the next menu. Press the **MODE** button briefly to change to the next display mode in the display.

8.13.1 Time Trip 2



- Press the **MODE** button briefly and repeatedly until **TRIP 2** appears on the display.
- Press the **SET** button briefly and repeatedly until the desired menu appears.

Riding time 2 based on **TRIP 2** is shown in this menu.

Press the **SET** button briefly.

Next menu on the display

Press the SET button for 3 seconds.	Display of TRIP 2 is reset
Press the MODE button briefly.	Next display mode on the display

8.13.2 Average Speed Trip2

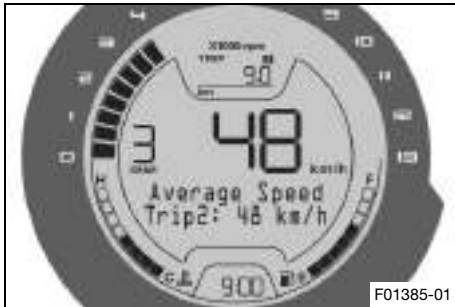

- Press the **MODE** button briefly and repeatedly until **TRIP 2** appears on the display.
- Press the **SET** button briefly and repeatedly until the desired menu appears.

Average speed 2 based on **TRIP 2** is shown in this menu.

Press the SET button briefly.	Next menu on the display
Press the SET button for 3 seconds.	Display of TRIP 2 is reset

8 COMBINATION INSTRUMENT

Press the **MODE** button briefly.

Next display mode on the display

8.13.3 Avg F.C. Trip 2



- Press the **MODE** button briefly and repeatedly until **TRIP 2** appears on the display.
- Press the **SET** button briefly and repeatedly until the desired menu appears.

Average fuel consumption 2 based on **TRIP 2** is shown in this menu.

Press the **SET** button briefly.

Next menu on the display

Press the **SET** button for 3 seconds.

Display of **TRIP 2** is reset

Press the **MODE** button briefly.

Next display mode on the display

8.14 Setting the units

i Info

Make the setting according to the country.

If you change the unit, the value **ODO** is retained and converted accordingly.



F01402-01

Condition

The motorcycle is stationary.

- Press the **MODE** button briefly and repeatedly until **ODO** appears on the display.
- Press the **MODE** button for 5 seconds.
- ✓ The units display appears.

i Info

The units display is shown on the **ODO** display for each menu by keeping the **MODE** button pressed.

- Press the **SET** button briefly and repeatedly until the desired unit appears.
- Do not actuate **MODE** button and **SET** button for about 5 seconds.
- ✓ The units display disappears and the selected unit of the first line is adopted and saved.

8 COMBINATION INSTRUMENT



Info

km or **miles** can be set as a length unit.
l, **USGa**, or **UKGa** can be set as a volume unit.

8.15 Setting the clock



Info

The clock is displayed in 24-hour format.

The time must be reset if the battery was disconnected from the vehicle or the fuse was removed.

Condition

The motorcycle is stationary.

- Press the **MODE** button briefly and repeatedly until **ODO** appears on the display.
 - Press the **MODE** button and **SET** button simultaneously for 5 seconds.
- ✓ The time display begins to flash.

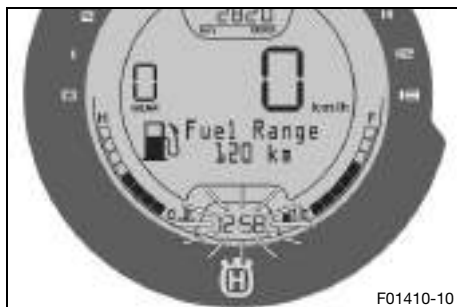

Info

The clock can be set in the **ODO** display for each menu by keeping the **MODE** button and **SET** button pressed simultaneously.

- Set the hours display using the **MODE** button.
- Set the minutes display using the **SET** button.
- Press the **MODE** button and **SET** button simultaneously.
 - ✓ The set time is adopted and saved.



8.16 Adjusting the shift speed RPM1

Condition

The motorcycle is stationary.

ODO > 1000 km (621 mi).

- Press the **MODE** button briefly and repeatedly until **TRIP 1** appears on the display.
- Press the **MODE** button for 5 seconds.
 - ✓ The **RPM1** display appears.

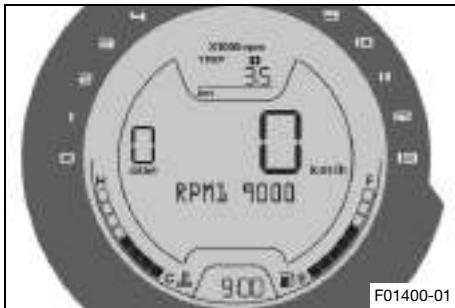

Info

The **RPM1** display appears in the **TRIP 1** display for each menu by keeping the **MODE** button pressed.

RPM1 is the engine speed above which the shift warning light starts flashing.

The engine speed can be set at intervals of 50.

The shift speed **RPM1** can only be set up to maximum 50 revolutions per minute below the shift speed **RPM2**.

- Set the speed with the **MODE** button and **SET** button.

8 COMBINATION INSTRUMENT



Info

The **MODE** button increases the value.
The **SET** button decreases the value.

- Press the **MODE** button and **SET** button simultaneously.
 - ✓ The **RPM1** display disappears and the set shift speed **RPM1** is adopted and saved.

8.17 Adjusting the shift speed RPM2

Condition

The motorcycle is stationary.

ODO > 1000 km (621 mi).

- Press the **MODE** button briefly and repeatedly until **TRIP 2** appears on the display.
- Press the **MODE** button for 5 seconds.
 - ✓ The **RPM2** display appears.

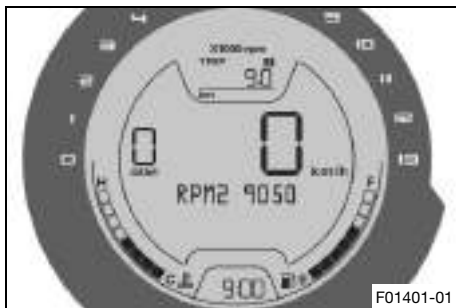

**Info**

The **RPM2** display appears in the **TRIP 2** display for each menu by keeping the **MODE** button pressed.

RPM2 is the engine speed above which the shift warning light lights up.

The engine speed can be set at intervals of 50.

The shift speed **RPM2** can only be set from a minimum of 50 revolutions per minute above the shift speed **RPM1**.

-
- Set the speed with the **MODE** button and **SET** button.

**Info**

The **MODE** button increases the value.

The **SET** button decreases the value.

-
- Press the **MODE** button and **SET** button simultaneously.
 - ✓ The **RPM2** display disappears and the set shift speed **RPM2** is adopted and saved.



9.1 Advice on preparing for first use



Danger

Danger of accidents A rider who is not fit to ride poses a danger to him or herself and others.

- Do not operate the vehicle if you are not fit to ride due to alcohol, drugs or medication.
- Do not operate the vehicle if you are physically or mentally impaired.



Warning

Risk of injury Missing or poor protective clothing presents an increased safety risk.

- Wear appropriate protective clothing such as helmet, boots, gloves as well as trousers and a jacket with protectors on all rides.
- Always wear protective clothing that is in good condition and meets the legal regulations.



Warning

Danger of crashing Different tire tread patterns on the front and rear wheel impair the handling characteristic.

Different tire tread patterns can make the vehicle significantly more difficult to control.

- Make sure that only tires with a similar tire tread pattern are fitted to the front and rear wheel.



Warning

Danger of accidents Non-approved or non-recommended tires and wheels impact the handling characteristic.

- Only use tires/wheels approved by Husqvarna Motorcycles with the corresponding speed index.

**Warning**

Danger of accidents New tires have reduced road grip.

The contact surface on new tires is not yet roughened.

- Run in new tires with moderate riding at alternating angles.
Running-in phase 200 km (124 mi)

**Info**

When using the vehicle, remember that others may feel disturbed by excessive noise.

- Ensure that the pre-delivery inspection work has been carried out by an authorized Husqvarna Motorcycles workshop.
 - ✓ The delivery certificate and the Service and Manufacturer Warranty Booklet must be transferred with the vehicle.
- Read the entire Owner's Manual before riding for the first time.
- Get to know the controls.
- Get used to handling the motorcycle in a suitable area before undertaking a more demanding ride. Also, ride as slowly as possible to get a better feeling for the motorcycle.
- Hold the handlebar firmly with both hands and keep your feet on the footrests when riding.
- Do not make any trips that exceed your personal ability and experience.
- Run the engine in. (📖 p. 84)



9 PREPARING FOR USE

9.2 Running in the engine

- During the running-in phase, do not exceed the specified engine speed.

Guideline

Maximum engine speed	
During the first: 1,000 km (620 mi)	7,500 rpm



Info

During the running-in phase, the shift warning light is set to a specified value and cannot be changed.

- Avoid fully opening the throttle!

9.3 Loading the vehicle



Warning

Danger of accidents Total weight and axle loads influence the handling characteristic.

The total weight consists of: motorcycle ready for operation and with a full tank, driver and passenger with protective clothing and helmet, and luggage.

- Do not exceed the maximum permissible overall weight or the axle loads.



Warning

Danger of accidents Improper mounting of cases or the tank rucksack impairs the handling characteristic.

- Mount and secure cases and tank rucksack according to the manufacturer's instructions.



Warning

Danger of accidents The luggage system will be damaged if it is overloaded.

- Read the manufacturer information on maximum payload when mounting cases.



Warning

Danger of accidents Luggage which has slipped impairs visibility.

If the tail light is covered, you are less visible to traffic behind you, especially when it is dark.

- Check that your luggage is fixed properly at regular intervals.



Warning

Danger of accidents A high payload alters the handling characteristic and increases the stopping distance.

- Adapt your speed to your payload.



Warning

Danger of accidents Pieces of luggage which have slipped impair the handling characteristic.

- Check that your luggage is fixed properly at regular intervals.

9 PREPARING FOR USE

- If luggage is carried, ensure it is fixed firmly as close as possible to the center of the vehicle and ensure even weight distribution between the front and rear wheels.
- Do not exceed maximum permissible weight and maximum permissible axle loads.

Guideline

Maximum permissible overall weight	355 kg (783 lb.)
Maximum permissible front axle load	135 kg (298 lb.)
Maximum permissible rear axle load	230 kg (507 lb.)

10.1 Checks and maintenance measures when preparing for use



Info

Before every trip, check the condition of the vehicle and ensure that it is roadworthy. The vehicle must be in perfect technical condition when it is being operated.

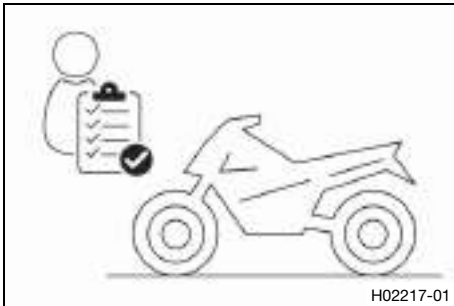

- Check the engine oil level. (📖 p. 211)
- Check the front brake fluid level. (📖 p. 148)
- Check the rear brake fluid level. (📖 p. 153)
- Check the front brake linings. (📖 p. 152)
- Check the rear brake linings. (📖 p. 156)
- Check that the brake system is functioning properly.
- Check the coolant level. (📖 p. 199)
- Check for chain dirt accumulation. (📖 p. 136)
- Check the chain tension. (📖 p. 138)
- Check the tire condition. (📖 p. 171)
- Check the tire air pressure. (📖 p. 174)
- Check the settings of all controls and ensure that they can be operated smoothly.
- Check that the electrical system is functioning properly.
- Check that luggage is properly secured.
- Sit on the motorcycle and check the rear mirror setting.
- Check the fuel level.



10.2 Starting



Danger

Danger of poisoning Exhaust gases are toxic and inhaling them may result in unconsciousness and death.

- Always make sure there is sufficient ventilation when running the engine.
- Use an effective exhaust extraction system when starting or running the engine in an enclosed space.



Caution

Danger of accidents Electronic components and safety devices will be damaged if the battery is discharged or missing.

- Never operate the vehicle with a discharged battery or without a battery.

Note

Engine damage Unfiltered intake air has a negative effect on the service life of the engine.

Dust and dirt will enter the engine without an air filter.

- Never start to use the vehicle without an air filter.

Note

Engine damage High revving speed with a cold engine negatively impacts the lifespan of the engine.

- Always run the engine warm at a low speed.

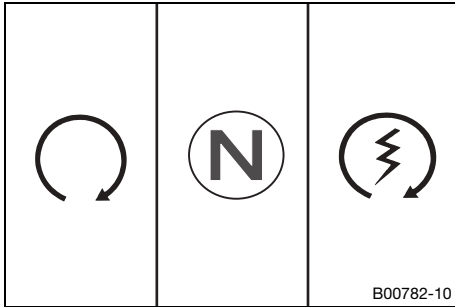

- Unlock the steering. (🔑 p. 41)
- Sit on the vehicle, take the weight off of the side stand, and move up all the way.
- Turn the emergency OFF switch to the position ○.
- Switch on the ignition by turning the ignition key to the position ○.
 - ✓ After you switch on the ignition, you can hear the fuel pump working for about two seconds. The function check of the combination instrument is run at the same time.
- Shift gear to neutral.
 - ✓ The green idle indicator lamp **N** lights up.
 - ✓ The ABS warning lamp lights up and goes back out after starting off.
- Press the electric starter button (🔌).



Info

Do not press the electric starter button until the combination instrument function check is finished.

When starting, **DO NOT** open the throttle. If you open the throttle during the starting procedure, fuel is not injected by the engine management system and the engine cannot start.

Press the starter for a maximum of 5 seconds. Wait for a least 5 seconds before trying again.

This motorcycle is equipped with a safety starting system. You can only start the engine if the transmission is in neutral or if the clutch lever is pulled when a gear is engaged. If the side stand is folded out and you shift into gear and release the clutch, the engine stops.

10.3 Starting off

- Pull the clutch lever, engage 1st gear, release the clutch lever slowly, and simultaneously open the throttle carefully.



Tip

If the engine dies while starting off, only pull the clutch lever and press the electric starter button. You do not need to shift into neutral.

10.4 Shifting, riding



Warning

Danger of accidents Abrupt load alterations can cause the vehicle to get out of control.

- Avoid abrupt load alterations and sudden braking actions.
- Adapt your speed to the road conditions.



Warning

Danger of accidents If you change down at high engine speed, the rear wheel blocks and the engine races.

- Do not change into a low gear at high engine speed.



Warning

Danger of accidents An incorrect ignition key position causes malfunctions.

- Do not change the ignition key position while driving.



Warning

Danger of accidents Adjustments to the vehicle distract attention from traffic activity.

- Make all adjustments when the vehicle is at a standstill.



Warning

Risk of injury The passenger may fall from the motorcycle if they conduct themselves incorrectly.

- Ensure that the passenger sits correctly on the passenger seat, places his or her feet on the passenger foot pegs and holds on to the rider or the grab handles.
- Note the regulations governing the minimum age of passengers in your country.



Warning

Danger of accidents A risky riding style constitutes a major risk.

- Comply with traffic regulations and ride defensively and with foresight to detect sources of danger as early as possible.



Warning

Danger of accidents Cold tires have reduced road grip.

- Ride the first miles carefully on every journey at moderate speed until the tires reach operating temperature.



Warning

Danger of accidents New tires have reduced road grip.

The contact surface on new tires is not yet roughened.

- Run in new tires with moderate riding at alternating angles.
Running-in phase 200 km (124 mi)

**Warning**

Danger of accidents Pieces of luggage which have slipped impair the handling characteristic.

- Check that your luggage is fixed properly at regular intervals.

**Warning**

Danger of accidents A fall can damage the vehicle more seriously than it may first appear.

- Check the vehicle after a fall as you do when preparing for use.

Note

Engine failure Overheating damages the engine.

- If the coolant temperature warning is displayed, stop immediately and take care not to endanger yourself or other traffic participants in the process.
 - Allow the engine and cooling system to cool down.
 - Check and, if necessary, correct the coolant level on the cooling system while it is in a cooled state.
-
-

**Info**

If unusual noises occur during operation, stop immediately, switch off the engine, park the vehicle properly, and contact an authorized Husqvarna Motorcycles workshop.

10 RIDING INSTRUCTIONS

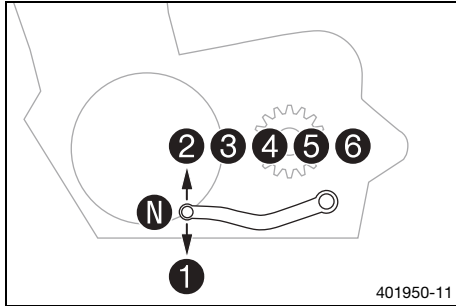

- Shift into a higher gear when conditions allow (incline, road situation, etc.).
- Release the throttle while simultaneously pulling the clutch lever, shift into the next gear, release the clutch lever, and open the throttle.



Info

You can see the positions of the 6 forward gears in the figure. The idle position is between the first and second gears. First gear is used for starting off or for steep inclines.

- Accelerate only up to a speed suitable for the road surface and weather conditions. Particularly in bends, do not shift, and accelerate very carefully.
- Brake if necessary and close the throttle at the same time in order to shift down.
- Pull the clutch lever and shift into a lower gear, release the clutch lever slowly, and open the throttle or shift again.
- Switch off the engine if running at idle or stationary for a long time.
- After reaching maximum speed by fully opening the throttle grip, turn the throttle back so it is $\frac{3}{4}$ open. This will barely reduce the speed but fuel consumption will be considerably lower.

- Accelerate only up to a speed suitable for the road surface and weather conditions. Particularly in bends, do not shift, and accelerate very carefully.
- Brake if necessary and close the throttle at the same time in order to shift down.
- Pull the clutch lever and shift into a lower gear, release the clutch lever slowly, and open the throttle or shift again.
- If the engine stalls (e.g. at a crossroads), just pull the clutch lever and press the electric starter button. You do not have to shift into neutral.
- If the malfunction indicator lamp  lights up during a trip, please contact an authorized Husqvarna Motorcycles workshop as soon as possible.
- If the general warning symbol begins to flash in the display during the trip, several warnings have been detected.

**Info**

Warnings which have occurred are shown and saved in the **Info** display until these are no longer active.



10.5 Applying the brakes



Warning

Danger of accidents Moisture and dirt impair the brake system.

- Brake carefully several times to dry out and remove dirt from the brake linings and the brake discs.



Warning

Danger of accidents A spongy pressure point on the front or rear brake reduces braking efficiency.

- Check the brake system and do not continue riding until the problem is eliminated. (Your authorized Husqvarna Motorcycles workshop will be glad to help.)



Warning

Danger of accidents The brake system fails in the event of overheating.

If the foot brake lever is not released, the brake linings drag continuously.

- Take your foot off the foot brake lever when you are not braking.



Warning

Danger of accidents Higher total weight increases the stopping distance.

- Take the longer stopping distance into account when carrying a passenger or luggage with you.



Warning

Danger of accidents Salt on the roads impairs the brake system.

- Brake carefully several times to remove salt from the brake linings and the brake discs.

**Warning**

Danger of accidents ABS may increase the stopping distance in certain situations.

- Adjust application of the brakes to the respective riding situation and riding surface conditions.

**Warning**

Danger of accidents Excessively forceful application of the brakes blocks the wheels.

The ABS effectiveness is only ensured if it is switched on.

- Leave the ABS switched on in order to benefit from the protective effect.

- When braking, release the throttle and apply the front and rear brakes at the same time.

**Info**

When the ABS is enabled, maximum braking power can be achieved even with low road grip surfaces such as sandy, wet, or slippery terrain without locking the wheels.

**Warning**

Danger of accidents The rear wheel can lock due to the engine braking effect.

- Pull in the clutch, if you perform emergency or full braking, or if you brake on a slippery ground.

**Warning**

Danger of accidents Banked or laterally sloping ground reduces the maximum possible delay.

- If possible finish braking before going into a bend.

- Always finish braking before you go into a bend. Shift down to a lower gear appropriate to your speed.

10 RIDING INSTRUCTIONS

- Use the braking effect of the engine on long downhill stretches. Shift back one or two gears, but do not overrev the engine when doing so. This means that significantly less braking is required and the brake system does not overheat.

10.6 Stopping, parking



Warning

Risk of injury People who act without authorization endanger themselves and others.

- Do not leave the vehicle unattended if the engine is running.
- Protect the vehicle against access by unauthorized persons.
- Lock the steering and remove the ignition key if you leave the vehicle unattended.



Warning

Danger of burns Some vehicle components become very hot when the vehicle is operated.

- Do not touch any parts such as the exhaust system, radiator, engine, shock absorber, or brake system before the vehicle parts have cooled down.
- Let the vehicle parts cool down before you perform any work on the vehicle.

Note

Material damage The vehicle may be damaged by incorrect procedure when parking.

Significant damage may be caused if the vehicle rolls away or falls over.

The components for parking the vehicle are designed only for the weight of the vehicle.

- Park the vehicle on a firm and level surface.
- Ensure that nobody sits on the vehicle when the vehicle is parked on a stand.

Note

Fire hazard Hot vehicle components pose a fire hazard and explosion risk.

- Do not park the vehicle near to materials which are highly flammable or explosive.
 - Allow the vehicle to cool down before covering it.
-

- Apply the brakes on the motorcycle.
 - Shift gear to neutral.
 - Switch off the ignition by turning the ignition key to the position ☒.
-

**Info**

If the engine is switched off with the emergency OFF switch and the ignition remains switched on at the ignition lock, power continues to flow to most power consumers and the battery will discharge. You should therefore always switch off the engine with the ignition lock – the emergency OFF switch is intended for emergencies only.

- Park the motorcycle on a firm surface.
- Swing the side stand forward with your foot as far as it will go and lean the vehicle on it.
- Lock the steering. (📖 p. 40)



10.7 Transport

Note

Danger of damage The parked vehicle can roll away or fall over.

- Park the vehicle on a firm and level surface.

Note

Fire hazard Hot vehicle components pose a fire hazard and explosion risk.

- Do not park the vehicle near to materials which are highly flammable or explosive.
- Allow the vehicle to cool down before covering it.

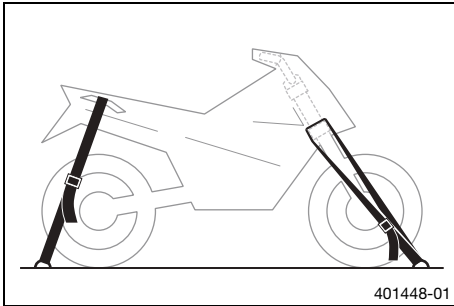

- Switch off the engine and remove the ignition key.
- Use tension belts or other suitable devices to secure the motorcycle against accidents or falling over.

10.8 Refueling



Danger

Fire hazard Fuel is highly flammable.

The fuel in the fuel tank expands when warm and can escape if overfilled.

- Do not refuel the vehicle in the vicinity of open flames or lit cigarettes.
- Switch off the engine for refueling.
- Make sure that no fuel is spilled; particularly not on hot parts of the vehicle.
- If any fuel is spilled, wipe it off immediately.
- Observe the specifications for refueling.



Warning

Danger of poisoning Fuel is poisonous and a health hazard.

- Avoid skin, eye and clothing contact with fuel.
- Immediately consult a doctor if you swallow fuel.
- Do not inhale fuel vapors.
- In case of skin contact, rinse the affected area with plenty of water.
- Rinse the eyes thoroughly with water, and consult a doctor in case of fuel contact with the eyes.
- Change your clothing in case of fuel spills on them.

Note

Material damage Inadequate fuel quality causes the fuel filter to quickly become clogged.

10 RIDING INSTRUCTIONS

In some countries and regions, the available fuel quality and cleanliness may not be sufficient. This will result in problems with the fuel system.

- Refuel only with clean fuel that meets the specified standards. (Your authorized Husqvarna Motorcycles workshop will be glad to help.)



Note

Environmental hazard Improper handling of fuel is a danger to the environment.

- Do not allow fuel to enter the groundwater, the soil, or the sewage system.



- Switch off the engine.
- Open the filler cap. (📖 p. 41)
- Fill the fuel tank with fuel up to the plate ❶.

Total fuel tank capacity, approx.	9.5 l (2.51 US gal)	Super unleaded (ROZ 95/RON 95/PON 91) (📖 p. 248)
-----------------------------------	------------------------	---

- Close the filler cap. (📖 p. 43)

11.1 Additional information

Any further work that results from the required work or from the recommended work must be ordered separately and invoiced separately.

Different service intervals may apply in your country, depending on the local operating conditions.

Individual service intervals and scopes may change in the course of technical developments. The most up-to-date service schedule can always be found on Husqvarna Motorcycles Dealer.net. Your authorized Husqvarna Motorcycles dealer will be glad to advise you.

11.2 Required work

	Every two years				
	Every year				
	every 15,000 km (9,300 mi)				
	every 7,500 km (4,650 mi)				
	after 1,000 km (620 mi)				
Read out the fault memory using the Husqvarna Motorcycles diagnostics tool. 🛠️	○	●	●	●	●
Check that the electrical system is functioning properly. 🛠️	○	●	●	●	●
Change the engine oil and oil filter and clean the oil screens. 🛠️ (📖 p. 212)	○	●	●	●	●
Check the brake discs. (📖 p. 146)	○	●	●	●	●
Check the front brake linings. (📖 p. 152)	○	●	●	●	●
Check the rear brake linings. (📖 p. 156)	○	●	●	●	●
Check the brake lines for damage and leakage. 🛠️	○	●	●	●	●
Check the front brake fluid level. (📖 p. 148)	○	●	●	●	●

11 SERVICE SCHEDULE

	Every two years				
	Every year				
	every 15,000 km (9,300 mi)				
	every 7,500 km (4,650 mi)				
	after 1,000 km (620 mi)				
Check the rear brake fluid level. (📖 p. 153)	○	●	●	●	●
Check the tire condition. (📖 p. 171)	○	●	●	●	●
Check the tire air pressure. (📖 p. 174)	○	●	●	●	●
Retighten the spokes. 🛠️	○				
Check the spoke tension. (📖 p. 175)		●	●	●	●
Check the rim run-out. 🛠️	○	●	●	●	●
Check the shock absorber and fork for leaks. 🛠️	○	●	●	●	●
Clean the dust boots of the fork legs. (📖 p. 114)		●	●		
Check the chain, rear sprocket, and engine sprocket. (📖 p. 141)		●	●	●	●
Check the chain tension. (📖 p. 138)	○	●	●	●	●
Check the coolant level. (📖 p. 199)	○	●	●	●	●
Check that the radiator fan is functioning properly. 🛠️	○	●	●	●	●
Change the air filter, clean the air filter box. 🛠️		●	●		
Check that the throttle cables are undamaged, routed without sharp bends, and set correctly. 🛠️	○	●	●	●	●
Check the cables for damage and for routing without kinks. 🛠️	○	●	●	●	●
Check the valve clearance. 🛠️	○				

	Every two years				
	Every year				
	every 15,000 km (9,300 mi)				
	every 7,500 km (4,650 mi)				
	after 1,000 km (620 mi)				
Check the valve clearance, change the spark plugs. 🛠️			●		
Change the front brake fluid. 🛠️					●
Change the rear brake fluid. 🛠️					●
Check the play of the steering head bearing. 🛠️	○	●	●	●	●
Check the headlight setting. (📖 p. 191)	○	●	●		
Final check: Check the vehicle is roadworthy and take a test ride. 🛠️	○	●	●	●	●
Read out the fault memory after the test ride using the Husqvarna Motorcycles diagnostics tool. 🛠️	○	●	●	●	●
Set the service interval display. 🛠️	○	●	●	●	●
Make the service entry in the Husqvarna Motorcycles Dealer.net and in the Service and Manufacturer Warranty Booklet. 🛠️	○	●	●	●	●

- One-time interval
- Periodic interval

11 SERVICE SCHEDULE

11.3 Recommended work

	Every four years			
	Every year			
	every 30,000 km (18,600 mi)			
	every 7,500 km (4,650 mi)			
	after 1,000 km (620 mi)			
Check the frame. 🛠️		•		
Check the swingarm. 🛠️		•		
Check the swingarm bearing for play. 🛠️		•	•	
Check the wheel bearing for play. 🛠️		•	•	
Check the antifreeze. 🛠️	○	•	•	•
Change the coolant. 🛠️ (📖 p. 205)				•
Empty the drainage hoses. 🛠️	○	•	•	•
Check all hoses (e.g. fuel, cooling, bleeder, drainage, etc.) and sleeves for cracking, leaks, and incorrect routing. 🛠️	○	•	•	•
Grease all moving parts (e.g. side stand, hand lever, chain, etc.) and check for smooth operation. 🛠️	○	•	•	•
Check the screws and nuts for tightness. 🛠️	○	•	•	•

- One-time interval
- Periodic interval

12.1 Adjusting the spring preload of the shock absorber ↗



Warning

Danger of accidents Modifications to the suspension setting may seriously alter the handling characteristic.

- Ride slowly to start with after making adjustments to get the feel of the new handling characteristic.



Info

The spring preload defines the initial status of the spring operation on the shock absorber. The best spring preload setting is achieved when it is set for the weight of the rider and that of any luggage and a passenger, thus ensuring an ideal compromise between handling and stability.



- Set the spring preload by turning adjusting ring ① using the hook wrench and the extension from the tool set.

Guideline

Spring preload	
Standard	5 clicks
Full payload	10 clicks



Info

The spring preload can be set to 10 different positions.

13 SERVICE WORK ON THE CHASSIS

13.1 Raising the motorcycle with the rear lifting gear

Note

Danger of damage The parked vehicle can roll away or fall over.

- Park the vehicle on a firm and level surface.



Condition

Rear wheel is not removed.

- Remove screw ❶.

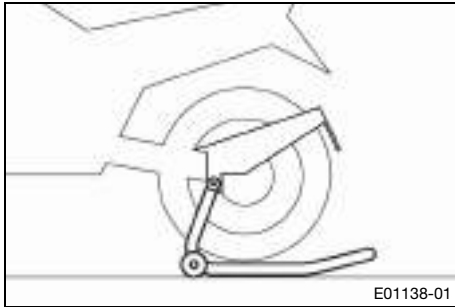

- Mount the supports of the lifting gear.

Guideline

Screw on left side: M10x70

- Insert the adapter in the rear lifting gear.

Universal V adapter with bushings (61029955244)

Rear wheel work stand (6932996510033)

- Stand the motorcycle upright, align the lifting gear with the swingarm and the adapters, and lift the motorcycle.

Condition

Rear wheel is removed.

- Remove the license plate holder. (📖 p. 127)
- Mount the supports of the lifting gear.
- Insert the adapter in the rear lifting gear.

Universal V adapter with bushings (61029955244)

Rear wheel work stand (6932996510033)

- Stand the motorcycle upright, align the lifting gear with the swingarm and the adapters, and lift the motorcycle.

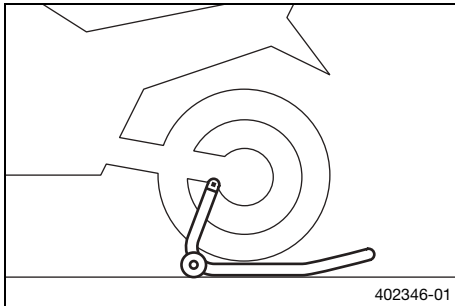

13 SERVICE WORK ON THE CHASSIS

13.2 Removing the rear of the motorcycle from the lifting gear

Note

Danger of damage The parked vehicle can roll away or fall over.

- Park the vehicle on a firm and level surface.

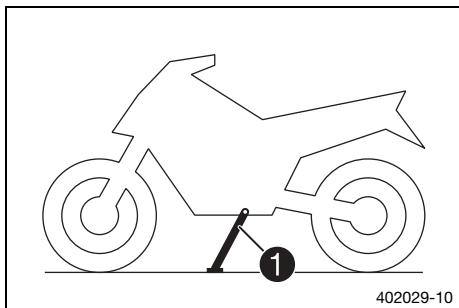

Condition

Rear wheel was not removed.

- Secure the motorcycle against falling over.
- Remove the rear lifting gear and lean the vehicle on side stand **1**.
- Remove bushings kit.



Info

Do not ride with mounted bushings, as the bushings can collide with the main silencer.



E01124-11

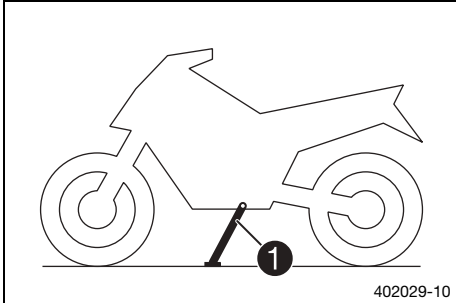

402029-10

- Mount and tighten screw ②.

Guideline

Screw, license plate holder	M10x30	45 Nm (33.2 lbf ft) Loctite®243™
-----------------------------	--------	--

Condition

Rear wheel was removed.

- Secure the motorcycle against falling over.
- Remove the rear lifting gear and lean the vehicle on side stand ①.
- Remove bushings kit.



Info

Do not ride with mounted bushings, as the bushings can collide with the main silencer.

- Install the license plate holder. (📖 p. 131)

13.3 Lifting the motorcycle with the front lifting gear

Note

Danger of damage The parked vehicle can roll away or fall over.

- Park the vehicle on a firm and level surface.

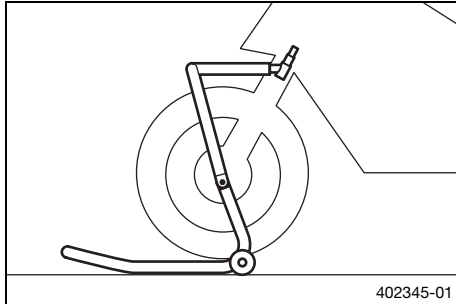

Preparatory work

- Raise the motorcycle with the rear lifting gear. (📖 p. 108)

Main work

- Move the handlebar to the straight-ahead position. Position the lifting gear.

Mounting pin (69329965030)

Front wheel work stand, large (6932995500033)

Info

Always raise the motorcycle at the rear first.

- Lift the motorcycle at the front.

13.4 Taking the motorcycle off the front lifting gear

Note

Danger of damage The parked vehicle can roll away or fall over.

- Park the vehicle on a firm and level surface.

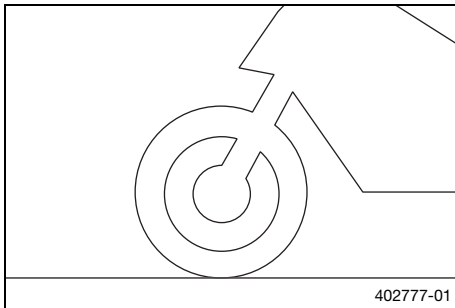

Main work

- Secure the motorcycle against falling over.
- Remove the front lifting gear.

Finishing work

- Remove the rear of the motorcycle from the lifting gear.
(📖 p. 110)



13.5 Cleaning the dust boots of the fork legs

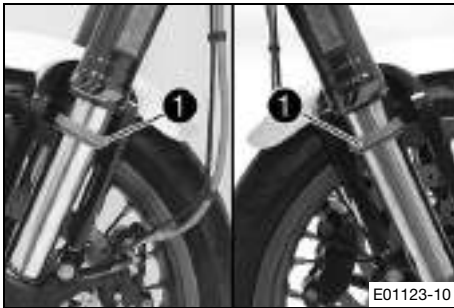

Preparatory work

- Raise the motorcycle with the rear lifting gear. (📖 p. 108)
- Lift the motorcycle with the front lifting gear. (📖 p. 112)

Main work

- Push dust boots ❶ of both fork legs downward.



Info

The dust boots should remove dust and coarse dirt particles from the fork tubes. Over time, dirt can accumulate behind the dust boots. If this dirt is not removed, the oil seals behind can start to leak.



Warning

Danger of accidents Oil or grease on the brake discs reduces the braking effect.

- Always keep the brake discs free of oil and grease.
 - Clean the brake discs with brake cleaner when necessary.
-
- Clean and oil the dust boots and inner fork tubes of both fork legs.

Universal oil spray (📖 p. 250)

- Press the dust boots back into their installation position.
- Remove excess oil.

Finishing work

- Take the motorcycle off the front lifting gear. (📖 p. 113)
- Remove the rear of the motorcycle from the lifting gear. (📖 p. 110)



13.6 Removing the seat

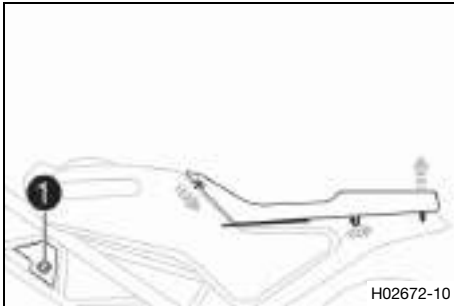

- Insert the ignition key in seat lock ① and turn it clockwise.
- Raise the rear of the seat, pull the seat back, and lift it off.
- Remove the key.



13 SERVICE WORK ON THE CHASSIS

13.7 Mounting the seat

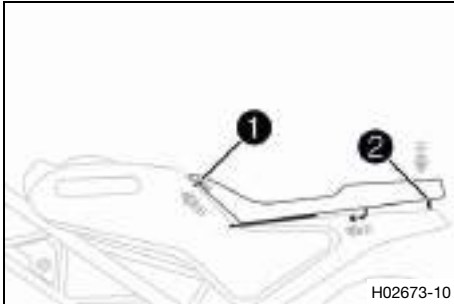

- Hook the catch ❶ of the seat onto the fuel tank, lower the rear and push it forward.
- Insert locking pin ❷ into the lock housing and push down the rear of the seat until the locking pin engages with a click.
- Check that the seat is correctly mounted.

13.8 Removing the left side cover 🛠️

Preparatory work

- Remove the seat. (📖 p. 115)



Main work

- Remove screws ① with the bushings.

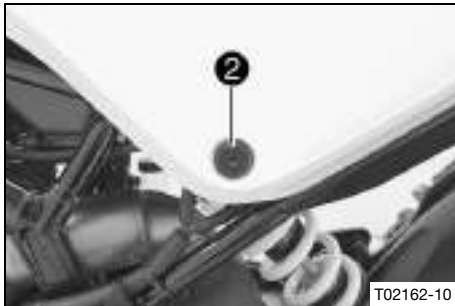

- Remove screw ②.

13 SERVICE WORK ON THE CHASSIS

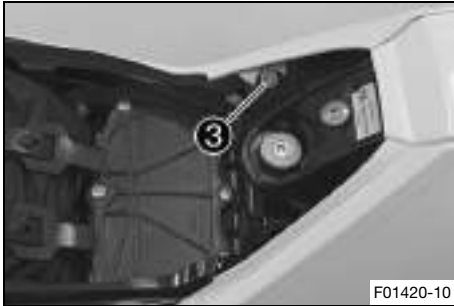

- Remove screw ③.



- Pull off holding lug in area ①.
- Take off the side cover forwards.

13.9 Installing the left side cover ↩

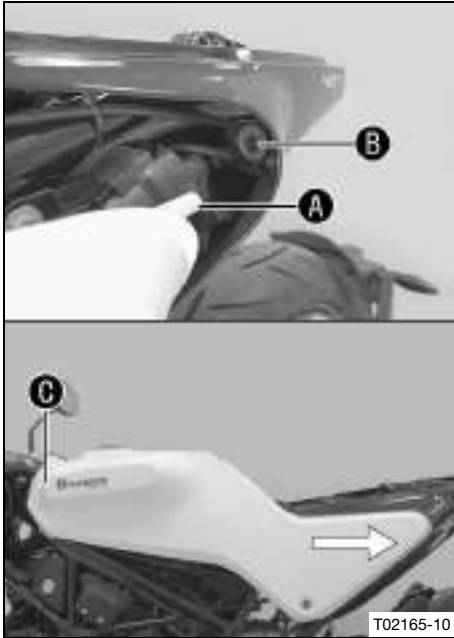

Main work

- Position the side cover.
- ✓ The catch **A** engages in the bracket **B**.
- Engage side cover in area **C**.

13 SERVICE WORK ON THE CHASSIS

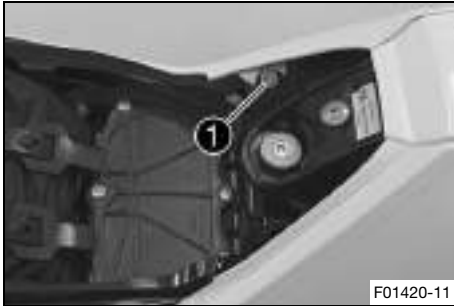

- Mount and tighten screw ①.

Guideline

Screw, fuel tank bridge	M6	5 Nm (3.7 lbf ft)
-------------------------	----	-------------------



- Mount and tighten screw ②.

Guideline

Screw, front trim	M6x15	5 Nm (3.7 lbf ft)
-------------------	-------	-------------------



- Mount screws ③ with bushings and tighten.

Guideline

Screw, front trim	M6x25	5 Nm (3.7 lbf ft)
-------------------	-------	-------------------

Finishing work

- Mount the seat. (📖 p. 116)



13.10 Removing the right side cover 🛠️

Preparatory work

- Remove the seat. (📖 p. 115)

13 SERVICE WORK ON THE CHASSIS

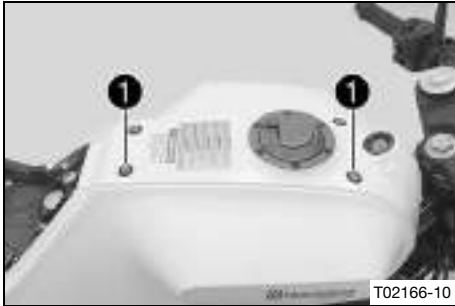

Main work

- Remove screws ① with the bushings.



- Remove screw ②.

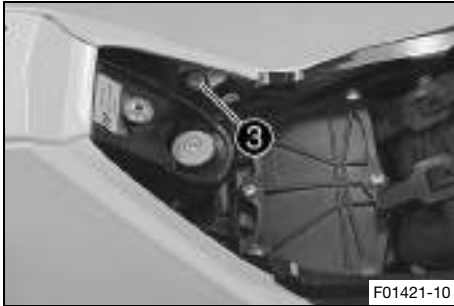

- Remove screw ③.



- Pull off holding lug in area ①.
- Take off the side cover forwards.



13 SERVICE WORK ON THE CHASSIS

13.11 Installing the right side cover ↩

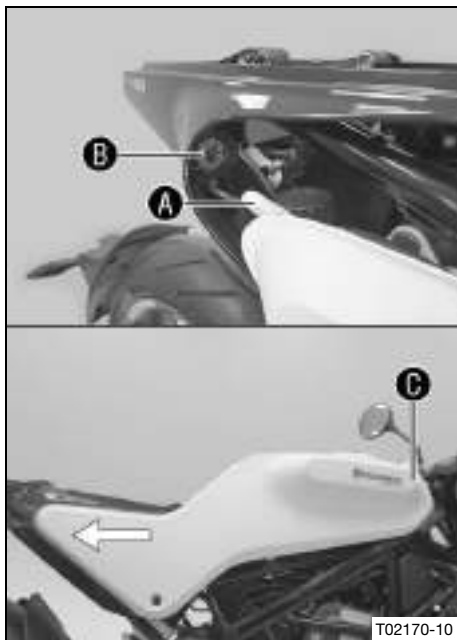

Main work

- Position the side cover.
 - ✓ The catch **A** engages in the bracket **B**.
- Engage side cover in area **C**.

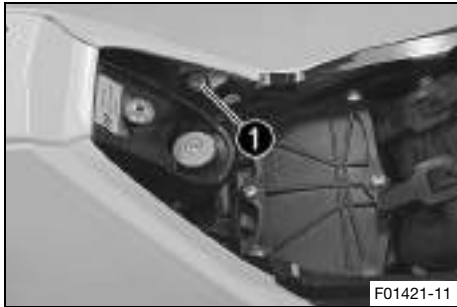

- Mount and tighten screw ❶.

Guideline

Screw, fuel tank bridge	M6	5 Nm (3.7 lbf ft)
-------------------------	----	-------------------

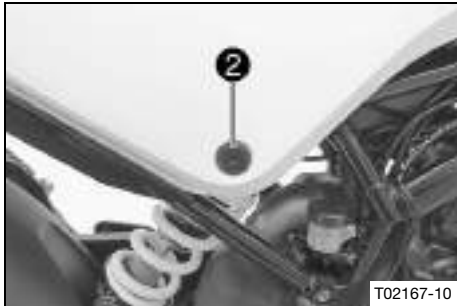

- Mount and tighten screw ❷.

Guideline

Screw, front trim	M6x15	5 Nm (3.7 lbf ft)
-------------------	-------	-------------------

13 SERVICE WORK ON THE CHASSIS

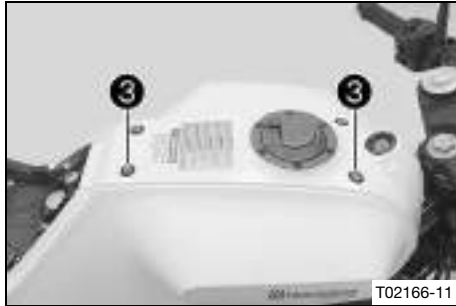

- Mount screws ③ with bushings and tighten.

Guideline

Screw, front trim	M6x25	5 Nm (3.7 lbf ft)
-------------------	-------	-------------------

Finishing work

- Mount the seat. (📖 p. 116)

13.12 Removing the license plate holder

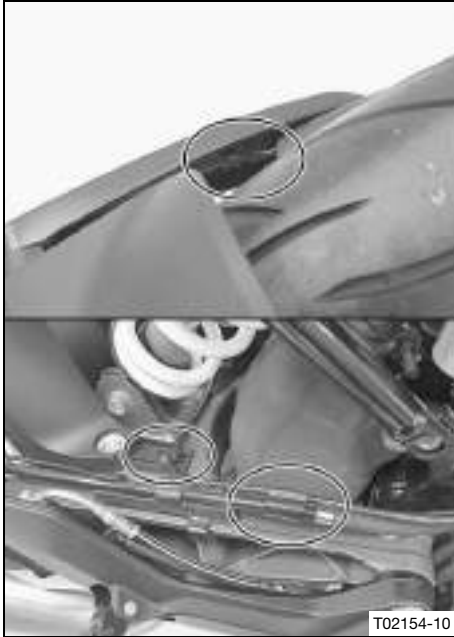

- Take the cable out of holders.

13 SERVICE WORK ON THE CHASSIS

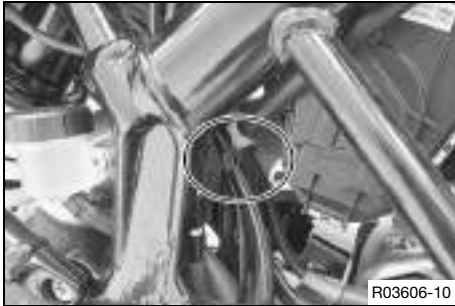

- Remove the cable tie.

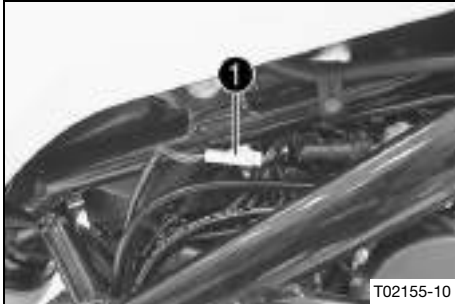

- Disconnect plug-in connector ①.
- Expose the cable.



- Remove screw ②.

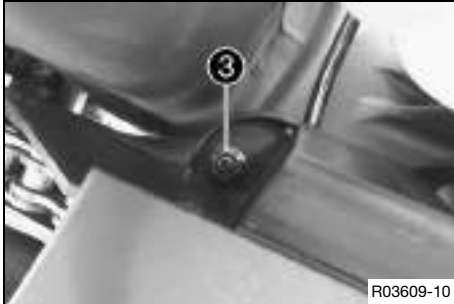

- Remove nut ③.

13 SERVICE WORK ON THE CHASSIS

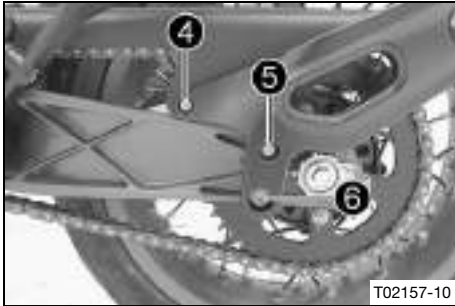

- Remove screws ④, ⑤ and ⑥.



- Remove screw ⑦.
- Take off the license plate holder.

13.13 Installing the license plate holder

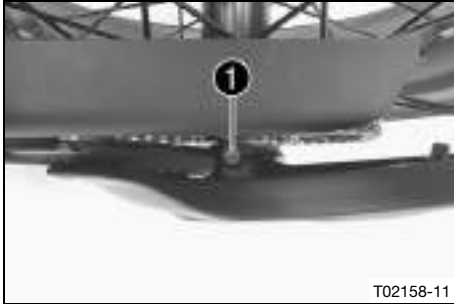

- Position the license plate holder.
- Mount screw ❶ but do not tighten yet.

Guideline

Screw, license plate holder	M8x20	20 Nm (14.8 lbf ft) Loctite®243™
-----------------------------	-------	--

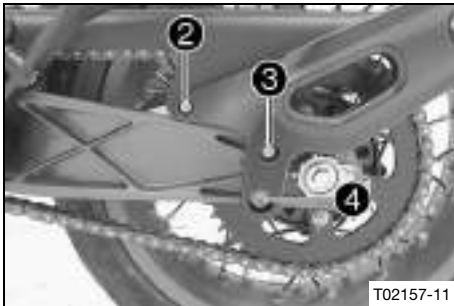

- Mount screw ❷ but do not tighten yet.

Guideline

Screw, license plate holder	M6	5 Nm (3.7 lbf ft)
-----------------------------	----	-------------------

- Mount screw ❸ but do not tighten yet.

Guideline

Screw, license plate holder	M8x35	25 Nm (18.4 lbf ft) Loctite®243™
-----------------------------	-------	--

- Mount and tighten screw ❹.

13 SERVICE WORK ON THE CHASSIS

Guideline

Screw, license plate holder	M10x30	45 Nm (33.2 lbf ft) Loctite®243™
-----------------------------	--------	--

- Tighten screws ❶, ❷, and ❸.

Guideline

Screw, license plate holder	M8x20	20 Nm (14.8 lbf ft) Loctite®243™
Screw, license plate holder	M6	5 Nm (3.7 lbf ft)
Screw, license plate holder	M8x35	25 Nm (18.4 lbf ft) Loctite®243™

- Mount and tighten nut ❺.

Guideline

Remaining nuts, chassis	M5	5 Nm (3.7 lbf ft)
-------------------------	----	-------------------



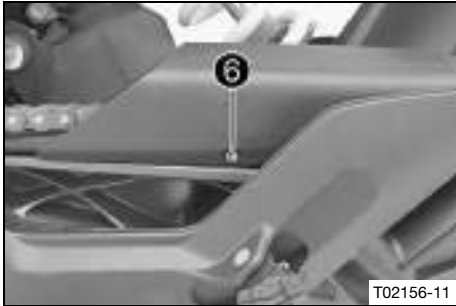

- Mount and tighten screw ⑥.

Guideline

Screw, chain guard	M5	7 Nm (5.2 lbf ft) Loctite®243™
--------------------	----	--

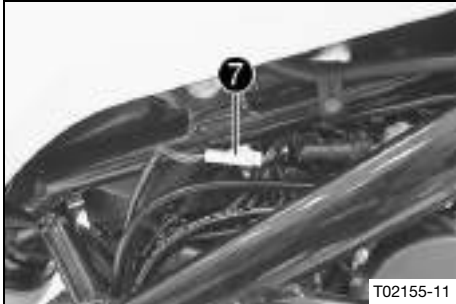

- Route the cable without tension.
- Join plug-in connector ⑦.

13 SERVICE WORK ON THE CHASSIS

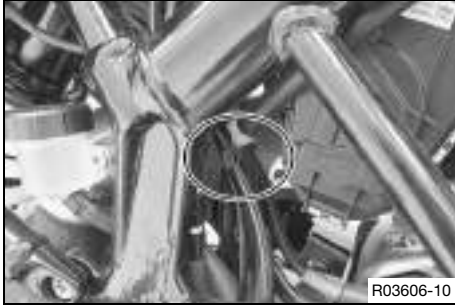

- Mount new cable ties.

- Secure the cable in the holders.

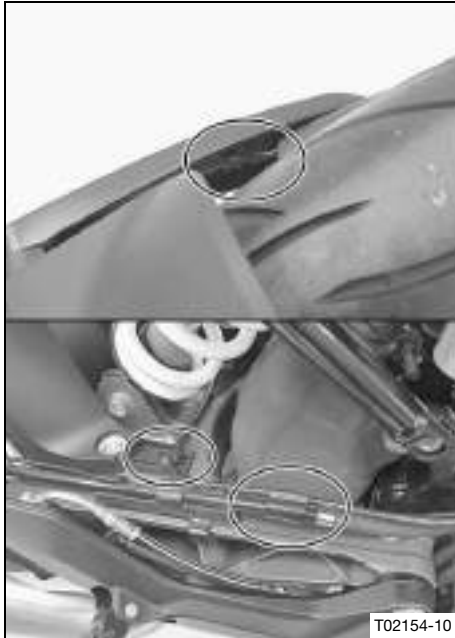

13 SERVICE WORK ON THE CHASSIS

13.14 Checking for chain dirt accumulation

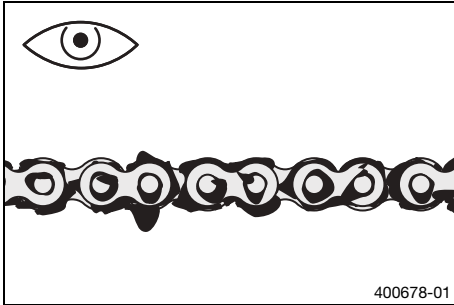

- Check the chain for coarse dirt accumulation.
 - » If the chain is very dirty:
 - Clean the chain. (📖 p. 136)

13.15 Cleaning the chain



Warning

Danger of accidents Oil or grease on the tires reduces the road grip.

- Remove the lubricant from the tires using a suitable cleaning agent.



Warning

Danger of accidents Oil or grease on the brake discs reduces the braking effect.

- Always keep the brake discs free of oil and grease.
- Clean the brake discs with brake cleaner when necessary.



Note

Environmental hazard Hazardous substances cause environmental damage.

- Dispose of oils, grease, filters, fuel, cleaning agents, brake fluid, etc., correctly and in compliance with the applicable regulations.



Info

The service life of the chain depends largely on its maintenance.

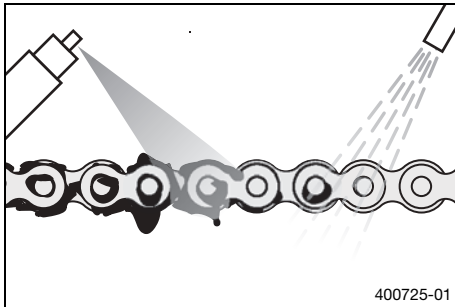

Preparatory work

- Raise the motorcycle with the rear lifting gear. (📖 p. 108)

Main work

- Clean the chain regularly.
- Rinse off loose dirt with a soft jet of water.
- Remove old grease remains with chain cleaner.

Chain cleaner (📖 p. 249)

- After drying, apply chain spray.

Chain lube for road use (📖 p. 249)

Finishing work

- Remove the rear of the motorcycle from the lifting gear. (📖 p. 110)

13.16 Checking the chain tension



Warning

Danger of accidents Incorrect chain tension damages components and results in accidents.

If the chain is tensioned too much, the chain, engine sprocket, rear sprocket, transmission and rear wheel bearings wear more quickly. Some components may break if overloaded.

If the chain is too loose, the chain may fall off the engine sprocket or the rear sprocket. As a result, the rear wheel locks or the engine will be damaged.

- Check the chain tension regularly.
- Set the chain tension in accordance with the specification.

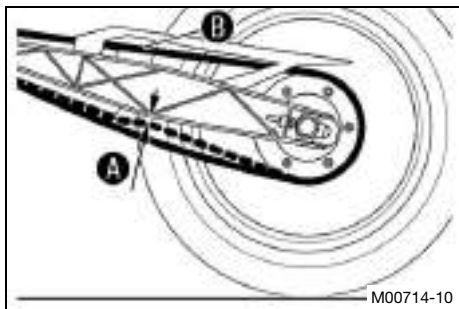

Preparatory work

- Raise the motorcycle with the rear lifting gear. (📖 p. 108)

Main work

- Shift gear to neutral.
- In the area of the chain sliding guard, press the chain upward toward the swingarm and determine chain tension **A**.



Info

The upper part of chain **B** must be taut.
Chain wear is not always even, so you should repeat this measurement at different chain positions.

Chain tension	5 ... 7 mm (0.2 ... 0.28 in)
---------------	------------------------------

- » If the chain tension does not meet the specification:
 - Adjust the chain tension. (📖 p. 139)
- Remove the rear of the motorcycle from the lifting gear. (📖 p. 110)



13.17 Adjusting the chain tension



Warning

Danger of accidents Incorrect chain tension damages components and results in accidents.

If the chain is tensioned too much, the chain, engine sprocket, rear sprocket, transmission and rear wheel bearings wear more quickly. Some components may break if overloaded.

If the chain is too loose, the chain may fall off the engine sprocket or the rear sprocket. As a result, the rear wheel locks or the engine will be damaged.

- Check the chain tension regularly.
- Set the chain tension in accordance with the specification.

Preparatory work

- Raise the motorcycle with the rear lifting gear. (📖 p. 108)
- Check the chain tension. (📖 p. 138)

13 SERVICE WORK ON THE CHASSIS

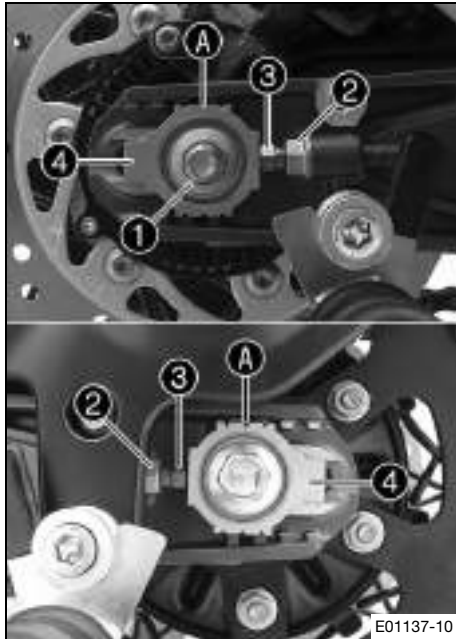

Main work

- Loosen nut ①.
- Loosen nuts ②.
- Adjust the chain tension by turning adjusting screws ③ left and right.

Guideline

Chain tension	5 ... 7 mm (0.2 ... 0.28 in)
Turn the adjusting screws ③ on the left and right so that the markings on the left and right chain adjusters ④ are in the same position relative to the reference marks A. The rear wheel is then correctly aligned.	

Info

The upper part of the chain must be taut. Chain wear is not always even, so you should check the setting at different chain positions.

- Tighten nuts ②.
- Make sure that chain adjusters ④ are fitted correctly on adjusting screws ③.
- Tighten nut ①.

Guideline

Nut, rear wheel spindle	M14x1.5	90 Nm (66.4 lbf ft)
-------------------------	---------	---------------------

Finishing work

- Remove the rear of the motorcycle from the lifting gear.
(📖 p. 110)



13.18 Checking the chain, rear sprocket, and engine sprocket

Preparatory work

- Raise the motorcycle with the rear lifting gear. (📖 p. 108)

Main work

- Check the rear sprocket and engine sprocket for wear.
 - » If the rear sprocket and engine sprocket are worn:
 - Change the drivetrain kit. 🛠️

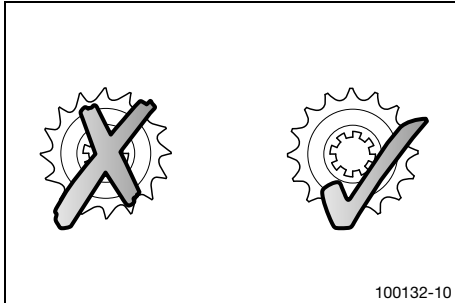

Info

The engine sprocket, rear sprocket and chain should always be replaced together.

13 SERVICE WORK ON THE CHASSIS

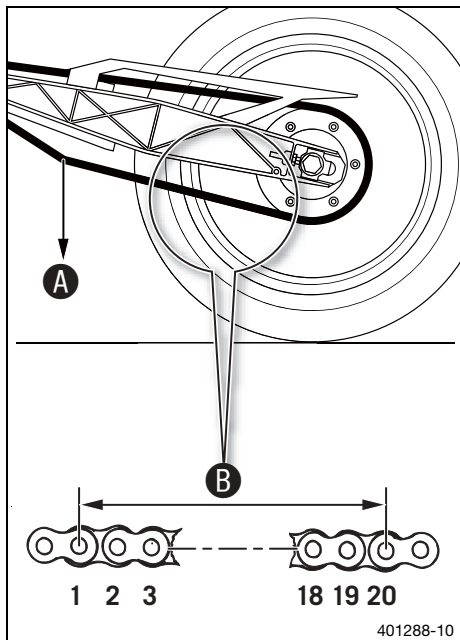

- Shift gear to neutral.
- Pull the lower chain section with specified weight **A**.

Guideline

Weight, chain wear measurement	15 kg (33 lb.)
--------------------------------	----------------

- Measure distance **B** of 20 chain rollers in the lower chain section.

i Info

Chain wear is not always even, so you should repeat this measurement at different chain positions.

Maximum distance B from 20 chain rollers at the longest chain section	304.0 mm (11.968 in)
--	----------------------

- » If distance **B** is greater than the specified measurement:
 - Change the drivetrain kit. 🛠️

i Info

When a new chain is mounted, the rear sprocket and engine sprocket should also be changed.
New chains wear out faster on old, worn sprockets.

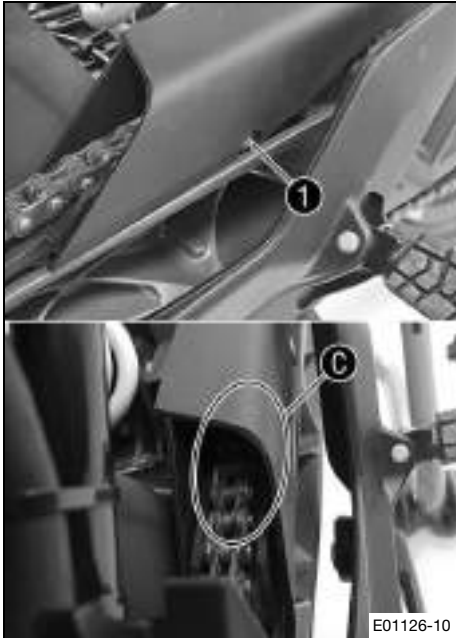

- Check the chain sliding guard for wear.
 - » If in area **C** by the chain sliding guard screw **1** is visible from above:
 - Change the chain sliding guard. 🛠️
- Check that the chain sliding guard is firmly seated.
 - » If the chain sliding guard is loose:
 - Tighten the screw of the chain sliding guard.

Guideline

Screw, chain sliding guard	M6	7 Nm (5.2 lbf ft)
----------------------------	----	-------------------

Finishing work

- Remove the rear of the motorcycle from the lifting gear. (📖 p. 110)



14 BRAKE SYSTEM

14.1 Antilock brake system (ABS)

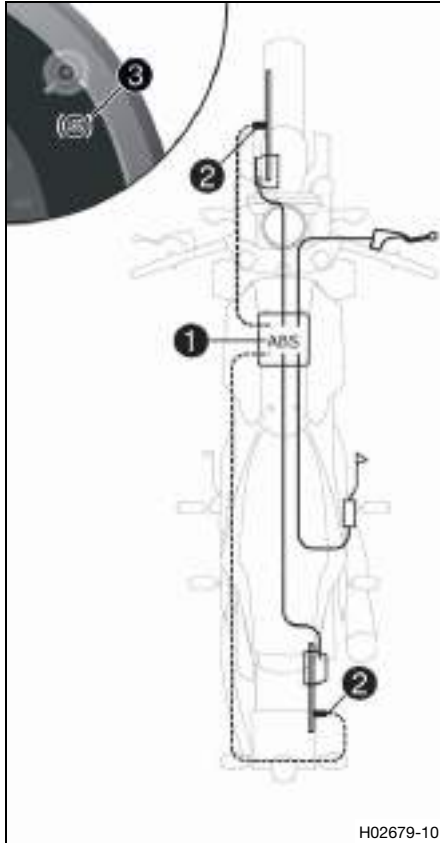

The ABS module **1**, which consists of a hydraulic unit, ABS control unit, and return pump, is installed under the fuel tank. One wheel speed sensor **2** is located in each case on the front and the rear wheel.



Warning

Danger of accidents Changes to the vehicle impair the function of the ABS.

- Only allow the rear wheel to spin with the front brake applied if the ABS is switched off (burn out).
- Do not make any changes to the suspension travel.
- Only use spare parts on the brake system which have been approved and recommended by Husqvarna Motorcycles.
- Only use tires/wheels approved by Husqvarna Motorcycles with the corresponding speed index.
- Maintain the specified tire air pressure.
- Service work and repairs must be performed properly. (Your authorized Husqvarna Motorcycles workshop will be glad to help.)

The ABS is a safety system that prevents locking of the wheels when driving straight ahead without the influence of lateral forces.



Warning

Danger of accidents Driving aids can only prevent a rollover within the physical limitations.

It is not always possible to compensate for extreme riding situations, for example with luggage loaded with a high center of gravity, varying road surfaces, steep descents or full braking without disengaging the gear.

- Adapt your riding style to the road conditions and your driving ability.

The ABS operates with two independent brake circuits (front and rear brakes). During normal operation, the brake system operates like a conventional brake system without ABS. When the ABS control unit detects a locking tendency in a wheel, ABS begins regulating the brake pressure. The control function causes a slight pulsing of the hand and foot brake levers.

The ABS warning lamp **3** must light up after the ignition is switched on and go out after starting off. If it does not go out after starting off or if it lights up while riding, this indicates a fault in the ABS. In this case, the ABS is no longer enabled and the

wheels may lock during braking. The brake system itself stays functional; only ABS control is not available. The ABS warning lamp may also light up if the rotating speeds of the front and rear wheels differ greatly under extreme riding conditions, for example when making "wheelies" or if the rear wheel spins. This causes the ABS to switch off. To reactivate the ABS, stop the vehicle and switch off the ignition. The ABS is reactivated when the vehicle is switched on again. The ABS warning lamp goes out when you start off.

14.2 Checking the brake discs



Warning

Danger of accidents Worn-out brake discs reduce the braking effect.

- Make sure that worn-out brake discs are replaced immediately. (Your authorized Husqvarna Motorcycles workshop will be glad to help.)

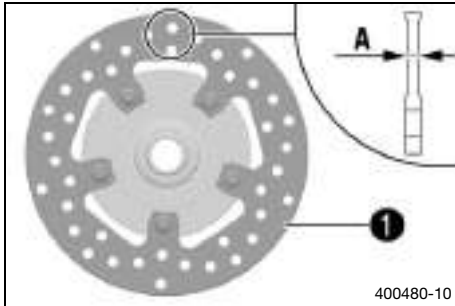

- Check the front and rear brake disc thickness at multiple points for the dimension **A**.



Info

Wear will reduce the thickness of the brake disc at contact surface **1** of the brake linings.

Brake discs - wear limit

front	4.5 mm (0.177 in)
rear	3.6 mm (0.142 in)

- » If the brake disc thickness is less than the specified value.
 - Change the front brake disc. 🛠️
 - Change the rear brake disc. 🛠️
- Check the front and rear brake discs for damage, cracking, and deformation.
 - » If the brake disc exhibits damage, cracking, or deformation:
 - Change the front brake disc. 🛠️
 - Change the rear brake disc. 🛠️



14.3 Checking the front brake fluid level



Warning

Danger of accidents An insufficient brake fluid level will cause the brake system to fail.

If the brake fluid level drops below the specified marking or the specified value, the brake system is leaking or the brake linings are worn down.

- Check the brake system and do not continue riding until the problem is eliminated. (Your authorized Husqvarna Motorcycles workshop will be glad to help.)



Warning

Danger of accidents Old brake fluid reduces the braking effect.

- Make sure that brake fluid for the front and rear brake is changed in accordance with the service schedule. (Your authorized Husqvarna Motorcycles workshop will be glad to help.)



- Move the brake fluid reservoir mounted on the handlebar to a horizontal position.
- Check the brake fluid level in the viewer.
 - » If the brake fluid level has dropped below the marking **A**:
 - Add front brake fluid. 📖 (p. 149)

14.4 Adding front brake fluid



Warning

Danger of accidents An insufficient brake fluid level will cause the brake system to fail.

If the brake fluid level drops below the specified marking or the specified value, the brake system is leaking or the brake linings are worn down.

- Check the brake system and do not continue riding until the problem is eliminated. (Your authorized Husqvarna Motorcycles workshop will be glad to help.)



Warning

Skin irritation Brake fluid causes skin irritation.

- Keep brake fluid out of the reach of children.
- Wear suitable protective clothing and safety glasses.
- Do not allow brake fluid to come into contact with the skin, the eyes or clothing.
- Consult a doctor immediately if brake fluid has been swallowed.
- Rinse the affected area with plenty of water in the event of contact with the skin.
- Rinse eyes thoroughly with water immediately and consult a doctor if brake fluid comes into contact with the eyes.
- If brake fluid spills on to your clothing, change the clothing.



Warning

Danger of accidents Old brake fluid reduces the braking effect.

- Make sure that brake fluid for the front and rear brake is changed in accordance with the service schedule. (Your authorized Husqvarna Motorcycles workshop will be glad to help.)



Note

Environmental hazard Hazardous substances cause environmental damage.

- Dispose of oils, grease, filters, fuel, cleaning agents, brake fluid, etc., correctly and in compliance with the applicable regulations.



Info

Never use DOT 5 brake fluid. It is silicone-based and purple in color. Oil seals and brake lines are not designed for DOT 5 brake fluid.

Avoid contact between brake fluid and painted parts. Brake fluid attacks paint.

Only use clean brake fluid from a sealed container.

Preparatory work

- Check the front brake linings. (📖 p. 152)

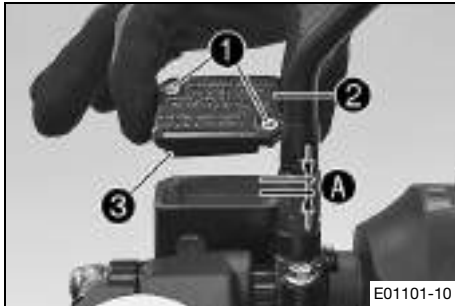

Main work

- Move the brake fluid reservoir mounted on the handlebar to a horizontal position.
- Remove screws ❶.
- Take off cover ❷ with membrane ❸.
- Add brake fluid to level A.

Guideline

Dimension A	5 mm (0.2 in)
-------------	---------------

Brake fluid DOT 4 / DOT 5.1 (📖 p. 246)
--

- Position the cover with the membrane. Mount and tighten the screws.



Info

Clean up overflowed or spilled brake fluid immediately with water.



14.5 Checking the front brake linings



Warning

Danger of accidents Worn-out brake linings reduce the braking effect.

- Ensure that worn-out brake linings are replaced immediately. (Your authorized Husqvarna Motorcycles workshop will be glad to help.)



Warning

Danger of accidents Damaged brake discs reduce the braking effect.

If the brake linings are not changed in time, the brake lining carriers grind against the brake disc. As a consequence, the braking effect is greatly reduced and the brake discs are destroyed.

- Check the brake linings regularly.

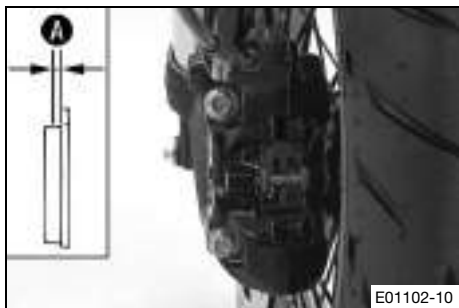

- Check the brake linings for minimum thickness **A**.

Minimum thickness A	$\geq 1 \text{ mm } (\geq 0.04 \text{ in})$
----------------------------	---

- » If the minimum thickness is less than specified:
 - Change the front brake linings. 🛠️
- Check the brake linings for damage and cracking.
 - » If there is wear or tearing:
 - Change the front brake linings. 🛠️

14.6 Checking the rear brake fluid level



Warning

Danger of accidents An insufficient brake fluid level will cause the brake system to fail.

If the brake fluid level drops below the **MIN** marking, the brake system is leaking or the brake linings are worn down.

- Check the brake system and do not continue riding until the problem is eliminated. (Your authorized Husqvarna Motorcycles workshop will be glad to help.)



Warning

Danger of accidents Old brake fluid reduces the braking effect.

- Make sure that brake fluid for the front and rear brake is changed in accordance with the service schedule. (Your authorized Husqvarna Motorcycles workshop will be glad to help.)



- Stand the vehicle upright.
- Check the brake fluid level of the brake fluid reservoir.
 - » If the fluid level reaches the **MIN** marking ①:
 - Add rear brake fluid. 📖 (p. 154)

14.7 Adding rear brake fluid



Warning

Danger of accidents An insufficient brake fluid level will cause the brake system to fail.

If the brake fluid level drops below the **MIN** marking, the brake system is leaking or the brake linings are worn down.

- Check the brake system and do not continue riding until the problem is eliminated. (Your authorized Husqvarna Motorcycles workshop will be glad to help.)



Warning

Skin irritation Brake fluid causes skin irritation.

- Keep brake fluid out of the reach of children.
- Wear suitable protective clothing and safety glasses.
- Do not allow brake fluid to come into contact with the skin, the eyes or clothing.
- Consult a doctor immediately if brake fluid has been swallowed.
- Rinse the affected area with plenty of water in the event of contact with the skin.
- Rinse eyes thoroughly with water immediately and consult a doctor if brake fluid comes into contact with the eyes.
- If brake fluid spills on to your clothing, change the clothing.

**Warning**

Danger of accidents Old brake fluid reduces the braking effect.

- Make sure that brake fluid for the front and rear brake is changed in accordance with the service schedule. (Your authorized Husqvarna Motorcycles workshop will be glad to help.)

**Note**

Environmental hazard Hazardous substances cause environmental damage.

- Dispose of oils, grease, filters, fuel, cleaning agents, brake fluid, etc., correctly and in compliance with the applicable regulations.

**Info**

Never use DOT 5 brake fluid. It is silicone-based and purple in color. Oil seals and brake lines are not designed for DOT 5 brake fluid.

Avoid contact between brake fluid and painted parts. Brake fluid attacks paint.

Only use clean brake fluid from a sealed container.

Preparatory work

- Check the rear brake linings. (📖 p. 156)

14 BRAKE SYSTEM

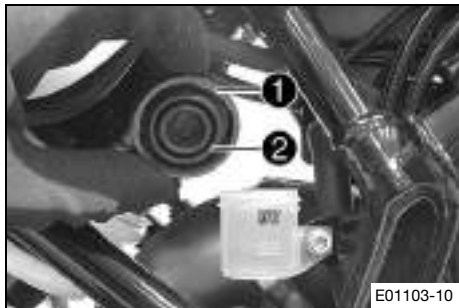

Main work

- Stand the vehicle upright.
- Remove screw cap ① with insert and membrane ②.
- Add brake fluid up to the **MAX** marking.

Brake fluid DOT 4 / DOT 5.1 (📖 p. 246)

- Mount and tighten screw cap with insert and membrane.



Info

Clean up overflowed or spilled brake fluid immediately with water.

14.8 Checking the rear brake linings



Warning

Danger of accidents Worn-out brake linings reduce the braking effect.

- Ensure that worn-out brake linings are replaced immediately. (Your authorized Husqvarna Motorcycles workshop will be glad to help.)



Warning

Danger of accidents Damaged brake discs reduce the braking effect.

If the brake linings are not changed in time, the brake lining carriers grind against the brake disc. As a consequence, the braking effect is greatly reduced and the brake discs are destroyed.

- Check the brake linings regularly.

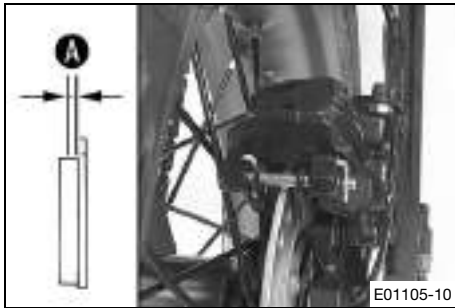

- Check the brake linings for minimum thickness **A**.

Minimum thickness A	$\geq 1 \text{ mm } (\geq 0.04 \text{ in})$
----------------------------	---

- » If the minimum thickness is less than specified:
 - Change the rear brake linings. 🛠️
- Check the brake linings for damage and cracking.
 - » If there is wear or tearing:
 - Change the rear brake linings. 🛠️

14.9 Checking the free travel of the foot brake lever



Warning

Danger of accidents The brake system fails in the event of overheating.

If there is no free travel on the foot brake lever, pressure builds up in the brake system on the rear brake.

- Set the free travel on the foot brake lever in accordance with the specification.

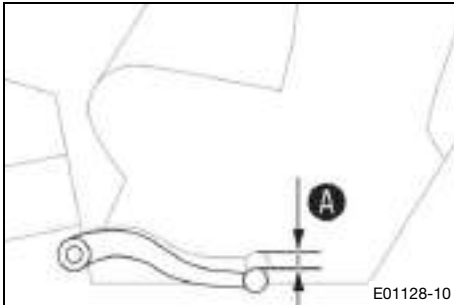

- Move the foot brake lever back and forth between the end stop and the contact to the foot brake cylinder piston and check free travel **A**.

Guideline

Free travel at foot brake lever	3 ... 5 mm (0.12 ... 0.2 in)
---------------------------------	------------------------------

- » If the free travel does not match the specification:
 - Adjust the free travel of the foot brake lever. 🛠️ (📖 p. 159)

14.10 Adjusting the free travel of the foot brake lever ↗



Warning

Danger of accidents The brake system fails in the event of overheating.

If there is no free travel on the foot brake lever, pressure builds up in the brake system on the rear brake.

- Set the free travel on the foot brake lever in accordance with the specification.

14 BRAKE SYSTEM

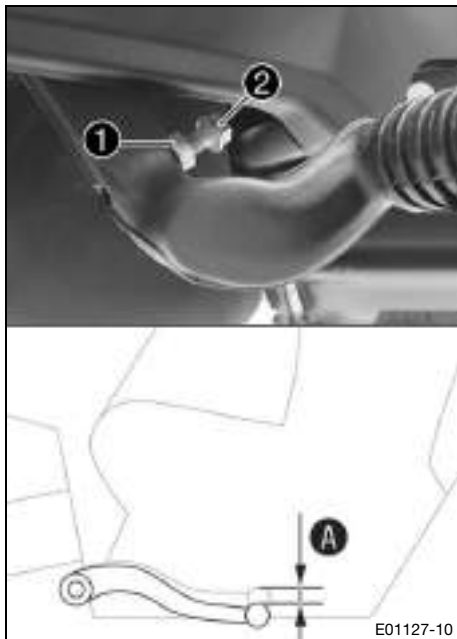

- Release nut ① and use screw ② to adjust the specified free travel A.

Guideline

Free travel at foot brake lever	3 ... 5 mm (0.12 ... 0.2 in)
---------------------------------	------------------------------

i **Info**

The range of adjustment is limited.

- Hold screw ② and tighten nut ①.

15.1 Removing the front wheel ↩

Preparatory work

- Raise the motorcycle with the rear lifting gear. (📖 p. 108)
- Lift the motorcycle with the front lifting gear. (📖 p. 112)

Main work

- Remove screws **1** with washers and push the fender slightly to the side.
- Remove screw **2** and pull wheel speed sensor **3** out of the hole.
- Loosen screw **4** by several rotations.
- Loosen screws **5**.
- Press on screw **4** to push the wheel spindle out of the axle clamp.
- Remove screw **4**.



Warning

Danger of accidents Reduced braking effect caused by damaged brake discs.

- Always lay the wheel down in such a way that the brake discs are not damaged.

- Holding the front wheel, withdraw the wheel spindle. Take the front wheel out of the fork.

15 WHEELS, TIRES



Info

Do not pull the hand brake lever when the front wheel is removed.

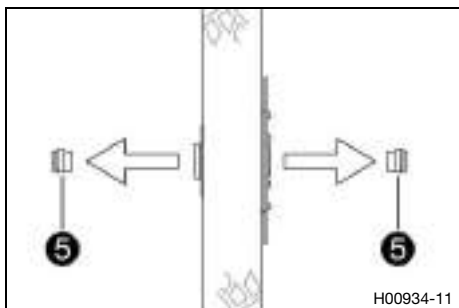

- Remove spacers ⑤.

15.2 Installing the front wheel ↻



Warning

Danger of accidents Oil or grease on the brake discs reduces the braking effect.

- Always keep the brake discs free of oil and grease.
- Clean the brake discs with brake cleaner when necessary.

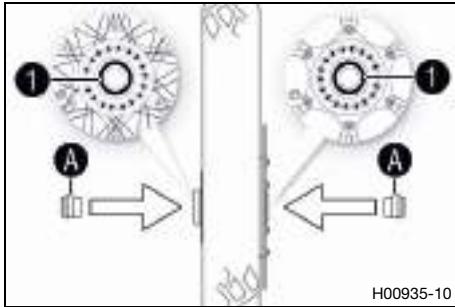

- Check the wheel bearing for damage and wear.
 - » If the wheel bearing is damaged or worn:
 - Change front wheel bearing. 🛠️
- Clean and grease shaft seal rings **1** and contact surfaces **A** of the spacers.
- Insert the spacers.

Long-life grease (📖 p. 249)

15 WHEELS, TIRES



- Clean the thread of the wheel spindle and screw ②.
- Clean and grease the wheel spindle.

Long-life grease (📖 p. 249)

- Position the front wheel and insert the wheel spindle.
✓ The brake linings are correctly positioned.
- Mount and tighten screw ②.

Guideline

Screw, front wheel spindle	M8	26 Nm (19.2 lbf ft)
----------------------------	----	---------------------

- Position wheel speed sensor ③ in the drill hole.
- Mount and tighten screw ④.

Guideline

Screw, wheel speed sensor	M6	8 Nm (5.9 lbf ft)
---------------------------	----	-------------------

- Position the fender, and mount and tighten screws ⑤ with the washers.

Guideline

Screw, fender on axle clamp	M6	7 Nm (5.2 lbf ft)
-----------------------------	----	-------------------

- Operate the hand brake lever repeatedly until the brake linings are in contact with the brake disc and there is a pressure point.

- Take the motorcycle off the front lifting gear. (📖 p. 113)
- Remove the rear of the motorcycle from the lifting gear. (📖 p. 110)
- Operate the front brake and compress the fork a few times firmly.
 - ✓ The fork legs straighten.
- Tighten screws ⑥.

Guideline

Screw, fork stub	M8	15 Nm (11.1 lbf ft)
------------------	----	---------------------



15.3 Removing the rear wheel ↩

Preparatory work

- Raise the motorcycle with the rear lifting gear. (📖 p. 108)

15 WHEELS, TIRES

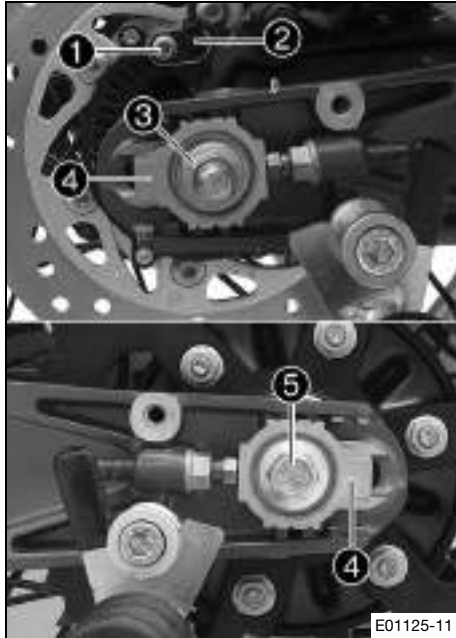

Main work

- Remove screw ① and pull wheel speed sensor ② out of the hole.
- Remove nut ③ with the washer.
- Remove chain adjuster ④.
- Holding the rear wheel, withdraw wheel spindle ⑤ with the washer and chain adjuster ④.
- Push the rear wheel forward as far as possible and take the chain off the rear sprocket.
- Push chain guard to the side.



Warning

Danger of accidents Damaged brake discs reduce the braking effect.

- Always lay the wheel down in such a way that the brake disc is not damaged.

- Pull the rear wheel back and take it out of the swingarm.



Info

Do not operate the foot brake lever when the rear wheel is removed.

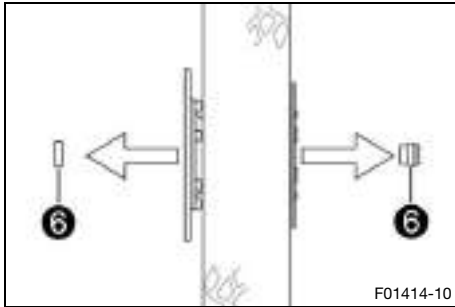

- Remove spacers ⑥.

15.4 Installing the rear wheel 🛠️



Warning

Danger of accidents Oil or grease on the brake discs reduces the braking effect.

- Always keep the brake discs free of oil and grease.
- Clean the brake discs with brake cleaner when necessary.



Warning

Danger of accidents There is no braking effect to start with at the rear brake after installing the rear wheel.

- Actuate the foot brake several times before going on a ride until you can feel a firm pressure point.

Main work

- Check the rear hub rubber dampers. 🛠️ (📖 p. 170)

15 WHEELS, TIRES

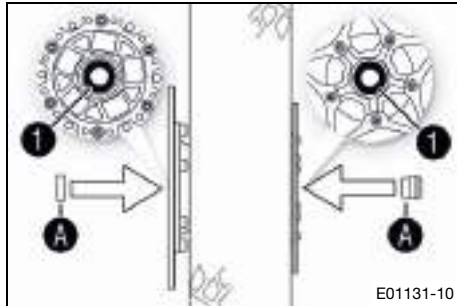

- Check the wheel bearing for damage and wear.
 - » If the wheel bearing is damaged or worn:
 - Change the rear wheel bearing. 🛠️
- Clean and grease shaft seal rings ① and contact surfaces ② of the spacers.

Long-life grease (📖 p. 249)
- Clean the thread of the wheel spindle and axle nut.
- Clean and grease the wheel spindle.

Long-life grease (📖 p. 249)
- Clean the contact areas of the brake caliper support and swingarm.
- Mount the rubber damper and rear sprocket carrier on the rear wheel.
- Insert the narrow spacer into the side of the rear sprocket.
- Insert the wide spacer into the side of the brake disc.
- Position the rear wheel.
 - ✓ The brake linings are correctly positioned.
- Push the rear wheel forward as far as possible and lay the chain on the rear sprocket.
- Position the chain guard.

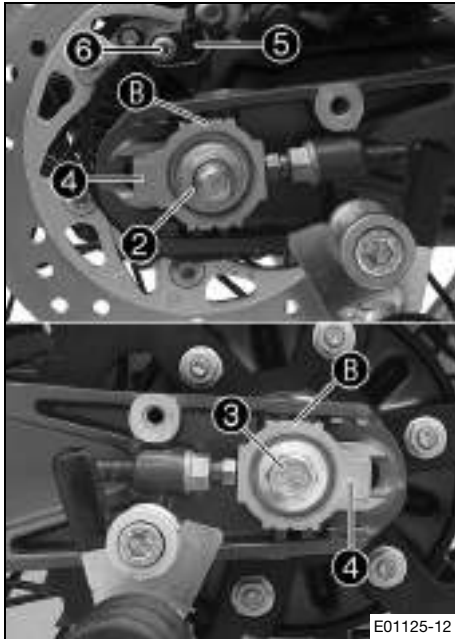

E01125-12

- Pull the rear wheel back and mount wheel spindle **3** with the washer and chain adjuster **4**.

Guideline

Mount left and right chain adjusters **4** in the same position.

- Mount nut **2** with the washer.
- Make sure that the chain adjusters are fitted correctly on the screws.
- Check the chain tension. (📖 p. 138)
- Tighten nut **2**.

Guideline

In order for the rear wheel to be correctly aligned, the markings on the left and right chain adjusters must be in the same position relative to reference markings **B**.

Nut, rear wheel spindle	M14x1.5	90 Nm (66.4 lbf ft)
-------------------------	---------	---------------------

- Position wheel speed sensor **5** in the drill hole.
- Mount and tighten screw **6**.

Guideline

Screw, wheel speed sensor	M6	8 Nm (5.9 lbf ft)
---------------------------	----	-------------------

Finishing work

- Remove the rear of the motorcycle from the lifting gear.
(📖 p. 110)

15.5 Checking the rear hub rubber dampers 🛠️

i Info

The engine power is transmitted from the rear sprocket to the rear wheel via 6 rubber dampers. They eventually wear out during operation. If the rubber dampers are not changed in time, the rear sprocket carrier and the rear hub will be damaged.

Preparatory work

- Raise the motorcycle with the rear lifting gear. (📖 p. 108)
- Remove the rear wheel. 🛠️ (📖 p. 165)

Main work

- Check bearing ❶.
 - » If the bearing is damaged or worn:
 - Change the bearing. 🛠️
- Check the rubber dampers ❷ of the rear hub for damage and wear.
 - » If the rubber dampers of the rear hub are damaged or worn:
 - Change all rubber dampers in the rear hub.

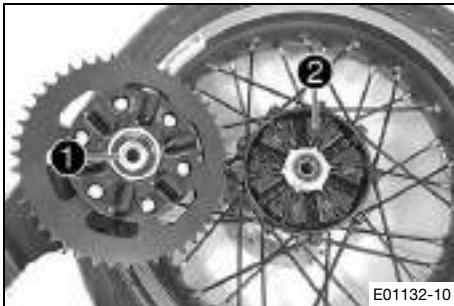



- Lay the rear wheel on a workbench with the rear sprocket facing upwards and insert the wheel spindle in the hub.
- To check the play **A**, hold the rear wheel tight and try to rotate the rear sprocket.



Info

Measure the play on the outside of the rear sprocket.

Play in rubber dampers, rear wheel	$\leq 5 \text{ mm } (\leq 0.2 \text{ in})$
------------------------------------	--

- » If play **A** is larger than the specified value:
 - Change all rubber dampers in the rear hub.

Finishing work

- Install the rear wheel. 🛠️ (📖 p. 167)
- Remove the rear of the motorcycle from the lifting gear. (📖 p. 110)



15.6 Checking the tire condition



Warning

Danger of accidents If a tire bursts while riding, the vehicle becomes uncontrollable.

- Ensure that damaged or worn tires are replaced immediately. (Your authorized Husqvarna Motorcycles workshop will be glad to help.)



Warning

Danger of crashing Different tire tread patterns on the front and rear wheel impair the handling characteristic.

Different tire tread patterns can make the vehicle significantly more difficult to control.

- Make sure that only tires with a similar tire tread pattern are fitted to the front and rear wheel.



Warning

Danger of accidents Non-approved or non-recommended tires and wheels impact the handling characteristic.

- Only use tires/wheels approved by Husqvarna Motorcycles with the corresponding speed index.



Warning

Danger of accidents New tires have reduced road grip.

The contact surface on new tires is not yet roughened.

- Run in new tires with moderate riding at alternating angles.

Running-in phase 200 km (124 mi)



Info

The type, condition, and air pressure of the tires all have a major impact on the handling of the motorcycle.

Worn tires have a negative effect on handling characteristics, especially on wet surfaces.

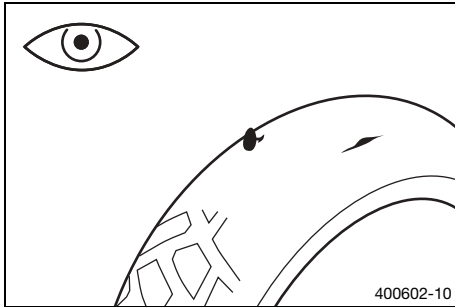

- Check the front and rear tires for cuts, run-in objects, and other damage.
 - » If the tires have cuts, run-in objects, or other damage:
 - Change the tires. 🛠️
- Check the tread depth.



Info

Observe the minimum profile depth required by national law.

Minimum tread depth	≥ 2 mm (≥ 0.08 in)
---------------------	--------------------

- » If the tread depth is less than the minimum tread depth:
 - Change the tires. 🛠️
- Check the tire age.



Info

The tire date of manufacture is usually contained in the tire label and is indicated by the last four digits of the **DOT** number. The first two digits indicate the week of manufacture and the last two digits the year of manufacture.

Husqvarna Motorcycles recommends that the tires be changed after 5 years at the latest, regardless of the actual state of wear.

- » If the tires are more than 5 years old:
 - Change the tires. 🐼

15.7 Checking the tire air pressure

i Info

Low tire air pressure leads to abnormal wear and overheating of the tire.
Correct tire air pressure ensures optimal riding comfort and maximum tire service life.

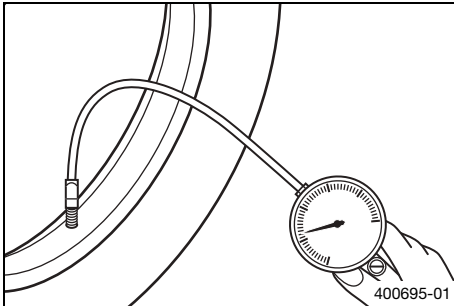

- Remove the dust cap.
- Check tire air pressure when the tires are cold.

Tire air pressure, solo	
front	2.0 bar (29 psi)
rear	2.0 bar (29 psi)

Tire air pressure with passenger / full payload	
front	2.0 bar (29 psi)
rear	2.0 bar (29 psi)

- » If the tire air pressure does not meet specifications:
 - Correct the tire air pressure.
- Mount the dust cap.

15.8 Checking spoke tension



Warning

Danger of accidents Incorrectly tensioned spokes impair the handling characteristic and result in secondary damage.

The spokes break due to being overloaded if they are too tightly tensioned. If the tension in the spokes is too low, then lateral and radial run-out will form in the wheel. Other spokes will become looser as a result.

- Check spoke tension regularly, and in particular on a new vehicle. (Your authorized Husqvarna Motorcycles workshop will be glad to help.)

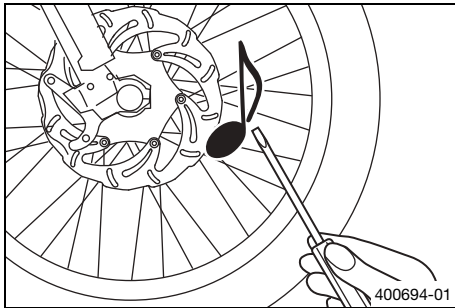

- Strike each spoke briefly using a screwdriver blade.



Info

The frequency of the sound depends on the spoke length and spoke diameter.

If spokes of the same length and diameter vibrate with a different tone, this is an indication that the spoke tensions differ.

You should hear a high note.

- » If the spoke tension differs:
 - Correct the spoke tension. 🛠️

16.1 Removing the battery ↴



Warning

Risk of injury Battery acid and battery gases cause serious chemical burns.

- Keep batteries out of the reach of children.
- Wear suitable protective clothing and safety glasses.
- Avoid contact with battery acid and battery gases.
- Keep sparks or open flames away from the battery.
- Only charge batteries in well-ventilated rooms.
- Rinse the affected area immediately with plenty of water in the event of contact with the skin.
- Rinse eyes with water for at least 15 minutes and consult a doctor immediately if battery acid and battery gases get into the eyes.



Caution

Danger of accidents Electronic components and safety devices will be damaged if the battery is discharged or missing.

- Never operate the vehicle with a discharged battery or without a battery.

Preparatory work

- Switch off the ignition by turning the ignition key to the position ☒.
- Remove the seat. (📖 p. 115)



Main work

- Open rubber bands ① and remove tool set ②.

16 ELECTRICAL SYSTEM

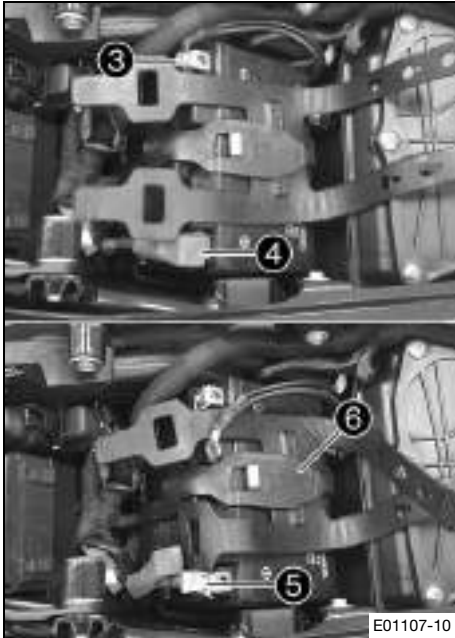

- Disconnect negative cable ③ from the battery.
- Pull back positive terminal cover ④.
- Disconnect positive cable ⑤ from the battery.
- Detach rubber band ⑥.
- Pull the battery up and out of the battery holder.

16.2 Installing the battery ↘

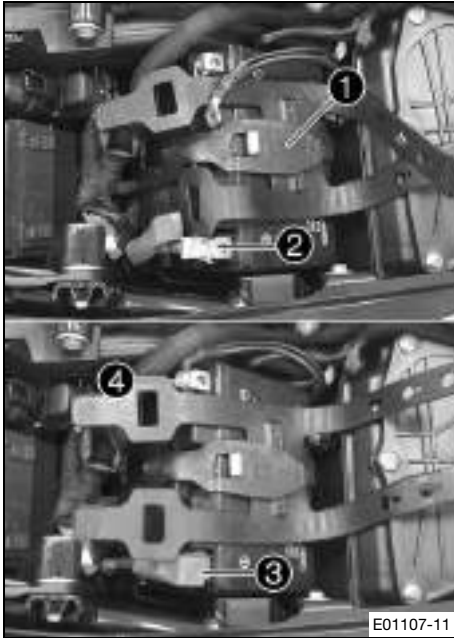
**Main work**

- Position the battery in the battery holder.

Battery (HTZ12A-BS) (見 p. 237)

- Reconnect rubber band ①.
- Position positive cable ② and mount and tighten the screw.
- Position positive terminal cover ③.
- Position negative cable ④; mount and tighten the screw.

16 ELECTRICAL SYSTEM



- Position tool set ⑤ and mount rubber bands ⑥.

Finishing work

- Mount the seat. (📖 p. 116)
- Set the clock. (📖 p. 78)

16.3 Recharging the battery ↴



Warning

Risk of injury Battery acid and battery gases cause serious chemical burns.

- Keep batteries out of the reach of children.
- Wear suitable protective clothing and safety glasses.
- Avoid contact with battery acid and battery gases.
- Keep sparks or open flames away from the battery.
- Only charge batteries in well-ventilated rooms.
- Rinse the affected area immediately with plenty of water in the event of contact with the skin.
- Rinse eyes with water for at least 15 minutes and consult a doctor immediately if battery acid and battery gases get into the eyes.



Note

Environmental hazard Batteries contain environmentally-hazardous materials.

- Do not dispose of batteries as household waste.
- Dispose of batteries at a collection point for used batteries.



Note

Environmental hazard Hazardous substances cause environmental damage.

- Dispose of oils, grease, filters, fuel, cleaning agents, brake fluid, etc., correctly and in compliance with the applicable regulations.



Info

Even when there is no load on the battery, it discharges steadily.

The charging level and the method of charging are very important for the service life of the battery.

Rapid recharging with a high charging current shortens the service life of the battery.





If the charging current, charging voltage, or charging time is exceeded, electrolyte escapes through the safety valves. This reduces the battery capacity.

If the battery is depleted by repeated starting, the battery must be charged immediately.

If the battery is left in a discharged state for an extended period, it will become over-discharged and sulfated, destroying the battery.

The battery is maintenance-free. The acid level does not have to be checked.

Preparatory work

- Switch off the ignition by turning the ignition key to the position .
- Remove the seat.  p. 115)
- Remove the battery.   p. 176)

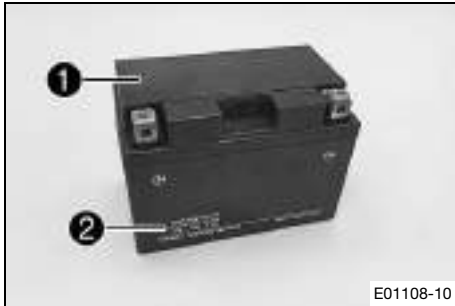

Main work

- Connect the battery charger to the battery. Switch on the battery charger.

Guideline

The battery charger must be suitable for the vehicle battery.

i Info

Never remove cover **1**.

Charge the battery to a maximum of 10% of the capacity specified on battery housing **2**.

- Switch off the battery charger after charging and disconnect from the battery.

Guideline

The charging current, charging voltage, and charging time must not be exceeded.

Charge the battery regularly when the motorcycle is not in use	3 months
--	----------

Finishing work

- Install the battery. 🛠️ (📖 p. 179)
- Mount the seat. (📖 p. 116)
- Set the clock. (📖 p. 78)



16.4 Changing the ABS fuses



Info

Two fuses for the ABS are located under the protection cap next to the fuse box. These fuses protect the return pump and the hydraulic unit of the ABS. The third fuse, which protects the ABS control unit, is located in the fuse box.

Preparatory work

- Switch off the ignition by turning the ignition key to the position ☒.
- Remove the seat. (📖 p. 115)

To change the fuse of the ABS hydraulic unit:

- Take off the protection cap and remove fuse ①.

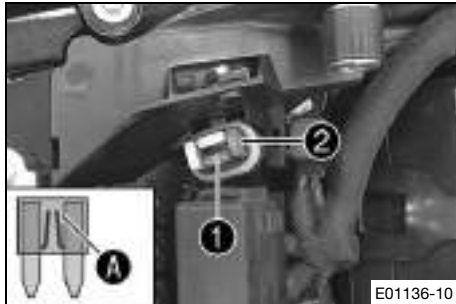

Info

You can recognize a faulty fuse by a burned-out fuse wire **A**.

**Warning**

Fire hazard Incorrect fuses overload the electrical system.

- Only use fuses with the required ampere value.
- Do not bypass or repair fuses.

- Use spare fuses with the correct rating only.

Fuse (75011088015) (📖 p. 237)

**Tip**

Replace spare fuse ② in the fuse box so that it is available if needed.

- Mount the protection cap.

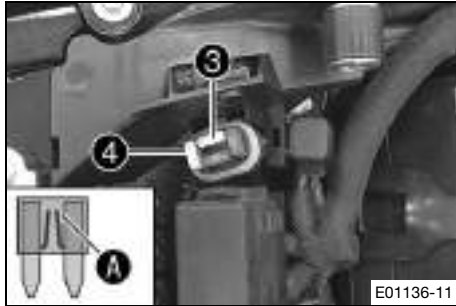

To change the fuse of the ABS return pump:

- Take off the protection cap and remove fuse ③.



Warning

Fire hazard Incorrect fuses overload the electrical system.

- Only use fuses with the required ampere value.
- Do not bypass or repair fuses.

- Use spare fuses with the correct rating only.

Fuse (90111088025) (📖 p. 237)



Tip

Replace spare fuse ④ in the fuse box so that it is available if needed.

- Mount the protection cap.

Finishing work

- Mount the seat. (📖 p. 116)



16.5 Changing the fuses of individual power consumers



Info

The fuse box with the main fuse and the fuses of the individual power consumers are located under the seat.

Preparatory work

- Switch off the ignition by turning the ignition key to the position .
- Remove the seat. ( p. 115)

16 ELECTRICAL SYSTEM



Main work

- Open fuse box cover ①.
- Remove the faulty fuse.

Guideline

Fuse 1 - 30 A - main fuse
Fuse 2 - 10 A - combination instrument
Fuse 3 - 10 A - power relay, engine electronics control unit
Fuse 4 - 15 A - ignition coil, fuel pump, start auxiliary relay, horn
Fuse 5 - 10 A - radiator fan
Fuse 6 - 15 A - brake light, turn signal, high beam, low beam, position light, tail light, license plate lamp
Fuse 7 - 10 A - ABS control unit, combination instrument, diagnostics connector
Fuse 8 - 10 A - emergency off
Fuse 9 - 10 A - permanent positive for auxiliary equipment (ACC1 front)
Fuse 10 - 10 A - positive connected with ignition for auxiliary equipment (ACC2 front, ACC2 rear)
Fuse SPARE - 10 A/15 A/30 A - spare fuses

**Info**

You can recognize a faulty fuse by a burned-out fuse wire **A**.

**Warning**

Fire hazard Incorrect fuses overload the electrical system.

- Only use fuses with the required ampere value.
- Do not bypass or repair fuses.

- Use spare fuses with the correct rating only.

Fuse (75011088010)  p. 237

Fuse (75011088015)  p. 237

Fuse (75011088030)  p. 237

**Tip**

Replace the spare fuse in the fuse box so that it is available if needed.

- Check that the power consumer is functioning properly.
- Close the fuse box cover **1**.

Finishing work

- Mount the seat.  p. 116



16.6 Changing the turn signal bulb

Note

Damage to reflector Grease on the reflector reduces the brightness.

Grease on the bulb will evaporate due to the heat and be deposited on the reflector.

- Clean and degrease the bulbs before mounting.
- Do not touch the bulbs with your bare hands.

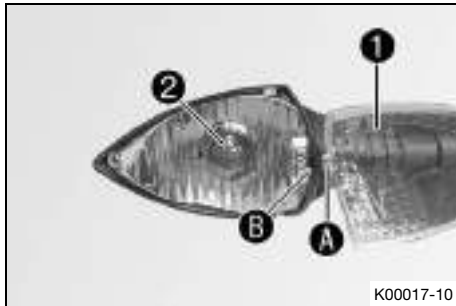

- Remove the screw on the rear of the turn signal housing.
- Carefully remove diffuser ❶.
- Push bulb ❷ lightly into the socket, turn approx. 30° counterclockwise, and pull it out of the socket.



Info

Do not touch the reflector with your fingers and keep it free from grease.

- Lightly push the new lamp into the socket and turn all the way clockwise.

Turn signal (RY10W / socket BAU15s) (📖 p. 237)

- Check that the turn signal is functioning properly.
- Position the diffuser.

**Info**

Insert catch **A** into recess **B**.

- Insert the screw and first turn counterclockwise until it engages in the thread with a small jerk. Tighten the screw lightly.



16.7 Checking the headlight setting

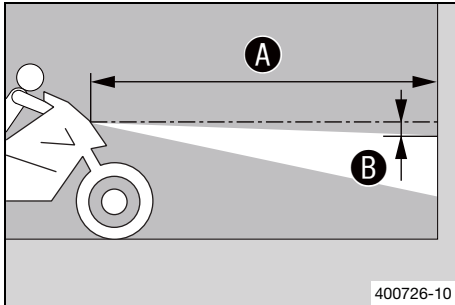

- Position the vehicle upright on a horizontal surface in front of a light wall and make a marking at the height of the center of the low beam headlight.
- Make another mark at a distance **B** under the first marking.

Guideline

Distance B	5 cm (2 in)
-------------------	-------------

- Position the vehicle perpendicular to the wall at a distance **A** from the wall and switch on the low beam.

Guideline

Distance A	5 m (16 ft)
-------------------	-------------

- The rider now mounts the motorcycle with luggage and passenger if applicable.
- Check the headlight setting.

The light-dark boundary must lie exactly on the lower marking when the motorcycle is ready to operate with the rider mounted along with any luggage and a passenger if applicable.

- » If the light-dark border does not meet specifications:
 - Adjust the headlight range. (📖 p. 192)

16.8 Adjusting the headlight range

Preparatory work

- Check the headlight setting. (📖 p. 191)

Main work

- Loosen screw ❶.
- To set the headlight range of the headlight, swivel the headlight upwards or downwards.

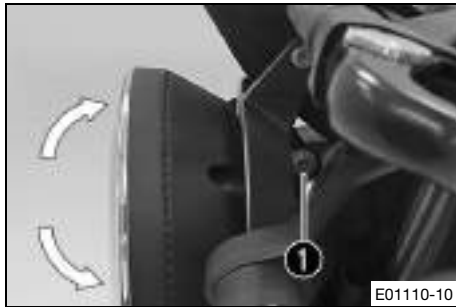

Info

Swiveling the headlight upwards increases the headlight range. Swiveling the headlight downwards reduces the headlight range. If you have a payload, you may have to correct the headlight range.

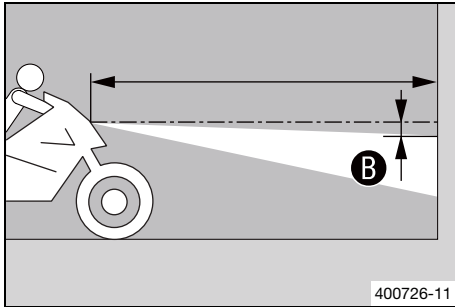

- Set the headlight to marking **B**.

Guideline

The light-dark boundary must lie exactly on lower marking **B** when the motorcycle is ready to operate with the rider mounted along with any luggage and a passenger if applicable.

- Tighten screw **1**.



Info

Screw **1** also secures the headlight. Make sure that screw is always tightened.

16.9 Diagnostics connector

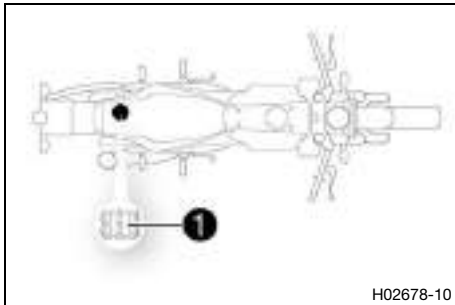

Diagnostics connector **1** is located under the seat.

16 ELECTRICAL SYSTEM

16.10 Front ACC1 and ACC2



Installation location

- Power supplies ACC1 ① and ACC2 ② front are located under the cover in front of the steering stem.

16.11 ACC2 rear



Installation location

- Power supplies ACC2 ① rear are located under the seat.

17.1 Cooling system



Water pump ❶ in the engine ensures forced circulation of the coolant.

The pressure resulting from the warming of the cooling system is regulated by a valve in radiator cap ❷. Heat expansion causes excess coolant to flow into compensating tank ❸. When the temperature falls, this surplus coolant is sucked back into the cooling system. This ensures that operating the vehicle at the specified coolant temperature will not result in a risk of malfunctions.

110 °C (230 °F)

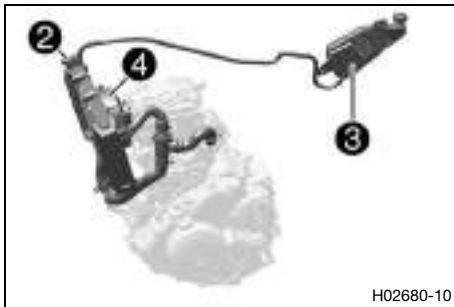

The coolant is cooled by the air stream and a radiator fan ❹, which is activated at high temperature.

The lower the speed, the less the cooling effect. Dirty cooling fins also reduce the cooling effect.

i Info

If the cooling system overheats, the maximum engine speed is limited.

17.2 Checking the antifreeze and coolant level



Warning

Danger of scalding During motorcycle operation, the coolant gets very hot and is under pressure.

- Do not open the radiator, the radiator hoses or other cooling system components if the engine or the cooling system are at operating temperature.
- Allow the cooling system and the engine to cool down before you open the radiator, the radiator hoses or other components of the cooling system.
- In the event of scalding, rinse the area affected immediately with lukewarm water.



Warning

Danger of poisoning Coolant is toxic and a health hazard.

- Keep coolant out of the reach of children.
- Do not allow coolant to come into contact with the skin, the eyes and clothing.
- Consult a doctor immediately if coolant is swallowed.
- Rinse the affected area immediately with plenty of water in the event of contact with the skin.
- Rinse eyes thoroughly with water and consult a doctor immediately if coolant gets into the eyes.
- Change clothing if coolant spills onto your clothing.

Condition

The engine is cold.

Preparatory work

- Remove the seat. (📖 p. 115)
- Remove the right side cover. 🛠️ (📖 p. 121)



Main work

- Stand the motorcycle upright on a horizontal surface.
- Remove cap ❶ of the compensating tank.
- Check the antifreeze in the coolant.

-25 ... -45 °C (-13 ... -49 °F)

- » If the antifreeze in the coolant does not match the specified value:
 - Correct the antifreeze in the coolant.
- Check the coolant level in the compensating tank.

The coolant level must be between **MIN** and **MAX**.

- » If the coolant level does not match the specified value:
 - Correct the coolant level.

Coolant (📖 p. 246)

- Mount the cap of the compensating tank.

17 COOLING SYSTEM

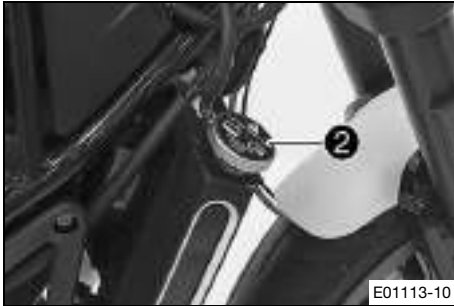

- Remove radiator cap ②.
- Check the antifreeze in the coolant.

-25 ... -45 °C (-13 ... -49 °F)

» If the antifreeze in the coolant does not match the specified value:

- Correct the antifreeze in the coolant.

- Check the coolant level in the radiator.

The radiator must be filled completely.

» If the coolant level does not match the specified value:

- Check the coolant level and the reason for the loss.

Coolant (📖 p. 246)

» If you had to add more coolant than the specified amount:

> 0.20 l (> 0.21 qt.)

- Fill/bleed the cooling system. 🛠️ (📖 p. 202)

- Mount the radiator cap.

Finishing work

- Install the right side cover. 🛠️ (📖 p. 124)

- Mount the seat. (📖 p. 116)

17.3 Checking the coolant level



Warning

Danger of scalding During motorcycle operation, the coolant gets very hot and is under pressure.

- Do not open the radiator, the radiator hoses or other cooling system components if the engine or the cooling system are at operating temperature.
- Allow the cooling system and the engine to cool down before you open the radiator, the radiator hoses or other components of the cooling system.
- In the event of scalding, rinse the area affected immediately with lukewarm water.



Warning

Danger of poisoning Coolant is toxic and a health hazard.

- Keep coolant out of the reach of children.
- Do not allow coolant to come into contact with the skin, the eyes and clothing.
- Consult a doctor immediately if coolant is swallowed.
- Rinse the affected area immediately with plenty of water in the event of contact with the skin.
- Rinse eyes thoroughly with water and consult a doctor immediately if coolant gets into the eyes.
- Change clothing if coolant spills onto your clothing.

Condition

The engine is cold.

17 COOLING SYSTEM



- Stand the motorcycle upright on a horizontal surface.
- Check the coolant level in compensating tank ①.

The coolant level must be between **MIN** and **MAX**.

- » If the coolant level does not match the specified value:
 - Correct the coolant level.

Coolant (📖 p. 246)



- Remove radiator cap ② and check the coolant level in the radiator.

The radiator must be filled completely.

- » If the coolant level does not match the specified value:
 - Check the coolant level and the reason for the loss.
- » If you had to add more coolant than the specified amount:
 - > 0.20 l (> 0.21 qt.)
 - Fill/bleed the cooling system. 🛠️ (📖 p. 202)

- Mount the radiator cap.

17.4 Draining the coolant ↻



Warning

Danger of scalding During motorcycle operation, the coolant gets very hot and is under pressure.

- Do not open the radiator, the radiator hoses or other cooling system components if the engine or the cooling system are at operating temperature.
- Allow the cooling system and the engine to cool down before you open the radiator, the radiator hoses or other components of the cooling system.
- In the event of scalding, rinse the area affected immediately with lukewarm water.



Warning

Danger of poisoning Coolant is toxic and a health hazard.

- Keep coolant out of the reach of children.
- Do not allow coolant to come into contact with the skin, the eyes and clothing.
- Consult a doctor immediately if coolant is swallowed.
- Rinse the affected area immediately with plenty of water in the event of contact with the skin.
- Rinse eyes thoroughly with water and consult a doctor immediately if coolant gets into the eyes.
- Change clothing if coolant spills onto your clothing.

Condition

The engine is cold.

17 COOLING SYSTEM



- Position the motorcycle upright.
- Place a suitable container under the engine.
- Remove screw ①.
- Remove the radiator cap.
- Completely drain the coolant.
- Mount and tighten screw ① with a new seal ring.

Guideline

Screw plug, water pump drain hole	M6	10 Nm (7.4 lbf ft)
-----------------------------------	----	--------------------

17.5 Filling/bleeding the cooling system ↴



Warning

Danger of poisoning Coolant is toxic and a health hazard.

- Keep coolant out of the reach of children.
- Do not allow coolant to come into contact with the skin, the eyes and clothing.
- Consult a doctor immediately if coolant is swallowed.
- Rinse the affected area immediately with plenty of water in the event of contact with the skin.
- Rinse eyes thoroughly with water and consult a doctor immediately if coolant gets into the eyes.
- Change clothing if coolant spills onto your clothing.

Preparatory work

- Remove the seat. (📖 p. 115)
- Remove the right side cover. 🛠️ (📖 p. 121)

Main work

- Remove radiator cap ❶.

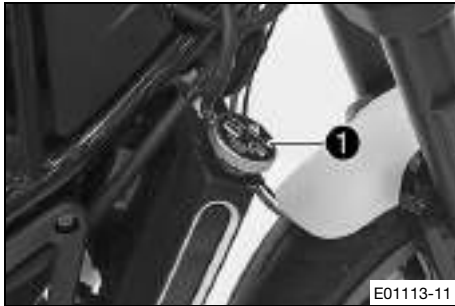

- Loosen bleeder screw ❷.

Guideline

3 turns

- Tilt the vehicle slightly to the right.
- Pour in coolant until it emerges without bubbles at the bleeder screw, and then mount and tighten the bleeder screw immediately.

Coolant (📖 p. 246)

- Completely fill the radiator with coolant. Mount the radiator cap.
- Rest the vehicle on the side stand.





Danger

Danger of poisoning Exhaust gases are toxic and inhaling them may result in unconsciousness and death.

- Always make sure there is sufficient ventilation when running the engine.
- Use an effective exhaust extraction system when starting or running the engine in an enclosed space.

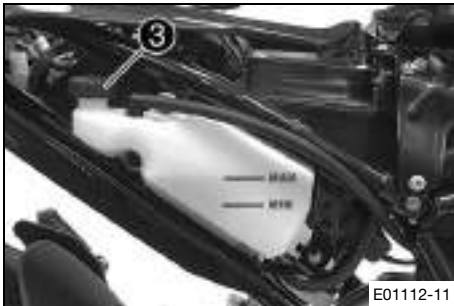

- Start the engine and let it warm up.
- Stop the engine and allow it to cool down.
- When the engine is cool, check the coolant level in the radiator and, if necessary, add coolant.
- Remove the cover **3** of the compensating tank and top up the coolant level up to the **MAX** marking.
- Mount the cover of the compensating tank.

Finishing work

- Install the right side cover. (🔧📖 p. 124)
- Mount the seat. (📖 p. 116)

17.6 Changing the coolant 🛠️



Warning

Danger of scalding During motorcycle operation, the coolant gets very hot and is under pressure.

- Do not open the radiator, the radiator hoses or other cooling system components if the engine or the cooling system are at operating temperature.
- Allow the cooling system and the engine to cool down before you open the radiator, the radiator hoses or other components of the cooling system.
- In the event of scalding, rinse the area affected immediately with lukewarm water.



Warning

Danger of poisoning Coolant is toxic and a health hazard.

- Keep coolant out of the reach of children.
- Do not allow coolant to come into contact with the skin, the eyes and clothing.
- Consult a doctor immediately if coolant is swallowed.
- Rinse the affected area immediately with plenty of water in the event of contact with the skin.
- Rinse eyes thoroughly with water and consult a doctor immediately if coolant gets into the eyes.
- Change clothing if coolant spills onto your clothing.

Condition

The engine is cold.

Preparatory work

- Remove the seat. (📖 p. 115)
- Remove the right side cover. 🛠️ (📖 p. 121)

17 COOLING SYSTEM



Main work

- Position the motorcycle upright.
- Place a suitable container under the engine.
- Remove screw ❶.



- Remove radiator cap ❷.
- Completely drain the coolant.
- Mount and tighten screw ❶ with a new seal ring.

Guideline

Screw plug, water pump drain hole	M6	10 Nm (7.4 lbf ft)
-----------------------------------	----	--------------------



- Loosen bleeder screw ③.

Guideline

3 turns

- Tilt the vehicle slightly to the right.
- Pour in coolant until it emerges without bubbles at the bleeder screw, and then mount and tighten the bleeder screw immediately.

Coolant (📖 p. 246)

- Completely fill the radiator with coolant.
- Mount the radiator cap.
- Rest the vehicle on the side stand.



Danger

Danger of poisoning Exhaust gases are toxic and inhaling them may result in unconsciousness and death.

- Always make sure there is sufficient ventilation when running the engine.
- Use an effective exhaust extraction system when starting or running the engine in an enclosed space.

- Start the engine and let it warm up.

17 COOLING SYSTEM



- Stop the engine and allow it to cool down.
- When the engine is cool, check the coolant level in the radiator and, if necessary, add coolant.
- Remove the cover of compensating tank ④ and top up the coolant level up to the **MAX** marking.
- Mount the cover of the compensating tank.

Finishing work

- Install the right side cover. 🛠️ (📖 p. 124)
- Mount the seat. (📖 p. 116)

18.1 Checking the clutch lever play

Note

Clutch damage If there is no free travel by the clutch lever, the clutch will begin to slip.

- Check the free travel of the clutch lever each time before using the motorcycle.
- Adjust the free travel of the clutch lever when necessary in accordance with the specification.

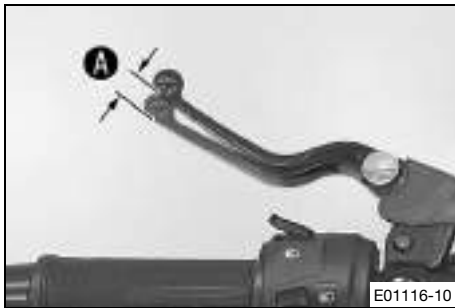

- Check the clutch lever for smooth operation.
- Move the handlebar to the straight-ahead position.
- Pull the clutch lever until resistance is perceptible, and determine the play in the clutch lever **A**.

Clutch lever play A	1 ... 3 mm (0.04 ... 0.12 in)
----------------------------	-------------------------------

- » If the clutch lever play does not meet the specified value:
 - Adjust play in the clutch lever. 🛠️ (p. 210)
- Move the handlebar to and fro over the entire steering range.

The clutch lever play must not change.
--

- » If the clutch lever play changes:
 - Check the routing of the clutch cable.



18.2 Adjusting play in the clutch lever

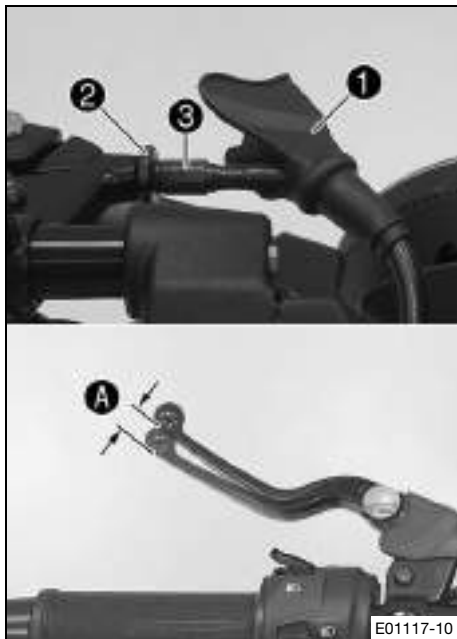

- Move the handlebar to the straight-ahead position.
- Push back sleeve **1**.
- Loosen lock nut **2**.
- Adjust the play in the clutch level **A** by turning adjusting screw **3**.

Guideline

Clutch lever play A	1 ... 3 mm (0.04 ... 0.12 in)
----------------------------	-------------------------------

- Tighten lock nut **2**.
- Position bellows **1**.

19.1 Checking the engine oil level

Condition

The engine is at operating temperature.

Preparatory work

- Stand the motorcycle upright on a horizontal surface.

Main work

- Check the engine oil level.

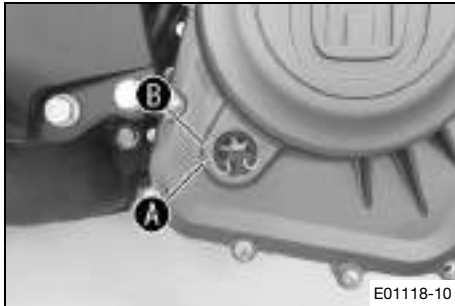

Info

After switching off the engine, wait one minute before checking the level.

The engine oil must be between the **A** and **B** markings .

- » When the engine oil level is below the **A** marking:
 - Add the engine oil. (📖 p. 216)
- » When the engine oil level is above the **B** marking:
 - Correct the engine oil level.

19.2 Changing the engine oil and oil filter, cleaning the oil screens ↴



Warning

Danger of scalding Engine and gear oil get very hot when the motorcycle is ridden.

- Wear suitable protective clothing and safety gloves.
- In the event of scalding, rinse the area affected immediately with lukewarm water.



Note

Environmental hazard Hazardous substances cause environmental damage.

- Dispose of oils, grease, filters, fuel, cleaning agents, brake fluid, etc., correctly and in compliance with the applicable regulations.



Info

Drain the engine oil while the engine is at operating temperature.

Preparatory work

- Stand the motorcycle on its side stand on a horizontal surface.

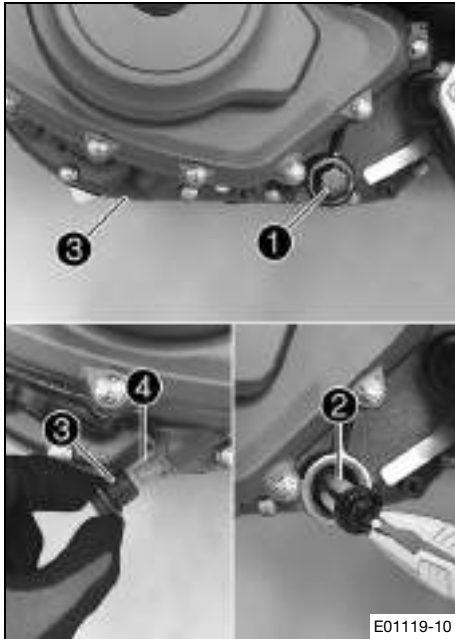

Main work

- Place a suitable container under the engine.
- Remove oil drain plug ① with the O-ring.
- Remove oil screen ② with the O-ring.
- Remove screw plug ③ with oil screen ④.
- Completely drain the engine oil.
- Thoroughly clean the oil drain plugs and oil screens.
- Position oil screen ② and mount and tighten oil drain plug ① with the O-ring.

Guideline

Oil drain plug	M24x1.5	15 Nm (11.1 lbf ft)
----------------	---------	---------------------

- Mount and tighten screw plug ③ with oil screen ④ and the O-ring.

Guideline

Oil screen screw plug, small	M17x1.5	12 Nm (8.9 lbf ft)
------------------------------	---------	--------------------

19 SERVICE WORK ON THE ENGINE

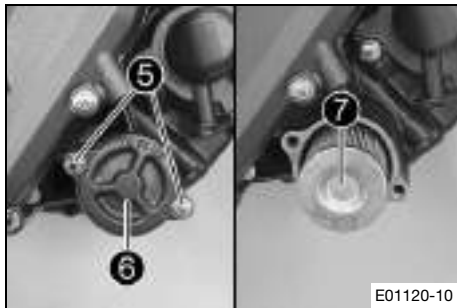

- Remove screws ⑤. Take off oil filter cover ⑥ with the O-ring.
- Pull oil filter ⑦ out of the oil filter housing.
- Completely drain the engine oil.
- Thoroughly clean the parts and sealing surface.

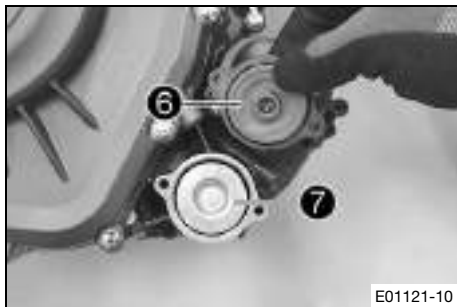

- Insert new oil filter ⑦.
- Oil the O-ring of the oil filter cover. Mount oil filter cover ⑥.
- Mount and tighten the screws.

Guideline

Screw, oil filter cover	M6	10 Nm (7.4 lbf ft)
-------------------------	----	--------------------

Info

Too little engine oil or poor-quality engine oil will result in premature wear of the engine.

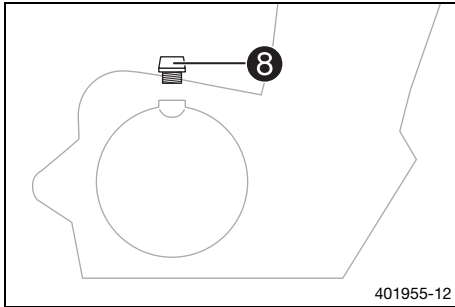

- Remove filler plug **8** from the clutch cover together with the O-ring, and fill up with engine oil.

Engine oil	1.7 l (1.8 qt.)	Engine oil (SAE 15W/50) (📖 p. 247)
------------	-----------------	--

- Mount and tighten the filler plug together with the O-ring.



Danger

Danger of poisoning Exhaust gases are toxic and inhaling them may result in unconsciousness and death.

- Always make sure there is sufficient ventilation when running the engine.
- Use an effective exhaust extraction system when starting or running the engine in an enclosed space.

- Start the engine and check that it is oil-tight.

Finishing work

- Check the engine oil level. (📖 p. 211)



19.3 Adding engine oil



Info

Too little engine oil or poor-quality engine oil results in premature wear to the engine.

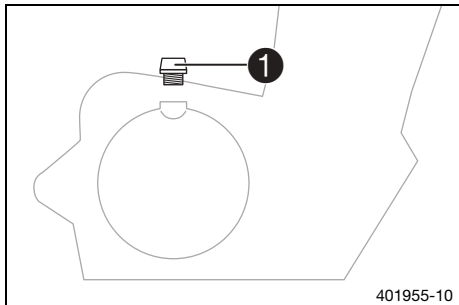

Main work

- Remove the oil filler plug ❶ with the O-ring from the clutch cover and fill up with engine oil.

Engine oil (SAE 15W/50) (📖 p. 247)



Info

In order to achieve optimal engine performance, it is not advisable to mix different engine oils. We recommended changing the engine oil when necessary.

- Install and tighten the oil filler plug with the O-ring.



Danger

Danger of poisoning Exhaust gases are toxic and inhaling them may result in unconsciousness and death.

- Always make sure there is sufficient ventilation when running the engine.
- Use an effective exhaust extraction system when starting or running the engine in an enclosed space.

- Start the engine and check that it is oil-tight.

Finishing work

- Check the engine oil level. (📖 p. 211)



20.1 Cleaning the motorcycle

Note

Material damage Components become damaged or destroyed if a pressure cleaner is used incorrectly. The high pressure forces water into the electrical components, connectors, throttle cables, and bearings, etc. Pressure which is too high causes malfunctions and destroys components.

- Do not direct the water jet directly on to electrical components, connectors, throttle cables or bearings.
- Maintain a minimum distance between the nozzle of the pressure cleaner and the component.

Minimum clearance

60 cm (23.6 in)



Note

Environmental hazard Hazardous substances cause environmental damage.

- Dispose of oils, grease, filters, fuel, cleaning agents, brake fluid, etc., correctly and in compliance with the applicable regulations.
-



Info

Clean the motorcycle regularly to maintain its value and appearance over a long period. Avoid direct sunshine when cleaning the motorcycle.

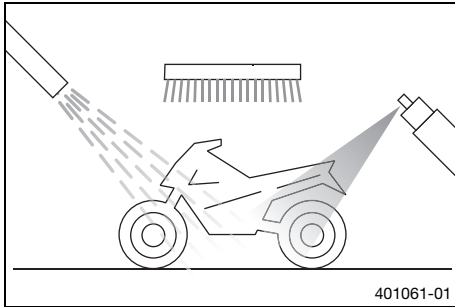

- Close off the exhaust system to keep water from entering.
- Remove loose dirt first with a soft jet of water.
- Spray heavily soiled parts with a normal commercial motorcycle cleaner and then brush off with a soft brush.

Motorcycle cleaner (📖 p. 250)



Info

Use warm water containing normal motorcycle cleaner and a soft sponge.

Never apply motorcycle cleaner to a dry motorcycle; always rinse the vehicle with water first.

Clean the motorcycle with cold water if it has been used on salted roads. Warm water enhances the corrosive effects of salt.

- After rinsing the motorcycle with a gentle spray of water, allow it to dry thoroughly.
- Remove the closure of the exhaust system.



Warning

Danger of accidents Moisture and dirt impair the brake system.

- Brake carefully several times to dry out and remove dirt from the brake linings and the brake discs.

- After cleaning, ride the vehicle a short distance until the engine warms up.



Info

The heat produced causes water at inaccessible locations in the engine and on the brake system to evaporate.

- Push back the sleeves of the handlebar controls to allow any water that has penetrated to evaporate.
- After the motorcycle has cooled off, lubricate all moving parts and pivot points.
- Clean the chain. (📖 p. 136)
- Treat bare metal (except for brake discs and the exhaust system) with a corrosion inhibitor.

Preserving materials for paints, metal and rubber
(📖 p. 250)

- Treat all painted parts with a mild paint care product.

Perfect Finish and high gloss polish for paints (📖 p. 250)

**Info**

Do not polish parts that were matte when delivered as this would strongly impair the material quality.

- Treat all plastic parts and powder-coated parts with a mild cleaning and care product.

Special cleaner for glossy and matte paint finishes, metal and plastic surfaces (📖 p. 250)

- Oil the ignition/steering lock.

Universal oil spray (📖 p. 250)



20.2 Checks and maintenance steps for winter operation

**Info**

If you use the motorcycle in winter, you must expect salt on the roads. You should therefore take precautions against aggressive road salt.

Clean the motorcycle with cold water if it has been used on salted roads. Warm water enhances the corrosive effects of salt.

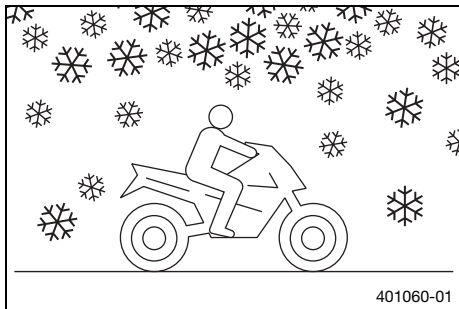

- Clean the motorcycle. (📖 p. 218)
- Clean the brakes.

i Info

After **EVERY** trip on salted roads, thoroughly clean the motorcycle and, in particular, the brake calipers and brake linings while cooled and installed with cold water and dry carefully.

-
- Treat the engine, the swingarm, and all other bare or zinc plated parts (except brake discs) with a wax-based corrosion inhibitor.

i Info

Corrosion inhibitor is not permitted to come in contact with the brake discs as this would greatly reduce the braking force.

-
- Clean the chain. (📖 p. 136)
- 

21.1 Storage

**Info**

If you plan to garage the motorcycle for a longer period, perform the following steps or have them performed.

Before storing the motorcycle, check all parts for function and wear. If service, repairs, or replacements are necessary, you should do this during the storage period (less workshop overload). In this way, you can avoid long workshop waiting times at the start of the new season.

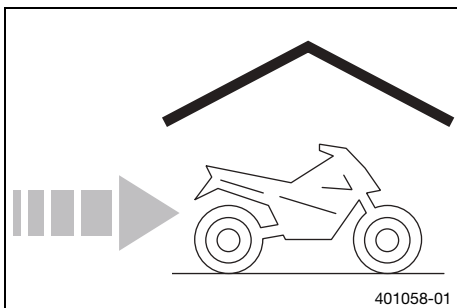

- When refueling for the last time before taking the motorcycle out of service, add fuel additive.

Fuel additive (📖 p. 249)

- Refuel. (📖 p. 101)
- Clean the motorcycle. (📖 p. 218)
- Change the engine oil and oil filter and clean the oil screens. 🛠️ (📖 p. 212)
- Check the antifreeze and coolant level. (📖 p. 196)
- Check the tire air pressure. (📖 p. 174)
- Remove the battery. 🛠️ (📖 p. 176)
- Recharge the battery. 🛠️ (📖 p. 181)

Guideline

Storage temperature of battery without direct sunshine	0 ... 35 °C (32 ... 95 °F)
--	----------------------------

- Store the vehicle in a dry location that is not subject to large fluctuations in temperature.



Info

Husqvarna Motorcycles recommends raising the motorcycle.

-
- Raise the motorcycle with the rear lifting gear. (📖 p. 108)
 - Lift the motorcycle with the front lifting gear. (📖 p. 112)
 - Cover the vehicle with a tarp or similar cover that is permeable to air.



Info

Do not use non-porous materials since they prevent humidity from escaping, thus causing corrosion. Avoid running the engine for a short time only. Since the engine cannot warm up properly, the water vapor produced during combustion condenses and causes valves and the exhaust system to rust.

21.2 Preparing for use after storage

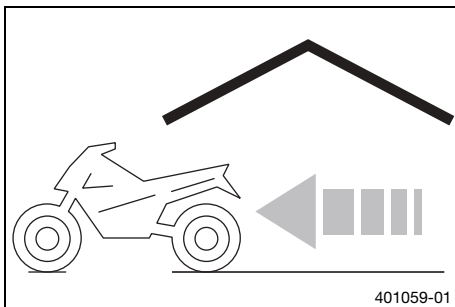

- Take the motorcycle off the front lifting gear. (📖 p. 113)
- Remove the rear of the motorcycle from the lifting gear. (📖 p. 110)
- Install the battery. 🛠️ (📖 p. 179)
- Set the clock. (📖 p. 78)
- Perform checks and maintenance measures when preparing for use. (📖 p. 87)
- Take a test ride.



Faults	Possible cause	Action
Engine does not crank when the electric starter button is pressed	Operating error	– Carry out the start procedure. (📖 p. 88)
	Battery discharged	– Recharge the battery. 🛠️ (📖 p. 181)
	Fuse 1 , 3 , 4 , or 7 is blown	– Change the fuses of individual power consumers. (📖 p. 187)
	No ground connection present	– Check the ground connection.
Engine turns only if the clutch lever is drawn	The vehicle is in gear	– Shift gear to neutral.
	The vehicle is in gear and the side stand is folded out	– Shift gear to neutral.
Engine turns but does not start	Operating error	– Carry out the start procedure. (📖 p. 88)
	Fault in fuel injection system	– Read out the fault memory using the Husqvarna Motorcycles diagnostics tool. 🛠️
Engine has too little power	Air filter is very dirty	– Change the air filter.
	Fuel filter is very dirty	– Check the fuel pressure. 🛠️
	Fault in fuel injection system	– Read out the fault memory using the Husqvarna Motorcycles diagnostics tool. 🛠️
Engine overheats	Too little coolant in cooling system	– Check the cooling system for leakage. – Check the coolant level. (📖 p. 199)
	Radiator fins very dirty	– Clean the radiator fins.

Faults	Possible cause	Action
Engine overheats	Foam formation in cooling system	<ul style="list-style-type: none"> – Drain the coolant. 🛠️ (📖 p. 201) – Fill/bleed the cooling system. 🛠️ (📖 p. 202)
	Thermostat defective	– Check the thermostat. 🛠️
	Fuse 5 blown	– Change the fuses of individual power consumers. (📖 p. 187)
	Defect in radiator fan system	– Check the radiator fan system. 🛠️
Malfunction indicator lamp lights up yellow	Fault in fuel injection system	– Read out the fault memory using the Husqvarna Motorcycles diagnostics tool. 🛠️
Engine dies during the trip	Lack of fuel	– Refuel. (📖 p. 101)
	Fuse 1, 3, 4, or 7 is blown	– Change the fuses of individual power consumers. (📖 p. 187)
ABS warning lamp lights up	ABS fuse is blown	– Change the ABS fuses. (📖 p. 184)
	Large difference in wheel speeds of the front and rear wheels	– Stop the vehicle, switch off the ignition, and start it again.
	Malfunction in ABS	– Read out the ABS fault memory using the Husqvarna Motorcycles diagnostics tool. 🛠️
High oil consumption	Engine vent hose bent	– Route the vent hose without bends or change it if necessary.

22 TROUBLESHOOTING

Faults	Possible cause	Action
High oil consumption	Engine oil level too high	– Check the engine oil level. (📖 p. 211)
	Engine oil too thin (low viscosity)	– Change the engine oil and oil filter and clean the oil screens. 🛠️ (📖 p. 212)
Headlight and position light are not functioning	Fuse 6 blown	– Change the fuses of individual power consumers. (📖 p. 187)
Turn signal, brake light, and horn are not functional	Fuse 4 or 6 blown	– Change the fuses of individual power consumers. (📖 p. 187)
Time is not displayed or not correctly displayed	Fuse 2 or 7 blown	– Change the fuses of individual power consumers. (📖 p. 187)
Battery discharged	Ignition was not switched off when vehicle was parked	– Recharge the battery. 🛠️ (📖 p. 181)
	Battery is not being charged by alternator	– Check the charging voltage. 🛠️ – Check the open-circuit current. 🛠️
The combination instrument shows nothing on the display	Fuse 2 or 7 blown	– Change the fuses of individual power consumers. (📖 p. 187)
Speedometer in combination instrument not functioning	Speedometer wiring harness is damaged or plug-in connector is oxidized	– Check the wiring harness and plug-in connector.

23.1 Engine

Design	1-cylinder 4-stroke engine, water-cooled
Displacement	373 cm ³ (22.76 cu in)
Stroke	60 mm (2.36 in)
Bore	89 mm (3.5 in)
Compression ratio	12.6:1
Control	DOHC, 4 valves controlled via cam lever, chain drive
Valve diameter, intake	36 mm (1.42 in)
Valve diameter, exhaust	29 mm (1.14 in)
Valve clearance, intake, cold	0.10 ... 0.15 mm (0.0039 ... 0.0059 in)
Valve clearance, exhaust, cold	0.15 ... 0.20 mm (0.0059 ... 0.0079 in)
Crankshaft bearing	2 slide bearings
Conrod bearing	Sleeve bearing
Pistons	Forged light alloy
Piston rings	1 compression ring, 1 tapered compression piston ring, 1 oil scraper ring
Engine lubrication	Pressure circulation lubrication with two rotary pumps
Primary transmission	30:80
Clutch	Slipper clutch in oil bath/mechanically operated
Transmission	6-gear, claw shifted

Transmission ratio	
1st gear	12:32
2nd gear	14:26
3rd gear	19:27
4th gear	21:24
5th gear	23:22
6th gear	25:21
Mixture preparation	Electronically controlled fuel injection
Ignition	Contactless controlled fully electronic ignition with digital ignition adjustment
Alternator	12 V, 230 W
Spark plug	BOSCHVR5NEU
Spark plug electrode gap	1 mm (0.04 in)
Cooling	Water cooling, permanent circulation of coolant by water pump
Idle speed	1,680 ± 50 rpm
Starting aid	Electric starter

23.2 Engine tightening torques

Oil nozzle	M5	6 Nm (4.4 lbf ft)	Loctite®243™
------------	----	-------------------	---------------------

Screw, gear sensor	M5	6 Nm (4.4 lbf ft)	Loctite®243™
Screw, ignition pulse generator	M5	6 Nm (4.4 lbf ft)	Loctite®243™
Screw, retaining bracket	M5	6 Nm (4.4 lbf ft)	Loctite®243™
Screw, retaining bracket, stator cable	M5	8 Nm (5.9 lbf ft)	Loctite®243™
Screw, stator	M5	8 Nm (5.9 lbf ft)	Loctite®243™
Cylinder head screw	M6	12 Nm (8.9 lbf ft)	
Nut, water pump impeller	M6	10 Nm (7.4 lbf ft)	Loctite®243™
Oil nozzle	M6	6 Nm (4.4 lbf ft)	Loctite®243™
Screw plug, water pump drain hole	M6	10 Nm (7.4 lbf ft)	
Screw, alternator cover	M6	12 Nm (8.9 lbf ft)	
Screw, bearing retainer	M6	12 Nm (8.9 lbf ft)	Loctite®243™
Screw, camshaft bearing support	M6	10 Nm (7.4 lbf ft)	
Screw, camshaft, decompression shaft	M6	10 Nm (7.4 lbf ft)	Loctite®243™

23 TECHNICAL DATA

Screw, chain securing guide	M6	10 Nm (7.4 lbf ft)	Loctite®243™
Screw, clutch cover	M6	12 Nm (8.9 lbf ft)	
Screw, clutch spring	M6	10 Nm (7.4 lbf ft)	
Screw, engine case	M6x35	12 Nm (8.9 lbf ft)	Loctite®243™
Screw, engine case	M6x75	12 Nm (8.9 lbf ft)	
Screw, engine vent plate	M6	10 Nm (7.4 lbf ft)	Loctite®243™
Screw, freewheel gear retaining bracket	M6	12 Nm (8.9 lbf ft)	Loctite®243™
Screw, lock washer, engine sprocket	M6	12 Nm (8.9 lbf ft)	Loctite®243™
Screw, locking lever	M6	12 Nm (8.9 lbf ft)	Loctite®243™
Screw, oil filter cover	M6	10 Nm (7.4 lbf ft)	
Screw, oil pump	M6	12 Nm (8.9 lbf ft)	Loctite®243™
Screw, retaining bracket	M6	12 Nm (8.9 lbf ft)	Loctite®243™
Screw, retaining bracket, clutch cable pull	M6	6 Nm (4.4 lbf ft)	Loctite®243™

Screw, retaining bracket, shaft seal ring, clutch cover	M6	12 Nm (8.9 lbf ft) Loctite®243™
Screw, shift drum locating	M6	12 Nm (8.9 lbf ft) Loctite®243™
Screw, starter motor	M6	12 Nm (8.9 lbf ft)
Screw, timing chain tensioner	M6	12 Nm (8.9 lbf ft)
Screw, timing chain tensioning rail	M6	12 Nm (8.9 lbf ft) Loctite®243™
Screw, unlocking of timing chain tensioner	M6	6 Nm (4.4 lbf ft)
Screw, valve cover	M6	12 Nm (8.9 lbf ft)
Screw, water pump cover	M6	12 Nm (8.9 lbf ft)
Nut, exhaust flange	M8	8 Nm (5.9 lbf ft)
Screw plug	M8	12 Nm (8.9 lbf ft) Loctite®243™
Screw, balancer shaft gear	M8	40 Nm (29.5 lbf ft) Loctite®243™
Screw, return spring, quick shifter	M8	20 Nm (14.8 lbf ft) Loctite®243™
Stud, exhaust flange	M8	22 Nm (16.2 lbf ft)
Screw, conrod bearing	M8x1	34 Nm (25.1 lbf ft)
Oil pressure sensor	M10	14 Nm (10.3 lbf ft)

23 TECHNICAL DATA

Screw, camshaft drive sprocket	M10	36 Nm (26.6 lbf ft) Loctite®243™
Screw, cylinder head	M10	1st stage 30 Nm (22.1 lbf ft) 2nd stage 60 Nm (44.3 lbf ft) Thread is oiled, head flat is greased
Screw, rotor	M10	105 Nm (77.4 lbf ft) Loctite®243™
Water temperature sensor	M10	14 Nm (10.3 lbf ft)
Screw plug, cam lever axis	M10x1	10 Nm (7.4 lbf ft)
Spark plug	M12	15 Nm (11.1 lbf ft)
Nut, inner clutch hub	M16LHx1.5	120 Nm (88.5 lbf ft) Loctite®243™
Nut, primary gear/timing chain sprocket	M16x1.5	120 Nm (88.5 lbf ft) Loctite®243™
Oil screen screw plug, small	M17x1.5	12 Nm (8.9 lbf ft)
Screw plug, alternator cover	M18x1.5	10 Nm (7.4 lbf ft)
Oil drain plug	M24x1.5	15 Nm (11.1 lbf ft)
Screw plug, alternator cover	M24x1.5	10 Nm (7.4 lbf ft)
Nut, drive wheel for balancer shaft	M28	60 Nm (44.3 lbf ft)

23.3 Capacities

23.3.1 Engine oil

Engine oil	1.7 l (1.8 qt.)	Engine oil (SAE 15W/50) (📖 p. 247)
------------	-----------------	------------------------------------

23.3.2 Coolant

Coolant	1.2 l (1.3 qt.)	Coolant (📖 p. 246)
---------	-----------------	--------------------

23.3.3 Fuel

Total fuel tank capacity, approx.	9.5 l (2.51 US gal)	Super unleaded (ROZ 95/RON 95/PON 91) (📖 p. 248)
-----------------------------------	---------------------	--

Fuel reserve, approx.	1.5 l (1.6 qt.)
-----------------------	-----------------

23.4 Chassis

Frame	Lattice frame of steel tubes, powder-coated
Fork	WP Performance Systems Up Side Down 4357
Shock absorber	WP Performance Systems 4614
Brake system	
front	Disc brake with four-pot brake caliper
rear	Disc brake with single-pot brake caliper, floating

Suspension travel	
front	142 mm (5.59 in)
rear	150 mm (5.91 in)
Brake discs - diameter	
front	320 mm (12.6 in)
rear	230 mm (9.06 in)
Brake discs - wear limit	
front	4.5 mm (0.177 in)
rear	3.6 mm (0.142 in)
Tire air pressure, solo	
front	2.0 bar (29 psi)
rear	2.0 bar (29 psi)
Tire air pressure with passenger / full payload	
front	2.0 bar (29 psi)
rear	2.0 bar (29 psi)
Secondary ratio	15:45
Chain	5/8 x 1/4" (520) X-ring
Steering head angle	65°
Wheelbase	1,357 ± 15.5 mm (53.43 ± 0.61 in)
Seat height, unloaded	835 mm (32.87 in)
Ground clearance, unloaded	170 mm (6.69 in)

Weight without fuel, approx.	148 kg (326 lb.)
Maximum permissible front axle load	135 kg (298 lb.)
Maximum permissible rear axle load	230 kg (507 lb.)
Maximum permissible overall weight	355 kg (783 lb.)

23.5 Electrical system

Battery	HTZ12A-BS	Battery voltage: 12 V Nominal capacity: 10 Ah Maintenance-free
Fuse	75011088010	10 A
Fuse	75011088015	15 A
Fuse	90111088025	25 A
Fuse	75011088030	30 A
Headlight	LED	
Position light	LED	
Instrument lights and indicator lamps	LED	
Turn signal	RY10W / socket BAU15s	12 V 10 W
Brake/tail light	LED	
License plate lamp	LED	

23.6 Tires



Info

Hoses must be used in the tubeless tires on this vehicle.

Front tire	Rear tire
110/70 R 17 M/C 54H TL Metzeler Sportec M5 Interact	150/60 R 17 M/C 66H TL Metzeler Sportec M5 Interact
The tires specified represent one of the possible series production tires. Additional information is available in the Service section under: www.husqvarna-motorcycles.com	

23.7 Fork

Fork article number	05.58.6Q.07	
Fork	WP Performance Systems Up Side Down 4357	
Fork length	744 mm (29.29 in)	
Spring rate		
Medium (standard)	6 N/mm (34 lb/in)	
Spring length with preload spacer(s)	356 mm (14.02 in)	
Fork oil per fork leg	445 ml (15.05 fl. oz.)	Fork oil (SAE 5) (📖 p. 248)

23.8 Shock absorber

Shock absorber article number	01.58.4Q.07
Shock absorber	WP Performance Systems 4614
Spring preload	
Standard	5 clicks
Full payload	10 clicks
Static sag	13 mm (0.51 in)
Riding sag	46 mm (1.81 in)
Inbuilt length	304 mm (11.97 in)
Spring rate	
Medium (standard)	100 ... 150 N/mm (571 ... 857 lb/in)
Spring length	180 mm (7.09 in)

23.9 Chassis tightening torques

Exhaust clamp	-	20 Nm (14.8 lbf ft)
Screw, chain guard	EJOT PT® 40x12	1.5 Nm (1.11 lbf ft)
Screw, combination instrument	EJOT PT® K50x12	2 Nm (1.5 lbf ft)
Screw, headlight mask	EJOT PT® K50x12	2 Nm (1.5 lbf ft)
Screw, license plate lamp	EJOT PT® 40x12	1.5 Nm (1.11 lbf ft)
Screw, rear trim	EJOT PT® 40x12	1.5 Nm (1.11 lbf ft)

Remaining nuts, chassis	M4	4 Nm (3 lbf ft)
Remaining screws, chassis	M4	4 Nm (3 lbf ft)
Nut, chain guard	M5	7 Nm (5.2 lbf ft)
Remaining nuts, chassis	M5	5 Nm (3.7 lbf ft)
Remaining screws, chassis	M5	5 Nm (3.7 lbf ft)
Screw, anti-rotation lock, handle-bar stub	M5	4 Nm (3 lbf ft)
Screw, cable guide holder on license plate holder	M5x12	4 Nm (3 lbf ft)
Screw, fender	M5x12	3 Nm (2.2 lbf ft)
Screw, fender	M5x20	2 Nm (1.5 lbf ft)
Screw, fuel tank bridge	M5	3 Nm (2.2 lbf ft)
Screw, fuel tank cover	M5	3 Nm (2.2 lbf ft)
Screw, headlight fixation on combination instrument	M5	2 Nm (1.5 lbf ft)
Screw, seat fixing	M5	3 Nm (2.2 lbf ft)
Screw, tail light	M5	2 Nm (1.5 lbf ft)
Spoke nipple	M5	4 Nm (3 lbf ft)
Fitting, ABS module retaining bracket	M6	7 Nm (5.2 lbf ft)
Nut, foot brake lever adjustment	M6	7 Nm (5.2 lbf ft)
Nut, radiator	M6	5 Nm (3.7 lbf ft)

Nut, radiator fan	M6	3 Nm (2.2 lbf ft) Loctite®243™
Remaining nuts, chassis	M6	10 Nm (7.4 lbf ft)
Remaining screws, chassis	M6	10 Nm (7.4 lbf ft)
Screw, air filter box	M6	3 Nm (2.2 lbf ft)
Screw, brake line guide	M6	7 Nm (5.2 lbf ft)
Screw, brake line holder	M6	6 Nm (4.4 lbf ft) Loctite®243™
Screw, chain sliding guard	M6	7 Nm (5.2 lbf ft)
Screw, compensating tank	M6	5 Nm (3.7 lbf ft) Loctite®243™
Screw, control unit holder	M6	5 Nm (3.7 lbf ft) Loctite®243™
Screw, engine shift lever	M6	7 Nm (5.2 lbf ft)
Screw, engine sprocket cover	M6	8 Nm (5.9 lbf ft)
Screw, fender on axle clamp	M6	7 Nm (5.2 lbf ft)
Screw, foot brake cylinder	M6	9 Nm (6.6 lbf ft) Loctite®243™
Screw, front trim	M6x15	5 Nm (3.7 lbf ft)
Screw, front trim	M6x25	5 Nm (3.7 lbf ft)
Screw, fuel pump	M6	4 Nm (3 lbf ft)
Screw, fuel tank bridge	M6	5 Nm (3.7 lbf ft)

23 TECHNICAL DATA

Screw, fuel tank fastening	M6	8 Nm (5.9 lbf ft)
Screw, handlebar stub	M6	14 Nm (10.3 lbf ft) Loctite®243™
Screw, headlight	M6	5 Nm (3.7 lbf ft)
Screw, headlight fixation on triple clamp	M6	7 Nm (5.2 lbf ft)
Screw, license plate holder	M6	5 Nm (3.7 lbf ft)
Screw, main silencer	M6	12 Nm (8.9 lbf ft)
Screw, shift rod	M6	8 Nm (5.9 lbf ft) Loctite®243™
Screw, splash protector	M6	6 Nm (4.4 lbf ft)
Screw, wheel cover holder on license plate holder	M6x30	12 Nm (8.9 lbf ft) Loctite®243™
Screw, wheel cover holder on license plate holder	M6x12	5 Nm (3.7 lbf ft) Loctite®243™
Screw, wheel cover license plate holder	M6	5 Nm (3.7 lbf ft)
Screw, wheel speed sensor	M6	8 Nm (5.9 lbf ft)
Nut, rear sprocket	M8	35 Nm (25.8 lbf ft) Loctite®243™
Remaining nuts, chassis	M8	25 Nm (18.4 lbf ft)
Remaining screws, chassis	M8	25 Nm (18.4 lbf ft)
Screw, bottom triple clamp	M8	12 Nm (8.9 lbf ft)

Screw, engine bearer	M8	22 Nm (16.2 lbf ft)
Screw, fork stub	M8	15 Nm (11.1 lbf ft)
Screw, front brake caliper	M8	30 Nm (22.1 lbf ft) Loctite®243™
Screw, front brake disc	M8	35 Nm (25.8 lbf ft) Loctite®243™
Screw, front wheel spindle	M8	26 Nm (19.2 lbf ft)
Screw, fuel tank bridge	M8x40	21 Nm (15.5 lbf ft)
Screw, fuel tank bridge	M8x30	26 Nm (19.2 lbf ft)
Screw, handlebar clamp	M8	20 Nm (14.8 lbf ft) Loctite®243™
Screw, license plate holder	M8x20	20 Nm (14.8 lbf ft) Loctite®243™
Screw, license plate holder	M8x35	25 Nm (18.4 lbf ft) Loctite®243™
Screw, main silencer	M8	23 Nm (17 lbf ft)
Screw, rear brake disc	M8	22 Nm (16.2 lbf ft) Loctite®243™
Screw, top triple clamp	M8	17 Nm (12.5 lbf ft)
Banjo bolt, brake line	M10	25 Nm (18.4 lbf ft)
Fitting, engine mounting bracket	M10	49 Nm (36.1 lbf ft)
Nut, side stand	M10	30 Nm (22.1 lbf ft)
Remaining nuts, chassis	M10	45 Nm (33.2 lbf ft)

23 TECHNICAL DATA

Remaining screws, chassis	M10	45 Nm (33.2 lbf ft)	
Screw, foot brake lever	M10	30 Nm (22.1 lbf ft)	Loctite®243™
Screw, grab handle	M10	25 Nm (18.4 lbf ft)	Loctite®243™
Screw, handlebar support	M10	20 Nm (14.8 lbf ft)	
Screw, license plate holder	M10x30	45 Nm (33.2 lbf ft)	Loctite®243™
Screw, shift lever	M10	30 Nm (22.1 lbf ft)	Loctite®243™
Screw, side stand bracket	M10	55 Nm (40.6 lbf ft)	Loctite®243™
Screw, bottom shock absorber	M10x1.25	52 Nm (38.4 lbf ft)	
Screw, top shock absorber	M10x1.25	52 Nm (38.4 lbf ft)	Loctite®243™
Nut, rear wheel spindle	M14x1.5	90 Nm (66.4 lbf ft)	
Nut, swingarm pivot	M14x1.5	100 Nm (73.8 lbf ft)	
Screw, steering head, top	M16	53 Nm (39.1 lbf ft)	Loctite®243™
Lambda sensor	M18	19 Nm (14 lbf ft)	

Nut, steering head	M30x1	1st stage 55 Nm (40.6 lbf ft) 2nd stage (loosen, counterclockwise) 2 turns 3rd stage 5 Nm (3.7 lbf ft)
--------------------	-------	---

Brake fluid DOT 4 / DOT 5.1

Standard/classification

- DOT

Guideline

- Use only brake fluid that complies with the specified standard (see specifications on the container) and that exhibits the corresponding properties.

Recommended supplier

Castrol

- **REACT PERFORMANCE DOT 4**

Motorex®

- **Brake Fluid DOT 5.1**

Coolant

Guideline

- Only use high-grade, silicate-free coolant with corrosion inhibitor additive for aluminum motors. Low grade and unsuitable antifreeze causes corrosion, deposits and frothing.
- Do not use pure water as only coolant is able to meet the requirements needed in terms of corrosion protection and lubrication properties.
- Only use coolant that complies with the requirements stated (see specifications on the container) and that has the relevant properties.

Antifreeze protection to at least	-25 °C (-13 °F)
-----------------------------------	-----------------

The mixture ratio must be adjusted to the necessary antifreeze protection. Use distilled water if the coolant needs to be diluted.

The use of premixed coolant is recommended.

Observe the coolant manufacturer specifications for antifreeze protection, dilution and miscibility (compatibility) with other coolants.

Recommended supplier

Motorex®

- **COOLANT M3.0**

Engine oil (SAE 15W/50)

Standard/classification

- JASO T903 MA (📖 p. 251)
- SAE (📖 p. 251) (SAE 15W/50)

Guideline

- Use only engine oils that comply with the specified standards (see specifications on the container) and that possess the corresponding properties.

Partially synthetic engine oil

Recommended supplier

Motorex®

- **Formula 4T**

Fork oil (SAE 5)

Standard/classification

- SAE (📖 p. 251) (SAE 5)

Guideline

- Use only oils that comply with the specified standards (see specifications on the container) and that possess the corresponding properties.

Recommended supplier

Motorex®

- Racing Fork Oil

Super unleaded (ROZ 95/RON 95/PON 91)

Standard/classification

- DIN EN 228 (ROZ 95/RON 95/PON 91)

Guideline

- Only use unleaded super fuel that matches or is equivalent to the specified fuel grade.
- Fuel with an ethanol content of up to 10 % (E10 fuel) is safe to use.



Info

Do **not** use fuel containing methanol (e. g. M15, M85, M100) or more than 10 % ethanol (e. g. E15, E25, E85, E100).

Chain cleaner

Recommended supplier

Motorex®

- Chain Clean

Chain lube for road use

Guideline

Recommended supplier

Motorex®

- Chainlube Road

Fuel additive

Recommended supplier

Motorex®

- Fuel Stabilizer

Long-life grease

Recommended supplier

Motorex®

- Bike Grease 2000

Motorcycle cleaner

Recommended supplier

Motorex®

- Moto Clean

Perfect Finish and high gloss polish for paints

Recommended supplier

Motorex®

- Moto Polish & Shine

Preserving materials for paints, metal and rubber

Recommended supplier

Motorex®

- Moto Protect

Special cleaner for glossy and matte paint finishes, metal and plastic surfaces

Recommended supplier

Motorex®

- Quick Cleaner

Universal oil spray

Recommended supplier

Motorex®

- Joker 440 Synthetic

JASO T903 MA

Different technical development directions required a separate specification for motorcycles – the **JASO T903 MA** standard.

Earlier, engine oils from the automobile industry were used for motorcycles because there was no separate motorcycle specification.

Whereas long service intervals are demanded for automobile engines, the focus for motorcycle engines is on high performance at high engine speeds.

In most motorcycle engines, the transmission and clutch are lubricated with the same oil.

The **JASO MA** standard meets these special requirements.

SAE

The SAE viscosity classes were defined by the Society of Automotive Engineers and are used for classifying oils according to their viscosity. The viscosity describes only one property of oil and says nothing about quality.

27 INDEX OF SPECIAL TERMS



ABS	ABS	Safety system that prevents locking of the wheels when driving straight ahead without the influence of lateral forces
OBD	On-board diagnosis	Vehicle system, which monitors the specified parameters of the vehicle electronics

Art. no.	Article number
ca.	circa
cf.	compare
e.g.	for example
etc.	et cetera
i.a.	inter alia
no.	number
poss.	possibly

29 LIST OF SYMBOLS



29.1 Yellow and orange symbols

Yellow and orange symbols indicate an error condition that requires prompt intervention. Active driving aids are also represented by yellow or orange symbols.

	Malfunction indicator lamp lights up yellow – The OBD has detected an error in the vehicle electronics. Come safely to a halt, and contact an authorized Husqvarna Motorcycles workshop.
	ABS warning lamp lights up yellow – Status or error messages relating to ABS.

29.2 Green and blue symbols

Green and blue symbols reflect information.

	The turn signal indicator lamp flashes green simultaneously with the turn signal – The turn signal is switched on.
	The idle indicator lamp lights up green – The transmission is in idle.
	The high beam indicator lamp lights up blue – The high beam is switched on.

A	
ABS	144
ABS fuses	
changing	184
ACC1	
front	194
ACC2	
front	194
rear	194
Accessories	24
Antifreeze	
checking	196
Antilock brake system	144
Apply the brakes.	96
Auxiliary substances	24
B	
Battery	
installing	179
recharging	181
removing	176

Brake discs	
checking	146
Brake fluid	
front brake, adding	149
of rear brake, adding	154
Brake fluid level	
front brake, checking	148
rear brake, checking	153
Brake linings	
front brake, checking	152
rear brake, checking	156
Brakes	96

C	
Capacity	
coolant	235
engine oil	235
fuel	102, 235
Chain	
chain dirt accumulation, checking	136
checking	141
cleaning	136

Chain tension		
adjusting	139	
checking	138	
Chassis number	32	
Clutch lever	35	
basic position, adjusting	49	
Clutch lever play		
checking	209	
Combination instrument	52-81	
activation and test	53	
Average Speed Trip1	72	
Average Speed Trip2	75	
Avg F.C. Trip 1	73	
Avg F.C. Trip 2	76	
coolant temperature indicator	65	
display	63	
fuel level display	64	
Fuel Range	68	
function buttons	66	
indicator lamps	59	
Info display	67	
ODO display	68	
overview	52	
Service	69	
	shift warning light	61
	Time Trip 1	71
	Time Trip 2	74
	TRIP 1 display	70
	TRIP 2 display	74
	warning notes	54
Coolant		
changing	205	
draining	201	
Coolant level		
checking	196, 199	
Cooling system	195	
filling/bleeding	202	
Customer service	25	
D		
Diagnostics connector	193	
E		
Electric starter button	39	
Emergency OFF switch	38	
Engine		
running in	84	
Engine number	33	

Engine oil	
adding	216
changing	212
Engine oil level	
checking	211
Engine sprocket	
checking	141
Environment	23
F	
Figures	25
Filler cap	
closing	43
opening	41
Foot brake lever	47
free travel, adjusting	159
free travel, checking	158
Fork legs	
dust boots, cleaning	114
Front wheel	
installing	162
removing	161
Fuse	
individual power consumers, changing	187
G	
Grab handle	45
H	
Hand brake lever	35
basic position, adjusting	49
Headlight	
range, adjusting	192
Headlight setting	
checking	191
High beam flasher button	36
Horn button	38
I	
Ignition lock	39
Implied warranty	24
Indicator lamps	59
K	
Key number	34

L

License plate holder	
installing	131
removing	127
Light switch	37
Loading the vehicle	84
Luggage	84

M

Misuse	11
Motorcycle	
cleaning	218
lifting with front lifting gear	112
raising with the rear lifting gear	108
removing the rear from the lifting gear	110
taking off front lifting gear	113

O

Oil filter	
changing	212
Oil screens	
cleaning	212
Operating substances	24
Owner's Manual	23

P

Parking	98
Passenger foot pegs	45
Play in the clutch lever	
adjusting	210
Preparing for use	
advice on preparing for first use	82
after storage	225
checks and maintenance measures when preparing for use	87
Protective clothing	22

R

Rear hub rubber dampers	
checking	170
Rear sprocket	
checking	141
Rear wheel	
installing	167
removing	165
Refueling	
fuel	101

Riding	91	Side cover, left	
starting off	90	installing	119
Right side cover		removing	116
installing	124	Side stand	47
removing	121	Spare parts	24
S		Spoke tension	
Safe operation	21	checking	175
Seat		Starting	88
mounting	116	Steering	
removing	115	locking	40
Seat lock	44	unlocking	41
Service	25	Steering lock	39
Service schedule	103-106	Stopping	98
Shift lever	46	Storage	223
adjusting	50	Switch	
Shift speed RPM1		on the left side of the handlebar	36
adjusting	79	on the right side of the handlebar	38
Shift speed RPM2		T	
adjusting	80	Technical data	
Shifting	91	capacities	235
Shock absorber		chassis	235
spring preload, adjusting	107	chassis tightening torques	239

electrical system	237	U	
engine	229	Units	
engine tightening torques	230	adjusting	77
fork	238	Use definition	11
shock absorber	239	V	
tires	238	View of vehicle	
Throttle grip	36	front left	28
Time		rear right	30
adjusting	78	W	
Tire air pressure		Warranty	24
checking	174	Winter operation	
Tire condition		checks and maintenance steps	221
checking	171	Work rules	22
Tool set	44		
Transport	100		
Troubleshooting	226-228		
Turn signal bulb			
changing	190		
Turn signal switch	37		
Type label	32		

PIONEERING SINCE 1903



3402207en

01/2018



Husqvarna Motorcycles GmbH
Stallhofenerstraße 3 | 5230 Menden
www.husqvarna-motorcycles.com

<https://www.motorcycle-manual.com/>

Husqvarna Motorcycles GmbH