

**DODGE**

**2011**

**Ram Truck**

---

**OWNER'S MANUAL**

# TABLE OF CONTENTS

SECTION		PAGE
1	INTRODUCTION .....	3
2	THINGS TO KNOW BEFORE STARTING YOUR VEHICLE .....	9
3	UNDERSTANDING THE FEATURES OF YOUR VEHICLE .....	77
4	UNDERSTANDING YOUR INSTRUMENT PANEL .....	173
5	STARTING AND OPERATING .....	261
6	WHAT TO DO IN EMERGENCIES .....	357
7	MAINTAINING YOUR VEHICLE .....	379
8	MAINTENANCE SCHEDULES .....	429
9	IF YOU NEED CONSUMER ASSISTANCE .....	447
10	INDEX .....	457



# INTRODUCTION

## CONTENTS

---

■ Introduction . . . . .	4	■ Van Conversions/Campers . . . . .	6
■ How To Use This Manual . . . . .	4	■ Vehicle Identification Number . . . . .	7
■ Warnings And Cautions . . . . .	6	■ Vehicle Modifications/Alterations . . . . .	7

### INTRODUCTION

Congratulations on selecting your new Chrysler Group LLC vehicle. Be assured that it represents precision workmanship, distinctive styling, and high quality - all essentials that are traditional to our vehicles.

This Owner's Manual has been prepared with the assistance of service and engineering specialists to acquaint you with the operation and maintenance of your vehicle. It is supplemented by a Warranty Information Booklet, located on the DVD, and various customer-oriented documents. Please take the time to read these publications carefully. Following the instructions and recommendations in this manual will help assure safe and enjoyable operation of your vehicle.

**NOTE:** After you read the manual, it should be stored in the vehicle for convenient referencing and remain with the vehicle when sold, so that the new owner will be aware of all safety warnings.

When it comes to service, remember that your authorized dealer knows your vehicle best, has factory-trained technicians and genuine MOPAR® parts, and cares about your satisfaction.

### HOW TO USE THIS MANUAL

Consult the Table of Contents to determine which section contains the information you desire.

Since the specification of your vehicle depends on the items of equipment ordered, certain descriptions and illustrations may differ from your vehicle's equipment

The detailed index at the back of this Owner's Manual contains a complete listing of all subjects.

Consult the following table for a description of the symbols that may be used on your vehicle or throughout this Owner's Manual:

											<b>ESP BAS</b> ELECTRONIC STABILITY PROGRAM / BRAKE ASSIST SYSTEM
											
										<b>AWD!</b>	
										<b>4WD!</b>	<b>BRAKE</b> BRAKE SYSTEM WARNING PARKING BRAKE
											<b>TOW/HAUL</b> TOW / HAUL
											<b>4 LOW</b> FOUR WHEEL DRIVE LOW
			<b>SRS AIRBAG</b> SUPPLEMENTAL RESTRAINT SYSTEM							<b>A/C PUSH</b> AIR CONDITIONER	

## **WARNINGS AND CAUTIONS**

This Owner's Manual contains **WARNINGS** against operating procedures that could result in an accident or bodily injury. It also contains **CAUTIONS** against procedures that could result in damage to your vehicle. If you do not read this entire manual, you may miss important information. Observe all Warnings and Cautions.

## **VAN CONVERSIONS/CAMPERS**

The Manufacturer's Warranty does not apply to body modifications or special equipment installed by van conversion/camper manufacturers/body builders. Refer to the Warranty information book, Section 2.1.C. Such equipment includes video monitors, VCRs, heaters, stoves, refrigerators, etc. For warranty coverage and service on these items, contact the applicable manufacturer.

Operating instructions for the special equipment installed by the conversion/camper manufacturer should also be supplied with your vehicle. If these instructions are missing, please contact your authorized dealer for assistance in obtaining replacement documents from the applicable manufacturer.

For information on the Body Builders Guide refer to: [www.dodgebodybuilder.com](http://www.dodgebodybuilder.com). This website contains dimensional and technical specifications for your vehicle. It is intended for Second Stage Manufacturer's technical support. For service issues, contact your authorized dealer.

## VEHICLE IDENTIFICATION NUMBER

The Vehicle Identification Number (VIN) is found on the left front corner of the instrument panel, visible through the windshield. This number also appears on the Automobile Information Disclosure Label affixed to a window on your vehicle, the vehicle registration and title.

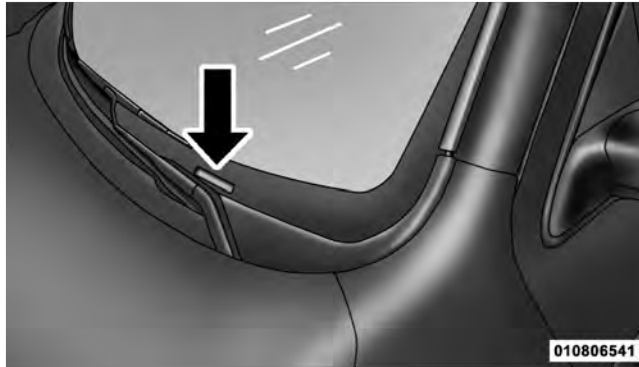

Vehicle Identification Number

**NOTE:** It is illegal to remove or alter the VIN.

## VEHICLE MODIFICATIONS/ALTERATIONS

### WARNING!

Any modifications or alterations to this vehicle could seriously affect its roadworthiness and safety and may lead to an accident resulting in serious injury or death.





# THINGS TO KNOW BEFORE STARTING YOUR VEHICLE

## CONTENTS

---

■ A Word About Your Keys . . . . .	12	□ General Information . . . . .	17
□ Wireless Ignition Node (WIN) — If Equipped . . . . .	12	■ Vehicle Security Alarm — If Equipped . . . . .	18
□ Key FOB . . . . .	13	□ Rearming Of The System . . . . .	18
□ Removing Key FOB From Ignition . . . . .	14	□ To Set The Alarm . . . . .	18
□ Key-In-Ignition Reminder . . . . .	15	□ To Disarm The System . . . . .	18
■ Sentry Key® . . . . .	15	■ Illuminated Entry — If Equipped . . . . .	19
□ Replacement Keys . . . . .	16	■ Remote Keyless Entry (RKE) — If Equipped . . . . .	20
□ Customer Key Programming . . . . .	17	□ To Unlock The Doors . . . . .	20
		□ To Lock The Doors . . . . .	22

## 10 THINGS TO KNOW BEFORE STARTING YOUR VEHICLE

- Remote Open Window Feature — If Equipped . . . . . 23
- Using The Panic Alarm . . . . . 24
- Programming Additional Transmitters . . . . . 24
- Transmitter Battery Replacement . . . . . 24
- General Information . . . . . 25
- Remote Starting System — If Equipped . . . . . 25
  - How To Use Remote Start . . . . . 26
- Door Locks . . . . . 28
  - Manual Door Locks . . . . . 28
  - Power Door Locks — If Equipped . . . . . 29
  - Child Protection Door Lock . . . . . 32
- Windows . . . . . 34
  - Power Windows – If Equipped . . . . . 34
  - Wind Buffeting . . . . . 37
- Occupant Restraints . . . . . 37
  - Lap/Shoulder Belts . . . . . 38
  - Adjustable Upper Shoulder Belt Anchorage . . . 46
  - Center Lap Belts . . . . . 47
  - Automatic Locking Retractor (ALR) Mode – If Equipped . . . . . 47
  - Enhanced Seat Belt Use Reminder System (BeltAlert®) . . . . . 48
  - Seat Belts And Pregnant Women . . . . . 49
  - Seat Belt Extender . . . . . 49

□ Driver And Right Front Passenger Supplemental Restraint System (SRS) – Airbag . . . . .	50
□ Airbag System Components . . . . .	51
□ Advanced Front Airbag Features . . . . .	51
□ Airbag Deployment Sensors And Controls . . . . .	54
□ Event Data Recorder (EDR) . . . . .	59
□ Child Restraint . . . . .	61

**THINGS TO KNOW BEFORE STARTING YOUR VEHICLE 11**

■ Engine Break-In Recommendations . . . . .	72
■ Safety Tips . . . . .	73
□ Transporting Passengers . . . . .	73
□ Exhaust Gas . . . . .	74
□ Safety Checks You Should Make Inside The Vehicle . . . . .	74
□ Periodic Safety Checks You Should Make Outside The Vehicle . . . . .	75

## A WORD ABOUT YOUR KEYS

### *Key Fob with Remote Keyless Entry (RKE) — If Equipped*

Your vehicle uses a keyless ignition system. This system consists of a Key Fob with Remote Keyless Entry (RKE) transmitter and a Wireless Ignition Node (WIN) with integral ignition switch. You can insert the Key Fob into the ignition switch with either side up.

### *Standard Blade Ignition Key — If Equipped*

Your vehicle may use a standard blade key ignition system. The authorized dealer that sold you your vehicle has the key code numbers for your vehicle locks. These numbers can be used to order duplicate keys from your authorized dealer. Ask your authorized dealer for these numbers and keep them in a safe place. You can insert the double-sided standard blade key into the ignition switch with either side up.

### **Wireless Ignition Node (WIN) — If Equipped**

The Wireless Ignition Node (WIN) operates similar to an ignition switch. It has four operating positions, three with detents and one that is spring-loaded. The detent positions are OFF, ACC, and ON. The START position is a spring-loaded momentary contact position. When released from the START position, the switch automatically returns to the ON position.

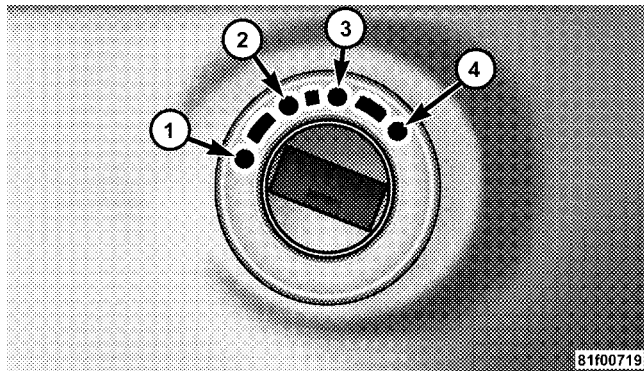

Wireless Ignition Node (WIN)

- 1 — OFF
- 2 — ACC (ACCESSORY)
- 3 — ON
- 4 — START

### Key Fob

The Key Fob operates the ignition switch. It also contains the Remote Keyless Entry (RKE) transmitter and an emergency key, which stores in the rear of the Key Fob.

The emergency key allows for entry into the vehicle should the battery in the vehicle or the RKE transmitter go dead. You can keep the emergency key with you when valet parking.

## 14 THINGS TO KNOW BEFORE STARTING YOUR VEHICLE

To remove the emergency key, slide the mechanical latch at the top of the Key Fob sideways with your thumb and then pull the key out with your other hand.

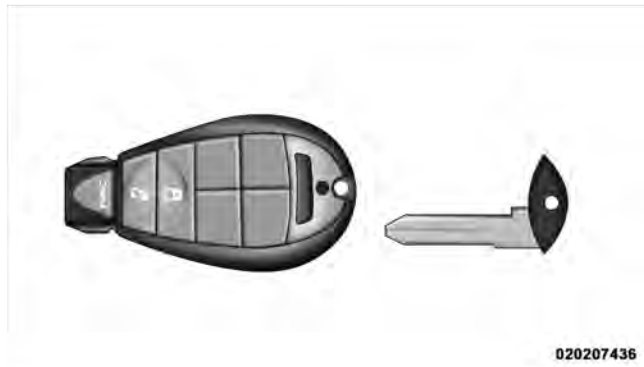

### Emergency Key Removal

**NOTE:** You can insert the double-sided emergency key into the lock cylinder with either side up.

### Removing Key Fob From Ignition

Place the shift lever in PARK. Turn the Key Fob to the OFF position and then remove the Key Fob.

#### NOTE:

- For vehicles not equipped with the Electronic Vehicle Information Center (EVIC), the power window switches, radio, power sunroof (if equipped), and power outlets will remain active for 10 minutes after the ignition switch is turned to the OFF position. Opening either front door will cancel this feature.
- For vehicles equipped with the EVIC, the power window switches, radio, power sunroof (if equipped), and power outlets will remain active for up to 10 minutes after the ignition switch is turned to the OFF position. Opening either front door will cancel this feature. The time for this feature is programmable. Refer to “Electronic Vehicle Information Center

(EVIC)/Personal Settings (Customer-Programmable Features)” in “Understanding Your Instrument Panel” for further information.

### **WARNING!**

**Never leave children alone in a vehicle. Leaving unattended children in a vehicle is dangerous for a number of reasons. A child or others could be seriously or fatally injured. Do not leave the key in the ignition. A child could operate power windows, other controls, or move the vehicle.**

### **CAUTION!**

**An unlocked car is an invitation to thieves. Always remove the key from the ignition and lock all doors when leaving the vehicle unattended.**

### **Key-In-Ignition Reminder**

Opening the driver’s door when the Key Fob is in the ignition and the ignition switch position is OFF or ACC, sounds a signal to remind you to remove the Key Fob.

#### **NOTE:**

- The Key-In-Ignition reminder only sounds when the Key Fob is placed in the OFF or ACC ignition position.
- If equipped with Electronic Vehicle Information Center (EVIC) the EVIC will display “Key In Ignition”.

### **SENTRY KEY®**

The Sentry Key® Immobilizer System prevents unauthorized vehicle operation by disabling the engine. The system does not need to be armed or activated. Operation is automatic, regardless of whether the vehicle is locked or unlocked.

The system uses Key Fob with factory-mated Remote Keyless Entry (RKE) transmitter and Wireless Ignition



Node (WIN) to prevent unauthorized vehicle operation. Therefore, only Key Fobs that are programmed to the vehicle can be used to start and operate the vehicle. The system will not allow the engine to crank if an invalid Key Fob is used to start and operate the vehicle.

**NOTE:** A Key Fob that has not been programmed is also considered an invalid key.

During normal operation, after turning on the ignition switch, the Vehicle Security Light will turn on for three seconds for a bulb check. If the light remains on after the bulb check, it indicates that there is a problem with the electronics. In addition, if the light begins to flash after the bulb check, it indicates that someone used an invalid Key Fob to try to start the engine. Either of these conditions will result in the engine being shut off after two seconds.

If the Vehicle Security Light turns on during normal vehicle operation (vehicle running for longer than 10 seconds), it indicates that there is a fault in the electronics. Should this occur, have the vehicle serviced as soon as possible by an authorized dealer.

**NOTE:** The Sentry Key® Immobilizer System is not compatible with some aftermarket remote starting systems. Use of these systems may result in vehicle starting problems and loss of security protection.

All of the Key Fobs provided with your new vehicle have been programmed to the vehicle electronics.

### **Replacement Keys**

**NOTE:** Only Key Fobs that are programmed to the vehicle electronics can be used to start and operate the vehicle. Once a Key Fob is programmed to a vehicle, it cannot be programmed to any other vehicle.

**CAUTION!**

**Always remove the Sentry Keys® from the vehicle and lock all doors when leaving the vehicle unattended.**

At the time of purchase, the original owner is provided with a four-digit Personal Identification Number (PIN). Keep the PIN in a secure location. This number is required for authorized dealer replacement of Key Fobs. Duplication of Key Fobs may be performed at an authorized dealer, this procedure consists of programming a blank Key Fob to the vehicle electronics. A blank Key Fob is one that has never been programmed.

**NOTE:**

- When having the Sentry Key® Immobilizer System serviced, bring all vehicle keys with you to an authorized dealer.

- If a programmed Key Fob is lost, see your authorized dealer to have all remaining Key Fobs erased from the system's memory. This will prevent the lost Key Fobs from starting your vehicle. The remaining Keys Fobs must then be reprogrammed.

**Customer Key Programming**

Programming Key Fobs or RKE transmitters may be performed at an authorized dealer.

**General Information**

The Sentry Key® system complies with FCC rules Part 15 and with RSS-210 of Industry Canada. Operation is subject to the following conditions:

- This device may not cause harmful interference.
- This device must accept any interference that may be received, including interference that may cause undesired operation.

## VEHICLE SECURITY ALARM — IF EQUIPPED

The Vehicle Security Alarm monitors the vehicle doors and ignition for unauthorized operation. When the Vehicle Security Alarm is activated, the system provides both audible and visible signals. For the first three minutes the horn will sound and the headlights, park lamps and/or turn signals will flash and Vehicle Security Light will flash repeatedly. For an additional 15 minutes only, the headlights, park lamps and/or turn signals and Vehicle Security Light will flash. The engine will run only if a valid Sentry Key® is used to start the vehicle. Use of the Sentry Key® will disable the alarm.

### Rearming of the System

The Vehicle Security Alarm will rearm itself after the 15 additional minutes of headlights and Vehicle Security Light flashing, if the system has not been disabled. If the condition which initiated the alarm is still present, the system will ignore that condition and monitor the remaining doors and ignition.

### To Set the Alarm

The Vehicle Security Alarm will set when you use the power door locks, or use the Remote Keyless Entry (RKE) transmitter to lock the doors. After all the doors are locked and closed, the Vehicle Security Light in the instrument panel cluster will flash rapidly for about 16 seconds to indicate that the alarm is being set. After the alarm is set, the Vehicle Security Light will flash at a slower rate to indicate that the system is armed.

**NOTE:** If the Vehicle Security Light stays on continuously during vehicle operation, have the system checked by an authorized dealer.

### To Disarm the System

Use the RKE transmitter to unlock the door. If something has triggered the system in your absence, the horn will sound three times when you unlock the doors and the Vehicle Security Light will flash for 30 seconds. Check the vehicle for tampering.

The Vehicle Security Alarm will also disarm if the vehicle is started with a programmed Sentry Key®. If an unprogrammed Sentry Key® is used to start a vehicle, the engine will run for two seconds and then the alarm will be initiated. To exit the alarming mode, press the RKE transmitter UNLOCK button, or start the vehicle with a programmed Sentry Key®.

The Vehicle Security Alarm is designed to protect your vehicle; however, you can create conditions where the system will give you a false alarm. If one of the previously described arming sequences has occurred, the Vehicle Security Alarm will arm regardless of whether you are in the vehicle or not. If you remain in the vehicle and open a door, the alarm will sound. If this occurs, disarm the Vehicle Security Alarm.

## ILLUMINATED ENTRY — IF EQUIPPED

The courtesy lights will turn on when you use the Remote Keyless Entry (RKE) transmitter or open the doors. This feature is only available if you have Remote Keyless Entry.

The lights will fade to off after approximately 30 seconds, or they will immediately fade to off once the ignition switch is turned ON.

### NOTE:

- The front courtesy overhead console and door courtesy lights do not turn off if the dimmer control is in the interior lights ON position (extreme right position).
- The illuminated entry system will not operate if the dimmer control is in the extreme left position.

## REMOTE KEYLESS ENTRY (RKE) — IF EQUIPPED

The RKE system allows you to lock or unlock the doors and activate the Panic Alarm from distances up to approximately 66 ft (20 m) using a hand-held radio transmitter with integrated key. The transmitter does not need to be pointed at the vehicle to activate the system.

**NOTE:** Inserting the Key Fob with RKE transmitter into the ignition switch disables all buttons on that RKE transmitter; however, the buttons on the remaining RKE transmitters will continue to work. Driving at speeds 5 mph (8 km/h) and above disables all RKE transmitter buttons for all RKE transmitters.



### Key Fob With Remote Keyless Entry (RKE) Transmitter To Unlock the Doors

Press and release the UNLOCK button on the RKE transmitter once to unlock the driver's door, or twice within five seconds to unlock all doors. The turn signal lights will flash to acknowledge the unlock signal. The illuminated entry system will also turn on.

### Remote Key Unlock, Driver Door/All Doors First

This feature lets you program the system to unlock either the driver's door or all doors on the first press of the UNLOCK button on the RKE transmitter. To change the current setting, proceed as follows:

- For vehicles equipped with the EVIC, refer to "Electronic Vehicle Information Center (EVIC)/Customer-Programmable Features (System Setup)" in "Understanding Your Instrument Panel" for further information.
- For vehicles not equipped with the EVIC, perform the following procedure:
  1. Press and hold the LOCK button on a programmed RKE transmitter for at least four seconds, but no longer than ten seconds. Then, press and hold the UNLOCK

button while still holding the LOCK button.

2. Release both buttons at the same time.
3. Test the feature while outside of the vehicle by pressing the LOCK/UNLOCK buttons on the RKE transmitter with the ignition switch in the OFF position and the key removed.
4. Repeat these steps if you want to return this feature to its previous setting.

**NOTE:** Pressing the LOCK button on the RKE transmitter while you are inside the vehicle will activate the Vehicle Security Alarm System. Opening a door with the Vehicle Security Alarm System activated will cause the alarm to sound. Press the UNLOCK button to deactivate the Vehicle Security Alarm System.

### Flash Lamps with Remote Key Lock

This feature will cause the turn signal lights to flash when the doors are locked or unlocked with the RKE transmitter. This feature can be turned on or turned off. To change the current setting, proceed as follows:

- For vehicles equipped with the EVIC, refer to “Electronic Vehicle Information Center (EVIC)/Customer-Programmable Features (System Setup)” in “Understanding Your Instrument Panel” for further information.
- For vehicles not equipped with the EVIC, perform the following procedure:
  1. Press and hold the UNLOCK button on a programmed RKE transmitter for at least four seconds, but no longer than ten seconds. Then, press and hold the LOCK button while still holding the UNLOCK button.
  2. Release both buttons at the same time.

3. Test the feature while outside of the vehicle by pressing the LOCK/UNLOCK buttons on the RKE transmitter with the ignition switch in the OFF position and the key removed.

4. Repeat these steps if you want to return this feature to its previous setting.

**NOTE:** Pressing the LOCK button on the RKE transmitter while you are in the vehicle will activate the Vehicle Security Alarm System. Opening a door with the Vehicle Security Alarm System activated will cause the alarm to sound. Press the UNLOCK button to deactivate the Vehicle Security Alarm System.

### To Lock the Doors

Press and release the LOCK button on the RKE transmitter to lock all doors. The turn signal lights will flash and the horn will chirp to acknowledge the signal.

### Sound Horn with Remote Key Lock

This feature will cause the horn to chirp when the doors are locked with the RKE transmitter. This feature can be turned on or turned off. To change the current setting, proceed as follows:

- For vehicles equipped with the EVIC, refer to “Electronic Vehicle Information Center (EVIC)/Customer-Programmable Features (System Setup)” in “Understanding Your Instrument Panel” for further information.
- For vehicles not equipped with the EVIC, perform the following procedure:
  1. Press the LOCK button on a programmed RKE transmitter for at least four seconds, but no longer than ten seconds. Then, press the PANIC button while still holding the LOCK button.
  2. Release both buttons at the same time.

3. Test the feature while outside of the vehicle by pressing the LOCK button on the RKE transmitter with the ignition switch in the OFF position and the key removed.
4. Repeat these steps if you want to return this feature to its previous setting.

**NOTE:** Pressing the LOCK button on the RKE transmitter while you are in the vehicle will activate the Vehicle Security Alarm System. Opening a door with the Vehicle Security Alarm System activated will cause the alarm to sound. Press the UNLOCK button to deactivate the Vehicle Security Alarm System.

### Remote Open Window Feature — If Equipped

This feature allows you to remotely lower both front door windows at the same time. To use this feature, press and release the UNLOCK button on the RKE transmitter and then immediately press and hold the UNLOCK button until the windows lower to the level desired or until they lower completely.



### Using the Panic Alarm

To turn the Panic Alarm feature ON or OFF, press and hold the PANIC button on the RKE transmitter for at least one second and release. When the Panic Alarm is on, the headlights and park lights will flash, the horn will pulse on and off, and the interior lights will turn on.

The Panic Alarm will stay on for three minutes unless you turn it off by either pressing the PANIC button a second time or drive the vehicle at a speed of 15 mph (24 km/h) or greater.

#### NOTE:

- The interior lights will turn off if you turn the ignition switch to the ACC or ON position while the Panic Alarm is activated. However, the exterior lights and horn will remain on.

- You may need to be less than 35 ft (11 m) from the vehicle when using the RKE transmitter to turn off the Panic Alarm due to the radio frequency noises emitted by the system.

### Programming Additional Transmitters

If you do not have a programmed RKE transmitter, contact your authorized dealer for details.

### Transmitter Battery Replacement

The recommended replacement battery is one CR2032 battery.

#### NOTE:

- Perchlorate Material — special handling may apply. See [www.dtsc.ca.gov/hazardouswaste/perchlorate](http://www.dtsc.ca.gov/hazardouswaste/perchlorate)
- Do not touch the battery terminals that are on the back housing or the printed circuit board.

1. With the RKE transmitter buttons facing down, use a flat blade to pry the two halves of the RKE transmitter apart. Make sure not to damage the seal during removal.
2. Remove and replace the battery. Avoid touching the new battery with your fingers. Skin oils may cause battery deterioration. If you touch a battery, clean it with rubbing alcohol.
3. To assemble the RKE transmitter case, snap the two halves together.

### General Information

This device complies with Part 15 of the FCC rules and RSS 210 of Industry Canada. Operation is subject to the following conditions:

- This device may not cause harmful interference.
- This device must accept any interference received, including interference that may cause undesired operation.

**NOTE:** Changes or modifications not expressly approved by the party responsible for compliance could void the user's authority to operate the equipment.

If your RKE transmitter fails to operate from a normal distance, check for these two conditions:

1. A weak battery in the RKE transmitter. The expected life of the battery is a minimum of three years.
2. Closeness to a radio transmitter such as a radio station tower, airport transmitter, and some mobile or CB radios.

### REMOTE STARTING SYSTEM — IF EQUIPPED

 This system uses the Remote Keyless Entry (RKE) transmitter to start the engine conveniently from outside the vehicle while still maintaining security. The system has a range of approximately 328 ft (100 m).

**NOTE:** The vehicle must be equipped with an automatic transmission to be equipped with Remote Start.

## How To Use Remote Start

All of the following conditions must be met before the engine will remote start:

- Shift lever in PARK
- Doors closed
- Hood closed
- HAZARD switch off
- BRAKE switch inactive (brake pedal not pressed)
- Ignition key removed from ignition switch
- Battery at an acceptable charge level
- RKE PANIC button not pressed
- Fuel meets minimum requirement

### WARNING!

- Do not start or run an engine in a closed garage or confined area. Exhaust gas contains Carbon Monoxide (CO) which is odorless and colorless. Carbon Monoxide is poisonous and can cause serious injury or death when inhaled.
- Keep Remote Keyless Entry (RKE) transmitters away from children. Operation of the Remote Start System, windows, door locks or other controls could cause serious injury or death.

### Remote Start Abort Message on Electronic Vehicle Information Center (EVIC) — If Equipped

The following messages will display in the EVIC if the vehicle fails to remote start or exits remote start prematurely:

- Remote Start Aborted - Door Ajar

- Remote Start Aborted - Hood Ajar
- Remote Start Aborted - Fuel Low
- Remote Start Aborted - System Fault

The EVIC message stays active until the ignition is turned to the ON/RUN position.

### To Enter Remote Start Mode



Press and release the REMOTE START button on the RKE transmitter twice, within five seconds. The parking lights will flash and the horn will chirp twice (if programmed). Once the vehicle has started, the engine will run for 15 minutes.

### NOTE:

- The park lamps will turn on and remain on during Remote Start mode.

- For security, power window and power sunroof operation (if equipped) are disabled when the vehicle is in the Remote Start mode.
- The engine can be started two consecutive times (two 15-minute cycles) with the RKE transmitter. However, the ignition switch must be cycled to the ON position before you can repeat the start sequence for a third cycle.

### To Exit Remote Start Mode without Driving the Vehicle

Press and release the REMOTE START button one time or allow the engine to run for the entire 15-minute cycle.

**NOTE:** To avoid unintentional shut downs, the system will disable the one time press of the REMOTE START button for two seconds after receiving a valid Remote Start request.

**To Exit Remote Start Mode and Drive the Vehicle**

Before the end of the 15-minute cycle, press and release the UNLOCK button on the RKE transmitter to unlock the doors and disarm the Vehicle Security Alarm System (if equipped). Insert the Key Fob into the ignition switch and turn the switch to the ON/RUN position.

**NOTE:**

- The ignition switch must be in the ON/RUN position in order to drive the vehicle.
- For vehicles equipped with the Electronic Vehicle Information Center (EVIC), the message “Insert Key/Turn To On” will flash in the EVIC until you insert the Key Fob into the ignition switch. Once inserted, the message “Turn To On” will flash in the EVIC until you turn the ignition switch to the ON/RUN position.

**Remote Start Comfort Systems — If Equipped**

When remote start is activated, the heated steering wheel, and driver heated seat features will automatically

turn on in cold weather. In warm weather, the driver vented seat feature will automatically turn on when the remote start is activated. These features will stay on through the duration of remote start or until the ignition switch is turned to the ON position.

The Remote Start Comfort System can be activated and deactivated through the Electronic Vehicle Information Center (EVIC). For more information on Remote Start Comfort System operation refer to “Electronic Vehicle Information Center (EVIC)/Customer-Programmable Features (System Setup)” in “Understanding Your Instrument Panel”.

**DOOR LOCKS****Manual Door Locks**

Front and rear doors may be locked by moving the lock plunger down or unlocked by moving the lock plunger up.

Front doors may be opened with the inside door handle without lifting the lock plunger.

Doors locked before closing will remain locked when closed.

The emergency key will unlock the driver door lock on your vehicle.

### WARNING!

- For personal security and safety in the event of an accident, lock the vehicle doors when you drive as well as when you park and leave the vehicle.
- Never leave children alone in a vehicle. Leaving unattended children in a vehicle is dangerous for a number of reasons. A child or others could be seriously or fatally injured. Don't leave the key in the ignition. A child could operate power windows, other controls, or move the vehicle.

### Power Door Locks — If Equipped

A power door LOCK switch is on each front door trim panel. Use this switch to lock or unlock the doors.



Power Door Lock Switch Location

1 - Unlock

2 - Lock

If you press the power door LOCK switch while the Key Fob is in the ignition, and any front door is open, the power locks will not operate. This prevents you from accidentally locking your Key Fob in the vehicle. Removing the Key Fob or closing the door will allow the locks to operate. A chime will sound if the Key Fob is in the ignition switch and a door is open, as a reminder to remove the Key Fob.

### **Auto Lock Doors – If Equipped**

If this feature is enabled, your door locks will lock automatically when the vehicle's speed exceeds 15 mph (24 km/h).

### **Auto Lock Doors Programming**

The Auto Lock Doors feature can be enabled or disabled as follows:

- For vehicles equipped with the EVIC, refer to “Electronic Vehicle Information Center (EVIC)/Personal Settings (System Setup)” in “Understanding Your Instrument Panel” for further information.
- For vehicles not equipped with the EVIC, perform the following procedure:
  1. Enter your vehicle and close all doors.
  2. Fasten your seat belt. (Fastening the seat belt will cancel any chiming that may confuse you during this programming procedure.)
  3. Place the Key Fob into the ignition.
  4. Within 15 seconds cycle the Key Fob from the OFF position to the ON position a minimum of four times, ending in the OFF position. **(Do not start the engine).**
  5. Within 30 seconds, press the driver's door LOCK switch.
  6. A single chime will be heard to indicate the feature has been disabled.
  7. To reactivate this feature, repeat the above steps.

8. If a chime is not heard, program mode was canceled before the feature could be disabled. If necessary, repeat the above procedure.

### **Auto Unlock Doors — If Equipped**

This feature unlocks all of the doors of the vehicle when either front door is opened. This will occur only after the vehicle has been shifted into the PARK position after the vehicle has been driven (shifted out of PARK and all doors closed).

### **Auto Unlock Doors Programming — If Equipped**

The Auto Unlock Doors feature can be enabled or disabled as follows:

- For vehicles equipped with the EVIC, refer to “Electronic Vehicle Information Center (EVIC)/Personal Settings (System Setup)” in “Understanding Your Instrument Panel” for further information.
- For vehicles not equipped with the EVIC, perform the following procedure:

1. Enter your vehicle and close all doors.
2. Fasten your seat belt. (Fastening the seat belt will cancel any chimes that may be confusing during this programming procedure.)
3. Insert the Key Fob into the ignition.
4. Within 15 seconds, cycle the Key Fob from the OFF position to the ON position a minimum of four times, ending in the OFF position. **(Do not start the engine).**
5. Within 30 seconds, press the driver’s door UNLOCK switch.
6. A single chime will sound to indicate the feature has been changed.
7. Repeat the above steps to alternate the availability of this feature.
8. If a chime is not heard, the program mode was canceled before the feature could be changed. If necessary, repeat the above procedure.



### Child Protection Door Lock

To provide a safer environment for children riding in the rear seat, the rear doors (if equipped) of your vehicle have the child protection door lock system.



Child Protection Door Lock Location

To use the system, open each rear door, use a flat blade screwdriver (or emergency key) and rotate the dial counterclockwise to engage the lock and clockwise to disengage the child protection locks. When the system on a door is engaged, that door can only be opened by using the outside door handle even if the inside door lock is in the unlocked position.



Child Lock Control

**WARNING!**

Avoid trapping anyone in a vehicle in a collision. Remember that the rear doors can only be opened from the outside when the child protection locks are engaged.

**NOTE:**

- After setting the child protection door lock system, always test the door from the inside to make certain it is in the desired position.
- For emergency exit with the system engaged, move the door lock switch to the UNLOCK position, roll down the window and open the door with the outside door handle.

## WINDOWS

### Power Windows – If Equipped

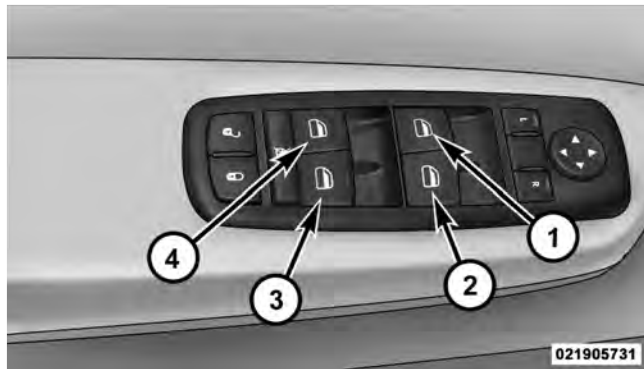

Power Window Switches

1 – Left Front  
2 – Right Front

3 – Right Rear  
4 – Left Rear

The control on the left front door panel has UP-DOWN switches that give you fingertip control of all power

windows. There is a single opening and closing switch on the front passenger door for passenger window control and on the rear doors of the Crew Cab models. The windows will operate when the ignition switch is turned to the ON or ACC position, and for up to 10 minutes after the ignition is turned OFF or until a front door is opened.

**NOTE:** The Key Off Power Delay feature will allow the power windows to operate for up to 10 minutes after the ignition is turned OFF. This feature is cancelled when either front door is opened.

### WARNING!

Never leave children alone in a vehicle. Leaving unattended children in a vehicle is dangerous for a number of reasons. A child or others could be seriously or fatally injured. Don't leave the key in the ignition. A child could operate power windows, other controls, or move the vehicle.

### Auto-Down

Both the driver and front passenger window switch have an Auto-Down feature. Press the window switch past the first detent, release, and the window will go down automatically. To cancel the Auto-Down movement, operate the switch in either the up or down direction and release the switch.

To stop the window from going all the way down during the Auto-Down operation, pull up on the switch briefly.

To open the window part way, press to the first detent and release it when you want the window to stop.

### Auto-Up Feature with Anti-Pinch Protection (4-Door Models Driver's and Front Passenger Door Only) — If Equipped

Lift the window switch to the second detent, release, and the window will go up automatically.

To stop the window from going all the way up during the Auto Up operation, push down on the switch briefly.

To close the window part way, lift the window switch to the first detent and release when you want the window to stop.

#### NOTE:

- If the window runs into any obstacle during the auto-closure, it will reverse direction and then go back down. Remove the obstacle and use the window switch again to close the window. Any impact due to rough road conditions may trigger the auto reverse function unexpectedly during auto closure. If this happens, pull the switch lightly to the first detent and hold to close the window manually.
- If the Auto-Up function is lost, reset the Auto-Up function by running the window all the way up (by holding the switch in the first up detent) and then hold the switch in the full up position for two seconds.

**WARNING!**

There is no anti-pinch protection when the window is almost closed. Be sure to clear all objects from the window before closing.

**Window LOCKOUT Switch (4-Door Models Only)**

The window LOCKOUT switch on the driver's door allows you to disable the window control on the other doors. To disable the window controls on the other doors, press the window LOCK button into the latched or down position. To enable the window controls, press the window LOCK button again and return the switch to the released or up position.

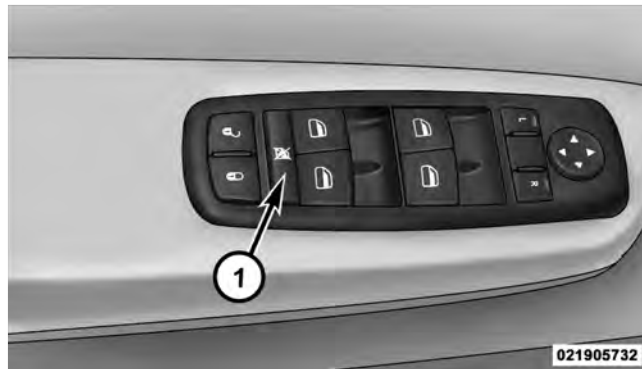

**Window Lockout Switch**

1 – Window Lockout Switch

## Wind Buffeting

Wind buffeting can be described as the perception of pressure on the ears or a helicopter-type sound in the ears. Your vehicle may exhibit wind buffeting with the windows down or in partially open positions. This is a normal occurrence and can be minimized. If the buffeting occurs with the rear windows open, open the front and rear windows together to minimize the buffeting.

## OCCUPANT RESTRAINTS

Some of the most important safety features in your vehicle are the restraint systems:

- Three-point lap and shoulder belts for the driver and all passengers
- Advanced Front Airbags for driver and front passenger — if equipped
- An energy-absorbing steering column and steering wheel

- Knee bolsters/blockers for front seat occupants
- All seat belt systems (except driver's, first and second row center position) include Automatic Locking Retractors (ALR)

If you will be carrying children too small for adult-sized seat belts, the seat belts or the Lower Anchors and Tether for CHildren (LATCH) feature also can be used to hold infant and child restraint systems.

**NOTE:** The Advanced Front Airbags have a multistage inflator design. This allows the airbag to have different rates of inflation based on severity and type of collision.

**Please pay close attention to the information in this section. It tells you how to use your restraint system properly, to keep you and your passengers as safe as possible.**

**WARNING!**

**In a collision, you and your passengers can suffer much greater injuries if you are not properly buckled up. You can strike the interior of your vehicle or other passengers, or you can be thrown out of the vehicle. Always be sure you and others in your vehicle are buckled up properly.**

Buckle up even though you are an excellent driver, even on short trips. Someone on the road may be a poor driver and cause a collision that includes you. This can happen far away from home or on your own street.

Research has shown that seat belts save lives, and they can reduce the seriousness of injuries in a collision. Some of the worst injuries happen when people are thrown from the vehicle. Seat belts reduce the possibility of

ejection and the risk of injury caused by striking the inside of the vehicle. **Everyone in a motor vehicle should be belted at all times.**

**Lap/Shoulder Belts**

All seating positions except the Crew Cab front center seating position have combination lap/shoulder belts. The belt webbing retractor is designed to lock during very sudden stops or collisions. This feature allows the shoulder part of the belt to move freely with you under normal conditions. But in a collision, the belt will lock and reduce the risk of you striking the inside of the vehicle or being thrown out.

**WARNING!**

- It is extremely dangerous to ride in a cargo area, inside or outside of a vehicle. In a collision, people riding in these areas are more likely to be seriously injured or killed.
- Do not allow people to ride in any area of your vehicle that is not equipped with seats and seat belts.
- Be sure everyone in your vehicle is in a seat and using a seat belt properly.

*(Continued)*

**WARNING! (Continued)**

- Wearing a seat belt incorrectly is dangerous. Seat belts are designed to go around the large bones of your body. These are the strongest parts of your body and can take the forces of a collision best. Wearing your belt in the wrong place could make your injuries in a collision much worse. You might suffer internal injuries, or you could even slide out of part of the belt. Follow these instructions to wear your seat belt safely and to keep your passengers safe, too.
- Two people should never be belted into a single seat belt. People belted together can crash into one another in an accident, hurting one another badly. Never use a lap/shoulder belt or a lap belt for more than one person, no matter what their size.



### Lap/Shoulder Belt Operating Instructions

1. Enter the vehicle and close the door. Sit back and adjust the seat.
2. The seat belt latch plate is above the back of the front seat, next to your arm in the rear seat. Grasp the latch plate and pull out the belt. Slide the latch plate up the webbing as far as necessary to allow the belt to go around your lap.

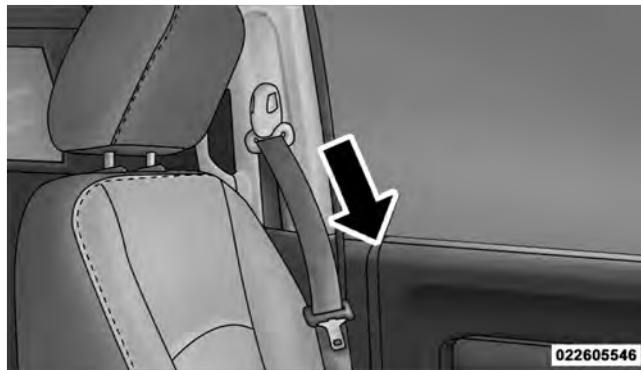

Pulling Out Latch Plate And Webbing

3. When the belt is long enough to fit, insert the latch plate into the buckle until you hear a “click.”



Latch Plate To Buckle

## WARNING!

- A belt buckled into the wrong buckle will not protect you properly. The lap portion could ride too high on your body, possibly causing internal injuries. Always buckle your belt into the buckle nearest you.
- A belt that is too loose will not protect you as well. In a sudden stop you could move too far forward, increasing the possibility of injury. Wear your seat belt snugly.
- A belt that is worn under your arm is very dangerous. Your body could strike the inside surfaces of the vehicle in a collision, increasing head and neck injury. A belt worn under the arm can cause internal injuries. Ribs aren't as strong as shoulder bones. Wear the belt over your shoulder so that your strongest bones will take the force in a collision.

*(Continued)*

**WARNING! (Continued)**

- A shoulder belt placed behind you will not protect you from injury during a collision. You are more likely to hit your head in a collision if you do not wear your shoulder belt. The lap and shoulder belt are meant to be used together.

4. Position the lap belt across your thighs, below your abdomen. To remove slack in the lap belt portion, pull up on the shoulder belt. To loosen the lap belt if it is too tight, tilt the latch plate and pull on the lap belt. A snug belt reduces the risk of sliding under the belt in a collision.

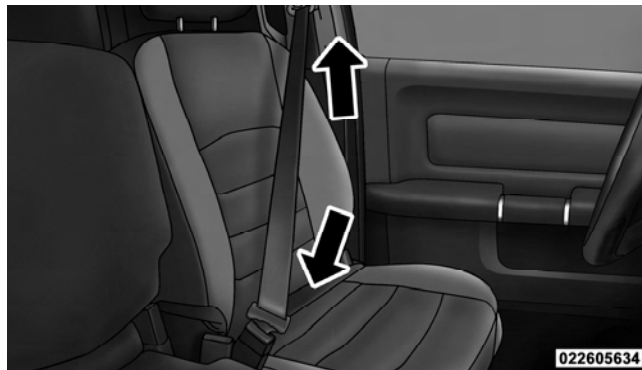

Removing Slack From Belt

**WARNING!**

- A lap belt worn too high can increase the risk of internal injury in a collision. The belt forces won't be at the strong hip and pelvic bones, but across your abdomen. Always wear the lap belt as low as possible and keep it snug.
- A twisted belt can't do its job as well. In a collision, it could even cut into you. Be sure the belt is straight. If you can't straighten a belt in a vehicle, take it to your authorized dealer and have it fixed.

**WARNING!**

A frayed or torn belt could rip apart in a collision and leave you with no protection. Inspect the belt system periodically, checking for cuts, frays, or loose parts. Damaged parts must be replaced immediately. Do not disassemble or modify the system. Seat belt assemblies must be replaced after a collision if they have been damaged (bent retractor, torn webbing, etc.) or if the airbag deployed.

**2**

5. Position the shoulder belt on your chest so that it is comfortable and not resting on your neck. The retractor will withdraw any slack in the belt.

6. To release the belt, push the red button on the buckle. The belt will automatically retract to its stowed position. If necessary, slide the latch plate down the webbing to allow the belt to retract fully.

**Regular Cab Front Center Three Point Belt**

1. The front center seat belt on the Regular Cab may be disconnected to open up utilization of the storage areas behind the front seats. The black latch plate can be detached from the black keyed seat belt buckle located on the inboard side of the passenger seat. Insert the seat belt tongue into the center red slot on the black buckle. The black buckle latch plate can be removed when the seat

belt tongue is pressed into the buckle. Allow the retractor to take up the surplus webbing, and the buckles will hang vertically from the cab back exit bezel, thus freeing up all the area behind the front seats.

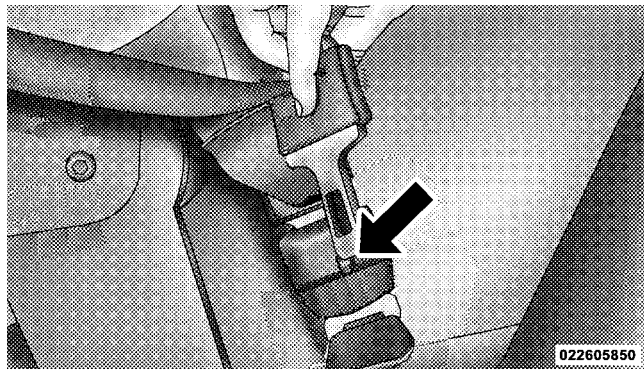

Detaching Buckle With Seat Belt Tongue

2. To reattach the seat belt to the front center seat, pull the black buckle latch plate forward from the cab back

panel and insert it into the black keyed buckle until there is an audible “click”. For proper seatbelt usage, refer “Lap/Shoulder Belt Operating Instructions”.

### WARNING!

- If the black latch and black buckle are not properly connected when the seat belt is used by an occupant, the seat belt will not be able to provide proper restraint and will increase the risk of injury in a collision.
- When reattaching the black latch and black buckle, ensure the seat belt webbing is not twisted. If the webbing is twisted, follow the preceding procedure to detach the black latch and black buckle, untwist the webbing, and reattach the black latch and black buckle.

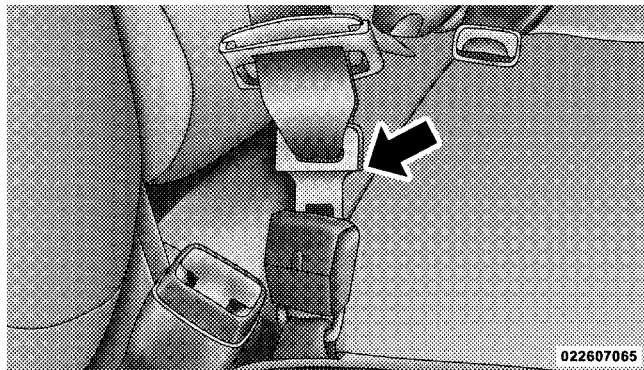

Inserting Latch Plate

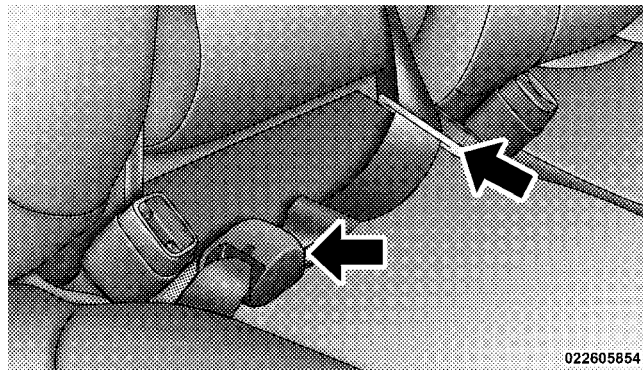

In Use Position

**WARNING!**

- If the black latch and black buckle are not properly connected when the seat belt is used by an occupant, the seat belt will not be able to provide proper restraint and will increase the risk of injury in a collision.
- When reattaching the black latch and black buckle, ensure the seat belt webbing is not twisted. If the webbing is twisted, follow the preceding procedure to detach the black latch and black buckle, untwist the webbing, and reattach the black latch and black buckle.

**Adjustable Upper Shoulder Belt Anchorage**

In the front row outboard seats, the shoulder belt can be adjusted upward or downward to help position the belt

away from your neck. Press the button located on the upper belt guide, and then move it up or down to the position that fits you best.

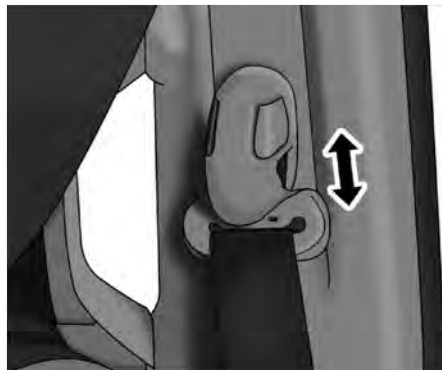

022605853

**Adjusting Upper Shoulder Belt**

As a guide, if you are shorter than average you will prefer a lower position, and if you are taller than average

you will prefer a higher position. When you release the anchorage, try to move it up or down to make sure that it is locked in position.

### Center Lap Belts

The center seating position for the Crew Cab front seat has a lap belt only. To fasten the lap belt, slide the latch plate into the buckle until you hear a "click." To lengthen the lap belt, tilt the latch plate and pull. To remove slack, pull the loose end of the webbing. Wear the lap belt snug against the hips. Sit back and erect in the seat, then adjust the belt as tightly as is comfortable.

#### WARNING!

- A lap belt worn too loose or too high is dangerous.
- A belt worn too loose can allow you to slip down and under the belt in a collision.

*(Continued)*

#### WARNING! (Continued)

- A belt that is too loose or too high will apply crash forces to the abdomen, not to the stronger hip bones. In either case, the risk of internal injuries is greater. Wear a lap belt low and snug.

### Automatic Locking Retractor (ALR) Mode – If Equipped

In this mode, the shoulder belt is automatically pre-locked. The belt will still retract to remove any slack in the shoulder belt.

### When To Use The Automatic Locking Mode

Use the Automatic Locking Mode any time a child safety seat is installed in a passenger seating position. Children 12 years old and younger should be properly restrained in the rear seat whenever possible.



### How To Use The Automatic Locking Mode

1. Buckle the combination lap/shoulder belt.
2. Grasp the shoulder portion and pull downward until the entire belt is extracted.
3. Allow the belt to retract. As the belt retracts, you will hear a clicking sound. This indicates the safety belt is now in the Automatic Locking Mode.

### How To Disengage The Automatic Locking Mode

Disconnect the combination lap/shoulder belt and allow it to retract completely to disengage the Automatic Locking Mode and activate the vehicle sensitive (emergency) locking mode.

### Enhanced Seat Belt Use Reminder System (BeltAlert®)

If the driver's seat belt has not been buckled within 60 seconds of starting the vehicle and if the vehicle speed is greater than 5 mph (8 km/h), the BeltAlert® will alert

the driver to buckle the seat belt. The driver should also instruct all other occupants to buckle their seat belts. Once the warning is triggered, the BeltAlert® will continue to chime and flash the Seat Belt Reminder Light for 96 seconds or until the driver's seat belt is buckled. The BeltAlert® will be reactivated if the driver's seat belt is unbuckled for more than 10 seconds and the vehicle speed is greater than 5 mph (8 km/h).

BeltAlert® can be enabled or disabled by your authorized dealer or by following these steps:

**NOTE:** The following steps must occur within the first 60 seconds of the ignition switch being turned to the ON or START position. Chrysler Group LLC does not recommend deactivating the BeltAlert®.

1. With all doors closed and the ignition switch in any position except ON or START, buckle the driver's seat belt.

2. Turn the ignition switch to the ON position and wait for the Seat Belt Reminder Light to turn off.
3. Within 60 seconds of starting the vehicle, unbuckle and then re-buckle the driver's seat belt at least three times within 10 seconds, ending with the seat belt buckled.
4. Turn off the engine. A single chime will sound to signify that you have successfully completed the programming.

BeltAlert® can be reactivated by repeating this procedure.

**NOTE:** Although BeltAlert® has been deactivated, the Seat Belt Reminder Light will continue to illuminate while the driver's seat belt remains unbuckled.

## Seat Belts and Pregnant Women

We recommend that pregnant women use seat belts throughout their pregnancies. Keeping the mother safe is the best way to keep the baby safe.

Pregnant women should wear the lap part of the belt across the thighs and as snug against the hips as possible. Keep the belt low so that it does not come across the abdomen. That way the strong bones of the hips will take the force if there is a collision.

## Seat Belt Extender

If a seat belt is too short even when fully extended, your authorized dealer can provide you with a seat belt extender. This extender should be used only if the existing belt is not long enough. When it is not required, remove the extender and store it.

**WARNING!**

Using a seat belt extender when not needed can increase the risk of injury in a collision. Only use the seat belt extender when the lap belt is not long enough when it is worn low and snug, and in the recommended seating positions. Remove and store the extender when not needed.

**Driver and Right Front Passenger Supplemental Restraint System (SRS) – Airbag**

This vehicle has airbags for both the driver and front passenger (if equipped) as a supplement to the seat belt restraint systems. The driver's front airbag is mounted in the center of the steering wheel. The passenger's front airbag is mounted in the instrument panel, above the glove compartment. The words SRS AIRBAG are embossed on the airbag covers.

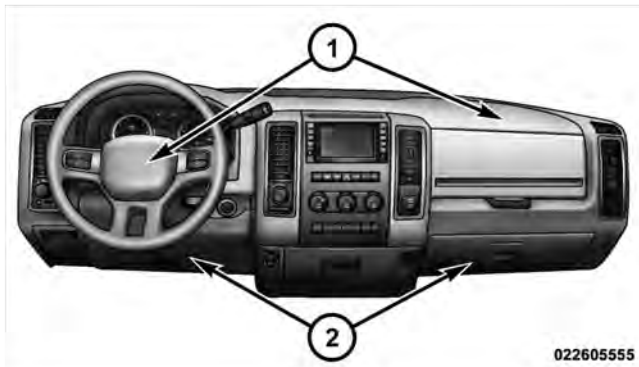

022605555

**Airbag and Knee Boltser Location**

1 — Driver and Passenger Air-  
bag (if equipped)    2 — Knee Boltser

**NOTE:** These airbags are certified to the new Federal regulations for Advanced Airbags.

The Advanced Front Airbags have a multistage inflator design. This allows the airbag to have different rates of inflation based on the severity and type of collision.

**NOTE:** Airbag covers may not be obvious in the interior trim; but they will open during airbag deployment.

### Airbag System Components

The airbag system consists of the following:

- Occupant Restraint Controller (ORC)
- Airbag Warning Light
- Driver Front Airbag
- Front Passenger Airbag — if equipped
- Steering Wheel and Column
- Instrument Panel
- Knee Impact Bolster

### Advanced Front Airbag Features

The Advanced Front Airbag system has multistage driver and front passenger (if equipped) airbags. This system provides output appropriate to the severity and type of collision as determined by the Occupant Restraint Controller (ORC).

The first stage inflator is triggered immediately during an impact that requires airbag deployment. The timing of the second stage determines whether the output force is low, medium, or high. If a low output is sufficient to meet the need, the remaining gas in the inflator is expended.

#### **WARNING!**

- **No objects should be placed over or near the airbag on the instrument panel, because any such objects could cause harm if the vehicle is in a crash severe enough to cause the airbag to inflate.**

*(Continued)*

**WARNING! (Continued)**

- Do not put anything on or around the airbag covers or attempt to open them manually. You may damage the airbags and you could be injured because the airbags may no longer be functional. The protective covers for the airbag cushions are designed to open only when the airbags are inflating.
- Do not drill, cut or tamper with the knee bolster in any way.
- Do not mount any accessories to the knee bolster such as alarm lights, stereos, citizen band radios, etc.

**Knee Impact Bolsters**

The Knee Impact Bolsters help protect the knees of the driver and the front passenger, and position everyone for the best interaction with the Advanced Front Airbag.

Here are some simple steps you can take to minimize the risk of harm from a deploying airbag:

Children 12 years old and younger should always ride buckled up in a rear seat.

**WARNING!**

**Infants in rear-facing child restraints should NEVER ride in the front seat of a vehicle with a passenger front airbag. An airbag deployment can cause severe injury or death to infants in that position.**

Children that are not big enough to wear the vehicle seat belt properly (see Section on Child Restraints) should be secured in the rear seat in child restraints or belt-positioning booster seats. Older children who do not use child restraints or belt-positioning booster seats should

ride properly buckled up in the rear seat. Never allow children to slide the shoulder belt behind them or under their arm.

If a child from 1 to 12 years old (not in a rear facing child seat) must ride in the front passenger seat, move the seat as far back as possible and use the proper child restraint. (Refer to “Child Restraints”)

You should read the instructions provided with your child restraint to make sure that you are using it properly.

All occupants should ALWAYS wear their lap and shoulder belts properly.

The driver and front passenger seats should be moved back as far as practical to allow the Advanced Front Airbags room to inflate.

If the airbag system in this vehicle needs to be modified to accommodate a disabled person, contact the Customer Center. Phone numbers are provided under “If You Need Assistance”.

### WARNING!

- **Relying on the airbags alone could lead to more severe injuries in a collision. The airbags work with your seat belt to restrain you properly. In some collisions, the airbags won't deploy at all. Always wear your seat belts even though you have airbags.**
- **Being too close to the steering wheel or instrument panel during front airbag deployment could cause serious injury, including death. Airbags need room to inflate. Sit back, comfortably extending your arms to reach the steering wheel or instrument panel.**

## Airbag Deployment Sensors and Controls

### Occupant Restraint Controller (ORC)

The ORC is part of a Federally regulated safety system required for this vehicle.

The ORC determines if deployment of the front airbags in a frontal collision is required. Based on impact sensor signals a central electronic ORC deploys the Advanced Front Airbags, as required, depending on severity and type of impact.

Advanced Front Airbags are designed to provide additional protection by supplementing the seat belts in certain frontal collisions depending on the severity and type of collision. Advanced Front Airbags are not expected to reduce the risk of injury in rear, side or rollover collisions.

The Advanced Front Airbags will not deploy in all frontal collisions, including some that may produce substantial

vehicle damage — for example, some pole collisions, truck underrides, and angle offset collisions. On the other hand, depending on the type and location of impact, Advanced Front Airbags may deploy in crashes with little vehicle front-end damage but that produce a severe initial deceleration.

Because airbag sensors measure vehicle deceleration over time, vehicle speed and damage by themselves are not good indicators of whether or not an airbag should have deployed.

Seat belts are necessary for your protection in all collisions, and also are needed to help keep you in position, away from an inflating airbag.

The ORC monitors the readiness of the electronic parts of the system whenever the ignition switch is in the START or ON position. If the key is in the LOCK position, in the ACC position, or not in the ignition, the airbags are not on and will not inflate.

The ORC contains a backup power supply system that may deploy the airbags even if the battery loses power or it becomes disconnected prior to deployment.



Also, the ORC turns on the Airbag Warning Light in the instrument panel for approximately six to eight seconds for a self-check when the ignition is first turned on. After the self-check, the Airbag Warning Light will turn off. If the ORC detects a malfunction in any part of the system, it turns on the Airbag Warning Light, either momentarily or continuously. A single chime will sound if the light comes on again after initial startup.

It also includes diagnostics that will illuminate the instrument cluster Airbag Warning Light if a malfunction is noted. The diagnostics also record the nature of the malfunction.

## WARNING!

**Ignoring the Airbag Warning Light in your instrument panel could mean you won't have the airbags to protect you in a collision. If the light does not come on, stays on after you start the vehicle, or if it comes on as you drive, have the airbag system checked right away.**

### Driver and Passenger Airbag Inflator Units

The Driver and Passenger Airbag/Inflator Units are located in the center of the steering wheel and the right side of the instrument panel (if equipped). When the ORC detects a collision requiring the airbags, it signals the inflator units. A large quantity of non-toxic gas is generated to inflate the Advanced Front Airbags. Different airbag inflation rates are possible, based on the collision type and severity. The steering wheel hub trim cover and the upper right side of the instrument panel



separate and fold out of the way as the bags inflate to their full size. The bags fully inflate in about 50 to 70 milliseconds. This is about half of the time it takes to blink your eyes. The bags then quickly deflate while helping to restrain the driver and front passenger.

The driver front airbag gas is vented through the vent holes in the sides of the airbag. The passenger front airbag gas is vented through the vent holes in the sides of the airbag. In this way, the airbags do not interfere with your control of the vehicle.

### **Enhanced Accident Response System**

In the event of an impact causing airbag deployment, if the communication network remains intact, and the power remains intact, depending on the nature of the event the ORC will determine whether to have the Enhanced Accident Response System perform the following functions:

- Cut off fuel to the engine.
- Flash hazard lights as long as the battery has power or until the ignition key is turned off.
- Turn on the interior lights, which remain on as long as the battery has power or until the ignition key is removed.
- Unlock the doors automatically.

### **If a Deployment Occurs**

The airbags are designed to deflate immediately after deployment.

**NOTE:** Front airbags will not deploy in all collisions. This does not mean something is wrong with the airbag system.

If you do have a collision which deploys the airbags, any or all of the following may occur:

- The nylon airbag material may sometimes cause abrasions and/or skin reddening to the driver and front passenger as the airbags deploy and unfold. The abrasions are similar to friction rope burns or those you might get sliding along a carpet or gymnasium floor. They are not caused by contact with chemicals. They are not permanent and normally heal quickly. However, if you haven't healed significantly within a few days, or if you have any blistering, see your doctor immediately.
- As the airbags deflate, you may see some smoke-like particles. The particles are a normal by-product of the process that generates the non-toxic gas used for airbag inflation. These airborne particles may irritate the skin, eyes, nose, or throat. If you have skin or eye irritation, rinse the area with cool water. For nose or

throat irritation, move to fresh air. If the irritation continues, see your doctor. If these particles settle on your clothing, follow the garment manufacturer's instructions for cleaning.

Do not drive your vehicle after the airbags have deployed. If you are involved in another collision, the airbags will not be in place to protect you.

### **WARNING!**

**Deployed airbags cannot protect you in another collision. Have the airbags replaced by an authorized dealer as soon as possible. Also, have the Occupant Restraint Controller (ORC) system serviced as well.**

## Maintaining Your Airbag System

**WARNING!**

- Modifications to any part of the airbag system could cause it to fail when you need it. You could be injured if the airbag system is not there to protect you. Do not modify the components or wiring, including adding any kind of badges or stickers to the steering wheel hub trim cover or the upper right side of the instrument panel. Do not modify the front bumper, vehicle body structure, or add aftermarket side steps or running boards.
- It is dangerous to try to repair any part of the airbag system yourself. Be sure to tell anyone who works on your vehicle that it has an airbag system.

*(Continued)*

**WARNING! (Continued)**

- Do not attempt to modify any part of your advanced airbag system. The airbag may inflate accidentally or may not function properly if modifications are made. Take your vehicle to an authorized dealer for any advanced airbag system service. If your seat, including your trim cover and cushion, needs to be serviced in any way (including removal or loosening/tightening of seat attachment bolts), take the vehicle to your authorized dealer. Only manufacturer approved seat accessories may be used. If it is necessary to modify an advanced airbag system for persons with disabilities, contact your authorized dealer.

## Airbag Warning Light



You will want to have the airbags ready to inflate for your protection in a collision. While the airbag system is designed to be maintenance free, if any of the following occurs, have an authorized dealer service the system immediately.

- The Airbag Warning Light does not come on for approximately six to eight seconds when the ignition switch is first turned ON.
- The light remains on after the approximate four to six-second interval.
- The light comes on and remains on while driving.

**NOTE:** If the speedometer, tachometer, or any engine related gauges are not working, the Occupant Restraint Controller (ORC) may also be disabled. The airbags may not be ready to inflate for your protection. Promptly check the fuse block for blown fuses. Refer to the label

located on the inside of the fuse block cover for the proper airbag fuses. See your authorized dealer if the fuse is good.

## Event Data Recorder (EDR)

In the event of an accident, your vehicle is designed to record up to five seconds of specific vehicle data parameters (see list below) in an event data recorder prior to the moment of airbag deployment, or near deployment (if applicable), and up to a quarter second of either high-speed deceleration data or change in velocity during and/or after airbag deployment or near-deployment. EDR data is **ONLY** recorded if an airbag deploys, or nearly deploys, and is otherwise unavailable.

**NOTE:**

1. A near-deployment event occurs when the airbag sensor detects severe vehicle deceleration usually indicative of a crash, but not severe enough to warrant airbag deployment.

2. Under certain circumstances, EDR data may not be recorded (e.g., loss of battery power).

In conjunction with other data gathered during a complete accident investigation, the electronic data may be used by Chrysler Group LLC and others to learn more about the possible causes of crashes and associated injuries in order to assess and improve vehicle performance. In addition to crash investigations initiated by Chrysler Group LLC, such investigations may be requested by customers, insurance carriers, government officials, and professional crash researchers, such as those associated with universities, and with hospital and insurance organizations.

In the event that an investigation is undertaken by Chrysler Group LLC (regardless of initiative), the company or its designated representative will first obtain permission of the appropriate custodial entity for the vehicle (usually the vehicle owner or lessee) before

accessing the electronic data stored, unless ordered to download data by a court with legal jurisdiction (i.e., pursuant to a warrant). A copy of the data will be provided to the custodial entity upon request. General data that does not identify particular vehicles or crashes may be released for incorporation in aggregate crash databases, such as those maintained by the U.S. government and various states. Data of a potentially sensitive nature, such as would identify a particular driver, vehicle, or crash, will be treated confidentially. Confidential data will not be disclosed by Chrysler Group LLC to any third party except when:

1. Used for research purposes, such as to match data with a particular crash record in an aggregate database, provided confidentiality of personal data is thereafter preserved.
2. Used in defense of litigation involving a Chrysler Group LLC product.

3. Requested by police under a legal warrant.
4. Otherwise required by law.

Data parameters that are recorded:

- Diagnostic trouble code(s) and warning light status for electronically-controlled safety systems, including the airbag system
- Vehicle speed
- Engine RPM
- Brake switch status
- Pedal position
- And other parameters depending on vehicle configuration

### **Child Restraint**

Everyone in your vehicle needs to be buckled up all the time, including babies and children. Every state in the

United States and all Canadian provinces require that small children ride in proper restraint systems. This is the law, and you can be prosecuted for ignoring it.

Children 12 years and younger should ride properly buckled up in a rear seat, if available. According to crash statistics, children are safer when properly restrained in the rear seats rather than in the front.

### **WARNING!**

**In a collision, an unrestrained child, even a tiny baby, can become a projectile inside the vehicle. The force required to hold even an infant on your lap can become so great that you could not hold the child, no matter how strong you are. The child and others could be badly injured. Any child riding in your vehicle should be in a proper restraint for the child's size.**

## Infants and Small Children

There are different sizes and types of restraints for children from newborn size to the child almost large enough for an adult safety belt. Use the restraint that is correct for your child.

- Safety experts recommend that children ride rearward-facing in the vehicle until they are at least one year old and weigh at least 20 lbs (9 kg). Two types of child restraints can be used rearward-facing: infant carriers and "convertible" child seats. Both types of child restraints are held in the vehicle by the lap/shoulder belt.
- The infant carrier is only used rearward-facing in the vehicle. It is recommended for children who weigh up to about 20 lbs (9 kg). "Convertible" child seats can be used either rearward-facing or forward-facing in the vehicle. Convertible child seats often have a higher weight limit in the rearward-facing direction than infant carriers do, so they can be used rearward-facing by children who weigh more than 20 lbs (9 kg) but are less than one year old.
- Rearward-facing child seats must **NEVER** be used in the front seat of a vehicle with a front passenger airbag. An airbag deployment could cause severe injury or death to infants in this position.
- Children who weigh more than 20 lbs (9 kg) and who are older than one year can ride forward-facing in the vehicle. Forward-facing child seats and convertible child seats used in the forward-facing direction are for children who weigh 20 to 40 lbs (9 to 18 kg) and who are older than one year. These child seats are also held in the vehicle by the lap/shoulder belt.
- The belt-positioning booster seat is for children weighing more than 40 lbs (18 kg), but who are still too small to fit the vehicle's seat belts properly. If the child cannot sit with knees bent over the vehicle's seat

cushion while the child's back is against the seat back, they should use a belt-positioning booster seat. The child and booster seat are held in the vehicle by the lap/shoulder belt.

**NOTE:** For additional information, refer to [www.seatcheck.org](http://www.seatcheck.org) or call 1-866-SEATCHECK. Canadian residents, should refer to Transport Canada's website for additional information. <http://www.tc.gc.ca/roadsafety/safedrivers/childsafety/index.htm>

### **WARNING!**

- Improper installation can lead to failure of an infant or child restraint. It could come loose in a collision. The child could be badly injured or killed. Follow the manufacturer's directions exactly when installing an infant or child restraint.
- A rearward-facing child restraint should only be used in a rear seat.

**Here are some tips for getting the most out of your child restraint:**

- Before buying any restraint system, make sure that it has a label certifying that it meets all applicable Safety Standards. We also recommend that you make sure that you can install the child restraint in the vehicle where you will use it before you buy it.
- The restraint must be appropriate for your child's weight and height. Check the label on the restraint for weight and height limits.
- Carefully follow the instructions that come with the restraint. If you install the restraint improperly, it may not work when you need it.
- In the rear seat, you may have trouble tightening the lap/shoulder belt on the child restraint because the buckle or latch plate is too close to the belt path opening on the restraint. Disconnect the latch plate



from the buckle and twist the short buckle-end belt several times to shorten it. Insert the latch plate into the buckle with the release button facing out.

- If the belt still can't be tightened, or if pulling and pushing on the restraint loosens the belt, disconnect the latch plate from the buckle, turn the latch plate around, and insert the latch plate into the buckle again. If you still can't make the child restraint secure, try a different seating position.
- Buckle the child into the seat according to the child restraint manufacturer's directions.
- When your child restraint is not in use, secure it in the vehicle with the seat belt or remove it from the vehicle. Do not leave it loose in the vehicle. In a sudden stop or collision, it could strike the occupants or seat backs and cause serious personal injury.

**WARNING!**

**Improper installation can lead to failure of an infant or child restraint. It could come loose in a collision. The child could be badly injured or killed. Follow the manufacturer's directions exactly when installing an infant or child restraint.**

**Lower Anchors and Tether for Children (LATCH)**

Each vehicle is equipped with the child restraint anchor-age system called LATCH, which stands for Lower Anchors and Tether for CHildren. LATCH child restraint anchorage systems are installed in the Crew Cab rear seat outboard positions. LATCH equipped seating positions feature both lower anchor bars, located at the back of the seat cushion, and tether strap anchorages, located behind the seat back (refer to "Child Restraint Tether Anchor").

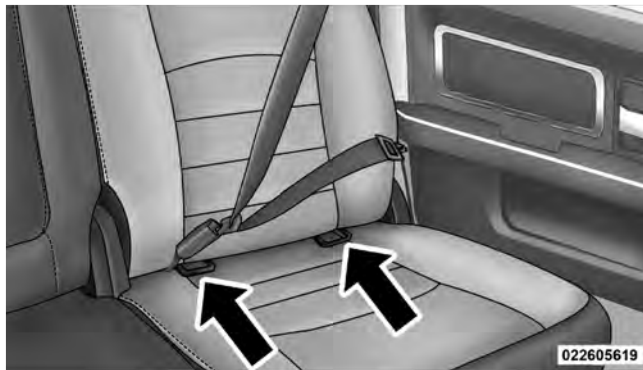

#### Crew Cab Rear Outboard Seats Driver Side

Child restraint systems having attachments designed to connect to the lower anchorages are now available. Child restraints having tether straps and hooks for connection to the seat back tether anchorage have been available for

some time. In fact, many child restraint manufacturers will provide add-on tether strap kits for some of their older products.

Because the lower anchorages are to be introduced to passenger carrying vehicles over a period of years, child restraint systems having attachments for those anchorages will continue to have features for installation in vehicles using the lap or lap/shoulder belt. They will also have tether straps, and you are urged to take advantage of all of the available attachments provided with your child restraint in any vehicle.

#### NOTE:

- When using the LATCH attaching system to install a child restraint, please ensure that all seat belts not being used for occupant restraints are stowed and out of reach of children. It is recommended that before installing the child restraint, buckle the seat belt so the seat belt is tucked behind the child restraint and out of

reach. If the buckled seat belt interferes with the child restraint installation, instead of tucking the seat belt behind the child restraint, route the seat belt through the child restraint belt path and then buckle it. This should stow the seat belt out of the reach of an inquisitive child. Remind all children in the vehicle that the seat belts are not toys and should not be played with, and never leave your child unattended in the vehicle.

- If your child restraint seat is not LATCH-compatible, install the restraint using the vehicle seat belting.

## Installing the Child Restraint System

### **WARNING!**

**Do not install child restraint systems equipped with LATCH attachments in the center position of a Crew Cab model rear seat. The LATCH anchorages in this seat are designed for the two outboard seating positions only. A child may be placed in the rear center seating position of a Crew Cab model using the seat belt and child tether anchorage. Failure to follow this may result in serious or fatal injury.**

We urge you to carefully follow the directions of the manufacturer when installing your child restraint. Many, but not all, restraint systems will be equipped with separate straps on each side, with each having a hook or connector, and a means for adjusting the tension in the strap. Forward-facing toddler restraints and some

rearward-facing infant restraints will also be equipped with a tether strap, a hook and means for adjusting the tension in the strap.

In general, you will first loosen the adjusters on the lower straps and tether straps so that you can more easily attach the hook or connector to the lower anchorages and tether anchorages. Then tighten all three straps as you push the child restraint rearward and downward into the seat.

Not all child restraint systems will be installed as we have described here. Again, carefully follow the instructions that come with the child restraint system.

### **WARNING!**

**Improper installation of a child restraint to the LATCH anchorages can lead to failure of an infant or child restraint. The child could be badly injured or killed. Follow the manufacturer's directions exactly when installing an infant or child restraint.**

### **Installing Child Restraints Using the Vehicle Seat Belt**

The seat belts in the passenger seating positions are equipped with either an Automatic Locking Retractor (ALR) or a cinching latch plate or both. Both types of seat belts are designed to keep the lap portion of the seat belt tight around the child restraint so that it is not necessary to use a locking clip. The ALR will make a ratcheting noise if you extract the entire belt from the retractor and

then allow the belt to retract into the retractor. For additional information on ALR, refer to “Automatic Locking Mode”.

To install a child restraint, first, pull enough of the seat belt webbing from the retractor to route it through the belt path of the child restraint and slide the latch plate into the buckle. Next, extract all the seat belt webbing out of the retractor and then allow the belt to retract into the retractor. Finally, pull on any excess webbing to tighten the lap portion around the child restraint. Any seat belt system will loosen with time, so check the belt occasionally, and pull it tight if necessary.

### **Child Restraint Tether Anchor**

Child restraints having tether straps and hooks for connection to tether anchors have been available for some time. In fact, many child restraint manufacturers will provide add-on tether strap kits for their older products. Regular Cab models have two tether anchorages, one

each behind the front center and right seats. Crew Cab models have three anchorages, one behind each of the rear seats.

### **WARNING!**

**An incorrectly anchored tether strap could lead to seat failure and injury to the child. In a collision, the seat could come loose and allow the child to crash into the inside of the vehicle or other passengers, or even be thrown from the vehicle. Use only the anchor positions directly behind the child seat to secure a child restraint top tether strap. Follow the instructions below. See your authorized dealer for help if necessary.**

### Tether Anchorage Points at the Right and Center Front Seat (Regular Cab - All Seats)

1. Place the child restraint on the seat and adjust the tether strap so that it will reach over the seat back under the head restraint to the tether anchor directly behind the seat.
2. Lift the cover (if so equipped), and attach the hook to the square opening in the sheet metal.
3. Install the child restraint and remove the slack in the tether strap according to the manufacturer's instructions.

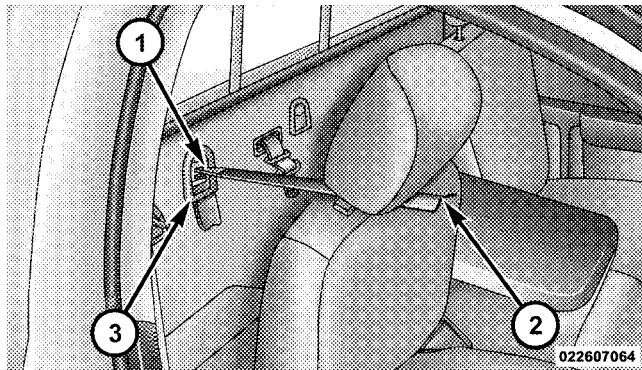

Regular Cab Tether Strap Mounting

- 1 — Tether Strap Hook
- 2 — Tether Strap to Child Restraint
- 3 — Tether Anchor

### Multiple Child Restraint Installation Sequence (Crew Cab — Rear Seats)

1. Obtain tether straps by raising the head restraints and reaching between the rear glass and rear seat. The tether strap may be retained with an elastic band. Accessibility to the tether strap is greatly improved by raising the seat cushion to the “up” position. Remove the elastic before use.

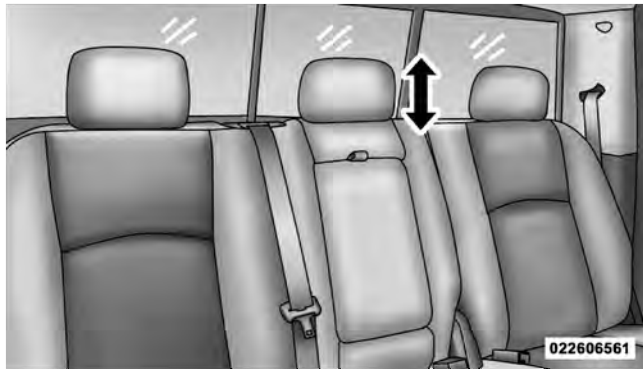

2. Place a child restraint on each outboard rear seat and adjust the tether strap so that it will reach under the head restraint to the tether anchor directly behind the seat and then to the anchor directly behind the center rear seat.
3. Pass each tether strap hook under the head restraint and through the loop of webbing behind the child seat.
4. Route each tether strap to the anchor behind the center seat, and attach the hooks to the metal ring.
5. Place a child restraint on the center rear seat and adjust the tether strap so that it will reach under the head restraint to the tether anchor directly behind the seat and to the anchor directly behind the right seat.
6. Install each child restraint and remove the slack in the tether strap according to the child restraint manufacturer's instructions.

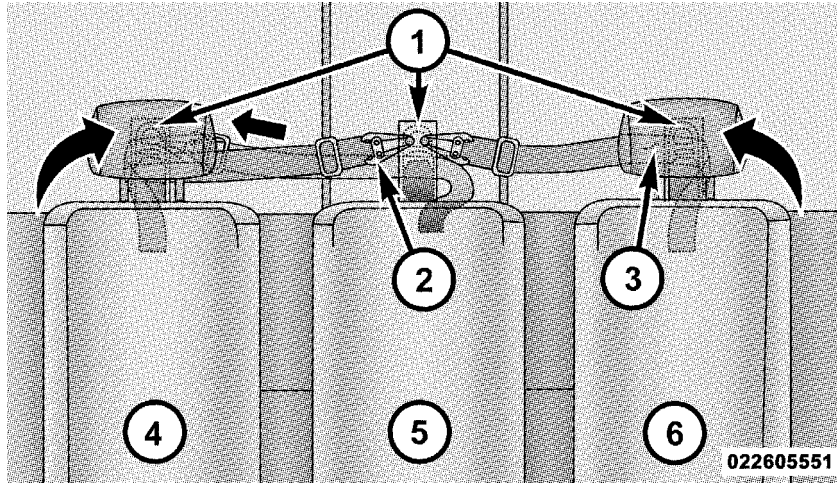

2

**Multiple Child Restraint Crew Cab**

- 1 — Inner Anchor Strap Ring(s)
- 2 — Snap Hook
- 3 — Tether Strap

- 4 — Passenger's Side Rear Child Seat
- 5 — Rear Center Child Seat
- 6 — Driver's Side Rear Child Seat



### Children Too Large for Booster Seats

Children who are large enough to wear the shoulder belt comfortably, and whose legs are long enough to bend over the front of the seat when their back is against the seat back should use the lap/shoulder belt in a rear seat.

- Make sure that the child is upright in the seat.
- The lap portion should be low on the hips and as snug as possible.
- Check belt fit periodically. A child's squirming or slouching can move the belt out of position.

If the shoulder belt contacts the face or neck, move the child closer to the center of the vehicle. Never allow a child to put the shoulder belt under an arm or behind their back.

### Transporting Pets

Airbags deploying in the front seat could harm your pet. An unrestrained pet will be thrown about and possibly

injured, or injure a passenger during panic braking or in a collision. Pets should be restrained in the rear seat in pet harnesses or pet carriers that are secured by seat belts.

### ENGINE BREAK-IN RECOMMENDATIONS

A long break-in period is not required for the engine and drivetrain (transmission and axle) in your vehicle.

Drive moderately during the first 300 miles (500 km). After the initial 60 miles (100 km), speeds up to 50 or 55 mph (80 or 90 km/h) are desirable.

While cruising, brief full-throttle acceleration within the limits of local traffic laws, contributes to a good break-in. Wide-open throttle acceleration in low gear can be detrimental and should be avoided.

The engine oil installed in the engine at the factory is a high-quality energy conserving type lubricant. Oil changes should be consistent with anticipated climate conditions under which vehicle operations will occur. For

the recommended viscosity and quality grades refer to “Maintenance Procedures” in “Maintaining Your Vehicle”. NON-DETERGENT OR STRAIGHT MINERAL OILS MUST NEVER BE USED.

A new engine may consume some oil during its first few thousand miles (kilometers) of operation. This should be considered a normal part of the break-in and not interpreted as an indication of difficulty.

## **SAFETY TIPS**

### **Transporting Passengers**

NEVER TRANSPORT PASSENGERS IN THE CARGO AREA.

### **WARNING!**

- It is extremely dangerous to ride in a cargo area, inside or outside of a vehicle. In a collision, people riding in these areas are more likely to be seriously injured or killed.
- Do not allow people to ride in any area of your vehicle that is not equipped with seats and seat belts.
- Be sure everyone in your vehicle is in a seat and using a seat belt properly.

## Exhaust Gas

### **WARNING!**

**Exhaust gases can injure or kill. They contain carbon monoxide (CO), which is colorless and odorless. Breathing it can make you unconscious and can eventually poison you. To avoid breathing (CO) follow these safety tips:**

Do not run the engine in a closed garage or in confined areas any longer than needed to move your vehicle in or out of the area.

If it is necessary to sit in a parked vehicle with the engine running, adjust your heating or cooling controls to force outside air into the vehicle. Set the blower at high speed.

The best protection against carbon monoxide entry into the vehicle body is a properly maintained engine exhaust system.

Whenever a change is noticed in the sound of the exhaust system, when exhaust fumes can be detected inside the vehicle, or when the underside or rear of the vehicle is damaged, have a competent mechanic inspect the complete exhaust system and adjacent body areas for broken, damaged, deteriorated, or mispositioned parts. Open seams or loose connections could permit exhaust fumes to seep into the passenger compartment. In addition, inspect the exhaust system each time the vehicle is raised for lubrication or oil change. Replace as required.

## **Safety Checks You Should Make Inside the Vehicle**

### **Seat Belts**

Inspect the belt system periodically, checking for cuts, frays, and loose parts. Damaged parts must be replaced immediately. Do not disassemble or modify the system.

Front seat belt assemblies must be replaced after a collision. Rear seat belt assemblies must be replaced after

a collision if they have been damaged (i.e., bent retractor, torn webbing, etc.). If there is any question regarding belt or retractor condition, replace the belt.

### **Airbag Warning Light**

The light should come on and remain on for six to eight seconds as a bulb check when the ignition switch is first turned ON. If the light is not lit during starting, see your authorized dealer. If the light stays on, flickers, or comes on while driving, have the system checked by an authorized dealer.

### **Defroster**

Check operation by selecting the defrost mode and place the blower control on high speed. You should be able to feel the air directed against the windshield. See your authorized dealer for service if your defroster is inoperable.

## **Periodic Safety Checks You Should Make Outside the Vehicle**

### **Tires**

Examine tires for excessive tread wear and uneven wear patterns. Check for stones, nails, glass, or other objects lodged in the tread. Inspect the tread and sidewall for cuts and cracks. Check the wheel nuts for tightness. Check the tires (including spare) for proper pressure.

### **Lights**

Have someone observe the operation of exterior lights while you work the controls. Check turn signal and high beam indicator lights on the instrument panel.

### **Door Latches**

Check for positive closing, latching, and locking.

### **Fluid Leaks**

Check area under vehicle after overnight parking for fuel, engine coolant, oil, or other fluid leaks. Also, if gasoline fumes are detected or if fuel, power steering fluid, or brake fluid leaks are suspected, the cause should be located and corrected immediately.

# UNDERSTANDING THE FEATURES OF YOUR VEHICLE

## CONTENTS

---

■ Mirrors . . . . .	81	□ “Slide-On-Rod” Features Of Sun Visor — If Equipped . . . . .	86
□ Inside Day/Night Mirror . . . . .	81	□ Trailer Towing Mirrors — If Equipped . . . . .	86
□ Automatic Dimming Mirror — If Equipped . . . . .	82	■ Uconnect™ Phone — If Equipped . . . . .	87
□ Outside Mirrors . . . . .	82	□ Operation . . . . .	90
□ Outside Mirrors Folding Feature . . . . .	83	□ Phone Call Features . . . . .	98
□ Power Mirrors — If Equipped . . . . .	84	□ Uconnect™ Phone Features . . . . .	101
□ Heated Mirrors — If Equipped . . . . .	85	□ Advanced Phone Connectivity . . . . .	105
□ Illuminated Vanity Mirror — If Equipped . . . . .	85	□ Things You Should Know About Your Uconnect™ Phone . . . . .	107

## 78 UNDERSTANDING THE FEATURES OF YOUR VEHICLE

- General Information . . . . . 116
- Voice Command — If Equipped . . . . . 116
  - Voice Command System Operation . . . . . 116
  - Commands . . . . . 118
  - Voice Training . . . . . 121
- Seats . . . . . 121
  - Manual Seat Adjuster — If Equipped . . . . . 122
  - Manual Reclining Seats — If Equipped . . . . . 123
  - Adjustable Head Restraints . . . . . 124
  - Eight-Way Power Seats — If Equipped . . . . . 127
  - Power Lumbar — If Equipped . . . . . 128
  - Heated Seats — If Equipped . . . . . 129
  - Ventilated Seats — If Equipped . . . . . 131
  - 40-20-40 Front Bench Seat — If Equipped . . . . . 131
- Driver Memory Seat — If Equipped . . . . . 132
  - Setting Memory Positions And Linking RKE Transmitter To Memory . . . . . 133
  - Memory Position Recall . . . . . 134
  - To Disable a RKE Transmitter Linked To Memory . . . . . 134
  - Self-Limiting Control . . . . . 135
  - Driver Easy Exit And Easy Entry Control . . . . . 135
- To Open And Close The Hood . . . . . 136
- Lights . . . . . 138
  - Headlights . . . . . 139
  - Automatic Headlights . . . . . 139
  - Headlight Delay . . . . . 140

□ Parking Lights And Panel Lights . . . . .	140	■ Driver Adjustable Pedals — If Equipped . . . . .	148
□ Fog Lights — If Equipped . . . . .	140	□ Adjustment . . . . .	148
□ Interior Lights . . . . .	141	■ Heated Steering Wheel — If Equipped . . . . .	149
□ Cargo Light . . . . .	142	■ Electronic Speed Control — If Equipped . . . . .	150
□ Lights-On Reminder . . . . .	143	□ To Activate . . . . .	151
□ Battery Saver . . . . .	143	□ To Set a Desired Speed . . . . .	152
□ Daytime Running Lights — If Equipped . . . . .	143	□ Deactivating Electronic Speed Control . . . . .	152
□ Multifunction Lever . . . . .	143	□ To Resume Speed . . . . .	152
■ Windshield Wipers And Washers . . . . .	145	□ Varying The Speed Setting . . . . .	152
□ Windshield Wipers . . . . .	145	□ To Accelerate For Passing . . . . .	153
□ Windshield Washers . . . . .	146	■ Overhead Console — If Equipped . . . . .	154
□ Mist Feature . . . . .	147	□ Courtesy/Reading Lights . . . . .	154
■ Tilt Steering Column . . . . .	147	■ Electrical Power Outlets . . . . .	156



## 80 UNDERSTANDING THE FEATURES OF YOUR VEHICLE

- Cigar Lighter And Ash Receiver —  
If Equipped . . . . . 159
- Power Inverter — If Equipped . . . . . 160
- Cupholders . . . . . 161
  - Front Instrument Panel Cupholders —  
(40–20–40 Seats) . . . . . 161
  - Front Instrument Panel Cupholders — Floor  
Storage Bin . . . . . 162
  - Rear Cupholder — Crew Cab . . . . . 162
- Storage . . . . . 163
  - Glove Box Storage . . . . . 163
  - Door Storage . . . . . 165
  - Center Storage Compartment —  
If Equipped . . . . . 166
  - Seatback Storage . . . . . 168
  - Storage (Regular Cab) . . . . . 168
  - Storage And Seats (Crew Cab) . . . . . 169
  - Plastic Grocery Bag Retainers  
(Regular Cab Models) . . . . . 170
- Rear Window Features . . . . . 170
  - Rear Window Defroster . . . . . 170
  - Power Sliding Rear Window —  
If Equipped . . . . . 171
  - Manual Sliding Rear Window —  
If Equipped . . . . . 172

## MIRRORS

### Inside Day/Night Mirror

Headlight glare can be reduced by moving the small control lever under the mirror to the night position (lever flipped toward the rear of vehicle).

The mirror should be adjusted with the lever set in the day position (lever flipped toward the windshield). The mirror should be adjusted to center on the view through the rear window.

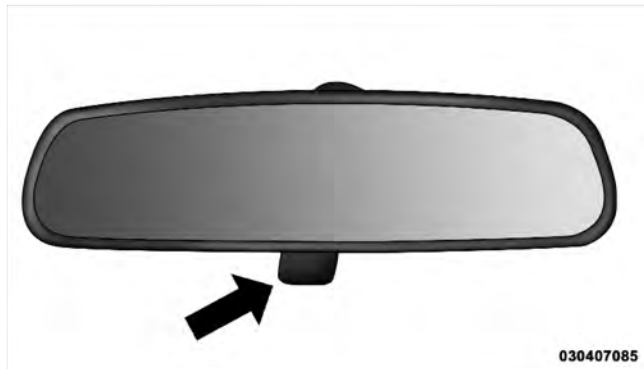

030407085

Adjusting Rearview Mirror

### Automatic Dimming Mirror — If Equipped

This mirror automatically adjusts for headlight glare from vehicles behind you. You can turn the feature on or off by pressing the power button at the base of the mirror. A light next to the button will illuminate when the dimming feature is activated.



Automatic Dimming Mirror

### CAUTION!

**To avoid damage to the mirror during cleaning, never spray any cleaning solution directly onto the mirror. Apply the solution onto a clean cloth and wipe the mirror clean.**

### Outside Mirrors

To receive maximum benefit, adjust the outside mirror(s) to center on the adjacent lane of traffic with a slight overlap of the view obtained on the inside mirror.

**WARNING!**

Vehicles and other objects seen in a passenger side convex mirror will look smaller and farther away than they really are. Relying too much on your passenger side convex mirror could cause you to collide with another vehicle or other object. Use your inside mirror when judging the size or distance of a vehicle seen in the passenger side convex mirror. Some vehicles will not have a convex right side mirror.

**Outside Mirrors Folding Feature**

All outside mirrors are hinged and may be moved either forward or rearward to resist damage.

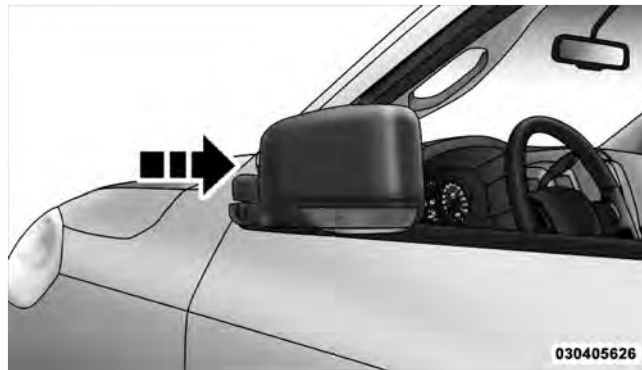

Folding Mirror

**CAUTION!**

It is recommended to fold the mirrors into the full rearward position to resist damage when entering a car wash or a narrow location.

### Power Mirrors — If Equipped

The controls for the power mirrors are located on the driver's door trim panel.

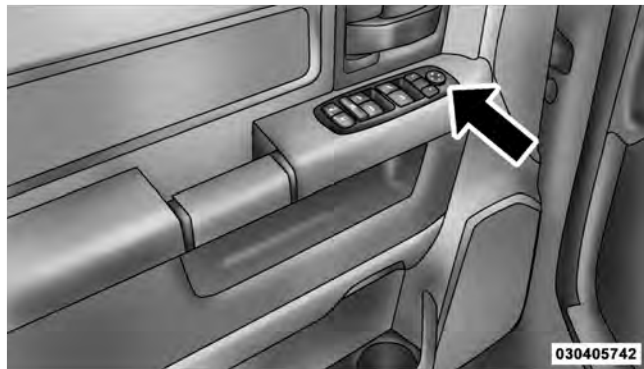

#### Power Mirror Controls

The power mirror controls consist of mirror select buttons and a four-way mirror control switch.



#### Power Mirror Controls

- 1 — Mirror Select Buttons
- 2 — Mirror Control

To adjust a mirror, press the mirror select button for the mirror that you want to adjust. Using the mirror control switch, press on any of the four arrows for the direction that you want the mirror to move.



Power Mirror Movement

### Heated Mirrors — If Equipped



These mirrors are heated to melt frost or ice. This feature is activated by pressing the rear window defroster button.

### Illuminated Vanity Mirror — If Equipped

Illuminated vanity mirrors are located on each sun visor. To use the mirror, rotate the sun visor down and swing the mirror cover upward. The lights will turn on automatically. Closing the mirror cover turns off the light.

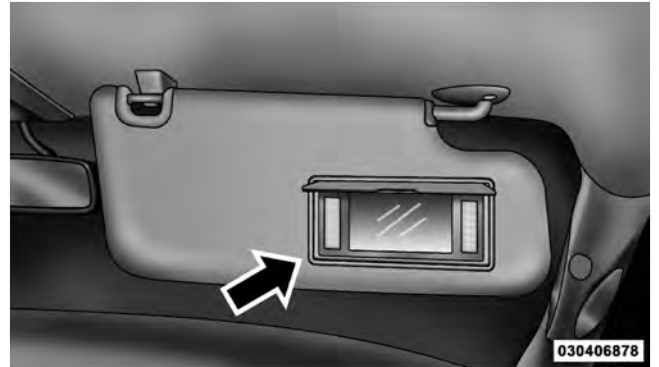

Illuminated Vanity Mirror

### **“Slide-On-Rod” Features of Sun Visor — If Equipped**

The sun visor “Slide-On-Rod” feature allows for additional flexibility in positioning the visor to block out the sun.

To use the “Slide-On-Rod” feature, rotate the sun visor downward and unclip it. Pull the sun visor along the “Slide-On-Rod” until the sun visor is in the desired position.

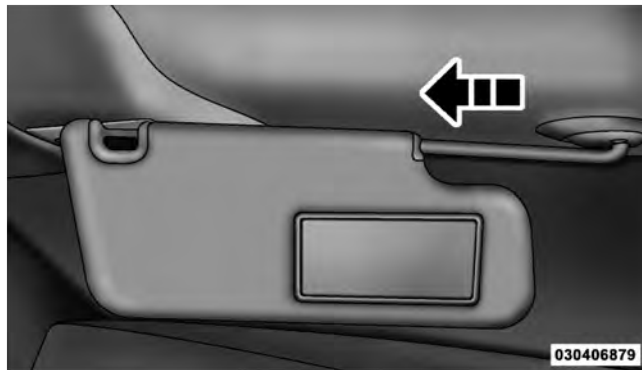

**Slide-On-Rod Extender**

### **Trailer Towing Mirrors — If Equipped**

These mirrors are designed with an adjustable mirror head to provide a greater vision range when towing extra-wide loads. To change position inboard or outboard, the mirror head should be rotated (flipped in or out).



### Trailer Towing Position

**NOTE:** Fold the trailer towing mirrors rearward prior to entering an automated car wash.

A small blindspot mirror is located next to main mirror and can be adjusted separately.



### Blindspot Mirror

#### Uconnect™ Phone — IF EQUIPPED

Uconnect™ Phone is a voice-activated, hands-free, in-vehicle communications system. Uconnect™ Phone allows you to dial a phone number with your cellular phone using simple voice commands (e.g., "Call" ... "Mike" ... "Work" or "Dial" ... "248-555-1212"). Your cellular



phone's audio is transmitted through your vehicle's audio system; the system will automatically mute your radio when using the Uconnect™ Phone.

**NOTE:** The Uconnect™ Phone requires a cellular phone equipped with the Bluetooth® "Hands-Free Profile," Version 0.96 or higher. See the Uconnect™ website for supported phones.

For Uconnect™ customer support, visit the following websites:

- [www.chrysler.com/uconnect](http://www.chrysler.com/uconnect)
- [www.dodge.com/uconnect](http://www.dodge.com/uconnect)
- [www.jeep.com/uconnect](http://www.jeep.com/uconnect)
- or call 1-877-855-8400



Uconnect™ Phone allows you to transfer calls between the system and your cellular phone as you enter or exit your vehicle and enables you to mute the system's microphone for private conversation.

The Uconnect™ Phone is driven through your Bluetooth® "Hands-Free Profile" cellular phone. Uconnect™ features Bluetooth® technology - the global standard that enables different electronic devices to connect to each other without wires or a docking station, so Uconnect™ Phone works no matter where you stow your cellular phone (be it your purse, pocket, or briefcase), as long as your phone is turned on and has been paired to the vehicle's Uconnect™ Phone. The Uconnect™ Phone allows up to seven cellular phones to be linked to the system. Only one linked (or paired) cellular phone can be used with the system at a time. The system is available in English, Spanish, or French languages.

**WARNING!**

Any voice commanded system should be used only in safe driving conditions following local laws and phone use. All attention should be kept on the roadway ahead. Failure to do so may result in an accident causing serious injury or death.

*Uconnect™ Phone Button*

 Depending on the vehicle options, either the radio or the mirror will contain the two control buttons  (Uconnect™ Phone button) and  (Voice Command button) that will enable you to access the system.

*Voice Command Button*

 Actual button location may vary with the radio. The individual buttons are described in the “Operation” section.

The Uconnect™ Phone can be used with any Hands-Free Profile certified Bluetooth® cellular phone. See the Uconnect™ website for supported phones. If your cellular phone supports a different profile (e.g., Headset Profile) you may not be able to use any Uconnect™ Phone features. Refer to your cellular service provider or the phone manufacturer for details.

The Uconnect™ Phone is fully integrated with the vehicle’s audio system. The volume of the Uconnect™ Phone can be adjusted either from the radio volume control knob or from the steering wheel radio control (right switch), if so equipped.

The radio display will be used for visual prompts from the Uconnect™ Phone such as “CELL” or caller ID on certain radios.

## Operation

Voice commands can be used to operate the Uconnect™ Phone and to navigate through the Uconnect™ Phone menu structure. Voice commands are required after most Uconnect™ Phone prompts. You will be prompted for a specific command and then guided through the available options.

- Prior to giving a voice command, one must wait for the beep, which follows the "Ready" prompt or another prompt.
- For certain operations, compound commands can be used. For example, instead of saying "Setup" and then "Phone Pairing," the following compound command can be said: "Setup Phone Pairing."
- For each feature explanation in this section, only the combined form of the voice command is given. You can also break the commands into parts and say each part of the command when you are asked for it. For



example, you can use the combined form voice command "Phonebook New Entry," or you can break the combined form command into two voice commands: "Phonebook" and "New Entry." Please remember, the Uconnect™ Phone works best when you talk in a normal conversational tone, as if speaking to someone sitting a few feet/meters away from you.

## Voice Command Tree

Refer to "Voice Tree" in this section.

## Help Command

If you need assistance at any prompt, or if you want to know your options at any prompt, say "Help" following the beep. The Uconnect™ Phone will play all the options at any prompt if you ask for help.

To activate the Uconnect™ Phone from idle, simply press the  button and follow the audible prompts for directions. All Uconnect™ Phone sessions begin with a press of the  button on the radio control head.

### Cancel Command

At any prompt, after the beep, you can say "Cancel" and you will be returned to the main menu. However, in a few instances the system will take you back to the previous menu.

### Pair (Link) Uconnect™ Phone to a Cellular Phone

To begin using your Uconnect™ Phone, you must pair your compatible Bluetooth® enabled cellular phone.

To complete the pairing process, you will need to reference your cellular phone Owner's Manual. The Uconnect™ website may also provide detailed instructions for pairing.

The following are general phone to Uconnect™ Phone pairing instructions:

- Press the  button to begin.
- After the "Ready" prompt and the following beep, say "Setup Phone Pairing."

- When prompted, after the beep, say "Pair a Phone" and follow the audible prompts.
- You will be asked to say a four-digit Personal Identification Number (PIN), which you will later need to enter into your cellular phone. You can enter any four-digit PIN. You will not need to remember this PIN after the initial pairing process.
- For identification purposes, you will be prompted to give the Uconnect™ Phone a name for your cellular phone. Each cellular phone that is paired should be given a unique phone name.
- You will then be asked to give your cellular phone a priority level between one and seven, with one being the highest priority. You can pair up to seven cellular phones to your Uconnect™ Phone. However, at any given time, only one cellular phone can be in use, connected to your Uconnect™ Phone. The priority allows the Uconnect™ Phone to know which cellular

phone to use if multiple cellular phones are in the vehicle at the same time. For example, if priority three and priority five phones are present in the vehicle, the Uconnect™ Phone will use the priority three cellular phone when you make a call. You can select to use a lower priority cellular phone at any time (refer to "Advanced Phone Connectivity" in this section).

### Dial by Saying a Number

- Press the  button to begin.
- After the "Ready" prompt and the following beep, say "Dial."
- The system will prompt you to say the number you want to call.
- For example, you can say "234-567-8901".

- The Uconnect™ Phone will confirm the phone number and then dial. The number will appear in the display of certain radios.

### Call by Saying a Name

- Press the  button to begin.
- After the "Ready" prompt and the following beep, say "Call."
- The system will prompt you to say the name of the person you want to call.
- After the "Ready" prompt and the following beep, say the name of the person you want to call. For example, you can say "John Doe," where John Doe is a previously stored name entry in the Uconnect™ phonebook or downloaded phonebook. To learn how to store a name in the phonebook, refer to "Add Names to Your Uconnect™ Phonebook," in the phonebook.

- The Uconnect™ system will confirm the name and then dial the corresponding phone number, which may appear in the display of certain radios.

### Add Names to Your Uconnect™ Phonebook

**NOTE:** Adding names to the Uconnect™ Phonebook is recommended when the vehicle is not in motion.

- Press the  button to begin.
- After the "Ready" prompt and the following beep, say "Phonebook New Entry."
- When prompted, say the name of the new entry. Use of long names helps the Voice Command and it is recommended. For example, say "Robert Smith" or "Robert" instead of "Bob."

- When prompted, enter the number designation (e.g., "Home," "Work," "Mobile," or "Pager"). This will allow you to store multiple numbers for each phonebook entry, if desired.
- When prompted, recite the phone number for the phonebook entry that you are adding.

After you are finished adding an entry into the phonebook, you will be given the opportunity to add more phone numbers to the current entry or to return to the main menu.

The Uconnect™ Phone will allow you to enter up to 32 names in the phonebook with each name having up to four associated phone numbers and designations. Each language has a separate 32-name phonebook accessible only in that language. In addition, if equipped and supported by your phone, Uconnect™ Phone automatically downloads your cellular phone's phonebook.

### Phonebook Download – Automatic Phonebook Transfer From Cellular Phone

If equipped and specifically supported by your phone, Uconnect™ Phone automatically downloads names (text names) and number entries from the cellular phone's phonebook. Specific Bluetooth® Phones with Phone Book Access Profile may support this feature. See Uconnect™ website for supported phones.

- To call a name from downloaded (or Uconnect™) Phonebook, follow the procedure in “Call by Saying a Name” section.
- Automatic download and update, if supported, begins as soon as the Bluetooth® wireless phone connection is made to the Uconnect™ Phone, for example, after you start the vehicle.
- A maximum of 1000 entries per phone will be downloaded and updated every time a phone is connected to the Uconnect™ Phone.
- Depending on the maximum number of entries downloaded, there may be a short delay before the latest downloaded names can be used. Until then, if available, the previous downloaded phonebook is available for use.
- Only the phonebook of the currently connected cellular phone is accessible.
- Only the cellular phone's phonebook is downloaded. SIM card phonebook is not part of the Mobile phonebook.
- This downloaded phonebook cannot be edited or deleted on the Uconnect™ Phone. These can only be edited on the cellular phone. The changes are transferred and updated to Uconnect™ Phone on the next phone connection.

### Phonebook Download — Single Entry

If equipped and supported by your phone, Uconnect™ Phone allows the user to download entries from their phone via Bluetooth®. To use this feature, press the  button and say "Phonebook Download." The system prompts, "Ready to accept "V" card entry via Bluetooth®..." The system is now ready to accept phonebook entries from your phone using the Bluetooth® Object Exchange Profile (OBEX). Please see your phone Owner's Manual for specific instructions on how to send these entries from your phone.

#### NOTE:

- The phone handset must support Bluetooth® OBEX transfers of phonebook entries to use this feature.
- Some phones cannot send phonebook entries if they are already connected to any system via Bluetooth®, and you may see a message on the phone display that the Bluetooth® link is busy. In this case, the user must

first disconnect or drop the Bluetooth® connection to the Uconnect™ Phone, and then send the address book entry via Bluetooth®. Please see your phone Owner's Manual for specific instructions on how to drop the Bluetooth® connection.

- If the phonebook entry is longer than 24 characters, it will only use the first 24 characters.

### Edit Uconnect™ Phonebook Entries

#### NOTE:

- Editing names in the phonebook is recommended when the vehicle is not in motion.
- Automatic downloaded phonebook entries cannot be deleted or edited.
- Press the  button to begin.
- After the "Ready" prompt and the following beep, say "Phonebook Edit."





- You will then be asked for the name of the phonebook entry that you wish to edit.
- Next, choose the number designation (home, work, cellular, or pager) that you wish to edit.
- When prompted, recite the new phone number for the phonebook entry that you are editing.

After you are finished editing an entry in the phonebook, you will be given the opportunity to edit another entry in the phonebook, call the number you just edited, or return to the main menu.

"Phonebook Edit" can be used to add another phone number to a name entry that already exists in the phonebook. For example, the entry John Doe may have a cellular and a home number, but you can add "John Doe's" work number later using the "Phonebook Edit" feature.

### Delete Uconnect™ Phonebook Entry

**NOTE:** Editing phonebook entries is recommended when the vehicle is not in motion.

- Press the  button to begin.
- After the "Ready" prompt and the following beep, say "Phonebook Delete."
- After you enter the Phonebook Delete menu, you will then be asked for the name of the entry that you wish to delete. You can either say the name of a phonebook entry that you wish to delete or you can say "List Names" to hear a list of the entries in the phonebook from which you choose. To select one of the entries from the list, press the  button while the Uconnect™ Phone is playing the desired entry and say "Delete."



- After you enter the name, the Uconnect™ Phone will ask you which designation you wish to delete: home, work, cellular, pager, or all. Say the designation you wish to delete.
- Note that only the phonebook entry in the current language is deleted.
- Automatic downloaded phonebook entries cannot be deleted or edited.

### Delete/Erase "All" Uconnect™ Phonebook Entries

- Press the  button to begin.
- After the "Ready" prompt and the following beep, say "Phonebook Erase All."
- The Uconnect™ Phone will ask you to verify that you wish to delete all the entries from the phonebook.
- After confirmation, the phonebook entries will be deleted.

- Note that only the phonebook in the current language is deleted.
- Automatic downloaded phonebook entries cannot be deleted or edited.

### List All Names in the Uconnect™ Phonebook

- Press the  button to begin.
- After the "Ready" prompt and the following beep, say "Phonebook List Names."
- The Uconnect™ Phone will play the names of all the phonebook entries, including the downloaded phonebook entries, if available.
- To call one of the names in the list, press the  button during the playing of the desired name, and say "Call."

**NOTE:** The user can also exercise "Edit" or "Delete" operations at this point.

- The Uconnect™ Phone will then prompt you as to the number designation you wish to call.
- The selected number will be dialed.

### Phone Call Features

The following features can be accessed through the Uconnect™ Phone if the feature(s) are available on your cellular service plan. For example, if your cellular service plan provides three-way calling, this feature can be accessed through the Uconnect™ Phone. Check with your cellular service provider for the features that you have.

#### Answer or Reject an Incoming Call - No Call Currently in Progress

When you receive a call on your cellular phone, the Uconnect™ Phone will interrupt the vehicle audio system, if on, and will ask if you would like to answer the call. Press the  button to accept the call. To reject the

call, press and hold the  button until you hear a single beep, indicating that the incoming call was rejected.

#### Answer or Reject an Incoming Call - Call Currently in Progress



If a call is currently in progress and you have another incoming call, you will hear the same network tones for call waiting that you normally hear when using your cellular phone. Press the  button to place the current call on hold and answer the incoming call.

**NOTE:** The Uconnect™ Phone compatible phones in the market today do not support rejecting an incoming call when another call is in progress. Therefore, the user can only answer an incoming call or ignore it.

### **Making a Second Call While Current Call is in Progress**

To make a second call while you are currently on a call, press the  button and say "Dial" or "Call" followed by the phone number or phonebook entry you wish to call. The first call will be on hold while the second call is in progress. To go back to the first call, refer to "Toggling Between Calls" in this section. To combine two calls, refer to "Conference Call" in this section.

### **Place/Retrieve a Call From Hold**

To put a call on hold, press the  button until you hear a single beep. This indicates that the call is on hold. To bring the call back from hold, press and hold the  button until you hear a single beep.

### **Toggling Between Calls**



If two calls are in progress (one active and one on hold), press the  button until you hear a single beep,

indicating that the active and hold status of the two calls have switched. Only one call can be placed on hold at a time.



### **Conference Call**

When two calls are in progress (one active and one on hold), press and hold the  button until you hear a double beep indicating that the two calls have been joined into one conference call.

### **Three-Way Calling**

To initiate three-way calling, press the  button while a call is in progress, and make a second phone call, as described under "Making a Second Call While Current Call is in Progress." After the second call has established, press and hold the  button until you hear a double beep, indicating that the two calls have been joined into one conference call.

### Call Termination

To end a call in progress, momentarily press the  button. Only the active call(s) will be terminated and if there is a call on hold, it will become the new active call. If the active call is terminated by the phone far end, a call on hold may not become active automatically. This is cell phone-dependent. To bring the call back from hold, press and hold the  button until you hear a single beep.

### Redial

- Press the  button to begin.
- After the "Ready" prompt and the following beep, say "Redial."
- The Uconnect™ Phone will call the last number that was dialed from your cellular phone.

**NOTE:** This may not be the last number dialed from the Uconnect™ Phone.

### Call Continuation

Call continuation is the progression of a phone call on the Uconnect™ Phone after the vehicle ignition key has been switched to OFF. Call continuation functionality available on the vehicle can be any one of three types:

- After the ignition key is switched to OFF, a call can continue on the Uconnect™ Phone either until the call ends, or until the vehicle battery condition dictates cessation of the call on the Uconnect™ Phone and transfer of the call to the cellular phone.
- After the ignition key is switched to OFF, a call can continue on the Uconnect™ Phone for a certain duration, after which the call is automatically transferred from the Uconnect™ Phone to the cellular phone.
- An active call is automatically transferred to the cellular phone after the ignition key is switched to OFF.

## Uconnect™ Phone Features

### Language Selection

To change the language that the Uconnect™ Phone is using:

- Press the  button to begin.
- After the "Ready" prompt and the following beep, say the name of the language you wish to switch to English, Espanol, or Francais.
- Continue to follow the system prompts to complete the language selection.

After selecting one of the languages, all prompts and voice commands will be in that language.

**NOTE:** After every Uconnect™ Phone language change operation, only the language-specific 32-name phone-book is usable. The paired phone name is not language-specific and usable across all languages.

### Emergency Assistance

If you are in an emergency and the cellular phone is reachable:

- Pick up the phone and manually dial the emergency number for your area.

If the phone is not reachable and the Uconnect™ Phone is operational, you may reach the emergency number as follows:

- Press the  button to begin.
- After the "Ready" prompt and the following beep, say "Emergency" and the Uconnect™ Phone will instruct the paired cellular phone to call the emergency number. This feature is supported in the U.S., Canada, and Mexico.

**NOTE:**

- The emergency number dialed is based on the country where the vehicle is purchased (911 for the U.S. and

Canada and 060 for Mexico). The number dialed may not be applicable with the available cellular service and area.

- If supported, this number may be programmable on some systems. To do this, press the  button and say 'Setup', followed by 'Emergency'.
- The Uconnect™ Phone does slightly lower your chances of successfully making a phone call as to that for the cellular phone directly.

### WARNING!

**Your phone must be turned on and paired to the Uconnect™ Phone to allow use of this vehicle feature in emergency situations, when the cellular phone has network coverage and stays paired to the Uconnect™ Phone.**

### Towing Assistance

If you need towing assistance:

- Press the  button to begin.
- After the "Ready" prompt and the following beep, say "Towing Assistance."

### NOTE:

- The towing assistance number dialed is based on the country where the vehicle is purchased (1-800-528-2069 for the U.S., 1-877-213-4525 for Canada, 55-14-3454 for Mexico City and 1-800-712-3040 for outside Mexico City in Mexico). Please refer to the 24-Hour "Towing Assistance" coverage details on the DVD in the Warranty Information Booklet and the 24-Hour Towing Assistance references.
- If supported, this number may be programmable on some systems. To do this, press the  button and say "Setup", followed by "Towing Assistance".

### **Paging**

To learn how to page, refer to "Working with Automated Systems." Paging works properly except for pagers of certain companies, which time out a little too soon to work properly with the Uconnect™ Phone.



### **Voice Mail Calling**

To learn how to access your voice mail, refer to "Working with Automated Systems."

### **Working with Automated Systems**

This method is used in instances where one generally has to press numbers on the cellular phone keypad while navigating through an automated telephone system.

You can use your Uconnect™ Phone to access a voice mail system or an automated service, such as a paging service or automated customer service line. Some services require immediate response selection. In some instances, that may be too quick for use of the Uconnect™ Phone.

When calling a number with your Uconnect™ Phone that normally requires you to enter in a touch-tone sequence on your cellular phone keypad, you can press the  button and say the sequence you wish to enter, followed by the word "Send." For example, if required to enter your PIN followed with a pound, (3 7 4 6 #), you can press the  button and say, "3 7 4 6 # Send." Saying a number, or sequence of numbers, followed by "Send," is also to be used for navigating through an automated customer service center menu structure, and to leave a number on a pager.

You can also send stored Uconnect™ phonebook entries as tones for fast and easy access to voice mail and pager entries. To use this feature, dial the number you wish to call and then press the  button and say, "Send." The system will prompt you to enter the name or number and say the name of the phonebook entry you wish to send.



The Uconnect™ Phone will then send the corresponding phone number associated with the phonebook entry, as tones over the phone.

**NOTE:**

- You may not hear all of the tones due to cellular phone network configurations. This is normal.
- Some paging and voice mail systems have system time out settings that are too short and may not allow the use of this feature.

**Barge In - Overriding Prompts**

The “Voice Command” button can be used when you wish to skip part of a prompt and issue your voice command immediately. For example, if a prompt is asking “Would you like to pair a phone, clear a...,” you could press the  button and say, “Pair a Phone” to select that option without having to listen to the rest of the voice prompt.

**Turning Confirmation Prompts ON/OFF**

Turning confirmation prompts off will stop the system from confirming your choices (e.g., the Uconnect™ Phone will not repeat a phone number before you dial it).

- Press the  button to begin.
- After the “Ready” prompt and the following beep, say “Setup Confirmations.” The Uconnect™ Phone will play the current confirmation prompt status and you will be given the choice to change it.

**Phone and Network Status Indicators**

If available on the radio and/or on a premium display such as the instrument panel cluster, and supported by your cellular phone, the Uconnect™ Phone will provide notification to inform you of your phone and network status when you are attempting to make a phone call using Uconnect™ Phone. The status is given for roaming, network signal strength, phone battery strength, etc.

### Dialing Using the Cellular Phone Keypad

You can dial a phone number with your cellular phone keypad and still use the Uconnect™ Phone (while dialing via the cellular phone keypad, the user must exercise caution and take precautionary safety measures). By dialing a number with your paired Bluetooth® cellular phone, the audio will be played through your vehicle's audio system. The Uconnect™ Phone will work the same as if you dial the number using Voice Command.

**NOTE:** Certain brands of cellular phones do not send the dial ring to the Uconnect™ Phone to play it on the vehicle audio system, so you will not hear it. Under this situation, after successfully dialing a number the user may feel that the call did not go through even though the call is in progress. Once your call is answered, you will hear the audio.

### Mute/Un-Mute (Mute OFF)

When you mute the Uconnect™ Phone, you will still be able to hear the conversation coming from the other party, but the other party will not be able to hear you. In order to mute the Uconnect™ Phone:

- Press the  button.
- Following the beep, say "Mute."

In order to un-mute the Uconnect™ Phone:

- Press the  button.
- Following the beep, say "Mute off."

### Advanced Phone Connectivity

#### Transfer Call to and from Cellular Phone

The Uconnect™ Phone allows ongoing calls to be transferred from your cellular phone to the Uconnect™ Phone without terminating the call. To transfer an ongoing call

from your Uconnect™ Phone paired cellular phone to the Uconnect™ Phone or vice versa, press the  button and say "Transfer Call."

### Connect or Disconnect Link Between the Uconnect™ Phone and Cellular Phone

Your cellular phone can be paired with many different electronic devices, but can only be actively "connected" with one electronic device at a time.

If you would like to connect or disconnect the Bluetooth® connection between a Uconnect™ Phone paired cellular phone and the Uconnect™ Phone, follow the instructions described in your cellular phone User's Manual.



### List Paired Cellular Phone Names

- Press the  button to begin.
- After the "Ready" prompt and the following beep, say "Setup Phone Pairing."

- When prompted, say "List Phones."
- The Uconnect™ Phone will play the phone names of all paired cellular phones in order from the highest to the lowest priority. To "select" or "delete" a paired phone being announced, press the  button and say "Select" or "Delete." Also, see the next two sections for an alternate way to "select" or "delete" a paired phone.



### Select Another Cellular Phone

This feature allows you to select and start using another phone paired with the Uconnect™ Phone.

- Press the  button to begin.
- After the "Ready" prompt and the following beep, say "Setup Select Phone" and follow the prompts.
- You can also press the  button at any time while the list is being played, and then choose the phone that you wish to select.

- The selected phone will be used for the next phone call. If the selected phone is not available, the Uconnect™ Phone will return to using the highest priority phone present in or near (approximately within 30 ft (9 m)) the vehicle.

### Delete Uconnect™ Phone Paired Cellular Phones

- Press the  button to begin.
- After the "Ready" prompt and the following beep, say "Setup Phone Pairing."
- At the next prompt, say "Delete" and follow the prompts.
- You can also press the  button at any time while the list is being played, and then choose the phone you wish to delete.

### Things You Should Know About Your Uconnect™ Phone



#### Uconnect™ Phone Tutorial

To hear a brief tutorial of the system features, press the  button and say "Uconnect™ Tutorial."

#### Voice Training

For users experiencing difficulty with the system recognizing their voice commands or numbers, the Uconnect™ Phone Voice Training feature may be used. To enter this training mode, follow one of the two following procedures:

From outside the Uconnect™ Phone mode (e.g., from radio mode):

- Press and hold the  button for five seconds until the session begins, or,
- Press the  button and say the "Setup, Voice Training" command.

Repeat the words and phrases when prompted by the Uconnect™ Phone. For best results, the Voice Training session should be completed when the vehicle is parked with the engine running, all windows closed, and the blower fan switched off.

This procedure may be repeated with a new user. The system will adapt to the last trained voice only.

To restore the Voice Command system to factory default settings, enter the Voice Training session via the above procedure and follow the prompts.

### **Voice Command**

- For best performance, adjust the rearview mirror to provide at least ½ in (1 cm) gap between the overhead console (if equipped) and the mirror.
- Always wait for the beep before speaking.
- Speak normally, without pausing, just as you would speak to a person sitting a few feet/meters away from you.
- Make sure that no one other than you is speaking during a Voice Command period.
- Performance is maximized under:
  - low-to-medium blower setting,
  - low-to-medium vehicle speed,
  - low road noise,
  - smooth road surface,
  - fully closed windows,
  - dry weather condition.
- Even though the system is designed for users speaking in North American English, French, and Spanish accents, the system may not always work for some.

- When navigating through an automated system such as voice mail, or when sending a page, at the end of speaking the digit string, make sure to say "Send."
- Storing names in the phonebook when the vehicle is not in motion is recommended.
- It is not recommended to store similar sounding names in the Uconnect™ Phonebook.
- Phonebook (Downloaded and Uconnect™ Phone Local) name recognition rate is optimized when the entries are not similar.
- Numbers must be spoken in single digits. "800" must be spoken "eight-zero-zero" not "eight hundred".
- You can say "O" (letter "O") for "0" (zero).
- Even though international dialing for most number combinations is supported, some shortcut dialing number combinations may not be supported.
- In a convertible vehicle, system performance may be compromised with the convertible top down.

### Phone Far End Audio Performance

- Audio quality is maximized under:
  - low-to-medium blower setting,
  - low-to-medium vehicle speed,
  - low road noise,
  - smooth road surface,
  - fully closed windows,
  - dry weather conditions, and
  - operation from the driver's seat.

- Performance, such as audio clarity, echo, and loudness to a large degree rely on the phone and network, and not the Uconnect™ Phone.
- Echo at the phone far end can sometimes be reduced by lowering the in-vehicle audio volume.
- In a convertible vehicle, system performance may be compromised with the convertible top down.

### **Bluetooth® Communication Link**

Cellular phones have been found to lose connection to the Uconnect™ Phone. When this happens, the connection can generally be reestablished by switching the phone off/on. Your cellular phone is recommended to remain in Bluetooth® ON mode.

### **Power-Up**

After switching the ignition key from OFF to either the ON or ACC position, or after a language change, you must wait at least five seconds prior to using the system.

**Voice Tree**

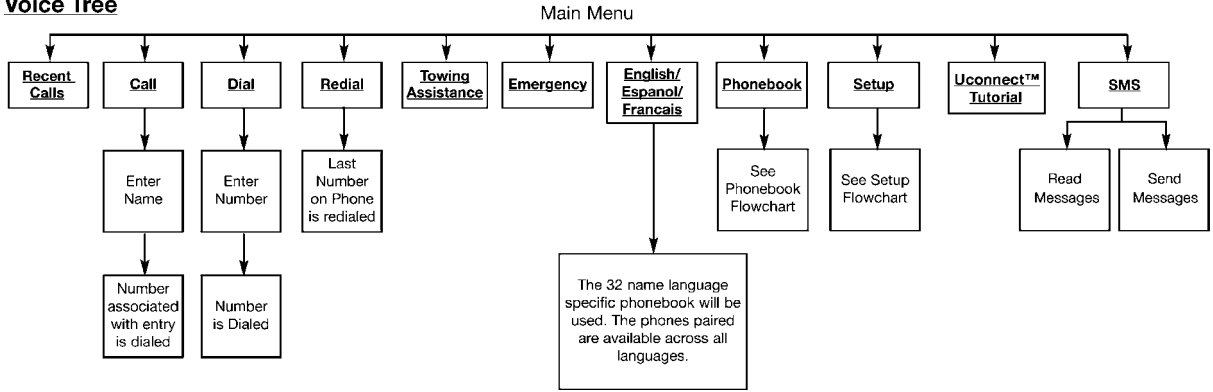

**Note:** Available Voice commands are shown in bold face and are underlined.

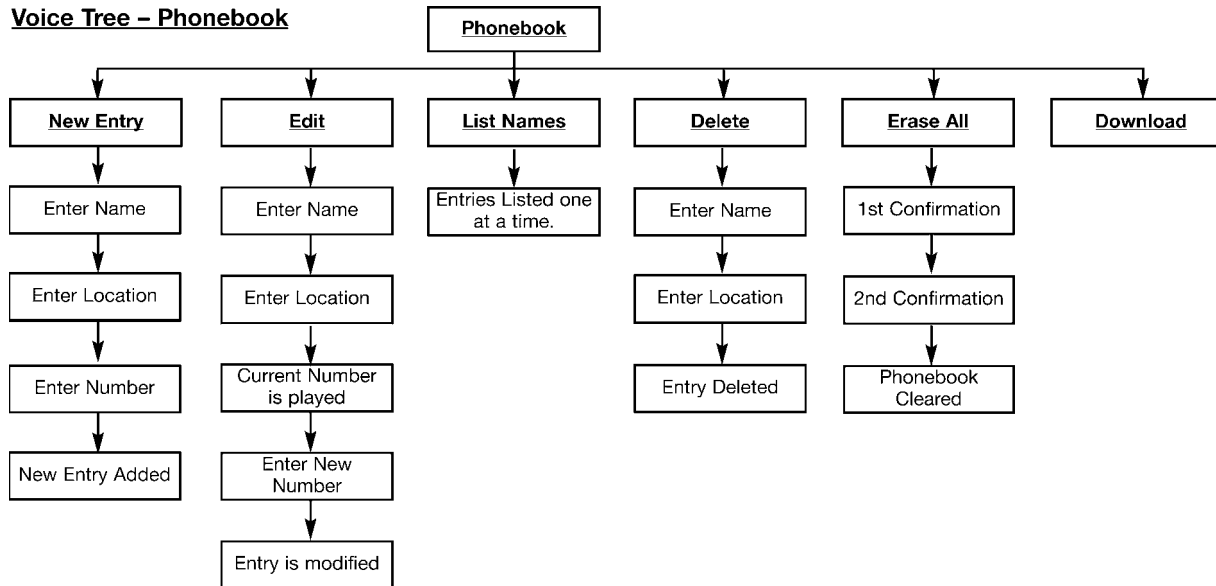

**Voice Tree – Phonebook**

**Note:** Available Voice commands are shown in bold face and are underlined.

**Voice Tree – Setup**

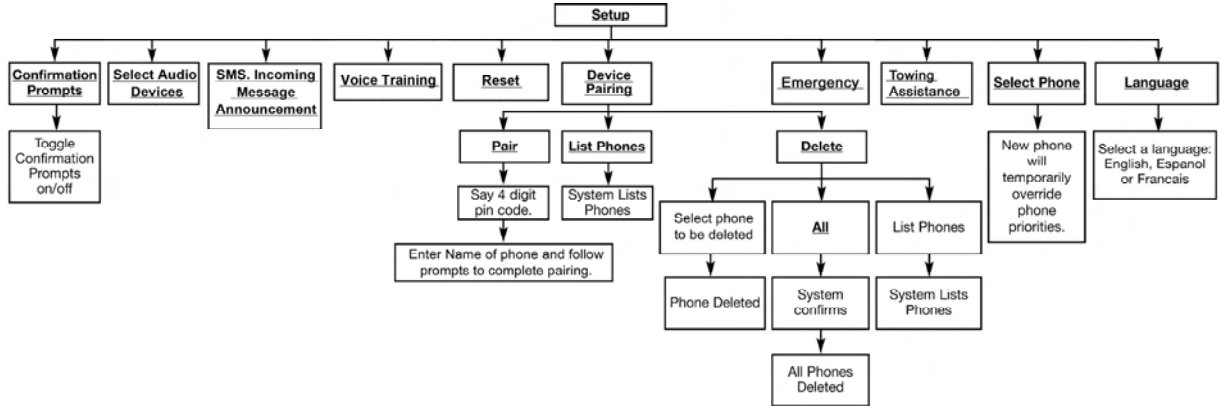

**Note:** Available Voice commands are shown in bold face and are underlined.

030605540

Voice Commands	
Primary	Alternate(s)
zero	
one	
two	
three	
four	
five	
six	
seven	
eight	
nine	
star (*)	
plus (+)	
pound (#)	
add location	
all	

Voice Commands	
Primary	Alternate(s)
call	
cancel	
confirmation prompts	
continue	
delete	
dial	
download	
edit	
emergency	
English	
erase all	
Espanol	
Francais	
help	
home	

Voice Commands	
Primary	Alternate(s)
language	
list names	
list phones	
mobile	
mute	
mute off	
new entry	
no	
pager	
pair a phone	
phone pairing	pairing
phonebook	phone book
previous	
record again	
redial	

Voice Commands	
Primary	Alternate(s)
return to main menu	return or main menu
select phone	select
send	
set up	phone settings or phone set up
towing assistance	
transfer call	
Uconnect™ Tutorial	
try again	
voice training	
work	
yes	

### General Information

This device complies with Part 15 of the FCC rules and RSS 210 of Industry Canada. Operation is subject to the following conditions:

- Changes or modifications not expressly approved by the party responsible for compliance could void the user's authority to operate the equipment.
- This device may not cause harmful interference.
- This device must accept any interference received, including interference that may cause undesired operation.

### VOICE COMMAND — IF EQUIPPED

#### Voice Command System Operation

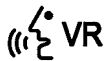

This Voice Command system allows you to control your AM, FM radio, satellite radio, disc player, and a memo recorder.

**NOTE:** Take care to speak into the Voice Interface System as calmly and normally as possible. The ability of the Voice Interface System to recognize user voice commands may be negatively affected by rapid speaking or a raised voice level.

### WARNING!

**Any voice commanded system should be used only in safe driving conditions following local laws and phone use. All attention should be kept on the roadway ahead. Failure to do so may result in an accident causing serious injury or death.**

When you press the Voice Command  button, you will hear a beep. The beep is your signal to give a command.

**NOTE:** If you do not say a command within a few seconds, the system will present you with a list of options.

If you ever wish to interrupt the system while it lists options, press the Voice Command  button, listen for the beep, and say your command.

Pressing the Voice Command  button while the system is speaking is known as “barging in.” The system will be interrupted, and after the beep, you can add or change commands. This will become helpful once you start to learn the options.

**NOTE:** At any time, you can say the words “Cancel”, “Help” or “Main Menu”.

These commands are universal and can be used from any menu. All other commands can be used depending upon the active application.

For example, if you are in the disc menu and you are listening to FM radio, you can speak commands from the disc menu or from the FM radio menu.

When using this system, you should speak clearly and at a normal speaking volume.

The system will best recognize your speech if the windows are closed, and the heater/air conditioning fan is set to low.

At any point, if the system does not recognize one of your commands, you will be prompted to repeat it.

To hear the first available Menu, press the Voice Command  button and say “Help” or “Main Menu”.

## Commands

The Voice Command system understands two types of commands. Universal commands are available at all times. Local commands are available if the supported radio mode is active.

## Changing the Volume

1. Start a dialogue by pressing the Voice Command  button.
2. Say a command (e.g., “Help”).
3. Use the ON/OFF VOLUME rotary knob to adjust the volume to a comfortable level while the Voice Command system is speaking. Please note the volume setting for Voice Command is different than the audio system.

## Main Menu

Start a dialogue by pressing the Voice Command  button. You may say “Main Menu” to switch to the main menu.

In this mode, you can say the following commands:

- “Radio” (to switch to the radio mode)
- “Disc” (to switch to the disc mode)
- “Memo” (to switch to the memo recorder)
- “System Setup” (to switch to system setup)

## Radio AM (or Radio Long Wave or Radio Medium Wave — If Equipped)

To switch to the AM band, say “AM” or “Radio AM”. In this mode, you may say the following commands:

- “Frequency” (to change the frequency)
- “Next Station” (to select the next station)
- “Previous Station” (to select the previous station)
- “Radio Menu” (to switch to the radio menu)
- “Main Menu” (to switch to the main menu)

### Radio FM

To switch to the FM band, say “FM” or “Radio FM”. In this mode, you may say the following commands:

- “Frequency” (to change the frequency)
- “Next Station” (to select the next station)
- “Previous Station” (to select the previous station)
- “Radio Menu” (to switch to the radio menu)
- “Main Menu” (to switch to the main menu)

### Satellite Radio

To switch to satellite radio mode, say “Sat” or “Satellite Radio”. In this mode, you may say the following commands:

- “Channel Number” (to change the channel by its spoken number)
- “Next Channel” (to select the next channel)

- “Previous Channel” (to select the previous channel)
- “List Channel” (to hear a list of available channels)
- “Select Name” (to say the name of a channel)
- “Radio Menu” (to switch to the radio menu)
- “Main Menu” (to switch to the main menu)

### Disc



To switch to the disc mode, say “Disc”. In this mode, you may say the following commands:

- “Track” (#) (to change the track)
- “Next Track” (to play the next track)
- “Previous Track” (to play the previous track)
- “Main Menu” (to switch to the main menu)



## Memo

To switch to the voice recorder mode, say “Memo”. In this mode, you may say the following commands:

- “New Memo” (to record a new memo) — During the recording, you may press the Voice Command  button to stop recording. You proceed by saying one of the following commands:
  - “Save” (to save the memo)
  - “Continue” (to continue recording)
  - “Delete” (to delete the recording)
- “Play Memos” (to play previously recorded memos) — During the playback you may press the Voice Command  button to stop playing memos. You proceed by saying one of the following commands:
  - “Repeat” (to repeat a memo)
  - “Next” (to play the next memo)

- “Previous” (to play the previous memo)
- “Delete” (to delete a memo)
- “Delete All” (to delete all memos)

## System Setup

To switch to system setup, say “Setup”. In this mode, you may say the following commands:

- “Language German”
- “Language Dutch”
- “Language Italian”
- “Language English”
- “Language French”
- “Language Spanish”
- “Tutorial”
- “Voice Training”

**NOTE:** Keep in mind that you have to press the Voice Command  button first and wait for the beep before speaking the “Barge In” commands.

### Voice Training

For users experiencing difficulty with the system recognizing their voice commands or numbers the Uconnect™ Voice “Voice Training” feature may be used.

1. Press the Voice Command  button, say “System Setup” and once you are in that menu then say “Voice Training.” This will train your own voice to the system and will improve recognition.

2. Repeat the words and phrases when prompted by Uconnect™ Voice. For best results, the “Voice Training” session should be completed when the vehicle is parked, engine running, all windows closed, and the blower fan switched off. This procedure may be repeated with a new user. The system will adapt to the last trained voice only.

### SEATS

Seats are a primary part of the Occupant Restraint System of the vehicle. Proper use of the seats is needed for safe operation of the vehicle.

#### WARNING!

- It is extremely dangerous to ride in a cargo area, inside or outside of a vehicle. In a collision, people riding in these areas are more likely to be seriously injured or killed.
- Do not allow people to ride in any area of your vehicle that is not equipped with seats and seat belts.
- Be sure everyone in your vehicle is in a seat and using a seat belt properly.

**Manual Seat Adjuster — If Equipped**

Both front seats are independently adjustable forward or rearward and are equipped with a seatback recliner. The manual forward or rearward seat adjustment handle is found under the seat cushion at the front edge of each seat. Pull up on the handle and slide the seat forward or backward to move the seat into the most comfortable position, then release the handle to lock the seat into position. Using body pressure, move forward and rearward on the seat to be sure that the seat adjusters have latched.

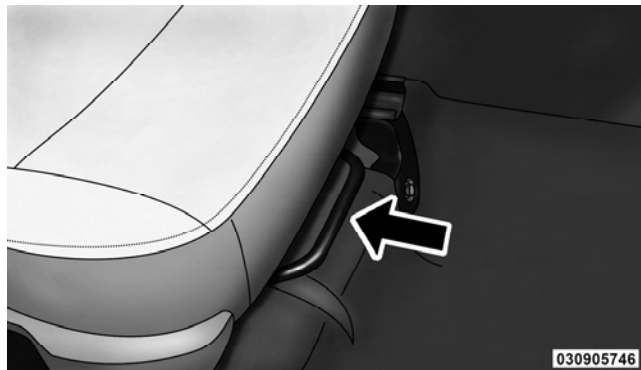

Manual Seat Adjuster

**WARNING!**

Adjusting a seat while the vehicle is moving is dangerous. The sudden movement of the seat could cause you to lose control. The seat belt might not be properly adjusted and you could be injured. Adjust any seat only while the vehicle is parked.

**Manual Reclining Seats — If Equipped**

The recliner handle is located on the outside of the seat cushion and is used to adjust the seatback position. To adjust the seatback, lift upward on the handle, lean back on the seatback and release the handle at the desired position. To return the seatback, lift upward on the handle, lean forward and release the handle at the desired position.

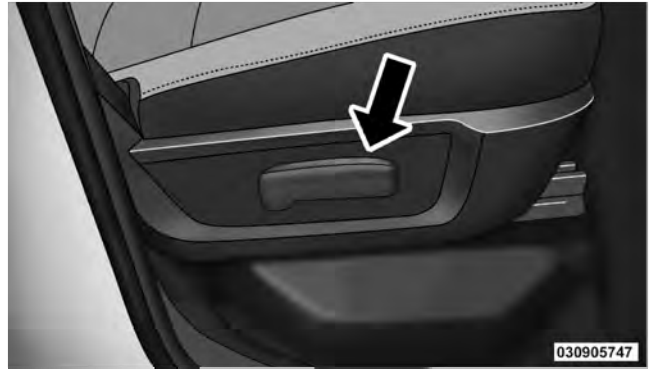
**Recline Handle**

**WARNING!**

- Actuating the recliner handle will allow the seatback to swing (dump) forward on manual recliner seats. Do not stand or lean in front of the seat while actuating the handle. The seatback may swing forward and hit you causing injury. This dump feature allows access to the storage bin behind the seat. To avoid injury, place your hand on the seatback and actuate the handle then position the seatback in the desired position.

*(Continued)*

**WARNING! (Continued)**

- You can be seriously, even fatally, injured riding in a seat with the seatback reclined. Do not ride with the seatback reclined so that the shoulder belt is no longer resting against your chest. If you ride in this position, the shoulder harness will no longer be restraining you. In a collision you could slide under the seat belt and receive serious or fatal injuries. Recline in a seat only when the vehicle is parked.

**Adjustable Head Restraints**

Head restraints can reduce the risk of injury in the event of a rear impact. The head restraint should be adjusted so the top of the head restraint is located above the top of your ear.

To raise the head restraint, pull upward on the head restraint. To lower the head restraint, press the large button, located on the base of the head restraint, and push downward on the head restraint.

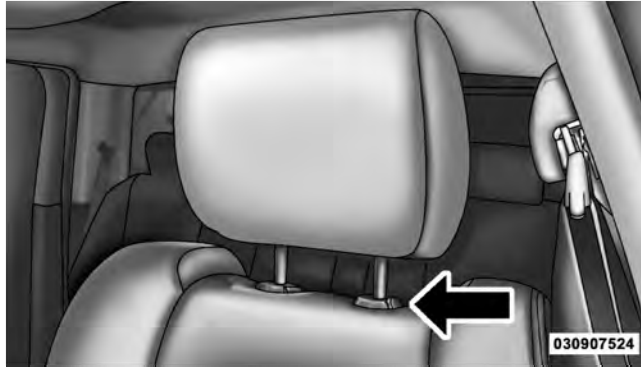

**Adjusting Head Restraint**

To remove the head restraint, pull upward on the head restraint to its highest position, push in both buttons at the base of each head restraint rod, and simultaneously pull up on the head restraint.

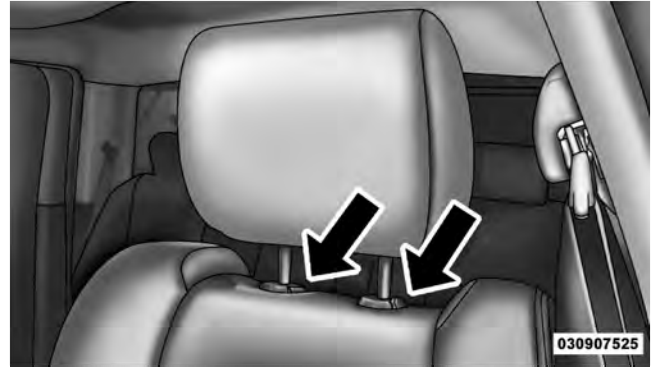

**Removing Head Restraint**

To install the head restraint, insert the head restraint rods into each guide, apply pressure down on the headrest

until the head restraint reaches the first lock position, push the large button in and push down and adjust head restraint to desired position.

**NOTE:** Ensure that the front of the head restraint is facing toward the front of the vehicle.

### WARNING!

Driving a vehicle with the head restraints removed or improperly adjusted could cause serious injury or death in the event of a collision. The head restraints should always be checked prior to operating the vehicle and never adjusted while the vehicle is in motion. Always adjust the head restraints when the vehicle is in PARK.

### Rear Head Restraints

The outboard head restraints can be adjusted. To raise the head restraint, pull upward on the head restraint. To

lower the head restraint, press the large button, located on the base of the head restraint, and push downward on the head restraint.



### Adjustable Rear Head Restraints

**NOTE:** The rear center head restraint (Crew Cab only) is fixed and cannot be adjusted.

### Eight-Way Power Seats — If Equipped

The power seat controls are on the outboard side of the front seat cushions. The power seat switch can be moved forward and backward as well as up and down to control the position of the seat. The power seatback switch is used to adjust the angle of the seatback to position yourself in the most comfortable driving position. Push forward or rearward on the switch and the seatback will move in either direction.

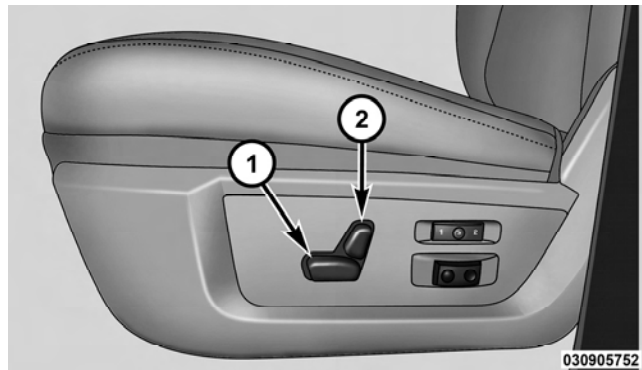

**Power Seat Switches**

- 1 — Power Seat Switch
- 2 — Power Seatback Switch



**WARNING!**

Adjusting a seat while the vehicle is moving is dangerous. The sudden movement of the seat could cause you to lose control. The seat belt might not be properly adjusted and you could be injured. Adjust any seat only while the vehicle is parked.

**CAUTION!**

DO NOT place any article under a power seat or impede its ability to move as it may cause damage to the seat controls. Seat travel may become limited if movement is stopped by an obstruction in the seat's path.

**Power Lumbar — If Equipped**

The lumbar controls are located on the outboard side of the seat cushion. The lumbar support can be increased by pressing the front of the switch and decreased by pressing the back of the switch.

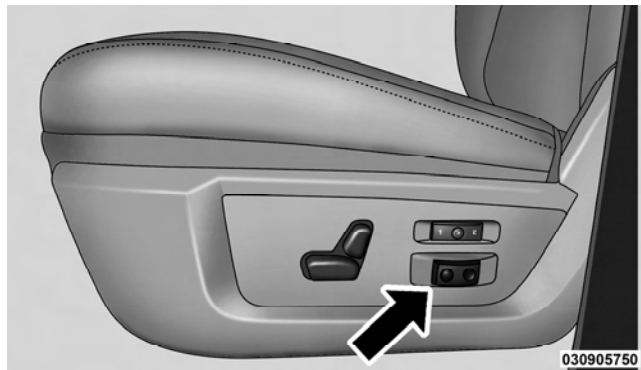

Lumbar Control Switch

**WARNING!**

Adjusting a seat while the vehicle is moving is dangerous. The sudden movement of the seat could cause you to lose control. The seat belt might not be properly adjusted and you could be injured. Adjust any seat only while the vehicle is parked.

**Heated Seats — If Equipped**

Both front seats and rear passenger outboard seats can be equipped with heaters. The switches for the front seats are located in the instrument panel under the climate controls. The switches for the rear passenger seats are located on the back of the center console.

After turning the ignition ON, you can choose from High, Low, or Off heat settings. Amber indicator lights in each switch indicate the level of heat in use. Two indicator lights will illuminate for High, one for Low, and none for Off.



030905580

Press the switch once to select High-level heating. Press the switch a second time to select Low-level heating. Press the switch a third time to shut the heating elements Off.

**NOTE:** The engine must be running for the heated seats to operate.

The heated seats switch from High to Low and from Low to Off automatically, based on time and temperature of the seat. The heated seats can operate on High heat for as little as 4 minutes and up to 30 minutes before switching to Low heat. Once a seat has switched to the Low heat setting it may operate for an additional 60 minutes before automatically shutting Off. The heated seats can shut Off early or may not turn on when the seat is already warm.

**NOTE:** The driver's heated seat can be programmed to come on during a remote start. Refer to "Remote Starting System — If Equipped" in "Things to Know Before Starting Your Vehicle" for further information.

**WARNING!**

- Persons who are unable to feel pain to the skin because of advanced age, chronic illness, diabetes, spinal cord injury, medication, alcohol use, exhaustion or other physical condition must exercise care when using the seat heater. It may cause burns even at low temperatures, especially if used for long periods of time.

*(Continued)*

**WARNING! (Continued)**

- Do not place anything on the seat that insulates against heat, such as a blanket or cushion. This may cause the seat heater to overheat. Sitting in a seat that has been overheated could cause serious burns due to the increased surface temperature of the seat.

**CAUTION!**

Repeated overheating of the seat could damage the heating element and/or degrade the material of the seat.

### Ventilated Seats — If Equipped

Located in the seat cushion and seatback are small fans that draw the air from around the occupant and exhaust it underneath the seat and into the passenger compartment. The fans draw this air across the surface of the seat using air ducts and fine perforations in the covering to help keep the driver cooler in higher ambient temperatures.

The ventilated seat switches are located in the switch bank in the center stack of the instrument panel, just below the climate controls. The fans operate at two speeds, High and Low.



030905581

Press the switch once to choose High, press it a second time to choose Low. Pressing the switch a third time will turn the ventilated seat Off. When High speed is selected both lights on

the switch will be illuminated. When Low speed is selected one light will be illuminated.

#### NOTE:

- The engine must be running for the ventilated seats to operate.
- The driver's ventilated seat can be programmed to come on during a remote start. Refer to "Remote Starting System — If Equipped" in "Things to Know Before Starting Your Vehicle" for further information.

### 40-20-40 Front Bench Seat — If Equipped

The seat is divided into three segments. The outboard seat portions are each 40% of the total width of the seat. The back of the center portion (20%) easily folds down to provide an armrest/center storage compartment (if equipped).

**DRIVER MEMORY SEAT — IF EQUIPPED**

The memory seat buttons are located on the outboard side of the driver's seat cushion.

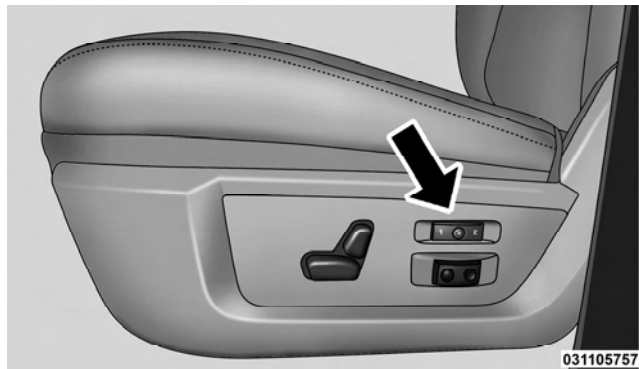

**Memory Seat Buttons**

The memory buttons 1 and 2 can be programmed to recall the driver's seat position, driver's outside mirror position, adjustable brake, accelerator pedals position, Automatic Temperature Control (ATC) temperature setting and radio station preset settings. Your Remote Keyless Entry (RKE) transmitters can also be programmed to recall the same positions when the UNLOCK button is pressed.

**NOTE:** The power lumbar option is not programmable with driver memory seats.

Your vehicle was delivered with two RKE transmitters. One or both RKE transmitters can be linked to either memory position. The memory system can accommodate up to two RKE transmitters, each RKE transmitter linked to either of the two memory positions.

## Setting Memory Positions and Linking RKE Transmitter to Memory

**NOTE:** Each time the S (SET) button and a numbered button (1 or 2) are pressed, you erase the memory settings for that button and store new settings.

1. Turn the vehicle key to the ON/RUN position.
2. Adjust the driver's seat, recliner, and both sideview mirrors to the desired positions.

**NOTE:** Not all motors may be moved at one time. Refer to "Seats/Eight-Way Power Seat" in this section for further information.

3. Adjust the brake and accelerator pedals to the desired positions.
4. Turn on the radio and set the radio station presets (up to 10 AM and 10 FM stations can be set).

5. Adjust the Automatic Temperature Control (ATC) while the ATC is in Auto mode.

6. Press and release the SET button located on the driver's seat.

7. Within five seconds, press and release MEMORY button 1 or 2 on the driver's seat. The next steps must be performed within 10 seconds if you desire to also use a RKE transmitter to recall memory positions.

8. Turn the ignition OFF and remove the key.

9. Press and release the LOCK button on one of the RKE transmitters.

10. Repeat the above steps to set the next memory position using the other numbered memory button or to link another RKE transmitter to memory.

**NOTE:** A chime sound may be heard if Setting Memory was inhibited for any reason.

## Memory Position Recall

### NOTE:

- The vehicle must be in PARK to recall memory positions.
- Not all motors may be moved at one time. Refer to the “Seats/Eight-Way Power Seat” in this section for further information.

To recall the memory settings for driver one, press MEMORY button number 1 on the driver’s seat or the UNLOCK button on the RKE transmitter linked to memory position 1.

To recall the memory setting for driver two, press MEMORY button number 2 on the driver’s seat or the UNLOCK button on the RKE transmitter linked to memory position 2.

A recall can be cancelled by pressing any of the MEMORY buttons on the driver’s seat during a recall (S,

1, or 2), or pressing any one of the power seat buttons, pressing the adjustable pedals button, or pressing either the LOCK or UNLOCK button on the RKE transmitter when not in the ignition switch. When a recall is cancelled, the driver’s seat and the pedals stop moving. A delay of one second will occur before another recall can be selected.

**NOTE:** A chime sound may be heard if setting memory was inhibited for any reason.

### To Disable a RKE Transmitter Linked to Memory

1. Turn the ignition switch to the OFF position and remove the key.
2. Press and release the memory SET button located on the driver’s seat.
3. Within 10 seconds, press and release the UNLOCK button on the RKE transmitter.

To disable another RKE transmitter linked to either memory position, repeat Steps 1-3 for each RKE transmitter.

**NOTE:** The capability to link RKE transmitters to memory is enabled when delivered from the factory. The capability to link RKE transmitters to memory can be disabled (or later re-enabled) by an authorized dealer. For vehicles equipped with the Electronic vehicle Information Center (EVIC), refer to “Electronic Vehicle Information Center (EVIC)/Customer-Programmable Features” in “Understanding Your Instrument Panel” for further information.

### **Self-Limiting Control**

The memory system includes a self-limiting control for full travel positioning of power seat and adjustable pedal movement (all directions). This self-limiting control may, however, develop an unintended movement limitation if an obstruction is encountered sometime during usage.

One example of such an occurrence may include a box or package obstructing the full rearward movement of the driver’s seat. Once the obstruction is removed, the self-limiting control may store a new maximum position. The self-limiting control may be reset by reaching the new stored position, then press and release MEMORY button 1 or 2. Continued seat travel beyond the new stored position will indicate the self-limiting control has been reset.

### **Driver Easy Exit and Easy Entry Control**

This additional feature provides automatic driver’s seat positioning which will enhance driver mobility into and out of the vehicle. The seat cushion will move rearward approximately 2.5 in (60 mm) when the key is removed from the ignition switch. The seat will move forward approximately 2.5 in (60 mm) when the key is placed into the ignition and turned out of the LOCK position. Each stored memory setting will have an associated Easy Exit and Easy Entry position. The Easy Exit and Easy Entry



feature may be automatically disabled if the seat is positioned rearward enough and there is no benefit in moving the seat any farther rearward.

**NOTE:** The Easy Entry/Easy Exit feature can be enabled or disabled through the programmable features in the Electronic Vehicle Information Center (EVIC). Refer to “Electronic Vehicle Information Center (EVIC)/Customer-Programmable Features” in “Understanding Your Instrument Panel” for further information.

### TO OPEN AND CLOSE THE HOOD

To open the hood, two latches must be released.

1. Pull the hood release lever located below the steering wheel at the base of the instrument panel.

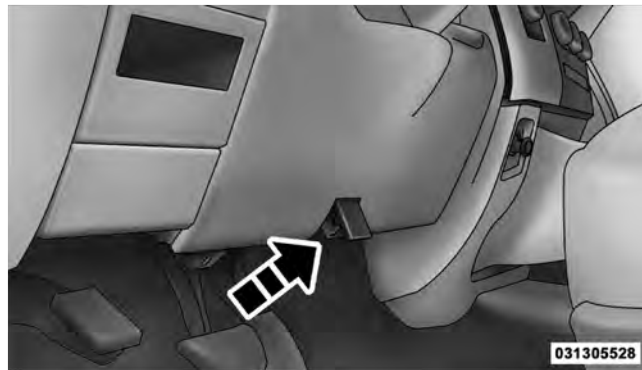

Hood Release

2. Reach into the opening beneath the center of the hood and push the safety latch lever from right to left to release it, before raising the hood.



031305529

Safety Latch (1500 Series Shown)

### CAUTION!

To prevent possible damage, do not slam the hood to close it. Use a firm downward push at the front center of the hood to ensure that both latches engage.

### WARNING!

Be sure the hood is fully latched before driving your vehicle. If the hood is not fully latched, it could open when the vehicle is in motion and block your vision. Failure to follow this warning could result in serious injury or death.

## LIGHTS

The headlight switch is located on the left side of the instrument panel, next to the steering wheel. The headlight switch controls the operation of the headlights, parking lights, instrument panel lights, cargo lights and fog lights (if equipped).

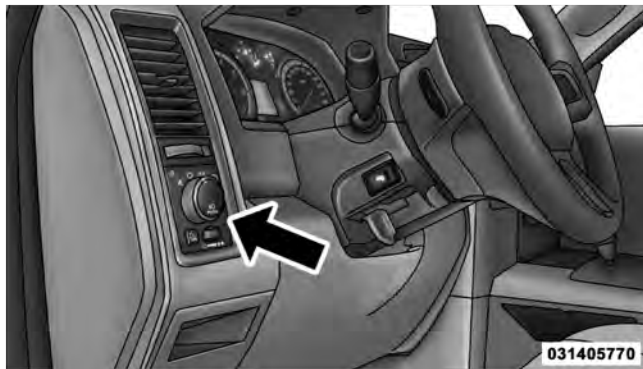

Headlight Switch Location

Your vehicle is equipped with plastic headlight and fog light (if equipped) lenses that are lighter and less susceptible to stone breakage than glass lights. Plastic is not as scratch resistant as glass and therefore different lens cleaning procedures must be followed.

To minimize the possibility of scratching the lenses and reducing light output, avoid wiping with a dry cloth. To remove road dirt, wash with a mild soap solution followed by rinsing.

### CAUTION!

Do not use abrasive cleaning components, solvents, steel wool or other abrasive materials to clean the lenses.

## Headlights



To turn on the headlights, rotate the headlight switch clockwise. When the headlight switch is on the parking lights, taillights, license plate light and instrument panel lights are also turned on. To turn off the headlights, rotate the headlight switch back to the O (Off) position.

## Automatic Headlights

This system automatically turns the headlights on or off according to ambient light levels. To turn the system on, rotate the headlight switch to the A (AUTO) position.



031405773

### Automatic Headlight Position

When the system is on, the Headlight Delay feature is also on. This means the headlights will stay on for up to 90 seconds after you turn the ignition switch to the OFF position. To turn the automatic headlights off, turn the headlight switch out of the AUTO position.

**NOTE:** The engine must be running before the headlights will turn on in the Automatic Mode.

### **Headlight Delay**

To aid in your exit, your vehicle is equipped with a headlight delay that will leave the headlights on for approximately 90 seconds. This delay is initiated when the ignition is turned OFF while the headlight switch is on, and then the headlight switch is cycled off. Headlight delay can be cancelled by either turning the headlight switch on then off, or by turning the ignition ON.

The headlight delay time is programmable on vehicles equipped with an Electronic Vehicle Information Center (EVIC). Refer to “Electronic Vehicle Information Center (EVIC)/Customer-Programmable Features (SETUP)” in “Understanding Your Instrument Panel” for further information.

### **Parking Lights and Panel Lights**

 To turn on the parking lights and instrument panel lights, rotate the headlight switch clockwise. To turn off the parking lights, rotate the headlight switch back to the O (Off) position.

### **Fog Lights — If Equipped**

The fog lights are turned on by placing the headlight rotary control in the parking light or headlight position and pushing in the headlight rotary control.



### Fog Light Switch

The fog lights will operate only when the parking lights are on or when the vehicle headlights are on low beam. An indicator light located in the instrument cluster will illuminate when the fog lights are on. The fog lights will

turn off when the switch is pushed a second time, when the headlight switch is rotated to the off position, or the high beam is selected.

### Interior Lights

Courtesy and dome lights are turned on when the front doors are opened, when the dimmer control (rotating wheel on the bottom of the switch) is rotated to the far right detent position, or if equipped, when the UNLOCK button is pressed on the Remote Keyless Entry (RKE) transmitter. When a door is open and the interior lights are on, rotating the dimmer control all the way left, to the OFF detent, will cause all the interior lights to go out. This is also known as the "Party" mode because it allows the doors to stay open for extended periods of time without discharging the vehicle's battery.

The brightness of the instrument panel lighting can be regulated by rotating the dimmer control right (brighter) or left (dimmer). When the headlights are on you can supplement the brightness of the odometer, trip odometer, radio and overhead console by rotating the control to the right until you hear a click. This feature is termed the "Parade" mode and is useful when headlights are required during the day.



Dimmer Control

031405772

## Cargo Light

The cargo lights are turned on by pressing on the cargo button.



031405776

## Cargo Light Switch

The cargo lights will also turn on for approximately 30 seconds when a RKE transmitter UNLOCK button is pressed, as part of the Illuminated Entry feature.

### Lights-on Reminder

If the headlights, parking lights, or cargo lights are left on after the ignition is turned OFF, a chime will sound when the driver's door is opened.

### Battery Saver

To protect the life of your vehicle's battery, load shedding is provided for both the interior and exterior lights.

If the ignition is OFF and any door is left ajar for 10 minutes or the dimmer control is rotated right for 10 minutes, the interior lights will automatically turn off.

If the headlights remain on while the ignition is cycled OFF, the exterior lights will automatically turn off after eight minutes. If the headlights are turned on and left on for eight minutes while the ignition is OFF, the exterior lights will automatically turn off.

**NOTE:** Battery saver mode is cancelled if the ignition is ON.

### Daytime Running Lights — If Equipped

The headlights on your vehicle will illuminate when the engine is started and the transmission is in any gear except PARK. This provides a constant "Lights ON" condition until the ignition is turned OFF. The lights illuminate at less than 50% of normal intensity. If the parking brake is applied, the Daytime Running Lights (DRL) will turn OFF. Also, if a turn signal is activated, the DRL lamp on the same side of the vehicle will turn off for the duration of the turn signal activation. Once the turn signal is no longer active, the DRL lamp will illuminate.

### Multifunction Lever

The multifunction lever is located on the left side of the steering column.



### Turn Signals

Move the multifunction lever up or down and the arrows on each side of the instrument cluster flash to show proper operation of the front and rear turn signal lights.

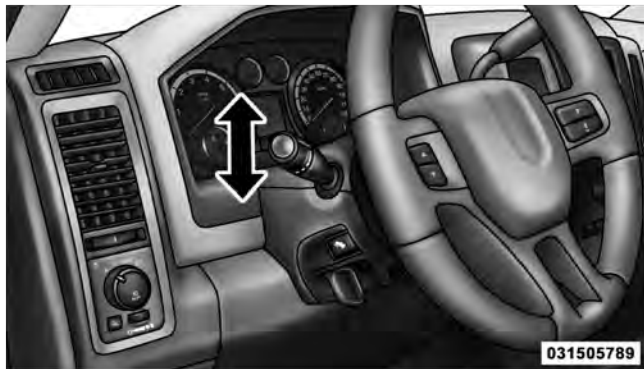

Turn Signal Lever

**NOTE:** If either light remains on and does not flash, or there is a very fast flash rate, check for a defective outside light bulb. If an indicator fails to light when the lever is moved, it would suggest that the indicator bulb is defective.

### Lane Change Assist

Tap the lever up or down once, without moving beyond the detent, and the turn signal (right or left) will flash three times then automatically turn off.

### Flash-To-Pass

You can signal another vehicle with your headlights by partially pulling the multifunction lever toward the steering wheel. This will cause the high beam headlights to turn on until the lever is released.

### High/Low Beam Switch

Push the multifunction lever toward the instrument panel to switch the headlights to high beam. Pulling the multifunction back toward the steering wheel will turn the low beams back on, or shut the high beams off.



High/Low Beam

### WINDSHIELD WIPERS AND WASHERS

#### Windshield Wipers

The wipers and washers are operated by a switch in the multifunction lever. Turn the end of the handle to select the desired wiper speed.



Windshield Wiper/Washer Switch

### **Intermittent Wiper System**

The intermittent feature of this system was designed for use when weather conditions make a single wiping cycle, with a variable pause between cycles, desirable. For maximum delay between cycles, rotate the control knob into the upper end of the delay range.

The delay interval decreases as you rotate the knob until it enters the low continual speed position. The delay can be regulated from a maximum of about 18 seconds between cycles, to a cycle every two seconds. The delay intervals will double in duration when the vehicle speed is 10 mph (16 km/h) or less.

### **Windshield Washers**

To use the windshield washer, push the washer knob, located on the end of the multifunction lever, inward to the second detent. Washer fluid will be sprayed until the washer knob is released from this position. If the washer knob is depressed while in the delay range, the wiper will

operate for several seconds after the washer knob is released. It will then resume the intermittent interval previously selected. If the washer knob is pushed for a period greater than one second while in the off position, the wiper will cycle approximately three times after the wash knob is released.

To prevent freeze-up of your windshield washer system in cold weather, select a solution or mixture that meets or exceeds the temperature range of your climate. This rating information can be found on most washer fluid containers.

**WARNING!**

Sudden loss of visibility through the windshield could lead to an accident. You might not see other vehicles or other obstacles. To avoid sudden icing of the windshield during freezing weather, warm the windshield with the defroster before and during windshield washer use.

**Mist Feature**

Push the washer knob, located on the end of the multi-function lever, inward to the first detent. The wipers will cycle one time and automatically shut off to clear road mist or spray from a passing vehicle.

**TILT STEERING COLUMN**

This feature allows you to tilt the steering column upward or downward. The tilt lever is located on the steering column, below the multifunction lever.

Pull the lever toward the steering wheel to unlock the steering column. With one hand firmly on the steering wheel, move the steering column up or down, as desired. Release the lever to lock the steering column firmly in place.



Tilt Steering Lever

**WARNING!**

Do not adjust the steering column while driving. Adjusting the steering column while driving or driving with the steering column unlocked, could cause the driver to lose control of the vehicle. Be sure the steering column is locked before driving your vehicle. Failure to follow this warning may result in serious injury or death.

**DRIVER ADJUSTABLE PEDALS — IF EQUIPPED**

The power adjustable accelerator and brake pedals allow the driver to establish a comfortable position relative to the steering wheel and pedals.

**Adjustment**

1. Position the driver's seat so that you are at least 10 in (25.4 cm) away from the airbag, located in the center of the steering wheel.

2. Fasten and adjust the seatbelts.

3. Move the adjustable pedal switch, located to the left side of the steering column, in the direction you desire the pedals to move.



**Adjustable Pedals Switch**

**NOTE:** The pedals **cannot** be adjusted when the vehicle is in REVERSE or when the Electronic Speed Control is set.

### CAUTION!

Do not place any article under the adjustable pedals or impede its ability to move as it may cause damage to the pedal controls. Pedal travel may become limited if movement is stopped by an obstruction in the adjustable pedal's path.

### WARNING!

Do not adjust the pedals while the vehicle is moving. You could lose control and have an accident. Always adjust the pedals while the vehicle is parked.

### HEATED STEERING WHEEL — IF EQUIPPED

The steering wheel contains a heating element that helps warm your hands in cold weather. The heated steering wheel has only one temperature setting. Once the heated steering wheel has been turned on it will operate for approximately 58 to 70 minutes before automatically shutting off. The heated steering wheel can shut off early or may not turn on when the steering wheel is already warm.

The heated steering wheel switch is located on the switch bank below the climate controls.



031705825

Press the switch to turn on the heated steering wheel. The light on the switch will illuminate to indicate the steering wheel heater is on. Pressing the switch a second time will turn off the heated steering wheel and light indicator.

**NOTE:**

- The engine must be running for the heated steering wheel to operate.
- The heated steering wheel can be programmed to come on during a remote start. Refer to “Remote Starting System — If Equipped” in Section 4 for further information.

**WARNING!**

- **Persons who are unable to feel pain to the skin because of advanced age, chronic illness, diabetes, spinal cord injury, medication, alcohol use, exhaustion, or other physical conditions must exercise care when using the steering wheel heater. It may cause burns even at low temperatures, especially if used for long periods.**

*(Continued)*

**WARNING! (Continued)**

- **Do not place anything on the steering wheel that insulates against heat, such as a blanket or cushion. This may cause the steering wheel heater to overheat.**

**ELECTRONIC SPEED CONTROL — IF EQUIPPED**

When engaged, Electronic Speed Control takes over the accelerator operation at speeds greater than 25 mph (40 km/h). The Electronic Speed Control lever is located on the right side of the steering wheel.



81bc4c2c

### Electronic Speed Control Lever

**NOTE:** In order to ensure proper operation, the Electronic Speed Control System has been designed to shut down if multiple Speed Control functions are operated

simultaneously. If this occurs, the Electronic Speed Control System can be reactivated by pushing the Electronic Speed Control ON/OFF button and resetting the desired vehicle set speed.

### To Activate

Push the ON/OFF button (located in the end of the lever) once and the cruise indicator light (located in the message window of the cluster) will illuminate showing that the Electronic Speed Control system is on. To turn the Electronic Speed Control system off, push the ON/OFF button a second time and both the Electronic Speed Control system and indicator will turn off.



**WARNING!**

Leaving the Electronic Speed Control system on when not in use is dangerous. You could accidentally set the system or cause it to go faster than you want. You could lose control and have an accident. Always leave the Electronic Speed Control system off when you are not using it.

**To Set a Desired Speed**

When the vehicle has reached the desired speed, press the SET lever downward and then release. Lift your foot off the accelerator and the vehicle will operate at the selected speed.

**Deactivating Electronic Speed Control**

A soft tap on the brake pedal or pulling the Electronic Speed Control lever (CANCEL) toward you will deactivate the Electronic Speed Control without erasing the set

speed memory. Pushing the ON/OFF button to the OFF position or turning OFF the ignition erases the set speed memory.

**To Resume Speed**

To resume a previously set speed, raise the Electronic Speed Control lever (RESUME ACCEL) upwards and release. Resume can be used at any speed above 30 mph (50 km/h).

**Varying The Speed Setting**

When the Electronic Speed Control is set, you can increase speed by pushing up and holding the RESUME ACCEL lever. If the lever is continually held in the RESUME ACCEL position, the set speed will continue to increase until the lever is released, then the new set speed will be established.

Raising the Electronic Speed Control lever RESUME ACCEL upwards once will result in a 1 mph (1 km/h)

speed increase. Each time the lever is tapped upward speed increases, so tapping the lever three times will increase speed by 3 mph (5 km/h), etc.

To decrease speed while the Electronic Speed Control is set, push down and hold the SET DECEL lever. If the lever is continually held in the SET DECEL position, the set speed will continue to decrease until the lever is released. Release the lever when the desired speed is reached, and the new set speed will be established.

Tapping the Electronic Speed Control lever SET DECEL downward once will result in a 1 mph (1 km/h) speed decrease. Each time the lever is tapped downward, speed decreases.

### **To Accelerate for Passing**

Press the accelerator as you would normally. When the pedal is released, the vehicle will return to the set speed.

**NOTE:** The Electronic Speed Control system maintains speed up and down hills. A slight speed change on moderate hills is normal.

Your vehicle may experience a downshift (automatic transmissions only) while climbing uphill or descending downhill. This downshift is necessary to maintain vehicle set speed.

On steep hills a greater speed loss or gain may occur so it may be preferable to drive without Electronic Speed Control.

**WARNING!**

Electronic Speed Control can be dangerous where the system cannot maintain a constant speed. Your vehicle could go too fast for the conditions, and you could lose control. An accident could be the result. Do not use Electronic Speed Control in heavy traffic or on roads that are winding, icy, snow-covered or slippery.

**OVERHEAD CONSOLE — IF EQUIPPED**

The overhead console is located on the headliner above the review mirror. The overhead console contains the following features:

- Courtesy/Reading Lights
- Power Sliding Rear Window Switch — If Equipped



Overhead Console

**Courtesy/Reading Lights**

Both lights in the overhead console and rear passenger compartment will illuminate as courtesy lights when a door is opened, when the dimmer control is rotated to the courtesy light position (full right position), or when the UNLOCK button is pressed on the Remote Keyless Entry

(RKE) transmitter, if equipped. These lights are also operated individually as reading lights by pressing on the corresponding lens.

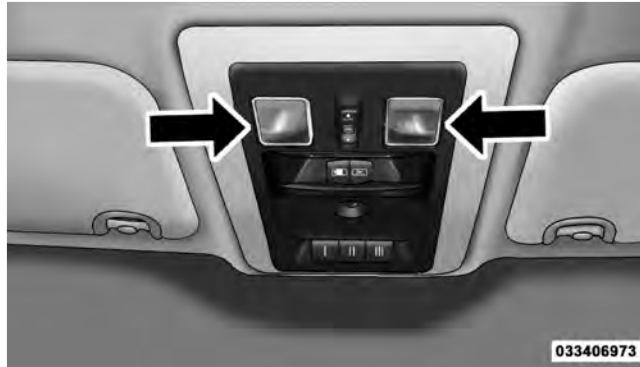

**Front Courtesy/Reading Lights**

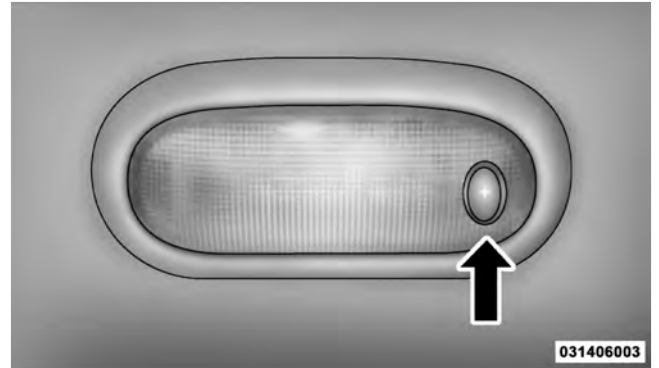

**Rear Passenger Courtesy/Reading Light**

**NOTE:** The courtesy/reading lights will remain on until the switch is pressed a second time, so be sure they have been turned off before leaving the vehicle. If the interior lights are left on after the ignition is turned OFF, they will extinguish after 15 minutes.

## ELECTRICAL POWER OUTLETS

The auxiliary 12 Volt (13 Amp) power outlets can provide power for in-cab accessories designed for use with the standard “cigar lighter” plug. The 12 Volt power outlets have a cap attached to the outlet indicating “12V DC”, together with either a key symbol or a battery symbol.

A key symbol indicates that the key must be in the ON or ACC positions for the outlet to provide power. The battery symbol indicates that the outlet is connected to the battery, and can provide power at all times.

### NOTE:

- To ensure proper operation a MOPAR® knob and element must be used.
- Do not exceed the maximum power of 160 Watts (13 Amps) at 12 Volts. If the 160 Watt (13 Amp) power rating is exceeded the fuse protecting the system will need to be replaced.

The auxiliary power outlets can be found in the following locations:

- Lower left and lower right of the center stack.
- Inside the top storage tray.



Power Outlet — Floor Storage Bin

- Inside the upper lid of the center storage compartment — if equipped.

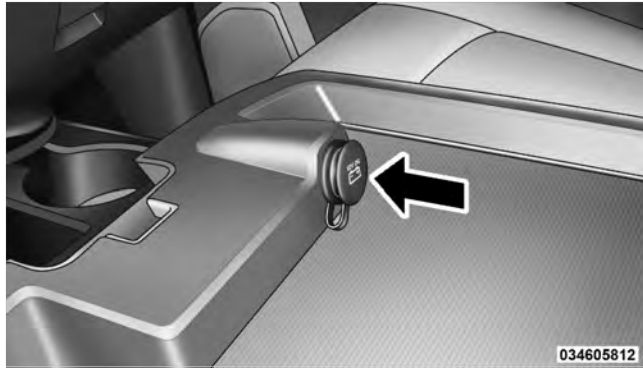

**Power Outlet — Upper Lid**

- Rear of the center console storage compartment — Crew Cab.

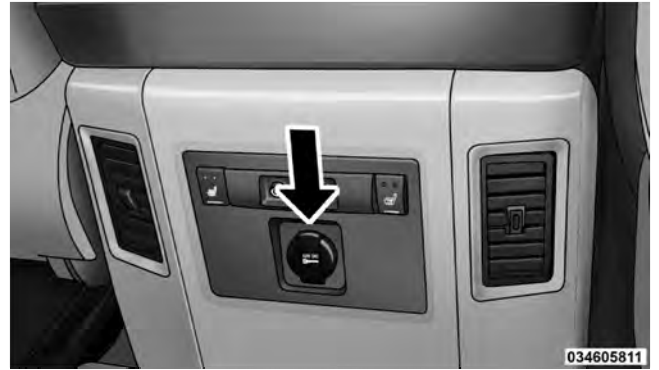

**Power Outlet — Rear Center Console**

The key symbol indicates that this outlet can supply power when the key is in the ON or ACC positions.

All accessories connected to the outlet(s) should be removed or turned off when the vehicle is not in use to protect the battery against discharge.

**WARNING!**

To avoid serious injury or death:

- Only devices designed for use in this type of outlet should be inserted into any 12 Volt outlet.
- Do not touch with wet hands.
- Close the lid when not in use and while driving the vehicle.
- If this outlet is mishandled, it may cause an electric shock and failure.

**CAUTION!**

- Many accessories that can be plugged in draw power from the vehicle's battery, even when not in use (i.e., cellular phones, etc.). Eventually, if plugged in long enough, the vehicle's battery will discharge sufficiently to degrade battery life and/or prevent the engine from starting.
- Accessories that draw higher power (i.e., coolers, vacuum cleaners, lights, etc.), will discharge the battery even more quickly. Only use these intermittently and with greater caution.
- After the use of high power draw accessories, or long periods of the vehicle not being started (with accessories still plugged in), the vehicle must be driven a sufficient length of time to allow the generator to recharge the vehicle's battery.

## CIGAR LIGHTER AND ASH RECEIVER — IF EQUIPPED

A removable ash receiver and cigar lighter are available. For vehicles with a bench seat the cupholder tray can be used to hold the ash receiver.

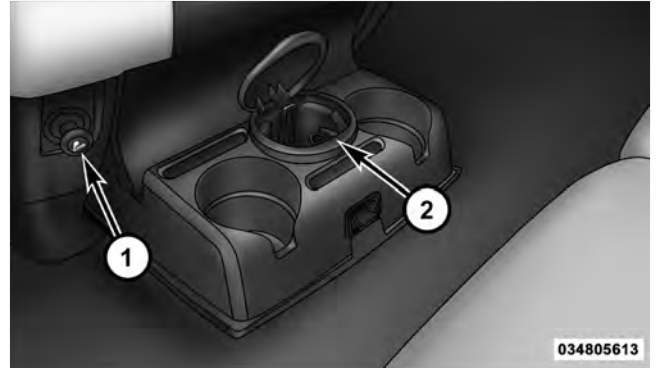

Ash Receiver and Cigar Lighter (Bench Seat)

- 1 — Cigar Lighter
- 2 — Ash Receiver

---

For vehicles equipped with a floor console the cupholders may be used.



**POWER INVERTER — IF EQUIPPED**

A 115 Volt (150 Watts Maximum) outlet is located on the center stack of the instrument panel, to the right of the radio. This outlet can power cellular phones, electronics and other low power devices requiring power up to 150 Watts. Certain high-end video games, such as Playstation3 and XBox360 will exceed this power limit, as will most power tools.

The power inverter is designed with built-in overload protection. If the power rating of 150 Watts is exceeded, the power inverter will automatically shut down. Once the electrical device has been removed from the outlet the inverter should automatically reset. If the power rating exceeds approximately 170 Watts, the power inverter may have to be reset manually. To reset the inverter manually press the power inverter button OFF and ON. To avoid overloading the circuit, check the power ratings on electrical devices prior to using the inverter.



035005840

**Power Inverter Outlet**

The power inverter switch is located on the switch bank below the Climate Controls. To turn on the power outlet, press the switch once. Press the switch a second time to turn the power outlet off.

**NOTE:**

- When the power inverter switch is pressed, there will be a delay of approximately one second before the power inverter status indicator turns on. The status indicator of the AC power inverter indicates whether the inverter is producing AC power.
- Due to built-in overload protection, the power inverter will shut down if the power rating is exceeded.

**WARNING!**

To avoid serious injury or death:

- Do not use a three-prong adapter.
- Do not insert any objects into the receptacles.
- Do not touch with wet hands.
- Close the lid when not in use.
- If this outlet is mishandled it may cause an electric shock and failure.

**CUPHOLDERS****Front Instrument Panel Cupholders — (40–20–40 Seats)**

The cupholders are located in the pull-out tray on the center stack of the instrument panel.

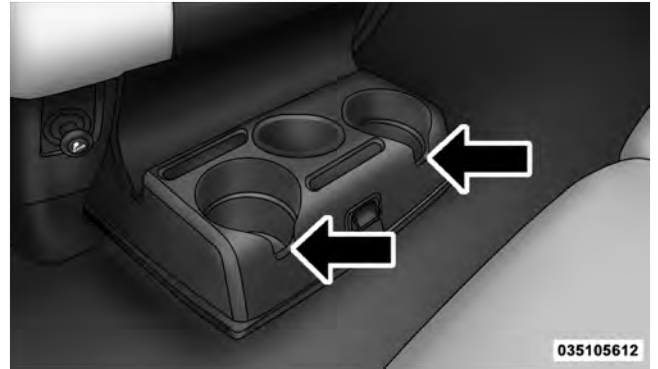

Front Cupholders

### Front Instrument Panel Cupholders — Floor Storage Bin

For vehicles equipped with bucket seats two cupholders are located in the floor storage bin.

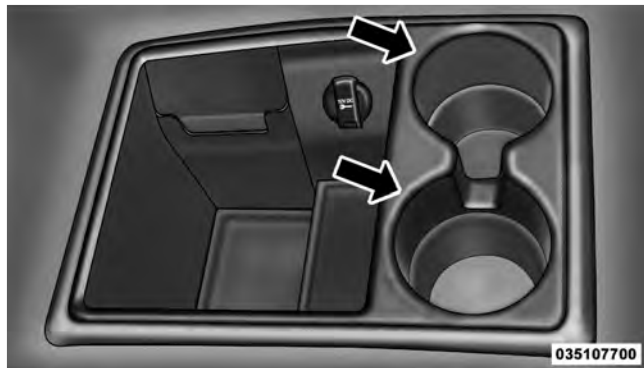

Cupholders

### Rear Cupholder — Crew Cab

Crew Cab vehicles are equipped with rear cupholders located in the center armrest.



Crew Cab Rear Armrest Cupholder

## STORAGE

### Glove Box Storage

The glove box is located on the passenger side of the instrument panel and features both an upper (if equipped) and lower storage area.

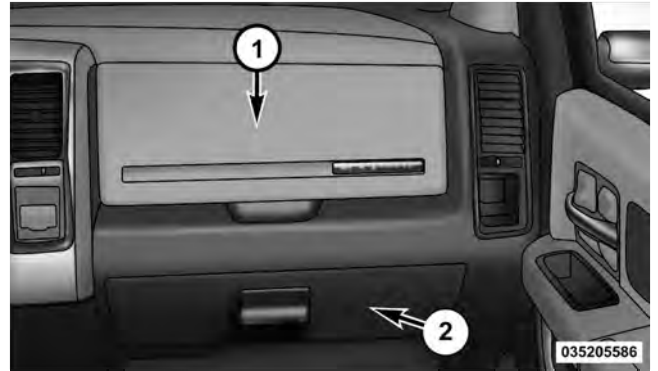

3

### Glove Box

- 1 — Upper Glove Box (If Equipped)
  - 2 — Lower Glove Box
-

## 164 UNDERSTANDING THE FEATURES OF YOUR VEHICLE

To open the upper glove box push upward on the handle release. The glove box door will automatically open.

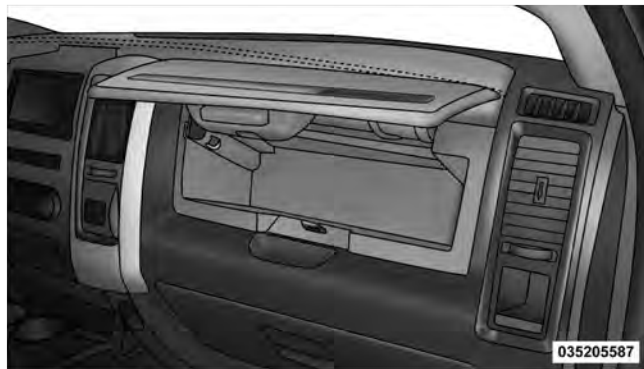

Upper Glove Box

To open the lower glove box, pull on the handle to release the latch and lower the door.



Lower Glove Box

## Door Storage

### Front Door Storage — If Equipped

Storage areas and bottle holders (drivers side only) are located in the door trim panels.

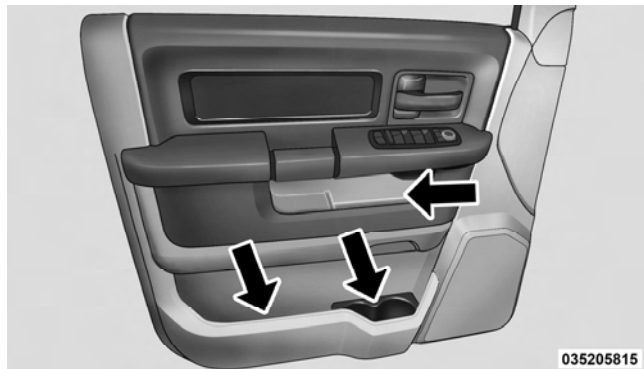

Front Door Storage

### Rear Door Storage — Crew Cab

Storage compartments are located in both the driver and passenger door trim panels.

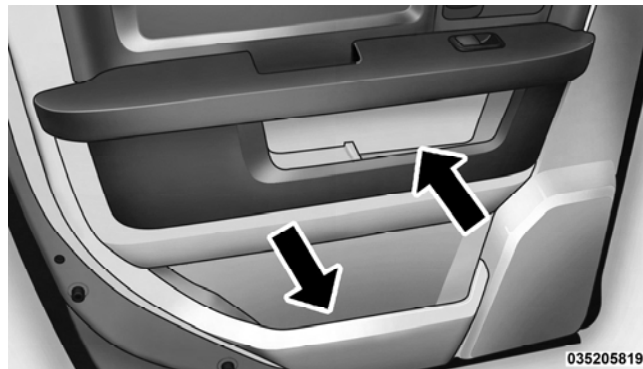

Rear Door Storage

### Center Storage Compartment — If Equipped

The center storage compartment is located between the driver and passenger seats. The storage compartment provides an armrest and contains both an upper and lower storage area.

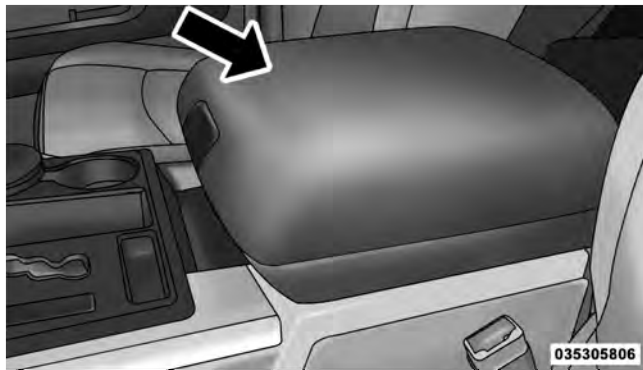

Center Storage Compartment

### WARNING!

- This armrest is not a seat. Anyone seated on the armrest could be seriously injured during vehicle operation, or an accident. Only use the center seating position when the armrest is fully upright.
- In an accident, the latch may open if the total weight of the items stored exceeds about 10 lbs (4.5 kg). These items could be thrown about endangering occupants of the vehicle. Items stored should not exceed a total of 10 lbs (4.5 kg).

Pull on the upper handle on the front of the armrest to raise the cover. The upper storage area contains a 12 Volt power outlet that can be used to power small electrical devices, refer to “Electrical Power Outlets” for further information.



Upper Storage Compartment

With the upper lid closed, pull on the lower handle to open the lower storage bin.

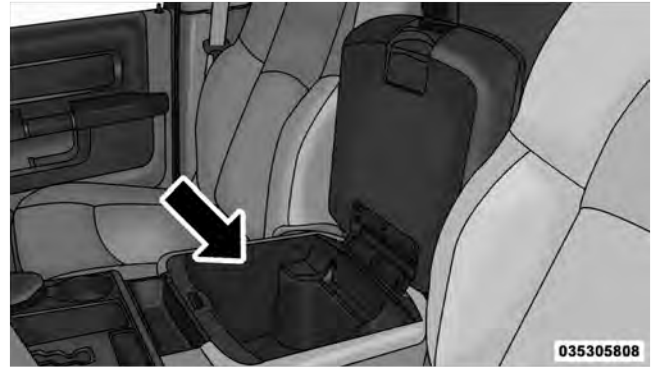

Lower Storage Bin



### Seatback Storage

Located in the back of both the driver and passenger front seats are pockets that can be used for storage.

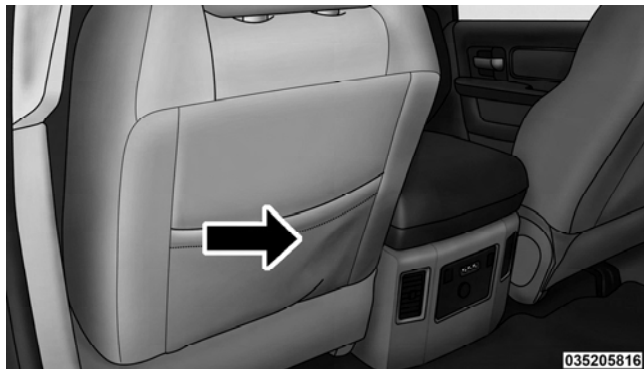

Drivers Side Seatback Storage

### Storage (Regular Cab)

The storage bin is located behind the front seats and runs the length of the cab.



Storage Bin

### Storage and Seats (Crew Cab)

The Crew Cab models provide additional storage under the rear seats. Lift the seats to access the storage compartment.

To open the storage compartments, lift upward on the handle of the latch and open the lid.

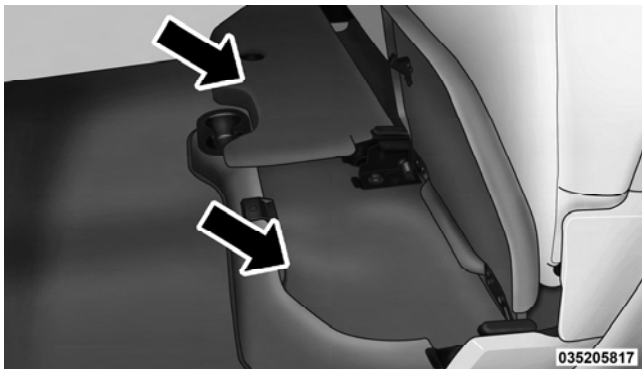

Crew Cab Storage

### CAUTION!

Always lift the storage compartment lids by using the handle. Failure to lift the lids by using the handle can result in damage to the lids.

### Plastic Grocery Bag Retainers (Regular Cab Models)

Retainer hooks which will hold plastic grocery bag handles are built into the back panel of the cab, behind the seats.

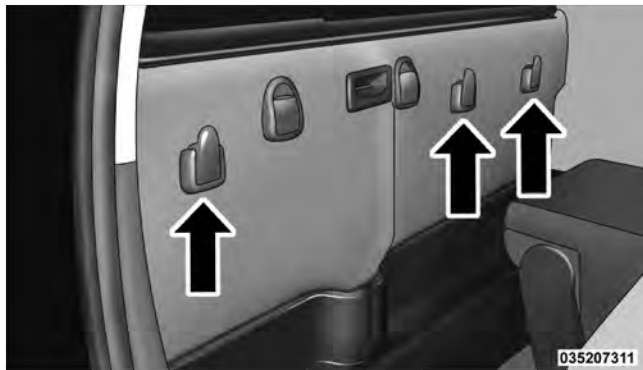

Grocery Bag Hooks

### REAR WINDOW FEATURES

#### Rear Window Defroster



The rear window defroster button is located on the climate control panel. Press this button to turn on the rear window defroster and the heated outside mirrors (if equipped). An indicator in the button will illuminate when the rear window defroster is on. The rear window defroster automatically turns off after approximately 10 minutes. For an additional five minutes of operation, press the button a second time.

**NOTE:** To prevent excessive battery drain, use the rear window defroster only when the engine is operating.

**CAUTION!**

Failure to follow these cautions can cause damage to the heating elements:

- Use care when washing the inside of the rear window. Do not use abrasive window cleaners on the interior surface of the window. Use a soft cloth and a mild washing solution, wiping parallel to the heating elements. Labels can be peeled off after soaking with warm water.
- Do not use scrapers, sharp instruments, or abrasive window cleaners on the interior surface of the window.
- Keep all objects a safe distance from the window.

**Power Sliding Rear Window — If Equipped**

The switch for the power sliding rear window is located on the overhead console. Press the left side of the switch to open the glass and the right side of the switch to close the glass.

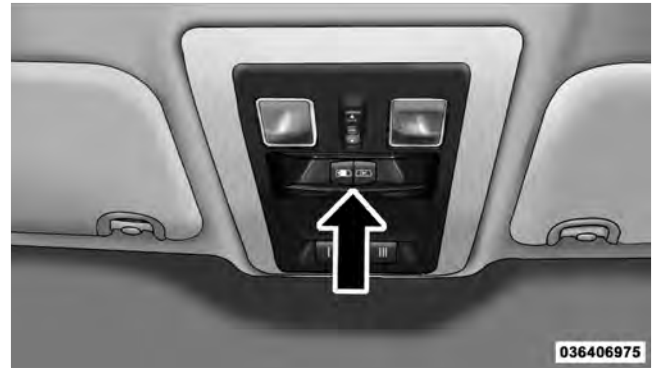
**3**

Rear Window Switch

### **Manual Sliding Rear Window — If Equipped**

A locking device in the center of the window helps to prevent entry from the rear of the vehicle. Squeeze the lock to release the window.

# UNDERSTANDING YOUR INSTRUMENT PANEL

## CONTENTS

---

■ Instrument Panel Features . . . . .	177	□ EVIC Average Fuel Economy . . . . .	201
■ Instrument Cluster — Base . . . . .	178	□ Trip Functions . . . . .	201
■ Instrument Cluster — Premium . . . . .	179	□ Vehicle Info (Customer Information Features) . . . . .	202
■ Instrument Cluster Descriptions . . . . .	180	□ Units . . . . .	202
■ Electronic Vehicle Information Center (EVIC) — If Equipped . . . . .	194	□ Compass / Temperature Display . . . . .	202
□ Electronic Vehicle Information Center (EVIC) Displays . . . . .	196	□ Customer-Programmable Features (System Setup) . . . . .	205
□ Distance To Empty (DTE) . . . . .	200		

- Media Center 730N/430 (RER/RBZ) — AM/FM Stereo Radio And CD/DVD/HDD/NAV — If Equipped . . . . . 210
  - Operating Instructions — Voice Command System — If Equipped . . . . . 211
  - Operating Instructions — Uconnect™ Phone — If Equipped . . . . . 211
  - Clock Setting Procedure — RBZ Radio . . . . . 211
  - Clock Setting Procedure — RER Radio . . . . . 212
- Media Center 130 (RES) — AM/FM Stereo Radio With CD Player (MP3 AUX Jack). . . . . 215
  - Operating Instructions — Radio Mode . . . . . 215
  - Operation Instructions — CD Mode For CD And MP3 Audio Play . . . . . 218
  - Notes On Playing MP3 Files . . . . . 220
  - Operation Instructions - Auxiliary Mode . . . . . 223
- Media Center 130 (RES/RSC) — AM/FM Stereo Radio With CD Player (MP3 AUX Jack) And Sirius Radio . . . . . 224
  - Operating Instructions — Radio Mode . . . . . 224
  - Operation Instructions — CD Mode For CD And MP3 Audio Play . . . . . 230
  - Notes On Playing MP3 Files . . . . . 232
  - List Button (CD Mode For MP3 Play) . . . . . 235
  - Info Button (CD Mode For MP3 Play) . . . . . 235
- Universal Consumer Interface (UCI) — If Equipped . . . . . 236
  - Connecting The iPod® . . . . . 237
  - Using This Feature . . . . . 238

□ Controlling The iPod® Using Radio Buttons . . . . .	238	□ Operating Instructions - Uconnect™ Phone (If Equipped) . . . . .	246
□ Play Mode . . . . .	238	■ Remote Sound System Controls — If Equipped . . . . .	246
□ List Or Browse Mode . . . . .	240	□ Radio Operation . . . . .	247
■ Uconnect™ Multimedia (Satellite Radio) — If Equipped (REN/RER/RES Radios Only). . . . .	242	□ CD Player . . . . .	247
□ System Activation . . . . .	242	■ CD/DVD Disc Maintenance . . . . .	247
□ Electronic Serial Number/Sirius Identification Number (ESN/SID) . . . . .	242	■ Radio Operation And Cellular Phones . . . . .	248
□ Selecting Uconnect™ Multimedia (Satellite) Mode . . . . .	243	■ Climate Controls . . . . .	248
□ Satellite Antenna . . . . .	243	□ Manual Heating And Air Conditioning System . . . . .	249
□ Reception Quality . . . . .	243	□ Automatic Temperature Control (ATC) — If Equipped . . . . .	253
□ Operating Instructions - Uconnect™ Multimedia (Satellite) Mode . . . . .	244	□ Summer Operation . . . . .	258



**176 UNDERSTANDING YOUR INSTRUMENT PANEL**

---

□ Winter Operation . . . . .	258	□ Outside Air Intake . . . . .	259
□ Vacation/Storage . . . . .	259	□ Operating Tips . . . . .	260
□ Window Fogging And Frosting . . . . .	259		

## INSTRUMENT PANEL FEATURES

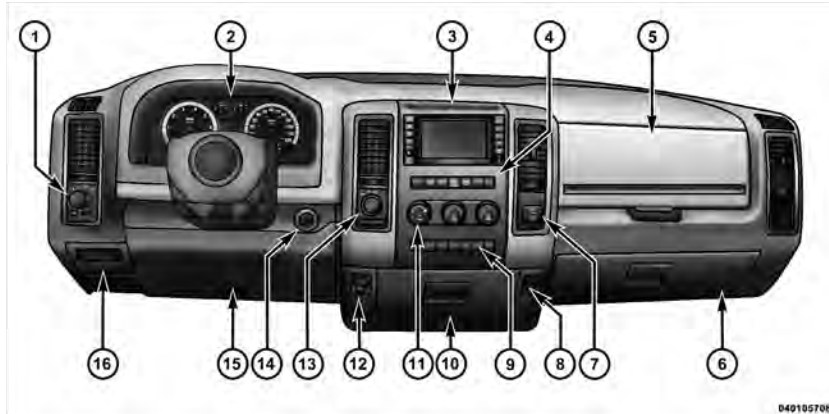

- 1 — Headlight Switch
- 2 — Instrument Cluster
- 3 — Radio
- 4 — Upper Switch Bank
- 5 — Upper Glove Compartment
- 6 — Lower Glove Compartment

- 7 — 115v Power Inverter Outlet
- 8 — Power Outlet
- 9 — Lower Switch Bank
- 10 — Cup Holders
- 11 — Climate Controls
- 12 — Power Outlet/Cigar Lighter

- 13 — Transfer Case Position Switch
- 14 — Ignition Switch
- 15 — Hood Release
- 16 — Parking Brake Release

**INSTRUMENT CLUSTER — BASE**

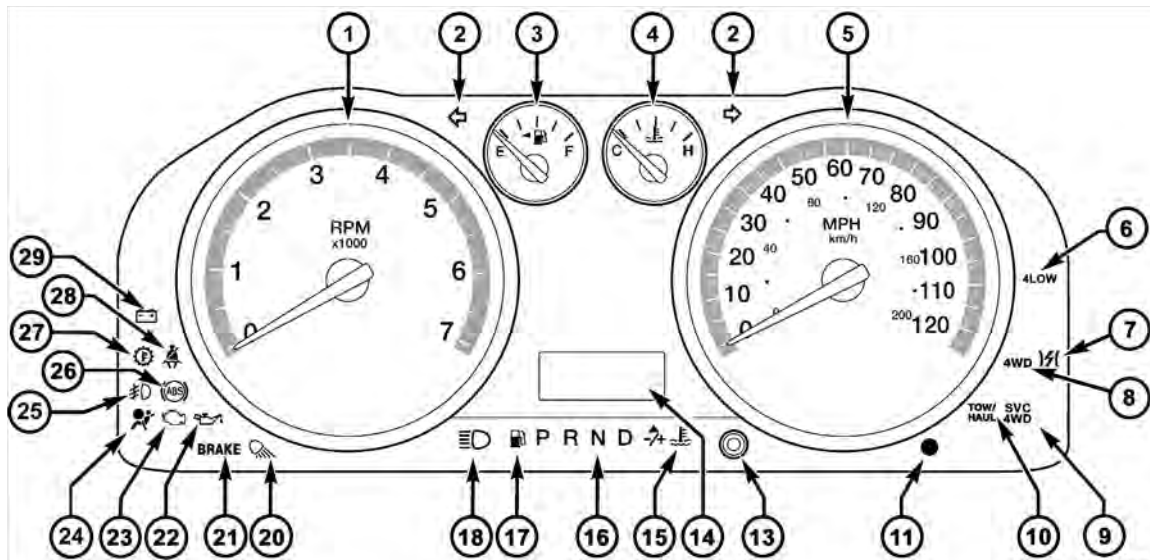

040307722

INSTRUMENT CLUSTER — PREMIUM

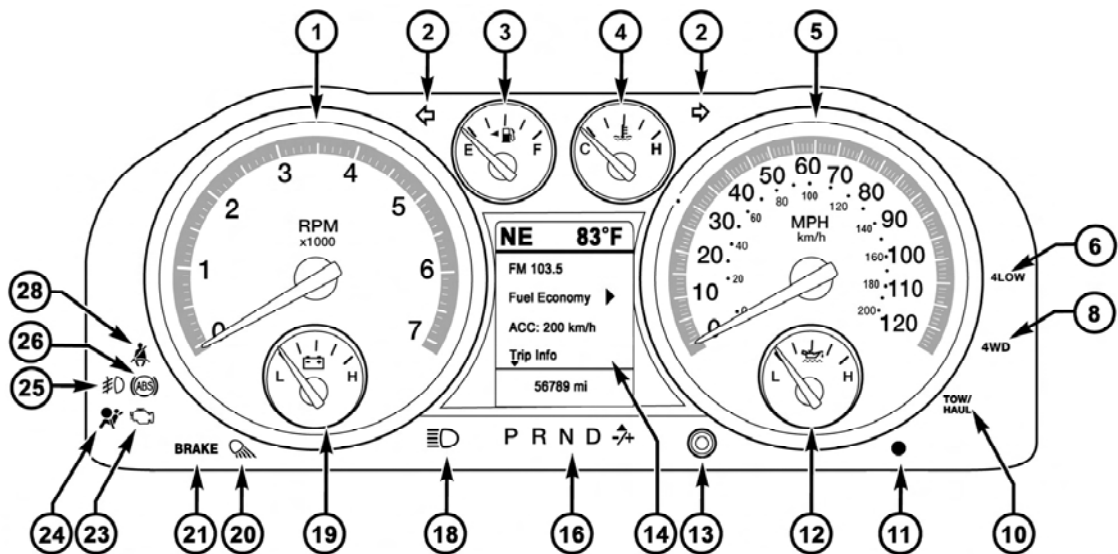

040307723

## INSTRUMENT CLUSTER DESCRIPTIONS

### 1. *Tachometer*

The Tachometer indicates engine speed in revolutions per minute.

#### CAUTION!

**Do not operate the engine with the tachometer pointer at high RPM for extended periods. Engine damage may occur.**

### 2. *Turn Signal Indicators*

 The arrow will flash with the exterior turn signal when the turn signal lever is operated.

#### NOTE:

- A continuous chime will sound if the vehicle is driven more than 1 mile (1.6 km) with either turn signal on.

- Check for an inoperative outside light bulb if either indicator flashes at a rapid rate.

### 3. *Fuel Gauge*

Shows level of fuel in tank when ignition switch is in the ON position.

### 4. *Temperature Gauge*

The temperature gauge shows engine coolant temperature. Any reading within the normal range indicates that the engine cooling system is operating satisfactorily.

The gauge pointer will likely indicate a higher temperature when driving in hot weather, up mountain grades, or when towing a trailer. It should not be allowed to exceed the upper limits of the normal operating range.

**CAUTION!**

Driving with a hot engine cooling system could damage your vehicle. If temperature gauge reads "H" pull over and stop the vehicle. Idle the vehicle with the air conditioner turned off until the pointer drops back into the normal range. If the pointer remains on the "H" and you hear continuous chimes, turn the engine off immediately, and call an authorized dealership for service.

**WARNING!**

A hot engine cooling system is dangerous. You or others could be badly burned by steam or boiling coolant. You may want to call an authorized dealership for service if your vehicle overheats. If you decide to look under the hood yourself, see "Maintaining Your Vehicle". Follow the warnings under the Cooling System Pressure Cap paragraph.

**5. Speedometer**

The speedometer shows the vehicle speed in miles per hour and/or kilometers per hour (mph/km/h).

**6. 4 LOW**

This light alerts the driver that the vehicle is in the four-wheel drive LOW mode. The front and rear driveshafts are mechanically locked together forcing the front and rear wheels to rotate at the same speed. Low range provides a greater gear reduction ratio to provide increased torque at the wheels.

**7. Electronic Throttle Control (ETC) Light**

This light informs you of a problem with the Electronic Throttle Control (ETC) system. The light will come on when the ignition is first turned ON and remain on briefly as a bulb check. If the light does not come on during starting, have the system checked by an authorized dealer.

If a problem is detected, the light will come on while the engine is running. Cycle the ignition key when the vehicle has completely stopped and the shift lever is placed in the PARK position, the light should turn off.

If the light remains lit with the engine running, your vehicle will usually be drivable; however, see an authorized dealer for service as soon as possible. If the light is flashing when the engine is running, immediate service is required and you may experience reduced performance, an elevated/rough idle or engine stall and your vehicle may require towing.

For vehicles equipped with a premium cluster this indicator will display in the Electronic Vehicle Information Center (EVIC). Refer to "Electronic Vehicle Information Center (EVIC) — If Equipped" for further information.

#### 8. 4WD Indicator

**4WD**

This light indicates the vehicle is in four-wheel drive and 4LOCK. 4WD allows all four wheels to receive torque from the engine simultaneously.

#### 9. SERV (Service) 4WD

**SERV  
4WD**

The SERV 4WD light monitors the electric shift four-wheel drive system. If the SERV 4WD light stays on or comes on during driving, it means that the four-wheel drive system is not functioning properly and that service is required.

For vehicles equipped with a premium cluster this indicator will display in the Electronic Vehicle Information Center (EVIC). Refer to "Electronic Vehicle Information Center (EVIC) — If Equipped" for further information.

## 10. TOW/HAUL

### **TOW/ HAUL**

The TOW HAUL button is located on the center stack switch bank. This light will illuminate when TOW HAUL mode is selected

## 11. Vehicle Security Light — If Equipped



This light will flash at a fast rate for approximately 15 seconds, when the vehicle security alarm is arming, and then will flash slowly until the vehicle is disarmed.

## 12. Oil Pressure Gauge — If Equipped

The pointer should always indicate some oil pressure when the engine is running. A continuous high or low reading under normal driving conditions may indicate a lubrication system malfunction. Immediate service should be obtained from an authorized dealer.

## 13. Odometer/Trip Odometer Button

Press this button to toggle between the odometer and the trip odometer display. Holding the button in resets the trip odometer reading when in trip mode.

## 14. Odometer / Electronic Vehicle Information Center (EVIC) Display Area

### *Odometer Display*

The odometer shows the total distance the vehicle has been driven. Regulations require that upon transfer of vehicle ownership, the seller certify to the purchaser the correct mileage that the vehicle has been driven. If your odometer needs to be repaired or serviced, the repair technician should leave the odometer reading the same as it was before the repair or service. If s/he cannot do so, then the odometer must be set at zero, and a sticker must be placed in the door jamb stating what the mileage was before the repair or service. It is a good idea for you to make a record of the odometer reading before the repair/



service, so that you can be sure that it is properly reset, or that the door jamb sticker is accurate if the odometer must be reset at zero.

The two trip odometers show individual trip mileage. To switch from odometer to trip odometers, press and release the TRIP ODOMETER button.

To reset a trip odometer, display the desired trip odometer to be reset then push and hold the button for approximately two seconds until the display resets.

### *Vehicle Odometer Messages*

When the appropriate conditions exist, the following messages will display in the odometer:

<b>noFUSE</b> . . . . .	Fuse Fault
<b>CHAnGE OIL</b> . . . . .	Oil Change Required
<b>LoWASH</b> . . . . .	Low Washer Fluid

**NOTE:** There is also an engine hour function. This indicates the total number of hours the engine has been running. To display the engine hours on the base cluster, perform the following: Place the ignition in RUN, but do not start the engine. With the odometer value displayed, hold the TRIP button down for a period of six seconds. The odometer will change to trip value first, then it will display the engine hour value. The engine hours will be displayed for a period of 30 seconds until the ignition is turned OFF or the engine is started.

Some of the above warnings will be displayed in the Electronic Vehicle Information Center (EVIC) Display Area located in the instrument cluster. Refer to "Electronic Vehicle Information Center (EVIC) — If Equipped" for further information.



### Loose Gascap Indicator

If the vehicle diagnostic system determines that the fuel filler cap is loose, improperly installed, or damaged, a loose gascap indicator will display in the odometer display area. Tighten the fuel filler cap properly and press the TRIP button to turn off the message. If the problem continues, the message will appear the next time the vehicle is started.

A loose, improperly installed, or damaged fuel filler cap may also turn on the Malfunction Indicator Light (MIL).

### *noFUSE*

If the vehicle diagnostic system determines that the Ignition Off Draw (IOD) fuse is improperly installed, or damaged, a “noFUSE” message will display in the odometer display area. For further information on fuses and fuse locations refer to “Fuses” in “Maintaining Your Vehicle”.

### *CHAngE OIL*

Your vehicle is equipped with an engine oil change indicator system. The **CHAngE OIL** message will flash in the instrument cluster odometer for approximately 12 seconds after a single chime has sounded to indicate the next scheduled oil change interval. The engine oil change indicator system is duty cycle-based, which means the engine oil change interval may fluctuate dependent upon your personal driving style.

Unless reset, this message will continue to display each time you turn the ignition switch to the ON position. To turn off the message temporarily, press and release the Trip Odometer button on the instrument cluster. To reset the oil change indicator system (after performing the scheduled maintenance), refer to the following procedure:

1. Turn the ignition switch to the ON position (**Do not start the engine**).

2. Fully depress the accelerator pedal slowly three times within 10 seconds.
3. Turn the ignition switch to the OFF/LOCK position.

**NOTE:** If the indicator message illuminates when you start the vehicle, the oil change indicator system did not reset. If necessary repeat this procedure.

### 15. *Engine Temperature Warning Light*



This light warns of an overheated engine condition. As temperatures rise and the gauge approaches **H**, this indicator will illuminate and a single chime will sound after reaching a set threshold. Further overheating will cause the temperature gauge to pass **H**, the indicator will continuously flash and a continuous chime will occur until the engine is allowed to cool.

If the light turns on while driving, safely pull over and stop the vehicle. If the A/C system is on, turn it off. Also,

shift the transmission into NEUTRAL and idle the vehicle. If the temperature reading does not return to normal, turn the engine off immediately and call for service. Refer to “If Your Engine Overheats” in “What To Do In Emergencies” for further information.

For vehicles equipped with a premium cluster this indicator will display in the Electronic Vehicle Information Center (EVIC). Refer to “Electronic Vehicle Information Center (EVIC) — If Equipped” for further information.

### 16. *Shift Lever Indicator*

The Shift Lever Indicator is self-contained within the instrument cluster. It displays the gear position of the automatic transmission.

**NOTE:** In vehicles with a 4.7L or 5.7L engine, the highest available transmission gear is displayed in the lower right corner of the Electronic Vehicle Information Center (EVIC) whenever the Electronic Range Select (ERS) feature is active. Use the +/- selector on the shift

lever to activate ERS. Refer to “Automatic Transmission” in “Starting And Operating” for further information.

### 17. *Low Fuel Light*



When the fuel level reaches approximately 3.0 gal (11.0 L) this light will turn on, and remain on until fuel is added.

For vehicles equipped with a premium cluster this indicator will display in the Electronic Vehicle Information Center (EVIC). Refer to “Electronic Vehicle Information Center (EVIC) — If Equipped” for further information.

### 18. *High Beam Indicator*



This indicator shows that headlights are on high beam. Push the multifunction lever forward to switch the headlights to high beam, and pull toward yourself (normal position) to return to low beam.

### 19. *Voltmeter — If Equipped*

When the engine is running, the gauge indicates the electrical system voltage. The pointer should stay within the normal range if the battery is charged. If the pointer moves to either extreme left or right and remains there during normal driving, the electrical system should be serviced.

**NOTE:** The voltmeter may show a gauge fluctuation at various engine temperatures. This cycling operation is caused by the post-heat cycle of the intake manifold heater system. The number of cycles and the length of the cycling operation is controlled by the engine control module. Post-heat operation can run for several minutes, and then the electrical system and voltmeter needle will stabilize.

## 20. Cargo Light



The cargo light will illuminate when the cargo light is activated by pressing the cargo light button on the headlight switch.

## 21. Brake Warning Light

**BRAKE** This light monitors various brake functions, including brake fluid level and parking brake application. If the brake light turns on, it may indicate that the parking brake is applied, that the brake fluid level is low, or that there is a problem with the Anti-lock Brake System reservoir.

If the light remains on when the parking brake has been disengaged, and the fluid level is at the full mark on the master cylinder reservoir, it indicates a possible brake hydraulic system malfunction or that a problem with the Brake Booster has been detected by the Anti-Lock Brake System (ABS). In this case, the light will remain on until the condition has been corrected. If the problem is related

to the brake booster, the ABS pump will run when applying the brake and a brake pedal pulsation may be felt during each stop.

The dual brake system provides a reserve braking capacity in the event of a failure to a portion of the hydraulic system. A leak in either half of the dual brake system is indicated by the Brake Warning Light, which will turn on when the brake fluid level in the master cylinder has dropped below a specified level.

The light will remain on until the cause is corrected.

**NOTE:** The light may flash momentarily during sharp cornering maneuvers, which change fluid level conditions. The vehicle should have service performed, and the brake fluid level checked.

If brake failure is indicated, immediate repair is necessary.

**WARNING!**

**Driving a vehicle with the red brake light on is dangerous. Part of the brake system may have failed. It will take longer to stop the vehicle. You could have an accident. Have the vehicle checked immediately.**

Vehicles equipped with the ABS, are also equipped with Electronic Brake Force Distribution (EBD). In the event of an EBD failure, the Brake Warning Light will turn on along with the ABS Light. Immediate repair to the ABS system is required.

Operation of the Brake Warning Light can be checked by turning the ignition switch from the OFF position to the ON position. The light should illuminate for approximately two seconds. The light should then turn off unless the parking brake is applied or a brake fault is detected. If the light does not illuminate, have the light inspected by an authorized dealer.

The light also will turn on when the parking brake is applied with the ignition switch in the ON position.

**NOTE:** This light shows only that the parking brake is applied. It does not show the degree of brake application.

### 22. *Oil Pressure Warning Light*



This light indicates low engine oil pressure. The light should turn on momentarily when the engine is started. If the light turns on while driving, stop the vehicle and shut off the engine as soon as possible. A chime will sound for four minutes when this light turns on.

Do not operate the vehicle until the cause is corrected. This light does not indicate how much oil is in the engine. The engine oil level must be checked under the hood.

For vehicles equipped with a premium cluster this indicator will display in the Electronic Vehicle Information

Center (EVIC). Refer to "Electronic Vehicle Information Center (EVIC) — If Equipped" for further information.

### 23. *Malfunction Indicator Light (MIL)*



The Malfunction Indicator Light (MIL) is part of an onboard diagnostic (OBDII) system which monitors the emissions and engine control system. If the vehicle is ready for emissions testing, the light will come on when the ignition is first turned on and remain on, as a bulb check, until the engine is started. If the vehicle is not ready for emissions testing the light will come on when the ignition is first turned on and remain on for 15 seconds, then blink for 5 seconds, and remain on until the vehicle is started. If the bulb does not come on during starting, have the condition investigated promptly.

If this light comes on and remains on while driving, it suggests a potential engine control problem and the need for system service.

Although your vehicle will usually be drivable and not need towing, see your authorized dealer for service as soon as possible.

#### **CAUTION!**

**Prolonged driving with the MIL on could cause damage to the engine control system. It also could affect fuel economy and drivability. If the MIL is flashing, severe catalytic converter damage and power loss will soon occur. Immediate service is required.**

**WARNING!**

A malfunctioning catalytic converter, as referenced above, can reach higher temperatures than in normal operating conditions. This can cause a fire if you drive slowly or park over flammable substances such as dry plants or wood or cardboard, etc. This could result in death or serious injury to the driver, occupants or others.

**24. Airbag Warning Light**

This light turns on and remains on for six to eight seconds as a bulb check when the ignition switch is first turned ON. If the light is not on during starting, stays on, or turns on while driving, have the system inspected by an authorized dealer as soon as possible. Refer to “Occupant Restraints” in “Things To Know Before Starting Your Vehicle” for further information.

**25. Front Fog Light Indicator — If Equipped**

This indicator will illuminate when the front fog lights are on.

**26. Anti-Lock Brake (ABS) Light**

This light monitors the Anti-lock Brake System (ABS). The light will turn on when the ignition switch is turned to the ON position and may stay on for as long as four seconds.

If the ABS light remains on or turns on while driving, it indicates that the anti-lock portion of the brake system is not functioning and that service is required. However, the conventional brake system will continue to operate normally if the BRAKE warning light is not on.

If the ABS light is on, the brake system should be serviced as soon as possible to restore the benefits of anti-lock brakes. If the ABS light does not turn on when the ignition switch is turned to the ON position, have the light inspected by an authorized dealer.



### 27. *Transmission Temperature Warning Light*



This light indicates that there is excessive transmission fluid temperature that might occur with severe usage such as trailer towing. It may also occur when operating the vehicle in a high torque converter slip condition, such as 4-wheel-drive operation (e.g., snow plowing, off-road operation). If this light comes on, stop the vehicle and run the engine at idle or faster, with the transmission in NEUTRAL until the light goes off.

#### **CAUTION!**

**Continuous driving with the Transmission Temperature Warning Light illuminated will eventually cause severe transmission damage or transmission failure.**

#### **WARNING!**

**Continued operation with the Transmission Temperature Warning Light illuminated could cause the fluid to boil over, come in contact with hot engine or exhaust components causing a fire that may result in personal injury.**

For vehicles equipped with a premium cluster this warning light will display in the Electronic Vehicle Information Center (EVIC). Refer to "Electronic Vehicle Information Center (EVIC) — If Equipped" for further information.

### 28. *Seat Belt Reminder Light*



When the ignition switch is first turned ON, this light will turn on for five to eight seconds as a bulb check. During the bulb check, if the driver's seat belt is unbuckled, a chime will sound. After the bulb check or when driving, if the driver's seat belt remains unbuckled, the seat belt reminder light will flash or remain on continuously. Refer to "Occupant Restraints" in "Things To Know Before Starting Your Vehicle" for further information.

### 29. *Charging System Light*



This light shows the status of the electrical charging system. The light should come on when the ignition switch is first turned ON and remain on briefly

as a bulb check. If the light stays on or comes on while driving, turn off some of the vehicle's non-essential electrical devices or increase engine speed (if at idle). If the charging system light remains on, it means that the vehicle is experiencing a problem with the charging system. Obtain **SERVICE IMMEDIATELY**. See an authorized dealer.

If jump starting is required, refer to "Jump Starting Procedures" in "What To Do In Emergencies".

For vehicles equipped with a premium cluster this indicator will display in the Electronic Vehicle Information Center (EVIC). Refer to "Electronic Vehicle Information Center (EVIC) — If Equipped" for further information.

## ELECTRONIC VEHICLE INFORMATION CENTER (EVIC) — IF EQUIPPED

The Electronic Vehicle Information Center (EVIC) features a driver-interactive display that is located in the instrument cluster.



Electronic Vehicle Information Center (EVIC)

**NOTE:** The compass on your vehicle is self-calibrating, eliminating the need to manually calibrate the compass.

This system conveniently allows the driver to select a variety of useful information by pressing the switches mounted on the steering wheel. The EVIC consists of the following:

- Vehicle Info display
- Vehicle information warning message displays
- Customer-Programmable Features (System Setup)
- Compass display
- Outside temperature display
- Trip computer functions
- Distance To Empty (DTE) display
- Average Fuel Economy

- Audio Modes display



Steering wheel EVIC control button, as it appears on the left side of the steering wheel.



Press and release the UP button to scroll upward through the main menus (DTE, mi/gal, System Info, Messages, Units, Setup) and sub menus.



Press and release the DOWN button to scroll downward through the main menus and sub menus.



Steering wheel EVIC control button as it appears on the right side of the steering wheel.



Press and release the SELECT button for access to main menus, sub menus or to select a personal setting in the system setup menu.



Press the BACK button to scroll back to a previous menu or sub menu.

**Electronic Vehicle Information Center (EVIC)****Displays**

When the appropriate conditions exist, the EVIC displays the following messages:

- Door(s) Ajar (with a single chime, if vehicle is in motion)
- Hood Ajar (if equipped with hood switch)
- Key In Ignition
- Wrong Key
- Damaged Key
- Key Not Programmed
- Turn Signal On
- RKE Battery Low
- LOW WASHER FLUID
- Oil Change Required
- Left Front Turn Signal Light Out
- Left Rear Turn Signal Light Out
- Right Front Turn Signal Light Out
- Right Rear Turn Signal Light Out
- Service Park Assist System
- Personal Settings Not Available — Vehicle Not in Park
- Check Trailer Brake Wiring
- Service Trailer Brake System
- Trailer Brake Connected
- Trailer Brake Disconnected
- Trailer Brake (with icon and voltage readout)

## EVIC Warning Lights

- *Door Ajar*



This light will turn on to indicate that one or more door may be ajar.

- *Oil Pressure Warning Light*



This light indicates low engine oil pressure. The light should turn on momentarily when the engine is started. If the light turns on while driving, stop the vehicle and shut off the engine as soon as possible. A chime will sound for four minutes when this light turns on.

Do not operate the vehicle until the cause is corrected. This light does not show how much oil is in the engine. The engine oil level must be checked under the hood.

- *Charging System Light*



This light shows the status of the electrical charging system. The light should come on when the ignition switch is first turned ON and remain on briefly as a bulb check. If the light stays on or comes on while driving, turn off some of the vehicle's non-essential electrical devices or increase engine speed (if at idle). If the charging system light remains on, it means that the vehicle is experiencing a problem with the charging system. Obtain SERVICE IMMEDIATELY. See an authorized dealer.

- *Electronic Speed Control Light*



This light will turn on when the electronic speed control is ON.

- *Electronic Throttle Control (ETC) Light*



This light informs you of a problem with the Electronic Throttle Control (ETC) system. The light will come on when the ignition is first turned ON and remain on briefly as a bulb check. If the light does not come on during starting, have the system checked by an authorized dealer.

If a problem is detected, the light will come on while the engine is running. Cycle the ignition key when the vehicle has completely stopped and the shift lever is placed in the PARK position. The light should turn off.

If the light remains lit with the engine running your vehicle, will usually be drivable, however, see an authorized dealer for service as soon as possible. If the light is flashing when the engine is running, immediate service is required and you may experience reduced performance, an elevated/rough idle or engine stall and your vehicle may require towing.

- *Engine Temperature Warning Light*



This light warns of an overheated engine condition. As temperatures rise and the gauge approaches **H**, this indicator will illuminate and a single chime will sound after reaching a set threshold. Further overheating will cause the temperature gauge to pass **H**, the indicator will continuously flash and a continuous chime will occur until the engine is allowed to cool.

If the light turns on while driving, safely pull over and stop the vehicle. If the A/C system is on, turn it off. Also, shift the transmission into NEUTRAL and idle the vehicle. If the temperature reading does not return to normal, turn the engine off immediately and call for service. Refer to “If Your Engine Overheats” in “What To Do In Emergencies” for more information.

- *SERV 4WD*



The SERV 4WD light monitors the electric shift 4WD system. If the SERV 4WD light stays on or comes on during driving, it means that the 4WD system is not functioning properly and that service is required.

- *Transmission Temperature Light*



This light indicates that there is excessive transmission fluid temperature that might occur with severe usage such as trailer towing. It may also occur when operating the vehicle in a high torque converter slip condition, such as 4-wheel-drive operation (e.g., snow plowing, off-road operation). If this light comes on, stop the vehicle and run the engine at idle or faster, with the transmission in NEUTRAL until the light goes off.

- *Loose Gascap Message*



If the vehicle diagnostic system determines that the fuel filler cap is loose, improperly installed, or damaged, a loose gascap icon will display in the telltale display area. Tighten the fuel filler cap properly and press the SELECT button to turn off the message. If the problem continues, the message will appear the next time the vehicle is started.

A loose, improperly installed, or damaged fuel filler cap may also turn on the Malfunction Indicator Light (MIL).

### **Oil Change Required**

Your vehicle is equipped with an engine oil change indicator system. The **Oil Change Required** message will flash in the EVIC display for approximately 10 seconds after a single chime has sounded to indicate the next scheduled oil change interval. The engine oil change



indicator system is duty-cycle based, which means the engine oil change interval may fluctuate dependent upon your personal driving style.

Unless reset, this message will continue to display each time you turn the ignition switch to the ON position. To turn off the message temporarily, press and release the RETURN button. To reset the oil change indicator system (after performing the scheduled maintenance) perform the following steps.

1. Turn the ignition switch to the ON position. (Do not start the engine)
2. Fully depress the accelerator pedal slowly three times within 10 seconds.
3. Turn the ignition switch to the OFF position.

**NOTE:** If the indicator message illuminates when you start the engine, the oil change indicator system did not reset. If necessary, repeat these steps.

### Distance To Empty (DTE)

Shows the estimated distance that can be traveled with the fuel remaining in the tank. This estimated distance is determined by a weighted average of the instantaneous and average fuel economy, according to the current fuel tank level. DTE cannot be reset through the RETURN button.

**NOTE:** Significant changes in driving style or vehicle loading will greatly affect the actual drivable distance of the vehicle, regardless of the DTE displayed value.

When the DTE value is less than 10 miles (16 km) estimated driving distance, the DTE display will change to a text display of "LOW FUEL." This display will continue until the vehicle runs out of fuel. Adding a significant amount of fuel to the vehicle will turn off the "LOW FUEL" text and a new DTE value will display.

## EVIC Average Fuel Economy

Shows the average fuel economy since the last reset. When the fuel economy is reset, the display will read "RESET" or show dashes for two seconds. Then, the history information will be erased and the averaging will continue from the last fuel average reading before the reset.

## Trip Functions

Press and release the ODOMETER/TRIP ODOMETER button until one of the following Trip Functions displays in the EVIC:

- Trip A
- Trip B
- Elapsed Time

Press the ODOMETER/TRIP ODOMETER button to cycle through all the Trip Computer functions.

The Trip Functions mode displays the following information.

- *Trip A*

Shows the total distance traveled for Trip A since the last reset.

- *Trip B*

Shows the total distance traveled for Trip B since the last reset.

- *Elapsed Time*

Shows the total elapsed time of travel since the last reset when the ignition switch is in the ACC position. Elapsed time will increment when the ignition switch is in the ON or START position.

### To Reset The Display

Reset will only occur while a resettable function is being displayed. Press and release the ODOMETER/TRIP ODOMETER button once to clear the resettable function being displayed.

### Vehicle Info (Customer Information Features)

Press and release the UP or DOWN button until “Vehicle Info” displays in the EVIC and press the SELECT button. Press the UP and DOWN button to scroll through the available information displays, then press SELECT to display anyone of the following choices.

- *Coolant Temp*

Displays the actual coolant temperature.

- *Oil Temperature*

Displays the actual oil temperature.

- *Oil Pressure*

Displays the actual oil pressure.

- *Trans Temperature*

Displays the actual transmission temperature.

- *Engine Hours*

Displays the hours of engine operation.

### Units

Press and release the UP or DOWN button until “Units” displays in the EVIC and press the SELECT button. The EVIC, odometer, and navigation system (if equipped) can be changed between English and Metric units of measure. To make your selection, scroll up or down until the preferred setting is highlighted, then press and release the SELECT button until a check-mark appears next to the setting, showing that setting has been selected.

### Compass / Temperature Display

The compass readings indicate the direction the vehicle is facing. The EVIC will display one of eight compass readings and the outside temperature.

**NOTE:**

- The system will display the last known outside temperature when starting the vehicle and may need to be driven several minutes before the updated temperature is displayed. Engine temperature can also affect the displayed temperature, therefore temperature readings are not updated when the vehicle is not moving.
- During snowplow usage on vehicles equipped with outside temperature display, the display may show higher temperatures than the outside ambient temperature. The higher displayed temperature is due to blocked or reduced airflow to the underhood ambient temperature sensor caused by the snowplow. In addition, on vehicles equipped with Automatic Temperature Control (ATC), it is suggested that the interior cabin temperature be manually controlled should the system not perform as desired while in automatic

mode. Both the outside temperature display and ATC operation will return to normal when the snowplow is removed.

**Automatic Compass Calibration**

This compass is self-calibrating, which eliminates the need to manually reset the compass. When the vehicle is new, the compass may appear erratic and the EVIC will display CAL until the compass is calibrated. You may also calibrate the compass by completing one or more 360-degree turns (in an area free from large metal or metallic objects) until the CAL indicator displayed in the EVIC turns off. The compass will now function normally.

**NOTE:** A good calibration requires a level surface and an environment free from large metallic objects such as buildings, bridges, underground cables, railroad tracks, etc.

### Manual Compass Calibration

If the compass appears erratic and the CAL indicator does not appear in the EVIC display, you must put the compass into the Calibration Mode manually, as follows:

1. Turn ON the ignition switch.
2. Press the UP or DOWN button until the System Setup (Customer-Programmable Features) menu is reached, then press the SELECT button.
3. Press the DOWN button until “Calibrate Compass” is displayed in the EVIC.
4. Press and release the SELECT button to start the calibration. The “CAL” indicator will be displayed in the EVIC.
5. Complete one or more 360-degree turns (in an area free from large metal or metallic objects) until the “CAL” indicator turns off. The compass will now function normally.

### Compass Variance

Compass Variance is the difference between Magnetic North and Geographic North. To compensate for the differences the variance should be set for the zone where the vehicle is driven, per the zone map. Once properly set, the compass will automatically compensate for the differences, and provide the most accurate compass heading. For the most accurate compass performance, the compass must be set using the following steps.

**NOTE:** Keep magnetic materials away from the top of the instrument panel, such as iPod’s, Cell Phones, Laptops and Radar Detectors. This is where the compass module is located, and it can cause interference with the compass sensor, and it may give false readings.

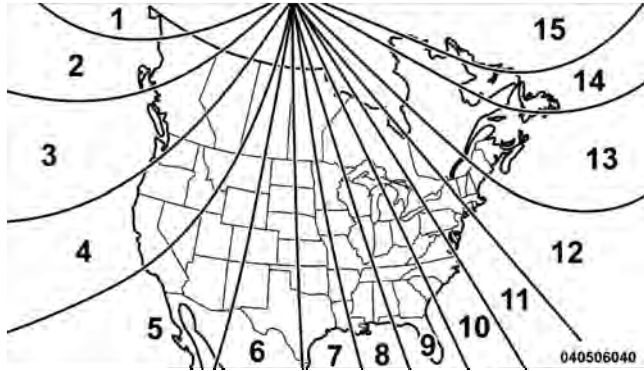

Compass Variance Map

1. Turn the ignition switch ON.
2. Press the UP or DOWN button until the System Setup (Customer-Programmable Features) menu is reached, then press the SELECT button.

3. Press the DOWN button until the "Compass Variance" message is displayed in the EVIC, then press the SELECT button. The last variance zone number displays in the EVIC.

4. Press and release the SELECT button until the proper variance zone is selected, according to the map.

5. Press and release the BACK button to exit.

### Customer-Programmable Features (System Setup)

Personal Settings allows you to set and recall features when the transmission is in PARK. If the transmission is out of PARK or the vehicle begins moving, a warning message **SYSTEM SETUP NOT AVAILABLE**, is followed in three seconds by, **VEHICLE NOT IN PARK**.

Press and release the UP or DOWN button until System Setup displays in the EVIC.

Use the UP or DOWN button to display one of the following choices.

### **Select Language**

When in this display you may select one of five languages for all display nomenclature, including the trip functions and the navigation system (if equipped). Press the UP or DOWN button while in this display and scroll through the language choices. Press the SELECT button to select English, Spanish (Español), French (Français), Italian (Italiano), German (Deutsch), and Dutch (Nederlands). Then, as you continue, the information will display in the selected language.

### **Nav-Turn By Turn**

When this feature is selected, the navigation system utilizes voice commands, guiding through the drive route, mile by mile, turn-by-turn until the final destination is reached. To make your selection, press and release the SELECT button until a check-mark appears next to

the feature showing the system has been activated or the check-mark is removed, showing the system has been deactivated.

### **Auto Lock Doors**

When this feature is selected, all doors will lock automatically when the vehicle reaches a speed of 15 mph (24 km/h). To make your selection, press and release the SELECT button until a check-mark appears next to the feature showing the system has been activated, or the check-mark is removed showing the system has been deactivated.

### **Auto Unlock Doors**

When this feature is selected, all doors will unlock when the vehicle is stopped and the transmission is in the PARK or NEUTRAL position and the driver's door is opened. To make your selection, press and release the SELECT button until a check-mark appears next to the

feature showing the system has been activated, or the check-mark is removed showing the system has been deactivated.

### **Remote Unlock Sequence**

When **Driver Door 1st Press** is selected, only the driver's door will unlock on the first press of the RKE transmitter UNLOCK button. When **Driver Door 1st Press** is selected, you must press the RKE transmitter UNLOCK button twice to unlock the passenger's doors. When **All Doors 1st Press** is selected, all of the doors will unlock on the first press of the RKE transmitter UNLOCK button. To make your selection, press and release the SELECT button until "Driver Door 1st Press" or "All Doors 1st Press" appears.

### **RKE Linked To Memory**

When this feature is selected the memory seat, mirror, and radio settings will return to the memory set position

when the Remote Keyless Entry (RKE) transmitter UNLOCK button is pressed. If this feature is not selected then the memory seat, mirror, and radio settings can only return to the memory set position using the seat mounted switch. To make your selection, press and release the SELECT button until a check-mark appears next to the feature showing the system has been activated or the check-mark is removed, showing the system has been deactivated.

### **Horn With Remote Start**

When this feature is selected, a short horn sound will occur when the RKE transmitter REMOTE START button is pressed. To make your selection, press and release the SELECT button until a check-mark appears next to the feature showing the system has been activated or the check-mark is removed, showing the system has been deactivated.



### **Horn With Remote Lock**

When this feature is selected, a short horn sound will occur when the RKE transmitter LOCK button is pressed. This feature may be selected with or without the Flash Lamps with Lock feature. To make your selection, press and release the SELECT button until a check-mark appears next to the feature showing the system has been activated or the check-mark is removed, showing the system has been deactivated.

### **Flash Lamps With Lock**

When this feature is selected, the front and rear turn signals will flash when the doors are locked or unlocked with the RKE transmitter. This feature may be selected with or without the sound horn on lock feature selected. To make your selection, press and release the SELECT button until a check-mark appears next to the feature showing the system has been activated or the check-mark is removed, showing the system has been deactivated.

### **Headlamp Off Delay**

When this feature is selected, the driver can choose to have the headlights remain on for 0, 30, 60, or 90 seconds when exiting the vehicle. To make your selection, scroll up or down until the preferred setting is highlighted, then press and release the SELECT button until a check-mark appears next to the setting, showing that setting has been selected.

### **Headlamps With Wipers**

When this feature is selected and the HEADLIGHT switch is in the AUTO position, the headlights will turn on approximately 10 seconds after the wipers are turned on. The headlights will also turn off when the wipers are turned off if they were turned on by this feature. To make your selection, press and release the SELECT button until a check-mark appears next to the feature showing the system has been activated or the check-mark is removed, showing the system has been deactivated.

### **Key-Off Power Delay**

When this feature is selected, the power window switches, radio, hands-free system (if equipped), DVD video system (if equipped), power sunroof (if equipped), and power outlets will remain active for up to 10 minutes after the ignition switch is turned OFF. Opening a vehicle door will cancel this feature. To make your selection, scroll up or down until the preferred setting is highlighted, then press and release the SELECT button until a check-mark appears next to the setting, showing that setting has been selected.

### **Illuminated Approach**

When this feature is selected, the headlights will activate and remain on for 0, 30, 60, or 90 seconds when the doors are unlocked with the RKE transmitter. To make your selection, scroll up or down until the preferred setting is highlighted, then press and release the SELECT button until a check-mark appears next to the setting, showing that setting has been selected.

### **Easy Exit Seat — If Equipped**

This feature provides automatic driver seat positioning to enhance driver mobility when entering and exiting the vehicle. To make your selection, press and release the SELECT button until a check-mark appears next to the feature showing the system has been activated or the check-mark is removed, showing the system has been deactivated.

**NOTE:** The seat will return to the memorized seat location (if Recall Memory with Remote Key Unlock is set to ON) when the RKE transmitter is used to unlock the door. Refer to “Driver Memory Seat” in “Understanding The Features Of Your Vehicle” for further information.

### **Tilt Mirror In Reverse — If Equipped**

When this feature is selected and the shift lever is placed in reverse gear, the side mirrors tilt downward to allow the driver to see into the previous blind spot and avoid objects in close proximity to the rear of the vehicle. To

make your selection, press and release the SELECT button until a check-mark appears next to the feature showing the system has been activated or the check-mark is removed, showing the system has been deactivated.

### **Remote Start Comfort Sys.**

When this feature is selected and the remote start is activated, the heated steering wheel and driver heated seat features will automatically turn on in cold weather. In warm weather, the driver vented seat feature will automatically turn on when the remote start is activated. These features will stay on through the duration of remote start or until the key is turned to RUN. To make your selection, press and release the SELECT button until a check-mark appears next to the feature showing the system has been activated or the check-mark is removed, showing the system has been deactivated.

### **Compass Variance**

Refer to “Compass Display” for more information.

### **Calibrate Compass**

Refer to “Compass Display” for more information.

### **MEDIA CENTER 730N/430 (RER/RBZ) — AM/FM STEREO RADIO AND CD/DVD/HDD/NAV — IF EQUIPPED**

**NOTE:** The sales code is located on the lower right side of the unit’s faceplate.

The RER and RBZ radios contain a CD/DVD player, USB port, and a 30-gigabyte hard drive (HDD). Sirius Satellite Radio is optional. The 6.5 in (16.5 cm) touch screen allows for easy menu selection.

The RER radio also contains a Global Positioning System (GPS)-based Navigation system.

Refer to your Uconnect™ Multimedia RER or RBZ user’s manual for detailed operating instructions.

### **Operating Instructions — Voice Command System — If Equipped**

For the radio, refer to “Voice Command” in “Understanding The Features Of Your Vehicle”.

### **Operating Instructions — Uconnect™ Phone — If Equipped**

Refer to “Uconnect™ Phone” in “Understanding The Features Of Your Vehicle”.

### **Clock Setting Procedure — RBZ Radio**

#### **To Manually Set the Clock**

1. Turn on the radio.
2. Touch the screen where the time is displayed, the clock setting menu will appear on the screen.

3. To move the hour forward, touch the screen where the word “Hour” with the arrow pointing upward is displayed. To move the hour backward, touch the screen where the word “Hour” with the arrow pointing downward is displayed.

4. To move the minute forward, touch the screen where the word “Min” with the arrow pointing upward is displayed. To move the minute backward, touch the screen where the word “Min” with the arrow pointing downward is displayed.

5. To save the new time setting, touch the screen where the word “Save” is displayed.

### **Changing Daylight Savings Time**

When selected, this feature will display the time of day in daylight savings time. Proceed as follows to change the current setting:

1. Turn on the radio.

2. Touch the screen where the time is displayed. The clock setting menu will appear on the screen.
3. When this feature is on, a check mark will appear in the box next to the words “Daylight Savings.” Touch the screen where the words “Daylight Savings” are displayed to change the current setting.

### **Show Time if Radio is Off**

When selected, this feature will display the time of day on the touch screen when the radio is turned off. Proceed as follows to change the current setting:

1. Turn on the radio.
2. Touch the screen where the time is displayed. The clock setting menu will appear on the screen.
3. When this feature is on, a check mark will appear in the box next to the words “Show Time if Radio is Off.” Touch the screen where the words “Show Time if Radio is Off” are displayed to change the current setting.

### **Changing the Time Zone**

1. Turn on the radio.
2. Touch the screen where the time is displayed. The clock setting menu will appear on the screen.
3. Touch the screen where the words “Set Time Zone” are displayed. The time zone selection menu will appear on the screen.
4. Select a time zone by touching the screen where your selection appears. If you do not see a time zone that you want to select, touch the screen where the word “Page” is displayed to view additional time zones in the menu.
5. Touch the screen where the word “Save” is displayed.

### **Clock Setting Procedure — RER Radio**

#### **Uconnect® gps — RER Only**

The GPS receiver used in this system is synchronized to the time data being transmitted by the GPS satellite. The

satellite clock is Greenwich Mean Time (GMT). This is the worldwide standard for time. This makes the system's clock very accurate once the appropriate time zone and daylight savings information is set.

### To Manually Set the Clock — RER

1. Turn on the radio.
2. Touch the screen where the time is displayed.
3. Touch the screen where "User Clock" is displayed, the clock setting menu will appear on the screen.
4. To move the hour forward, touch the screen where the word "Hour" with the arrow pointing upward is displayed. To move the hour backward, touch the screen where the word "Hour" with the arrow pointing downward is displayed.
5. To move the minute forward, touch the screen where the word "Min" with the arrow pointing upward is

displayed. To move the minute backward, touch the screen where the word "Min" with the arrow pointing downward is displayed.

6. To save the new time setting, touch the screen where the word "Save" is displayed.

### Changing Daylight Savings Time

When selected, this feature will display the time of day in daylight savings time. Proceed as follows to change the current setting:

1. Turn on the radio.
2. Touch the screen where "User Clock" is displayed, the clock setting menu will appear on the screen.
3. When this feature is on, a check mark will appear in the box next to the words "Daylight Savings." Touch the screen where the words "Daylight Savings" are displayed to change the current setting.

### Show Time if Radio is Off

When selected, this feature will display the time of day on the touch screen when the radio is turned off. Proceed as follows to change the current setting:

1. Turn on the radio.
2. Touch the screen where the time is displayed.
3. Touch the screen where “User Clock” is displayed, the clock setting menu will appear on the screen.
4. When this feature is on, a check mark will appear in the box next to the words “Show Time if Radio is Off.” Touch the screen where the words “Show Time if Radio is Off” are displayed to change the current setting.

### Changing the Time Zone

1. Turn on the radio.
2. Touch the screen where the time is displayed.
3. Touch the screen where “User Clock” is displayed, the clock setting menu will appear on the screen.
4. Touch the screen where the words “Set Time Zone” are displayed. The time zone selection menu will appear on the screen.
5. Select a time zone by touching the screen where your selection appears. If you do not see a time zone that you want to select, touch the screen where the word “Page” is displayed to view additional time zones in the menu.
6. Touch the screen where the word “Save” is displayed.

## MEDIA CENTER 130 (RES) — AM/FM STEREO RADIO WITH CD PLAYER (MP3 AUX JACK)

**NOTE:** The radio sales code is located on the lower right side of the radio faceplate.

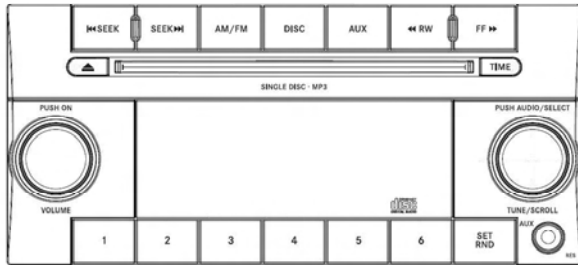

042305232

RES Radio

## Operating Instructions — Radio Mode

**NOTE:** The ignition switch must be in the ON or ACC position to operate the radio.

### Power Switch/Volume Control (Rotary)

Push the ON/VOLUME control knob to turn on the radio. Push the ON/VOLUME control knob a second time to turn off the radio.

### Electronic Volume Control

The electronic volume control turns continuously (360 degrees) in either direction, without stopping. Turning the ON/VOLUME control knob to the right increases the volume, and to the left decreases it.

When the audio system is turned on, the sound will be set at the same volume level as last played.



### **SEEK Buttons**

Press and release the SEEK buttons to search for the next listenable station in AM/FM mode. Press the right switch to seek up and the left switch to seek down. The radio will remain tuned to the new station until you make another selection. Holding either button will bypass stations without stopping, until you release it.

### **TIME Button**

Press the TIME button to alternate display of the time and radio frequency.

### **Clock Setting Procedure**

1. Press and hold the TIME button until the hours blink.
2. Adjust the hours by turning the right side TUNE/SCROLL control knob.
3. After adjusting the hours, press the right side TUNE/SCROLL control knob to set the minutes. The minutes will begin to blink.

4. Adjust the minutes using the right side TUNE/SCROLL control knob. Press the TUNE/SCROLL control knob to save time change.

5. To exit, press any button/knob, or wait five seconds.

### **RW/FF**

Pressing the RW (Rewind) or FF (Fast Forward) buttons causes the tuner to search for the next frequency in the direction of the arrows. This feature operates in either AM or FM frequencies.

### **TUNE Control**

Turn the rotary TUNE/SCROLL control knob clockwise to increase or counterclockwise to decrease the frequency.

### **Setting the Tone, Balance, and Fade**

Push the rotary TUNE/SCROLL control knob and BASS will display. Turn the TUNE/SCROLL control knob to the right or left to increase or decrease the bass tones.

Push the rotary TUNE/SCROLL control knob a second time and MID will display. Turn the TUNE/SCROLL control knob to the right or left to increase or decrease the mid-range tones.

Push the rotary TUNE/SCROLL control knob a third time and TREBLE will display. Turn the TUNE/SCROLL control knob to the right or left to increase or decrease the treble tones.

Push the rotary TUNE/SCROLL control knob a fourth time and BALANCE will display. Turn the TUNE/SCROLL control knob to the right or left to adjust the sound level from the right or left side speakers.

Push the rotary TUNE/SCROLL control knob a fifth time and FADE will display. Turn the TUNE/SCROLL control knob to the left or right to adjust the sound level between the front and rear speakers.

Push the rotary TUNE/SCROLL control knob again to exit setting tone, balance, and fade.

### **AM/FM Button**

Press the buttons to select either AM or FM mode.

### **SET/RND Button — To Set the Pushbutton Memory**

When you are receiving a station that you wish to commit to pushbutton memory, press the SET/RND button. The symbol SET 1 will now show in the display window. Select the button (1 to 6) you wish to lock onto this station and press and release that button. If a button is not selected within five seconds after pressing the SET/RND button, the station will continue to play but will not be stored into pushbutton memory.

You may add a second station to each pushbutton by repeating the above procedure with this exception: Press the SET/RND button twice and SET 2 will show in the display window. Each button can be set for SET 1 and

SET 2 in both AM and FM. This allows a total of 12 AM and 12 FM stations to be stored into pushbutton memory. The stations stored in SET 2 memory can be selected by pressing the pushbutton twice.

Every time a preset button is used, a corresponding button number will display.

### **Buttons 1 - 6**

These buttons tune the radio to the stations that you commit to pushbutton memory (12 AM and 12 FM stations).

### **DISC Button**

Pressing the DISC button will allow you to switch from AM/FM modes to Disc modes.

## **Operation Instructions — CD MODE For CD And MP3 Audio Play**

### **NOTE:**

- The ignition switch must be in the ON or ACC position to operate the radio.
- This radio is capable of playing compact discs (CD), recordable compact discs (CD-R), rewritable compact discs (CD-RW), compact discs with MP3 tracks and multisession compact discs with CD and MP3 tracks.

### **Inserting Compact Disc(s)**

Gently insert one CD into the CD player with the CD label facing up. The CD will automatically be pulled into the CD player and the CD icon will illuminate on the radio display. If a CD does not go into the slot more than 1.0 in (2.5 cm), a disc may already be loaded and must be ejected before a new disc can be loaded.

If you insert a disc with the ignition ON and the radio ON, the unit will switch from radio to CD mode and begin to play when you insert the disc. The display will show the track number, and index time in minutes and seconds. Play will begin at the start of track 1.

### CAUTION!

- **This CD player will accept 4-3/4 in (12 cm) discs only. The use of other sized discs may damage the CD player mechanism.**
- **Do not use adhesive labels. These labels can peel away and jam the player mechanism.**
- **RES is a single CD player. Do not attempt to insert a second CD if one is already loaded.**
- **Dual-media disc types (one side is a DVD, the other side is a CD) should not be used, and they can cause damage to the player.**

### EJECT Button - Ejecting a CD

Press the EJECT button to eject the CD.



If you have ejected a disc and have not removed it within 10 seconds, it will be reloaded. If the CD is not removed, the radio will reinsert the CD but will not play it.

A disc can be ejected with the radio and ignition OFF.

**NOTE:** Ejecting with the ignition OFF is not allowed on convertible or soft-top models (if equipped).

### SEEK Button

Press the right SEEK button for the next selection on the CD. Press the left SEEK button to return to the beginning of the current selection, or return to the beginning of the previous selection if the CD is within the first second of

the current selection. Pressing and holding the SEEK button will allow faster scrolling through the tracks in CD and MP3 modes.

### **TIME Button**

Press this button to change the display from a large CD playing time display to a small CD playing time display.

### **RW/FF**

Press and hold the FF (Fast Forward) button and the CD player will begin to fast forward until FF is released, or RW or another CD button is pressed. The RW (Reverse) button works in a similar manner.

### **AM/FM Button**

Press the button to select either AM or FM mode.

### **SET/RND Button (Random Play Button)**

Press this button while the CD is playing to activate Random Play. This feature plays the selections on the compact disc in random order to provide an interesting change of pace.

Press the right SEEK button to move to the next randomly selected track.

Press the RND button a second time to stop Random Play.

### **Notes on Playing MP3 Files**

The radio can play MP3 files; however, acceptable MP3 file recording media and formats are limited. When writing MP3 files, pay attention to the following restrictions.

### **Supported Media (Disc Types)**

The MP3 file recording media supported by the radio are CDDA, CD-R, CD-RW, MP3, and CDDA+MP3.

### Supported Medium Formats (File Systems)

The medium formats supported by the radio are ISO 9660 Level 1 and Level 2 and includes the Joliet extension. When reading discs recorded using formats other than ISO 9660 Level 1 and Level 2, the radio may fail to read files properly and may be unable to play the file normally. UDF and Apple HFS formats are not supported.

The radio uses the following limits for file systems:

- Maximum number of folder levels: 8
- Maximum number of files: 255
- Maximum number of folders. (The radio display of file names and folder names is limited. For large numbers of files and/or folders, the radio may be unable to display the file name and folder name, and will assign a number instead. With a maximum number of files,

exceeding 20 folders will result in this display. With 200 files, exceeding 50 folders will result in this display.)

- Maximum number of characters in file/folder names:
  - Level 1: 12 (including a separator "." and a three-character extension)
  - Level 2: 31 (including a separator "." and a three-character extension)

Multisession disc formats are supported by the radio. Multisession discs may contain combinations of normal CD audio tracks and computer files (including MP3 files). Discs created with an option such as "keep disc open after writing" are most likely multisession discs. The use of multisession for CD audio or MP3 playback may result in longer disc loading times.

### Supported MP3 File Formats

The radio will recognize only files with the \*.MP3 extension as MP3 files. Non-MP3 files named with the \*.MP3 extension may cause playback problems. The radio is designed to recognize the file as an invalid MP3 and will not play the file.

When using the MP3 encoder to compress audio data to an MP3 file, the bit rate and sampling frequencies in the following table are supported. In addition, variable bit rates (VBR) are also supported. The majority of MP3 files use a 44.1 kHz sampling rate and a 192, 160, 128, 96 or VBR bit rate.

MPEG Specification	Sampling Frequency (kHz)	Bit Rate (kbps)
MPEG-1 Audio Layer 3	48, 44.1, 32	320, 256, 224, 192, 160, 128, 112, 96, 80, 64, 56, 48, 40, 32

MPEG Specification	Sampling Frequency (kHz)	Bit Rate (kbps)
MPEG-2 Audio Layer 3	24, 22.05, 16	160, 128, 144, 112, 96, 80, 64, 56, 48, 40, 32, 24, 16, 8

ID3 Tag information for artist, song title, and album title are supported for version 1 ID3 tags. ID3 version 2 is not supported by the radios.

Playlist files are not supported. MP3 Pro files are not supported.

### Playback of MP3 Files

When a medium containing MP3 data is loaded, the radio checks all files on the medium. If the medium contains a lot of folders or files, the radio will take more time to start playing the MP3 files.

Loading times for playback of MP3 files may be affected by the following:

- Media - CD-RW media may take longer to load than CD-R media
- Medium formats - Multisession discs may take longer to load than non-multisession discs
- Number of files and folders - Loading times will increase with more files and folders

To increase the speed of disc loading, it is recommended to use CD-R media and single-session discs. To create a single-session disc, enable the “Disc at Once” option before writing to the disc.

### **Operation Instructions - Auxiliary Mode**

The auxiliary (AUX) jack is an audio input jack, which allows the user to plug in a portable device, such as an

MP3 player, or cassette player, and utilize the vehicle’s audio system to amplify the source and play through the vehicle speakers.

Pressing the DISC/AUX button will change the mode to auxiliary device if the AUX jack is connected.

**NOTE:** The AUX device must be turned on and the device’s volume set to proper level. If the AUX audio is not loud enough, turn the device’s volume up. If the AUX audio sounds distorted, turn the device’s volume down.

### **TIME Button (Auxiliary Mode)**

Press this button to change the display to time of day. The time of day will display for five seconds (when ignition is OFF).



## MEDIA CENTER 130 (RES/RSC) — AM/FM STEREO RADIO WITH CD PLAYER (MP3 AUX JACK) AND SIRIUS RADIO

**NOTE:** The radio sales code is located on the lower right side of the radio faceplate.

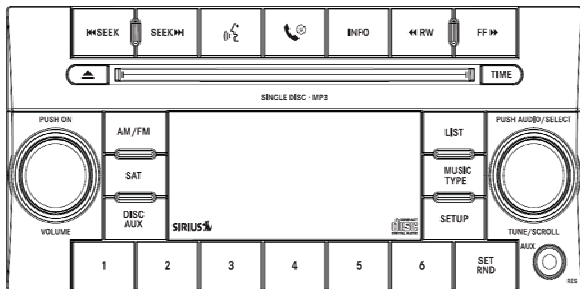

042305233

### RES/RSC Radio

## Operating Instructions — Radio Mode

**NOTE:** The ignition switch must be in the ON or ACC position to operate the radio.

### Power Switch/Volume Control (Rotary)

Push the ON/VOLUME control knob to turn on the radio. Push the ON/VOLUME control knob a second time to turn off the radio.

### Electronic Volume Control

The electronic volume control turns continuously (360 degrees) in either direction without stopping. Turning the ON/VOLUME control knob to the right increases the volume and to the left decreases it.

When the audio system is turned on, the sound will be set at the same volume level as last played.

### **SEEK Buttons**

Press and release the SEEK buttons to search for the next listenable station in AM/FM mode. Press the right switch to seek up and the left switch to seek down. The radio will remain tuned to the new station until you make another selection. Holding either button will bypass stations without stopping until you release it.

### **Voice Command System (Radio) — If Equipped**

Refer to “Voice Command” in “Understanding The Features If Your Vehicle”.

### **Voice Command Button Uconnect™ Phone — If Equipped**

Press this button to operate the Uconnect™ Phone feature (if equipped). Refer to “Uconnect™ Phone” in “Understanding The Features If Your Vehicle”.

If your vehicle is not equipped with or this feature is not available on your vehicle, a “Not Equipped With Uconnect” message will display on the radio screen.

### **Phone Button Uconnect™ Phone — If Equipped**

Press this button to operate the Uconnect™ Phone feature (if equipped). Refer to “Uconnect™ Phone” in “Understanding The Features If Your Vehicle”.

If your vehicle is not equipped with or this feature is not available on your vehicle, a “Not Equipped With Uconnect” message will display on the radio screen.

### **TIME Button**

Press the TIME button to alternate display of the time and radio frequency.

### **Clock Setting Procedure**

1. Press and hold the TIME button until the hours blink.
2. Adjust the hours by turning the right side TUNE/SCROLL control knob.

3. After adjusting the hours, press the right side TUNE/SCROLL control knob to set the minutes. The minutes will begin to blink.
4. Adjust the minutes using the right side TUNE/SCROLL control knob. Press the TUNE/SCROLL control knob to save time change.
5. To exit, press any button/knob or wait five seconds.

The clock can also be set by pressing the SETUP button. For vehicles equipped with satellite radio, press the SETUP button, use the TUNE/SCROLL control to select SET CLOCK, and then follow the above procedure, starting at Step 2. For vehicles not equipped with satellite radio, press the SETUP button and then follow the above procedure, starting at Step 2.

### **INFO Button**

Press the INFO button for an RDS station (one with call letters displayed). The radio will return a Radio Text message broadcast from an FM station (FM mode only).

### **RW/FF**

Pressing the RW (Rewind) or FF (Fast Forward) buttons causes the tuner to search for the next frequency in the direction of the arrows. This feature operates in either AM or FM frequencies.

### **TUNE Control**

Turn the rotary TUNE/SCROLL control knob clockwise to increase or counterclockwise to decrease the frequency.

### **Setting the Tone, Balance, and Fade**

Push the rotary TUNE/SCROLL control knob and BASS will display. Turn the TUNE/SCROLL control knob to the right or left to increase or decrease the bass tones.

Push the rotary TUNE/SCROLL control knob a second time and MID will display. Turn the TUNE/SCROLL control knob to the right or left to increase or decrease the mid-range tones.

Push the rotary TUNE/SCROLL control knob a third time and TREBLE will display. Turn the TUNE/SCROLL control knob to the right or left to increase or decrease the treble tones.

Push the rotary TUNE/SCROLL control knob a fourth time and BALANCE will display. Turn the TUNE/SCROLL control knob to the right or left to adjust the sound level from the right or left side speakers.

Push the rotary TUNE/SCROLL control knob a fifth time and FADE will display. Turn the TUNE/SCROLL control knob to the left or right to adjust the sound level between the front and rear speakers.

Push the rotary TUNE/SCROLL control knob again to exit setting tone, balance, and fade.

### **MUSIC TYPE Button**

Pressing this button once will turn on the Music Type mode for five seconds. Pressing the MUSIC TYPE button or turning the TUNE/SCROLL control knob within five seconds will allow the program format type to be selected. Many radio stations do not currently broadcast Music Type information.

Toggle the MUSIC TYPE button to select the following format types:

Program Type	16-Digit Character Display
No program type or undefined	None
Adult Hits	Adlt Hit
Classical	Classicl
Classic Rock	Cls Rock
College	College
Country	Country
Foreign Language	Language
Information	Inform
Jazz	Jazz
News	News
Nostalgia	Nostalgia
Oldies	Oldies

Program Type	16-Digit Character Display
Personality	Persnlty
Public	Public
Rhythm and Blues	R & B
Religious Music	Rel Musc
Religious Talk	Rel Talk
Rock	Rock
Soft	Soft
Soft Rock	Soft Rck
Soft Rhythm and Blues	Soft R&B
Sports	Sports
Talk	Talk
Top 40	Top 40
Weather	Weather

By pressing the SEEK button when the Music Type icon is displayed, the radio will be tuned to the next frequency station with the same selected Music Type name. The Music Type function only operates when in the FM mode.

If a preset button is activated while in the Music Type (Program Type) mode, the Music Type mode will be exited and the radio will tune to the preset station.

### **SETUP Button**

Pressing the SETUP button allows you to select between the following items:

- **Set Clock** — Pressing the SELECT button will allow you to set the clock. Adjust the hours by turning the TUNE/SCROLL control knob. After adjusting the hours, press the TUNE/SCROLL control knob to set the minutes. The minutes will begin to blink. Adjust

the minutes using the right side TUNE/SCROLL control knob. Press the TUNE/SCROLL control knob to save time change.

### **AM/FM Button**

Press the button to select either AM or FM mode.

### **SET/RND Button — To Set the Pushbutton Memory**

When you are receiving a station that you wish to commit to pushbutton memory, press the SET/RND button. The symbol SET 1 will now show in the display window. Select the button (1–6) you wish to lock onto this station and press and release that button. If a button is not selected within five seconds after pressing the SET/RND button, the station will continue to play but will not be stored into pushbutton memory.

You may add a second station to each pushbutton by repeating the above procedure with this exception: Press the SET/RND button twice and SET 2 will show in the

display window. Each button can be set for SET 1 and SET 2 in both AM and FM. This allows a total of 12 AM and 12 FM stations to be stored into pushbutton memory. The stations stored in SET 2 memory can be selected by pressing the pushbutton twice.

Every time a preset button is used, a corresponding button number will display.

### **Buttons 1 - 6**

These buttons tune the radio to the stations that you commit to pushbutton memory (12 AM and 12 FM stations).

### **DISC/AUX Button**

Pressing the DISC/AUX button will allow you to switch from AM/FM modes to DISC/AUX mode.

## **Operation Instructions — CD MODE for CD and MP3 Audio Play**

### **NOTE:**

- The ignition switch must be in the ON or ACC position to operate the radio.
- This radio is capable of playing compact discs (CD), recordable compact discs (CD-R), rewritable compact discs (CD-RW), compact discs with MP3 tracks and multisession compact discs with CD and MP3 tracks.

### **Inserting Compact Disc(s)**

Gently insert one CD into the CD player with the CD label facing up. The CD will automatically be pulled into the CD player and the CD icon will illuminate on the radio display. If a CD does not go into the slot more than 1.0 in (2.5 cm), a disc may already be loaded and must be ejected before a new disc can be loaded.

If you insert a disc with the ignition ON and the radio ON, the unit will switch from radio to CD mode and begin to play when you insert the disc. The display will show the track number, and index time in minutes and seconds. Play will begin at the start of track 1.

### CAUTION!

- **This CD player will accept 4-3/4 in (12 cm) discs only. The use of other sized discs may damage the CD player mechanism.**
- **Do not use adhesive labels. These labels can peel away and jam the player mechanism.**
- **RES is a single CD player. Do not attempt to insert a second CD if one is already loaded.**
- **Dual-media disc types (one side is a DVD, the other side is a CD) should not be used, and they can cause damage to the player.**

### EJECT Button - Ejecting a CD

Press the EJECT button to eject the CD.



If you have ejected a disc and have not removed it within 10 seconds, it will be reloaded. If the CD is not removed, the radio will reinsert the CD but will not play it.

A disc can be ejected with the radio and ignition OFF.

**NOTE:** Ejecting with the ignition OFF is not allowed on convertible or soft-top models (if equipped).

### SEEK Button

Press the right SEEK button for the next selection on the CD. Press the left SEEK button to return to the beginning of the current selection, or return to the beginning of the previous selection if the CD is within the first second of



the current selection. Pressing and holding the SEEK button will allow faster scrolling through the tracks in CD and MP3 modes.

### **TIME Button**

Press this button to change the display from a large CD playing time display to a small CD playing time display.

### **RW/FF**

Press and hold FF (Fast Forward) and the CD player will begin to fast forward until FF is released or RW or another CD button is pressed. The RW (Reverse) button works in a similar manner.

### **AM/FM Button**

Press the button to select either AM or FM mode.

### **SET/RND Button (Random Play Button)**

Press this button while the CD is playing to activate Random Play. This feature plays the selections on the compact disc in random order to provide an interesting change of pace.

Press the right SEEK button to move to the next randomly selected track.

Press the SET/RND button a second time to stop Random Play.

### **Notes On Playing MP3 Files**

The radio can play MP3 files; however, acceptable MP3 file recording media and formats are limited. When writing MP3 files, pay attention to the following restrictions.

### **Supported Media (Disc Types)**

The MP3 file recording media supported by the radio are CDDA, CD-R, CD-RW, MP3, and CDDA+MP3.

### Supported Medium Formats (File Systems)

The medium formats supported by the radio are ISO 9660 Level 1 and Level 2 and includes the Joliet extension. When reading discs recorded using formats other than ISO 9660 Level 1 and Level 2, the radio may fail to read files properly and may be unable to play the file normally. UDF and Apple HFS formats are not supported.

The radio uses the following limits for file systems:

- Maximum number of folder levels: 8
- Maximum number of files: 255
- Maximum number of folders. (The radio display of file names and folder names is limited. For large numbers of files and/or folders, the radio may be unable to display the file name and folder name and will assign a number instead. With a maximum number of files,

exceeding 20 folders will result in this display. With 200 files, exceeding 50 folders will result in this display.)

- Maximum number of characters in file/folder names:
  - Level 1: 12 (including a separator "." and a three-character extension)
  - Level 2: 31 (including a separator "." and a three-character extension)

Multisession disc formats are supported by the radio. Multisession discs may contain combinations of normal CD audio tracks and computer files (including MP3 files). Discs created with an option such as "keep disc open after writing" are most likely multisession discs. The use of multisession for CD audio or MP3 playback may result in longer disc loading times.

### Supported MP3 File Formats

The radio will recognize only files with the \*.MP3 extension as MP3 files. Non-MP3 files named with the \*.MP3 extension may cause playback problems. The radio is designed to recognize the file as an invalid MP3 and will not play the file.

When using the MP3 encoder to compress audio data to an MP3 file, the bit rate and sampling frequencies in the following table are supported. In addition, variable bit rates (VBR) are also supported. The majority of MP3 files use a 44.1 kHz sampling rate and a 192, 160, 128, 96 or VBR bit rates.

MPEG Specification	Sampling Frequency (kHz)	Bit Rate (kbps)
MPEG-1 Audio Layer 3	48, 44.1, 32	320, 256, 224, 192, 160, 128, 112, 96, 80, 64, 56, 48, 40, 32

MPEG Specification	Sampling Frequency (kHz)	Bit Rate (kbps)
MPEG-2 Audio Layer 3	24, 22.05, 16	160, 128, 144, 112, 96, 80, 64, 56, 48, 40, 32, 24, 16, 8

ID3 Tag information for artist, song title, and album title are supported for version 1 ID3 tags. ID3 version 2 is not supported by the radios.

Playlist files are not supported. MP3 Pro files are not supported.

### Playback of MP3 Files

When a medium containing MP3 data is loaded, the radio checks all files on the medium. If the medium contains a lot of folders or files, the radio will take more time to start playing the MP3 files.

Loading times for playback of MP3 files may be affected by the following:

- Media - CD-RW media may take longer to load than CD-R media
- Medium formats - Multisession discs may take longer to load than non-multisession discs
- Number of files and folders - Loading times will increase with more files and folders

To increase the speed of disc loading, it is recommended to use CD-R media and single-session discs. To create a single-session disc, enable the "Disc at Once" option before writing to the disc.

### **LIST Button (CD Mode for MP3 Play)**

Pressing the LIST button will bring up a list of all folders on the disc. Scrolling up or down the list is done by turning the TUNE/SCROLL control knob. Selecting a folder by pressing the TUNE/SCROLL control knob will

begin playing the files contained in that folder (or the next folder in sequence if the selection does not contain playable files).

The folder list will time out after five seconds.

### **INFO Button (CD Mode for MP3 Play)**

Pressing the INFO button repeatedly will scroll through the following TAG information: Song Title, Artist, File Name, and Folder Name (if available).

Press the INFO button once more to return to "elapsed time" priority mode.

Press and hold the INFO button for three seconds or more and the radio will display song titles for each file.

Press and hold the INFO button again for three seconds to return to "elapsed time" display.

**Operation Instructions - Auxiliary Mode**

The auxiliary (AUX) jack is an audio input jack which allows the user to plug in a portable device such as an MP3 player or cassette player and utilize the vehicle's audio system to amplify the source and play through the vehicle speakers.

Pressing the AUX button will change the mode to auxiliary device if the AUX jack is connected.

**NOTE:** The AUX device must be turned on and the device's volume set to the proper level. If the AUX audio is not loud enough, turn the device's volume up. If the AUX audio sounds distorted, turn the device's volume down.

**TIME Button (Auxiliary Mode)**

Press this button to change the display to time of day. The time of day will display for five seconds (when the ignition is OFF).

**Operating Instructions - Uconnect™ Phone (If Equipped)**

Refer to "Uconnect™ Phone" in "Understanding The Features If Your Vehicle".

**Operating Instructions - Uconnect™ Multimedia (Satellite Radio) (If Equipped)**

Refer to "Uconnect™ Multimedia (Satellite Radio)".

**UNIVERSAL CONSUMER INTERFACE (UCI) — IF EQUIPPED**

**NOTE:** This section is for sales code RES and REQ/REL/RET radios only with uconnect™. For sales code RER, RBZ, REN, REP, REW, RB2 or REZ touch-screen radio UCI feature, refer to the separate RER, REN, RBZ, RB2 or REZ User's Manual. UCI is available only if equipped as an option with these radios.

This feature allows you to plug an iPod® into the vehicle's sound system through a 16-pin connector, using the provided interface cable.

UCI supports Mini, 4G, Photo, Nano, 5G iPod® and iPhone® devices. Some iPod® software versions may not fully support the UCI features. Please visit Apple's website for software updates.

**NOTE:**

- If the radio has a USB port, connecting an iPod® to this port does not play the media. For playing an iPod®, use the separate 16-pin connector port (in the glove compartment on some vehicles).
- Connecting an iPod® to the AUX port located in the radio faceplate, plays media, but does not use the UCI feature to control the connected device.

**Connecting The iPod®**

Use the provided connection cable to connect an iPod® to the vehicle's 16-pin connector port (which is located in the glove compartment on some vehicles). Once the iPod® is connected and synchronized to the vehicle's UCI system (iPod® may take a few seconds to connect), the iPod® starts charging and is ready for use by pressing radio switches, as described below.

**NOTE:**

- You may have to remove the connector pin protection cap from the 16-pin connector port, prior to connecting the cable.
- If the iPod® battery is completely discharged, it may not communicate with the UCI system until a minimum charge is attained. Leaving the iPod® connected to the UCI system may charge it to the required level.

## Using This Feature

By using the provided connection cable to connect an iPod® to the vehicle's UCI 16-pin connector port:

- The iPod® audio can be played on the vehicle's sound system, providing metadata (artist, track title, album, etc.) information on the radio display.
- The iPod® can be controlled using the radio buttons to Play, Browse, and List the iPod® contents.
- The iPod® battery charges when plugged into the UCI connector (if supported by the specific iPod® device)

## Controlling The iPod® Using Radio Buttons

To get into the UCI (iPod®) mode and access a connected iPod®, press the "AUX" button on the radio faceplate. Once in the UCI (iPod®) mode, iPod® audio tracks (if available from iPod®) start playing over the vehicle's audio system.

## Play Mode

When switched to UCI mode, the iPod® automatically starts Play mode. In Play mode, you may use the following buttons on the radio faceplate to control the iPod® and display data:

- Use the TUNE control knob to select the next or previous track.
  - Turning it clockwise (forward) by one click, while playing a track, skips to the next track.
  - Turning it counterclockwise (backward) by one click, during the first two seconds of the track, will jump to the previous track in the list. Turning this button at any other time in the track, will jump to the beginning of the current track.

- Jump backward in the current track by pressing and holding the **<< RW** button. Holding the **<< RW** button long enough will take you to the beginning of the current track.
- Jump forward in the current track by pressing and holding the **FF >>** button.
- A single press backward **<< RW** or forward **FF >>** will jump backward or forward respectively, for five seconds.
- Use the **<< SEEK** and **SEEK >>** buttons to jump to the previous or next track. If the **<< SEEK** button is pressed during the first two seconds of the track, it will jump to the previous track in the list; if you press this button at any other time in the track, it will jump to the beginning of the track. If you press the **SEEK >>** button during play mode, it will jump to the next track in the list.
- While a track is playing, press the **INFO** button to see the associated metadata (artist, track title, album, etc.) for that track. Pressing the **INFO** button again jumps to the next screen of data for that track. Once you have seen all screens, the last **INFO** button press will take you back to the play mode screen on the radio.
- Pressing the **REPEAT** button will change the iPod® mode to repeat the current playing track.
- Press the **SCAN** button to use iPod® scan mode, which will play the first five seconds of each track in the current list and then forward to the next song. To stop SCAN mode and start playing the desired track, when it is playing the track, press the **SCAN** button again. During Scan mode, you can also press the **<< SEEK** and **SEEK >>** buttons to select the previous and next tracks.



- **RND** button (available on sales code RES radio only): Pressing this button toggles between Shuffle ON and Shuffle OFF modes for the iPod®. If the **RND** icon is showing on the radio display, then the shuffle mode is ON.

### List Or Browse Mode

During Play mode, pressing any of the buttons described below, takes you to List mode. List mode enables you to scroll through the list of menus and tracks on the iPod®.

- **TUNE** control knob: The **TUNE** control knob functions in a similar manner as the scroll wheel on the iPod®.
  - Turning it clockwise (forward) and counterclockwise (backward) scrolls through the lists, displaying the track detail on the radio display. Once you have the track to be played highlighted on the radio display, press the **TUNE** control knob to select and start playing the track. Turning the **TUNE** control

knob fast will scroll through the list faster. During fast scroll, you may notice a slight delay in updating the information on the radio display.

- During all List modes, the iPod® displays all lists in “wrap-around” mode. So if the track is at the bottom of the list, just turn the wheel backwards (counter-clockwise) to get to the track faster.
- In List mode, the radio **PRESET** buttons are used as shortcuts to the following lists on the iPod®.
  - Preset 1 – Playlists
  - Preset 2 – Artists
  - Preset 3 – Albums
  - Preset 4 – Genres
  - Preset 5 – Audiobooks
  - Preset 6 – Podcasts

- Pressing a **PRESET** button will display the current list on the top line and the first item in that list on the second line.
- To Exit List mode without selecting a track, press the same **PRESET** button again to go back to **Play mode**.
- **LIST** button: The **LIST** button will display the top level menu of the iPod®. Turn the **TUNE** control knob to list the top-menu item you wish to select and press the **TUNE** control knob. This will display the next sub-menu list item on the iPod® then you can follow the same steps to go to the desired track in that list. Not all iPod® sub-menu levels are available on this system.
- **MUSIC TYPE** button: The **MUSIC TYPE** button is another shortcut button to the genre listing on your iPod®.

**CAUTION!**

- Leaving the iPod® (or any supported device) anywhere in the vehicle in extreme heat or cold can alter the operation or damage the device. Follow the device manufacturer's guidelines.
- Placing items on the iPod®, or connections to the iPod® in the vehicle, can cause damage to the device and/or to the connectors.

**WARNING!**

**Do not plug in or remove the iPod® while driving. Failure to follow this warning could result in an accident.**

**Uconnect™ Multimedia (SATELLITE RADIO) — IF EQUIPPED (REN/RER/RES RADIOS ONLY)**

Satellite radio uses direct satellite-to-receiver broadcasting technology to provide clear digital sound, coast to coast. The subscription service provider is Sirius Satellite Radio. This service offers over 130 channels of music, sports, news, entertainment, and programming for children, directly from its satellites and broadcasting studios.

**NOTE:** Sirius service is not available in Hawaii and has limited coverage in Alaska.

**System Activation**

Sirius Satellite Radio service is pre-activated, and you may begin listening immediately to the one year of audio service that is included with the factory-installed satellite radio system in your vehicle. Sirius will supply a welcome kit that contains general information, including how to setup your on-line listening account. For further

information, call the toll-free number 888-539-7474, or visit the Sirius web site at [www.sirius.com](http://www.sirius.com), or at [www.siriuscanada.ca](http://www.siriuscanada.ca) for Canadian residents.

**Electronic Serial Number/Sirius Identification Number (ESN/SID)**

Please have the following information available when calling:

1. The Electronic Serial Number/Sirius Identification Number (ESN/SID).
2. Your Vehicle Identification Number.

To access the ESN/SID, refer to the following steps:

**ESN/SID Access With RES Radios**

With the ignition switch in the ON/RUN or ACC position and the radio on, press the SETUP button and scroll using the TUNE/SCROLL control knob until Sirius ID is selected. Press the TUNE/SCROLL control knob and the

Sirius ID number will display. The Sirius ID number display will time out in two minutes. Press any button on the radio to exit this screen.

### **ESN/SID Access With REN/RER Radios**

While in SAT mode, press the MENU button on the radio faceplate.

Next, touch the SUBSCRIPTION tab on the touch screen. All the ESNs that apply to your vehicle will display.

### **Selecting Uconnect™ Multimedia (Satellite) Mode**

Press the SAT button until "SAT" appears in the display. A CD may remain in the radio while in the Satellite radio mode.

### **Satellite Antenna**

To ensure optimum reception, do not place items on the roof around the rooftop antenna location. Metal objects placed within the line of sight of the antenna will cause decreased performance. Larger luggage items such as

bikes should be placed as far rearward as possible, within the loading design of the rack. Do not place items directly on or above the antenna.

### **Reception Quality**

Satellite reception may be interrupted due to one of the following reasons:

- The vehicle is parked in an underground parking structure or under a physical obstacle.
- Dense tree coverage may interrupt reception in the form of short audio mutes.
- Driving under wide bridges or along tall buildings can cause intermittent reception.
- Placing objects over or too close to the antenna can cause signal blockage.

## Operating Instructions - Uconnect™ Multimedia (Satellite) Mode

**NOTE:** The ignition switch must be in the ON or ACC position to operate the radio.

### SEEK Buttons

Press and release the SEEK buttons to search for the next channel in Satellite mode. Press the right switch to seek up and the left switch to seek down. The radio will remain tuned to the new channel until you make another selection. Holding either button will bypass channels without stopping until you release it.

### SCAN Button

Pressing the SCAN button causes the tuner to search for the next channel, pausing for eight seconds before continuing to the next. To stop the search, press the SCAN button a second time.

### INFO Button

Pressing the INFO button will cycle the display information between Artist, Song Title, and Composer (if available). Also, pressing and holding the INFO button for an additional three seconds will make the radio display the Song Title all of the time (press and hold again to return to normal display).

### RW/FF

Pressing the RW (Rewind) or FF (Fast Forward) buttons causes the tuner to search for the next channel in the direction of the arrows.

### TUNE Control (Rotary)

Turn the rotary TUNE/SCROLL control knob clockwise to increase or counterclockwise to decrease the channel.

### **MUSIC TYPE Button**

Pressing this button once will turn on the Music Type mode for five seconds. Pressing the MUSIC TYPE button or turning the TUNE/SCROLL control knob within five seconds will allow the program format type to be selected.

Toggle the MUSIC TYPE button again to select the music type.

By pressing the SEEK button when the Music Type function is active, the radio will be tuned to the next channel with the same selected Music Type name.

If a preset button is activated while in the Music Type (Program Type) mode, the Music Type mode will be exited and the radio will tune to the preset channel.

### **SETUP Button**

Pressing the SETUP button allows you to select the following items:

- Display Sirius ID number — Press the AUDIO/SELECT button to display the Sirius ID number. This number is used to activate, deactivate, or change the Sirius subscription.

### **SET Button – To Set the Pushbutton Memory**

When you are receiving a channel that you wish to commit to pushbutton memory, press the SET button. The symbol SET 1 will now show in the display window. Select the button (1-6) you wish to lock onto this channel and press and release that button. If a button is not selected within five seconds after pressing the SET button, the channel will continue to play but will not be stored into pushbutton memory.

You may add a second channel to each pushbutton by repeating the above procedure with this exception: Press the SET button twice and SET 2 will show in the display window. Each button can be set for SET 1 and SET 2. This allows a total of 12 Satellite channels to be stored into

pushbutton memory. The channels stored in SET 2 memory can be selected by pressing the pushbutton twice.

Every time a preset button is used, a corresponding button number will display.

### **Buttons 1 - 6**

These buttons tune the radio to the channels that you commit to pushbutton memory (12 Satellite stations).

### **Operating Instructions - Uconnect™ Phone (If Equipped)**

Refer to “Uconnect™ Phone” in “Understanding The Features Of Your Vehicle”.

### **REMOTE SOUND SYSTEM CONTROLS — IF EQUIPPED**

The remote sound system controls are located on the rear surface of the steering wheel. Reach behind the wheel to access the switches.



045105562

### **Remote Sound System Controls (Back View Of Steering Wheel)**

The right hand control is a rocker type switch with a pushbutton in the center. Pressing the top of the switch will increase the volume, and pressing the bottom of the switch will decrease the volume.

The button located in the center of the right hand control will switch modes to Radio, CD or other valid audio source.

The left hand control is a rocker type switch with a pushbutton in the center. The function of the left hand control is different depending on which mode you are in.

The following describes the left hand control operation in each mode.

### **Radio Operation**

Pressing the top of the switch will SEEK up for the next listenable station and pressing the bottom of the switch will SEEK down for the next listenable station.

The button located in the center of the left hand control will tune to the next pre-set station that you have programmed in the radio pre-set pushbuttons.

### **CD Player**

Pressing the top of the switch once will go to the next track on the CD. Pressing the bottom of the switch once will go to the beginning of the current track or to the beginning of the previous track if it is within one second after the current track begins to play.

If you press the switch up or down twice it plays the second track, three times, it will play the third, etc.

The button in the center of the left hand switch changes CDs on the 6-Disc in-dash CD changer radio. This button does not function for all other radios.

### **CD/DVD DISC MAINTENANCE**

To keep a CD/DVD in good condition, take the following precautions:

1. Handle the disc by its edge; avoid touching the surface.



2. If the disc is stained, clean the surface with a soft cloth, wiping from center to edge.
3. Do not apply paper or tape to the disc; avoid scratching the disc.
4. Do not use solvents such as benzene, thinner, cleaners, or anti-static sprays.
5. Store the disc in its case after playing.
6. Do not expose the disc to direct sunlight.
7. Do not store the disc where temperatures may become too high.

**NOTE:** If you experience difficulty in playing a particular disc, it may be damaged (i.e., scratched, reflective coating removed, a hair, moisture or dew on the disc) oversized, or have protection encoding. Try a known good disc before considering disc player service.

## **RADIO OPERATION AND CELLULAR PHONES**

Under certain conditions, the operation of a cellular phone in your vehicle can cause erratic or noisy performance from your radio. This condition may be lessened or eliminated by relocating the cellular phone antenna. This condition is not harmful to the radio. If your radio performance does not satisfactorily “clear” by the repositioning of the antenna, it is recommended that the radio volume be turned down or off during cellular phone operation.

## **CLIMATE CONTROLS**

The Climate Control System allows you to regulate the temperature, amount, and direction of air circulating throughout the vehicle. The controls are located on the instrument panel below the radio.

**NOTE:** During snowplow usage on vehicles equipped with outside temperature display, the display may show

higher temperatures than the outside ambient temperature. The higher displayed temperature is due to blocked or reduced airflow to the underhood ambient temperature sensor caused by the snowplow. In addition, on vehicles equipped with Automatic Temperature Control (ATC), it is suggested that the interior cabin temperature be manually controlled should the system not perform as desired while in automatic mode. Both the outside temperature display and ATC operation will return to normal when the snowplow is removed.

### Manual Heating and Air Conditioning System

The controls for the manual heating and air conditioning system in this vehicle consist of a series of outer rotary dials and inner push knobs. These comfort controls can be set to obtain desired interior conditions.

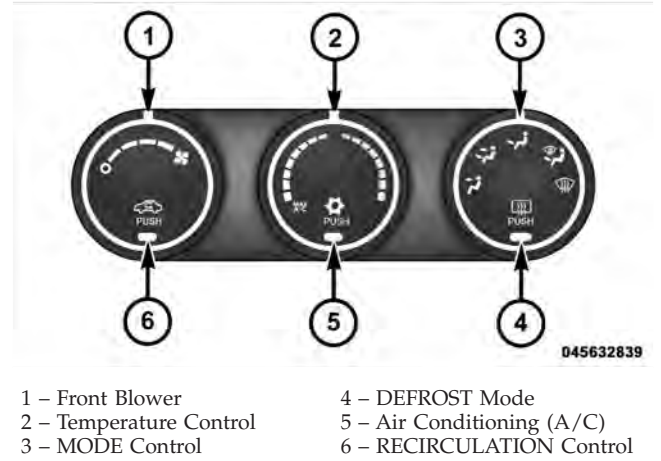

## Front Blower Control



045632841

There are four blower speeds. Use this control to regulate the amount of air forced through the system in any mode you select. The blower speed increases as you move the control clockwise from the OFF position.

**NOTE:** For vehicles equipped with Remote Start, the climate controls will not function during Remote Start operation if the blower control is left in the OFF position.

## Temperature Control



045632845

Use this control to regulate the temperature of the air inside the passenger compartment. Rotating the knob counterclockwise, from top center into the blue area of the scale, indicates cooler

temperatures. Rotating the knob clockwise, into the red area, indicates warmer temperatures.

**NOTE:** If your air conditioning performance seems lower than expected, check the front of the A/C condenser (located in front of the radiator), for an accumulation of dirt or insects. Clean with a gentle water spray from behind the radiator and through the condenser. Fabric front fascia protectors may reduce airflow to the condenser, reducing air conditioning performance.

## Mode Control (Air Direction)



045632842

Mode control allows you to choose from several patterns of air distribution. You can select either a primary mode, as identified by the symbols, or a blend of two of these modes. The closer the control is to a particular mode, the more air distribution you

receive from that mode.

### Panel Mode

 Air is directed through the outlets in the instrument panel. These outlets can be adjusted to direct airflow.

### Bi-Level Mode

 Air is directed through the panel and floor outlets.

**NOTE:** There is a difference in temperature (in any conditions other than full cold or full hot), between the upper and lower outlets for added comfort. The warmer air goes to the floor outlets. This feature gives improved comfort during sunny but cool conditions.

### Floor Mode

 Air is directed through the floor outlets with a small amount through the defrost and side window demist outlets.

### Mix Mode

 Air is directed through the floor, defrost and side window demist outlets. This setting works best in cold or snowy conditions that require extra heat at the windshield. This setting is good for maintaining comfort, while reducing moisture on the windshield.

### Defrost Mode

 Air is directed through the windshield and side window demist outlets. Use the DEFROST mode with maximum blower and warm temperature settings for best windshield and side window defrosting.

**NOTE:** The air conditioning compressor operates in MIX and DEFROST, or a blend of these modes even if the A/C button is not pressed. This dehumidifies the air to help dry the windshield. To improve fuel economy, use these modes only when necessary.

## Recirculation Control



045632843

Press this button to choose between outside air intake or recirculation of the air inside the vehicle. A LED will illuminate when you are in Recirculation mode. Only use the Recirculation mode to temporarily block out any outside odors, smoke, or dust, and to

cool the interior rapidly upon initial start-up in very hot or humid weather.

### NOTE:

- If the RECIRCULATION button is pressed when the system is in Mix or Defrost mode the Recirculation LED indicator will flash three times and then turn off to indicate Recirculation mode is not allowed.
- Continuous use of the Recirculation mode may make the inside air stuffy and window fogging may occur. Extended use of this mode is not recommended.

- In cold or damp weather, the use of the Recirculation mode will cause windows to fog on the inside because of moisture buildup inside the vehicle. For maximum defogging, select the Outside Air position.
- The A/C can be deselected manually without disturbing the mode control selection by pressing the A/C button.

## Air Outlets

The airflow from each of the instrument panel outlets can be adjusted for direction, and turned on or off to control airflow.

**NOTE:** For maximum airflow to the rear, the center instrument panel outlets can be directed toward the rear seat passengers.

### Economy Mode

If ECONOMY mode is desired, press the A/C button to turn off the LED indicator and the A/C compressor. Rotate the temperature control knob to the desired temperature.

### Air Conditioning Operation



045632844

Push this button to engage the Air Conditioning (A/C). A LED will illuminate when the A/C system is engaged.

### MAX A/C



045632845

For maximum cooling, when MAX A/C is selected the A/C is turned on automatically and the air is recirculated.

**NOTE:** A/C cannot be deselected when in MAX A/C position. The LED will blink three times if the A/C button is pushed.

### Automatic Temperature Control (ATC) — If Equipped

- The Automatic Temperature Control (ATC) allows both driver and front passenger seat occupants to select individual comfort settings.
- When occupants in the vehicle select an Auto mode operation, Auto blower operation is set by using rotary knobs on the control unit and a comfort temperature setting by using the temperature up and down buttons.
- The system provides set-and-forget operation for optimum comfort and convenience.

## 254 UNDERSTANDING YOUR INSTRUMENT PANEL

- The system can be controlled manually, if desired.
- SYNC feature links the temperature controls, the passenger side temperature becomes the same as the temperature selected by the driver.

The ATC system automatically maintains the interior comfort level desired by the driver and all passengers.

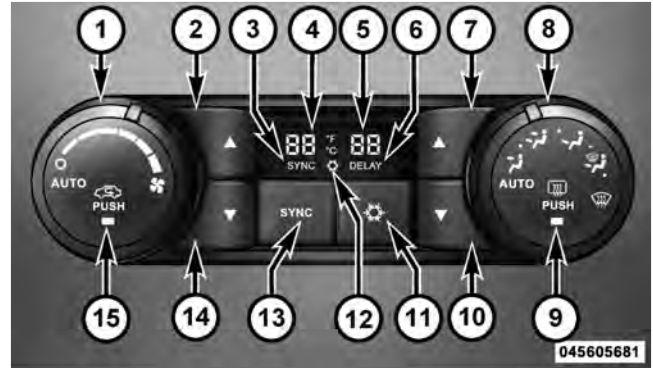

**Automatic Temperature Control (ATC) Panel**

- |                                 |                              |
|---------------------------------|------------------------------|
| 1 - Blower Control              | 9 - DEFROST                  |
| 2 - Left Temperature Up         | 10 - Right Temperature Down  |
| 3 - SYNC Indicator              | 11 - A/C                     |
| 4 - Left Temperature Indicator  | 12 - A/C Indicator           |
| 5 - Right Temperature Indicator | 13 - SYNC Temperature Button |
| 6 - DELAY Indicator             | 14 - Left Temperature Down   |
| 7 - Right Temperature Up        | 15 - RECIRCULATE             |
| 8 - MODE                        |                              |

## Automatic Operation

1. Position the MODE control knob to the Auto position on the Automatic Temperature Control (ATC) Panel.
2. Position the BLOWER control knob in the Auto position on the ATC Panel.
3. Next, adjust the temperature you would like the system to maintain by adjusting the driver and front passenger temperature buttons. Once the desired temperature is displayed, the system will achieve and automatically maintain that comfort level.
4. When the system is set up for your comfort level, it is not necessary to change the settings. You will experience the greatest efficiency by simply allowing the system to function automatically.

## NOTE:

- It is not necessary to move the temperature settings for cold or hot vehicles. The system automatically adjusts the temperature, mode and fan speed to provide comfort as quickly as possible.
- The temperature can be displayed in U.S. or Metric units by selecting the US/M customer-programmable feature. Refer to the “Electronic Vehicle Information Center (EVIC) — Customer-Programmable Features (SETUP)” in this section of the manual.

To provide you with maximum comfort in the Automatic mode, during cold start-ups the blower fan will remain on low and the DELAY symbol will appear in the ATC display until the engine warms up. The blower will increase in speed and transition into Auto mode and DELAY will no longer be illuminated in the display. The



blower will engage immediately if the Defrost mode is selected, or by adjusting the blower control knob and setting the fan to any fixed speed.

### Manual Operation

This system offers a full complement of manual override features.

**NOTE:** Each of these features operate independently from each other. If any one feature is controlled manually, the temperature doors will continue to operate automatically.



045605986

**Blower Control**

There are six fixed blower speeds. Use this control to regulate the amount of air forced through the system in any mode you select. The blower speed increases as you move the control clockwise from the OFF position.

The blower fan speed can be set to any fixed speed by adjusting the blower control knob. The fan will now operate at a fixed speed until additional speeds are selected. This allows the front occupants to control the volume of air circulated in the vehicle and cancel the Auto mode.

The operator can also select the direction of the airflow by selecting one of the following positions.

### Panel Mode

 Air comes from the outlets in the instrument panel. Each of these outlets can be individually adjusted to direct the flow of air. The air vanes of the center outlets and outboard outlets can be rotated to regulate or shut off the airflow from these outlets.

### Bi-Level Mode

 Air comes from the instrument panel outlets, floor outlets and defrost outlets.

**NOTE:** In many temperature positions, the BI-LEVEL mode is designed to provide cooler air out of the panel outlets and warmer air from the floor outlets.

### Floor Mode

 Air comes from the floor outlets. A slight amount of air is directed through the defrost and side window demister outlets.

### Mix Mode

 Air comes from the floor, defrost and side window demist outlets. This mode works best in cold or snowy conditions. It allows you to stay comfortable while keeping the windshield clear.

### Defrost Mode

 Air comes from the windshield and side window demister outlets. Use Defrost mode with maximum blower and temperature settings for best windshield and side window defrosting.

**NOTE:** While operating in the other modes, the system will not automatically sense the presence of fog, mist or ice on the windshield. Defrost mode must be manually selected to clear the windshield and side glass.



The Air Conditioning (A/C) button allows the operator to manually activate or deactivate the air conditioning system. When in A/C mode and the ATC is set to a cool temperature, dehumidified air flows through the air outlets. If Economy mode is desired, press the A/C button to turn off the A/C mode in the ATC display and deactivate the A/C system.

### NOTE:

- If the system is in Mix, Bi-Level or Defrost Mode, the A/C can be turned off, but the A/C system shall remain active to prevent fogging of the windows.
- If fog or mist appears on the windshield or side glass, select Defrost mode and increase blower speed.

## Recirculation Control



When outside air contains smoke, odors, or high humidity, or if rapid cooling is desired, you may wish to recirculate interior air by pressing the RECIRCULATION control button.

Recirculation mode should only be used temporarily. The recirculation LED will illuminate on the blower control knob when this button is selected. Push the button a second time to turn off the Recirculation mode LED and allow outside air into the vehicle.

**NOTE:** In cold weather, use of Recirculation mode may lead to excessive window fogging. The Recirculation mode is not allowed in the Floor/Defrost Mix and Defrost modes to improve window clearing operation. Recirculation will be disabled automatically if these modes are selected.

## Summer Operation

The engine cooling system in air conditioned vehicles must be protected with a high-quality antifreeze coolant to provide proper corrosion protection and to protect against engine overheating. A solution of 50% ethylene glycol antifreeze coolant and 50% water is recommended. Refer to “Maintenance Procedures” in “Maintaining Your Vehicle” for proper coolant selection.

## Winter Operation

To ensure the best possible heater and defroster performance, make sure the engine cooling system is functioning properly and the proper amount, type, and concentration of coolant is used. Refer to “Maintenance Procedures” in “Maintaining Your Vehicle” for proper coolant selection. Use of the air Recirculation mode during Winter months is not recommended because it may cause window fogging.

### **Vacation/Storage**

Any time you store your vehicle or keep it out of service (i.e., vacation) for two weeks or more, run the air conditioning system at idle for about five minutes in fresh air with the blower setting in high. This will ensure adequate system lubrication to minimize the possibility of compressor damage when the system is started again.

### **Window Fogging and Frosting**











Vehicle windows tend to fog on the inside of the glass in mild, rainy and/or humid weather. Windows may frost on the inside of the glass in very cold weather. To clear

the windows, select Defrost or Mix mode and increase the front blower speed. Do not use the Recirculation mode without A/C for long periods, as fogging may occur.

### **Outside Air Intake**

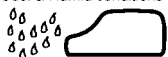
Make sure the air intake, located directly in front of the windshield, is free of obstructions such as leaves. Leaves collected in the air intake may reduce airflow, can cause odor, and if they enter the plenum they could plug the water drains. In Winter months make sure the air intake is clear of ice, slush and snow.

## Operating Tips

WEATHER	CONTROL SETTINGS
Hot weather and vehicle interior is very hot 	Set the mode control to  ,  on, and blower on high. Roll down the windows for a minute to flush out the hot air. Once comfort is achieved adjust controls for comfort.
Warm weather 	Turn  on and set the mode control to the  position.
Cool Sunny	Operate in  position.
Cool & Humid conditions 	Set the mode control to  and turn on  to keep windows clear.
Cold Weather	Set the mode control to the  position. If windshield fogging starts to occur, move the control towards the  position.

# STARTING AND OPERATING

## CONTENTS

---

■ Starting Procedures . . . . .	265	□ Brake/Transmission Interlock Manual Override . . . . .	269
□ Normal Starting . . . . .	265	□ Five-Speed Automatic Transmission (545RFE) — 5.7L Engine Only . . . . .	270
□ Automatic Transmission . . . . .	265	■ Four-Wheel Drive Operation — If Equipped . .	277
□ If Engine Fails To Start . . . . .	266	□ Manually Shifted Transfer Case – If Equipped . . . . .	277
□ After Starting . . . . .	267	□ Shifting Procedure – Manually Shifted Transfer Case . . . . .	279
■ Engine Block Heater — If Equipped . . . . .	267	□ Transfer Case Position Indicator Light . . . . .	280
■ Automatic Transmission . . . . .	268		
□ Key Ignition Park Interlock . . . . .	269		
□ Brake/Transmission Shift Interlock System . .	269		

- Electronically Shifted Transfer Case  
(Four-Position Switch) – If Equipped . . . . . 280
- Shifting Procedure . . . . . 285
- Limited-Slip Differential . . . . . 287
- Driving On Slippery Surfaces . . . . . 288
- Driving Through Water . . . . . 288
  - Flowing/Rising Water . . . . . 289
  - Shallow Standing Water . . . . . 289
- Power Steering . . . . . 291
  - Power Steering Fluid Check . . . . . 292
- Parking Brake . . . . . 292
- Brake System . . . . . 295
  - Dual Rear Wheel Models Only . . . . . 295
  - Four-Wheel Anti-Lock Brake System . . . . . 295
- Tire Safety Information . . . . . 297
  - Tire Markings . . . . . 297
  - Tire Identification Number (TIN) . . . . . 301
  - Tire Terminology And Definitions . . . . . 302
  - Tire Loading And Tire Pressure . . . . . 303
- Tires — General Information . . . . . 307
  - Tire Pressure . . . . . 307
  - Tire Inflation Pressures . . . . . 308
  - Radial Ply Tires . . . . . 313
  - Tire Spinning . . . . . 313
  - Tread Wear Indicators . . . . . 314
  - Life Of Tire . . . . . 314

□ Replacement Tires . . . . .	315	□ Fuel System Cautions . . . . .	324
■ Supplemental Tire Pressure Information — If Equipped . . . . .	317	□ Carbon Monoxide Warnings . . . . .	325
■ Tire Chains . . . . .	317	■ Adding Fuel . . . . .	326
■ Snow Tires . . . . .	319	□ Loose Fuel Filler Cap Message . . . . .	327
■ Tire Rotation Recommendations . . . . .	319	■ Vehicle Loading . . . . .	328
□ Dual Rear Wheels . . . . .	320	□ Certification Label . . . . .	328
■ Fuel Requirements . . . . .	321	■ Trailer Towing . . . . .	330
□ Reformulated Gasoline . . . . .	322	□ Common Towing Definitions . . . . .	330
□ Gasoline/Oxygenate Blends . . . . .	322	□ Trailer Hitch Classification . . . . .	333
□ E-85 Usage In Non-Flex Fuel Vehicles . . . . .	323	□ Trailer Towing Weights (Maximum Trailer Weight Ratings) . . . . .	334
□ MMT In Gasoline . . . . .	323	□ Trailer And Tongue Weight . . . . .	334
□ Materials Added To Fuel . . . . .	324	□ Towing Requirements . . . . .	335



- Towing Tips . . . . . 343
- Snowplow . . . . . 344
  - Before Plowing . . . . . 345
  - Snowplow Prep Package Model Availability . . . . . 345
  - Over The Road Operation With Snowplow Attached . . . . . 346
  - Operating Tips . . . . . 346
- General Maintenance . . . . . 347
- Recreational Towing (Behind Motorhome, Etc.) . . . . . 347
  - Recreational Towing – Two-Wheel Drive Models . . . . . 347
  - Recreational Towing – Four-Wheel Drive Models . . . . . 348

## STARTING PROCEDURES

Before starting your vehicle, adjust your seat, adjust both inside and outside mirrors, and fasten your seat belt.

The starter should not be operated for more than 15-second intervals. Waiting a few seconds between such intervals will protect the starter from overheating.

### WARNING!

- Accidents can be caused by inadvertently moving the shift lever or by pressing the accelerator pedal. This may cause excessive heat in the exhaust system, resulting in overheating and vehicle fire which may cause serious or fatal injuries.
- Do not leave children or animals inside parked vehicles in hot weather. Interior heat buildup may cause serious injury or death.

## Normal Starting

Normal starting of either a warm or cold engine is obtained without pumping or pressing the accelerator pedal. Turn the key fob to the START position and release when the engine starts. If the engine fails to start within 10 seconds, turn the key fob to the OFF position, wait five seconds, then repeat the “Normal Starting” procedure.

## Automatic Transmission

Start the engine with the shift lever in the NEUTRAL or PARK position. Apply the brake before shifting into any driving range.

**NOTE:** This vehicle is equipped with a transmission shift interlocking system. The brake pedal must be pressed to shift out of PARK.

### Tip Start Feature

Do not press the accelerator. Turn the ignition switch briefly to the START position and release it. The starter motor will continue to run but will automatically disengage when the engine is running.

### If Engine Fails To Start

If the engine fails to start after you have followed the "Normal Starting" procedure, it may be flooded. Push the accelerator pedal all the way to the floor and hold it there while cranking the engine. This should clear any excess fuel in case the engine is flooded.

#### CAUTION!

To prevent damage to the starter, do not crank the engine for more than 15 seconds at a time. Wait 10 to 15 seconds before trying again.

#### WARNING!

- Never pour fuel or other flammable liquids into the throttle body air inlet opening in an attempt to start the vehicle. This could result in a flash fire causing serious personal injury.
- Do not attempt to push or tow your vehicle to get it started. Vehicles equipped with an automatic transmission cannot be started this way. Unburned fuel could enter the catalytic converter and once the engine has started, ignite and damage the converter and vehicle.
- If the vehicle has a discharged battery, booster cables may be used to obtain a start from a booster battery or the battery in another vehicle. This type of start can be dangerous if done improperly. Refer to "Jump Starting" in "What To Do In Emergencies" for further information.

If the engine has been flooded, it may start to run, but not have enough power to continue running when the key fob is released. If this occurs, continue cranking with the accelerator pedal pushed all the way to the floor. Release the accelerator pedal and the key fob once the engine is running smoothly.

If the engine shows no sign of starting after two 15-second periods of cranking with the accelerator pedal held to the floor, the “Normal Starting” procedure should be repeated.

### **After Starting**

The idle speed is automatically controlled and will decrease as the engine warms up.

### **ENGINE BLOCK HEATER — IF EQUIPPED**

The engine block heater warms the engine and permits quicker starts in cold weather. Connect the cord to a standard 110-115 Volt AC electrical outlet with a grounded, three-wire extension cord.

### **3500 Models — 5.7L Engine Only**

The engine block heater cord is routed through the grille by the right front tow hook.

It includes a removable cap that is secured by a tethered strap. It also has a c-clip that is used for storage when not in use for the winter months. During winter months, remove the heater cord wiring assembly from itself on the c-clip.

### **WARNING!**

**Remember to disconnect the cord before driving. Damage to the 110-115 Volt electrical cord could cause electrocution.**

**AUTOMATIC TRANSMISSION****CAUTION!**

Damage to the transmission may occur if the following precautions are not observed:

- Shift into PARK only after the vehicle has come to a complete stop.
- Shift into or out of REVERSE only after the vehicle has come to a complete stop and the engine is at idle speed.
- Do not shift from REVERSE, PARK, or NEUTRAL into any forward gear when the engine is above idle speed.
- Before shifting into any gear, make sure your foot is firmly on the brake pedal.

**WARNING!**

- It is dangerous to move the shift lever out of PARK or NEUTRAL if the engine speed is higher than idle speed. If your foot is not firmly on the brake pedal, the vehicle could accelerate quickly forward or in reverse. You could lose control of the vehicle and hit someone or something. Only shift into gear when the engine is idling normally and when your right foot is firmly on the brake pedal.

*(Continued)*

**WARNING! (Continued)**

- Unintended movement of a vehicle could injure those in and near the vehicle. As with all vehicles, you should never exit a vehicle while the engine is running. Before exiting a vehicle, you should always shift the transmission into PARK, remove the key fob from the ignition, and apply the parking brake. Once the key fob is removed from the ignition, the shift lever is locked in the PARK position, securing the vehicle against unwanted movement. Furthermore, you should never leave unattended children inside a vehicle.

**Key Ignition Park Interlock**

This vehicle is equipped with a Key Ignition Park Interlock which requires the shift lever to be placed in PARK prior to rotating the ignition switch to the LOCK position. The key fob can only be removed from the ignition

switch when the ignition switch is in the LOCK position and once removed the shift lever is locked in PARK.

**Brake/Transmission Shift Interlock System**

This vehicle is equipped with a Brake Transmission Shift Interlock System (BTSI) that holds the shift lever in the PARK position when the ignition switch is in the LOCK position. To move the shift lever out of the PARK position, the ignition switch must be turned to any other ignition switch position (ACC, ON, or START) (engine running or not) and the brake pedal must be pressed.

**Brake/Transmission Interlock Manual Override**

There is an override for the BTSI that allows you to move the shift lever out of the PARK position if an electrical system malfunction occurs (i.e., dead battery).

1. Turn the ignition switch to the ACC or ON position without starting the engine.
2. Tilt the steering wheel to the full up position

3. Firmly set the parking brake.
4. Press and maintain firm pressure on the brake pedal.
5. Using the screwdriver or other suitable tool, press and hold the override tab through the access port (ringed circle) on the bottom of the steering column.

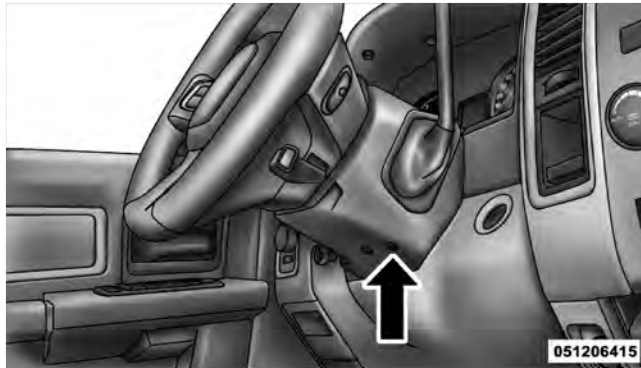

**Interlock Manual Override**

6. Move the shift lever into the NEUTRAL position.
7. The vehicle may then be started in NEUTRAL.

### **Five-Speed Automatic Transmission (545RFE) — 5.7L Engine Only**

The shift lever display located in the instrument panel cluster indicates the transmission gear range. The shift lever is mounted either on the right side of the steering column (if equipped) or on the floor console (if equipped). You must press the brake pedal to move the shift lever out of the PARK position. To drive, move the shift lever from PARK or NEUTRAL to the DRIVE position. Pull the shift lever toward you when shifting into REVERSE or PARK, or when shifting out of PARK.

### **Electronic Range Select (ERS) Operation**

The Electronic Range Select (ERS) shift control allows you to limit the highest available gear when the shift lever is in the DRIVE position. Move the console shift lever left (-) or right (+), or toggle the switch on the

column shift lever down (-) or up (+) to select the desired top gear. For example, if the driver shifts the transmission into 3 (third gear), the transmission will never shift above third gear, but can shift down to 2 (second gear) or 1 (first gear), when needed.

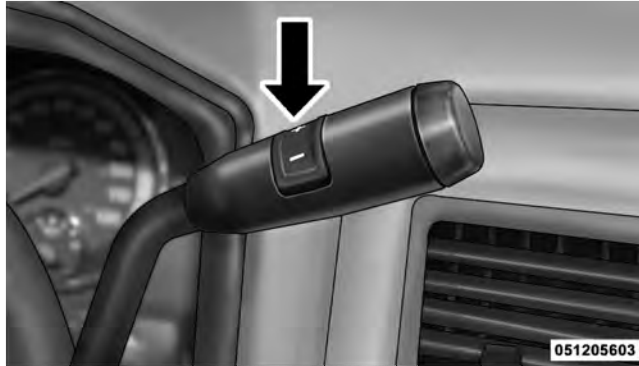

Column Shift Lever

On vehicles equipped with 5.7L engines, use of ERS (or “TOW/HAUL” mode) also enables an additional underdrive gear which is not normally used during through-gear accelerations. This additional gear improves vehicle performance and cooling capability when towing a trailer on certain grades. In ERS mode, first through third gear are underdrive gears, and fourth gear is direct drive. ERS fifth gear (Overdrive) is the same as the normal fourth gear.

When in the DRIVE position in first through fourth gear, the first tap down (-), will display the ERS designation for the current gear (the transmission will not downshift). For example, if you are in DRIVE and are in third (direct) gear, when you tap the shift lever/switch one time in the (-) direction, the display will show 4 (ERS 4 is direct gear). Another tap down (-) will shift the transmission down to ERS 3 (the added underdrive gear). When in the DRIVE position in fifth gear, the first tap down (-) will downshift



the transmission and display 5 (ERS 5 is the same as normal fourth gear). Another tap down (-) will shift the transmission down to ERS 4 (direct gear).

To exit ERS mode, press and hold the top of the switch/shift lever in the (+) direction until "D" is once again highlighted in the instrument cluster display.

### WARNING!

**Do not downshift for additional engine braking on a slippery surface. The drive wheels could lose their grip and the vehicle could skid.**

Screen Display	<b>1</b>	<b>2</b>	<b>3</b>	<b>4</b>	<b>5</b>	<b>D</b>
Actual Gear(s) Allowed	1	1-2	1-3	1-4	1-5	1-5

**NOTE:** To select the proper gear position for maximum deceleration (engine braking), press and hold the ERS (-) button. The transmission will shift to the lowest range possible without overspeeding the engine.

### Gear Ranges

Do not race the engine when shifting from PARK or NEUTRAL position into another gear range.

### PARK

This range supplements the parking brake by locking the transmission. The engine can be started in this range. Never use PARK while the vehicle is in motion. Apply the parking brake when leaving the vehicle in this range. Always apply the parking brake first, then place the shift lever in the PARK position. On four-wheel drive vehicles, be sure that the transfer case is in a DRIVE position.

**WARNING!**

- Never use the PARK position as a substitute for the parking brake. Always apply the parking brake fully when parked to guard against vehicle movement and possible injury or damage.
- Your vehicle could move and injure you and others if it is not completely in PARK. Check by trying to move the shift lever back and forth without first pulling it toward you after you have set it in PARK. Make sure it is in PARK before leaving the vehicle.

*(Continued)*

**WARNING! (Continued)**

- It is dangerous to move the shift lever out of PARK or NEUTRAL if the engine speed is higher than idle speed. If your foot is not firmly on the brake pedal, the vehicle could accelerate quickly forward or in reverse. You could lose control of the vehicle and hit someone or something. Only shift into gear when the engine is idling normally and when your foot is firmly on the brake pedal.

**5****REVERSE**

This range is for moving the vehicle rearward. Use this range only after the vehicle has come to a complete stop.

**NEUTRAL**

This range is for when the vehicle is standing for prolonged periods with the engine running. The engine may be started in this range. Set the parking brake if you must leave the vehicle.

### *DRIVE*

This range provides all forward gears, including third gear direct and fourth and fifth gear overdrive (Refer to Overdrive Operation). Use this range for most city and highway driving.

### **Overdrive Operation**

The Overdrive automatic transmission contains an electronically controlled fourth and fifth gear (Overdrive). The transmission will automatically shift from DRIVE to Overdrive if the following conditions are present:

- the shift lever is in DRIVE;
- the engine coolant (antifreeze) has reached normal operating temperature;
- vehicle speed is above approximately 30 mph (48 km/h);
- the “TOW/HAUL” switch has not been activated;

- transmission has reached normal operating temperature.

**NOTE:** If the vehicle is started in extremely cold temperatures, the transmission may not shift into Overdrive and will automatically select the most desirable gear for operation at this temperature. Normal operation will resume when the transmission fluid temperature has risen to a suitable level.

If the transmission temperature gets extremely hot, the transmission will automatically select the most desirable gear for operation at this temperature. If the transmission temperature becomes hot enough, the “Transmission Temperature Warning Light” may illuminate and the transmission may downshift out of Overdrive until the transmission cools down. After cool down, the transmission will resume normal operation.

The transmission will downshift from Overdrive to DRIVE if the accelerator pedal is fully pressed at vehicle speeds above approximately 35 mph (56 km/h).

### When To Use “TOW/HAUL” Mode

When driving in hilly areas, towing a trailer, carrying a heavy load, etc., and frequent transmission shifting occurs, press the “TOW/HAUL” switch. This will improve performance and reduce the potential for transmission overheating or failure due to excessive shifting. When operating in the “TOW/HAUL” mode, fifth gear is disabled and 2-3 and 3-4 shift patterns are modified.



### TOW/HAUL Switch

Shifts into Overdrive (normal fourth gear) are allowed during steady cruise (for improved fuel economy) and automatic closed-throttle downshifts to direct gear and a special underdrive gear (refer to “Electronic Range Select” in this section) are performed (for improved braking) when driving conditions warrant.

The “TOW/HAUL Indicator Light” will illuminate in the instrument cluster to indicate when the switch has been activated. Pressing the switch a second time restores normal operation. If the “TOW/HAUL” mode is desired, the button must be pressed each time the engine is started.

### **Torque Converter Clutch**

A feature designed to improve fuel economy has been included in the automatic transmission on your vehicle. A clutch within the torque converter engages automatically at calibrated speeds. This may result in a slightly different feeling or response during normal operation in the upper gears. When the vehicle speed drops or during acceleration when the transmission downshifts to second gear, the clutch automatically disengages.

#### **NOTE:**

- The torque converter clutch will not engage until the transmission fluid and engine coolant (antifreeze) are

warm [usually after 1 to 3 miles (1.6 to 4.8 km) of driving]. Because the engine speed is higher when the torque converter clutch is not engaged, it may seem as if the transmission is not shifting into Overdrive when cold. This is normal. Pressing the “TOW/HAUL” switch when the transmission is sufficiently warm will demonstrate that the transmission is able to shift into and out of Overdrive.

- If the vehicle has not been driven in several days, the first few seconds of operation after shifting the transmission into gear may seem sluggish. This is due to the fluid partially draining from the torque converter into the transmission. This condition is normal and will not cause damage to the transmission. The torque converter will refill within five seconds of shifting from PARK into any other gear position.

## FOUR-WHEEL DRIVE OPERATION — IF EQUIPPED

Four-wheel drive trucks are equipped with either a manually shifted transfer case or an electronically shifted transfer case. Refer to the operating instructions for your transfer case, located in this section for further information.

### Manually Shifted Transfer Case – If Equipped

The transfer case provides four mode positions.

- Two-wheel drive high range (2H)
- Four-wheel drive high range (4H)
- Neutral (N)
- Four-wheel drive low range (4L)

This transfer case is intended to be driven in the 2H position for normal street and highway conditions such as dry, hard surfaced roads.

When additional traction is required, the 4H and 4L positions can be used to lock the front and rear drive-shafts together and force the front and rear wheels to rotate at the same speed. This is accomplished by simply moving the shift lever to the desired positions. The 4H and 4L positions are intended for loose, slippery road surfaces only. Driving in the 4H and 4L positions on dry, hard surfaced roads may cause increased tire wear and damage to the driveline components.

The “Transfer Case Position Indicator Light” in the instrument cluster will alert the driver that the vehicle is in four-wheel drive and that the front and rear drive-shafts are locked together. This light will illuminate when the transfer case is shifted into either the 4H or 4L position. There is no light for the 2H or NEUTRAL positions.

When operating your vehicle in 4L, the engine speed is approximately three times that of the 2H or 4H positions

at a given road speed. Take care not to overspeed the engine and do not exceed 25 mph (40 km/h).

Proper operation of four-wheel drive vehicles depends on tires of equal size, type and circumference on each wheel. Any difference will adversely affect shifting and can cause damage to the transfer case.

**NOTE:** Do not attempt to make a shift while only the front or rear wheels are spinning. The transfer case is not equipped with a synchronizer and therefore the front and rear driveshaft speeds must be equal for the shift to take place. Shifting while only the front or rear wheels are spinning can cause damage to the transfer case.

Because four-wheel drive provides improved traction, there is a tendency to exceed safe turning and stopping speeds. Do not go faster than road conditions permit.

**NOTE:** Delayed shifts out of four-wheel drive may be experienced due to uneven tire wear, low or uneven tire pressures, excessive vehicle loading, or cold temperatures.

### **WARNING!**

**You or others could be injured if you leave the vehicle unattended with the transfer case in the NEUTRAL position without first fully engaging the parking brake. The transfer case NEUTRAL position disengages both the front and rear driveshafts from the powertrain and will allow the vehicle to move regardless of the transmission position. The parking brake should always be applied when the driver is not in the vehicle.**

For additional information on the appropriate use of each transfer case mode position, see the information below:

### **2H**

Rear-Wheel Drive High Range - This range is for normal street and highway driving on dry hard surfaced roads.

### **4H**

Four-Wheel Drive High Range - This range locks the front and rear driveshafts together forcing the front and rear wheels to rotate at the same speed. Additional traction for loose, slippery road surfaces only.

### **N**

Neutral - This range disengages the front and rear driveshafts from the powertrain. To be used for flat towing behind another vehicle. Refer to “Recreational Towing” in “Starting and Operating” for further information.

### **4L**

Four-Wheel Drive Low Range - This range locks the front and rear driveshafts together forcing the front and rear wheels to rotate at the same speed. Additional traction and maximum pulling power for loose, slippery road surfaces only. Do not exceed 25 mph (40 km/h).

## **Shifting Procedure – Manually Shifted Transfer Case**

### **2H ⇔ 4H**

Shifting between 2H and 4H can be made with the vehicle stopped or in motion. If the vehicle is in motion, shifts can be made up to 55 mph (88 km/h). With the vehicle in motion, the transfer case will engage/disengage faster if you momentarily release the accelerator pedal after completing the shift. Apply a constant force when shifting the transfer case lever.



**2H or 4H ⇔ 4L**

With the vehicle rolling at 2 to 3 mph (3 to 5 km/h), shift the transmission into NEUTRAL. While the vehicle is coasting at 2 to 3 mph (3 to 5 km/h), shift the transfer case lever firmly to the desired position. Do not pause in transfer case NEUTRAL.

**NOTE:**

- Pausing in transfer case NEUTRAL in vehicles equipped with an automatic transmission may require shutting the engine OFF to avoid gear clash while completing the shift. If difficulty occurs, shift the transmission into NEUTRAL, hold foot on brake, and turn the engine OFF. Make shift to the desired mode.
- Shifting into or out of 4L is possible with the vehicle completely stopped, however difficulty may occur due to the mating clutch teeth not being properly aligned. Several attempts may be required for clutch teeth alignment and shift completion to occur. The preferred

method is with the vehicle rolling 2 to 3 mph (3 to 5 km/h). Avoid attempting to engage or disengage 4L with the vehicle moving faster than 2 to 3 mph (3 to 5 km/h).

- Do not attempt to shift into or from 4L while the transmission is in gear.

**Transfer Case Position Indicator Light**

The “Transfer Case Position Indicator Light” in the instrument cluster is used to alert the driver that the front axle is fully engaged and all four wheels are driving.

**Electronically Shifted Transfer Case (Four-Position Switch) – If Equipped**

This is an electronic shift transfer case and is operated by the 4WD Control Switch (Transfer Case Switch), which is located on the instrument panel.

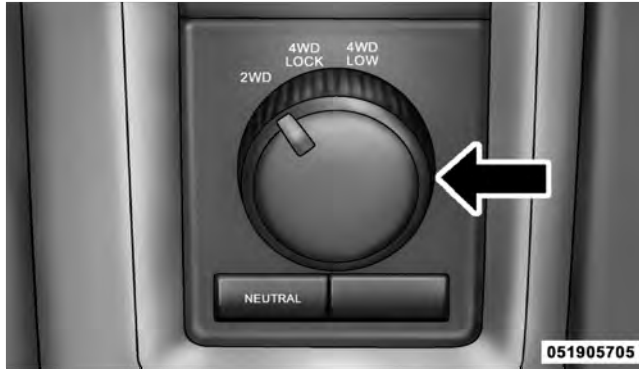

### Transfer Case Switch (Four-Position)

This electronically shifted transfer case provides four mode positions:

- Two-wheel drive high range (2WD)
- Four-wheel drive lock range (4WD LOCK)
- Four-wheel drive low range (4WD LOW)

- Neutral (NEUTRAL)

This electronically shifted transfer case is designed to be driven in the two-wheel drive position (2WD) for normal street and highway conditions on dry, hard surfaced roads.

When additional traction is required, the transfer case 4WD LOCK and 4WD LOW positions can be used to lock the front and rear driveshafts together, forcing the front and rear wheels to rotate at the same speed. This is accomplished by rotating the 4WD Control Switch to the desired position. Refer to “Shifting Procedure” for specific shifting instructions. The 4WD LOCK and 4WD LOW positions are designed for loose, slippery road surfaces only. Driving in the 4WD LOCK and 4WD LOW positions on dry hard surfaced roads may cause increased tire wear and damage to the driveline components.

**NOTE:** The transfer case NEUTRAL position is selected by pressing the recessed button located on the lower left hand corner of the 4WD Control Switch. The transfer case NEUTRAL position is to be used for recreational towing only. Refer to "Recreational Towing" in "Starting and Operating" for further information.

### **Transfer Case Position Indicator Lights**

The Transfer Case Position Indicator Lights (4WD and 4LOW) are located in the instrument cluster and indicate the current and desired transfer case selection. When you select a different transfer case position, the indicator lights will do the following:

#### **If All Shift Conditions Are Met:**

1. The current position indicator light will turn OFF.
2. The selected position indicator light will flash until the transfer case completes the shift.

3. When the shift is complete, the indicator light for the selected position will stop flashing and remain ON.

#### **If One Or More Shift Conditions Are Not Met:**

1. The indicator light for the current position will remain ON.
2. The newly selected position indicator light will continue to flash.
3. The transfer case **will not** shift.

**NOTE:** Before retrying a selection, make certain that all the necessary requirements for selecting a new transfer case position have been met. To retry the selection, turn the control knob back to the current position, wait five seconds, and retry selection. To find the shift requirements, refer to the "Shifting Procedure" in this section for further information.

The “SVC 4WD Warning Light” monitors the electronic shift four-wheel drive system. If this light remains on after engine start up or illuminates during driving, it means that the four-wheel drive system is not functioning properly and that service is required.

### WARNING!

**Always engage the parking brake when powering down the vehicle if the “SVC 4WD Warning Light” is illuminated. Not engaging the parking brake may allow the vehicle to roll, which may cause personal injury.**

**NOTE:** Do not attempt to make a shift while only the front or rear wheels are spinning, as this can cause damage to driveline components.

When operating your vehicle in 4WD LOW, the engine speed is approximately three times that of the 2WD or 4WD LOCK positions at a given road speed. Take care not to overspeed the engine and do not exceed 25 mph (40 km/h).

Proper operation of four-wheel drive vehicles depends on tires of equal size, type and circumference on each wheel. Any difference in tire size can cause damage to the transfer case.

Because four-wheel drive provides improved traction, there is a tendency to exceed safe turning and stopping speeds. Do not go faster than road conditions permit.

**WARNING!**

**You or others could be injured if you leave the vehicle unattended with the transfer case in the NEUTRAL position without first fully engaging the parking brake. The transfer case NEUTRAL position disengages both the front and rear driveshafts from the powertrain and will allow the vehicle to move regardless of the transmission position. The parking brake should always be applied when the driver is not in the vehicle.**

For additional information on the appropriate use of each transfer case mode position, see the information below:

**2WD**

Rear Wheel Drive High Range - This range is for normal street and highway driving on dry, hard surfaced roads.

**4WD LOCK**

Four-Wheel Drive Lock Range - This range locks the front and rear driveshafts together forcing the front and rear wheels to rotate at the same speed. This range provides additional traction for loose, slippery road surfaces only.

**4WD LOW**

Four-Wheel Drive Low Range - This range provides low speed four-wheel drive. It locks the front and rear driveshafts together forcing the front and rear wheels to rotate at the same speed. This range provides additional traction and maximum pulling power for loose, slippery road surfaces only. Do not exceed 25 mph (40 km/h).

**N**

Neutral - This range disengages both the front and rear driveshafts from the powertrain. To be used for flat towing behind another vehicle. Refer to "Recreational Towing" in Starting and Operating" for further information.

## Shifting Procedure

### NOTE:

- If any of the requirements to select a new transfer case position have not been met, the transfer case will not shift. The position indicator light for the previous position will remain ON and the newly selected position indicator light will continue to flash until all the requirements for the selected position have been met. To retry a shift: return the control knob back to the original position, make certain all shift requirements have been met, wait five seconds and try the shift again.
- If all the requirements to select a new transfer case position have been met, the current position indicator light will turn OFF, the selected position indicator light will flash until the transfer case completes the shift.

When the shift is complete, the position indicator light for the selected position will stop flashing and remain ON.

### 2WD ⇔ 4WD LOCK

Rotate the 4WD control switch to the desired position. Shifts between 2WD and 4WD LOCK can be done with the vehicle stopped or in motion. With the vehicle in motion, the transfer case will engage/disengage faster if you momentarily release the accelerator pedal after turning the control switch. If the vehicle is stopped, the ignition switch must be in the ON position with the engine either running or off. This shift cannot be completed if the ignition switch is in the ACC position.

**NOTE:** The four-wheel drive system will not allow shifts between 2WD/4WD LOCK if the front and/or rear wheels are spinning (no traction). In this situation, the

selected position indicator light will flash and the original position indicator light will remain ON. At this time, reduce speed and stop spinning the wheels to complete the shift.

### **2WD or 4WD LOCK ⇔ 4WD LOW**

**NOTE:** When shifting into or out of 4WD LOW some gear noise may be heard. This noise is normal and is not detrimental to the vehicle or occupants.

Shifting can be performed with the vehicle rolling 2 to 3 mph (3 to 5 km/h) or completely stopped. You can use either of the following procedures:

#### **Preferred Procedure**

1. With the engine running, slow the vehicle to 2 to 3 mph (3 to 5 km/h).
2. Shift the transmission into NEUTRAL.

3. While still rolling, rotate the transfer case control switch to the desired position.
4. After the desired position indicator light is ON (not flashing), shift the transmission back into gear.

#### **Alternate Procedure**

1. Bring the vehicle to a complete stop.
2. With the ignition switch in the ON position, and the engine either OFF or running, shift the transmission into NEUTRAL.
3. Rotate the transfer case control switch to the desired position.
4. After the desired position indicator light is ON (not flashing), shift the transmission back into gear.

**NOTE:**

- If Steps 1 or 2 of either the Preferred or Alternate Procedure are not satisfied prior to attempting the shift, then the desired position indicator light will flash continuously while the original position indicator light is ON, until all requirements have been met.
- The ignition switch must be in the ON position for a shift to take place and for the position indicator lights to be operable. If the ignition switch is not in the ON position, the shift will not take place and no position indicator lights will be on or flashing.

**LIMITED-SLIP DIFFERENTIAL**

The limited-slip differential provides additional traction on snow, ice, mud, sand and gravel, particularly when there is a difference between the traction characteristics of the surface under the right and left rear wheels. During

normal driving and cornering, the limited-slip unit performs similarly to a conventional differential. On slippery surfaces, however, the differential delivers more of the driving effort to the rear wheel having the better traction.

The limited-slip differential is especially helpful during slippery driving conditions. With both rear wheels on a slippery surface, a slight application of the accelerator will supply maximum traction. When starting with only one rear wheel on an excessively slippery surface, slight momentary application of the parking brake may be necessary to gain maximum traction.



**WARNING!**

**On vehicles equipped with a limited-slip differential never run the engine with one rear wheel off the ground since the vehicle may drive through the rear wheel remaining on the ground. You could lose control of the vehicle.**

Care should be taken to avoid sudden accelerations when both rear wheels are on a slippery surface. This could cause both rear wheels to spin, and allow the vehicle to slide sideways on the crowned surface of a road or in a turn.

**DRIVING ON SLIPPERY SURFACES**

When driving on wet or slushy roads, it is possible for a wedge of water to build up between the tire and road surface. This is known as hydroplaning and may cause partial or complete loss of vehicle control and stopping

ability. To reduce this possibility, the following precautions should be observed:

1. Slow down during rainstorms or when roads are slushy.
2. Slow down if the road has standing water or puddles.
3. Replace tires when tread wear indicators first become visible.
4. Keep tires properly inflated.
5. Maintain sufficient distance between your vehicle and the car in front of you to avoid a collision in a sudden stop.

**DRIVING THROUGH WATER**

Driving through water more than a few inches/centimeters deep will require extra caution to ensure safety and prevent damage to your vehicle.

## Flowing/Rising Water

### WARNING!

Do not drive on or across a road or path where water is flowing and/or rising (as in storm run-off). Flowing water can wear away the road or path's surface and cause your vehicle to sink into deeper water. Furthermore, flowing and/or rising water can carry your vehicle away swiftly. Failure to follow this warning may result in injuries that are serious or fatal to you, your passengers, and others around you.

## Shallow Standing Water

Although your vehicle is capable of driving through shallow standing water, consider the following Caution and Warning before doing so.

### CAUTION!

- Always check the depth of the standing water before driving through it. Never drive through standing water that is deeper than the bottom of the tire rims mounted on the vehicle.
- Determine the condition of the road or the path that is under water and if there are any obstacles in the way before driving through the standing water.
- Do not exceed 5 mph (8 km/h) when driving through standing water. This will minimize wave effects.

*(Continued)*

**CAUTION! (Continued)**

- Driving through standing water may cause damage to your vehicle's drivetrain components. Always inspect your vehicle's fluids (i.e., engine oil, transmission/transaxle, axle, etc.) for signs of contamination (i.e., fluid that is milky or foamy in appearance) after driving through standing water. Do not continue to operate the vehicle if any fluid appears contaminated, as this may result in further damage. Such damage is not covered by the New Vehicle Limited Warranty.
- Getting water inside your vehicle's engine can cause it to lock up and stall out, and cause serious internal damage to the engine. Such damage is not covered by the New Vehicle Limited Warranty.

**WARNING!**

- Driving through standing water limits your vehicle's traction capabilities. Do not exceed 5 mph (8 km/h) when driving through standing water.
- Driving through standing water limits your vehicle's braking capabilities, which increases stopping distances. Therefore, after driving through standing water, drive slowly and lightly press on the brake pedal several times to dry the brakes.
- Getting water inside your vehicle's engine can cause it to lock up and stall out, and leave you stranded.
- Failure to follow these warnings may result in injuries that are serious or fatal to you, your passengers, and others around you.

## POWER STEERING

The standard power steering system will give you good vehicle response and increased ease of maneuverability in tight spaces. The system will provide mechanical steering capability if power assist is lost.

If for some reason the power assist is interrupted, it will still be possible to steer your vehicle. Under these conditions, you will observe a substantial increase in steering effort, especially at very low vehicle speeds and during parking maneuvers.

### NOTE:

- Increased noise levels at the end of the steering wheel travel are considered normal and do not indicate that there is a problem with the power steering system.
- Upon initial start-up in cold weather, the power steering pump may make noise for a short amount of time. This is due to the cold, thick fluid in the steering

system. This noise should be considered normal, and it does not in any way damage the steering system.

### WARNING!

**Continued operation with reduced power steering assist could pose a safety risk to yourself and others. Service should be obtained as soon as possible.**

### CAUTION!

**Prolonged operation of the steering system at the end of the steering wheel travel will increase the steering fluid temperature and it should be avoided when possible. Damage to the power steering pump may occur.**

### Power Steering Fluid Check

Checking the power steering fluid level at a defined service interval is not required. The fluid should only be checked if a leak is suspected, abnormal noises are apparent, and/or the system is not functioning as anticipated. Coordinate inspection efforts through an authorized dealer.

#### CAUTION!

**Do not use chemical flushes in your power steering system as the chemicals can damage your power steering components. Such damage is not covered by the New Vehicle Limited Warranty.**

#### WARNING!

**Fluid level should be checked on a level surface and with the engine off to prevent injury from moving parts and to ensure accurate fluid level reading. Do not overfill. Use only manufacturer's recommended power steering fluid.**

If necessary, add fluid to restore to the proper indicated level. With a clean cloth, wipe any spilled fluid from all surfaces. Refer to "Fluids, Lubricants, and Genuine Parts" in "Maintaining Your Vehicle" for further information.

### PARKING BRAKE

Before leaving the vehicle, make sure that the parking brake is fully applied, the engine is off and the key fob is removed from the ignition switch. Also, be certain to leave an automatic transmission in PARK, or manual transmission in REVERSE or first gear.

The foot operated parking brake is located below the lower left corner of the instrument panel. To apply the park brake, firmly push the park brake pedal fully. To release the parking brake, pull the parking brake release handle.

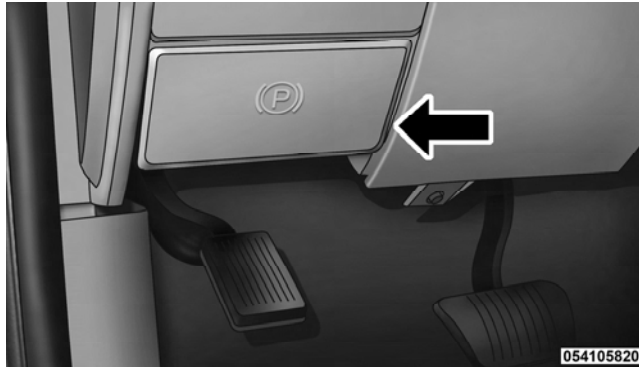

**Parking Brake Release**

When the parking brake is applied with the ignition switch ON, the “Brake Warning Light” in the instrument cluster will illuminate.

**NOTE:**

- When the parking brake is applied and the automatic transmission is placed in gear, the “Brake Warning Light” will flash. If vehicle speed is detected, a chime will sound to alert the driver. Fully release the parking brake before attempting to move the vehicle.
- This light only shows that the parking brake is applied. It does not show the degree of brake application.

When parking on a hill, it is important to turn the front wheels toward the curb on a downhill grade and away from the curb on an uphill grade. For vehicles equipped with an automatic transmission, apply the parking brake before placing the shift lever in PARK, otherwise the load on the transmission locking mechanism may make it difficult to move the shift lever out of PARK.

The parking brake should always be applied whenever the driver is not in the vehicle.

**WARNING!**

- Never leave children alone in a vehicle. Leaving unattended children in a vehicle is dangerous for a number of reasons. A child or others could be seriously or fatally injured.
- Do not leave the key fob in the ignition switch. A child could operate power windows, other controls, or move the vehicle.
- Be sure the parking brake is fully disengaged before driving; failure to do so can lead to brake failure and an accident.

*(Continued)*

**WARNING! (Continued)**

- Always fully apply the parking brake when leaving your vehicle or it may roll and cause damage or injury. Also, be certain to leave an automatic transmission in PARK, a manual transmission in REVERSE or first gear. Failure to do so may cause the vehicle to roll and cause damage or injury.

**CAUTION!**

If the "Brake Warning Light" remains on with the parking brake released, a brake system malfunction is indicated. Have the brake system serviced by an authorized dealer immediately.

## BRAKE SYSTEM

If power assist is lost for any reason (for example, repeated brake applications with the engine off), the brakes will still function. However, you will experience a substantial increase in braking effort to stop the vehicle.

If either the front or rear hydraulic system loses normal braking capability, the remaining system will still function with some loss of overall braking effectiveness. This will be evident by increased pedal travel during application, greater pedal force required to slow or stop, and activation of the “Brake Warning Light” and the “ABS Warning Light” (if equipped) during brake use.

### Dual Rear Wheel Models Only

The brake system power assist is provided by a hydro-boost unit which shares fluid with the power steering system. You may experience some clicking or hissing noises from the hydro-boost system during hard braking conditions.

**NOTE:** Under cold temperatures, pedal effort will be higher than normal until the power steering fluid reaches operating temperature.

## Four-Wheel Anti-Lock Brake System

### WARNING!

**The Four-Wheel Anti-Lock Brake System contains sophisticated electronic equipment. It may be susceptible to interference caused by improperly installed or high output radio transmitting equipment. This interference can cause possible loss of anti-lock braking capability. Installation of such equipment should be performed by qualified professionals.**

The Four-Wheel Anti-Lock Brake System (ABS) is designed to aid the driver in maintaining vehicle control under adverse braking conditions. The system operates



with a separate computer to modulate hydraulic pressure to prevent wheel lockup and help avoid skidding on slippery surfaces.

The system's pump motor runs during an ABS stop to provide regulated hydraulic pressure. The pump motor makes a low humming noise during operation. This is normal.

The ABS conducts a low-speed selftest at about 10 mph (16 km/h). If you have your foot lightly on the brake while this test is occurring, you may feel slight pedal movement. The movement can be more apparent on ice and snow. This is normal.

When you are in a severe braking condition involving use of the ABS, you will experience some pedal drop as the vehicle comes to a complete stop. This is the result of the system reverting to the base brake system and is normal.

Engagement of the ABS may be accompanied by a pulsing sensation. You may also hear a clicking noise. These occurrences are normal, and indicate that the system is functioning.

### **ABS Warning Light**

The ABS includes an amber warning light. When the light is illuminated, the ABS is not functioning. The system reverts to standard, non-anti-lock brakes.

#### **WARNING!**

- **Pumping of the anti-lock brakes will diminish their effectiveness and may lead to an accident. Pumping makes the stopping distance longer. Just press firmly on your brake pedal when you need to slow down or stop.**

*(Continued)*

**WARNING! (Continued)**

- The Anti-Lock Brake System (ABS) cannot prevent the natural laws of physics from acting on the vehicle, nor can it increase braking or steering efficiency beyond that afforded by the condition of the vehicle brakes and tires or the traction afforded.
- The ABS cannot prevent accidents, including those resulting from excessive speed in turns, following another vehicle too closely, or hydroplaning. Only a safe, attentive, and skillful driver can prevent accidents.
- The capabilities of an ABS-equipped vehicle must never be exploited in a reckless or dangerous manner which could jeopardize the user's safety or the safety of others.

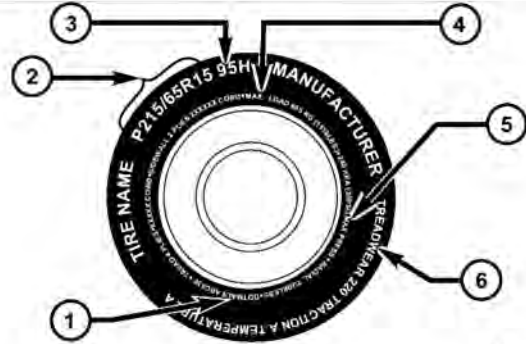
**TIRE SAFETY INFORMATION****Tire Markings**

054903773

1 — U.S. DOT Safety Standards Code (TIN)

2 — Size Designation

3 — Service Description

4 — Maximum Load

5 — Maximum Pressure

6 — Treadwear, Traction and Temperature Grades

**NOTE:**

- P (Passenger) - Metric tire sizing is based on U.S. design standards. P-Metric tires have the letter "P" molded into the sidewall preceding the size designation. Example: P215/65R15 95H.
- European-Metric tire sizing is based on European design standards. Tires designed to this standard have the tire size molded into the sidewall beginning with the section width. The letter "P" is absent from this tire size designation. Example: 215/65R15 96H.
- LT (Light Truck) - Metric tire sizing is based on U.S. design standards. The size designation for LT-Metric tires is the same as for P-Metric tires except for the letters "LT" that are molded into the sidewall preceding the size designation. Example: LT235/85R16.
- Temporary spare tires are high-pressure compact spares designed for temporary emergency use only. Tires designed to this standard have the letter "T" molded into the sidewall preceding the size designation. Example: T145/80D18 103M.
- High flotation tire sizing is based on U.S. design standards and it begins with the tire diameter molded into the sidewall. Example: 31x10.5 R15 LT.

## Tire Sizing Chart

EXAMPLE:
<b>Size Designation:</b>
<p><b>P</b> = Passenger car tire size based on U.S. design standards  <b>"...blank..."</b> = Passenger car tire based on European design standards  <b>LT</b> = Light truck tire based on U.S. design standards  <b>T</b> = Temporary spare tire  <b>31</b> = Overall diameter in inches (in)</p>
<p><b>215</b> = Section width in millimeters (mm)</p>
<p><b>65</b> = Aspect ratio in percent (%)  — Ratio of section height to section width of tire</p>
<p><b>10.5</b> = Section width in inches (in)</p>
<p><b>R</b> = Construction code  — "R" means radial construction  —"D" means diagonal or bias construction</p>
<p><b>15</b> = Rim diameter in inches (in)</p>

**EXAMPLE:****Service Description:**

95 = Load Index

— A numerical code associated with the maximum load a tire can carry

H = Speed Symbol

— A symbol indicating the range of speeds at which a tire can carry a load corresponding to its load index under certain operating conditions

— The maximum speed corresponding to the speed symbol should only be achieved under specified operating conditions (i.e., tire pressure, vehicle loading, road conditions, and posted speed limits)

**Load Identification:**

"...blank..." = Absence of any text on the sidewall of the tire indicates a Standard Load (SL) tire

**Extra Load (XL)** = Extra load (or reinforced) tire

**Light Load** = Light load tire

**C, D, E** = Load range associated with the maximum load a tire can carry at a specified pressure

**Maximum Load** — Maximum load indicates the maximum load this tire is designed to carry

**Maximum Pressure** — Maximum pressure indicates the maximum permissible cold tire inflation pressure for this tire

**Tire Identification Number (TIN)**

The TIN may be found on one or both sides of the tire, however, the date code may only be on one side. Tires with white sidewalls will have the full TIN, including the date code, located on the white sidewall side of the tire.

Look for the TIN on the outboard side of black sidewall tires as mounted on the vehicle. If the TIN is not found on the outboard side, then you will find it on the inboard side of the tire.

**EXAMPLE:****DOT MA L9 ABCD 0301**

**DOT** = Department of Transportation

— This symbol certifies that the tire is in compliance with the U.S. Department of Transportation tire safety standards and is approved for highway use

**MA** = Code representing the tire manufacturing location (two digits)

**L9** = Code representing the tire size (two digits)

**ABCD** = Code used by the tire manufacturer (one to four digits)

**03** = Number representing the week in which the tire was manufactured (two digits)

—03 means the 3rd week.

**01** = Number representing the year in which the tire was manufactured (two digits)

—01 means the year 2001

— Prior to July 2000, tire manufacturers were only required to have one number to represent the year in which the tire was manufactured. Example: 031 could represent the 3rd week of 1981 or 1991

**Tire Terminology and Definitions**

<b>Term</b>	<b>Definition</b>
<b>B-Pillar</b>	The vehicle B-Pillar is a structural member of the body located between the front and rear door (of a four-door vehicle) running from the sill to the roof.
<b>Cold Tire Pressure</b>	Cold tire inflation pressure is defined as the tire pressure after the vehicle has not been driven for at least 3 hours, or driven less than 1 mile (1.6 km) after sitting for a three hour period. Inflation pressure is measured in units of PSI (pounds per square inch) or KPa (kilopascals).
<b>Maximum Inflation Pressure</b>	The maximum inflation pressure is the maximum permissible cold tire inflation pressure for this tire. The max inflation pressure is molded into the sidewall.
<b>Recommended Inflation Pressure</b>	Vehicle manufacturer's recommended tire inflation pressure as shown on the tire placard.
<b>Tire Placard</b>	A paper label permanently attached to the vehicle showing the vehicle's loading capacity, the original equipment tire size and the recommended inflation pressure.

## Tire Loading and Tire Pressure

### Tire Placard Location

**NOTE:** The proper cold tire inflation pressure is listed on the driver's side B-Pillar.

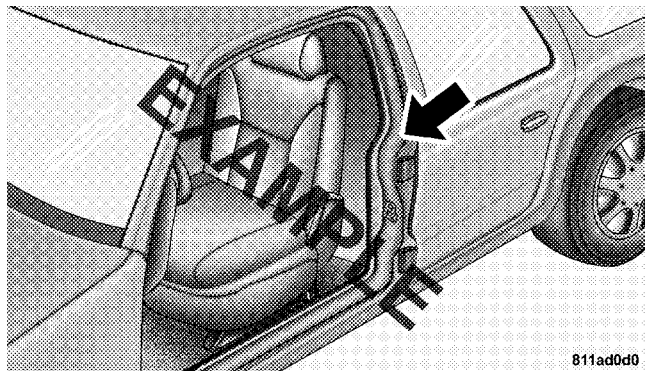

Tire Placard Location

### Tire and Loading Information Placard

**TIRE AND LOADING INFORMATION**

SEATING CAPACITY - TOTAL 5 FRONT 2 REAR 3

THE COMBINED WEIGHT OF OCCUPANTS AND CARGO SHOULD NEVER EXCEED XXX KG OR XXX LBS.

TIRE	FRONT	REAR	SPARE
ORIGINAL TIRE SIZE	P195/70R14	P195/70R14	T125/70D15
COLD TIRE INFLATION PRESSURE	200kPa, 29PSI	200kPa, 29PSI	420kPa, 60PSI

SEE OWNER'S MANUAL FOR ADDITIONAL INFORMATION

4N109268

811b5a9a

### Tire and Loading Information Placard

This placard tells you important information about the:

- 1) number of people that can be carried in the vehicle
- 2) total weight your vehicle can carry
- 3) tire size designed for your vehicle
- 4) cold tire inflation pressures for the front, rear, and spare tires.



## Loading

The vehicle maximum load on the tire must not exceed the load carrying capacity of the tire on your vehicle. You will not exceed the tire's load carrying capacity if you adhere to the loading conditions, tire size, and cold tire inflation pressures specified on the Tire and Loading Information placard and in the "Vehicle Loading" section of this manual.

**NOTE:** Under a maximum loaded vehicle condition, gross axle weight ratings (GAWRs) for the front and rear axles must not be exceeded. For further information on GAWRs, vehicle loading, and trailer towing, refer to "Vehicle Loading" in this section.

To determine the maximum loading conditions of your vehicle, locate the statement "The combined weight of

occupants and cargo should never exceed XXX lbs or XXX kg" on the Tire and Loading Information placard. The combined weight of occupants, cargo/luggage and trailer tongue weight (if applicable) should never exceed the weight referenced here.

### *Steps for Determining Correct Load Limit*

1. Locate the statement "The combined weight of occupants and cargo should never exceed XXX lbs or XXX kg" on your vehicle's placard.
2. Determine the combined weight of the driver and passengers that will be riding in your vehicle.
3. Subtract the combined weight of the driver and passengers from XXX lbs or XXX kg.

4. The resulting figure equals the available amount of cargo and luggage load capacity. For example, if “XXX” amount equals 1,400 lbs (635 kg) and there will be five 150 lb (68 kg) passengers in your vehicle, the amount of available cargo and luggage load capacity is 650 lbs (295 kg) (since  $5 \times 150 = 750$ , and  $1400 - 750 = 650$  lbs [295 kg]).

5. Determine the combined weight of luggage and cargo being loaded on the vehicle. That weight may not safely exceed the available cargo and luggage load capacity calculated in Step 4.

6. If your vehicle will be towing a trailer, load from your trailer will be transferred to your vehicle. Consult this manual to determine how this reduces the available cargo and luggage load capacity of your vehicle.

**NOTE:**

- The following table shows examples on how to calculate total load, cargo/luggage, and towing capacities of your vehicle with varying seating configurations and number and size of occupants. This table is for illustration purposes only and may not be accurate for the seating and load carry capacity of your vehicle.
- For the following example, the combined weight of occupants and cargo should never exceed 865 lbs (392 kg).

Occupants			Combined weight of occupants and cargo from Tire Placard	MINUS	Combined Occupant's weight	=	AVAILABLE Cargo/Luggage and Trailer Tongue Weight
TOTAL	FRONT	REAR					
<u>EXAMPLE 1</u>							
5	2	3	865 lbs	minus	670 lbs	=	195 lbs
					Occupant 1: 200 lbs Occupant 2: 130 lbs Occupant 3: 160 lbs Occupant 4: 100 lbs Occupant 5: 80 lbs TOTAL WEIGHT: 670 lbs		
<u>EXAMPLE 2</u>							
3	2	1	865 lbs	minus	540 lbs	=	325 lbs
					Occupant 1: 210 lbs Occupant 2: 180 lbs Occupant 3: 150 lbs TOTAL WEIGHT: 540 lbs		
<u>EXAMPLE 3</u>							
2	2	0	865 lbs	minus	400 lbs	=	465 lbs
					Occupant 1: 200 lbs Occupant 2: 200 lbs TOTAL WEIGHT: 400 lbs		

**WARNING!**

Overloading of your tires is dangerous. Overloading can cause tire failure, affect vehicle handling, and increase your stopping distance. Use tires of the recommended load capacity for your vehicle. Never overload them.

**TIRES — GENERAL INFORMATION****Tire Pressure**

Proper tire inflation pressure is essential to the safe and satisfactory operation of your vehicle. Three primary areas are affected by improper tire pressure:

**Safety****WARNING!**

- Improperly inflated tires are dangerous and can cause accidents.
- Under-inflation increases tire flexing and can result in tire failure.
- Over-inflation reduces a tire's ability to cushion shock. Objects on the road and chuckholes can cause damage that result in tire failure.
- Unequal tire pressures can cause steering problems. You could lose control of your vehicle.
- Over-inflated or under-inflated tires can affect vehicle handling and can fail suddenly, resulting in loss of vehicle control.

*(Continued)*

**WARNING! (Continued)**

- Unequal tire pressures from one side of the vehicle to the other can cause the vehicle to drift to the right or left.
- Always drive with each tire inflated to the recommended cold tire inflation pressure.

**Economy**

Improper inflation pressures can cause uneven wear patterns to develop across the tire tread. These abnormal wear patterns will reduce tread life resulting in a need for earlier tire replacement. Under-inflation also increases tire rolling resistance and results in higher fuel consumption.

**Ride Comfort and Vehicle Stability**

Proper tire inflation contributes to a comfortable ride. Over-inflation produces a jarring and uncomfortable ride.

**Tire Inflation Pressures**

The proper cold tire inflation pressure is listed on the driver's side "B" Pillar.

Some vehicles may have Supplemental Tire Pressure Information for vehicle loads that are less than the maximum loaded vehicle condition. These pressure conditions will be found in the "Supplemental Tire Pressure Information" section of this manual.

The pressure should be checked and adjusted as well as inspecting for signs of tire wear or visible damage at least once a month. Use a good quality pocket-type gauge to check tire pressure. Do not make a visual judgement when determining proper inflation. Radial tires may look properly inflated even when they are under-inflated.

**CAUTION!**

**After inspecting or adjusting the tire pressure, always reinstall the valve stem cap. This will prevent moisture and dirt from entering the valve stem, which could damage the valve stem.**

Inflation pressures specified on the placard are always “cold tire inflation pressure.” Cold tire inflation pressure is defined as the tire pressure after the vehicle has not been driven for at least three hours, or driven less than 1 mile (1.6 km) after a three hour period. The cold tire inflation pressure must not exceed the maximum inflation pressure molded into the tire sidewall.

Check tire pressures more often if subject to a wide range of outdoor temperatures, as tire pressures vary with temperature changes.

Tire pressures change by approximately 1 psi (7 kPa) per 12°F (7°C) of air temperature change. Keep this in mind when checking tire pressure inside a garage, especially in the winter.

Example: If garage temperature = 68°F (20°C) and the outside temperature = 32°F (0°C) then the cold tire inflation pressure should be increased by 3 psi (21 kPa), which equals 1 psi (7 kPa) for every 12°F (7°C) for this outside temperature condition.

Tire pressure may increase from 2 to 6 psi (13 to 40 kPa) during operation. DO NOT reduce this normal pressure build up or your tire pressure will be too low.

### **Tire Inflation Pressure – 4500/5500 with Steel Carcass Ply Tires**

This type of tire utilizes steel cords in the sidewall. As such, they cannot be treated like normal light truck tires. Adjusting tire pressure must be performed by personnel trained, supervised and equipped accordingly.

### ***Inflation Pressure Adjustment When Mounted to Vehicle***

During procedures when adding tire inflation pressure, the technician or individual must utilize a remote inflation device, and ensure that all persons are clear of the trajectory area.

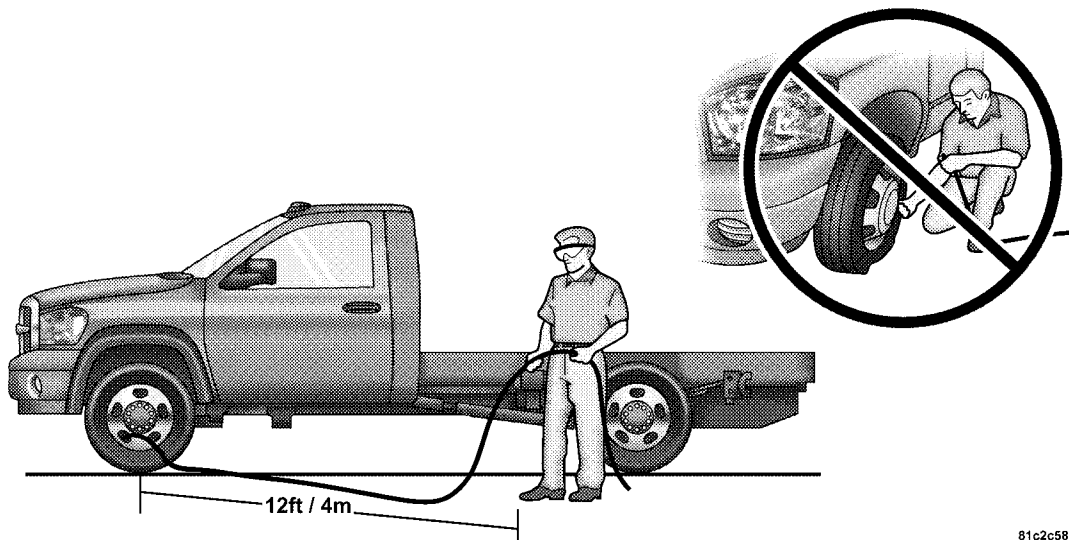

4500/5500 Tire Inflation

81c2c587



When adjusting inflation pressure to a tire and wheel assembly mounted on a vehicle, use a Remote Mount Automatic Inflation Kit or see your authorized dealer.

**NOTE:** Never attempt to re-inflate a tire and wheel assembly which has been run flat or is extremely under-inflated without first removing the tire from the wheel assembly for inspection.

Personnel trained, supervised, and equipped according to Federal Occupational Safety and Health Administration (OSHA) should perform this work.

#### *Inflation Pressure Adjustment When Not Mounted to Vehicle*

When adjusting inflation pressure to a tire and wheel assembly not mounted on a vehicle, use a Remote Mount Automatic Inflation Kit and a Tire Inflation Cage or see your authorized dealer.

#### **Tire Pressures for High Speed Operation**

The manufacturer advocates driving at safe speeds within posted speed limits. Where speed limits or conditions are such that the vehicle can be driven at high speeds, maintaining correct tire inflation pressure is very important. Increased tire pressure and reduced vehicle loading may be required for high-speed vehicle operation. Refer to original equipment or an authorized tire dealer for recommended safe operating speeds, loading and cold tire inflation pressures.

#### **WARNING!**

**High speed driving with your vehicle under maximum load is dangerous. The added strain on your tires could cause them to fail. You could have a serious accident resulting in serious injury or death. Don't drive a vehicle loaded to the maximum capacity at continuous speeds above 75 mph (120 km/h).**

## Radial Ply Tires

### WARNING!

Combining radial ply tires with other types of tires on your vehicle will cause your vehicle to handle poorly. The instability could cause an accident resulting in serious injury or death. Always use radial ply tires in sets of four (or six, in case of trucks with dual rear wheels). Never combine them with other types of tires.

Cuts and punctures in radial tires are repairable only in the tread area because of sidewall flexing. Consult your authorized tire dealer for radial tire repairs.

## Tire Spinning

When stuck in mud, sand, snow, or ice conditions, do not spin your vehicle's wheels faster than 30 mph (48 km/h) or for longer than 30 seconds continuously without stopping when you are stuck.

Refer to "Freeing A Stuck Vehicle" in "What To Do In Emergencies" for further information.

### WARNING!

Fast spinning tires can be dangerous. Forces generated by excessive wheel speeds may cause tire damage or failure. A tire could explode and injure someone. Do not spin your vehicle's wheels faster than 30 mph (48 km/h) or for more than 30 seconds continuously when you are stuck, and don't let anyone near a spinning wheel, no matter what the speed.

## Tread Wear Indicators

Tread wear indicators are in the original equipment tires to help you in determining when your tires should be replaced.

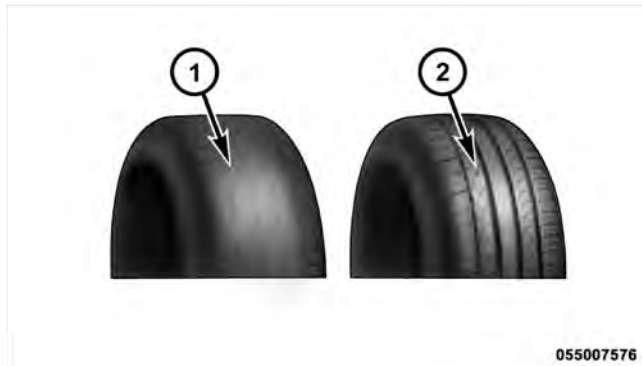

- 1 — Worn Tire  
2 — New Tire

These indicators are molded into the bottom of the tread grooves. They will appear as bands when the tread depth becomes 1/16 in (2 mm). When the tread is worn to the tread wear indicators, the tire should be replaced.

Many states have laws requiring tire replacement at this point.

## Life of Tire

The service life of a tire is dependent upon varying factors including, but not limited to:

- Driving style
- Tire pressure
- Distance driven

**WARNING!**

**Tires and spare tire should be replaced after six years, regardless of the remaining tread. Failure to follow this warning can result in sudden tire failure. You could lose control and have an accident resulting in serious injury or death.**

Keep dismounted tires in a cool, dry place with as little exposure to light as possible. Protect tires from contact with oil, grease, and gasoline.

**Replacement Tires**

The tires on your new vehicle provide a balance of many characteristics. They should be inspected regularly for

wear and correct cold tire inflation pressure. The manufacturer strongly recommends that you use tires equivalent to the originals in size, quality and performance when replacement is needed (refer to the paragraph on “Tread Wear Indicators”). Refer to the Tire and Loading Information placard for the size designation of your tire. The service description and load identification will be found on the original equipment tire. Failure to use equivalent replacement tires may adversely affect the safety, handling, and ride of your vehicle. We recommend that you contact your original equipment or an authorized tire dealer with any questions you may have on tire specifications or capability.

**WARNING!**

- Do not use a tire, wheel size or rating other than that specified for your vehicle. Some combinations of unapproved tires and wheels may change suspension dimensions and performance characteristics, resulting in changes to steering, handling, and braking of your vehicle. This can cause unpredictable handling and stress to steering and suspension components. You could lose control and have an accident resulting in serious injury or death. Use only the tire and wheel sizes with load ratings approved for your vehicle.

*(Continued)*

**WARNING! (Continued)**

- Never use a tire with a smaller load index or capacity, other than what was originally equipped on your vehicle. Using a tire with a smaller load index could result in tire overloading and failure. You could lose control and have an accident resulting in serious injury or death.
- Failure to equip your vehicle with tires having adequate speed capability can result in sudden tire failure and loss of vehicle control resulting in serious injury or death.

**CAUTION!**

Replacing original tires with tires of a different size may result in false speedometer and odometer readings.

## SUPPLEMENTAL TIRE PRESSURE INFORMATION — IF EQUIPPED

A light load vehicle condition is defined as two passengers [150 lbs (68 kg) each] plus 200 lbs (91 kg) of cargo. Cold tire inflation pressures for a lightly loaded vehicle will be found on the face of the driver's door.

### TIRE CHAINS

Use "Class U" chains or other traction aids that meet SAE Type "U" specifications.

**NOTE:** Chains must be the proper size for the vehicle, as recommended by the chain manufacturer.

### CAUTION!

To avoid damage to your vehicle, tires or chains, observe the following precautions:

*(Continued)*

### CAUTION! (Continued)

- Because of limited chain clearance between tires and other suspension components, it is important that only chains in good condition are used. Broken chains can cause serious vehicle damage. Stop the vehicle immediately if noise occurs that could suggest chain breakage. Remove the damaged parts of the chain before further use.
- Install chains as tightly as possible and then retighten after driving about 1/2 mi (0.8 km).
- Do not exceed 45 mph (72 km/h).
- Drive cautiously and avoid severe turns and large bumps, especially with a loaded vehicle.
- Do not install tire chains on front wheels of 4x2 vehicles.
- Do not drive for a prolonged period on dry pavement.

*(Continued)*

**CAUTION! (Continued)**

- **Observe the tire chain manufacturer's instructions on method of installation, operating speed, and conditions for usage. Always use the lower suggested operating speed of the chain manufacturer if different than the speed recommended by the manufacturer.**

These cautions apply to all chain traction devices, including link and cable (radial) chains.

Tire chain use is permitted only on the rear tires of your 4X2 trucks.

**NOTE:**

- The use of class "U" chains is permitted on the front and rear of 4X4 vehicles, trucks with dual rear wheels and LT235/80R17E tires.

- On 4X2 vehicles, class "U" snow chains are permitted on the rear wheels only of vehicles equipped with LT245/70R17, LT265/70R17, and LT235/80R17 size tires.
- On 4X4 Single Rear Wheel (SRW) vehicles, class "U" snow chains are permitted on the rear wheels only on vehicles equipped with LT265/70R17.

**CAUTION!**

**Do not use tire chains on the 4X2 front wheels of SRW (Single Rear Wheels) equipped with LT245/70R17, LT265/70R17 tires or 4X4 front tires of vehicles equipped with LT265/70R17 tires. There may not be adequate clearance for the chains and you are risking structural or body damage to your vehicle.**

## SNOW TIRES

Snow tires should be of the same size and type construction as the front tires. Consult the manufacturer of the snow tire to determine any maximum vehicle speed requirement associated with the tire. These tires should always be operated at the vehicle maximum capacity inflation pressures under any load condition.

While studded tires improve performance on ice, skid and traction capability on wet or dry surfaces may be poorer than that of non-studded tires. Some states prohibit studded tires; therefore, local laws should be checked before using these tire types.

## TIRE ROTATION RECOMMENDATIONS

Tires on the front and rear axles of vehicles operate at different loads and perform different steering, driving, and braking functions. For these reasons, they wear at unequal rates, and develop irregular wear patterns. These effects can be reduced by timely rotation of tires. The benefits of rotation are especially worthwhile with aggressive tread designs such as those on On/Off Road type tires. Rotation will increase tread life, help to maintain mud, snow, and wet traction levels, and contribute to a smooth, quiet ride.



Refer to “Maintenance Schedule” for the proper maintenance intervals. More frequent rotation is permissible if desired. The reasons for any rapid or unusual wear should be corrected prior to rotation being performed.

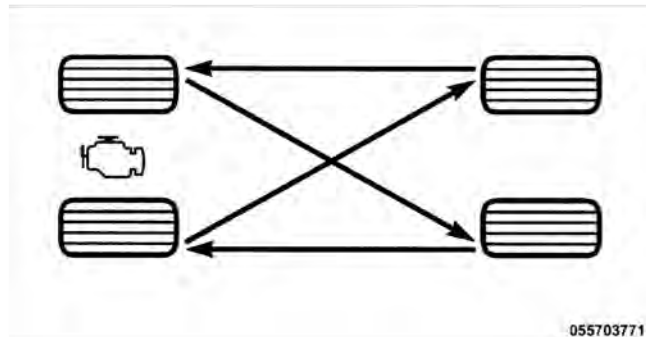

Tire Rotation

055703771

**NOTE:** On Canadian vehicles only, if your vehicle is equipped with All-Season type tires on the front and On/Off Road type tires mounted on the rear, do not use

a front to back rotation pattern. Instead, rotate your tires side to side at the recommended intervals.

### Dual Rear Wheels

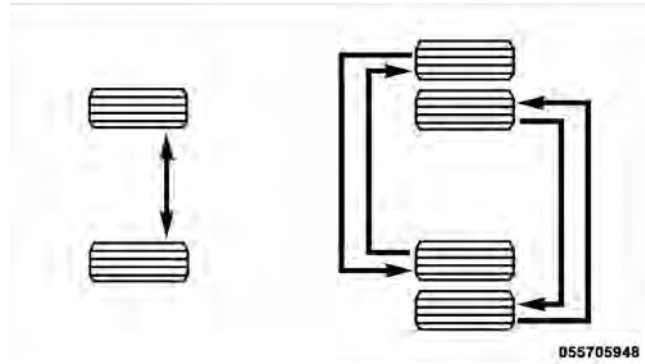

Tire Rotation

055705948

The tires used on dual wheel assemblies should be matched for wear to prevent overloading one tire in a set.

To check if tires are even, lay a straight edge across all four tires. The straight edge should touch all the tires.

### CAUTION!

**4500/5500 Dual Rear Tires have only one approved direction of rotation. This is to accommodate the asymmetrical design (tread pattern) of the On/Off road tire.**

- **When replacing a flat, the spare tire may have to be remounted on the rim or installed at a different location to maintain the correct placement of the tire on the wheel relative to the tire/wheel position on the vehicle. For example, if the spare is used to replace an outer rear tire it will have to be remounted on the rim so that the wheel is dished inward. That way the tread design of asymmetrical tires will maintain proper position.**

## FUEL REQUIREMENTS



The 5.7L engine is designed to meet all emissions regulations and provide satisfactory fuel economy and performance when using high-quality unleaded gasoline having an octane range of 87 to 89. The manufacturer recommends the use of 89 octane for optimum performance. The use of premium gasoline is not recommended, as it will not provide any benefit over regular gasoline in these engines.

Light spark knock at low engine speeds is not harmful to your engine. However, continued heavy spark knock at high speeds can cause damage and immediate service is required.

Poor quality gasoline can cause problems such as hard starting, stalling and hesitations. If you experience these symptoms, try another brand of "regular" gasoline before considering service for the vehicle.

Over 40 auto manufacturers worldwide have issued and endorsed consistent gasoline specifications (the Worldwide Fuel Charter, WWFC) to define fuel properties necessary to deliver enhanced emissions, performance and durability for your vehicle. We recommend the use of gasolines that meet the WWFC specifications if they are available.

### **Reformulated Gasoline**

Many areas of the country require the use of cleaner burning gasoline referred to as “Reformulated Gasoline” Reformulated gasolines contain oxygenates, and are specifically blended to reduce vehicle emissions and improve air quality.

The manufacturer supports the use of reformulated gasolines. Properly-blended reformulated gasolines will provide excellent performance and durability of engine and fuel system components.

### **Gasoline/Oxygenate Blends**

Some fuel suppliers blend unleaded gasoline with oxygenates such as 10% ethanol, MTBE, and ETBE. Oxygenates are required in some areas of the country during the Winter months to reduce carbon monoxide emissions. Fuels blended with these oxygenates may be used in your vehicle.

#### **CAUTION!**

**DO NOT use gasolines containing Methanol or E85 Ethanol. Use of these blends may result in starting and drivability problems and may damage critical fuel system components.**

Problems that result from using methanol/gasoline or E85 Ethanol blends are not the responsibility of the manufacturer. While MTBE is an oxygenate made from Methanol, it does not have the negative effects of Methanol.

### **E-85 Usage In Non-Flex Fuel Vehicles**

Non-FFV vehicles are compatible with gasoline containing 10% ethanol (E10). Gasoline with higher ethanol content may void the vehicle's warranty.

If a Non-FFV vehicle is inadvertently fueled with E-85 fuel, the engine will have some or all of these symptoms:

- operate in a lean mode
- OBD II "Malfunction Indicator Light" on
- poor engine performance
- poor cold start and cold drivability
- increased risk for fuel system component corrosion

To fix a Non-FFV vehicle inadvertently fueled once with E-85 perform the following:

- drain the fuel tank (see your authorized dealer)
- change the engine oil and oil filter

- disconnect and reconnect the battery to reset the engine controller memory

More extensive repairs will be required for prolonged exposure to E-85 fuel.

### **MMT In Gasoline**

MMT is a manganese containing metallic additive that is blended into some gasoline to increase octane. Gasoline blended with MMT provides no performance advantage beyond gasoline of the same octane number without MMT. Gasoline blended with MMT reduces spark plug life and reduces emission system performance in some vehicles. The manufacturer recommends that gasoline without MMT be used in your vehicle. The MMT content of gasoline may not be indicated on the gasoline pump, therefore, you should ask your gasoline retailer whether or not the gasoline contains MMT. It is even more important to look for gasolines without MMT in Canada, because MMT can be used at levels higher than those

allowed in the United States. MMT is prohibited in Federal and California reformulated gasoline.

### Materials Added To Fuel

All gasolines sold in the United States are required to contain effective detergent additives. Use of additional detergents or other additives is not needed under normal conditions and would result in unnecessary cost. Therefore, you should not have to add anything to the fuel.

### Fuel System Cautions

#### CAUTION!

Follow these guidelines to maintain your vehicle's performance:

- The use of leaded gas is prohibited by Federal law. Using leaded gasoline can impair engine performance, damage the emission control system.

*(Continued)*

#### CAUTION! (Continued)

- An out-of-tune engine, or certain fuel or ignition malfunctions, can cause the catalytic converter to overheat. If you notice a pungent burning odor or some light smoke, your engine may be out of tune or malfunctioning and may require immediate service. Contact your authorized dealer for service assistance.
- When pulling a heavy load or driving a fully-loaded vehicle when the humidity is low and the temperature is high, use a premium unleaded fuel to help prevent spark knock. If spark knock persists, lighten the load, or engine piston damage may result.

*(Continued)*

**CAUTION! (Continued)**

- The use of fuel additives which are now being sold as octane enhancers is not recommended. Many of these products contain high concentrations of methanol. Fuel system damage or vehicle performance problems resulting from the use of such fuels or additives is not the responsibility of the manufacturer.

**NOTE:** Intentional tampering with emissions control systems can result in civil penalties being assessed against you.

**Carbon Monoxide Warnings****WARNING!**

Carbon monoxide (CO) in exhaust gases is deadly. Follow the precautions below to prevent carbon monoxide poisoning:

- Do not inhale exhaust gases. They contain carbon monoxide, a colorless and odorless gas which can kill. Never run the engine in a closed area, such as a garage, and never sit in a parked vehicle with the engine running for an extended period. If the vehicle is stopped in an open area with the engine running for more than a short period, adjust the ventilation system to force fresh, outside air into the vehicle.

*(Continued)*

**WARNING! (Continued)**

- Guard against carbon monoxide with proper maintenance. Have the exhaust system inspected every time the vehicle is raised. Have any abnormal conditions repaired promptly. Until repaired, drive with all side windows fully open.

**ADDING FUEL**

The fuel tank filler tube has a restricting door about 2 in (50 mm) inside the opening. If using a portable fuel container, it should have a flexible nozzle long enough to force open the restricting door.

**CAUTION!**

- Damage to the fuel system or emissions control system could result from using an improper fuel tank filler tube cap (gas cap). A poorly fitting cap could let impurities into the fuel system. Also, a poorly-fitted aftermarket cap can cause the MIL (Malfunction Indicator Light) to illuminate due to fuel vapors escaping from the system.
- A poorly fitting gas cap may cause the MIL to turn on.
- To avoid fuel spillage and overfilling, do not “top off” the fuel tank after filling.

**NOTE:** When the fuel nozzle “clicks” or shuts off the fuel tank is full.

**WARNING!**

- Never have any smoking materials lit in or near the vehicle when the gas cap is removed or the tank filled.
- Never add fuel to the vehicle when the engine is running. This is in violation of most state and federal fire regulations and will cause the MIL to turn on.

**NOTE:** Tighten the gas cap 1/4 turn until you hear one click. This is an indication that the cap is properly tightened.

If the gas cap is not tightened properly, the Malfunction Indicator Light will come on, Be sure the gas cap is tightened every time the vehicle is refueled.

**WARNING!**

A fire may result if gasoline is pumped into a portable container that is inside of a vehicle. You could be burned. Always place gas containers on the ground while filling.

**Loose Fuel Filler Cap Message**

If the vehicle diagnostic system determines that the fuel filler cap is loose, improperly installed, or damaged, a loose gascap indicator will display in the EVIC telltale display area. Refer to “Electronic Vehicle Information Center (EVIC) in “Understanding Your Instrument Panel” for further information. Tighten the fuel filler cap properly and press the SELECT button to turn off the message. If the problem continues, the message will appear the next time the vehicle is started.



## VEHICLE LOADING

### Certification Label

As required by National Highway Traffic Safety Administration regulations, your vehicle has a certification label affixed to the driver's side door or pillar.

This label contains the month and year of manufacture, Gross Vehicle Weight Rating (GVWR), Gross Axle Weight Rating (GAWR) front and rear, and Vehicle Identification Number (VIN). A Month-Day-Hour (MDH) number is included on this label and indicates the Month, Day and Hour of manufacture. The bar code that appears on the bottom of the label is your Vehicle Identification Number (VIN).

### Gross Vehicle Weight Rating (GVWR)

The GVWR is the total permissible weight of your vehicle including driver, passengers, vehicle, options and cargo. The label also specifies maximum capacities of front and

rear axle systems (GAWR). Total load must be limited so GVWR and front and rear GAWR are not exceeded.

### Payload

The payload of a vehicle is defined as the allowable load weight a truck can carry, including the weight of the driver, all passengers, options and cargo.

### Gross Axle Weight Rating (GAWR)

The GAWR is the maximum permissible load on the front and rear axles. The load must be distributed in the cargo area so that the GAWR of each axle is not exceeded.

Each axle GAWR is determined by the components in the system with the lowest load carrying capacity (axle, springs, tires or wheels). Heavier axles or suspension components sometimes specified by purchasers for increased durability does not necessarily increase the vehicle's GVWR.

**Tire Size**

The tire size on the Label represents the actual tire size on your vehicle. Replacement tires must be equal to the load capacity of this tire size.

**Rim Size**

This is the rim size that is appropriate for the tire size listed.

**Inflation Pressure**

This is the cold tire inflation pressure for your vehicle for all loading conditions up to full GAWR.

**Curb Weight**

The curb weight of a vehicle is defined as the total weight of the vehicle with all fluids, including vehicle fuel, at full capacity conditions, and with no occupants or cargo loaded into the vehicle. The front and rear curb weight values are determined by weighing your vehicle on a commercial scale before any occupants or cargo are added.

**Loading**

The actual total weight and the weight of the front and rear of your vehicle at the ground can best be determined by weighing it when it is loaded and ready for operation.

The entire vehicle should first be weighed on a commercial scale to insure that the GVWR has not been exceeded. The weight on the front and rear of the vehicle should then be determined separately to be sure that the load is properly distributed over front and rear axle. Weighing the vehicle may show that the GAWR of either the front or rear axles has been exceeded but the total load is within the specified GVWR. If so, weight must be shifted from front to rear or rear to front as appropriate until the specified weight limitations are met. Store the heavier items down low and be sure that the weight is distributed equally. Stow all loose items securely before driving.

Improper weight distributions can have an adverse effect on the way your vehicle steers and handles and the way the brakes operate.

### CAUTION!

**Do not load your vehicle any heavier than the GVWR or the maximum front and rear GAWR. If you do, parts on your vehicle can break, or it can change the way your vehicle handles. This could cause you to lose control. Also overloading can shorten the life of your vehicle.**

## TRAILER TOWING

In this section you will find safety tips and information on limits to the type of towing you can reasonably do with your vehicle. Before towing a trailer, carefully review this information to tow your load as efficiently and safely as possible.

To maintain warranty coverage, follow the requirements and recommendations in this manual concerning vehicles used for trailer towing.

## Common Towing Definitions

The following trailer towing related definitions will assist you in understanding the following information:

### Gross Vehicle Weight Rating (GVWR)

The GVWR is the total allowable weight of your vehicle. This includes driver, passengers, cargo and tongue weight. The total load must be limited so that you do not exceed the GVWR.

### Gross Trailer Weight (GTW)

The GTW is the weight of the trailer plus the weight of all cargo, consumables and equipment (permanent or temporary) loaded in or on the trailer in its "loaded and ready for operation" condition. The recommended way to

measure GTW is to put your fully loaded trailer on a vehicle scale. The entire weight of the trailer must be supported by the scale.

### **Gross Combination Weight Rating (GCWR)**

The GCWR is the total permissible weight of your vehicle and trailer when weighed in combination.

**NOTE:** The GCWR rating includes a 150 lbs (68 kg) allowance for the presence of a driver.

### **Gross Axle Weight Rating (GAWR)**

The GAWR is the maximum capacity of the front and rear axles. Distribute the load over the front and rear axles evenly. Make sure that you do not exceed either front or rear GAWR.

## **WARNING!**

**It is important that you do not exceed the maximum front or rear GAWR. A dangerous driving condition can result if either rating is exceeded. You could lose control of the vehicle and have an accident.**

### **Tongue Weight (TW)**

The tongue weight is the downward force exerted on the hitch ball by the trailer. In most cases it should not be less than 10% or more than 15% of the trailer load. You must consider this as part of the load on your vehicle.

### **Frontal Area**

The frontal area is the maximum height and maximum width of the front of a trailer.

### **Trailer Sway Control**

The trailer sway control is a telescoping link that can be installed between the hitch receiver and the trailer tongue

that typically provides adjustable friction associated with the telescoping motion to dampen any unwanted trailer swaying motions while traveling.

### **Weight-Carrying Hitch**

A weight-carrying hitch supports the trailer tongue weight, just as if it were luggage located at a hitch ball or some other connecting point of the truck. These kind of hitches are the most popular on the market today and they're commonly used to tow small- and medium-sized trailers.

### **Weight-Distributing Hitch**

A weight-distributing system works by applying leverage through spring (load) bars. They are typically used for heavier loads to distribute trailer tongue weight to the tow vehicle's front axle and the trailer axle(s). When used in accordance with the manufacturer's directions, it provides for a more level ride, offering more consistent steering and brake control, thereby enhancing towing

safety. The addition of a friction/hydraulic sway control also dampens sway caused by traffic and crosswinds and contributes positively to tow vehicle and trailer stability. Trailer sway control and a weight distributing (load equalizing) hitch are recommended for heavier Tongue Weights (TW) and may be required depending on vehicle and trailer configuration/loading to comply with GAWR requirements.

#### **WARNING!**

- **An improperly adjusted weight distributing hitch system may reduce handling, stability and braking performance and could result in an accident.**
- **Weight distributing systems may not be compatible with surge brake couplers. Consult with your hitch and trailer manufacturer or a reputable Recreational Vehicle dealer for additional information.**

### Fifth-Wheel Hitch

The fifth-wheel hitch is a special high platform with a coupling that mounts over the rear axle of the tow vehicle in the truck bed. It connects a vehicle and fifth-wheel trailer with a coupling king pin.

### Gooseneck Hitch

The gooseneck hitch employs a pivoted coupling arm which attaches to a ball mounted in the bed of a pickup truck. The coupling arm connects to the hitch mounted over the rear axle in the truck bed.

### Trailer Hitch Classification

Your vehicle may be factory equipped for safe towing of trailers weighing over 5,000 lbs (2 268 kg) with the optional Trailer Tow Prep Package. See your authorized dealer for package content.

The following chart provides the industry standard for the maximum trailer weight a given trailer hitch class can tow and should be used to assist you in selecting the

correct trailer hitch for your intended towing condition. Refer to “Trailer Towing Weights (Maximum Trailer Weight Ratings)” for the website address that contains the necessary information for your specific drivetrain.

Trailer Hitch Classification Definitions	
Class	Max. Trailer Hitch Industry Standards
Class I - Light Duty	2,000 lbs (907 kg)
Class II - Medium Duty	3,500 lbs (1587 kg)
Class III - Heavy Duty	5,000 lbs (2268 kg)
Class IV - Extra Heavy Duty	10,000 lbs (4540 kg)
Fifth Wheel/Gooseneck	Greater than 10,000 lbs (4540 kg)
Refer to the “Trailer Towing Weights (Maximum Trailer Weight Ratings)” for the Maximum Gross Trailer Weight (GTW) towable for your given drivetrain.	

All trailer hitches should be professionally installed on your vehicle.

### Trailer Towing Weights (Maximum Trailer Weight Ratings)

**NOTE:** For additional trailer towing information (maximum trailer weight ratings) refer to the following website addresses:

- [http:// www.dodge.com](http://www.dodge.com).
- [http:// www.dodge.ca](http://www.dodge.ca) (Canada).

### Trailer and Tongue Weight

Always load a trailer with 60% to 65% of the weight in the front of the trailer. This places 10% to 15% of the GTW on the tow hitch of your vehicle. Loads balanced over the wheels or heavier in the rear can cause the trailer to sway **severely** side to side which will cause loss of control of the vehicle and trailer. Failure to load trailers heavier in front is the cause of many trailer accidents.

Never exceed the maximum tongue weight stamped on your trailer hitch.

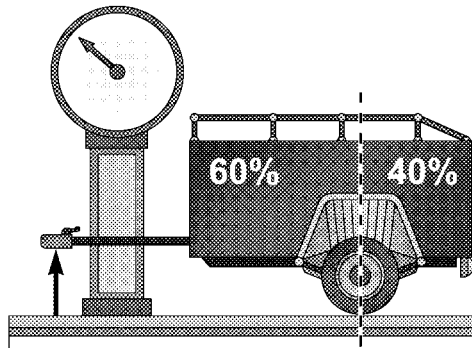

Consider the following items when computing the weight on the rear axle of the vehicle:

- The tongue weight of the trailer

- The weight of any other type of cargo or equipment put in or on your vehicle
- The weight of the driver and all passengers.

**NOTE:** Remember that everything put into or on the trailer adds to the load on your vehicle. Also, additional factory-installed options or dealer-installed options must be considered as part of the total load on your vehicle. Refer to “Tire Safety Information/Tire and Loading Information Placard” in “Starting and Operating” for further information.

### **Towing Requirements**

To promote proper break-in of your new vehicle drive-train components the following guidelines are recommended:

#### **CAUTION!**

- Do not tow a trailer at all during the first 500 miles (805 km) the new vehicle is driven. The engine, axle or other parts could be damaged.
- Then, during the first 500 miles (805 km) that a trailer is towed, do not drive over 50 mph (80 km/h) and do not make starts at full throttle. This helps the engine and other parts of the vehicle wear in at the heavier loads.

#### **WARNING!**

**Improper towing can lead to an injury accident. Follow these guidelines to make your trailer towing as safe as possible:**

*(Continued)*



**WARNING! (Continued)**

- Make certain that the load is secured in the trailer and will not shift during travel. When trailering cargo that is not fully secured, dynamic load shifts can occur that may be difficult for the driver to control. You could lose control of your vehicle and have an accident.
- When hauling cargo or towing a trailer, do not overload your vehicle or trailer. Overloading can cause a loss of control, poor performance or damage to brakes, axle, engine, transmission, steering, suspension, chassis structure or tires.
- Safety chains must always be used between your vehicle and trailer. Always connect the chains to the hook retainers of the vehicle hitch. Cross the chains under the trailer tongue and allow enough slack for turning corners.

*(Continued)*

**WARNING! (Continued)**

- Vehicles with trailers should not be parked on a grade. When parking, apply the parking brake on the tow vehicle. Put the tow vehicle transmission in PARK. For four-wheel drive vehicles, make sure the transfer case is not in NEUTRAL. Always, block or "chock" the trailer wheels.
- GCWR must not be exceeded.
- Total weight must be distributed between the tow vehicle and the trailer such that the following four ratings are not exceeded:
  1. GVWR
  2. GTW
  3. GAWR

*(Continued)*

**WARNING! (Continued)**

4. Trailer tongue weight rating for the trailer hitch utilized (This requirement may limit the ability to always achieve the 10% to 15% range of tongue weight as a percentage of total trailer weight).

**Towing Requirements – Tires**

- Do not attempt to tow a trailer while using a compact spare tire.
- Proper tire inflation pressures are essential to the safe and satisfactory operation of your vehicle. Refer to “Tires–General Information” in “Starting and Operating” for proper tire inflation procedures.
- Check the trailer tires for proper tire inflation pressures before trailer usage.

- Check for signs of tire wear or visible tire damage before towing a trailer. Refer to “Tires–General Information” in “Starting and Operating” for the proper inspection procedure.
- When replacing tires, refer to “Tires–General Information” in “Starting and Operating” for proper tire replacement procedures. Replacing tires with a higher load carrying capacity will not increase the vehicle’s GVWR and GAWR limits.

**Towing Requirements – Trailer Brakes**

- Do **not** interconnect the hydraulic brake system or vacuum system of your vehicle with that of the trailer. This could cause inadequate braking and possible personal injury.
- An electronically actuated trailer brake controller is required when towing a trailer with electronically

actuated brakes. When towing a trailer equipped with a hydraulic surge actuated brake system, an electronic brake controller is not required.

- Trailer brakes are recommended for trailers over 1,000 lbs (454 kg) and required for trailers in excess of 2,000 lbs (907 kg).

### CAUTION!

If the trailer weighs more than 1,000 lbs (454 kg) loaded, it should have its own brakes and they should be of adequate capacity. Failure to do this could lead to accelerated brake lining wear, higher brake pedal effort, and longer stopping distances.

### WARNING!

- Do not connect trailer brakes to your vehicle's hydraulic brake lines. It can overload your brake system and cause it to fail. You might not have brakes when you need them and could have an accident.
- Towing any trailer will increase your stopping distance. When towing you should allow for additional space between your vehicle and the vehicle in front of you. Failure to do so could result in an accident.

### Integrated Trailer Brake Module – If Equipped

Your vehicle may have a Integrated Trailer Brake Module for electric trailer brakes.

**NOTE:** This module is designed for only electric trailer brakes. To determine the type of brakes on your trailer, check with your trailer manufacturer or dealer.

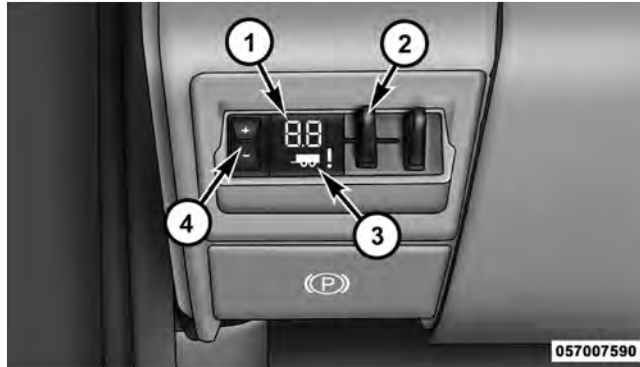

- 1 — GAIN/Brake Output Power Display
- 2 — Manual Brake Control Lever
- 3 — Trailer Brake Status Indicator Light
- 4 — GAIN Adjustment Buttons

The user interface consists of the following:

### *GAIN/ Brake Output Power Display*

Shows the current GAIN setting.

This display may also be used to display diagnostic information, if needed.

- SC — Short Circuit to Ground
- Sb — Short to Battery
- CF — Controller Fault – If this message appears on the display, see your authorized dealer.

When the vehicle brakes are applied, the display will no longer show GAIN and will change to the output to the trailer brakes.

### *Manual Brake Control Lever*

Slide the manual brake control lever to the right to activate power to the trailer's electric brakes independent of the tow vehicle's brakes. If the manual brake control lever is activated while the brake is also applied, the greater of the two inputs determines the power sent to the trailer brakes.

The trailer and the vehicle's brake lamps will come on when either vehicle braking or manual trailer brakes are applied.

### *Trailer Brake Status Indicator Light*

This light indicates the trailer electrical connection status.

If no electrical connection is detected after the ignition is turned on, pressing the GAIN adjustment button or sliding the manual brake control lever will display the GAIN setting for 10 seconds and the "Trailer Brake Status Indicator Light" will not be displayed.

If a fault is detected in the trailer wiring or the Integrated Trailer Brake Module (ITBM), the "Trailer Brake Status Indicator Light" will flash.

### *GAIN Adjustment Buttons (+/-)*

Pressing these buttons will adjust the brake control power output to the trailer brakes in 0.5 increments. The GAIN setting can be increased to a maximum of 10 or decreased to a minimum of 0 (no trailer braking).

### *GAIN*

The GAIN setting is used to set the trailer brake control for the specific towing condition and should be changed as towing conditions change. Changes to towing conditions include trailer load, vehicle load, road conditions and weather.

## Adjusting GAIN

**NOTE:** This should only be performed in a traffic free environment at speeds of approximately 20–25 mph (30–40 km/h).

1. Make sure the trailer brakes are in good working condition, functioning normally, and properly adjusted. See your trailer dealer if necessary.
2. Hook up the trailer and make the electrical connections according to the trailer manufacturer's instructions.
3. When a trailer with electric brakes is plugged in, the GAIN setting will illuminate.
4. Use the GAIN adjustment (+/-) buttons to increase or decrease the GAIN setting to the desired starting point. A GAIN setting of 6 is a good starting point for heavier loads.

5. In a traffic-free environment, tow the trailer on a dry, level surface at a speed of 20–25 mph (30–40 km/h) and squeeze the manual brake control lever completely.

6. If the trailer wheels lockup (indicated by squealing tires), reduce the GAIN setting; if the trailer wheels turn freely, increase the GAIN setting.

Repeat Steps 5 and 6 until the GAIN setting is at a point just below trailer wheel lockup. If towing a heavier trailer, trailer wheel lockup may not be attainable even with the maximum GAIN setting of 10.

### *EVIC Display Messages*

The trailer brake control interacts with the Electronic Vehicle Information Center (EVIC). Display messages, along with a single chime, will be displayed when a malfunction is determined in the trailer connection, trailer brake control, or on the trailer. Refer to “Electronic Vehicle Information Center (EVIC)” in “Understanding Your Instrument Panel” for further information.

**CAUTION!**

Connecting a trailer that is not compatible with the ITBM system may result in reduced or complete loss of trailer braking. There may be a increase in stopping distance or trailer instability which could result in damage to your vehicle, trailer, or other property.

**WARNING!**

Connecting a trailer that is not compatible with the ITBM system may result in reduced or complete loss of trailer braking. There may be a increase in stopping distance or trailer instability which could result in personal injury.

**NOTE:** A aftermarket controller may be available for use with trailers with air or electric-over-hydraulic trailer

brake systems. To determine the type of brakes on your trailer and the availability of controllers, check with your trailer manufacturer or dealer.

**Towing Requirements – Trailer Lights and Wiring**

Whenever you pull a trailer, regardless of the trailer size, stop lights and turn signals on the trailer are required for motoring safety.

**NOTE:** Do not cut or splice wiring into the vehicle's wiring harness.

**WARNING!**

Any work done to the vehicle's electrical system or wiring should be performed by a qualified automotive technician. If done improperly it may cause damage to the electrical system wiring and could result in serious or fatal injury.

## Towing Tips

Before setting out on a trip, practice turning, stopping and backing the trailer up in an area away from heavy traffic.

## Automatic Transmission

The “DRIVE” range can be selected when towing. However, if frequent shifting occurs while in this range, select “TOW/HAUL” mode (if equipped) or select a lower gear using the Electronic Range Select (ERS) feature.

**NOTE:** Using “TOW/HAUL” mode or a lower gear range while operating the vehicle under heavy operating conditions will improve performance and extend transmission life by reducing excessive shifting and heat build up. This action will also provide better engine braking.

The automatic transmission fluid and filter should be changed if you regularly tow a trailer for more than 45 minutes of continuous operation. Refer to “Maintenance Schedule” for the proper maintenance intervals.

**NOTE:** Check the automatic transmission fluid level before towing.

## Tow/Haul

To reduce potential for automatic transmission overheating, turn the “TOW/HAUL” feature ON when driving in hilly areas, or select a lower gear range (using the Electronic Range Select (ERS) feature) on more severe grades.

## Electronic Speed Control – If Equipped

- Do not use in hilly terrain or with heavy loads.
- When using the speed control, if you experience speed drops greater than 10 mph (16 km/h), disengage until you can get back to cruising speed.
- Use speed control in flat terrain and with light loads to maximize fuel efficiency.



### Cooling System

To reduce potential for engine and transmission overheating, take the following actions:

– *City Driving*

When stopped for short periods of time, shift the transmission into NEUTRAL and increase engine idle speed.

– *Highway Driving*

Reduce speed.

– *Air Conditioning*

Turn off temporarily.

### SNOWPLOW

Snowplow Prep Packages are available as a factory installed option. These packages include components necessary to equip your vehicle with a snowplow.

**NOTE:** Before installation of a snowplow it is highly recommended that the owner/installer obtain and follow the recommendations contained within the current

Dodge Body Builders Guide. See your authorized dealer, installer or snowplow manufacturer for this information. There are unique electrical systems that must be connected to properly assure operator safety and prevent overloading vehicle systems.

#### **WARNING!**

Attaching a snowplow to this vehicle could adversely affect performance of the airbag system in an accident. Do not expect that the airbag will perform as described earlier in this manual

#### **CAUTION!**

The “Lamp Out” indicator could illuminate if exterior lamps are not properly installed.

## Before Plowing

- Check the hydraulic system for leaks and proper fluid level.
- Check the mounting bolts and nuts for proper tightness.
- Check the runners and cutting edge for excessive wear. The cutting edge should be 1/4 to 1/2 in (6 cm to 1.2 cm) above ground in snow plowing position.
- Check that snowplow lighting is connected and functioning properly.

### Snowplow Prep Package Model Availability

For information about snowplow applications visit [www.dodge.com](http://www.dodge.com) or refer to the current Dodge Body Builders Guide.

1. The maximum number of occupants in the truck should not exceed two.

2. The total GVWR or the Front GAWR or the Rear GAWR should never be exceeded.

3. Cargo capacity will be reduced by the addition of options or passengers, etc.

The loaded vehicle weight, including the snowplow system, all aftermarket accessories, driver, passengers, options, and cargo, must not exceed either the Gross Vehicle Weight (GVWR) or Gross Axle Weight (GAWR) ratings. These weights are specified on the Safety Compliance Certification Label on the driver's side door opening.

**NOTE:** Detach the snowplow when transporting passengers.

Vehicle front end wheel alignment was set to specifications at the factory without consideration for the weight of the plow. Front end toe-in should be checked and reset

if necessary at the beginning and end of the snowplow season. This will help prevent uneven tire wear.

The blade should be lowered whenever the vehicle is parked.

Maintain and operate your vehicle and snowplow equipment following the recommendations provided by the specific snowplow manufacturer.

### **Over the Road Operation With Snowplow Attached**

The blade restricts air flow to the radiator and causes the engine to operate at higher than normal temperatures. Therefore, when transporting the plow, angle the blade completely and position it as low as road or surface conditions permit. Do not exceed 40 mph (64 km/h). The operator should always maintain a safe stopping distance and allow adequate passing clearance.

### **Operating Tips**

Under ideal snow plowing conditions, 20 mph (32 km/h) should be maximum operating speed. The operator should be familiar with the area and surface to be cleaned. Reduce speed and use extreme caution when plowing unfamiliar areas or under poor visibility.

**NOTE:** During snowplow usage on vehicles equipped with outside temperature display, the display may show higher temperatures than the outside ambient temperature. The higher displayed temperature is due to blocked or reduced airflow to the underhood ambient temperature sensor caused by the snowplow. In addition, on vehicles equipped with Automatic Temperature Control (ATC), it is suggested that the interior cabin temperature be manually controlled should the system not perform as desired while in automatic mode. Both the outside temperature display and ATC operation will return to normal when the snowplow is removed.

## General Maintenance

Snowplows should be maintained in accordance with the plow manufacturer's instructions.

Keep all snowplow electrical connections and battery terminals clean and free of corrosion.

When plowing snow, to avoid transmission and drive-train damage, the following precautions should be observed.

- Operate with transfer case in 4L when plowing small or congested areas where speeds are not likely to exceed 15 mph (24 km/h). At higher speeds operate in 4H.
- Vehicles with automatic transmissions should use 4L range when plowing deep or heavy snow for extended periods of time to avoid transmission overheating.

- Do not shift the transmission unless the engine has returned to idle and wheels have stopped. Make a practice of stepping on the brake pedal before shifting the transmission.

## RECREATIONAL TOWING (BEHIND MOTORHOME, ETC.)

### CAUTION!

Front or rear wheel lifts should not be used. Internal damage to the transmission or transfer case will occur if a front or rear wheel lift is used when recreational towing.

## Recreational Towing – Two-Wheel Drive Models

Recreational towing of two-wheel drive models is not allowed. Towing with the rear wheels on the ground can result in severe transmission damage.

## Recreational Towing – Four-Wheel Drive Models

### CAUTION!

Failure to follow these requirements can cause severe damage to the transmission and/or transfer case.

**NOTE:** Both the manual shift and electronic shift transfer cases must be shifted into NEUTRAL for recreational towing. Automatic transmissions must be shifted into the PARK position for recreational towing. Refer to the following for the proper transfer case NEUTRAL shifting procedure for your vehicle.

### Recreational Towing Procedure (Manual Shift Transfer Case) – If Equipped

Use the following procedure to prepare your vehicle for recreational towing:

### WARNING!

You or others could be injured if you leave the vehicle unattended with the transfer case in the NEUTRAL position without first fully engaging the parking brake. The transfer case NEUTRAL position disengages both the front and rear driveshafts from the powertrain and will allow the vehicle to move, even if the transmission is in PARK. The parking brake should always be applied when the driver is not in the vehicle.

### CAUTION!

It is necessary to follow these steps to be certain that the transfer case is fully in NEUTRAL before recreational towing to prevent damage to internal parts.

1. Bring the vehicle to a complete stop.
2. Shut OFF the engine.
3. Press the brake pedal.
4. Shift the transmission into NEUTRAL.
5. Shift the transfer case lever into NEUTRAL.
6. Start the engine.
7. Shift the transmission into REVERSE.
8. Release the brake pedal for five seconds and ensure that there is no vehicle movement.
9. Repeat steps 7 and 8 with the transmission in DRIVE.
10. Turn OFF the engine and place the ignition switch in the OFF position.
11. Shift the transmission into PARK.
12. Apply the parking brake.

13. Attach the vehicle to the tow vehicle with the tow bar.
14. Release the parking brake.

**CAUTION!**

**Damage to the transmission may occur if the transmission is shifted into PARK with the transfer case in NEUTRAL and the engine running. With the transfer case in NEUTRAL ensure that the engine is OFF prior to shifting the transmission into PARK.**

**5****Returning to Normal Operation – Manual Shift Transfer Case**

Use the following procedure to prepare your vehicle for normal usage:

1. Bring the vehicle to a complete stop.
2. Apply the parking brake.
3. Shut OFF the engine.

4. Press the brake pedal.
5. Shift the transmission into NEUTRAL.
6. Shift the transfer case lever into desired position.
7. Shift the transmission into PARK.

**WARNING!**

You or others could be injured if you leave the vehicle unattended with the transfer case in the NEUTRAL position without first fully engaging the parking brake. The transfer case NEUTRAL position disengages both the front and rear driveshafts from the powertrain and will allow the vehicle to move, even if the transmission is in PARK. The parking brake should always be applied when the driver is not in the vehicle.

**CAUTION!**

- Do not use a bumper-mounted clamp-on tow bar on your vehicle. The bumper face bar will be damaged.
- Do not disconnect the rear driveshaft because fluid will leak from the transfer case and damage the internal parts.

### Recreational Towing Procedure (Electronic Shift Transfer Case) – If Equipped

Use the following procedure to prepare your vehicle for recreational towing:

#### WARNING!

You or others could be injured if you leave the vehicle unattended with the transfer case in the NEUTRAL position without first fully engaging the parking brake. The transfer case NEUTRAL position disengages both the front and rear driveshafts from the powertrain and will allow the vehicle to move, even if the transmission is in PARK. The parking brake should always be applied when the driver is not in the vehicle.

#### CAUTION!

It is necessary to follow these steps to be certain that the transfer case is fully in NEUTRAL before recreational towing to prevent damage to internal parts.

1. Bring the vehicle to a complete stop.
2. Turn OFF the engine.
3. Turn the ignition switch to the ON position, but do not start the engine.
4. Press the brake pedal.
5. Shift the transmission into NEUTRAL.
6. Press the transfer case switch NEUTRAL button for four seconds.
7. After the shift is completed and the NEUTRAL light comes on, release the NEUTRAL button.



8. Start the engine.
9. Shift the transmission into REVERSE.
10. Release the brake pedal for five seconds and ensure that there is no vehicle movement.
11. Repeat Steps 9 and 10 with the transmission in DRIVE.
12. Turn the engine OFF and place the ignition switch in the OFF position.
13. Shift the transmission into PARK.
14. Apply the parking brake.
15. Attach the vehicle to the tow vehicle with the tow bar.
16. Release the parking brake.

**NOTE:**

- The transfer case cannot be shifted into NEUTRAL from the 4WD AUTO (if equipped) position.
- Steps 1 through 5 are requirements that must be met prior to pressing the NEUTRAL button, and must continue to be met until the four seconds elapses and the shift has been completed. If any of these requirements (with the exception of 3 - Key ON) are not met prior to pressing the NEUTRAL button or are no longer met during the four second timer, then the NEUTRAL indicator light will flash continuously until all requirements are met or until the NEUTRAL button is released.
- The ignition switch must be in the ON position for a shift to take place and for the position indicator lights to be operable. If the ignition switch is not in the ON position, the shift will not take place and no position indicator lights will be on or flashing.
- The flashing NEUTRAL indicator light indicates that shift requirements have not been met.

**CAUTION!**

Damage to the transmission may occur if the transmission is shifted into PARK with the transfer case in NEUTRAL and the engine running. With the transfer case in NEUTRAL, ensure that the engine is OFF prior to shifting the transmission into PARK.

**Returning to Normal Operation – Electronic Shift Transfer Case**

Use the following procedure to prepare your vehicle for normal usage:

1. Bring the vehicle to a complete stop.
2. Turn OFF the engine.
3. Turn the ignition switch to the ON position, but do not start the engine.
4. Press the brake pedal.

5. Shift the transmission into NEUTRAL.
6. Press the transfer case switch NEUTRAL button for one second.
7. After the NEUTRAL indicator light turns off, release the NEUTRAL button.
8. After the NEUTRAL button has been released, the transfer case will shift to the position identified by the selector switch.
9. Shift the transmission into PARK.

**NOTE:**

- Steps 1 through 5 are requirements that must be met prior to pressing the transfer case NEUTRAL button and must continue to be met until one second elapses and the shift has been completed. If any of these requirements (with the exception of step 3 - key ON) are not met prior to pressing the NEUTRAL button, or are no longer met during the one second time, then all

of the mode position indicator lights will flash continuously until all requirements are met or until the NEUTRAL button is released.

- The ignition switch must be in the ON position for a transfer case shift to take place and for the position indicator lights to be operable. If the ignition switch is not in the ON position, the shift will not take place and no position indicator lights will be on or flashing.
- The flashing NEUTRAL position indicator light indicates that shift requirements have not been met.

**WARNING!**

**You or others could be injured if you leave the vehicle unattended with the transfer case in the NEUTRAL position without first fully engaging the parking brake. The transfer case NEUTRAL position disengages both the front and rear driveshafts from the powertrain and will allow the vehicle to move, even if the transmission is in PARK. The parking brake should always be applied when the driver is not in the vehicle.**

**CAUTION!**

- Do not use a bumper-mounted clamp-on tow bar on your vehicle. The bumper face bar will be damaged.
- Do not disconnect the rear driveshaft because fluid will leak from the transfer case and fluid loss will damage internal parts.



# WHAT TO DO IN EMERGENCIES

## CONTENTS

---

■ Hazard Warning Flasher . . . . .	358	□ Preparations For Jump-Start . . . . .	371
■ Jacking And Tire Changing . . . . .	358	□ Jump-Starting Procedure . . . . .	372
□ 3500 Models — If Equipped . . . . .	359	■ Freeing A Stuck Vehicle . . . . .	374
□ Preparations For Jacking . . . . .	360	■ Emergency Tow Hooks — If Equipped . . . . .	375
□ Jacking Instructions . . . . .	361	■ Towing A Disabled Vehicle . . . . .	376
■ Hoisting . . . . .	370	□ Four-Wheel Drive Vehicles . . . . .	376
■ Jump-Starting Procedures . . . . .	370	□ Two-Wheel Drive Vehicles . . . . .	376

## HAZARD WARNING FLASHER

The Hazard Warning flasher switch is located on the upper switch bank just below the radio.



Press the switch to turn on the Hazard Warning flasher. When the switch is activated, all directional turn signals will flash on and off to warn oncoming traffic of an emergency. Press the switch a second time to turn off the Hazard Warning flasher.

This is an emergency warning system and should not be used when the vehicle is in motion. Use it when your vehicle is disabled and is creating a safety hazard for other motorists.

When you must leave the vehicle to seek assistance, the Hazard Warning flasher will continue to operate even though the ignition switch is OFF.

**NOTE:** With extended use, the Hazard Warning flasher may discharge your battery.

## JACKING AND TIRE CHANGING

### WARNING!

- **Being under a jacked-up vehicle is dangerous. The vehicle could slip off the jack and fall on you. You could be crushed. Never put any part of your body under a vehicle that is on a jack. Never start or run the engine while the vehicle is on a jack. If you need to get under a raised vehicle, take it to a service center where it can be raised on a lift.**
- **The jack is designed to use as a tool for changing tires only. The jack should not be used to lift the vehicle for service purposes. The vehicle should be jacked on a firm level surface only. Avoid ice or slippery areas.**

### 3500 Models — If Equipped

The jack and jack tools are stored under the front passenger seat. Lift the flap on the side of the seat for access.

Remove the jack and tools by removing the wing bolt and sliding the assembly from under the seat.

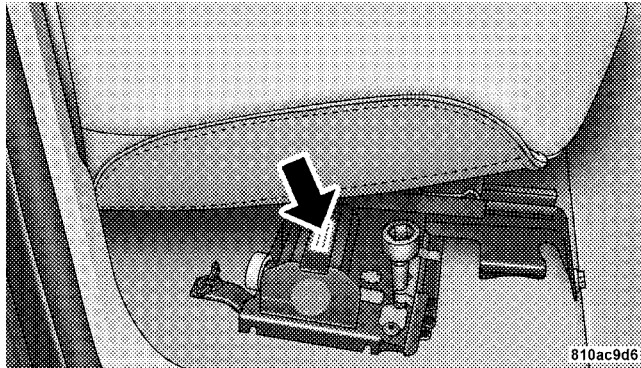

Jack Location

### WARNING!

After using the jack and tools, always reinstall them in the original carrier and location. While driving you may experience abrupt stopping, rapid acceleration, or sharp turns. A loose jack, tools, bracket or other objects in the vehicle may move around with force, resulting in serious injury.

### 4500/5500 Models

These vehicles do not come equipped with a jack.

**NOTE:** Jacking and tire changing on 4500/5500 models should be performed by an authorized dealer, or knowledgeable service personnel with the appropriate heavy duty equipment, like a tire service company.



## Preparations For Jacking

1. Park the vehicle on a firm, level surface. Avoid ice or slippery areas.

### WARNING!

**Do not attempt to change a tire on the side of the vehicle close to moving traffic. Pull far enough off the road to avoid the danger of being hit when operating the jack or changing the wheel.**

2. Set the parking brake.

3. Place the shift lever into PARK (automatic transmission) or REVERSE (manual transmission). On 4-Wheel drive vehicles, shift the transfer case to the "4L" position.

4. Turn OFF the ignition.

5. Turn on the Hazard Warning flasher.

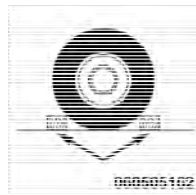

6. Block both the front and rear of the wheel diagonally opposite the jacking position. For example, if the right front wheel is being changed, block the left rear wheel.

**NOTE:** Passengers should not remain in the vehicle when the vehicle is being jacked.

## Jacking Instructions

### Instructions

#### WARNING!

Carefully follow these tire changing warnings to help prevent personal injury or damage to your vehicle:

- Always park on a firm, level surface as far from the edge of the roadway as possible before raising the vehicle.
- Block the wheel diagonally opposite the wheel to be raised.
- Set the parking brake firmly and set an automatic transmission in PARK; a manual transmission in REVERSE.

*(Continued)*

#### WARNING! (Continued)

- Never start or run the engine with the vehicle on a jack.
- Do not let anyone sit in the vehicle when it is on a jack.
- Do not get under the vehicle when it is on a jack.
- Only use the jack in the positions indicated and for lifting this vehicle during a tire change.
- If working on or near a roadway, be extremely careful of motor traffic.

*(Continued)*

**WARNING! (Continued)**

- To assure that spare tires, flat or inflated, are securely stowed, spares must be stowed with the valve stem facing the ground.
- Turn on the Hazard Warning flasher.



Jack Warning Label

1. If equipped, remove the spare wheel, jack, and tools from storage.
2. Using the wheel wrench, loosen, but do not remove, the wheel nuts by turning them counterclockwise one turn while the wheel is still on the ground.

3. When changing the front wheel, assemble the jack drive tube to the jack and connect the drive tube to the extension tube. Place the jack under the axle as close to the tire as possible with the drive tubes extending to the front. Connect the jack tube extension and wheel wrench.

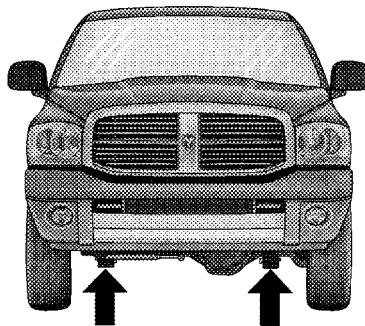

Front Jacking Locations

060505397

When changing a rear wheel, assemble the jack drive tube to the jack and connect the drive tube to the extension tube. Securely place the jack under the sway bar bracket (unless both tires are flat on one side, then place jack under shock bracket) facing forward in vehicle. Connect the jack tube extension and lug wrench.

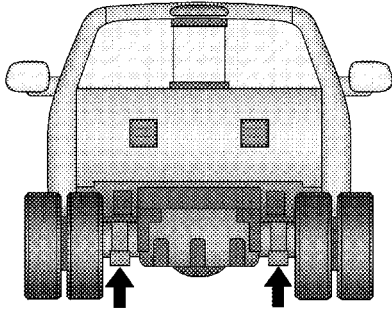

Rear Jacking Location

060505668

**Before raising the wheel off the ground, make sure that the jack will not damage surrounding truck parts and adjust the jack position as required.**

**NOTE:** If the jack will not lower by turning the dial (thumbwheel) by hand, it may be necessary to use the jack drive tube in order to lower the jack.

4. By rotating the wheel wrench clockwise, raise the vehicle until the wheel just clears the surface.

### WARNING!

Raising the vehicle higher than necessary can make the vehicle unstable and cause an accident. It could slip off the jack and hurt someone near it. Raise the vehicle only enough to remove the tire.

5. Remove the wheel nuts and pull the wheel off. Install the spare wheel and wheel nuts with the cone shaped end of the nuts toward the wheel on single rear wheel (SRW) models. On dual rear wheel models (DRW) the lug nuts are a two-piece assembly with a flat face. Lightly tighten the nuts. To avoid risk of forcing the vehicle off the jack, do not fully tighten the nuts until the vehicle has been lowered.

6. Using the wheel wrench, finish tightening the nuts using a crisscross pattern. The correct nut tightness is 135 ft lbs (183 N·m) torque for single rear wheel (SRW) models and 145 ft lbs (197 N·m) for dual rear wheel models. If in doubt about the correct tightness, have them checked with a torque wrench by your authorized dealer or at a service station.

**WARNING!**

**A loose tire or jack thrown forward in a collision or hard stop could injure someone in the vehicle. Always stow the jack parts and the extra tire and wheel in the places provided.**

7. Install wheel center cap (if equipped) and remove wheel blocks. Do not install chrome or aluminum wheel center caps on the spare wheel. This may result in cap damage.

8. Lower the jack to its fully closed position. If the jack will not lower by turning the dial (thumbwheel) by hand, it may be necessary to use the jack drive tube in order to lower the jack. Stow the replaced tire, jack, and tools as previously described.

9. Adjust the tire pressure when possible.

**NOTE:** Do not oil wheel studs. For chrome wheels, do not substitute with chrome plated wheel nuts.

### **Hub Caps/Wheel Covers — If Equipped**

The hub caps must be removed before raising the vehicle off the ground.

#### **CAUTION!**

Use extreme caution when removing the front and rear center caps. Damage can occur to the center cap and/or the wheel if screwdriver type tools are used. A pulling motion, not a pry off motion, is recommended to remove the caps.

For single rear wheel (SRW) models, use the blade on the end of the lug wrench to pry the hub cap off. Insert the blade end into the pry off notch and carefully pop off the hub cap with a back and forth motion.

On 3500 models with dual rear wheels (DRW), you must first remove the hub caps. The jack handle driver has a hook at one end that will fit in the pry off notch of the rear hub caps. Position the hook and pull out on the ratchet firmly. The hub cap should pop off. The wheel skins can now be removed. For the front hub cap on models use the blade on the end of the lug wrench to pry the caps off. The wheel skin can now be removed.

#### **CAUTION!**

- Use a back and forth motion to remove the hub cap. Do not use a twisting motion when removing the hub cap, damage to the hub cap; finish may occur.
- The rear hub caps on the dual rear wheel has two pry off notches. Make sure that the hook of the jack handle driver is located squarely in the cap notch before attempting to pull off.

You must use the flat end of the lug wrench to pry off the wheel skins. Insert the flat tip completely and using a back and forth motion, loosen the wheel skin. Repeat this procedure around the tire until the skin pops off.

Replace the wheel skins first using a rubber mallet. When replacing the hub caps, tilt the cap retainer over the lug nut bolt circle and strike the high side down with a rubber mallet. Be sure that the hub caps and wheel skins are firmly seated around the wheel.

### Dual Rear Wheels

Dual wheels are flat mounted, center piloted. The lug nuts are a two-piece assembly. When the tires are being rotated or replaced, clean these lug nuts and add two drops of oil at the interface between the hex and the washer.

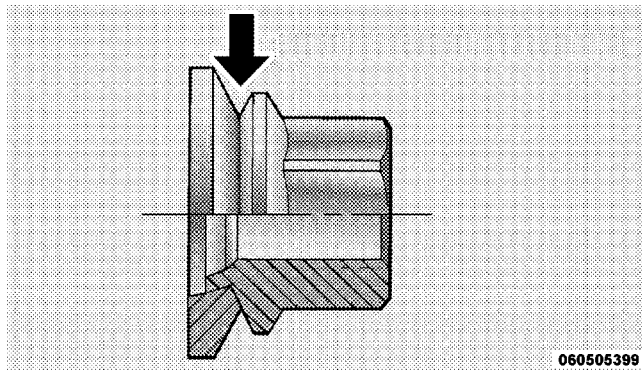

#### Oiling Location

Slots in the wheels will assist in properly orienting the inner and outer wheels. Align these slots when assembling the wheels for best access to the tire valve on the inner wheel. The tires of both dual wheels must be completely off the ground when tightening to insure wheel centering and maximum wheel clamping.

Dual wheel models require a special heavy-duty lug nut tightening adapter (included with the vehicle) to correctly tighten the lug nuts. Also, when it is necessary to remove and install dual rear wheels, use a proper vehicle lifting device.

**NOTE:** When installing a spare tire (if equipped) as part of a dual rear wheel end combination, the tire diameter of the two individual tires must be compared. If there is a significant difference, the larger tire should be installed in a front location. The correct direction of rotation for dual tire installations must also be observed.

**These dual rear wheels should be tightened as follows:**

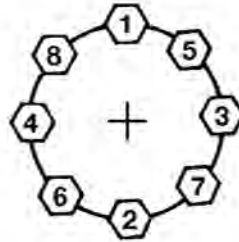

Tightening Pattern (8 Studs)



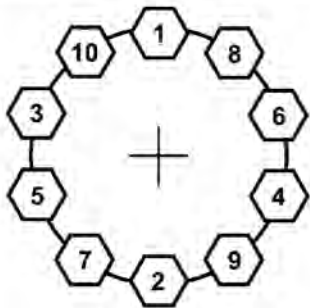

060505669

Tightening Pattern (10 Studs)

1. Tighten the wheel nuts in the numbered sequence to a snug fit.
2. Retighten the wheel nuts in the same sequence to the torques listed in the table. Go through the sequence a second time to verify that specific torque has been achieved. Retighten to specifications at 100 miles (160 km) and after 500 miles (800 km).

It is recommended that wheel stud nuts be kept torqued to specifications at all times. Torque wheel stud nuts to specifications at each lubrication interval.

### Wheel Nut Torque

All wheel nuts should be tightened occasionally to eliminate the possibility of wheel studs being sheared or the bolt holes in the wheels becoming elongated. This is especially important during the first few hundred miles/kilometers of operation to allow the wheel nuts to become properly set. All nuts should first be firmly

seated against the wheel. The nuts should then be tightened to recommended torque. Tighten the nuts to final torque in increments. Progress around the bolt circle, tightening the nut opposite to the nut just previously tightened until final torque is achieved. Recommended torques are shown in the following chart.

Disc Wheels	Type Nut	Stud Size	Torque Ft Lbs	Torque Newton Meters
	Cone	9/16-18	120-150	160-200
	Flanged	9/16-18	130-160	190-220

### To Stow The Flat Or Spare — If Equipped

Refer to Upfitters Body Builders Guide for information on stowing your spare tire (if equipped).

## HOISTING

A conventional floor jack may be used at the jacking locations. Refer to the graphics that show jacking locations. However, a floor jack or frame hoist must never be used on any other parts or the underbody.

### CAUTION!

Never use a floor jack directly under the differential housing of a loaded truck or damage to your vehicle may result.

## JUMP-STARTING PROCEDURES

If your vehicle has a discharged battery it can be jump-started using a set of jumper cables and a battery in another vehicle or by using a portable battery booster pack. Jump-starting can be dangerous if done improperly so please follow the procedures in this section carefully.

**NOTE:** When using a portable battery booster pack follow the manufacturer's operating instructions and precautions.

### CAUTION!

Do not use a portable battery booster pack or any other booster source with a system voltage greater than 12 Volts or damage to the battery, starter motor, alternator or electrical system may occur.

### WARNING!

When temperatures are below the freezing point, electrolyte in a discharged battery may freeze. Do not attempt jump-starting because the battery could rupture or explode and cause personal injury. Battery temperature must be brought above the freezing point before attempting a jump-start.

## Preparations for Jump-Start

The battery in your vehicle is located in the front of the engine compartment, behind the left headlight assembly.

**NOTE:** The positive battery post is covered with a protective cap. Lift up on the cap to gain access to the positive battery post.

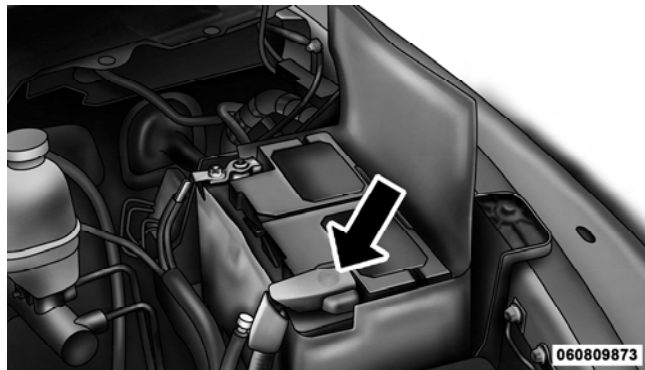

Positive Battery Post

## WARNING!

- Take care to avoid the radiator cooling fan whenever the hood is raised. It can start anytime the ignition switch is on. You can be injured by moving fan blades.
- Remove any metal jewelry such as watch bands or bracelets that might make an inadvertent electrical contact. You could be seriously injured.
- Batteries contain sulfuric acid that can burn your skin or eyes and generate hydrogen gas which is flammable and explosive. Keep open flames or sparks away from the battery.

1. Set the parking brake, shift the automatic transmission into PARK and turn the ignition to LOCK.
2. Turn off the heater, radio, and all unnecessary electrical accessories.

3. If using a another vehicle to jump-start the battery, park the vehicle within the jumper cables reach, set the parking brake and make sure the ignition is OFF.

**WARNING!**

Do not allow vehicles to touch each other as this could establish a ground connection and personal injury could result.

**Jump-Starting Procedure****WARNING!**

Failure to follow this procedure could result in personal injury or property damage due to battery explosion.

**CAUTION!**

Failure to follow these procedures could result in damage to the charging system of the booster vehicle or the discharged vehicle.

1. Connect the positive (+) end of the jumper cable to the positive (+) post of the discharged vehicle.
2. Connect the opposite end of the positive (+) jumper cable to the positive (+) post of the booster battery.
3. Connect the negative end (-) of the jumper cable to the negative (-) post of the booster battery.
4. Connect the opposite end of the negative (-) jumper cable to a good engine ground (exposed metal part of the discharged vehicle's engine) away from the battery and the fuel injection system.

**WARNING!**

**Do not connect the cable to the negative post (-) of the discharged battery. The resulting electrical spark could cause the battery to explode and could result in personal injury.**

5. Start the engine in the vehicle that has the booster battery, let the engine idle a few minutes, and then start the engine in the vehicle with the discharged battery.

Once the engine is started, remove the jumper cables in the reverse sequence:

6. Disconnect the negative (-) jumper cable from the engine ground of the vehicle with the discharged battery.
7. Disconnect the negative end (-) of the jumper cable from the negative (-) post of the booster battery.

8. Disconnect the opposite end of the positive (+) jumper cable from the positive (+) post of the booster battery.
9. Disconnect the positive (+) end of the jumper cable from the positive (+) post of the discharged vehicle.

If frequent jump-starting is required to start your vehicle you should have the battery and charging system inspected at your authorized dealer.

**CAUTION!**

**Accessories that can be plugged into the vehicle power outlets draw power from the vehicle's battery, even when not in use (i.e., cellular phones, etc.). Eventually, if plugged in long enough, the vehicle's battery will discharge sufficiently to degrade battery life and/or prevent the engine from starting.**

## **FREEING A STUCK VEHICLE**

If the vehicle becomes stuck in snow, sand, or mud, it can often be moved by a rocking motion. Move the shift lever rhythmically between DRIVE and REVERSE while applying slight pressure to the accelerator.

In general, the least amount of accelerator pedal pressure to maintain the rocking motion without spinning the wheels or racing the engine, is most effective. Racing the engine or spinning the wheels, due to the frustration of not freeing the vehicle, may lead to transmission overheating and failure. Allow the engine to idle with the shift lever in NEUTRAL for at least one minute after every five rocking-motion cycles. This will minimize overheating and reduce the risk of transmission failure during prolonged efforts to free a stuck vehicle.

### **CAUTION!**

- **When “rocking” a stuck vehicle by moving between 1st and REVERSE, do not spin the wheels faster than 15 mph (24 km/h), or drivetrain damage may result.**
- **Revvng the engine or spinning the wheels too fast may lead to transmission overheating and failure. It can also damage the tires. Do not spin the wheels above 30 mph (48 km/h).**

**WARNING!**

Fast spinning tires can be dangerous. Forces generated by excessive wheel speeds may cause damage, or even failure, of the axle and tires. A tire could explode and injure someone. Do not spin your vehicle's wheels faster than 30 mph (48 km/h) or for longer than 30 seconds continuously without stopping when you are stuck and do not let anyone near a spinning wheel, no matter what the speed.

**WARNING!**

- Chains are not recommended for freeing a stuck vehicle. Chains may break, causing serious injury or death.
- Stand clear of vehicles when pulling with tow hooks. Tow straps and chains may break, causing serious injury.

**CAUTION!**

Tow hooks are for emergency use only to rescue a vehicle stranded off-road. Do not use tow hooks for tow truck hookup or highway towing. You could damage your vehicle.

**EMERGENCY TOW HOOKS — IF EQUIPPED**

Your vehicle may be equipped with emergency tow hooks.

**NOTE:** For off-road recovery, it is recommended to use both of the front tow hooks to minimize the risk of damage to the vehicle.



## TOWING A DISABLED VEHICLE

Proper towing or lifting equipment is required to prevent damage to your vehicle. Use only tow bars and other equipment designed for the purpose, following equipment manufacturer's instructions. Use of safety chains is mandatory. Attach a tow bar or other towing device to the main structural members of the vehicle—not to bumpers or associated brackets. State and local laws applying to vehicles under tow must be observed.

### Four-Wheel Drive Vehicles

<b>CAUTION!</b>
To avoid damage to the transfer case while towing, always use one of the following methods.

**NOTE:** The transfer case must be in the NEUTRAL position, and the transmission must be in PARK (automatic transmission), or in gear (manual transmission) to tow a four-wheel drive vehicle, unless all its wheels are **OFF** the ground.

The manufacturer recommends towing with all wheels **OFF** the ground. Acceptable methods are to tow the vehicle on a flatbed or with one end of vehicle raised and the opposite end on a towing dolly.

### Two-Wheel Drive Vehicles

Provided that the transmission is operable, tow with the transmission in NEUTRAL and the ignition key in the OFF position along with the front wheels raised and the rear wheels on the ground. Speed must not exceed 30 mph (50 km/h) and the distance must not exceed 15 miles (25 km).

**CAUTION!**

**Towing faster than 30 mph (50 km/h) or for more than 15 miles (25 km) can cause severe damage to the transmission. Such damage is not covered by the New Vehicle Limited Warranty.**

If the vehicle is to be towed faster than 30 mph (50 km/h) or more than 15 miles (25 km) the vehicle must be towed with the rear wheels OFF the ground. It may be towed on a flatbed, or with the front wheels raised and the rear wheels on a dolly, or (when using a suitable steering wheel stabilizer to hold the front wheels in the straight position) with the rear wheels raised and the front wheels on the ground.



# MAINTAINING YOUR VEHICLE

## CONTENTS

---

■ Engine Compartment — 5.7L . . . . .	381	□ Engine Oil Filter . . . . .	388
■ Onboard Diagnostic System (OBD II) . . . . .	382	□ Engine Air Cleaner Filter . . . . .	388
□ Loose Fuel Filler Cap Message . . . . .	382	□ Maintenance-Free Battery . . . . .	389
■ Emissions Inspection And Maintenance Programs . . . . .	383	□ Air Conditioner Maintenance . . . . .	390
■ Replacement Parts . . . . .	384	□ Front Prop Shaft Lubrication – Four-Wheel Drive Models . . . . .	391
■ Dealer Service . . . . .	385	□ Body Lubrication . . . . .	392
■ Maintenance Procedures . . . . .	385	□ Windshield Wiper Blades . . . . .	392
□ Engine Oil . . . . .	386	□ Adding Washer Fluid . . . . .	393

□ Exhaust System . . . . .	394	■ Replacement Bulbs . . . . .	420
□ Cooling System . . . . .	396	■ Bulb Replacement . . . . .	420
□ Brake System . . . . .	401	□ Dual Or Quad Headlamp/Front Park And Turn Signal – If Equipped . . . . .	420
□ Rear Axle And 4X4 Front Driving Axle Fluid Level . . . . .	404	□ Fog Lamps – If Equipped . . . . .	422
□ Transfer Case . . . . .	405	□ Center High-Mounted Stoplamp (CHMSL) With Cargo Lamp . . . . .	423
□ Automatic Transmission . . . . .	405	□ Cab Top Clearance Lamps – If Equipped . . . .	424
□ Appearance Care And Protection From Corrosion . . . . .	409	■ Fluid Capacities . . . . .	426
■ Fuses . . . . .	414	■ Fluids, Lubricants And Genuine Parts . . . . .	427
□ Totally Integrated Power Module . . . . .	414	□ Engine . . . . .	427
■ Vehicle Storage . . . . .	419	□ Chassis . . . . .	428

## ENGINE COMPARTMENT — 5.7L

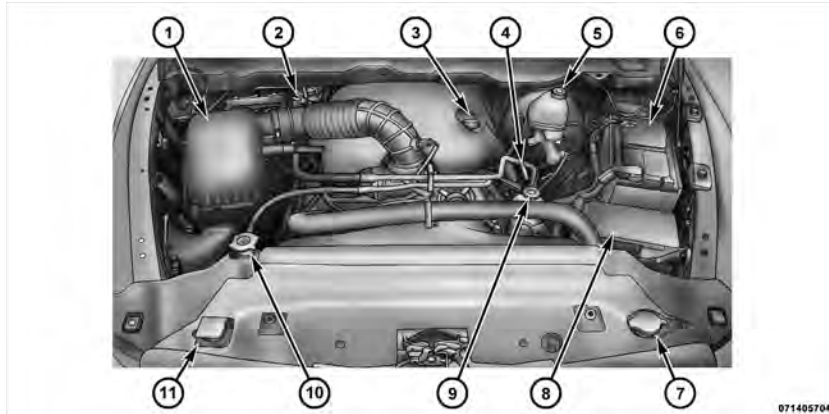

071405704

- 1 — Air Cleaner Filter
- 2 — Automatic Transmission Dipstick
- 3 — Engine Oil Fill
- 4 — Engine Oil Dipstick
- 5 — Brake Fluid Reservoir
- 6 — Battery

- 7 — Washer Fluid Reservoir
- 8 — Integrated Power Module
- 9 — Power Steering Fluid Reservoir
- 10 — Coolant Pressure Cap
- 11 — Engine Coolant Reservoir

## ONBOARD DIAGNOSTIC SYSTEM (OBD II)

Your vehicle is equipped with a sophisticated onboard diagnostic system called OBDII. This system monitors the performance of the emissions, engine, and automatic transmission control systems. When these systems are operating properly, your vehicle will provide excellent performance and fuel economy, as well as engine emissions well within current government regulations.

If any of these systems require service, the OBD II system will turn on the Malfunction Indicator Light (MIL). It will also store diagnostic codes and other information to assist your service technician in making repairs. Although your vehicle will usually be drivable and not need towing, see your authorized dealer for service as soon as possible.

### CAUTION!

- **Prolonged driving with the MIL on could cause further damage to the emission control system. It could also affect fuel economy and drivability. The vehicle must be serviced before any emissions tests can be performed.**
- **If the MIL is flashing, severe catalytic converter damage and power loss will soon occur. Immediate service is required.**

### Loose Fuel Filler Cap Message



If the vehicle diagnostic system determines that the fuel filler cap is loose, improperly installed, or damaged, a loose gascap indicator will display in the EVIC telltale display area. Refer to “Electronic Vehicle Information Center (EVIC) in “Understanding Your Instrument Panel” for further information. Tighten the fuel filler cap properly and press

the SELECT button to turn off the message. If the problem continues, the message will appear the next time the vehicle is started.

A loose, improperly installed, or damaged fuel filler cap may also turn on the Malfunction Indicator Light (MIL).

## EMISSIONS INSPECTION AND MAINTENANCE PROGRAMS

In some localities, it may be a legal requirement to pass an inspection of your vehicle's emissions control system. Failure to pass could prevent vehicle registration.



For states that require an Inspection and Maintenance (I/M), this check verifies the "Malfunction Indicator Light (MIL)" is functioning and is not on when the engine is running, and that the OBD II system is ready for testing.

Normally, the OBD II system will be ready. The OBD II system may **not** be ready if your vehicle was recently serviced, recently had a dead battery or a battery replacement. If the OBD II system should be determined not ready for the I/M test, your vehicle may fail the test.

Your vehicle has a simple ignition key-actuated test, which you can use prior to going to the test station. To check if your vehicle's OBD II system is ready, you must do the following:

1. Turn the ignition switch to the ON position, but do not crank or start the engine.
2. If you crank or start the engine, you will have to start this test over.
3. As soon as you turn the ignition switch to the ON position, you will see the MIL symbol come on as part of a normal bulb check.



4. Approximately 15 seconds later, one of two things will happen:

a. The MIL will flash for about 10 seconds and then return to being fully illuminated until you turn OFF the ignition or start the engine. This means that your vehicle's OBD II system is **not ready** and you should **not** proceed to the I/M station.

b. The MIL will not flash at all and will remain fully illuminated until you turn OFF the ignition or start the engine. This means that your vehicle's OBD II system is **ready** and you can proceed to the I/M station.

If your OBD II system is **not ready**, you should see your authorized dealer or repair facility. If your vehicle was recently serviced or had a battery failure or replacement, you may need to do nothing more than drive your vehicle as you normally would in order for your OBD II system to update. A recheck with the above test routine may then indicate that the system is now ready.

Regardless of whether your vehicle's OBD II system is ready or not, if the MIL is illuminated during normal vehicle operation you should have your vehicle serviced before going to the I/M station. The I/M station can fail your vehicle because the MIL is on with the engine running.

### REPLACEMENT PARTS

Use of genuine MOPAR® parts for normal/scheduled maintenance and repairs is highly recommended to ensure the designed performance. Damage or failures caused by the use of non-MOPAR® parts for maintenance and repairs will not be covered by the manufacturer's warranty.

## DEALER SERVICE

Your authorized dealer has the qualified service personnel, special tools, and equipment to perform all service operations in an expert manner. Service Manuals are available which include detailed service information for your vehicle. Refer to these manuals before attempting any procedure yourself.

**NOTE:** Intentional tampering with emissions control systems may void your warranty and could result in civil penalties being assessed against you.

### WARNING!

You can be badly injured working on or around a motor vehicle. Only do service work for which you have the knowledge and the proper equipment. If you have any doubt about your ability to perform a service job, take your vehicle to a competent mechanic.

## MAINTENANCE PROCEDURES

The pages that follow contain the **required** maintenance services determined by the engineers who designed your vehicle.

Besides those maintenance items specified in the fixed maintenance schedule, there are other components which may require servicing or replacement in the future.

### CAUTION!

- Failure to properly maintain your vehicle or perform repairs and service when necessary could result in more costly repairs, damage to other components or negatively impact vehicle performance. Immediately have potential malfunctions examined by an authorized Chrysler Group LLC dealership or qualified repair center.

*(Continued)*

**CAUTION! (Continued)**

- Your vehicle has been built with improved fluids that protect the performance and durability of your vehicle and also allow extended maintenance intervals. Do not use chemical flushes in these components as the chemicals can damage your engine, transmission, power steering or air conditioning. Such damage is not covered by the New Vehicle Limited Warranty. If a flush is needed because of component malfunction, use only the specified fluid for the flushing procedure.

**Engine Oil****Checking Oil Level**

To assure proper lubrication of your vehicle's engine, the engine oil must be maintained at the correct level. Check the oil level at regular intervals, such as every fuel stop.

The best time to check the engine oil level is about five minutes after a fully warmed up engine is shut off.

Checking the oil while the vehicle is on level ground will improve the accuracy of the oil level readings. Always maintain the oil level within the SAFE zone on the dipstick. Adding one quart of oil when the reading is at the bottom of the SAFE zone will result in a reading at the top of the safe zone on these engines.

**CAUTION!**

Overfilling or underfilling the crankcase will cause oil aeration or loss of oil pressure. This could damage your engine.

**Change Engine Oil**

The oil change indicator system will remind you that it is time to take your vehicle in for scheduled maintenance. Refer to "Maintenance Schedule" for further information.

**NOTE:** Under no circumstances should oil change intervals exceed 6,000 miles (10 000 km) or six months, whichever occurs first.

### Engine Oil Selection

For best performance and maximum protection under all types of operating conditions, the manufacturer only recommends engine oils that are API Certified and meet the requirements of Chrysler Material Standard MS-6395.

### American Petroleum Institute (API) Engine Oil Identification Symbol



This symbol means that the oil has been certified by the American Petroleum Institute (API). The manufacturer only recommends API Certified engine oils.

### CAUTION!

**Do not use chemical flushes in your engine oil as the chemicals can damage your engine. Such damage is not covered by the New Vehicle Limited Warranty.**

### Engine Oil Viscosity (SAE Grade)

SAE 5W-20 engine oil is recommended for all operating temperatures. This engine oil improves low temperature starting and vehicle fuel economy. The engine oil filler cap also shows the recommended engine oil viscosity for your engine. For information on engine oil filler cap location, refer to "Engine Compartment" in "Maintaining Your Vehicle" for further information.

Lubricants which do not have both the engine oil certification mark and the correct SAE viscosity grade number should not be used.

### **Synthetic Engine Oils**

You may use synthetic engine oils if the recommended oil quality requirements are met and the recommended maintenance intervals for oil and filter changes are followed.

### **Materials Added to Engine Oil**

The manufacturer strongly recommends against the addition of any additives (other than leak detection dyes) to the engine oil. Engine oil is an engineered product and its performance may be impaired by supplemental additives.

### **Disposing of Used Engine Oil and Oil Filters**

Care should be taken in disposing of used engine oil and oil filters from your vehicle. Used oil and oil filters, indiscriminately discarded, can present a problem to the environment. Contact your authorized dealer, service

station or governmental agency for advice on how and where used oil and oil filters can be safely discarded in your area.

### **Engine Oil Filter**

The engine oil filter should be replaced at every engine oil change.

### **Engine Oil Filter Selection**

The manufacturer's engines have a full-flow type oil filter. Use a filter of this type for replacement. The quality of replacement filters varies considerably. Only high-quality filters should be used to assure most efficient service. MOPAR® engine oil filters are a high-quality oil filter and are recommended.

### **Engine Air Cleaner Filter**

Refer to "Maintenance Schedule" for the proper maintenance intervals.

**WARNING!**

The air induction system (air cleaner, hoses, etc.) can provide a measure of protection in the case of engine backfire. Do not remove the air induction system (air cleaner, hoses, etc.) unless such removal is necessary for repair or maintenance. Make sure that no one is near the engine compartment before starting the vehicle with the air induction system (air cleaner, hoses, etc.) removed. Failure to do so can result in serious personal injury.

**Engine Air Cleaner Filter Selection**

The quality of replacement engine air cleaner filters varies considerably. Only high quality filters should be used to assure most efficient service. MOPAR® engine air cleaner filters are a high quality filter and are recommended.

**Maintenance-Free Battery**

The top of the maintenance-free battery is permanently sealed. You will never have to add water or is periodic maintenance required.

**WARNING!**

- Battery fluid is a corrosive acid solution and can burn or even blind you. Do not allow battery fluid to contact your eyes, skin or clothing. Do not lean over a battery when attaching clamps. If acid splashes in your eyes or on your skin, flush the area immediately with large amounts of water.
- Battery gas is flammable and explosive. Keep flame or sparks away from the battery. Do not use a booster battery or any other booster source with an output greater than 12 volts. Do not allow cable clamps to touch each other.

*(Continued)*

**WARNING! (Continued)**

- Battery posts, terminals and related accessories contain lead and lead compounds. Wash hands after handling.

**CAUTION!**

- It is essential when replacing the cables on the battery that the positive cable is attached to the positive post and the negative cable is attached to the negative post. Battery posts are marked (+) positive and (-) negative and are identified on the battery case.
- If a "fast charger" is used while the battery is in the vehicle, disconnect both vehicle battery cables before connecting the charger to the battery. Do not use a "fast charger" to provide starting voltage.

**Air Conditioner Maintenance**

For best possible performance, your air conditioner should be checked and serviced by an authorized dealer at the start of each warm season. This service should include cleaning of the condenser fins and a performance test. Drive belt tension should also be checked at this time.

**CAUTION!**

Do not use chemical flushes in your air conditioning system as the chemicals can damage your air conditioning components. Such damage is not covered by the New Vehicle Limited Warranty.

**WARNING!**

- Use only refrigerants and compressor lubricants approved by the manufacturer for your air conditioning system. Some unapproved refrigerants are flammable and can explode, injuring you. Other unapproved refrigerants or lubricants can cause the system to fail, requiring costly repairs. Refer to Section 3 of the Warranty Information Book, located on the DVD, for further warranty information.
- The air conditioning system contains refrigerant under high pressure. To avoid risk of personal injury or damage to the system, adding refrigerant or any repair requiring lines to be disconnected should be done by an experienced repairman.

**NOTE:** Use only manufacturer approved A/C System Sealers, Stop Leak Products, Seal Conditioners, Compressor Oil, or Refrigerants.

**Refrigerant Recovery and Recycling**

R-134a Air Conditioning Refrigerant is a hydrofluorocarbon (HFC) that is endorsed by the Environmental Protection Agency (EPA) and is an ozone-saving product. However, the manufacturer recommends that air conditioning service be performed by authorized dealers or other service facilities using recovery and recycling equipment.

**Front Prop Shaft Lubrication – Four-Wheel Drive Models**

Lubricate the front driveshaft grease fitting at each oil change. Refer to “Maintenance Schedule” for the proper maintenance intervals. Use MOPAR® Type MS-6560 (lithium-based grease), or equivalent.



### Body Lubrication

Locks and all body pivot points, including such items as seat tracks, door hinge pivot points and rollers, liftgate, tailgate, sliding doors and hood hinges, should be lubricated periodically with a lithium based grease, such as MOPAR® Spray White Lube or equivalent, to assure quiet, easy operation and to protect against rust and wear. Prior to the application of any lubricant, the parts concerned should be wiped clean to remove dust and grit. After lubricating, excess oil and grease should be removed. Particular attention should also be given to hood latching components to ensure proper function. When performing other underhood services, the hood latch, release mechanism and safety catch should be cleaned and lubricated.

The external lock cylinders should be lubricated twice a year, preferably in the Fall and Spring. Apply a small

amount of a high quality lubricant such as MOPAR® Lock Cylinder Lubricant or equivalent directly into the lock cylinder.

### Windshield Wiper Blades

Clean the rubber edges of the wiper blades and the windshield periodically with a sponge or soft cloth and a mild nonabrasive cleaner. This will remove accumulations of salt or road film.

Operation of the wipers on dry glass for long periods may cause deterioration of the wiper blades. Always use washer fluid when using the wipers to remove salt or dirt from a dry windshield.

Avoid using the wiper blades to remove frost or ice from the windshield. Keep the blade rubber out of contact with petroleum products such as engine oil, gasoline, etc.

**NOTE:** Life expectancy of wiper blades varies depending on geographical area and frequency of use. Poor

performance of blades may be present with chattering, marks, water lines or wet spots. If any condition is present please proceed to clean wiper blades with humid cloth removing any debris that may be affecting its function.

### **Adding Washer Fluid**

The fluid reservoir is located under the hood and should be checked for fluid level at regular intervals. Fill the reservoir with windshield washer solvent only (not radiator antifreeze). When refilling the washer fluid reservoir, take some washer fluid and apply it to a cloth or towel and wipe the wiper blades clean. This will help blade performance.

To prevent freeze-up of your windshield washer system in cold weather, select a solution or mixture that meets or exceeds the temperature range of your climate. This rating information can be found on most washer fluid containers.

The washer fluid reservoir will hold a full gallon of fluid when the Low Washer Fluid Light illuminates.

### **WARNING!**

**Commercially available windshield washer solvents are flammable. They could ignite and burn you. Care must be exercised when filling or working around the washer solution.**

After the engine has warmed up, operate the defroster for a few minutes to reduce the possibility of smearing or freezing the fluid on the cold windshield. Windshield washer solution used with water as directed on the container, aids cleaning action, reduces the freezing point to avoid line clogging, and is not harmful to paint or trim.

## Exhaust System

The best protection against carbon monoxide entry into the vehicle body is a properly maintained engine exhaust system.

Whenever a change is noticed in the sound of the exhaust system, when exhaust fumes can be detected inside the vehicle or when the underside or rear of the vehicle is damaged, have a competent mechanic inspect the complete exhaust system and adjacent body areas for broken, damaged, deteriorated, or mispositioned parts. Open seams or loose connections could permit exhaust fumes to seep into the passenger compartment. In addition, inspect the exhaust system each time the vehicle is raised for lubrication or oil change. Replace as required.

### WARNING!

Exhaust gases can injure or kill. They contain carbon monoxide (CO) which is colorless and odorless. Breathing it can make you unconscious and can eventually poison you. To avoid breathing CO, refer to "Safety Tips/Exhaust Gas" in "Things To Know Before Starting Your Vehicle" for further information.

### CAUTION!

The catalytic converter requires the use of unleaded fuel only. Leaded gasoline will destroy the effectiveness of the catalyst as an emissions control device and may seriously reduce engine performance and cause serious damage to the engine.

Under normal operating conditions, the catalytic converter will not require maintenance. However, it is important to keep the engine properly tuned to assure proper catalyst operation and prevent possible catalyst damage.

### CAUTION!

Damage to the catalytic converter can result if your vehicle is not kept in proper operating condition. In the event of engine malfunction, particularly involving engine misfire or other apparent loss of performance, have your vehicle serviced promptly. Continued operation of your vehicle with a severe malfunction could cause the converter to overheat, resulting in possible damage to the converter and the vehicle.

**NOTE:** Intentional tampering with emissions control systems can result in civil penalties being assessed against you.

### WARNING!

A hot exhaust system can start a fire if you park over materials that can burn. Such materials might be grass or leaves coming into contact with your exhaust system. Do not park or operate your vehicle in areas where your exhaust system can contact anything that can burn.

In unusual situations involving grossly malfunctioning engine operation, a scorching odor may indicate severe and abnormal catalyst overheating. If this occurs, the vehicle should be stopped, the engine shut off and the vehicle allowed to cool. Thereafter, service, including a tune-up to manufacturer's specifications, should be obtained immediately.

To minimize the possibility of catalyst damage:

- Do not shut off the engine or interrupt the ignition when the transmission is in gear and the vehicle is in motion.
- Do not try to start the engine by pushing or towing the vehicle.
- Do not idle the engine with any spark plug wires disconnected or removed, such as when diagnostic testing or for prolonged periods during very rough idling or malfunctioning operating conditions.

## Cooling System

### **WARNING!**

**You or others can be badly burned by hot coolant or steam from your radiator. If you see or hear steam coming from under the hood, do not open the hood until the radiator has had time to cool. Never try to open a cooling system pressure cap when the radiator is hot.**

### **Engine Coolant Checks**

Check the engine coolant (antifreeze) protection every 12 months (before the onset of freezing weather, where applicable). If the engine coolant (antifreeze) is dirty or rusty in appearance, the system should be drained, flushed and refilled with fresh coolant. Check the front of the A/C condenser for any accumulation of bugs, leaves, etc. If dirty, clean by gently spraying water from a garden hose vertically down the face of the condenser.

Check the coolant recovery bottle tubing for brittle rubber, cracking, tears, cuts and tightness of the connection at the bottle and radiator. Inspect the entire system for leaks.

With the engine at normal operating temperature (but not running), check the cooling system pressure cap for proper vacuum sealing by draining a small amount of engine coolant (antifreeze) from the radiator drain cock. If the cap is sealing properly, the engine coolant (antifreeze) will begin to drain from the coolant recovery bottle. **DO NOT REMOVE THE COOLANT PRESSURE CAP WHEN THE COOLING SYSTEM IS HOT.**

### Cooling System – Drain, Flush and Refill

If the engine coolant (antifreeze) is dirty or contains a considerable amount of sediment, clean and flush with a reliable cooling system cleaner. Follow with a thorough rinsing to remove all deposits and chemicals. Properly dispose of old engine coolant (antifreeze) solution.

Refer to “Maintenance Schedule” for proper maintenance intervals.

### Selection Of Coolant

Use only the manufacturer’s recommended engine coolant (antifreeze). Refer to “Fluids, Lubricants, and Genuine Parts” in “Maintaining Your Vehicle” for further information.

#### CAUTION!

- **Mixing of engine coolant (antifreeze) other than specified HOAT engine coolant (antifreeze), may result in engine damage and may decrease corrosion protection. If a non-HOAT engine coolant (antifreeze) is introduced into the cooling system in an emergency, it should be replaced with the specified engine coolant (antifreeze) as soon as possible.**

*(Continued)*

**CAUTION! (Continued)**

- **Do not use water alone or alcohol-based engine coolant (antifreeze) products. Do not use additional rust inhibitors or antirust products, as they may not be compatible with the engine coolant (antifreeze) and may plug the radiator.**
- **This vehicle has not been designed for use with Propylene Glycol based engine coolant (antifreeze). Use of Propylene Glycol based engine coolant (antifreeze) is not recommended.**

**Adding Coolant**

Your vehicle has been built with an improved engine coolant (antifreeze) that allows extended maintenance intervals. This engine coolant (antifreeze) can be used up to 5 Years or 102,000 miles (170 000 km) before replacement. To prevent reducing this extended maintenance period, it is important that you use the same engine coolant (antifreeze) throughout the life of your vehicle.

Please review these recommendations for using Hybrid Organic Additive Technology (HOAT) engine coolant (antifreeze).

When adding engine coolant (antifreeze):

- The manufacturer recommends using MOPAR® Antifreeze/Coolant 5 Year/100,000 Mile Formula HOAT (Hybrid Organic Additive Technology) or equivalent.
- Mix a minimum solution of 50% HOAT engine coolant (antifreeze) and distilled water. Use higher concentrations (not to exceed 70%) if temperatures below -34°F (-37°C) are anticipated.
- Use only high purity water such as distilled or deionized water when mixing the water/engine coolant (antifreeze) solution. The use of lower quality water will reduce the amount of corrosion protection in the engine cooling system.

Please note that it is the owner's responsibility to maintain the proper level of protection against freezing according to the temperatures occurring in the area where the vehicle is operated.

**NOTE:** Mixing engine coolant (antifreeze) types will decrease the life of the engine coolant (antifreeze) and will require more frequent engine coolant (antifreeze) changes.

### Cooling System Pressure Cap

The cap must be fully tightened to prevent loss of engine coolant (antifreeze), and to ensure that the engine coolant (antifreeze) will return to the radiator from the coolant recovery bottle.

The cap should be inspected and cleaned if there is any accumulation of foreign material on the sealing surfaces.

### WARNING!

- The warning words "DO NOT OPEN HOT" on the cooling system pressure cap are a safety precaution. Never add engine coolant (antifreeze) when the engine is overheated. Do not loosen or remove the cap to cool an overheated engine. Heat causes pressure to build up in the cooling system. To prevent scalding or injury, do not remove the pressure cap while the system is hot or under pressure.
- Do not use a pressure cap other than the one specified for your vehicle. Personal injury or engine damage may result.



### Disposal of Used Coolant

Used ethylene glycol-based engine coolant (antifreeze) is a regulated substance requiring proper disposal. Check with your local authorities to determine the disposal rules for your community. To prevent ingestion by animals or children do not store ethylene glycol-based engine coolant (antifreeze) in open containers or allow it to remain in puddles on the ground. If ingested by a child or pet, seek emergency assistance immediately. Clean up any ground spills immediately.

### Coolant Level

The coolant bottle provides a quick visual method for determining that the coolant level is adequate. With the engine cold, the level of the engine coolant (antifreeze) in the coolant recovery bottle should be between the ranges indicated on the bottle.

The radiator normally remains completely full, so there is no need to remove the radiator cap unless checking for

engine coolant (antifreeze) freeze point or replacing engine coolant (antifreeze). Advise your service attendant of this. As long as the engine operating temperature is satisfactory, the coolant bottle need only be checked once a month.

When additional engine coolant (antifreeze) is needed to maintain the proper level, it should be added to the coolant bottle. Do not overfill.

### Points to Remember

**NOTE:** When the vehicle is stopped after a few miles (a few kilometers) of operation, you may observe vapor coming from the front of the engine compartment. This is normally a result of moisture from rain, snow, or high humidity accumulating on the radiator and being vaporized when the thermostat opens, allowing hot coolant to enter the radiator.

If an examination of your engine compartment shows no evidence of radiator or hose leaks, the vehicle may be safely driven. The vapor will soon dissipate.

- Do not overfill the coolant recovery bottle.
- Check engine coolant (antifreeze) freeze point in the radiator and in the coolant recovery bottle. If engine coolant (antifreeze) needs to be added, contents of coolant recovery bottle must also be protected against freezing.
- If frequent engine coolant (antifreeze) additions are required, or if the level in the coolant recovery bottle does not drop when the engine cools, the cooling system should be pressure tested for leaks.
- Maintain engine coolant (antifreeze) concentration at 50% HOAT engine coolant (antifreeze) (minimum) and distilled water for proper corrosion protection of your engine, which contains aluminum components.

- Make sure that the radiator and coolant recovery bottle overflow hoses are not kinked or obstructed.
- Keep the front of the radiator clean. If your vehicle is equipped with air conditioning, keep the front of the condenser clean, also.
- Do not change the thermostat for Summer or Winter operation. If replacement is ever necessary, install **ONLY** the correct type thermostat. Other designs may result in unsatisfactory engine coolant (antifreeze) performance, poor gas mileage, and increased emissions.

### **Brake System**

In order to assure brake system performance, all brake system components should be inspected periodically. Refer to "Maintenance Schedule" for the proper maintenance intervals.

**WARNING!**

**Riding the brakes can lead to brake failure and possibly an accident. Driving with your foot resting or riding on the brake pedal can result in abnormally high brake temperatures, excessive lining wear, and possible brake damage. You would not have your full braking capacity in an emergency.**

**Brake Fluid Level Check**

The fluid level of the master cylinder should be checked when performing under the hood service or immediately if the brake system warning lamp indicates system failure.

The brake master cylinder has a translucent plastic reservoir. On the outboard side of the reservoir, there is a "MAX" dot and an "MIN" dot. The fluid level must be kept within these two dots. Do not add fluid above the MAX mark because leakage may occur at the cap.

With disc brakes the fluid level can be expected to fall as the brake linings wear. However, an unexpected drop in fluid level may be caused by a leak and a system check should be conducted.

Use only the manufacturer's recommended brake fluid. Refer to "Fluids, Lubricants, and Genuine Parts" in "Maintaining Your Vehicle" for further information.

**WARNING!**

- Use only manufacturer's recommended brake fluid. Refer to "Fluids, Lubricants, and Genuine Parts" in "Maintaining Your Vehicle" for further information. Using the wrong type of brake fluid can severely damage your brake system and/or impair its performance. The proper type of brake fluid for your vehicle is also labeled on the original factory installed hydraulic master cylinder reservoir.

*(Continued)*

**WARNING! (Continued)**

- To avoid contamination from foreign matter or moisture, use only new brake fluid or fluid that has been in a tightly closed container. Keep the master cylinder reservoir cap secured at all times. Brake fluid in an open container absorbs moisture from the air resulting in a lower boiling point. This may cause it to boil unexpectedly during hard or prolonged braking, resulting in sudden brake failure. This could result in an accident.
- Overfilling the brake fluid reservoir can result in spilling brake fluid on hot engine parts, causing the brake fluid to catch fire. Brake fluid can also damage painted and vinyl surfaces, care should be taken to avoid its contact with these surfaces.

*(Continued)*

**WARNING! (Continued)**

- Do not allow petroleum based fluid to contaminate the brake fluid. Brake seal components could be damaged, causing partial or complete brake failure. This could result in an accident.

**Rear Axle And 4x4 Front Driving Axle Fluid Level**

For models with 9.25 in Front Axles and 11.5 in Rear Axles, refer to “Fluids, Lubricants, and Genuine Parts” in “Maintaining Your Vehicle” for further information. For normal service, periodic fluid level checks are not required. When the vehicle is serviced for other reasons, the exterior surfaces of the axle assembly should be inspected.

When checking the fluid level (4500/5500 only), the vehicle should be in a level position. The fluid level should be  $1/4$  in  $\pm$   $1/4$  in (6.4 mm  $\pm$  6.4 mm) below the

fill hole on the front axle. The fluid level should be level with the bottom of the fill hole on the rear axle.

**Drain And Refill**

On 4500/5500 vehicles, remove the lower bolt to drain the axle fluid.

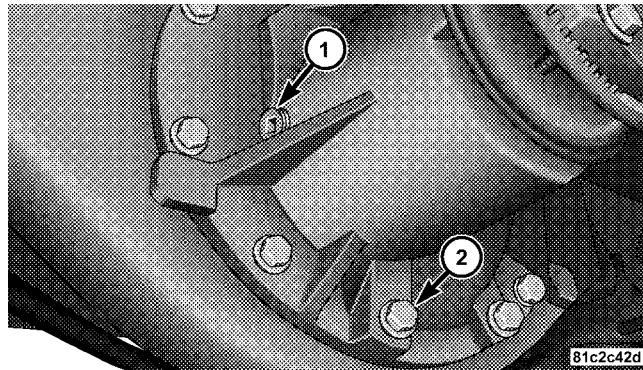

- 1 — 4500/5500 Rear Axle Fluid Fill Plug  
2 — 4500/5500 Rear Axle Fluid Drain Plug

Refer to “Maintenance Schedule” for the proper maintenance intervals.

### **Lubricant Selection**

Refer to “Fluids, Lubricants, and Genuine Parts” in “Maintaining Your Vehicle” for further information.

**NOTE:** The presence of water in the gear lubricant will result in corrosion and possible failure of differential components. Operation of the vehicle in water, as may be encountered in some off-highway types of service, will require draining and refilling the axle to avoid damage.

**Limited-Slip Differentials DO NOT REQUIRE** any limited slip oil additive (friction modifiers).

**NOTE:** Slight noise and mild shuddering may be evident while turning a vehicle with limited slip differential on concrete or dry pavement. These conditions should be considered normal operation of the limited slip differential.

### **Transfer Case**

#### **Drain and Refill**

Refer to “Maintenance Schedule” for proper maintenance intervals.

#### **Lubricant Selection**

Refer to “Fluids, Lubricants, and Genuine Parts” in “Maintaining Your Vehicle” for further information.

#### **Fluid Level Check**

This fluid level can be checked by removing the filler plug. The fluid level should be to the bottom edge of the filler plug hole with the vehicle in a level position.

### **Automatic Transmission**

#### **Selection Of Lubricant**

It is important that the proper lubricant is used in the transmission to assure optimum transmission performance. Use only the manufacturer’s recommended transmission fluid. Refer to “Fluids, Lubricants, and Genuine

Parts" in "Maintaining Your Vehicle" for further information. It is important that the transmission fluid be maintained at the prescribed level using the recommended fluid.

**CAUTION!**

- Do not use chemical flushes in your transmission as the chemicals can damage your transmission components. Such damage is not covered by the New Vehicle Limited Warranty.

*(Continued)*

**CAUTION! (Continued)**

- Using a transmission fluid other than the manufacturer's recommended fluid may cause deterioration in transmission shift quality and/or torque converter shudder. Using a transmission fluid other than the manufacturer's recommended fluid will result in more frequent fluid and filter changes. Refer to "Fluids, Lubricants, and Genuine Parts" in "Maintaining Your Vehicle" for further information.

**Fluid Level Check**

If equipped with a dipstick, use the following procedure. If your vehicle has a capped dipstick tube, it is sealed and should not be tampered with. Your authorized dealer has the proper tools to ensure that the fluid level is set properly. The fluid level should be checked when the engine is fully warmed up and the fluid in the transmission is at normal operating temperature. Operation of the

transmission with an improper fluid level will greatly reduce the life of the transmission and of the fluid. Check the fluid level whenever the vehicle is serviced.

### Fluid Level Check – 545RFE

Check the fluid level while the transmission is at normal operating temperature 82°C (180°F). This occurs after at least 15 miles (25 km) of driving. At normal operating temperature the fluid cannot be held comfortably between the fingertips.

To check the automatic transmission fluid level properly, the following procedure must be used:

1. Operate the engine at idle speed and normal operating temperature.
2. The vehicle must be on level ground.
3. Fully apply the parking brake and press the brake pedal.

4. Place the shift lever momentarily into each gear position ending with the lever in PARK.

5. Remove the dipstick, wipe it clean and reinsert it until seated.

6. Remove the dipstick again and note the fluid level on both sides. The fluid level should be between the “HOT” (upper) reference holes on the dipstick at normal operating temperature. Verify that solid coating of oil is seen on both sides of the dipstick. If the fluid is low, add as required into the dipstick tube. **Do not overfill.** After adding any quantity of oil through the oil fill tube, wait a minimum of two minutes for the oil to fully drain into the transmission before rechecking the fluid level.

**NOTE:** If it is necessary to check the transmission **below** the operating temperature, the fluid level should be between the two “COLD” (lower) holes on the dipstick with the fluid at approximately 70°F (21°C) (room temperature). If the fluid level is correctly established at



room temperature, it should be between the “HOT” (upper) reference holes when the transmission reaches 180°F (82°C). Remember it is best to check the level at the normal operating temperature.

### CAUTION!

**Be aware that if the fluid temperature is below 50°F (10°C) it may not register on the dipstick. Do not add fluid until the temperature is elevated enough to produce an accurate reading.**

7. Check for leaks. Release parking brake.

To prevent dirt and water from entering the transmission after checking or replenishing fluid, make certain that the dipstick cap is properly reseated. It is normal for the dipstick cap to spring back slightly from its fully seated position, as long as its seal remains engaged in the dipstick tube.

### Automatic Transmission Fluid and Filter Change

Refer to “Maintenance Schedule” for the proper maintenance intervals.

**NOTE:** If the transmission is disassembled for any reason, the fluid and filter(s) should be changed.

It is important that proper lubricant is used in the transmission. Refer to “Fluids, Lubricants, and Genuine Parts” in “Maintaining Your Vehicle” for further information.

### Special Additives

Automatic Transmission Fluid (ATF) is an engineered product and its performance may be impaired by supplemental additives. Therefore, do not add any fluid additives to the transmission. The only exception to this policy is the use of special dyes to aid in detecting fluid leaks. In addition, avoid using transmission sealers as they may adversely affect seals.

## Appearance Care and Protection from Corrosion

### Protection of Body and Paint from Corrosion

Vehicle body care requirements vary according to geographic locations and usage. Chemicals that make roads passable in snow and ice, and those that are sprayed on trees and road surfaces during other seasons, are highly corrosive to the metal in your vehicle. Outside parking, which exposes your vehicle to airborne contaminants, road surfaces on which the vehicle is operated, extreme hot or cold weather and other extreme conditions will have an adverse affect on paint, metal trim, and underbody protection.

The following maintenance recommendations will enable you to obtain maximum benefit from the corrosion resistance built into your vehicle.

#### What Causes Corrosion?

Corrosion is the result of deterioration or removal of paint and protective coatings from your vehicle.

The most common causes are:

- Road salt, dirt and moisture accumulation.
- Stone and gravel impact.
- Insects, tree sap and tar.
- Salt in the air near seacoast localities.
- Atmospheric fallout/industrial pollutants.

### Washing

- Wash your vehicle regularly. Always wash your vehicle in the shade using MOPAR® Car Wash or equivalent, or a mild car wash soap and rinse the panels completely with clear water.
- If insects, tar or other similar deposits have accumulated on your vehicle, use MOPAR® Super Kleen Bug and Tar Remover or equivalent to remove.

- Use a high quality cleaner wax, such as MOPAR® Cleaner Wax or equivalent to remove road film, stains and to protect your paint finish. Take care never to scratch the paint.
- Avoid using abrasive compounds and power buffing that may diminish the gloss or thin out the paint finish.

**CAUTION!**

- **Do not use abrasive or strong cleaning materials such as steel wool or scouring powder which will scratch metal and painted surfaces.**
- **Use of power washers exceeding 1,200 psi (8 274 kPa) can result in damage or removal of paint and decals.**

**Special Care**

- If you drive on salted or dusty roads or if you drive near the ocean, hose off the undercarriage at least once a month.
- It is important that the drain holes in the lower edges of the doors, rocker panels and trunk be kept clear and open.
- If you detect any stone chips or scratches in the paint, touch them up immediately. The cost of such repairs is considered the responsibility of the owner.
- If your vehicle is damaged due to an accident or similar cause which destroys the paint and protective coating, have your vehicle repaired as soon as possible. The cost of such repairs is considered the responsibility of the owner.

- If you carry special cargo such as chemicals, fertilizers, de-icer salt, etc., be sure that such materials are well packaged and sealed.
- If a lot of driving is done on gravel roads, consider mud or stone shields behind each wheel.
- Use MOPAR® Touch Up Paint or equivalent on scratches as soon as possible. Your authorized dealer has touch up paint to match the color of your vehicle.

### Wheel and Wheel Trim Care

All wheels and wheel trim, especially aluminum and chrome-plated wheels should be cleaned regularly with a mild soap and water to prevent corrosion. To remove heavy soil and/or excessive brake dust, use MOPAR® Wheel Cleaner or equivalent or select a nonabrasive, non-acidic cleaner. Do not use scouring pads, steel wool, a bristle brush, or metal polishes. Only MOPAR® or equivalent is recommended. Do not use oven cleaner.

Avoid automatic car washes that use acidic solutions or harsh brushes that may damage the wheels' protective finish.

### Stain Repel Fabric Cleaning Procedure – If Equipped

Stain Repel seats may be cleaned in the following manner:

- Remove as much of the stain as possible by blotting with a clean, dry towel.
- Blot any remaining stain with a clean, damp towel.
- For tough stains, apply MOPAR® Total Clean or equivalent, or a mild soap solution to a clean, damp cloth and remove stain. Use a fresh, damp towel to remove soap residue.

- For grease stains, apply MOPAR® Multi-Purpose Cleaner or equivalent to a clean, damp cloth and remove stain. Use a fresh, damp towel to remove soap residue.
- Do not use any harsh solvents or any other form of protectants on Stain Repel products.

### Interior Care

Use MOPAR® Total Clean or equivalent to clean fabric upholstery and carpeting.

Use MOPAR® Total Clean or equivalent to clean vinyl upholstery.

MOPAR® Total Clean or equivalent is specifically recommended for leather upholstery.

Your leather upholstery can be best preserved by regular cleaning with a damp soft cloth. Small particles of dirt can act as an abrasive and damage the leather upholstery and should be removed promptly with a damp cloth.

Stubborn soils can be removed easily with a soft cloth and MOPAR® Total Clean or equivalent. Care should be taken to avoid soaking your leather upholstery with any liquid. Please do not use polishes, oils, cleaning fluids, solvents, detergents, or ammonia-based cleaners to clean your leather upholstery. Application of a leather conditioner is not required to maintain the original condition.

### WARNING!

**Do not use volatile solvents for cleaning purposes. Many are potentially flammable, and if used in closed areas they may cause respiratory harm.**

### Cleaning Headlights

Your vehicle is equipped with plastic headlights and fog lights (if equipped) that are lighter and less susceptible to stone breakage than glass headlights.

Plastic is not as scratch resistant as glass and therefore different lens cleaning procedures must be followed.

To minimize the possibility of scratching the lenses and reducing light output, avoid wiping with a dry cloth. To remove road dirt, wash with a mild soap solution followed by rinsing.

Do not use abrasive cleaning components, solvents, steel wool or other aggressive material to clean the lenses.

### **Glass Surfaces**

All glass surfaces should be cleaned on a regular basis with MOPAR® Glass Cleaner or any commercial household-type glass cleaner. Never use an abrasive type cleaner. Use caution when cleaning the inside rear window equipped with electric defrosters or the right rear quarter window equipped with the radio antenna. Do not use scrapers or other sharp instruments which may

scratch the elements. When cleaning the rearview mirror, spray cleaner on the towel or rag that you are using. Do not spray cleaner directly on the mirror.

### **Cleaning Plastic Instrument Cluster Lenses**

The lenses in front of the instruments in this vehicle are molded in clear plastic. When cleaning the lenses, care must be taken to avoid scratching the plastic.

1. Clean with a wet soft rag. A mild soap solution may be used, but do not use high alcohol content or abrasive cleaners. If soap is used, wipe clean with a clean damp rag.
2. Dry with a soft tissue.

### **Seat Belt Maintenance**

Do not bleach, dye or clean the belts with chemical solvents or abrasive cleaners. This will weaken the fabric. Sun damage can also weaken the fabric.

If the belts need cleaning, use a mild soap solution or lukewarm water. Do not remove the belts from the car to wash them.

Replace the belts if they appear frayed or worn or if the buckles do not work properly.

Dry with a soft tissue.

## FUSES

### Totally Integrated Power Module

The totally integrated power module (TIPM) is located in the engine compartment near the battery. This center contains cartridge fuses and mini fuses. A description of each fuse and component may be stamped on the inside cover, otherwise the cavity number of each fuse is stamped on the inside cover that corresponds to the following chart.

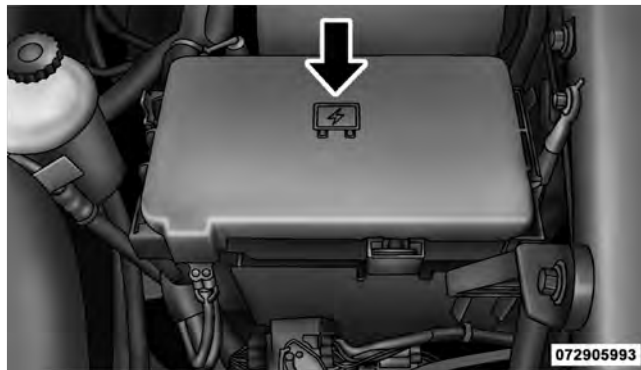

Totally Integrated Power Module (TIPM)

Cavity	Cartridge Fuse	Mini Fuse	Description
J01	30 Amp Pink		Bat – Presafe #1 / CM2200
J02	30 Amp Pink		Bat – Trailer Tow Main

Cavity	Cartridge Fuse	Mini Fuse	Description
J03	25 Amp Natural		Bat – Passenger Door Node
J04	40 Amp Green		Bat – ABS Pump
J05	30 Amp Pink		Bat – ABS Valve
J06	30 Amp Pink		Bat – H/Lamp Wash/MTV/CM2200/Elec Vac Pump
J07	25 Amp Natural		Bat – Driver Door Node
J08	30 Amp Pink		Bat – DTCM/Axle Locks
J09	30 Amp Pink		Bat – Plg/Electric Brake
J10	40 Amp Green		Bat – L/Bar/Off-Road

Cavity	Cartridge Fuse	Mini Fuse	Description
J11	30 Amp Pink		Bat – Sway/Thatchum/Rear Doors
J12	40 Amp Green		Starter Solenoid
J13	60 Amp Yellow		Bat – Rad Fan #1/#2/SSR
J14	40 Amp Green		Bat – Folding Seat/PZEV
J15	60 Amp Yellow		Bat – IOD Main
J16	40 Amp Green		Frt HVAC Motor
M17		25 Amp Natural	Bat – Sunroof/Skylight
M18		25 Amp Natural	TCM/Trans Range



Cavity	Cartridge Fuse	Mini Fuse	Description
M19		5 Amp Tan	Ign R/ACC – Sunroof/Window Sw Illum
M20		25 Amp Natural	Frt Wiper
M21		25 Amp Natural	Door Locks
M22		20 Amp Yellow	Fuel Pump
M23		20 Amp Yellow	Bat – Trlr Light/Pre-Safe #2
M24		20 Amp Yellow	Bat – Trlr Tow BUX/HGM
M25		10 Amp Red	Bat – J1962 Diag/Mirrors
M26		10 Amp Red	Bat – Ign Sw, WIN, PASS

Cavity	Cartridge Fuse	Mini Fuse	Description
M27		15 Amp Blue	Bat – CHMSL/Brake Sw
M28		10 Amp Red	Bat – Corax TPM/PEM/HVAC Htr Pump
M29		15 Amp Blue	Bat – Folding Mirror
M30		25 Amp Natural	Bat – Inverter
M31		20 Amp Yellow	Bat – Pwr Out #1
M32		20 Amp Yellow	Fr/Rr Washer
M33		15 Amp Blue	Bat – NGC/EATX/PCM
M34		15 Amp Blue	Bat – CCN/Interior Light/SCM/Sw Bank

Cavity	Cartridge Fuse	Mini Fuse	Description
M35		20 Amp Yellow	Htd Seat/Htd Str Wheel/Rear Htd Seat
M36		20 Amp Yellow	Ign R-Rear Seat/Steer Wheel
M37		10 Amp Red	Horn #1
M38		20 Amp Yellow	IOD-CCN/Interior Mods
M39		30 Amp Green	IOD-Amp/Radio
M40		25 Amp Natural	Rear Wiper
M41		15 Amp Blue	IOD-SDARS/VES 2-3/DVD/HFM/UGDO/Vanity Lamp
M42		10 Amp Red	IOD-HVAC, U/Hood Lamp

Cavity	Cartridge Fuse	Mini Fuse	Description
M43		10 Amp Red	Horn #2
M44		10 Amp Red	IGN R/S-ORC/OCM
M45		10 Amp Red	IGN R-ORC/Trail Tow (BUX) Sense
M46		20 Amp Yellow	IGN R-Trail Tow (BUX)
M47		10 Amp Red	IGN R-H/Lamp Wash/HVAC/Park Assist/Ir Sns
M48		20 Amp Yellow	IGN R/ACC-Pwr Outlet #2
M49		20 Amp Yellow	IGN R/ACC/Bat-Pwr Outlet #3
M50		25 Amp Natural	ASD #1, #2

Cavity	Cartridge Fuse	Mini Fuse	Description
M51		20 Amp Yellow	ASD #3
M52		10 Amp Red	IGN R/S-SWAY/ TCASE/DTCM/ FAD/TRLR BRAKE MOD.
M53		15 Amp Blue	IGN R/S-MFSW/ CNN/SCM/TPM/RR View
M54		20 Amp Yellow	IOD – Spare

**CAUTION!**

- When installing the totally integrated power module cover, it is important to ensure the cover is properly positioned and fully latched. Failure to do so may allow water to get into the totally integrated power module and possibly result in an electrical system failure.
- When replacing a blown fuse, it is important to use only a fuse having the correct amperage rating. The use of a fuse with a rating other than indicated may result in a dangerous electrical system overload. If a properly rated fuse continues to blow, it indicates a problem in the circuit that must be corrected.

## VEHICLE STORAGE

If you are storing your vehicle for more than 21 days, we recommend that you take the following steps to minimize the drain on your vehicle's battery:

- Disconnect the Ignition-Off Draw (IOD) fuse located in the Integrated Power Module, located in the engine compartment. The IOD cavity includes a snap-in retainer that allows the fuse to be disconnected without removing it from the fuse block.
- As an alternative to the above steps you may disconnect the negative cables from both batteries.
- Any time you store your vehicle or keep it out of service (i.e., vacation) for two weeks or more, run the air conditioning system at idle for about five minutes in the fresh air and high blower setting. This will ensure adequate system lubrication to minimize the possibility of compressor damage when the system is started again.

### NOTE:

- When reinstalling the IOD fuse push firmly until fully seated; the gauges in the instrument cluster will do a full sweep when the ignition switch is turned to the RUN position. This is a normal condition.
- When the vehicle is shipped from the factory, the IOD fuse is in the up or extracted position. If the radio, interior lamps, keyless entry or other features do not work with the key OFF, check the position of the fuse (or check to see if the fuse is blown) to ensure that it is fully seated. When the IOD fuse is extracted, the instrument cluster in the odometer window will display "NO FUSE."

**REPLACEMENT BULBS**

<b>LIGHT BULBS – Interior</b>	<b>Bulb No.</b>
Overhead Console Lamps . . . . .	TS 212-2
Dome Lamp . . . . .	7679

**NOTE:** For lighted switches, see your authorized dealer for replacement instructions.

All of the inside bulbs are brass or glass-wedge base. Aluminum base bulbs are not approved.

<b>LIGHT BULBS – Exterior</b>	<b>Bulb No.</b>
Center High Mounted Stop Lamp (CHMSL) . . . . .	921
Fog Lamp . . . . .	9145
Dual Headlamp . . . . .	H13
Quad Headlamp – Low Beam . . . . .	H11
Quad Headlamp – High Beam . . . . .	9005
Side Marker (Dual Headlamp) . . . . .	3157K
Side Marker (Quad Headlamp). . . . .	3157NA
Rear Cargo Lamp . . . . .	921
Cab Roof Marker Lamps . . . . .	194NA

**BULB REPLACEMENT****Dual or Quad Headlamp/Front Park and Turn Signal – If Equipped**

1. Open the hood.
2. Disconnect and isolate the negative battery cable.
3. Remove the four plastic push-in fasteners that secure the upper radiator seal to the grille support and both fender ledges.
4. Remove the two plastic push-in rivets that secure the upper radiator seal to the radiator.
5. Remove the upper radiator seal from the vehicle.
6. Remove the two headlamp assembly attachment screws.

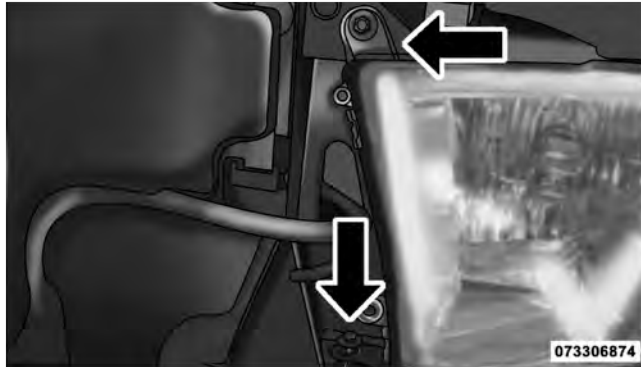

7. Reach into the front wheel house ahead of the front wheel, remove the fastener, and lift the cover over the access hole in the front of the wheel house splash shield. Access to the rear of the lamp can be gained through this access hole.

8. Reach through the access hole of the wheel house splash shield and lift the slide lock upward far enough to disengage it from the lock post on the back of the front lamp unit housing.

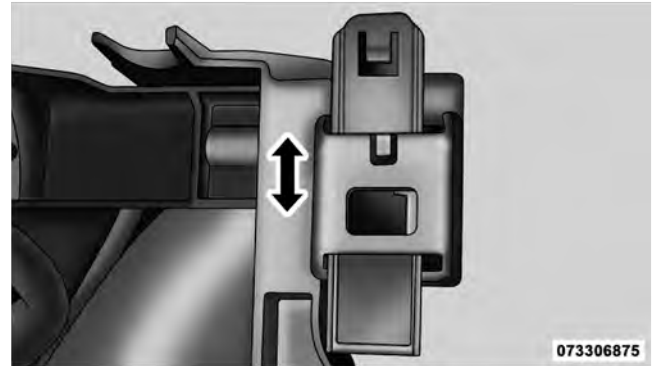

9. Remove the headlamp assembly. Grasp the outboard edge of the lamp and pull it straight forward to disengage the ball stud from the plastic grommet.

10. Disconnect electrical connectors.
11. Replace bulb(s) as necessary.

**CAUTION!**

- Do not contaminate the bulb glass by touching it with your fingers or by allowing it to contact other oily surfaces. Shortened bulb life will result.
- Always use the correct bulb size and type for replacement. An incorrect bulb size or type may overheat and cause damage to the lamp, the bulb socket, or the lamp wiring.

**NOTE:** There are access covers over both headlamp bulb access holes in the quad front lamp unit housing (if equipped). These covers **MUST** be reinstalled after the bulb has been replaced.

**Fog Lamps – If Equipped**

1. Reach under and behind the front bumper to access the back of the front fog lamp housing.
2. Disconnect the fog lamp wiring harness connector from the fog lamp bulb.
3. Rotate the bulb counterclockwise  $\frac{1}{4}$  turn to unlock the bulb from the housing.
4. Pull the bulb straight out from the housing.

**CAUTION!**

**Do not contaminate the bulb glass by touching it with your fingers or by allowing it to contact other oily surfaces. Shortened bulb life will result.**

## Center High-Mounted Stoplamp (CHMSL) With Cargo Lamp

1. Remove the two screws holding the housing/lens to the body as shown.

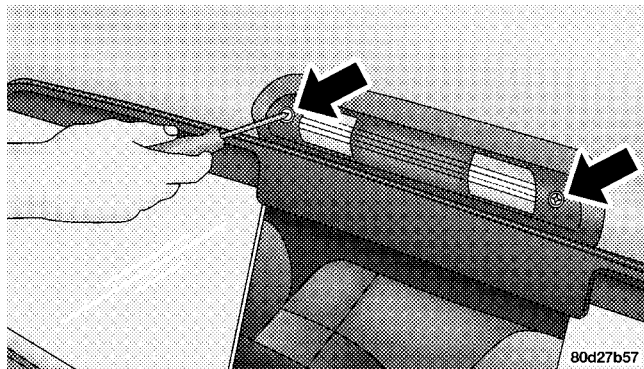

2. Separate the connector holding the housing and wiring harness to the body.

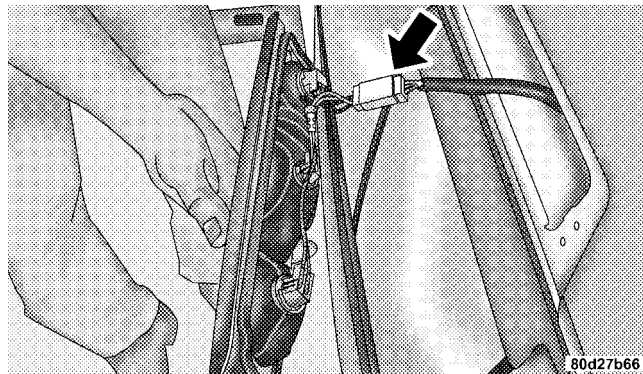

3. Turn the desired bulb socket  $\frac{1}{4}$  turn and remove the socket and bulb from housing.



4. Pull the desired bulb straight from the socket.

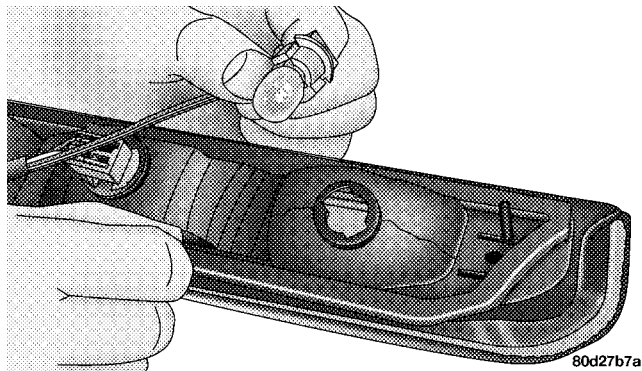

**CAUTION!**

Do not contaminate the bulb glass by touching it with your fingers or by allowing it to contact other oily surfaces. Shortened bulb life will result.

- Outside Bulbs: Cargo Lamps
  - Inside Bulb: Center High-Mounted Stop Lamp
5. Reverse the procedure for installation of bulbs and housing.

**Cab Top Clearance Lamps – If Equipped**

1. Remove the two screws from the top of the lamp.

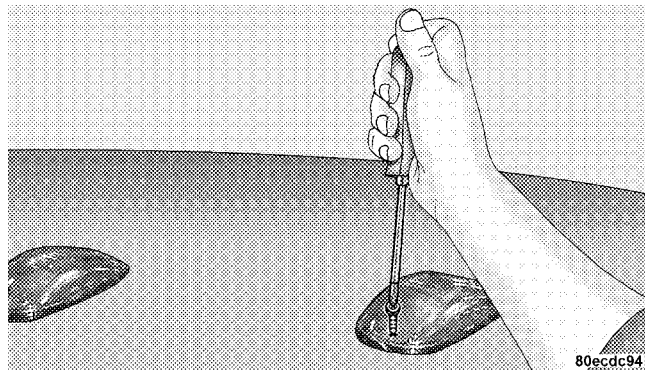

2. Rotate the socket  $\frac{1}{4}$  turn and pull it from the lamp assembly.

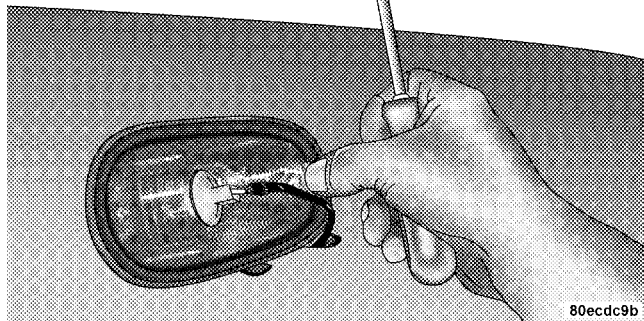

3. Pull the bulb straight from its socket and replace.

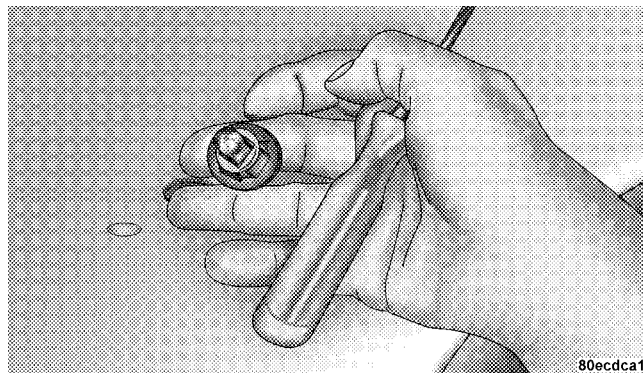

**FLUID CAPACITIES**

	U.S.	Metric
<b>Fuel (Approximate)</b>		
Standard Rear Tank	52 Gallons	197 Liters
Optional Midship Tank	22 Gallons	83 Liters
<b>Engine Oil with Filter</b>		
5.7L Engine (SAE 5W-20, API Certified)	7 Quarts	6.6 Liters
<b>Cooling System</b>		
5.7L Engine (MOPAR® Antifreeze/Coolant 5 Year/100,000 Mile Formula) or equivalent.	18.7 Quarts	17.7 Liters

## FLUIDS, LUBRICANTS AND GENUINE PARTS

### Engine

Component	Fluid, Lubricant, or Genuine Part
Engine Coolant	Antifreeze/Coolant 5-Year/100,000 Mile Formula HOAT (Hybrid Organic Additive Technology) or equivalent.
Engine Oil – 5.7L Engine	Use API Certified SAE 5W-20 Engine Oil, meeting the requirements of Chrysler Material Standard MS-6395. Refer to your engine oil filler cap for correct SAE grade.
Engine Oil Filter – 5.7L Engine	MOPAR® Engine Oil Filter or equivalent.
Spark Plugs – 5.7L Engine	LZFR5C-11 (Gap 0.043 in [1.09 mm])
Fuel Selection – 5.7L Engine	87 Octane Acceptable - 89 Octane Recommended

**Chassis**

<b>Component</b>	<b>Fluid, Lubricant, or Genuine Part</b>
Automatic Transmission (Five-Speed 545RFE)	MOPAR® ATF+4® Automatic Transmission Fluid or equivalent licensed ATF+4® product.
Transfer Case	MOPAR® ATF+4® Automatic Transmission Fluid or equivalent licensed ATF+4® product.
Front and Rear Axle Fluid (4500/5500)	GL-5 SAE 75W-90 Synthetic (MS-9763) or equivalent.
Brake Master Cylinder	MOPAR® DOT 3 and SAE J1703 should be used or equivalent. If DOT 3 brake fluid is not available, then DOT 4 is acceptable. Use only recommended brake fluids.
Power Steering Reservoir	MOPAR® Power Steering Fluid +4, MOPAR® ATF+4® Automatic Transmission Fluid or equivalent licensed ATF+4® product.

# MAINTENANCE SCHEDULES

## CONTENTS

---

<ul style="list-style-type: none"> <li>■ Emissions Control System Maintenance . . . . . 430</li> <li>■ Maintenance Schedule . . . . . 430</li> </ul>	<ul style="list-style-type: none"> <li>□ 5.7L Gas Engine . . . . . 430</li> </ul>
--	---

## EMISSIONS CONTROL SYSTEM MAINTENANCE

The Scheduled Maintenance services listed in **bold type** must be done at the times or mileages specified to ensure the continued proper functioning of the emissions control system. These and all other maintenance services included in this manual, should be done to provide best vehicle performance and reliability. More frequent maintenance may be needed for vehicles in severe operating conditions, such as dusty areas and very short trip driving.

Inspection and service should also be done anytime a malfunction is suspected.

**NOTE:** Maintenance, replacement or repair of the emissions control devices and systems on your vehicle may be performed by any automotive repair establishment or individual using any automotive part that has been certified pursuant to U.S. EPA or in the State of California, California Air Resources Board regulations.

## MAINTENANCE SCHEDULE

### 5.7L Gas Engine

The oil change indicator system will remind you that it is time to take your vehicle in for scheduled maintenance.

On Electronic Vehicle Information Center (EVIC) equipped vehicles, "Oil Change Due" will be displayed in the EVIC and a single chime will sound, indicating that an oil change is necessary.

On Non-EVIC equipped vehicles, "Change Oil" will flash in the instrument cluster odometer and a single chime will sound, indicating that an oil change is necessary.

Based on engine operation conditions the oil change indicator message will illuminate, this means that service is required for your vehicle. Have your vehicle serviced as soon as possible, within the next 500 miles (805 km).

**NOTE:**

- The oil change indicator message will not monitor the time since the last oil change. Change your vehicle's oil if it has been 6 months since your last oil change even if the oil change indicator message is NOT illuminated.
- Change your engine oil more often if you drive your vehicle off-road for an extended period of time.
- Under no circumstances should oil change intervals exceed 6,000 miles (10,000 km) or 6 months, whichever comes first.

Your authorized dealer will reset the oil change indicator message after completing the scheduled oil change. If a scheduled oil change is performed by someone other than your authorized dealer, the message can be reset by referring to the steps described under "Electronic Vehicle Information Center (EVIC)/Oil Change Due" in "Understanding Your Instrument Panel" or under "Instrument

Cluster Description/Odometer/Trip Odometer" in "Understanding Your Instrument Panel" for further information.

*At Each Stop for Fuel*

- Check the engine oil level about 5 minutes after a fully warmed engine is shut off. Checking the oil level while the vehicle is on level ground will improve the accuracy of the oil level reading. Add oil only when the level is at or below the ADD or MIN mark.
- Check the windshield washer solvent and add if required.

*Once a Month*

- Check tire pressure and look for unusual wear or damage.
- Inspect the battery and clean and tighten the terminals as required.



**432 MAINTENANCE SCHEDULES**

- Check the fluid levels of coolant reservoir, brake master cylinder, power steering and transmission and add as needed.
- Check all lights and other electrical items for correct operation.

*At Each Oil Change*

- Change the engine oil filter.
- Inspect the brake hoses and lines.
- Lubricate outer tie rod ends.

**CAUTION!**

**Failure to perform the required maintenance items may result in damage to the vehicle.**

**Required Maintenance Intervals**

Refer to the Maintenance Schedules on the following pages for the required maintenance intervals.

### 6,000 Miles (10,000 km) or 6 Months Maintenance Service Schedule

- Change the engine oil and engine oil filter.
- Rotate tires.
- Lube front drive shaft fitting (4x4 only).
- Lubricate outer tie rod ends.

\_\_\_\_\_  
Odometer Reading Date

\_\_\_\_\_  
Repair Order # Dealer Code

\_\_\_\_\_  
Signature Authorized Chrysler Dealer

### 12,000 Miles (20,000 km) or 12 Months Maintenance Service Schedule

- Change the engine oil and engine oil filter.
- Rotate tires.
- If using your vehicle for any of the following: Dusty or off-road conditions. Inspect the engine air cleaner filter, replace if necessary.
- Inspect the brake linings, replace if necessary.
- Lube front drive shaft fitting (4x4 only).
- Lubricate outer tie rod ends.
- Inspect the CV joints. Perform the first inspection at 12,000 miles (20 000 km) or 12 months.
- Inspect exhaust system. Perform the first inspection at 12,000 miles (20 000 km) or 12 months.

\_\_\_\_\_  
Odometer Reading Date

\_\_\_\_\_  
Repair Order # Dealer Code

\_\_\_\_\_  
Signature Authorized Chrysler Dealer

**18,000 Miles (30,000 km) or 18 Months Maintenance Service Schedule**

- Change the engine oil and engine oil filter.
- Rotate tires.
- Lube front drive shaft fitting (4x4 only).
- Lubricate outer tie rod ends.
- Inspect the front & rear axle fluid.  
Change if using your vehicle for police, taxi, fleet, off-road or frequent trailer towing.

\_\_\_\_\_ Date

\_\_\_\_\_ Dealer Code

\_\_\_\_\_  
Signature Authorized Chrysler Dealer

**24,000 Miles (40,000 km) or 24 Months Maintenance Service Schedule**

- Change the engine oil and engine oil filter.
- Rotate tires.
- If using your vehicle for any of the following: Dusty or off-road conditions. Inspect the engine air cleaner filter, replace if necessary.
- Inspect the brake linings, replace if necessary.
- Lubricate outer tie rod ends.
- Inspect the front suspension, tie rod ends, and boot seals, replace if necessary.
- Lube front drive shaft fitting (4x4 only).
- Inspect the CV joints.
- Inspect exhaust system.

\_\_\_\_\_ Date

\_\_\_\_\_ Dealer Code

\_\_\_\_\_  
Signature Authorized Chrysler Dealer

### 30,000 Miles (50,000 km) or 30 Months Maintenance Service Schedule

- Change the engine oil and engine oil filter.
- Rotate tires.
- Replace the engine air cleaner filter.
- Replace the spark plugs (5.7L engine).**
- Adjust parking brake on vehicles equipped with four wheel disc brakes.
- Lube front drive shaft fitting (4x4 only).
- Lubricate outer tie rod ends.
- Inspect the transfer case fluid.

\_\_\_\_\_  
Odometer Reading Date

\_\_\_\_\_  
Repair Order # Dealer Code

\_\_\_\_\_  
Signature Authorized Chrysler Dealer

### 36,000 Miles (60,000 km) or 36 Months Maintenance Service Schedule

- Change the engine oil and engine oil filter.
- Rotate tires.
- If using your vehicle for any of the following: Dusty or off-road conditions. Inspect the engine air cleaner filter, replace if necessary.
- Inspect the brake linings, replace if necessary.
- Lube front drive shaft fitting (4x4 only).
- Lubricate outer tie rod ends.
- Inspect the front & rear axle fluid. Change if using your vehicle for police, taxi, fleet, off-road or frequent trailer towing.

\_\_\_\_\_  
Odometer Reading Date

\_\_\_\_\_  
Repair Order # Dealer Code

\_\_\_\_\_  
Signature Authorized Chrysler Dealer

**42,000 Miles (70,000 km) or 42 Months Maintenance Service Schedule**

- Change the engine oil and engine oil filter.
- Rotate tires.
- Lube front drive shaft fitting (4x4 only).
- Lubricate outer tie rod ends.

\_\_\_\_\_  
Odometer Reading Date

\_\_\_\_\_  
Repair Order # Dealer Code

\_\_\_\_\_  
Signature Authorized Chrysler Dealer

**48,000 Miles (80,000 km) or 48 Months Maintenance Service Schedule**

- Change the engine oil and engine oil filter.
- Rotate tires.
- If using your vehicle for any of the following: Dusty or off-road conditions. Inspect the engine air cleaner filter, replace if necessary.
- Inspect the brake linings, replace if necessary.
- Lubricate outer tie rod ends.
- Inspect the front suspension, tie rod ends, and boot seals, replace if necessary.
- Lube front drive shaft fitting (4x4 only).
- Inspect the CV Joints.
- Inspect exhaust system.

\_\_\_\_\_  
Odometer Reading Date

\_\_\_\_\_  
Repair Order # Dealer Code

\_\_\_\_\_  
Signature Authorized Chrysler Dealer

**54,000 Miles (90,000 km) or 54 Months Maintenance Service Schedule**

- Change the engine oil and engine oil filter.
- Rotate tires.
- Lube front drive shaft fitting (4x4 only).
- Lubricate outer tie rod ends.
- Inspect the front & rear axle fluid.  
Change if using your vehicle for police, taxi, fleet, off-road or frequent trailer towing.

\_\_\_\_\_  
Odometer Reading Date

\_\_\_\_\_  
Repair Order # Dealer Code

\_\_\_\_\_  
Signature Authorized Chrysler Dealer

**60,000 Miles (100,000 km) or 60 Months Maintenance Service Schedule**

- Change the engine oil and engine oil filter.
- Rotate tires.
- Replace the engine air cleaner filter.
- Replace the spark plugs (5.7L engine).**
- Adjust parking brake on vehicles equipped with four wheel disc brakes.
- Inspect the brake linings, replace if necessary.
- Lube front drive shaft fitting (4x4 only).
- Lubricate outer tie rod ends.
- Change the automatic transmission fluid & filter(s) if using your vehicle for any of the following: police, taxi, fleet, snow plowing, or frequent trailer towing.
- Inspect the transfer case fluid, add if necessary.
- Flush and replace the engine coolant at 60 months if not done at 102,000 miles (170 000 km).

\_\_\_\_\_  
Odometer Reading Date

\_\_\_\_\_  
Repair Order # Dealer Code

\_\_\_\_\_  
Signature Authorized Chrysler Dealer

**66,000 Miles (110,000 km) or 66 Months Maintenance Service Schedule**

- Change the engine oil and engine oil filter.
- Rotate tires.
- Lube front drive shaft fitting (4x4 only).
- Lubricate outer tie rod ends.

\_\_\_\_\_ Date

\_\_\_\_\_ Dealer Code

\_\_\_\_\_  
Signature Authorized Chrysler Dealer

**72,000 Miles (120,000 km) or 72 Months Maintenance Service Schedule**

- Change the engine oil and engine oil filter.
- Rotate tires.
- If using your vehicle for any of the following: Dusty or off-road conditions. Inspect the engine air cleaner filter, replace if necessary.
- Inspect the brake linings, replace if necessary.
- Lubricate outer tie rod ends.
- Inspect the front suspension, tie rod ends, and boot seals, replace if necessary.
- Lube front drive shaft fitting (4x4 only).
- Inspect the front & rear axle fluid. Change if using your vehicle for police, taxi, fleet, off-road or frequent trailer towing.
- Inspect the CV Joints.
- Inspect exhaust system.

\_\_\_\_\_ Date

\_\_\_\_\_ Dealer Code

\_\_\_\_\_  
Signature Authorized Chrysler Dealer

### 78,000 Miles (130,000 km) or 78 Months Maintenance Service Schedule

- Change the engine oil and engine oil filter.
- Rotate tires.
- Lube front drive shaft fitting (4x4 only).
- Lubricate outer tie rod ends.

\_\_\_\_\_  
Odometer Reading Date

\_\_\_\_\_  
Repair Order # Dealer Code

\_\_\_\_\_  
Signature Authorized Chrysler Dealer

### 84,000 Miles (140,000 km) or 84 Months Maintenance Service Schedule

- Change the engine oil and engine oil filter.
- Rotate tires.
- If using your vehicle for any of the following: Dusty or off-road conditions. Inspect the engine air cleaner filter, replace if necessary.
- Inspect the brake linings, replace if necessary.
- Lube front drive shaft fitting (4x4 only).
- Lubricate outer tie rod ends.

\_\_\_\_\_  
Odometer Reading Date

\_\_\_\_\_  
Repair Order # Dealer Code

\_\_\_\_\_  
Signature Authorized Chrysler Dealer



**90,000 Miles (150,000 km) or 90 Months Maintenance Service Schedule**

- Change the engine oil and engine oil filter.
- Rotate tires.
- Replace the engine air cleaner filter.
- Replace the spark plugs (5.7L engine).**
- Inspect and replace PCV valve if necessary. †**
- Adjust parking brake on vehicles equipped with four wheel disc brakes.
- Lube front drive shaft fitting (4x4 only).
- Lubricate outer tie rod ends.
- Inspect the front & rear axle fluid. Change if using your vehicle for police, taxi, fleet, off-road or frequent trailer towing.
- Inspect the transfer case fluid.

\_\_\_\_\_ Date

\_\_\_\_\_ Dealer Code

\_\_\_\_\_ Signature Authorized Chrysler Dealer

### 96,000 Miles (160,000 km) or 96 Months Maintenance Service Schedule

- Change the engine oil and engine oil filter.
- Rotate tires.
- If using your vehicle for any of the following: Dusty or off-road conditions. Inspect the engine air cleaner filter, replace if necessary.
- Inspect the brake linings, replace if necessary.
- Lubricate outer tie rod ends.
- Inspect the front suspension, tie rod ends, and boot seals, replace if necessary.
- Lube front drive shaft fitting (4x4 only).
- Inspect the CV Joints.
- Inspect exhaust system.

\_\_\_\_\_ Date  
Odometer Reading

\_\_\_\_\_ Dealer Code  
Repair Order #

\_\_\_\_\_  
Signature Authorized Chrysler Dealer

### 102,000 Miles (170,000 km) or 102 Months Maintenance Service Schedule

- Change the engine oil and engine oil filter.
- Rotate tires.
- Lube front drive shaft fitting (4x4 only).
- Lubricate outer tie rod ends.
- Flush and replace the engine coolant if not done at 60 months.
- Flush and replace power steering fluid.

\_\_\_\_\_ Date  
Odometer Reading

\_\_\_\_\_ Dealer Code  
Repair Order #

\_\_\_\_\_  
Signature Authorized Chrysler Dealer

**108,000 Miles (180,000 km) or 108 Months Maintenance Service Schedule**

- Change the engine oil and engine oil filter.
- Rotate tires.
- If using your vehicle for any of the following: Dusty or off-road conditions. Inspect the engine air cleaner filter, replace if necessary.
- Inspect the brake linings, replace if necessary.
- Lube front drive shaft fitting (4x4 only).
- Lubricate outer tie rod ends.
- Inspect the front & rear axle fluid. Change if using your vehicle for police, taxi, fleet, off-road or frequent trailer towing.

\_\_\_\_\_ Date

Odometer Reading

\_\_\_\_\_ Dealer Code

Repair Order #

\_\_\_\_\_

Signature Authorized Chrysler Dealer

**114,000 Miles (190,000 km) or 114 Months Maintenance Service Schedule**

- Change the engine oil and engine oil filter.
- Rotate tires.
- Lube front drive shaft fitting (4x4 only).
- Lubricate outer tie rod ends.

\_\_\_\_\_ Date

Odometer Reading

\_\_\_\_\_ Dealer Code

Repair Order #

\_\_\_\_\_

Signature Authorized Chrysler Dealer

**120,000 Miles (200,000 km) or 120 Months Maintenance Service Schedule**

- Change the engine oil and engine oil filter.
- Rotate tires.
- Replace the engine air cleaner filter.
- Replace the spark plugs (5.7L engine).**
- Adjust parking brake on vehicles equipped with four wheel disc brakes.
- Inspect the brake linings, replace if necessary.
- Lubricate outer tie rod ends.
- Inspect the front suspension, tie rod ends, and boot seals, replace if necessary.
- Lube front drive shaft fitting (4x4 only).
- Inspect the CV Joints.
- Inspect exhaust system.
- Inspect the transfer case fluid, change if using your vehicle for any of the following: fleet, off-road, or frequent trailer towing.
- Change the automatic transmission fluid & filter(s).
- Replace accessory drive belt(s).

---

Odometer Reading Date

---

Repair Order # Dealer Code

---

Signature Authorized Chrysler Dealer

**126,000 Miles (210,000 km) or  
126 Months Maintenance  
Service Schedule**

- Change the engine oil and engine oil filter.
- Rotate tires.
- Lube front drive shaft fitting (4x4 only).
- Lubricate outer tie rod ends.
- Inspect the front & rear axle fluid.  
Change if using your vehicle for police, taxi, fleet, off-road or frequent trailer towing.

\_\_\_\_\_ Date  
Odometer Reading

\_\_\_\_\_ Dealer Code  
Repair Order #

\_\_\_\_\_  
Signature Authorized Chrysler Dealer

**132,000 Miles (220,000 km) or  
132 Months Maintenance  
Service Schedule**

- Change the engine oil and engine oil filter.
- Rotate tires.
- If using your vehicle for any of the following: Dusty or off-road conditions. Inspect the engine air cleaner filter, replace if necessary.
- Inspect the brake linings, replace if necessary.
- Lube front drive shaft fitting (4x4 only).
- Lubricate outer tie rod ends.

\_\_\_\_\_ Date  
Odometer Reading

\_\_\_\_\_ Dealer Code  
Repair Order #

\_\_\_\_\_  
Signature Authorized Chrysler Dealer

**138,000 Miles (230,000 km) or  
138 Months Maintenance  
Service Schedule**

- Change the engine oil and engine oil filter.
- Rotate tires.
- Lube front drive shaft fitting (4x4 only).
- Lubricate outer tie rod ends.

\_\_\_\_\_ Date  
Odometer Reading

\_\_\_\_\_ Dealer Code  
Repair Order #

\_\_\_\_\_  
Signature Authorized Chrysler Dealer

### 144,000 Miles (240,000 km) or 144 Months Maintenance Service Schedule

- Change the engine oil and engine oil filter.
- Rotate tires.
- If using your vehicle for any of the following: Dusty or off-road conditions. Inspect the engine air cleaner filter, replace if necessary.
- Inspect the brake linings, replace if necessary.
- Lubricate outer tie rod ends.
- Inspect the front suspension, tie rod ends, and boot seals, replace if necessary.
- Lube front drive shaft fitting (4x4 only).
- Inspect the front & rear axle fluid. Change if using your vehicle for police, taxi, fleet, off-road or frequent trailer towing.
- Inspect the CV Joints.
- Inspect exhaust system.

\_\_\_\_\_ Date

Odometer Reading

\_\_\_\_\_ Dealer Code

Repair Order #

\_\_\_\_\_

Signature Authorized Chrysler Dealer

### 150,000 Miles (250,000 km) or 150 Months Maintenance Service Schedule

- Change the engine oil and engine oil filter.
- Rotate tires.
- Replace the engine air cleaner filter.
- Replace the spark plugs (5.7L engine).**
- Adjust parking brake on vehicles equipped with four wheel disc brakes.
- Lube front drive shaft fitting (4x4 only).
- Lubricate outer tie rod ends.
- Inspect the transfer case fluid.

\_\_\_\_\_ Date

Odometer Reading

\_\_\_\_\_ Dealer Code

Repair Order #

\_\_\_\_\_

Signature Authorized Chrysler Dealer

## 446 MAINTENANCE SCHEDULES

† This maintenance is recommended by the manufacturer to the owner, but is not required to maintain emissions warranty.

**WARNING!**

You can be badly injured working on or around a motor vehicle. Do only that service work for which you have the knowledge and the right equipment. If you have any doubt about your ability to perform a service job, take your vehicle to a competent mechanic.

# IF YOU NEED CONSUMER ASSISTANCE

## CONTENTS

---

■ Suggestions For Obtaining Service For Your Vehicle. . . . .	449	□ Customer Assistance For The Hearing Or Speech Impaired (TDD/TTY) . . . . .	451
□ Prepare For The Appointment . . . . .	449	□ Service Contract . . . . .	451
□ Prepare A List . . . . .	449	■ Warranty Information . . . . .	452
□ Be Reasonable With Requests . . . . .	449	■ MOPAR® Parts . . . . .	452
■ If You Need Assistance . . . . .	449	■ Reporting Safety Defects . . . . .	452
□ Chrysler Group LLC Customer Center . . . . .	450	□ In The 50 United States And Washington, D.C. . . . .	452
□ Chrysler Canada Inc. Customer Center . . . . .	450	□ In Canada . . . . .	453
□ In Mexico Contact . . . . .	450		



**448 IF YOU NEED CONSUMER ASSISTANCE**

■ Publication Order Forms . . . . .	453	□ Traction Grades . . . . .	455
■ Department Of Transportation Uniform Tire Quality Grades . . . . .	454	□ Temperature Grades . . . . .	456
□ Treadwear . . . . .	455		

## **SUGGESTIONS FOR OBTAINING SERVICE FOR YOUR VEHICLE**

### **Prepare For The Appointment**

If you're having warranty work done, be sure to have the right papers with you. Take your warranty folder. All work to be performed may not be covered by the warranty. Discuss additional charges with the service manager. Keep a maintenance log of your vehicle's service history. This can often provide a clue to the current problem.

### **Prepare A List**

Make a written list of your vehicle's problems or the specific work you want done. If you've had an accident or work done that is not on your maintenance log, let the service advisor know.

### **Be Reasonable With Requests**

If you list a number of items and you must have your vehicle by the end of the day, discuss the situation with

the service advisor and list the items in order of priority. At many authorized dealers, you may obtain a rental vehicle at a minimal daily charge. If you need a rental, it is advisable to make these arrangements when you call for an appointment.

### **IF YOU NEED ASSISTANCE**

The manufacturer and its authorized dealers are vitally interested in your satisfaction. We want you to be happy with our products and services.

Warranty service must be done by an authorized dealer. We strongly recommend that you take the vehicle to an authorized dealer. They know your vehicle the best, and are most concerned that you get prompt and high quality service. The manufacturer's authorized dealers have the facilities, factory-trained technicians, special tools, and the latest information to ensure the vehicle is fixed correctly and in a timely manner.

## 450 IF YOU NEED CONSUMER ASSISTANCE

This is why you should always talk to an authorized dealer's service manager first. Most matters can be resolved with this process.

- If for some reason you are still not satisfied, talk to the general manager or owner of the authorized dealership. They want to know if you need assistance.
- If an authorized dealership is unable to resolve the concern, you may contact the manufacturer's customer center.

Any communication to the manufacturer's customer center should include the following information:

- Owner's name and address
- Owner's telephone number (home and office)
- Authorized dealership name
- Vehicle Identification Number (VIN)

- Vehicle delivery date and mileage

### **Chrysler Group LLC Customer Center**

P.O. Box 21-8004

Auburn Hills, MI 48321-8004

Phone: (866) 726-4636

### **Chrysler Canada Inc. Customer Center**

P.O. Box 1621

Windsor, Ontario N9A 4H6

Phone: (800) 465-2001

### **In Mexico contact:**

Av. Prolongacion Paseo de la Reforma, 1240

Sante Fe C.P. 05109

Mexico, D. F.

In Mexico City: 5081-7568

Outside Mexico City: 1-800-505-1300

### **Customer Assistance For The Hearing Or Speech Impaired (TDD/TTY)**

To assist customers who have hearing difficulties, the manufacturer has installed special TDD (Telecommunication Devices for the Deaf) equipment at its customer center. Any hearing or speech impaired customer, who has access to a TDD or a conventional teletypewriter (TTY) in the United States, can communicate with the manufacturer by dialing 1-800-380-CHRY.

Canadian residents with hearing difficulties that require assistance can use the special needs relay service offered by Bell Canada. For TTY teletypewriter users, dial 711 and for Voice callers, dial 1 800 855-0511 to connect with a Bell Relay Service operator.

### **Service Contract**

You may have purchased a service contract for a vehicle to help protect you from the high cost of unexpected repairs after the manufacturer's New Vehicle Limited Warranty expires. The manufacturer stands behind only

the manufacturer's service contracts. If you purchased a manufacturer's service contract, you will receive Plan Provisions and an Owner Identification Card in the mail within three weeks of the vehicle delivery date. If you have any questions about the service contract, call the manufacturer's Service Contract National Customer Hotline at 1-800-521-9922 (Canadian residents, call 1-800-485-2001).

The manufacturer will not stand behind any service contract that is not the manufacturer's service contract. It is not responsible for any service contract other than the manufacturer's service contract. If you purchased a service contract that is not a manufacturer's service contract, and you require service after the manufacturer's New Vehicle Limited Warranty expires, please refer to the contract documents, and contact the person listed in those documents.

We appreciate that you have made a major investment when you purchased the vehicle. An authorized dealer has also made a major investment in facilities, tools, and training to assure that you are absolutely delighted with the ownership experience. You'll be pleased with their sincere efforts to resolve any warranty issues or related concerns.

**WARNING!**

Engine exhaust, some of its constituents, and certain vehicle components contain, or emit, chemicals known to the State of California to cause cancer and birth defects, or other reproductive harm. In addition, certain fluids contained in vehicles and certain products of component wear contain, or emit, chemicals known to the State of California to cause cancer and birth defects, or other reproductive harm.

**WARRANTY INFORMATION**

See the Warranty Information Booklet, located on the DVD, for the terms and provisions of Chrysler Group LLC warranties applicable to this vehicle and market.

**MOPAR® PARTS**

MOPAR® fluids, lubricants, parts, and accessories are available from an authorized dealer. They are recommended for your vehicle in order to help keep the vehicle operating at its best.

**REPORTING SAFETY DEFECTS**

**In the 50 United States and Washington, D.C.**

If you believe that your vehicle has a defect that could cause a crash or cause injury or death, you should immediately inform the National Highway Traffic Safety Administration (NHTSA) in addition to notifying the manufacturer.

If NHTSA receives similar complaints, it may open an investigation, and if it finds that a safety defect exists in a group of vehicles, it may order a recall and remedy campaign. However, NHTSA cannot become involved in individual problems between you, your authorized dealer, and the manufacturer.

To contact NHTSA, you may either call the Auto Safety Hotline toll free at 1-888-327-4236 (TTY: 1-800-424-9153), or go to <http://www.safercar.gov>; or write to: Administrator, NHTSA, 1200 New Jersey Avenue, SE., West Building, Washington, D.C. 20590. You can also obtain other information about motor vehicle safety from <http://www.safercar.gov>.

### **In Canada**

If you believe that your vehicle has a safety defect, you should contact the Customer Service Department immediately. Canadian customers who wish to report a safety defect to the Canadian government should write to:

Transport Canada, Motor Vehicle Defect Investigations and Recalls, 2780 Sheffield Road, Ottawa, Ontario K1B 3V9.

### **PUBLICATION ORDER FORMS**

To order the following manuals, you may use either the website or the phone numbers listed below. Visa, Mastercard, American Express, and Discover orders are accepted. If you prefer mailing your payment, please call for an order form.

**NOTE:** A street address is required when ordering manuals (no P.O. Boxes).

- *Service Manuals*

These comprehensive Service Manuals provide the information that students and professional technicians need in diagnosing/troubleshooting, problem solving, maintaining, servicing, and repairing Chrysler Group LLC vehicles. A complete working knowledge of the

vehicle, system, and/or components is written in straightforward language with illustrations, diagrams, and charts.

- *Diagnostic Procedure Manuals*

Diagnostic Procedure Manuals are filled with diagrams, charts and detailed illustrations. These practical manuals make it easy for students and technicians to find and fix problems on computer-controlled vehicle systems and features. They show exactly how to find and correct problems the first time, using step-by-step troubleshooting and drivability procedures, proven diagnostic tests and a complete list of all tools and equipment.

- *Owner's Manuals*

These Owner's Manuals have been prepared with the assistance of service and engineering specialists to

acquaint you with specific Chrysler Group LLC vehicles. Included are starting, operating, emergency and maintenance procedures as well as specifications, capabilities and safety tips.

*Call toll free at:*

- 1-800-890-4038 (U.S.)
- 1-800-387-1143 (Canada)

Or

*Visit us on the Worldwide Web at:*

- [www.techauthority.com](http://www.techauthority.com)

## **DEPARTMENT OF TRANSPORTATION UNIFORM TIRE QUALITY GRADES**

The following tire grading categories were established by the National Highway Traffic Safety Administration. The specific grade rating assigned by the tire's manufacturer

in each category is shown on the sidewall of the tires on your vehicle.

All passenger car tires must conform to Federal safety requirements in addition to these grades.

### **Treadwear**

The Treadwear grade is a comparative rating, based on the wear rate of the tire when tested under controlled conditions on a specified government test course. For example, a tire graded 150 would wear one and one-half times as well on the government course as a tire graded 100. The relative performance of tires depends upon the actual conditions of their use, however, and may depart significantly from the norm due to variations in driving habits, service practices, and differences in road characteristics and climate.

### **Traction Grades**

The Traction grades, from highest to lowest, are AA, A, B, and C. These grades represent the tire's ability to stop on wet pavement, as measured under controlled conditions on specified government test surfaces of asphalt and concrete. A tire marked C may have poor traction performance.

#### **WARNING!**

**The traction grade assigned to this tire is based on straight-ahead braking traction tests, and does not include acceleration, cornering, hydroplaning, or peak traction characteristics.**



### Temperature Grades

The temperature grades are A (the highest), B, and C, representing the tire's resistance to the generation of heat and its ability to dissipate heat, when tested under controlled conditions on a specified indoor laboratory test wheel. Sustained high temperature can cause the material of the tire to degenerate and reduce tire life, and excessive temperature can lead to sudden tire failure. The grade C corresponds to a level of performance, which all passenger car tires must meet under the Federal Motor Vehicle Safety Standard No. 109. Grades B and A represent higher levels of performance on the laboratory test wheel, than the minimum required by law.

#### **WARNING!**

**The temperature grade for this tire is established for a tire that is properly inflated and not overloaded. Excessive speed, under-inflation, or excessive loading, either separately or in combination, can cause heat buildup and possible tire failure.**

---

# INDEX

- Adding Fuel . . . . . 326
- Adjustable Pedals . . . . . 148
- Air Cleaner, Engine (Engine Air Cleaner Filter) . . . 388
- Air Conditioner Maintenance . . . . . 390
- Air Conditioning . . . . . 249
- Air Conditioning Controls . . . . . 249
- Air Conditioning, Operating Tips . . . . . 260
- Air Conditioning Refrigerant . . . . . 390,391
- Air Conditioning System . . . . . 249,253,390
- Air Pressure, Tires . . . . . 308,317
- Airbag . . . . . 50
- Airbag Deployment . . . . . 56
- Airbag Light . . . . . 51,55,59,75,191
- Airbag Maintenance . . . . . 58
- Airbag, Side . . . . . 54
- Airbag, Window (Side Curtain) . . . . . 54
- Alarm Light . . . . . 183
- Alarm, Panic . . . . . 24
- Alarm (Security Alarm) . . . . . 18
- Alarm System (Security Alarm) . . . . . 18
- Alterations/Modifications, Vehicle . . . . . 7
- Antenna, Satellite Radio . . . . . 243
- Antifreeze (Engine Coolant) . . . . . 397,398
- Capacities . . . . . 426
- Disposal . . . . . 400
- Anti-Lock Warning Light . . . . . 191,296
- Anti-Theft Security Alarm (Theft Alarm) . . . . . 18
- Anti-Theft System . . . . . 18
- Appearance Care . . . . . 409
- Ashtray . . . . . 159
- Assistance Towing . . . . . 102
- Auto Down Power Windows . . . . . 35
- Automatic Dimming Mirror . . . . . 82
- Automatic Headlights . . . . . 139
- Automatic Temperature Control (ATC) . . . . . 253
- Automatic Transmission
- Adding Fluid . . . . . 407
- Fluid and Filter Changes . . . . . 408

Fluid Level Check . . . . .	405,406,407	Parking . . . . .	292
Fluid Type . . . . .	405,428	Warning Light . . . . .	188
Shifting . . . . .	270	Brake/Transmission Interlock . . . . .	269
Special Additives . . . . .	408	Bulb Replacement . . . . .	420
Axle Fluid . . . . .	404,405,428	Bulbs, Light . . . . .	75,420
Axle Lubrication (Axle Fluid) . . . . .	404,405	Cab Top Clearance Lights . . . . .	424
Battery . . . . .	389	Calibration, Compass . . . . .	204
Keyless Transmitter Replacement (RKE) . . . . .	24	Capacities, Antifreeze (Engine Coolant) . . . . .	426
Saving Feature (Protection) . . . . .	143	Capacities, Fluid . . . . .	426
Belts, Seat . . . . .	38,74	Caps, Filler	
Body Builders Guide . . . . .	6	Oil (Engine) . . . . .	387
Body Mechanism Lubrication . . . . .	392	Power Steering . . . . .	292
B-Pillar Location . . . . .	303	Radiator (Coolant Pressure) . . . . .	399
Brake Fluid . . . . .	402,428	Car Washes . . . . .	409
Brake System . . . . .	295,401	Carbon Monoxide Warning . . . . .	74,325
Anti-Lock (ABS) . . . . .	295	Cargo Light . . . . .	142
Fluid Check . . . . .	402	Cellular Phone . . . . .	87
Master Cylinder . . . . .	402	Center High Mounted Stop Light . . . . .	423

Center Lap Belts . . . . .	47	Compass Variance . . . . .	204
Center Seat Storage Compartment . . . . .	166	Computer, Trip/Travel . . . . .	201
Certification Label . . . . .	328	Connector	
Chart, Tire Sizing . . . . .	299	UCI . . . . .	236
Check Engine Light		Universal Consumer Interface (UCI) . . . . .	236
(Malfunction Indicator Light) . . . . .	190,383	Console, Overhead . . . . .	154
Checking Your Vehicle For Safety . . . . .	73	Contract, Service . . . . .	451
Checks, Safety . . . . .	73	Coolant Pressure Cap (Radiator Cap) . . . . .	399
Child Restraint . . . . .	61,62	Cooling System . . . . .	396
Child Restraint Tether Anchors . . . . .	64,68	Adding Coolant (Antifreeze) . . . . .	398
Child Seat . . . . .	62,66	Coolant Capacity . . . . .	426
Cigar Lighter . . . . .	159	Coolant Level . . . . .	396,400
Cleaning		Disposal of Used Coolant . . . . .	400
Wheels . . . . .	411	Drain, Flush, and Refill . . . . .	397
Climate Control . . . . .	248	Inspection . . . . .	400
Clock . . . . .	211,212,216,225	Points to Remember . . . . .	400
Compact Disc (CD) Maintenance . . . . .	247	Pressure Cap . . . . .	399
Compass . . . . .	202	Radiator Cap . . . . .	399
Compass Calibration . . . . .	204	Selection of Coolant (Antifreeze) . . . . .	397,427

- Cruise Control (Speed Control) . . . . . 150
- Cupholders . . . . . 161
- Customer Assistance . . . . . 449
  
- Daytime Running Lights . . . . . 143
- Dealer Service . . . . . 385
- Defroster, Rear Window . . . . . 170
- Defroster, Windshield . . . . . 75,251,257
- Delay (Intermittent) Wipers . . . . . 146
- Differential, Limited-Slip . . . . . 287
- Dipsticks
  - Automatic Transmission . . . . . 407
  - Power Steering . . . . . 292
- Disposal
  - Antifreeze (Engine Coolant) . . . . . 400
- Door Locks . . . . . 28
- Driving
  - Through Flowing, Rising, or Shallow Standing Water . . . . . 288
- Dual Rear Wheels . . . . . 320,366
- Electric Rear Window Defrost . . . . . 170
- Electrical Power Outlets . . . . . 156
- Electronic Range Select (ERS) . . . . . 270
- Electronic Speed Control (Cruise Control) . . . . . 150
- Electronic Vehicle Information Center (EVIC) . . . . . 194
- Electronically Shifted Transfer Case . . . . . 280
- Emergency Brake . . . . . 292
- Emergency, In Case of
  - Freeing Vehicle When Stuck . . . . . 374
  - Hazard Warning Flasher . . . . . 358
  - Jump Starting . . . . . 370
  - Tow Hooks . . . . . 375
  - Towing . . . . . 376
- Emission Control System Maintenance . . . . . 383,430
- Engine . . . . . 381
  - Air Cleaner . . . . . 388
  - Block Heater . . . . . 267

Break-In Recommendations . . . . .	72	Engine Fuel . . . . .	427
Compartment Identification . . . . .	381	Engine Oil . . . . .	388,427
Coolant (Antifreeze) . . . . .	427	Engine Oil Disposal . . . . .	388
Exhaust Gas Caution . . . . .	74,325	Flashers	
Flooded, Starting . . . . .	266	Turn Signal . . . . .	75,144,180
Jump Starting . . . . .	370	Flat Tire Stowage . . . . .	369
Oil . . . . .	386,427	Flooded Engine Starting . . . . .	266
Oil Filler Cap . . . . .	387	Fluid, Brake . . . . .	428
Oil Selection . . . . .	387	Fluid Capacities . . . . .	426
Oil Synthetic . . . . .	388	Fluid Leaks . . . . .	76
Temperature Gauge . . . . .	180	Fluid Level Checks	
Enhanced Accident Response Feature . . . . .	56	Automatic Transmission . . . . .	407
Exhaust Gas Caution . . . . .	74,325,394	Brake . . . . .	402
Exhaust System . . . . .	74,394	Power Steering . . . . .	292
Exterior Lighting . . . . .	139	Fluids, Lubricants and Genuine Parts . . . . .	427
Exterior Lights . . . . .	75	Fog Lights . . . . .	140,191,422
Filters		Four Wheel Drive . . . . .	277
Air Cleaner . . . . .	388	Four-Way Hazard Flasher . . . . .	358
		Freeing A Stuck Vehicle . . . . .	374

Front Axle (Differential) . . . . .	404	Oil Pressure . . . . .	183
Fuel . . . . .	321	Speedometer . . . . .	181
Adding . . . . .	326	Tachometer . . . . .	180
Diesel . . . . .	427	Voltmeter . . . . .	187
Filler Cap (Gas Cap) . . . . .	327	Gear Ranges . . . . .	272
Filter . . . . .	427	General Information . . . . .	17,25,116
Gauge . . . . .	180	Glass Cleaning . . . . .	413
Light . . . . .	187	Grocery Bag Retainer . . . . .	170
Octane Rating . . . . .	321	Gross Axle Weight Rating . . . . .	331
Requirements . . . . .	321	Gross Vehicle Weight Rating . . . . .	330
Tank Capacity . . . . .	426	Guide, Body Builders . . . . .	6
Fuses . . . . .	414	GVWR . . . . .	328
Gas Cap (Fuel Filler Cap) . . . . .	327,382	Hands-Free Phone (Uconnect™) . . . . .	87
Gasoline (Fuel) . . . . .	321	Hazard	
Gasoline, Reformulated . . . . .	322	Driving Through Flowing, Rising, or Shallow	
Gauges		Standing Water . . . . .	288
Coolant Temperature . . . . .	180	Hazard Warning Flasher . . . . .	358
Fuel . . . . .	180	Head Restraints . . . . .	124



Headlights . . . . .	420	Ignition . . . . .	14
Automatic . . . . .	139	Key . . . . .	12,14
Cleaning . . . . .	412	Ignition Key Removal . . . . .	14
High Beam . . . . .	145	Illuminated Entry . . . . .	19
High Beam/Low Beam Select Switch . . . . .	145	Immobilizer (Sentry Key) . . . . .	15
Lights On Reminder . . . . .	143	Infant Restraint . . . . .	61,62
Passing . . . . .	144	Inflation Pressure Tires . . . . .	317
Switch . . . . .	139	Information Center, Vehicle . . . . .	194
Heated Mirrors . . . . .	85,170	Inside Rearview Mirror . . . . .	81
Heated Seats . . . . .	129	Instrument Cluster . . . . .	178,180
Heater . . . . .	249	Instrument Panel and Controls . . . . .	177
Heater, Engine Block . . . . .	267	Instrument Panel Lens Cleaning . . . . .	413
High Beam/Low Beam Select (Dimmer) Switch . . . . .	145	Integrated Power Module (Fuses) . . . . .	414
Hitches		Integrated Trailer Brake Controls . . . . .	338
Trailer Towing . . . . .	333	Interior Appearance Care . . . . .	412
Hoisting . . . . .	370	Interior Lights . . . . .	141
Hood Release . . . . .	136	Intermittent Wipers (Delay Wipers) . . . . .	146
Hub Caps . . . . .	365	Introduction . . . . .	4
		Inverter Outlet (115V) . . . . .	160

Jack Location . . . . .	358	Life of Tires . . . . .	314
Jump Starting . . . . .	370	Light Bulbs . . . . .	75
Key, Programming . . . . .	17	Lights . . . . .	75,138
Key, Replacement . . . . .	16	Airbag . . . . .	51,55,59,75,191
Key, Sentry (Immobilizer) . . . . .	15	Alarm . . . . .	183
Key-In Reminder . . . . .	15	Anti-Lock . . . . .	191
Keyless Entry System . . . . .	20	Anti-Lock Warning . . . . .	296
Keys . . . . .	12	Automatic Headlights . . . . .	139
Knee Bolster . . . . .	51	Brake Warning . . . . .	188
		Bulb Replacement . . . . .	420
Lane Change and Turn Signals . . . . .	144	Cap Top Clearance . . . . .	424
Lane Change Assist . . . . .	144	Cargo . . . . .	142
Lap Belts . . . . .	47	Center Mounted Stop . . . . .	423
Lap/Shoulder Belts . . . . .	38	Check Engine (Malfunction Indicator) . . . . .	190
LATCH (Lower Anchors and Tether for CHildren) . . . . .	64	Courtesy/Reading . . . . .	154
Latches . . . . .	75	Daytime Running . . . . .	143
Leaks, Fluid . . . . .	76	Exterior . . . . .	75
		Fog . . . . .	140,191,422
		Four-Wheel Drive Indicator . . . . .	280

Hazard Warning Flasher . . . . .	358	Limited-Slip Differential . . . . .	287,405
Headlights . . . . .	139	Loading Vehicle . . . . .	328
High Beam . . . . .	145,187	Tires . . . . .	303
High Beam Indicator . . . . .	187	Locks . . . . .	28
High Beam/Low Beam Select . . . . .	145	Child Protection . . . . .	32
Illuminated Entry . . . . .	19	Door . . . . .	28
Instrument Cluster . . . . .	180	Power Door . . . . .	29
Interior . . . . .	141,154	Lower Anchors and Tether for Children (LATCH) . . . . .	64
Lights On Reminder . . . . .	143	Lubrication, Body . . . . .	392
Low Fuel . . . . .	187	Lug Nuts . . . . .	364,366
Oil Pressure . . . . .	189	Maintenance Free Battery . . . . .	389
Passing . . . . .	144	Maintenance Procedures . . . . .	385
Seat Belt Reminder . . . . .	193	Maintenance Schedule . . . . .	430,432
Security Alarm (Theft Alarm) . . . . .	183	Maintenance Schedules . . . . .	430
Service . . . . .	420	Malfunction Indicator Light (Check Engine) . . . . .	383
Theft Alarm (Security Alarm) . . . . .	183	Manual, Service . . . . .	453
Transfer Case . . . . .	280		
Turn Signal . . . . .	75,144,420		
Warning (Instrument Cluster Description) . . . . .	180		

Manual Transmission		Occupant Restraints	37,54,56
Fluid Level Check	405	Occupant Restraints (Sedan)	54
Lubricant Selection	428	Octane Rating, Gasoline (Fuel)	321
Memory Seat	132	Odometer	183
Mini-Trip Computer	201	Trip	183
Mirrors	81	Oil Change Indicator	185,199
Automatic Dimming	82	Oil Change Indicator, Reset	185,199
Electric Powered	84	Oil, Engine	386,427
Heated	85	Capacity	426
Memory	132	Change Interval	386
Outside	82	Dipstick	386
Rearview	81	Disposal	388
Trailer Towing	86	Filter	388,427
Modifications/Alterations, Vehicle	7	Filter Disposal	388
Mopar Parts	384,452	Identification Logo	387
Multi-Function Control Lever	143	Materials Added to	388
New Vehicle Break-In Period	72	Pressure Gauge	183
		Recommendation	387
		Synthetic	388

- Viscosity . . . . . 387
- Onboard Diagnostic System . . . . . 382,383
- Operating Precautions . . . . . 382
- Operator Manual (Owner's Manual) . . . . . 4
- Outside Rearview Mirrors . . . . . 82
- Overdrive . . . . . 274
- Overdrive OFF Switch . . . . . 274
- Overhead Console . . . . . 154
- Overheating, Engine . . . . . 181
- Owner's Manual (Operator Manual) . . . . . 4,453
- Panic Alarm . . . . . 24
- Parking Brake . . . . . 292
- Passing Light . . . . . 144
- Pedals, Adjustable . . . . . 148
- Personal Settings . . . . . 205
- Pets . . . . . 72
- Pets, Transporting . . . . . 72
- Phone, Cellular . . . . . 87
- Phone, Hands-Free (Uconnect™) . . . . . 87
- Placard, Tire and Loading Information . . . . . 303
- Power
- Door Locks . . . . . 29
  - Mirrors . . . . . 84
  - Outlet (Auxiliary Electrical Outlet) . . . . . 156,160
  - Seats . . . . . 127
  - Sliding Rear Window . . . . . 171
  - Steering . . . . . 291,292
  - Windows . . . . . 34
- Power Steering Fluid . . . . . 428
- Pregnant Women and Seat Belts . . . . . 49
- Programmable Electronic Features . . . . . 205
- Programming Transmitters  
(Remote Keyless Entry) . . . . . 20
- Radial Ply Tires . . . . . 313
- Radiator Cap (Coolant Pressure Cap) . . . . . 397,399
- Radio, Satellite (Uconnect® studios) . . . . . 242

Rear Axle (Differential) . . . . .	404,405	Resetting Oil Change Indicator . . . . .	185,199
Rear Window Features . . . . .	170	Restraint, Head . . . . .	124
Rear Window, Sliding . . . . .	172	Restraints, Child . . . . .	61,66
Reclining Front Seats . . . . .	123	Restraints, Occupant . . . . .	37
Recreational Towing . . . . .	347	Rotation, Tires . . . . .	319
Shifting into Transfer Case Neutral (N) . . . . .	348,351	Safety Checks Inside Vehicle . . . . .	74
Shifting out of Transfer Case Neutral (N) . . . . .	349,353	Safety Checks Outside Vehicle . . . . .	75
Reformulated Gasoline . . . . .	322	Safety Defects, Reporting . . . . .	452
Refrigerant . . . . .	391	Safety, Exhaust Gas . . . . .	74
Reminder, Seat Belt . . . . .	48	Safety Information, Tire . . . . .	297
Remote Control		Safety Tips . . . . .	73
Starting System . . . . .	25	Satellite Radio Antenna . . . . .	243
Remote Keyless Entry (RKE) . . . . .	20	Satellite Radio (Uconnect <sup>®</sup> studios) . . . . .	242
Remote Sound System (Radio) Controls . . . . .	246	Schedule, Maintenance . . . . .	430
Remote Starting System . . . . .	25	Seat Belt Maintenance . . . . .	413
Replacement Keys . . . . .	16	Seat Belt Reminder . . . . .	48
Replacement Parts . . . . .	384	Seat Belts . . . . .	37,38,74
Replacement Tires . . . . .	315	Adjustable Upper Shoulder Anchorage . . . . .	46
Reporting Safety Defects . . . . .	452		

And Pregnant Women . . . . .	49	Service Contract . . . . .	451
Child Restraint . . . . .	61,72	Service Manuals . . . . .	453
Extender . . . . .	49	Setting the Clock . . . . .	211,212,216,225
Front Seat . . . . .	38	Settings, Personal . . . . .	205
Inspection . . . . .	74	Shifting . . . . .	268
Reminder . . . . .	193	Automatic Transmission . . . . .	270
Seats . . . . .	121,131	Transfer Case . . . . .	279
Adjustment . . . . .	121	Transfer Case, Shifting into Transfer Case Neutral (N) . . . . .	348,351
Child . . . . .	72	Transfer Case, Shifting out of Transfer Case Neutral (N) . . . . .	349,353
Heated . . . . .	129	Shoulder Belt Upper Anchorage . . . . .	46
Memory . . . . .	132	Shoulder Belts . . . . .	38
Power . . . . .	127	Signals, Turn . . . . .	75,144,180
Reclining . . . . .	123	Sliding Rear Window	
Security Alarm (Theft Alarm) . . . . .	18	Power . . . . .	171
Selection of Coolant (Antifreeze) . . . . .	397,427	Snow Chains (Tire Chains) . . . . .	317
Sentry Key (Immobilizer) . . . . .	15	Snow Plow . . . . .	344
Sentry Key Programming . . . . .	17	Snow Tires . . . . .	319
Sentry Key Replacement . . . . .	16		
Service Assistance . . . . .	449		

Spark Plugs . . . . .	427	Synthetic Engine Oil . . . . .	388
Speed Control (Cruise Control) . . . . .	150	System, Remote Starting . . . . .	25
Speedometer . . . . .	181		
Starting . . . . .	25,265	Tachometer . . . . .	180
Automatic Transmission . . . . .	265	Temperature Control, Automatic (ATC) . . . . .	253
Engine Fails to Start . . . . .	266	Temperature Gauge, Engine Coolant . . . . .	180
Remote . . . . .	25	Tether Anchor, Child Restraint . . . . .	64,68
Starting Procedures (Gas Engines) . . . . .	265	Tilt Steering Column . . . . .	147
Steel Carcass Ply Tires . . . . .	310	Tip Start . . . . .	266
Steering		Tire and Loading Information Placard . . . . .	303,317
Power . . . . .	291,292	Tire Identification Number (TIN) . . . . .	301
Wheel, Heated . . . . .	149	Tire Markings . . . . .	297
Wheel, Tilt . . . . .	147	Tire Safety Information . . . . .	297
Steering Wheel Mounted Sound		Tires . . . . .	75,307,454
System Controls . . . . .	246	Aging (Life of Tires) . . . . .	314
Storage Compartment, Center Seat . . . . .	166	Air Pressure . . . . .	307
Storage, Vehicle . . . . .	259,419	Chains . . . . .	317
Storing Your Vehicle . . . . .	419	Dual . . . . .	320,366
Supplemental Tire Pressure Information . . . . .	317	General Information . . . . .	307



High Speed . . . . .	312	24-Hour Towing Assistance . . . . .	102
Inflation Pressures . . . . .	308	Disabled Vehicle . . . . .	376
Life of Tires . . . . .	314	Guide . . . . .	334
Load Capacity . . . . .	303,304	Recreational . . . . .	347
Quality Grading . . . . .	454	Weight . . . . .	334
Radial . . . . .	313	Towing Assistance . . . . .	102
Replacement . . . . .	315	Traction . . . . .	288
Rotation . . . . .	319	Trailer Towing . . . . .	330
Safety . . . . .	297,307	Cooling System Tips . . . . .	344
Sizes . . . . .	299	Hitches . . . . .	333
Snow Tires . . . . .	319	Minimum Requirements . . . . .	335
Spinning . . . . .	313	Mirrors . . . . .	86
Steel Carcass Ply . . . . .	310	Trailer and Tongue Weight . . . . .	334
Tread Wear Indicators . . . . .	314	Wiring . . . . .	342
Wheel Nut Torque . . . . .	364	Trailer Towing Guide . . . . .	334
Tongue Weight/Trailer Weight . . . . .	334	Trailer Weight . . . . .	334
Torque Converter Clutch . . . . .	276	Transfer Case . . . . .	405
Tow Hooks, Emergency . . . . .	375	Electronically Shifted . . . . .	280
Towing . . . . .	330	Fluid . . . . .	428

Transmission		Variance, Compass . . . . .	204
Automatic . . . . .	270,405	Vehicle Identification Number (VIN) . . . . .	7
Fluid . . . . .	428	Vehicle Loading . . . . .	304,328
Maintenance . . . . .	405	Vehicle Modifications/Alterations . . . . .	7
Shifting . . . . .	268	Vehicle Storage . . . . .	259,419
Transmitter Battery Service		Voice Recognition System (VR) . . . . .	116
(Remote Keyless Entry) . . . . .	24	Voltmeter . . . . .	187
Transmitter Programming		Warning Lights	
(Remote Keyless Entry) . . . . .	20	(Instrument Cluster Description) . . . . .	180
Transmitter, Remote Keyless Entry (RKE) . . . . .	20	Warnings and Cautions . . . . .	6
Tread Wear Indicators . . . . .	314	Warranty Information . . . . .	452
Trip Odometer . . . . .	183	Washers, Windshield . . . . .	146,393
Turn Signals . . . . .	144,180,420	Washing Vehicle . . . . .	409
UCI Connector . . . . .	236	Water	
Uconnect™ (Hands-Free Phone) . . . . .	87	Driving Through . . . . .	288
Uniform Tire Quality Grades . . . . .	454	Wheel and Wheel Trim . . . . .	411
Universal Consumer Interface (UCI) Connector . . . . .	236	Wheel and Wheel Trim Care . . . . .	411
		Wheel Cover . . . . .	365

Wheel Nut Torque . . . . .	364,369	Windshield Washers . . . . .	145,146,393
Wind Buffeting . . . . .	37	Fluid . . . . .	145,393
Window Fogging . . . . .	259	Windshield Wiper Blades . . . . .	392
Windows . . . . .	34	Windshield Wipers . . . . .	145
Power . . . . .	34	Wiper Blade Replacement . . . . .	392
Rear Sliding . . . . .	172	Wipers, Intermittent . . . . .	146
Windshield Defroster . . . . .	75		



STICK WITH THE SPECIALISTS®

Chrysler Group LLC

11DD43-126-AA



1st Edition

Printed in U.S.A.