



3-2850.090

Rev F 06/03 English

WARNING



SAFETY INSTRUCTIONS

1. Depressurize and vent system prior to installation or removal.
2. Confirm chemical compatibility before use.
3. Do not exceed maximum temperature/pressure specifications.
4. Wear safety goggles or faceshield during installation/service.
5. Do not alter product construction.
6. When using chemicals or solvents care should be taken and appropriate eye, face, hand, body, and/or respiratory protection should be used.

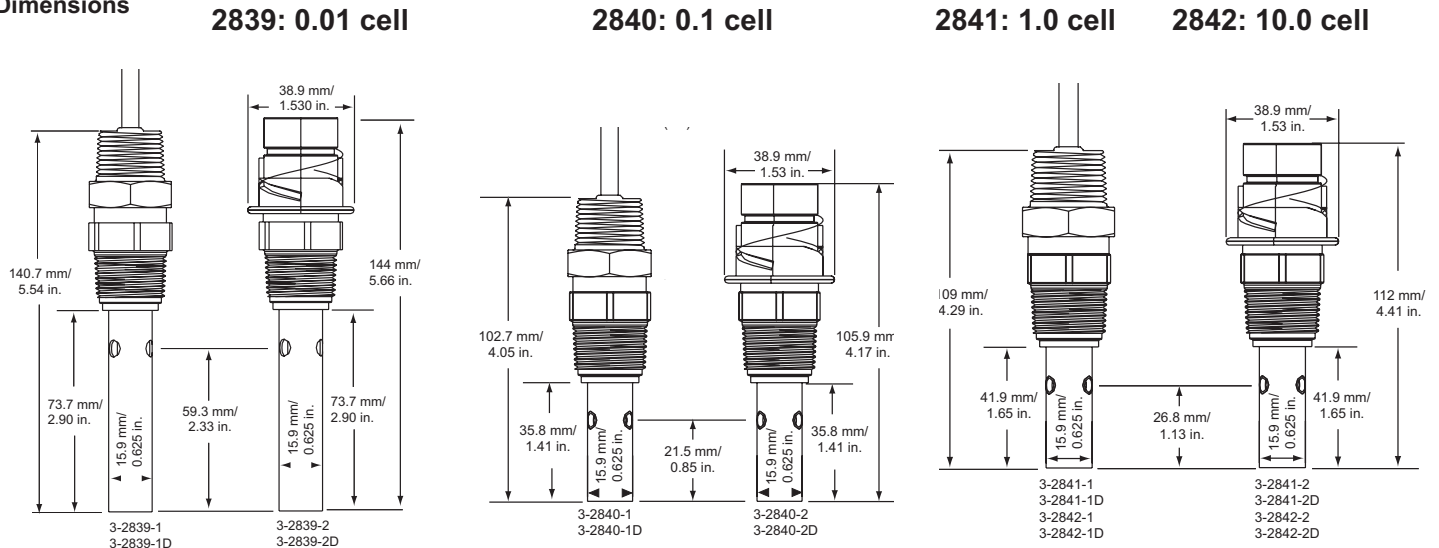

Table of Contents

1. Specifications
2. Cell constant selection
3. In-line Installation
4. Submersible or Tank installation
5. Wiring
6. Maintenance
7. Ordering information

1. Specifications

Dimensions



General

Compatibility:

	2850	5800CR	5900	8850-X	8860	8900	9050CR
CR Electrodes with Cable (-1X)		●	●	●	●		●
CR Electrodes with DryLoc™ (-2X)	●					●	

Quality Standard:

- Manufactured under ISO 9001, ISO 14001
- CE

Shipping Weight:

2839: 0.34 kg (0.74 lb)
 2840, 2841, 2842: 0.30 kg (0.66 lb)

Process connection:

-1 and -2 versions: 3/4 in. NPT
 -1D and -2D versions: ISO 7/1-R3/4

Cable (28XX-1X only):

4.6 m (15 ft.) std., 3 cond w/shld 22 AWG, max length 30 m (100 ft.)
 (For resistivity measurements above 10 MΩ or below 20°C, maximum cable length is 25 ft. (7.6 m))

Performance:

Accuracy: ±2% of cell value

Temperature measurement: PT1000

Temperature response time (τ):

2839:	5 s	2840:	10 s
2841:	20 s	2842:	30 s

BAR PSI

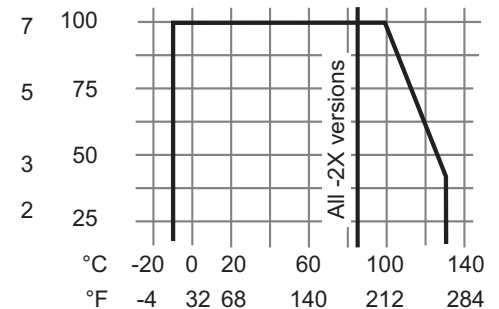

Operating temperature/pressure:

(with thread engagement per ANSI B1.20.1)

-1X versions:

-10°C to 100°C @ 6.9 bar (14°F to 212°F @ 100 psi)
 -10°C to 131°C @ 2.76 bar (14°F to 268°F @ 40 psi)

-2X versions:

-10°C to 85°C @ 6.9 bar (14°F to 185°F @ 100 psi)

Storage temperature: -20°C to 131°C (-4°F to 268°F)

Wetted materials:

DryLoc connector (-2 versions only): CPVC
 Threaded fitting: PEEK™
 Insulator: PEEK™
 Insulator O-ring (2841, 2842): FPM
 Electrode contacts: 316L stainless steel

PEEK™ is a trademark of Victrex plc

2. Cell constant selection

The nominal process value should be near the center of the range. Ranges below are for use with +GF+ SIGNET Conductivity instruments:

- 2839 (0.01 cell): 0.010 to 100 μS (10 $\text{k}\Omega$ /to 100 $\text{M}\Omega$)
- 2840 (0.1 cell): 1 to 1000 μS (1 $\text{M}\Omega$ to 1 $\text{k}\Omega$)
- 2841 (1.0 cell): 10 to 10,000 μS
- 2842 (10.0 cell): 100 to 200,000 μS

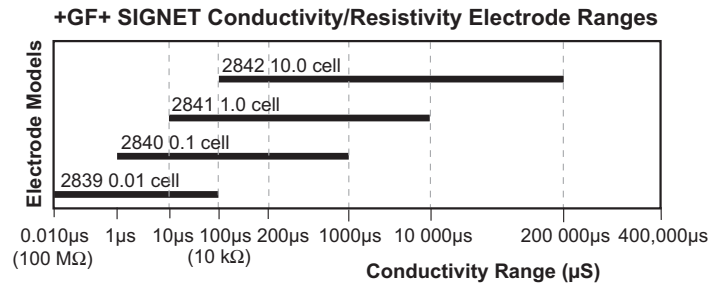

3. In-line installation for all -1X electrodes

- Inspect threads to ensure integrity. Do not install an electrode with damaged threads.
- Apply sealant or PTFE tape to threads.
- Wetted materials include 316L stainless steel, PEEK™ and FPM (FPM O-ring inside 2841, 2842). Check for chemical compatibility before installing electrode.
- The -1X electrodes are supplied with 5 m (15 ft.) of cable. It may be extended to a maximum 30 m (100 ft.)
- For resistivity measurements above 10 $\text{M}\Omega$ or below 20°C, maximum cable length is 25 ft. (7.6 m)

If the electrode is mounted vertically in a tee, do not recess the openings inside the tee. Mounting upside down may help prevent air entrapment.

An oversized tee may also be helpful for inline installations.

At least 4 threads (ANSI B1.20.1) must be engaged to provide pressure capacity per published specifications.

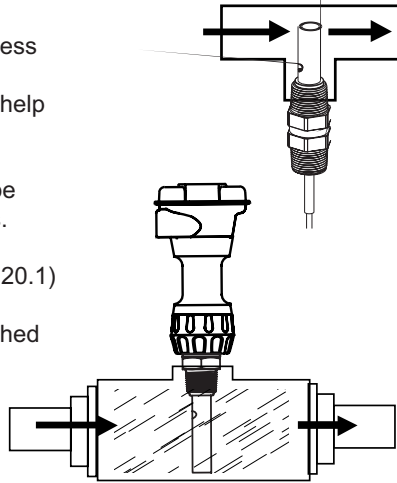

The preferred installation for in-line applications directs flow straight into the electrode. This configuration dislodges entrapped air bubbles, and provides the best continuous sampling of the fluid content.

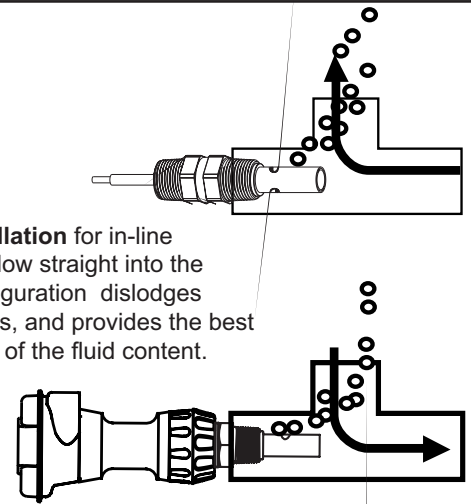

4. Submersible installation for all -1X electrodes

- Wetted materials include 316L stainless steel, PEEK™ (FPM O-ring inside 2841, 2842).
- Check for chemical compatibility before installing electrode.
- The -1X electrodes are supplied with 15 ft. of cable. It may be extended to a maximum 30 m (100 ft.)
- For resistivity measurements above 10 $\text{M}\Omega$ or below 20°C, maximum cable length is 25 ft. (7.6 m)

1. Feed cable into watertight conduit.
2. Apply thread sealant to the electrode before threading conduit onto electrode. Avoid twisting the cable.
3. Secure cable with conduit or cable gland.
4. For additional defense against possible accumulation of condensation at the back seal area of the electrode, fill the lower 3-4 inches (75-100 mm) of conduit or extension pipe with a flexible sealant such as silicone.

3/4 in. NPT or
ISO 7/1-R3/4



In aerated vessels install the electrode in a stillwell to prevent air from being trapped inside the electrode.

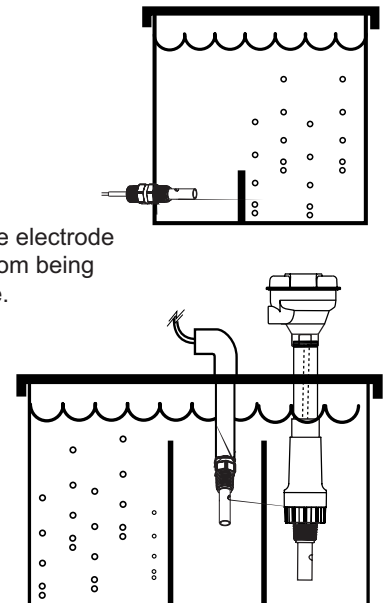

5. Wiring for all -1X electrodes

- Do not route electrode cable in conduit containing AC power wiring. Electrical noise may interfere with electrode signal.
- Routing electrode cable in grounded metal conduit will help prevent electrical noise and mechanical damage.
- Seal cable entry points to prevent moisture damage.
- For resistivity measurements above 10 MΩ or below 20°C, maximum cable length is 25 ft. (7.6 m)

Integral installation detail for all -1X electrodes

- 3-8052 Integral Kit and 3-9000.392-X Liquid Tight Connector kit are required. (See Parts and Accessories on back page)
- Cut the cable to approx. 15 cm (6 in.)
- Strip outer cable cover back 5 cm (2 in.)
- Strip each conductor to expose 1 cm (3/8 in.) of bare wire.
- Tin each conductor with solder for best results.

All -2X DryLoc electrodes connect directly to the 2850 Conductivity Sensor with no interconnecting wiring. Consult the 2850 Instruction manual for details.

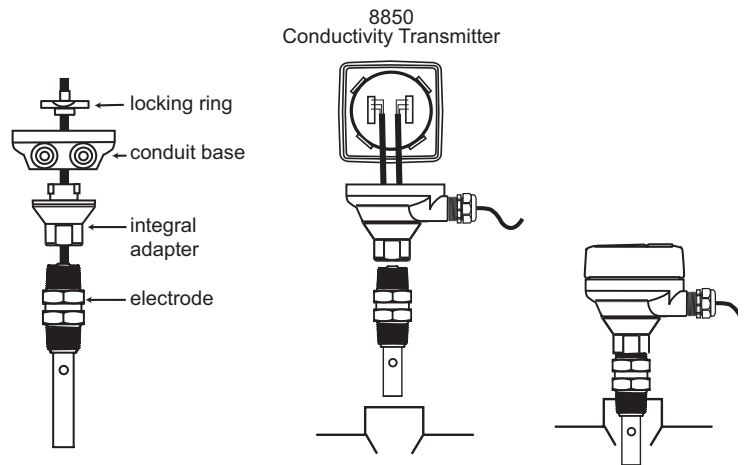

ProcessPro

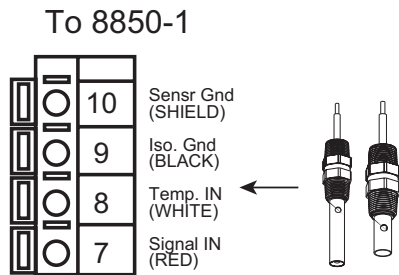

To 8850-2 and 8850-3

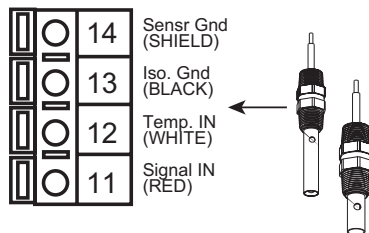

To 8860

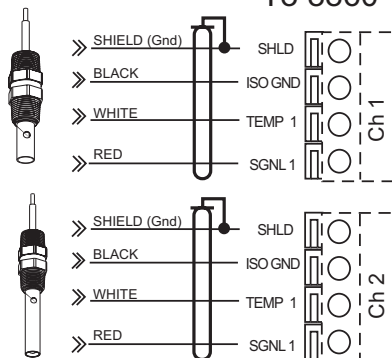

ProPoint

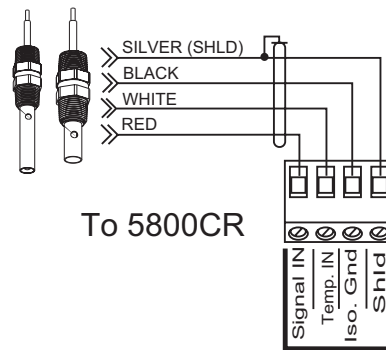

Intelek-Pro

To 9050CR

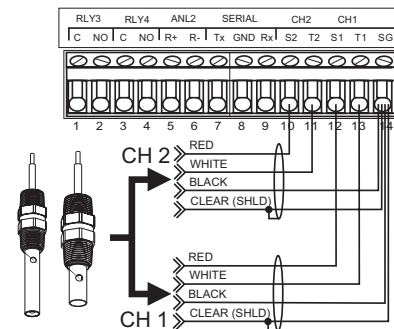

Installation for -2X DryLoc electrodes

Installation instructions for the -2 DryLoc version of these electrodes is located in the associated instrument manual.

6. Maintenance

Conductivity electrodes require little maintenance except for periodic cleaning in installations where contaminants are present.

- Keep metal surfaces clean and free of coatings.

6.1 Replacement Insulator, 2842 electrode only

- 2842 electrodes have a removable insulator so the internal cavity can be cleaned.
- After the insulator snaps into position it cannot be removed without damage.
- Order insulator replacement kit 3-2842.390 before attempting maintenance.

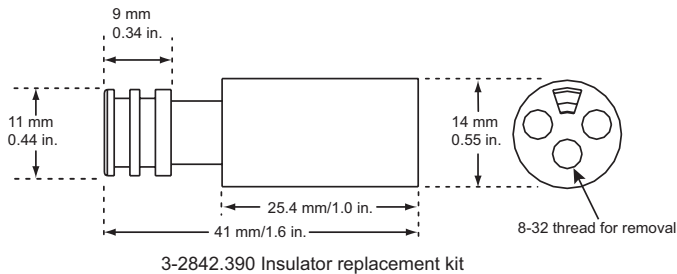

Insulator removal and replacement

- Thread the screw into the insulator (8-32 thread)
- Pull to remove the old insulator.
- Clean any coating or deposits inside the electrode.
- Insert the new insulator and press into place.

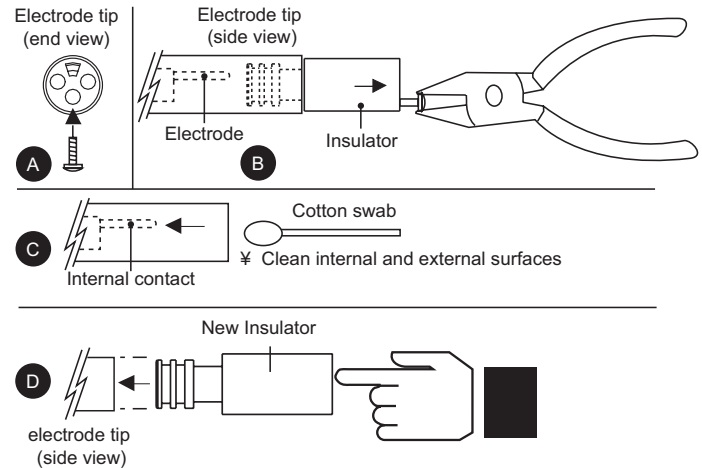

7. Ordering Information

Mfr. Part No.	Code	Description
3-2839-1	159 000 921	Cell 0.01, 15 ft cable, NPT
3-2839-1D	159 000 923	Cell 0.01, 15 ft cable, ISO
3-2840-1	159 000 786	Cell 0.1, 15 ft cable, NPT
3-2840-1D	159 000 788	Cell 0.1, 15 ft cable, ISO
3-2841-1	159 000 790	Cell 1.0, 15 ft cable, NPT
3-2841-1D	159 000 792	Cell 1.0, 15 ft cable, ISO
3-2842-1	159 000 794	Cell 10.0, 15 ft cable, NPT
3-2842-1D	159 000796	Cell 10.0, 15 ft cable, ISO
3-2839-2	159 000 922	Cell 0.01, DryLoc, NPT
3-2839-2D	159 000 924	Cell 0.01, DryLoc, ISO
3-2840-2	159 000 787	Cell 0.1, DryLoc, NPT
3-2840-2D	159 000 789	Cell 0.1, DryLoc, ISO
3-2841-2	159 000 791	Cell 1.0, DryLoc, NPT
3-2841-2D	159 000 793	Cell 1.0, DryLoc, ISO
3-2842-2	159 000 795	Cell 10.0, DryLoc, NPT
3-2842-2D	159 000 797	Cell 10.0, DryLoc, ISO

Parts and Accessories

3-8052	159 000 188	3/4 in. Integral mounting kit
3-9000.392-1	159 000 839	Liquid-tight connector kit, 1 set, 1/2 in. NPT
3-9000.392-2	159 000 841	Liquid-tight connector kit, 1 set, PG 13.5
3-2842.390	159 000 925	2842 replacement insulator, PEEK™ with FPM O-ring
3-2850-1	159 000 783	Conductivity Sensor, In-line
3-2850-2	159 000 784	Conductivity Sensor, In-line w/EasyCal
3-2850-3	159 000 785	Conductivity Sensor, Submersible
3-2850-4	159 000 857	Conductivity Sensor, Submersible



George Fischer Signet Inc., 3401 Aerojet Avenue, El Monte, CA 91731-2882 U.S.A. • Tel. (626) 571-2770 • Fax (626) 573-2057
For Worldwide Sales and Service, visit our website: www.gfsignet.com • Or call (in the U.S.): (800) 854-4090

