

User Guide

Process Refractometer
PR-43 Series



PUBLISHED BY

Vaisala Oyj
Vanha Nurmijärventie 21, FI-01670 Vantaa, Finland
P.O. Box 26, FI-00421 Helsinki, Finland
+358 9 8949 1

Visit our Internet pages at www.vaisala.com.

© Vaisala 2020

No part of this document may be reproduced, published or publicly displayed in any form or by any means, electronic or mechanical (including photocopying), nor may its contents be modified, translated, adapted, sold or disclosed to a third party without prior written permission of the copyright holder. Translated documents and translated portions of multilingual documents are based on the original English versions. In ambiguous cases, the English versions are applicable, not the translations.

The contents of this document are subject to change without prior notice.

Local rules and regulations may vary and they shall take precedence over the information contained in this document. Vaisala makes no representations on this document's compliance with the local rules and regulations applicable at any given time, and hereby disclaims any and all responsibilities related thereto.

This document does not create any legally binding obligations for Vaisala towards customers or end users. All legally binding

obligations and agreements are included exclusively in the applicable supply contract or the General Conditions of Sale and General Conditions of Service of Vaisala.

This product contains software developed by Vaisala or third parties. Use of the software is governed by license terms and conditions included in the applicable supply contract or, in the absence of separate license terms and conditions, by the General License Conditions of Vaisala Group.

This product may contain open source software (OSS) components. In the event this product contains OSS components, then such OSS is governed by the terms and conditions of the applicable OSS licenses, and you are bound by the terms and conditions of such licenses in connection with your use and distribution of the OSS in this product. Applicable OSS licenses are included in the product itself or provided to you on any other applicable media, depending on each individual product and the product items delivered to you.

Table of contents

| | | |
|-----------|--------------------------------------------|----|
| 1. | About this document | 5 |
| 1.1 | Version information..... | 5 |
| 1.2 | Related manuals..... | 5 |
| 1.3 | Documentation conventions..... | 5 |
| 1.4 | Trademarks..... | 6 |
| 2. | Product overview | 7 |
| 2.1 | Safety..... | 7 |
| 3. | Refractometer connections | 8 |
| 3.1 | Power supply..... | 8 |
| 3.2 | mA output..... | 8 |
| 3.3 | Cable connections..... | 8 |
| 3.3.1 | Split cable connections..... | 9 |
| 3.4 | Ethernet connection..... | 10 |
| 3.4.1 | IP settings for PR-43..... | 12 |
| 3.4.2 | IP settings for stand-alone computer..... | 12 |
| 3.4.3 | Configuring refractometer network..... | 13 |
| 3.4.4 | Testing Ethernet connection..... | 14 |
| 3.4.5 | Troubleshooting connection..... | 14 |
| 4. | Web interface | 16 |
| 4.1 | Main page..... | 16 |
| 4.2 | Diagnostics..... | 17 |
| 4.2.1 | Diagnostic values..... | 18 |
| 4.3 | Parameters..... | 18 |
| 4.3.1 | Measuring field samples..... | 19 |
| 4.3.2 | Optical image..... | 20 |
| 4.4 | Verification..... | 21 |
| 5. | Startup | 23 |
| 5.1 | Startup..... | 23 |
| 5.1.1 | Initial check..... | 23 |
| 5.1.2 | mA check..... | 23 |
| 5.1.3 | Calibration check..... | 23 |
| 5.2 | Viewing refractometer status..... | 23 |
| 6. | Configuration and calibration | 24 |
| 6.1 | Configuring refractometer..... | 24 |
| 6.1.1 | Signal damping..... | 24 |
| 6.1.2 | Configuring mA output..... | 26 |
| 6.1.3 | Ethernet speed setting..... | 27 |
| 6.1.4 | Skip count..... | 28 |
| 6.2 | Calibrating concentration measurement..... | 29 |
| 6.2.1 | Chemical curve..... | 30 |
| 6.2.2 | Field calibration..... | 30 |

- 7. Troubleshooting..... 32**
 - 7.1 Diagnostic message priorities.....32
 - 7.2 Hardware..... 32
 - 7.3 Measurement..... 33

- 8. Principle of measurement..... 35**

- 9. Ethernet protocol specification..... 37**
 - 9.1 Communication protocol..... 37
 - 9.1.1 Request format..... 37
 - 9.1.2 Response format..... 37
 - 9.1.3 Request and response errors..... 38
 - 9.2 Request-response pair specification.....38
 - 9.3 Error message specification..... 40

- 10. Instrument verification..... 42**
 - 10.1 Refractometer verification..... 42
 - 10.1.1 Handling R.l. liquids..... 43
 - 10.2 Verification procedure..... 43
 - 10.3 Corrective action..... 45

- Appendix A: PR-43 refractometer field calibration form..... 46**

- Appendix B: EU declaration of conformity..... 47**

- Warranty..... 49**

- Technical support..... 49**

- Recycling..... 49**

List of figures

| | | |
|-----------|-------------------------------------------------------------------------------------------------------------|----|
| Figure 1 | Analogue connection..... | 8 |
| Figure 2 | mA and Ethernet output (with M12 ethernet connector)..... | 9 |
| Figure 3 | mA and Ethernet output (with RJ-45 ethernet connector)..... | 9 |
| Figure 4 | RJ45 network connection with Ethernet converter cable PR-8442..... | 10 |
| Figure 5 | Three refractometers in the same network..... | 11 |
| Figure 6 | Connecting refractometer(s) via wireless..... | 11 |
| Figure 7 | Using fiber link to connect refractometer(s)..... | 11 |
| Figure 8 | Typical IP configuration for stand-alone laptop connected to refractometer (laptop WLAN turned off)..... | 13 |
| Figure 9 | Example PR-43 network..... | 13 |
| Figure 10 | Pinging address 169.254.43.43; ping returned fully and connection OK..... | 15 |
| Figure 11 | Main page..... | 17 |
| Figure 12 | Measurement cycles since last login..... | 17 |
| Figure 13 | Diagnostics page..... | 18 |
| Figure 14 | Parameters page..... | 19 |
| Figure 15 | Measuring field samples..... | 20 |
| Figure 16 | Raw optical image of compact refractometer..... | 21 |
| Figure 17 | Raw optical image of probe refractometer..... | 21 |
| Figure 18 | Verification page..... | 22 |
| Figure 19 | Exponential damping..... | 25 |
| Figure 20 | Linear damping..... | 25 |
| Figure 21 | Slew rate damping..... | 26 |
| Figure 22 | Default mA output values..... | 27 |
| Figure 23 | Setting secondary mA default..... | 27 |
| Figure 24 | Choosing ethernet speed..... | 28 |
| Figure 25 | Setting skip count value..... | 28 |
| Figure 26 | Concentration calibration layers..... | 29 |
| Figure 27 | Refractometer principle..... | 35 |
| Figure 28 | Optical images..... | 36 |
| Figure 29 | From image detection to concentration..... | 36 |
| Figure 30 | Universal sample holder PR-1012..... | 44 |

List of tables

| | | |
|---------|------------------------------------------|----|
| Table 1 | Document versions (English)..... | 5 |
| Table 2 | PR-43 manuals..... | 5 |
| Table 3 | Hardware messages..... | 32 |
| Table 4 | Measurement messages..... | 33 |
| Table 5 | Request-response pair specification..... | 39 |

1. About this document

1.1 Version information

This document provides instructions for installing and using the Vaisala K-PATENTS® Process Refractometers in the PR-43 series.

This product manual is delivered to the end user with a Vaisala K-PATENTS® product. Information in this manual is subject to change without notice. When the manual is changed, a revised copy is published at www.kpatents.com.

Table 1 Document versions (English)

| Document code | Date | Description |
|-----------------------|------------|--------------------------------------------------------------------------------------|
| M212455EN-B | April 2020 | Manual updated to new format, template, and document code. Minor changes to content. |
| IM-EN-PR43GEN v. 2.00 | June 2018 | First version. |

1.2 Related manuals

Table 2 PR-43 manuals

| Document Code | Name |
|----------------|--------------------------------------------------------------------|
| IM-EN-CI | <i>Compact User Interface CI Instruction Manual</i> |
| IM-EN-MI | <i>Multichannel User Interface MI Instruction Manual</i> |
| M212438EN | <i>Sanitary Process Refractometer PR-43-AC/AP User Guide</i> |
| IM-EN-PR43GCCP | <i>Process Refractometer PR-43-GC/GP Instruction Manual</i> |
| IM-EN-PR43IAAX | <i>Process Refractometer PR-43-...-IA/AX/CU Instruction Manual</i> |

1.3 Documentation conventions



WARNING! Warning alerts you to a serious hazard. If you do not read and follow instructions carefully at this point, there is a risk of injury or even death.



CAUTION! Caution warns you of a potential hazard. If you do not read and follow instructions carefully at this point, the product could be damaged or important data could be lost.



Note highlights important information on using the product.



Tip gives information for using the product more efficiently.



Lists tools needed to perform the task.



Indicates that you need to take some notes during the task.

1.4 Trademarks

Vaisala® and K-PATENTS® are registered trademarks of Vaisala Oyj.

Linux® is a registered trademark of Linus Torvalds.

Windows® is either a registered trademark or trademark of Microsoft Corporation in the United States and other countries.

All other product or company names that may be mentioned in this publication are trade names, trademarks, or registered trademarks of their respective owners.

2. Product overview

The Vaisala K-PATENTS® in-line process refractometer is an instrument for measuring liquid concentration in the process line. The measurement is based on the refraction of light in the process medium, an accurate and safe way of measuring liquid concentration. See [Principle of measurement \(page 35\)](#) for more information on the measurement principle.

PR-43 refractometers come in three standard packages: a stand-alone refractometer with Web user interface WI, a refractometer with Compact user interface CI and 1-4 refractometers with Multichannel user interface MI.

The web user interface WI is for direct control system integration in applications where no industrial computer or monitoring display is required. For more information, see [Refractometer connections \(page 8\)](#), [Startup \(page 23\)](#) and [Web interface \(page 16\)](#). Compact user interface provides a local or remote display with the same information as WI (see *Compact User Interface CI Instruction Manual*). Multichannel user interface provides high performance industrial computing e.g. for multiple connectivity and wash control (see *Multichannel User Interface MI Instruction Manual*).

2.1 Safety

This product has been tested for safety. Note the following precautions:



WARNING! Only licensed experts may install electrical components. They must adhere to local and state legislation and regulations.

The process medium may be hot or otherwise hazardous. Use shields and protective clothing adequate for the process medium. Do not rely on avoidance of contact with the process medium.



Wear protective eyewear.



Wear protective gloves.

Precautions when removing a sensor from the process line :

- Check that the process line is depressurized and drained
- Loosen the flowcell screws cautiously; be prepared to tighten again
- Ensure you are clear of any possible spillage and you have a clear emergency escape path

3. Refractometer connections

The refractometer has an Ethernet connection for digital data acquisition and configuration. The standard connection cable is made with an 8-pin industrial M12 connector in the refractometer end. For more information on the cables, see the manual for your refractometer model.

3.1 Power supply

The PR-43 refractometer requires a 24 V DC power supply (allowable tolerance is $\pm 10\%$). The current consumption of the refractometer is less than 80 mA. The power supply should be shielded from external voltage surges.

3.2 mA output

The PR-43 refractometer can be connected with just an mA output. The analogue connection transmits measurement signal only.

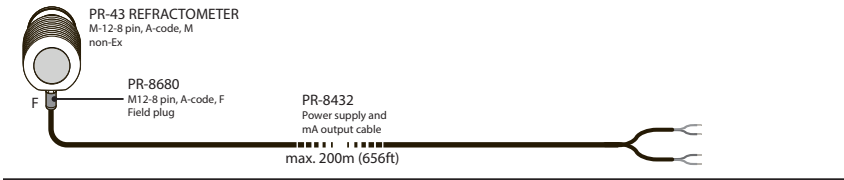

Figure 1 Analogue connection

3.3 Cable connections

If the refractometer is connected with Split cable PR-8431, both mA and Ethernet outputs are available.

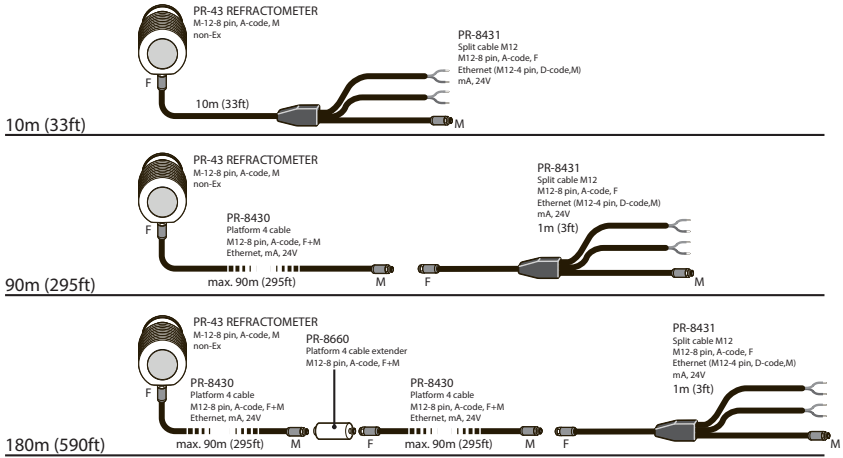

Figure 2 mA and Ethernet output (with M12 ethernet connector)

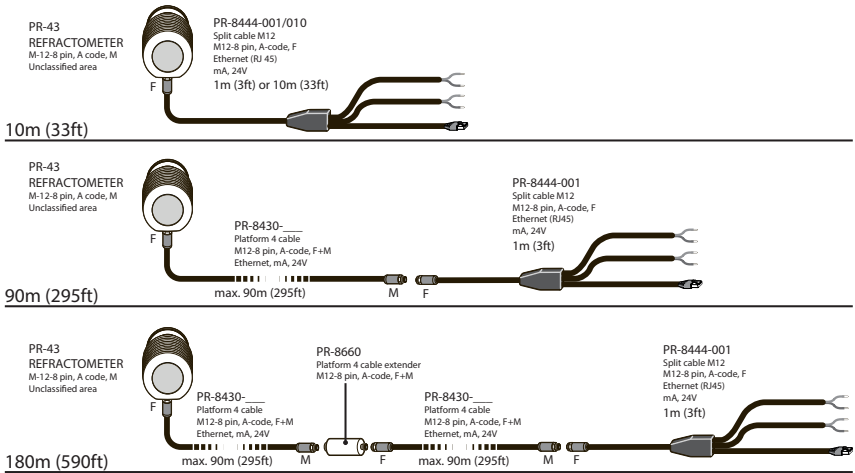

Figure 3 mA and Ethernet output (with RJ-45 ethernet connector)

3.3.1 Split cable connections

In split cables PR-8431 and PR-8444 the power cable and the mA output cable are marked near the end of the cable.

The power cable includes the following color-coded internal cabling:

- White: +24 DC
- Brown: GND

The mA output cable includes the following color-coded internal cabling:

- White: mA+
- Brown: mA-

3.4 Ethernet connection

The Ethernet connection enables data download from a refractometer to a computer. Any type of computer, for example PC, Mac or mainframe, with a compatible network connection can be configured to view and download data from the refractometer. The refractometer can be configured and monitored without any special software by using a standard web browser. [Ethernet protocol specification \(page 37\)](#) provides all the specifications necessary to write a data acquisition program.

 The connection on the Split cable PR-8431 is an industrial M12 connector. If connection to a device that uses RJ45 is desired, for example, to connect with a laptop, Split cable PR-8444 is needed. Alternatively, you can use Ethernet converter cable PR-8442.

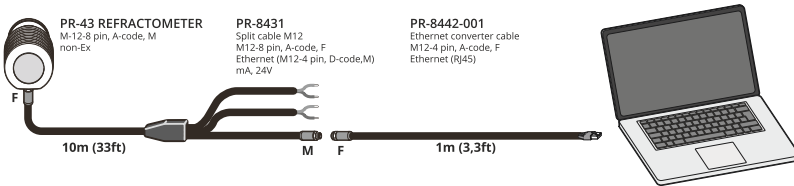

Figure 4 RJ45 network connection with Ethernet converter cable PR-8442

Several refractometers can be connected to the same Ethernet network. The refractometer also has an automatic function (known as Auto MDI/MDIX) to detect the polarity of the network so that the network may utilize either crossover or straight interconnecting cables.

The following figure shows an example of how to connect three refractometers to an existing LAN with a switch.

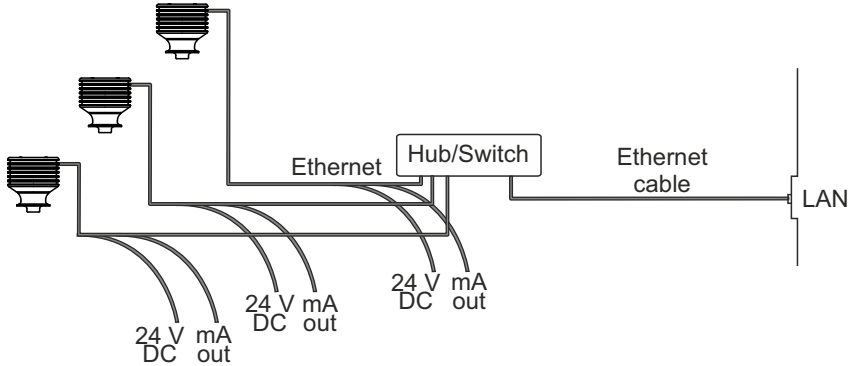

Figure 5 Three refractometers in the same network

It is possible to use a WLAN access point to decrease the number of cables.

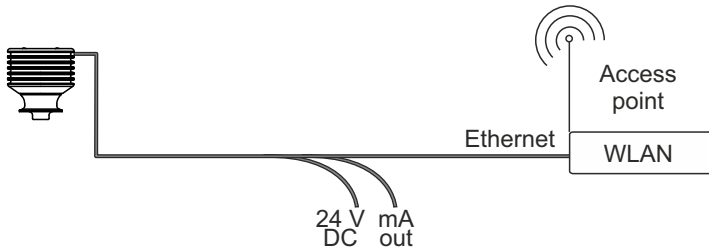

Figure 6 Connecting refractometer(s) via wireless

The maximum distance of a single Ethernet connection is 100 m (including one joint adapter/coupler), but if longer distances are required, a fiber link may be used to extend the range (see the following figure). The range may be up to several kilometers with a suitable fiber connection.

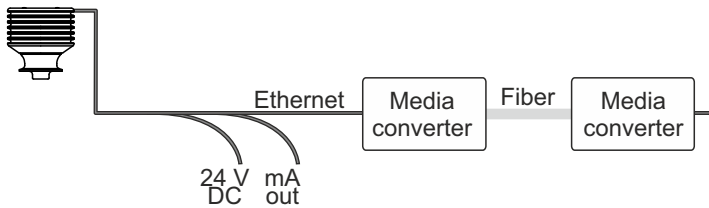

Figure 7 Using fiber link to connect refractometer(s)

3.4.1 IP settings for PR-43

All PR-43 refractometers are shipped with the factory default IP address of 169.254.43.43.

This address belongs to the Zeroconf addresses (as defined in IETF standard RFC 3927) so that it can easily be reached from a stand-alone computer, usually without changing the network settings of the computer. *This address remains in the refractometer even after a different IP address has been set. The refractometer answers in the address that is first called up after startup.*



If there are more than one refractometer in the same network, this address cannot be used. See [Configuring refractometer network \(page 13\)](#).

The IP address of the refractometer can be changed through the refractometer homepage, see [Web interface \(page 16\)](#).

3.4.2 IP settings for stand-alone computer

When a computer with automatic IP settings (DHCP enabled) is turned on in a network with only the refractometer, the computer should automatically obtain an IP address 169.254.x.x. In this case the factory default address of the refractometer can be used for connecting without any further changes in settings. If this does not work, make sure that the WLAN (Wireless network connection) is not active on the computer that is connected to the refractometer. If the WLAN is active, the computer's Ethernet connection may not function as expected. Also, obtaining the 169.254.x.x. address may take up to a minute.

If the connection to the refractometer still cannot be achieved, the computer's IP address can be checked by opening the command window (command prompt) and by typing the command ipconfig at the command prompt (press **ENTER** to give the command), see the figure below (in Mac OS X and Linux the same command is called **ifconfig**). The information given includes the computer's IP address. If the address does not start with 169.254, the IP address of the computer needs to be configured manually to, for example, 169.254.43.44, netmask 255.255.0.0.

For further troubleshooting, see [Troubleshooting connection \(page 14\)](#).



The connection does not work if the computer and the refractometer have exactly the same IP address.

When the network settings of the refractometer and / or computer have been configured according to the instructions above, the next step is to test the connection as instructed in [Testing Ethernet connection \(page 14\)](#).

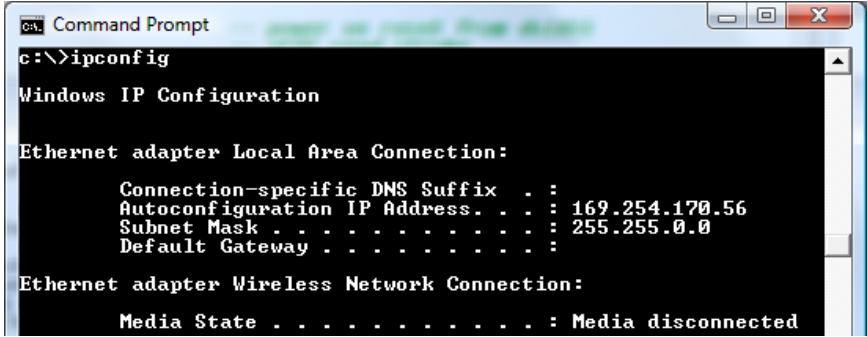

Figure 8 Typical IP configuration for stand-alone laptop connected to refractometer (laptop WLAN turned off)

3.4.3 Configuring refractometer network

If there are is than one refractometer in a network, their IP addresses have to be configured manually as the factory default does not work.

If the refractometer is to be connected to a factory network, consult the network administrator for the correct settings.

If the network is a stand-alone network with only one refractometer and one or more computers with no connection to any other network, then the IP addresses can be chosen rather freely. One possibility is to number the refractometers so that they all have 192.168.43.x addresses so that every computer and refractometer has a different number x between 1 254. The subnet mask (or netmask) is in this case 255.255.255.0.

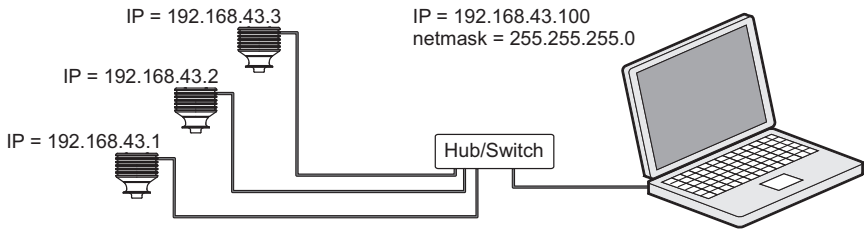

Figure 9 Example PR-43 network



There are no settings for subnet mask, default gateway or name servers in the refractometer, as these settings are not required.

3.4.4 Testing Ethernet connection

When the refractometer is connected to a switch, the corresponding link light illuminates in the switch.

Once the refractometer is powered up, it should be reachable from any correctly configured computer. Typing the IP address of the refractometer to the address bar of a web browser brings up the refractometer homepage, see [Web interface \(page 16\)](#).



The factory-default IP address of the refractometer is 169.254.43.43. This address always responds, see [IP settings for PR-43 \(page 12\)](#).

3.4.5 Troubleshooting connection

If the refractometer cannot be reached through the network, check the following:

1. The refractometer receives power; the Ethernet switch link light is lit.
2. The network settings of the computer are compatible with those of the refractometer, see [IP settings for stand-alone computer \(page 12\)](#).
3. If the refractometer should be at IP address 169.254.43.43, but cannot be reached, check that there is only one refractometer in the same network, as otherwise there is an address conflict.
4. Check that the software firewall of the computer does not block the connections.

A useful test to determine whether the problem is in network settings is to set up a small network. Perform the following steps:

1. Set up a network of only one refractometer and one computer.
2. Check that the computer has suitable network settings and that its WLAN connection is turned off, see [IP settings for stand-alone computer \(page 12\)](#).
3. Use the ping utility of the computer to try and reach the refractometer.

The ping utility is available in Windows systems by using the Command Prompt (usually found in the Accessories; or open Run, type **cmd** in the empty line and press **ENTER** to open Command Prompt). Go to the command interface, type the name of the command and the IP address you want to check and press **ENTER**. If the Ethernet connection is physically working and the address given to ping is correct, the refractometer answers the ping and return any data packets sent to it.

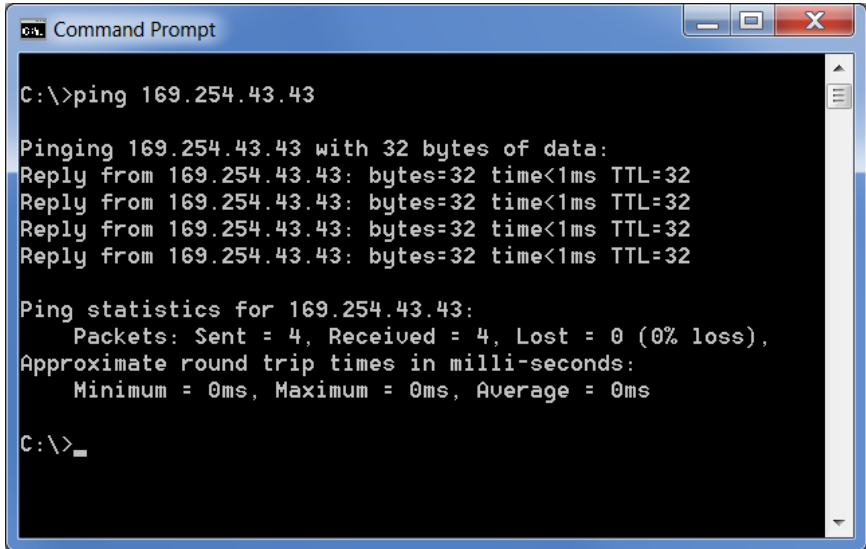
A screenshot of a Windows Command Prompt window. The title bar reads "Command Prompt". The command prompt shows the user entering the command "C:\>ping 169.254.43.43". The output shows four successful replies from 169.254.43.43, each with 32 bytes of data, a time of less than 1ms, and a TTL of 32. Below the replies, the ping statistics are displayed: "Ping statistics for 169.254.43.43: Packets: Sent = 4, Received = 4, Lost = 0 (0% loss), Approximate round trip times in milli-seconds: Minimum = 0ms, Maximum = 0ms, Average = 0ms". The prompt ends with "C:\>_" and a cursor.

```
C:\>ping 169.254.43.43

Pinging 169.254.43.43 with 32 bytes of data:
Reply from 169.254.43.43: bytes=32 time<1ms TTL=32
Reply from 169.254.43.43: bytes=32 time<1ms TTL=32
Reply from 169.254.43.43: bytes=32 time<1ms TTL=32
Reply from 169.254.43.43: bytes=32 time<1ms TTL=32

Ping statistics for 169.254.43.43:
    Packets: Sent = 4, Received = 4, Lost = 0 (0% loss),
    Approximate round trip times in milli-seconds:
        Minimum = 0ms, Maximum = 0ms, Average = 0ms

C:\>_
```

Figure 10 Pinging address 169.254.43.43; ping returned fully and connection OK

4. Web interface

Every PR-43 refractometer has a built-in web server with a homepage. The refractometer homepage allows you to configure, monitor, verify and diagnose the refractometer.

Once a refractometer is connected, the homepage is accessed by simply entering the refractometer's IP address into the address bar of the computer's web browser.

Opening the refractometer homepage:

1. Establish a functioning ethernet connection to the refractometer. For further details, see [Ethernet connection \(page 10\)](#).
2. Open your preferred web browser (for example Mozilla Firefox, Internet Explorer, Safari, Edge or Chrome).
3. The address (URL) to access the refractometer's homepage is the refractometer's IP address, which for a factory default set PR-43 it is 169.254.43.43. Type the IP address in the browser address bar, then "enter", just as you would enter any other web address (for example <http://www.kpatents.com/>)
4. Wait until the homepage is loaded, this may take a few seconds.
The page looks approximately as in [Main page \(page 16\)](#); the exact appearance of the page depends on your browser and screen settings.
5. Using the links in the link bar at the left side of the page you may access more extensive refractometer information.



JavaScript support must be enabled in the browser in order for the web pages to function as intended.

4.1 Main page

Once the refractometer homepage has loaded, it displays all the essential information regarding the refractometer.

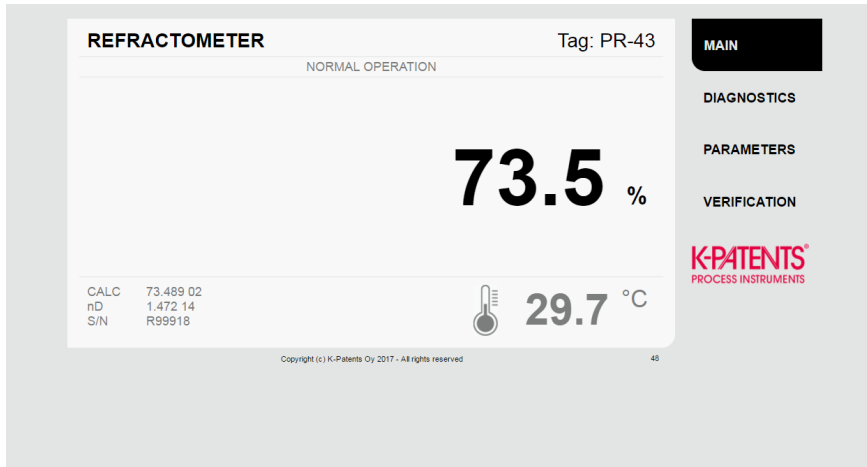

Figure 11 Main page

The main page shows the measurement values, serial number and the tag for the refractometer. The small numeric display in the bottom right of the page indicates the number of measurement cycles (one per second) since the last login to the refractometer.

48

Figure 12 Measurement cycles since last login

4.2 Diagnostics

The **Diagnostics** page displays the diagnostic values produced by the refractometer. In addition to the measurement results, the page shows several intermediate results and other diagnostic values.

The optical images produced by the refractometer can be seen on this page. Both the images and the diagnostic values are live values, updated with an interval of a few seconds.

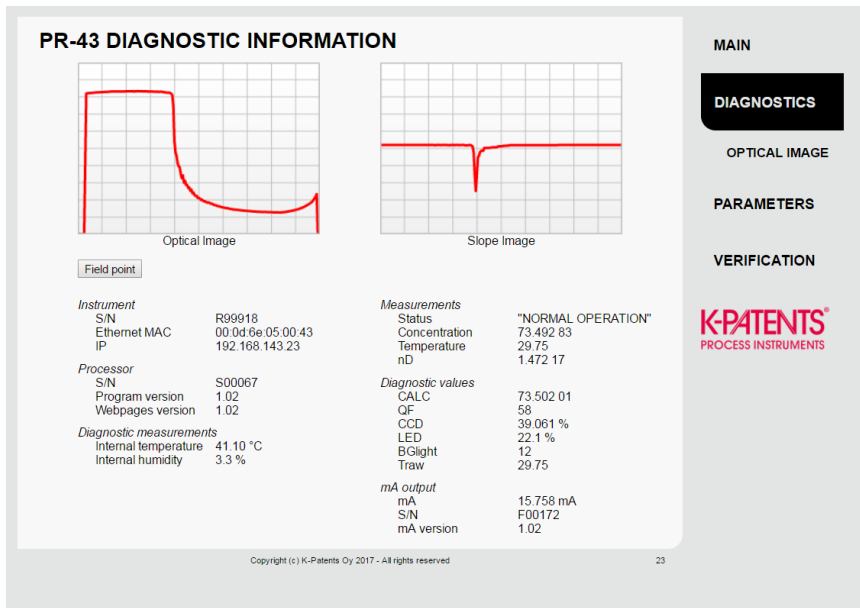

Figure 13 Diagnostics page

4.2.1 Diagnostic values

The diagnostic values provide additional information about the measurement.

- **CALC** is the calculated concentration value without the field calibration adjustment.
- **QF** or **Quality Factor** is a value in the range 0 - 200. The QF value depends on process medium optical properties. A typical good value is 100, but there are process media where 50 is acceptable. The QF value should stay constant during the process. Falling QF value may indicate prism coating.
- **CCD** gives the position of the shadow edge on CCD in %.
- **LED** is a measure of the amount of light from the light source in %. The value should be below 100 %.
- **BGlght** indicates the amount of outside light reaching the CCD. A value above 120 triggers a warning. A value above 240 triggers **OUTSIDE LIGHT ERROR**.
- **Traw** is the uncompensated process temperature.

4.3 Parameters

All the refractometer's functional parameters can be changed using the **Parameters** page. The link to the **Parameters** page is located in the menu displayed on the right-hand side of the computer display.

PR-43 PARAMETERS

Display settings

Concentration unit:

Number of decimals: ▼

Temperature unit: ▼

Tag:

Ethernet settings

IP address:

Communication speed: ▼

Output settings

Damping time: s

Slew rate (output units): /s

Skip count: s

Damping type: ▼

mA output calibration

Min (%):

Max (%):

Default (mA):

Secondary default mode: ▼

Secondary default (mA):

Field calibration

F00: F01: F02:

F10: F11: F12:

F20: F21: F22:

T0:

C0:

Temperature bias:

MAIN

DIAGNOSTICS

PARAMETERS

VERIFICATION



Figure 14 Parameters page

Most parameters are changed by deleting the old parameter and writing a new one in the field. Some, for example the temperature unit, are drop-down lists, click the little triangle on the right to see the list and to change the parameter. When you have changed a parameter, click the **Submit changes** button to apply the changes. The parameter update may take a few seconds to apply.

If you have edited a parameter but not submitted the change yet, you can undo all changes by clicking the **Undo changes** button.



The parameter changes are only saved when you click the **Submit changes** button. If you make parameter changes, but go to the **Diagnostics** page, the parameters are not changed and you'll get the old parameters.

4.3.1 Measuring field samples

The **Diagnostics** page offers a possibility to measure samples for field calibration purposes.

A sample can be measured by clicking the **Field point** button on the page. After clicking the button, the refractometer measures the sample ten times and then shows the average and standard deviation of the measurements. Also the measurement status is shown, and if the status is not **Normal operation**, the point is not accepted.

Several points may be measured, and all the points are shown on the page until the page is reloaded.

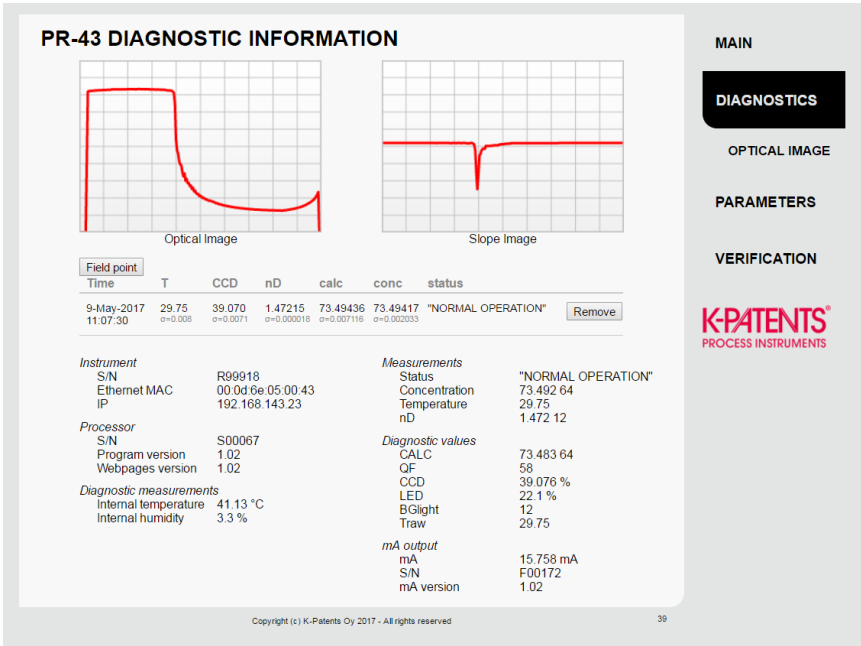

Figure 15 Measuring field samples

4.3.2 Optical image

The raw optical image which contains all optical information can be seen by clicking on the **Optical image** link on the right side of the **Diagnostics** page.

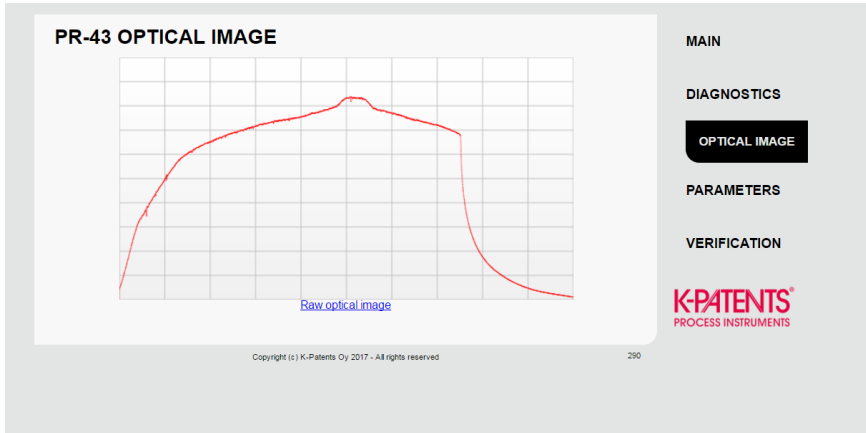

Figure 16 Raw optical image of compact refractometer

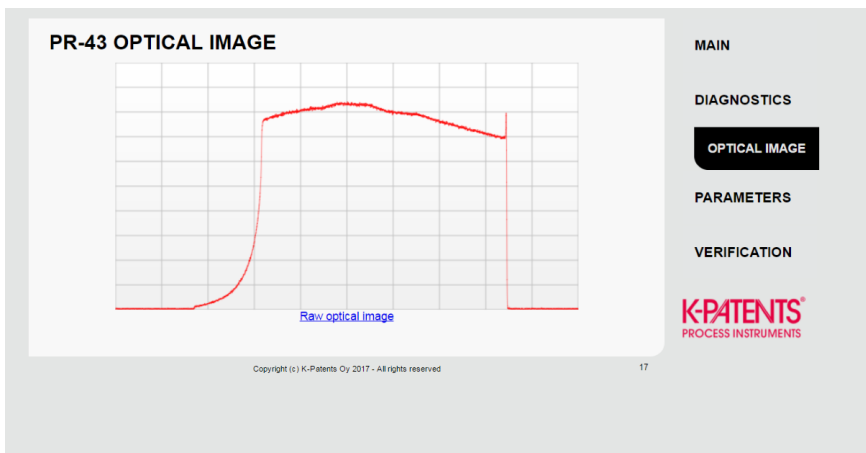

Figure 17 Raw optical image of probe refractometer

4.4 Verification

Refractometer verification can be performed on this page. Follow the instructions on the verification page to perform instrument verification. For more information on the verification procedure, see [Instrument verification \(page 42\)](#).

INSTRUMENT VERIFICATION

The instrument verification can be carried out by using standard refractive index liquids (available from K-Patents). The procedure consists of measuring a number of these liquids one-by-one and verifying the reading of the instrument.

Before starting the verification, please read through the following checklist:

- The verification requires the instrument to be removed from the process and placed onto a table prism pointing up.
- Depending on the instrument model, a sample holder may be needed.
- To carry out an acceptable verification, at least five R.I. standard liquids have to be measured successfully. The verification is valid only within the range of these liquids.
- The instrument must reach a stable temperature before verification. This temperature must be between 20 °C and 30 °C. The nominal temperature for the liquids is 25 °C, but there is an automatic temperature compensation which enables a wider temperature range.

To carry out the verification, do the following for each standard R.I. liquid:

1. Make sure the prism (and sample holder) is clean and dry before placing the liquid on the prism.
2. Keep an eye on the optical image; it will help in determining the sufficient amount of liquid on the prism; if there is too little liquid, the shape of the optical image will change.
3. Once the liquid is on the prism, click the "New verification point" button. A progress indicator will show the progress. Once the point is measured, the measured values are reported.
4. Clean the prism and repeat the procedure for each standard liquid.

You may remove a failed point by clicking the "Remove" button on the line. If you use the same liquid several times, only the newest result will be recorded.

Once you have carried out the measurement for all points, click the "Save verification" button. This will save the verification results into the instrument and show the verification report. The latest verification report can always be seen by clicking the "Verification report" link in the menu.

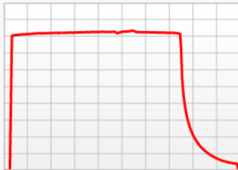

S/N R99918
 NORMAL OPERATION
 nD 1.36116
 T 28.18
 CCD 75.020
 LED 0.3

| STANDARD LIQUID | | MEASUREMENT | | | VERIFICATION RESULT | |
|-----------------|-----|-------------|----|-----|---------------------|--------|
| @ 25°C | @ T | T | nD | CCD | nD error | Status |

Too few points for a valid verification, please add points

[New verification point](#) [Save verification](#)

MAIN

DIAGNOSTICS

PARAMETERS

VERIFICATION

VERIFICATION REPORT

K-PATENTS
 PROCESS INSTRUMENTS

Figure 18 Verification page

5. Startup

5.1 Startup

5.1.1 Initial check

Connect the refractometer, and check that it powers up properly, see [Testing Ethernet connection \(page 14\)](#). Use a web browser to open the refractometer homepage and check that the serial number of the refractometer corresponds to that on the refractometer nameplate.

Check the parameters on the **Parameters** page and adjust them as needed, see [Parameters \(page 18\)](#). Remember to submit changes.

5.1.2 mA check

Measure the mA output. If the refractometer is not in the line (i.e. message is **NO SAMPLE**), mA out sends default mA. The default mA and mA maximum and minimum are set via web browser on the **Parameters** page, see [Parameters \(page 18\)](#).

5.1.3 Calibration check

Wait until normal process conditions occur. The concentration reading is precalibrated at delivery and a copy of the Refractometer calibration certificate is shipped with the refractometer. If the diagnostic message is **Normal operation** but the concentration reading does not agree with the laboratory results, see [Calibrating concentration measurement \(page 29\)](#).

5.2 Viewing refractometer status

The basic information on the measurements is shown on the **Main** page of the refractometer, see [Main page \(page 16\)](#). More information is shown on the **Diagnostics** page, see [Diagnostics \(page 17\)](#).

The measurement result is calculated from the refractive index (n_D) and process temperature (T) values. Both of these values are on the **Main** page.

In addition to these measurements, the refractometer monitors its internal temperature and humidity, which both are available on the **Diagnostics** page. The internal temperature should not be above 55 °C, and the humidity should be below 30 %.

6. Configuration and calibration

The following sections describe how to configure the refractometer and calibrate concentration measurement.

6.1 Configuring refractometer

In PR-43, all parameter changes are made with a web browser through the **Parameters** page, see [Parameters \(page 18\)](#).

6.1.1 Signal damping

The system provides the possibility to enter signal damping to diminish the influence of process noise. The damping is applied to the CONC value (and thus the output signal).

The PR-43 offers the following types of signal damping:

- **Exponential (standard) damping** works for most processes and is the standard choice for slow and continuous processes.
- If the process has fast step changes, **linear (fast) damping** gives shorter settling time.
- **Slew rate** damping limits the maximum change for the output signal in one second.

The damping time is set separately. What the damping time means in practice, depends on the damping type:

In *exponential damping*, the damping time is the time it takes for the concentration measurement to reach half of its final value at a step change. For example, if the concentration changes from 50 % to 60 % and damping time is 10 s, it takes 10 seconds for the refractometer to display concentration 55 %. A damping time of 5 - 15 seconds seems to work best in most cases.

In *linear damping* (fast damping), the output is the average of the signal during damping time. After a step change the signal rises linearly and reaches the final value after the damping time. The figures below show how the damping time affects the measurement.

The *slew rate* parameter is presented in output units. For example when the concentration is measured in percentages, typical slew rate value is 0.05 % to 1 %. It should be noted that the slew rate limit damping is recommended for random noise suppression as it is non-linear.



The factory setting for damping in PR-43 is **5 s linear**. Avoid overdamping, the signal should not be made insensitive.

The following figures show the effect of damping time on measurement.

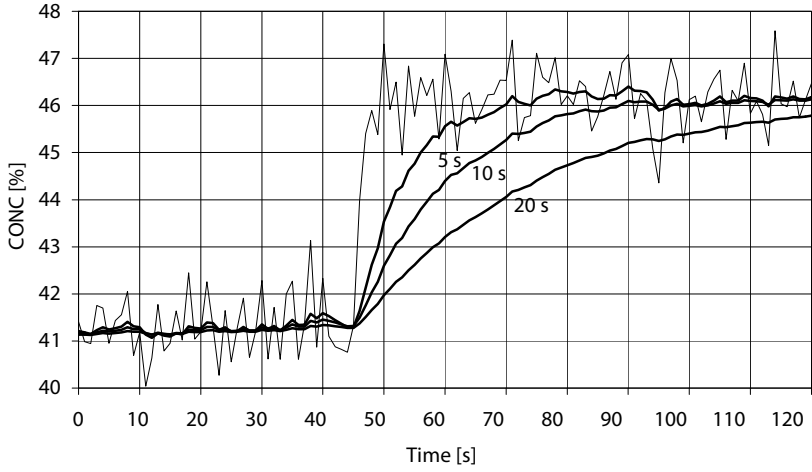

Figure 19 Exponential damping

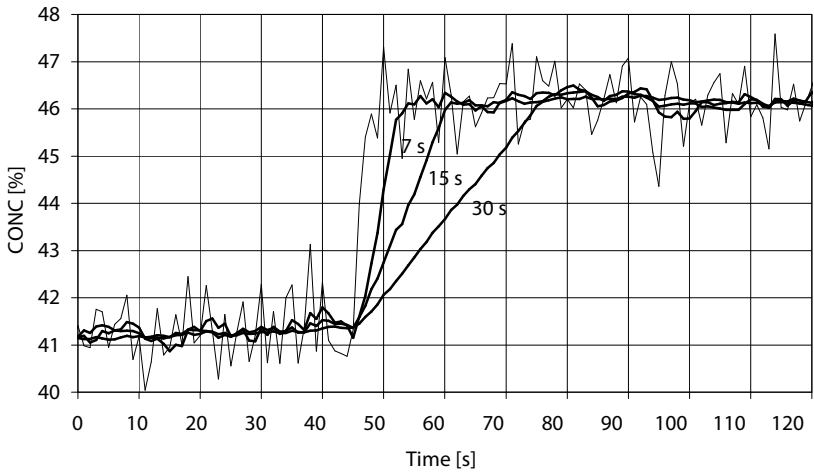

Figure 20 Linear damping

The following figure shows the effect of slew rate on measurement.

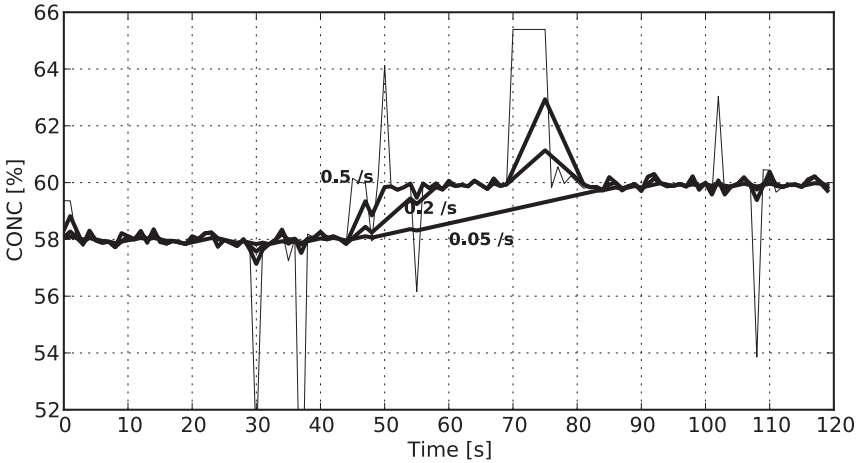

Figure 21 Slew rate damping

6.1.2 Configuring mA output

The mA output values are set on the Parameters page (see section 3.3). Minimum and maximum values set the measurement range. If your measurement unit is CONC% and you want to measure the range 15–25 CONC%, the output signal for minimum 15 will be 4 mA and for maximum 25 it'll be 20 mA. Default mA sets an mA default output value that the refractometer returns to in certain situations. The value can be set to a low or high mA value, e.g. 3.0 mA or 22 mA.



NAMUR is an international association of users of automation in process industries. The association recommendation NE 43 promotes a standardization of the signal level for failure information. The goal of NE 43 is to set a basis for proactively using transmitter failure signals in process control strategies. Using these failure signals, instrument faults are separated from process measurements.

NAMUR NE 43 uses the 3.8 to 20.5 mA signal range for measurement information, with ≥ 21 mA or ≤ 3.6 mA to indicate diagnostic failures, as shown in the figure below. With that information, it is easier to detect a failure condition on a refractometer, for example, it clearly tells you whether you have an empty pipe or a failed instrument.

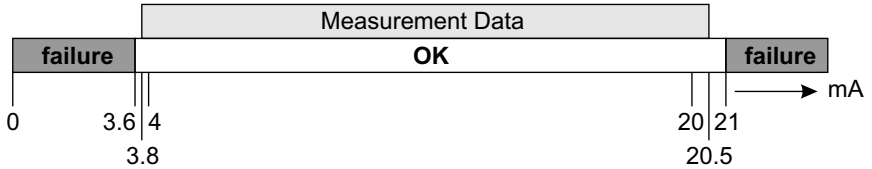

Figure 22 Default mA output values

The refractometer sends default mA if the message is **NO OPTICAL IMAGE, TEMP MEASUREMENT FAULT, OUTSIDE LIGHT ERROR, NO SAMPLE** or **PRISM COATED**.

An optional **secondary mA output default** can be set for **NO SAMPLE** state to differentiate it from the other messages that cause the measurement to revert to default mA.

The factory setting for secondary mA default is factory set at *Disable*. To implement secondary mA default, go to the mA output calibration section on the parameter page and set secondary default mode to **NO SAMPLE** and then set the mA output value desired.

mA output calibration

| | |
|-------------------------|---------------------------------------------------------------|
| Min (%): | <input style="width: 100%;" type="text" value="0.0"/> |
| Max (%): | <input style="width: 100%;" type="text" value="100.0"/> |
| Default (mA): | <input style="width: 100%;" type="text" value="3.4"/> |
| Secondary default mode: | <input style="width: 100%;" type="text" value="No sample ▼"/> |
| Secondary default (mA): | <input style="width: 100%;" type="text" value="3.2"/> |

Submit changes
Undo changes

Figure 23 Setting secondary mA default

6.1.3 Ethernet speed setting

For long Ethernet cabling it is recommended to use 10 Mb/s ethernet speed. This can be selected from the **Ethernet settings - Communication speed** section on the **Parameters** page. The default setting is *auto-negotiation*.

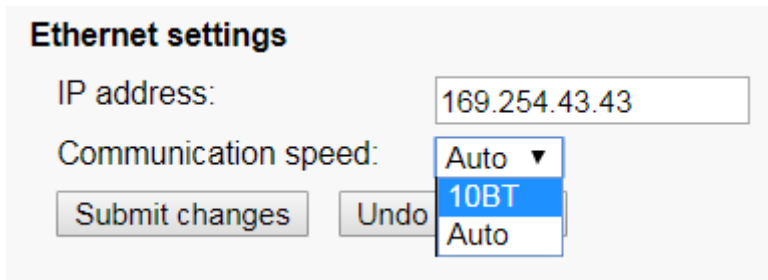

Ethernet settings

IP address:

Communication speed: ▾

- 10BT
- Auto

Figure 24 Choosing ethernet speed

6.1.4 Skip count

When the sample is removed, the refractometer goes to **NO SAMPLE** state. However, if *skip count* is greater than 0, the CONC is frozen to its last value for the number of measurement cycles (one per second) indicated by skip count.

Skip count is set in **Output settings** section of the **Parameters** page.

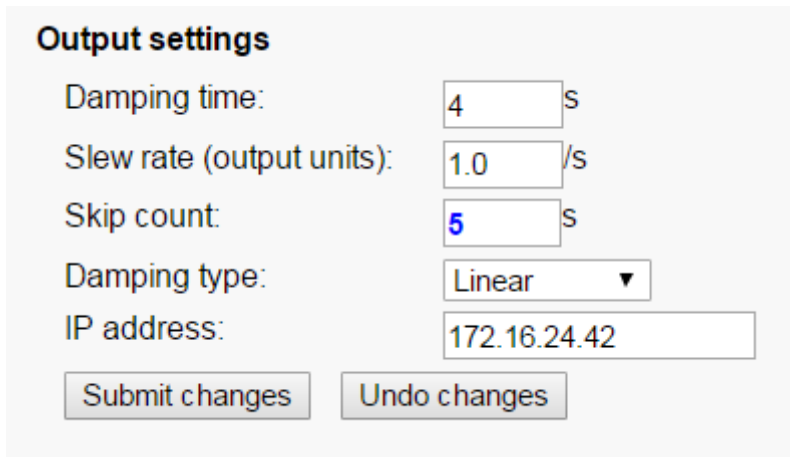

Output settings

Damping time: S

Slew rate (output units): /s

Skip count: S

Damping type: ▾

IP address:

Figure 25 Setting skip count value

6.2 Calibrating concentration measurement

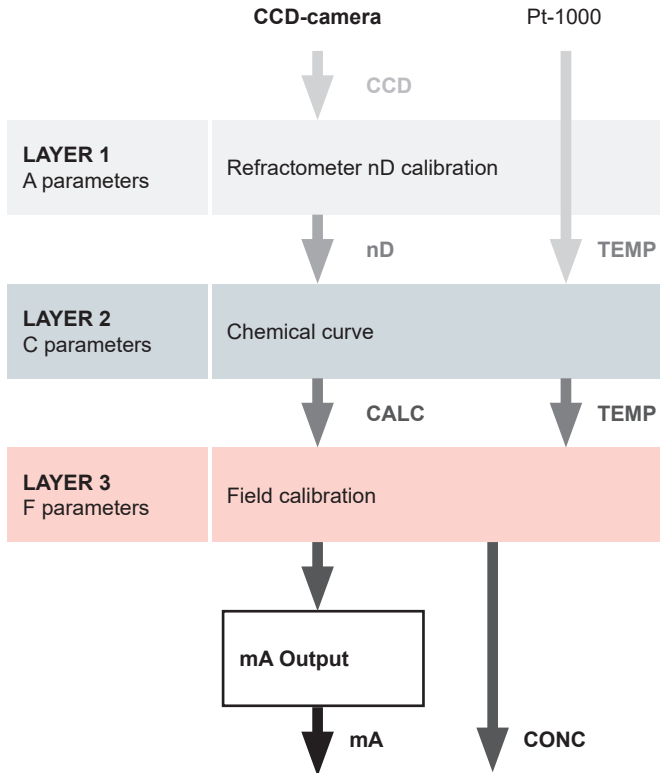

Figure 26 Concentration calibration layers

The concentration calibration is organized in 3 layers:

- Refractometer n_D calibration
- Chemical curve
- Field calibration

The advantages of the layer feature are free interchangeability of refractometers, applications and recipes without any need for mechanical calibration adjustment in the field.

The optical image information is detected by the CCD-element and transformed into a number (CCD). The process temperature is measured by a Pt-1000 resistance.

Layer 1: The refractometer calibration: The actual refractive index n_D is calculated from the CCD.

Layer 2: The chemical curve: The refractometer calculates the Brix or concentration value based on n_D and TEMP. The result is a temperature compensated calculated concentration value CALC.

Layer 3: Field calibration: Adjustment of the calculated concentration value CALC may be required in order to compensate for some process conditions or to fit the measurement to the laboratory results. The field calibration procedure determines the appropriate adjustment to CALC. The adjusted concentration is called CONC.

Output signal: The output signal is transmitted over the 4–20 mA current output or through the Ethernet connection.

6.2.1 Chemical curve

The chemical curve is the theoretical concentration curve based on n_D and TEMP. It is defined by a set of 16 parameters.

A chemical curve is specific to the given process medium, for example sucrose or sodium hydroxide. The set of parameters is given by Vaisala and should not be altered, except in case of changing to another process medium.

6.2.2 Field calibration

Vaisala provides a *field calibration service* that adapts the calibration to the factory laboratory determinations based on the data supplied. The field calibration procedure should be made under normal process conditions using standard laboratory determinations of sample concentration.

Record the calibrating data on the [PR-43 refractometer field calibration form \(page 46\)](#), also available by emailing a request to helpdesk@vaisala.com. Email the completed field calibration form to either helpdesk@vaisala.com or your local Vaisala K-PATENTS® representative. A computer analysis of the data is made at Vaisala and optimal calibration parameters are sent to you to be entered in the system.

For a complete report, 10 - 15 valid data points (see below) are needed. **A data point is of use for calibration only when the diagnostic message is Normal operation.**

- LAB%: Sample concentration determined by the user
- CALC: Calculated concentration value
- T: Process temperature measurement in Centigrade
- nD: Actual refractive index n_D
- CONC: Measurement in concentration units, the large size number

In addition to the calibration data, write down the refractometer serial number.

Accurate calibration is only achieved if the sample is taken correctly. Pay special attention to following details:

- The sampling valve and the refractometer should be installed close to each other in the process



WARNING! Wear protective clothing appropriate to your process when operating the sampling valve and handling the sample.

- Run the sample before starting to collect data points to avoid sampling old process liquid that has remained in the sampling valve
- Read the values CALC, T(emp), nD and CONC at exactly the same time with sampling
- Use a tight container for the sample to avoid evaporation



CAUTION! Offline calibration using process liquid very seldom gives reliable results, as problems are caused by:

- Low flow which makes sample to form an unrepresentative film on the prism
- Sample evaporation at high temperature or undissolved solids at low temperature giving deviations from laboratory determinations
- An ageing sample which is not representative
- Outside light reaching the prism

Calibration using the process liquid must always be made inline.

The concentration measurement value can also be directly adjusted by changing the field adjustment parameter f00.

The value of the bias parameter f00 will be added to the concentration value:

$NEW\ CONC = OLD\ CONC + f00.$

7. Troubleshooting

The following chapter discusses refractometer error messages and other error conditions. To view the error messages you need Web user interface WI, Compact user interface CI, or Multichannel user interface MI. The error messages are visible on the main page/display on the user interface.



A status message is always shown. However, message **Normal operation** means that there are no errors.

7.1 Diagnostic message priorities



The messages are listed in descending order of priority. For example, if both **NO OPTICAL IMAGE** and **TEMP MEASUREMENT FAULT** are activated, only **NO OPTICAL IMAGE** displays.

- **OUTSIDE LIGHT ERROR**
- **NO OPTICAL IMAGE**
- **TEMP MEASUREMENT FAULT**
- **HIGH SENSOR HUMIDITY**
- **HIGH SENSOR TEMP**
- **NO SAMPLE**
- **PRISM COATED**
- **OUTSIDE LIGHT TO PRISM**
- **LOW IMAGE QUALITY**
- **Normal operation**

The following sections list the diagnostic messages, their causes and corrective actions.

7.2 Hardware

The following table describes the hardware messages and their related actions.

Table 3 Hardware messages

| Message | Description | Corrective action |
|-------------------------------|-------------------------------------------------------------------------------------------------------------------------------------------------------------------------|-------------------|
| HIGH INTERNAL HUMIDITY | Tells that humidity measured inside the refractometer exceeds 60 % relative humidity. The reason may be moisture leaking in through prism seal or the cover being open. | Contact Vaisala. |

| Message | Description | Corrective action |
|---------------------------|------------------------------------------------------------------------------------------------------------------------------------------------------------------------------------------|-----------------------------------------------------------------------------------------------------------------------------------------------------------------------------------------------------------|
| HIGH INTERNAL TEMP | The temperature inside the refractometer exceeds 65 °C (150 °F). To read this temperature, go to the diagnostics page. For more information, see Diagnostics (page 17) . | See the refractometer specific manual about choosing mounting location and cooling the refractometer head. It is also possible to cool the refractometer head with a water cooled cooling cover PR-14038. |

7.3 Measurement

The following table describes the measurement messages and their related actions.

Table 4 Measurement messages

| Message | Description | Corrective action |
|-------------------------------------------------------------|------------------------------------------------------------------------------------------------------------------------------------------|--------------------------------------------------------------------------------------------------------------------------------------------------------------------------------------|
| OUTSIDE LIGHT ERROR or OUTSIDE LIGHT TO PRISM | The measurement is not possible or is disturbed because outside light reaches the camera. | Identify the light source and block the light from getting to the prism at the sensor tip. The amount of outside light can be seen at BGlight on the Diagnostics page. |
| NO OPTICAL IMAGE | The prism is heavily coated. | Remove sensor from line and clean prism manually. |
| | There is moisture condensation in the refractometer. | See Hardware (page 32) . |
| | The refractometer temperature is too high. | |
| | The light source is faulty. When the refractometer is removed from the process, the yellow flashing light can be seen through the prism. | Check the LED value on the Diagnostics page. For more information, see Diagnostics (page 17) . |
| |  The light is only visible at an oblique angle. | If the value is clearly below 100, LED fault is not likely. If the value is above 100, contact Vaisala. |
| | There are negative spikes in the optical image. The probable cause is contamination on the optical path. | Contact Vaisala. |
| | The CCD card in the refractometer is faulty. | |

| Message | Description | Corrective action |
|----------------------------------------------------|------------------------------------------------------------------------------------------------------------------------------------------------------------|----------------------------------------------------------------------------------------------------------------------------------------------------------------------------------------------------------------------------------------------------------------------------------------------------------------------------------------------------------------|
| PRISM COATED | The optical surface of the prism is coated by the process medium or impurities in the process medium. | Remove refractometer from line and clean prism manually. |
| LOW IMAGE QUALITY | The most likely cause for this message is coating on the prism. There still is an optical image available, but the measurement quality may not be optimal. | If the problem is recurrent, consider improving the flow conditions (see refractometer specific manual for choosing mounting location). Automatic prism wash may also be a solution. |
| NO SAMPLE | The operation of the equipment is OK but there is no process liquid on the prism. In some cases this message may also be caused by coating on the prism. | |
| TEMP MEASUREMENT FAULT | Indicates faulty temperature element. | Contact Vaisala. <div style="background-color: #e0e0e0; padding: 10px; border: 1px solid #ccc;">  A difference to some other process temperature measurement is not a fault. The refractometer shows the true temperature of the prism surface. </div> |
| Concentration drift during Normal operation | For drift upward or downwards to zero, cause is likely the prism coating. | Remove sensor from line and clean prism manually. If the problem is recurrent, consider improving the flow conditions (see refractometer specific manual for choosing mounting location). |

8. Principle of measurement

The Vaisala K-PATENTS® inline refractometer determines the refractive index n_D of the process solution. It measures the critical angle of refraction using a yellow LED light source with the same wavelength (589 nm) as the sodium D line (hence n_D). Light from the light source (L) in the figure below is directed to the interface between the prism (P) and the process medium (S). Two of the prism surfaces (M) act as mirrors bending the light rays so that they meet the interface at different angles.

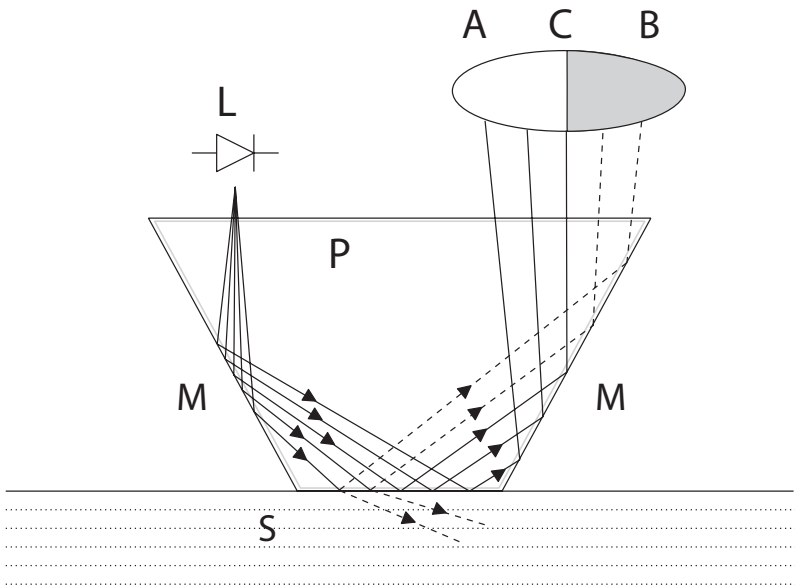

Figure 27 Refractometer principle

The reflected rays of light form an image (ACB), where (C) is the position of the critical angle ray. The rays at (A) are totally internally reflected at the process interface, the rays at (B) are partially reflected and partially refracted into the process solution. In this way the optical image is divided into a light area (A) and a dark area (B). The position of the shadow edge (C) indicates the value of the critical angle. The refractive index n_D can then be determined from this position.

The refractive index n_D changes with the process solution concentration and temperature. For most solutions the refractive index increases when the concentration increases. At higher temperatures the refractive index is smaller than at lower temperatures. From this follows that the optical image changes with the process solution concentration as shown in the figure below. The color of the solution, gas bubbles or undissolved particles do not affect the position of the shadow edge (C).

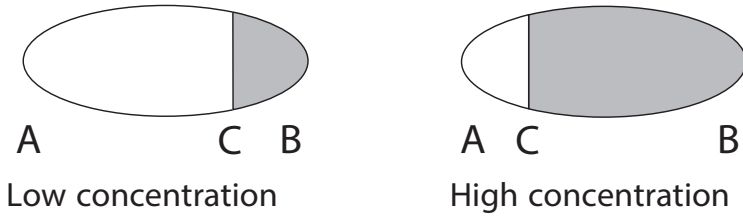

Figure 28 Optical images

The position of the shadow edge is measured digitally using a CCD element and is converted to a refractive index value n_D by a processor inside the instrument. This value is used together with the measured process temperature to calculate the concentration.

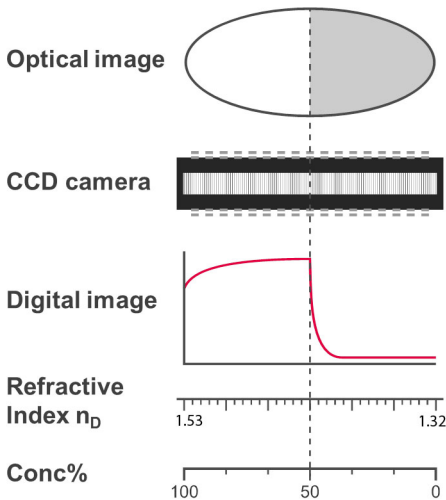

Figure 29 From image detection to concentration

9. Ethernet protocol specification

The main purpose of the Ethernet connection is to collect measurement data from the refractometer. For this data acquisition, you'll need to have suitable software on your computer. You can program a data acquisition program yourself following the specifications below.

For examples and ready-made applications, contact Vaisala.

9.1 Communication protocol

The communications protocol is based on **UDP/IP to port 50023**. It is a client/server protocol, where the refractometer is the server and thus only sends information when the client (your computer) requests it. The server should answer to all requests within 100 ms.

9.1.1 Request format

The client to server communication, i.e. the requests sent from your computer to the refractometer, is in binary format. The request packets contain the following binary data (all integers are in the network order, MSB first):

- 32-bit integer: packet number
- 32-bit integer: request ID
- (any): request data (depends on the request)
- (any): fill-indata



The maximum size of the message is 1472 octets(bytes).

The **packet number** is echoed back by the refractometer, but not processed in any way.

The packet numbers do not have to be sequential, any 32-bit value is valid.

The **request ID** is a 32-bit value that identifies the requested function, for example refractometer information. See [Request-response pair specification \(page 38\)](#) for request IDs.

The **request data** consists of 0 to 1464 octets of additional data associated with the request.

The **fill-indata** can be used to increase the number of octets in a message. Any number of NULL characters (0x00) may be added to the end of the request as long as the total size of the message does not exceed the maximum of 1472 octets. This may be useful, for example, if the client implementation uses fixed-length packets.

9.1.2 Response format

The response data sent by the refractometer is in ASCII format. With the exception of the packet number, the data is human-readable. The data structure is very simple:

- Packet number (32-bit integer)
- Zero or more lines of ASCII (text) keys and values associated with these keys (for example temperature key and process temperature in Celsius)

The **packet number** is echoed back without change. The client (software on computer) can use the packet number to check the response against the packet number of the request.

The **message text** consists of lines of text, each line a single key (of one word) and its value or values. The values are separated from the key by an equal sign (=) and multiple values are separated by a comma. White space (space or tabulator) is allowed anywhere except within a single value or key name.

If the response consists of a character string, it is enclosed in double quotes ("). For example, all these are valid message text lines:

```
ok
```

```
temp = 23.45
```

```
StatusMessage = "Normal Operation"
```



All the key identifiers, see [Request-response pair specification \(page 38\)](#), are case-insensitive. However, it is recommended that they are written as in this specification.

The server (refractometer) may send the response keys in any order. The server sends the mandatory keys of the specific request, marked with an asterisk in [Request-response pair specification \(page 38\)](#), but it may omit any other keys. The server may also send keys that are not specified in this document, but the client (computer) may ignore them.

9.1.3 Request and response errors

When the server (refractometer) detects an error, it responds with an error message. For more information, see [Error message specification \(page 40\)](#). An error message can be caused, for example, by an unknown request or inability to collect data for the mandatory keys of a response.

9.2 Request-response pair specification

The following table describes the query messages, i.e. request-response pairs, used for data collection using the Ethernet connection.



Those response keys that are always sent are preceded by an asterisk (*).

Table 5 Request-response pair specification

| Specification | Description | Request ID | Request data | Response key |
|---------------------------|--------------------------------------------------------------------------------------------------------------------------------------------------------------------|------------|-------------------------|--------------------------------------------------------------------------------------------------------------------------------------------------------------------------------------------------------------------------------------------------------------------------------------------------------------------------------------------------------------------------------------|
| NULL message | Included in query messages for debugging purposes as it can be used to check whether the server is listening. The message gives a high-level 'ping' functionality. | 0x00000000 | (none) | <ul style="list-style-type: none"> • IP: IP address • MAC: Ethernet MACaddress |
| Protocol version | Responded to with a value representing the server (refractometer) protocol version. | 0x00000001 | (none) | *Version: integer, the server protocol version (currently 3) |
| Refractometer information | Gives the basic information of the refractometer. | 0x00000003 | 0x00000000: always zero | <ul style="list-style-type: none"> • *SensorSerial: string, refractometer serial number • *SProcSerial: string, processor card serial number • *SensorVersion: string, version number of the refractometer software • mASerial : string, mA interface card serial number • mAVersion : string, mA interface card software version |

| Specification | Description | Request ID | Request data | Response key |
|---------------------|------------------------------------------------------------------------------|------------|------------------------------|------------------------------------------------------------------------------------------------------------------------------------------------------------------------------------------------------------------------------------------------------------------------------------------------------------------------------------------------------------------------------------------------------------------------------------------------------------------------------------------------------------------------------------------------------------------------------------------------------------------------------------------------------------------------------------------------------------------------------------------------------------------------------------------------------------------------------------------------------------------------------|
| Measurement results | Gives the measured and calculated measurement values from the refractometer. | 0x00000004 | 0x00000000 0: always zero | <ul style="list-style-type: none"> • Status : string, refractometer status message • LED : float, LED value • CCD : float, image shadow edge position • nD : float, calculated n_D value • T : float, process temperature • Tsens : float, refractometer internal temperature • Traw : float, process temperature (without bias) • RHsens : float, internal humidity • CALC : float, calculated concentration value • CONC : float, final concentration value • PTraw : integer, PT1000 value • QF : float, image quality factor • mA : float, mA output value • BGLight : integer, background light level • Seq : integer, sequence number of measurement • Timestamp : integer, time since device start-up |

9.3 Error message specification

If the server (refractometer) does not recognize the request or cannot fulfill it, it responds with an error message. The error message has the following keys:

- *Error : integer, error code 0x00000000 : Unknown request
- *Error : integer, error code 0x00000001 : Invalid request (request recognized, invalid request data)
- *Error : integer, error code 0x00000002 : Invalid refractometer number
- ErrorMessage : string, error details

There may also be error-dependent extra keys. Other error codes may be returned. 0x00000003 is to be handled as unknown request. Codes with higher numbers refer to internal errors; contact Vaisala for more information on these.

10. Instrument verification

The following sections describe the process and steps for refractometer verification, and the corrective actions necessary.

10.1 Refractometer verification

The verification of the PR-43 calibration is made using a set of standard refractive index liquids. In order to perform a valid verification, at least three liquids need to be used. The verification is valid only within the refractive index range defined by these three liquids.

The instrument recognizes automatically the following refractive index standard liquids (the values are stated at +25 °C):

- 1.3200
- 1.3300
- 1.3400
- 1.3500
- 1.3600
- 1.3700
- 1.3800
- 1.3900
- 1.4000
- 1.4100
- 1.4200
- 1.4300
- 1.4400
- 1.4500
- 1.4600
- 1.4700
- 1.4800
- 1.4900
- 1.5000
- 1.5100
- 1.5200

The accuracy of the certified standard refractive index liquids is ± 0.0002 and they can be traced back to NIST standards # 1823 and # 1823 II. As the specified accuracy of the PR-43 is ± 0.0002 , then the representative level is the sum of the two accuracy specifications, that is ± 0.0004 .

Vaisala provides a set of standard R.I. liquids, PR-2300, containing five selected liquids (1.3300, 1.3700, 1.4200, 1.4700, 1.5200). The set can be ordered from Vaisala. Other liquids are available on request.

10.1.1 Handling R.I. liquids

Use gloves and safety glasses or goggles. Make sure the ventilation is good, local ventilation is preferable. Please review the safety instructions and the MSDS shipped with the liquids (valid inside R.I. range 1.30-1.57, safety markings valid in EU/EEA areas). Do not put tissues or liquid bottles in household waste, dispose of waste according to local regulations for chemical waste.

10.2 Verification procedure

The instrument verification can be performed by using the web interface on the instrument verification page, see [Verification \(page 21\)](#). The standard liquids are placed on the prism as instructed by the instructions on the screen. Once the liquid has settled, sample is measured by clicking the **New verification point** button.

The liquids are automatically detected, and the quality of the measurement is constantly monitored throughout the process. If the same liquid is measured several times, new result will replace the older one. A single measurement point can be removed by clicking the **Remove** button.

The verification result is shown on the page. Please note that reloading the page removes all points. After measuring a sufficient number of points the verification may be saved by clicking the **Save verification** button.

In order to avoid verification errors, please make sure:

- The temperature has settled, i.e., the refractometer is in the ambient temperature
- The temperature of the refractometer is between 20 °C and 30 °C
- The prism is cleaned properly before placing the sample
- The test liquid wets the prism properly

The temperature of the refractometer can be checked by following the temperature measurement on the **Verification** page. The temperature should be constant.

The sample holder keeps the sample on the prism surface and also blocks the ambient light from reaching the prism. The universal sample holder PR-1012 can be used with any Vaisala K-PATENTS refractometer.



Figure 30 Universal sample holder PR-1012

The optical image displayed on the page helps determining whether the prism is wetted completely. The image should have a sharp corner as in [Figure 18 \(page 22\)](#).



The position of the corner depends on the refractive index

A soft image may indicate improper cleaning of the prism. Also, if there is not enough liquid on the prism, the image tends to flatten. If the image changes its shape during the measurement of a single liquid, please redo the measurement. The most likely reason is that the liquid leaks from the sample holder.

After a sample has been measured, remove the sample and clean the prism and the sample holder. The prism can be cleaned by soft tissue and ethanol or other suitable solvent. Repeat the procedure (cleaning, replacing the sample, measuring) for each nD liquid. In case you perform the procedure more than once for a single sample, the latest measurement will replace earlier measurements.

The table on the verification page keeps a real time record of the points measured and the status (pass/fail) of the verification. If you have a failed point, you may either remove it or remeasure it.

Once all liquids have been measured, the verification can be saved by clicking the **Save verification** button. Please note that the button is only available after a sufficient number of points has been measured.

The limit for acceptance is that all measurements must be within ± 0.0004 of the nominal values.



The refractometer verification concerns only the refractive index n_D measurement. The calculation of concentration from n_D and process temperature TEMP is not included, see [Configuration and calibration \(page 24\)](#).

10.3 Corrective action

If the verification is not passed, first check that the prism and the sample holder are absolutely clean and the sample holder sits tightly on the refractometer tip before a standard liquid is applied. Make sure the standard liquids are in good condition and not past their expiration date. Also, inspect the prism surface, checking that it is flat and shiny without any scratches, digs or deposition on it.

Repeat the verification procedure. If the verification still fails, print out (or photograph) the verification report. Send the data to helpdesk@vaisala.com or your nearest Vaisala K-PATENTS representative and wait for further instructions.

Appendix A. PR-43 refractometer field calibration form

Fill in this form and email it to helpdesk@vaisala.com or to your local service representative.

Refractometer serial no:

Refractometer model:

Customer:

Address:

Email:

Sample description:

Solvent (water/other):

Laboratory method:

Date:

Data collected by:

| Sample no. | LAB% | CALC | T | n_D | CONC |
|------------|------|------|---|-------|------|
| | | | | | |
| | | | | | |
| | | | | | |
| | | | | | |
| | | | | | |
| | | | | | |
| | | | | | |
| | | | | | |
| | | | | | |
| | | | | | |
| | | | | | |
| | | | | | |
| | | | | | |
| | | | | | |
| | | | | | |
| | | | | | |

For more information, see [Field calibration \(page 30\)](#).

Appendix B. EU declaration of conformity

VAISALA

2019-09-01/JAMO

1 (1)

EU DECLARATION OF CONFORMITY

Manufacturer: Vaisala Oyj
Mail address: P.O. Box 26, FI-00421 Helsinki, Finland
Street Address: Vanha Nurmijärventie 21, Vantaa, Finland

This declaration of conformity is issued under the sole responsibility of the manufacturer.

Object of the declaration:

K-Patents Process Refractometer PR-43 series

The object of the declaration described above is in conformity with Directives:

RoHS Directive (2011/65/EU)
EMC Directive (2014/30/EU)

The conformity is declared using the following standards:

EN 50581:2012 Technical documentation for the assessment of electrical and electronic products with respect to the restriction of hazardous substances

EN 61010-1:2010 Safety requirements for electrical equipment for measurement, control and laboratory use – Part 1: General requirements

EN 61326-1:2013 Electrical equipment for measurement, control and laboratory use – EMC requirements – intended for use in industrial locations

Signed for and on behalf of Vaisala Oyj, in Vantaa, on 1st September 2019



Jukka Lyömiö
Standards and Approvals Manager

Warranty

For standard warranty terms and conditions, see www.vaisala.com/warranty.

Please observe that any such warranty may not be valid in case of damage due to normal wear and tear, exceptional operating conditions, negligent handling or installation, or unauthorized modifications. Please see the applicable supply contract or Conditions of Sale for details of the warranty for each product.

Technical support



Contact Vaisala technical support at helpdesk@vaisala.com. Provide at least the following supporting information as applicable:

- Product name, model, and serial number
- Software/Firmware version
- Name and location of the installation site
- Name and contact information of a technical person who can provide further information on the problem

For more information, see www.vaisala.com/support.

Recycling



Recycle all applicable material.



Follow the statutory regulations for disposing of the product and packaging.

VAISALA

www.vaisala.com

