

EasyCut Li-18/23 R
Art. 9823

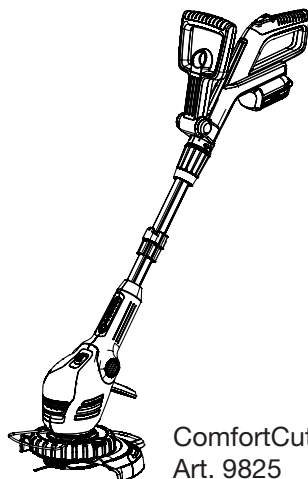

ComfortCut Li-18/23 R
Art. 9825

- D Betriebsanleitung**
Accu-Turbotrimmer
-
- GB Operating Instructions**
Accu Turbotrimmer
-
- F Mode d'emploi**
Coupe-bordures à batterie
-
- NL Gebruiksaanwijzing**
Accu-Turbotrimmer
-
- S Bruksanvisning**
Accu-Turbotrimmer
-
- DK Brugsanvisning**
Accu-turbotrimmer
-
- FI Käyttöohje**
Accu-turbotrimmeri
-
- N Bruksanvisning**
Batteri-turbotrimmer
-
- I Istruzioni per l'uso**
Turbotrimmer a batteria
-
- E Instrucciones de empleo**
Recortabordes con accu
-
- P Manual de instruções**
Aparador de relva Accu-Turbotrimmer
-
- PL Instrukcja obsługi**
Podkaszarka akumulatorowa
-
- H Használati utasítás**
Akkumulátoros damilos fűszegélynyíró
-
- CZ Návod k obsluze**
Akumulátorový turbotrimmer

- SK Návod na obsluhu**
Akumulátorový turbotrimmer
-
- GR Οδηγίες χρήσης**
Επαναφορτιζόμενο κορευτικό πετόνιας
-
- RUS Инструкция по эксплуатации**
Аккумуляторный турботриммер
-
- SLO Navodilo za uporabo**
Akumulatorski turbo trimmer obrezovalnik
-
- HR Upute za uporabu**
Baterijski turbo trimmer za travu
-
- SRB Uputstvo za rad**
BIH Baterijska turbo trimmer-kosilica
-
- UA Інструкція з експлуатації**
Акумуляторний турботриммер
-
- RO Instrucțiuni de utilizare**
Turbotrimmer cu baterie
-
- TR Kullanma Kılavuzu**
Akülü Turbo Tirpan
-
- BG Инструкция за експлоатация**
Акумулаторен Турботриммер
-
- AL Manual përdorimi**
Kositëse bari turbo me bateri
-
- EST Kasutusjuhend**
Akuga turbotrimmer
-
- LT Eksploatavimo instrukcija**
Akumuliatorinė turbo žoliapjovė
-
- LV Lietošanas instrukcija**
Turbotrimmeris ar akumulatoru

GARDENA EasyCut Li-18/23 R, ComfortCut Li-18/23 R



Translation of the original German operating instructions.

Please read the operating instructions carefully and observe the notes given. Use these operating instructions to familiarise yourself with the product, the proper use and the safety instructions.



For safety reasons, children and young people under the age of 16, as well as people not familiar with these operating instructions, may not use this product. Persons with reduced physical or mental abilities may use the product only if they are supervised or instructed by a responsible person. Children must be supervised to ensure that they do not play with the product. Never operate the product when you are tired, ill or under the influence of alcohol, drugs or medicine.

→ Keep these operating instructions in a safe place.

Contents:

1. Area of application of your GARDENA Turbotrimmer.	12
2. Safety Instructions	12
3. Assembly.	14
4. Initial Operation.	15
5. Operation	16
6. Putting into Storage	18
7. Maintenance	18
8. Troubleshooting	19
9. Available accessories	20
10. Technical Data	20
11. Service/Warranty	21

1. Area of application of your GARDENA Turbotrimmer

Purpose:

The GARDENA Turbotrimmer is designed for trimming and cutting areas of grass and lawns in private house and hobby gardens.

The Turbotrimmer must not be used in public facilities, parks, sports grounds, next to roads or in agriculture or forestry.

Please note:



For safety reasons, the GARDENA Turbotrimmer must not be used for hedge trimming or for shredding for composting.

2. Safety Instructions

→ Please read the notes on safety on the Trimmer.



CAUTION!

→ Please read the operating instructions before using this tool.

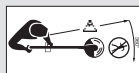

DANGER!

Risk of injury to other people!

→ Keep bystanders away.



DANGER!

→ Keep your Turbotrimmer away from water and rain!





DANGER! Eye and ear injuries!
→ **Wear eye and hearing protection!**

Check your Trimmer before each use

- Always visually inspect your Trimmer before each use.
- Check that the ventilation slots are not obstructed in any way.

Do not use the trimmer if it is damaged or if safety devices (pressure switch, safety cover) and/or the blade holder are damaged or worn.

- Never bypass the safety devices.
- Inspect the area to be cut before you begin work. Remove any foreign objects and look out for foreign objects (such as stones, pieces of wood, strings and wires) while you are working.
- However, should you encounter an obstacle during work, take the trimmer out of operation and remove the battery. Remove the obstacle; inspect the trimmer for potential damage and arrange for it to be repaired if necessary.

Use / responsibility



DANGER! Tool does not stop immediately when turned off!
Keep hands and feet away from the work area until the blade is stationary!

The Trimmer can cause serious injuries.

- Use the Trimmer only for the purpose specified in these operating instructions.
- You are responsible for safety in the work area (2 metre radius).
- Ensure that no other people (especially children) and animals are in close proximity to the danger area (15 metre radius).

Remove the battery after use and regularly inspect the trimmer, especially the blade holder, for damage and arrange appropriate repair if necessary.

- Always wear an eye shield or safety goggles!
- Wear sturdy shoes and long trousers in order to protect your legs. Keep fingers and feet away from the plastic blade – especially during commissioning!
- Always ensure that you have a secure foothold whilst working.

Take extra care when walking backwards. You may stumble!

- Only work in the daylight or when visibility is good.

Interrupting work

- Never leave the Trimmer unattended where you are working.
- When stopping work, remove the battery and store the trimmer in a safe place.
- If you stop work in order to move to another work area, the trimmer must be switched off, wait until the work tool is stationary and remove the battery. Always carry the trimmer at the additional handle.

Familiarise yourself with the surroundings

- Familiarise yourself with the surroundings and look out for possible dangers which you may not hear due to machine noise.
- Never use the Trimmer when there is a risk of thunderstorms, when it is raining or in damp, wet areas.

Battery safety

- Please observe the safety instructions on the battery.



FIRE RISK! Short-circuit!

- Do not bridge the contacts of the battery with metal components.



FIRE RISK!

- Never charge the batteries near acids or easily inflammable materials.

Only use the original GARDENA Battery Charger for charging. The use of other battery chargers may damage the batteries irreparably and even cause a fire.



RISK OF EXPLOSION!

Protect battery from heat and fire. Do not leave on radiators or expose to strong sunshine for long periods.



Do not use the battery charger outdoors.

- **Protect the the battery charger from damp or wet areas.**

Only use the battery in ambient temperatures of between 0 °C and 40 °C.

A non-functioning battery must be disposed of correctly. It may not be sent via post. For further details, please contact your local disposal companies.

The charging cable should be checked regularly for signs of damage or ageing (brittleness) and may only be used if it is in perfect condition.

The charger unit provided may only be used to charge the rechargeable batteries supplied with the Turbotrimmer.

Non-rechargeable batteries must not be charged with this battery charger (danger of fire).

The Trimmer must not be operated during charging.

Only charge battery between 0 – 45 °C. After heavy duty service allow battery to cool down first.

Only the original GARDENA battery may be used.

Storage

The trimmer must not be stored over 35 °C or under direct exposure to sunlight.

Do not store the trimmer in places with static electricity.

3. Assembly

Assembling the trimmer:

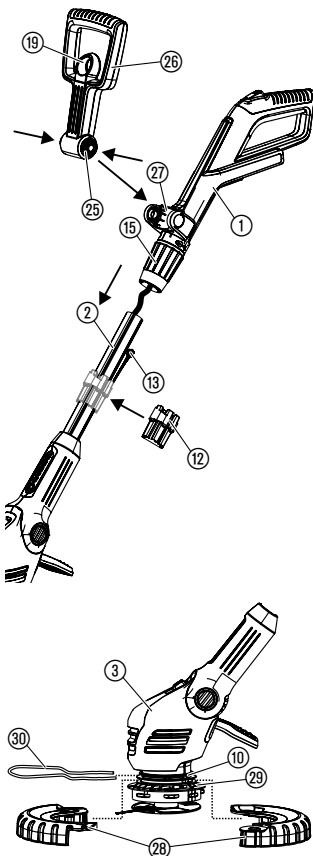

CAUTION!

The handle may only be assembled if the cable between the handle and the shaft is in a perfect condition. The handle may not be assembled if the cable is damaged. Contact GARDENA customer service in such a case.



CAUTION!

The trimmer may only be operated provided that the protective cover (11) is assembled.

1. Carefully remove the handle ① together with the shaft ② from the packaging. In doing so, no stress may be exerted upon the cable.
2. Ensure that the threaded collar ⑮ is in an open position (*padlock symbol open*).
3. Slide the handle ① onto the shaft ② until it audibly engages. In doing so, the cable may not become twisted or jammed.
4. By pulling on the handle ①, check whether it is firmly fixed to the shaft ②. Once assembled, the handle ① and shaft ② cannot be separated.
5. Close the threaded collar ⑮ (*padlock symbol closed*).
6. Pull the lock ⑱ belonging to the additional handle ⑳, push in both of the snap-fits ㉔ belonging to the additional handle ⑳ and, with the grooves pointing forwards, snap them into the holder ㉗.
7. **Only for art. 9825:** Place both halves of the impeller ㉘ around the lower groove ㉙ of the trimmer head ③ and close until they audibly engage.
8. From the front, push the plant guard ㉚ into the upper groove ⑩ of the trimmer head ③. In doing so, ensure that the impeller ㉘ can rotate freely (i.e. insert the bow with the kink pointing upwards).

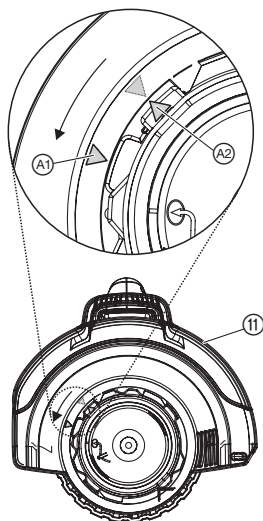

9. Push the protective cover ⑪ onto the trimmer head ③ in such a manner that the two arrows ①^{A1}, ②^{A2} are opposite one another.
 10. Rotate the protective cover ⑪ anti-clockwise until it audibly engages.
 11. Slightly widen the magazine ⑫ at the open point and slide onto the shaft ②.
 12. Slide up to 6 plastic blades ⑬ into the magazine ⑫ until the blades clamp into place.
- 20 plastic blades and a magazine for spare blades are included in the delivery. Up to 6 spare blades can be stored in the magazine.

For information regarding the assembly of the blade into the blade holders, please consult 8. Troubleshooting "Replacing the plastic blade".

4. Initial Operation

Charging the battery:

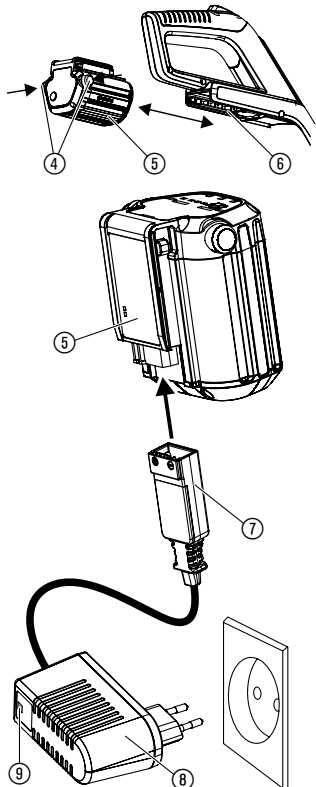

WARNING!

Overvoltage damages batteries and the battery charger.

→ Ensure the correct mains voltage.

Before using for the first time, the battery must be fully charged. Charging time (for uncharged battery) see 10. Technical Data.

The lithium-ion battery can be charged in any state of charge, and the charging process can be interrupted at any time without harming the battery (no memory effect).

1. Depress both locking buttons ④ and remove the battery ⑤ from the battery holder ⑥ on the handle.
2. Plug the plug of the charger cable ⑦ into the battery ⑤.
3. Plug battery charger ⑧ into a mains socket.

Charging indicator lamp ⑨ at the charger unit flashes green once per second: Battery is being charged.

Charging indicator lamp ⑨ at the charger unit is lit green: Battery is fully charged.

(For charging time, see 10. Technical Data.)

Battery charging status indicator during charging:

100 % charged	L1, L2 and L3 lit.
66 – 99 % charged	L1 and L2 lit, L3 flashing.
33 – 65 % charged	L1 lit, L2 flashing.
0 – 32 % charged	L1 flashing.

4. First remove the charging cable ⑦ from the battery ⑤ and then unplug the battery charger ⑧ from the mains socket.
5. Slide the battery ⑤ onto the battery holder ⑥ on the handle until it audibly engages.

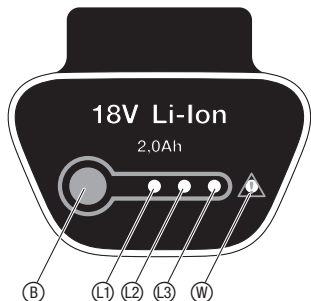

Avoid exhaustive discharge:

If the battery is empty, the full discharge protection automatically switches off the device to prevent the battery from discharging fully. To prevent the fully charged battery from self-discharging via the unplugged charger, it should be disconnected from the charger after charging. If the battery was stored for more than 1 year, it must be fully recharged.

If the battery was fully discharged, the charging indicator lamp ⑨ will flash rapidly at the start of charging (twice per second).

If the charging indicator lamp ⑨ still flashes rapidly after 10 minutes, a fault has occurred (see 8. Troubleshooting).

If the error-LED ⑩ on the battery flashes, a fault has occurred (see 8. Troubleshooting). In case of a completely empty battery it will take approx. 20 minutes until the LEDs on the battery will indicate charging. But the charging process is indicated by the flashing LED ⑨ on the charger.

Battery charging status indicator during operation:

→ Press button ⑧ on the battery.

66 – 99 % charged L1, L2 and L3 lit.

33 – 65 % charged L1 and L2 lit.

10 – 32 % charged L1 lit.

1 – 9 % charged L1 flashing.

0 % charged No indicator.

5. Operation

DANGER!



Risk of injury if the Turbotrimmer does not switch off when you release the start button.

→ Never bypass the safety devices or switches (e.g. by tying the safety lock to the handle).

Risk of injury!

→ Remove the battery prior to each adjustment of the working position, to the shaft length, additional handle or plant guard!

Setting the working position:

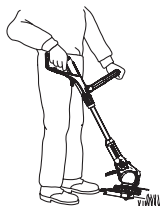

Working position 1:
Standard trimming

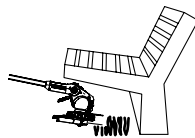

Working position 2:
Trimming beneath
obstacles



Working position 3:
Vertical trimming
of overhanging lawn
edges

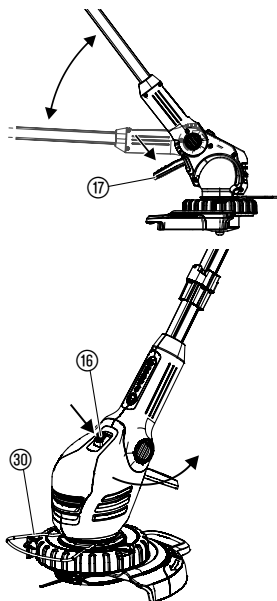

Setting the trimmer to body height:

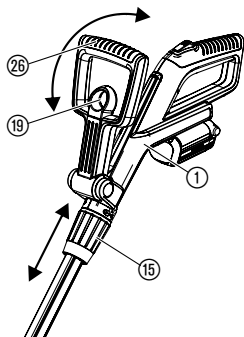

Adjusting the plant guard:

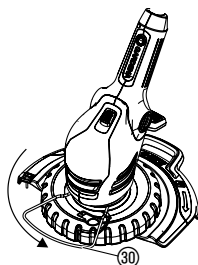

Working position

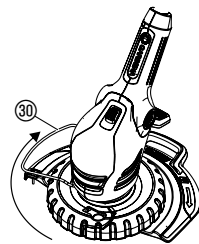

Parking position

→ Turn plant guard 30 through 90° into the required position until it locks into place.

Working position 1:

For standard trimming.

Working position 2:

1. Press the foot pedal 17 and lower the shaft downwards into the desired working position.
2. Release the foot pedal 17 and allow the shaft to engage.

CAUTION! Avoid contact between the ground and the trimmer head in working position 1 + 2.

Working position 3 (only for art. 9825):

The upright must be in the uppermost position in working position 3.

1. Turn the plant guard 30 by 90° to its **parking position** until it locks into place.
2. Press the foot pedal 17 and move the upright into the uppermost position.
3. Press the button 16 and rotate the trimmer head from 0° to 90° until it engages.
4. With the impeller, move the trimmer along the lawn edge.

CAUTION! The trimmer may only be used provided that the trimmer head is engaged at an angle of 0° or 90°.

Setting the shaft length:

→ Loosen the clamping sleeve 15, extend the handle 1 to the desired shaft length and re-tighten the threaded collar 15.

The clamping sleeve 15 must be fastened firmly enough to prevent the shaft from being moved.

Setting the additional handle:

→ Pull the lock 19 belonging to the additional handle 26, set the additional handle 26 to the desired incline and release the lock 19.

If the trimmer is correctly set to the body height, the posture is upright and the trimmer head in **working position 1** is tilted forwards slightly.

→ Hold the trimmer by the handle 1 and additional handle 26 in such a manner that the trimmer head is tilted forwards slightly.

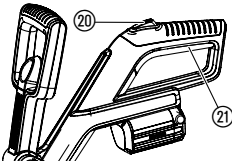
Starting the trimmer:**Switching the trimmer on:**

1. Press and hold the safety lock (20) and then press the start button (21) on the handle.
2. Release the safety lock (20) again.

Switching the trimmer off:

→ Release the start button (21) on the handle.

6. Putting into Storage

Storage:

Store out of the reach of children.

1. Charge battery.
2. Store your Turbotrimmer in a dry place where it is protected from frost.

Recommendation:

The trimmer can be suspended by the handle.
The trimmer head is not placed upon any unnecessary strain if stored in a suspended manner.

Disposal:

(in accordance with
RL 2012/19/EU)



The product must not be added to normal household waste. It must be disposed of in line with local environmental regulations.

→ Important: Make sure that the unit is disposed of via your municipal recycling collection centre.

Disposal of batteries:

Li-ion

The GARDENA battery contains lithium-ion cells that should not be discarded with normal household waste at the end of their life.

Important:

Please return the lithium-ion batteries to your GARDENA dealer or dispose of them properly at a public recycling centre.

1. Discharge lithium-ion batteries completely.
2. Dispose of lithium-ion batteries properly.

7. Maintenance

DANGER!**Risk of injury from blade!**

→ Remove the battery immediately before maintenance!

Risk of injury and risk of damage to property!

→ Never clean the trimmer with water or with a water jet (in particular a high-pressure water jet).

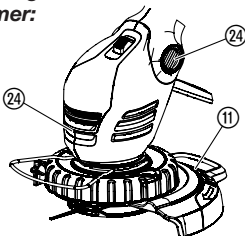
Cleaning the trimmer:**The ventilation slots must always be free of dirt.**

→ Clean all moving parts after each use, and especially remove any grass and dirt from the cover (11) and ventilation slots (24).

8. Troubleshooting

DANGER!
Risk of cutting injuries!



Risk of injury from blade!
→ Remove the battery immediately in the event of faults!

Replacing the plastic blade:

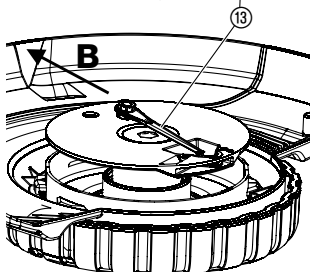
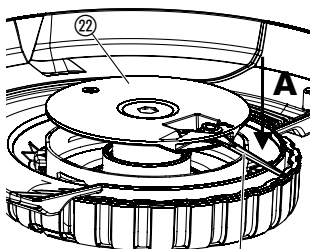

DANGER! Risk of cutting injuries!
→ Never use metal cutting elements or spare parts and accessories not intended for use by GARDENA.

The blades may only become worn to half the original length at most. Only use original GARDENA Spare Blades. Spare blades are available from your GARDENA dealer or direct from GARDENA Service.

• GARDENA Spare Blades for Turbotrimmer **Art. No. 5368**



Disassembling the plastic blade:

1. Turn the trimmer over.
2. Press end of blade down slightly (A), slide blade (13) inside through blade carrier (22) (B) and pull out.

Assembling the plastic blade:

- Slide new blade (13) from inside through slot in metal of blade carrier (22) until it snaps into place.
When the new blade is correctly inserted, it can be moved more easily.

Problem	Possible Cause	Remedy
The Trimmer is not cutting cleanly or not cutting at all	Blade worn or too short.	→ Replace blade.
	Blade broken off.	→ Replace blade.
The trimmer vibrates severely	The blade is excessively worn and creates an unbalance.	→ Replace blade.
The trimmer does not start	Battery is flat.	→ Charge battery (see 4. Initial Operation).
	Battery not pushed onto the handle properly.	→ Push battery onto the handle and make sure that the locking buttons snap in correctly.
	Motor blockage.	→ Unblock and restart the device.
The trimmer stops. Error-LED (W) flashes	Battery overload.	→ Wait for 10 sec. Press button (E) on the battery and restart.
	High temperature. The allowed operation temperature was exceeded.	→ Leave battery to cool for approx. 15 min. Press button (E) on the battery and restart.
Charging indicator lamp (9) on the charger does not light up	Battery charger or charging cable not plugged in properly.	→ Plug in battery charger and charging cable properly.
Charging control lamp (9) on the charger flashes rapidly (twice per second)	Charging error.	→ Unplug charger and plug in again.

Problem	Possible Cause	Remedy
The trimmer stops. Error-LED  flashes	Battery error/ battery defective.	→ Press button  on the battery and restart.
The battery can no longer be charged	Battery is defective.	→ Replace the battery (Art. No. 9840).

Only an original GARDENA BLi 18 Replaceable Battery (Art. 9840) may be used.
This can be obtained from your GARDENA dealer or directly from GARDENA Service.



For any other malfunctions please contact the GARDENA service department.
Repairs must only be carried out by GARDENA service departments or specialist dealers authorised by GARDENA.

9. Available accessories

GARDENA Replacement Battery BLi 18	Battery for additional operating time or for replacement with 2.0 Ah.	Art. No. 9840
GARDENA Spare Blades for Turbotrimmer		Art. No. 5368
GARDENA Replacement blade carrier	Available via the GARDENA Service.	

10. Technical Data

Turbotrimmer	EasyCut Li-18/23 R (Art. No. 9823)	ComfortCut Li-18/23 R (Art. No. 9825)
Cutting width	230 mm	230 mm
Rpm of blade carrier	approx. 9300 rpm	approx. 9300 rpm
Weight including battery	approx. 2.8 kg	approx. 3.1 kg
Workplace-related emission values $L_{pa}^{1)}$ Uncertainty k_{pa}	68 dB (A) 3 dB (A)	68 dB (A) 3 dB (A)
Noise level $L_{WA}^{2)}$ Uncertainty k_{WA}	measured 83 dB (A) / guaranteed 88 dB (A) 4.5 dB (A)	measured 82 dB (A) / guaranteed 86 dB (A) 4.2 dB (A)
Hand/arm vibration $a_{vhw}^{3)}$ Uncertainty k_a	< 2.5 m/s ² 1.5 m/s ²	< 2.5 m/s ² 1.5 m/s ²
Battery	lithium ion (18 V)	
Battery capacity	2.0 Ah	
Battery charging time	approx. 3 h 80 % / approx. 5 h 100 %	
Idling time	approx. 50 min. (with full battery)	

Battery charger

Mains voltage	230 V / 50 – 60 Hz
Max. output current	600 mA
Output voltage	18 V (DC)

Measuring process complying with ¹⁾ DIN EN 60335-2-91 ²⁾ RL 2000/14/EC ³⁾ DIN EN 786. The stated vibration emission value has been measured according to a standardised test procedure and can be used for comparison of one electric power tool with another. It can also be used for preliminary evaluation of exposure. The vibration emission value can vary during actual use of the electric power tool.

11. Service / Warranty

Warranty:

GARDENA guarantees this product for 2 years (from date of purchase). This guarantee covers all serious defects of the unit that can be proved to be material or manufacturing faults. Under warranty we will either replace the unit or repair it free of charge if the following conditions apply:

- The unit must have been handled properly and in keeping with the requirements of the operating instructions.
- Neither the purchaser or a non-authorized third party have attempted to repair the unit.

As wear parts, the blade and blade holder are excluded from the warranty.

This manufacturer's guarantee does not affect the user's existing warranty claims against the dealer/seller.

If you have any problems with this product, please contact our Service or return the defective unit together with a short description of the problem – in case of guarantee, with a copy of the receipt – postage paid to one of the GARDENA Service Centres listed on the back of this leaflet.

D Produkthaftung

Wir weisen ausdrücklich darauf hin, dass wir nach dem Produkthaftungsgesetz nicht für durch unsere Geräte hervorgerufene Schäden einzustehen haben, sofern diese durch unsachgemäße Reparatur verursacht oder bei einem Teileaustausch nicht unsere originale GARDENA Teile oder von uns freigegebene Teile verwendet wurden und die Reparatur nicht vom GARDENA Service oder dem autorisierten Fachmann durchgeführt wird. Entsprechendes gilt für Ergänzungssteile und Zubehör.

GB Product Liability

We expressly point out that, in accordance with the product liability law, we are not liable for any damage caused by our units if it is due to improper repair or if parts exchanged are not original GARDENA parts or parts approved by us, and, if the repairs were not carried out by a GARDENA Service Centre or an authorised specialist. The same applies to spare parts and accessories.

F Responsabilité

Nous vous signalons expressément que GARDENA n'est pas responsable des dommages causés par ses appareils, dans la mesure où ces dommages seraient causés suite à une réparation non conforme, dans la mesure où, lors d'un échange de pièces, les pièces d'origine GARDENA n'auraient pas été utilisées, ou si la réparation n'a pas été effectuée par le Service Après-Vente GARDENA ou l'un des Centres SAV agréés GARDENA. Ceci est également valable pour tout ajout de pièces et d'accessoires autres que ceux préconisés par GARDENA.

NL Productaansprakelijkheid

Wij wijzen er nadrukkelijk op, dat wij op grond van de wet aansprakelijkheid voor producten niet aansprakelijk zijn voor schade ontstaan door onze apparaten, indien deze door onvakkundige reparatie veroorzaakt zijn, of er bij het uitwisselen van onderdelen geen gebruik gemaakt werd van onze originele GARDENA onderdelen of door ons vrijgegeven onderdelen en de reparatie niet door de GARDENA technische dienst of de bevoegde vakman uitgevoerd werd. Ditzelfde geldt voor extra-onderdelen en accessoires.

S Produktansvar

Tillverkaren är inte ansvarig för skada som orsakats av produkten om skadan beror på att produkten har reparerats felaktigt eller om, vid reparation eller utbyte, andra än Original GARDENA reservdelar har använts. Samma sak gäller för kompletteringsdelar och tillbehör.

DK Produktansvar

Vi gør udtrykkeligt opmærksom på, at vi i henhold til produktansvarsloven ikke er ansvarlige for skader forårsaget af vores udstyr, såfremt det sker på grund af uautoriserede reparationer eller hvis dele er skiftet ud og der ikke er anvendt originale GARDENA dele eller dele godkendt af os, eller hvis reparationerne ikke er udført af GARDENA-service eller en autoriseret fagmand. Det samme gælder for ekstra udstyr og tilbehør.

FI Tuotevastuu

Korostamme nimenomaan, että tuotevastuulain nojalla emme ole vastuussa laitteistamme johtuneista vahingoista, mikäli nämä ovat aiheutuneet epäasianmukaisesta korjauksesta tai osia vaihdettaessa ei ole käytetty alkuperäisiä GARDENA-varaosia tai hyväksymiämme osia ja korjauksen on suorittanut muu kuin GARDENA-huoltokeskus tai valtuuttamamme ammattihenkilö. Tämä pätee myös lisäksiin ja lisävarusteisiin.

I Responsabilità del prodotto

Si rende espressamente noto che, conformemente alla legislazione sulla responsabilità del prodotto, non si risponde di danni causati da nostri articoli se originati da riparazioni eseguite non correttamente o da sostituzioni di parti effettuate con materiale non originale GARDENA o comunque da noi non approvato e, in ogni caso, qualora l'intervento non venga eseguito da un centro assistenza GARDENA o da personale specializzato autorizzato. Lo stesso vale per le parti complementari e gli accessori.

E Responsabilidad de productos

Advertimos que conforme a la ley de responsabilidad de productos no nos responsabilizamos de daños causados por nuestros aparatos, siempre y cuando dichos daños hayan sido originados por arreglos o reparaciones indebidas, por recambios con piezas que no sean piezas originales GARDENA o bien piezas no autorizadas por nosotros, así como en aquellos casos en que la reparación no haya sido efectuada por un Servicio Técnico GARDENA o por un técnico autorizado. Lo mismo es aplicable para las piezas complementarias y accesorios.

P Responsabilidade sobre o produto

Queremos salientar que segundo a lei da responsabilidade do fabricante, nós não nos responsabilizaremos por danos causados pelo nosso equipamento, quando estes ocorrerem em decorrência de reparações inadequadas ou da substituição de peças por peças não originais da GARDENA, ou peças não autorizadas.

A responsabilidade tornar-se-à nula também depois de reparações realizadas por oficinas não autorizadas pela GARDENA. Esta restrição valerá também para peças adicionais e acessórios.

PL Odpowiedzialność za produkt

Zwracamy Państwu uwagę, że nie ponosimy odpowiedzialności za uszkodzenia naszych maszyn, bądź szkody spowodowane ich wadliwym funkcjonowaniem, powstałe na skutek nieprawidłowo przeprowadzonych napraw lub użycia nieoryginalnych części zamiennych. Naprawy winny być przeprowadzane tylko przez punkty serwisowe Husqvarna lub autoryzowane serwisy. Dotyczy to również części uzupełniających i oprzyrządowania.

H Termékszavatosság

Nyomatékosan utalunk arra a tényre, hogy a termékszavatossági törvény szerint nem kell jótállást vállalnunk azokra a károokra, amelyeket nem a mi készülékeink okoztak, ha ezeket átkészületlen javítás okozta vagy egy alkatrész kicserélésénél nem a mi eredeti GARDENA alkatrészeinket vagy általunk engedélyezett alkatrészeket használtak fel és a javítást nem a GARDENA szerviz vagy egy erre felhatalmazott szakember végezte. Hasonlóképpen érvényes ez a kiegészítő alkatrészekre és tartozékokra is.

CZ Odpovědnost za výrobek

Výslovně upozorňujeme na to, že podle zákona o odpovědnosti za výrobek neneseme odpovědnost za škody způsobené našimi přístroji, pokud byly způsobené neodbornou opravou nebo použitím jiných než našich originálních náhradních dílů GARDENA nebo námi schválených dílů a neprovedením opravy servisem GARDENA nebo autorizovaným odborníkem. Odpovídající platí i pro doplňkové díly a příslušenství.

SK Predmet záruky

Upozorňujeme dôrazne na to, že podľa zákona o poskytovaní záruk nezodpovedáme za škody spôsobené našimi výrobkami, v prípade, že boli boli vyvolané neodbornými opravami, výmenou dielcov, ktoré nepatria k originálnym dielom GARDENA alebo neboli nami schválené a rovnako boli spôsobené servisnými zásahmi, ktoré neboli vykonané servisom GARDENA alebo autorizovaným odborníkom. Rovnako to platí pre doplnky a príslušenstvo.

GR Ευθύνη για το προϊόν

Σας υπενθυμίζουμε ρητά, ότι σύμφωνα με το νόμο περί ευθύνης για τα προϊόντα δεν ευθυνόμαστε για ενδεχόμενες βλάβες που προκαλούνται από τις συσκευές μας, εφόσον οφείλονται σε μία ακατάλληλη επισκευή ή σε μια αντικατάσταση τμημάτων για την οποία δεν έχουν χρησιμοποιηθεί τα πρωτότυπα ανταλλακτικά της GARDENA ή τα από μας εγκεκριμένα ανταλλακτικά και σε περίπτωση που δεν εκτελείται η επισκευή από το Τμήμα Εξυπηρέτησης Πελατών της GARDENA ή από έναν εξουσιοδοτημένο εξειδικευμένο τεχνίτη. Το ίδιο ισχύει για εξαρτήματα και συμπληρωματικά τμήματα.

SLO Jamstvo za izdelek

Pismo poudarjamo, da po zakonu jamstva za izdelek nismo odgovorni za škodo, ki bi nastala zaradi uporabe našega izdelka, prav tako tudi ne za škodo ki bi nastala zaradi nepravilnega popravila izdelka ali pri napačni zamenjavi delov, ki niso originalni deli GARDENA ali pri uporabi z naše strani potrjenih delov, ki pa niso bili vgrajeni v servisu GARDENA ali v naši pooblašteni servisni službi. Enako velja tudi za nadomestne dele in opremo.

HR Odgovornost za proizvod

Izričito napominjemo da u skladu sa Zakonom o odgovornosti za proizvode nismo odgovorni za štete uzrokovane našim uređajima ako su one izazvane nestručnim popravkom ili u slučaju zamjene dijelova nisu korišteni originalni GARDENA dijelovi ili dijelovi koje smo odobrili i popravak nije izvršio GARDENA servis ili ovlašteni stručnjak. Isto vrijedi i za dodatne dijelove i pribor.

RO Responsabilitatea legala a produsului

Menționăm în mod expres ca, în concordanță cu responsabilitatea legală a produsului, nu suntem răspunzători de nici un accident provocat de produsele noastre dacă se datorează reparării necorespunzătoare sau dacă piesele de schimb nu sunt originale GARDENA sau aprobate de GARDENA, sau dacă reparațiile nu au fost efectuate de un Centru de Service GARDENA sau un specialist autorizat. Aceleași prevederi se aplică și pieselor de schimb și accesoriilor.

BG Отговорност за качество

Изрично подчертаваме, че съгласно закона за отговорност за качество, ние не носим отговорност за вредите причинени от нашите уреди, ако същите са причинени от неправилен ремонт или при подмяната на части не са използвани оригинални части на GARDENA или части одобрени от нас и ремонта не е извършен от сервиз на GARDENA или оторизиран специалист. Същото важи за допълнителните части и принадлежности.

EST Tootevastutus

Juhime teie tähelepanu sellele, et tootevastutusseaduse kohaselt ei vastuta me meie seadmete poolt põhjustatud kahjude eest, kui need on tekkinud asjatundmatu paranduse tagajärjel või kui detaili vahetamisel ei kasutatud GARDENA originaalvaruosi ega meie poolt kasutada lubatud varuosia ja kui parandustöid ei ole teinud GARDENA klienditeenindusspetsialistid ega meie volitatud spetsialistid. Sama kehtib lisadetailide ja tarvikute kohta.

LT Atsakomybė už produkciją

Nurodome, kad remdamiesi Atsakomybės už produkciją įstatymu, neatsakome už nuostolius, sukeltus mūsų prietaisy, jei jie atsirado dėl netinkamo remonto, arba, jei keičiant dalis, buvo naudojamasi neoriginalios GARDENA dalys arba dalys, kurių mes neleidome naudoti, o remontą atliko ne GARDENA servisas arba neįgaliotasis specialistas. Tas pats galioja papildomoms dalims ir priedams.

LV Produkta atbildība

Mēs skaidri norādām uz to, ka saskaņā ar Produktu atbildības likumu, mēs neatbildam par mūsu iekārtu radītiem zaudējumiem, ciktāl tos ir izraisījis neatbilstošs remonts vai daļu nomaiņa ar neoriģinālām GARDENA daļām vai ne ar mūsu norādītajām detaļām un remontu nav veicis GARDENA serviss vai pilnvarots speciālists. Tas pats attiecas uz papildinošajām daļām un piederumiem.

<p>D EG-Konformitätserklärung Der Unterzeichnete Husqvarna AB, 561 82 Huskvarna, Sweden bestätigt, dass die nachfolgend bezeichneten Geräte in der von uns in Verkehr gebrachten Ausführung die Anforderungen der harmonisierten EU-Richtlinien, EU-Sicherheitsstandards und produktspezifischen Standards erfüllen. Bei einer nicht mit uns abgestimmten Änderung der Geräte verliert diese Erklärung ihre Gültigkeit.</p>	<p>H EU-Megfelelőeségi nyilatkozat Alulírott, a Husqvarna AB, 561 82 Huskvarna, Sweden igazolja azt, hogy az alábbiakban megnevezett készülékek, az általunk forgalomba hozott kiviteltől teljesítik a harmonizációs EU-irányelvek, az EU biztonsági szabványok és a termékre jellemző szabványok követelményeit. Ha a készülékeken a mi beleegyezésünk nélkül változtatást végeznek, akkor ez a nyilatkozat érvényét veszti.</p>
<p>GB EU Declaration of Conformity The undersigned Husqvarna AB, 561 82 Huskvarna, Sweden hereby certifies that, when leaving our factory, the units indicated below are in accordance with the harmonised EU guidelines, EU standards of safety and product specific standards. This certificate becomes void if the units are modified without our approval.</p>	<p>CZ Prohlášení o shodě EU Podepsaný Husqvarna AB, 561 82 Huskvarna, Sweden potvrzuje, že dále uvedené přístroje v námi do provozu uvedeném provedení splňují požadavky harmonizačních směrnic EU, bezpečnostních norem EU a norem specifických pro výrobek. Při námi neschválené změně přístrojů ztrácí toto prohlášení platnost.</p>
<p>F Certificat de conformité aux directives européennes Le constructeur, soussigné : Husqvarna AB, 561 82 Huskvarna, Sweden déclare qu'à la sortie de ses usines le matériel neuf désigné ci-dessous élit conforme aux prescriptions des directives européennes énoncées ci-après et conforme aux règles de sécurité et autres règles qui lui sont applicables dans le cadre de l'Union européenne. Toute modification portée sur ce produit sans l'accord express de GARDENA supprime la validité de ce certificat.</p>	<p>SK EU-Vyhlasenie o zhode Nižšie uvedená firma Husqvarna AB, 561 82 Huskvarna, Sweden vyhlasuje, že uvedené zariadenia, ktoré sme uviedli na trh v ich vyhotovení spĺňajú požiadavky harmonizačných predpisov EU, bezpečnostných štandardov EU a výrobo-spezifických štandardov. Pri zmene zariadenia, ktorá nebola odsúhlasená výrobcom stráca toto vyhlásenie platnosť.</p>
<p>NL EU-overeenstemmingsverklaring Ondergetekende Husqvarna AB, 561 82 Huskvarna, Sweden bevestigt, dat de volgende genoemde apparaten in de door ons in de handel gebrachte uitvoering voldoen aan de eis van, en in overeenstemming zijn met de EU-richtlijnen, de EU-veiligheidsstandaard en de voor het product specifieke standaard. Bij een niet met ons afgestemde verandering aan de apparaten verliest deze verklaring haar geldigheid.</p>	<p>GR Δήλωση Συμμόρφωσης προς τις Οδηγίες της ΕΕ Η υπογράφουσα Husqvarna AB, 561 82 Huskvarna, Sweden δηλώνει, ότι τα εξής αναφερόμενα εκδοόμενα από την εταιρία μας προϊόντα ανταποκρίνονται σε όλες τις εναρμονισμένες προδιαγραφές της ΕΕ, στα πρότυπα ασφαλείας της ΕΕ και στα ειδικά για το προϊόν πρότυπα. Σε μία μη συμφωνημένη με την εταιρία μας τροποποίηση των συσκευών αυτή η δήλωση χάνει την ισχύ της.</p>
<p>S EU Tillverkarintyg Undertecknad firma Husqvarna AB, 561 82 Huskvarna, Sweden intygar härmed att nedan nämnda produkter överensstämmer med EU:s direktiv, EU:s säkerhetsstandard och produktspecifikation. Detta intyg upphör att gälla om produkten ändras utan vårt tillstånd.</p>	<p>SLO EU-izjava o skladnosti Podpisani proizvajalca «Husqvarna AB, 561 82 Huskvarna, Sweden» s podpisom potrjuje, da sledeče opisana naprava, ki smo jo poslali na tržišče izpolnjuje zahteve harmoniziranih standardov ES-smernic, ES-varnostnih standardov in izdelku specifičnih standardov. V primeru spremembe na napravi brez našega pisnega dovoljenja ta izjava izgubi svoj pomen in veljavnost.</p>
<p>DK EU Overensstemmelse certifikat Undertegnede Husqvarna AB, 561 82 Huskvarna, Sweden bekræfter hermed, at enheder listede herunder, ved afsendelse fra fabrikken, er i overensstemmelse med harmoniserede EU retningslinjer, EU sikkerheds standarder og produkt specifikations standarder. Dette certifikat træder ud af kraft hvis enhederne er ændret uden vor godkendelse.</p>	<p>HR Izjava o skladnosti EU-a Dolje potpisana tvrtka Husqvarna AB, 561 82 Huskvarna, Sweden ovime potvrđuje da dolje navedeni uređaji u izvedbi plasiranoj na tržište ispunjavaju zahtjeve harmoniziranih EU smjernica, EU sigurnosnih normi i normi za odresene proizvode. Ova izjava postaje ništavna u slučaju izmjene uređaja koje nismo odobrili.</p>
<p>FI EY-vaatimustenmukaisuusvakuutus Allekirjoittanut Husqvarna AB, 561 82 Huskvarna, Sweden vakuuttaa, että alla mainittu laitteet täyttävät tehtaaltamme lähtiesään yhdenmukaistettujen EY-direktiivien, EY-turvallisuusstandardien ja tuotekohtaisten standardien vaatimukset. Laitteisiin tehyd muutokset, joista ei ole sovittu kanssamme, joutavat tämän vakuutuksen raukaamiseen.</p>	<p>RO UE-Certificat de conformitate Prin prezenta Husqvarna AB, 561 82 Huskvarna, Sweden, certifica faptul ca, in momentul in care produsele mentionate mai jos ies din fabrica sunt in concordanta cu directivele UE, standardele de siguranta UE si standardele specifice ale produsului UE. Acest certificat devine nul in cazul modificării aparatului fără aprobarea noastră.</p>
<p>I Dichiarazione di conformità alle norme UE La sottoscritta Husqvarna AB, 561 82 Huskvarna, Sweden certifica che il prodotto qui di seguito indicato, nei modelli da noi commercializzati, è conforme alle direttive armonizzate UE nonché agli standard di sicurezza e agli standard specifici di prodotto. Qualunque modifica apportata al prodotto senza nostra specifica autorizzazione invalida la presente dichiarazione.</p>	<p>BG ЕС-Декларация за съответствие Подписаната фирма Husqvarna AB, 561 82 Huskvarna, Sweden декларира, че описаните по-долу уреди, пуснати в продажба съгласно нашата спецификация, изпълняват изискванията на хармонизираните ЕС-директиви, ЕС-стандарти за безопасност и специфични производствени стандарти. При промяна на уреда, която не е съгласувана с нас, тази декларация губи своята валидност.</p>
<p>E Declaración de conformidad de la UE El que suscribe Husqvarna AB, 561 82 Huskvarna, Sweden declara que la presente mercancía, objeto de la presente declaración, cumple con todas las normas de la UE, en lo que a normas técnicas, de homologación y de seguridad se refiere. En caso de realizar cualquier modificación en la presente mercancía sin nuestra previa autorización, esta declaración pierde su validez.</p>	<p>EST Eli vastavusdeklaratsioon Allekirjutanu Husqvarna AB, 561 82 Huskvarna, Sweden kinnitab, et kirjeldatud seade vastab meie poolt ringluse viidud kujul ELi harmoniseeritud direktiividele, ELi ohutusstandarditele ja tootega seotud standarditele. Meiega kooskõlastamata muudatuse tegemise korral seadmel kaotab see deklaratsioon kehtivuse.</p>
<p>P Certificado de conformidad da UE Os abaixo mencionados Husqvarna AB, 561 82 Huskvarna, Sweden, por este meio certificam que ao sair da fábrica os aparelhos abaixo mencionados estão de acordo com as direttrizes harmonizadas da UE, padrões de segurança e de produtos específicos. Este certificado ficará nulo se as unidades forem modificadas sem a nossa aprovação.</p>	<p>LT ES Atitikties deklaracija Pasirašanti firma Husqvarna AB, 561 82 Huskvarna, Sweden patvirtina, kad žemiau nurodyti prietaisai ir jų modeliai, kuriuos paleidome į apyvartą, patenkina harmonizuotus ES direktyvas, ES saugumo standartus ir specifinius gaminių standartus. Atlikus bet kokį prietaiso pakeitimą, kuris nėra suderintas su mumis, ši deklaracija praranda galiojimą.</p>
<p>PL Deklaracja zgodności Unii Europejskiej Husqvarna AB, 561 82 Huskvarna, Sweden potwierdza, że poniżej określone urządzenia w wersji oferowanej przez nas do sprzedaży spełniają wymagania zharmonizowanych dyrektyw Unii Europejskiej, standardu bezpieczeństwa Unii Europejskiej i standardu specyficznego dla tego typu produktu. W przypadku zmiany urządzenia, która nie została z nami uzgodniona, niniejsza deklaracja traci moc obowiązującą.</p>	<p>LV ES-atbilstības deklarācija Parakstījusies Husqvarna AB, 561 82 Huskvarna, Sweden, Vācija apstiprina, ka sekojoši apzīmētās iekārtas, kurās mēs izplatām, savā izpildījumā atbilst harmonizētajām ES direktīvām, ES drošības standartiem un produkta specifiskajiem standartiem. Ar mūsu neapstiprinātām izmaiņām iekārtā šī deklarācija zaudē savu derīgumu.</p>

<p>Bezeichnung der Geräte: Description of the units: Désignation du matériel : Omschrijving van de apparaten: Produktbeskrivning: Beskrivelse af produktet: Laitteiden nimitys: Descrizione del prodotto: Descripción de la mercancía: Descrição dos aparelhos:</p> <p>Nazwa urządzenia: A készülékek megnevezése:</p> <p>Označení přístrojů: Označenie zariadenia: Όνομασία της συσκευής:</p> <p>Opis naprave: Oznaka urešaja: Descrierea articolelor: Обозначение на уредите: Seadmete nimetus: Prietaisų pavadinimas: Iekārtu apzīmējums:</p>	<p>Accu-Turbotrimmer Accu Turbotrimmer Coupe-bordures à batterie</p> <p>Accu-Turbotrimmer Accu-Turbotrimmer Accu-turbotrimmer Accu-turbotrimmeri Turbotrimmer a batteria Recortabordes con accu Aparador de relva Accu-Turbotrimmer Podkaszarka akumulatorowa Akkumulátoros damilos fűszegélynyíró Akumulátorový turbotrimmer Akumulátorový turbotrimmer Επαναφορτιζόμενο κοιρρευτικό πετονιάς Akumulatorski turbo obrezovalnik Baterijski turbo trimer za travu Turbotrimmer cu baterie Акумуляторен Турботример Akuga turbotrimmer Akumulátorinē turbo žoliapjāvē Turbotrimmeris ar akumulatoru</p>	<p>Schall-Leistungspegel: Noise level: Puissance acoustique : Geluidsniveau: Ljudnivá: Lydytrksnivaeu: Melun tehotas: Livello rumorosità: Nivel sonoro: Nível de ruído: Poziom nateżenia dźwięku: Zajteljesítmény szint: Hluková hladina výkonu: Výkonová hladina hluku: Επίπεδο ισχύος ήχου: Nivo hrupa: Razina zvučne snage Nivel de putere acustică: Ниво на шума: Helivõimsuse tase: Garso stiprumo lygis: Troksņu jaudas līmenis:</p>	<p>gemessen/garantiert measured/guaranteed mesurée/garantie gemeten/gegarandeerd uppmätt/garanterad afmätt/garanti mitattu/taattu testatu/garantito medido/garantizado medido/garantido zmierzone/gwarantowane mért/garantált naměřeno/garantovano meraná/garantovaná μετρήθηκαν/εγγυημένα izmerjeno/zagotovljeno izmjereno/garantirano mäsarat/garantat измерено/гарантирано mõõdetud/garanteeritud išmatuotas/garantuotas izmērtais/garantētais</p>
<p>Typen: Types: Types : Type: Typ: Typer: Typit: Tipi: Tipos: Tipos: Typu:</p>	<p>Art.-Nr.: Art. No.: Référence : Art.nr.: Art.nr.: Art. nr.: Tuoten:o Art.: Art. No: Art. no: Nr artykulu:</p> <p>Cikkszám: Císlo artiklu: Art.: Αριθ. είδους: Art št.: br. art. Nr art.: Art. номер: Toote nr : Gaminio nr.: Izstr.:</p>	<p>Art. 9823 Art. 9825</p>	<p>83 dB (A) / 88 dB (A) 82 dB (A) / 86 dB (A)</p>
<p>EasyCut Li-18/23 R ComfortCut Li-18/23 R</p>	<p>Art. 9823 Art. 9825</p>	<p>Anbringningsjaar der CE-Kennzeichnung: Year of CE marking: Année d'apposition du marquage CE : Installatiejaar van de CE-aanduiding: Märkningsår: CE-Mærkningsår: CE-merkin kiinnitysvuosi: Anno di applicazione della certificazione CE: Colocación del distintivo CE: Ano de marcação pela CE: Rok nadania oznakowania CE: CE-jelzés elhelyezésének éve:</p>	<p>Rok umístění značky CE: Rok udelenia značky CE: Έτος σήματος CE: Leto namestitve CE-oznake: Godina dobivanja CE oznake: Anul de marcare CE: Година на поставяне на CE-маркировка: CE-märkjistuse paigaldamise aasta: Metai, kuriais pažymėta CE-Zenklui: CE-marķējuma uzlikšanas gads:</p>
<p>EU-Richtlinien: EU directives: Directives européennes : EU-richtlijnen: EU directiv: EU Retningslinier: EY-direktiivi: Direttive UE: Normativa UE: Directrices da UE: Dyrektywy Unii Europejskiej: EU-irányelvek: Směrnice EU: EU-Predpisy: Οδηγίες της ΕΕ:</p>	<p>ES-smernice: EU smjernice: Directive UE: ЕС-директиви: ELI direktiivid: ES direktivos: ES-direktivas:</p> <p>2006/42/EG 2004/108/EG 2011/65/EG 2000/14/EG 2006/95/EG</p>	<p>Ulm, den 04.11.2013 Ulm, 04.11.2013 Fait à Ulm, le 04.11.2013 Ulm, 04-11-2013 Ulm, 2013.11.04. Ulm, 04.11.2013 Ulmissa, 04.11.2013 Ulm, 04.11.2013 Ulm, 04.11.2013 Ulm, 04.11.2013 Ulm, dná 04.11.2013 Ulm, 04.11.2013 Ulm, 04.11.2013 Ulm, dana 04.11.2013 Ulm, 04.11.2013 Ulm, 04.11.2013 Ulm, 04.11.2013 Ulm, 04.11.2013 Ulm, 04.11.2013 Ulm, 04.11.2013 Ulm, 04.11.2013</p>	<p>Der Bevollmächtigte Authorised representative Le mandataire De gevolmachtigde Autoriseret representant Autoriseret repræsntant Valtuutettu edustaja Persona delegata La persona autorizada O representante Pelnomocnik Meghatalmazott Zplnomocnenec Spilnomocnený Ο εξουσιοδοτημένος Pooblaščenec Ovlaštena osoba Conducerea tehnică Упълномощен Volitatud esindaja Igaliotasis atstovas Pilnvarotā persona</p>
<p>Harmonisierte EN: EN ISO 12100 EN 60335-2-91 IEC 62133</p>	<p>EN 60335-1 IEC 60335-1 IEC 60355-2-29</p>	<p>Hinterlegte Dokumentation: GARDENA-Technische Dokumentation, M. Kugler 89079 Ulm Deposited Documentation: GARDENA Technical Documentation, M. Kugler 89079 Ulm Dokumentation déposée: Documentation technique GARDENA, M. Kugler 89079 Ulm</p>	<p>Konformitätsbewertungs- verfahren: Nach 2000/14/ EG Art. 14 Anhang VI Conformity Assessment Procedure: according to 2000/14/EC Art.14 Annex VI Procédure d'évaluation de la conformité : Selon 2000/14/CE art. 14 Annexe VI</p> <p> Peter Lameli Chief Technical Officer</p>

