

KAWAI

Concert Performer

CP 3

Owner's Manual

Part Names
& Functions
1

Listening to
the Piano
2

Playing the Piano
(Basic Controls)
3

Recording a Song
4

Using a Style
5

Music Menu
6

Settings Menu
7

Virtual
Technician
8

Using USB
Memory
9

Appendices
10

Thank you for purchasing this KAWAI Concert Performer (CP) Series Ensemble Digital Piano.

The CP Series piano has been designed to provide you with the ultimate musical experience, no matter your skill level. Featuring superbly realistic instrument tones and the most finely crafted keyboard in its class, the CP is a unique musical instrument resulting from the combination of KAWAI's eighty-five-plus years experience in making acoustic pianos, along with cutting-edge digital music technologies.

With over 1000 different instrument and drum sounds at your disposal, you will have the flexibility to perform any kind of music ranging from traditional to contemporary. The Auto-Accompaniment Styles provide the enjoyment of playing rich, fully orchestrated music in hundreds of musical genres. Thanks to the Song Stylist feature, you will never have to worry about finding the best sounds and style to perform a particular song.

The Concert Performer incorporates many professional features, such as a 16-track Recorder, Microphone Input, USB to Device functionality and MP3 recording/playback. For the non-player, KAWAI's unique Concert Magic feature creates the thrill of being a performing musician simply by tapping any key on the keyboard.

The Concert Performer offers tremendous opportunities for anyone who is interested in learning, playing, and listening to music. Please read this manual thoroughly and keep it handy as a reference so that you can get the most out of this incredible instrument.

We hope you enjoy every moment that you spend with your Concert Performer.

Table of Contents

◆ Important Safety Instructions.....6

1. Part Names and Functions 10

- 1) Parts and Names 10
 - ◇ Pedals 12
 - ◇ Front Terminals..... 12
 - ◇ Rear Terminals 12
- 2) Overview of Controls 13

2. Listening to the Piano 15

- 1) Demonstrations 15

3. Playing the Piano (Basic Controls) 16

- 1) Selecting a Part to Play 16
 - ◇ Splitting the keyboard..... 17
- 2) Selecting Sounds..... 18
 - ◇ Favorite Sounds. 19
- 3) Mixer 20
- 4) Effects..... 22
 - ◇ Adding Reverb 22
 - ◇ Adding Chorus 23
 - ◇ Adding an Effect..... 24
 - ◇ Effect Priority Guidelines..... 25
- 5) Transpose and Octave Shift..... 27
- 6) Metronome 28
- 7) Piano Only 29
- 8) KBD Settings Button..... 30
 - ◇ LEFT PEDAL and CENTER PEDAL Override 30
 - ◇ KBD SETTINGS BUTTON ASSIGN (Portamento, Panel Lock) 31
 - ◇ LEFT MODE 32

4. Recording a Song 33

- 1) Easy Recording 34
 - ◇ Re-recording or adding another Part 35
 - ◇ Storing the song in Internal Memory..... 36
 - ◇ Erasing the song 36
 - ◇ Easy Loop 37
 - ◇ Display of a Score 37
- 2) Advanced Recording 39
 - ◇ Real-time Recording 39
 - ◇ Mixer 41
 - ◇ Track Settings..... 42
 - ◇ Loop Settings 43
 - ◇ Style Paste 44
 - ◇ Punch-In Recording 45
 - ◇ Step Recording 46
 - ◇ Song Edit 48
 - ◇ Bar Editing 49
 - ◇ Event Edit..... 55
 - ◇ Style Maker 56

5. Using a Style 57

- 1) Selecting and Playing a Style 57
 - ◇ Intro/Ending..... 59
 - ◇ Fill-In and Variation 59
 - ◇ Favorites Button 59
- 2) Auto Accompaniment System 60
- 3) 1-2 Play 62
- 4) Registration 63
- 5) Song Stylist..... 66
- 6) Keyboard Harmony..... 69
- 7) Creating Your Own Styles 70
- 8) Conductor..... 71
 - ◇ Easy Edit..... 71
 - ◇ Style Effect..... 72
- 9) Making a Style with Get Phrase from Recorder 73
 - ◇ Auto-accompaniment System 75
- 10) Making a Style with Phrase Combination..... 77
- 11) Editing Sounds 79
 - ◇ Editing the Preset Effect Settings..... 79
 - ◇ Making a User Sound 80

6. Music Menu..... 82

- 1) Concert Magic 82
 - ◇ Selecting a Concert Magic Song..... 82
 - ◇ Performing a Concert Magic Song 84
 - ◇ Concert Magic Song Arrangements..... 86
 - ◇ Steady Beat Play..... 87
 - ◇ Creating a Concert Magic Song..... 87
- 2) Lesson Function 88
 - ◇ Selecting a Lesson Book/Song 88
 - ◇ Listening to the selected Lesson Song 89
 - ◇ Repeating a passage of the selected Lesson Song... 89
 - ◇ Adjusting the Left/Right hand volume balance..... 90
 - ◇ Adjusting the playback tempo 90
 - ◇ Recording a Lesson Song practise 90
 - ◇ Finger Exercises 91
- 3) My Songs..... 92

7. Settings Menu 93

- 1) Tuning 93
- 2) Concert Magic Sound..... 94
- 3) Pedal Assign..... 95
- 4) Fill-in Mode 97
- 5) Effect for Sound..... 98
- 6) Sound Select Mode 99
- 7) Style Select Mode..... 100
- 8) MIDI Menu 101
 - ◇ MIDI Settings 101
 - ◇ Transmit MIDI Data 102
 - ◇ Channel Receive On/Off 102
 - ◇ MIDI Accordion 103
 - ◇ MIDI Sound Settings 103
- 9) Power Up Settings 104
- 10) Registration Filter 105
- 11) Soft Reset..... 106
- 12) Software Version..... 107
- Display Control 108

8. Virtual Technician 109

1) Touch Curve.....	110
◇ User Touch Curve	110
2) Voicing	111
3) Resonance	112
4) Noise Settings	112
5) Pedal Settings.....	113
6) Temperament.....	113
◇ Brief Explanation of Temperaments	114
7) Stretch	115
8) 88 Key Volume.....	116
9) Hammer Delay.....	117
10) Top Board	117
11) Decay Time.....	118
12) Minimum Touch.....	118

9. Using USB Memory 119

USB Menu	119
Saving Data to USB Memory.....	119
Loading Data from USB Memory.....	121
Erasing Data from USB Memory	123
Formatting a USB Memory Device	124
Play MIDI Song.....	125
Controlling Song Playback.....	126
Playing MP3/WAV Audio.....	128
Recording MP3/WAV Audio	130
Recording with additional sound sources	131

10. Appendices 133

1) Connection Examples.....	133
2) USB MIDI Information.....	135
3) Assembly Instructions.....	136
4) Preset Styles	138
5) Song Stylists.....	140
6) Concert Magic Songs	143
7) Lesson Songs.....	145
8) Accompaniment Chord Types.....	149
9) Program Change Numbers.....	150
10) Drum & SFX Kit Mapping	152
11) Specifications	154
12) MIDI Implementation Chart	155
User Notes.....	156

Important Safety Instructions

SAVE THESE INSTRUCTIONS

INSTRUCTIONS PERTAINING TO A RISK OF FIRE, ELECTRIC SHOCK, OR INJURY TO PERSONS

	<div style="border: 1px solid black; padding: 5px;"> <p>CAUTION RISK OF ELECTRIC SHOCK DO NOT OPEN</p> </div>	
---	--	---

WARNING
TO REDUCE THE RISK OF FIRE OR ELECTRIC SHOCK, DO NOT EXPOSE THIS PRODUCT TO RAIN OR MOISTURE.

AVIS : RISQUE DE CHOC ELECTRIQUE - NE PAS OUVRIR.

TO REDUCE THE RISK OF ELECTRIC SHOCK, DO NOT REMOVE COVER (OR BACK). NO USER-SERVICEABLE PARTS INSIDE. REFER SERVICING TO QUALIFIED SERVICE PERSONNEL.





The lightning flash with arrowhead symbol, within an equilateral triangle, is intended to alert the user to the presence of uninsulated "dangerous voltage" within the product's enclosure that may be of sufficient magnitude to constitute a risk of electric shock to persons.



The exclamation point within an equilateral triangle is intended to alert the user to the presence of important operating and maintenance (servicing) instructions in the literature accompanying the product.

Examples of Picture Symbols

	denotes that care should be taken. The example instructs the user to take care not to allow fingers to be trapped.
	denotes a prohibited operation. The example instructs that disassembly of the product is prohibited.
	denotes an operation that should be carried out. The example instructs the user to remove the power cord plug from the AC outlet.

Read all the instructions before using the product.

- 1) Read these instructions.
- 2) Keep these instructions.
- 3) Heed all warnings.
- 4) Follow all instructions.
- 5) Do not use this apparatus near water.
- 6) Clean only with dry cloth.
- 7) Do not block any ventilation openings. Install in accordance with the manufacturer's instructions.
- 8) Do not install near any heat sources such as radiators, heat registers, stoves, or other apparatus (including amplifiers) that produce heat.
- 9) Do not defeat the safety purpose of the polarized or grounding-type plug. A polarized plug has two blades with one wider than the other. A grounding type plug has two blades and a third grounding prong. The wide blade or the third prongs are provided for your safety. If the provided plug does not fit into your outlet, consult an electrician for replacement of the obsolete outlet.
- 10) Protect the power cord from being walked on or pinched particularly at plugs, convenience receptacles, and the point where they exit from the apparatus.
- 11) Only use attachments/accessories specified by the manufacturer.
- 12) Use only with the cart, stand, tripod, bracket, or table specified by the manufacturer, or sold with the apparatus. When a cart is used, use caution when moving the cart/apparatus combination to avoid injury from tip-over. 
- 13) Unplug this apparatus during lightning storms or when unused for long periods of time.
- 14) Refer all servicing to qualified service personnel. Servicing is required when the apparatus has been damaged in any way, such as power-supply cord or plug is damaged, liquid has been spilled or object have fallen into the apparatus, the apparatus has been exposed to rain or moisture, does not operate normally, or has been dropped.

WARNING - When using electric products, basic precautions should always be followed, including the following.



WARNING

Indicates a potential hazard that could result in death or serious injury if the product is handled incorrectly.

Do not use this product near water - for example, near a bathtub, washbowl, kitchen sink, in a wet basement, or near a swimming pool, or the like.

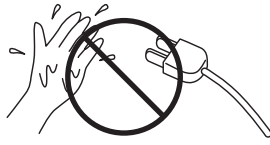

Do not touch the power plug with wet hands. There is a risk of electrical shock. Treat the power cord with care as well. Stepping on or tripping over it can break or short-circuit the wire inside.

The product should be connected to a power supply only of the type described in the operating instructions or as marked on the product.

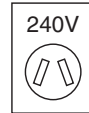
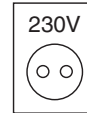
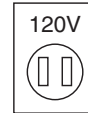

When disconnecting the AC power cord's plug, always hold the plug and pull it to remove it.



Pulling the AC power cord itself may damage the cord, causing a fire, electric shock or short-circuit.

Do not attempt to service the product beyond that described in the user-maintenance instructions. All other servicing should be referred to qualified service personnel.



This product in combination with an amplifier and headphones or speakers, may be capable of producing sound level that could cause permanent hearing loss. Do not operate for a long period of time at a high volume level or at a level that is uncomfortable. If you experience any hearing loss or ringing in the ear, you should consult an audiologist.

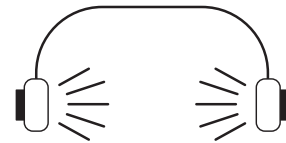

This product may be equipped with a polarized line plug (one blade wider than the other). This is a safety feature. If you are unable to insert the plug into the outlet, contact an electrician to replace your obsolete outlet. Do not defeat the safety purpose of the plug.

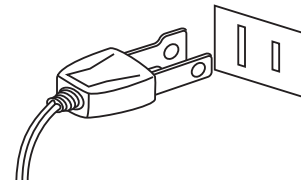

CAUTION

Indicates a potential hazard that could result in injury or damage to the product or other property if the product is handled incorrectly.

Do not use the product in the following areas.

- Areas, such as those near windows, where the product is exposed to direct sunlight.
- Extremely hot areas, or close to heat sources such as radiators, heat registers, or other products that produce heat.
- Extremely cold areas, such as outside.
- Extremely humid areas.
- Areas where a large amount of sand or dust is present.
- Areas where the product is exposed to excessive vibrations.

Using the product in such areas may result in product breakdown.

Always turn the power off when the instrument is not in use. The product is not completely disconnected from the power supply even when the power switch is turned off. The power supply cord of the product should be unplugged from the outlet when left unused for a long period of time.



It is a good practice to have the instrument near the AC outlet and the power cord plug in a position so that it can readily be disconnected in an emergency.

Before connecting cords, make sure that the power to this product and other devices is turned OFF.

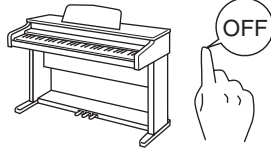

Failure to do so may cause breakdown of this product and other devices.

The product should be located so that its location or position does not interfere with its proper ventilation.

Keep the instrument away from electrical motors, neon signs, fluorescent light fixture, and other sources of electrical noises.

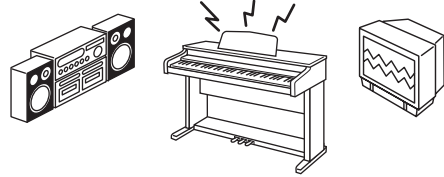

Care should be taken so that objects do not fall and liquids are not spilled into the enclosure through openings. The product shall not be exposed to dripping or splashing. No objects filled with liquids, such as vases, shall be placed on the product.

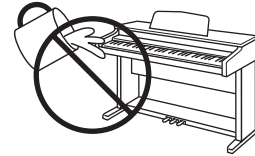

When connecting the AC power cord and other cords, take care not to get them tangled.



Failure to do so may damage them, resulting in fire, electric shock or short-circuit.

Take care not to drop the product. Please note that the product is heavy and must be handled by more than one person. Dropping the product may result in breakdown.



Do not lean against the product. Doing so may cause the product to move unexpectedly, resulting in injury.



Do not stand on the product or exert excessive force. Doing so may cause the product to become deformed or fall over, resulting in breakdown or injury.



Do not wipe the product with benzene or thinner. Doing so may result in discoloration or deformation of the product. When cleaning the product, put a soft cloth in lukewarm water, squeeze it well, then wipe the product.



To reduce the risk of injury, close supervision is necessary when a product is used near children.

This product should be used only with the stand that is provided by the manufacturer.

The product should be serviced by qualified service personnel when:

- The power supply cord or the plug has been damaged.
- Objects have fallen, or liquid has been spilled into the product.
- The product has been exposed to rain.
- The product does not appear to operate normally or exhibits a marked change in performance.
- The product has been dropped, or the enclosure damaged.

Should an abnormality occur in the product, immediately turn the power OFF, disconnect the power cord plug, and then contact the shop from which the product was purchased.

CAUTION:

To prevent electric shock, match wide blade of plug to wide slot, fully insert.

ATTENTION:

Pour éviter les chocs électriques, introduire la lame la plus large de la fiche dans la borne correspondante de la prise et pousser jusqu'au fond.

FCC Information

This equipment has been tested and found to comply with the limits for a Class B digital device, pursuant to Part 15 of the FCC Rules. These limits are designed to provide reasonable protection against harmful interference in a residential installation. This equipment generates, uses and can radiate radio frequency energy and, if not installed and used in accordance with the instructions, may cause harmful interference to radio communications.

If this equipment does cause harmful interference to radio or television reception, which can be determined by turning the equipment off and on, the user is encouraged to try to correct the interference by one or more of the following measures:

- Reorient or relocate the receiving antenna.
- Increase the separation between the equipment and receiver.
- Connect the equipment into an outlet on a different electrical circuit from the receiver.
- Consult the dealer or an experienced radio/TV technician for help.

Declaration of Conformity

Products :	Electronic Piano
Model Number :	CP3
Responsible Party Name :	Kawai America Corporation
Address :	2055 East University Drive Rancho Dominguez, CA 90220
Telephone :	310-631-1771

This device complies with Part 15 of the FCC Rules.

Operation is subject to the following two conditions:

- (1) this device may not cause harmful interference, and
- (2) this device must accept any interference received, including interference that may cause undesired operation.

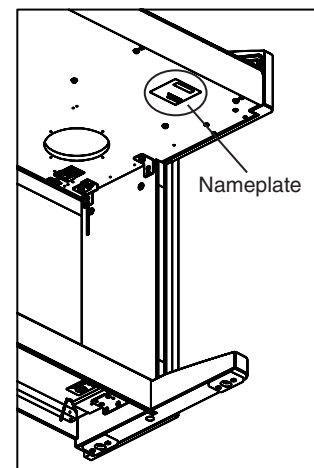

CP3

This applies only to products distributed by Kawai America Corporation.

1. Part Names & Functions

1) Parts and Names

◇ Control Panel

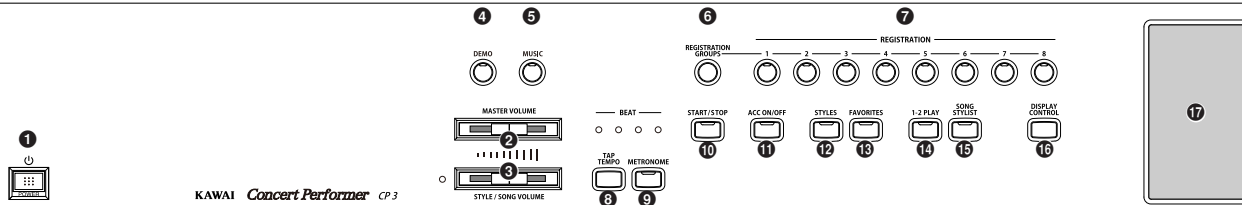

1 POWER

Turns the instrument on/off.

2 MASTER VOLUME

This slider is used to adjust the overall volume level of the instrument.

3 STYLE / SONG VOLUME

This slider is used to adjust the volume level of the Auto Accompaniment Styles. Also used to adjust the volume level of a MIDI song played from the CP's Internal Recorder or directly from USB memory. This slider does not affect the Master Volume Slider setting.

4 DEMO (page 15)

This button is used to select the built-in demo songs.

5 MUSIC (page 82)

This button is used to show the Music Menu, used to select the CP's Concert Magic, Piano Music, and Lesson Function features.

6 REGISTRATION GROUPS (page 63)

This button is used to select one of the 10 groups of preset and user registrations.

7 REGISTRATIONS (page 63)

These buttons are used to recall one of the eight panel settings available in the currently selected Registration group.

8 TAP TEMPO (page 28)

This button is used to tap in the desired tempo for a song or Style.

9 METRONOME (page 28)

This button is used to turn the Metronome on/off.

10 START / STOP (page 57)

This button is used to start and stop the accompaniment style.

11 ACC ON/OFF (page 60)

This button is used to turn the Auto-Accompaniment function on/off.

12 STYLES (page 57)

This button is used show the Styles interface in the LCD display.

13 FAVORITES (page 59)

This button is used to show the Style Favorites screen.

14 1-2 PLAY (page 62)

This button is used to automatically choose an appropriate sound and setup for the selected style.

15 SONG STYLIST (page 66)

This button is used to select the Song Stylist Registrations.

16 DISPLAY CONTROL (page 108)

This button is used to access and adjust settings for the LCD screen.

17 LCD TOUCH SCREEN

Displays information about the CP's current sound selections, options, and settings, etc., while also controlling many aspects of the CP.

18 TEMPO / VALUE Dial

This Dial is used to adjust tempo, scroll through different selections, and adjust data values for items on the LCD screen.

19 EXIT

This button is used to back up to the next-higher screen level. Keep pressing the Exit button from any screen on the CP will bring you back to the CP's main play screen.

20 TRANSPOSE (page 27)

These buttons are used to change the overall pitch of the CP in half-note steps.

21 OCTAVE SHIFT (page 27)

These buttons are used to change the pitch of the selected part in octave steps.

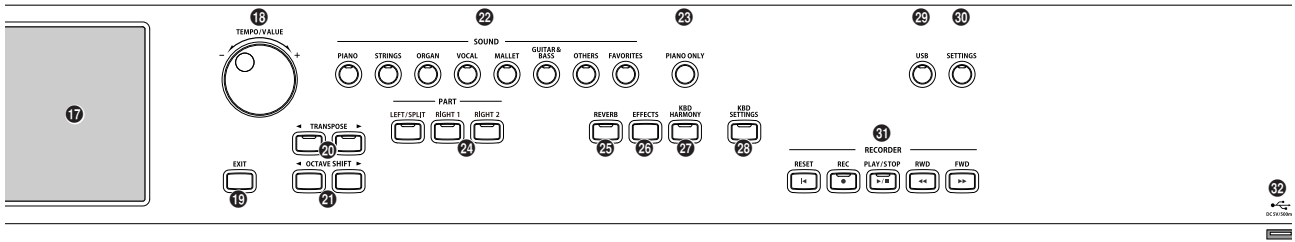
**22 SOUND** (page 18)

These buttons are used to select the desired sound category. Touch the sound name as shown on the LCD display, or rotate the Dial to select a sound within the category.

23 PIANO ONLY (page 29)

This button is used to automatically assign the Concert Grand sound to the RIGHT1 part. Press and hold this button to reset all sounds and styles to the Start Up settings.

24 PART (page 16)

Selects which of the three parts (LEFT/SPLIT, RIGHT1, RIGHT2) are active and ready to be played with the sounds assigned to them.

25 REVERB (page 22)

This button turns on/off the Reverb. Press and hold the button to select the Reverb settings menu.

26 EFFECTS (page 23)

This button is used to select the Effects and Chorus settings menu.

27 KBD HARMONY (page 69)

This button turns on/off the Harmony for instrument sounds. Press and hold this button to access the Harmony Select screen.

28 KBD SETTINGS (page 30)

This button shows the Keyboard Settings screen. Press and hold this button to access settings for the LEFT/SPLIT part as well as the left and Center pedals.

29 USB (page 119)

This button is used to access the USB memory and MP3/WAV play back/record functions.

30 SETTINGS (page 93)

This button is used to access the system settings menu.

31 RECORDER (page 33)

These buttons are used to record and play back a MIDI song stored in internal memory or on a USB device.

32 USB PORT (page 119)

This jack is used to connect a standard USB memory device to read and write user data and record/play MP3/WAV audio files etc.

◇ Pedals

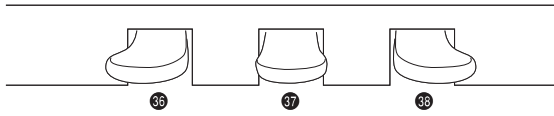
**36 Soft Pedal**

Depressing this pedal softens the sound and reduces its volume. This pedal can also be assigned to control other functions. (See page 95)

37 Sostenuto Pedal

Depressing this pedal after playing the keyboard and before releasing the keys sustains the sound of only the keys just played. This pedal can also be assigned to control other functions. (See page 95)

38 Damper Pedal

Sustains the sound after lifting your hands from the keyboard. The damper pedal is capable of responding to half pedaling.

◇ Front Terminals

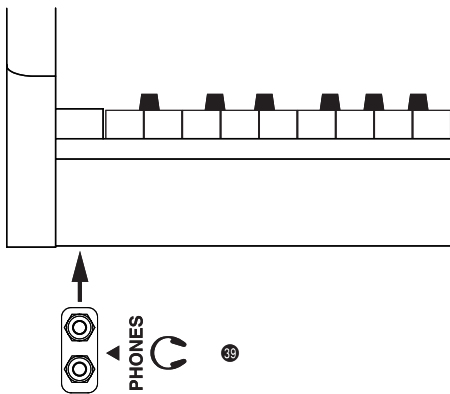
**39 Headphone Jacks**

These jacks are used to connect up to two headphones to the CP piano.

◇ Rear Terminals

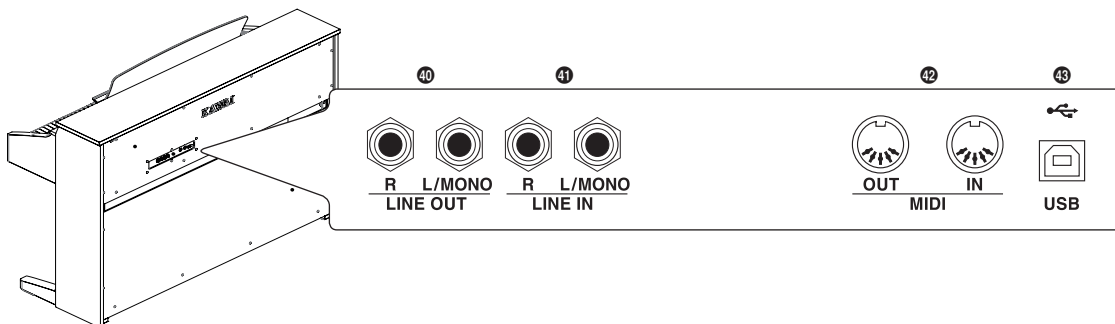
**40 Line Out Jacks**

These jacks are used to provide stereo output of the CP's sound to amplifiers, tape recorders or similar equipment. The audio signal coming through the LINE IN jacks is also routed to these jacks.

41 Line In Jacks

These jacks are used to connect stereo outputs from other audio equipment or electronic instruments to the CP's speakers. The audio signal coming through these jacks bypasses the CP's volume control.

42 MIDI Jacks

These jacks are used to connect external MIDI devices to the CP.

43 USB Jack

This jack is used to connect a personal computer to the CP.

2) Overview of Controls

This manual provides you with all the information you will need in order to take full advantage of the Concert Performer's potential. Before you begin learning how to use the specific features, it is important to understand some of the basic ideas behind the instrument's design.

The Concert Performer has been designed to have an easy and intuitive user interface. However, the instrument has so many features that it is simply impractical to have a dedicated button for every single one. As a result, many features and functions are selected by choosing them from lists, or "menus", that are presented to you on the CP's large display screen. Often times selecting an item from a menu may access another "sub-menu" of options specific to that item. This system of menus and sub-menus keeps everything logical and straightforward and becoming familiar with how to make your way through them is very easy.

◆ Panel Buttons

Most of the buttons on the front panel are used to directly select a function on the CP that you would like to work with. In most cases, the specific function name is printed on the front panel directly above the button. For example, there are buttons labeled START/STOP, STYLES, and so on. In this manual, references to these buttons are always printed in capital letters for clarity. Most of these buttons have an LED Indicator (small light) on them. This Indicator will be turned ON when a function is in use so that you can quickly see if that function is active.

◆ LCD Touch Screen

The LCD Touch Screen is the window through which the Concert Performer communicates with you. The large display size allows many items to be clearly displayed at the same time, allowing for not only words but graphics to be shown as well.

As well as providing information about the current sound and style selections, and other important settings, the LCD display can also be used to control numerous functions of the CP3. Simply touch the part of the screen that corresponds to the function you wish to control or adjust. Below is an example of the default MAIN screen that appears when the instrument is first turned on.

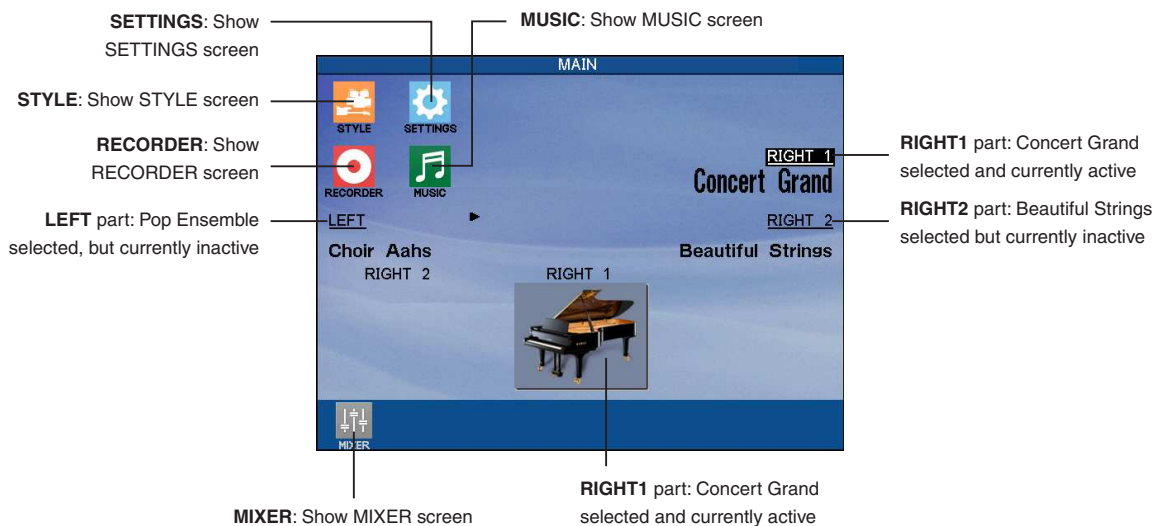

In some cases when you touch an item displayed on the screen, that item will become highlighted (shown in reverse color) to indicate you it has been selected. However, in other cases a submenu screen relating to that item will be displayed, presenting you with further options.

To exit a screen, press the EXIT button, or touch the X icon (when visible) positioned in the top right corner of the screen.

Note that in order to avoid possible confusion within this owner's manual, operating instructions related to the touch screen will use the verb *touch*, while instructions related to the button panel will use the verb *press*.

E.g.:

- *Touch* the **PAGE** ► button on the LCD display.
- *Press* the **RIGHT1** panel button.

If no panel buttons are pressed, and the LCD display is not touched while showing different screen menus (such as the sound or style category lists), the LCD display will automatically return to the MAIN screen after a period of 20 seconds. To adjust this waiting period, or to prevent the MAIN screen from returning automatically, please refer to the **Display Control** instructions on page 108 of this owner's manual.

◆ Dial

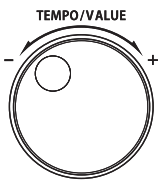

The Dial is used to change data values and scroll through options that are displayed on the LCD screen.

When you turn the Dial, you will notice that whatever item on the LCD screen is currently selected (highlighted) will be affected. For example, when a Part is selected, turning the Dial will change the sound of that Part, while if the mixer screen is shown, turning the Dial will increase/decrease the level of the selected part.

Alternatively, when the screen presents you with a list of choices, turning the Dial will allow you to quickly scroll through the list until you arrive at your choice.

2. Listening to the Piano

1) Demonstrations

The Concert Performer features a variety of built-in Demonstration songs that really show off the musical potential of the instrument. These songs were composed by some of the top musicians in the music industry, and will undoubtedly impress and inspire you. There are two types of Demonstrations programmed in the CP piano.

◆ Sound Category Demos

Each Sound category has a song, or songs, that demonstrate the sound choices and capabilities found in the category.

◆ Style Category Demos

Each Style category has a song, or songs, that demonstrate how the Auto-Accompaniment Styles can be used.

◆ To listen to a Guided Tour/Sound/Style Demo

□ Step 1

Press the DEMO button.



A Sound or Style demonstration will be selected at random and begin to play. The name of the Sound/Style demonstration will be shown in the LCD display.



SKIP : Skip to the next demonstration song in the category.

□ Step 2

Select your preferred Demo.

- ◆ Press a SOUND category button to select a SOUND category demo.
- ◆ Press the STYLES button, then touch a STYLE category to select a STYLE category demo.

SOUND or STYLE categories may play more than one demo song in sequence.

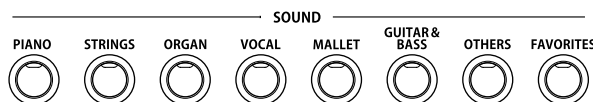

The SOUND category buttons are used to select the demo for that Sound category.

□ Step 3

To exit, press the EXIT, PLAY/STOP or the DEMO button.

- When a selected Demo song ends, another song of the same type will be randomly chosen from another category and played. You can select another demo song at any time by pressing the appropriate button.

3. Playing the Piano (Basic Controls)

This chapter discusses the basic operations that are used to play the Concert Performer, such as sound selection, Part configuration and effect settings.

1) Selecting a Part to Play

When the CP's main play screen is displayed (For example, when the CP is first turned on), you are presented with three sound Parts that can be played from the keyboard. These three Parts are named LEFT/SPLIT, RIGHT1, and RIGHT2, and each one has an instrument sound assigned to it. You can selectively turn on/off any combination of these three Parts, allowing you to have up to three different sounds at the same time across the keyboard.

Sound assigned to Parts RIGHT1 and RIGHT2 will be layered on top of each other when both parts are active at the same time.

Activating the LEFT/SPLIT Part automatically splits the keyboard so that the sound assigned to the LEFT/SPLIT Part is only heard when you play below a specified key (split point). Each Part has a dedicated button on the front panel that selects and turns on/off that Part. You can also select a Part by touching the appropriate area of the screen.

◆ Selecting a Part is easy:

□ Step 1

Press the PART button for the Part you wish to activate.

The PART button LED will light.

□ Step 2

Press the PART button again to turn that Part off.

- If the LCD screen is currently showing the main play screen, you can tell which Parts are active by looking at the name of the sound assigned to it. If the name of a sound is in a large typeface, then the Part it is assigned to is active. If the sound name is displayed in a small typeface, then the Part is not active.



◇ Splitting the keyboard

When the LEFT/SPLIT Part is activated, the CP automatically splits the keyboard and only the sound assigned to the LEFT/SPLIT Part will be heard when you play below a specified key (split point) on the keyboard. The default split point is between F3 and F#3 but you can freely change the split point to any key on the keyboard.

To change the split point:

□ Step 1

Press the LEFT/SPLIT button to activate the LEFT/SPLIT Part.

The LEFT/SPLIT button LED will light.

□ Step 2

Press and hold the LEFT/SPLIT button, then press the desired key on the keyboard that you want to serve as the split point.

The key you press will become the lowest note the Right hand Parts will play (RIGHT1, and RIGHT2). The LEFT/SPLIT sound will be heard when keys below the split point are played.

□ Step 3

The split point for the LEFT/SPLIT part can also be set from the KBD SETTINGS button menu.

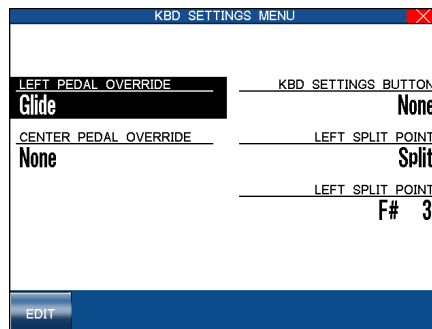

- Moving the split point completely to the LEFT end of the keyboard will allow the LEFT/SPLIT Part to function as a layer with the three right hand Parts. In this manner you can create a three part layer across the entire keyboard.

2) Selecting Sounds

The Concert Performer has over 700 instrument and drum sounds available from the front panel. You can freely assign any of these sounds to the three Parts. Remember that there is always a sound assigned to each of the Parts, even if some of the Parts are not currently active.

The sounds span a tremendous variety of instruments, ranging from traditional acoustic sounds to modern electronic tones. To help you quickly find the sound that you want, the sounds have been organized into 8 categories, each with a dedicated Sound Selection button on the front panel.

Pressing the OTHERS button will display a separate menu, with an extra 9 sub-categories of additional sounds to be selected. Within the OTHERS display, the USER category provides convenient access to User edited sounds.

Finally, the FAVORITES button allows up to 20 of your favorites sounds to be stored and recalled simply and conveniently.

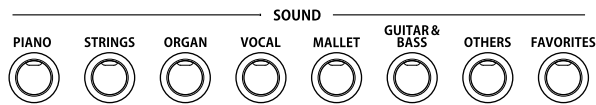

◆ To select a Sound:

□ Step 1

In the main play screen, touch the Part to which you wish to assign a new sound.

The selected Part will become highlighted.

□ Step 2

Press the SOUND button for the sound category that you are interested in.

Sounds from the first page of the Master tab will be displayed. The Master tab lists all available instruments from the chosen category, and typically spans several pages. It is also possible to display only the instruments of a particular sub-category by touching the relevant tab. For example to display drawbar organ sounds only, first press the ORGAN button, then touch the Drawbar tab. Remember that each tab can list several pages of instrument sounds.

□ Step 3

Select a sound by touching the displayed name.

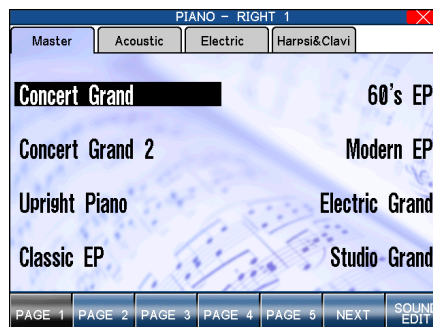

PAGE : Selects the different pages of Sounds within a category.

SOUND EDIT : Takes you to the Sound Edit menu. (See "Editing Sounds" on page 86.)

□ Step 4

Touch the PAGE buttons to show the Sounds on the other pages for the same category.

□ Step 5

You can also use the Dial to scroll through all of the categories and sounds one by one.

◇ Favorite Sounds

Because of the sheer number of sounds available, it can take a while to scroll through the various categories, sub-category tabs, and pages in order to find a particular sound. Fortunately, the Favorites category allows you to store your favorite sounds on a separate button menu for easy selection.

◆ To create a Favorite sound:

□ Step 1

Press the FAVORITES sound button.

The FAVORITES screen will be shown, with a list of predefined Favorite sounds.

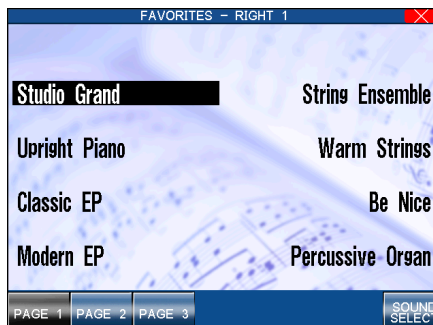

PAGE: Selects the different pages

SOUND SELECT: Chose the sound for the selected Favorite position.

□ Step 2

Touch one of the Favorite sound names.

That entry will become selected.

□ Step 3

Touch the SOUND SELECT button.

The Favorites screen will enter EDIT mode.

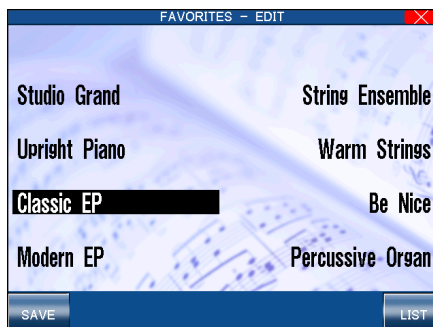

SAVE: Save the favourites list to memory

LIST: Return to LIST mode.

□ Step 4

Press one of the SOUND category buttons, then select the desired sound.

The selected sound will become a Favorite sound.

□ Step 5

Press the EXIT button or touch the LIST button to return to the FAVOURITES screen.

□ Step 6

Touch the SAVE button.

The Favorites list will be saved to the internal memory.

- If the Favorites list is not saved, the list will return to the default setting when the power is turned off, and any stored Favorites will be lost.

3) Mixer

This Mixer screen allows you to change the volume, panning, reverb and chorus levels, as well as turn the effect on/off for each Part.

◆ To use the Mixer:

□ Step 1

Touch the MIXER button while on the main play screen.

The Mixer screen will be shown.



STYLE MIXER : Show the Style Mixer screen.
PART BUTTONS : Selects the part to adjust.
HARMONY : Show the Harmony screen.

□ Step 2

Touch the buttons at the bottom of the screen to select the Part to be adjusted.

□ Step 3

Touch the slider that you wish to adjust.

A larger version of the selected slider will be shown.

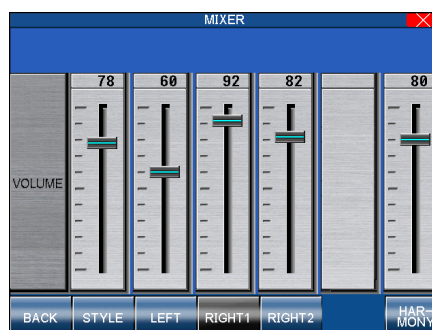

BACK : Return to the main Mixer screen.
PART BUTTONS : Selects the part to adjust.
HARMONY : Show the Harmony screen.

□ Step 4

Use the Dial or touch and drag the slider to adjust the value.

■ Volume level can be also adjusted from the main play screen, using the VOLUME buttons, then using the Dial.

◆ To adjust the individual Section level:

The Mixer not only lets you set the overall volume level for the Style, but set individual volume levels for the 6 Sections within a Style.

Step 1

On the Mixer screen, touch the STYLE MIXER button.

The Style Mixer screen will be shown.



BACK : Return to the main Mixer screen.
PART BUTTONS : Selects the Section to adjust.

Step 2

Touch the buttons at the bottom of the screen to select the Part to be adjusted.

Step 3

Use the Dial, or touch and drag the slider to adjust the value.

Step 4

Touch the the BACK button to go back the previous Mixer screen, or press the EXIT button to go back to the main play screen.

4) Effects

You might have noticed that when you select some of the sounds, the LED indicator for the REVERB button is turned on. The reason for this is some of the sounds are automatically set up to use reverb with one or more additional effect on as part of their initial setting.

Adding an effect to the sound enhances tonal quality and improves acoustical realism. The CP piano is provided with three separate groups of effects. The first is REVERB, the second is CHORUS, and third group EFFECTS contains other useful effects such as Delay, Phaser, Rotary Speaker etc. The Concert Performer has a selection of 34 different Reverb, Chorus, and Effect types that can be used to enhance or even dramatically alter the instrument sounds. Each of the over 700 instrument and drum sounds has already been assigned a REVERB and CHORUS setting and an additional EFFECT that suits that particular type of instrument. For example, a moderate Delay effect is used on the Church Organ to recreate the sense of being in a large church, and a Rotary speaker effect is used on the Drawbar organ to give it an authentic, vintage feel.

If you wish, you can change any of these effect settings separately for each sound, then save them as the new Preset effect settings for that Sound. In addition, by setting the Effect For Sound function in the Settings Menu to "Panel" the CP will ignore the preset effects settings for each Sound (see Effect For Sound on page 98).

(The CP piano can also remember your Effect settings as part of a Registration. See Registration on page 63.)

◇ Adding Reverb

□ Step 1

Press the REVERB button.



The REVERB button LED will light.

□ Step 2

If you wish to edit the settings, hold down the REVERB button for a moment until the Reverb Settings screen is displayed.

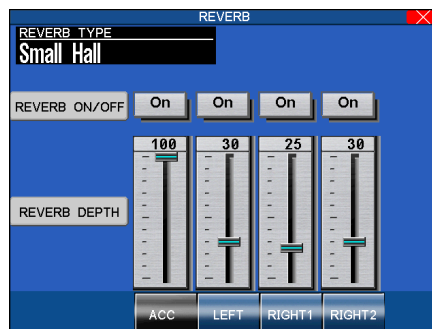

PART BUTTONS : Selects the part to adjust.

□ Step 3

Use the Dial to select the Reverb type.

□ Step 4

Touch the buttons above each slider to turn the reverb effect on or off.

□ Step 5

Touch the slider/Part that you wish to adjust.

□ Step 6

Use the Dial or touch and drag the slider to adjust the value.

□ Step 7

Press the EXIT button to leave the Reverb Settings menu.

□ Step 8

If you wish to turn the reverb effect off, press the REVERB button again.

◆ Type of Reverb

Room	Simulates the ambiance of a living room or small rehearsal room.
Lounge	Simulates the ambiance of a piano lounge.
Small Hall	Simulates the ambiance of a small hall.
Concert Hall	Simulates the ambiance of a concert hall or theater.
Live Hall	Simulates the ambiance of a live hall or stage.
Cathedral	Simulates the ambiance of a large cathedral.

■ The LED Indicator on the REVERB button will be lit whenever Reverb is turned on for the any Part except ACC (regardless of each part's Effect Priority). See "Effect Priority Guidelines" later in this chapter for an explanation of Effect Priority.

◇ Adding Chorus

□ Step 1

Press the EFFECTS button.



The EFFECT/CHORUS select screen will be displayed.

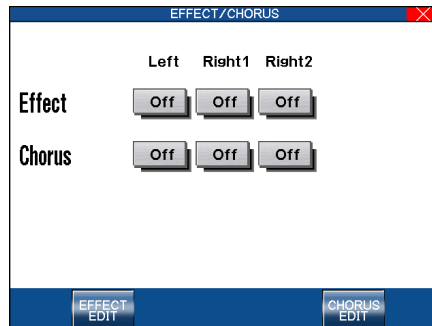

EFFECT EDIT : Show the Effect Edit screen.
CHORUS EDIT : Show the Chorus Edit screen.

□ Step 2

Touch the CHORUS EDIT button.

The CHORUS settings screen will be displayed.

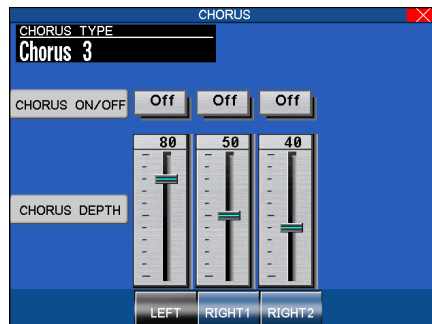

PART BUTTONS : Selects the part to adjust.

□ Step 3

Use the Dial to select the Chorus type.

- Step 4
Touch the buttons above each slider to turn the Chorus effect on or off.
- Step 5
Touch the slider/Part that you wish to adjust.
- Step 6
Use the Dial or touch and drag the slider to adjust the value.
- Step 7
Press the EXIT button to leave the Chorus settings screen.

■ You can select from four chorus types when in the Chorus Settings menu. There is a fifth chorus type which is assigned as an Effect from the Effect Settings menu. In this way, you can actually have two chorus effects active if so desired.

◇ Adding an Effect

- Step 1
Press the EFFECTS button.



The EFFECT/CHORUS screen will be displayed.

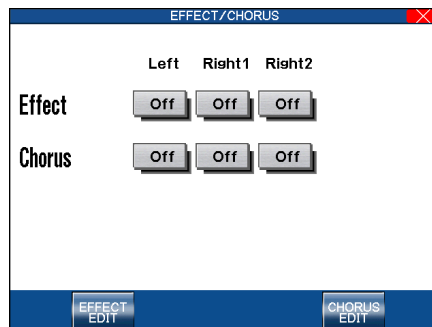

EFFECT EDIT : Show the Effect Edit screen.
CHORUS EDIT : Show the Chorus Edit screen.

- Step 2
Touch the EFFECTS EDIT button.

The EFFECTS settings screen will be displayed.

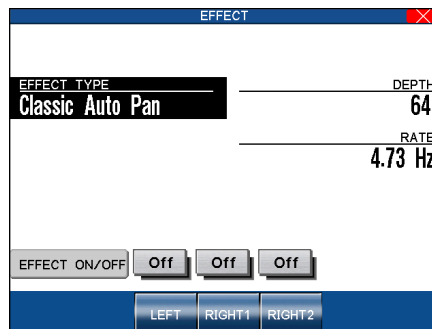

PART BUTTONS : Selects the part to adjust.

- Step 3
Use the Dial to select the Effect type.

- Step 4**
Touch the buttons to turn the Effect on or off.
- Step 5**
Touch the Effect parameters that you wish to adjust.
- Step 6**
Turn the Dial to adjust the value.
- Step 7**
Press the EXIT button to leave the Effect settings screen.

Effect Name	Description
Chorus, Classic Chorus	Simulates the rich character of a vocal choir or string ensemble, by layering a slightly detuned version of the sound over the original to enrich it. Classic Chorus is similar in principle to Chorus, but intended for vintage electric piano sounds.
Celeste	A three-phase chorus without modulation.
Ensemble	A three-phase chorus with a slight modulation to each phase.
Flanger	Creates a shifting comb-filter, which adds motion and a "hollow" tone to the sound.
Phaser, Classic Phaser	Creates a phase change, adding motion to the sound. Classic Phaser replicates a vintage effect.
Auto Wah	Sweeps a tone filter up and down the a note, recreating the popular vintage wah pedal sound.
Tremolo, Classic Tremolo	Modulates the volume of the sound. This is a vibrato type effect. Classic Tremolo replicates a vintage effect.
Tremulant	A combination of Tremolo and Vibrato. It simulates the tremulant pipes of a church organ.
Auto Pan, Classic A.P.	Moves the sound left and right across the stereo field at a variable rate. Classic Auto Pan replicates a vintage effect.
Standard Delay, Pingpong Delay, Triple Delay	Adds echoes to the sound. The three types differ in the length of time between the echoes.
Overdrive	Simulates the tonal character of an overdriven valve amplifier.
Distortion	Adds frequencies that were not present in the original sound, resulting in a "fuzzy" or warmer tone.
Rotary1 ~ Rotary6	Simulates the sound of a rotary speaker commonly used with vintage electronic organs. There are three different levels of overdrive, with and without a Chorus effect. The soft pedal can be used to alternate the speed of the rotary simulation between 'Slow' and 'Fast' effect modes.
Compressor	Boosts the level of softer notes while limiting the level of louder notes to create a more 'even' volume.
Standard EQ	Applies user-definable 3-band equalisation to the sound.
Enhancer	Emphasizes high frequencies to make a sound more easily discernible in a mix.
Combination Effects	Different combinations of the above effects, applied simultaneously. Combination effect types: Chorus+Chorus, Tremolo+Chorus, Phaser+AutoPan, Phaser+Chorus.
Amplified Effects	A selection of the above effects, with a vintage electric piano speaker effect applied.

◇ Effect Priority Guidelines

Reverb and Chorus are global effects. In other words, all of the Parts and the Accompaniment Style must share the same Reverb and Chorus type. However each of these Parts can have a different amount of Reverb and Chorus applied to them. In addition Reverb and Chorus can be independently turned on/off for each part. However, since the CP's EFFECT section can only have one Effect turned on at a time (in addition to the REVERB and CHORUS), what happens if you have two (or more) Parts active, with entirely different sounds, each with a different Effect setting? In these cases, the CP's Effects section can only use the Effect settings for one of the Parts. The EFFECT section chooses which Effect settings to use based upon a predetermined priority order for each of the Parts.

Effect part priority

RIGHT1 > RIGHT2 > LEFT/SPLIT

The preset effect settings for the Priority Part will be used and the other Parts will either share these settings or may have their Effects automatically turned off.

This “**Priority Part**” depends on the current situation. If you only have one Part active, regardless of which Part it is, the preset effect settings for that sound will be used. If you have two or more Parts active, then the CP will treat one of them as the Priority Part, and ignore the settings of the other(s).

If the the Effect For Sound is set to “Panel” in the System then the Preset effect settings for each Sound will be ignored and the Part Priority will be ignored. (See Effect For Sound on page 98).

Here are some guidelines for Effect Priority:

- Priority is given to the Parts in the following order: RIGHT1 > RIGHT2 > LEFT. This means that anytime the RIGHT1 Part is active, its Effect settings will be used, not only for its sound but for any sound in any other Part, that you want to add effects to. Likewise, the only time an active LEFT Part’s settings will be applied is if the other 2 Parts are inactive.
- Unless you change them, the Effect settings will only change in response to a change in the Priority Part being activated/deactivated, or a new sound is assigned to an active Priority Part. In the latter case, the new Effect settings will reflect the Preset effect settings for the new sound.
- When the Effect settings change for the Piority Part, the Effects will be automatically turned off for the other Parts.
- You can, however, turn the effect on for any Part by adjusting the Effect On/Off option in the display for that Part.

◆ Example

Assume that your CP is set up according to the following chart.

	RIGHT1	RIGHT2	LEFT
Part	Active	Inactive	Active
Effect	On	Off	On

If you then select a different sound for RIGHT1, the Effect setting for the RIGHT2, LEFT will be turned off automatically. This is because RIGHT1 is the Priority Part.

The chart would now look like this:

	RIGHT1	RIGHT2	LEFT
Part	Active	Inactive	Active
Effect	On	<u>Off</u>	<u>Off</u>

5) Transpose and Octave Shift

Transpose raises or lowers the CP's pitch in half-step increments. Octave Shift does the same but in octave increments.

Transpose can be especially useful when you have learned a song in one key and have to play it in another key. The transpose feature allows you to play the song in the original key, but hear it in another key. You can transpose the Concert Magic songs, the Accompaniment Styles, and any of the over 700 instrument and drum sounds available in the CP. MP3/WAV audio data saved to USB memory cannot be transposed once it has been recorded.

Octave shift can be very useful when you are playing multiple sounds across the keyboard. You may want to use the octave shift to adjust a bass sound assigned to the LEFT/SPLIT Part to play in the proper pitch range, or to set one sound in a layer to play in a different octave so that it mixes well with other sounds in the layer. Octave shift is only available for the three Parts: LEFT/SPLIT, RIGHT1, and RIGHT2.

◆ To Transpose:

□ Step 1

Press either the ◀ or ▶ TRANSPOSE buttons.

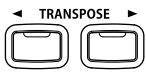

The transpose amount will be displayed in the top right corner of the LCD screen. The LCD screen shows you a number telling you how many half steps up or down you have transposed the piano. -5, for example, represents a transposition that is 5 half steps lower.

□ Step 2

To cancel the Transpose setting, press both the ◀ and ▶ buttons at the same time.

The transpose amount will disappear from the LCD screen, indicating that the CP is now back to its original setting.

◆ To use the Octave Shift:

□ Step 1

Select the Part that you would like to apply the shift to.

□ Step 2

Press either the ◀ or ▶ OCTAVE SHIFT buttons.



The number of shifted octaves (up or down) will be displayed with an ◀ in the LCD screen.

□ Step 3

To cancel the octave shift setting, press both the ◀ and ▶ buttons at the same time.

The symbols will disappear from the screen, indicating that the selected Part is back to its normal octave range.

The Octave Shift amount is represented by the number and direction of triangles shown beside the relevant Part name.



The Transpose amount is displayed in the top right corner of the LCD screen.

- The Octave Shift has a range of four octaves in each direction. However, some on board sounds may have a limited range in which they play properly. If you shift too far out of this range, the instrument may sound strange or may not play at all. This has no affect on the CP's proper function though, and you should feel encouraged to use this feature as a means of getting interesting tonal variations out of the preset Sounds.

6) Metronome

Rhythm is one of the most important elements when learning music. It is important to practice playing the piano at the correct tempo and with a steady rhythm. The CP piano's metronome is a tool that helps you to achieve this by providing a steady beat for you play along with.

◆ To use the Metronome:

□ Step 1

Press the METRONOME button.



The CP piano will start counting with an audible steady beat.

A metronome icon and the beat (time signature) will appear next to the Tempo value.

□ Step 2

Touch the BEAT (or TEMPO) button to alternate between TEMPO and BEAT adjustment mode.

□ Step 3

Use the Dial to change the TEMPO or BEAT value.



You can also adjust the tempo by tapping on the TAP TEMPO button. Simply tap on the button with your finger three or more times at the desired tempo, and the CP will automatically translate that into a tempo value on the screen.

□ Step 4

Touch the VOLUME button.

□ Step 5

Use the Dial or touch the VOLUME - and VOLUME + buttons to adjust the metronome volume.

□ Step 6

To stop the metronome, press the METRONOME button again.

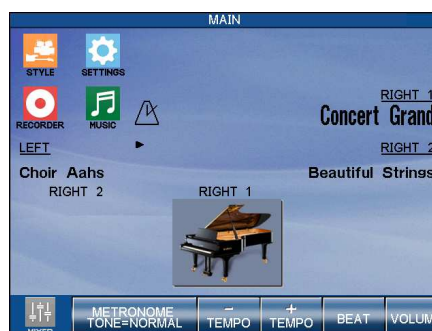

MIXER : Takes you to the Mixer menu.

METRONOME TONE : Alternates the metronome tone between a bell chime and a spoken voice count.

BEAT/TEMPO : Adjusts the beat or tempo of the metronome.

VOLUME : Adjusts the volume level of the metronome.

- It is also possible to change the sound of the metronome from a standard bell chime to a spoken voice count by touching the METRONOME TONE button.

7) Piano Only

The Piano Only button provides a way to quickly set the Concert Performer up to play the Concert Grand piano sound. Pressing the Piano Only button immediately turns off all Parts except the RIGHT1 part and sets the RIGHT1 sound to Concert Grand.

The Piano Only button also turns off all auto-accompaniment functions and stops the Easy/Advanced Recorder. Additionally, pressing the Piano Only button will cause the CP to exit any function or editing screen (except for Concert Magic) and immediately return to the Main Screen.

When you are using Concert Magic, pressing the Piano Only button will change the Concert Magic song's preset sounds to Concert Grand piano.

Pressing and holding the PIANO ONLY button will revert the panel settings to their original factory settings.

- You can also use the Piano Only button as a “panic button” to immediately stop any unintended accompaniment style or recording, or to quickly exit any confusing situation and return to a familiar piano sound.

◆ To use Piano Only:

Press the PIANO ONLY button.



The Main Screen is displayed and the Concert Grand sound is assigned to RIGHT1.

8) KBD Settings Button

The KBD SETTINGS button puts several useful performance functions conveniently at your fingertips by grouping them under one button. You can customize settings and access them via the KBD SETTINGS button for the following functions:

- LEFT pedal override
- CENTER pedal override
- KBD SETTINGS button
- LEFT mode
- LEFT split point

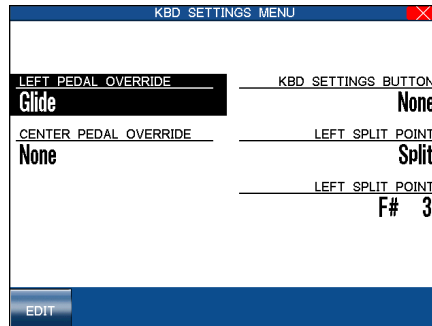

◇ LEFT PEDAL and CENTER PEDAL Override

You can assign the following four functions to the left pedal and center pedal. Settings made in the KBD SETTINGS button menu will override the settings made in the system.

Glide	Bends the pitch up and down as programmed by you.
Modulation	Applies programmable vibrato to the sound.
Registration Increment	Switches from one Registration to another 1 to 8.
Registration Decrement	Switches from one Registration to another 8 to 1.

◆ To set the pedals:

□ Step 1

Press and hold the KBD SETTINGS button.



The KBD Settings screen will be displayed.

□ Step 2

Touch LEFT PEDAL OVERRIDE or CENTER PEDAL OVERRIDE and use the Dial to select the function to be assigned to the pedals.

When Glide or Modulation is selected, additional settings can be adjusted using the edit button:

□ Step 3

Press the KBD SETTINGS button to exit this screen.

□ Step 4

Press the KBD SETTINGS button again.

The KBD SETTINGS button LED will turn on and the settings for the pedals will override the system settings. If the LEFT or CENTER pedal is set to None, the system settings for that pedal will be used. The words LP or CP will be displayed in the upper left on the main screen to indicate the LEFT or CENTER pedal override is active.

□ Step 5

Press the KBD SETTINGS button.

The LED will turn off and the system settings for the pedals will be used. The words LP or CP will disappear from the main screen.

◆ KBD SETTINGS BUTTON ASSIGN (Panel Lock)

You can assign Panel Lock to the KBD SETTINGS button.

Panel Lock

Locks all buttons on the panel to prevent them from being tampered with or pressed accidentally while you are playing. When the KBD Settings Button is turned On the panel buttons will be locked. Turn the KBD Settings button Off to unlock the panel buttons.

◆ To assign Panel Lock:

Step 1

Press and hold the KBD SETTINGS button.

The KBD SETTINGS screen will be displayed.

Step 2

Touch KBD SETTINGS BUTTON and use the Dial to assign a function.

Step 3

Press the KBD SETTINGS button to exit.

Step 4

Press the KBD SETTINGS button.

The LED will light and the function assigned to the button will be activated. If Panel Lock is assigned, the words "PANEL LOCKED !" will appear at the top of the screen, and the CP will not respond to button pushes until the panel is unlocked.

Step 5

Press the KBD SETTINGS button.

The LED will turn off and the function will be deactivated. The word "BUTTON" will disappear from the main screen and the Panel Lock function will be deactivated.

■ If the LEFT and CENTER PEDAL OVERRIDE and KBD SETTINGS BUTTON are all set to None, the LED will not light when you press the KBD SETTINGS button.

◇ LEFT MODE

When using the Left part, you can select between two Modes, Split or Layer.

Split

When the LEFT/SPLIT Part is activated, the CP automatically splits the keyboard and only the sound assigned to the LEFT/SPLIT Part will be heard when you play below a specified key (split point) on the keyboard. The default split point is between F3 and F#3 but you can freely change the split point to any key on the keyboard.

Layer

When the LEFT/SPLIT Part is activated, the LEFT/SPLIT Part will function as a layer with the two right hand Parts. In this manner you can create a three part layer across the entire keyboard.

◆ To set the Left Mode and Split point:

- Step 1**
Press and hold the KBD SETTINGS button.
The KBD SETTINGS screen will be displayed.
- Step 2**
Touch LEFT MODE and use the Dial to select the mode.
- Step 3**
If Left Mode is set to Split, touch LEFT SPLIT POINT and use the Dial or press a key to set the split point.
- Step 4**
Press the KBD SETTINGS button to exit.

4. Recording a Song

The CP has built-in recording capabilities that allow you to record and play back your performances. Since the CP records your performances as digital data, not audio data, you can easily edit your performances after recording them. There are two ways to use the CP's recording feature:

Easy Recorder records your playing much like a tape recorder and is just as easy to use. The CP will record all of your playing as well as any changes you make to the front panel settings during the recording.

Advanced Recorder is useful for creating more complex recordings. Advanced Recorder gives you the ability to record on up to 16 independent tracks separately. In addition, with Advanced Recorder you can edit your recorded data one measure or even one note at a time. There is also a step recording mode in which you can enter notes or other MIDI data events one step at a time for even more accurate control.

Song data created on other instruments in the Standard MIDI File format (SMF) can also be loaded into the CP's recorder to be played or edited. The CP's recorder can read both Type 1 and 0 SMF files.

Please read the following sections carefully to learn more about the capabilities of the Easy and Advanced recorder.

1) Easy Recording

The Easy Recorder will record all of your playing as well as any settings you have made on the front panel or in the mixer screen at the touch of a button. Simply press the REC button and the CP will begin recording with the first note you play. You can also record a Style along with your playing if you like. Before you begin recording it's a good idea to select your desired sound(s) and make any panel settings you would like to record.

◆ To record:

□ Step 1

Press the REC button.

The REC button LED will blink and the LCD screen will show Rec Ready. If you want to, you can still change sounds or panel settings before proceeding.



□ Step 2

Start recording in one of the following ways:

- A. Play the keys and the CP will automatically start recording with the first note you play.
- B. If you are recording with a Style, press the START/STOP button to start the recorder with the Style. Pressing the INTRO/ENDING button will include an Intro phrase at the beginning of the recording.
- C. You can also press the SYNC button to begin recording the Style and your own playing together.
- D. Press the PLAY/STOP button to start with a 2-bar countdown to help you get ready.

□ Step 3

When you are finished recording, press the PLAY/STOP button.

You may resume recording from the point where you stopped by repeating these steps from step 2.

The current bar number is displayed beside the tempo.



You can make changes to the panel settings before and during recording.

*MORE : Display additional menu options (Delete etc.)
MIXER : Show the Mixer screen.
PART BUTTONS : Changes the part status.*

- You may resume recording from the bar where you stopped by repeating these steps. You can also change sounds, tempo, and make other changes to the panel settings before you continue recording.
- To Re-record or make other changes to a previously recorded section of a song, please read the section titled “Re-recording or adding another Part” on page 40.

◆ To play back the recorded song:

□ Step 1

Press the RESET button in the RECORDER section of the front panel to return to the first bar of the song.



□ Step 2

Press the PLAY/STOP button to play back the song.

□ Step 3

Press the PLAY/STOP button again to stop at any time.

□ Step 4

Pressing the PLAY/STOP button again resumes the playback from the bar where you stopped.

□ Step 5

Use the RWD or FWD buttons to rewind or fast-forward through the recording.

◆ Part Status

The playback and record status for the RIGHT/LEFT Parts and the Style are displayed at the bottom of the LCD screen. Whether you are in the process of recording or playing back your song it is helpful to know the status for each of these Parts.

The LCD screen will show the following Part status messages at the bottom of the screen:

- REC** This Part is ready to be recorded. This message is only displayed after the REC button has been pressed.
- PLAY** This Part has been recorded and will be heard both on playback and while recording.
- MUTE** This Part has been recorded but will be silent both on playback and while recording.
- - - This part has not been recorded.

After you have recorded a song you can change the status for a Part by touching the appropriate Part button, at the bottom of the LCD screen. Touching these Part buttons during playback will select PLAY or MUTE. REC can only be selected after you press the REC button but before you begin recording.

During recording you can however set any Part to PLAY or MUTE by touching the appropriate Part button.

You can record all RIGHT/LEFT Parts as well as the Style simultaneously or only certain Parts as you choose. When you first record a song all Parts and the Style will be automatically set to REC but only the active Parts and the Style will be recorded. When you are finished recording the status for any active Parts and the Style will automatically change from REC to PLAY. After recording, the status for any RIGHT/LEFT Parts that were not active during recording will be automatically changed to - - - to show they have not been recorded yet.

When you press the PLAY/STOP button to listen to your song any Parts set to PLAY status will be heard.

◇ Re-recording or adding another Part

After you have recorded a song you can Re-record a Part or add (overdub) other Parts if you like with the following procedure. Re-recording a Part completely erases the previous performance for that Part automatically.

◆ To Re-record or add a Part:

- Step 1**
Make sure the Part(s) you wish to Re-record are active, then select any sounds or change panel settings as desired.
- Step 2**
Press the REC button.
- Step 3**
Touch the appropriate Part button(s) at the bottom of the LCD screen to set the desired Part(s) to REC.
- Step 4**
Begin recording by following step 2 in the “To Record” section on page 40.

Remember Re-Recording a Part completely erases the previously recorded performance for that Part. You can Re-record or add any of the RIGHT/LEFT Parts as many times as you like but you can only have one performance/sound for each RIGHT/LEFT Part.

◇ Storing the song in Internal Memory

Once you finish recording a song you should store it in the internal memory before you turn the power OFF. Once the power is turned OFF your song data will be lost.

■ If you press the EXIT button to get out of the Easy Recorder, the CP will automatically prompt you to save your work.

◆ To Store a song to the internal memory:

□ Step 1

Touch the MORE button.

Additional buttons will be displayed at the bottom of the screen.

□ Step 2

Touch the SAVE button.

The Save My Song screen will be shown, with a virtual keyboard used for entering a name of the song.

□ Step 3

Touch the screen to enter a name for the song.

□ Step 4

Touch the EXEC button to store the song.

◇ Erasing the song

Whenever a Part is selected for recording, the new performance is written right over any existing one that may be there for that Part. In this sense, the Easy Recorder is just like a tape machine. A new song will simply erase the old song during the recording process.

However, if you wish to simply erase all the Parts and the Style in a song at once you can use the Delete function.

◆ To delete a song:

□ Step 1

Touch the MORE button.

Additional buttons will be displayed at the bottom of the screen.

□ Step 2

Touch the DELETE button

The CP will ask if you are sure

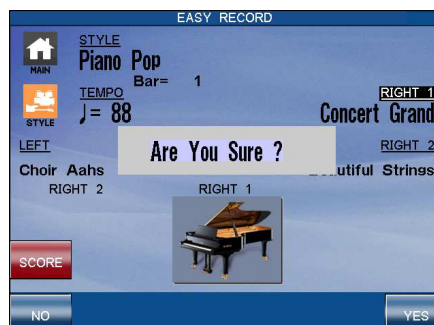

NO : Cancels erasing the song.
YES : Proceeds with erasing the song.

Step 2

Touch the YES button to proceed, or the NO button to cancel.

- DELETE erases all of the performance data for all Parts and the Style in the song. The panel setup, such as Style, Tempo, and Sound settings are not erased by the DELETE function.

◇ Easy Loop

You can set the loop on Playback.

◆ To set the Loop:

Step 1

Assign Easy Loop to the Left pedal or Center pedal in the Pedal Assign screen of the Settings menu.

Step 2

In the Easy Recorder screen press the PLAY/STOP button to start the playback.

Step 3

Depress the pedal you assigned the Easy Loop.

Loop top will be selected and the Loop will be displayed.

Step 4

Depress the pedal again.

Loop end will be selected and the bars between Loop top and Loop end will be repeated.

Step 5

To clear the loop, depress the pedal again or stop the playback by pressing the PLAY/STOP button.

◇ Display of a Score

In the Easy Recorder screen, a score can be displayed. Touch the SCORE button to display the current song as a notated score.



PRINT : Saves a snapshot of the current screen to USB memory.

PART1 : Turns Part 1 on/off.

PART2 : Turns Part 2 on/off.

< PAGE > : Move through the pages of the score.

MORE : Takes you to the next screen.

◇ Touch MORE - You can select the channel of Part1 and Part 2 to be displayed in the screen.



PART1 : Selects a channel of Part 1.
PART2 : Selects a channel of Part 2.
BACK : Takes you to the previous screen.
MORE : Takes you to the next screen.

- ◇ Touch MORE - You can display the chord name, and also the channel to use for chord recognition.



CHORD : Show hide the name of the chord.
CHORD CH : Select the channel to be used for chord recognition.
BACK : Takes you to the previous screen.
MORE : Takes you to the next screen.

- ◇ Transpose

Allows the key signature of the notated score to be changed.

- ◇ Quantize

Allows the length and timing of recorded notes to be corrected automatically.



< C > : Adjusts the transpose amount.
QUANTIZE : Quantize the notes.
BACK : Takes you to the previous screen.
MORE : Takes you to the next screen.

2) Advanced Recording

The Advanced Recorder is a full featured sixteen track MIDI recorder that includes many of the same professional features found on dedicated MIDI sequencing (recording) devices. In addition to sixteen MIDI tracks the CP Advanced recorder provides a separate Style, chord, and tempo track for even more flexibility.

Even though you can create recordings of great musical complexity using the Advanced recorder you will find that it is still very straightforward and easy to use.

Using the Advanced Recorder allows you much greater control over the recording and compositional process than that offered by the Easy Recorder. However, songs created using the Easy Recorder can also be edited using the Advanced Recorder by simply touching the ADV RECORDER button.

◆ To go to the Advanced Recorder Menu:

□ Step 1

While in Easy Recorder mode, touch the MORE button.



The BACK, SAVE, DELETE buttons, and MY SONGS and ADVANCED RECORDER icon will appear in the bottom bar.

■ The ADVANCED RECORDER icon is also accessible via the SETTINGS menu.

□ Step 2

Touch the ADVANCED RECORDER icon.



The Advanced Recorder menu will be displayed on the screen.

MIXER : Change the Reverb, Effect, Panning, Volume level and Chorus for each of the 16 tracks.

Real Time Rec : Prepares the track for real-time recording.

Punch In/Out : Re-record specific measures within your song.

Step Recording : Record by entering data note by note.

Track Settings : Select the sound to be assigned to each of the 16 tracks, and change the track's recording and play back status.

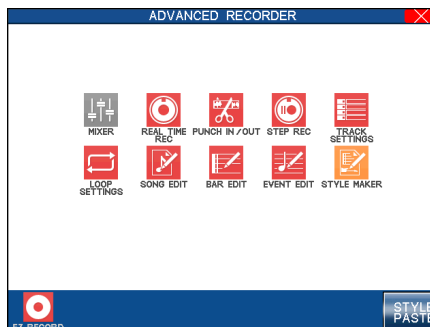

Loop Settings : Edit loop settings for the song.

Song Edit : Edit the general settings for the song.

Bar Edit : Edit the song by bars.

Event Edit : Edit the song by MIDI events.

Style Maker : Create your own new user Style.

EZ RECORD : Return to Easy Recorder screen.

PAGE : Show Style Paste screen.

◇ Real-time Recording

With Real-time record, the CP records your performance as you are playing it, in real-time. You can select any of the sixteen instrument tracks or the Style and tempo tracks to record, but you can only record on one track at a time. Since the Advanced Recorder only records on one track at a time, only the RIGHT1 Part is active in the Advanced Recorder. Any other active Parts are automatically turned OFF when the ADVANCED RECORDER button is pressed. In addition to selecting the desired track to record, the Real-time recording screen provides many other useful Real-time recording functions.

◆ To use Real-time recording:

□ Step 1

From the Advanced Recorder menu, touch Real Time REC, or simply press the REC button.

The REC button LED will blink and the LCD screen will display the "Real Time REC" screen.

Step 2

Touch the screen to select a function to edit. Use the Dial to change the values.

 Step 3

If necessary, you can go to the Mixer and Track Settings screens by touching the appropriate buttons.

 Step 4

Start recording by pressing the PLAY/STOP button while the REC button LED is blinking. There is an automatic two bar count in before the CP begins recording. If you are recording on the Style track you must press the START/STOP button instead of the PLAY/STOP button.

When recording a Style there is no two bar count in, recording begins immediately.

You can cancel recording at anytime by pressing the REC button again or by touching the MENU button to return to the Advanced Recorder menu.

REC TRACK : Selects the track on which you want to record. There are 16 Instrument tracks, 1 Tempo track, and 1 Style track.

REC SOUND : Selects the sound or Style that you want to record with.

BAR : Shows the current bar and beat number.

START BAR : Selects the starting bar for the Loop feature. This function is available only when Loop is turned ON.

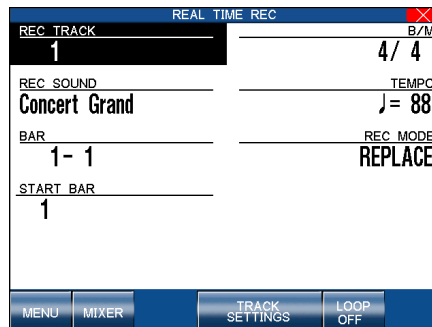

B/M : Changes the time signature.

TEMPO : Changes the tempo.

REC MODE : Selects the recording mode. **REPLACE** erases the previous data and records the new data in its place. **OVERDUB** mixes the new data with the previous data so that both are heard together. Repeatedly touching **REC MODE** switches between the **REPLACE** and **OVERDUB**.

MENU : Cancels the real-time recording setup and returns you to the Advanced Recorder menu.

MIXER : Takes you to the Mixer menu.

TRACK SETTINGS : Shows the Track Settings menu.

LOOP : Turns the Loop feature on/off.

- When you select a Style to record the default tempo for that Style is ignored. The Style will use the current tempo setting for the song instead. You can set the desired tempo on the Real-time record screen before recording or change the tempo after you have recorded in Song Edit or on the tempo track in Event Edit.
- When you are recording on the Style track only the Style will be recorded. The style track will record any chords (to the chord track) you play but the actual notes you are playing will not be recorded.
- When the recording is done, the Mixer screen will automatically be displayed.

◆ To play back the recorded song:

 Step 1

Press the RESET button in the RECORDER section of the front panel to return to the first bar of the song.

 Step 2

Press the PLAY/STOP button to play back the song.

 Step 3

Press the PLAY/STOP button again to stop at any time.

 Step 4

Pressing the PLAY/STOP button again resumes the playback from the bar where you stopped.

 Step 5

Press the RWD or FWD buttons to rewind or fast-forward through the recording.

◇ Mixer

On the Mixer screen, you can change the following settings for each of the 16 tracks: Reverb level, Chorus level, Effect on/off, Panning, Track mute, Volume level.

◆ To use the Mixer:

□ Step 1

Touch the number of the track or the ◀ TRACK ▶ buttons to select the track you wish to make changes to.

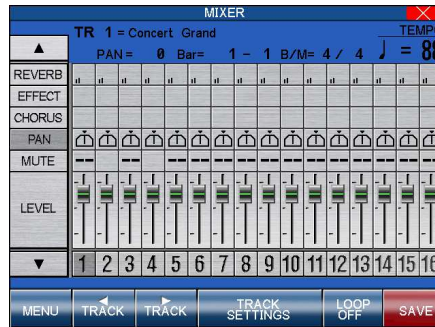

MENU : Returns you to the Advanced Recorder menu.
TRACK : Selects the track that you wish to edit.
TRACK SETTINGS : Shows the Track Settings menu.
LOOP : Turns Loop ON/OFF.
SAVE : Saves the Mixer settings as part of the song.

□ Step 2

Touch the buttons along the side of the screen to choose the setting that you wish to change.

□ Step 3

Use the Dial to change the value.

□ Step 4

Alternatively, touch the setting for the track that you wish to change.

A zoomed version of the selected area will be shown, allowing adjustments to be made more easily.

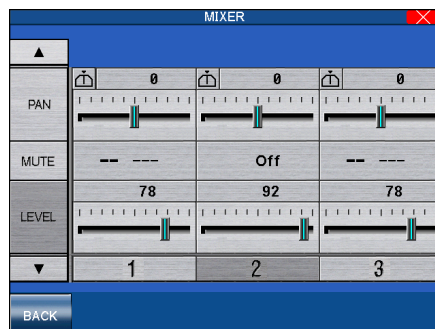

BACK : Returns you to the Advanced Recorder menu.

□ Step 5

At this point, you can start recording or go to another menu to continue setting up.

- You can make changes on the Mixer screen at any time except while the CP is busy recording. The Mixer screen is accessible from the Advanced Recorder menu, Track Settings screen and Real-time Rec screen.
- You can save any changes you have made to the settings on the Mixer screen at any bar or beat in your song. Simply play back the song or press the FWD/RWD buttons until you reach the exact bar and beat where you want to make changes to the Mixer settings and stop the song. Make any changes on the Mixer screen, then touch the SAVE button. You can do this as many times and in as many places within your song as you wish.

Note: "Saving" here only means any changes you made on the Mixer screen were saved as part of the song.

◆ Track Settings

The Track Settings screen shows you the Play, Record, and Mute status for each track. In addition it shows you what sound is assigned for the sixteen instrument tracks. You can change the track status or select a different sound for each track.

The Track Status screen will show the following Status messages.

- Rec** This track is ready to be recorded.
- Play** This track has been recorded and will be heard both on playback and while recording.
- MIDI Rec** MIDI Rec enables the CP to record incoming MIDI data from an external MIDI instrument connected to the MIDI jacks. You can set more than one track to MIDI Rec, enabling the CP to record on several tracks simultaneously over MIDI.
- Mute** This track has been recorded but will be silent both on playback and while recording.
- Empty** This track has not been recorded.

After you have recorded a song you can change the status for a track by touching the STATUS button at the bottom of the LCD screen. Touching the STATUS button during playback will select Play or Mute. Touching the STATUS button after entering Real-time record but before recording begins, will select Play, MIDI Rec, or Mute. Rec can only be selected from the Real-time Record screen. The Track settings screen cannot be accessed during recording.

◆ To use the Track Settings screen:

- Step 1**
Touch TRACK SETTINGS in the Advanced Recorder menu.
- Step 2**
Touch the arrows at the side of the screen to select the track that you wish to edit.

Jumps to tracks 1-9.

Selects the tracks one at a time.

Jumps to tracks 10-16, Tempo, and Style.

Track	Status	Sound
1	Empty	Concert Grand
2	Play	Concert Grand
3	Empty	Concert Grand
4	Play	Acoustic Bass
5	Empty	Concert Grand
6	Empty	Concert Grand
7	Empty	Concert Grand
8	Empty	Concert Grand
9	Empty	Concert Grand

TEMPO : Changes the tempo. Use the Dial to change the value.

MENU : Returns you to the Advanced Recorder menu.

MIXER : Takes you to the Mixer.

STATUS : Changes the track's status.

SOUND : Selects a different sound for the track.

SAVE : Saves the Track settings as part of the song.

- Step 3**
Touch the STATUS button to change the status to PLAY, MUTE or MIDI REC.
- Step 4**
If you wish to change the sound assigned to the track, touch the ◀ SOUND ▶ buttons. You can also select sounds by pressing any of the SOUND buttons, or using the Dial.
- Step 5**
When you are finished, touch the MENU button to return to the Advanced Recorder menu or touch the MIXER button to go to the Mixer menu.

- As discussed in the above section, MIDI Rec enables the CP to record incoming MIDI data from an external MIDI instrument connected to the MIDI jacks. You can set more than one track to MIDI REC, enabling the CP to record on several tracks simultaneously over MIDI. Each MIDI Rec track will record on the incoming MIDI channel that corresponds to its track number. Track 1 records MIDI channel 1 and so on.

◇ Loop Settings

The Loop function lets you specify certain bars or your entire song to repeat over and over. Loop is a global function and all tracks will be looped equally. You cannot have different loop settings for each track.

◆ To set the Loop:

- Step 1**
Touch Loop Settings on the Advanced Recorder menu.
- Step 2**
Touch the screen to select the different loop settings, then use the Dial to change the values.

LOOP : Turns the Loop ON/OFF.

START BAR : Specifies the starting bar.

END BAR : Specifies the ending bar.

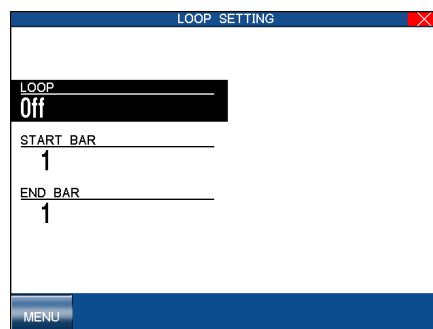

MENU : Takes you back to the Advanced Recorder menu.

- Step 3**
Touch LOOP to turn the Loop ON/OFF.
- Step 4**
Touch START BAR to specify the bar where you want the Loop to start.
- Step 5**
Touch END BAR to specify the bar where you want the Loop to end.
- Step 6**
Touch the MENU button to return to the Advanced Recorder menu when you are finished.

- You can turn looping on and off in the Mixer menu. However, you still have to set the Start and End Bar from the Loop Settings menu.
- You can set up looping for recording in the Real-time REC menu as well. In the Real-time REC menu, when you turn on the looping, the Start Bar and End Bar information will be automatically copied from the Loop Settings menu.

◇ Style Paste

When you record a Style as part of your song, the Style data is automatically recorded on the Style track. This data is unique to the CP, and cannot be used with any other musical instruments. Additionally the instrument tracks that are part of the Style cannot be edited individually.

Style Paste converts any Style data recorded on the Style track into MIDI note and event data and places it on separate tracks (Trks 9-16). Once the Style data is converted into actual note data, you can view and edit the individual Style tracks as if you had recorded the data yourself. Also your song including the Style can now be played back by any other MIDI instrument that reads Standard MIDI File (SMF) format song data.

- Before you use Style Paste, you need to make sure Tracks 9-16 are empty or don't contain important data. When the Style is pasted, the data from the Style track will be pasted into these tracks and will replace any existing data.

◆ To use Style Paste:

□ Step 1

Touch **STYLE PASTE** while you are in the Advanced Recorder menu.

The LCD screen will prompt you for confirmation.

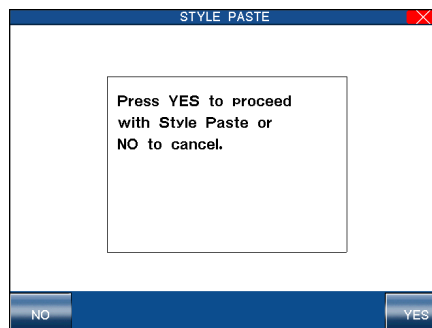

*NO : Cancels the Style Paste.
YES : Proceeds with Style Paste.*

□ Step 2

If you would like to proceed, touch the **YES** button, or touch the **NO** button to cancel.

◇ Punch-In Recording

Punching In means being able to automatically start recording right in the middle of a track that is playing back, continue recording new data on that track for a specified number of measures, and then automatically stop recording at a specific measure and hear the rest of the track play to the end. This tool is very valuable if you wish to record over some misplayed notes in the middle of a track, but would like to preserve the music in the measures leading up to, and following, the trouble spot.

◆ To use Punch-in recording:

□ Step 1

Select **Punch In/Out** in the Advanced Recorder menu.

□ Step 2

Touch the screen to select the options and change their values using the Dial.

Touch **AUTO** to have the CP automatically handle the punching in/out while you play.

□ Step 3

Touch the **REHEARSAL** button to listen to the song for rehearsal. If you need to adjust mixing or if you would like to loop the song, touch the **MIXER** or **LOOP ON/OFF** buttons.

□ Step 4

When you are ready to record, press the REC button and then the PLAY button.

The music will start immediately from the Start Bar that you have chosen. Once the song reaches the Punch In Bar, any notes that you play on the keyboard will be recorded.

Recording will stop when the song reaches the Punch-Out Bar, but the CP will keep playing back the song to the end unless you press the STOP button.

You can repeat the punch-in/out section by turning the looping on with the LOOP button.

□ Step 5

Listen to what you have recorded and re-record if necessary.

REC TRACK : Selects the track to Punch in on.

BAR : Shows te current bar and measure.

START BAR : Selects the measure in the song from where you want the CP to start playing.

PUNCH IN BAR : Selects the measure where the CP will punch-in and start recording.

PUNCH OUT BAR : Selects the measure where the CP will punchout and stop recording.

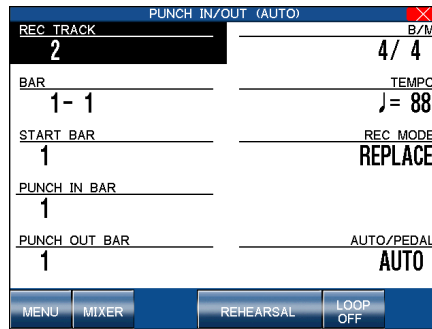

B/M : Changes the time signature.

TEMPO : Changes the tempo.

REC MODE : Selects the recording mode. REPLACE erases the previous data and records the new data in its place. OVERDUB mixes the new data with the previous data so that both are heard together. Repeatedly pressing REC MODE switches between the REPLACE and OVERDUB.

AUTO/PEDAL : Selects the Punch-in method, Auto or Pedal. Repeatedly pressing AUTO/PEDAL switches between the Auto and Pedal.

MENU : Takes you to the Advanced Recorder menu.
MIXER : Takes you to the Mixer Settings menu.
REHEARSAL : Plays the song for rehearsal.
LOOP : Turns Loop on/off.

- If you set the CP to Punch-In at the very first measure of the song, the metronome will automatically play a two-measure intro to assist you with the timing. These “ticks” will not be recorded as part of the track.

◆ **Punch-In recording using the pedal (To use the pedal to Punch-In/Out:)**

Instead of specifically setting an automatic Punch-In and Punch-Out Bar, you can use the center pedal to manually Punch In and Out.

- You can punch in and out with pedal one time for each pass over the track that you make.

□ Step 1

Touch AUTO/PEDAL to select Pedal in the Punch In/Out menu.

□ Step 2

Touch the screen to set up other recording options.

REC TRACK : Selects the track to Punch in on.

BAR : Shows te current bar and measure.

START BAR : Selects the measure in the song from where you want the CP to start playing.

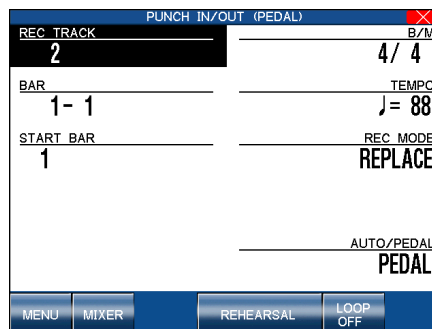

B/M : Changes the time signature.

TEMPO : Changes the tempo.

REC MODE : Selects the recording mode. REPLACE erases the previous data and records the new data in its place. OVERDUB mixes the new data with the previous data so that both are heard together. Repeatedly pressing REC MODE switches between the REPLACE and OVERDUB.

AUTO/PEDAL : Selects the Punch-in method, Auto or Pedal.

MENU : Takes you to the Advanced Recorder menu.
MIXER : Takes you to the Mixer Settings menu.
REHEARSAL : Plays the song for rehearsal.
LOOP : Turns Loop on/off.

Step 3

Press the REC button to start.

The song will start playing.

 Step 4

When the song reaches the bar where you wish to punch in, press the center pedal and play the keyboard.

 Step 5

When you reach the bar where you wish to punch out, press the pedal again to stop recording.

The song will continue to play until the end (i.e. it is no longer recording) or until you press STOP.

◇ Step Recording

Step Recording is a method of recording a song by manually entering notes one after another as data, instead of playing the keyboard in real-time. This method may be useful when trying to create a phrase with a precise rhythm, or when recording a phrase that is beyond your playing skill level.

◆ To set up Step recording:

 Step 1

In the Advanced Recorder menu select Step Rec.

The Step Record Stand-By menu will be displayed.

 Step 2

Touch the screen to select options and use the Dial to adjust values.

REC TRACK : Selects the recording track.

REC SOUND : Selects which sound is assigned to the track.

START BAR : Selects which measure you'd like to start recording at.

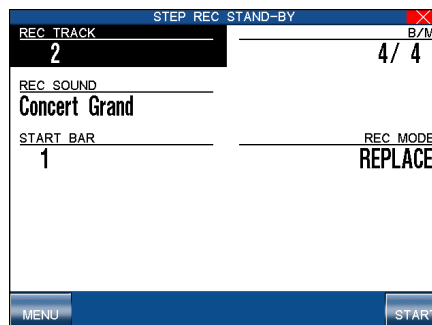

B/M : Changes the time signature.

REC MODE : Selects the recording mode. *REPLACE* erases the previous data and records the new data in its place. *OVERDUB* mixes the new data with the previous data so that both are heard together. Repeatedly pressing *REC MODE* switches between the *REPLACE* and *OVERDUB*.

MENU : Cancels Step recording and takes you to the Advanced Recorder menu.

START : Proceeds to the data entry screen of the Step Record menu.

 Step 3

Touch the START button.

You will be presented with the data entry screen.

◆ To use the Step Recorder:

 Step 1

Touch the buttons and the bottom of the screen to select Note value, Note length, and Velocity, then use the Dial to change its value.

The value will be displayed above the buttons at the bottom of the screen.

Velocity value can be entered by actually hitting a key on the keyboard. To enable this, select "Key" for the Velocity value instead of a number.

□ Step 2

To enter a note event, play the note using the keyboard.

The note data will be displayed on the screen. Continue entering as many notes as you wish; notice how previously entered notes continue to be displayed as a list, screen room permitting. The graphic navigator near the bottom of the screen gives you feedback as to what bar you are in.

ARROWS : Moves the cursor up and down the list of entered notes in OVERDUB mode.

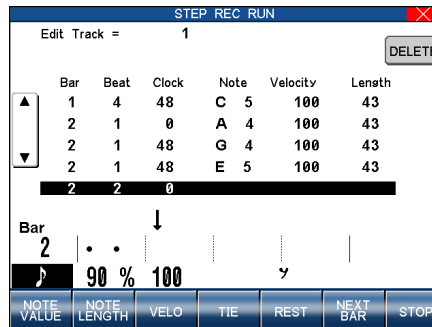

DELETE : Deletes the last note entered in OVERDUB mode.

NOTE VALUE : Selects the note value.

NOTE LENGTH : Adjusts the note length.

VELO : Selects the velocity value. Values are from 1–127 or Key.

TIE : Enters Tied note values.

REST : Enters a rest.

NEXT BAR : Takes you to the beginning of the next measure.

STOP : Stops recording.

Note	Rest	Clock value
	—	384
	—	192
		96
	()	64
		48
	()	32
		24
	()	16
		12
	()	8

□ Step 3

If you enter a wrong note and wish to delete it, touch the DELETE button. When you are using the REPLACE mode for recording, every time you press DELETE the list of your entered notes on the screen scrolls back one event, and that event is erased immediately. Therefore, if you scroll back to the first beat of bar 5 of a 10-bar list of notes, everything from bar 5 on will be erased. In OVERDUB mode, however, you can delete only the most recently added note, and scrolling back over the list using the arrow buttons will not automatically erase events. When using OVERDUB, you need to touch the Delete button to erase the event.

□ Step 4

If you would like to enter a rest, touch the REST button. This moves the cursor to the next beat without entering any data. The rest value is the same as the note value.

If you would like to enter a rest for the remainder of the measure, touch the NEXT BAR button. This will bring the cursor to the top of the next measure.

□ Step 5

When you like to tie notes, touch the TIE button while holding down the key. This doubles the length of the note. If you touch the TIE button twice while holding down the key, the length of the note is tripled.

Step 6

In OVERDUB mode, if you go back to certain point to enter a note, use the arrow buttons to move the cursor up and down to get to the event time where you want to insert the new data.

 Step 7

Touch the STOP button or the PLAY/STOP button to stop recording.

- Transpose and Octave Shift can be in effect as you are entering notes. The transposed pitches are the note values that are recorded.
- The navigator graphic represents the current bar that you are recording. The partitions represent each beat, and thus the number of partitions matches the time signature of the music. For example, there would be 4 partitions if the time signature is 4/4, and 6 partitions if it is 6/8. Each partition consists of a number of spaces where dots (•) will be displayed to mark time. Each space represents 24 clock pulses. Therefore the number of displayed spaces per partition represents the duration of the beat.

For example, if you choose the 4/4 time signature in the Step Recording settings, the navigator should look as illustrated below.

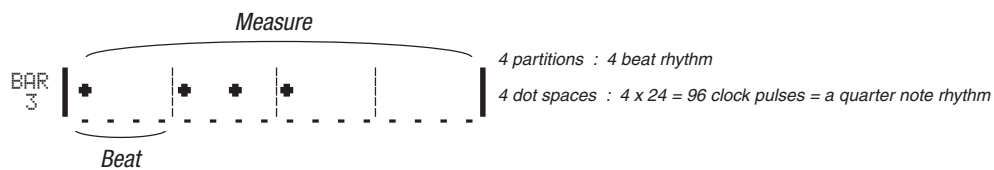

The dots do not represent the duration of the notes. They just tell you where they are.

For a further explanation of the CP's Clock, and what is meant by "clock pulses" see the Clock Move description in the Bar Edit section.

◇ Song Edit

Song Edit lets you name, transpose, and change initial tempo settings for your song.

◆ To edit the song:

 Step 1

Select Song Edit from the Advanced Recorder menu.

The Song Edit screen is displayed.

 Step 2

Touch the screen to select the setting that you wish to change, then use the Dial to adjust the value.

 Step 3

Touch NAME, then enter a name for the song using the virtual keyboard screen.

- Step 4**
Touch INITIAL TEMPO and adjust the initial tempo of the song.
- Step 5**
Touch TRANSPOSE and set the transpose amount.
You can transpose your song +/- 24 in half step increments.
- Step 6**
When you are finished, touch the MENU button to return to the Advanced Recorder menu.

NAME : Names the song.

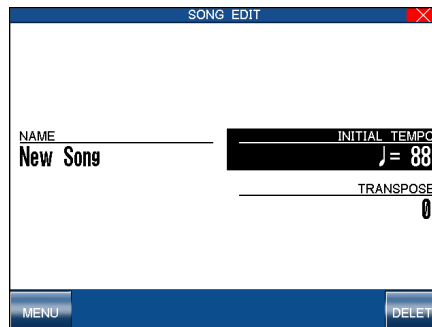

INITIAL TEMPO : Sets the initial tempo of the song.

TRANSPOSE : Adjusts transposition.

MENU : Takes you to the Advanced Recorder menu.
DELETE : Deletes the song.

◇ Bar Editing

Bar Edit contains many useful editing functions. You can edit your song one bar or any number of bars at a time.

◆ To use Bar Edit:

- Step 1**
Select Bar Edit in the Advanced Recorder menu select Bar Edit.
The Bar Edit screen will be displayed.
- Step 2**
Use the touch screen to select the desired editing function.
The editing screen for that function will be displayed.

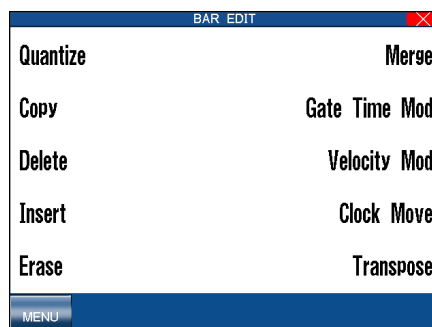

MENU : Takes you to the Advanced Recorder menu.

◆ Quantize

Quantize automatically shifts the timing of a note. This can be used to correct imperfect timing in a performance by shifting notes that were played either too early or too late so they will fall exactly on the correct beat. For example, you can accurately align any out of time notes to the nearest 8th or 16th-note beat depending on the type of song you are quantizing. Sometimes quantizing all of your notes to exactly the same beat can make your playing sound too stiff. The Advanced Recorder quantize function allows you to set a quantize “Range” so only the notes that were very early or late are quantized. Notes that were almost perfect are not quantized thus keeping more of the original feeling in your music.

TRACK : Selects the track that you wish to quantize.

START BAR/END BAR : Selects the bar range that you want to quantize.

NOTE LOW : Selects the lowest note that you want to quantize.

NOTE HIGH : Selects the highest note that you want to quantize. Use the Dial to change the note value.

QUANTIZE	
TRACK	1
START BAR	1
END BAR	1
NOTE LOW	C -1
NOTE HIGH	G 9
RESOLUTION	96
RANGE LOW	0
RANGE HIGH	0
BACK	UNDO
EXEC	

RESOLUTION : Selects the note Resolution for quantization

RANGE LOW/RANGE HIGH : Sets the Low and High Range for quantization.

BACK : Returns you to the Advanced Recorder menu.
UNDO : Undoes the quantization which was just applied.
EXEC : Applies the quantization to your recording.

- Resolution determines the timing value the quantize function will use to shift the notes you want to quantize. For example, setting a quarter note resolution will shift all of the quantized notes to the nearest quarter beat. Setting an eighth note resolution will shift all of the quantized notes to the nearest eighth beat and so on. In the Advanced Recorder, quantize values are expressed in note values and as a number that indicates how many clock beats each note value contains. The Advanced Recorder divides each beat in a bar into 96 smaller clock beats. A Quarter note is 96 clock beats, an eighth note is 48 clock beats, and a sixteenth note is 24 clock beats and so on. The quantize resolution range is from quarter notes (96 clocks), to 64th note triplets (4 clocks).
- Range sets up timing “borders” around the Resolution value you specify. Notes within these borders will not be quantized and notes outside the borders will be moved to the nearest beat specified by the resolution value (Quarter note, Eighth note, etc.). The negative value represents the placement of the “border” before the beat, and the positive value represents the placement the “border” after the beat. Together, these two “borders” form a timing “range” around the specified beat.

Selecting zero Range results in no “range”, and all notes are shifted to the precise beat.

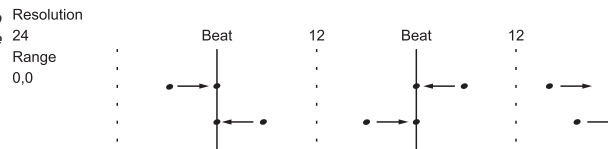

The notes that fall beyond the Range are moved to the closest “border” of the Range.

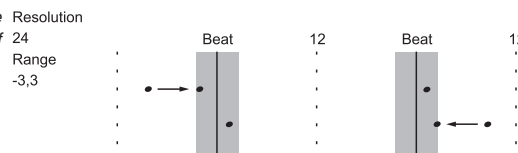

The notes that fall inside the Range are not shifted at all.

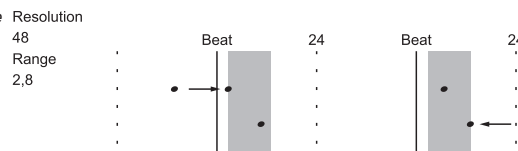

By experimenting with Resolution and Range settings, you can correct the timing of the notes in your recording while still allowing for a natural, human feel.

◆ Copy

The Copy function allows you to copy a section or all of the data on a track to another location. The destination may be on the same track, or it can be on another track.

- The destination of the copied data must either be:
 - 1) A location that already has data in it.
 - 2) The first blank bar after the end of a track (Bar 1 if the destination track is empty).

For example, if a track only has 10 bars in it, you cannot copy data onto bar 20. You can, however, copy data to bars 1 through 11.

- Copied data replaces any current data that may be at the destination.

TO TRACK : Selects the destination track. Use the Dial to select the track number 1-16, Tempo, or Chord.

BAR : Selects the bar in the destination track where the copied data will be placed.

FROM TRACK : Selects the track to be copied. Use the Dial to select the track numbers 1-16, Tempo, or Chord.

START BAR : Selects the bar where the data that you are copying starts. Use the Dial to change the bar number.

END BAR : Selects the bar where the data that you are copying ends. Use the Dial to change the bar number.

BACK : Returns you to the Advanced Recorder menu.

UNDO : Undoes the copying. This option is not always available.

EXEC : Proceed with copying.

◆ Delete

Delete completely erases and removes the bars that you specify.

TRACK : Selects the track to be deleted. Use the Dial to choose 1-16, Tempo, Chord or All.

START BAR : Selects the first bar that has the data you want to delete. Use the Dial to change bars.

END BAR : Selects the last bar that contains the data that you want to delete. Use the Dial to change bars.

BACK : Returns you to the Advanced Recorder menu.

UNDO : Undoes the copying. This option is not always available.

EXEC : Proceed with copying.

◆ **Insert**

The Insert function duplicates data from specified bars and copies it to a certain location. However, the current data at the destination is not erased, but instead is pushed back to make room for the copied data.

TO TRACK : Selects the destination track where you want this data inserted. Choose from 1-16, Tempo, Chord or All.

BAR : Selects the bar in the destination track where you want this data inserted.

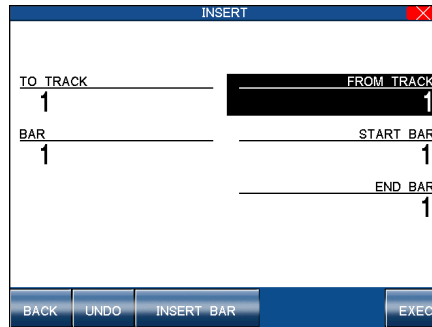

FROM TRACK : Selects the track that contains the data you wish to duplicate. Choose from 1-16, Tempo, Chord or All.

START BAR : Selects the first bar that has the data you want to duplicate.

END BAR : Selects the last bar that has the data you want to duplicate.

BACK : Returns you to the Advanced Recorder menu.
UNDO : Undoes the insert. This option is not always available.
INSERT BAR : Takes you to the Insert Bar menu.
EXEC : Proceed with the insert.

■ If you just wish to insert empty bars into a track, select **INSERT BAR**, and a sub-menu will be displayed. You can insert empty bars into a track between bars that have data, or at the first blank bar at the end of the track.

TO TRACK : Selects the track where the empty bars are going to be inserted. Choose 1-16, Tempo, Chord or All.

BAR : Selects the location in the destination track where you want the empty bars inserted.

Use the Dial to choose the location.

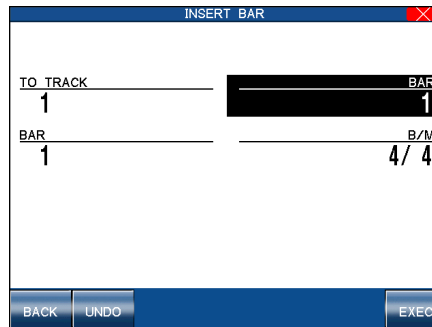

BAR : Selects the number of empty bars you wish to insert. Use the Dial to change the value.

B/M : Selects the time signature for the bars that are going to be inserted. Use the Dial to change the value.

BACK : Returns you to the Advanced Recorder menu.
UNDO : Undoes the insert. This option is not always available.
EXEC : Proceed with the insert.

◆ **Erase**

Erases data in the bars that you specify, and leaves them as empty bars.

TRACK : Selects the track that has the bars you want to erase. Choose 1-16, Tempo or Chord.

START BAR : Selects the first bar to be erased. Use the Dial to change the bar.

END BAR : Selects the last bar to be erased. Use the Dial to change the bar.



BACK : Returns you to the Advanced Recorder menu.
UNDO : Undoes the erase. This option is not always available.
EXEC : Proceed with the erase..

◆ Merge

Merge combines data from two tracks. You can make complex musical phrases using several tracks, then combine them together on one track. Remember that there can only be one instrument sound assigned to each track, so the resulting merged track will play all the combined data using one instrument sound. Merge can be useful for making rhythm patterns by first recording different drum/ percussion parts using the same drum kit on several tracks for easy editing of each instrument, or recording the right and left hand parts of a piano piece and combining them later on one track to free up extra tracks for more recording.

- Merge does not automatically erase the track from where you copied the data.

TO TRACK : Select the track where you want this data merged to. Choose 1-16.

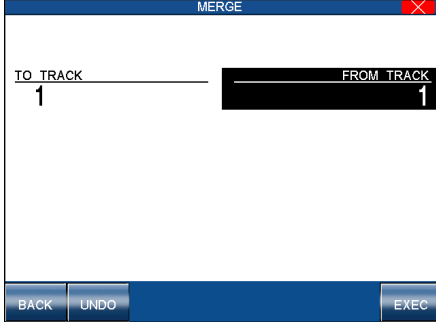

FROM TRACK : Selects the track from where you want to copy data. Choose 1-16.

*BACK : Returns you to the Advanced Recorder menu.
 UNDO : Undoes the merge. This option is not always available.
 EXEC : Proceed with the merge..*

◆ Gate Time Modify

Gate time refers to the length of a note as a percentage. Whatever the length of a note is when it is first recorded, this value is considered as its Gate time of 100%. By editing the length of the note, you can shorten it to 10% or lengthen it to 300% of the original value.

TRACK : Selects the track in which you want to modify Gate times. Use the Dial to choose the track.

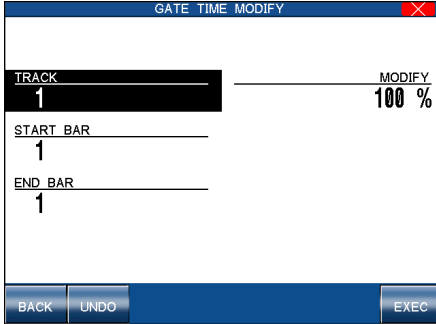

MODIFY : Adjusts the Gate time in 10% increments. Use the Dial to select a value from 10%-300%.

*START BAR : Selects the first bar of the data that you want to modify Gate times for. Use the Dial to change bars.
 END BAR : Selects the last bar of the data that you want to modify Gate times for. Use the Dial to change bars.*

*BACK : Takes you to the Advanced Recorder menu.
 UNDO : Undoes the Gate time adjustment. This option is not always available.
 EXEC : Proceeds with applying the Gate time adjustment.*

◆ Velocity Modify

Velocity refers to how hard a key is struck, which translates into the dynamics of how loud the produced sound is.

A note's Velocity is a numerical value from 1-127. When editing the note Velocities in your recording, you can change them within a +/-100 range of their original values.

TRACK : Selects the track in which you want to adjust Velocity.

START BAR : Selects the bar where the data you want to adjust starts.

END BAR : Selects the bar where the data you want to adjust ends.

MODIFY : Adjusts Velocity from -100 to +100 of their current values.

BACK : Takes you to the Advanced Recorder menu.

UNDO : Undoes the Velocity adjustment. This option is not always available.

EXEC : Proceeds with adjusting the Velocity values.

◆ Clock Move

In the Resolution section of this manual we learned that the CP Advanced recorder divides each beat in a bar into 96 clock beats, also expressed as a quarter note. Therefore there are 48 clocks per eighth note, and 24 clocks per sixteenth note and so on. This relationship holds true regardless of the song's tempo.

On the CP, you can shift the timing of all notes in a track by shifting the entire track ahead (negative values) or behind (positive values) the beat by a certain clock value. Clock move is useful for adjusting the overall timing of a track. For example, if a certain sound you recorded responds slowly and sounds behind the beat, you could shift the timing of the notes ahead of the beat to compensate for the sounds slow response and make its timing feel more natural.

TRACK : Selects the track that you wish to move.
Choose from 1-16.

CLOCK : Sets how many clocks you wish to move the track. Choose from -999 to +999.

BACK : Takes you to the Advanced Recorder menu.

UNDO : Undoes the clock move. This option is not always available.

EXEC : Proceeds with applying the clock move.

◆ Transpose

This will transpose the notes within a specified bar(s) up or down in half-step increments.

TRACK : Selects the track that has the notes you want to transpose. Choose from 1-16.

START BAR : Selects the bar where the notes you want to transpose start.

END BAR : Selects the bar where the notes you want to transpose end.

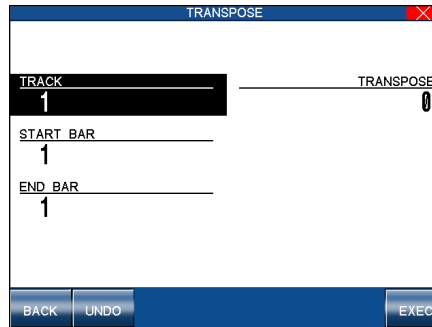

TRANSPOSE : Adjusts transposition amount in half-step increments from -24 to 24.

BACK : Takes you to the Advanced Recorder menu.

UNDO : Undoes the transposition. This option is not always available.

EXEC : Proceeds with applying the transposition.

◇ Event Edit

Event Edit enables you to examine and edit your performance note by note.

◆ To use Event Edit:

□ Step 1

Select Event Edit in the Advanced Recorder menu.

The Event Edit screen will be displayed.

□ Step 2

Select the track that you want to edit using the TRACK buttons. Note that the Style, Chord, and Tempo track can be edited as well.

DOUBLE ARROWS : Moves the cursor forward and backward through the bars.

SINGLE ARROWS : Moves the cursor forward and backward through the selected beat, clock, event, etc..

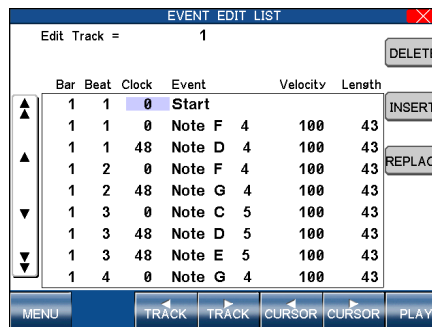

DELETE : Removes the selected event.

INSERT : Creates a new event.

REPLACE : Modifies the existing event.

MENU : Takes you to the Advanced Recorder menu.

TRACK : Selects the track to work with.

CURSOR : Moves the cursor across the columns in the event list.

PLAY : Starts playing the Track.

□ Step 3

Touch the ARROW buttons to scroll up or down the event list until you find the specific event that you want to edit. You can also use the Dial to scroll through the event list.

You will hear the individual events being played as you scroll over them.

□ Step 4

Use the CURSOR buttons to determine how you want to scroll through the event list.

Selecting Bar scrolls through the event list bar by bar, selecting Beat scrolls through the event list beat by beat and so on.

The selection will become highlighted.

□ Step 5

Select the function that you would like to apply to this event. You can select DELETE to remove the event, INSERT to create a new event at any specified location, or REPLACE to change the existing event. Enter new values in the pop up Entry Box when you select INSERT or REPLACE. When Inserting or Replacing an event, use the CURSOR buttons to select the specific part of the event you want to edit. Use the Dial to change the value.

DOUBLE ARROWS : Moves the cursor forward and backward through the bars.

SINGLE ARROWS : Moves the cursor forward and backward through the selected beat, clock, event, etc..

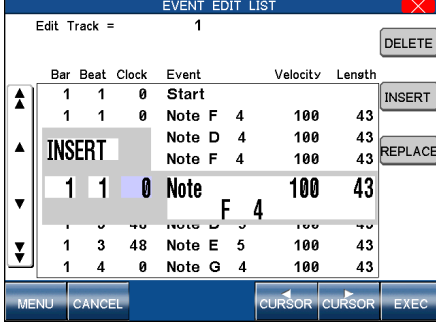

DELETE : Removes the selected event.

INSERT : Creates a new event.

REPLACE : Modifies the existing event.

MENU : Takes you to the Advanced Recorder Menu.

CANCEL : Cancel the edit.

CURSOR : Moves the cursor across the columns in the event list.

EXEC : Proceeds with applying the Event Edit changes.

□ Step 6

Touch the EXEC button to proceed, or press CANCEL.

The CP will prompt you for confirmation.

□ Step 7

Touch the MENU button to return to the Advanced Recorder menu when you are done editing.

◇ Style Maker

The Style Maker allows you to create your own Style accompaniments. See page 70 for more information.

5. Using a Style

The Concert Performer contains over 200 built-in Styles for you to play along with, covering a wide variety of musical genres. You can choose from a simple drum or percussion accompaniment or add in a fully orchestrated arrangement. In addition to the Full Styles which provide a full musical arrangement including Drums, Bass, and other accompanying instruments, there are Intimate Styles with Solo Piano Styles if you just want to play along with a piano accompaniment. If the on board variety of styles is not enough, or if you have creative ideas of your own, the CP contains other features such as Style Maker and Conductor to help you edit or create your own custom Styles. These features are explained in the section of this manual "Creating Your Own Styles", page 70.

1) Selecting and Playing a Style

◆ To select a Style:

□ Step 1

Press the STYLES button or touch the STYLE icon.

The main STYLE screen will be shown in the LCD display.

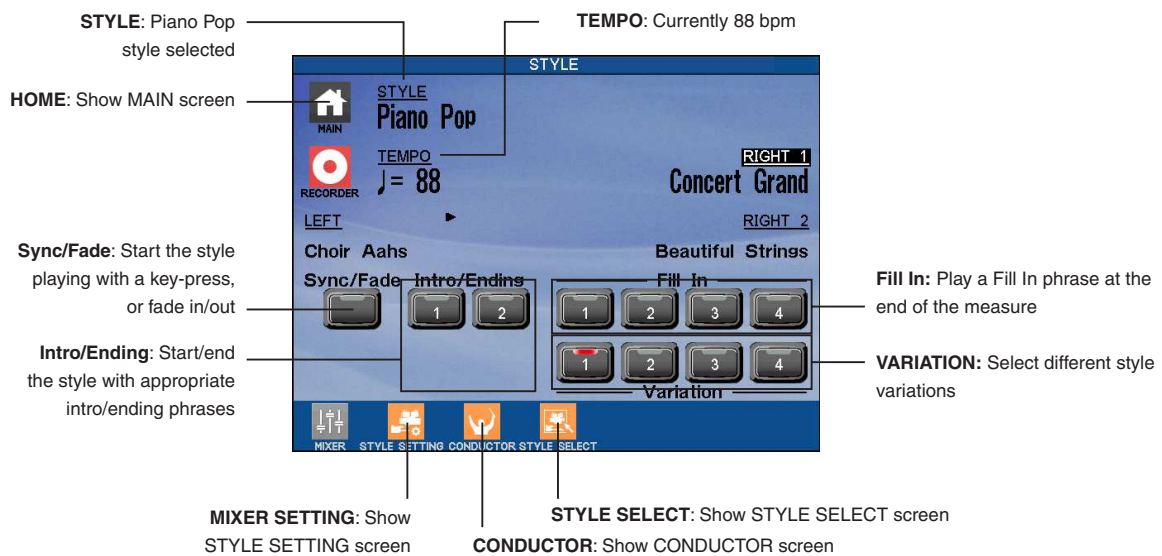

□ Step 2

Touch the STYLE SELECT icon.

The STYLE CATEGORY selection screen will be shown in the LCD display.



Press the X icon to return to the MAIN screen.

□ Step 3

Touch the name of the Style you wish to select.

Tempo will be displayed in the top left corner of the LCD screen.

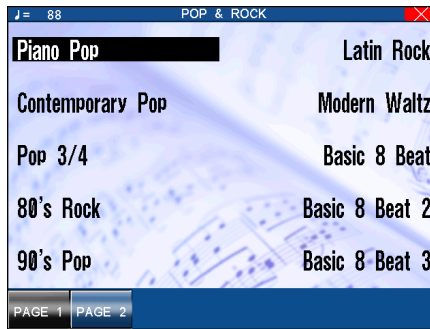

Press the X icon to return to the STYLE CATEGORY screen.

Touch the screen to select your desired Style.

PAGE : Select the different pages within a Style category.

□ Step 4

Each Style category has several pages of styles. If you don't see your desired Style on the currently displayed page, you can touch the PAGE buttons to select the other page.

Alternatively, press the EXIT button to return to the STYLE CATEGORY screen and select another category.

□ Step 5

Press the EXIT button to until the STYLE screen is shown in the LCD display.

□ Step 6

If you wish to play the selected Style, press the START/STOP button to start the Style playing immediately, or touch the INTRO/ENDING buttons to start the Style with an Intro pattern.

You can also touch the SYNC/FADE button before starting a Style or touching the INTRO/END buttons.

When the SYNC/FADE OUT button is pressed, the Style will not start until you play a note or chord on the keyboard.

□ Step 7

To adjust the tempo of the Style, use the Dial to change the Tempo.

The tempo will be displayed in the top left corner of the LCD screen.

You can also use the TAP TEMPO button. Tap the button three or more times at the desired tempo, and the CP will automatically translate your taps into an on-screen Tempo value.

□ Step 8

To stop the Style, press either the START/STOP button to stop the Style immediately, or touch the INTRO/ENDING buttons to stop with an ending pattern,

You can also press the SYNC/FADE OUT button and have the Style fade out gradually.



When this button is touched before starting a Style or before touching the INTRO/ENDING button, the Style will not start until you play a note or chord on the keyboard. When this button is touched while the Style is running the Style will gradually fade out. When this button is touched during a fade out the Style will gradually fade back in and you may resume playing the Style. You can touch the SYNC/FADE button at any time while any of the patterns (Intro, Variation, Ending) in the Style are running to fade in or out of the Style.

START/STOP



Starts or stops the Style immediately.

- You can also select a Style when you are in the main Style screen, simply by using the Dial. Touch the name of the style and it will become highlighted, then use the Dial to select another Style.
- The CP remembers the last Style selection that you made within each category while the power is on. When you touch a STYLE button, the CP will automatically select the Style previously chosen in the same category.
- When you switch from one Style to another while it is running, the new Style will wait until the beginning of the next measure before it begins to play.

◇ Intro/Ending

When one of the Intro/Ending buttons is touched to start a Style, the selected Intro pattern will be played before the selected Variation pattern plays. There are both major and minor versions for each Intro. The Auto-accompaniment System will decide which Intro to use based upon the first Chord you play (major or minor). The LCD screen will display a countdown in bars to show how many bars you have until the variation begins playing. When one of these buttons is pressed while the Style is running the selected Ending pattern will be played before the Style stops.

There are major and minor versions for each Ending.

Each Style two different Intros and Endings.

- ◆ Intro/Ending 1 is the main Intro/Ending for the style.
- ◆ Intro/Ending 2 is a shorter Intro/Ending.

◇ Fill-In and Variation

Each Style is made of four Variation patterns and four Fill-in patterns.

- ◆ Fill-ins are short patterns that temporarily embellish the Style. Fill-ins can add excitement and rhythmic change to the Style and be used as a musical lead in between the Variations. To use a Fill-in, just touch one of the FILL IN buttons. You will hear the fill-in begin playing immediately from a musically appropriate spot.
 - ◆ Fill-ins can also be used as a short intro. First press the SYNC/FADE OUT button then touch one of the FILL-IN buttons to select a desired Fill-in. Press any key on the keyboard to start the style. After the Fill-in plays, the selected Variation will play.
 - ◆ To select a Variation, touch one of the four VARIATION buttons to select the desired Variation. The Selected VARIATION button LED will light.
- You can set the CP to automatically play a Fill-in anytime you press a VARIATION button as you switch from one Variation to another. Select your preferred option in the Fill-in mode. (See page 97)

◇ Favorites Button

The Favorites (STYLE) button allows favorite styles to be stored on a separate list for easy selection, and functions in a similar to the Favorites sound category button.

□ Step 1

Press the FAVORITES button.



The LCD screen will display the FAVORITES (STYLE) screen.

□ Step 2

Touch one of the favorite style entries, then touch the STYLE SELECT button to edit.

□ Step 3

Touch the STYLE SELECT icon, then touch the desired category and style.

The selected style will be added to the FAVORITES (STYLE) screen.

2) Auto Accompaniment System

The Auto-accompaniment System (ACC) is a powerful feature that determines how the Styles will interact with you as you play. The ACC System analyzes your playing and adjusts the notes the Style plays to follow the Chords that you play on the keyboard. The ACC System is capable of recognizing single finger as well as more complex chord voicings. The CP recognizes 61 chord types as well as most of their inversions. (See the appendix for a chord table.) There are three modes of key recognition—One Finger, Fingered, and Full Keyboard. Your choice of which mode to use depends on your skill level and the selected musical style.

Fingered The player must play at least three notes of a chord below the split point (LEFT/SPLIT Part) before the ACC System will recognize the chord type.

One Finger Uses a simplified chord method that allows beginners to specify a chord type by playing only one or two notes below the split point. The types of chords that can be recognized in this manner are limited to Major, Minor, 7th and Major 7th.

While the player can trigger basic chords with as little as one finger, the ACC System will recognize more complex chord types if you play them, even if you are in the One Finger mode.

Full Keyboard The player must play at least three notes of a chord anywhere across the 88 keys before the ACC System will recognize the chord type. This mode is similar to Fingered however, Full Keyboard recognizes chord types from three or more notes played anywhere across the 88 keys not just below the split point.

Bass Inversion

When Bass Inversion is on, the Bass Section of the Style will follow the lowest note of the chord voicing played on the keyboard. With Bass Inversion on it is possible to specify a chord over a certain bass note by the chord voicing you play. For example, a C chord over a G bass, or a Bb7 chord over a C Bass. Bass Inversion will work with all three key recognition modes but when in One Finger mode, you play at least two notes of a chord for Bass Inversion to function.

Style Lock

When Style Lock is on, the current Style settings (e.g. Style selection, tempo, Key Recognition mode, Bass Inversion etc.) will be retained, even if the REGISTRATION buttons are used. This allows the REGISTRATION buttons to be used without affecting the current Style settings.

◆ To turn Auto-accompaniment (ACC) on:

Step 1
Select a Style that you would like to play.

Step 2
Touch the STYLE SETTINGS button.



The LCD screen will display the STYLE SETTINGS menu:

STYLE LOCK : Prevents the selected style from changing when REGISTRATION buttons are pressed

BASS INV. : Enable Bass Inversion

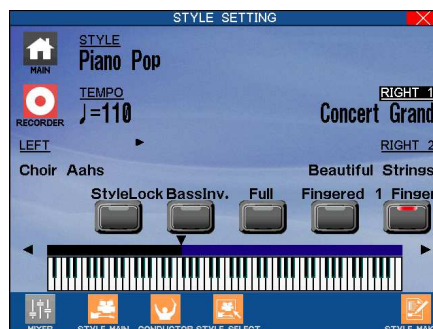

FULL KBD : Select Full Keyboard ACC mode

FINGERED : Select Fingered ACC mode

ONE FINGER : Select One Finger ACC mode.

*MIXER : Show the Style Mixer screen.
STYLE MAIN : Show the main Style screen.
CONDUCTOR : Show the Conductor screen
STYLE SELECT : Show the Style selection screen.
STYLE MAKER : Show the Style Maker screen.*

Step 3

Touch the screen to select the ACC Key Recognition mode.

The LCD indicator for each virtual button will turn on or off to indicate that the selected Key Recognition mode is enabled.

 Step 4

Touch the BASS INVERSION button if you would like to turn it on.

The LED indicator for the virtual button will turn on.

 Step 6

Touch the STYLE LOCK button if you would like to turn it on or off accordingly.

 Step 7

Press the ACC ON/OFF button to activate the Auto-accompaniment System (ACC).

The selected Key recognition mode will be displayed in the bottom left corner of the LCD screen, together with a hand icon to indicate One Finger and Fingered/Full Keyboard modes.

 Step 8

Press the START/STOP button to start the Style, and play some chords in the LEFT/SPLIT Part.

You will hear the Style start and also change keys and chord types as you play different chords.

 Step 9

If you want to cancel or stop the Auto-accompaniment, press the ACC ON/OFF button again.

If you turn the ACC off without stopping the Style the drum rhythms will continue to play.

■ When you play along with the Auto-accompaniment using the Fingered or Full Keyboard modes, you may hear two sounds playing the chords: one is selected by the front panel and the other is pre programmed for the Style. This is because the sounds used by the Auto-accompaniment Style are independent of the Left and Right Part sound settings. Therefore you will hear the instrument sounds played by your hand as well as those generated by the accompaniment.

In most cases, these are just duplicate notes being played using different sounds. In some cases however, you may hear different notes or an unexpected chord inversion. If the overall musical effect is undesirable, try turning the LEFT/SPLIT Part off and let the accompaniment play alone.

■ You can use the Auto-accompaniment (ACC) System without the Style running. In this way you can make use of the chord recognition without having the pre programmed rhythms or patterns playing. Just turn the ACC on and play without starting the Style. You will hear the bass and chord parts only. This may be useful when you play a musical piece that is not played with drums. The accompaniment sounds are pre programmed to best suit the different Styles, and you cannot alter them. When playing in One Finger mode, however, you can replace the chord sound with the sound chosen for the LEFT/SPLIT Part. Assign your preferred sound and make the LEFT/SPLIT Part active.

You can also start a Style without the ACC on. In this way you can have just drums and percussion accompany you.

3) 1-2 Play

If you want to play using an Accompaniment Style, but have no idea as to what sounds you should use for the right and left-hand parts, try using the 1-2 Play feature. This feature gives you a preprogrammed panel setup with appropriate sounds and settings for the Style you have chosen.

◆ To use 1-2 Play:

Step 1
Select the Style you would like to play.

Step 2
Press the 1-2 PLAY button.



The 1-2 Play indicator will become lit, and the words “1-2 Play” are displayed in the Main Screen. The SYNC button is activated as well.

Step 3
Activate one of the INTO/ENDING buttons if you want the Style to begin with an introduction. Start the Style by playing a key on the left side of the keyboard, or by pressing the START/STOP button.

Step 4
Press the 1-2 PLAY button again to turn it off.

- Among the settings contained in the 1-2 Play setting are the Sounds assigned to the keyboard Parts (RIGHT1/2, Left), Tempo, and Mixer settings.

4) Registration

A Registration is a setup that remembers the panel settings along with many other performance functions so that you can recall them at the touch of a button. This lets you begin to play quickly instead of spending a lot of time programming all the settings and values manually.

◇ Registration Buttons

There are 8 Registration buttons on the panel of the Concert Performer. Each button contains a different registration. Pressing any of the Registration buttons activates the setup stored there. Pressing another Registration button changes to the registration stored in that button. Pressing the active Registration button again deactivates the registration and returns you to the original panel setup.

◇ Registration Groups

There are 10 Registration Groups in the Concert Performer. Each group contains settings for the 8 Registration buttons on the panel. Each group represents a “family” of settings for the CP. The sound and performance capability of the Concert Performer is remarkable, and each registration group is designed to take full advantage of certain types of sounds available in the instrument. Switching from one Registration Group to another instantly changes the Registration buttons from Pipe Organ settings to Orchestra settings, for example.

- The default Registration Group is “American Pop”, a family of registrations designed to play popular music from the 1940’s through today.

With 8 Registration buttons and 10 Registration Groups, you have a total of 80 pre-programmed Registrations available. Plus, you can overwrite any registration with your own unique setups.

◆ To use a Registration:

□ Step 1

Press the REGISTRATION GROUPS button.



Ten Registration Groups will be displayed.

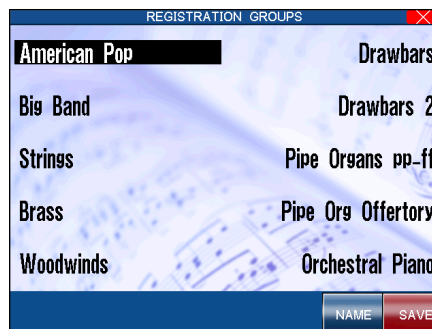

Touch the name to select the Registration Group, then press one of eight REGISTRATION buttons to call the desired setup..

*PAGE : Lists the Registration Groups on the other pages.
NAME : Takes you to the Registration Group Name screen.
SAVE : Takes you to the Registration Group Save screen.*

□ Step 2

Touch the desired the desired Registration Group name to select it.

□ Step 3

Press one of the eight REGISTRATION buttons to activate a Registration from your selected Registration Group.

□ Step 4

To return to the Main Screen, press the EXIT button.

- The CP remembers how the front panel was setup before you chose a Registration so that after exiting the Registration, the prior settings will be restored.
- It is not necessary to always begin with the REGISTRATION GROUP button when selecting a Registration. If the group you want to use is already selected, pressing one of the REGISTRATION buttons will activate a setup from that group. The CP will remember the Registration Group last chosen as long as the power remains on.
- You cannot use the 1-2 Play function and Registrations at the same time. Choosing one always cancels the other.

◆ **To create your own Registration:**

- **Step 1**
Set up the instrument's panel and functions in the way that you'd like to save them.
- **Step 2**
Press the REGISTRATION GROUPS button.
- **Step 2**
Touch the SAVE button, then touch one of the five Registration Groups listed in which to save your setup. Touch the PAGE buttons to view the 10 Registration Groups in sets of five.

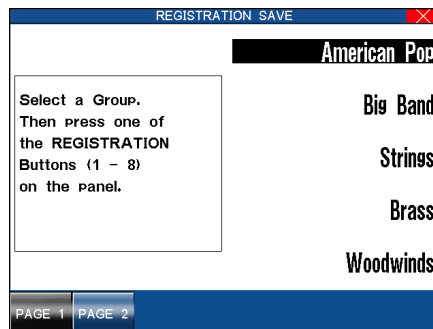

Touch the name to select the Registration Group.

PAGE : Display Registration Groups listed on pther pages.

- **Step 3**
Press one of the 8 REGISTRATION buttons to specify which location you'd like to save your Registration to.

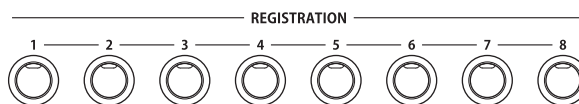

Press the specific REGISTRATION button where you'd like to save to.

- The following settings can be stored in a Registration:
Sounds (Right1, Right2, Left), Split Point, Style and Variation, Fill-in mode, Tempo, Accompaniment settings, Mixer settings, Chorus settings, Effect settings, Harmony settings, Voicing, Detune, Resonance, Left Pedal functions.
- You can save your Registrations to a USB memory device and load them into the CP later. (See page 119)

◆ To rename the Registration Group:

- Step 1**
Press the REGISTRATION GROUPS button.

- Step 2**
Select the Group that you wish to rename.

- Step 3**
Touch the NAME button.
The display will show a virtual keyboard.

- Step 4**
Touch the screen to enter a new name for the Registration Group.



BACK : Takes you to the previous menu.
SAVE : Saves the new Registration Group name

- Step 5**
Touch the SAVE button to confirm the new Registration Group name.

5) Song Stylist

With over 700 Sounds and 200 Styles, it can sometimes be difficult to decide the best settings with which to play a song. Even if you are very familiar with the Concert Performer, you may want a quick way to change the CP's setup to play another song. The Song Stylist feature was created to handle this situation for you. You simply pick the name of the song you want to play and the Concert Performer sets up everything for you.

The Song Stylist contains a list of over 700 popular song titles. In the Song Stylist, there is an appropriate setup for each of those songs. You may search for your favorite title either alphabetically by song name, or by category of musical genre. Once you've found the song you want to play, simply press one button and the CP is immediately setup for that song and ready for you to begin.

- The Song Stylist contains no prerecorded music, only the setup to play the chosen song. You must play the actual music yourself.

◆ To use the Song Stylist:

□ Step 1

Press the SONG STYLIST button.



The Name Menu list appears, showing alphabet letters to search for the SONG STYLIST.

Touch the relevant part of the screen to begin searching for the title of a song.



Touch the screen to select your desired song title's capital letter.

SHOW BY CATEGORY : Shows the categories of song title.
USB : Searches for a title stored on a USB device.

□ Step 2

Press the SEARCH BY CATEGORY button.

The Category list appears, showing the different musical genres for the SONG STYLIST.



Touch the screen to select your desired category.

SEARCH BY CATEGORY : Shows the other categories.
SEARCH BY NAME : Shows the song list in alphabetical order.
USB : Searches for a title stored on a USB device.

□ Step 3

Touch the SEARCH BY CATEGORY button to display the Category choices on the other page.

Then touch the desired category to select it.

A list of songs within that musical category will appear.

□ Step 4

Touch the PAGE buttons to display the Song Titles on the other pages in the same category.



Touch the desired song name to select it.

PAGE : Searches for a title on the other pages.
GROUP : Jumps to the Song Stylist Category menu.
ABC : Searches for a title in alphabetical order.
USB : Searches for a title stored on a USB device.
SELECT : Selects the Song.

Selecting a song stored on a USB device.



PAGE : Searches for a title on the other pages.
CHAIN : Starts the Chain Play.
PRESET : Searches for a title from the internal presets.
SELECT : Selects the song.

□ Step 5

Touch the screen to select one of the ten songs displayed.

The CP automatically returns to the Main Screen ready with all of the settings for that song.

□ Step 6

You may start and play the song in your usual manner. You can operate the CP normally and make any changes to the Song Stylist setup that you wish.

STYLE : Highlights the Style.

TEMPO : Adjusts the Tempo.

LEFT : Highlights the LEFT Part.



RIGHT1 : Highlights the RIGHT1 Part.

RIGHT2 : Highlights the RIGHT2 Part.

SONG LIST : Takes you back to the Song List screen.

□ Step 7

To play another song, touch the SONG LIST button.

To exit, press the SONG STYLIST button again or press the EXIT button.

- You may use different Sounds, Styles, Tempo and other settings to customize to your taste.
- When choosing a Song Stylist created by you (or someone else) and saved to a USB device, there may be a recorded melody and chord track available. The chord track, called the Auto Chord Progression, will provide you with the chord changes to the song.

You may also find a song title by searching the list alphabetically.

◆ **To search the Song Stylist by Song Title:**

Step 1

Touch the SONG LIST button.

The Category list appears, showing the different musical genres for the SONG STYLIST.

Step 2

Touch the SEARCH BY NAME buttons.

Touch the screen to take you to the first letter of the name of the desired song.

Step 3

Touch the PAGE buttons to search for the name of your song.

Then touch the song name to select it.

The CP automatically returns to the Main Screen ready with all of the settings for that song.

6) Keyboard Harmony

When the Auto-Accompaniment is enabled, selecting the Keyboard Harmony function will automatically add notes to your right hand (melody) part, helping you to sound more professional. This function analyzes the notes you play and automatically adds notes from the Accompaniment chord (shown in the Main Screen when the Accompaniment is on), creating a “harmony” part (even if you are only playing single notes in the left and right hands).

There are 10 types of Harmony.

Block	Adds three or four notes based on the chord.
Open	Adds three or four notes based on the chord. Harmony notes may extend over one octave below the lowest right-hand note.
Jazz	Adds three or four notes based on the chord.
Rockn'	Adds a note at a fifth (or fourth) interval to the lowest note played in the RIGHT Part.
Dynamic	Adds three or four notes based on the chord. Harmony notes are played within one octave below the lowest note played in the right hand.
Duet	Adds a note according to the lowest note played in the right hand and based on the chord.
Octave	Takes the highest note played in the right hand and doubles it an octave down.
Octave Duet	Adds an Octave note and a Duet note.
Vocal 1	Adds a single note above the top note of the right hand based on the chord.
Vocal 2	Adds three notes based on the chord. The lowest note will always be the root of the chord.

◆ To use Harmony:

□ Step 1

Press the KBD HARMONY button.

The button will be lit to show that it is active. The Harmony symbol will also appear in the Main Screen.

□ Step 2

To change the Harmony type, hold down the KBD HARMONY button for a moment until the Harmony Select menu is displayed.

□ Step 3

Touch the desired Harmony type to select it.

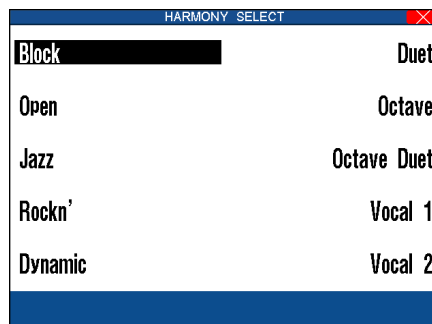

Touch the screen to select your desired Harmony type.

□ Step 4

Press the EXIT button to leave the Harmony Select menu.

□ Step 5

To turn off the Harmony, press the KBD HARMONY button again.

- The additional notes created by Harmony are added to the RIGHT1 Part, if that part is on. If the RIGHT1 Part is off, the additional notes are added to the RIGHT2 Part. If both parts are off, there will be no Harmony even though the KBD HARMONY button is lit. The Harmony notes are played with the same sound as the part they are added to.
- You can volume mix the Harmony separately in the MIXER screen.
- If the Accompaniment is not enabled, you will not be able to activate Harmony.

7) Creating Your Own Styles

The Concert Performer contains nearly 200 built-in Styles covering a wide variety of musical genres. There are two powerful features that allow you to edit any of these Styles to better suit your musical tastes, or even create your own Style entirely from scratch! These are the Conductor and the Style Maker.

The Conductor allows you to edit the Style data and personalize it to your taste.

The Style Maker allows you to create Styles of your own.

There are three ways of using this feature: Make a New Style, Edit an Existing Style, and Phrase Combination.

The CP can store up to 20 User Styles on board at one time. However since you can also save your original Styles to USB memory, your library of Styles is virtually unlimited.

8) Conductor

The Conductor is used to edit Preset or User Style data.

Easy Style Edit

The CP built-in styles are comprised three different types, Full, Intimate, and Solo Piano Styles. A Full Style consists of six instrument tracks called Sections. These are the Drums, Bass, and four Accompaniment tracks. The Intimate Styles have four Sections, Drum, Bass, And Two Accompaniment tracks. The Solo piano Styles have two Accompaniment Tracks (Right and Left hand) and no Drum or Bass tracks.

When you play a Style, each of these sections plays a musical Phrase composed for that type of instrument. Each section can play one of four different musical phrases, one for each of the four variations within a Style.

Easy Edit lets you assign which of these four Phrases will be played by each section for each of the four variations within the style. This means you can mix and match the different phrases for each section to create your own unique arrangements. Once you are satisfied with your edits, you can save your Easy Style edits to the PRESET STYLE.

◇ Easy Edit

□ Step 1

Select the Style and the Variation (1-4) that you would like to edit.

□ Step 2

Touch the CONDUCTOR icon.



The LCD screen will display the Easy Style Edit screen.

□ Step 3

Touch the part buttons at the bottom of the screen to select a Section to edit.

Touch the buttons on the side of the screen to select the desired Phrase (1-4) for each Section.

STYLE EFFECT : Show the Style Effect screen.

PHR. 1-4 : Selects a Phrase for the Section.



SAVE TO PRESET: Saves the changes to the Preset Style.

PART : Selects which Section is being changed. Touching again will mute the Section.

□ Step 4

Alternatively, touch the empty squares to select the phrase for each corresponding sound.

You can edit while the Style is playing to hear your changes.

□ Step 5

Touch the part buttons at the bottom of the screen to mute/un-mute each Section

□ Step 6

If you would like to save your edits, touch the **SAVE TO PRESET** button in the top right corner.

The saved contents will be written to the **PRESET STYLE**. If you don't save your edits, they will be lost when you turn the power OFF.

□ Step 7

Press the **EXIT** button to leave the **Easy Style Edit** screen.

- Touching the **SAVE** button will save all Styles at one time. You cannot save styles individually.
- For Intimate Styles the **ACC 3/4** Sections are not used and cannot be edited.
- For Solo Piano Styles the **Drum, Bass, and ACC 3/4** Sections are not used and cannot be edited.

◆ **Resetting the Style**

The CP always remembers the original **Preset Style** settings. If you wish to restore those factory settings before saving your edits, simply touch the **RESET** button in the **Conductor**.

- If you would like to revert all Styles back to their original factory settings, after you have pressed the **SAVE** button, use **reset Conductor** on the **Soft Reset** screen. See the section titled "Soft Reset" on page 106.

Note:

Easy Edit doesn't allow you to edit the **Intro, Ending and Fill-ins**. However, muting a **Section** in the **Style** will result in automatic muting of the same **Section** in the **Intro, Ending and Fill-ins**. If you mute a certain **Section**, you need to consider what effect it will have on the overall **Style**.

◇ **Style Effect**

The **Style Effect** screen allows a defined effect to be applied to each **Section** of the style.

□ Step 1

Touch the **STYLE EFFECT** icon.



The LCD screen will display the **Style Effect** screen.

□ Step 2

Touch the screen and use the **Dial** to select the style effect and effect settings.

Touch the part buttons at the bottom of the screen to turn the effect on/off for each **Section**.

EFFECT TYPE : Selects the type of effect to be applied to the style.

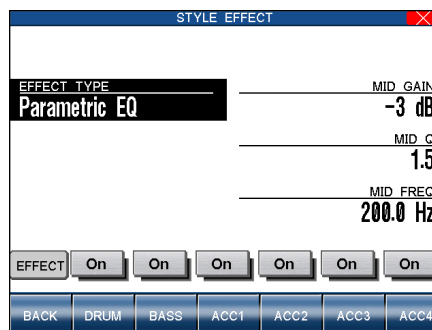

STYLE SETTINGS: Adjust the selected effect's settings.

*BACK : Back to the EASY STYLE EDIT settings.
PART : Turn the select effect on or off for each Section.*

9) Making a Style with Get Phrase from Recorder

This is the most flexible way to create a new Style.

You can take music that you have recorded using the CP's own Recorder and convert it into Style data. Or, you can use an external MIDI device or a personal computer to create the musical phrases, then load the data into the CP's Recorder and convert those.

◇ Configuration of a Style

A complete Style consists of the following patterns:

Basic pattern	4 patterns (Variation 1-4)	Max 16 measures
Fill-in	4 patterns (Fill-In 1-4)	1 or 2 measures
Intro Major	2 pattern	Max 16 measures
Intro Minor	2 pattern	Max 16 measures
Ending Major	2 pattern	Max 16 measures
Ending Minor	2 pattern	Max 16 measures

- Each of these are made of six Sections: Drum, Bass, ACC1, ACC2, ACC3 and ACC4. However you don't necessarily have to have all of them to create a Style. For example, you may not need to use some Variations or Sections to accomplish your musical idea. These unused sections may be left blank, or filled with Section data copied from the initial source Style that you were asked to choose at the beginning of the Style Maker process.
- The different Sections can be of varying bar lengths as long as they stay within the limit. Having them all the same length may make the Style easier to use in a song, but you may find that having uneven bar lengths among the Sections can create interesting musical results.
- Before you can generate a Style from these phrases, you have to have them loaded into the Recorder, keeping in mind which tracks in the Recorder are going hold data for which Sections in the new Style.
- The source recording in the CP's Recorder can be in any key. However, you need to know what key that is, because you will have to specify that as part of generating a new Style. For simplicity's sake it is advisable to record in C if you are planning on using the recording with the Style Maker.

◆ To create a Style:

□ Step 1

From the recorder screen, touch the **ADVANCED RECORDER** button.



The LCD screen will display the Advanced Recorder menu.

□ Step 2

In the Advanced Recorder menu, touch **Style Maker**.

The LCD screen will display the first Style Maker screen.



MENU : Go to the Advanced Recorder menu.
ENTER : Enters the selected Style Maker menu.

□ Step 3

To make a completely new Style, touch **Make New Style**.

To edit an existing style, touch **Edit Existing Style**, then use the Dial to select the style you wish to edit.

□ Step 4

Touch the ENTER button.

The Get Phrase From Recorder screen will be displayed.

□ Step 5

Touch the part buttons at the bottom of the screen to select the Recorder track that contains the data you want to use for each Section of the Style.

You can switch off a Section by touching it twice, and the Section will not be created in your Style.

PATTERN : Selects which pattern you are currently creating.

START BAR : Selects the first bar of the phrase in the recording that you want to convert.

BAR LENGTH : Selects the last bar of the phrase in the recording that you want to convert.

CHORD : Enter the key that the phrase was in.

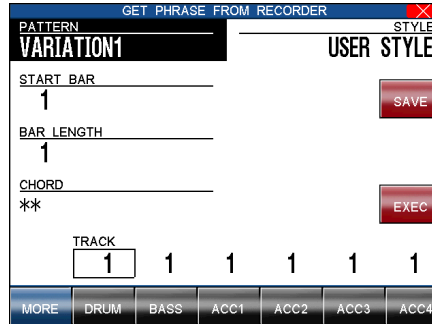

SAVE : Saves the new Style.

EXEC : Generates the new Style from your settings.

MORE : Takes you to the next menu for more options.

PART : Selects which Section(s) you are working with. Pressing twice deactivates the Section so that it will not be incorporated into the new Style.

□ Step 6

Touch the screen to set up the options and select the proper data from the Recorder.

You may have different options for each track.

□ Step 7

Touch the MORE button to adjust advanced settings, if necessary.

□ Step 8

Touch the EXEC button to generate the Style. You can listen to it by pressing the START/STOP button.

□ Step 9

If you would like to save the new style, touch the SAVE button.

□ Step 10

Touch PRESET TEMPO, then use the Dial to set the default tempo for the new Style.

SAVE TO : The location to which the new Style will be saved.

NAME : The name of the new Style.

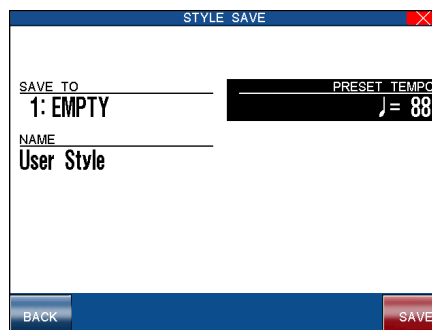

Preset Tempo : The tempo that is set automatically when the new style is selected.

BACK : Takes you to the previous menu.

SAVE : Saves the style to User Style.

- **Step 11**
Touch **SAVE TO**, then use the **Dial** to select the location to save your new **Style**.

- **Step 12**
Touch **NAME**, then use the virtual keyboard to enter a name for the new **Style**.

- **Step 13**
Touch the **SAVE** button
The new **Style** will be saved to the **CP**'s internal memory.

◇ Auto-accompaniment System

The Concert Performer Auto-Accompaniment System (**ACC**) analyzes your playing and adjusts the note data recorded in the different **Phrases** in a pattern to match the root key and chord type you are playing. The **ACC** System also shifts the octave for each phrase to keep each section playing within its musically useful range. To get the most out of this System, any new **Style** you create can benefit from some fine tuning of these settings.

When you touch the **MORE** button on the **Style Maker Record** screen, the **Style Maker Detail Settings** screen will be displayed.

Accompaniment Type (ACC Type)

This setting determines how **Phrases** being played by a particular section in a pattern will be analyzed by the Auto-accompaniment (**ACC**) System. There are Two Accompaniment Types: **Chordal** and **Scalic** (melodic). **Chordal** **Phrases** usually consist of block chords or arpeggiated chords. You should set this kind **Phrase** to **Chordal**. **Scalic** **Phrases** usually play melodic phrases that serve to add interest to the style as well as provide counter melodies and riffs. **Melodic** **Phrases** or **Phrases** that contain chromatic passages should be set to **Scalic**. **Scalic** **Phrases** can also contain chords but they will be analyzed differently than chords in a **Chordal** **Phrase**. The **Bass** section is automatically set to **Scalic** since it will rarely if ever play chords.

The terms **Open** and **Close** apply to **Chordal** **Phrases**, and refer to how the **CP** will regulate the voicing of a **Chordal** **Phrase**. Setting a **Section** to **Open** will allow for open-voiced chords, which might be good for guitar and string sounds. Setting a **Section** to **Close** maintains closed voiced chords, which are better suited to piano parts and other chording or comping instruments.

Range

This determines the chord inversions that a **Chordal** **Phrase** will play.
The term "range" here has nothing to do with the span of actual chord notes. It selects which note in the chord will serve as the basis of the chord inversion.
HI is the initial setting and is recommended as a starting point. **MID** plays an inversion based on the next lower note in relation to **HI**, while **LO** plays an inversion based two-notes lower.

Crossover

This determines the point where a **Scalic** **Phrase** will be transposed to keep the notes in a musically useful range. When notes in a **Scalic** **Phrase** fall below the **Crossover** point you select they will be transposed up one octave by the **Accompaniment** System. For example if you set the **Crossover** point to **E**, the **Phrase** would begin to be transposed up one octave whenever you play a chord with an **E** as the root.

Experiment with the different **Chordal** and **Scalic** settings to find the one that works best with each **Phrase**.

Bass Limit

This is an option for the **Bass** section and sets the limit for the lowest note the **Bass** will play. If a note in a **Bass** **Phrase** falls below the limit, it will automatically be transposed up an octave.

◆ To adjust the auto-accompaniment system:

□ Step 1

Touch the buttons on the left side of the screen to select the settings you wish to change.

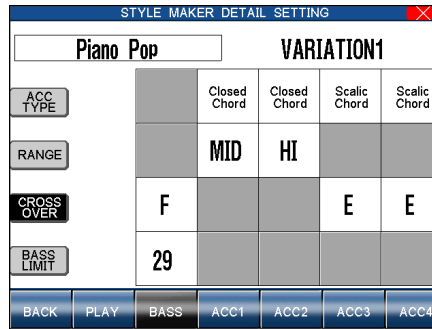

BACK : Takes you to the previous menu.

PLAY : Plays the style.

PART : Selects the Section.

□ Step 2

Touch the buttons at the bottom of the screen to select the Section.

□ Step 3

Use the Dial to select or change a value.

□ Step 4

When done, touch the BACK button to return to the previous menu, then save the Style if necessary.

10) Making a Style with Phrase Combination

Phrase Combination is similar to Easy Style Edit in the Conductor. Phrase Combination however, lets you not only combine Phrases from within the selected Style but you can also combine Phrases from any of the Styles in the CP to create a new Style. Additionally you can edit Fill-ins and basic patterns (Variations).

- You cannot change the Intro and Ending Phrases. These will remain the same as in your selected Style.

◆ To use Phrase Combination:

- Step 1**
In the Advanced Recorder menu, touch Style Maker.
The LCD screen will display the first Style Maker screen.
- Step 2**
Touch Phrase Combination, then use the Dial to select the initial style.
- Step 3**
Touch the ENTER button to proceed to the next screen.
The LCD screen will display the first Phrase Combination screen.
- Step 4**
Touch the screen to select which of the four Fill-ins and Variations you would like to change.

< ARROW : Selects the pattern to change.
Choose Variation 1–4 or Fill-in 1–4.

Selects the Section to be modified.

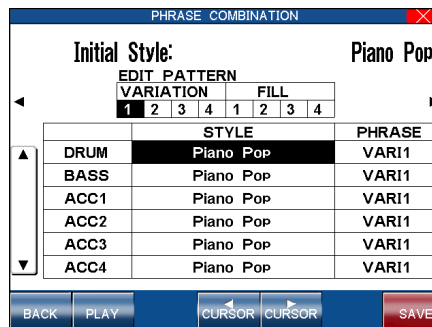

ARROW > : Selects the pattern to change.
Choose Variation 1–4 or Fill-in 1–4.

BACK : Takes you to the previous menu.
PLAY : Plays the new style.
CURSOR : Moves the cursor between the Style and
Phrase columns.
SAVE : Saves the modified data as a new Style.

- Step 5**
Touch the screen to select the Section to change.
- Step 6**
Touch the CURSOR buttons to move the cursor between the Style and Phrase column.
- Step 7**
Use the Dial to change the current Style or Phrase. You can jump to the desired Style category by pressing the Style select buttons directly.
- Step 8**
Touch the PLAY button to listen to the new Style.

- **Step 9**
Touch the **SAVE** button to save the new Style.

- **Step 10**
Touch **PRESET TEMPO** button and use the Dial to set the default tempo for the style.

SAVE TO : Selects the location to be saved.
NAME : Names the style.

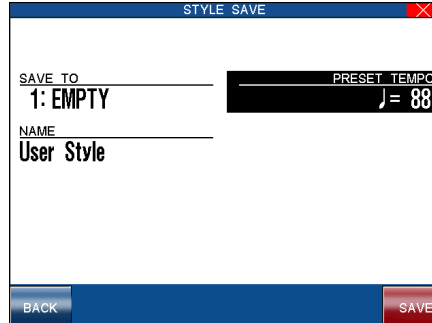

PRESET TEMPO : Sets the default tempo for the style.

BACK : Takes you to the previous menu.
SAVE : Saves the style to User Style.

- **Step 11**
Touch the **SAVE TO** button, then use the Dial to select the location that the style should be saved to.

- **Step 12**
Touch **NAME**, then use the virtual keyboard to enter a name for the new Style.

- **Step 13**
Touch the **SAVE** button.

11) Editing Sounds

Even though the Concert Performer has over 700 high quality instrument and drum sounds built-in, there may be times when you would like to change some of the qualities of a sound to really get the tonal character that you have in mind. The CP allows you edit certain settings for individual sounds. You can choose to change subtle nuances of the sound or even drastically change the sound's character to the point where you can no longer recognize what it was originally! Once you have made these changes, you can save up to 20 User Sounds in the User Sound Category, or a virtually unlimited number to USB memory.

◇ Editing the Preset Effect Settings

Each of the CP instrument Sounds has preset Chorus and Effect settings that are applied automatically whenever that sound is selected. You can change these settings to suit your tastes and save them so they become the preset settings for that Sound.

◆ To adjust the settings:

□ Step 1

Select the sound you want to edit and touch the SOUND EDIT button.

The LCD screen will display the Sound Edit Menu.

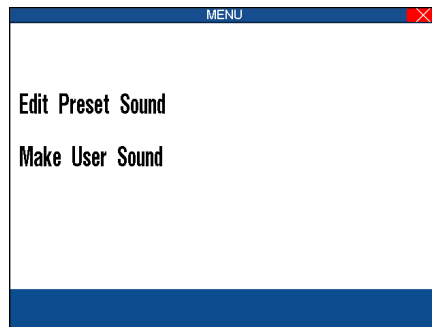

□ Step 2

Touch Edit Preset Sound Settings.

The Preset Sound Settings screen will be displayed.

□ Step 3

Use the Dial to select the preset sound that you wish to modify.

SOUND NAME : Selects the preset sound to edit.

CHORUS : Turns the Chorus on/off.

EFFECT : Turns the Effect on/off.

EFFECT TYPE : Selects an effect type.

EFFECT EDIT : Adjusts the effect settings.

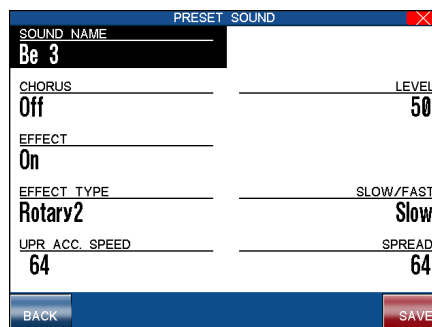

LEVEL : Adjusts the chorus level.

EFFECT EDIT : Adjusts the effect settings.

BACK : Takes you to the previous menu.

SAVE : Saves the settings.

Step 4

Touch the screen to select the different effect settings, then use the Dial to change their values.

 Step 5

When you are finished, touch the SAVE button to save your settings.

- Touching the SAVE button will save all changes made in the Preset Effect Settings menu. If you exit the Preset Effect Settings menu without saving your changes, the settings will remain unchanged.

◇ Making a User Sound

There are two steps to making a User Sound: Editing the effect settings - as described in the previous section - and editing the sound's character. You can adjust seven parameters of the sound character: Vibrato Depth, Vibrato Delay, Brightness, Attack, Decay, Sustain, and Release.

Vibrato Depth controls the depth of the Vibrato effect. Positive values produce a deeper Vibrato. Negative values produce a shallower Vibrato. The actual speed of the vibrato is preset for each sound.

Vibrato Delay determines how soon the vibrato effect will start after you press a key. Positive values produce a longer delay time before the vibrato effect starts. Negative values produce a shorter delay time before the vibrato effect starts. When this parameter is set to 0 the vibrato effect starts as soon as you press a key.

Brightness controls the Strength of the high frequencies. Higher values produce a brighter sound, lower values produce a darker sound.

Attack determines how quickly a sound reaches its maximum volume after you press a key. Positive values produce a slower attack that is more gradual and smooth, while negative values produce a faster attack that is more percussive in nature.

Decay determines how quickly the volume of the sound decreases after it reaches its maximum volume while the key is still held down. Positive values produce a slower decay, while negative values produce a faster decay.

Sustain determines the volume level of the sound after the decay portion of the sound is complete. Positive values produce a louder volume, while negative values produce a softer volume.

Release determines how long it takes for the sound to fade away to silence after you release the key. Positive values produce a slower fade, while negative values produce a faster fade.

Note:

For some sounds, changing the values for these parameters may have no effect. Each sound has a pre-programmed setting for each of these parameters. When you change the values you are increasing or decreasing the value from the pre-programmed setting. If the setting for a certain sound parameter is 0 for example, then changing the value will have no effect.

◆ To make a User Sound:

 Step 1

Select the sound you want to edit, then touch the SOUND EDIT button.

The LCD screen will display the Sound Edit Menu.

 Step 2

In the Sound Edit menu, select Make User Sound.

The User Sound Settings screen will be displayed.

 Step 3

You can edit the settings for Vibrato, Delay Vibrato time, Brightness, Attack, Decay, Sustain and Release.

□ Step 4

Touch the parameter buttons at the bottom of the screen, then use the Dial to change its value.
Alternatively, touch the area above/below each parameter bar to adjust the value directly.

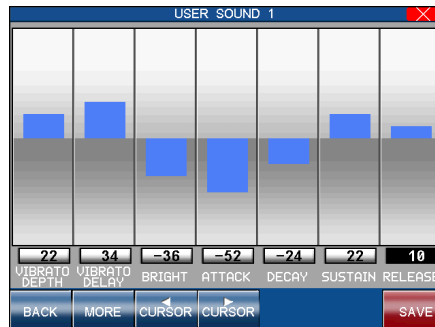

BACK : Takes you to the previous menu.
MORE : Takes you to the Preset Effect Settings menu.
SAVE : Proceeds with saving the sound.

□ Step 5

Touch the MORE button to edit the Effect Settings for your new sound.

This is the same screen as described in the previous section.

□ Step 6

Touch the SAVE button.

The Sound Edit Save screen will be displayed.

SAVE TO USER SOUND : Selects the location where the sound will be saved.

NAME : Names the Sound

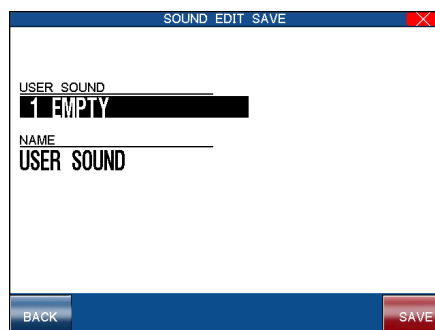

BACK : Takes you to the previous menu.
SAVE : Saves the edited sound to User Sound.

□ Step 7

Touch SAVE TO USER SOUND, then use the Dial to select the User Sound location where the new sound will be save.

□ Step 8

Touch NAME, then enter the name for the User Sound using the virtual keyboard.

□ Step 9

Touch the SAVE button.

The new sound will be saved to the USER category.

- To select and play your new User Sound, press the OTHERS button located in the SOUND section of the front panel, next select the USER sub-tageory, then select your desired User Sound.

6. Music Menu

The CP's Music Menu consists of various functions for listening, learning and playing music. The Concert Magic function allows non-pianists to enjoy creating music, while the Lesson function is a fun way for budding pianists to learn to play or improve their existing skills.

1) Concert Magic

Thanks to Kawai's innovative CONCERT MAGIC (CM) feature, absolutely anyone can sit at the Concert Performer and experience the joy of being a real performing musician... even if they have never touched a musical instrument in their life!

Concert Magic allows you to play a song by simply tapping any key on the keyboard. Regardless of what keys you play, the notes that are heard will be the correct ones for the song. However, what makes this really exciting is that you control the timing of the notes, as well as their dynamics. This lets you add a level of expressiveness and individuality to the song that makes it real musical performance.

As you play a CM song, a handy Note Navigator display helps you keep track of where you are in the music, as well as suggesting how the rhythm of the song should be tapped out on the keys. Many of the CM songs have lyrics that can be displayed as the song is being performed. As the song is played, a Bouncing Ball makes its way over the lyrics, following the player's performance and encouraging everyone around the instrument to sing along.

The Concert Performer can also automatically play any of the Concert Magic songs. Listening to the song first can make it easier to play. There is also a Chain Play mode, giving you options to listen to groups of CM songs.

◇ Selecting a Concert Magic Song

The 176 on-board Concert Magic songs are divided into eight groups by song category: Children's Songs, American Classics, Patriotic Songs, Christmas Songs, Hymns, Classics, Special Occasions, and International songs.

■ In addition, you can create and play your own Concert Magic songs using a USB memory device.

◆ To select a song:

- Step 1**
Press the MUSIC button.



The MUSIC menu will be shown in the LCD display.

- Step 2**
Touch the CONCERT MAGIC icon.



The song selection menu will be displayed.

Ten song titles from the Children's Songs category will be displayed. The category name is displayed at the very top of the screen.



CATEGORY : Searches by song category.

NAME : Searches by song name.

CHAIN PLAY : Enters the Chain Play mode of the Concert Magic.

USB : Searches for a song on a USB memory device.

SELECT : Can also be used select the song.

Step 3

If you want to go to another song category, touch SEARCH BY CATEGORY. You can also search for a specific title by using SEARCH BY NAME, which will list all 176 song titles in alphabetical order. You may also use the Dial to scroll through all the titles one after another.

- If you wish to play a CM song from a USB memory device, touch the USB button to see the list of songs available.

Step 4

When you have found the song that you want to play, touch the name to choose it.

The Note Navigator screen will be displayed, and you are ready to perform!

◇ Performing a Concert Magic Song

Playing the Concert Magic song you've selected is very easy. Just begin tapping any key on the keyboard and the song will play. Concert Magic plays the correct notes of the song, but you must provide the rhythm. Being familiar with how a particular song sounds does make it easier, but watching the Note Navigator screen can help you play a song that you've never heard before.

The Note Navigator provides an outline of the song's rhythm that looks a lot like the real music. The dots (•) in the display are the notes that you play. The spacing of the notes gives a clue to the timing (rhythm) of the notes. Notes that are closer together are played faster; notes that are farther apart are played longer. Notes that are evenly spaced are played evenly, and so on.

Up to four lines of music are displayed. After you've played past a note in the song, the dot becomes a cross (+) to help you keep track of where you now are. When you get to the bottom of the screen, the top lines change to show the next lines of music, as if you had turned the page. When you get to the end of the song you will see a double line, and then the song will reset to the beginning.

◆ To play a selected CM song:

□ Step 1

In the Note Navigator screen touch PLAY if you want to first listen to the song. The CP will play the song. Touch the STOP button to stop the song.

Notice how the Note Navigator displays the rhythm as the song is playing.

SCORE : Selects the score display.

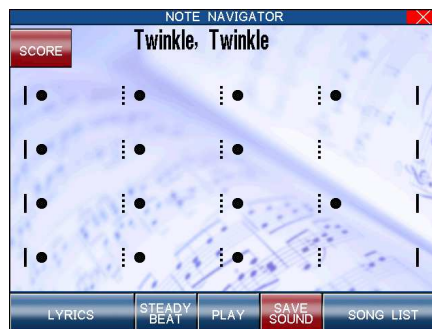

LYRICS : Displays the selected song's lyrics, if available.

STEADY BEAT : Allows you to play any song by steady tapping.

PLAY : Starts and stops the song. Also used to reset the song when performing.

SAVE SOUND : Saves the changed Sounds.

SONG LIST : Return to the song list to select another song.

□ Step 2

If you wish to play the CM song yourself, start tapping any of 88 keys while the song is stopped, and the song will play.

□ Step 3

After starting to play, touch the RESET button at any time to start at the beginning of the song again.

□ Step 4

To play another song, touch the SONG LIST button to display the list.

□ Step 5

If you have selected a song that has lyrics, you may view them by touching the LYRICS button.

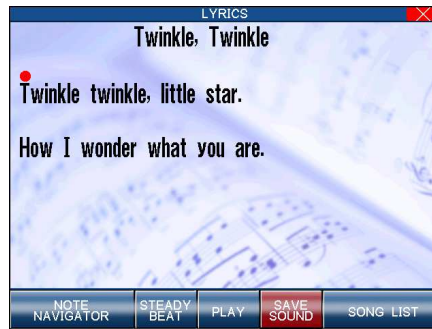

□ Step 6

If you would like to play any song by steady tapping (instead of following the original rhythm), touch the STEADY BEAT button.

□ Step 7

Touch the SCORE button to display the selected song as a musical score.

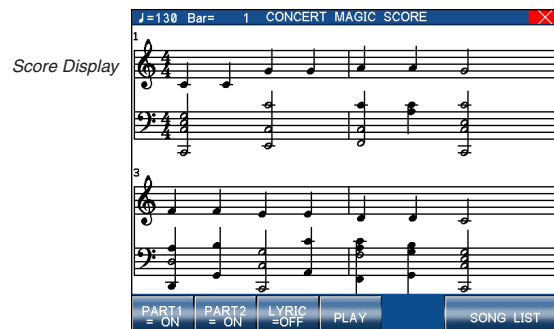

PART1 : Turns the score display for part 1 ON/OFF.
PART2 : Turns the score display for part 2 ON/OFF.
LYRIC : Turns the selected song's lyric ON/OFF.
PLAY : Starts and stops the song. Also used to reset the song when performing.
SONG LIST : Returns to the song list to select another song.

□ Step 8

To exit Concert Magic, simply press the EXIT button.

- When you reach the end of the song, press any key one more time. This will not produce sound, but instead resets the song to the beginning for another performance.
- The Bouncing Ball only works with song files that are specifically designed for Concert Magic to take advantage of this feature.
- A Concert Magic song is made of two parts - a melody part and accompaniment part. Many of the songs have different instrument sounds assigned each part to make the music more interesting. You can select different sounds for each part separately. The RIGHT1 Part plays the melody. To change its sound, press any Sound category button and select a new sound. The LEFT Part handles the accompaniment. To change its sound, first turn off the RIGHT1 Part and then press any Sound category button to select a new sound. Don't forget to turn the RIGHT1 Part back on before you begin to play.
- You can use the PIANO ONLY button to quickly change the sound for both parts to the Concert Grand piano.
- You can also activate the RIGHT2 Part to use as a layer (additional sound) for the melody. You can also select any new sound for the RIGHT2 part. Turn off all Parts except the one you wish to change, and then select the new sound. Don't forget to turn all necessary Parts back on before you begin to play.



- You can save your new sound settings by touching the SAVE button. The Soft Reset function will be required to return the sounds to their original settings (see page 106).
- You can transpose the song by pressing the TRANSPOSE buttons.

◆ To enter the Chain Play mode of the Concert Magic:

- Step 1**
Press the MUSIC button.
The MUSIC menu will be shown in the LCD display.
- Step 2**
Touch the CONCERT MAGIC icon.
The song selection menu will be displayed.
- Step 3**
Touch the CHAIN PLAY button.
The Chain Play menu will be displayed.
- Step 4**
Touch the screen to highlight a setting, then turn the Dial to change that setting. You can choose to play songs from any one category, or to play all 176 CM songs. You can also choose to use each song's preset sounds, or to play the songs using the Concert Grand piano sound only.

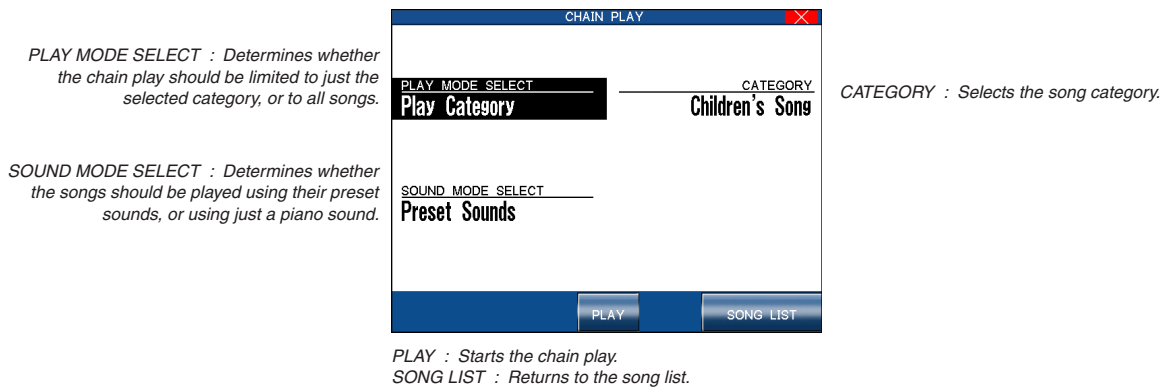

- Step 5**
Touch the PLAY button to start playing the songs.
- Step 6**
To exit Concert Magic, press the EXIT button again.

◇ Concert Magic Song Arrangements

Concert Magic songs are specially arranged so that they will work well with your key tapping. Each of the 176 CM songs falls into one of three categories of musical arrangements of varying difficulty.

EASY BEAT

These are the easiest songs to play. To perform them, simply tap any key with a constant beat. You can easily see which songs are Easy Beat songs when you look at the Note Navigator. The dots will line up at a constant interval in the screen, indicating a constant beat.

MELODY PLAY

These songs are also quite easy to play, especially if you are familiar with them. To perform them, tap the keys to the rhythm of the melody (as if you were singing).

SKILLFUL

These songs are more challenging. To perform them, carefully follow the rhythm as shown in the Note Navigator. It may require some practice to successfully play these songs. Even skilled players will enjoy the challenge that these songs offer.

◇ Steady Beat Play

After you choose a song, you can touch the STEADY BEAT button to play the song by steady tapping instead of the original rhythm. You can play any song from any arrangement category by tapping steady beats.

◇ Creating a Concert Magic Song

You can also use Concert Magic to play a song that isn't one of the 176 built-in titles. You can record a new song using the Concert Performer's Recorder and then save to a USB memory device as a Standard MIDI File (SMF). The song can now be selected by pressing the USB button when you are in the Concert Magic song selection screen.

- You can also record a song for Concert Magic by using an external sequencer. Remember to save it to your USB memory device as a Standard MIDI File.

As you might imagine, getting your song to sound exactly the way you want it to in Concert Magic may require a few adjustments to the original arrangement. The most important consideration is to keep the musical arrangement as simple as possible. Concert Magic "pauses" the song after every note as it waits for you to tap the next key. If there are complex rhythm patterns that have many notes per beat, the song may become overly difficult to play. Here are some suggestions for creating a Concert Magic song:

- Step 1**
Record the melody first using the RIGHT1 Part in the Easy Recorder (or Track 2 in the Advanced Recorder).
- Step 2**
Then record the accompaniment using the LEFT Part in the Easy Recorder (or Track 4 in the Advanced Recorder).
- Step 3**
Arrange the accompaniment so that its notes fall on the same beats as the melody. (This creates a Melody Play arrangement.)
- Step 4**
If you want to be a little more adventurous, insert a few carefully placed accompaniment notes in between melody notes. (This creates a Skillful arrangement.)
- Step 5**
If you are recording your song using an external sequencer, record the melody on channel 2 and the accompaniment on channel 4.
- Step 6**
For best results, you should quantize your parts.

- Of course, these are merely suggestions. There are no steadfast rules for how to compose your CM song. In fact, very rewarding musical experiences may come out of simple trial and error.

2) Lesson Function

The Lesson function allows budding pianists to practice the piano using a selection of built-in song books and finger exercises. The left and right hand parts of each piece can be practiced separately, adjusting the tempo to perfect difficult passages, before being recorded for self-evaluation.

◆ Selecting a Lesson Book/Song

The built-in Lesson songs are divided into several books:

- Alfred's Basic Piano Library Lesson Book Level 1A
- Alfred's Basic Piano Library Lesson Book Level 1B
- Alfred's Basic Adult Piano Course Lesson Book Level 1
- Alfred's Premier Piano Course Lesson 1A
- Alfred's Premier Piano Course Lesson 1B
- Burgmüller 25 (25 Etudes Faciles, Opus 100)
- Czerny 30 (Etudes de Mécanisme, Opus 849)
- Czerny 100 (Hundert Übungsstücke, Opus 139)
- Beyer (Vorschule im Klavierspiel, Opus 101)
- J.S. Bach: Inventionen, Sonatinen Album 1
- Scales
- Arpeggios
- Cadences
- Chords

◆ To select a book/song:

□ Step 1

Press the MUSIC button.



The MUSIC menu will be shown in the LCD display.

□ Step 2

Touch the LESSON icon.



The Lesson function screen will be shown in the LCD display.

BOOK LIST NAME: Indicates the currently selected Lesson book.

BOOK LIST: Show the lesson book selection screen.

SONG NO./SONG NAME: Indicates the currently selected song.

L-R BALANCE: Adjust the volume balance between the left and right hands.

MAIN: Show the MAIN screen.

MUSIC MENU: Show the MUSIC MENU screen

REC/PLAY/RWD/FWD: Record, play, rewind, fast-forward the selected Lesson song.

BAR-BEAT: Indicates the current bar and beat of the lesson song.

TEMPO: Indicates the current tempo of the lesson song.

LOOP: Repeat a defined passage of the lesson son.

The screenshot shows a screen titled 'LESSON' with a red 'X' in the top right corner. It displays 'AlfredPremr1A' as the book list name, 'No.1' as the song name, and '5-5' as the L-R balance. The bar-beat is '1-1' and the tempo is '♩=104'. There is a 'LOOP OFF' button and a bottom navigation bar with icons for MAIN, MUSIC MENU, and playback controls (REC, PLAY, RWD, FWD).

Step 3

Touch the BOOK LIST icon to show the list of available lesson books. Alternatively, if the BOOK LIST NAME field is highlighted, use the Dial to select the desired lesson book.

 Step 4

Touch the SONG NO./SONG NAME field to highlight it, then use the Dial to select the desired lesson song.

◇ Listening to the selected Lesson Song

After selecting the lesson book/song, it may be desirable to listen to the song before practising.

◆ To play the selected song:

 Step 1

Touch the  icon to play the selected lesson song.

 Step 2

Touch the   icons to rewind or cue the playback position (Bar) of the current song.

The playback position can also be changed by touching the BAR-BEAT field, then using the Dial.

 Step 3

Touch the  icon to pause playback of the selected lesson song.

 Step 4

Touch the  icon again to resume song playback.

◇ Repeating a passage of the selected Lesson Song

In order to aid practise, it may be desirable to automatically repeat passages of the song.

◆ To repeat (loop) a passage of the selected song:

While a song is playing:

 Step 1

Touch the  button to set the first bar of the loop.

 Step 2

Touch the  button again to set the last bar of the loop.

The defined passage will play continuously, with a 1 bar count-in before each repetition.

■ The left/right balance and playback tempo can continue to be adjusted while the A-B loop is in operation.

 Step 3

Touch the  button to deactivate the loop and resume normal playback.

◇ Adjusting the Left/Right hand volume balance

Adjusting the Left/Right hand balance allows the volume of each part to be reduced or increased. Setting the volume of either the left or right hand part to 0, allows that part to be practised individually while the other hand is played by the CP.

◆ To adjust the Left/Right hand volume balance:

□ Step 1

Touch the L-R BALANCE field, then use the Dial to set the balance to 5-1.



The volume of the right hand part will reduce until it is no longer audible.

This allows the right hand part to be practised while the left hand part is played by the CP.

□ Step 2

Touch the L-R BALANCE field, then use the Dial to set the balance to 1-5.



The volume of the left hand part will reduce until it is no longer audible.

This allows the left hand part to be practised while the right hand part is played by the CP.

- If the Beyer lesson book is selected, increasing the left hand value will decrease the volume of the student's part, while increasing the right hand value will decrease the volume of the teacher's part.

◇ Adjusting the playback tempo

It may also be desirable to reduce the tempo of a lesson song in order to allow complicated passages to be practised more easily, or for learned passages to be polished.

◆ To adjust the tempo of the selected song:

□ Step 1

Touch the TEMPO field, then use the Dial to adjust the song tempo in BPM (beats per minute).

- Depending on the lesson song, playback tempo can be adjusted within the range of 10 ~ 300 BPM.
- To reset the playback tempo, re-select the lesson song.

◇ Recording a Lesson Song practise

The Record feature allows the left or right-hand parts of the selected lesson song to be recorded to internal memory, and then played back for self-evaluation.

◆ To record a lesson song practise

□ Step 1

Touch the  icon.

Recording will begin after a 1 bar count-in. The CP will record while the lesson song is playing.

□ Step 2

Play the lesson song using the keyboard.

□ Step 3

Touch the  icon.

Recording will stop and the lesson song will also stop playing.

◆ To play back a recorded lesson song practise

□ Step 1

Touch the  icon to play the recorded lesson song.

- The left/right hand volume balance and playback tempo can be adjusted while the recorded lesson song practise is playing.
- The 'A-B' loop function cannot be used when recording a lesson song practise.
- The recorded practice will be erased automatically when a different lesson song is selected.

◇ Finger Exercises

When major/minor scales, arpeggios, chords, cadences, and Hanon exercises are selected, the CP can also evaluate one's practice, analysing note accuracy, timing evenness, and note volume consistency, before displaying results for each category. Using this function, players can objectively review their performances, and concentrate on improving a particular area of their technique.

◆ Recording a finger exercise for evaluation:

□ Step 1

Select a finger exercise lesson book and song.

For example 'Hannon', lesson No.1.

□ Step 2

Touch the  icon.

Recording will begin after a 1 bar count-in.

□ Step 3

Play the lesson song as accurately as possible.

When the lesson song has finished, the CP will analyse your playing and show an assessment screen:

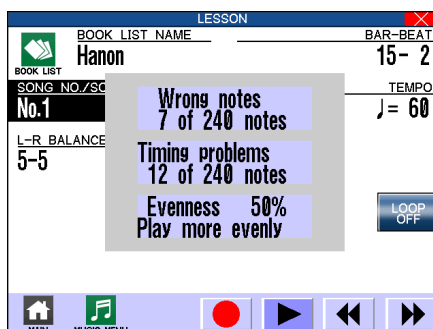

□ Step 4

Touch the  icon to play the recorded lesson song.

3) My Songs

The My Songs screen allows you to load, save, and delete Easy Recorder and Advanced Recorder songs that have been stored in the CP's internal memory.

◆ Load My Song

Step 1

From the My Songs menu, select the Load option

The display will show a list of the songs stored in the CP's internal song memory.

Step 2

Touch the song that you want to load, then touch the EXEC button.

The selected song will be loaded into the recorder memory.

Step 3

Press the PLAY/STOP button.

The selected song will start to play.

◆ Save My Song

This function will store the recorded song to the CP's internal memory, allowing it to be used for My Music lists.

Step 1

From the My Songs menu, select the Save option

The display will show a virtual keyboard.

Step 2

Touch the screen to enter a new name for the song, then touch the EXEC button.

The recorder song will be stored to the CP's internal song memory.

◆ Delete My Song

Step 1

From the My Songs menu, select the Delete option

The display will show a list of the songs stored in the CP's internal song memory.

Step 2

Touch the song that you want to delete, then touch the EXEC button.

The selected song will be deleted from the CP's internal memory.

7. Settings Menu

The Settings Menu contains all of the functions that affect the overall performance of the CP piano. This includes functions such as the system settings, tuning, and MIDI Setup. By adjusting these settings you can tailor the CP's performance to your taste.

◆ To use the Settings Menu:

□ Step 1

Press the SETTINGS button.

SETTINGS



The SETTINGS MENU will be shown in the LCD display:

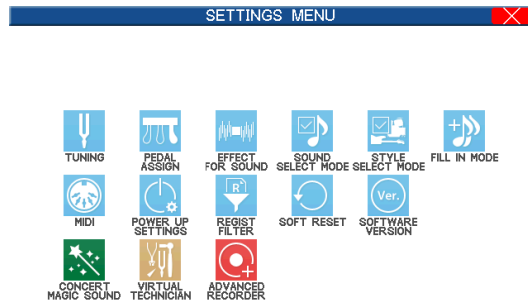

MAIN: —
Show the MAIN screen.



□ Step 2

Touch the screen to access the Settings Menu pages.

1) Tuning

Tuning allows you to adjust the CP's pitch. You may need to adjust the tuning when playing with other instruments.

The master pitch is displayed in Hertz. The range of adjustment is from 427.0 to 453.0 Hz. The factory preset value is set to the modern standard A = 440.0 Hz.

- You can also adjust the tuning for each Part separately. This can be used to simulate a chorus-like effect by layering the same sound in RIGHT1 and RIGHT2 and slightly detuning them. Each Part can be raised or lowered by up to 50 cents. (50 cents = 1/4 tone).

MASTER TUNE : Selects the master pitch.

LEFT : Selects the pitch for the LEFT Part.

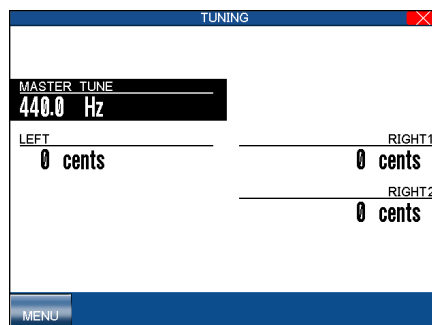

RIGHT1 : Selects the pitch for the RIGHT1 Part.

RIGHT2 : Selects the pitch for the RIGHT2 Part.

MENU : Takes you to the Settings menu.

2) Concert Magic Sound

This function determines which sounds the Concert Magic songs will be played with.

Preset Plays all the Concert Magic songs with the Preset Sounds assigned to each song.

Piano Plays all the Concert Magic songs with the Concert Grand piano.

Preset : Selects Preset sounds.

Piano : Selects Piano sound.

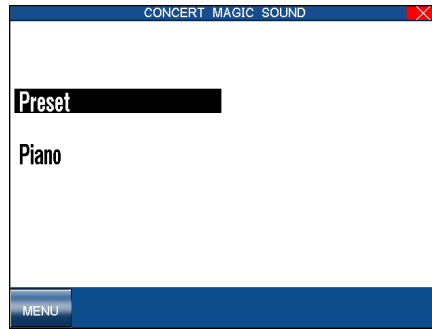

MENU : Takes you to the Settings menu.

3) Pedal Assign

The Soft, Sostenuto and Damper pedals on the Concert Performer function as much more than just traditional piano pedals. These pedals can be assigned to control various other functions on the CP piano.

Note:

The settings you make for the Soft (left) and Sostenuto (center) pedals here in the system are different from the settings in the KBD Settings button menu. When the KBD Settings button is turned On, the performance menu settings for these pedals will override the system settings. When the KBD Settings button is turned Off the settings made here in the system will be used.

◇ Damper Pedal (Right)

- Sustain** Can be activated or deactivated separately for each Part.
- Damper Hold** The Damper Hold On/Off allows you to determine if the sound such as organ or strings should be held (on) or gradually decayed (off) when the damper pedal is depressed.

◇ Pedal assignment options for Soft Pedal (Left) and Sostenuto Pedal (Center)

- Soft** Softens the sound and reduces its volume.
- Sostenuto** Sustains only notes that were held when pedal was depressed.
- Start/Stop** Controls start/stop for Styles and Songs.
- Harmony on/off** Turns the instrument Harmony function on/off.
- Registration** Switches from one Registration to another. You may choose the order, 1 to 8 or 8 to 1.
- Style Variation** Switches from one Style Variation to another. You may choose the order, 1 to 4 or 4 to 1.
- Intro/Ending** Plays the Intro or Ending.
- Fill In** Plays the Fill-in currently selected.
- Break** Interrupts the whole Style.
- Drums Only** Interrupts the Style except Drum part.
- Sync/Fade Out** Controls the SYNC/FADE OUT button.
- Glide** Bends the pitch up and down as programmed by you.
- Modulation** Applies programmable vibrato to the sound.
- Rotary Fast/Slow** Controls the speed of rotary speaker effect. This function will be automatically assigned to the Soft Pedal (Left) when a sound that has the rotary effect turned on is selected as the Priority Part.
- Left Hand Hold** Holds the notes played in the LEFT/SPLIT Part as long as the pedal is depressed.
- Panel Lock** Locks all buttons on the panel to prevent them from being tampered with or pressed accidentally while you are playing. Press the assigned pedal once to lock the panel buttons. Press the assigned pedal again to unlock the panel buttons.
- Easy Loop** Repeats the selected bars again and again. 1st press: assign the loop top, 2nd press: assign the loop end, 3rd press: cancel the loop.

- The pedal assignments made to the Left pedal will be saved as part of a Registration. The pedal assignments made to the Center pedal are global and are not saved as part of a Registration.

□ Step 1

Select the Pedal Assign option in the Settings menu (page 1).

The LCD screen will display the Pedal Assign screen.

Touch the screen to select which pedal you want to make assignments for.

Damper : Selects the Right pedal (Damper).

Center : Selects the Center pedal (Sostenuto).

Left : Selects the Left pedal (Soft)

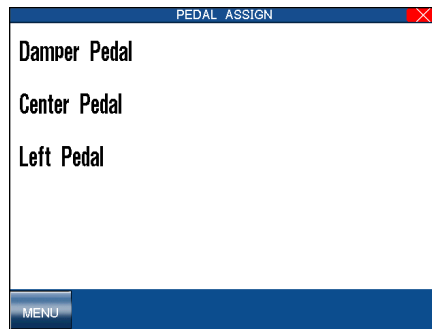

MENU : Takes you to the Settings menu.

□ Step 2

Touch the screen to select the setting and use the Dial to change its value.

FUNCTION : Selects a function to assign to the pedal.

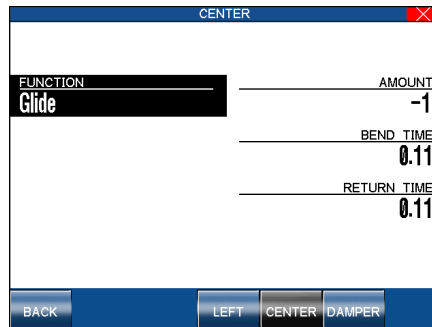

Touch the other parameters and use the Dial to adjust the values.

BACK : Back to the Pedal Assign menu.
PEDAL : Selects the different pedals.

4) Fill-in Mode

This determines whether or not a Fill-in will be automatically played each time a VARIATION button is pressed. There are two options.

Normal A Fill-in will not be automatically played each time a VARIATION button is pressed. Fill ins will only be played if a FILL button is pressed.

Auto A Fill-in will be played each time a VARIATION button is pressed. The Fill-in that is played will be the one that accompanies the Variation that you are leaving. For example, if Variation 1 is currently active, and you select Variation 2, the Fill-in for Variation 1 will be played.

Normal : Selects Normal mode.

Auto : Selects Auto mode.

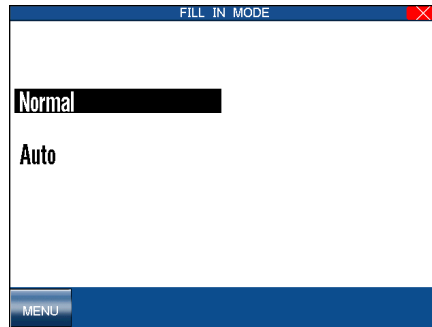

MENU : Takes you to the Settings menu.

5) Effect for Sound

This function determines whether or not the Preset Effects settings assigned to each Sound will be used or not.

Preset The Preset Effect settings for each Sound will be used. This is the default setting.

Panel The Preset Effect settings for each Sound will not be used. In other words, changing the Sounds will not change the Effect types and other settings for the Effects. This allows you to set each Effect section (REVERB, CHORUS, and EFFECTS) to your own taste and use your Effect settings for all sounds. The Panel setting is very useful if you only want to use certain Effects at all times or if you want to prevent the Effects from constantly changing each time you select a new Sound.

Preset : Selects Preset.

Panel : Selects Panel.

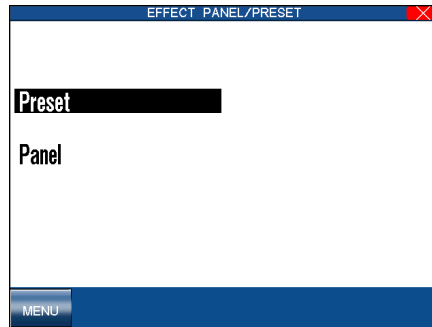

MENU : Takes you to the Settings menu.

6) Sound Select Mode

This function determines how sounds will be selected. There are two options.

Auto Select This is the factory default. The sound changes immediately to the highlighted sound on the selected sound page when you press a Sound Selection button or select a new sound page within a category. You can also use the Dial to scroll through all of the categories one by one.

Manual Select The sound does not change automatically when you press a Sound Selection button or select a new sound page within a category. The sound only changes when you select the desired sound by touching the LCD screen. In Manual Select mode the Dial wheel cannot be used to select sounds.

Auto Select : Selects the Auto mode.

Manual Select : Selects the Manual mode.

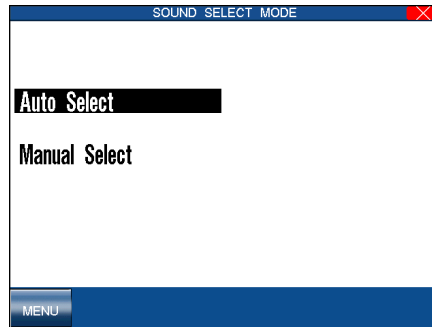

MENU : Takes you to the Settings menu.

7) Style Select Mode

This function determines how Styles will be selected. There are two options.

Auto Select This is the factory default. The style changes immediately to the highlighted style on the selected style page when you press a Style Selection button or select a new style page within a category.

Manual Select The style does not change automatically when you press a Sound Selection button or select a new sound page within a category. The style only changes when you select the desired style from the current style page by touching the LCD display.

- This mode is helpful when searching for a particular style while a style is running. In Manual mode the CP waits for you to select a style instead of automatically selecting and changing the active style whenever you press a Style Selection button.

Auto Select : Selects the Auto mode.

Manual Select : Selects the Manual mode.

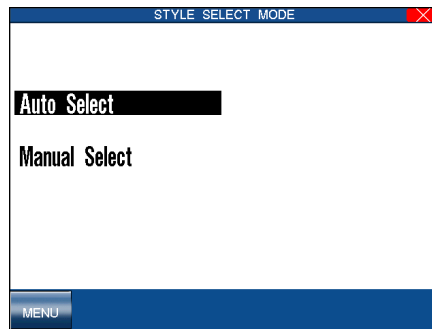

MENU : Takes you to the Settings menu.

8) MIDI Menu

The letters MIDI stand for Musical Instrument Digital Interface, an international standard for connecting MIDI equipped synthesizers, drum machines, and other electronic instruments so that they can exchange data. Personal computers can also be equipped for MIDI communication. Electronic instruments equipped with MIDI can transmit and receive performance data such as, notes, what sound to play, pedal information, volume, etc. through the MIDI In/Out Jacks. This data can be recorded with a device like a sequencer or a computer.

- In this manual we will only discuss the basic MIDI functions that pertain directly to the CP. For detailed literature on MIDI, please visit the music department of your local bookstore.

◇ MIDI Settings

On page one of the MIDI Settings menu you can configure the following settings.

Right Transmit Channel

Sets the MIDI Transmit Channel for the RIGHT hand Parts. You can select MIDI Channels 1-16.

Left Transmit Channel

Sets the MIDI Transmit Channel for the LEFT/SPLIT Part. You can select MIDI Channels 1-16.

Chord Transmit Channel

Sets the MIDI Transmit channel the Chord data created by the Accompaniment System uses when it analyzes the notes you play in the lower section of the keyboard. You can select MIDI Channels 1-16 and OFF. OFF disables MIDI transmission of the chord data.

Chord Detect Channel

Sets the MIDI receive channel for chord data being sent to the CP. The Accompaniment System can be controlled remotely on this MIDI channel by an external MIDI controller. You can select MIDI channels 1-16, OFF, All, or MIDI Accordion. When set to ALL the Accompaniment System will respond to any chord data it receives on ANY MIDI channel.

Local Control ON/OFF

This determines whether the CP's sound will be played from the piano's keyboard ("ON") or only from an external MIDI instrument ("OFF"). Even with local control "off" the CP's keyboard will still transmit to an external MIDI instrument or personal computer.

Clock

Clock is a data code that a MIDI instrument uses as the reference for its Tempo settings as well as Style Start/Stop commands. When it is set to INTERNAL, the CP uses its own built-in clock to control tempo settings. When set to EXTERNAL, the CP reads the clock data that it receives via MIDI and uses this data to control the Tempo.

◆ To configure the MIDI Settings:

□ Step 1

Touch the MIDI icon.

The LCD screen will display the first MIDI settings page.

□ Step 2

Touch the screen to select settings, and the Dial to change values.

RIGHT TRANSMIT CH : Selects Transmit channel for the RIGHT Part. Choose 1-16.

LEFT TRANSMIT CH : Selects Transmit channel for the LEFT Part. Choose 1-16.

CHORD TRANSMIT CH : Selects Transmit channel for the chord data. Choose 1-16 or OFF.

CHORD DETECT CH : Selects the chord detect Receive channel. Choose 1-16, OFF, All, or MIDI Accordion.

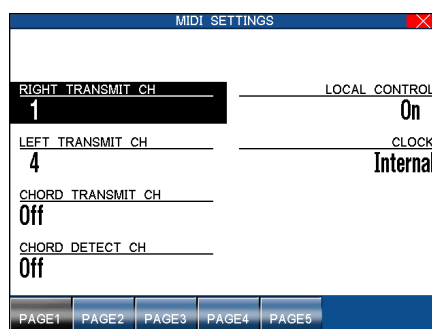

LOCAL CONTROL : Turns Local Control on/off.

CLOCK : Selects the Clock source.

PAGE : Selects the other MIDI Settings pages.

◇ Transmit MIDI Data

On page two of the MIDI Setting menu you can determine what MIDI data will be transmitted from the CP.

- “Keyboard = On/Off” Determines whether or not note data that is generated by the keys being played will be transmitted.
- “Program = On/Off” Determines whether or not the CP piano will transmit program change information when a Sound is selected on the CP.
- “Control = On/Off” Determines whether or not changes in controllers (such as the pedals being depressed) will be transmitted.
- “System Exclusive = On/Off” Determines whether or not all of the CP’s settings will be transmitted in a special format that is understood by another CP.
- “Clock = On/Off” Determines whether or not the CP’s Clock data will be transmitted.
- “ACC = On/Off” Determines whether or not the data from the Auto Accompaniment System will be transmitted.

KEYBOARD : Selects whether note data is transmitted.

PROGRAM(&BANK) : Selects whether Bank and Program Change data is transmitted.

CONTROL EXCEPT BNK : Selects whether Controller data is transmitted.

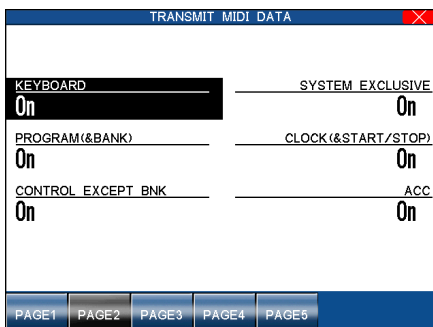

SYSTEM EXCLUSIVE : Selects whether System Exclusive data is transmitted.

CLOCK(&START/STOP) : Selects whether Clock data is transmitted.

ACC : Selects whether Auto-accompaniment data is transmitted.

PAGE : Selects the other MIDI Settings pages.

◇ Channel Receive On/Off

On page three of the MIDI Settings menu, you can determine which MIDI channels the CP will receive MIDI data on. The CP can receive MIDI data on all 16 MIDI channels at once or only certain MIDI channels.

Each of the 16 MIDI channels can be set separately to On or Off.

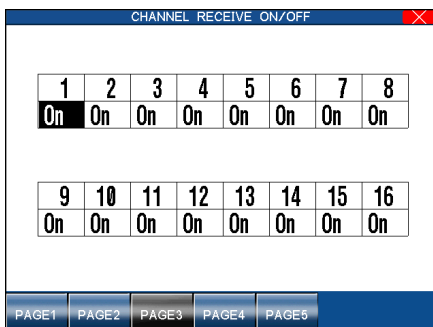

Touch the MIDI channel to set it On or Off.

PAGE : Selects the other MIDI Settings pages.

◇ MIDI Accordion

On page four of the MIDI Settings Menu you can configure the CP to be played from a MIDI Accordion.

MELODY CH. (RIGHT1) : Selects receive channel for the Melody (Right1) part. Choose 1-16.

BASS CH. (RIGHT2) : Selects receive channel for the Bass (Right2) part. Choose 1-16.

CHORD CH. (LEFT) : Selects receive channel for the Chord (Left) part. Choose 1-16.

PAGE : Selects the other MIDI Settings pages.

◇ MIDI Sound Settings

On page five of the MIDI Settings you can determine which sound will be played by the CP when it receives note information from an external MIDI device for each MIDI channel.

Touch the screen to select the MIDI channel, then use the Dial to select the defined sound.

Track	Sound
1	Concert Grand
2	Concert Grand
3	Concert Grand
4	Concert Grand
5	Concert Grand
6	Concert Grand
7	Concert Grand
8	Concert Grand

RESET : Resets the sound to "Concert Grand" for all 16 MIDI channels.

*PAGE : Selects the other MIDI settings pages.
SOUND : Selects a different sound for the highlighted channel.*

9) Power Up Settings

This determines whether the CP stores your preferred panel and system settings as the default settings and applies them automatically when the instrument is turned on.

Select **Save Current Settings** in the Power Up Setting menu to save the current panel settings automatically as the default settings when the CP is turned on.

Select **Restore Factory Settings** to return the CP to the factory default settings. The original factory settings will now be used by the CP when it is turned on.

- The CP never automatically stores Panel and System settings. If you make any new changes that you want to save, you must use the Save Current Settings command.

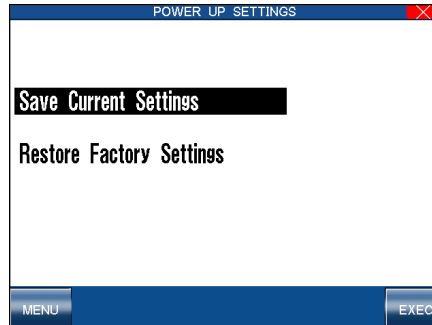

MENU : Takes you to the Settings menu.
EXEC : Applies the selected settings.

10) Registration Filter

A Registration is a setup that remembers the current panel settings along with many other performance functions so that you can recall them at the touch of a button. In some cases you may not want certain parameters such as tempo or transpose to be changed each time you select a new Registration. The Registration Filter function allows you to determine whether or not the following memorized registration parameters will be used each time you select a new registration.

- Transpose On/Off** Determines if the memorized Transposed value will be used (On) or ignored (Off) when a registration is selected.
- Split Point On/Off** Determines if the memorized Split Point will be used (On) or ignored (Off) when a registration is selected.
- Tempo On/Off** Determines if the memorized Tempo value will be used (On) or ignored (Off) when a registration is selected.
- ACC On/Off** Determines if the memorized ACC mode, ACC on/off or Bass on/off value will be used (On) or ignored (Off) when a registration is selected.
- Left Pedal On/Off** Determines if the memorized Left Pedal setting will be used (On) or ignored (Off) when a registration is selected.
- Sound Only On/Off** When set to ON only the sound settings for the registration will be used. All other memorized registration settings will be ignored. When set to OFF all memorized registration settings will be used in accordance with any registration filter settings.
- Reset All SW** Resets all the above settings back to ON except Sound Only which will be set to OFF (Factory Default).

TRANSPOSE : Selects Transpose.

SPLIT POINT : Selects Split Point.

LEFT PEDAL : Selects Left Pedal.

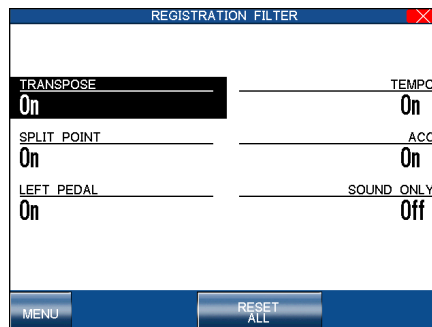

Touch the screen to select a parameter, then use the Dial to change the settings.

TEMPO : Selects Tempo.

ACC : Selects ACC.

SOUND ONLY : Selects Sound Only.

MENU : Takes you to the Settings menu.

RESET ALL : Resets TRANSPOSE, SPLIT POINT, LEFT PEDAL TEMPO and ACC back to the Factory default (ON). SOUND ONLY will be turned OFF.

11) Soft Reset

The Soft Reset function allows you to return all of the User Settings back to the original Factory Settings. You can instantly reset all of the user settings or only the ones you want to Reset at the touch of a button.

◆ To perform a Soft Reset:

□ Step 1

Touch the SOFT RESET icon.

The Soft Reset screen will be displayed.

□ Step 2

Touch the screen to choose the type of data you want to reset:

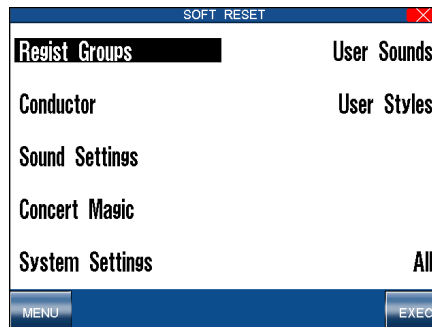

*MENU : Takes you to the Settings menu without resetting data.
EXEC : Proceeds with the Reset.*

□ Step 3

Touch the EXEC button.

□ Step 4

Touch YES to proceed, or NO to return to the previous menu.

12) Software Version

This function is used to show what system software version is currently installed on the CP.

◆ To show the software version:

- Step 1
Touch the Software Version icon.
- Step 2
The software version will appear in the LCD screen.

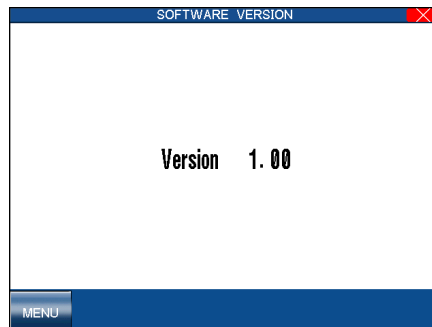

MENU : Takes you to the Settings menu.

- The version number of the software installed on your CP instrument may be different to that shown in the image above.

Display Control

This function controls the background screen design, brightness and Screen Hold of the display.

◇ Screen Hold

Most of the on-screen menus that you work with on the Concert Performer will remain displayed until you select something or press a particular button. However, some screens may be displayed only temporarily, switching back to a main screen if you allow the CP to sit idle without pressing any buttons. You can adjust a time setting for how long these screens stay displayed before switching, or even choose to have them hold without switching.

This adjustable time function is effective with the following menus:

- Sound Select menu
- Style Select menu
- Keyboard Settings menu called up by holding down the KBD SETTINGS button.
- Effect/Chorus Settings menu called up holding down the EFFECTS button.
- Reverb Settings menu called up by holding down the REVERB button.
- Keyboard Harmony Settings menu called up by holding down the KBD HARMONY button.

□ Step 1

Press the DISPLAY CONTROL button on the panel.

□ Step 2

Touch the screen to select the option, then use the Dial to change the settings.

SCREEN : Selects the background screen.

BRIGHTNESS : Adjusts the brightness of the screen (0-9).

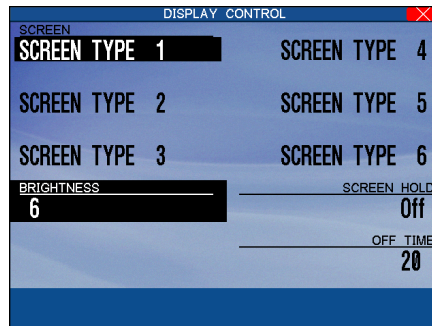

SCREEN : Selects the background screen.

SCREEN HOLD : Turns the Screen Hold On and Off.

OFF TIME : Adjusts the time before switching when the Screen Hold is Off (5-20 seconds).

8. Virtual Technician

An experienced piano technician is essential to fully realise the potential of a fine acoustic piano. In addition to meticulously tuning each note, the technician also performs numerous regulation and voicing adjustments that allow the instrument to truly sing.

The Virtual Technician menu of the CP piano features settings that simulate these refinements digitally, allowing performers to shape various aspects of the instrument's character to suit their personal preferences.

◆ To use the Virtual Technician:

□ Step 1

Press the **SETTINGS** button.



The **SETTINGS** MENU will be shown in the LCD display:

□ Step 2

Touch the Virtual Technician icon.



The Virtual Technician menu will be shown in the LCD display:

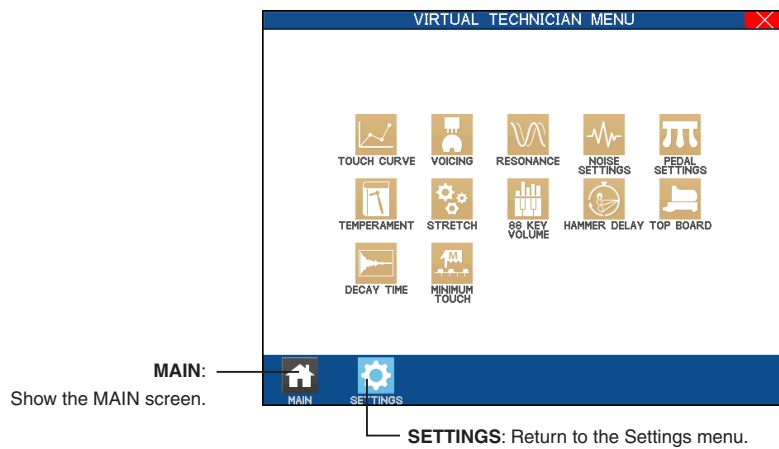

□ Step 2

Touch the screen to access the Virtual Technician pages.

1) Touch Curve

When playing a piano, the volume of the sound produced increases in direct relation to how hard a key is struck. The CP's Normal Touch curve offers the standard feel of an acoustic piano for practicing music. The CP offers five other touch curves ranging from light to heavy. You can also create your own touch curves tailored to your personal playing style.

Normal This is the standard touch of an acoustic piano.

Light 1, 2 For those still developing finger strength, such as a child, a louder sound is produced even when the piano is played with a soft touch. Light 2 is lighter than Light 1.

Heavy 1, 2 Perfect for those with strong fingers. Requires a heavier touch to produce a loud volume. Heavy 2 is heavier than Heavy 1.

Off A constant volume is produced regardless of how hard the keys are struck. This setting is suitable for sounds that have a fixed dynamic range such as Organ or Harpsichord.

User 1, 2 You can create two of your own custom touch curves.

■ LIGHT and HEAVY do not represent the physical weight of the keys. These are settings that affect the sensitivity of the keys, which determines the volume level in response to the key movement.

Normal : Selects the normal setting.

Light 1 : Selects a moderately light touch.

Light 2 : Selects a light touch.

Heavy 1 : Selects a moderately heavy touch.

Heavy 2 : Selects a heavy touch.

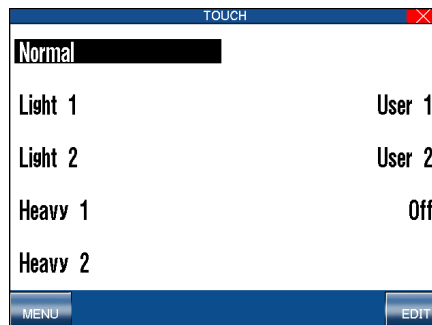

User 1 : Selects the User 1 touch.

User 2 : Selects the User 2 touch.

Off : Turns off the Touch sensitivity entirely.

MENU : Takes you to the Virtual Technician menu.

EDIT : Takes you to the User Touch Curve screen.

◇ User Touch Curve

You can create your own custom touch curve to fit your playing style. Two User Touch curves can be saved.

◆ To create a User Touch Curve:

□ Step 1

Touch the EDIT button in the Touch Curve screen.

The LCD screen will display the User Touch screen.

□ Step 2

Now start playing dynamically from soft to loud in order to let the CP analyze your playing style.

While you are playing, a musical note will blink in the right corner of the LCD display.

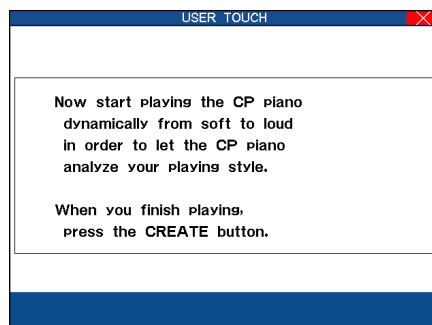

MENU : Takes you to the previous menu.

CREATE : Creates a user touch curve.

□ Step 3

Touch the CREATE button when you finish playing.

The CP will analyze your playing and create a custom touch curve for you based upon your playing style. The User Touch Exec screen will be displayed.

Use the Dial to select either User 1 or User 2 as the location for your new touch curve.

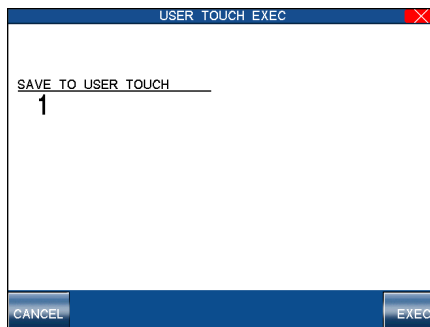

CANCEL : Cancels the saving procedure.
EXEC : Proceeds with saving procedure.

□ Step 4

Use the Dial to select either User 1 or User 2 as the location for your new touch curve.

□ Step 5

Touch the EXEC button to save your new touch curve.

The CP will ask for your confirmation.

□ Step 6

Touch YES to confirm.

- The user touch curve data is saved automatically even after the power is turned off. However, You must re-select the user touch curve each time the power is turned on unless you make your User touch curve the default by selecting "Save Current Settings" from the Power Up Settings screen (See Power Up Settings on page 115).

2) Voicing

Voicing is a technique used by piano technicians to mold the character of a piano's sound. The Voicing function lets you change the CP piano's tone quality by choosing one of four types of voicings.

- Normal** Produces the normal timbre of an acoustic piano throughout the entire dynamic range. This is the default setting.
- Bright** Produces a brighter tone throughout the entire dynamic range.
- Mellow** Produces a mellower tone throughout the entire dynamic range.
- Dynamic** The tone will change dramatically from mellow to bright according to your playing.

- The current voicing selection is global for all the instrument Sounds. You cannot have an individual setting for each Sound.
- While voicing is a technique used for optimizing the tone of an acoustic piano, this function can be used on all the Sounds on the CP piano.

Normal : Selects Normal.

Mellow : Selects Mellow.

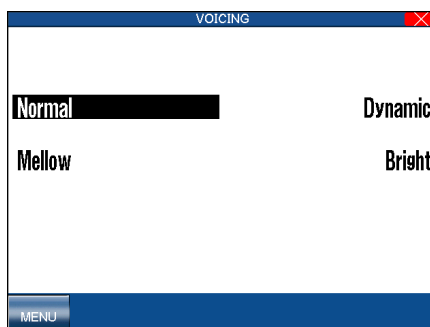

Dynamic : Selects Dynamic.

Bright : Selects Bright.

MENU : Takes you to the Virtual Technician menu.

3) Resonance

◇ Damper Resonance

When the damper pedal is depressed on an acoustic piano, all the dampers are lifted up allowing the strings to vibrate freely. In this condition, when you play a note not only will the strings for the note you played vibrate but other strings will vibrate due to sympathetic resonance. The Damper Resonance function simulates this phenomenon. You can select the level of effect from 0 (Off), 1 to 10. The default setting is 5.

◇ String Resonance

Even when the damper pedal is not depressed on an acoustic piano, the strings for any notes you are holding will be un-damped and will resonate freely in sympathy with the strings of other notes that you play if they are part of the same harmonic series. In addition, adjacent notes will also be resonated. The String Resonance function simulates this phenomenon. You can select the level of resonance from 0 (off), 1 to 10. The default setting is 5. String resonance is not active when the damper pedal is depressed.

DAMPER RESONANCE : Selects the level of damper resonance.

STRING RESONANCE : Selects the level of string resonance.

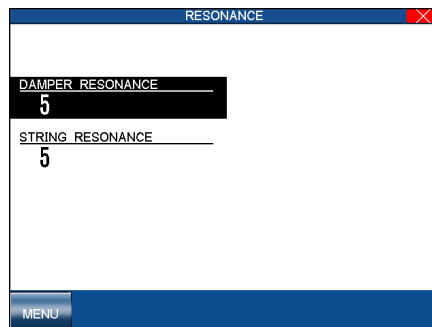

MENU : Takes you to the Virtual Technician menu.

4) Noise Settings

◇ Damper Noise

When the damper pedal of an acoustic piano is pressed and released, it is often possible to hear the sound of the damper head touching and releasing the strings. The Damper Noise setting allowing the volume of this sound to be adjusted. You can select the level of noise from 0 (Off), 1 to 10. The default setting is 5.

◇ Key Off Effect

When playing an acoustic piano – particularly in the bass region of the keyboard – if a key is played with force and released quickly, it is often possible to hear the faint sound of the damper touching the strings immediately before the vibrations are stopped.

In addition, the speed at which keys are lifted will also affect the character of the sound. For example, when lifting the keys quickly (e.g. staccato playing) the ‘release’ portion of the sound will be noticeably shorter than when lifting the keys slowly (e.g. legato playing). You can select the level of noise from 0 (Off), 1 to 10. The default setting is 5.

◇ Key Action Noise

When playing an acoustic piano, it is often possible to hear the faint sound of the keyboard action returning (i.e. ‘falling back’) to the neutral position after a key is released. The Key Action Noise setting allowing the volume of this sound to be adjusted. You can select the level of noise from 0 (off), 1 to 10. The default setting is 5.

DAMPER NOISE : Selects the level of damper noise.

KEY OFF EFFECT : Selects the level of key-off effect.

KEY ACTION NOISE : Selects the level of key action noise.

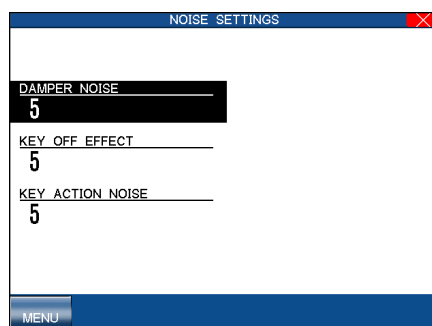

MENU : Takes you to the Virtual Technician menu.

5) Pedal Settings

◇ Half Pedal Point

The Half-Pedal Adjust setting allows the point at which the damper/sustain pedal becomes effective (i.e. when the dampers of the piano begin to lift from the strings) to be adjusted. This setting may be useful for pianists that habitually rest their right foot on the damper/sustain pedal, but do not necessarily wish to sustain the sound. You can select the half pedal point from 1 to 10. The default setting is 5.

◇ Soft Pedal Depth

The Soft Pedal Depth setting adjusts the effectiveness (i.e. depth/strength) of the soft pedal. You can select the soft pedal depth from 1 to 10. The default setting is 5.

HALF PEDAL POINT : Selects the half pedal point.

SOFT PEDAL DEPTH : Selects the soft pedal depth.

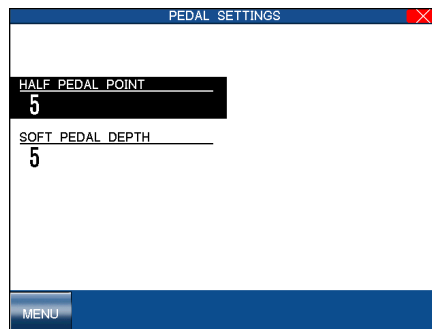

MENU : Takes you to the Virtual Technician menu.

6) Temperament

The CP offers not only equal temperament (the modern standard) but also immediate access to temperaments popular during the Renaissance and Baroque periods.

You can also create your own User tuning Temperament as well.

□ Step 1

Select Temperament form the Virtual Technician menu.

The LCD screen will display the Temperament screen.

□ Step 2

Touch the screen to select your desired Temperament.

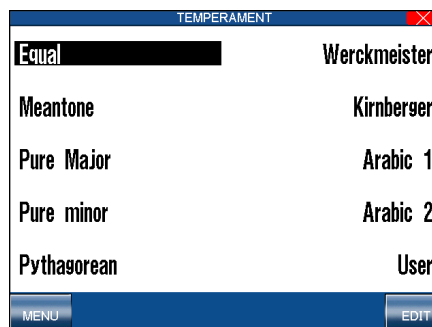

MENU : Takes you to the Settings menu.

KEY : Selects the temperament key.

EDIT : Takes you to the User Temperament screen.

□ Step 3

Set the Temperament Key by touching the ◀ KEY ▶ buttons.

Temperament Keys

Limitless modulation of the key became available only after the invention of Equal temperament. When you use a temperament other than Equal temperament, you must carefully choose the key to play in. For example, if the song you are going to play is written in D major, choose "D" to set the temperament key.

◇ Brief Explanation of Temperaments

Equal Temperament (Flat)

This is an “unstretched” equal temperament that divides the scale into twelve equal semitones. This produces the same chordal intervals in all twelve keys, and has the advantage of limitless modulation of the key. However the tonality of each key becomes less characteristic and no chord is in pure consonance.

Equal Temperament (Stretched)

This is the most popular piano temperament and is the initial setting. The hearing ability of a human is uneven and is not as accurate with high frequency and low frequency as it is with the middle range. This temperament’s tuning is stretched to compensate for this so the sound will be heard naturally to the ears. This “Stretched” equal temperament is a practical variation of the “unstretched” equal temperament which was invented on a mathematical basis.

Pure Temperament

This temperament, which eliminates dissonances for thirds and fifths is still popular for choral music because of its perfect harmony. You need to be aware what key you are playing in with this temperament. Any key modulation will result in dissonances. When you play music in a particular key, you need to match the key of the temperament as well.

Pythagorean Temperament

This temperament, which uses mathematical ratios to eliminate dissonance for fifths, is very limited for use with chords, but it produces very characteristic melodic lines.

Meantone Temperament

This temperament, which uses a mean between a major and minor whole tone to eliminate dissonance for thirds, was devised to eliminate the lack of consonance’s experienced with certain fifths for the Pure temperament. It produces chords that are more beautiful than those with the equal temperament.

Werckmeister III, Kirnberger III Temperament

These two temperaments are placed in between Meantone and Pythagorean. For music with few accidentals, this temperament produces the beautiful chords of the mean tone, but as accidentals increase, the temperament produces the characteristic melodies of the Pythagorean temperament. It is used primarily for classical music written in the Baroque era to revive the original characteristics.

Arabic

Some oriental scales, including the Arabic, are characterized for “quarter-tone” which is half of a half-tone (50 cents). This makes the music sound very different from traditional western music. The CP Piano provides two of the most popular Arabic scales, although you can create more variations with the User Temperament function. With Arabic 1, the notes B and E are a quartertone lower than the Occidental Scale, while the notes A and E are lower with Arabic 2.

◆ To create a User Temperament:

□ Step 1

On the Temperament screen, touch the EDIT button.

The User Temperament screen will be displayed.

□ Step 2

Touch the screen to select the note to edit.

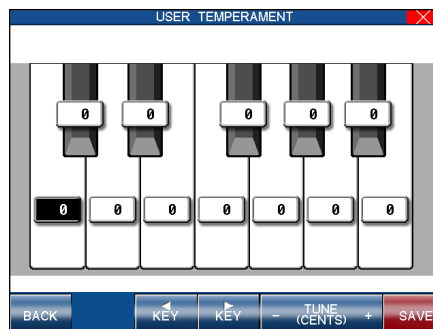

BACK : Takes you to the Temperament menu.
KEY : Selects the key/note to edit.
TUNE : Adjust the tuning value of the selected key/note.
SAVE : Saves the User Temperament.

□ Step 3

Use the Dial or touch the - TUNE + buttons to change the value.

The value is represented in cents above or below Equal temperament and ranges from -50 to +50.

□ Step 4

Touch the SAVE button to save the User Temperament.

- The User Temperament alters the tuning for each octave equally. In other words, you cannot alter the tuning of different sections of the CP’s keyboard range separately.

7) Stretch

Stretch tuning is a piano-specific tuning method in which the tuning for the lower notes is slightly lower and the tuning for the higher notes is slightly higher than the settings made in the Equal temperament. The Stretch setting allows the degree of stretch tuning to be adjusted when Equal (piano) or Equal temperament are selected. It is also possible to create custom tuning methods using one of the four User types.

Off	Stretch tuning is turned Off for all instrument sounds.
Piano Normal	Stretch tuning is set to Normal for piano sounds only*.
Piano Wide	Stretch tuning is set to Wide for piano sounds only.*
Normal	Stretch tuning is set to Normal for all instrument sounds.
Wide	Stretch tuning is set to Wide for all instrument sounds.
User1~4	A custom stretched tuning applied to piano sounds only*.

- If Piano Normal/Piano Wide is selected, the tuning for any other active sounds layered with a piano sound will be stretched to match the piano. If no piano sound is active the tuning for any active sounds will not be stretched.

TYPE : Selects the type of stretch tuning.

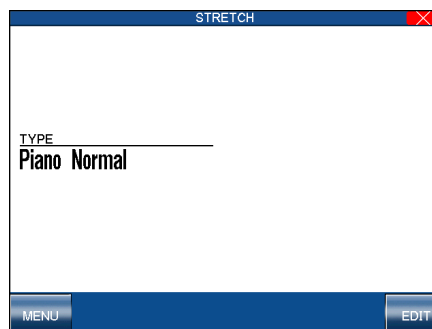

*MENU : Takes you to the Virtual Technician menu.
EDIT : Edit the selected User Stretch Tuning.*

◆ To create a User Stretch tuning:

□ Step 1

On the Stretch screen, touch the EDIT button.

The User Stretch screen will be displayed.

□ Step 2

Touch the KEY field and use the Dial or press a key to select the note to edit.

TYPE : Selects the User Stretch Tuning memory.

KEY : Selects the key to be adjusted.

TUNING : Adjusts the pitch of the selected key.

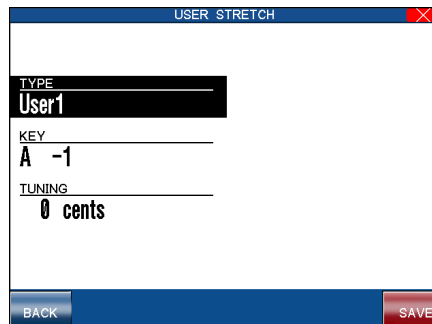

*BACK : Takes you to the Temperament menu.
SAVE : Saves the User Temperament.*

□ Step 3

Touch the TUNING field and Use the Dial to change the stretch tuning value.

The value is represented in cents above or below Equal temperament and ranges from -50 to +50.

□ Step 4

Touch the SAVE button to save the User Stretch tuning.

8) 88 Key Volume

The 88 Key Volume settings allows the volume of each of the 88-keys to be adjusted individually. It is possible to create four different user key volume types.

Off	The key volume is consistent for every key.
User1~4	Custom key volumes for each key..

TYPE : Selects the type of 88 key volume.

MENU : Takes you to the Virtual Technician menu.
EDIT : Edit the selected User 88 Key Volume.

◆ To create a User 88 Key Volume:

- Step 1**
On the 88 Key Volume screen, touch the EDIT button.
The User 88 Key Volume screen will be displayed.
- Step 2**
Touch the KEY field and use the Dial or press a key to select the note to edit.

TYPE : Selects the User 88 Key Volume memory.

KEY : Selects the key to be adjusted.

TUNING : Adjusts the volume of the selected key.

BACK : Takes you to the Temperament menu.
SAVE : Saves the User Temperament.

- Step 3**
Touch the VOLUME field and Use the Dial to change the volume value.
The value is represented in cents above or below Equal temperament and ranges from -50 to +50.
- Step 4**
Touch the SAVE button to save the User 88 Key Volume.

9) Hammer Delay

When playing pianissimo passages using an acoustic piano, there may be a perceived delay between a key being pressed and the hammer striking the strings. The Hammer Delay setting allows this delay to be adjusted. You can select the amount of delay from Off, 1 to 10. The default setting is Off.

- Off** No delay between playing a key and the sound being heard.
- 1 ~ 10** An increasing amount of delay will be applied before the sound is heard.

HAMMER DELAY : Selects the amount of Hammer Delay

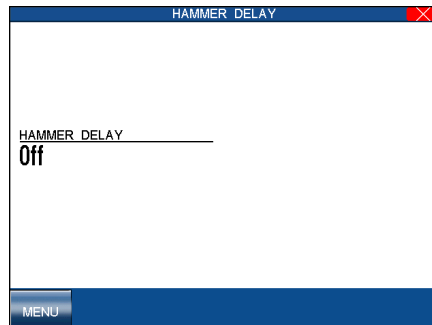

MENU : Takes you to the Virtual Technician menu.

10) Top Board

When playing an acoustic grand piano, the position of the instrument's topboard (lid) affects both the volume and 'openness' of the tone produced. A fully open topboard allows sound waves to reflect off the polished lid surface and project into the room, while a closed lid has the opposite effect, resulting in a darker, more opaque tone. The Top Board setting allows the position of the 'virtual' topboard to be set to one of our positions, with the default position being the most open – Open 3.

- Open 3** Simulates the character of a fully open topboard.
- Open 2** Simulates the character of a half open topboard.
- Open 1** Simulates the character of a partially open topboard.
- Closed** Simulates the character of a closed topboard.

TOP BOARD : Selects the top board position.

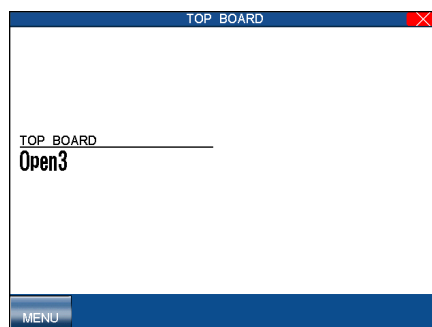

MENU : Takes you to the Virtual Technician menu.

11) Decay Time

When playing an acoustic grand piano, the length of the instrument influences the speed at which held notes decay, with longer grand pianos (i.e. longer strings) characterised by longer decay times. The Decay Time setting allows the length of decay while keys are pressed to be adjusted. You can select the amount of delay from 1 to 10. The default setting is 5, with higher values extending the decay length.

DECAY TIME : Sets the amount of decay.

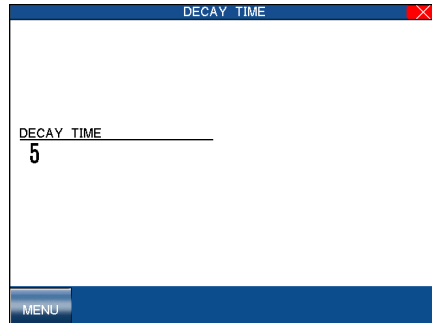

MENU : Takes you to the Virtual Technician menu.

12) Minimum Touch

The Minimum Touch setting allows the minimum key velocity required to produce a sound to be adjusted. By default, this setting attempts to recreate the extremely fine touch sensitivity of a concert grand piano, allowing a very soft sound to be produced with the slightest of key touches. However, it may be desirable to reduce this sensitivity, when wishing to recreate the sensitivity of a small grand piano or an upright piano. The Minimum Touch setting allows the sensitivity of the minimum touch to keys are pressed to be adjusted. You can set the Minimum Touch amount from 1 to 10. The default setting is 1, with higher values requiring greater force to produce a sound.

MINIMUM TOUCH : Sets the Minimum Touch level.

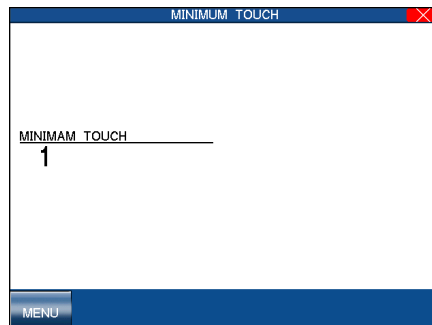

MENU : Takes you to the Virtual Technician menu.

9. Using USB Memory

The Concert Performer's USB connector provides a convenient way to load and save various types of data, ranging from recorded compositions and user settings, to MP3/WAV audio data and Standard Midi (GM) songs. In this chapter we shall investigate the various ways in which USB memory can be used.

◇ USB Menu

The USB menu provides access to the main USB operations.

- **Step 1**
Press the USB button.

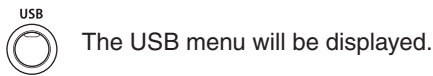

- **Step 2**
Touch the screen to select the desired function.

Load : Display the USB Load menu.
Save : Display the USB Save menu.
Delete : Delete data from the USB device.
Format : Format the USB device.

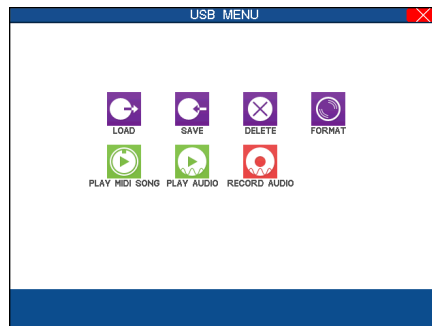

Play MIDI Song : Play MIDI or CP recorder song files directly from the USB device.
Play Audio : Play MP3/WAV audio files.
Record Audio : Record MP3/WAV audio files.

◇ Saving data to USB Memory

This important function stores your custom data to disk so that you can retrieve it at a later time. You can save the following data:

Song	Song data currently in the Recorder. You can save it as the CP's own unique format (Internal) or as Standard MIDI File format (SMF) or Stylist format (Internal format plus Registration setting).
User Style	Each User Style or all 20 User Styles at once.
User Sound	Each User Sound or all 20 User Sounds at once.
Regist Group	Each Registration Group, containing 8 Registrations, or all 10 Registration Groups at once.
User Touch Curve	Two User Touch Curve settings.
User Temperament	One User Temperament setting.
User Stretch Curve	One User Stretch Curve setting.
User 88 Key Volume	One User 88 Key Volume setting.
All Settings	This allows you to save the current settings of the above data types except for Song data at once, as a single file.
Favorite Sound	Sounds that have been stored in the Favorites sound category button.
Favorite Style	Styles that have been stored in the Favorites style category button.

◆ **To save your data:**

- **Step 1**
In the USB menu, touch **SAVE**.
The USB Save menu will be displayed.

- **Step 2**
Touch the screen to select the type of data to save.

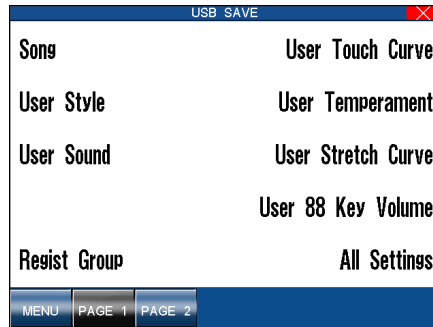

Touch the screen to select the type of data to save.

MENU : Takes you to the USB menu.
PAGE : Show the other page.

- **Step 3**
Use the virtual keyboard screen to enter a name for the new data file.
When saving a Song, select the **FORMAT** option, then use the Dial to set whether the song data file will be stored in the **INTERNAL** (CP's unique) format, **SMF** (Standard MIDI File) format, or **CP Stylist** format.

Example: Saving a Style

USER STYLE : Selects which file you would like to save, or if all files are to be saved as a single "all" file.

NAME : Names the data file.

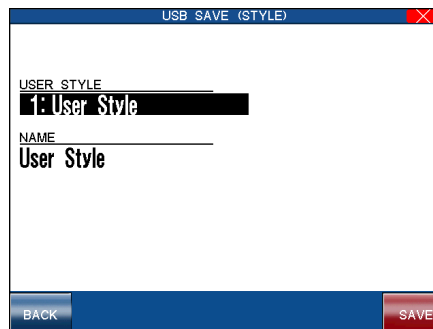

BACK : Takes you to the previous menu.
SAVE : Saves the data file to the USB memory device.

Example: Saving a Song

NAME : Names the data file.

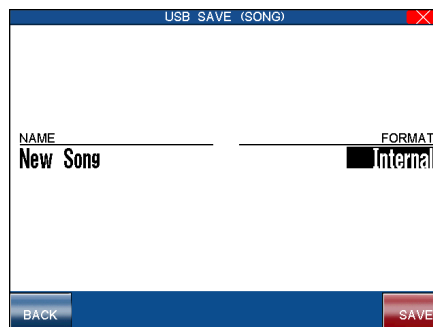

FORMAT : Selects which format the data should be saved as.

- The data saved in Stylist format can be called up only in Song Stylist mode.
- When you select SMF format, data in the style track will be automatically pasted to tracks 9-16. This will erase any existing data on tracks 9-16.

- **Step 4**
Ensure that the USB memory is connected, then touch the **SAVE** button to save the selected data.

◇ Loading data from USB Memory

This function allows you to load data that has been stored on a USB memory device.

Song	One Song can be loaded into the Recorder from USB.
User Style	Up to 20 Styles can be loaded from USB. This number varies depending on the size of the data contained in the Styles.
User Sound	Up to 20 User Sounds can be loaded from USB.
Regist Group	Up to 20 Groups, containing 8 Registrations each, can be loaded from USB.
User Touch Curve	Two User Touch Curves can be loaded from USB.
User Temperament	One User Temperament can be loaded from USB.
User Stretch Curve	One User Stretch Curve setting can be loaded from USB..
User 88 Key Volume	One User 88 Key Volume setting can be loaded from USB.
All Settings	Loads the "All Settings" file from USB.
Favorite Sound	Sounds that can be stored in the Favorites sound category button.
Favorite Style	Styles that can be stored in the Favorites style category button.

◆ To load the data from USB memory:

- Step 1**
In the USB menu, touch LOAD.
The USB Load menu will be displayed.
- Step 2**
Connect a USB memory device.
- Step 3**
Touch the screen to select the type of data to load.

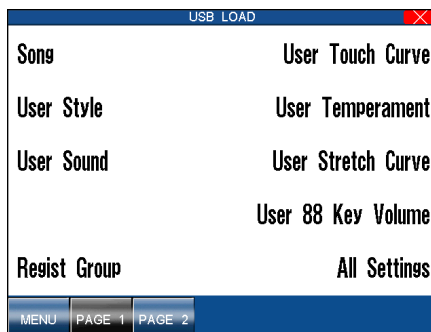

Touch the screen to select the type of data to load.

MENU : Takes you to the USB menu.
PAGE : Show the other page.

- Step 4**
When loading User Style, User Sound or Registration data, you can choose whether to load data that was stored individually or to load all the data that was saved as an "All" file.

Touch ALL to load data that was saved as an "All" file.
or
Touch EACH if data files were saved individually.

The 'D' icon represents a sub-directory.

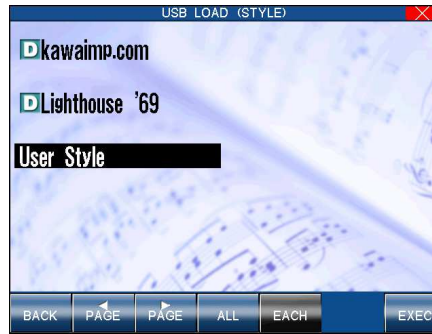

Touch the screen to select the data to load.

BACK : Takes you to the previous menu.
 ALL : Selects the "All" file type if that is how the files were saved.
 EACH : Displays data files that were saved individually.
 EXEC : Proceeds to the next screen.

- Step 5
Touch the screen to select the data to load.

- Step 6
Touch the the EXEC button to proceed.
The screen will display the destination where the data will be loaded.

- Step 7
When loading an individual data file, touch NAME then use Dial to select the preferred destination.

TO : Selects the destination to load individually a Style, Conductor, Sound or Registration.

NAME : The name of the file to load.

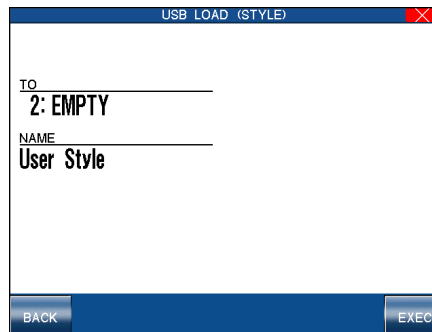

BACK : Takes you to the previous menu.
 EXEC : Loads the data.

- Step 8
Touch the EXEC button to load the selected data into the CP.
or
Touch the BACK button to cancel loading.

◇ Erasing data from USB Memory

This function allows you to erase data that is no longer required from the USB memory device.
The following types of data can be erased:

- Song
- User Style, User Sound, User Touch, User Temperament, etc.
- Favorite Sound, Favorite Style
- Registrations, ALL saved data
- MP3/WAV Audio Files

◆ To erase data from a USB memory device:

- Step 1**
In the USB menu touch DELETE.
The USB Delete menu will be displayed.
- Step 2**
Connect a USB memory device.
- Step 3**
Touch the screen to select the type of data to erase.
- Step 4**
When you erase User Style, User Sound or Registration data, select whether you wish to erase individual data files (EACH) or all data (ALL) by touching the relevant button.



Touch the screen to select the data.

*BACK : Takes you to the previous menu.
PAGE : Displays more selections.
INT : Displays internal format CP song files only.
SMF : Displays SMF files only.
STYLIST : Displays Song Stylist files only.
EXEC : Proceeds to the next screen.*

- Step 5**
Touch EXEC to erase the selected data from the USB memory.
or
Or touch BACK to cancel erasing and go back to the previous menu.

◇ Formatting a USB Memory Device

The format function allows all data stored on the USB memory device to be cleared.

◆ To format a USB memory:

- Step 1**
In the USB menu, touch **FORMAT**.
The USB Format menu will be displayed.
- Step 2**
Connect a USB memory device.
- Step 3**
Touch **YES**, then touch **EXEC** to proceed.
The screen will prompt you for confirmation.
- Step 4**
Touch **YES** again to start formatting.
or
TOUCH **NO** to cancel formatting and go back to the previous menu.

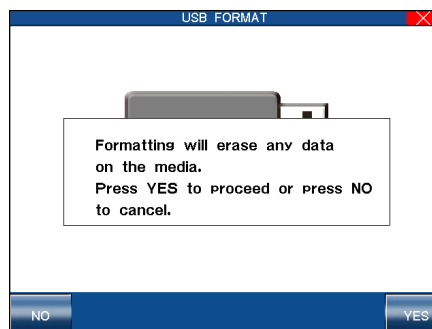

*NO : Cancels formatting and takes you to the USB menu.
YES : Starts formatting the USB memory device..*

- The amount of time required to fully format a USB memory device will vary depending on the size of the device.
- Once the formatting is complete, the LCD screen returns to the USB menu automatically.

◇ Play MIDI Song

The CP is capable of playing back songs recorded in either the CP's Internal Format or the Standard MIDI File (SMF) format. Songs stored in the CP's internal format are typically those that have been recorded using your own instrument, although it is of course possible to exchange songs with other CP owners. SMF format songs, however, are available from many sources, including disks for sale from professional musicians and publishers, songs shared among musicians and hobbyists, and Internet sites that feature SMF songs available for download.

If you wish to play a song quickly, without any intentions to make permanent changes or additional recordings, you can simply use the CP's USB Song Play function to load the song for playback. Using the USB memory in this way makes the Concert Performer an enjoyable source of entertainment for parties and other social events, as well as a great tool for the professional musician or music educator.

- The CP recognizes song files written in the Standard MIDI File format as long as they have DOS file names ending with ".MID". There are two types of Standard MIDI File formats, Format 0 and 1. The CP can read the song data of both formats, however it will only display the lyrics of a song written as format 0.
- Songs that have been composed with the General MIDI (GM) standard will sound fine without any additional work, because data in the files will inform the CP as to what sounds to use when playing the song. If the song was not composed to the GM standard, you may find it necessary to edit the song to assign the correct sounds to the various tracks. Fortunately, almost all commercially available MIDI files adhere to the General MIDI standard.

◆ To play a MIDI song:

□ Step 1

Connect a USB memory device to the USB port, then press the USB button.



The USB menu will be shown in the LCD display.

□ Step 2

Select Play MIDI Song.

A list of playable songs stored on the USB memory device will be shown in the LCD display.

□ Step 3

Touch the screen to select the song you wish to listen to.

You can also select a song by using the Dial.

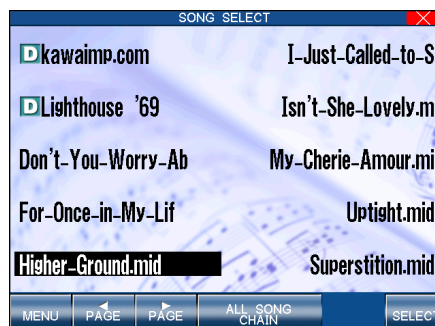

Touch the screen to select the desired song.

MENU : Takes you to the USB menu.
PAGE : Lists the next or previous ten titles.
ALL SONG CHAIN : Starts the Chain Play.
SELECT : Selects the song and takes you to the USB Song Play screen.

- **Step 4**
Press the **PLAY/STOP** button to load the song and start playback automatically.
You may also touch the **SELECT** button to load the song, but wait for playback to be started manually.
- **Step 5**
Touch the **SONG CHAIN** button to have the CP automatically play all songs in a folder, one after another.
- **Step 6**
Use the Recorder control buttons on the right side of the panel to control the playback of the song.

◇ Controlling Song Playback

As the song plays, you can adjust the tempo, play or sing along, and even turn on/off the different instrument parts (tracks) in the song.

The status of the song parts is displayed at the bottom of the LCD screen. You will see the parts referred to as the CP's four Parts + Style if the song was created on the CP, or as Channels (ch 1-16) if the song is a MIDI file. Displayed above each part is its current status:

PLAY	The part will be heard when you play the song.
MUTE	The part has data, but it won't be heard when you play the song.
----	The part has no data to play.

■ **Transpose and Octave Shift** are available when a song is playing. Octave Shift affects only the notes you play "live" on the keyboard, not the music playing from the song file. Transpose can be applied separately to the keyboard sound and the song sounds. This lets you play the keyboard in your preferred key along with a song recorded in a different (or more difficult) key. Use the front panel's dedicated **TRANSPOSE** buttons to affect the keyboard sound. Touch the **Song Transpose** buttons to affect the song data.

■ The **Song Transpose** option is available only for the song data in Standard MIDI file.

◆ To make adjustments to the song:

- **Step 1**
Touch the buttons at the bottom of the screen to play and mute any of the song's instrument parts

Mixer : Takes you to the Mixer screen.

Show Lyrics : Displays the song's lyrics (if available in the data).



Song Transpose : Adjust the playback pitch of the song.

SONG LIST : Takes you to the USB Song Select menu.
PART/xCH : Turns the song part on/off.
MORE : Displays the status of the next set of 4 song parts.
(Ch 5-8, Ch9-12, Ch 13-16).

- **Step 2**
Touch the **Mixer** button to make adjustments to the song's instrument parts.
- **Step 3**
Touch the **Song Transpose** arrows to raise/lower the pitch of the song.

□ **Step 4**

To adjust the tempo, touch the **TEMPO** box, then use the Dial to change the values.

If the song you are playing has lyrics included in the data, the **Show Lyrics** button will appear on the Song Play screen. If you touch the **Show Lyrics** button, the song's lyrics will then appear inside a box. You can follow a ball moving over the lyrics as the song plays.

Touch the **Full Screen** button to expand the lyrics display to the full screen. To return to the normal lyrics screen press the **Normal Screen** button. Finally, in the normal lyrics screen, touch the **Play Screen** button to return to the Song Play screen.

TEMPO : Adjusts the tempo of the song.

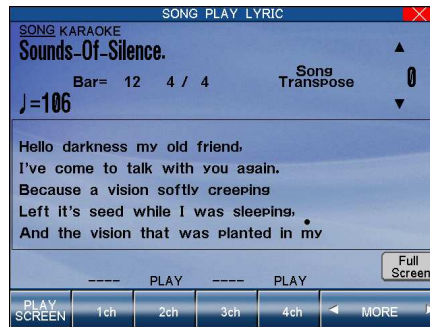

Song Transpose : Raise or lower the pitch of the song, without affecting the keyboard.

Full Screen : Show the song lyrics in full screen mode.

PLAY SCREEN : Returns to the Song Play screen.

PART/xCH : Turns the song parts on/off.

MORE : Displays the status of the next set of 4 song parts (Ch 5–8, Ch9–12, Ch 13–16).

- You cannot record or permanently edit the song while using the USB Song Play function. If you would like to record your live performance along with the song from the USB memory, or if you want to make detailed and permanent edits to the song, you will need to load the song's data into the Recorder using the USB Load function. See the chapter "Recording a Song" (page 33) for details on how to record a song, and "Using USB Memory" (page 119) for an explanation of how to load a song into the Recorder.

◇ Playing MP3/WAV Audio

The CP's Audio Player function allows MP3 or WAV audio files stored on USB memory to be played back directly through the instrument's speaker system. This feature is particularly useful when attempting to learn the chords or melody to a new piece, or when you simply wish to play along with your favorite song.

To use the Audio Player function, first prepare a selection of MP3 audio files and copy them to a USB memory device

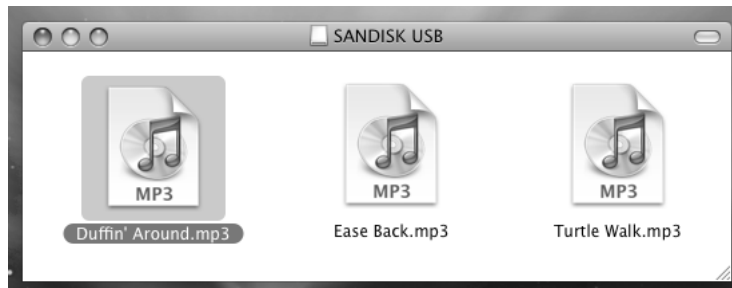

□ Step 1

Connect a USB memory device to the USB port, then press the USB button.



The USB menu will be shown in the LCD display.

□ Step 2

Select Play Audio.

A list of playable MP3 audio files stored on the USB memory device will be shown in the LCD display.

□ Step 3

Touch the screen to select the desired MP3 audio file.

You can also select a song by using the Dial, then touching the SELECT button.

Touch the WAV button to show WAV files stored on the USB memory device.

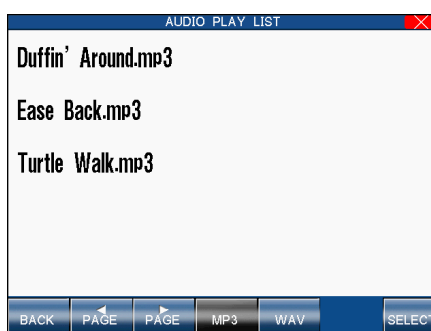

Touch the screen to select the desired MP3 audio file..

BACK : Takes you to the USB menu.
PAGE : Lists the next or previous ten files.
MP3 : Show MP3 files (selected automatically).
WAV : Show WAV files.
SELECT : Selects the audio file and takes you to the USB Audio Play screen.

□ Step 4

Touch the ► button to start playing the audio file.

□ Step 5

Touch the on-screen volume slider to adjust the volume of the audio file.

REPEAT : Repeat the current audio file.

NAME : The name of the current audio file.

VOLUME : Adjust the volume using the Dial.

VOCAL ON : Enable the vocal remove function (see below)

MAIN SCREEN : Return to the MAIN SCREEN..

REPEAT : Off

PLAY MODE : All

NAME : Turtle Walk.mp3

VOLUME : 60

TIME : 2:11

VOCAL ON : [Button]

MAIN SCREEN : [Button]

REPEAT AB : [Button]

MENU : [Button]

TRANSPORT BUTTONS : [Buttons]

PLAY MODE : Adjust the type of play mode for the audio files (All / Program / Random / Single).

SONG LIST : Return to the list of audio files.

REPEAT AB : Repeat one section of a song continuously.

MENU : Return to the USB menu.

TRANSPORT BUTTONS : Control playback of audio files.



Playback of the MP3/WAV audio file can be controlled by touching the transport buttons at the bottom of the screen:

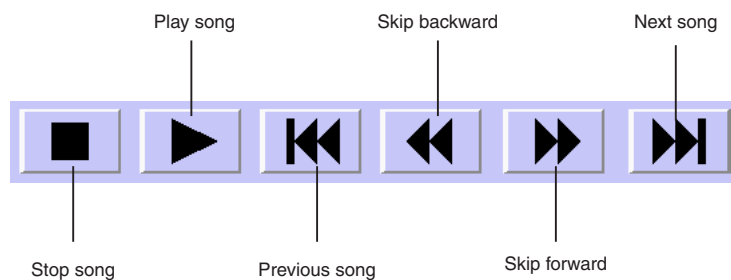

□ Step 6

Touch the REPEAT AB button once to set the start of the section to be repeated.

Touch the REPEAT AB button again to set the end of the section to be repeated.

The AB section will repeat continuously until the REPEAT AB button is touched for a third time, thus deactivating the function and resuming normal playback.

□ Step 7

Touch the MAIN SCREEN button to return to the MAIN SCREEN.

Pressing the USB panel button again will return you directly to the AUDIO PLAY screen.

◆ About the Vocal On/Remove function

When playing MP3/WAV audio files, the CP's Vocal Remove function attempts to remove the vocal track from commercially produced music.

VOCAL ON: The audio file will playback as recorded.

VOCAL REMOVE: Vocal or melody sounds that are heard from the center when playing back an audio file will be removed so you can sing or play the melody yourself.

Please note that for some audio files, it may not be possible to completely eliminate the melody.

◇ Recording MP3/WAV Audio

The CP's Record Audio function allows you to create digital audio files from your performances in just a few steps. The recordings are saved to USB memory in either MP3 or WAV format, allowing them to be emailed to friends and family, or played back on other devices such as a portable music player or tablet.

This function will also record line-in as well as MIDI songs. It is even possible to record audio while playing back MP3/WAV audio files, or a combination of sources, allowing material to be over-dubbed and remixed directly – all from the CP instrument.

□ Step 1

Connect a USB memory device to the USB port, then press the USB button.



The USB menu will be shown in the LCD display.

□ Step 2

Select Record Audio.

The AUDIO RECORD SETUP screen will be shown in the LCD display.

INPUT SONG NAME : The name to be used for the new MP3/WAV audio file.

SELECT FORMAT : The audio format to be used for the new recording (MP3 or WAV).

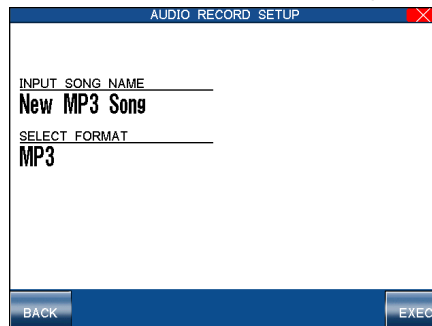

BACK : Return to the main USB menu.

EXEC : Accept the name and format and continue to AUDIO RECORD screen.

□ Step 3

Touch INPUT SONG NAME and enter a name for the new recording using the virtual keyboard.

Touch SELECT FORMAT to set the audio format for the new recording.

Touch EXEC to accept the name and audio format and continue to the AUDIO RECORD screen.

The AUDIO RECORDER screen will be shown in the LCD display.

NAME : The name of the audio file.

STYLE : The selected Style.

TEMPO : The tempo of the selected Style.

LEFT : The sound assigned to the LEFT part.

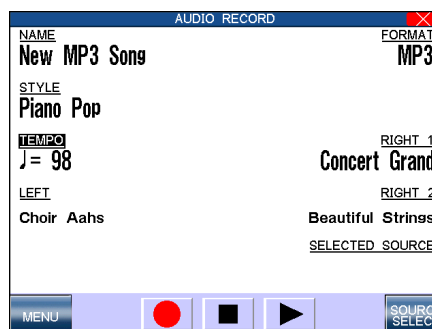

FORMAT : The audio format for the recording.

RIGHT1 : The sound assigned to the RIGHT1 part.

RIGHT2 : The sound assigned to the RIGHT2 part.

SELECTED SOURCE : Displays additional sources of audio, if selected.

MENU : Return to the main USB menu.

TRANSPORT BUTTONS : Control recording of audio file.

SOURCE SELECT : Select additional audio sources to add to the recording.

□ Step 4

Before recording, make any changes to the selected sounds, style, tempo etc.

Step 5

Touch the ● button (record).

The audio recorder will enter 'Ready' mode.

Touch the ► button (play).

The audio recorder will enter 'Recording' mode. All sounds created by the instrument, including line-in and microphone sound, will be recorded to the MP3/WAV file.

Step 6

Play the keyboard.

Touch the ■ button (stop) to stop recording.

All sounds created by the instrument will be recorded as a digital audio file and saved to the USB memory device.

- If you wish to record with a Style accompaniment, select the desired Style and SYNC/FADE OUT function before entering the USB recorder, start the audio recorder in 'Ready' mode, then press the START/STOP button to start the accompaniment and recorder at the same time.

◇ Recording with additional sound sources

It is also possible to record MP3/WAV audio files while the CP is playing back a song from MIDI, or another MP3/WAV audio file.

Step 1

Repeat steps 1-4 in the previous section to prepare for recording audio.

Step 2

Touch the SOURCE SELECT button.

The SOURCE SELECT screen will be shown in the LCD display.

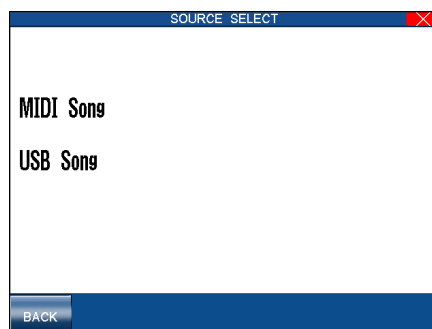

BACK : Return to the previous menu.

◆ To select a MIDI Song source:

Step 3

Touch MIDI Song.

A list of playable songs stored in the CP's internal memory will be shown in the LCD display.

Touch USB SONGS to list songs stored on the connected USB memory device.

Select the desired MIDI song to be played and added to the recording.

Step 4

Touch the ● button, then press the PLAY/STOP panel button to play the selected MIDI song.

The MIDI song will be recorded as a digital audio file, along with any other sounds produced.

◆ **To select a USB Song (Audio Play) Song source:**

Step 3

Touch USB Song.

A list of playable MP3 audio files stored on the USB memory device will be shown in the LCD display.

Touch WAV to list WAV audio files stored on the connected USB memory device.

Select the desired MP3/WAV audio file to be played and added to the recording.

Step 4

Touch the ● button, then press the PLAY/STOP to play the selected MP3/WAV audio file.

The MP3/WAV audio file will be recorded as a digital audio file, along with any other sounds produced.

10. Appendices

1) Connection Examples

A. Using External Speakers

The Concert Performer has an amplifier and built-in speakers and together, they produce a powerful sound. However, for larger venues or outdoor performances, you may need to use additional amplification and speaker systems.

Standard 1/4-inch audio cables can be plugged into the CP's stereo Line Out jacks for this purpose. The CP's Master Volume will affect the signal's levels output from the Line Out Jacks.

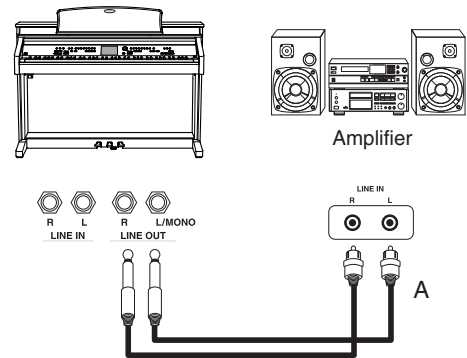

B. Using the Concert Performer with Home Audio Systems

You can connect audio cables from your stereo system or another source to the CP's Line In jacks. The sound of your stereo playing a tape, CD, or even radio will be heard through the CP's speaker system and mixed in with any sounds from the CP itself, enabling you to play along with your favorite songs.

Connect the CP with your CD player or other device as illustrated.

C. Recording Your Performance with Your Tape Recorder

You can still make a recording from your CP using the Line out Jacks. Simply connect an external CD-R recorder or other recording device (Cassette, Audio software from a personal computer etc.) to the CP's Line Out Jacks. Everything that you hear coming out of the CP's built-in speaker system is also sent out through the Line Out Jacks and can be recorded. You can also record anything that is connected to the Line In Jacks along with anything being played by the CP.

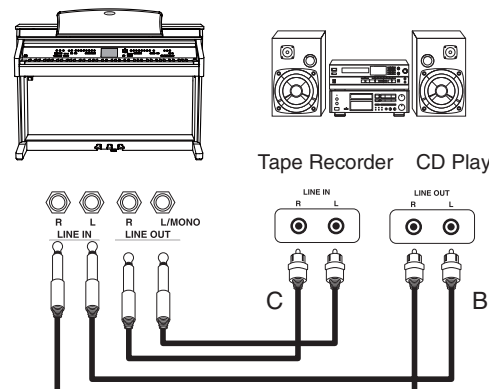

D. Using the Concert Performer with an External MIDI Instrument

MIDI lets you expand the creative possibilities of the CP by connecting it to an external MIDI device or personal computer.

Use a MIDI cable to connect the CP's MIDI Out jack to the other device's MIDI In. Likewise, connect the MIDI Out jack of the other device to the CP's MIDI In.

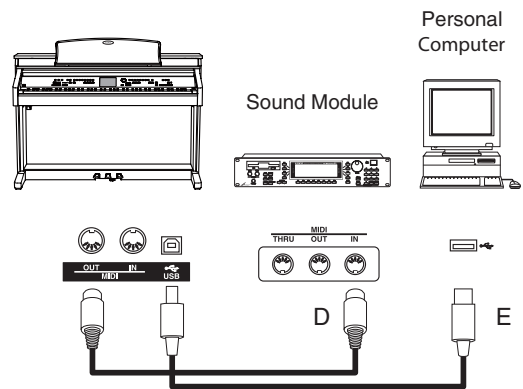

E. Using The Concert Performer with a Computer

Your personal computer can be used as a MIDI device as well. In order to connect your computer to the CP you will need a MIDI interface. Check with your local music store or computer dealer for more information about particular models of these interface devices.

Once you have your computer connected to your Concert Performer, you can think of it as a powerful extension of the CP's own music processing abilities. There are hundreds of software programs available that you can use to do everything from learn the basics of piano playing, to creating film scores for your home movies, to composing the next great digital symphony.

If you don't wish to purchase a MIDI interface device for your computer, the Concert Performer can also be connected directly to the back of your computer via a USB cable. In order for the CP and your computer to properly communicate over this USB cable, your computer must have a USB driver installed. Please read the instruction in the following section for more details about USB and the USB driver software.

2) USB MIDI Information

The MP11 features a 'USB to Host' type connector, allowing the instrument to be connected to a computer using an inexpensive USB cable and utilised as a MIDI device. Depending on the type of computer and operating system installed, additional driver software may be required for USB MIDI communication to function correctly.

◆ USB MIDI Driver

Operating System	USB MIDI Driver Support
Windows ME Windows XP (no SP, SP1, SP2, SP3) Windows XP 64-bit Windows Vista (SP1, SP2) Windows Vista 64-bit (SP1, SP2) Windows 7 (no SP, SP1) Windows 7 64-bit Windows 8 Windows 8 64-bit	<p>Additional USB MIDI driver software NOT required.</p> <p>The standard (built-in) Windows USB MIDI driver will be installed automatically when the instrument is connected to the computer.</p> <p>* After driver installation, ensure that the 'USB Audio Device' (Windows ME/Windows XP) or 'USB-MIDI' (Windows Vista/Windows 7/Windows 8) device is correctly selected in the application software.</p>
Windows 98 se Windows 2000 Windows Vista (no SP)	<p>Additional USB MIDI driver software required.</p> <p>Please download the USB MIDI driver from the Kawai Japan website: → http://www.kawai.co.jp/english</p> <p>* After driver installation, ensure that the 'KAWAI USB MIDI' device is correctly selected in the application software.</p>
Windows Vista 64-bit (no SP)	<p>USB MIDI is not supported.</p> <p>Please upgrade to service pack 1 or service pack 2.</p>
Mac OS X	<p>Additional USB MIDI driver software NOT required.</p> <p>The standard (built-in) Mac OS X USB MIDI driver will be installed automatically when the instrument is connected to the computer.</p>
Mac OS 9	<p>USB MIDI is not supported.</p> <p>Please use the standard MIDI IN/OUT connectors.</p>

◆ USB MIDI Information

■ The instrument's USB MIDI port and MIDI IN/OUT jacks can be connected and used simultaneously. To adjust MIDI routing, please refer to the MIDI parameters in the Settings menu, explained on page 101.

■ Ensure that the instrument is turned OFF before attempting to connect the USB MIDI cable.

■ When connecting the instrument to a computer using the USB MIDI port, there may be a short delay before communications begin.

■ If the instrument is connected to a computer via a USB hub and USB MIDI communication becomes unreliable/unstable, please connect the USB MIDI cable directly to the one of the computer's USB ports.

■ Disconnecting the USB MIDI cable suddenly, or turning the instrument on/off while using USB MIDI may cause computer instability in the following situations:

- while installing the USB MIDI driver
- while starting up the computer
- while MIDI applications are performing tasks
- while the computer is in energy saver mode

■ If there are any further problems experienced with USB MIDI communication while the instrument is connected, please double-check all connections and relevant MIDI settings in the computer's operating system.

* 'MIDI' is a registered trademark of the Association of Manufacturers of Electronic Instruments (AMEI).

* 'Windows' is registered trademark of Microsoft Corporation.

* 'Macintosh' is registered trademark of Apple Computer, Inc.

* MPEG Layer-3 audio coding technology licensed from Fraunhofer IIS and Thomson.

* MP3 codec is Copyright (c) 1995-2007, SPIRIT

* Other company names and product names mentioned referenced herein may be registered trademarks or trademarks of respective owners.

3) Assembly Instructions

- ⚠ Caution**
- Ensure that this section is read thoroughly before attempting to assemble the CP3 digital piano, and that two or more people work on unit assembly.
 - When moving the CP3 digital piano, ensure that hands are not caught in the unit, and that the piano is not dropped on an individual's feet.

Before attempting to assemble the CP3 digital piano, ensure that all parts are included.
A Phillips-head screwdriver will also be required to assemble the unit (not included).

■ PARTS PROVIDED

- Main Unit (A)..... 1 pc.
- Side Panel (B)..... 2 pcs.
- Pedal Board (C) 1 pc.
- Back Board (D) 1 pc.
- End Panel (E)..... 2 pcs.
- Music Rack (F)..... 1 pc.
- Screw Long (G)..... 4 pcs.
- Screw Black (H) 4 pcs.
- Screw Silver (I)..... 4 pcs.
- Long Bolt (J) 4 pcs.
- Short Bolt (K) 4 pcs.
- Headphone hook set
 - Headphone hook (M)..... 1 pc.
 - Tapping screw (N)..... 2 pcs.

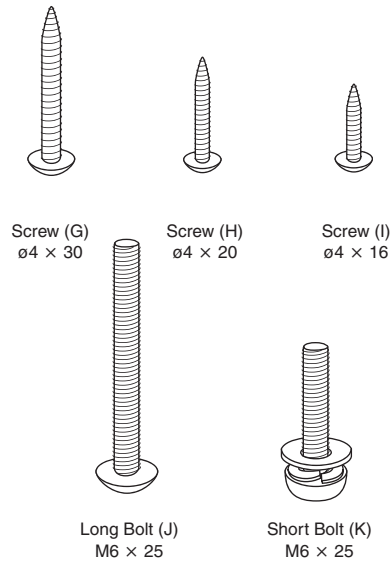

■ ASSEMBLY SEQUENCE

1. Untie and extend the connection cord from the underside of the Pedal Board (C).

Loosely fasten the left and right Side Panels (B) to the Pedal Board (C) using a single short screw (I) for each side. After ensuring that the correct Side Panels are used for the left and right side, and that the pedal cable is not caught between the assembled parts, securely fasten the Side Panels to the Pedal Board using an additional four short screws (I) on each side.

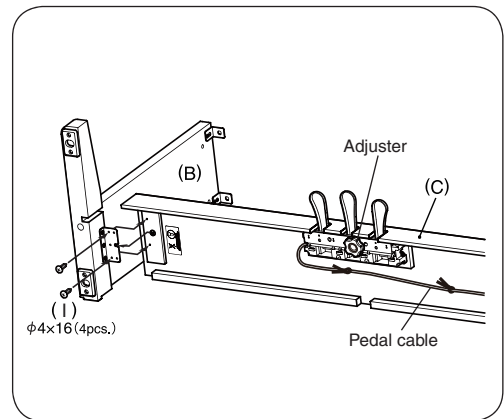

2. Fasten the Back Panel (D) to the left and right Side Panels (B) using a single long screw (G) on either side.

Then, fasten the Back Panel to the Pedal Board using four medium screws (H).

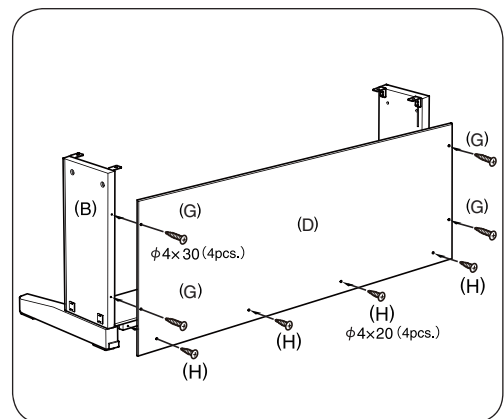

3. Place the Main Unit (A) on the front half of the stand so that the metal fitting holes are seen when viewed from the top. Slide the piano backward while holding it with one hand so that it does not incline and fall from the stand. The hooks on the piano are then engaged with the metal fittings on the Side Panels. Pay attention so that hands or fingers are not caught between the stand and piano. Fasten the piano and the stand with four short bolts (with plain washers and spring washers) (K). First, loosely tighten the bolts to adjust the unit position in order to make sure that all four bolts can be inserted straight, then tighten the bolts. Make sure that the bolts are tightened until the spring washers collapse.

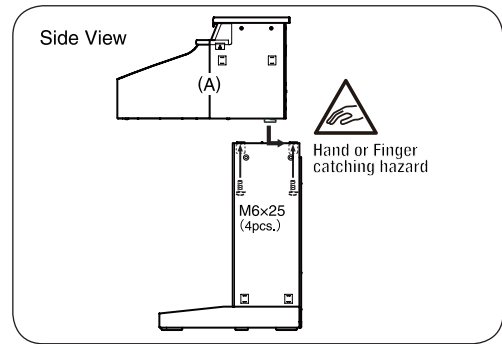

Caution • Ensure that the CP3 digital piano is correctly secured to the stand by using the bolts included. Failing to do so may result in the unit falling from the stand, causing damage or personal injury.

4. Attach the bottom of the End Panel (E) to the bottom of the Side Panel (B) using the Velcro fastening tape. Then attach the top of the End Panel to the top of the Main Unit (A). Finally, secure the panels using two Long Bolts (J) on either side.

Turn the Adjuster anti-clockwise, extending the bolt until it makes contact with the floor and supports the **pedals firmly**.

Caution • The pedal board may break if the adjuster is not touching the floor correctly. When moving the CP3 digital piano, ensure that the unit is lifted clearly from the floor and not dragged.

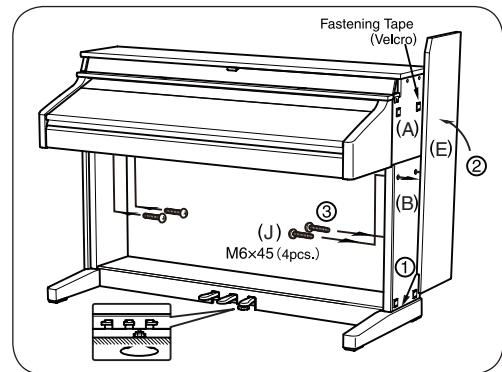

5. Insert the pedal connection cord that comes from Pedal Board (C) into the piano's pedal jack and fasten with cord clamps..

Connect the power cable to the AC IN terminal on the base of the main body, then pass the cable through the back board aperture, and out to the rear of the instrument.

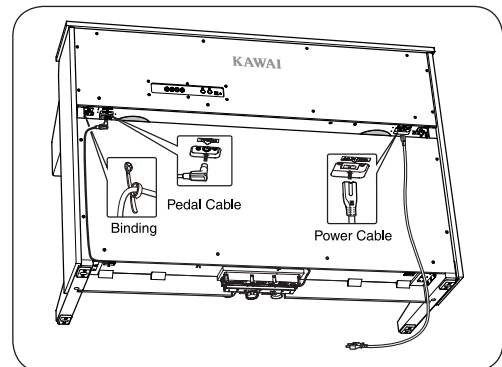

6. Attach the music rack by first positioning it slightly to the right of centre of the instrument.

Then slide the music rack to the left to lock it into position at the centre of the instrument.

* In order to remove the music rack, first raise it slightly, then slide it to the right.

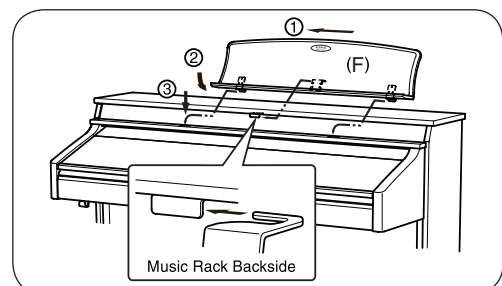

7. A headphone hook (M) is included with the CP3 digital piano and can be used to hang headphones when not in use.

If desired, attach the headphone hook to the underside of the main Unit using the two tapping screws (N) provided.

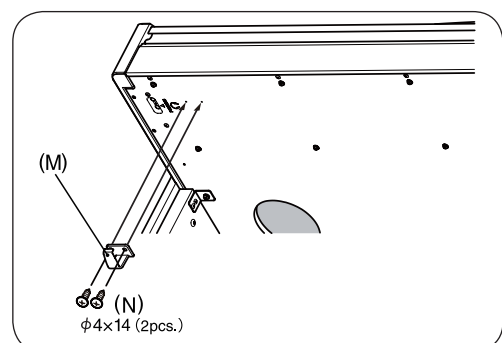

4) Preset Styles

POP & ROCK

PAGE 1	PAGE 2
Piano Pop	Cont 8 Beat
Contemporary Pop	Cont 8 Beat 2
Pop 3/4	Pop Shuffle
80's Rock	Rock Shuffle
90's Pop	Basic Shuffle
Latin Rock	Piano Rock
Modern Waltz	80's Dance
Basic 8 Beat	
Basic 8 Beat 2	
Basic 8 Beat 3	

OLDIES

PAGE 1	PAGE 2	PAGE 3	PAGE 4
50's Rock	50's Folk	70's Country Rock	Motown
50's Rock 2	50's Rock 3	60's R&B	Motown 2
50's Rockabilly	50's Rock Rhumba	60's R&B 2	
60's Beach	60's Guitar Folk	Surf Rock 2	
60's Pop	60's Rock	60's Rock 2	
Surf Rock	60's Pop 2	Folk Rock	
70's Philly Soul	60's Folk Rock	70's Pop/Funk	
Disco	70's Pop/Rock	Disco 2	
70's Pop	70's R&B	Disco 3	
Slow Classic Rock	70's R&B 2	Classic Rock	

COUNTRY

PAGE 1	PAGE 2
Country Shuffle	Train Beat
Country Piano	Texas Swing
Road Trip	Boot Scootin
Mod Country Ballad	Redneck Rock
Country Ballad	Country Rock 2
Country Two Beat	Country Waltz
Country Rock	Country Waltz 2
Bluegrass	Country Pop Ballad
Country Stomp	Country Pop 2 Beat
Modern Train Beat	

SHOW & ORCHESTRAL

PAGE 1	PAGE 2
Fast Show Beat	Fast Show Beat 2
Medium Show Beat	Medium Show Beat 2
Medium Show Swing	3/4 Show
Dixie Show	12/8 Slow
6/8 Show March	Table for Two
Showman	
Orchestral Waltz	
Orchestral Ballad	
Pops Piano	
Slow Show	

SOLO PIANO

PAGE 1	PAGE 2
Swing	Fast Show
Two Beat	Swing Standard
Two Beat Shuffle	New Age
Bossa	New Age 2
Boogie	New Age 3
Dixieland	Pop Waltz
Pop	Country Waltz
3/4 Standard	6/8 Pop/Rock
Jazz Waltz	Standard Ballad
Pop Ballad	Country Ballad

BALLAD

PAGE 1	PAGE 2	PAGE 3
Soft Rock Ballad	Modern Ballad	70's Rock Ballad
Soft Rock Ballad 2	Modern Ballad 2	
50's Ballad	Modern Ballad 3	
70's Pop Ballad	Pop Piano Ballad	
Rock Legend Ballad	Pop Ballad	
Rock Ballad	Pop Ballad 2	
Rock Ballad 2	Folk Rock Ballad	
R&B Ballad	50's Ballad 2	
R&B Ballad 2	Oldies 6/8 Ballad	
Contemp R&B Ballad	Triplet Ballad	

LATIN & ISLAND

PAGE 1	PAGE 2
Salsa	Hawaiian
Samba	Reggae
Tango	Reggae 2
Mambo	Cha Cha 2
Rhumba	
Bossa Nova	
Bossa Nova 2	
Beguine	
Cha Cha	
Calypso	

SWING & BIG BAND

PAGE 1	PAGE 2
Medium Piano Swing	Medium Swing 2
Medium Swing	Slow Swing 2
Fast Big Band	Night Club
Fast Big Band 2	Slow Big Band
Medium Big Band	
Nice and Easy	
Slow Swing	
Swing Ballad	
Vegas Big Band	
Torchlight	

BLUES

PAGE 1
Piano Blues
KC Blues
Fast R&B
Blues/Rock
Slow Blues
Slow R&B

JAZZ

PAGE 1
Smooth Jazz
Jammin Organ
Jazz Swing
5/4 Jazz
Jazz/Pop
Smooth Jam
Jazz R&B
Jazz Waltz
Latin Jazz
Latin Jazz 2

CONTEMPORARY

PAGE 1
16 Beat
16 Beat 2
16th Shuffle
16 Shuffle 2
Slow 16 Beat
Electro Pop
Electro Pop 2

TRADITIONAL

PAGE 1	PAGE 2
March	Ballroom
Polka	Basic Waltz
Dixieland	Classic Waltz
Foxtrot	Standard Waltz 2
Soft Shoe	European Waltz
Ragtime	March 2
Boogie	French Waltz
Two Beat	Polka 2
Standard Waltz	
Traditional Waltz	

WORSHIP

PAGE 1

6/8 Gospel
Gospel Shuffle
Fast Gospel
Slow Gospel
Southern Gospel

HOLIDAY

PAGE 1

Holiday 4/4
Holiday Two Beat
Holiday Shuffle
Holiday Rock
Holiday Waltz
Holiday Waltz 2
Holiday Waltz 3
Holiday Waltz 4

KIDS

PAGE 1

Toons
Kids March
Kids 6/8 March
Kids 2 Beat
Kids 2 Beat Shuffl
Kids Folk 2 Beat
Kids 3/4
3/4 Lullaby
4/4 Lullaby

5) Song Stylists

A

Achy Breaky Heart
 Across the Alley
 After The Love Has
 Ain't Misbehavin'
 Ain't No Woman
 Ain't Too Proud
 All For Love
 All I Have To Do
 All I Wanna Do
 All Of Me
 All Shook Up
 All That She Wants
 Alley Cat
 Aloha Oe
 Always
 Always A Woman
 Always On My Mind
 Amapola
 Amazing Grace
 America
 American Pie
 Annie's Song
 Anniversary Waltz
 Anything Goes
 April Showers
 Around The World
 Arrivederci Roma
 Arthur's Theme
 As Long As He Need
 As Tears Go By
 As Time Goes By
 At The Hop
 Auld Lang Syne
 Aura Lee
 Autumn Leaves
 Away In A Manger

B

Baby Baby
 Baby Face
 Bad Leroy Brown
 Ballad Davy Crockett
 Beautiful N My Eye
 Beauty & The Beast
 Beer Barrel Polka
 Begin The Beguine
 Behind Closed Door
 Benny And The Jets
 Best Of My Love
 Bewitched
 Bill Bailey
 Billie Jean

BINGO

Birthday Song
 Blue Bayou
 Blue Bossa
 Blue Moon
 Blue Suede Shoes
 Blue Velvet
 Blueberry Hill
 Body And Soul
 Boogie Bugle Boy
 Boot Scootin'
 Boy From NY City
 Breeze & I
 Brick House
 Bridge Over Water
 Brown Eyed Girl
 But Beautiful
 Button Up Overcoat
 By The Time I Get
 Bye Bye Love

C

Cabaret
 California Dreamin'
 California Girls
 Can You Feel Love
 Canadian Sunset
 Candle In The Wind
 Candy
 Can't Get Enough
 Can't Get Started
 Can't Help Falling
 Can't Hurry Love
 Can't Smile
 Can't Stop Loving
 Cara Mia
 Careless Whisper
 Celebration
 C'est Si Bon
 Chain Of Fools
 Chances Are
 Change The World
 Chantilly Lace
 Chapel Of Love
 Chatt. Choo Choo
 Chattahoochee
 Cherish
 Cherry Pink&Apple
 Chicago
 Christmas Song
 Clementine
 Climb Ev'ry Mtn
 Close To You

Colors Of The Wind

Come In From Rain
 Come Rain Or Shine
 Comin Up Roses
 Consider Yourself
 Copacabana
 Corcovado
 Could I Have Dance
 Could It Be I'm
 Could've Been
 Country Roads
 Coward Of County
 Cracklin Rose
 Crazy
 Crazy Little Thing
 Cruisin Down River
 Crusin'
 Cry
 Cry Me A River
 Crying In Chapel

D

Daddy
 Dance To The Music
 Dancin' In Street
 Daniel
 Daydream
 Days Of Wine Roses
 Deck The Halls
 Deep Purple
 Deja Vu
 Desafinado
 Desperado
 Didn't We Almost
 Do Re Mi
 Do Your Ears Hang
 Dock Of The Bay
 Dominique
 Don't Be Cruel
 Don't Cry For Me
 Don't Fall In Love
 Don't Fence Me In
 Don't Get Around
 Don't It Make My
 Don't Know Much
 Don't Let The Sun
 Don't Worry B Hapy
 Downtown
 Dream
 Dueling Banjos
 Dust In The Wind

E

Earth Angel
 Ebony & Ivory
 Edelweiss
 Elvira
 End Of The Road
 Endless Love
 Evergreen
 Every Breath You
 Every Rose Has Its
 Everybody Plays
 Everything I Do
 Everything Is Beau
 Evil Ways
 Exodus Song, The
 Eyes Of Love

F

Falling In Love
 Farmer In The Dell
 Fascinatin' Rhythm
 Fascination
 Fast Car
 Feelings
 Feels So Good
 Feels So Right
 Ferry Cross Mersey
 Fever
 Fields Of Gold
 Fire & Rain
 First Time Ever I
 Flashdance
 Fly Me To The Moon
 Foggy Day, A
 Folsom Prison
 For All We Know
 For He's A Jolly
 Forever And Ever
 Forever In Love
 Forrest Gump Theme
 Free Bird
 Free Ride
 Freeway Of Love
 Friends Low Places
 Friends See Me Now
 From A Distance
 Frosty The Snowman
 Fun, Fun, Fun

G

Gambler, The
 G'bye Yellow Brick
 Georgia On My Mind

Georgy Girl

Get Down Tonight
 Get Me To Church
 Getting To Know U
 Gimme Some Lovin'
 Girl From Ipanema
 Give My Regards To
 Glory Of Love, The
 Glow Worm
 God Bless Child
 Goin Out Of My Hed
 Good Golly MsMolly
 Good Morning
 Good Thing
 Got My Mind Set
 Grandpa's Farm
 Great Balls O Fire
 Greatest Love, The
 Green Door, The
 Green Green Grass
 Green Onions
 Groovin
 Guitars, Cadillacs

H

Handy Man
 Hang On Sloopy
 Happy Birthday
 Happy Together
 Happy Trails
 Harbor Lights
 Hard Days Night
 Hard Habit
 Harlem Nocturne
 Have I Told You
 Hawaiian Wedding
 Heard It Grapevine
 Heart Will Go On
 Heartbreak Hotel
 Heat Is On
 Heatwave
 Heaven
 Hello Dolly
 Hello Mary Lou
 Help
 Help Me Make It
 Here And Now
 Here Comes Santa
 Here's Rainy Day
 Hero
 Hey Jude
 Hold My Hand
 Hold Your Hand

<i>Holly Jolly Xmas</i>	<i>I'm A Believer</i>	L	<i>Michael Row Boat</i>	<i>One Sweet Day</i>
<i>Home For Holidays</i>	<i>I'm A Country Boy</i>	<i>La Bamba</i>	<i>Midnight Hour</i>	<i>One Tin Soldier</i>
<i>Honesty</i>	<i>I'm A Little Teapt</i>	<i>Lady</i>	<i>Midnight Train 2GA</i>	<i>Only You</i>
<i>Honey</i>	<i>I'm Beginning 2See</i>	<i>Lady Is A Tramp</i>	<i>Misty</i>	<i>Ooh Baby Baby</i>
<i>Honeysuckle Rose</i>	<i>Imagination</i>	<i>Last Dance</i>	<i>Monday Monday</i>	<i>Open Arms</i>
<i>Honky Tonk Man</i>	<i>Imagine</i>	<i>Last Date</i>	<i>Moon River</i>	<i>Opposites Attract</i>
<i>Honky Tonk Woman</i>	<i>In Still Of Night</i>	<i>Last Time Saw Pari</i>	<i>Moonlight In VT</i>	<i>Opus One</i>
<i>Hound Dog</i>	<i>In The Mood</i>	<i>Laughter In Rain</i>	<i>More</i>	<i>Orange Blossom</i>
<i>How Am I Supposed</i>	<i>Islands In Stream</i>	<i>Lay Down Sally</i>	<i>Morning Dance</i>	<i>Our Day Will Come</i>
<i>How Are Things In</i>	<i>Isn't It Romantic</i>	<i>Layla</i>	<i>Mr. Bojangles</i>	<i>Over The Rainbow</i>
<i>How Can You Mend</i>	<i>Isn't She Lovely</i>	<i>Leaving Jet Plane</i>	<i>Mr. Wonderful</i>	
<i>How Deep Is Love</i>	<i>It Had To Be You</i>	<i>Let It Be</i>	<i>Mrs. Robinson</i>	P
<i>How Great Thou Art</i>	<i>It's A Grand Night</i>	<i>Let It Snow!</i>	<i>Muffin Man</i>	<i>Paper Roses</i>
<i>How High The Moon</i>	<i>It's A Small World</i>	<i>Lets Get It On</i>	<i>Music Box Dancer</i>	<i>Party's Over, The</i>
<i>How Insensitive</i>	<i>It's All In Game</i>	<i>Let's Stay Togethr</i>	<i>Music Music Music</i>	<i>Peace In Valley</i>
<i>How Sweet It Is</i>	<i>It's Beginning To</i>	<i>Light My Fire</i>	<i>Music Of The Night</i>	<i>Peaceful Easy Feel</i>
<i>Hurts So Good</i>	<i>Its Matter Of Time</i>	<i>Lilli Marlene</i>	<i>My Cherie Amore</i>	<i>Peanuts' Theme</i>
<i>Hustle, The</i>	<i>It's My Party</i>	<i>Little Green Apple</i>	<i>My Coloring Book</i>	<i>Peg</i>
	<i>It's Not For Me</i>	<i>Loco-Motion, The</i>	<i>My Cup Runneth Ovr</i>	<i>Penn. 6-5000</i>
I	<i>It's Not Unusual</i>	<i>Lollipop</i>	<i>My Favorite Things</i>	<i>People</i>
<i>I Believe</i>	<i>It's Now Or Never</i>	<i>London Bridge</i>	<i>My Funny Valentine</i>	<i>People Will Say</i>
<i>I Could Have Dance</i>	<i>It's The Most Wond</i>	<i>Long Winding Road</i>	<i>My Girl</i>	<i>Phantom</i>
<i>I Could Write Book</i>	<i>It's Too Late</i>	<i>Look of Love</i>	<i>My Life</i>	<i>Physical</i>
<i>I Don't Have Heart</i>	<i>It's Unusual Day</i>	<i>Losing My Religion</i>	<i>My Love</i>	<i>Piano Man</i>
<i>I Don't Know How</i>	<i>Itsy Bitsy Spider</i>	<i>Lost In Your Eyes</i>	<i>My Wild Irish Rose</i>	<i>Pink Panther</i>
<i>I Don't Want 2 Set</i>	<i>I've Been Working</i>	<i>Love Boat, The</i>		<i>Please Mr. Postman</i>
<i>I Fall To Pieces</i>	<i>I've Got The World</i>	<i>Love First Degree</i>	N	<i>Please Please Me</i>
<i>I Get Around</i>		<i>Love Is A Many</i>	<i>Na Na Hey Hey Gbye</i>	<i>Please Release Me</i>
<i>I Got A Name</i>	J	<i>Love Is Blue</i>	<i>Nadia's Theme</i>	<i>Poinciana</i>
<i>I Got Rhythm</i>	<i>Jailhouse Rock</i>	<i>Love Me Tender</i>	<i>New Kid In Town</i>	<i>Polka Dots Moonbms</i>
<i>I Just Called To</i>	<i>Jambalaya</i>	<i>Love Will Keep Us</i>	<i>New York, New York</i>	<i>Pop Goes Weasel</i>
<i>I Love Paris</i>	<i>Jingle Bell Rock</i>	<i>Loves Me Like Rock</i>	<i>Night And Day</i>	<i>Power Of Love, The</i>
<i>I Love Rock'n Roll</i>	<i>Jingle Bells</i>	<i>Love's Theme</i>	<i>Night Fever</i>	<i>Precious Memories</i>
<i>I Love You</i>	<i>Jive Talkin</i>	<i>Luchenbach Texas</i>	<i>Nightingale Sang</i>	<i>Pretty Woman</i>
<i>I Need Your Lovin</i>	<i>John Jacob Jingle</i>	<i>Lucille</i>	<i>Nights White Satin</i>	<i>Proud Mary</i>
<i>I Only Have Eyes</i>	<i>Johnny B. Goode</i>	<i>Lyin Eyes</i>	<i>Norwegian Wood</i>	<i>Puff Magic Dragon</i>
<i>I Saw Mommy Kiss</i>	<i>Joy To The World</i>			
<i>I Shot The Sheriff</i>	<i>Juke Box Sat. Nite</i>	M	O	Q
<i>I Talk To Trees</i>	<i>Jump</i>	<i>Macho Man</i>	<i>Ode To Joy</i>	<i>Quando, Quando</i>
<i>I Walk The Line</i>	<i>June Is Bustin'</i>	<i>Mack The Knife</i>	<i>Oh My Pa-Pa</i>	<i>Que Sera, Sera</i>
<i>I Want To Know</i>	<i>Just A Closer Walk</i>	<i>Maizry Doats</i>	<i>Oh What A Beautifl</i>	
<i>I Will Always Love</i>	<i>Just A Gigolo</i>	<i>Mammas Don't Let</i>	<i>Oklahoma</i>	R
<i>I Will Survive</i>	<i>Just As I Am</i>	<i>Man In The Mirror</i>	<i>Old Cape Cod</i>	<i>Rag Mop</i>
<i>I Write The Songs</i>	<i>Just In Time</i>	<i>Managua Nicaragua</i>	<i>Old Devil Moon</i>	<i>Rainbow Connection</i>
<i>I'd Do Anything</i>	<i>Just My Imaginatn</i>	<i>Mandy</i>	<i>Old Lamplighter</i>	<i>Ramblin Rose</i>
<i>If Ever I Lose My</i>	<i>Just Once</i>	<i>Maniac</i>	<i>Old MacDonald</i>	<i>Red Red Wine</i>
<i>If I Had A Hammer</i>	<i>Just The Two Of Us</i>	<i>Margaritaville</i>	<i>Old Rugged Cross</i>	<i>Red Roses</i>
<i>If I Were Carpentr</i>	<i>Just Way You Are</i>	<i>Marianne</i>	<i>Old Soft Shoe</i>	<i>Red Sails Sunset</i>
<i>If You Don't Know</i>		<i>Mary Little Lamb</i>	<i>Old Time R & R</i>	<i>Rescue Me</i>
<i>I'll Be Around</i>	K	<i>Me And Bobby McGee</i>	<i>Old Time Religion</i>	<i>Respect</i>
<i>I'll Be Home Xmas</i>	<i>Kansas City</i>	<i>Me And My Shadow</i>	<i>On Street Where U</i>	<i>Reunited</i>
<i>I'll Be Loving You</i>	<i>King Of The Road</i>	<i>Meditation</i>	<i>On The Road Again</i>	<i>Rhinestone Cowboy</i>
<i>I'll Be There</i>	<i>Knock 3 Times</i>	<i>Memory</i>	<i>On The Sunny Side</i>	<i>River O Dreams, The</i>
<i>I'll Fly Away</i>	<i>Kokomo</i>	<i>Mercy Mercy Me</i>	<i>On Top Ole Smoky</i>	<i>Rock A Bye Baby</i>
<i>I'll Make Love To</i>	<i>Kum Ba Yah</i>	<i>Merry Little Xmas</i>	<i>One (Chorus Line)</i>	<i>Rock Around Clock</i>
<i>I'll Remember Aprl</i>		<i>Miami Vice</i>	<i>One More Try</i>	<i>Rock This Town</i>

<i>Rocket Man</i>	<i>Somewhere</i>	<i>Theme From Frasier</i>	<i>Watch What Happens</i>	<i>You Can't Be True</i>
<i>Rockin' Xmas Tree</i>	<i>Somewhere Out Ther</i>	<i>Then Came You</i>	<i>Wave</i>	<i>You Don't Bring Me</i>
<i>Rocky Mtn High</i>	<i>Song Sung Blue</i>	<i>There Must Be Way</i>	<i>Way We Were, The</i>	<i>You Light Up Life</i>
<i>Rocky Top</i>	<i>Soul Man</i>	<i>There'll Be Sad</i>	<i>Way You Do, The</i>	<i>You Make Me Feel</i>
<i>Rose Garden</i>	<i>Sound Of Music</i>	<i>There's No Bizness</i>	<i>Wayward Wind, The</i>	<i>You Needed Me</i>
<i>Rose, The</i>	<i>Spanish Eyes</i>	<i>These Dreams</i>	<i>We Are Family</i>	<i>You Send Me</i>
<i>Row Your Boat</i>	<i>Spanish Harlem</i>	<i>They Call The Wind</i>	<i>We Are The World</i>	<i>You'd Be So Nice</i>
<i>Rudolph</i>	<i>Speak Low</i>	<i>Things</i>	<i>We Built This City</i>	<i>You'll Never Walk</i>
	<i>St. Elmo's Fire</i>	<i>Things We Did Last</i>	<i>We Didn't Start</i>	<i>Young At Heart</i>
S	<i>St. Thomas</i>	<i>Think</i>	<i>We Wish U A Merry</i>	<i>Your Cheatin Heart</i>
<i>Sailing</i>	<i>Stand By Me</i>	<i>Third Man Theme</i>	<i>We're In This Love</i>	<i>Your Song</i>
<i>San Fran (Flowers)</i>	<i>Stand By Your Man</i>	<i>This Masquerade</i>	<i>We've Got Tonight</i>	<i>You're 16</i>
<i>San Francisco</i>	<i>Stardust</i>	<i>This Ole Man</i>	<i>We've Only Begun</i>	<i>You're So Vain</i>
<i>Sara</i>	<i>Starting Over</i>	<i>Those Were Th Days</i>	<i>What A Friend</i>	<i>You've Got Friend</i>
<i>Sara Smile</i>	<i>Stayin Alive</i>	<i>Three Coins In A</i>	<i>What Child Is This</i>	<i>You've Lost That</i>
<i>Sat Nite Is Loneli</i>	<i>Stompin' Savoy</i>	<i>Three Times A Lady</i>	<i>What I Did 4 Love</i>	
<i>Satin Doll</i>	<i>Stormy Weather</i>	<i>Through The Years</i>	<i>What Kind Of Fool</i>	
<i>Satisfaction</i>	<i>Strangers In Night</i>	<i>Tico Tico</i>	<i>What Wonderful Wrld</i>	
<i>Save Best For Last</i>	<i>String Of Pearls</i>	<i>Time After Time</i>	<i>What Would U Think</i>	
<i>Schindler's List</i>	<i>Summer Breeze</i>	<i>Time In A Bottle</i>	<i>Wheel Of Fortune</i>	
<i>Seasons In The Sun</i>	<i>Summer Place, A</i>	<i>Tiny Bubbles</i>	<i>Wheels On The Bus</i>	
<i>Seems Like Old Tms</i>	<i>Summer Samba</i>	<i>To All The Girls</i>	<i>When A Man Loves A</i>	
<i>Send In The Clowns</i>	<i>Summertime</i>	<i>Tom Dooley</i>	<i>When Can I See You</i>	
<i>Sentimental Reason</i>	<i>Summertime Blues</i>	<i>Tomorrow</i>	<i>When I Fall n Love</i>	
<i>September</i>	<i>Sunday Kind Love</i>	<i>Tonight</i>	<i>When I'm 64</i>	
<i>Seventy-six Bones</i>	<i>Sunny</i>	<i>Top Of The World</i>	<i>When Irish Eyes</i>	
<i>Shadow Your Smile</i>	<i>Sunrise, Sunset</i>	<i>Total Eclipse</i>	<i>When Sunny Gets</i>	
<i>Shake Your Booty</i>	<i>Surfin USA</i>	<i>TROUBLE</i>	<i>When The Saints Go</i>	
<i>Shake,Rattle,Roll</i>	<i>Surrey With Fringe</i>	<i>True Love</i>	<i>When U Wish Upon</i>	
<i>Sh-Boom</i>	<i>Sweet Caroline</i>	<i>Try To Remember</i>	<i>When You're Smiling</i>	
<i>She Believes In Me</i>	<i>Sweet Home Alabama</i>	<i>Turn Turn Turn</i>	<i>Where Did Love Go</i>	
<i>She Loves You</i>	<i>Swingin On A Star</i>	<i>Tutti Frutti</i>	<i>Where Flowers Gone</i>	
<i>She'll Be Coming</i>		<i>Tuxedo Junction</i>	<i>Where Has My Dog</i>	
<i>She's In Love</i>	T	<i>Twinkle Twinkle</i>	<i>White Christmas</i>	
<i>She's Like Wind</i>	<i>Take Five</i>	<i>Twist & Shout</i>	<i>Whiter Shade Pale</i>	
<i>Shoo Fly Pie</i>	<i>Take It Easy</i>	<i>Twist, The</i>	<i>Who Can I Turn To</i>	
<i>Shop Around</i>	<i>Take Me Out To The</i>	U	<i>Whole New World, A</i>	
<i>Sign, The</i>	<i>Take The A Train</i>	<i>Unchained Melody</i>	<i>Why Do Fools Fall</i>	
<i>Signed Sealed Del</i>	<i>Take This Job And</i>	<i>Under Boardwalk</i>	<i>Wide Open Spaces</i>	
<i>Silent Night</i>	<i>Takin Care Bizness</i>	<i>Unforgettable</i>	<i>Wind Beneath Wings</i>	
<i>Silly Love Songs</i>	<i>Tammy</i>	<i>Up On Housetop</i>	<i>Wind Of Change</i>	
<i>Silver Bells</i>	<i>Tea For Two</i>	<i>Up Up & Away</i>	<i>Winter Wonderland</i>	
<i>Singing In Rain</i>	<i>Tears In Heaven</i>	<i>Up Where We Belong</i>	<i>Wipe Out</i>	
<i>Sixteen Tons</i>	<i>Tell Her About It</i>		<i>With A Little Help</i>	
<i>Sleigh Ride</i>	<i>Tempted</i>	V	<i>With One Look</i>	
<i>Smile</i>	<i>Tennessee Watz</i>	<i>Vaya Con Dios</i>	<i>With Or Without U</i>	
<i>Smoke Gets In Eyes</i>	<i>Tequila</i>	<i>Ventura Highway</i>	<i>Woman</i>	
<i>Smooth Operator</i>	<i>Tequila Sunrise</i>	<i>Vision Of Love</i>	<i>Wonderful Wonderful</i>	
<i>Snow Bird</i>	<i>Thanks For Memory</i>		<i>Wooden Heart</i>	
<i>So In Love</i>	<i>That Kind Of Girl</i>	W	<i>Wunderbar</i>	
<i>Soldier Of Love</i>	<i>That'll Be The Day</i>	<i>Wake Little Susie</i>	Y	
<i>Some Day My Prince</i>	<i>That's All</i>	<i>Wake Me Up</i>	<i>Yakety Sax</i>	
<i>Some Enchanted Eve</i>	<i>That's Amore</i>	<i>Walk On By</i>	<i>Yesterday</i>	
<i>Something</i>	<i>That's Life</i>	<i>Walkin' Midnight</i>	<i>Yesterday When I</i>	
<i>Something To Talk</i>	<i>That's The Way</i>	<i>Wasted Days And</i>	<i>YMCA</i>	
<i>Sometimes When We</i>	<i>That's What Friend</i>			

6) Concert Magic Songs

Titles written in **bold type** indicate the song as displayed in the LCD screen.

Song Title	Type	Lyrics
Children's Songs		
<i>Twinkle, Twinkle, Little Star</i>	MP	✓
<i>I'm A Little Teapot</i>	MP	✓
<i>This Old Man</i>	MP	✓
<i>Mary Had A Little Lamb</i>	MP	✓
<i>London Bridge</i>	MP	✓
<i>Row, Row, Row Your Boat</i>	MP	✓
<i>Hickory Dickory Dock</i>	MP	✓
<i>Pop Goes The Weasel</i>	MP	✓
<i>Good Morning To You</i>	MP	✓
<i>Frère Jacques</i>	MP	✓
<i>The Farmer In The Dell</i>	MP	✓
<i>Bingo</i>	MP	✓
<i>Itsy, Bitsy Spider</i>	MP	✓
<i>Where, O Where Has My Little Dog Gone?</i>	EB	✓
<i>The Muffin Man</i>	MP	✓
<i>Three Blind Mice</i>	MP	✓
<i>Old MacDonald Had A Farm</i>	MP	✓
<i>Did You Ever See A Lassie?</i>	MP	✓
<i>Ten Little Indians</i>	MP	✓
<i>Brahm's Lullaby</i>	SK	✓
<i>Rock A Bye Baby</i>	MP	✓
<i>Here We Go Round The Mulberry Bush</i>	MP	✓
<i>Little Brown Jug</i>	MP	✓
<i>She'll Be Comin' Around The Mountain</i>	EB	✓
<i>Whistler And His Dog</i>	SK	✓
<i>Polly Wolly Doodle</i>	MP	✓
<i>Chopsticks</i>	SK	✓
Christmas Songs		
<i>Hark The Herald Angels Sing</i>	MP	✓
<i>Jingle Bells</i>	MP	✓
<i>Deck The Halls</i>	MP	✓
<i>O Come All Ye Faithful</i>	MP	✓
<i>Joy To The World</i>	MP	✓
<i>The First Noel</i>	MP	✓
<i>Silent Night</i>	MP	✓
<i>We Wish You A Merry Christmas</i>	MP	✓
<i>What Child Is This?</i>	MP	✓
<i>Angels We Have Heard On High</i>	MP	✓
<i>It Came Upon A Midnight Clear</i>	MP	✓
<i>Away In A Manger</i>	MP	✓
<i>O Holy Night</i>	EB	✓
<i>O Tannenbaum (O Christmas Tree)</i>	MP	✓
<i>The Twelve Days Of Christmas (12 Days of Christmas)</i> ..	MP	✓
<i>We Three Kings Of Orient Are</i>	MP	✓
<i>O Little Town Of Bethlehem</i>	MP	✓
<i>Ave Maria</i>	SK	✓
Patriotic Songs		
<i>My Country 'Tis Of Thee</i>	MP	✓
<i>Battle Hymn Of The Republic</i>	MP	✓
<i>America The Beautiful</i>	MP	✓
<i>Yankee Doodle</i>	MP	✓
<i>Hail To The Chief</i>	MP	✓
<i>Washington Post March</i>	SK	✓
<i>You're A Grand Old Flag</i>	EB	✓
<i>Stars And Stripes Forever</i>	SK	✓
<i>anchors Aweigh</i>	SK	✓
<i>Under The Double Eagle</i>	SK	✓
<i>Star Spangled Banner, The</i>	MP	✓
American Classics		
<i>Danny Boy</i>	EB	✓
<i>Down In The Valley</i>	EB	✓
<i>Let Me Call You Sweetheart</i>	EB	✓
<i>Home Sweet Home</i>	EB	✓
<i>My Bonnie Lies Over The Ocean</i>	MP	✓

Song Title	Type	Lyrics
<i>In The Good Old Summertime</i>	EB	✓
<i>For He's A Jolly Good Fellow</i>	MP	✓
<i>Bill Bailey Won't You Please Come Home</i>	EB	✓
<i>Give My Regards To Broadway</i>	SK	✓
<i>Clementine</i>	MP	✓
<i>Fascination</i>	SK	✓
<i>Home On The Range</i>	MP	✓
<i>Take Me Out To The Ballgame</i>	EB	✓
<i>Auld Lang Syne</i>	MP	✓
<i>Michael Row The Boat Ashore</i>	MP	✓
<i>Oh, Susanna</i>	SK	✓
<i>On Top Of Old Smokey</i>	EB	✓
<i>Bicycle Built For Two</i>	EB	✓
<i>The Camptown Races</i>	MP	✓
<i>The Band Played On</i>	EB	✓
<i>When Johnny Comes Marching Home</i>	MP	✓
<i>When The Saints Go Marching In</i>	EB	✓
<i>Beautiful Dreamer</i>	EB	✓
<i>Ta Ra Ra Boom De Ay</i>	MP	✓
<i>Turkey In The Straw</i>	SK	✓
<i>Blue Bells Of Scotland</i>	MP	✓
<i>Down By The Riverside</i>	SK	✓
<i>By The Light Of The Silvery Moon</i>	SK	✓
<i>Shine On Harvest Moon</i>	SK	✓
<i>American Patrol March</i>	MP	✓
<i>Dixie</i>	SK	✓
<i>Yellow Rose Of Texas</i>	SK	✓
<i>Arkansas Traveler</i>	MP	✓
<i>Old Kentucky Home</i>	SK	✓
<i>Red River Valley</i>	EB	✓
<i>The Entertainer</i>	SK	✓
<i>Old Folks At Home</i>	SK	✓
<i>Maple Leaf Rag</i>	SK	✓
<i>After The Ball Is Over</i>	SK	✓
<i>After You've Gone</i>	EB	✓
<i>Thunder And Blazes</i>	SK	✓
<i>Annie Laurie</i>	MP	✓
<i>Wabash Cannonball</i>	SK	✓
<i>I've Been Working On The Railroad</i>	EB	✓
<i>Grandfather's Clock</i>	EB	✓
<i>Aloha Oe</i>	MP	✓
Favorite Hymns		
<i>Fairest Lord Jesus</i>	MP	✓
<i>Amazing Grace</i>	MP	✓
<i>Doxology</i>	MP	✓
<i>For The Beauty Of The Earth</i>	MP	✓
<i>O Worship The King</i>	MP	✓
<i>The Old Rugged Cross</i>	MP	✓
<i>Holy, Holy, Holy</i>	MP	✓
<i>What A Friend We Have In Jesus</i>	MP	✓
<i>Rock Of Ages</i>	MP	✓
<i>Trust And Obey</i>	MP	✓
<i>Sweet Hour Of Prayer</i>	MP	✓
<i>Just As I Am</i>	MP	✓
<i>Jesus Loves The Little Children</i>	MP	✓
<i>A Mighty Fortress</i>	MP	✓
<i>Christ The Lord Is Risen Today</i>	MP	✓
<i>It Is Well With My Soul (When Peace Like)</i>	MP	✓
<i>Crown Him With Many Crowns</i>	MP	✓
<i>Blest Be The Tie That Binds</i>	MP	✓
<i>Come Thou Almighty King</i>	MP	✓
<i>My Jesus, I Love Thee</i>	MP	✓
<i>The Church's One Foundation</i>	MP	✓
<i>Gloria Patri</i>	MP	✓
<i>The Solid Rock</i>	MP	✓
<i>Standing On The Promises</i>	MP	✓
<i>I Need Thee Every Hour</i>	MP	✓
<i>Savior Like A Shepherd Lead Us</i>	MP	✓
<i>Stand Up, Stand Up For Jesus</i>	MP	✓
<i>Onward Christian Soldiers</i>	MP	✓
<i>All Hail The Power Of Jesus Name</i>	MP	✓
<i>To God Be The Glory</i>	MP	✓
<i>Hallelujah Chorus</i>	SK	✓
<i>Jesu, Joy of Man's Desiring</i>	SK	✓

EB: Easy Beat, MP: Melody Play, SK: Skillful

Song Title Type Lyrics

Classical Selections

<i>Andante</i> from <i>Symphony No. 94</i> by Haydn	MP
<i>Fur Elise</i> by Beethoven	EB
<i>An Die Freude (Ode To Joy)</i>	MP
<i>Clair De Lune</i> by Debussy	SK
<i>Skater's Waltz</i>	SK
<i>Peter And The Wolf</i>	SK
<i>Minuet In G</i> by J.S. Bach	SK
<i>Romeo And Juliet</i>	SK
<i>Blue Danube Waltz</i>	SK
<i>Sleeping Beauty Waltz</i>	EB
<i>Gavotte</i> by Gossec	SK
<i>Waltz Of The Flowers</i>	SK
<i>Toreador Song</i> from " <i>Carmen</i> " by Bizet	SK
" <i>Fledermaus</i> " by J. Strauss	EB
<i>Norwegian Dance</i> by Grieg	SK
<i>William Tell Overture</i>	SK
<i>Can Can</i>	SK
<i>Emperor Waltz</i>	SK
<i>March Militaire</i> by Chopin	SK
<i>Grand March</i> from " <i>Aida</i> " by Verdi	SK
<i>Gymnopedie</i> by Sati	SK
<i>Gypsy Chorus</i> from " <i>Carmen</i> " by Bizet	SK
<i>Largo</i> from <i>Symphony No. 9</i> by Dvorák	SK
<i>Prelude In A</i> by Chopin	MP
<i>Pizzicato Polka</i>	SK
<i>Rondeau</i> by Mouret	SK
<i>Voice Of Spring</i>	EB
<i>Allegro Moderato</i> from <i>Symphony Nr. 8</i> by Schubert	SK

Special Occasions

<i>Bridal Chorus</i> from " <i>Lohengrin</i> " by Wagner	MP ✓
<i>Wedding March</i> from " <i>Midsummer Night's Dream</i> " by Mendelssohn	SK
<i>Pomp And Circumstance</i>	SK
<i>Mazel Tov</i>	EB

International Songs

<i>When Irish Eyes Are Smiling</i>	EB ✓
<i>Hatikvah</i>	MP ✓
<i>My Wild Irish Rose</i>	MP ✓
<i>Chiapenacas</i>	SK
<i>Funiculi Funicula</i>	SK ✓
<i>La Marseillaise</i>	MP ✓
<i>La Paloma</i>	SK ✓
<i>Santa Lucia</i>	SK ✓
<i>Habanera</i>	SK
<i>'O Sole Mio</i>	SK

7) Lesson Songs

Premier Piano Course Lesson 1A

1	Steady Quarter Notes
2	Our Journey
3	Treasure Map
4	Treasure Chest
5	Practice Carefully
6	It's Fun to Play!
7	Taking Turns
8	Great News
9	Dream Big Dreams
10	Merrily We Roll Along
11	Old MacDonald Had a Dog
12	Fortune Cookies
13	Climbing the Music Ladder
14	Up the Attic Stairs
15	Down the Attic Stairs
16	Old MacDonald Had a Mouse
17	Rock Wall
18	Climbing Down
19	A Jazzy Tune
20	Hush, Little Baby
21	Let's Take a Trip
22	Big Ben
23	Gum Ball Machine
24	Early to Bed
25	Change on C
26	Arrowhead
27	My New Piece
28	Waltzing
29	Aspen Trees
30	Ice Pops
31	Twinkling Planets
32	Skating
33	Basketball
34	French Fries
35	Skateboard Champ
36	Minuet for Bach
37	Alouette
38	My Kite
39	All-Star Game
40	Ode to Joy
41	A Page or Tow
42	Snowy Day
43	Bike Ride
44	Old Joe Clark
45	Hopscotch
46	Rise and Shine!
47	The Wheels on the Bus
48	Eine Kleine Mozart
49	Haydn's Surprise
50	Time to Celebrate

Premier Piano Course Lesson 1B

1	The Boat Dock
2	At the Park
3	Walk to School
4	Snorkeling
5	Opening Day
6	Green Tea
7	The Library
8	Smoothies
9	Crispy Chips
10	In the Pool
11	Catch That Frog!
12	My Pony
13	Popcorn
14	Chopsticks
15	C, Over and Over
16	Row, Row, Row Your Boat
17	Picnic Ants
18	Butterfly
19	G, Over and Over
20	Symphony Hall
21	Sara's Musette
22	My Yo-Yo
23	In Old Hong Kong
24	Russian Folk Tale
25	Wind Chimes
26	The Bells of St. Joseph
27	Hot Air Balloon
28	Creepy Crawler
29	I Asked My Mother
30	Broadway Star
31	The Joke
32	My Sombrero
33	The Mythical Unicorn
34	Lunch Box Blues
35	Egyptian Pyramids
36	It's a Brand-New Day!

Basic Piano Library Lesson Book Level 1A

- 1 Right & Left
- 2 Left & Right
- 3 Merrily We Roll Along/O'er the Deep Blue Sea
- 4 Hand-Bells
- 5 Jolly Old Saint Nicholas
- 6 Old MacDonald
- 7 Batter Up!
- 8 My Clever Pup
- 9 The Zoo
- 10 Playing in a New Position
- 11 Sailing
- 12 Skating
- 13 Wishing Well
- 14 Rain, Rain!
- 15 A Happy Song
- 16 Position C
- 17 A Happy Song
- 18 See-Saws
- 19 Just a Second!
- 20 Balloons
- 21 Who's on Third?
- 22 Mexican Hat Dance
- 23 Rock Song
- 24 Rockets
- 25 Sea Divers
- 26 Play a Fourth
- 27 July the Fourth!
- 28 Old Uncle Bill
- 29 Love Somebody
- 30 My Fifth
- 31 The Donkey
- 32 Position G
- 33 Jingle Bells!
- 34 Willie & Tillie
- 35 A Friend Like You
- 36 My Robot
- 37 Rockin' Tune
- 38 Indian Song
- 39 Raindrops
- 40 It's Halloween!
- 41 Horse Sense

Basic Piano Library Lesson Book Level 1B

- 1 Step Right Up!
- 2 The Carousel
- 3 Hail to Thee, America!
- 4 Brother John
- 5 Good Sounds
- 6 The Cuckoo
- 7 Money Can't Buy Ev'rything!
- 8 Ping-Pong
- 9 Grandpa's Clock
- 10 When the Saints Go Marching In
- 11 G's in the "BAG"
- 12 Join the Fun
- 13 Oom-Pa-pa!
- 14 The Clown
- 15 Thumbs on C!
- 16 Waltz Time
- 17 Good King Wenceslas
- 18 The Rainbow
- 19 Good Morning to You!
- 20 Happy Birthday to You!
- 21 Yankee Doodle
- 22 The Windmill
- 23 Indians
- 24 New Position G
- 25 Pedal Play
- 26 Harp Song
- 27 Concert Time
- 28 Music Box Rock
- 29 A Cowboy's Song
- 30 The Magic Man
- 31 The Greatest Show on Earth!
- 32 The Whirlwind
- 33 The Planets
- 34 C Major Scale Piece
- 35 G Major Scale Piece
- 36 Carol in G Major
- 37 The Same Carol in C Major
- 38 French Lullaby
- 39 Sonata
- 40 When Our Band Goes Marching By!

Basic Adult Piano Course Lesson Book Level 1

- | | | | |
|----|--|----|---------------------------------------|
| 1 | Ode To Joy (Theme from Beethoven's 9th Symphony) | 31 | Happy Birthday To You! |
| 2 | Aura Lee | 32 | Standing In The Need Of Prayer |
| 3 | Rock-Along | 33 | The Gift To Be Simple |
| 4 | Mexican Hat Dance | 34 | Alouette |
| 5 | Au Claire De La Lune | 35 | Lavender's Blue |
| 6 | Tisket, A Tasket | 36 | Kum-Ba-Yah! |
| 7 | Rockin' Intervals | 37 | London Bridge |
| 8 | Good King Wenceslas | 38 | Michael, Row The Boat Ashore |
| 9 | My Fifth | 39 | Blow The Man Down! |
| 10 | Jingle Bells | 40 | Lone Star Waltz |
| 11 | Brother John | 41 | Café Vienna |
| 12 | Here's A Happy Song! | 42 | Rock It Away! |
| 13 | Merrily We Roll Along | 43 | Joy To The World |
| 14 | Largo (from "The New World") | 44 | Cockles And Mussels |
| 15 | Mary Ann | 45 | Got Those Blues! |
| 16 | Rockets | 46 | On Top Of Old Smoky |
| 17 | What Can I Share? | 47 | The Can-Can |
| 18 | When The Saints Go Marching In
(With RH Melody & LH Chords) | 48 | The Marine's Hymn |
| 19 | When The Saints Go Marching In
(With LH Melody & RH Chords) | 49 | Why Am I Blue? |
| 20 | Love Somebody! | 50 | Little Brown Jug |
| 21 | A Friend Like You | 51 | Chiapanecas |
| 22 | The Donkey | 52 | O Sole Mio! |
| 23 | Money Can't Buy Ev'rything! | 53 | Jericho |
| 24 | The Cuckoo | 54 | Greensleeves |
| 25 | Harp Song | 55 | Go Down, Moses |
| 26 | Beautiful Brown Eyes | 56 | Scarborough Fair |
| 27 | Alpine Melody | 57 | Raisins And Almonds |
| 28 | Thumbs on C! | 58 | He's Got The Whole World In His Hands |
| 29 | Waltz Time | 59 | The Entertainer |
| 30 | Good Morning To You! | 60 | Amazing Grace |

BURGMÜLLER 25 (25 ETUDES FACILES, OPUS 100)

1	La candeur
2	Arabesque
3	Pastorale
4	Petite réunion
5	Innocence
6	Progrès
7	Courant Limpide
8	La gracieuse
9	La chasse
10	Tendre fleur
11	La bergeronnette
12	Adieu
13	Consolation
14	La styrienne
15	Ballade
16	Douce plainte
17	Babillarde
18	Inquiétude
19	Ave Maria
20	Tarentelle
21	Harmonie des anges
22	Barcarolle
23	Retour
24	L'hirondelle
25	La chevaleresque

J.S.BACH: INVENTIONEN

1	No.1 BWV772
2	No.2 BWV773
3	No.3 BWV774
4	No.4 BWV775
5	No.5 BWV776
6	No.6 BWV777
7	No.7 BWV778
8	No.8 BWV779
9	No.9 BWV780
10	No.10 BWV781
11	No.11 BWV782
12	No.12 BWV783
13	No.13 BWV784
14	No.14 BWV785
15	No.15 BWV786

M.P. HELLER: SONATINEN ALBUM 1

1	Sonatine Op.20-1	F. Kuhlau
2	Sonatine Op.20-2	F. Kuhlau
3	Sonatine Op.20-3	F. Kuhlau
4	Sonatine Op.55-1	F. Kuhlau
5	Sonatine Op.55-2	F. Kuhlau
6	Sonatine Op.55-3	F. Kuhlau
7	Sonatine Op.36-1	M. Clementi
8	Sonatine Op.36-2	M. Clementi
9	Sonatine Op.36-3	M. Clementi
10	Sonatine Op.36-4	M. Clementi
11	Sonatine Op.36-5	M. Clementi
12	Sonatine Op.36-6	M. Clementi
13	Sonatine Hob. XV135	F.J. Haydn
14	Sonatine K.545	W.A. Mozart
15	Sonatine Op.49-2	L.v. Beethoven
16	Sonatine Op.49-1	L.v. Beethoven
17	Sonatine Op.20-1	J.L. Dussek
18	Präludium BWV 846	J.S. Bach
19	Adagio	F.J. Haydn
20	Andante Grazioso	F.J. Haydn
21	Allegro	F.J. Haydn
22	Andante	F.J. Haydn
23	Rondo K.485	W.A. Mozart
24	Rondo Op.51-1	L.v. Beethoven
25	Andante aus der Ersten Symphonie	L.v. Beethoven
26	Thema aus dem Impromptu Op.142-3	F.P. Schubert
27	Scherzo Op.posth	F.P. Schubert
28	Andante aus der A-dur Sonate Op.120	F.P. Schubert
29	Variation über "Vien' quà, Dorina bella" Op.7	C.M.v. Weber
30	Fantaisie Ou Caprice Op.16-1	FB. Mendelssohn

CZERNY 30 (ETUDES DE MÉCANISME, OPUS 849)**CZERNY 100 (HUNDERT ÜBUNGSSTÜCKE, OPUS 139)****BEYER (VORSCHULE IM KLAVIERSPIEL, OPUS 101)**

* No song names

8) Accompaniment Chord Types

The table below describes the fingering of all 61 types of chords, including inversions, that the CP piano recognizes. All chords are represented here in the key of C, however transposition of these chords into any other key also applies. Charts marked with an asterisk (*) indicate easy fingerings that can be recognized in One-Finger mode.

C Maj	
C7	
C Δ7	
C6	
C6 9	
C9	
C11	
C7 sus4	
C7 b5	
C7 b9	
Cm	
Cm7	
Cm6	
Cm9	
Cm add9	
C7 #9	
C7 b9 11	
C9 13	
C7 b9 11 13	
C7 #9 b13	
Cm7 b5	
Cm7 b5 11	
C Δ7 #5	
C Δ7 b5	
C Δ9	
C Δ7 13	
Cm9	
C dim	
C dim 9	
C sus4	
C aug	
C b5	
C add9	
C13	
C7 #5	
Cm#5	
Cm6 9	
Cm7 11	
Cm9 11	
C7 #11	
C7 b9 #11	
C7 #9 #11	
C9 11 13	
C9 #11 13	
C7 b9 13	
C7 #9 13	
C7 b13	
C9 b13	
C7 b9 b13	
Cm7 b5 9	
Cm7 b5 b9	
Cm7 b13	
Cm7 11 b13	
C Δ9 13	
C Δ9 #11	
CΔ7 #11 13	
CΔ9 #11 13	
CΔ9 #11 13	
C dim Δ7	
C dim b13	
C dim 11	

9) Program Change Numbers

Category	Sound Name	Bank Prog MSB LSB	Category	Sound Name	Bank Prog MSB LSB	Category	Sound Name	Bank Prog MSB LSB
PIANO	Concert Grand	1 121 0	ORGAN	Be 3	17 95 1	MALLET	Vibraphone	12 121 0
	Concert Grand 2	1 95 16		Be Nice	17 95 7		Octave Vibes	12 95 2
	Studio Grand	1 121 1		Jazzier	18 95 1		Wide Vibraphone	12 121 1
	Jazz Grand	1 95 8		Hi-Lo	17 95 3		Xylophone	14 121 0
	Upright Piano	1 95 25		Drawbar	17 121 0		Marimba	13 121 0
	Studio Grand2	1 95 17		Drawbar 2	17 121 3		Hard Marimba	13 95 1
	Mellow Grand	1 121 2		Percussive Organ	18 121 0		Soft Marimba	13 95 2
	Modern Piano	2 121 0		Percussive Organ 2	18 121 1		Wide Marimba	13 121 1
	Piano Octaves	1 95 1		Be More	17 95 2		Handbells	15 95 1
	Piano Octaves 2	1 95 2		Odd Man	17 95 6		Muted Handbells	15 95 2
	Honky Tonk	4 121 0		Screamin'	17 95 4		Church Bells	15 121 1
	Mono Grand	1 95 3		Full Organ	18 95 4		Carillon	15 121 2
	Rock Grand	2 121 1		Drawbar 3	17 121 1		Glockenspiel	10 121 0
	Piano & EP	2 95 1		Percussive Organ 3	18 121 2		Tubular Bells	15 121 0
	Piano & EP 2	2 95 2		Hollow	18 95 6		Steel Drums	115 121 0
	Piano & EP 3	2 95 3		Mellow	17 95 5		Steel Drums 2	115 95 1
	Piano & Vibes	1 95 12		Soft Solo	17 95 8		Rolling Steel Drum	115 121 0
	New Age Piano	1 95 9		Jazz Organ	18 95 11		Vibes & Guitar	12 95 1
	New Age Piano 2	1 95 10		Jazz Organ 2	18 95 12		Celesta	9 121 0
	New Age Piano 3	1 95 11		Rock Organ	19 121 0		Music Box	11 121 0
	Piano & Organ	1 95 6		Drawbar Bass	18 95 8		Rolling Vibes	12 121 0
	Piano & Organ 2	1 95 7		Pedal Percussion	18 95 9		Rolling Marimba	13 121 0
	Piano & Guitar	2 95 4		Key Click	122 95 1		Synth Mallet	99 121 1
	Wide Honky Tonk	4 121 1		8' Drawbar	19 95 2	GUITAR	Exp Guitar	26 95 5
	Classic EP	5 95 3		5 1/3' Drawbar	19 95 3		Exp Guitar 2	26 95 11
	Classic EP 2	5 121 0		4' Drawbar	19 95 4		Exp Nylon Guitar	25 95 2
	60's EP	5 121 3		2 2/3' Drawbar	19 95 5		Finger Nylon Gtr	25 95 4
	Electric Grand	3 121 0		2' Drawbar	19 95 6		Ballad Guitar	26 95 6
	Modern EP	6 121 0		1 3/5' Drawbar	19 95 7		Nylon Acoustic	25 121 0
	Modern EP 2	6 121 1		1 1/3' Drawbar	19 95 8		Nylon Acoustic 2	25 121 2
	EP Legend	6 121 3		1' Drawbar	19 95 9		Nylon Acoustic 3	25 121 3
	Crystal EP	6 95 1		16' Drawbar	19 95 1		Steel Guitar	26 121 0
	Classic EP 3	5 121 1		4' percussion	18 95 3		Mellow Steel Strg	26 95 1
	Classic EP 4	5 121 2		2 2/3' percussion	18 95 2		Folk Guitar	26 95 8
	Tremolo EP	5 95 1		Church Organ	20 121 0		Folk Guitar 2	26 95 12
	Electric Grand 2	3 121 1		8' & 4' Diapason	20 95 24		12 String	26 121 1
	Modern EP 3	6 121 2		8' & 2' Flute	21 95 3		Ukulele	25 121 1
	New Age EP	6 95 2		8' Celeste	20 95 5		Steel String 2	26 121 3
	New Age EP 2	6 95 3		8' Diapason	20 95 6		Electric Guitar	28 121 0
	New Age EP 3	6 95 4		Chiffy Tibia	20 95 17		Muted Electric	29 121 0
	EP Phase	6 121 4		Stopped Pipe	20 95 21		Country Lead	29 121 3
	Harpsichord	7 121 0		Church Organ 2	20 121 1		Pedal Steel	27 121 1
	Harpsichord 2	7 121 3		Reeds	20 95 10		Modern Jazz Gtr	27 95 10
	Harpsichord Octave	7 121 1		Small Ensemble	20 95 8		Dynamic Overdrive	30 121 1
	Harpsi & Strings	7 95 1		8' Diapason 2	18 95 7		Rhythm Guitar	28 121 2
	Clavi	8 121 0		Principle Pipe	20 95 22		Blues Lick	31 95 1
	Harpsi & Strings 2	7 95 2		Puff Organ	21 121 1		College	28 95 6
	Harpsi & Pipes	7 95 3		Church Organ 3	20 121 2		Hawaiian Guitar	27 95 1
	Harpsi & Pipes 2	7 95 4		8' Reed	21 95 1		Modern Jazz Gtr 2	27 95 11
	Synth Clavi	8 121 1		Baroque Mix	20 95 7		Comping Jazz Gtr	27 95 12
	Wide Harpsichord	7 121 2		Small Ensemble 2	20 95 25		Nylon Electric	28 95 1
STRINGS	Beautiful Strings	45 95 1		8' Flute Celeste	21 95 9		Electric Guitar 2	28 121 1
	String Ensemble	49 95 16		8' Diapason 3	20 95 20		Electric Guitar 3	29 121 2
	String Ensemble 2	50 121 0		8' Flute Chiff	21 95 7		Electric Guitar 4	28 95 2
	Warm Strings	49 95 1		Full Pipes	20 95 9		British	28 95 7
	Small String Ens	49 95 13		Principle Choir	20 95 23		Jazz Guitar	27 121 0
	Octave Strings	49 95 4		Mixer	18 95 5		Jazz Guitar 2	27 95 2
	Violin Ensemble	41 95 1		8' Flute	21 95 2		Dist Feedback	31 121 1
	Cello Ensemble	43 95 2		2 2/3' Flute Chiff	21 95 8		Overdrive	30 121 0
	Warm Strings 3	51 95 2		4' & 2' Flute	21 95 4		Distortion	31 121 0
	Tremolo Strings	45 121 0		2 2/3' Flute	21 95 5		Delayed Elec Gtr	28 95 4
	Strings Storzando	49 95 9		1 3/5' Flute	21 95 6		Pedal Steel 2	27 95 5
	Synth Strings	51 121 0		Theater Organ	20 95 1		Muted Guitar 2	29 95 1
	Synth Strings 2	52 121 0		Theater Organ 2	20 95 2		Jazz Guitar 3	27 95 3
	Synth Strings 3	51 121 1		Theater Organ 3	20 95 3		Cutting Guitar ES	28 95 5
	Synth String Orch	51 95 1		Theater Organ 4	20 95 4		Cutting Guitar	28 95 3
	Strings Sustaining	49 95 10		60's Organ	17 121 2		Dist Rhythm	31 121 2
	60's Strings	49 121 2		Electronic Organ	17 95 9		Cutting Guitar 2	29 121 1
	String Quartet	49 95 2		Electronic Organ 2	17 95 10		Acoustic Bass	33 121 0
	String Bass Ens	44 95 1	VOCAL	Reed Organ	21 121 0		Acoustic Bass 2	33 95 2
	Mono Strings	49 95 3		Choir Aahs	53 121 0		Ac Bass & Ride	33 95 1
	Basic Strings	49 121 0		Choir Aahs 2	53 121 1		Synth Bass	39 121 0
	Violin	41 121 0		Slow Choir	53 95 2		Finger Bass	34 121 0
	Cello	43 121 0		Breathy Choir	53 95 1		Finger Bass 2	34 95 5
	Contrabass	44 121 0		Ooh	54 95 1		Electric Bass	34 95 1
	Viola	42 121 0		Choir & String	53 95 3		Fretless Bass	36 121 0
	Slow Violin	41 121 1		Voice	86 121 0		Acoustic Bass 3	33 95 4
	Fiddle	111 121 0		Choir	92 121 0		Acoustic Bass 4	33 95 5
	Slow Fiddle	111 95 1		Voice Oohs	54 121 0		Ac Bass & Piano	33 95 3
	Slow Cello	43 95 1		Humming	54 121 1		Elec Bass & Piano	34 95 3
	Harp	47 121 0		50's Ooh Aah	54 95 4		Elec Bass & Ride	34 95 2
	Pizzicato	46 121 0					Electric Bass 2	34 95 4
	String & Harp	49 95 6					Slap Bass	37 121 0
	Strings & Bell	49 95 5					Finger Slap Bass	34 121 1
	Strings & Piano	1 95 4					Pick Bass	35 121 0
	Strings & Piano 2	1 95 5					Attack Bass	40 121 3
	Strings & Brass	49 121 1					Clavi Bass	39 121 3
	Orchestra Hit	56 121 0					Clavi Bass 2	39 95 2
							Octave Fretless	36 95 1

Category	Sound Name	Prog	MSB	LSB	Category	Sound Name	Prog	MSB	LSB	Category	Sound Name	Prog	MSB	LSB
GUITAR & BASS (cont.)					OTHERS: BRASS (cont.)					OTHERS: DRUM & PERCUSSION				
	Slap Bass 2	38	121	0		Brass Pad	62	95	2		StereoAmbience Kit	d3		
	Warm Synth Bass	39	121	1		Brass & Synth	62	95	3		Stereo Funk Kit	d4		
	Hammer Bass	39	121	4		Brass & Synth 2	62	95	4		Stereo Pop Kit	d5		
	Synth Bass 2	40	121	0		Synth Brass	63	121	0		Stereo Ballad Kit	d6		
	Synth Bass 3	39	121	2		Synth Brass 2	64	121	0		Standard Kit	d1		
	Synth Bass 4	40	121	1		Synth Brass 3	63	121	1		Jazz Kit	d33		
	Poly Synth Bass	39	95	1		Synth Brass 4	64	121	1		Brush Kit	d41		
	Rubber Bass	40	121	2							Room Kit	d9		
	Finger Bass 3	34	95	6		OTHERS: SYNTH					Power Kit	d17		
	Ac Bass Slap	121	121	2		Classic Synth	82	121	0		Analog Kit	d26		
	Strumming Ac Gtr	26	121	0		Classic Synth 2	82	121	1		Dance Kit	d27		
	Strumming Ac Gtr 2	25	121	0		Chiff	84	121	0		Electric Kit	d25		
	Picking Ac Gtr	25	121	0		Fifth	87	121	0		Standard Kit 2	d2		
	Picking Ac Gtr 2	26	121	0		Lead	82	121	2		Orchestra Kit	d49		
	Strumming Elec Gtr	28	121	2		Square Lead	81	95	3		Concert Bass Drum	117	121	1
	Picking Elec Gtr	27	121	0		Square	81	121	0		Orch Cymbal & BD	117	95	8
	Pick/Strum Gtr	26	121	1		Sine	81	121	2		Cym & Bass Drum	117	95	1
	Pick/Strum Gtr 2	26	121	0		Classic Synth 3	82	121	3		Bass Drum	117	95	7
	Guitar & Strings	26	95	2		Bass & Lead	88	121	0		Crash Cymbal Mute	120	95	7
	Guitar Pad	26	95	3		Caliope	83	121	0		Timpani	48	121	0
	Elec Gtr Harmonics	32	121	0		Charang	85	121	0		Soft Timpani	48	95	1
	Guitar Feedback	32	121	1		Square 2	81	121	1		Melodic Toms	118	121	0
	Gtr Fret Noise	121	121	0		Clean Square	81	95	1		Reverse Cymbal	120	121	0
	Gtr Cutting Noise	121	121	1		Wire Lead	85	121	1		Melodic Tom 2	118	121	1
	Cutting Noise2 ES	121	95	1		Soft Wire Lead	88	121	1		Woodblock	116	121	0
						Sequenced Analog	82	121	4		Castanet	116	121	1
						Analog Brass	83	121	2		Sleigh Bells	113	95	1
						Analog Brass 2	64	121	2		Triangle	113	95	2
						Polysynth	91	121	0		Tambourine	114	95	1
						Polysynth 2	91	95	1		Agogo	114	121	0
						Big Saw	82	95	1		Finger Snap	116	95	4
						Octave Saw	82	95	2		Hand Clap	116	95	3
						Square Comp	89	95	5		Synth Drum	119	121	0
						Saw Comp 2	89	95	6		Rhythm Box Tom	119	121	1
						Analog Brass 3	64	95	1		Electric Drum	119	121	2
						Euro Hit	56	121	3		Snare Roll	117	95	2
						Bass Hit Plus	56	121	1		Snare Roll 2	117	95	3
						6th Hit	56	121	2		Rolling Timpani	48	121	0
										Soft Timpani Roll	48	95	2	
						OTHERS: PAD				Repeating Castanet	116	121	1	
						Itopia	92	121	1		Metronome	116	95	2
						Warm Pad	90	121	0		Tinkle Bell	113	121	0
						Brightness	101	121	0		Taiko Drums	117	121	0
						Atmosphere	100	121	0					
						New Age	89	121	0		OTHERS: SOUND EFFECT			
						Sine Pad	90	121	1		SFX Kit	d57		
						Halo	95	121	0		Seashore	123	121	0
						Halo 2	95	95	1		Stream	123	121	4
						Crystal	99	121	0		Rain	123	121	1
						Synth Vocal	55	121	0		Thunder	123	121	2
						Brightness 2	101	95	1		Wind	123	121	3
						Warm Sweep	96	95	2		Wind Chime	125	121	5
						New Age 2	89	95	1		Dog Barking	124	121	1
						New Age 3	89	95	2		Horse Gallop	124	121	2
						New Age 4	89	95	3		Bird Tweet	124	121	0
						Sweep	96	121	0		Bird Tweet 2	124	121	3
						Bowed	93	121	0		Heartbeat	127	121	4
						Metallic	94	121	0		Applause	127	121	0
						Warm Saw Pad	94	95	1		Laughing	127	121	1
						Soundtrack	98	121	0		Screaming	127	121	2
						Bright Warm Pad	90	95	1		Foot Step	127	121	5
						Multi Sweep	96	95	1		Punch	127	121	3
						Rain Pad	97	121	0		Telephone	125	121	0
						Bright Saw Pad	93	95	1		Telephone 2	125	121	1
						Saw Pad	82	95	3		Helicopter	126	121	0
						Square Pad	81	95	2		Gunshot	128	121	0
						Echo Bell	103	121	1		Explosion	128	121	3
						Echoes	103	121	0		Machine Gun	128	121	1
						Sci-Fi	104	121	0		Siren	126	121	5
						Analog Voice	55	121	1		Car Passing	126	121	3
						Goblin	102	121	0		Car Stopping	126	121	2
						Echo Pan	103	121	2		Door Creak	125	121	2
										Door Slam	125	121	3	
						OTHERS: AMERICAN				Car Engine	126	121	1	
						Harmonica	23	121	0		Car Crash	126	121	4
						Blues Harmonica	23	95	2		Train	126	121	6
						Wah Harmonica	23	95	1		Jet Plane	126	121	7
						Wah Harmonica 2	23	95	3		Starship	126	121	8
						Banjo	106	121	0		Laser Gun	128	121	2
						Picking Banjo	106	121	0		Scratch	125	121	4
						Strumming Banjo	106	121	0		Trolley Bell	99	95	1
						Exp Mandolin 2	26	95	18		Whistle Down	126	95	6
						Mandolin	26	121	2		Whistle Up	126	95	7
						Strumming Mandolin	26	121	2		Bubble	123	121	5
						Mellow Mandolin	26	95	4		Burst Noise	126	121	9
										Breath Noise	122	121	0	
						OTHERS: INTERNATIONAL								
						Accordion	22	121	1		MIDI			
						French Accordion	22	121	0		GM2 Standard Set			
						French Accordion 2	22	95	1		GM2 Room Set			
						Tango Accordion	24	121	0		GM2 Power Set			
						Celtic Harp	47	121	1		GM2 Electronic Set			
						Bag Pipe	110	121	0		GM2 Analog Set			
						Accordion 2	22	95	2		GM2 Jazz Set			
						Shakuhachi	78	121	0		GM2 Brush Set			
						Koto	108	121	0		GM2 Orchestra Set			
						Shamisen	107	121	0					
						Sitar	105	121	0					
						Sitar 2	105	121	1					
						Taisho Koto	108	121	1					
						Shanai	112	121	0					
						Dulcimer	16	121	0					
						Blown Bottle	77	121	0					
						Kalimba	109	121	0					
						Ocarina	80	121	0					
						Whistle	79	121	0					
						Whistlers	79	95	1					

NOTES:
 ■ Picking / Strumming guitar sounds do not respond to MIDI messages.
 ■ For Drum Kits, send Exclusive Message (F0 40 7F 33 gg mm 10 On 7F kk F7) after Program Change.

10) Drum & SFX Kit Mapping

←: Same as Standard Kit

		Standard Kit	Standard Kit 2	Room Kit	Power Kit	Electric Kit	Analog Kit	Dance Kit	Jazz Kit	Brush Kit	Orchestra Kit	
C1	C	24										
	C#	25	←	←	←	←	←	←	←	←	←	
	D	26	←	←	←	←	←	←	←	←	←	
	D#	27	←	←	←	←	←	←	←	←	Std2 HHC	
	E	28	←	←	←	←	←	←	←	←	Std1 HHP	
	F	29	←	←	←	←	←	←	←	←	Std2 HHO	
	F#	30	←	←	←	←	←	←	←	←	Std1 Ride1	
	G	31	←	←	←	←	←	←	←	←	←	
	G#	32	←	←	←	←	←	←	←	←	←	
	A	33	←	←	←	←	←	←	←	←	←	
	A#	34	←	←	←	←	←	←	←	←	←	
	B	35	Std1 BD2	Std2 BD2	Room BD2	Power BD2	Elect BD2	Analog BD2	Dance BD2	Jazz BD2	Jazz BD2	Jazz BD1
C2	C	36	Std1 BD1	Std2 BD1	Room BD1	Power BD1	Elect BD1	Analog BD1	Dance BD1	Jazz BD1	Jazz BD1	Orch BD1
	C#	37	←	←	←	←	←	←	←	←	←	
	D	38	Std1 SD1	Std2 SD1	Room SD1	Power SD1	Elect SD1	Analog SD1	Dance SD1	Jazz SD1	Brush Tap	Orch SD1
	D#	39	←	←	←	←	←	←	←	←	←	
	E	40	Std1 SD2	Std2 SD2	Room SD2	Power SD2	Elect SD2	Analog SD2	Dance SD2	Jazz SD2	Brush Swirl	Orch SD1
	F	41	Std1 LowTom2	←	RoomLowTom2	PowerLowTom2	Elect LowTom2	Analog LowTom2	DanceLowTom2	←	BrushLowTom2	Timpani F
	F#	42	Std1 HHC	Std2 HHC	RoomLowTom2	PowerLowTom2	Elect LowTom2	Analog LowTom2	DanceLowTom2	←	BrushLowTom2	Timpani F#
	G	43	Std1 Low Tom1	←	RoomLowTom1	PowerLowTom1	Elect LowTom1	Analog LowTom1	DanceLowTom1	←	BrushLowTom1	Timpani G
	G#	44	Std1 HHP	←	←	←	←	←	←	←	←	Timpani G#
	A	45	Std1 Mid Tom2	←	RoomMidTom2	PowerMidTom2	Elect Mid Tom2	Analog Mid Tom2	DanceMidTom2	←	BrushMidTom2	Timpani A
	A#	46	Std1 HHO	Std2 HHO	Std1 HHO	Std2 HHO	Std1 HHO	Std2 HHO	Dance HHO	Std2 HHO	Brush HHO	Timpani A#
	B	47	Std1 Mid Tom1	←	RoomMidTom1	PowerMidTom1	Elect Mid Tom1	Analog Mid Tom1	DanceMidTom1	←	BrushMidTom1	Timpani B
C3	C	48	Std1 Hi Tom2	←	RoomHiTom2	Power Hi Tom2	Elect Hi Tom2	Analog Hi Tom2	DanceHiTom2	←	Brush Hi Tom2	Timpani c
	C#	49	Std1 Crash1	←	←	←	←	←	←	←	Brush Crash	Timpani c#
	D	50	Std1 Hi Tom1	←	RoomHiTom1	Power Hi Tom1	Elect Hi Tom1	Analog Hi Tom1	DanceHiTom1	←	Brush Hi Tom1	Timpani d
	D#	51	Std1 Ride1	←	←	←	←	←	←	←	Brush Ride1	Timpani d#
	E	52	China	←	←	←	ReverseCymbal	←	ReverseCymbal	←	←	Timpani e
	F	53	Cup	←	←	←	←	←	←	←	←	Timpani f
	F#	54	Tambourine	←	←	←	←	←	←	←	Brush Ride Bell	←
	G	55	Splash	←	←	←	←	←	←	←	←	←
	G#	56	Cowbell	←	←	←	←	Analog Cowbell	←	←	←	←
	A	57	Crash2	←	←	←	←	←	←	←	←	Orch Cymbal2
	A#	58	Vibra slap	←	←	←	←	←	←	←	←	←
	B	59	Ride2	←	←	←	←	←	←	←	←	Orch Cymbal1
C4	C	60	Hi Bongo	←	←	←	←	←	←	←	←	←
	C#	61	Low Bongo	←	←	←	←	←	←	←	←	←
	D	62	Mute Hi Conga	←	←	←	←	←	←	←	←	←
	D#	63	Hi Conga	←	←	←	←	Analog Hi Conga	←	←	←	←
	E	64	Low Conga	←	←	←	←	Analog Mid Conga	←	←	←	←
	F	65	Hi Timbale	←	←	←	←	Analog Low Conga	←	←	←	←
	F#	66	Low Timbale	←	←	←	←	←	←	←	←	←
	G	67	Hi Agogo	←	←	←	←	←	←	←	←	←
	G#	68	Low Agogo	←	←	←	←	←	←	←	←	←
	A	69	Cabasa	←	←	←	←	←	←	←	←	←
	A#	70	Maracas	←	←	←	←	Analog Maracas	←	←	←	←
	B	71	Short Whistle	←	←	←	←	←	←	←	←	←
C5	C	72	Long Whistle	←	←	←	←	←	←	←	←	←
	C#	73	Short Guiro	←	←	←	←	←	←	←	←	←
	D	74	Long Guiro	←	←	←	←	←	←	←	←	←
	D#	75	Claves	←	←	←	←	Analog Claves	←	←	←	←
	E	76	Hi Wood Blk	←	←	←	←	←	←	←	←	←
	F	77	Low Wood Blk	←	←	←	←	←	←	←	←	←
	F#	78	Mute Cuica	←	←	←	←	←	Hi Hoo	←	←	←
	G	79	Open Cuica	←	←	←	←	←	Low Hoo	←	←	←
	G#	80	Mute Triangle	←	←	←	←	Ele Mut Triangle	←	Ele Mut Triangle	←	←
	A	81	Open Triangle	←	←	←	←	Ele Open Triangle	←	←	←	←
	A#	82	Shaker	←	←	←	←	←	←	←	←	←
	B	83	Jingle Bell	←	←	←	←	←	←	←	←	←
C6	C	84	Bell Tree	Bar Chimes	←	←	←	←	←	←	←	←
	C#	85	Castanets	←	←	←	←	←	←	←	←	←
	D	86	Mute Surdo	←	←	←	←	←	←	←	←	←
	D#	87	Open Surdo	←	←	←	←	←	←	←	←	←
	E	88	←	←	←	←	←	←	←	←	←	Applause

	Stereo Ambience Kit	Stereo Funk Kit	Stereo Pop Kit	Stereo Ballad Kit	
C1 C	24				
C#	25				
D	26				
D#	27				
E	28				
F	29				
F#	30				
G	31				
G#	32				
A	33				
A#	34				
B	35	Ambi BD2	Funk BD2	Pop BD2	Bala BD2
C2 C	C2/36	Ambi BD1	Funk BD1	Pop BD1	Bala BD1
C#	37	Ambi Rim	Ambi Rim	Pop Rim	Ambi Rim
D	38	Ambi SD1	Funk SD1	Pop SD1	Bala SD1
D#	39	Hand Clap	Ambi Clap	Hand Clap	Hand Clap
E	40	Ambi SD2	Funk SD2	Pop SD2	Bala SD2
F	41	AmbiLowTom2	FunkLowTom	PopLowTom2	PopLowTom2
F#	42	Ambi HHC	Funk HHC	Pop HHC	Funk HHC
G	43	AmbiLowTom1	FunkLowTom1	PopLowTom1	PopLowTom1
G#	44	Ambi HHP	Funk HHP	Pop HHP	Funk HHP
A	45	AmbiMidTom2	FunkMidTom2	PopMidTom2	PopMidTom2
A#	46	Ambi HHO	Funk HHO	Pop HHO	Pop HHO
B	47	AmbiMidTom1	FunkMidTom1	PopMidTom1	PopMidTom1
C3 C	48	AmbiHITom2	FunkHITom2	PopHITom2	PopHITom2
C#	49	Ambi Crash1	Funk Crash1	Funk Crash1	Ambi Crash1
D	50	AmbiHITom1	FunkHITom1	PopHITom1	PopHITom1
D#	51	Pop Ride1	Funk Ride1	Pop Ride1	Pop Ride1
E	52				
F	53	Pop Cup	Funk Cup	Pop Cup	Pop Cup
F#	54				
G	55	Funk Splash	Funk Splash	Funk Splash	Funk Splash
G#	56				
A	57	Funk Crash2	Funk Crash2	Funk Crash2	Funk Crash2
A#	58				
B	59	Pop Ride2	Funk Ride2	Pop Ride2	Pop Ride2
C4 C	60				
C#	61				
D	62				
D#	63				
E	64				
F	65				
F#	66				
G	67				
G#	68				
A	69				
A#	70				
B	71				
C5 C	72				
C#	73				
D	74				
D#	75				
E	76				
F	77				
F#	78				
G	79				
G#	80				
A	81				
A#	82				
B	83				
C6 C	84	Bar Chimes		Bar Chimes	Bar Chimes
C#	85				
D	86				
D#	87				
E	88				
F	89				
F#	90				
G	91				
G#	92				
A	93				
A#	94				
B	95				

	SFX Kit	
A	21	
A#	22	
B	23	
C1 C	24	
C#	25	
D	26	
D#	27	
E	28	
F	29	
F#	30	
G	31	
G#	32	
A	33	
A#	34	
B	35	
C2 C	36	
C#	37	
D	38	
D#	39	High Q
E	40	Slap
F	41	Scratch Push
F#	42	Scratch Pull
G	43	Sticks
G#	44	Square Click
A	45	Metronome Click
A#	46	Metronome Bell
B	47	Guitar Fret Noise
C3 C	48	Gtr. Ctt. Noise/up
C#	49	Gtr. Ctt. Noise/down
D	50	String Slap of Bass
D#	51	Fl Key Click
E	52	Laughing
F	53	Scream
F#	54	Punch
G	55	Heart Beat
G#	56	Footsteps 1
A	57	Footsteps 2
A#	58	Applause
B	59	Door Creaking
C4 C	60	Door
C#	61	Scratch
D	62	Wind Chime
D#	63	Car-Engine
E	64	Car-Stop
F	65	Car-Pass
F#	66	Car-Crash
G	67	Siren
G#	68	Train
A	69	Jetplane
A#	70	Helicopter
B	71	Starship
C5 C	72	Gun Shot
C#	73	Mashine Gun
D	74	Lasergun
D#	75	Explosion
E	76	Dog
F	77	Horse-Gallop
F#	78	Birds
G	79	Rain
G#	80	Thunder
A	81	Wind
A#	82	Seashore
B	83	Stream
C6 C	84	Bubble
C#	85	
D	86	
D#	87	
E	88	
F	89	
F#	90	
G	91	
G#	92	
A	93	
A#	94	
B	95	
C7 C	96	
C#	97	
D	98	
D#	99	
E	100	
F	101	
F#	102	
G	103	
G#	104	
A	105	
A#	106	
B	107	
C8 C	108	

11) Specifications

	CP3
Keyboard	88 grade-weighted keys with Ivory Touch key surfaces Responsive Hammer II (RHII) action, with Let-Off and triple sensor
Sound Source	Harmonic Imaging™ XL (HI-XL), 88-key piano sampling
Polyphony	Maximum 256
Preset Sounds	Over 700 including Drum kits, 20 User Sounds
Styles	215 Styles (4 Variations per Style) Maximum 20 User Styles
Style Controls	Start/Stop, Intro/Ending (2 per Style), Fill-in (4 per Style), Fade Out, Sync Start, Tap Tempo
Metronome	♩ = 10–300, 1/4, 2/4, 3/4, 4/4, 5/4, 6/8, 7/8, 9/8, 12/8
Auto-Accompaniment	Fingered, One Finger, Full Keyboard, Bass Inversion, Harmony (10 types)
Song Stylist	736 Songs
Conductor	Easy Conductor
Effects	Chorus (5), Classic Chord, Celeste, Ensemble, Flanger, Phaser, Classic Phaser, Auto Wah, Tremolo, Classic Tremolo, Tremulant, Auto Pan, Classic Auto Pan, Standard Delay, Pingpong Delay, Triple Delay, Overdrive, Distortion, Rotary (6), Compressor, Standard EQ, Enhancer, Combination Effects, Reverb (Room, Lounge, Small Hall, Concert Hall, Live Hall, Cathedral)
Virtual Technician	Touch Curve Selection (Light1/2, Normal, Heavy1/2, Off, User 1/2), Voicing, Damper Resonance, String Resonance, Key-off Noise, Damper Noise, Key Action Noise, Half Pedal Point, Soft Pedal Depth, Temperament (9 types, 1 User Temperament), Stretch Tuning (including 88 Key User Stretch), 88 Key Volume, Hammer Delay, Top Board Position, Decay Time, Minimum Touch
Other Features	One-Two Play, 80 Registrations, Concert Magic (176 Preset Songs), 3 Parts (RIGHT1/2, LEFT), 2-Part Layer, Split (Selectable Split Point), Mixer, Master Volume, Accompaniment Volume, Transpose, Octave Shift, Tune, Portamento, Metronome, MIDI (16 Part Multi-Timbral Capability), Lesson Function (723 lesson songs)
Recorder	16 Tracks and separate Style, Chord and Tempo tracks, Punch-In Recording, Step Recording, Editing capability, Play MIDI Song (Reads/Writes Standard MIDI file format, Lyrics) Total memory capacity: approximately 50,000 notes. Internal user song memory: 1MB.
USB Audio Recorder	Play : MP3 (Bit Rate: 8k-320 kbps, Sampling: 44.1 kHz / 48 kHz / 32 kHz) WAV(44.1 kHz, 16 bit) Record : MP3 (Bit Rate: 192 kbps, Sampling: 44.1 kHz) WAV(44.1 kHz, 16 bit)
Display	5.7" 640*480 VGA color LCD with touch panel
Pedals	Sustain (8-Step Sensitive), Sostenuto, Soft (17 Functions can be assigned.)
Jacks	Headphones x 2, LINE IN (L/MONO, R), LINE OUT (L/MONO, R), MIDI (IN, OUT), USB to Device, USB to Host
Data Media	USB Flash Memory (FAT16/FAT32 filesystem)
Output Power	100 W
Speakers	6.3 inch Full Range x 2
Power Consumption	90 W
Dimensions (W x D x H)	56.1 x 22.8 x 38.1 inch (without music rack)
Weight (without bench)	146 lbs, 66 kg

User Notes

KAWAI

THE FUTURE OF THE PIANO

CP3 Owner's Manual
KPSZ-0699
OW1082E-J1406

