

snom



User Manual  
C520-WiMi  
IP Conference Phone

## Important safety instructions

When using the conference phone, basic safety precautions should always be followed to reduce the risk of fire, electric shock and injury to persons, including the following:

1. Read and understand all instructions.
2. Follow all warnings and instructions marked on the product.
3. Unplug this product from the wall outlet before cleaning. Do not use liquid or aerosol cleaners. Use a damp cloth for cleaning.
4. Do not use this product near water such as near a bathtub, wash bowl, kitchen sink, laundry tub or swimming pool, or in a wet basement or shower.
5. Do not place this product on an unstable table, shelf, stand or other unstable surfaces.
6. Slots and openings in the back or bottom of the base unit and wireless mic are provided for ventilation. To protect them from overheating, these openings must not be blocked by placing the product on a soft surface such as a bed, sofa or rug. This product should never be placed near or over a radiator or heat register. This product should not be placed in any area where proper ventilation is not provided.
7. This product should be operated only from the type of power source indicated on the marking label. If you are not sure of the type of power supply in your office, consult your dealer or local power company.
8. Do not allow anything to rest on the power cord. Do not install this product where the cord may be walked on.
9. Never push objects of any kind into this product through the slots in the base unit or wireless mic because they may touch dangerous voltage points or create a short circuit. Never spill liquid of any kind on the product.
10. To reduce the risk of electric shock, do not disassemble this product, but take it to an authorized service facility. Opening or removing parts of the base unit or wireless mic other than specified access doors may expose you to dangerous voltages or other risks. Incorrect reassembling can cause electric shock when the product is subsequently used.
11. Do not overload wall outlets and extension cords.
12. Unplug this product from the wall outlet and refer servicing to an authorized service facility under the following conditions:
  - When the power supply cord or plug is damaged or frayed.
  - If liquid has been spilled onto the product.
  - If the product has been exposed to rain or water.
  - If the product does not operate normally by following the operating instructions. Adjust only those controls that are covered by the operation instructions. Improper adjustment of other controls may result in damage and often requires extensive work by an authorized technician to restore the product to normal operation.

- If the product has been dropped and the base unit and/or wireless mic has been damaged.
  - If the product exhibits a distinct change in performance.
13. Avoid using the conference phone during an electrical storm. There is a remote risk of electric shock from lightning.
  14. Do not use the conference phone to report a gas leak in the vicinity of the leak. Under certain circumstances, a spark may be created when the adapter is plugged into the power outlet, or when the wireless mic is replaced in its cradle. This is a common event associated with the closing of any electrical circuit. The user should not plug the phone into a power outlet, and should not put a charged wireless mic onto the charging cradle, if the phone is located in an environment containing concentrations of flammable or flame-supporting gases, unless there is adequate ventilation. A spark in such an environment could create a fire or explosion. Such environments might include: medical use of oxygen without adequate ventilation; industrial gases (cleaning solvents; gasoline vapors; etc.); a leak of natural gas; etc.
  15. Only put the wireless mic next to your mouth when it is in normal talk mode.
  16. The power cables are intended to be correctly oriented in a vertical or floor mount position. The prongs are not designed to hold the plug in place if it is plugged into a ceiling or cabinet outlet.
  17. For pluggable equipment, the socket-outlet shall be installed near the equipment and shall be easily accessible.
  18. CAUTION: Use only the batteries indicated in this manual. There may be a risk of explosion if a wrong type of battery is used. Use only the supplied rechargeable battery or a replacement battery pack. Do not dispose of batteries in a fire. They may explode.
  19. If you are not using PoE, use only the adapter included with this product. Incorrect adapter polarity or voltage can seriously damage the product. Base unit power adapter: Input 100–240V AC 50/60Hz; output: 9V DC 1500mA.

## Disposal



This product is subject to European Directive 2002/96/EC and may not be disposed of with general household garbage. If you do not know where you may dispose of the device at the end of its lifespan, contact your municipality, your local waste management provider, or your seller.

## Battery disposal



The batteries provided with the products are subject to European Directive 2006/66/EC and may not be disposed of with general household garbage. If you do not know where you may dispose of the batteries at the end of their lifespan, contact your municipality, your local waste management provider, or your seller.

## For countries outside the European Union

Disposal of electrical and electronic products and of batteries should be done in line with local regulations. Please contact local authorities for further information.

# Table of contents

<b>Introduction.....</b>	<b>1</b>	Muting active calls.....	22
About the C520-WiMi Conference Phone	1	Temporarily silencing the ringer.....	23
<b>Introduction.....</b>	<b>2</b>	Locating wireless microphones .....	23
Parts checklist.....	2	Making and receiving calls on cell phone	24
<b>Getting Started.....</b>	<b>3</b>	Transferring Bluetooth calls from the C520-WiMi to your cell phone.....	25
Connecting .....	3	Conference calls with a Bluetooth- connected cell phone .....	25
Install the wireless mic battery .....	4	Playing audio with a Bluetooth- connected call phone .....	25
Before use .....	5	Using a Bluetooth headset .....	26
Base unit overview (front) .....	6	<b>Phone Features.....</b>	<b>27</b>
Base unit overview (front), continued.....	7	Using the Features menu.....	27
Base unit overview (front), continued.....	8	Using the Call menu.....	28
Base unit overview (rear) .....	8	Setting Do Not Disturb.....	29
Wireless microphone overview .....	9	Using the Bluetooth menu.....	32
Status indicators overview .....	10	Changing the C520-WiMi PIN.....	34
Idle screen.....	11	Using the local directory.....	35
Idle mode screen icons .....	11	Call history .....	38
Active call screen icons .....	12	Speed Dial .....	40
Using the phone menu .....	13	Entering speed dial numbers.....	40
Main menu items.....	13	Sending a Multicast Page .....	41
<b>Conference phone operation....</b>	<b>13</b>	<b>Configuring the Phone.....</b>	<b>42</b>
Making calls.....	14	Configuring the phone.....	42
Using a wireless microphone during a call 15		Using the User settings menu.....	42
Ending the call.....	15	Preferences .....	43
Answering a call.....	15	Setting the language.....	43
Missed call .....	16	Setting date and time preferences .....	43
Putting a call on hold.....	16	Restarting the phone .....	45
Transferring calls.....	17	Display.....	45
Making a conference call.....	20	Audio.....	46
Creating a conference with a held call:...	20	Registering wireless microphones.....	48
Setting up a network conference .....	21	Registering wireless C52 speakerphones	
Retrieving messages.....	21		
Redialing.....	22		

# Table of contents

49

Speakerphone operation ..... 50

## **WebUI ..... 51**

Using the Web User Interface (WebUI).... 51

Status ..... 52

Call Settings..... 53

User Preferences ..... 55

Program Dial Soft Keys..... 56

Speed Dial ..... 57

Directory ..... 58

Blacklist (Deny List) ..... 61

User Password..... 61

## **Appendix ..... 62**

Battery..... 62

## **Troubleshooting ..... 63**

## **Precautions for users of implanted cardiac pacemakers 68**

**About wireless mics ..... 68**

**Maintenance ..... 69**

**Technical specifications ..... 70**

# Introduction

## About the C520-WiMi Conference Phone

---

The phone is designed for use in office settings. It consists of the phone and two wireless microphones, enabling participants in a meeting room to deliver clear conversation during a conference call.

### Expand calling options with other devices

The C520-WiMi also has Bluetooth and DECT connectivity, giving you options for how and where you can make and answer calls with the conference phone. After pairing Bluetooth devices with the C520-WiMi, you can use the conference phone in parallel with your cell phone, or use a Bluetooth headset for a private conversation.

For large meeting rooms, you can extend the range of the C520-WiMi with up to three Snom C52 DECT expansion speakerphones.

The following accessories or devices can be paired with the C520-WiMi:

- Bluetooth-equipped cell phones and/or headsets  
A total of four Bluetooth devices can be paired, but not all of them can be connected and active. Two cell phones, or one cell phone and one headset, or one headset can be connected at a time.
- Snom C52 SIP DECT Wireless Speakerphone (up to three)
- Wireless DECT headset

You can use connected devices in the following situations:

- Enable all conference attendees to talk to your party from anywhere in a large meeting room using C52 Wireless Speakerphones.
- Answer calls to your connected cell phone on the C520-WiMi or on a C52 Wireless Speakerphone also connected to the C520-WiMi.
- Make calls on your cell line using the C520-WiMi.
- Answer incoming calls to the C520-WiMi or to your paired cell phone using a DECT cordless headset.
- Transfer SIP call audio from the C520-WiMi to a Bluetooth headset when you need to talk privately after a conference.

# Introduction

## Parts checklist

---

Your conference phone package contains the items shown below. Save your sales receipt and original packaging in the event warranty service is necessary.



Quick installation guide

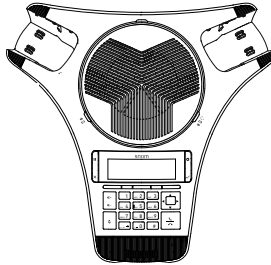

Base unit

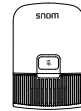

Wireless mic ×2

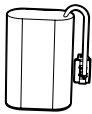

Battery ×2

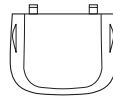

Battery door ×2

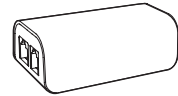

Power adapter

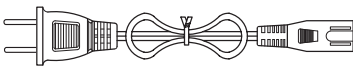

AC power cord

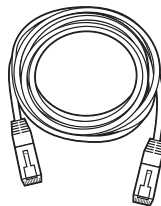

DC power cable  
(with yellow plugs)

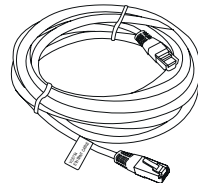

Ethernet cable

# Getting Started

## Connecting

The C520-WiMi can be powered by AC power or Power over Ethernet (PoE). If PoE is not available, use AC power, as shown below.

**Note:** the conference phone requires a network connection to an IP PBX to operate. This manual assumes that your network infrastructure is established and that your IP PBX phone service has been ordered and configured for your location.

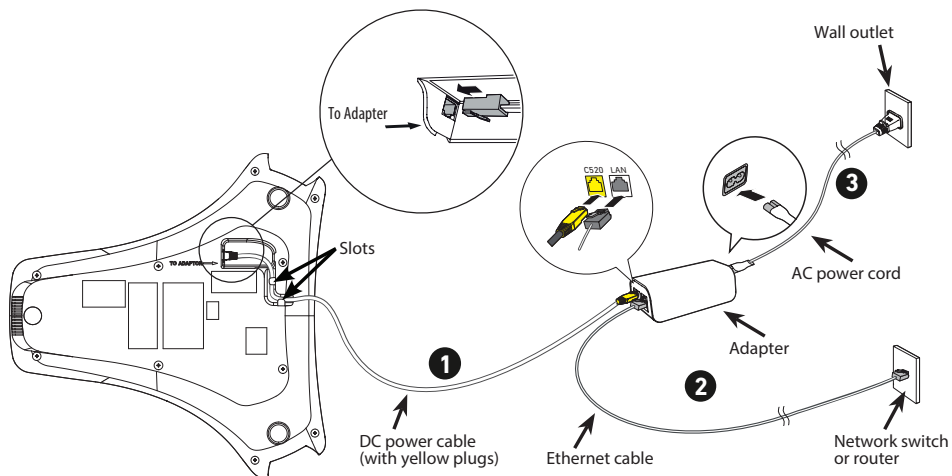

1. Plug one end of the DC power cable into the power jack of the phone, and plug the other end into the yellow **C520-WiMi** jack of the power adapter. Route the cord through the slots.
  2. Plug one end of the Ethernet cable into the **LAN** jack of the power adapter, and plug the other end into a network switch or router.
  3. Plug the small end of the AC power cord into the power jack of the adapter, and plug the large end into a wall outlet not controlled by a switch.
- The supplied power adapter is designed for use with only the Conference phone . It is not designed to power other network devices. Do not connect the supplied power adapter to any other network devices through the supplied DC power cable or any other Cat5e ethernet cable.
  - The AC power cord is intended for a vertical or floor mount position. The prongs are not designed to hold the plug in place if it is plugged into a ceiling or cabinet outlet.



# Getting Started

## To power the C520-WiMi using PoE:

1. Plug one end of the Ethernet cable into the Ethernet port on the bottom of the unit.
2. Plug the other end of the cable into your network router or switch. When the base unit is powered up, the status indicators turn green for about two seconds.

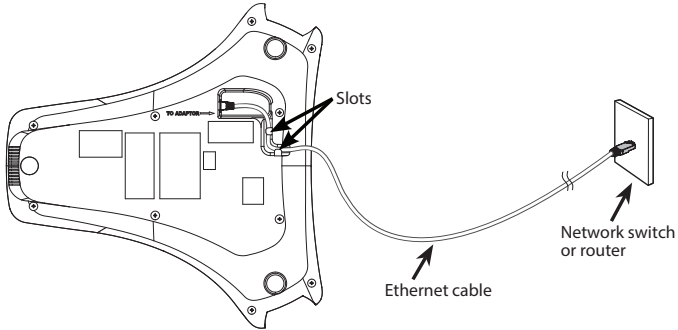

**Note:** You can connect the C520-WiMi to both PoE and AC power. Ensure that you connect the cables in the order shown in the diagram on page 2. The phone will use PoE; if PoE fails, the phone will use AC power as a backup.

## Install the wireless mic battery

1. Plug the battery connector securely into the socket inside the battery compartment. Insert the battery (with the label **THIS SIDE UP** facing up) into the battery compartment.
2. Slide the battery door until it clicks into place.

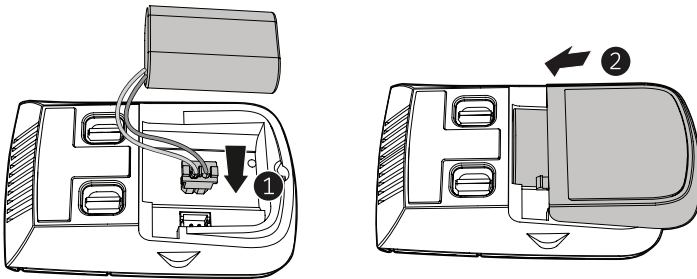

3. Place the wireless mic onto the charging cradle.

**Note:** The status indicator on the wireless mic turns orange when charging, and turns off when the wireless mic is fully charged.

# Getting Started

## Before use

---

### Check for dial tone

- Press . If you hear a dial tone, and see that the status indicator turns green on the base unit, the installation is successful.

### If you do not hear a dial tone:

- Recheck the installation diagram and the connections to the unit.
- Ensure the unit is correctly configured with the correct SIP account information. For more information, see the C520-WiMi Administrator and Provisioning Guide, available at [www.snom.com](http://www.snom.com).
- Consult your service provider if you require additional user accounts or if you suspect a service disruption is at fault.

### Operating range

The maximum range between the conference phone and its wireless microphones and any connected speakerphones can vary, depending on their locations and the layout of your office.

When a wireless microphone is out of range, it must be returned to the charging cradle to be able to reconnect with the phone.

If there is an incoming call while the wireless microphone is out of range, its green call LED will not flash to indicate an incoming call. If the wireless microphone is moved out of range during a telephone conversation, there may be interference. To improve reception, move it closer to the conference phone.

# Getting Started

## Base unit overview (front)

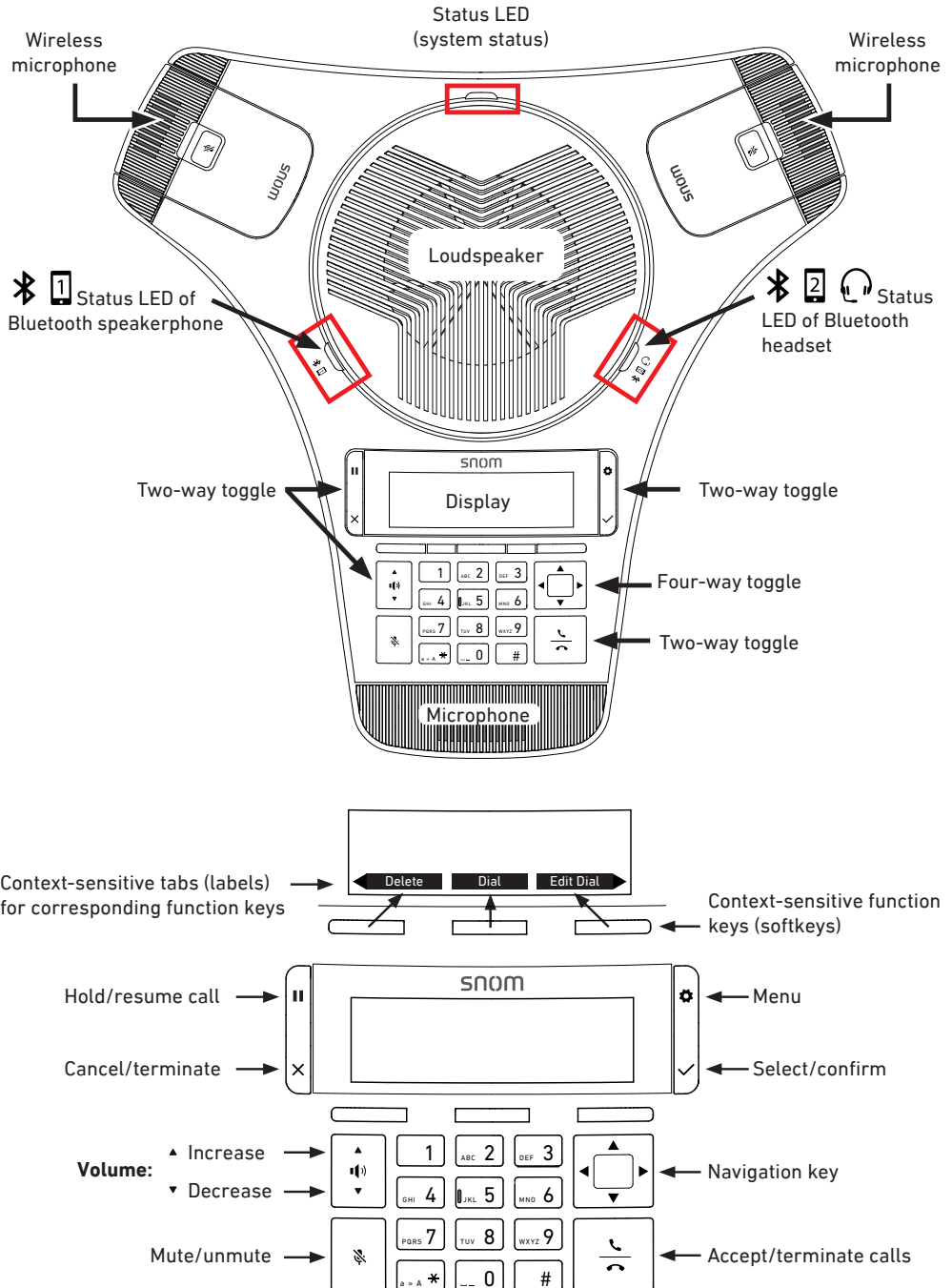

# Getting Started

## Base unit overview (front), continued

---

### 1. Status LED.

- Indicates the system status. See "Status indicators overview" on page 10.



### 2. Loudspeaker

### 3. Cell 2/Headset Bluetooth status LED

- Indicates the status of the Bluetooth-connected device. See "Status indicators overview" on page 10.

### 4. Display. LCD screen.

### 5. Menu/OK key (toggle).

- Press  to show the menu.
- Press  to select an item, or save an entry or setting in a menu.

### 6. Navigation keys (four-way toggle) ▲▼◀▶

- Press top or bottom edge to scroll up or down, respectively, while in a menu, phonebook, or call log.
- Press left or right edge to move the cursor left or right, respectively, while entering names or numbers.
- Press left or right edge to view additional function key labels and view multiple active calls.

### 7. Call key. Press to make, answer, or end a call.

### 8. Dial pad keys





- Press to enter numbers or characters.
- While editing names, press  to add a space.

### 9. Front microphone

### 10. Mute key

During a call, press  to mute and unmute all microphones in the system.

### 11. Volume key (toggle)

- When the phone is idle, press  to increase the ringer volume, press  to lower the ringer volume.
- During a call, press  to increase louspeaker volume, press  to lower louspeaker volume.

# Getting Started



## Base unit overview (front), continued

---

### 12. Context-sensitive function keys

Press to perform actions as indicated by the labels in the function key line on the display.

### 13. Hold/Cancel key (toggle)

- When in a call, press  to put the call on hold and to unhold the held call.
- When in a menu, press  to return to the previous menu.

### 14. Cell 1 Bluetooth status LED

Indicates the status of a Bluetooth-connected device **other than a headset**. See "Status indicators overview" on page 10.

## Base unit overview (rear)

---

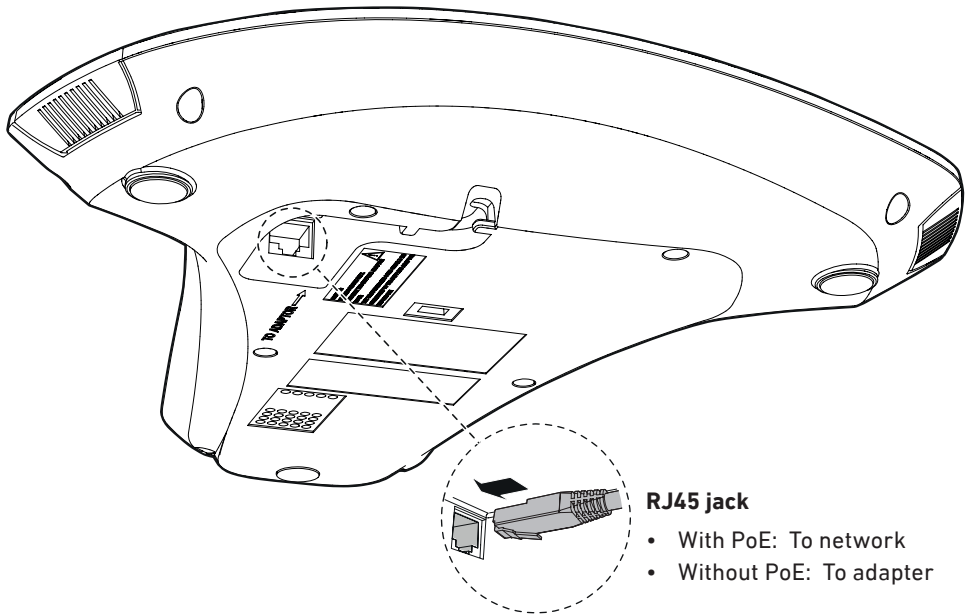

# Getting Started

## Wireless microphone overview

---

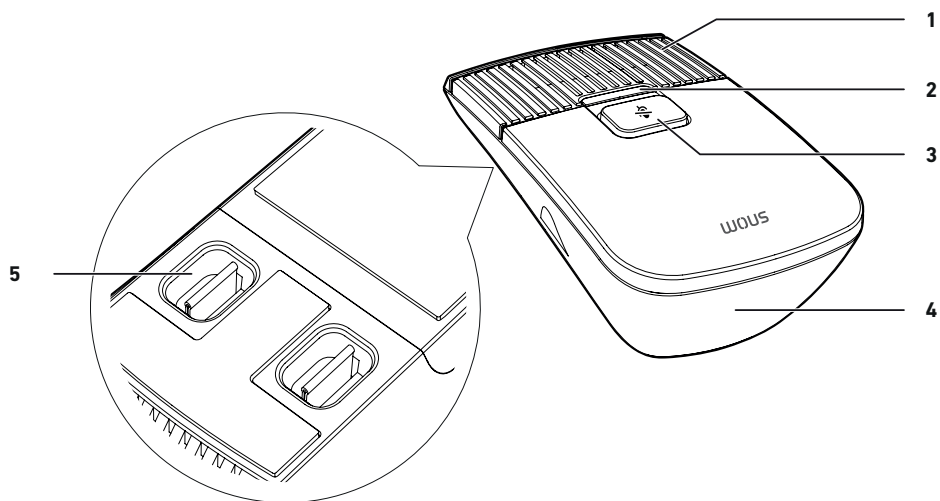

### 1. Microphone

- Functions as an extended microphone of the conference phone during a call.

### 2. Status LED

- Indicates the system status. See "Status indicators overview" on page 10.

### 3. MUTE ALL

- During a call, press to mute or end mute all microphones in the system.

### 4. Battery door

### 5. Charging contacts

# Getting Started

## Status indicators overview

---

### Status LED on the conference phone

Yellow (single short flash)	When phone is starting to power up and when it has powered up and is ready to use.
Green (fast flash)	Incoming call
Green (steady)	In a call
Green (slow flash)	Call on hold
Red (steady)	All microphones in the system (phone, wireless microphones, C 52 speakerphones) are muted during a call
Yellow (flashing)	No line registered or Network down.

### Bluetooth Status LEDs, blue

	CELL 1 LED (BLUE)	CELL 2/HEADSET LED (BLUE)
Steady	Bluetooth device 1 is connected	A second Bluetooth device / Bluetooth headset is connected
Fast flash	Incoming call on device 1	Incoming call on device 2
Slow flash	Device 1 is on hold	Device 2 is on hold
LEDs flash alternatingly	Phone is in discovery mode	Phone is in discovery mode

### Status LED on the wireless microphone

Orange (blinking 3x)	When phone is starting to power up
Orange	Charging on the cradle, phone in idle mode
Orange (flashing)	Battery is low
Red/green alternating	Wireless microphone is registering to the phone
Green (flashing)	Incoming call
Green (steady)	In a call (active or on hold)
Red	All microphones in the system (phone, wireless microphones, C 52 speakerphones) are muted during a call
Red (show flash)	Microphone is off the cradle while being paged, out of range, or unregistered
Off	Microphone is on the cradle, battery is fully charged, phone in idle mode

# Getting Started

## Idle screen

---

The idle screen appears after the phone is connected and configured for your SIP PBX service. The idle screen indicates that you have no active or held calls.

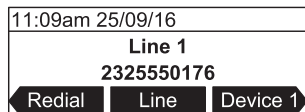

From the idle screen, press:



- **Redial** to view the list of dialed calls. See "Redialing" on page 22.
- **Line** to select another extension (account). When you make a call, the phone will use the selected extension/account. **Note:** **Line** appears only if more than one account is registered to your phone.
- **Device 1** to start a call using the connected Bluetooth cell phone. The soft key will appear only when a Bluetooth cell phone is connected. Instead of "Device 1", it will show the name of the device as it appears on the "Device" list. See "Using the Bluetooth menu" on page 32.
- **Device 2** to start a call using a second connected Bluetooth device which can be a cell phone. The soft key will appear only when a second Bluetooth device is connected. Instead of "Device 2", it will show the name of the device as it appears on the "Device" list. See "Using the Bluetooth menu" on page 32.
- **Connect** to view the "Device" list and to connect the C520-WiMi to a Bluetooth device.
- **Call Log** to view the phone's call history. See "Call history" on page 38.
- **Directory** to view the directories that are available to you. See "Using the local directory" on page 35.

Note that the default idle screen soft keys are shown above. Your phone's soft keys are programmable and may differ from what is listed here.

## Idle mode screen icons

---

In idle mode, the following screen icons indicate your phone's current settings.

Icon	Status
	Call Forward Always is active.
	The ringer is off.
	DND (do not disturb) is active.





# Getting Started

## Active call screen icons

---

During a call, the following screen icons indicate the call's status.

Icon	Status
	Speakerphone—the speakerphone is active.
	Headset—audio is being routed to a Bluetooth or DECT headset.
<b>1/2</b>	Call counter—more than one call is active.
	More than one call is active. Press ▲ or ▼ to view another call.





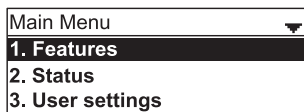

# Conference phone operation

## Using the phone menu

---

1. Press  to show the main menu.



2. Press  or  to highlight menu items.
3. Press  or the corresponding dial pad key to select a highlighted menu item.  
For example, when **Features** is highlighted, you can press  or  to view the Features submenu.
4. Press  or an appropriate soft key to save changes.
5. Press  to cancel an operation, exit the menu display or return to the idle screen.



## Main menu items

---

1. Features (see page 27)
2. Status (see page 63)
3. User settings (see page 42)
4. Admin settings (available only to your system administrator).

# Conference phone operation

## Making calls

You can make a call at any time by pressing  and then entering the number on the keypad. When the phone is in idle mode or has calls on hold, you can make a call by entering the phone number on the keypad and then pressing  or **Dial** to call the number.

### Making a call:

1. Press . You hear the dial tone.
2. Enter the phone number on the keypad.

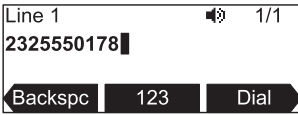

- Press **Backspc** to delete an incorrect digit.
  - Press **123** to change from entering digits to entering letters **abc** (if you need to enter a domain name as part of the number). In letter mode, press **\_\*** or **#** to enter symbols. For example, press **\_\*** twice for the @ symbol.
    - \_\***: Press once to enter the dot (.), twice to enter @, three times to enter an asterisk (\*).
    - #**: Press one to 11 times to enter parentheses (), square brackets [], curly braces {}, angle brackets <>, the slash /, the backslash \, and the pound/hash sign #.
  - Press **◀** or **▶** and **Redial** to view a list of previously dialed numbers.
3. Press **Dial**, or, if the number is valid, the phone dials the number after a short delay.

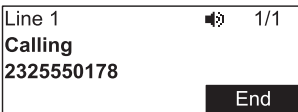

Note that the default live dial soft keys are shown above. Your phone's soft keys are programmable and may differ from what is shown here.

### Making a call in idle mode or with call(s) on hold:

1. Enter the phone number on the keypad.



## Conference phone operation

- Press **Backspc** to delete an incorrect digit.
- Press **123** to change from entering digits to entering letters **abc** (if you need to enter a domain name as part of the number). In letter mode, press **...** or **#** to enter symbols. For example, press **...** twice for the @ symbol.
  - ...**: Press once to enter the dot (.), twice to enter @, three times to enter an asterisk (\*).
  - #**: Press one to 11 times to enter parentheses (), square brackets [], curly braces {}, angle brackets <>, the slash /, the backslash \, and the pound/hash sign #.
- Press **◀** or **▶** and **Redial** to view the list of previously dialed numbers.

2. Dial the number by pressing  or **Dial**.

When the call is answered, the active call screen appears.

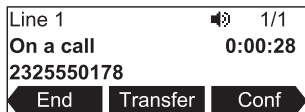

Note that the default active call screen soft keys are shown above. Your phone's soft keys are programmable and may differ from what is shown here.

## Using a wireless microphone during a call

1. Take the wireless microphone from the phone's charging cradle and place it on the table near the intended speaker(s).
2. Speak towards the microphone.
  - For best performance, the person speaking should be at a distance of **less than 3 feet** from the microphone.
  - Always return the wireless microphones to the charging cradles after use.

## Ending the call

To end the call, press  or **End**.

## Answering a call

On the phone, press , or press **Answer**.



- If you have multiple incoming calls, as indicated by  in the upper right corner of the display, press q or p to select the call you want to answer.

# Conference phone operation

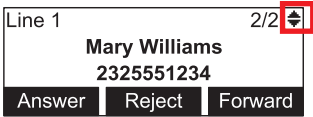

On the incoming call screen, you can also press:

- **Reject** to terminate the incoming call.
- **Forward** to forward the call to another number.

## Missed call

---

If you don't respond to an incoming call, the phone displays a missed-call alert screen.

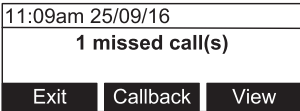

If a missed call alert screen appears, you can press:

- **Exit** to return to the Idle screen.
- **Callback** to immediately dial the caller's number.
- **View** to see the caller's information in the call history.

## Putting a call on hold

---

Use this feature to hold one call while you access another. The phone also puts calls on hold automatically when you answer another call by pressing the **Answer** key, transfer a call, or create a conference.

During a call, press **⏸**. The **On hold** screen appears. The status LED flashes green slowly.

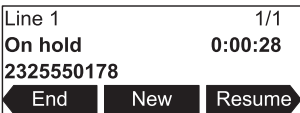

From the **On hold** screen, you can press:

- **End** to end the call.
- **New** to dial a new call.
- **Resume** to take the call off hold.
- **Transfer** to transfer the held call to another party.
- **Conf** to start a conference with the held call.

Note that the default On hold screen soft keys are shown above. Your phone's soft keys are programmable and may differ from what is shown here.

# Conference phone operation

If another party puts you on hold, you may see the message **Held by far end**. This message depends on compatibility between phones and PBX types, and may not always appear. Press **End** to end the call.



## Transferring calls

---

You can transfer connected calls as well as calls ringing on your phone.

- When you have a call on the line, there are two ways to transfer it to a third party:
  - Announcing the call to the third party first, to make sure the call is welcome and will be accepted: Attended transfer;
  - Transferring the call unannounced: Blind transfer. There will be no feedback on whether the third party is available and/or picking up the call.
- When a call is ringing on your phone, you can transfer it to a third party without answering it first (blind transfer only), either by entering the number yourself, or by selecting a number from the directory or call history (the call history stores the numbers for missed calls, received calls and dialed calls).

## Transferring ringing calls

### • Using manual dialing

1. With an incoming call ringing, press **Forward**. The phone stops ringing and the **Forward to** screen appears.



If you press **Cancel**, the phone begins ringing again and the incoming call screen reappears.

2. Enter the number to which you want to forward the call.



3. Press **Forward**. Your phone returns to idle mode if you have no other active calls.

# Conference phone operation

- **Using the directory or call history**

1. With an incoming call ringing, press **Forward**. The phone stops ringing and the **Forward to** screen appears.



2. Press **\***.
3. Press **1** or **✓** to select the *Features* menu
4. In the *Features* menu, press:
  - **3** (or scroll to 3 Directory and press **✓**) to access the Directory;
  - **4** (or scroll to 4 Call History and press **✓**) to access the call history.

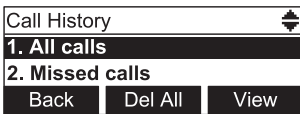

5. Select the Call History folder or Directory you want to access.

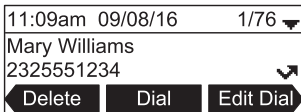

6. Select the number with **▲** or **▼**.
7. If necessary, press **◀** or **▶** until **Dial** appears and then press **Dial**. The **Call Forwarded** screen appears. Your phone returns to idle mode if you have no other active calls.



## Transferring active calls



- **Attended transfer**





1. During a call, press **Transfer**. The call is automatically put on hold and the transfer setup screen appears.

# Conference phone operation



2. Enter the number to which you want to transfer the call and either press **Dial** or wait for the phone to dial automatically.

You can also use a number from a list, such as the Directory or Call History. Press , then  or  to select the *Features* menu. In the *Features* menu, press:

-  (or scroll to 3 Directory and press ) to access the Directory;
-  (or scroll to 4 Call History and press ) to access the call history.

Select the number you want to access from one of the folders and either press **Dial** or wait for the phone to dial automatically.

3. When the second caller answers, you can talk to the caller to notify them of the transfer, then press **Transf** to transfer the call.

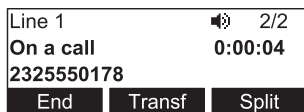

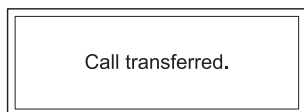

The **Call transferred** screen appears, and your phone returns to idle mode.





- **Cancel** on the transfer setup screen. The active call screen reappears.
- **End** when the second call is active. You will hang up on the second call.
- **Split** when the second call is active. You will stay connected to the second call. Your first call remains on hold.

## Blind transfer

1. During a call, press **Transfer**. The call is automatically put on hold and the transfer setup screen appears.
2. Press **Blind**.
3. Dial the number to which you want to transfer the call. You can also use a number from a list, such as the Directory or Call History. Press , then  or  to select the *Features* menu. In the *Features* menu, press:



# Conference phone operation

- DEF 3 (or scroll to 3 Directory and press ) to access the Directory;
- GHI 4 (or scroll to 4 Call History and press ) to access the call history.

Select the number you want to use from one of the folders.

4. Press **Transf**, or wait for the phone to automatically dial as soon as it has recognized a valid number.

The **Call transferred** screen appears, and your phone returns to idle mode.

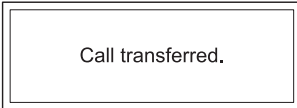

## Making a conference call

---

You can hold a conference call between yourself and two other callers.

1. During a call, press **Conf**. The call is automatically put on hold and the conference setup screen appears.

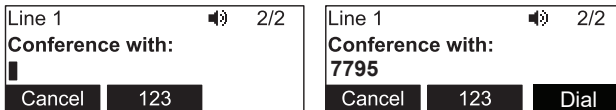

2. Enter the number for the party you want to join your conference and press **Dial** or wait until phone dials automatically. You can also use a number from a list, such as the Directory or Call History.
3. When the second call is established, press **Conf**. The conference begins and the conference screen appears.

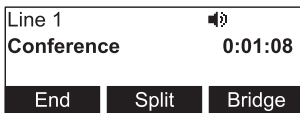

## Canceling the conference

- before dialing the second call: Press **Cancel** on the conference setup screen. Press **Resume** to resume the held call.
- with the second call on the line: Press **End**. Press **Resume** to resume the held call.

## Creating a conference with a held call:

---

When you have an active call and a held call, you can also create a conference with the held call.

## Conference phone operation

1. During a call, press ◀ or ▶ to view the next set of soft keys.
2. Press **ConfCall**. The call is automatically put on hold, and a **Conf. with target** screen showing all calls on hold appears.

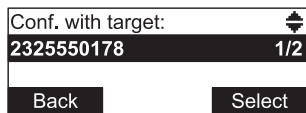

3. Highlight the desired call and press **Select**. You can now talk to the caller you selected.
4. Press **Conf**. The conference begins and the conference screen appears.

### Ending a conference call

Press one of the following soft keys:

- **End** to hang up on both calls.
- **Split** to put both calls on hold. The screen shows information for the second call. You will remain on the second call and your first call is put on hold.
- **Bridge** to combine the first and second calls and return your phone to idle mode.

### Setting up a network conference

---

A network conference is hosted by your service provider and allows multiple parties to join a conference. A Network Conference works in a similar way to the regular conference described above, except that the **Split** and **Bridge** functions will not be available.

In addition, the soft keys **Add** and/or **AddCall** will appear during a conference, allowing you to add more parties to the ongoing conference call.

### Retrieving messages

---

The phone displays the **New Message** alert screen when you have a new message.

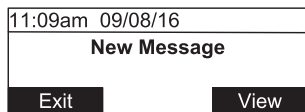

On the **New Message** alert screen, you can press:

- **Exit** to return to the Idle screen.
- **View** to access your messages. The Message menu appears.



# Conference phone operation

The Message menu displays the mailboxes you can access from your phone. If your phone has more than one line, you may be able to access multiple mailboxes. Press ▲ or ▼ to highlight the desired mailbox and press  to access messages in that mailbox.

When there is no **New Message** alert screen, you can access the Message menu using the phone menu.

## Viewing the Message menu

1. When the phone is idle, press .
2. With **Features** highlighted, press .
3. On the Features menu, press ▼ to highlight **Message**, and then press .

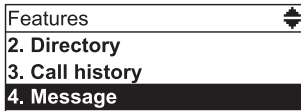

The Message menu appears.



4. On the Message menu, highlight the desired line and then press .

## Redialing



---

1. From the idle screen, press **Redial**. The last dialed call is shown on the display with time and date and the name of the party called, if available, or <Unknown>, if it is not.
2. Press ▼ or ▲ on the navigation key to view older dialed calls.
3. When the desired call is onscreen, press **Dial** to dial the number.

## Muting active calls

---



The mute function allows you to hear the other party but the other party cannot hear you.



- During a call, press  on the phone or a wireless microphone. The status LEDs turn red. All microphones in the system are muted until the mute function is turned off.
- Press  on the phone or a wireless microphone to end muting of all microphones in the system. The status LEDs turn green.

# Conference phone operation

## Temporarily silencing the ringer

---





When the conference phone is ringing, you can temporarily silence its ringer without disconnecting the call. The next call will ring normally at the preset volume. Press  on the base unit. The  symbol appears in the upper right corner of the display.

**Note:** You can also press  or  on the phone to adjust the ringer volume. The adjustment will be saved and applied to the next incoming call.

## Locating wireless microphones

---

This feature helps you find any misplaced wireless mics within the range of the base unit.

1. Press , press  to open the **Status** menu directly, or highlight **STATUS** and select by pressing .
2. With the **Status** menu on the display, press  to open the **Wireless microphone** menu directly, or scroll down and highlight **Wireless microphone**, then press .



3. With the **Wireless microphone** menu on the display, press .

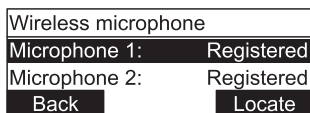



The display of the phone shows the message

*Wireless microphones will ring.  
Press CANCEL/Back to stop.*

All wireless microphones that are not on the charging cradles play the location tone for 30 seconds.

## Muting the location tone

- On the phone, press  or .
- On the wireless microphone(s), press .
- Putting the microphone(s) back onto the charging cradle will also mute the location tone.

# Conference phone operation

## Making and receiving calls on cell phone

You can connect up to two cell phones via Bluetooth and use them to make calls; the cell phone audio will be routed through the C520-WiMi.

**Adding or connecting a cell phone to the C520-WiMi:** See "Using the Bluetooth menu" on page 32.

## Making calls from connected cell phone

1. From the idle screen, press the function key underneath **Device 1** or **Device 2**, depending on which cell phone you want to use. **Note:** Instead of "Device 1" or "Device 2", respectively, the softkey will show the name of the device as it appears on the "Device" list.

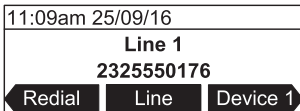

2. Use the keypad to enter the phone number you want to dial.



3. Press **Dial**.

You can also enter the number first and then press **Device 1** or **Device 2** to dial it with the cell phone. You may need to press ◀ or ▶ to put the soft keys onscreen.

## Answering calls to the cell phone

When a cell phone is connected to the C520-WiMi, incoming calls to the cell phone can be answered on the C520-WiMi.

**Note:** You can have concurrent cell phone and SIP account calls (one call will be on hold while the other call is active) on the C520-WiMi, but you cannot have more than one cell phone call.

- On the conference phone, press  or the function key underneath **Answer**.

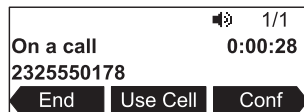
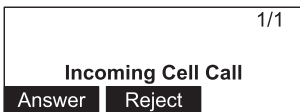

- If you have another incoming call on the cell phone, press **Swap** to answer the new call.

## Conference phone operation



- If you want to switch between calls again, you must use your cell phone's call application.

**Note:** When you have a call on your cell phone and come within range of the C520-WiMi, the C520-WiMi can reconnect with your cell. The audio on your cell may transfer to the C520-WiMi when the connection is reestablished.

### Transferring Bluetooth calls from the C520-WiMi to your cell phone

---

If you no longer want your call's audio to be broadcast through the C520-WiMi, press **Use Cell** to transfer the audio to your cell phone.

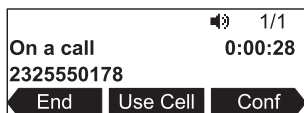

### Conference calls with a Bluetooth-connected cell phone

---

When you have an active cell phone call on the C520-WiMi, you can create a three-way conference between you, the cell phone call, and another SIP account caller.

For more information about creating conference calls, see "Making a conference call" on page 20 .

### Playing audio with a Bluetooth-connected call phone

---

When a cell phone is connected to the C520-WiMi, any audio from the cell phone is routed through the C520-WiMi and connected expansion speakerphone(s). This enables you to play music, podcasts, audio from videos, and Internet-streaming media over the speakerphone.

When you start playing audio over a connected cell phone, the C520-WiMi takes over audio automatically and the screen below appears.



You can control the volume either through the cell phone or the C520-WiMi.

To stop cell phone audio, press **End**. Cell phone audio also stops when an incoming or outgoing call or page is connected. Audio resumes after the call or page disconnects.

**Note:** After pressing **End**, pausing and resuming audio on the cell phone resumes playback on the C520-WiMi.

# Conference phone operation

## Using a Bluetooth headset

---

When a Bluetooth headset is connected, you can transfer audio from the conference phone to the headset.

**Note:** Only calls to a SIP account can be transferred to the Bluetooth headset. Audio for cell phone calls can only be routed between the C520-WiMi and the cell phone. You can use a DECT headset for both SIP account calls and cell phone calls.

To route audio to a BT headset, a SIP call must be established first at the C520-WiMi. You can then route the SIP call using the **Device 2** soft key or using the key on the Bluetooth headset.

### Transferring conference phone audio to a Bluetooth headset:

1. During an active SIP account call, press ◀ or ▶ to view the **Device 2** soft key.

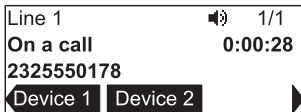

2. Press **Device 2**.

Audio is transferred to the headset and the headset icon appears.

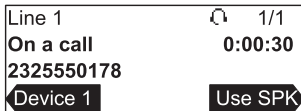

To transfer audio back to the C520-WiMi, press **Use SPK**.



# Phone Features

## Using the Features menu

---

On the **Features** menu, you can manage incoming calls, Bluetooth devices, use the directory, access your messages, view the call history, and manage your speed dial numbers.

### Accessing the Features menu:

1. When the phone is idle, press . The **Main Menu** appears.
2. If necessary, press **▲** or **▼** to highlight **Features**, and then press .

The **Features** menu appears.



The Features menu includes the following items:

Setting	See page...	Description
1. Call	28	Managing how your phone handles incoming calls.
2. Bluetooth	35	Managing Bluetooth-connected devices.
3. Directory	35	Storing contact information and call contacts.
4. Call history	38	Viewing the call lists: All calls, Missed calls, Received calls, Dialed calls.
5. Message	21	Accessing your voicemail.
6. Speed dial	40	Accessing your list of speed dial numbers.
7. Multicast Paging	41	Sending a page to the selected paging zone.



# Phone Features

## Using the Call menu

On the Call menu, you can manage how your phone handles incoming calls.

The settings available on the Call menu include:

Setting	See page	Description
1. Do Not Disturb	29	<p>You can set Do Not Disturb (DND) for each line assigned to your phone. When DND is set, the ringer is silenced and the phone rejects incoming calls and pages; the caller receives the busy signal. After rejecting a call, the phone displays the <b>Missed Calls</b> screen.</p> <p>You can enable the phone to answer incoming calls when DND is on. When DND answering is enabled, the incoming call screen appears. See "Setting Do Not Disturb" on page 29.</p>
2. Call forward	29	<p>Automatically forwards incoming calls depending on the setting. You can enable the following types of call forwarding:</p> <ul style="list-style-type: none"><li>• Call forward always: incoming calls are forwarded immediately and the phone does not ring.</li><li>• Call forward busy: incoming calls are forwarded if all your available lines are busy.</li><li>• Call forward no ans: incoming calls are forwarded after the no answer delay expires.</li></ul>
3. Block anonymous	30	<p>Enables the phone to reject incoming calls that have no caller ID.</p>
4. Dial as anonymous	30	<p>Enables the phone to make outgoing calls with the Caller ID hidden from the far end.</p>
5. Missed call alert	31	<p>Enables the missed call alert screen.</p>
6. Call waiting	31	<p>Enables or disables incoming call alerts while you are on another call.</p>

## Using the Call menu:

1. When the phone is idle, press .
2. If necessary, press ▲ or ▼ to highlight **Features**, and then press .
3. If necessary, press ▲ or ▼ to highlight **Call**, and then press .

# Phone Features

The *Call* menu appears.

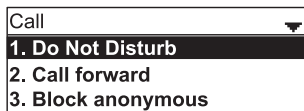

## Setting Do Not Disturb

---

1. From the *Call* menu, if necessary, press ▲ or ▼ to highlight **Do Not Disturb**.
2. Press .
3. On the Do Not Disturb menu, highlight the line for which you want to turn Do Not Disturb On or Off.

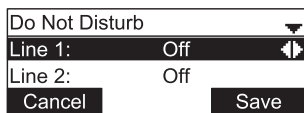

4. When the desired line is highlighted, press ◀ or ▶ to turn Do Not Disturb On or Off.
5. Press **Save**. When Do Not Disturb is on,  appears on the idle screen.

## Setting Call forward

---

1. From the Call menu, press ▼ to highlight **Call forward**.
2. Press .

The Call forward menu appears.

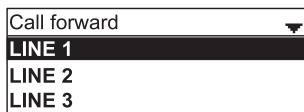

3. Highlight the line for which you want to configure call forward settings, and then press .
4. On the next screen, press ▼ to highlight the desired option:
  - Call forward always
  - Call forward busy
  - Call forward no ans.



5. Press .
6. On the next screen, press ◀ or ▶ to turn call forwarding On or Off.

# Phone Features

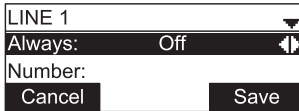

LINE 1
Always: Off
Number:
Cancel Save

7. Press ▼.
8. Enter the number to which you would like to forward calls.
9. (If you selected **Call forward no ans** earlier) Press ▼.
10. (If you selected **Call forward no ans** earlier) Press ◀ or ▶ to set the No answer delay between 1 to 10 rings.
11. Press **Save**.

When Call forward always is on,  appears on the idle screen.

## Blocking anonymous callers:

1. From the Call menu, press ▼ to highlight **Block anonymous**.
2. Press .

The *Block anonymous* menu appears.

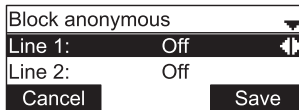

Block anonymous
Line 1: Off
Line 2: Off
Cancel Save

3. Highlight the desired line, and then press ◀ or ▶ to turn anonymous call blocking On or Off for that line.
4. Press **Save**.

## Dialing as an anonymous caller (hiding your caller ID):

1. From the Call menu, press ▼ to highlight **Dial as anonymous**.
2. Press . The *Dial as anonymous* menu appears.

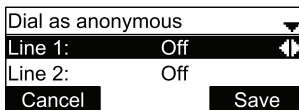

Dial as anonymous
Line 1: Off
Line 2: Off
Cancel Save

3. Highlight the desired line, and then press ◀ or ▶ to turn anonymous call dialing On or Off for that line.
4. Press **Save**.

# Phone Features

## Using the Call menu (continued)

---

### Enabling missed call alerts:

1. From the Call menu, press ▼ to highlight **Missed call alert**.

2. Press .

The Missed call alert menu appears.

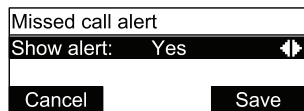

3. Press ◀ or ▶ to turn missed call alerts on (Yes) or off (No).

4. Press **Save**.

### Enabling call waiting alerts:

1. From the Call menu, press ▼ to highlight **Call waiting**.

2. Press .

The Call waiting menu appears.

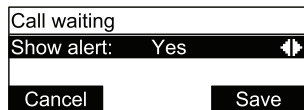

3. Press ◀ or ▶ to turn call waiting alerts on (Yes) or off (No).

4. Press **Save**.

When **Show alert** is on and you are on a call, incoming calls are displayed on the screen. When **Show alert** is off:

- Incoming calls are rejected and no notification appears on the screen.
- Rejected incoming calls are logged as missed calls.

See also **Call Waiting Settings** on page 56.

# Phone Features

## Using the Bluetooth menu

On the Bluetooth menu, you can manage Bluetooth devices used with the C520-WiMi. The settings available on the Bluetooth menu include:

Setting	See page...	Description
1. Device list	32	View your registered devices, connect to a paired device, or delete or rename a paired device. You can connect and use the devices that occupy the first two positions on the Device list. Device 1 will always be a cellular phone. Device 2 can be a cellular phone or a Bluetooth headset.
2. Add device	33	Add a cellular phone or Bluetooth headset to the device list. Once devices are added, the C520-WiMi can connect to a device.
3. Change PIN	34	Change the PIN that needs to be entered on a cell phone while it is being added to the C520-WiMi device list.

### Using the Bluetooth menu:

1. When the phone is idle, press .
2. If necessary, press **▲** or **▼** to highlight **Features**, and then press .
3. Press **▼** to highlight **Bluetooth**, and then press .

The Bluetooth menu appears.



### Connecting a registered device from the Device list:

1. From the Bluetooth menu, with **Device list** highlighted, press .

The Device list appears, showing the registered devices.

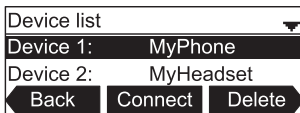

2. On your Bluetooth device, enable Bluetooth. Place your device close to the C520-WiMi.
3. On the Device list, highlight the device you want to connect and then press **Connect**.

The message **Connecting [device] to the base** followed by **Device Connected** appears.

# Phone Features

The blue **CELL 1** or **CELL 2/HEADSET** LED turns on (depending on the type of device you have connected), and the **Connect** soft key changes to **Discon'ct**.

**Note:** The C520-WiMi can use only the first two Bluetooth devices on the Device list for calls (as shown by the Device 1 and Device 2 soft keys on the Idle screen. See page 11 for information about the Idle screen). For example, if you highlight Device 3 on the Device list and then press **Connect**, the C520-WiMi will move that device up the Device list to make it available for calls. The device that occupied the Device 1 or Device 2 positions will move down the Device list.

## Deleting a device from the Device list

1. On the Device list, highlight the device you want to delete.
2. Press **Delete**.

The message **Remove [device] from device list?** appears.

**Note:** The device must be disconnected before the **Delete** soft key appears.

3. Press **Yes**.

The message **Device removed** appears. If you want to use this device with the C520-WiMi in the future, use the **Add device** menu to add it.

## Renaming a device on the Device list

1. On the Device list, highlight the device you want to rename. This name will appear on the Device list and on the soft key on the Idle screen used to activate the device. Names between 1 and 8 characters will best fit the space available on the soft key.
2. Press ◀ or ▶ to display the **Rename** soft key, and then press **Rename**.

The renaming screen appears.

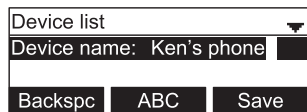



3. Use the dial pad keys to edit the device name.
  - Press **ABC** to switch between entering upper-case letters, lower-case letters, and numbers.
  - Press **Backspc** to delete characters.
4. Press **Save**.

**Adding a new cell phone: From the Bluetooth menu, highlight Add device list and then press** .

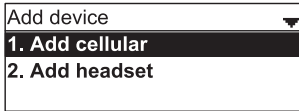

The **Add device** menu appears.

# Phone Features



5. With **Add cellular** highlighted, press .
6. Follow the instructions on the C520-WiMi screen.
7. Open the Settings menu on your cellular phone and activate Bluetooth. Ensure the phone searches for new Bluetooth devices.  
**Note:** Methods for activating Bluetooth may vary depending on your phone's operating system.
8. When the **CELL 1** and **CELL 2** LEDs flash on the C520-WiMi, select **C520-WiMi** on your phone's list of available Bluetooth devices.
9. If prompted by your phone, enter the C520-WiMi PIN. The default PIN is 0000.  
After the device connects, the applicable C520-WiMi **CELL** LED turns on.

## Adding a new headset

1. From the Bluetooth menu, highlight **Add device list** and then press .  
The **Add device** menu appears.
2. Highlight **Add headset**, and then press .
3. Follow the instructions on the C520-WiMi screen.  
The CELL 1 and CELL 2 LEDs flash on the C520-WiMi. After the headset connects, the **CELL 2/HEADSET** LED turns on.

**Note:** Once you have added a device, the device stays paired with the C520-WiMi. Even when your Bluetooth device is taken away or turned off, the C520-WiMi will reconnect to the device when it is again within range and turned on with Bluetooth enabled.

## Changing the C520-WiMi PIN

---

1. From the Bluetooth menu, highlight **Change PIN** and then press .  
The **Change PIN** menu appears.

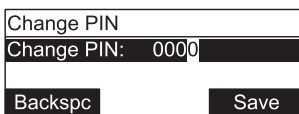

2. Use the **Backspc** soft key and the dial pad to edit the four-digit PIN.
3. Press **Save**. You will enter this PIN on your Bluetooth device when pairing it with the C520-WiMi.





# Phone Features

## Using the local directory

You can store the names and phone numbers for up to 200 contacts in the directory. Once directory entries are saved, you can dial them directly from the directory. You can also search directory entries by first or last name.

When adding an entry, you can enter numbers for work, mobile, and other. You can also select a ringtone for that contact. Later, you can edit entries if their contact information changes.

## Viewing the local directory

1. When the phone is idle, press .
2. With **Features** highlighted, press .
3. Press  to highlight **Directory**, and then press . The Directory menu appears, listing all your available directories and the blacklist. Any directories other than Local are server-based and will vary with your installation. You can edit the Local directory and the blacklist.

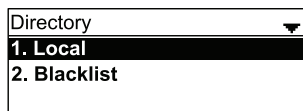

4. With **Local** highlighted, press . The Local directory appears, showing the first entry (sorted alphabetically by first name).



5. Press  or  to view other entries.

The following soft keys are available when viewing a directory entry:

<b>Back</b>	Returns to Directory list screen	<b>LastNme</b>	Sorts the list by last name from the top of the list	<b>Type</b>	Displays the contact's other numbers: Work, Mobile, Other
<b>Dial</b>	Dials the entry	<b>Edit</b>	Allows you to change the entry	<b>Search</b>	Allows you to search the list alphabetically by first or last name
<b>Add</b>	Allows you to add a new entry	<b>Delete</b>	Deletes the entry	<b>Del. all</b>	Deletes all entries



# Phone Features

## Calling a contact:

1. Press ▲ or ▼ or **Search** (see "Searching directory entries" on page 37) to select the directory entry.
2. To view other numbers for the entry, press **Type**.
3. When the desired number appears, press  or **Dial**.

**Note:** If you view a directory entry when the phone is in dial mode, press **Dial** to dial the number. You can use this feature when making a call, forwarding a call, transferring a call, and setting up a conference call.

## Adding a directory entry:

1. When viewing a directory entry, press ◀ or ▶ until the **Add** soft key appears.
2. Press **Add**.  
A blank directory entry appears.
3. Use the dial pad keys to enter the first name, last name, and contact numbers.
  - Press **ABC** to switch between entering upper-case letters, lower-case letters, and numbers.
  - Press **Backspc** to delete incorrect characters.
  - After completing a line, press ▼ to move to the next line.
4. When you have entered the desired information and selected the ringtone you want to use for this contact, press **Save**.

## Editing a directory entry:

1. When viewing the desired directory entry, press ◀ or ▶ until the **Edit** soft key appears.
2. Press **Edit**.  
The directory entry edit screen appears.

First name:	Mary Williams	
Last name:		
Work:	2325551234	
<b>Backspc</b>	<b>ABC</b>	<b>Save</b>

3. Use the dial pad keys to change the first name, last name, and contact numbers as desired.
  - You can edit the name and numbers, and change the ringtone.
  - Press **ABC** to switch between entering upper-case letters, lower-case letters, and numbers.
  - Press **Backspc** to delete incorrect characters.
  - After completing a line, press ▼ to move to the next line.
4. Press **Save**.

# Phone Features

## Searching directory entries

1. From the Local or Blacklist directory, press ◀ or ▶ until the **Search** soft key appears.
2. Press **Search** .  
The search screen appears.

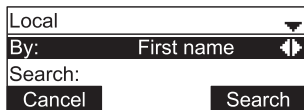

Local

By: First name

Search:

Cancel Search

3. To filter your search by first name or last name, press ◀ or ▶ .
4. Press ▼ to move to the **Search** field.

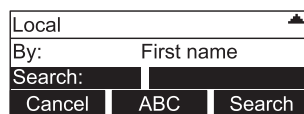

Local

By: First name

Search:

Cancel ABC Search

5. Press a dial pad key to enter a letter for your first name or last name search. Press **2** once for A, or three times for C, for example.
6. Press **Search** . The phone searches for the first name or last name beginning with the letter you entered.

The first entry found appears. If more than one entry was found, press ▲ or ▼ to view other entries.

## Deleting a directory entry:

1. Press ▲ or ▼ or **Search** (see "Searching directory entries", above) to select the directory entry.
2. Press ◀ or ▶ until the **Delete** soft key appears.

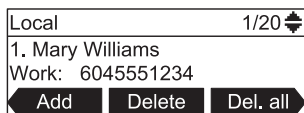

Local 1/20

1. Mary Williams

Work: 6045551234

Add Delete Del. all

3. Press **Delete** .
4. When the confirmation screen appears, press **Yes** .

## Deleting all directory entries:

1. From a directory entry, press ◀ or ▶ until the **Del. all** soft key appears.
2. Press **Del. all** .
3. When the confirmation screen appears, press **Yes** .

# Phone Features









## Call history

---



The call history provides available name and number information for the last 200 incoming and outgoing calls. The newest entries replace the oldest. You can view call history information for:

- All calls—all categories of calls
- Missed calls—incoming calls that were not answered
- Received calls—incoming calls that you answered, forwarded or rejected
- Dialed calls—all outgoing calls. You can use this as a redial list.

### Viewing the call history:

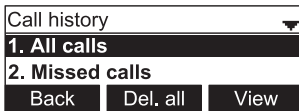
1. When the phone is idle, press .
2. If necessary, press  or  to highlight **Features**, then press .
3. Press  (or scroll with  or  to highlight **Call history** and press ). The *Call history* screen appears.



4. Press the corresponding number key for all, missed, received, or dialed calls (or scroll with  to highlight the desired call history folder and press  to see call history entries in the respective list. The first entry appears.

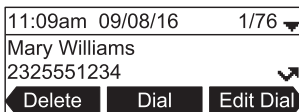

If the list is empty, the message **history is empty**, preceded by the respective call list, appears. For example, if the received calls list is empty, the message **Received calls history is empty** will be displayed.

5. Press  to view more entries.

The call history entry screen shows the time, date, name and number of the call, the number of entries in the folder, along with an icon indicating the type of call.



# Phone Features

The following soft keys are available when viewing a call history entry:

- **Delete** - deleting the entry
- **Dial** - dialing the entry
- **Edit dial** - displaying the predial screen so you can edit the number before dialing
- **Save** - saving the call information to the local directory

## Calling a call history entry

While viewing the entry, press  or **Dial**. The phone dials the number immediately. Alternatively, press **Edit Dial**. The predial screen appears, allowing you to edit the number before pressing **Dial**.

**Note:** If you view a call history entry when the phone is in dial mode, press the **Dial** soft key to dial the number. You can use this feature when making a call, forwarding a call, transferring a call, and setting up a conference call.

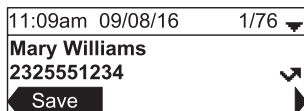

## Adding a call history entry to the directory

1. While viewing the desired entry, press ◀ or ▶ until the **Save** soft key appears.

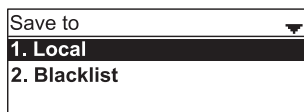

2. Press **Save**.
3. On the **Save to** menu, select the location to which you want to save the entry.



- To save the entry to your directory, highlight **Local** and then press .
- To save the entry to your blacklist, highlight **Blacklist** and then press .

The directory add/edit screen appears. The phone automatically fills in the name and number, if available.



- If necessary, edit the name and number. Press ▼ to move the cursor to the next line.
  - Press **Backspc** to delete incorrect characters.
4. Press **Save** to save the entry.

# Phone Features

## Deleting a single call history entry:

While viewing the desired entry, press **Delete** .

## Deleting multiple call history entries

1. While viewing the list of call history folders, press ▼ to highlight the folder for which you would like to delete all entries: All calls, Missed calls, Received calls, or Dialed calls.

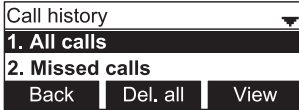

2. Press **Del. all** .
3. When the confirmation screen appears, press **Yes** .

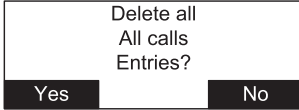

## Speed Dial

---



The speed dial menu allows you to enter up to 10 numbers that you dial frequently. To dial a speed dial number, press and hold the dial pad key that matches the speed dial entry number (for entry 10, press and hold **0**).

You can also enter speed dial numbers using the WebUI. See **Speed Dial** on page 57.

## Entering speed dial numbers

---

### To add a speed dial entry:

1. When the phone is idle, press .
2. With **Features** highlighted, press .
3. Press ▼ to highlight **Speed dial**, and then press .

The Speed dial menu appears.

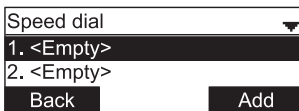

4. Press ▼ to highlight a speed dial entry marked **<Empty>**.
5. Press **Add** .

A blank speed dial entry appears.

# Phone Features

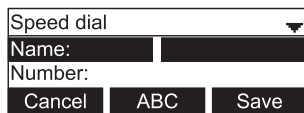

- Use the dial pad keys to enter the name and number.
  - Press **123** to switch between entering numbers, lower-case letters, and upper-case letters.
  - When you start entering characters, the **Cancel** soft key changes to **Backspc**. Press **Backspc** to delete incorrect characters.
  - After completing a line, press **▼** to move to the next line.
- Press **▼** and then press **◀** or **▶** to select the line you want to use for this speed dial entry.
- When you have entered the desired information, press **Save**.

## Sending a Multicast Page

---

Your phone supports multicast paging. You can send a page to a paging zone that has been set up by your system administrator. An incoming page may interrupt any active calls you are on, depending on how your system administrator has configured the paging function.

### To send a multicast page:

- When the phone is idle, press **☎**.
- With **Features** highlighted, press **☑**.
- Press **▼** to highlight **Multicast Paging**, and then press **☑**.
- On the Multicast Paging menu, press **▼** to highlight the desired paging zone.

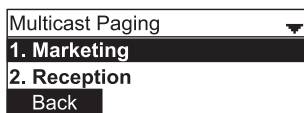

- Press **☑**.

You will hear a paging tone before you can begin broadcasting your message to the assigned paging zone.



- Press **End** to terminate the page.

# Configuring the Phone

## Configuring the phone

---

You can configure the phone using one of two methods:



1. The **User settings** menu on the phone
2. The Web UI which you access using your Internet browser.

This section describes the user settings menu. For information about the WebUI, see page 51.

## Using the User settings menu

---

### Viewing the User settings menu:

1. Press  when the phone is idle.
2. Press  to open the *User settings* menu. Alternatively, scroll with ▼ to highlight **User settings** and press .



3. Press the number key 1 - 6 on the keypad to open each respective submenu. Alternatively, scroll with ▼ to highlight the setting and press . The user settings are:

Setting	See page...	Options
1. Preferences	43	Language Date & Time (Clock time, Clock date, Time zone, DST, NTP server, Set manually) Restart phone
2. Display	45	Contrast (Level 1–7) Backlight ON (Off, Low, Medium, High) Backlight idle (Off, Low, Medium, High) Timeout (10–60 seconds)
3. Audio	46	Ringer tone (Line 1, Line 2...) Key tone (On, Off)
4. Wireless microphone	48	Register Deregister
5. DECT headset		Register Deregister
6. Wireless speaker	49	Register Deregister

# Configuring the Phone



## Preferences

---

Use the Preferences menu to set the language and the date and time formats, and to restart the phone.

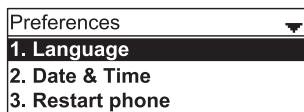
1. From the *User settings* menu, open the Preferences submenu by pressing 1 or . The *Preferences* menu appears.







2. Press the number key 1 - 3 on the keypad to open each respective submenu. Alternatively, scroll with , if necessary, to highlight the setting and press .

## Setting the language

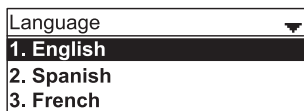
---

1. From the *Preferences* menu, open the *Language* submenu by pressing 1 or . The *Language* menu appears.





2. Scroll with  or  to highlight another language.
3. Press .

## Setting date and time preferences

---

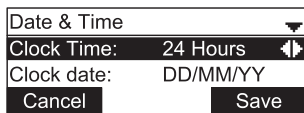

From the *Preferences* menu, open the *Date & Time* submenu by pressing ABC 2.

Alternatively, scroll with  or  to highlight the setting and press . The *Date & Time* menu appears.



**Note:** If the Network Time Protocol (NTP) server is enabled, you cannot manually set the date and time using this menu.

## Setting the time format:

1. From the Date & Time menu, ensure that **Clock Time** is highlighted.
2. Press  or  to select a 12-hour clock (12am/pm) or 24-hour clock.
3. Press Save.



# Configuring the Phone

## Setting the date format that appears on the idle screen:

1. From the *Date & Time* menu, press ▼ to highlight **Clock date**.
2. Press ◀ or ▶ to select the desired date format (DD/MM/YY, MM/DD/YY, YY/MM/DD)
3. Press **Save** .

## Setting the Time Zone:

1. From the *Date & Time* menu, press ▼ to highlight **Time Zone**.
2. Press **Edit** .
3. Scroll with ▼ or ▲ to select a time zone.
4. Press **Save** .

## Setting DST:

1. From the *Date & Time* menu, press ▼ to highlight **DST**.
2. Press ◀ or ▶ to select Enabled or Disabled.
3. Press **Save** .

## Enabling and disabling the NTP (Network Time Protocol) server:

1. From the *Date & Time* menu, press ▼ to highlight **NTP server**.
2. Press ◀ / ▶ to select Enabled or Disabled.
3. Press **Save** .

**Note:** If the NTP server is disabled, you must manually set the time and date. This setting is valid only if the system administrator has already configured the Network Time settings.

## Manually setting the Year, Month, Day, Hour and Minute:

1. From the *Date & Time* menu, press ▼ to highlight **Set manually**.
2. Press .

**Note:** If the NTP server is enabled, the manual settings cannot be accessed; a message appears on the display informing you that date and time cannot be edited.

3. For each setting, press ◀ or ▶ to select the desired setting, and then press ▼ to move to the next line.
4. When you have finished, press **Save** .

# Configuring the Phone

## Restarting the phone

---

From the *Preferences* menu, open the *Restart phone* submenu by pressing  3.

Alternatively, scroll with ▼ or ▲ to highlight the setting and press . The *Restart phone* screen appears.



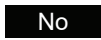

- To restart the phone, press .
- To return to the Preferences menu, press .

## Display

---

Use the Display menu to set screen appearance and backlight behavior.

1. From the *User settings* menu, open the Display submenu by pressing  2.

Alternatively, scroll with ▼ to highlight the submenu and press  or . The *Display* menu appears.

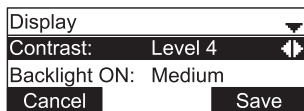

### Setting the contrast level:

1. From the *Display* menu, ensure that **Contrast** is highlighted.
2. Press ◀ or ▶ to set the contrast level from 1 to 7 (4 is the default setting).
3. Press .

### Setting the backlight level for the active phone

1. From the *Display* menu, press ▼ to highlight **Backlight ON**.
2. Press ◀ or ▶ to select Off, Low, Medium, or High (High is the default setting).
3. Press .

### Setting the backlight level for the idle phone

1. From the *Display* menu, press ▼ to highlight **Backlight idle**.
2. Press ◀ or ▶ to select Off, Low, Medium, or High (Off is the default setting).
3. Press .

# Configuring the Phone

## Setting the "backlight off" timeout:

This setting determines after how many seconds the backlight will revert to the idle setting when there has been no activity on the phone for the specified time. The default is 30 seconds.

1. From the *Display* menu, press ▼ to highlight **Timeout**.
2. Press ◀ or ▶ to select between 10 and 60 seconds in 5-second increments.
3. Press **Save** .

## Audio

---

Use the Audio menu to pick one of ten ringer tones for each account and turn key tones on and off.



**Note:** To adjust the ringer volume, press ▲ or ▼ while the phone is idle.

### Using the Audio menu:

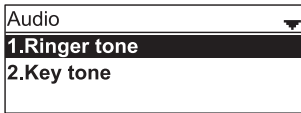
From the *User settings* menu, open the *Audio* submenu by pressing DEF 3. Alternatively, scroll with ▼ to highlight the setting and press .



### Selecting a ringer tone for each line:

1. From the *Audio* menu, open the **Ringer tone** screen by pressing 1 or .
2. Press ▼ to highlight the line for which to select a ringer tone and press .

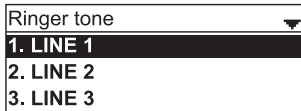

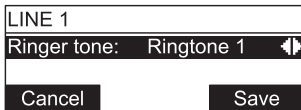

3. On the selected line screen, press ◀ or ▶ to select one of ten ringer tones. The default is 1. Ringer tone samples play when selected.





4. Press **Save** to save the selected ringer. To exit without saving a new ringer tone, press **Cancel** .

# Configuring the Phone

## Setting the key tone:

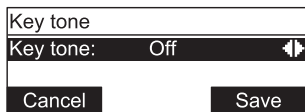
1. From the *Audio* menu, open the **Ringer tone** screen by pressing  **2**. Alternatively, scroll with ▼ to highlight the setting and press . The Key tone menu appears.





2. Press ◀ or ▶ to turn key tones on or off. When off, key presses are silent.
3. Press  .

# Configuring the Phone

## Registering wireless microphones

---

The wireless microphones delivered with the C520-WiMi are preregistered. If you do need to register a wireless microphone (e.g., if you have purchased a C520-WiMi Replacement Microphone), it must be registered to the phone.

- The phone must be idle when registering wireless microphones.
  - The phone supports two microphone registrations; previous registrations must be deregistered before you can register the two microphones you want to use.
  - Do not remove the wireless microphones from the charging cradles during the entire registration process. A microphone that was registered before but is not in the charging cradle during a new registration process will be deregistered.
  - The LED status indicator on each wireless microphone flashes red and green alternately during registration.
1. Place the microphones you want to register into the phone's charging cradles.
  2. Press .
  3. Press **3 User settings**.
  4. Press **4 Wireless microphones**.
  5. Press **2 Deregister** and confirm by pressing "**Yes**" to delete any previous registrations. If successful, the display will say "**Wireless microphones are deregistered**".
  6. Press **1 Register** to register one microphone. The display will say "**Registering....**". If successful, you will hear a confirmation tone and the display will say "**Registration succeeded**". The status indicator of the registered microphone switches to a steady red light while the second, unregistered microphone continues to flash red and green alternately.
  7. Press **1 Register** again to register the second microphone. The display will say "**Registering....**". If successful, you will hear a confirmation tone and the display will say "**Registration succeeded**". The status indicator of the second microphone switches to a steady red light.
    - If registration fails, the display will say "**Registration failed**". Remove the microphones from the charging cradles and put them back in. Repeat the entire registration process, steps 2 to 7.
    - To stop a registration in progress, press . The display says "**Registration cancelled**". One or both microphones may be deregistered. Repeat the registration process, steps 1 to 7, to register them.

# Configuring the Phone

## Registering wireless C52 speakerphones

---

For large meeting rooms, you can extend the range of the C520-WiMi with up to three wireless DECT Snom C52 Speakerphones. You can use the speakerphone to answer and end calls and mute the audio on the entire system (i.e., the conference phone and all connected devices like speakerphones and wireless microphones).

**Note:** If a DECT headset is already registered, you can register up to two C52 Speakerphones.

### Registering the C52 Speakerphone to the C520-WiMi

**Note:** If a speakerphone is already registered to the phone, you must first deregister all speakerphones before you can register another or a new one.

1. Put the battery pack in the C52, connect the power adapter, and plug the adapter into the wall outlet. The LEDs on the C52 flash orange slowly.
2. Press the white registration button underneath the battery compartment for five about seconds until its LEDs are flashing red and green alternatingly.

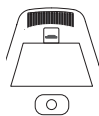

3. On the C520-WiMi Conference Phone, press .
4. In the **Main Menu**, press (or highlight **3 User settings** and press ).
5. In the **User settings** menu, press (or highlight **6 Wireless speaker** and press ).
6. Press to register the C52 speakerphone.









The screen displays **Registering...** and then **Registration succeeded**. The phone plays a confirmation tone. The registered speaker LEDs stop flashing red and green. The LEDs turn green briefly and then turn off while the red Power LED turns on.

7. Repeat steps 1 to 6 for any additional C52 speakerphones.
  - If a speakerphone fails to register, the conference phone will display **Registration failed**.
  - To cancel registration, press .

# Configuring the Phone

## Deregistering C52 Speakerphone(s)



1. On the C520-WiMi Conference Phone, press .
2. In the **Main Menu**, press  (or highlight **3 User settings** and press .
3. In the **User settings** menu, press  (or highlight **6 Wireless speaker** and press .
4. Press  to deregister all speakerphones.

## Speakerphone operation





---

**Answer calls:** Press . The call becomes active on the phone as well as all connected speakerphones and wireless microphones. The LEDs on all devices show a steady green light.

**End calls:** Press . The call is terminated on the phone as well as all connected speakerphones and wireless microphones. The LEDs turn off, and the red power LED comes on.

**Mute audio:** Press . The audio is muted on the phone as well as all connected speakerphones and wireless microphones; you cannot be heard by the other party. The LEDs on all devices show a steady red light. Press  again to unmute the audio on all devices, as indicated by the green LEDs.

**Ringer:** When a call is ringing on the C520-WiMi, it rings on the C52 as well, and the LEDs flash green. Press  to mute the ringer on the speakerphone for this call and this device only.

**Adjusting the volume:** When the speakerphone is idle, press the upper  or lower  edge of the volume key to adjust the ringer volume on the speakerphone only. During a call, press the upper  or lower  edge of the volume key to adjust the volume on the speakerphone only.

Loudspeaker LEDs (4 LEDs surrounding the loudspeaker)		Power-LED
LED color and behavior	Status description	
Green, steady light	Active call	On (red): Standby
Green, flashing	Incoming call	Off: In call (green loud-speaker LEDs are on)
Green, slowly blinking	Being paged by paired phone	
Red and green alternatingly, flashing	In registration mode	
Red, steady light	Active call, microphone muted	
Red, slowly blinking	Out of range or deregistered	
Orange, slowly blinking	Ready for registration/pairing	
Orange, on for 5 seconds	Power on	

# WebUI

## Using the Web User Interface (WebUI)





---

Use an Internet browser to access the Web User Interface (WebUI) of the conference phone. After you log on to the WebUI, you can configure the following features:



- Call Settings (See page 53)
- User Preferences (See page 55)
- Program Dial soft keys (See page 56)
- Speed Dial (See page 57)
- Local Directory (See page 58)
- Blacklist (See page 58)
- Call History (View only. You can click numbers that have hyperlinks to dial them.)
- User Password (See page 61)

The WebUI also has a status page, where you can view status and information.

### Accessing the WebUI

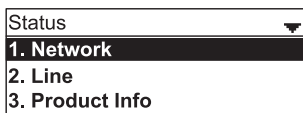
1. Ensure that your computer is connected to the same network as your phone.
2. Find the IP address of your phone:
  - a. When the phone is idle, press .
  - b. Press  (or scroll  to highlight **Status** and press ). The *Status* menu appears.



- c. In the Status menu, press  or . The *Network* screen with the IP address appears.

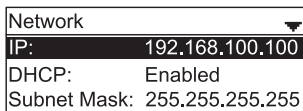

3. On your computer, open an Internet browser. Depending on your browser, some of the pages presented here may look different and have different controls.
4. Type the phone's IP address in the browser address bar and press **ENTER** on your computer keyboard. The login window appears.
5. Enter your **User Name** and **Password** or your **Admin Name** and **Password**. You can change the password after you have logged in. The factory defaults are:



# WebUI

	User mode	Admin mode
<b>Name</b>	user	admin
<b>Password</b>	user	admin

7. Click **Log In**. The Web UI appears.

Click topics from the navigation bar at the top of the page, and then click the desired setting on the left side of the Web UI to see the page for that setting. You view and change settings in two different types of fields: drop-down lists and entry fields into which you type information. For your security, the WebUI times out after 10 minutes, so if it is idle for that time, you must log on again.

The remaining procedures in this section assume that you have already logged on to the WebUI.

## Status

The Status page shows:

- **General** information about your phone, including model, MAC address, and firmware version.
- **Account Status** information about your SIP account registration.
- **Network** information regarding your phone's network address and network connection.

The Status page has no settings that you can change. You may need some of the status information for troubleshooting purposes.

STATUS	SYSTEM	CONTACTS	SERVICING
<b>System Status</b>			
<b>General</b>			
Model:	VCS752		
Serial Number:	VU800002228		
MAC Address:	00:12:2A:4B:3E:E7		
Boot Version:	1.xx		
Firmware Version:	1.x.x		
V-Series:	1.xx.x-x-ENG		
Hardware Version:	HW1.0		
EMC Version:			
<b>Account Status</b>			
Account 1:	Registered		
Account 2:	Registered		
Account 3:	Not Registered		
<b>Network</b>			
LAN Port IP Address:	10.88.52.55		
IP Type:	DHCP		
Subnet Mask:	255.255.0.0		
Link Status:	Connected		
Gateway:	10.88.3.149		
Primary DNS:	10.88.162.31		
Secondary DNS:	10.88.162.10		
Network Time Settings:	us.pool.ntp.org		

# WebUI

## Call Settings

To view the call settings, click **SYSTEM** in the WebUI header, and then click **Call Settings** in the sidebar. You can configure call settings for each account available to your phone. Click **Account 1**, **Account 2**, and so on to select the call settings page for the desired account.

Call Settings include Do Not Disturb and Call Forward settings. You can also set Do Not Disturb and Call Forward using the phone menu. See **Using the Call menu** on page 28.

When you have finished changing settings on this page, click **Save** to save them.

**SYSTEM**  
Call Settings  
Account 1  
Account 2  
Account 3  
User Preferences  
Programmable Keys  
Program Dial 1  
Program Dial 2  
Program Dial 3  
Speed Dial

**SYSTEM CALL SETTINGS 1**

STATUS SYSTEM CONTACTS SERVICING

**General Call Settings**

Anonymous Call Reject  
 Enable Anonymous Call

**Do Not Disturb**

Enable DND  
Incoming Calls: Show

**Call Forward**

Enable Call Forward Always  
Target Number:

Enable Call Forward Busy  
Target Number:

Enable Call Forward No Answer  
Target Number:

Delay: 6 rings

Save

### General Call Settings

Setting	Description
Anonymous Call Reject	Select to block incoming calls that have no caller ID.
Enable Anonymous Call	Select to make outgoing calls that remove your own caller ID information.

### Do Not Disturb Settings

Setting	Description	Range	Default
Enable DND	Turns Do Not Disturb on or off.	n/a	Disabled
Incoming Calls	Selects whether the phone displays incoming call information while Do Not Disturb is on.	Show, Reject	Reject

# WebUI

## Call Settings (continued)

---

### Call Forward Settings

Setting	Description
Enable Call Forward Always	Select to enable call forwarding for all calls on that account.
Target Number	Enter a number to which all calls will be forwarded.
Enable Call Forward Busy	Select to enable call forwarding for calls when you are on another call on that account.
Target Number	Enter a number to which calls will be forwarded when the line is busy.
Enable Call Forward No Answer	Select to enable call forwarding for unanswered calls on that account.
Target Number	Enter a number to which unanswered calls will be forwarded.
Delay	Select the number of rings before unanswered calls are forwarded. Range: 1 to 10 rings Default: 6 rings

# WebUI

## User Preferences

On the User Preferences page, you can configure some basic settings for your phone and set how your phone responds to calls.

After changing any settings on this page, click **Save** to save them.

**SYSTEM**

- Call Settings
- Account 1
- Account 2
- Account 3
- User Preferences**
- Programmable Keys
  - Program Dial 1
  - Program Dial 2
  - Program Dial 3
- Speed Dial

STATUS    SYSTEM    CONTACTS    SERVICING

### General User Settings

WebUI Language:

Phone Language:

Backlight Timer (secs):

Ringer Volume:

### Call Hold Reminder

Enable Call Hold Reminder Tone

Tone Interval (secs):

### Call Waiting

Call Waiting Off: Reject Incoming Call if already on a Call

Call Waiting On: View Incoming Call if already on a Call

Enable Call Waiting Tone

Tone Interval (secs):

## General User Settings

Setting	Description	Range	Default
WebUI Language	Sets the language that appears on the WebUI.	Any language supported by your phone. For example, English, French, Spanish, etc.	English
Phone Language	Sets the language that appears on your phone.	Any language supported by your phone. For example, English, French, Spanish, etc.	English
Backlight Timer	Sets how long the screen backlight stays on after the last button press.	10 to 60 seconds	30 seconds
Ringer Volume	Sets the ringer volume for incoming calls. You can also use the <b>VOLUME ▼</b> or <b>▲</b> keys on the phone.	Off, 1–9	5

# WebUI

## User Preferences (continued)

### Call Hold Reminder Settings

Setting	Description	Range	Default
Enable Call Hold Reminder Tone	Enables or disables the call hold reminder tone.	n/a — Select to enable	Enabled
Tone Interval (secs)	Sets the interval for the call hold reminder tone.	10–300 seconds	30 seconds

### Call Waiting Settings

Setting	Description	Range	Default
Call Waiting Off	Rejects additional incoming calls. No notification appears on the screen.	n/a — Select to enable	Disabled
Call Waiting On	Shows additional incoming calls on the screen.	n/a — Select to enable	Enabled
Enable Call Waiting Tone	Enables or disables Call Waiting Tone.	n/a — Select to enable	Enabled
Tone Interval (secs)	Sets the interval for the call waiting tone.	10–60 seconds	30 seconds

## Program Dial Soft Keys

The Program Dial feature allows you to dial numbers with a single press of a soft key. On the Program Dial pages, you can configure up to three Program Dial keys. Each key requires a label (short enough to fit in the soft key's area), an account and number that the key will dial, a location where the key will fit between the other soft keys, and the call modes during which the key will appear.

**SYSTEM**

- Call Settings
  - Account 1
  - Account 2
  - Account 3
- User Preferences
- Programmable Keys
  - Program Dial 1**
  - Program Dial 2
  - Program Dial 3
- Speed Dial

STATUS    SYSTEM    CONTACTS    SERVICING

### Program Dial 1

Label

Value

Account

<b>Enable</b>	<b>Mode</b>	<b>Insert Label Before</b>
<input type="checkbox"/>	Idle mode	<input type="text" value="dir"/>
<input type="checkbox"/>	Active mode	<input type="text" value="end"/>
<input type="checkbox"/>	Held mode	<input type="text" value="end"/>
<input type="checkbox"/>	Livedial mode	<input type="text" value="backspc"/>

# WebUI

## To enter program dial soft keys:

1. Enter the Program Dial key label. Labels that exceed the width of the soft key will end with ... when they appear on the phone.
2. Enter a value that the Program Dial key will dial.
3. Select an account that the Program Dial key will use.
4. Select the call modes for which you want the Program Dial key to appear.
5. Select the location for the Program Dial key for the selected call modes. You can place the key before another key, or place it last in the order.
6. Click **Save**.
7. Configure any additional Program Dial keys.

## Speed Dial

The speed dial keys are used for dialing numbers with one key press. To view the speed dial keys, click **SYSTEM** in the WebUI header, and then click **Speed Dial** in the sidebar.

On the Speed Dial page, you can enter up to 10 numbers that you dial frequently. To dial a speed dial number, press and hold the dial pad key that matches the speed dial entry number (for entry 10, press 0). For each speed dial number you enter, you must assign the account on which the number will be dialed out.

You can also add speed dial entries using the phone. The Speed dial list is accessed through the Features menu. See page 40.

After entering information on this page, click **Save** to save it.

Key	Name	Value	Account
Key 1	<input type="text"/>	<input type="text"/>	Default
Key 2	<input type="text"/>	<input type="text"/>	Default
Key 3	<input type="text"/>	<input type="text"/>	Default
Key 4	<input type="text"/>	<input type="text"/>	Default
Key 5	<input type="text"/>	<input type="text"/>	Default
Key 6	<input type="text"/>	<input type="text"/>	Default
Key 7	<input type="text"/>	<input type="text"/>	Default
Key 8	<input type="text"/>	<input type="text"/>	Default
Key 9	<input type="text"/>	<input type="text"/>	Default
Key 0	<input type="text"/>	<input type="text"/>	Default

## Entering speed dial numbers

1. In the **Name** column, enter a speed dial label for the desired key.
2. In the **Value** column, enter a phone number for the desired key.
3. In the **Account** column, select the account that this speed dial number will use.
4. Click **Save**.

# WebUI

## Directory

To view the local directory, click **CONTACTS** in the WebUI header, and then click **Local Directory** in the sidebar.

On the Local Directory page, you can manage your local directory entries. You can sort, edit, delete, and add contact information for up to 200 entries. The page also allows you to export your phone's local directory or import a local directory file. The export function lets you back up your contacts to your computer.

Phone numbers appear as links. If your service provider's **click to dial** feature is enabled, you can dial a number by clicking its link.

The Local Directory lists entries across several pages. Click **Next**, **First**, **Last**, or a page number to view the desired page of entries.

**Note:** You can also use the phone menu to manage your local directory entries. For more information, see **Using the local directory** on page 35.

### CONTACTS

- Local Directory
- Blacklist
- Call History

STATUS SYSTEM CONTACTS SERVICING

#### Local Directory

Select All  [Sort By Last Name](#)

Total: 21	First Name	Last Name	Ringer Tone	Work	Mobile	Other	Account	
<input type="checkbox"/>	Angela	Martin	0	<a href="tel:7325550118">7325550118</a>			1	<a href="#">Edit</a>
<input type="checkbox"/>	Bronwyn	McDonald	0	<a href="tel:2325550140">2325550140</a>			1	<a href="#">Edit</a>
<input type="checkbox"/>	Charlie	Johnson	0	<a href="tel:5550198">5550198</a>			1	<a href="#">Edit</a>
<input type="checkbox"/>	Dale	Appleton	0		<a href="tel:6045550135">6045550135</a>		1	<a href="#">Edit</a>
<input type="checkbox"/>	David	Carter	3	<a href="tel:2325550194">2325550194</a>	<a href="tel:2325550177">2325550177</a>		2	<a href="#">Edit</a>
<input type="checkbox"/>	Davis	Swerdlow	0		<a href="tel:2325550172">2325550172</a>		1	<a href="#">Edit</a>
<input type="checkbox"/>	Elkhart	Taxi	0		<a href="tel:6045550155">6045550155</a>		1	<a href="#">Edit</a>
<input type="checkbox"/>	Graham	Ball	0		<a href="tel:2325550176">2325550176</a>		1	<a href="#">Edit</a>
<input type="checkbox"/>	Kathryn	Dolphy	0		<a href="tel:6045550195">6045550195</a>		1	<a href="#">Edit</a>
<input type="checkbox"/>	Linda	Miller	0		<a href="tel:6045550117">6045550117</a>		2	<a href="#">Edit</a>
<input type="checkbox"/>	Lydia	Braithwaite	0	<a href="tel:2325550157">2325550157</a>			1	<a href="#">Edit</a>
<input type="checkbox"/>	Martin	Meyers	0	<a href="tel:2325550122">2325550122</a>			1	<a href="#">Edit</a>
<input type="checkbox"/>	Mary	Williams	0		<a href="tel:6045550145">6045550145</a>	<a href="tel:6045550146">6045550146</a>	1	<a href="#">Edit</a>
<input type="checkbox"/>	Richard	Serling	0		<a href="tel:6045550141">6045550141</a>	<a href="tel:7875550181">7875550181</a>	2	<a href="#">Edit</a>
<input type="checkbox"/>	Robert	Brown	2		<a href="tel:6045550105">6045550105</a>		2	<a href="#">Edit</a>
<input type="checkbox"/>	Sandro	Voss	0	<a href="tel:2325550149">2325550149</a>			1	<a href="#">Edit</a>
<input type="checkbox"/>	Stefan	Wheeler	0		<a href="tel:2325550161">2325550161</a>		1	<a href="#">Edit</a>
<input type="checkbox"/>	Susan	Ballance	0		<a href="tel:6045550170">6045550170</a>		1	<a href="#">Edit</a>
<input type="checkbox"/>	Terry	Ng	0		<a href="tel:2325550187">2325550187</a>		1	<a href="#">Edit</a>
<input type="checkbox"/>	Ursula	Baldwin	0	<a href="tel:6045550166">6045550166</a>			1	<a href="#">Edit</a>

**First** 1 [Next](#) [Last](#)

[Delete Selected Entries](#) [Add New Entry](#) [Clear Directory](#)

#### Import Local Directory

No File Chosen [Choose File](#)  
[Import](#)

#### Export Local Directory

# WebUI

## Local Directory

Click	To...
<a href="#">Sort By Last Name</a>	Sort the list by last name.
<a href="#">Edit</a>	Edit information for an entry.
<a href="#">Last</a>	View the last page of entries.
<a href="#">Next</a>	View the next page of entries.
<a href="#">Delete Selected Entries</a>	Delete selected entries from the directory. Click <b>Select All</b> to select every entry on the page you are viewing.
<a href="#">Add New Entry</a>	Add a new directory entry.
<a href="#">Clear Directory</a>	Delete all Directory entries

### Adding a directory entry:

1. Click **Add New Entry**.

The Create Local Directory Entry page appears.

2. Enter the required information. At minimum, a first and last name are required.

Setting	Description	Range	Default
First Name	Enter the appropriate names in these fields.	n/a	n/a
Last Name			
Ringer Tone	Sets a unique ringer tone for calls from this directory entry.	Auto, Tone 1–10	Auto
Account	Sets the account used when you dial this directory entry.	Default Account, Account 1–3	Default Account
Work Number	Enter the appropriate numbers in these fields.	n/a	n/a
Mobile Number			
Other Number			

3. Click **Save**.



# WebUI

## Directory (continued)

---

### Editing a directory entry:

1. Click **Edit** for the entry you want to edit.

The Edit Local Directory Entry page appears.

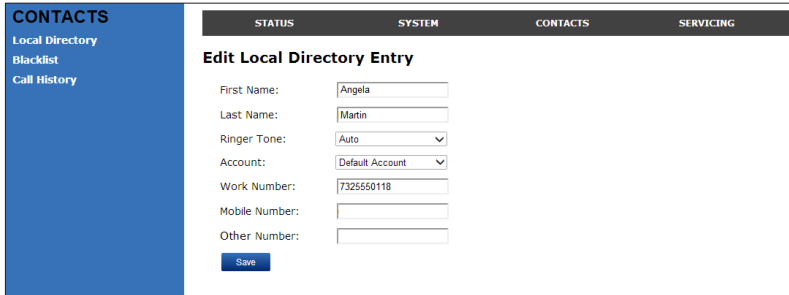

The screenshot shows a web interface for editing a contact. On the left is a blue sidebar with 'CONTACTS' and sub-items 'Local Directory', 'Blacklist', and 'Call History'. The main content area has a dark header with 'STATUS', 'SYSTEM', 'CONTACTS', and 'SERVICING'. Below the header is the title 'Edit Local Directory Entry'. The form contains the following fields: 'First Name' (text input with 'Angela'), 'Last Name' (text input with 'Martin'), 'Ringer Tone' (dropdown menu with 'Auto'), 'Account' (dropdown menu with 'Default Account'), 'Work Number' (text input with '7325550118'), 'Mobile Number' (text input), and 'Other Number' (text input). A blue 'Save' button is located at the bottom left of the form.

2. Edit or add the desired information.
3. Click **Save**.

### Importing Local Directory

You can import an existing local directory file. Importing a directory file replaces all your previous local directory entries. After importing a directory file, you can add, edit, or delete entries as desired.

**Note:** Directory files are .xml files containing contacts and contact information. For more information about creating or editing a directory file, consult your system administrator.

### Importing a local directory file

1. Click **Choose File**.
2. In the file window that opens, navigate to the directory file.
3. Click the file, and then click **Open**.
4. On the WebUI, click **Import**.

### Exporting Local Directory

You can export the directory and save it as an .xml file on your computer.

1. Click **Export**.
2. At your browser's prompt, save the file to the desired location on your computer.

# WebUI

## Blacklist (Deny List)

---

You can manage the blacklist of blocked numbers on the WebUI. Calls from blocked numbers will not ring your phone, or be recorded in your call history. The procedures for adding, deleting and editing entries are the same as for the Directory. See "Directory" on page 58.

To view the Blacklist, click **CONTACTS** in the WebUI header, and then click **Blacklist** in the sidebar.

## User Password

---

On the User Password page, you can change the password you use to log on to the WebUI. By changing your password from the default password ("user") you can prevent others from logging on to the WebUI remotely and changing your settings.

To view the User Password page, click **Servicing** on the WebUI header.

The User Password page appears.

SERVICING	STATUS	SYSTEM	CONTACTS	SERVICING
Security	<b>Passwords</b>			
	<b>User Password</b>			
	Enter Old Password: <input type="text"/>			
	Enter New Password: <input type="text"/>			
	Re-enter New Password: <input type="text"/>			
	<input type="button" value="Save"/>			

# Appendix

## Battery

It takes up to 8 hours for the battery pack of the wireless microphone to be fully charged (the orange status indicator turns off). Always return the wireless microphones to the charging cradles after use. When the batteries are fully charged, you can expect the following operating times:

Operation	Operating time
Talk time	Up to 8 hours
Standby (not in use ( i.e., talking) or charging)	Up to 70 hours

\* Actual talk time will be shorter for calls using HD audio (G.722).

### The battery needs charging when:

- A new battery is installed into the wireless microphone.
- The status indicator on the wireless microphone flashes orange.

### CAUTION:

#### To reduce the risk of fire or injury, read and follow these instructions:

- Use only the batteries provided or equivalent. To order a replacement, visit our website at [www.snom.com](http://www.snom.com).
- Do not dispose of the batteries in a fire. Check with local waste management codes for special disposal instructions.
- Do not open or mutilate the batteries. Released electrolyte is corrosive and may cause burns or injury to the eyes or skin. The electrolyte may be toxic if swallowed.
- Exercise care in handling batteries in order not to create a short circuit with conductive materials.
- Charge the batteries provided with or identified for use with this product only in accordance with the instructions and limitations specified in this manual.
- Observe proper polarity orientation between the battery and metallic contacts.
- To prevent fire or shock hazard, do not expose this product to water or any type of moisture.

### Battery disposal

	The batteries provided with the products are subject to European Directive 2006/66/EC and may not be disposed of with general household garbage. If you do not know where you may dispose of the batteries at the end of their lifespan, contact your municipality, your local waste management provider, or your seller.
--	---

### For countries outside the European Union





Disposal of electrical and electronic products and of batteries should be done in line with local regulations. Please contact local authorities for further information.

# Troubleshooting

If you have difficulty with your conference phone, please try the suggestions below.

## Finding the firmware version

As part of troubleshooting, you may need to provide the firmware version of the conference phone.

1. When the phone is idle, press .
2. In the *Main Menu*, press  (or scroll ▼ to highlight **2 Status** and press ).
3. In the *Status* menu, press  (or scroll ▼ to highlight **3 Product Info** and press ).

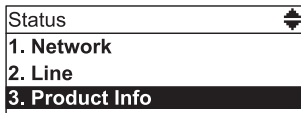

4. On the *Product Info* screen, press ▼ until **Firmware Ver.** appears.

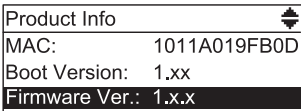

## My Conference phone does not work at all.

After powering up the phone (see page 3), the LCD display will show the display name and account number (extension) of the base. Press  to hear the dial tone. If any of this does not happen, please try the following:

- Make sure the DC power cable is securely plugged into the phone and the power adapter.
- Make sure the AC power cord is securely plugged into the power adapter and a wall outlet not controlled by a wall switch.

## I cannot dial out.

- Try all the above suggestions.
- Make sure there is a dial tone before dialing.
- If other telephones in your office are having the same problem, the problem is in the wiring or telephone service. Contact your IP PBX system administrator.
- Eliminate any background noise. Dial from another room in your office with less background noise.

# Troubleshooting

## The conference phone does not ring when there is an incoming call.

- Make sure there is a dial tone before dialing.
- Make sure the ringer volume of the phone is not set to off (page 6).
- Make sure the DC power cable, Ethernet cable, AC power cord, and the power adapter are plugged in properly (see page 3).
- If other telephones in your office are having the same problem, the problem is in the wiring or IP PBX service. Contact your service provider (charges may apply) or system administrator.
- Other electronic products such as ham radios and other DECT phones can cause interference with your conference phone. Try installing your conference phone as far away as possible from these types of electronic devices.
- Unplug the AC power cord from the wall outlet. Wait for approximately 15 seconds, and then plug it back in. If you still cannot get a dial tone, please contact our customer service hotline designated above for assistance.

## My wireless microphone does not work at all.

The LED on the wireless microphone turns green within 2 seconds when a call has been established on the conference phone.



If the LED remains off and inactive, please follow the steps below:

1. Remove the battery from battery compartment.
2. Insert the battery again, close the battery door, and return the wireless microphone to the charging cradle.
3. Make sure the wireless microphone is placed in the charging cradle correctly. The LED should turn orange.





If the status indicator does not turn orange, please follow the steps below:

1. Remove the microphone from the charging cradle and install the battery again (page 3).
2. Return the microphone to the charging cradle. The LED should turn orange. The microphone is charging now.
3. Allow the microphone to be charged for at least 30 minutes.
4. Remove the microphone from the charging cradle again.
5. Establish a call on the phone. The LED on the wireless microphone should turn green within 2 seconds.

If that still does not work, the microphone might have lost its connection to the C520-WiMi. Try deregistering both wireless microphones and registering them anew.





1. Place both microphones in the charging cradles.
2. Press .
3. In the *Main Menu*, press  3 User settings.

# Troubleshooting

4. In the *User Settings* menu, press  *Wireless microphones*.
5. In the *Wireless microphone* menu, press  *Deregister* and confirm by pressing "Yes". If successful, the display will say "Wireless microphones are deregistered". Their LEDs will flash red and green alternately.
6. Press  *Register* to register the first microphone. The display will say "Registering.....". If successful, you will hear a confirmation tone and the display will say "Registration succeeded". The status indicator of the registered microphone switches to a steady red light while the second, unregistered microphone continues to flash red and green alternately.
7. Press  *Register* again to register the second microphone. The display will say "Registering.....". If successful, you will hear a confirmation tone and the display will say "Registration succeeded". The status indicator of the second microphone switches to a steady red light.
8. Remove the microphones from the charging cradle.
9. The LED on each wireless microphone should turn red.





If that still does not work, the battery, the wireless microphone, or the charging cradle may be defective. Please contact customer service for assistance.

**Note:** If the wireless microphones are not in the charging cradles when the phone is powered up, they may need some time to connect to the phone. Please allow at least one minute for the microphones and the phone to synchronize.

**Note:** If you have more than one conference phone in the office, use the locate function ( >  *Status* >  *Wireless microphones* > press ) on each conference phone to identify the microphones connected to it. They will not work with the phone they are not registered at.

## The callers cannot hear me when I am using the wireless mic.

Try one of the following:

- Make sure the wireless microphone is not muted during a call.
- Move the microphone closer to the phone. It may be out of range.
- Speak into the microphone from a distance of no more than 3 feet.
- Reset the phone. Unplug the AC power cord from the wall outlet. Wait for approximately 15 seconds, and then plug it back in. Allow at least one minute for the microphone and the phone to synchronize.
- If you have more than one conference phone in the office, use the locate function ( >  *Status* >  *Wireless microphones* > press ) on each conference phone to identify the microphones connected to it. They will not work with the phone they are not registered at.

# Troubleshooting

- Other electronic products such as ham radios and other DECT phones can cause interference with the conference phone. Try installing the conference phone as far away as possible from these types of electronic devices.

## **Status Indicator on the wireless microphone flashes orange.**

The wireless microphone has low battery.

- Place the microphone onto the charging cradle for recharging.

For optimal battery life performances:

- Charge the wireless microphones for up to 8 hours before the first time of use.
- Return the wireless microphones to the charging cradle after use. Charge them for at least 30 minutes before subsequent uses.

## **Status Indicator on the wireless microphone flashes orange even after a long period of charging.**

The efficiency of the battery might have been reduced after having been used for some time.

- Make sure the wireless microphone is placed in the charging cradle correctly when charging.
- Remove and install the battery again and use it until the battery is fully depleted, and then charge the wireless microphone in the charging cradle for 8 hours.
- If the above measures do not solve the problem, replace the battery.

## **The status indicator on the wireless mic does not turn orange when in charging cradle.**

- The wireless mic might be fully charged.
- Clean the charging contacts on the wireless mic and the charging cradles each month with a pencil eraser or a dry non-abrasive fabric.
- Make sure the DC power cable, telephone line cord, AC power cord, and the power adapter are plugged in properly (see page 3).
- Make sure the wireless mic is placed in the charging cradle correctly.
- Unplug the power cable. Wait for 15 seconds before plugging it back in. Allow up to one minute for the wireless mic and base unit to reset.
- Lift the wireless mic and place it back into the charging cradle. If the wireless mic status indicator turns orange for 5 seconds, and then turns off, the battery is fully charged.

# Troubleshooting

**There is interference during a telephone conversation. My calls fade out when I am using the wireless microphone.**

- Move the wireless microphone closer to the phone. It may be out of range.
- Appliances plugged into the same circuit as the base unit can cause interference. Try moving the appliance or base unit to another outlet.

**I have accidentally set my language to Spanish or French, and I don't know how to change it back to English.**

- When the phone is not in use or on a call, press  > **3 User Settings** > **1 Preferences** > **1 Language** > **1 English.** >



# Precautions for users of implanted cardiac pacemakers

Cardiac pacemakers (applies only to digital cordless telephones):

Wireless Technology Research, LLC (WTR), an independent research entity, led a multidisciplinary evaluation of the interference between portable wireless telephones and implanted cardiac pacemakers. Supported by the U.S. Food and Drug Administration, WTR recommends to physicians that:

## Pacemaker patients

- Should keep the wireless telephone at least 30 cm from the pacemaker.
- Should NOT place wireless telephones directly over the pacemaker, such as in a breast pocket, when it is turned ON.
- Should use the wireless telephone at the ear opposite the pacemaker.

WTR's evaluation did not identify any risk to bystanders with pacemakers from other persons using wireless telephones.

## About wireless microphones

- **Privacy:** The same features that make a wireless microphone convenient create some limitations. Calls on conference phones are transmitted between the base unit and the wireless microphone by radio waves, so there is a possibility that the wireless microphone conversations could be intercepted by radio receiving equipment within range of the wireless microphone. For this reason, you should not think of conference phone conversations as being as private as those on corded telephones.
- **Electrical power:** The base unit of this conference phone must be connected to a working electrical outlet. The electrical outlet should not be controlled by a wall switch. Calls cannot be made from the conference phone if the base unit is unplugged, switched off or if the electrical power is interrupted.
- **Potential TV interference:** Wireless microphone operates at frequencies that may cause interference to televisions and VCRs. To minimize or prevent such interference, do not place the base unit near or on top of a TV or VCR. If interference is experienced, moving the wireless microphone farther away from the TV or VCR often reduces or eliminates the interference.
- **Rechargeable batteries:** Exercise care in handling batteries in order not to create a short circuit with conducting material such as rings, bracelets and keys. The battery or conductor may overheat and cause harm.
- **Nickel-metal hydride rechargeable batteries:** Dispose of these batteries in a safe manner. Do not burn or puncture. Like other batteries of this type, if burned or punctured, they could release caustic material which could cause injury.

# Maintenance

## **Taking care of the conference phone**

Your conference phone contains sophisticated electronic parts, so it must be treated with care.

### **Avoid rough treatment**

Place the wireless mic down gently. Save the original packing materials to protect the conference phone if you ever need to ship it.

### **Avoid water**

The conference phone can be damaged if it gets wet. Do not use the wireless mic outdoors in the rain, or handle it with wet hands. Do not install the base unit near a sink, bathtub or shower.

### **Electrical storms**

Electrical storms can sometimes cause power surges harmful to electronic equipment. For your own safety, take caution when using electrical appliances during storms.

### **Cleaning the conference phone**

The conference phone has a durable plastic casing that should retain its luster for many years. Clean it only with a soft cloth slightly dampened with water or mild soap. Do not use excess water or cleaning solvents of any kind.

Remember that electrical appliances can cause serious injury if used when you are wet or standing in water. If the base unit should fall into water, DO NOT RETRIEVE IT UNTIL YOU UNPLUG THE AC POWER CORD FROM THE WALL. Then, remove the telephone by the unplugged cords.

# Technical specifications

Frequency control	Crystal controlled PLL synthesizer
Transmit frequency	Wireless microphone: 1881.792-1897.344 MHz (EMEA) Conference phone: 1881.792-1897.344 MHz (EMEA)
Channels	5
Optimal and minimum distances	Optimal distance between the base unit/wireless mic and the participant: 60 cm Minimum distance between each wireless mic: 30 cm
Power requirements	Wireless mic: Ni-MH Battery Pack; 2.4V; 400mAH rechargeable battery Base unit adapter: Input: 100–240V AC 50/60Hz Output: 9V DC @ 1500mA
Memory	Local directory: 200 memory locations; up to 28 digits and 15 characters Call log: 200 memory locations; up to 16 digits and 15 characters

**Snom Technology GmbH**  
Wittestr. 30 G  
13509 Berlin, Deutschland  
Tel. +49 30 39 83 3 0  
Fax +49 30 39 83 31 11  
office.de@snom.com

Snom Technology GmbH  
Via A. Lusardi 10  
20122 Milano, Italia  
Tel. +39 02 00611212  
Fax +39 02 93661864  
office.it@snom.com

Snom Technology GmbH  
The Courtyard, High Street  
Ascot  
Berkshire SL5 7HP, UK  
Tel. +44 161 348 7500  
Fax +44 169 348 7509  
office.uk@snom.com

Snom Technology GmbH  
6 Parc des fontenelles  
78870 Bailly, France  
Tel. +33 1 80 87 62 87  
Fax +33 1 80 87 62 88  
office.fr@snom.com

VTech Communications Inc.  
Snom Americas  
9020 SW Washington Square Road, Suite  
555  
Tigard, OR 97223  
Phone support: (339) 227 6160  
Email support: supportusa@snom.com

Snom Technology Ltd.  
Rm. 828, 5F, No. 285, Sec. 4  
Zhongxiao E. Rd., Da'an Dist.  
Taipei City 10692, Taiwan  
Tel. +886 2 8751 1120  
Fax +886 2 8751 1130  
office.tw@snom.com

Your specialist retailer - Ihr Fachhändler -  
Votre distributeur - Su distribuidor - Il tuo rivenditore: