

# FORD **KUGA** Owner's Manual



The information contained in this publication was correct at the time of going to print. In the interest of continuous development, we reserve the right to change specifications, design or equipment at any time without notice or obligation. No part of this publication may be reproduced, transmitted, stored in a retrieval system or translated into any language in any form by any means without our written permission. Errors and omissions excepted.

© Ford Motor Company 2013

All rights reserved.

Part Number: CG3585en 03/2013 20130416113022

# Table of Contents

---

## Introduction

About This Manual.....	5
Symbols Glossary.....	5
Data Recording.....	7
Replacement Parts Recommendation.....	8
Mobile Communications Equipment.....	8

## At a Glance

At a Glance.....	10
------------------	----

## Child Safety

Child Seat Positioning.....	17
Installing Child Seats.....	19
Child Safety Locks.....	22

## Safety Belts

Fastening the Safety Belts.....	23
Safety Belt Height Adjustment.....	24
Safety Belt Minder.....	24

## Supplementary Restraints System

Principle of Operation.....	26
Driver Airbag.....	26
Passenger Airbag.....	27
Knee Airbag.....	27
Side Airbags.....	28
Side Curtain Airbags.....	28

## Keys and Remote Controls

General Information on Radio Frequencies.....	29
Remote Control.....	29
Replacing a Lost Key or Remote Control.....	31

## Locks

Locking and Unlocking.....	32
----------------------------	----

Manual Liftgate.....	34
Power Liftgate.....	35
Keyless Entry.....	37

## Security

Passive Anti-Theft System.....	40
Anti-Theft Alarm.....	40

## Steering Wheel

Adjusting the Steering Wheel.....	43
Audio Control.....	43
Voice Control.....	45
Cruise Control.....	45
Information Display Control.....	45

## Wipers and Washers

Windshield Wipers.....	46
Autowipers.....	46
Windshield Washers.....	47
Rear Window Wiper and Washers.....	47
Headlamp Washers.....	48

## Lighting

General Information.....	49
Lighting Control.....	49
Autolamps.....	50
Instrument Lighting Dimmer.....	50
Headlamp Exit Delay.....	50
Daytime Running Lamps.....	51
Automatic High Beam Control.....	51
Front Fog Lamps.....	52
Rear Fog Lamps.....	53
Headlamp Leveling.....	53
Cornering Lamps.....	54
Direction Indicators.....	54
Interior Lamps.....	54
Ambient Lighting.....	55

# Table of Contents

---

## Windows and Mirrors

Power Windows.....	57
Exterior Mirrors.....	58
Interior Mirror.....	59
Sun Visors.....	59
Moonroof.....	60
Global Opening and Closing.....	61

## Instrument Cluster

Gauges.....	63
Warning Lamps and Indicators.....	64
Audible Warnings and Indicators.....	67

## Information Displays

General Information.....	68
Clock.....	73
Trip Computer.....	73
Personalized Settings.....	73
Information Messages.....	74

## Climate Control

Principle of Operation.....	87
Air Vents.....	87
Manual Climate Control.....	88
Automatic Climate Control.....	89
Hints on Controlling the Interior Climate.....	91
Heated Windows and Mirrors.....	94
Auxiliary Heater.....	95

## Seats

Sitting in the Correct Position.....	96
Head Restraints.....	96
Manual Seats.....	98
Power Seats.....	99
Rear Seats.....	100
Heated Seats.....	100
Rear Seat Armrest.....	101

## Auxiliary Power Points

Auxiliary Power Points.....	102
-----------------------------	-----

## Storage Compartments

Cup Holders.....	104
Overhead Console.....	104
Seat Back Trays.....	104

## Starting and Stopping the Engine

General Information.....	105
Ignition Switch.....	105
Keyless Starting.....	105
Steering Wheel Lock.....	107
Starting a Gasoline Engine.....	108
Starting a Diesel Engine.....	109
Diesel Particulate Filter.....	109
Switching Off the Engine.....	110

## Unique Driving Characteristics

Start-Stop.....	111
-----------------	-----

## Fuel and Refueling

Safety Precautions.....	113
Fuel Quality - Gasoline.....	114
Fuel Quality - Diesel.....	114
Running Out of Fuel.....	114
Catalytic Converter.....	115
Refueling.....	116
Fuel Consumption.....	117
Technical Specifications.....	118

## Transmission

Manual Transmission.....	119
Automatic Transmission.....	119
Hill Start Assist.....	122

# Table of Contents

---

## Four-Wheel Drive

Principle of Operation.....	124
Using Four-Wheel Drive.....	124

## Brakes

General Information.....	129
Hints on Driving With Anti-Lock Brakes.....	129
Parking Brake.....	129

## Traction Control

Principle of Operation.....	131
Using Traction Control.....	131

## Stability Control

Principle of Operation.....	132
Using Stability Control.....	132

## Parking Aids

Principle of Operation.....	133
Parking Aid.....	133
Active Park Assist.....	135
Rear View Camera.....	137

## Cruise Control

Principle of Operation.....	139
Using Cruise Control.....	139
Using Adaptive Cruise Control.....	140

## Driving Aids

Blind Spot Monitor.....	145
Speed Limiter.....	147
Driver Alert.....	148
Lane Keeping System.....	150
Traffic Sign Recognition.....	152
Active City Stop.....	154
Eco Mode.....	155

## Load Carrying

General Information.....	156
Rear Under Floor Storage.....	156
Luggage Covers.....	157
Luggage Anchor Points.....	157
Roof Racks and Load Carriers.....	158

## Towing

Towing a Trailer.....	159
Tow Ball.....	159
Trailer Sway Control.....	162
Towing Points.....	162
Towing the Vehicle on Four Wheels.....	163

## Driving Hints

Breaking-In.....	164
Cold Weather Precautions.....	164
Driving Through Water.....	164
Floor Mats.....	164

## Roadside Emergencies

Hazard Warning Flashers.....	166
First Aid Kit.....	166
Warning Triangle.....	166
Fuel Shutoff.....	166
Jump-Starting the Vehicle.....	166

## Fuses

Fuse Box Locations.....	168
Fuse Specification Chart.....	169
Changing a Fuse.....	178

## Maintenance

General Information.....	179
Opening and Closing the Hood.....	179
Under Hood Overview - 1.6L EcoBoost (132kW/180PS) - Sigma.....	181
Under Hood Overview - 2.0L Duratorq-TDCi (DW) Diesel.....	182

# Table of Contents

---

Engine Oil Dipstick - 1.6L EcoBoost™	183
Engine Oil Dipstick - 2.0L Duratorq-TDCi (DW) Diesel	183
Engine Oil Check	183
Engine Coolant Check	184
Brake Fluid Check	184
Washer Fluid Check	184
Changing the 12V Battery	184
Checking the Wiper Blades	185
Changing the Wiper Blades	185
Removing a Headlamp	186
Changing a Bulb	186
Bulb Specification Chart	192
Technical Specifications	193

## Vehicle Care

Cleaning the Exterior	195
Repairing Minor Paint Damage	195
Cleaning the Interior	196
Cleaning the Alloy Wheels	196

## Wheels and Tires

General Information	197
Temporary Mobility Kit	197
Tire Care	201
Using Winter Tires	201
Using Snow Chains	201
Changing a Road Wheel	201
Technical Specifications	208

## Capacities and Specifications

Vehicle Identification Plate	210
Vehicle Identification Number	211
Technical Specifications	211

## Audio System

General Information	214
---------------------	-----

Audio unit - Vehicles With: AM/FM/CD	215
Audio unit - Vehicles With: AM/FM/CD/Digital Audio Broadcast (DAB) Radio/SYNC	220
Audio unit - Vehicles With: Digital Audio Broadcast (DAB) Radio/Navigation System/SYNC	225
Audio unit - Vehicles With: Digital Audio Broadcast (DAB) Radio/SYNC/Sony AM/FM/CD	231
Audio unit - Vehicles With: Digital Audio Broadcast (DAB) Radio/Navigation System/SYNC/Sony AM/FM/CD	237
Digital Audio	243
Auxiliary Input Jack	245
USB Port	246
Audio Troubleshooting	246

## SYNC™

General Information	247
Using Voice Recognition	248
Using SYNC™ With Your Phone	251
SYNC™ Applications and Services	261
Using SYNC™ With Your Media Player	264
SYNC™ Troubleshooting	268

## Navigation

Navigation	275
------------	-----

## Appendices

Electromagnetic compatibility	280
End User License Agreement	281

# Introduction

## ABOUT THIS MANUAL

Thank you for choosing Ford. We recommend that you take some time to get to know your vehicle by reading this manual. The more that you know about it, the greater the safety and pleasure you will get from driving it.

### WARNING



Driving while distracted can result in loss of vehicle control, crash and injury. We strongly recommend that you use extreme caution when using any device that may take your focus off the road. Your primary responsibility is the safe operation of your vehicle. We recommend against the use of any handheld device while driving and encourage the use of voice-operated systems when possible. Make sure you are aware of all applicable local laws that may affect the use of electronic devices while driving.

**Note:** This manual describes product features and options available throughout the range of available models, sometimes even before they are generally available. It may describe options not fitted to your vehicle.

**Note:** Some of the illustrations in this manual may be used for different models, so may appear different to you on your vehicle. However, the essential information in the illustrations is always correct.

**Note:** Always use and operate your vehicle in line with all applicable laws and regulations.

**Note:** Pass on this manual when selling your vehicle. It is an integral part of the vehicle.

This manual may qualify the location of a component as left-hand side or right-hand side. The side is determined when facing forward in the seat.

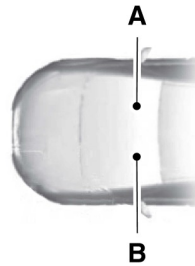

E154903

- A Right-hand side
- B Left-hand side

## Protecting the Environment

You must play your part in protecting the environment. Correct vehicle usage and the authorized disposal of waste, cleaning and lubrication materials are significant steps toward this aim.

## SYMBOLS GLOSSARY

These are some of the symbols you may see on your vehicle.



Safety alert



See Owner's Manual



Air conditioning system



Anti-lock braking system



Avoid smoking, flames or sparks



Battery

# Introduction



Battery acid



Brake fluid - non petroleum based



Brake system



Cabin air filter



Check fuel cap



Child safety door lock or unlock



Child seat lower anchor



Child seat tether anchor



Cruise control



Do not open when hot



Engine air filter



Engine coolant



Engine coolant temperature



Engine oil



Explosive gas



Fan warning



Fasten safety belt



Front airbag



Front fog lamps



Fuel pump reset



Fuse compartment



Hazard warning flashers



Heated rear window



Heated windshield



Interior luggage compartment release



Jack



Keep out of reach of children



Lighting control



Low tire pressure warning



# Introduction



Maintain correct fluid level



Note operating instructions



Panic alarm



Parking aid



Parking brake



Power steering fluid



Power windows front/rear



Power window lockout



Service engine soon



Side airbag



Shield the eyes



Stability control



Windshield wash and wipe

## DATA RECORDING

A large number of electronic components of your vehicle contain data storage modules temporarily or permanently storing technical data about the condition of the vehicle, events and errors.

In general, this technical information documents the condition of parts, modules, systems or the environment:

- Operating conditions of system components (e.g. filling levels).
- Status messages of the vehicle and its individual components (e.g. number of wheel revolutions/rotational speed, deceleration, lateral acceleration).
- Malfunction and defects in important system components (e.g. lighting and brake system).
- Vehicle reactions in particular driving situations (e.g. inflation of an airbag, activation of the stability regulation system).
- Environmental conditions (e.g. temperature).

These data are exclusively technical and help identification and correction of errors as well as optimisation of vehicle functions. Motion profiles indicating travelled routes cannot be created with these data.

If services are used (e.g. repair works, service processes, warranty cases, quality assurance), employees of the service network (including manufacturers) are able to read out this technical information from the event and error data storage modules using special diagnostic devices. If required, you will receive further information. After an error has been corrected, these data are deleted from the error storage module or they are constantly overwritten.

# Introduction

---

When using the vehicle, situations may occur in which these technical data related to other information (accident report, damages on the vehicle, witness statements etc.) may be associated with a specific person - possibly, with the assistance of an expert.

Additional functions contractually agreed upon with the client (e.g. vehicle location in emergency cases) allow the transmission of particular vehicle data from the vehicle.

## **REPLACEMENT PARTS RECOMMENDATION**

Your vehicle has been built to the highest standards using quality parts. We recommend that you demand the use of genuine Ford and Motorcraft parts whenever your vehicle requires scheduled maintenance or repair. You can clearly identify genuine Ford and Motorcraft parts by looking for the Ford, FoMoCo or Motorcraft branding on the parts or their packaging.

### **Scheduled Maintenance and Mechanical Repairs**

One of the best ways for you to make sure that your vehicle provides years of service is to have it maintained in line with our recommendations using parts that conform to the specifications detailed in this Owner's Manual. Genuine Ford and Motorcraft parts meet or exceed these specifications.

### **Collision Repairs**

We hope that you never experience a collision, but accidents do happen. Genuine Ford replacement collision parts meet our stringent requirements for fit, finish, structural integrity, corrosion protection and dent resistance. During vehicle

development we validate these parts deliver the intended level of protection as a whole system. A great way to know for sure you are getting this level of protection is to use genuine Ford replacement collision parts.

### **Warranty on Replacement Parts**

Genuine Ford and Motorcraft replacement parts are the only replacement parts that benefit from a Ford Warranty. Damage caused to your vehicle as a result of the failure of non-Ford parts may not be covered by the Ford Warranty. For additional information, refer to the terms and conditions of the Ford Warranty.

## **MOBILE COMMUNICATIONS EQUIPMENT**

Using mobile communications equipment is becoming increasingly important in the conduct of business and personal affairs. However, you must not compromise your own or others' safety when using such equipment. Mobile communications can enhance personal safety and security when appropriately used, particularly in emergency situations. Safety must be paramount when using mobile communications equipment to avoid negating these benefits. Mobile communication equipment includes, but is not limited to, cellular phones, pagers, portable email devices, text messaging devices and portable two-way radios.

# Introduction

---

## **WARNING**



Driving while distracted can result in loss of vehicle control, crash and injury. We strongly recommend that you use extreme caution when using any device that may take your focus off the road. Your primary responsibility is the safe operation of your vehicle. We recommend against the use of any hand-held device while driving and encourage the use of voice-operated systems when possible. Make sure you are aware of all applicable local laws that may affect the use of electronic devices while driving.

---

# At a Glance

## Front Exterior Overview

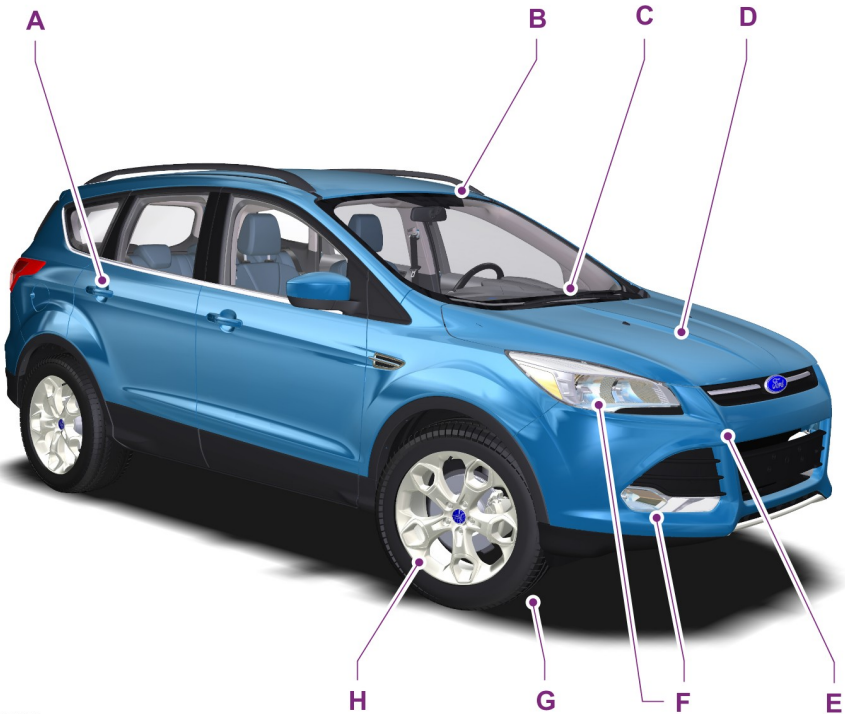

E152442

- A See **Locking and Unlocking** (page 32). See **Keyless Entry** (page 37).
- B See **Automatic High Beam Control** (page 51). See **Driver Alert** (page 148). See **Lane Keeping System** (page 150). See **Traffic Sign Recognition** (page 152). See **Active City Stop** (page 154).
- C See **Changing the Wiper Blades** (page 185).
- D See **Maintenance** (page 179).
- E See **Towing Points** (page 162).
- F See **Changing a Bulb** (page 186).

# At a Glance

- G Tire pressures. See **Technical Specifications** (page 208).
- H See **Changing a Road Wheel** (page 201).

## Vehicle Interior Overview

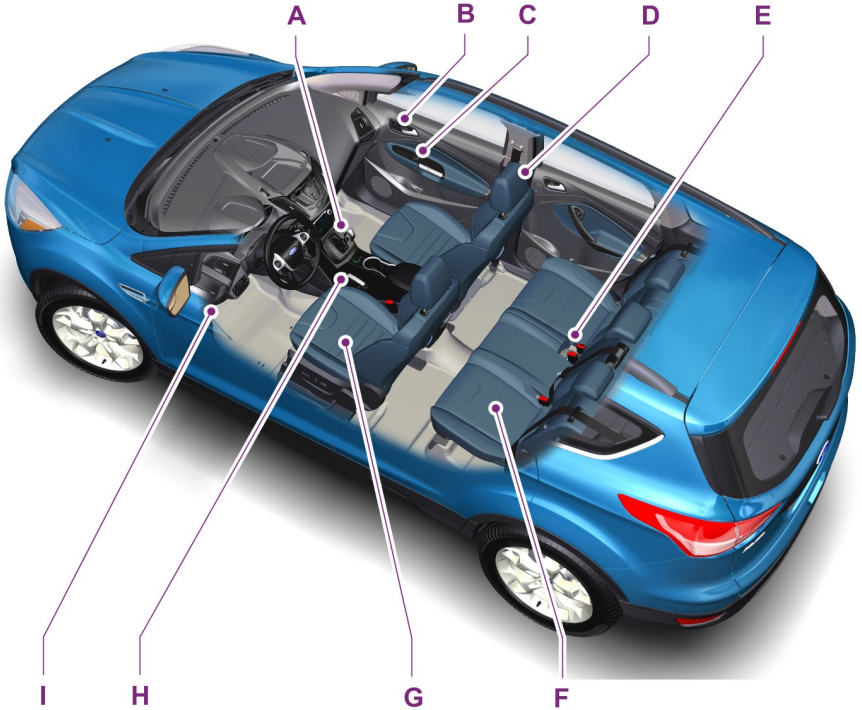

E152443

- A See **Transmission** (page 119).
- B See **Locking and Unlocking** (page 32).
- C See **Power Windows** (page 57). See **Exterior Mirrors** (page 58).
- D See **Head Restraints** (page 96).
- E See **Fastening the Safety Belts** (page 23).
- F See **Fastening the Safety Belts** (page 23).
- G Tire pressures. See **Technical Specifications** (page 208).
- H See **Changing a Road Wheel** (page 201).
- I See **Exterior Mirrors** (page 58).

# At a Glance

- F See **Rear Seats** (page 100).
- G See **Manual Seats** (page 98). See **Power Seats** (page 99).
- H See **Parking Brake** (page 129).
- I See **Opening and Closing the Hood** (page 179).

## Instrument Panel Overview

### Left-Hand Drive

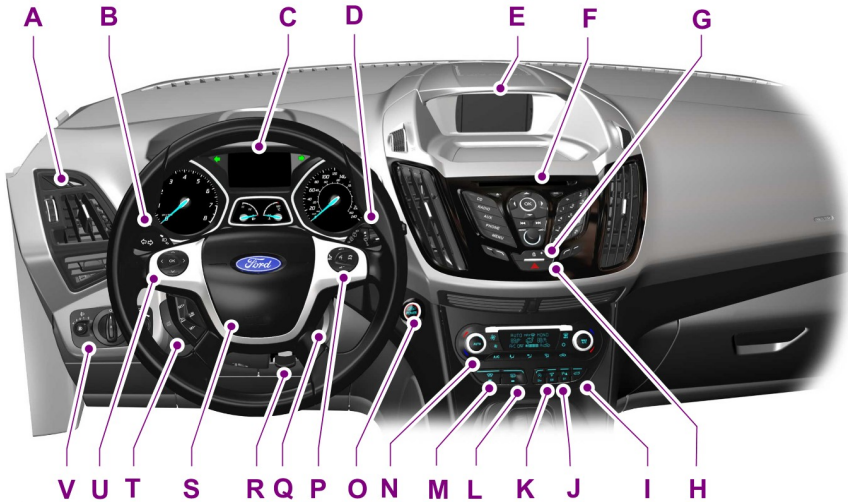

E152444

# At a Glance

## Right-Hand Drive

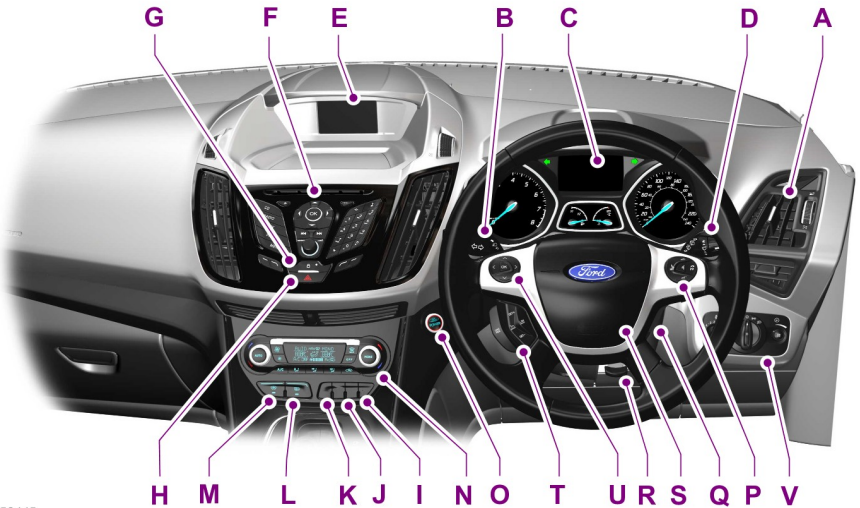

E152445

- A Air vents. See **Air Vents** (page 87).
- B Direction indicators. See **Direction Indicators** (page 54). High beam. See **Lighting Control** (page 49).
- C Instrument cluster. See **Gauges** (page 63). See **Warning Lamps and Indicators** (page 64).
- D Wiper lever. See **Wipers and Washers** (page 46).
- E Information and entertainment display.
- F Audio unit. See **Audio System** (page 214).
- G Door lock indicator. See **Locking and Unlocking** (page 32).
- H Hazard warning flasher switch. See **Hazard Warning Flashers** (page 166).
- I Parking aid switch. See **Parking Aids** (page 133).
- J Active park assist switch. See **Active Park Assist** (page 135).
- K Start-stop switch. See **Start-Stop** (page 111).
- L Heated rear window switch. See **Heated Windows and Mirrors** (page 94).
- M Heated windshield switch. See **Heated Windows and Mirrors** (page 94).
- N Climate controls. See **Climate Control** (page 87).

## At a Glance

---

- O Start button. See **Keyless Starting** (page 105).
- P Audio control. See **Audio Control** (page 43). Voice control. See **Voice Control** (page 45). Telephone control. See **Using SYNC™ With Your Phone** (page 251).
- Q Ignition switch. See **Ignition Switch** (page 105).
- R Steering wheel adjustment. See **Adjusting the Steering Wheel** (page 43).
- S Horn.
- T Cruise control switches. See **Using Cruise Control** (page 139). Adaptive cruise control (ACC) switches. See **Using Adaptive Cruise Control** (page 140).
- U Information display controls. See **Information Displays** (page 68).
- V Lighting control. See **Lighting Control** (page 49). Front fog lamps. See **Front Fog Lamps** (page 52). Rear fog lamp. See **Rear Fog Lamps** (page 53). Headlamp levelling control. See **Headlamp Leveling** (page 53). Instrument lighting dimmer. See (page 87).



# At a Glance

## Rear Exterior Overview

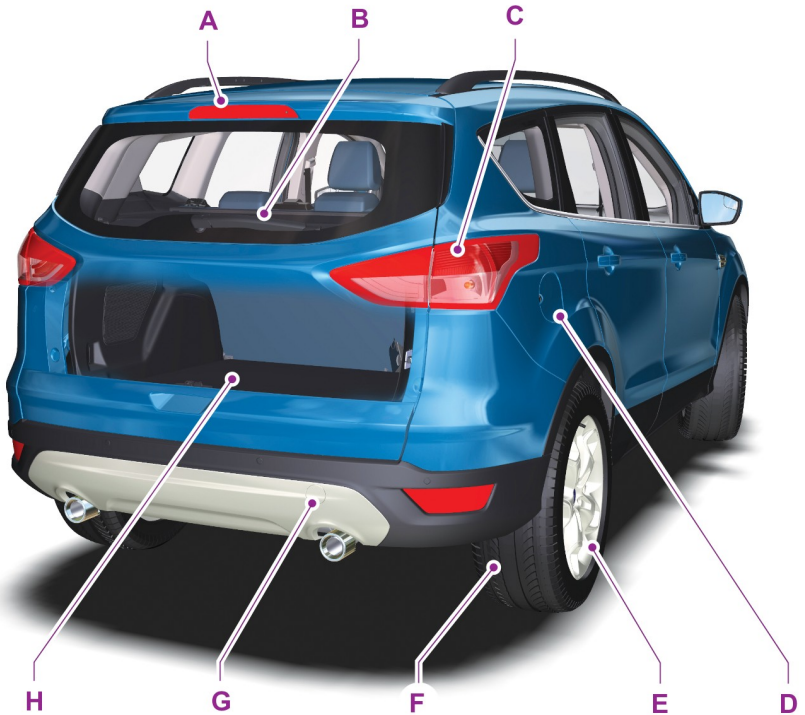

E152446

- A See **Changing a Bulb** (page 186).
- B See **Changing the Wiper Blades** (page 185).
- C See **Changing a Bulb** (page 186).
- D See **Refueling** (page 116).
- E See **Changing a Road Wheel** (page 201).
- F Tire pressures. See **Technical Specifications** (page 208).

## At a Glance

---

- G See **Towing Points** (page 162).
- H See **First Aid Kit** (page 166). See **Warning Triangle** (page 166). See **Temporary Mobility Kit** (page 197). Spare wheel, jack and wheel brace. See **Changing a Road Wheel** (page 201). Towing eye. See **Towing Points** (page 162). Fuel funnel. See **Running Out of Fuel** (page 114).

# Child Safety

## CHILD SEAT POSITIONING

### WARNINGS



See an authorized dealer for the latest details relating to our recommended child seats.



Extreme Hazard! Do not use a rearward facing child seat on a seat protected by an air bag in front of it!

### WARNINGS



When using a child seat with a support leg, the support leg must rest securely on the floor.



When using a child seat with a safety belt, make sure that the safety belt is not slack or twisted.



The child seat must rest tightly against the vehicle seat. It may be necessary to lift or remove the head restraint. See **Head Restraints** (page 96).

Seating positions	Mass group categories				
	0	0+	1	2	3
	Up to 22 lbs (10 kg)	Up to 29 lbs (13 kg)	20 - 40 lbs (9 - 18 kg)	33 - 55 lbs (15 - 25 kg)	46 - 79 lbs (22 - 36 kg)
Front passenger seat with airbag <b>ON</b>	X	X	UF <sup>1</sup>	UF <sup>1</sup>	UF <sup>1</sup>
Front passenger seat with airbag <b>OFF</b>	U <sup>1</sup>	U <sup>1</sup>	U <sup>1</sup>	U <sup>1</sup>	U <sup>1</sup>
Rear seats	U	U	U	U	U

X Not suitable for children in this mass group.

U Suitable for universal category child seats approved for use in this mass group.

U<sup>1</sup> Suitable for universal category child seats approved for use in this mass group. However, we recommend that you secure children in a government approved child seat, on the rear seat.

UF<sup>1</sup> Suitable for universal category forward facing child seats approved for use in this mass group. However, we recommend that you secure children in a government approved child seat, on the rear seat.

**Note:** When using a child seat on a front seat, always adjust the front passenger's seat to its fully rearward position. If it proves difficult to tighten the lap section of the safety belt without slack remaining, adjust the seatback to the fully upright position and raise the height of the seat. See **Seats** (page 96).

# Child Safety

## ISOFIX Child Seats

Seating positions		Mass group categories	
		O+	1
		Rear facing	Forward facing
		Up to 29 lbs (13 kg)	20 - 40 lbs (9 - 18 kg)
Front seat	Size class	Not ISOFIX equipped	
	Seat type		
Rear outboard seat ISOFIX	Size class	C, D, E <sup>1</sup>	A, B, B1 <sup>1</sup>
	Seat type	IL <sup>2</sup>	IL, IUF <sup>3</sup>
Rear center seat	Size class	Not ISOFIX equipped	
	Seat type		

IL Suitable for particular ISOFIX child seat systems of the semi-universal category. Please consult child seat systems suppliers' vehicle recommendation lists.

IUF Suitable for ISOFIX forward facing child seat systems of universal category approved for use in this mass group and ISOFIX size class.

<sup>1</sup>The ISOFIX size class for both universal and semi-universal child seat systems is defined by the capital letters A to G. These identification letters are displayed on ISOFIX child seat.

<sup>2</sup>At time of publishing the recommended Group O+ ISOFIX baby safety seat is the Britax Romer Baby Safe. See an authorized dealer for the latest details relating to our recommended child seats.

<sup>3</sup>At time of publishing the recommended Group 1 ISOFIX child seat is the Britax Romer Duo. See an authorized dealer for the latest details relating to our recommended child seats.

# Child Safety

## INSTALLING CHILD SEATS





E133140



E68916

### WARNINGS

-  Use an approved child seat to secure children less than 59 inches (150 centimeters) tall in the rear seat.
-  Extreme Hazard! Do not use a rearward facing child seat on a seat protected by an air bag in front of it!
-  Read and follow the manufacturer's instructions when you are installing a child seat.
-  Do not modify child seats in any way.
-  Do not hold a child on your lap when your vehicle is moving.
-  Do not leave unattended children in your vehicle.

### WARNINGS

-  If your vehicle has been involved in a crash, have the child seats checked by an authorized dealer.

**Note:** Mandatory use of child seats varies from country to country.

Only child seats certified to ECE-R44.03 (or later) have been tested and approved for use in your vehicle. A choice of these are available from an authorized dealer.

## Child Seats for Different Mass Groups

Use the correct child seat as follows:

### Baby Safety Seat



E68918

Secure children that weigh less than 29 pounds (13 kilograms) in a rearward facing baby safety seat (Group 0+) on the rear seat.

# Child Safety

## Child Safety Seat







E68920

Secure children that weigh between 29 and 40 pounds (13 and 18 kilograms) in a child safety seat (Group 1) on the rear seat.

## Booster Seats

### WARNINGS

-  Do not install a booster seat or a booster cushion with only the lap strap of the safety belt.
-  Do not install a booster seat or a booster cushion with a safety belt that is slack or twisted.
-  Do not put the safety belt under your child's arm or behind their back.
-  Do not use pillows, books or towels to boost your child's height.
-  Make sure that your children sit in an upright position.

**Note:** When using a child seat on a rear seat, make sure that the child seat rests tightly against the vehicle seat. It may be necessary to lift or remove the head restraint. See **Head Restraints** (page 96).

## Booster Seat (Group 2)



E70710

Secure children that weigh more than 33 pounds (15 kilograms) but are less than 59 inches (150 centimeters) tall in a booster seat or a booster cushion.

We recommend that you use a booster seat that combines a cushion with a backrest instead of a booster cushion only. The raised seating position will allow you to position the shoulder strap of the adult safety belt over the center of your child's shoulder and the lap strap tightly across their hips.

## Booster Cushion (Group 3)



E68924

# Child Safety

## ISOFIX Anchor Points

### WARNING



Use an anti-rotation device when using the ISOFIX system. We recommend the use of a top tether or support leg.

**Note:** When you are purchasing an ISOFIX seat, make sure that you know the correct mass group and ISOFIX size class for the intended seating locations. See **Child Seat Positioning** (page 17).

Your vehicle has ISOFIX anchor points that accommodate universally approved ISOFIX child seats.

The ISOFIX system comprises two rigid attachment arms on the child seat that attach to anchor points on the outboard rear seats, where the cushion and backrest meet. Tether anchor points are located behind the outboard rear seats for child seats with a top tether.

## Top Tether Anchor Points



E142244

## Attaching a Child Seat with Top Tethers

### WARNINGS



Do not attach a tether strap to anything other than the correct tether anchor point.



Make sure that the top tether strap is not slack or twisted and is properly located on the anchor point.

**Note:** Where applicable, remove the luggage cover to ease installation. See **Luggage Covers** (page 157).

**Note:** You may need to raise or remove the head restraint to ease installation. See **Head Restraints** (page 96).

1. Route the tether strap under the head restraint to the anchor point.



E87145

2. Push the child seat back firmly to engage the ISOFIX lower anchor points.
3. Tighten the tether strap in line with the child seat manufacturer's instructions.

# Child Safety

## CHILD SAFETY LOCKS

### Manual Child Safety Locks

When these locks are set, the rear doors cannot be opened from the inside.



E112197

The child safety locks are located on the rear edge of each rear door and must be set separately for each door.

### Left-Hand Side

Turn counterclockwise to lock and clockwise to unlock.

### Right-Hand Side

Turn clockwise to lock and counterclockwise to unlock.

## Electric Child Safety Locks



E124779

Press the switch to turn them on.

Press the switch again to turn them off.

**Note:** You cannot use the rear power window switches with the child safety locks on.



# Safety Belts

## FASTENING THE SAFETY BELTS

### WARNINGS



Insert the tongue into the buckle until you hear a distinct click. You have not fastened the safety belt correctly if you do not hear a click.



Make sure that your safety belt is securely stored away and is not outside your vehicle when closing the door.



E74124

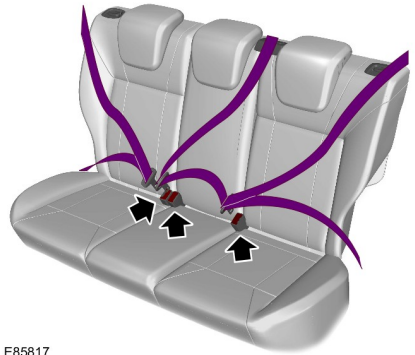

E85817

Pull the belt out steadily. It may lock if you pull it sharply or if your vehicle is on a slope.

The rear outer safety belts can lock if you return the seatback from a folded position to the upright position forcefully. Should the safety belt lock, recline the seat using the recline adjustment. See **Rear Seats** (page 100).

Press the red button on the buckle to release the belt. Hold the tongue and let it retract completely and smoothly to its stowed position.

### Using Safety Belts During Pregnancy

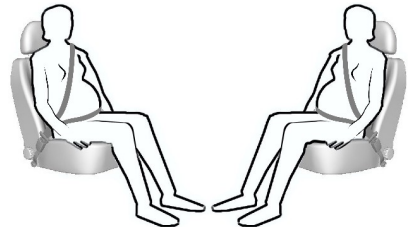

E68587

# Safety Belts

## WARNING



Position the safety belt correctly for your safety and that of your unborn child. Do not use only the lap strap or the shoulder strap.

Pregnant women should always wear their safety belt. The lap belt portion of a combination lap and shoulder belt should be positioned low across the hips below the belly and worn as tight as comfort will allow. The shoulder belt should be positioned to cross the middle of the shoulder and the center of the chest.

## SAFETY BELT HEIGHT ADJUSTMENT

### WARNING



Position the safety belt height adjusters so that the belt rests across the middle of your shoulder. Failure to adjust the safety belt correctly could reduce the effectiveness of the safety belt and increase the risk of injury in a crash.

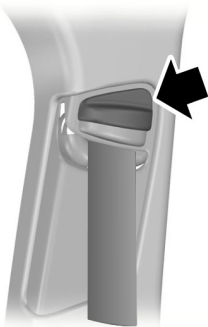

E87511

To adjust the shoulder belt height, squeeze the button and slide the height adjuster up or down. Release the button and pull down on the height adjuster to make sure it is locked in place.

## SAFETY BELT MINDER

### WARNING



The system will only provide protection when you use the safety belt correctly.

The warning lamp illuminates and an audible warning will sound when the following conditions have been met:

- The front safety belts have not been fastened.
- Your vehicle exceeds a relatively low speed.

It will also illuminate when a front safety belt is unfastened when your vehicle is moving.

If you do not fasten your safety belt both the audible and visual warnings will switch off automatically after approximately five minutes.

### Switching the Safety Belt Minder Off

See an authorized dealer.

### Rear Safety Belt Minder

#### WARNING



If multiple belts are unfastened within a few seconds of each other, only one audible chime will sound.

**Note:** Press **OK** on the steering wheel control to confirm the message.

# Safety Belts

---

The following status updates will be shown in the display:

- Tick symbol: Fastened safety belt.
- Exclamation mark: A safety belt that has been unfastened when your vehicle is moving. You will also hear an audible chime.

# Supplementary Restraints System

## PRINCIPLE OF OPERATION

### WARNINGS

 Extreme Hazard! Never use a rearward facing child restraint on a seat protected by an active airbag in front of it. Death or serious injury to the child can occur.

 Do not modify the front of your vehicle in any way. This could adversely affect deployment of the airbags. Failure to adhere to this warning could result in serious personal injury or death.

 Wear a safety belt and keep sufficient distance between yourself and the steering wheel. Only when you use the safety belt correctly, can it hold you in a position that allows the airbag to achieve its optimum effect. See **Sitting in the Correct Position** (page 96). Failure to adhere to this warning could result in serious personal injury or death.

 Repairs to the steering wheel, steering column, seats, airbags and safety belts must be carried out by an authorized dealer. Failure to adhere to this warning could result in serious personal injury or death.

 Keep the areas in front of the airbags free from obstruction. Do not affix anything to or over the airbag covers. In the event of a crash, hard objects could cause serious personal injury or death.

 Do not puncture the seat with sharp objects. This could damage and adversely affect deployment of the airbags. Failure to adhere to this warning could result in serious personal injury or death.

 Use seat covers designed for seats with side airbags. Have these fitted by an authorized dealer. Failure to adhere to this warning could result in serious personal injury or death.

**Note:** You will hear a loud bang and see a cloud of harmless powdery residue if an airbag deploys. This is normal.

**Note:** Only wipe airbag covers with a damp cloth.

## DRIVER AIRBAG

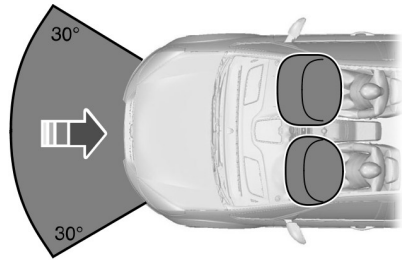

E74302

The airbag will deploy during significant frontal collisions or collisions that are up to 30 degrees from the left or the right. The airbag will inflate within a few thousandths of a second and deflate on contact with the occupant, thus cushioning forward body movement. During minor frontal collisions, overturns, rear collisions and side collisions, the airbag will not deploy.

# Supplementary Restraints System

## PASSENGER AIRBAG

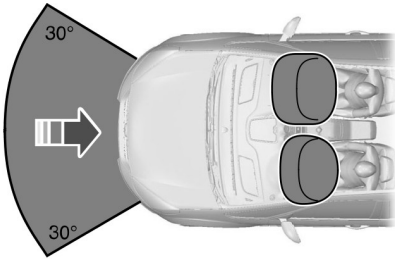

E74302

The airbag will deploy during significant frontal crashes or crashes that are up to 30 degrees from the left or the right. The airbag will inflate within a few thousandths of a second and deflate on contact with the occupant, thus cushioning forward body movement. During minor frontal crashes, overturns, rear crashes and side crashes, the airbag will not deploy.

### Switching the Passenger Airbag Off

#### WARNING



You must switch the airbag off when using a rearward facing child seat on the front seat.



E71313

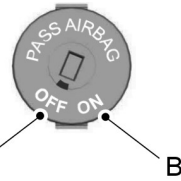

E71312

A Switch off

B Switch on

Turn the switch to position A.

When you switch the ignition on, check that the airbag deactivation warning lamp illuminates.

**Note:** The key switch is located on the end of the instrument panel on the passenger side with the airbag deactivation warning lamp in the overhead console.

### Switching the Passenger Airbag On

#### WARNING



You must switch the airbag on when you are not using a child seat on the front seat.

Turn the switch to position B.

## KNEE AIRBAG

#### WARNING



Do not attempt to open the airbag cover.

# Supplementary Restraints System

The airbag will deploy during frontal collisions or collisions that are up to 30 degrees from the left or the right. The airbag will inflate within a few thousandths of a second and deflate on contact with the occupants, thus providing a cushion between the driver's knees and the steering column. During overturns, rear collisions and side collisions, the knee airbag will not deploy.

For item location: See **At a Glance** (page 10).

**Note:** *The airbag has a lower deployment threshold than the front airbags. During a minor collision, it is possible that only the knee airbag will deploy.*

## SIDE AIRBAGS

### WARNING



Use seat covers designed for seats with side airbags. Have these fitted by an authorized dealer.



E72658

The airbags are located inside the seatback of the front seats. There is a label attached to the side of the seatback to indicate this.

The airbag will deploy during significant lateral collisions. The airbag will not deploy in minor lateral and frontal collisions, rear collisions, or overturns.

## SIDE CURTAIN AIRBAGS

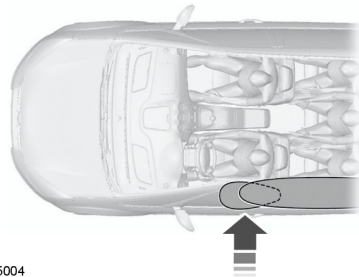

E75004

The airbags are located over the front and rear side windows.

The airbag will deploy during significant lateral collisions. It will also deploy during significant frontal angled collisions. The curtain airbag will not deploy in minor lateral and frontal collisions, rear collisions, or overturns.

# Keys and Remote Controls

## GENERAL INFORMATION ON RADIO FREQUENCIES

**Note:** Changes or modifications not expressly approved by the party responsible for compliance could void the user's authority to operate the equipment.

The typical operating range for your transmitter is approximately 33 ft (10 m).

A decrease in operating range could be caused by:

- weather conditions
- nearby radio towers
- structures around your vehicle
- other vehicles parked next to your vehicle.

The radio frequency used by your remote control can also be used by other short distance radio transmissions (e.g. amateur radios, medical equipment, wireless headphones, remote controls and alarm systems). If the frequencies are jammed, you will not be able to use your remote control. You can lock and unlock the doors with the key.

**Note:** Make sure your vehicle is locked before leaving it unattended.

**Note:** If you are in range, the remote control will operate if you press any button unintentionally.

## REMOTE CONTROL

### Reprogramming the Unlocking Function

**Note:** When you press the unlock button either all the doors are unlocked or only the driver's door and the liftgate are unlocked. Pressing the unlock button again unlocks all the doors.

Press and hold the unlock and lock buttons on the remote control simultaneously for at least four seconds with the ignition off. The direction indicators will flash twice to confirm the change.

To return to the original unlocking function, repeat the process.

### Changing the Remote Control Battery



Make sure that you dispose of old batteries in an environmentally friendly way.

Seek advice from your local authority regarding recycling.

### Remote Control with a Folding Key Blade

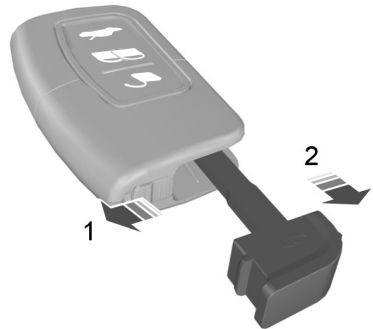

E78284

1. Slide the release slider in the direction of the arrow.
2. Remove the key blade.

# Keys and Remote Controls

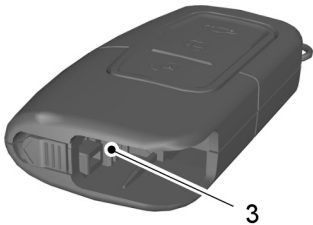

E105064

3. Twist the screwdriver in the position shown to separate the two halves of the remote control.
4. Carefully prise out the battery with the screwdriver.

**Note:** Do not touch the battery contacts or the printed circuit board with the screwdriver.

5. Install a new battery (3V CR 2032) with the + facing downwards.
6. Assemble the two halves of the remote control.
7. Install the key blade.

## Remote Control without a Folding Key Blade

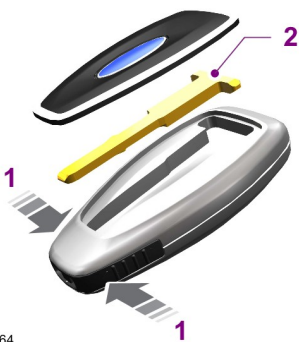

E87964

1. Press and hold the buttons on the edges to release the cover. Carefully remove the cover.
2. Remove the key blade.

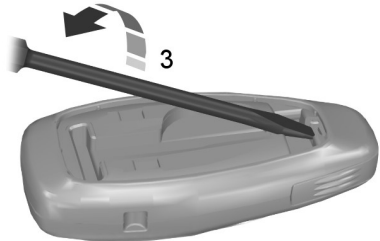

E105362

3. Twist the screwdriver in the position shown to start separating the two halves of the remote control.



E119190

4. Twist the screwdriver in the position shown to separate the two halves of the remote control.



# Keys and Remote Controls

---

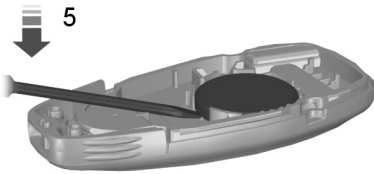

E125860

**Note:** Do not touch the battery contacts or the printed circuit board with the screwdriver.

5. Carefully prise out the battery with the screwdriver.
6. Install a new battery (3V CR 2032) with the + facing downwards.
7. Assemble the two halves of the remote control.
8. Install the key blade.

## REPLACING A LOST KEY OR REMOTE CONTROL

Replacement keys or remote controls can be purchased from an authorized dealer. Authorized dealers can program remote controls for your vehicle. See **Passive Anti-Theft System** (page 40).

To re-program the passive anti-theft system see an authorized dealer.

# Locks

## LOCKING AND UNLOCKING

### Power Door Locks

The power door lock control is located on the driver's and front passenger's door.

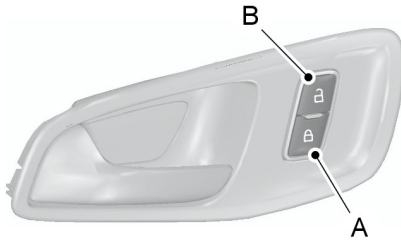

E148829

- A Lock
- B Unlock

### Remote Control

The remote control can be used any time your vehicle is not running.

### Unlocking the Doors



Press the button to unlock the driver's door. The direction indicators will flash once.

Press the button again within three seconds to unlock all doors. The direction indicators will flash once.

**Note:** You can unlock the driver's door with the key. Use the key when the remote control is not functioning.

**Note:** When you lock your vehicle for several weeks, the remote control will be switched off. Your vehicle must be unlocked and the engine started using the key. Unlocking and starting your vehicle once will enable the remote control.

### Reprogramming the Unlocking Function in keyless vehicles

You can reprogram the unlocking function so that only the driver's door is unlocked. See **Remote Control** (page 29).

### Locking the Doors



Press the button to lock all the doors. The direction indicators will illuminate.

Press the button again within three seconds to confirm that all the doors are closed. The doors will lock again, and the direction indicators will flash if all the doors and the luggage compartment are closed.

**Note:** If any door or the luggage compartment is not closed, or if the hood is not closed on vehicles that have an anti-theft alarm or remote start, the direction indicators will not flash.

### Double Locking

#### WARNING



Do not use double locking when passengers or animals are inside your vehicle. You will not be able to unlock the doors from the inside if you have double locked them.

Double locking is a theft protection feature that prevents someone from opening the doors from the inside. You can only double lock the doors if they are all closed.



Press the button twice within three seconds.

### Automatic Relocking

The doors will relock automatically if you do not open a door within 45 seconds of unlocking the doors with the remote control. The door locks and the alarm will return to their previous state.

# Locks

## Power Liftgate

### WARNINGS



Make sure all passengers are clear of the liftgate area before using the power liftgate control.



Close the liftgate properly to prevent exhaust fumes from entering your vehicle. This will prevent passengers and cargo from falling out. If you must drive with the liftgate open, keep the vents open so outside air can enter your vehicle.



Press twice within three seconds to open or close the liftgate, or to reverse the movement. See

**Power Liftgate** (page 35).

**Note:** Be careful when opening or closing the liftgate in a garage or other enclosed area to avoid damaging the liftgate.

## Locking and Unlocking the Doors from Inside

Use the lock and unlock buttons located on the driver's and front passenger's door.

## Locking and Unlocking the Doors with the Key

**Note:** Do not leave your keys in your vehicle.

### Locking with the Key

Turn the top of the key toward the front of your vehicle.

### Double Locking with the Key

Turn the key to the lock position twice within three seconds.

### Unlocking

Unlock the driver's door using the key. You can unlock all other doors individually by pulling the interior door handles.

**Note:** If the child safety locks are on and you pull the interior handle, you will only turn off the emergency locking, not the child safety lock. You can only open the doors using the external door handle.

**Note:** If the doors have been unlocked using this method, the doors must be locked individually until the central locking function has been repaired.

## Locking the Doors Individually with the Key

**Note:** When the central locking function fails to operate, lock the doors individually using the key in the position shown.

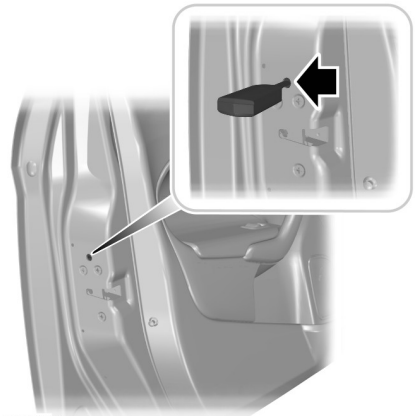

E112203

### Left-hand Side

Turn clockwise to lock.

### Right-hand Side

Turn counterclockwise to lock.

# Locks

## MANUAL LIFTGATE

### WARNINGS



It is extremely dangerous to ride in a cargo area, inside or outside of a vehicle. In a crash, people riding in these areas are more likely to be seriously injured or killed. Do not allow people to ride in any area of your vehicle that is not equipped with seats and safety belts. Be sure everyone in your vehicle is in a seat and using a safety belt properly. Failure to follow this warning could result in serious personal injury or death.



Make sure to close and latch the liftgate to prevent drawing exhaust fumes into your vehicle. This will also prevent passengers and cargo from falling out. If you must drive with the liftgate open, keep the vents or windows open so outside air comes into your vehicle. Failure to follow this warning could result in serious personal injury.

**Note:** Be careful when opening or closing the liftgate in a garage or other enclosed area to avoid damaging the liftgate.

**Note:** Do not hang anything, for example a bike rack, from the glass or liftgate. This could damage the liftgate and its components.

**Note:** Do not leave the liftgate open while driving. This could damage the liftgate and its components.

## Opening the Liftgate

### Manually

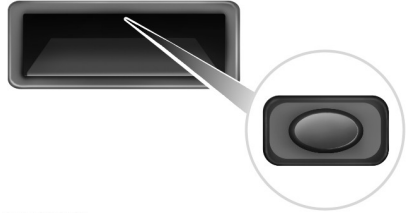

E138632

Press the button located in the top of the liftgate pull cup handle to unlatch the liftgate, and then pull on the outside handle.

### With the Remote Control



Press the button twice within three seconds.

## Closing the Liftgate







E155976

A handle is located inside the liftgate to help with closing.

# Locks

## POWER LIFTGATE

### WARNINGS

-  Do not operate the liftgate unless it is free from obstruction.
-  Careless opening and closing of the liftgate can override the protection function and cause injuries.
-  Do not place objects on the liftgate.
-  Make sure you fully close the liftgate after operation.
-  Operate the liftgate only when your vehicle is stationary.

You can operate the liftgate using the remote control, the center console switch, the liftgate switch, the liftgate release handle or the hands-free feature.

**Note:** Make sure there is enough headroom to open the liftgate.

**Note:** If your vehicle has an automatic transmission, make sure the transmission selector lever is in park.

**Note:** In extreme weather conditions, automatic opening and closing will not work with the liftgate frozen to the seal.

**Note:** The liftgate will stop automatically while opening and reverse some distance if there is an obstacle in the way.

**Note:** The liftgate will stop automatically while closing and fully open if there is an obstacle in the way.

**Note:** You can manually operate the liftgate.

## Liftgate switch

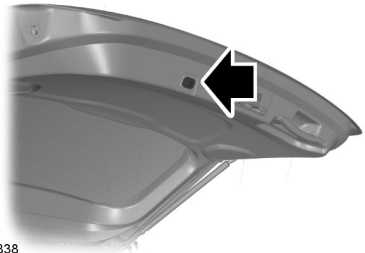

E129838

## Remote control and center console switch



**Note:** Switch the ignition on to operate the liftgate using the center console switch.

You will hear three chimes when the liftgate begins to close.

Five short chimes indicate a malfunction with the open or close request. This could be caused by one of the following:

- You switch the ignition on and the transmission selector lever is not in park.
- The battery voltage is below the minimum operating voltage.
- Your vehicle speed exceeds 3 mph (5 km/h).

To open a fully closed liftgate, you can either:

- Press the button on the remote control twice within three seconds.
- Press the center console switch.
- Use the liftgate release handle.
- Use the hands-free feature.

# Locks

To fully open a partially opened liftgate, you can either:

- Press the button on the remote control twice within three seconds.
- Press the center console switch or the liftgate switch.
- Use the liftgate release handle.
- Use the hands-free feature.

To stop the liftgate, you can either:

- Press the button on the remote control. A further remote control operation will be delayed for approximately three seconds.
- Press the center console switch or the liftgate switch.
- Use the liftgate release handle.
- Use the hands-free feature.

## Closing the Liftgate

### WARNING



The bounce-back feature will not work and it will not detect obstacles when the liftgate is in contact with the vehicle body.

**Note:** Do not leave a passive key in your vehicle when closing the liftgate. A message will be shown in the display. See **Information Messages** (page 74).

**Note:** A recessed grip is located inside the liftgate to help with closing.

You can either:

- Press the button on the remote control twice within three seconds.
- Press the center console switch or the liftgate switch.
- Use the liftgate release handle.
- Use the hands-free feature.
- Manually close the liftgate

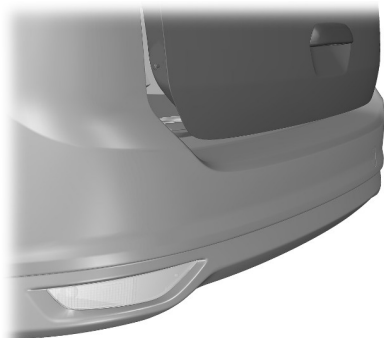

E130232

The liftgate will close automatically when it comes into contact with the vehicle body.

## Programming the Liftgate

1. Open the liftgate.
2. Manually move the liftgate to the new required position.
3. Press and hold the liftgate switch for at least three seconds. You will hear a chime.

## Hands-Free Feature

**Note:** Make sure you have a remote control within 3 feet (1 meter) of the liftgate.

1. Move your foot under and away from the rear bumper similar to a kicking motion.

# Locks



E161602

2. The liftgate will power open or close.

**Note:** Manually pushing or pulling the liftgate may enable the bounce-back feature and stop the liftgate from opening or closing.

**Note:** Splashing water may cause the liftgate to open. Keep the remote control away from the rear bumper detection area when washing your vehicle.

**Note:** This feature may not function correctly if your vehicle has a tow ball.

## KEYLESS ENTRY

### General Information

#### WARNING



The system may not function if the key is close to metal objects or electronic devices such as cell phones.

The system will not function if:

- Your vehicle battery has no charge.
- The passive key frequencies are jammed.
- The passive key battery has no charge.

**Note:** If the system does not function, you will need to use the key blade to lock and unlock your vehicle.

The system allows you to operate your vehicle without the use of a key or remote control.

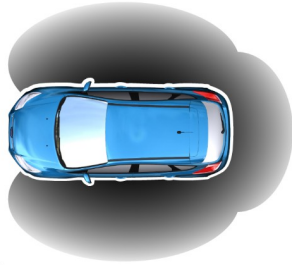

E78276

Passive locking and unlocking requires a valid passive key to be located within one of the three external detection ranges. These are located approximately five feet (1.5 meters) from the front door handles and the liftgate.

### Passive Key

Your vehicle can be locked and unlocked with the passive key. You can use the passive key as a remote control. See **Locking and Unlocking** (page 32).

### Locking Your Vehicle

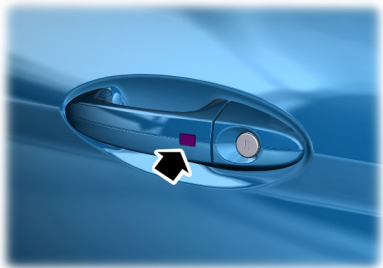

E87384

# Locks

## WARNING



Your vehicle does not lock itself automatically. If you do not press a locking button your vehicle will remain unlocked.

Locking buttons are located on each of the front doors.

For central locking and to arm the alarm, press a locking button once.

For double locking and to arm the alarm, press a locking button twice within three seconds.

**Note:** When locking your vehicle, do not grip the door handle.

**Note:** Your vehicle will remain locked for approximately three seconds. When the delay period is over, you can open the doors again, provided the passive key is within the respective detection range.

Two short flashes of the direction indicators confirms that all the doors and the liftgate have been locked and that the alarm has been armed.

## Liftgate

**Note:** The liftgate cannot be closed and will reopen if the passive key is located inside the luggage compartment with the doors locked.

**Note:** If a second valid passive key is located within the liftgate detection range, the liftgate can be closed.

## Unlocking Your Vehicle

One long flash of the direction indicators confirms that all the doors and the liftgate have been unlocked and that the alarm has been disarmed.

**Note:** When your vehicle remains locked for longer than three days, the system will enter an energy-saving mode. This is to prevent the vehicle battery running out of charge. When your vehicle is unlocked while in this mode, the reaction time of the system may be a little longer than normal. To exit the energy-saving mode, unlock your vehicle.

**Note:** A valid passive key must be located within the detection range of that door.

## Unlocking Only the Driver's Door

If the unlocking function is reprogrammed so that only the driver's door and the liftgate are unlocked. See **Remote Control** (page 29). Note the following:

If the driver's door is the first door which is opened, the other doors will remain locked. All the other doors can be unlocked from inside your vehicle by pressing the unlock button located on the driver's and front passenger's door. Doors can be unlocked individually by pulling the interior door handles on those doors.

If the front passenger's door is the first door which is opened, all the doors and the liftgate will be unlocked.

## Disabled Keys

Any keys left inside your vehicle interior when it is locked will be disabled.

You cannot use a disabled key to switch the ignition on or start the engine.

You must enable all passive keys again in order to use them.

To enable all your passive keys, unlock your vehicle using a passive key that has not been disabled or the remote control unlocking function.

All passive keys will then be enabled if you switch the ignition on or you start your vehicle with a valid key.



# Locks

---

## Locking and Unlocking the Doors with the Key Blade

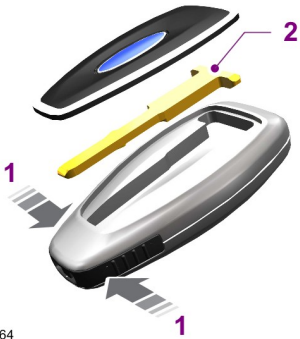

E87964

1. Carefully remove the cover.
2. Remove the key blade and insert it into the lock.

**Note:** Only the driver's door handle has a lock cylinder.

# Security

## PASSIVE ANTI-THEFT SYSTEM

### Principle of Operation

The system prevents someone from starting the engine with an incorrectly coded key.

### Coded Keys

If you lose a key, you can obtain a replacement from an authorized dealer. If possible, provide them with the key number from the tag provided with the original keys. You can also obtain extra keys from an authorized dealer.

**Note:** Have all of your remaining keys erased and recoded if you lose a key. Have replacement keys coded together with recoding your remaining keys. See an authorized dealer for further information.

**Note:** Do not shield your keys with metal objects. This may prevent the receiver from recognizing a coded key.

### Arming the Engine Immobilizer

When you switch the ignition off the engine immobilizer will arm automatically after a short time.

### Disarming the Engine Immobilizer

When you switch the ignition on the engine immobilizer will disarm automatically if a correctly coded key is used.

If you are unable to start the engine with a correctly coded key, have your vehicle checked by an authorized dealer.

## ANTI-THEFT ALARM

### Alarm System

Your vehicle may have one of the following alarm systems:

- Perimeter alarm.
- Perimeter alarm with interior sensors.
- Category one alarm with interior sensors and battery back-up sounder.

### Perimeter Alarm

The perimeter alarm is a deterrent against unauthorized access to your vehicle through the doors and the hood. It also protects the audio unit.

### Interior Sensors

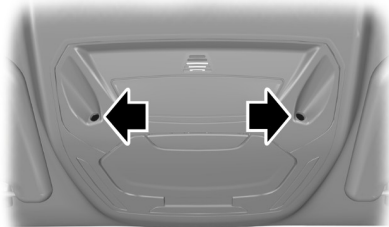

E131656

### WARNINGS



Do not cover up the interior lamp unit sensors.



Do not arm the alarm with full guard if passengers, animals or other moving objects are inside your vehicle.

The sensors act as a deterrent against unauthorized intrusion by sensing any movement within your vehicle.

# Security

## Battery Back-up Sounder

The battery back-up sounder is an extra alarm system which will sound a siren when the alarm is triggered. When you lock your vehicle the system is armed. The sounder has its own battery and will sound an alarm siren even if someone disconnects your vehicle battery or the battery back-up sounder itself.

## Triggering the Alarm

Once armed, the alarm is triggered in any of the following ways:

- If someone opens a door, the liftgate or the hood without a valid key or remote control.
- If someone removes the audio or navigation system.
- If you switch the ignition on without a valid key.
- If the interior sensors detect movement within your vehicle.
- On vehicles with a battery back-up sounder, if someone disconnects your vehicle battery or the battery back-up sounder itself.

If the alarm is triggered, the alarm horn will sound for 30 seconds and the hazard warning flasher will flash for five minutes.

Any further attempts to perform one of the above will trigger the alarm again.

## Full and Reduced Guard

### Full Guard

Full guard is the standard setting.

In full guard, the interior sensors are on when you arm the alarm.

**Note:** *This may result in false alarms if animals or moving objects are inside your vehicle.*

### Reduced Guard

In reduced guard, the interior sensors are off when you arm the alarm.

**Note:** *You can set the alarm to reduced guard for the current ignition cycle only. The alarm will reset to full guard the next time you switch the ignition on.*

### Ask on Exit (If Equipped)

You can set the information display to ask you each time which level of guard you wish to set.

If you select **Ask on Exit**, the message **Reduced guard** appears in the information display each time you switch the ignition off. See **Information Messages** (page 74).

If you wish to arm the alarm with reduced guard, press the **OK** button when this message appears.

If you wish to arm the alarm with full guard, leave your vehicle without pressing the **OK** button.

### Selecting Full or Reduced Guard

**Note:** *Selecting reduced guard does not set the alarm permanently to reduced guard. It sets it to reduced guard only for the current ignition cycle. If you regularly set the alarm to reduced guard, select **Ask on Exit**.*

You can select full or reduced guard using the information display. See **General Information** (page 68).

### Arming the Alarm

To arm the alarm, lock your vehicle. See **Locks** (page 32).

## Disarming the Alarm

### Vehicles Without Keyless Entry

#### **Perimeter Alarm**

Disarm and silence the alarm by unlocking the doors with the key and switching the ignition on with a correctly coded key or unlocking the doors with the remote control.

#### **Category One Alarm**

Disarm and silence the alarm by unlocking the doors with the key and switching the ignition on with a correctly coded key within 12 seconds or unlocking the doors with the remote control.

### Vehicles with Keyless Entry

**Note:** *A valid passive key must be located within the detection range of that door for keyless entry. See **Keyless Entry** (page 37).*

#### **Perimeter Alarm**

Disarm and silence the alarm by unlocking the doors and switching the ignition on or unlocking the doors with the remote control.

#### **Category One Alarm**

Disarm and silence the alarm by unlocking the doors and switching the ignition on within 12 seconds or unlocking the doors or the liftgate with the remote control.

# Steering Wheel

## ADJUSTING THE STEERING WHEEL

### WARNING

 Do not adjust the steering wheel when your vehicle is moving.

**Note:** Make sure that you are sitting in the correct position. See **Sitting in the Correct Position** (page 96).



E95178

1. Unlock the steering column.
2. Adjust the steering wheel to the desired position.



E95179

3. Lock the steering column.

## AUDIO CONTROL

Select the required source on the audio unit.

You can operate the following functions with the control:

# Steering Wheel

## Type 1

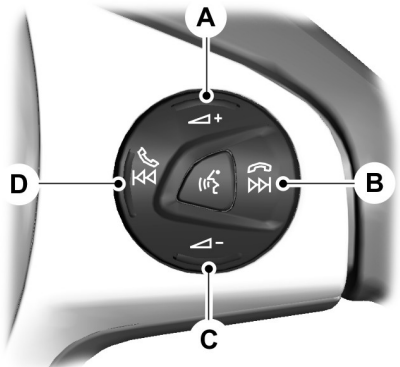

E159789

- A Volume up
- B Seek up, next or end call
- C Volume down
- D Seek down, previous or accept call

## Type 2

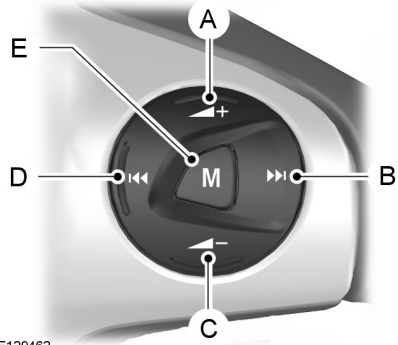

E129462

- A Volume up
- B Seek up or next
- C Volume down
- D Seek down or previous
- E Mode

Press **M** to select the audio source.

### Seek, Next or Previous

Press the seek button to:

- tune the radio to the next or previous stored preset
- play the next or the previous track.

Press and hold the seek button to:

- tune the radio to the next station up or down the frequency band
- seek through a track.

# Steering Wheel

## VOICE CONTROL



E159531

Press the button to select or deselect voice control. See **SYNC™** (page 247).

## INFORMATION DISPLAY CONTROL



E130248

See **Information Displays** (page 68).

## Multimedia Controls (If Equipped)

## CRUISE CONTROL



E157482

See **Cruise Control** (page 139).



E145434

Use the arrows on the right side of the steering wheel to navigate through the menus. Press **OK** to make a selection.

# Wipers and Washers

## WINDSHIELD WIPERS

**Note:** Fully defrost the windshield before switching on the windshield wipers.

**Note:** Make sure the windshield wipers are switched off before entering a car wash.

**Note:** Clean the windshield and wiper blades if they begin to leave streaks or smears. If that does not resolve the issue, install new wiper blades.

**Note:** Do not operate the wipers on a dry windshield. This may scratch the glass, damage the wiper blades or cause the wiper motor to burn out. Always use the windshield washers before wiping a dry windshield.

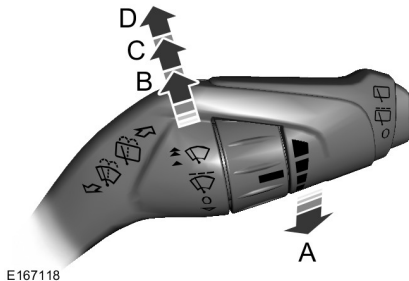

E167118

- A Single wipe
- B Intermittent wipe
- C Normal wipe
- D High speed wipe

## Intermittent Wipe

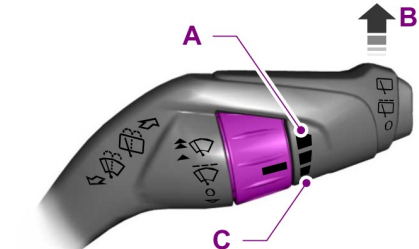

E167119

- A Short wipe interval
- B Intermittent wipe
- C Long wipe interval

Use the rotary control to adjust the intermittent wipe interval.

## Speed dependent wipers (if equipped)

When your vehicle speed increases, the interval between wipes will decrease.

## AUTOWIPERS (IF EQUIPPED)

**Note:** Fully defrost the windshield before switching on the windshield wipers.

**Note:** Make sure the windshield wipers are switched off before entering a car wash.

**Note:** Clean the windshield and wiper blades if they begin to leave streaks or smears. If that does not resolve the issue, install new wiper blades.

**Note:** If you switch autolamps on in conjunction with autowipers, the low beam headlamps will illuminate automatically when the rain sensor activates the windshield wipers continuously.

**Note:** Wet road conditions can cause unexpected wiping or smearing.



# Wipers and Washers

To reduce smearing we recommend the following:

- Lower the sensitivity of the autowipers.
- Switch to normal or high speed wipe.
- Switch the autowipers off.

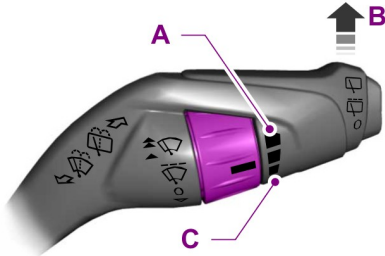

E167119

- A High sensitivity
- B On
- C Low sensitivity

The wipers will function when moisture is detected on the windshield. The rain sensor will continue to monitor the amount of moisture on the windshield and adjust the speed of the wipers automatically.

Use the rotary control to adjust the sensitivity of the rain sensor. With low sensitivity, the wipers will operate when the sensor detects a large amount of moisture on the windshield. With high sensitivity, the wipers will operate when the sensor detects a small amount of moisture on the windshield.

Keep the outside of the windshield clean. Sensor performance will be affected if the area around the interior mirror is dirty. The rain sensor is very sensitive and the wipers may operate if dirt, mist or flies hit the windshield.

## WINDSHIELD WASHERS

**Note:** Do not operate the washers when the washer reservoir is empty. This may cause the washer pump to overheat.



E129188

The washers will spray for as long as you pull the lever toward you. When you release the lever, the wipers will operate for a short time.

## REAR WINDOW WIPER AND WASHERS

### Rear Window Wiper



E167121

- A Intermittent wipe / Low speed wipe
- B Off

Press the top of the button at the end of the lever to change between intermittent and low speed wipe. Press the bottom of the button to turn the wiper off.

# Wipers and Washers

---

When you shift into R (Reverse), the rear wiper will switch on to intermittent if the front wipers are activated.

## Rear Window Washer

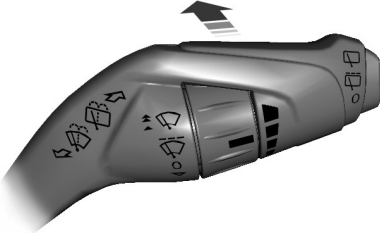

E167407

The washer will spray for as long as you push the lever away from you. When you release the lever, the wiper will operate for a short time.

## HEADLAMP WASHERS

When the headlamps are on, the headlamp washers will operate with the windshield washers.

**Note:** *The headlamp washers will not operate every time you use the windshield washers. This is to prevent the washer fluid reservoir from emptying quickly.*

# Lighting

## GENERAL INFORMATION

### Condensation in Lamp Assemblies

Exterior lamps have vents to accommodate normal changes in air pressure.

Condensation can be a natural by-product of this design. When moist air enters the lamp assembly through the vents, there is a possibility that condensation can occur when the temperature is cold. When normal condensation occurs, a fine mist can form on the interior of the lens. The fine mist eventually clears and exits through the vents during normal operation.

Clearing time may take as long as 48 hours under dry weather conditions.

Examples of acceptable condensation are:

- The presence of a fine mist (no streaks, drip marks or large droplets).
- A fine mist covers less than 50% of the lens.

Examples of unacceptable condensation are:

- A water puddle inside the lamp.
- Streaks, drip marks or large droplets present on the interior of the lens.

If you see any unacceptable condensation, have your vehicle checked by an authorized dealer.

## LIGHTING CONTROL

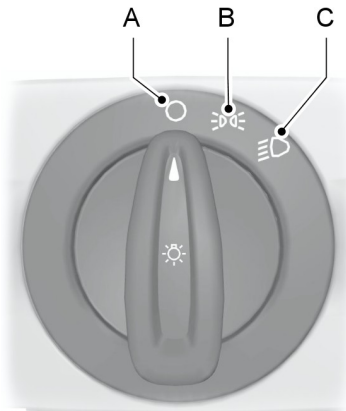

E70718

- A Off
- B Parking lamps, instrument panel lamps, license plate lamps and tail lamps
- C Headlamps

### High Beam



E130140

Push the lever forward to switch the high beam on.

Push the lever forward again or pull the lever toward you to switch the high beam off.

# Lighting

## Headlamp Flasher



E142450

Pull the lever toward you slightly and release it to flash the headlamps.

## AUTOLAMPS



E70719

The headlamps will turn on and off automatically in low light situations or during inclement weather.

**Note:** *It may be necessary to switch your headlamps on manually in severe weather conditions.*

The headlamps will remain on for a period of time after you switch the ignition off. You can adjust the time delay using the information display controls. See **Information Displays** (page 68).

**Note:** *If you switch autolamps on in conjunction with autowipers, low beam headlamps will illuminate automatically when the rain sensor activates the windshield wipers continuously.*

## INSTRUMENT LIGHTING DIMMER



E148739

## HEADLAMP EXIT DELAY

After you switch the ignition off, you can switch the headlamps on by pulling the direction indicator lever toward you. You will hear a short tone. The headlamps will switch off automatically after three minutes with any door open or 30 seconds after the last door has been closed. You can cancel this feature by pulling the direction indicator toward you again or switching the ignition on.

# Lighting

## DAYTIME RUNNING LAMPS

### WARNING

 Always remember to switch your headlamps on in low light situations or during inclement weather. The system does not activate the tail lamps and may not provide adequate lighting during these conditions. Failure to activate your headlamps under these conditions may result in a collision.

To switch the system on:

1. Switch the ignition on.
2. Switch the lighting control to the off or autolamp position.

## AUTOMATIC HIGH BEAM CONTROL

### WARNINGS

 The system does not relieve you of your responsibility to drive with due care and attention. A manual override may be necessary if the system fails to switch the high beam on or off.

 A manual override may be required when approaching other road users such as cyclists.

 Do not use the system in fog.

 In cold and severe weather conditions the system may not function. A manual override may be necessary in these cases.

 The system may not deactivate the high beam if the lights of oncoming vehicles are hidden by obstacles (for example guard rails).

### WARNINGS

 Check and replace wiper blades regularly to ensure the camera sensor has a clear view through the windscreen. Replacement wiper blades must be the correct length.

**Note:** *Keep the windscreen free from obstructions such as bird droppings, insects and snow or ice.*

**Note:** *Reflective road signs may be detected as oncoming traffic and the headlamps will be switched to low beam.*

**Note:** *Always fit Ford Original Parts when replacing headlamp bulbs. Other bulbs may reduce system performance.*

The system will automatically switch on high beams if it is dark enough and no other traffic is present. If it detects an approaching vehicle's headlamps or tail lamps, or street lighting ahead the system will switch off high beam before it can distract other road users. Low beam will remain on.

A camera sensor is centrally mounted behind the windshield of your vehicle. This monitors conditions continuously to decide when to switch the high beams on and off.

Once the system is active the high beam will switch on if:

- It is dark enough to require the use of high beams and
- there is no traffic or street lighting ahead and
- vehicle speed is greater than 25 mph (40 km/h).

The high beam will switch off if:

- The ambient light is high enough that high beam is not required.
- An approaching vehicle's headlamps or tail lamps are detected.
- Street lighting is detected.

# Lighting

- Vehicle speed falls below 16 mph (25 km/h).
- The camera sensor is too hot or becomes blocked.

## Switching the System On

Switch the system on using the information display. See **Information Displays** (page 68).



E70719

Turn the switch to the autolamps position. See **Autolamps** (page 50).



The indicator will illuminate to confirm when the system is ready to assist.

**Note:** The indicator will only illuminate when it is dark and headlamps have been switched on.

**Note:** The system may take a short time to initialize after first switching the ignition on, especially in very dark conditions. The high beam will not automatically switch on during this time.

## Setting the System Sensitivity

The system has three sensitivity levels which can be accessed via the information display. See **Information Displays** (page 68).

The set level determines the speed at which the high beam will be restored after detected traffic leaves the field of view.

## Manually Overriding the System

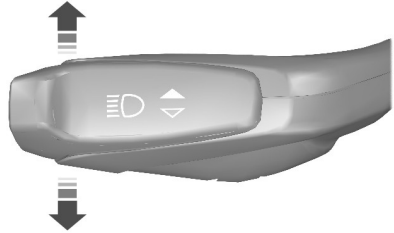

E133632

Push or pull the lever to switch between high and low beam.

**Note:** This is a temporary override and the system will return to automatic operation after a short period.

To permanently switch the system off, use the information display menu or turn the lighting control switch to the headlamps position.

## FRONT FOG LAMPS

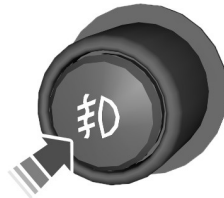

E70721

Press the control to switch the fog lamps on or off.

You can switch the fog lamps on when the lighting control is in any position except off.

# Lighting

## REAR FOG LAMPS



E70720

### WARNINGS



Only use the rear fog lamps when visibility is restricted to less than 164 feet (50 meters).



Do not use the rear fog lamps when it is raining or snowing and visibility is more than 164 feet (50 meters).

Press the control to switch the fog lamps on or off.

You can switch the fog lamps on when either the front fog lamps or low beam headlamps are on.

## HEADLAMP LEVELING

**Note:** Vehicles with Xenon headlamps have automatic headlamp leveling.

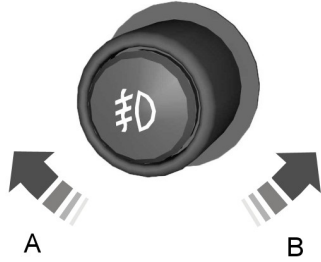

E70722

- A Raised headlamp beams
- B Lowered headlamp beams

You can adjust the level of the headlamp beams according to your vehicle load.

## Recommended Headlamp Leveling Switch Positions

Load		Load in luggage compartment*	Switch position
Front seats	Second row seats		
1-2	-	-	0
1-2	3	-	2
1-2	3	Max	2.5
1	-	Max	4

\* See **Vehicle Identification Plate** (page 210).

# Lighting

## CORNERING LAMPS (IF EQUIPPED)

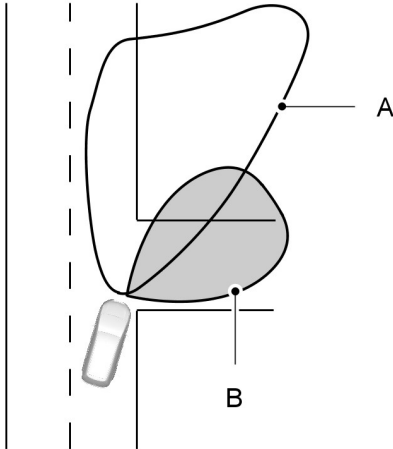

E72898

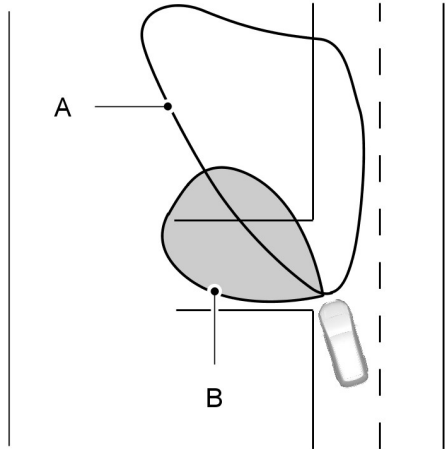

- A Headlamp beam
- B Cornering lamp beam

The cornering lamps illuminate the inside of a corner when you are turning.

## DIRECTION INDICATORS



E162681

Push the lever up or down to use the direction indicators.

**Note:** Tap the lever up or down to make the direction indicators flash three times to indicate a lane change.

## INTERIOR LAMPS

The lamps will switch on when one of the following conditions have been met:

- You open any door.
- You press a remote control button.
- You press switch B on the front interior lamp.



# Lighting

## Front Interior Lamp

### Without moonroof

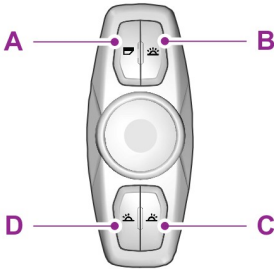

E161163

 (A) Door function switch. Press this switch to disable the interior lamps. The door function indicator lamp will illuminate yellow with lamps disabled. Press the switch again to turn interior lamps back on. The indicator lamp will illuminate blue.

 (B) All lamps on and off switch.

 (C) Passenger individual lamp on and off switch.

 (D) Driver individual lamp on and off switch.

### With moonroof

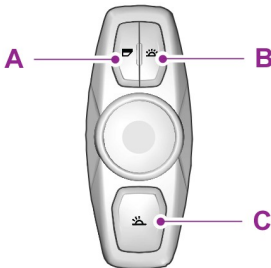

E142454



(A) Door function switch. Press this switch to disable the interior lamps. The door function indicator lamp will illuminate yellow with lamps disabled. Press the switch again to turn interior lamps back on. The indicator lamp will illuminate blue.



(B) All lamps on and off switch.



(C) Individual lamp on and off switch.

## Rear Interior Lamp (If Equipped)

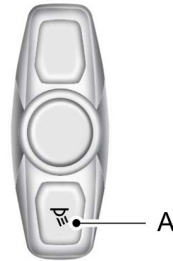

E142455

(A) You can switch individual map lamps on independently by pressing switch.

## AMBIENT LIGHTING (IF EQUIPPED)

The ambient lighting system illuminates the interior with a choice of several colors. The ambient lighting control is located in the overhead console.

# Lighting

---

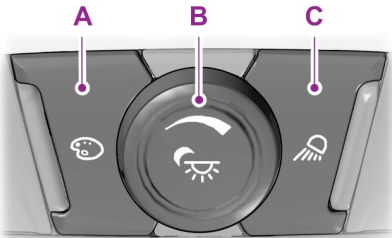

E142456

- A Color palette
- B Control knob
- C Search mode

Rotate B past the first detent to switch on and adjust to the desired brightness.

Press A to cycle through the color choices.

Press C to switch on all interior lamps and the ambient lighting. Press C again to switch off the interior lamps and return the ambient lighting to the previously selected color.

The ambient lighting will switch on when the following conditions have been met:

- you switch the ignition on
- you switch the headlamps on

The ambient lighting will remain on until you switch the ignition off and one of the following conditions have been met:

- you lock your vehicle
- the accessory delay timer expires.

# Windows and Mirrors

## POWER WINDOWS

### WARNINGS



Do not leave children unattended in your vehicle and do not let them play with the power windows. They may seriously injure themselves.



When closing the power windows, you should verify they are free of obstructions and make sure that children and pets are not in the proximity of the window openings.



E70848

**Note:** You may hear a pulsing noise when just one of the windows is open. Lower the opposite window slightly to reduce this noise.

Press the switch to open the window.

Lift the switch to close the window.

### One-Touch Down (If Equipped)

Press the switch fully and release it. Press again or lift it to stop the window.

### One-Touch Up (If Equipped)

Lift the switch fully and release it. Press or lift it again to stop the window.

## Window Lock



E70850

Press the control to lock or unlock the rear window controls. It will illuminate when the rear window controls are locked.

### Bounce-Back (If Equipped)

The window will stop automatically while closing. It will reverse some distance if there is an obstacle in the way.

### Overriding the Bounce-Back Feature

#### WARNING



When you override the bounce-back feature the window will not reverse if it detects an obstacle. Take care when closing the windows to avoid personal injury or damage to your vehicle.

Proceed as follows to override this protection feature when there is a resistance, for example in winter:

1. Close the window twice until it reaches the point of resistance and let it reverse.

# Windows and Mirrors

2. Close the window a third time to the point of resistance. The bounce-back feature is now disabled and you can close the window manually. The window will go past the point of resistance and you can close it fully.

See an authorized dealer as soon as possible if the window does not close after the third attempt.

## Resetting the Bounce-Back Feature

### WARNING



The bounce-back feature remains turned off until you reset the memory.

If you have disconnected the battery, you must reset the bounce-back memory separately for each window.

1. Lift and hold the switch until the window is fully closed.
2. Release the switch.
3. Lift the switch again for one more second.
4. Press and hold the switch until the window is fully open.
5. Release the switch.
6. Lift and hold the switch until the window is fully closed.
7. Open the window and then try to close it automatically.
8. Reset and repeat the procedure if the window does not close automatically.

## Accessory Delay (If Equipped)

You can use the window switches for several minutes after you have switched the ignition off or until either front door is opened.

## EXTERIOR MIRRORS

### Power Exterior Mirrors

#### WARNING



Do not adjust the mirrors when your vehicle is moving.

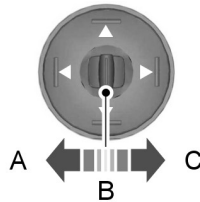

E70846

- A Left-hand mirror
- B Off
- C Right-hand mirror

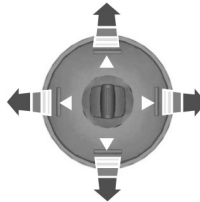

E70847

Press the arrows to adjust the mirror.

### Automatic Folding and Unfolding

The mirrors will fold automatically when you lock your vehicle with the key, the remote control or a keyless entry system request. The mirrors will unfold when you unlock your vehicle with the key, the remote control, a keyless entry system request or the driver side interior door handle.

**Note:** *If you fold the mirrors using the manual fold button, you can only unfold them again manually.*

# Windows and Mirrors

## Manual Folding and Unfolding

The electric folding mirrors operate with the ignition on, and for several minutes after you switch the ignition off.

**Note:** They will no longer operate if you switch the ignition off and open a door.

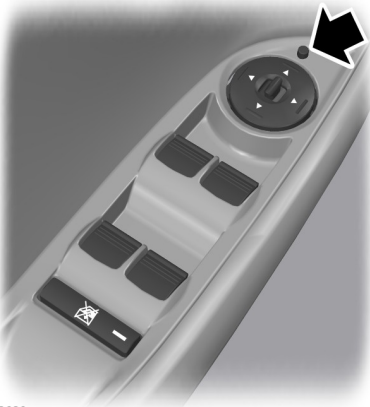

E72623

Press the button to fold or unfold the mirrors.

Press the button again to stop and reverse the direction of movement.

**Note:** Continuous folding and unfolding of the mirrors will cause them to overheat and shut down for a short time. This is to avoid permanent damage.

## Fold-Away Exterior Mirrors

Push the mirror toward the door window glass. Make sure that you fully engage the mirror in its support when returning it to its original position.

## INTERIOR MIRROR

### WARNING



Do not adjust the mirror when your vehicle is moving.

**Note:** Do not clean the housing or glass of any mirror with harsh abrasives, fuel or other petroleum or ammonia-based cleaning products.

You can adjust the interior mirror to your preference.

Pull the tab below the mirror toward you to reduce glare at night.

## Auto-Dimming Mirror

**Note:** Do not block the sensors on the front and back of the mirror. Mirror performance may be affected. A rear center passenger or raised rear center head restraint may also block light from reaching the sensor.

The mirror will dim automatically to reduce glare when bright lights are detected from behind your vehicle. It will automatically return to normal reflection when you select reverse gear to make sure you have a clear view when backing up.

## SUN VISORS

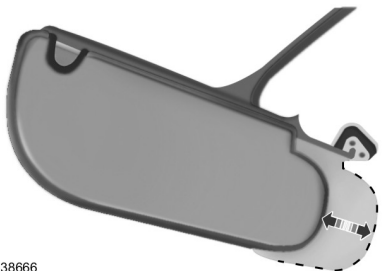

E138666

# Windows and Mirrors

Rotate the sun visor toward the side window and extend it rearward for extra shade.

## Illuminated Vanity Mirror (If Equipped)

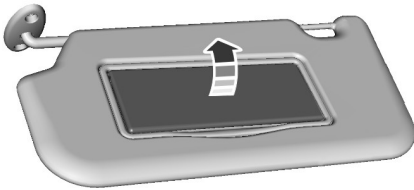

E162197

Lift the cover to switch the lamp on.

## MOONROOF (IF EQUIPPED)

### WARNINGS



Do not let children play with the moonroof or leave them unattended in the vehicle. They may seriously hurt themselves.



When closing the moonroof, you should verify that it is free of obstructions and make sure that children and pets are not in the proximity of the roof opening.

The moonroof and sunscreen controls are located on the overhead console.

The moonroof and sunscreen have a one-touch open and close feature. To stop them during one-touch operation, press the control a second time.

## Opening and Closing the Sunscreen



E138668

Press and release the rear of the control to open the sunroof.

Press and release the front of the control to close the sunroof. If it is open, the moonroof will automatically close before the sunroof closes.

## Opening and Closing the Moonroof

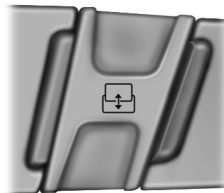

E138669

Press and release the rear of the control to open the moonroof. If it is closed, the sunroof will automatically open before the moonroof opens. The moonroof will stop short of the fully opened position.

**Note:** *This position helps to reduce wind noise or rumbling which may happen with the moonroof fully open. Press and hold the control again to fully open the moonroof.*

Press and release the front of the control to close the moonroof.

## Bounce-Back

The moonroof will stop automatically while closing. It will reverse some distance if there is an obstacle in the way.

# Windows and Mirrors

Press and hold the front of the control within two seconds of a bounce-back event to override this function. While bounce-back is active, the closing force increases for each of the next three times that you close the moonroof.

## Venting the Moonroof

Press and release the front of the control to vent the moonroof. Press and release the rear of the control to close the moonroof.

## GLOBAL OPENING AND CLOSING

You can also operate the power windows with the ignition off using the global opening and global closing function.

**Note:** *Global opening will only operate for a short period of time after you have unlocked your vehicle using the remote control.*

**Note:** *Global closing will only operate if you have set the memory correctly for each window. See **Power Windows** (page 57).*

### Global Opening

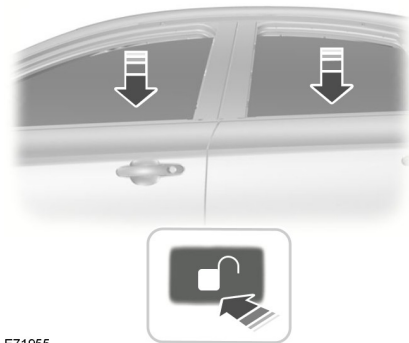

E71955

To open all the windows:

1. Press and release the remote control unlock button.
2. Press and hold the remote control unlock button for at least three seconds.

Press the lock or unlock button to stop the opening function.

## Global Closing

### Vehicles Without Keyless Entry

#### WARNING



Take care when using global closing. In an emergency, press the lock or unlock button immediately to stop.

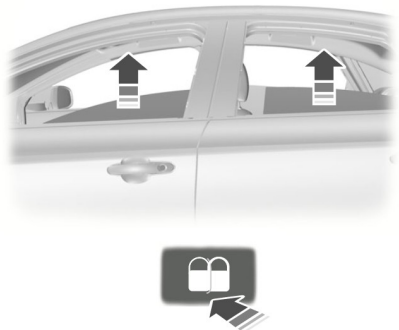

E71956

To close all the windows, press and hold the remote control lock button for at least three seconds. Press the lock or unlock button to stop the closing function. The bounce-back function is also on during global closing.

# Windows and Mirrors

---

## Vehicles With Keyless Entry

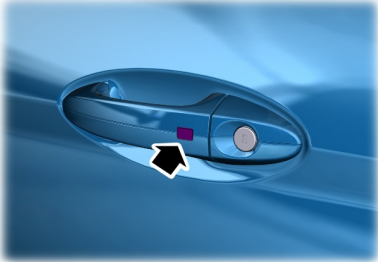

E87384

### WARNING



Take care when using global closing. In an emergency, touch a door handle lock sensor to stop.

**Note:** *Global closing can be switched on using the driver's door handle. Global opening and closing can also be switched on using the buttons on the passive key.*

To close all the windows, press and hold the driver's door handle for at least three seconds. The bounce-back function is also on during global closing.



# Instrument Cluster

## GAUGES

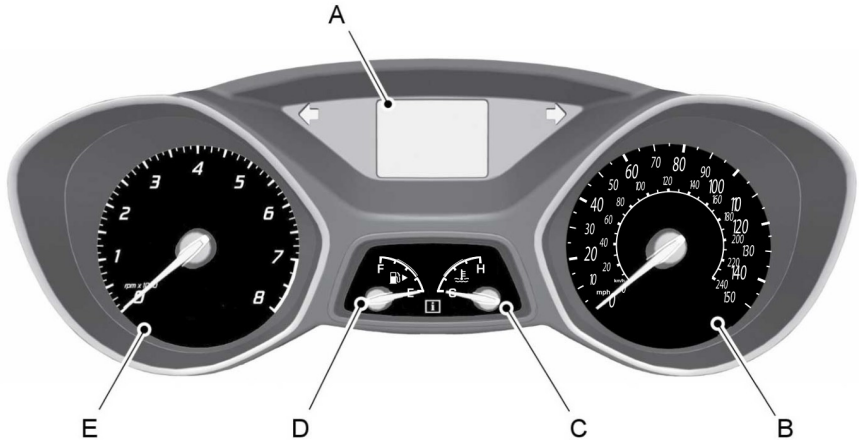

E145825

- A Information display
- B Speedometer
- C Engine coolant temperature gauge
- D Fuel gauge
- E Tachometer

### Information Display

#### Odometer

Located in the bottom of the information display, it registers the accumulated distance your vehicle has traveled.

#### Outside Air Temperature

Shows the outside air temperature.

### Trip Computer

See **Trip Computer** (page 73).

### Vehicle Settings and Personalization

See **General Information** (page 68).

# Instrument Cluster

## Engine Coolant Temperature Gauge

### WARNING



Never remove the coolant reservoir cap while the engine is running or hot.

At normal operating temperature, the needle will remain in the center section.

**Note:** Do not restart the engine until the cause of overheating has been resolved.

If the needle enters the red section, the engine is overheating. Stop the engine, switch the ignition off and determine the cause once the engine has cooled down. See **Engine Coolant Check** (page 184).

## Fuel Gauge

Switch the ignition on. The fuel gauge will indicate approximately how much fuel is left in the fuel tank. The fuel gauge may vary slightly when your vehicle is moving or on a gradient. The arrow adjacent to the fuel pump symbol indicates on which side of the vehicle the fuel filler door is located.

## WARNING LAMPS AND INDICATORS

The following warning lamps and indicators will alert you to a vehicle condition that may become serious. Some lamps will illuminate when you start your vehicle to make sure they work. If any lamps remain on after starting your vehicle, refer to the respective system warning lamp for further information.

**Note:** Some warning indicators appear in the information display and function the same as a warning lamp but do not display when you start your vehicle.

## Anti-Lock Braking System Warning Lamp



If it illuminates when you are driving, this indicates a malfunction. You will continue to have the normal braking system (without anti-lock braking system) unless the brake system warning lamp is also illuminated. Have your vehicle checked by an authorized dealer.

## Automatic High Beam Lamp (if

Equipped)



It will illuminate when this feature is on. See **Automatic High Beam Control** (page 51).

## Battery Warning Lamp



If it illuminates when driving, this indicates a malfunction. Switch off all unnecessary electrical equipment. Have your vehicle checked by an authorized dealer immediately.

## Blind Spot Monitor Indicator (if

Equipped)



It will illuminate when you switch this feature off or in conjunction with a message. See **Blind Spot Monitor** (page 145). See **Information Messages** (page 74).

## Brake System Warning Lamp



It will illuminate when you engage the parking brake with the ignition on.

# Instrument Cluster

If it illuminates when you are driving, check that the parking brake is not engaged. If the parking brake is not engaged, this indicates low brake fluid level or a brake system malfunction. Have your vehicle checked by an authorized dealer immediately.

## WARNING



Driving your vehicle with the warning lamp on is dangerous. A significant decrease in braking performance may occur. It will take you longer to stop your vehicle. Have your vehicle checked by an authorized dealer immediately. Driving extended distances with the parking brake engaged can cause brake failure and the risk of personal injury.

## Cruise Control Indicator (if Equipped)



It will illuminate when you switch this feature on. See **Using Cruise Control** (page 139).

## Direction Indicator



Illuminates when the left or right direction indicator or the hazard warning flasher is turned on. If the indicators stay on or flash faster, check for a burnt out bulb. See **Changing a Bulb** (page 186).

## Engine Oil Warning Lamp

### WARNING



Do not resume your journey if it illuminates despite the level being correct. Have your vehicle checked by an authorized dealer immediately.



If it illuminates with the engine running or when you are driving, this indicates a malfunction.

Stop your vehicle as soon as it is safe to do so and switch the engine off. Check the engine oil level. See **Engine Oil Check** (page 183).

## Engine Warning Lamps



Malfunction Indicator Lamp



Powertrain Warning Lamp

## All Vehicles

If either lamp illuminates when the engine is running, this indicates a malfunction. The engine will continue to run but it may have limited power. If it flashes when you are driving, reduce the speed of your vehicle immediately. If it continues to flash, avoid heavy acceleration or deceleration. Have your vehicle checked by an authorized dealer immediately.

### WARNING



Have this checked immediately.

If both lamps illuminate together, stop your vehicle as soon as it is safe to do so (continued use may cause reduced power and cause the engine to stop). Switch the ignition off and attempt to restart the engine. If the engine restarts have your vehicle checked by an authorized dealer immediately. When the engine does not restart have your vehicle checked by an authorized dealer.

# Instrument Cluster

## Fasten Safety Belt Warning Lamp



It will illuminate and a chime will sound to remind you to fasten your safety belt. See **Safety Belt Minder** (page 24).

## Front Airbag Warning Lamp



If it fails to illuminate when you start your vehicle, continues to flash or remains on, it indicates a malfunction. Have your vehicle checked by an authorized dealer.

## Front Fog Lamps Indicator (If Equipped)



It will illuminate when you switch the front fog lamps on.

## Frost Warning Lamp

### WARNING



Even if the temperature rises to above +4°C (39°F) there is no guarantee that the road is free of hazards caused by inclement weather.



It will illuminate and glow amber when the outside air temperature is between +4°C (39°F) and 0°C (32°F). It will glow red when the temperature is below 0°C (32°F).

## Glow Plug Indicator



See **Starting a Diesel Engine** (page 109).

## High Beam Indicator



It will illuminate when you switch the high beam headlamps on. It will flash when you use the headlamp flasher.

## Information Indicator (If Equipped)



It will illuminate when a new message is stored in the information display. It will be red or amber in color depending on the severity of the message and will remain on until the cause of the message has been rectified. See **Information Messages** (page 74).

## Lane Keeping System Indicator



It will illuminate when this feature is switched off or in conjunction with a message. See **Lane Keeping System** (page 150).

## Low Fuel Level Warning Lamp



If it illuminates, refuel as soon as possible.

## Headlamp and Parking Lamp Indicator



It will illuminate when you switch the headlamps or parking lamps on.

## Rear Fog Lamps Indicator



It will illuminate when you switch the rear fog lamps on.

## Shift Indicator



It will illuminate to inform you that shifting to a higher or lower gear as indicated may give



better fuel economy and lower CO<sub>2</sub> emissions. It will not illuminate during periods of high acceleration, braking or when the clutch pedal is pressed.

# Instrument Cluster

---

## Stability Control Off Indicator



It will illuminate when you switch the system off. It will go out when you switch the system back on or when you switch the ignition off.

## Stability Control Warning Lamp



It will flash when the system is active. If it remains illuminated or does not illuminate when you switch the ignition on, this indicates a malfunction. During a malfunction the system will switch off. Have your vehicle checked by an authorized dealer immediately.

## Start-Stop Indicator



It will illuminate to inform you when the engine shuts down or in conjunction with a message. See **Start-Stop** (page 111). See **Information Messages** (page 74).

## AUDIBLE WARNINGS AND INDICATORS

### Key in Ignition Warning Chime

Sounds when you open the driver's door and you have left the key in the ignition with it in the off or accessory position.

### Headlamps On Warning Chime

Sounds when you remove the key from the ignition and open the driver's door and you have left the headlamps or parking lamps on.

## Parking Brake On Warning Chime

Sounds when you have left the parking brake on and drive your vehicle. If the warning chime remains on after you have released the parking brake, have your vehicle checked by an authorized dealer immediately.

## Automatic Transmission Warning Chime

Sounds when you have not moved the transmission selector lever to park. A message will be shown in the display.

# Information Displays

## GENERAL INFORMATION

### WARNING



Driving while distracted can result in loss of vehicle control, accident and injury. We strongly recommend that you use extreme caution when using any device or feature that may take your focus off the road. Your primary responsibility is the safe operation of your vehicle. We recommend against the use of any handheld device while driving and that you comply with all applicable laws.

## Information Display Controls



E138659

Various systems on your vehicle can be controlled using the information display controls on the steering wheel. Corresponding information is displayed in the information display.

- Press the up or down arrow button to scroll through and highlight the options within a menu.
- Press the right arrow button to enter a submenu.
- Press the left arrow button to exit a submenu.
- Press and hold the left arrow button at any time to return to the main menu display.
- Press the **OK** button to choose and confirm settings or messages.

## Menu Structure - Information Display

You can access the menu using the information display control.

**Note:** *Some options may appear slightly different or not at all if the items are optional.*

Navigation	
Route	Active guidance
	Route sections list
	Block next section
	Unblock rte sctn
Destination input	Country
	City/postcode
	Street

# Information Displays

Navigation		
	District	
	Start guidance	
Traffic	TA	
	TMC for route	
	All TMC	
	Block next section	
	Route sections list	
	Unblock rte sctn	
Home address	Start guidance	
	Change address	
Last destinations		
Favourites	Favourites (A-Z)	
Points of interest	POIs nearby	
	Near destination	
	Along motorway	
	POIs near address	
	Search by name	
Tour planning	New tour	
	Stored tours	
Store position	Route	Eco
		Fast
		Short
		Always ask
Route options	Driver:	Leisurely
		Normal
		Fast
	Eco settings	Trailer

# Information Displays

<b>Navigation</b>	
	Roof box
	Dynamic
	Motorway
	Tunnel
	Ferry/motorail
	Toll
	Seasonal roads
	Toll sticker
Special functions	GPS info
	System info
	Enter position
	Demo mode

SYNC-Media allows you to access the SYNC features.

<b>SYNC-Phone</b>	
Dial a number	
Redial	
Phonebook	
Call history	
Speed Dial	
Text messaging	
BT Devices	
Phone settings	



# Information Displays

Menu		
SYNC-Settings	Bluetooth on	
	Set defaults	
	Master reset	
	Install on SYNC	
	System info	
	Voice settings	
	SYNC-Apps	
SYNC-Apps		
Navigation	Route options	Route
		Driver:
		Eco Settings
		Dynamic
		Motorway
		Tunnel
		Ferry/motorail
		Toll
		Seasonal roads
		Toll sticker
	Map display	Map content
		Arrows on map:
		Nav time display:
		Map heading up
		Best contrast
	Assistance options	Signs / lanes
		Speed limits
		Nav icons in list

# Information Displays

<b>Menu</b>	
	Hazard spot warning
	Personal data
	Clear last destinations
	Clear favourites
	Delete home address
	Clear all
	Reset all settings
Audio settings	Adaptive volume
	Sound
	Nav audio mixing
	DSP settings
	DSP equaliser
	TA
	News
	Alt. frequency
	RDS regional
	DAB service link
	Bluetooth
Clock settings	Auto time (GPS)
	Set time
	Set date
	Set time zone
	Summer time
	24-hour mode

# Information Displays

---

## System Check

All active warnings will display first if applicable. The system check menu may appear different based upon equipment options and current vehicle status. Press the up or down arrow button to scroll through the list.

## CLOCK

### Type 1

To adjust the clock, switch the ignition on and press buttons H or M on the information and entertainment display as necessary.

### Type 2

**Note:** Use the information display to adjust the clock. See **General Information** (page 68).

## TRIP COMPUTER

### Resetting the Trip Computer

Press and hold **OK** on the current screen to reset the respective trip, distance, time and average fuel information.

### Trip Odometer

Registers the distance traveled of individual journeys.

### Fuel Used

Indicates the approximate distance your vehicle will travel on the fuel remaining in the tank. Changes in driving pattern may cause the value to vary.

### Average Fuel

Indicates the average fuel consumption since the function was last reset.

Press the right arrow button on the current screen to see the EcoMode menu.

### All Value

Indicates all the respective trip, distance and average fuel information.

## PERSONALIZED SETTINGS

### Measure Units

To swap between imperial and metric units, scroll to this display and press the **OK** button.

Swapping between imperial and metric units will affect the following displays:

- Distance to empty.
- Average fuel consumption.
- Instantaneous fuel consumption.
- Average speed.

### Switching Chimes Off

To switch chimes off, scroll to this display and press the **OK** button.

The following chimes can be switched off:

- Warning messages.
- Information messages.

# Information Displays

## INFORMATION MESSAGES



E130248

Press the **OK** button to acknowledge and remove some messages from the information display. Other messages will be removed automatically after a short time.

Certain messages need to be confirmed before you can access the menus.

**Note:** Depending on the options on your vehicle, not all of the messages will display or be available. Certain messages may be abbreviated or shortened depending upon which cluster type is fitted to your vehicle.

### Message Indicator (If Equipped)

 The message indicator illuminates to supplement some messages. It will be red or amber in color depending on the severity of the message and will remain on until the cause of the message has been rectified.

Some messages will be supplemented by a system specific symbol with a message indicator.

## Active City Stop

Message	Indicator	Action
Active City Stop Sensor blocked Clean screen	amber	See <b>Active City Stop</b> (page 154).
Active City Stop not available	amber	See <b>Active City Stop</b> (page 154).
Active City Stop Auto braking	-	See <b>Active City Stop</b> (page 154).

## Airbag

Message	Message indicator	Action
Airbag fault Service now	amber	Displays when the system requires service due to a malfunction. Have your vehicle checked by an authorized dealer as soon as possible.

# Information Displays

## Alarm

Message	Message Indicator	Action
Alarm activated Check Vehicle	Amber	Displays when the alarm has been triggered due to unauthorized entry. See <b>Anti-Theft Alarm</b> (page 40).
Alarm fault Service required	-	Displays when the system requires service due to a malfunction. Have your vehicle checked by an authorized dealer as soon as possible.

## Automatic High Beam Control

Message	Indicator	Action
Front camera low visibility Clean screen	amber	Displays when the front camera sensor has reduced visibility. Clean the windshield.
Front camera fault Service required	amber	Displays when the front camera sensor has malfunctioned. Have this checked as soon as possible.
Front camera temporarily not available	-	Displays when the front camera sensor has malfunctioned. Wait a short period of time for the sensor to cool down.

## Battery and Charging System

Message	Message Indicator	Action
Electrical system over-voltage Stop safely	Red	Stop your vehicle as soon as it is safe to do so and switch the ignition off. Have your vehicle checked by an authorized dealer as soon as possible.
Battery low See manual	Red	Displays to warn of a low battery condition. Switch off all unneeded electrical accessories. Have your vehicle checked by an authorized dealer as soon as possible.

## Information Displays

### Blind Spot Monitor and Cross Traffic Alert System

Message	Message Indicator	Action
BLIS Low visibility See manual	Amber	Displayed when the blind spot information system and cross traffic alert system sensors are blocked. See <b>Blind Spot Monitor</b> (page 145).
BLIS: left sensor fault Service required	Amber	Displayed when a fault with the system has occurred. Have your vehicle checked by an authorized dealer as soon as possible.
BLIS: right sensor fault Service required	Amber	Displayed when a fault with the system has occurred. Have your vehicle checked by an authorized dealer as soon as possible.
BLIS not available Trailer attached	Amber	Displayed when the system is not available due to trailer use. See <b>Blind Spot Monitor</b> (page 145).
Cross Traffic Vehicle coming from left	Amber	Displayed when the system detects a vehicle. See <b>Blind Spot Monitor</b> (page 145).
Cross Traffic Vehicle coming from right	Amber	Displayed when the system detects a vehicle. See <b>Blind Spot Monitor</b> (page 145).
Cross Traffic Sensor blocked See manual	Amber	Displayed when the blind spot information system and cross traffic alert system sensors are blocked. See <b>Blind Spot Monitor</b> (page 145).
Cross Traffic fault Service required	Amber	Displays when the system requires service due to a malfunction. Have your vehicle checked by an authorized dealer as soon as possible.
Cross Traffic disabled Trailer attached	-	Displayed when the system is not available due to trailer use. See <b>Blind Spot Monitor</b> (page 145).

### Child Power Lock

Message	Message indicator	Action
Child lock fault Service required	amber	Displays when the system has detected a condition that requires service. Have your vehicle checked by an authorized dealer as soon as possible.

# Information Displays

## Climate Control

Message	Indicator	Action
Auxiliary heater on	amber	See <b>Auxiliary Heater</b> (page 95).
Auxiliary heater off	-	See <b>Auxiliary Heater</b> (page 95).

## Cruise Control and Adaptive Cruise Control (ACC)

Message	Indicator	Action
Front radar sensor blocked See manual	amber	See <b>Cruise Control</b> (page 139).
ACC not available	amber	See <b>Cruise Control</b> (page 139).
Collision Warning fault Service required	amber	See <b>Cruise Control</b> (page 139).
Collision Warn not available	amber	See <b>Cruise Control</b> (page 139).
ACC/Collision Warn fault Service required	amber	See <b>Cruise Control</b> (page 139).

## Driver Alert

Message	Indicator	Action
Driver fatigue warning Rest now	red	Stop and rest as soon as it is safe to do so.
Driver fatigue warning Rest suggested	amber	Take a rest break soon.

# Information Displays

## Doors

Message	Message Indicator	Action
Driver door ajar	Red	Displays when the door listed is not completely closed and your vehicle is moving.
Passenger door ajar	Red	Displays when the door listed is not completely closed and your vehicle is moving.
Driver side rear door ajar	Red	Displays when the door listed is not completely closed and your vehicle is moving.
Passenger side rear door ajar	Red	Displays when the door listed is not completely closed and your vehicle is moving.
Trunk ajar	Red	Displays when the luggage compartment is not completely closed and your vehicle is moving.
Hood open	Red	Displays when the hood is not completely closed and your vehicle is moving.
Driver door ajar	-	Displays when the door listed is not completely closed.
Passenger door ajar	-	Displays when the door listed is not completely closed.
Driver side rear door ajar	-	Displays when the door listed is not completely closed.
Passenger side rear door ajar	-	Displays when the door listed is not completely closed.
Trunk ajar	-	Displays when the luggage compartment is not completely closed.
Hood open	-	Displays when the hood is not completely closed.



# Information Displays

## Engine

Message	Message Indicator	Action
High engine temperature Stop safely	Red	Displays when the engine temperature is too high. Stop your vehicle in a safe place and allow the engine to cool. If the problem persists, have your vehicle checked by an authorized dealer. See <b>Engine Coolant Check</b> (page 184).
Engine fault Service now	Amber	Engine service is required. Have your vehicle checked by an authorized dealer as soon as possible.
Water detected in fuel Service required	Amber	Displays when water is detected in the fuel. Have your vehicle checked by an authorized dealer as soon as possible.
Engine oil level low Check level	-	Check the engine oil level See <b>Engine Oil Check</b> (page 183).

## Hill Start Assist

Message	Message Indicator	Action
Hill start assist not available	Amber	Displays when hill start assist is not available. Have your vehicle checked by an authorized dealer as soon as possible. See <b>Hill Start Assist</b> (page 122).

## Keyless Vehicle

Message	Message Indicator	Action
Ford KeyFree Key not inside car	Red	Displayed when a valid key is not detected within your vehicle. See <b>Keyless Starting</b> (page 105).
Ford KeyFree Key inside vehicle	Amber	Displays to remind you that the key is in the trunk. See <b>Keyless Starting</b> (page 105).
Switch ign. off Press ENGINE Start/Stop button	Red	Displayed as a reminder to switch the ignition off. See <b>Keyless Starting</b> (page 105).

## Information Displays

Message	Message Indicator	Action
Press brake to start	-	Displayed as a reminder to press the brake while starting your vehicle.
Key Battery low Replace soon	-	Displays when the key battery is low. Change the battery as soon as possible. See <b>Remote Control</b> (page 29).
Ford KeyFree No key detected	-	Displayed if the key is not detected by the system. See <b>Keyless Starting</b> (page 105).
Ford KeyFree Place key in key holder	-	See <b>Keyless Starting</b> (page 105).
Steering lock engaged turn steering wheel	-	See <b>Steering Wheel Lock</b> (page 107).

### Lane Keeping Aid

Message	Indicator	Action
Lane keeping sys Fault Service required	amber	Displays when the system has detected a condition that requires service. Have your vehicle checked by an authorized dealer.

### Lighting

Message	Message Indicator	Action
Headlamp fault Service required	Amber	Displays when an electrical system problem occurs with the headlamp system. See <b>Changing a Bulb</b> (page 186).
Low beam Bulb fault	-	Displays when the low beam headlamp bulb has burned out. See <b>Changing a Bulb</b> (page 186).
Brake lamp Bulb fault	-	Displays when the brake lamp bulb has burned out. See <b>Changing a Bulb</b> (page 186).

## Information Displays

Message	Message Indicator	Action
Rear fog lamp Bulb fault	-	Displays when the rear fog lamp bulb has burned out. See <b>Changing a Bulb</b> (page 186).
Trailer brake lamp Bulb fault	-	Displays when the trailer brake lamp bulb has burned out. Have your vehicle checked by an authorized dealer as soon as possible.
Trailer turn lamp Bulb fault	-	Displays when the trailer turn lamp bulb has burned out. Have your vehicle checked by an authorized dealer as soon as possible.

## Maintenance

Message	Message Indicator	Action
Brake fluid level low Service now	Red	Indicates the brake fluid level is low and the brake system should be inspected immediately. See <b>Brake Fluid Check</b> (page 184).
Washer fluid level low	-	Displays when the washer fluid is low and needs to be refilled. See <b>Washer Fluid Check</b> (page 184).
Check fuel fill inlet	-	Displays when the fuel fill inlet was not properly closed. See <b>Refueling</b> (page 116).
Oil change required	-	Displays when the engine oil life is depleted and requires a change. See <b>Engine Oil Check</b> (page 183).

## Occupant Protection

Message	Indicator	Action
Service Beltminder	-	Displays when the system has detected a condition that requires service. Have your vehicle checked by an authorized dealer as soon as possible.

## Information Displays

### Parking Aid

Message	Message Indicator	Action
Parking aid fault Service required	Amber	Displays when the system has detected a condition that requires service. Have your vehicle checked by an authorized dealer. See <b>Parking Aid</b> (page 133).
Rear park aid disabled Trailer attached	-	Displays when a trailer is attached.

### Parking Brake

Message	Message Indicator	Action
Park brake applied	Red	Displays when the parking brake is set, the engine is running and your vehicle is moving more than 3 mph (5 km/h). If the warning stays on after the parking brake is released, have your vehicle checked by an authorized dealer as soon as possible.
Park brake applied	Amber	See <b>Parking Brake</b> (page 129).
Park brake fault Service now	Amber	Displays when the system has detected a condition that requires service. Have your vehicle checked by an authorized dealer as soon as possible.

# Information Displays

## Power Steering

Message	Message Indicator	Action
Steering loss Stop safely	Red	The power steering system is not working. Stop your vehicle in a safe place. Have your vehicle checked by an authorized dealer as soon as possible.
Steering assist fault Service required	Amber	The power steering system is not working. Stop your vehicle in a safe place. Have your vehicle checked by an authorized dealer as soon as possible.
Steering fault Service now	Amber	The power steering system has detected a condition within the power steering system or passive entry or passive start system requires service. Have your vehicle checked by an authorized dealer as soon as possible.

## Start-Stop

Message	Message indicator	Action
Auto StartStop Switch ignition off	red	Switch the ignition off before leaving your vehicle if the system has shut down the engine. See <b>Start-Stop</b> (page 111).
Auto StartStop fault Service required	amber	Have your vehicle checked by an authorized dealer.
Auto StartStop Press a pedal to start engine	-	The engine needs to be restarted, press the clutch pedal to start. See <b>Start-Stop</b> (page 111).
Auto StartStop Select neutral	-	Select neutral for the system to restart the engine. See <b>Start-Stop</b> (page 111).
Auto StartStop Manual Start required	-	The system is not functioning. A manual restart is required.

# Information Displays

## Starting System

Message	Message Indicator	Action
Drive to clean exhaust filter See manual	Amber	See <b>Diesel Particulate Filter</b> (page 109).
Cleaning exhaust filter	-	See <b>Diesel Particulate Filter</b> (page 109).
Exhaust filter cleaning complete	-	See <b>Diesel Particulate Filter</b> (page 109).
Engine preheating	-	See <b>Starting a Diesel Engine</b> (page 109).
Press brake to start	-	Displays when starting your vehicle as a reminder to apply the brake.
Press clutch to start	-	Displays when starting your vehicle as a reminder to apply the clutch.
Press brake and clutch to start	-	Displays when starting your vehicle as a reminder to apply the brake and clutch.
Cranking time exceeded	-	Displays when your vehicle fails to start.

## Towing

Message	Message Indicator	Action
Trailer sway Reduce speed	Red	See <b>Trailer Sway Control</b> (page 162).

# Information Displays

## Transmission and Four-Wheel Drive

Message	Message Indicator	Action
Transmission too hot Press brake	Red	The transmission is overheating and needs to cool. Reduce your speed gradually and stop your vehicle as soon as it is safe to do so.
Transmission too hot Press brake	Amber	The transmission is overheating and needs to cool. Reduce your speed gradually and stop your vehicle as soon as it is safe to do so.
Transmission overtem- perature Stop safely	Amber	The transmission is overheating and needs to cool. Reduce your speed gradually and stop your vehicle as soon as it is safe to do so.
Transmission over- heating Stop safely	Amber	The transmission is overheating and needs to cool. Reduce your speed gradually and stop your vehicle as soon as it is safe to do so.
Transmission Service required	Amber	Have your vehicle checked by an authorized dealer as soon as possible.
4WD fault Service required	Amber	The system is not functioning correctly and defaulted to front-wheel drive. Have your vehicle checked by an authorized dealer as soon as possible. See <b>Using Four-Wheel Drive</b> (page 124).
4WD Off	Amber	Displays when the system disables automatically and enters front-wheel drive only mode to protect driveline components. See <b>Using Four-Wheel Drive</b> (page 124).
4WD Temporarily disabled	Amber	The system has overheated and defaulted to front-wheel drive. See <b>Using Four-Wheel Drive</b> (page 124).
4WD restored	-	Displays when system operation has been restored. See <b>Using Four-Wheel Drive</b> (page 124).
Transmission not in Park Select P	-	Displays as a reminder to move the transmission selector lever to park.
Transmission Hot Stop or Speed Up	-	Transmission is getting hot. Stop to let it cool or speed up.
Transmission Hot Wait ...	-	Transmission is hot. Wait as needed to let it cool.

## Information Displays

Message	Message Indicator	Action
Transmission too hot Press brake	-	Transmission is getting hot. Stop to let it cool down.
Transmission warming up Please wait	-	At low outside temperatures, after starting the engine, it may take the transmission several seconds to engage reverse or drive. Keep the brake pedal depressed until these messages disappear from the display.
Transmission limited function See manual	-	Some gears may not be available. Have your vehicle checked by an authorized dealer as soon as possible. See <b>Automatic Transmission</b> (page 119).
Press brake to unlock gearshift lever	-	Displays to request the operator to apply the brake as needed by the transmission.
Gearshift lever unlocked	-	Displays when the transmission shift lever is unlocked and free to select gears.

## Traction Control

Message	Message Indicator	Action
Traction control off	-	Displays when the traction control system has been switched off. See <b>Using Traction Control</b> (page 131).



# Climate Control

## PRINCIPLE OF OPERATION

### Outside Air

Keep the air intakes in front of the windshield free from obstruction (such as snow or leaves) to allow the climate control system to function effectively.

### Recirculated Air

#### WARNING



Prolonged use of recirculated air may cause the windows to mist up. If the windows mist up, follow the settings for demisting the windshield.

The air currently in the passenger compartment recirculates. Outside air does not enter your vehicle.

### Heating

Heating performance depends on the temperature of the engine coolant.

### Air Conditioning

**Note:** The air conditioning operates only when the temperature is above 39°F (4°C).

**Note:** When you use air conditioning, your vehicle uses more fuel.

The system directs air through the evaporator for cooling. The evaporator extracts humidity from the air to help keep the windows free of mist. The system directs the resulting condensation to the outside of your vehicle, which may cause a small pool to form under your vehicle. This is normal.

### General Information on Controlling the Interior Climate

Fully close all the windows.

### Warming the Interior

Direct the air toward your feet. In cold or humid weather conditions, direct some of the air toward the windshield and the door windows.

### Cooling the Interior

Direct the air toward your face.

## AIR VENTS

### Center

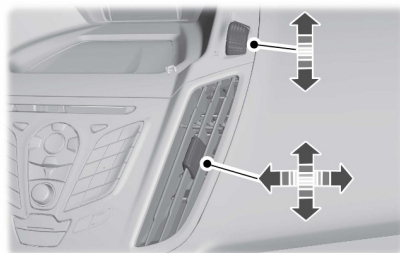

E152449



E159050

# Climate Control

## Side

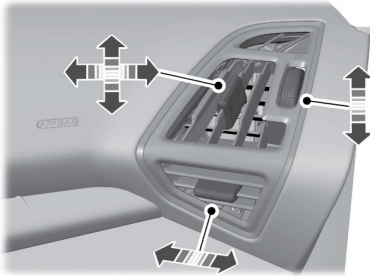

E152450

## Center Console

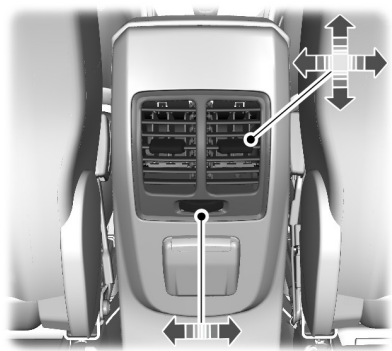

E159049

## MANUAL CLIMATE CONTROL

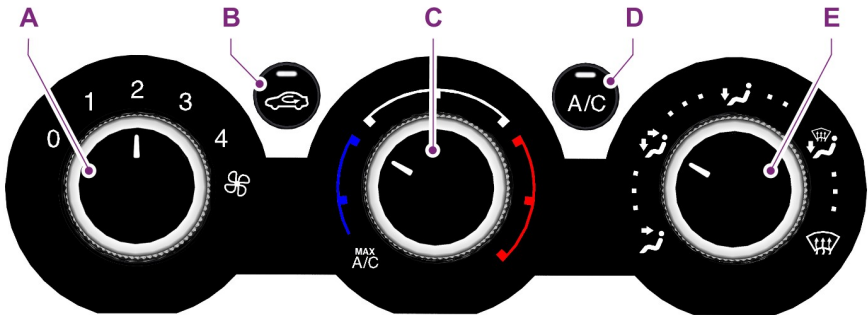

E141421

- A **Fan speed control:** Controls the volume of air circulated in your vehicle. Adjust to select the desired fan speed or switch off. If you switch the fan off, the windshield may fog up.
- B **Recirculated air:** Press the button to switch between outside air and recirculated air. When you select recirculated air, the button illuminates and the air currently in the passenger compartment recirculates. This can reduce the time needed to cool the interior and reduce unwanted odors from entering your vehicle.

# Climate Control

- C **Temperature control:** Controls the temperature of the air circulated in your vehicle. Adjust to select the desired temperature. If you select **MAX A/C**, the system distributes recirculated air through the instrument panel air vents. This mode is more economical and efficient than normal air conditioning. When the temperature control is in the **MAX A/C** position, the air conditioning or recirculated air can be turned on and off.
- D **Air conditioning:** Press the button to switch the air conditioning on or off. Air conditioning cools your vehicle using outside air.
- E **Air distribution control:** Adjust to select the desired air distribution.



Select to distribute air through the instrument panel air vents.



Select to distribute air through the instrument panel and footwell air vents.



Select to distribute air through the footwell air vents.



Select to distribute air through the windshield and footwell air vents.



Select to distribute air through the windshield air vents. You can also use this setting to defog and clear the windshield of a thin covering of ice. You can also increase the temperature and fan speed to improve clearing.

When the temperature is above 4°C (39°F), the air conditioning will switch on automatically. Make sure that the blower is on. The indicator in the switch will illuminate during defrosting and demisting.

## AUTOMATIC CLIMATE CONTROL

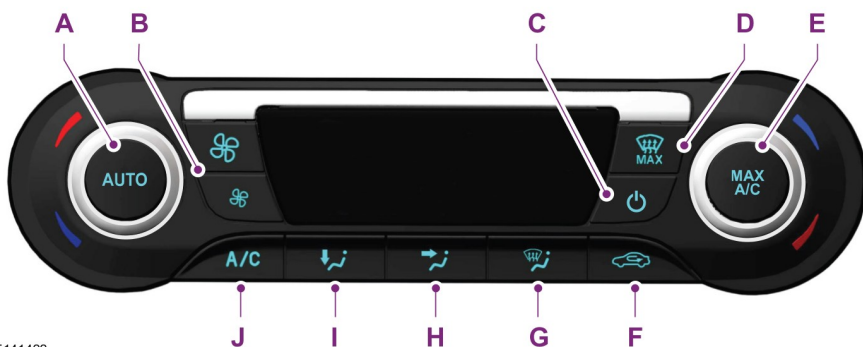

E141422

# Climate Control

- A **AUTO:** Press the button to select automatic operation. The system automatically controls the temperature, amount and distribution of the airflow to reach and maintain your previously selected temperature.
- B **Fan speed:** Controls the volume of air circulated in your vehicle. Press the buttons to select the desired fan speed. The setting is shown in the display.
- C **On and off button:** Press the button to switch the system on and off.
- D **MAX Defrost:** Press the button to distribute outside air through the windshield air vents. Air conditioning is automatically selected. The fan is set to the highest speed and the temperature to HI. When the air distribution is set in this position you are unable to select recirculated air or manually adjust the temperature control. Press the **AUTO** button to return to auto mode.
- E **MAX A/C:** Press the button to distribute maximum air conditioning through the instrument panel air vents. This mode is more economical and efficient than normal air conditioning.
- F **Recirculated air:** Press the button to switch between outside air and recirculated air. The air currently in the passenger compartment recirculates. This can reduce the time needed to cool the interior and reduce unwanted odors from entering your vehicle.
- G **Defrost:** Press the button to distribute air through the windshield air vents. You can also use this setting to defog and clear the windshield of a thin covering of ice.
- H **Instrument panel:** Press the button to distribute air through the instrument panel air vents.
- I **Footwell:** Press the button to distribute air through the footwell air vents.
- J **Air conditioning:** Press the button to switch the air conditioning on or off. Air conditioning cools your vehicle using outside air. To improve air conditioning when starting your vehicle, drive with the windows slightly open for two to three minutes.

## Temperature Control

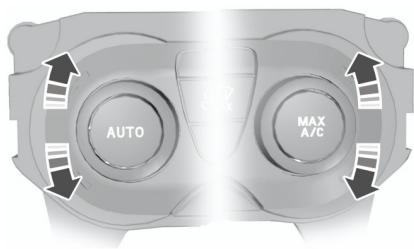

E133115

You can set the temperature between 60°F (15.5°C) and 85°F (29.5°C) in steps of 1°F (0.5°C). In position LO, 59°F (15°C), the system switches to permanent cooling. In position HI, 86°F (30°C), the system switches to permanent heating.

**Note:** *If you select either position LO or HI, the system does not regulate a stable temperature.*

# Climate Control

---

## Mono Mode

In this mode, the temperature settings for both the driver's side and passenger's side are linked. If you adjust the setting using the rotary control on the driver's side, the system adjusts the temperature to the same setting on the passenger's side.

## Switching Mono Mode Off

Select a temperature for the passenger's side using the rotary control on the passenger's side. Mono mode automatically switches off. The temperature on the driver's side remains unchanged. You can now adjust the driver's side and passenger's side temperatures independently. The temperature settings for each side are shown in the display.

## Switching Mono Mode Back On

Press and hold the **AUTO** button. The passenger's side temperature is adjusted to the driver's side temperature setting.

## HINTS ON CONTROLLING THE INTERIOR CLIMATE

### General Hints

**Note:** Prolonged use of recirculated air may cause the windows to fog up.

**Note:** A small amount of air may be felt from the footwell air vents regardless of the air distribution setting.

**Note:** To reduce humidity build-up inside your vehicle, do not drive with the system switched off or with recirculated air always switched on.

**Note:** Do not place objects under the front seats as this may interfere with the airflow to the rear seats.

**Note:** Remove any snow, ice or leaves from the air intake area at the base of the windshield.

## Manual Climate Control

**Note:** To reduce fogging of the windshield during humid weather, adjust the air distribution control to the windshield air vents position. Increase the temperature and fan speed to improve clearing, if required.

## Automatic Climate Control

**Note:** Do not adjust the settings when your vehicle interior is extremely hot or cold. The system automatically adjusts to the previously stored settings. For the system to function efficiently, the instrument panel and side air vents should be fully open.

**Note:** At low ambient temperatures with AUTO selected, the air stream is directed toward the windshield and side windows for as long as the engine remains cold.

**Note:** When the system is switched off, outside air is prevented from entering your vehicle.

**Note:** When the system is in AUTO mode, and the interior and exterior temperatures are high, the system automatically selects recirculated air to maximize cooling of the interior. When the selected air temperature is reached, the system automatically selects outside air.

**Note:** When you select windshield defrosting and defogging, the instrument panel and footwell level functions automatically switch off and air conditioning switches on. Outside air flows into your vehicle.

# Climate Control

## Heating the Interior Quickly

	<b>Vehicle With Manual Climate Control</b>	<b>Vehicle With Automatic Climate Control</b>
1	Adjust the fan speed to the highest speed setting.	Press the high fan speed button control.
2	Adjust the temperature control to the highest setting.	Adjust the temperature control to the highest setting.
3	Adjust the air distribution control to the footwell air vents position.	Press the footwell button to distribute air to the footwell air vents.

## Recommended Settings for Heating

	<b>Vehicle With Manual Climate Control</b>	<b>Vehicle With Automatic Climate Control</b>
1	Adjust the fan speed to the second speed setting.	Press the slow fan speed button.
2	Adjust the temperature control to the midway point of the hot settings.	Adjust the temperature control to the midway point of the hot settings.
3	Adjust the air distribution control to the footwell and windshield air vents position.	Press the footwell and windshield air distribution buttons.
4		Close the instrument panel air vents. Open the side air vents and direct them toward the side windows.

## Cooling the Interior Quickly

	<b>Vehicle With Manual Climate Control</b>	<b>Vehicle With Automatic Climate Control</b>
1	Adjust the fan speed to the highest speed setting.	Press the AUTO button.
2	Adjust the temperature control to the MAX A/C position.	Adjust the temperature control to the desired setting.
3	Adjust the air distribution control to the instrument panel air vents position.	

# Climate Control

## Recommended Settings for Cooling

	Vehicle With Manual Climate Control	Vehicle With Automatic Climate Control
1	Adjust the fan speed to the second speed setting.	Press the slow fan speed button.
2	Adjust the temperature control to the midway point of the cold settings.	Adjust the temperature control to the midway point of the cold settings.
3	Adjust the air distribution control to the instrument panel air vents position.	Press the instrument panel vent button to distribute air to the instrument panel air vents.

## Vehicle Stationary for Extended Periods During Extreme High Ambient Temperatures

	Vehicle With Manual Climate Control	Vehicle With Automatic Climate Control
1	Apply the parking brake.	Apply the parking brake.
2	Move the transmission selector lever to position P.	Move the transmission selector lever to position P.
3	Adjust the temperature control to the MAX A/C position.	Press the MAX A/C button.
4	Adjust the fan speed to the lowest speed setting.	

## Side Window Defogging in Cold Weather

	Vehicle With Manual Climate Control	Vehicle With Automatic Climate Control
1	Adjust the air distribution control to the instrument panel and footwell air vents positions.	Press the windshield defrosting and defogging button.
2	Press the A/C button.	Adjust the temperature control to the desired setting.
3	Adjust the temperature control to the desired setting.	

# Climate Control

	Vehicle With Manual Climate Control	Vehicle With Automatic Climate Control
4	Adjust the fan speed to the highest setting.	
5	Direct the instrument panel side air vents toward the side windows.	
6	Close the instrument panel vents.	

## Maximum Cooling Performance in Instrument Panel or Instrument Panel and Footwell Positions

1. Adjust the temperature control to the lowest setting.
2. Press the A/C and recirculated air buttons.
3. Adjust the fan speed to the highest setting initially and then adjust it to suit the desired comfort level.

## HEATED WINDOWS AND MIRRORS

**Note:** Make sure the engine is running before operating the heated windows.

### Heated Windshield



Press the button to clear the window of thin ice and fog.

### Heated Rear Window



Press the button to clear the window of thin ice and fog. Press the button again within 10 minutes to switch it off. It switches off automatically after 10 minutes, or when you switch the ignition off.

**Note:** Do not use razor blades or other sharp objects to clean the inside of the rear window or to remove decals from the inside of the rear window. This may cause damage to the heated grid lines and will not be covered by your warranty.

### Heated Exterior Mirror (If Equipped)

**Note:** Do not remove ice from the mirrors with a scraper or attempt to readjust the mirror glass if it is frozen in place. These actions could cause damage to the glass and mirrors.

**Note:** Do not clean the housing or glass of any mirror with harsh abrasives, fuel or other petroleum-based cleaning products.

Both mirrors are heated to remove ice, mist and fog when the heated rear window is switched on.



# Climate Control

---

## AUXILIARY HEATER

### Fuel Operated Heater

#### Vehicles with a Diesel Engine

##### WARNING



Do not operate the heater at filling stations, in enclosed spaces or near sources of combustible vapors and dust.

---

The heater operates independently of your vehicle's heater by heating the engine's coolant circuit. It uses fuel from your vehicle's fuel tank.

**Note:** *The heater will only operate if there is at least 1.6 gallons (7.5 liters) of fuel in the fuel tank and the ambient temperature is below 59°F (15°C). The heater will not operate if the battery is low.*

**Note:** *When the heater is on, exhaust fumes may come from under the sides of your vehicle. This is normal.*

**Note:** *If your vehicle has manual climate control, the heating of your vehicle interior is dependent on the temperature, air distribution and blower control settings.*

The heater aids in warming the engine and your vehicle. It switches on and off automatically depending on the outside air temperature and the coolant temperature, unless you have switched it off.

You can switch the heater off using the information display.

**Note:** *A cross appears in the box when the heater is on.*

# Seats

## SITTING IN THE CORRECT POSITION

### WARNINGS

 Do not recline the seatback too far as this can cause the occupant to slide under the safety belt, resulting in serious injury in the event of a collision.

 Sitting improperly, out of position or with the seatback reclined too far, can result in serious injury or death in the event of a collision. Always sit upright against your seatback, with your feet on the floor.

 Do not place objects higher than the seatback to reduce the risk of serious injury in the event of a collision or during heavy braking.

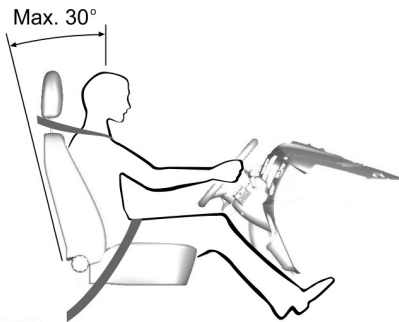

E68595

When you use them properly, the seat, head restraint, safety belt and air bags will provide optimum protection in the event of a collision.

We recommend that you follow these guidelines:

- Sit in an upright position with the base of your spine as far back as possible.
- Do not recline the seatback more than 30 degrees.

- Adjust the head restraint so that the top of it is level with the top of your head and as far forward as possible. Make sure that you remain comfortable.
- Keep sufficient distance between yourself and the steering wheel. We recommend a minimum of 10 inches (25 centimeters) between your breastbone and the air bag cover.
- Hold the steering wheel with your arms slightly bent.
- Bend your legs slightly so that you can press the pedals fully.
- Position the shoulder strap of the safety belt over the center of your shoulder and position the lap strap tightly across your hips.

Make sure that your driving position is comfortable and that you can maintain full control of your vehicle.

## HEAD RESTRAINTS

### WARNINGS

 Fully adjust the head restraint before you sit in or operate your vehicle. This will help minimize the risk of neck injury in the event of a collision. Do not adjust the head restraint when your vehicle is moving.

 The head restraint is a safety device. Whenever possible it should be installed and properly adjusted when the seat is occupied.

 Install the head restraint properly to help minimize the risk of neck injury in the event of a collision.

# Seats

## Front seat head restraint

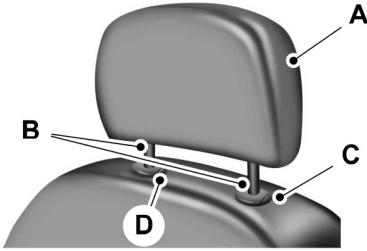

E138642

## Rear head restraints

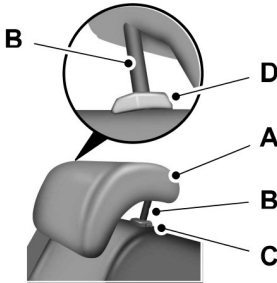

E138645

The head restraints consist of:

- A an energy absorbing head restraint
- B two steel stems
- C guide sleeve adjust and unlock button
- D guide sleeve unlock and remove button

**Note:** Adjust the seat back to an upright driving position before adjusting the head restraint. Adjust the head restraint so that the top of it is level with the top of your head and as far forward as possible. Make sure that you remain comfortable. If you are extremely tall, adjust the head restraint to its highest position.

## Adjusting the Head Restraint

### Raising the Head Restraint

Pull the head restraint up.

### Lowering the Head Restraint

1. Press and hold button C.
2. Push the head restraint down.

### Removing the Head Restraint

1. Pull the head restraint up until it reaches its highest position.
2. Press and hold buttons C and D.
3. Pull the head restraint up.

### Installing the Head Restraint

Align the steel stems into the guide sleeves and push the head restraint down until it locks.

### Tilting the Head Restraint

The front head restraints may have a tilting feature for extra comfort. To tilt the head restraint, do the following:



E144727

1. Adjust the seat back to an upright driving or riding position.
2. Pivot the head restraint forward toward your head to the desired position.

# Seats

After the head restraint reaches the forward-most tilt position, pivot it forward again to release it to the rearward, un-tilted position.

## MANUAL SEATS

### WARNING



Do not adjust the driver's seat or seatback when your vehicle is moving.

### Moving the Seat Backward and Forward



E130249

### WARNING



Rock the seat backward and forward after releasing the lever to make sure that it is fully engaged.

### Adjusting the Lumbar Support



E152451

### Adjusting the Height of the Driver's Seat

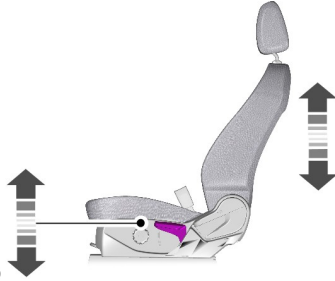

E70730

### Recline Adjustment

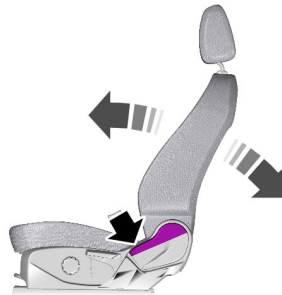

E138646



# Seats

## WARNING

 Do not place cargo or any objects behind the seatback before returning it to the original position. Pull on the seatback to make sure that it has fully latched after returning the seatback to its original position. An unlatched seat may become dangerous if you stop suddenly or have a collision.

## POWER SEATS

### WARNINGS

-  Do not adjust the driver's seat or seatback when your vehicle is moving. This could result in loss of vehicle control, serious personal injury or death.
-  Do not place cargo or any objects behind the seatback before returning it to the original position.

## 10-Way

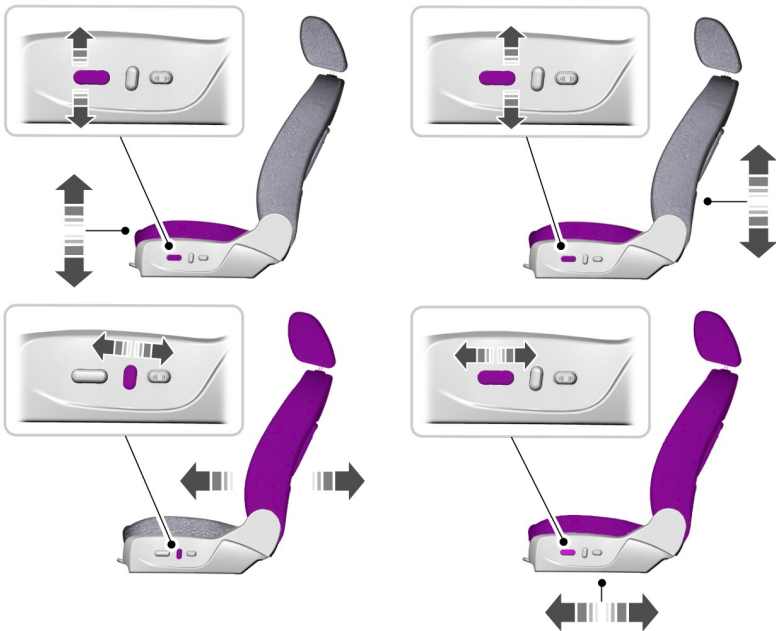

E138647

# Seats

## Power Lumbar



E138648

## REAR SEATS

### Folding the Seatback

#### WARNING



When folding the seatbacks down, take care not to get your fingers caught between the seatback and seat frame.



E159654

With the seat empty, pull the lever up to fold the seatback forward.

**Note:** Lower the head restraints. See **Head Restraints** (page 96).

### Unfolding the Seatback

#### WARNINGS



When folding the seatbacks up, make sure that the safety belts are visible to an occupant and not caught behind the seat.



Make sure that the seats and the seatbacks are secure and fully engaged in their catches.

### Recline Adjustment

With the seat occupied, pull the lever up to recline the seat backward.

### HEATED SEATS (IF EQUIPPED)

#### WARNING



People who are unable to feel pain to their skin because of advanced age, chronic illness, diabetes, spinal cord injury, medication, alcohol use, exhaustion or other physical conditions, must exercise care when using the heated seat. The heated seat may cause burns even at low temperatures, especially if used for long periods of time. Do not place anything on the seat that insulates against heat, such as a blanket or cushion. This may cause the heated seat to overheat. Do not puncture the seat with pins, needles or other pointed objects. This may damage the heating element which may cause the heated seat to overheat. An overheated seat may cause serious personal injury.

# Seats

---

Do not do the following:

- Place heavy objects on the seat.
- Operate the heated seat if water or any other liquid is spilled on the seat. Allow the seat to dry thoroughly.
- Operate the heated seats unless the engine is running. Doing so can cause the battery to lose charge.



E138653

Adjust the control to the desired heat setting.

## REAR SEAT ARMREST



E138656

Fold the armrest down to use the armrest and cupholder.

# Auxiliary Power Points

## 12 Volt DC Power Point

### WARNING



Do not plug optional electrical accessories into the cigar lighter socket. Incorrect use of the lighter can cause damage not covered by your warranty, and can result in fire or serious injury.

**Note:** Do not insert objects other than an accessory plug into the power point. This will damage the outlet and blow the fuse.

**Note:** Do not hang any type of accessory or accessory bracket from the plug.

**Note:** Do not use the power point over the vehicle capacity of 12 volts DC 180 watts or a fuse may blow.

**Note:** Do not use the power point for operating a cigar lighter element.

**Note:** Incorrect use of the power point can cause damage not covered by your warranty.

**Note:** Always keep the power point caps closed when not in use.

Run the engine for full capacity use of the power point. To prevent the battery from running out of charge:

- Do not use the power point longer than necessary when the engine is not running.
- Do not leave devices plugged in overnight or when your vehicle is parked for extended periods.

## Location

Power points may be found:

- on the center console
- on the rear of the center console
- in the luggage compartment.

## AC Power Point (If Equipped)

### WARNING



Do not keep electrical devices plugged in the power point whenever the device is not in use. Do not use any extension cord with the power point, since it will defeat the safety protection design. Doing so may cause the power point to overload due to powering multiple devices that can reach beyond the 150 watt load limit and could result in fire or serious injury.

**Note:** The power point will turn off when the ignition is switched off or the battery voltage drops below 11 volts.

**Note:** Depending on the country for which your vehicle was originally built, the voltage supply will be either 110 volts or 230 volts.

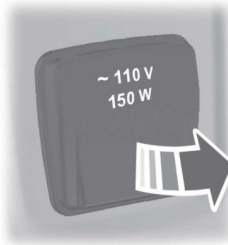

E143941

The power point is used for powering electrical devices that require up to 150 watt. It is located on the rear of the center console.

When the indicator light, located on the power point, is:

- on — power point is working, ignition is on and a device is plugged in.
- off — power point is off, ignition is off or no device is plugged in.
- flashing — power point is in fault mode.



# Auxiliary Power Points

---

The power point temporarily turns off power if the 150 watt limit is exceeded. It can also switch to a fault mode when it is overloaded, overheated, or shorted. Unplug your device and switch the ignition off then on for overloading and shorting conditions. Let the system cool off, then turn the ignition off then on for an overheating condition.

The power point is not designed for electric devices such as:

- Cathode ray tube type televisions
- Motor loads, such as vacuum cleaners, electric saws and other electric power tools, compressor-driven refrigerators, etc.
- Measuring devices, which process precise data, such as medical equipment, measuring equipment, etc.
- Other appliances requiring an extremely stable power supply: microcomputer-controlled electric blankets, touch sensor lamps, etc.

# Storage Compartments

---

## CUP HOLDERS

### WARNING

 Do not place hot drinks in the cup holders when your vehicle is moving.

---

## OVERHEAD CONSOLE

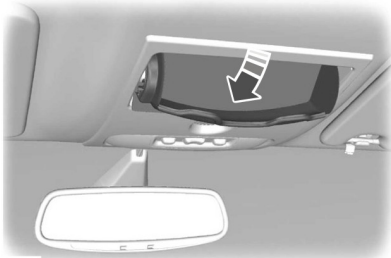

E75193

Press near the rear edge of the door to open it.

## SEAT BACK TRAYS

### WARNING

 Do not use the trays when your vehicle is moving. Make sure that you secure the trays in the lowered position before setting off.

---

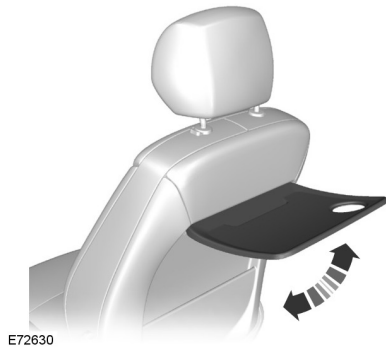



# Starting and Stopping the Engine

## GENERAL INFORMATION

### WARNINGS

 Extended idling at high engine speeds can produce very high temperatures in the engine and exhaust system, creating the risk of fire or other damage.

 Do not park, idle or drive your vehicle on dry grass or other dry ground cover. The emission system heats up the engine compartment and exhaust system, creating the risk of fire.

 Do not start the engine in a closed garage or in other enclosed areas. Exhaust fumes can be toxic. Always open the garage door before you start the engine.

 If you smell exhaust fumes inside your vehicle, have your vehicle checked by an authorized dealer immediately. Do not drive your vehicle if you smell exhaust fumes.

If you disconnect the battery, your vehicle may exhibit some unusual driving characteristics for approximately 5 miles (8 kilometers) after you reconnect it. This is because the engine management system must realign itself with the engine. You can disregard any unusual driving characteristics during this period.

The powertrain control system meets all Canadian interference-causing equipment standard requirements regulating the impulse electrical field or radio noise.

When you start the engine, avoid pressing the accelerator pedal before and during operation. Only use the accelerator pedal when you have difficulty starting the engine.

## IGNITION SWITCH



E72128

**0** (off) - The ignition is off.

**Note:** When you switch the ignition off and leave your vehicle, do not leave your key in the ignition. This could cause your vehicle battery to lose charge.

**I** (accessory) - Allows the electrical accessories such as the radio to operate while the engine is not running.

**Note:** Do not leave the ignition key in this position for too long to avoid your vehicle battery losing charge.

**II** (on) - All electrical circuits operational. Warning lamps and indicators are illuminated.

**III** (start) - cranks the engine. Release the key as soon as the engine starts.

## KEYLESS STARTING

### WARNING

 Always check that the steering wheel lock is deactivated before attempting to move your vehicle. Failure to deactivate the steering wheel lock could result in a crash.

**Note:** The system may not function if the remote control is close to metal objects or electronic devices such as cell phones.

# Starting and Stopping the Engine

**Note:** The ignition will automatically switch off if your vehicle is left unattended. This is to prevent the vehicle battery from losing charge.

**Note:** A valid passive key must be located inside your vehicle to switch the ignition on and start the engine.

## Switching the Ignition On (Accessory Mode)



E85766

Press the button once without your foot on the brake or clutch pedal. It is located on the instrument panel near the steering wheel. All electrical circuits and accessories are operational and the warning lamps and indicators illuminate.

Press the button again without your foot on the brake or clutch pedal to turn your vehicle off completely.

## Starting Your Vehicle

### Manual Transmission

1. Fully depress the clutch pedal.
2. Briefly press the button.

**Note:** Releasing the clutch pedal during engine start will stop the engine cranking and return to ignition on.

### Automatic Transmission

1. Move the transmission selector lever to park.
2. Fully depress the brake pedal.

3. Briefly press the button.

**Note:** Releasing the brake pedal during engine start will stop the engine cranking and return to ignition on.

### Diesel Engine

**Note:** Engine cranking will not commence until the engine glow plug cycle has been completed. This may take several seconds in extremely cold conditions.

### Failure to Start

The system does not function if:

- The passive key frequencies are jammed.
- The passive key battery has no charge.

If you are unable to start your vehicle, do the following.

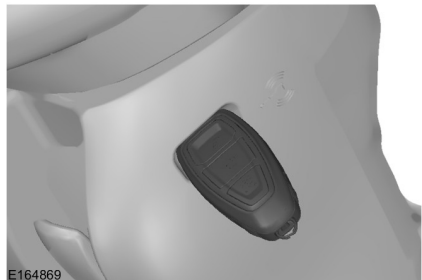

E164869

1. Place the passive key into the slot next to the symbol on the steering column.
2. With the passive key in this position, you can use the button to switch the ignition on and start your vehicle.

### Manual Transmission

If the engine does not crank when the clutch pedal has been fully depressed and the button is pressed:

1. Fully depress both the clutch and brake pedals.

# Starting and Stopping the Engine

---

2. Press the button until the engine has started.

**Note:** *Releasing the clutch pedal during engine start will stop the engine cranking and return to ignition on. A message will be shown in the display.*

## Stopping the Engine When Your Vehicle is Stationary

**Note:** *The ignition, all electrical circuits warning lamps and indicators will be switched off.*

### Manual Transmission

Briefly press the button.

### Automatic Transmission

1. Move the transmission selector lever to park.
2. Press the button.

## Stopping the Engine When Your Vehicle is Moving

### WARNING



Stopping the engine when your vehicle is moving will result in a loss of brake and steering assistance. The steering will not lock, but higher effort will be required. When the ignition is switched off some electrical circuits, warning lamps and indicators may also be off.

1. Press and hold the button for a moment, or press it three times within two seconds.
2. Move the transmission selector lever to neutral and use the brakes to bring your vehicle to a safe stop.
3. When your vehicle has stopped, move the transmission selector lever to park and switch the ignition off.

## Fast Restart

The fast restart feature allows you to restart your vehicle within 10 seconds of switching it off, even if a valid passive key is not detected.

Within 10 seconds of switching your vehicle off, press the brake pedal and press the button. After 10 seconds have expired, you can no longer start your vehicle if a valid passive key is not detected.

Once your vehicle has started, it remains running until you press the button, even if a valid passive key has not been detected. If you open and close a door while your vehicle is running, the system searches for a valid passive key. You cannot start your vehicle if a valid passive key is not detected within 10 seconds.

### Manual Transmission

If the engine does not crank when the clutch pedal has been fully depressed and the button is pressed:

1. Fully depress both the clutch and brake pedals
2. Press the button until the engine has started.

**Note:** *Releasing the clutch pedal during engine start will stop the engine cranking and return to ignition on. A message will be shown in the display.*

## STEERING WHEEL LOCK

### WARNING



Always check that the steering is unlocked before attempting to move your vehicle.

## Vehicles without Keyless Starting

To lock the steering wheel:

# Starting and Stopping the Engine

---

1. Remove the key from the ignition switch.
2. Rotate the steering wheel slightly to engage the lock.

## Vehicles with Keyless Starting

**Note:** *The steering wheel lock does not engage when the ignition is on or if your vehicle is moving.*

Your vehicle has an electronically controlled steering wheel lock. This operates automatically.

The steering wheel lock engages after a short period after you have parked your vehicle and the passive key is outside of your vehicle.

## Unlocking the Steering Wheel

### Vehicles with Automatic Transmission

Switch the ignition on or press the brake pedal.

### Vehicles with Manual Transmission

Switch the ignition on or press the clutch pedal.

## STARTING A GASOLINE ENGINE

**Note:** *You can only operate the starter for a limited period of time, for example 10 seconds. The number of start attempts is limited to approximately six. If you exceed this limit, the system will not allow you to try again until a period of time has elapsed, for example 30 minutes.*

## Cold or Hot Engine

### Vehicles with Manual Transmission

**Note:** *Do not touch the accelerator pedal.*

**Note:** *Releasing the clutch pedal while the engine is starting will stop the engine cranking and return to ignition on.*

1. Fully depress the clutch pedal.
2. Start the engine.

### Vehicles with Automatic Transmission

**Note:** *Do not touch the accelerator pedal.*

1. Move the transmission selector lever to position **P** or **N**.
2. Start the engine.

## All Vehicles

If the engine does not start within 10 seconds, wait for a short period and try again.

If the engine does not start after three attempts, wait 10 seconds and follow the flooded engine procedure.

If you have difficulty starting the engine when the temperature is below  $-13^{\circ}\text{F}$  ( $-25^{\circ}\text{C}$ ), press the accelerator pedal to the mid-way point of its travel and try again.

## Flooded Engine

### Vehicles with Manual Transmission

1. Fully depress the clutch pedal.
2. Fully depress the accelerator pedal and hold it there.
3. Start the engine.

### Vehicles with Automatic Transmission

1. Move the transmission selector lever to position **P** or **N**.
2. Fully depress the accelerator pedal and hold it there.
3. Start the engine.

## All Vehicles

If the engine does not start, repeat the cold or hot engine procedure.

# Starting and Stopping the Engine

## Engine Idle Speed after Starting

The speed at which the engine idles immediately after starting is optimized to minimize vehicle emissions and maximize cabin comfort and fuel economy.

The idle speed will vary depending on certain factors. These include vehicle component and ambient temperatures as well as electrical and climate system demands.

## Failure to Start

### Vehicles with Manual Transmission

If the engine does not crank when the clutch pedal has been fully depressed and the ignition key is turned to position **III**.

1. Fully depress the clutch and brake pedals.
2. Turn the key to position **III** until the engine has started.

## STARTING A DIESEL ENGINE

### Cold or Hot Engine

#### All Vehicles

**Note:** When the temperature is below 5°F (-15°C), you may need to crank the engine for up to 10 seconds.

**Note:** You can only operate the starter for a limited period of time.

**Note:** After a limited number of attempts to start your engine, the system will not allow you to try again until a period of time has elapsed, for example 30 minutes.



Switch the ignition on and wait until the glow plug indicator goes off.

### Vehicles With Manual Transmission

**Note:** Do not touch the accelerator pedal.

**Note:** Releasing the clutch pedal while the engine is starting will stop the engine cranking and return to ignition on.

1. Fully depress the clutch pedal.
2. Start the engine.

### Vehicles With Automatic Transmission

**Note:** Do not touch the accelerator pedal.

**Note:** Releasing the brake pedal while the engine is starting will stop the engine cranking and return to ignition on.

1. Move the transmission selector lever to position **P** or **N**.
2. Fully depress the brake pedal.
3. Start the engine.

## Failure to Start

### Vehicles With Manual Transmission

If the engine does not crank when the clutch pedal has been fully depressed and the ignition key is turned to position **III**.

1. Fully depress the clutch and brake pedals.
2. Turn the key to position **III** until the engine has started.

## DIESEL PARTICULATE FILTER

The filter forms part of the emissions reduction system on your vehicle. It filters harmful diesel particulates (soot) from the exhaust gas.

# Starting and Stopping the Engine

---

## Regeneration

### WARNINGS



Do not park or idle your vehicle over dry leaves, dry grass or other combustible materials. The regeneration process creates very high exhaust gas temperatures and the exhaust will radiate a considerable amount of heat during and after regeneration and after you have switched the engine off. This is a potential fire hazard.



Avoid running out of fuel.

**Note:** *During regeneration at low speed or engine idle, you may smell a hot metallic odor and could notice a clicking metallic sound. This is due to the high temperatures reached during regeneration and is normal.*

**Note:** *After you have switched your engine off the fans may continue to run for a short period of time.*

A normal filter requires periodic replacement. The diesel particulate filter on your vehicle requires periodic regeneration to maintain its correct function. Your vehicle will carry out this process automatically.

If your journeys meet one of the following conditions:

- You drive only short distances.
- You frequently switch the ignition on and off.
- Your journeys contain a high level of acceleration and deceleration.

You must carry out occasional trips with the following conditions to assist the regeneration process:

- Drive your vehicle in more favorable conditions, which you will find at higher vehicle speeds in normal driving, on a main road or freeway for a minimum of 20 minutes. This drive may include short stops that will not affect the regeneration process.
- Avoid prolonged idling and always observe speed limits and road conditions.
- Do not switch the ignition off.
- Select a suitable gear to ideally maintain engine speed between 1500 and 3000 RPM.

## SWITCHING OFF THE ENGINE

### Vehicles With a Turbocharger

#### WARNING



Do not switch the engine off when it is running at high speed. If you do, the turbocharger will continue running after the engine oil pressure has dropped to zero. This will lead to premature turbocharger bearing wear.

Release the accelerator pedal. Wait until the engine has reached idle speed and then switch it off.



# Unique Driving Characteristics

## START-STOP

**Note:** For vehicles with start-stop the battery requirement is different. It must be replaced by one of exactly the same specification as the original.

The system reduces fuel consumption and CO<sub>2</sub> emissions by shutting down the engine when your vehicle is idling, for example at traffic lights. The engine will automatically restart when you press the clutch pedal or when required by a vehicle system, for example to recharge the battery.

To obtain maximum benefit from the system, move the transmission selector lever to neutral and release the clutch pedal during any stop of longer than three seconds.

## Using Start-Stop

### WARNINGS



The engine may restart automatically if required by the system.



Switch the ignition off before opening the hood or carrying out any maintenance.



Always switch the ignition off before leaving your vehicle, as the system may have shut down the engine but the ignition will still be live.

**Note:** The system only operates when the engine is warm and the outside temperature is between 32°F (0°C) and 86°F (30°C).

**Note:** If you stall the engine, and then depress the clutch pedal within a short period of time, the system will automatically restart the engine.

**Note:** The start-stop indicator will illuminate green when the engine shuts down. See **Warning Lamps and Indicators** (page 64).



**Note:** When the start-stop indicator flashes amber, move the transmission selector lever to neutral or depress the clutch pedal.

**Note:** If the system detects a malfunction, it will switch off. Have your vehicle checked by an authorized dealer.

**Note:** When you switch the system off, the switch will illuminate.

**Note:** The system automatically turns on every time you switch the ignition on. To switch the system off, press the switch in the instrument panel. The system will only be switched off for the current ignition cycle. To turn it on, press the switch again. For item location: See **At a Glance** (page 10).

## To Stop the Engine

1. Stop your vehicle.
2. Move the transmission selector lever to neutral.
3. Release the clutch pedal.
4. Release the accelerator pedal.

The system may not shut down the engine under certain conditions, for example:

- To maintain the interior climate.
- Low battery voltage.
- The outside temperature is too low or too high.
- The driver's door has been opened.
- Low engine operating temperature.
- Low brake system vacuum.
- If a road speed of 3 mph (5 km/h) has not been exceeded.
- The driver's safety belt has not been fastened.

# Unique Driving Characteristics

---

## To Re-Start the Engine

**Note:** *The transmission selector lever must be in neutral.*

Depress the clutch pedal.

The system may automatically restart the engine under certain conditions, for example:

- Low battery voltage.
- To maintain the interior climate.

# Fuel and Refueling

## SAFETY PRECAUTIONS

### WARNINGS



Do not overfill the fuel tank. The pressure in an overfilled tank may cause leakage and lead to fuel spray and fire.



The fuel system may be under pressure. If you hear a hissing sound near the fuel filler door (Easy Fuel capless fuel system), do not refuel until the sound stops. Otherwise, fuel may spray out, which could cause serious personal injury.



Automotive fuels can cause serious injury or death if misused or mishandled.



The flow of fuel through a fuel pump nozzle can produce static electricity, which can cause a fire if fuel is pumped into an ungrounded fuel container.



Fuel ethanol and gasoline may contain benzene, which is a cancer-causing agent.



When refueling always shut the engine off and never allow sparks or open flames near the filler neck. Never smoke or use a cell phone while refueling. Fuel vapor is extremely hazardous under certain conditions. Avoid inhaling excess fumes.

Observe the following guidelines when handling automotive fuel:

- Extinguish all smoking materials and any open flames before refueling your vehicle.
- Always turn off the vehicle before refueling.
- Automotive fuels can be harmful or fatal if swallowed. Fuel such as gasoline is highly toxic and if swallowed can cause death or permanent injury. If fuel is swallowed, call a physician immediately, even if no symptoms are immediately apparent. The toxic effects of fuel may not be visible for hours.
- Avoid inhaling fuel vapors. Inhaling too much fuel vapor of any kind can lead to eye and respiratory tract irritation. In severe cases, excessive or prolonged breathing of fuel vapor can cause serious illness and permanent injury.
- Avoid getting fuel liquid in your eyes. If fuel is splashed in the eyes, remove contact lenses (if worn), flush with water for 15 minutes and seek medical attention. Failure to seek proper medical attention could lead to permanent injury.
- Fuels can also be harmful if absorbed through the skin. If fuel is splashed on the skin, clothing or both, promptly remove contaminated clothing and wash skin thoroughly with soap and water. Repeated or prolonged skin contact with fuel liquid or vapor causes skin irritation.
- Be particularly careful if you are taking "Antabuse" or other forms of disulfiram for the treatment of alcoholism. Breathing gasoline vapors, or skin contact could cause an adverse reaction. In sensitive individuals, serious personal injury or sickness may result. If fuel is splashed on the skin, promptly wash skin thoroughly with soap and water. Consult a physician immediately if you experience an adverse reaction.

# Fuel and Refueling

## FUEL QUALITY - GASOLINE

### WARNINGS



Do not mix gasoline with oil, diesel or other liquids. This could cause a chemical reaction.



Do not use leaded gasoline or gasoline with additives containing other metallic compounds (e.g. manganese-based). They could damage the emission system.

**Note:** We recommend that you use only high quality fuel.

**Note:** We do not recommend the use of additional additives or other engine treatments for normal vehicle use.

Use minimum 95 octane unleaded gasoline that meets the specification defined by EN 228 or the equivalent national specification.

Your vehicle is suitable for use with ethanol blends up to 10% (E5 and E10).

### Long-Term Storage

Most gasoline contains ethanol. We recommend that you fill the fuel tank with fuel that does not contain ethanol if you intend to store your vehicle for more than two months. Alternatively, we recommend that you seek advice from an authorized dealer.

## FUEL QUALITY - DIESEL

### WARNINGS



Do not mix diesel with oil, gasoline or other liquids. This could cause a chemical reaction.



Do not add kerosene, paraffin or gasoline to diesel. This could cause damage to the fuel system.

### WARNINGS



Use diesel that meets the specification defined by EN 590 or the relevant national specification.

**Note:** We recommend that you use only high quality fuel.

**Note:** We do not recommend the use of additional additives or other engine treatments for normal vehicle use.

**Note:** We do not recommend the use of additional additives to prevent fuel waxing.

### Long-Term Storage

Most diesel fuels contain biodiesel. We recommend that you fill the fuel tank with fuel that does not contain biodiesel if you intend to store your vehicle for more than two months. Alternatively, we recommend that you seek advice from your dealer.

## RUNNING OUT OF FUEL

Avoid running out of fuel because this situation may have an adverse effect on powertrain components.

If you have run out of fuel:

- You may need to cycle the ignition from off to on several times after refueling to allow the fuel system to pump the fuel from the tank to the engine. On restarting, cranking time will take a few seconds longer than normal. With keyless ignition, just start the engine. Crank time will be longer than usual.
- Normally, adding 1 gallon (4.6 liters) of fuel is enough to restart the engine. If your vehicle is out of fuel and on a steep grade, more than 1 gallon (4.6 liters) may be required.

# Fuel and Refueling

## Refilling with a Portable Fuel Container

### WARNINGS



Do not insert the nozzle of portable fuel containers or aftermarket funnels into the capless fuel system, they could become stuck. This could damage the fuel system and its seal, and may cause fuel to run onto the ground instead of filling the tank, which could result in serious personal injury.



Do not try to pry open or push open the capless fuel system with foreign objects. This could damage the fuel system and its seal and cause injury to you or others.

**Note:** Do not use aftermarket funnels; they will not work with the capless fuel system and can damage it. The included funnel has been specially designed to work safely with your vehicle.

When filling your vehicle's fuel tank from a portable fuel container, use the funnel included with your vehicle.



E157452

1. Locate the plastic funnel inside the foam box in the spare wheel well.
2. Slowly insert the funnel into the capless fuel system.

3. Fill your vehicle with fuel from the portable fuel container.
4. When done, clean the funnel or properly dispose of it. Extra funnels can be purchased from your authorized dealer if you choose to dispose of the funnel.

## CATALYTIC CONVERTER

### WARNING



Do not park or idle your vehicle over dry leaves, dry grass or other combustible materials. The exhaust will radiate a considerable amount of heat during use, and after you have switched the engine off. This is a potential fire hazard.

## Driving with a Catalytic Converter

### WARNINGS



Avoid running out of fuel.



Do not crank the engine for long periods.



Do not run the engine when a spark plug lead is disconnected.



Do not push-start or tow-start your vehicle. Use booster cables. See

**Jump-Starting the Vehicle** (page 166).





Do not switch the ignition off when driving.

# Fuel and Refueling

## REFUELING

### WARNINGS

 Do not attempt to start the engine if you have filled the fuel tank with the incorrect fuel. This could damage the engine. Have your vehicle checked by an authorized dealer immediately.

 Do not use any kind of flames or heat near the fuel system. The fuel system is under pressure. There is a risk of injury if the fuel system is leaking.

 If you use a high pressure spray to wash your vehicle, only spray the fuel filler flap briefly from a distance not less than 8 inches (200 millimeters).

 We recommend that you wait at least 10 seconds before removing the fuel nozzle to allow any residual fuel to drain into the fuel tank.

 Stop refueling after the fuel nozzle stops the second time. Additional fuel will fill the expansion space in the fuel tank which could lead to fuel overflowing. Fuel spillage could be hazardous to other road users.

 Do not remove the fuel nozzle from its fully inserted position during the entire refueling process.

**Note:** *Your vehicle does not have a fuel filler cap.*



E135934

1. Press the flap to open it. Open the flap fully until it engages.

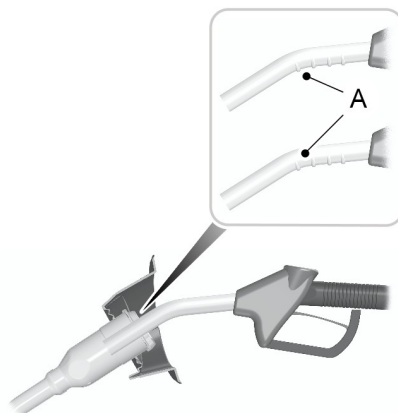

E139202

**Note:** *When you insert the correct size fuel nozzle, a spring loaded inhibitor will open. This helps to avoid filling up with the incorrect fuel.*

2. Insert the fuel nozzle up to and including the first notch on the fuel nozzle A. Keep it resting on the cover of the fuel pipe opening.

# Fuel and Refueling

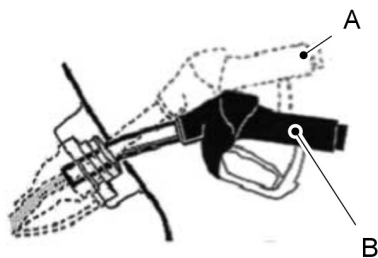

E139203

3. Hold the fuel nozzle in position B during refueling. Holding the fuel nozzle in position A can affect the flow of fuel and shut off the fuel nozzle before the fuel tank is full.

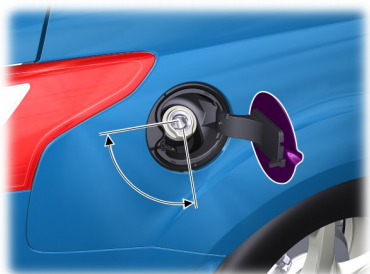

E152137

4. Operate the fuel nozzle within the area shown.

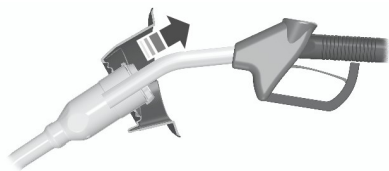

E119081

5. Slightly raise the fuel nozzle to remove it.

## FUEL CONSUMPTION

**Note:** *The amount of usable fuel in the empty reserve varies and should not be relied upon to increase driving range. When refueling your vehicle after the fuel gauge indicates empty, you might not be able to refuel the full amount of the advertised capacity of the fuel tank due to the empty reserve still present in the tank.*

The CO<sub>2</sub> and fuel consumption figures are derived from laboratory tests according to Regulation (EC) 715/2007 and subsequent amendments are carried out by all vehicle manufacturers.

They are intended as a comparison between makes and models of vehicles. They are not intended to represent the real world fuel consumption you may get from your vehicle. Real world fuel consumption is governed by many factors including: driving style, high speed driving, stop-start driving, air conditioning usage, the accessories fitted, payload, towing, etc.

The advertised capacity is the indicated capacity and the empty reserve combined. Indicated capacity is the difference in the amount of fuel in a full tank and a tank when the fuel gauge indicates empty. Empty reserve is the amount of fuel in the tank after the fuel gauge indicates empty.

## Filling the Tank

For consistent results when refueling:

- Switch the ignition off before refueling. An inaccurate reading results if you leave the engine running.
- Use the same fill rate (low-medium-high) each time the tank is filled.
- Allow no more than two automatic shut-offs when refueling.

Results are most accurate when the refueling method is consistent.

# Fuel and Refueling

## Calculating Fuel Economy

Do not measure fuel economy during the first 1000 miles (1600 km) of driving (this is your engine's break-in period). A more accurate measurement is obtained after 2000 - 3000 miles (3200 - 4800 km). Also, fuel expense, frequency of fill ups or fuel gauge readings are not accurate ways to measure fuel economy.

1. Fill the fuel tank completely and record the initial odometer reading.
2. Each time you fill the tank, record the amount of fuel added.
3. After at least three to five tank fill ups, fill the fuel tank and record the current odometer reading.

4. Subtract your initial odometer reading from the current odometer reading.
5. Calculate fuel economy by dividing miles traveled by gallons used (For Metric: Multiply liters used by 100, then divide by kilometers traveled).

Keep a record for at least one month and record the type of driving (city or freeway). This provides an accurate estimate of your vehicle's fuel economy under current driving conditions. Additionally, keeping records during summer and winter show how temperature impacts fuel economy. In general, lower temperatures mean lower fuel economy.

## TECHNICAL SPECIFICATIONS

### Fuel Consumption Figures

Variant	Urban	Extra-Urban	Combined	CO2 Emissions
	l/100 km (mpg)	l/100 km (mpg)	l/100 km (mpg)	g/km
1.6L EcoBoost with manual transmission and start-stop	8.3 (34)	5.6 (50.4)	6.6 (42.8)	154
1.6L EcoBoost with manual transmission, without start-stop	9.7 (29.1)	5.7 (49.6)	6.8 (41.5)	159
1.6L EcoBoost with automatic transmission	10.2 (27.7)	6.3 (44.8)	7.7 (36.7)	179
2.0L Duratorq-TDCi - DW with manual transmission and front-wheel drive	6.3 (44.8)	4.7 (60.1)	5.3 (53.3)	139
2.0L Duratorq-TDCi - DW with manual transmission and all-wheel drive	7.2 (39.2)	5.1 (55.4)	5.9 (47.9)	154
2.0L Duratorq-TDCi - DW with automatic transmission	7.4 (38.2)	5.5 (51.4)	6.2 (45.6)	162



# Transmission

## MANUAL TRANSMISSION

### Selecting Reverse Gear

Do not engage reverse gear when your vehicle is moving. This can cause damage to the transmission.

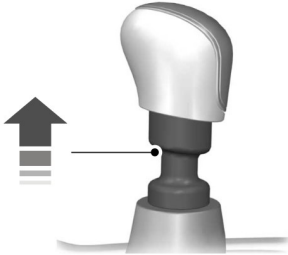

E99067

Raise the collar when you select reverse gear.

## AUTOMATIC TRANSMISSION

### WARNING

 Always set the parking brake fully and make sure you move the transmission selector lever to park. Switch the ignition off and remove the key whenever you leave your vehicle.

## Selector Lever Positions



E133124

- P Park
- R Reverse
- N Neutral
- D Drive
- S Sport mode and manual shifting
- + Manual shift up
- Manual shift down

### WARNING

 Apply the brakes before moving the transmission selector lever and keep them applied until you are ready to move off.

Press the button on the transmission selector lever to change to each position. The transmission selector lever position will be shown in the display.

### P (Park)

### WARNINGS

 Move the transmission selector lever to park only when your vehicle is stationary.

# Transmission

## WARNINGS



Apply the parking brake and move the transmission selector lever to park before leaving your vehicle.

Make sure that the transmission selector lever is latched in position.

In this position, power is not transmitted to the drive wheels and the transmission is locked. You can start the engine with the transmission selector lever in this position.

**Note:** An audible warning will sound if you open the driver's door and you have not moved the transmission selector lever to park.

## R (Reverse)

### WARNINGS



Move the transmission selector lever to reverse only when your vehicle is stationary and the engine is at idle speed.



Always come to a complete stop before shifting the transmission selector lever out of reverse.

Move the transmission selector lever to reverse to allow your vehicle to move backward.

## N (Neutral)

In this position, power is not transmitted to the drive wheels but the transmission is not locked. You can start the engine with the transmission selector lever in this position.

## D (Drive)

**Note:** A shift will occur only when your vehicle speed and the engine speed are appropriate.

**Note:** You may temporarily override the current gear selected using the + or - buttons.

Select drive to shift automatically through the forward gears.

The transmission will select the appropriate gear for optimum performance based on ambient temperature, road gradient, vehicle load and your input.

## Sport Mode and Manual Shifting

### Sport Mode

**Note:** In sport mode the transmission operates as normal but gears are selected more quickly and at higher engine speeds.

**Note:** In sport mode **S** will be shown in the display.

Switch on sport mode by moving the transmission selector lever to Sport. Sport mode will remain on until either you shift manually up or down the gears using the + or - buttons or move the transmission selector lever to drive.

### Manual Shifting

#### WARNINGS



Do not hold the buttons permanently in + or -.



The transmission will automatically downshift when the engine speed is too low.

Press the - button to shift down and press the + button to shift up.

Gears may be skipped by pressing the buttons repeatedly at short intervals.

Manual mode also provides a kickdown function. See Kickdown.

# Transmission

## Hints on Driving with an Automatic Transmission

### WARNING



Do not idle the engine for long periods of time in drive with the brakes applied.

### Moving Off

1. Release the parking brake.
2. Release the brake pedal and press the accelerator pedal.

### Stopping

1. Release the accelerator pedal and press the brake pedal.
2. Apply the parking brake.
3. Move the transmission selector lever to neutral or park.

### Kickdown

Press the accelerator pedal fully with the transmission selector lever in the drive position to select the next lowest gear for optimum performance. Release the accelerator pedal when you no longer require kickdown.

### If Your Vehicle Gets Stuck In Mud or Snow

If your vehicle gets stuck in mud or snow, it may be rocked out by shifting between forward and reverse gears, stopping between shifts in a steady pattern. Press lightly on the accelerator in each gear.

**Note:** Do not rock your vehicle if the engine is not at normal operating temperature or damage to the transmission may occur.

**Note:** Do not rock your vehicle for more than a minute or damage to the transmission and tires may occur, or the engine may overheat.

## Emergency Park Position Release Lever

### WARNINGS



Do not drive your vehicle until you verify that the brake lamps are working.



If the parking brake is fully released, but the brake warning lamp remains illuminated, the brakes may not be working correctly. See an authorized dealer.

Use the lever to move the transmission selector lever from the park position in the event of an electrical malfunction or if your vehicle battery has no charge.

1. Apply the parking brake and switch the ignition off before carrying out this procedure.



E161476

2. Remove the center console side panel.

# Transmission



E142627





**Note:** The lever is pink.

3. Apply the brake pedal. Using a suitable tool rotate the lever forward while pulling the selector lever out of the park position and into the neutral position.

**Note:** See an authorized dealer as soon as possible if this procedure is used.

## HILL START ASSIST

### WARNINGS

-  The system does not replace the parking brake. When you leave your vehicle, always apply the parking brake and move the transmission selector lever into position **P** (Park).
-  You must remain in your vehicle once you have turned the system on.
-  During all times, you are responsible for controlling your vehicle, supervising the system and intervening, if required.
-  If the engine is revved excessively or if a malfunction is detected, the system will turn off.

The system makes it easier to pull away when your vehicle is on a slope without the need to use the parking brake.

When the system is active, your vehicle will remain stationary on the slope for two to three seconds after you release the brake pedal. This allows you time to move your foot from the brake to the accelerator pedal. The brakes are released automatically once the engine has developed sufficient drive to prevent your vehicle from rolling down the slope. This is an advantage when pulling away on a slope, (for example from a car park ramp, traffic lights or when reversing uphill into a parking space).

The system will turn on automatically on any slope which can result in significant vehicle rollback.

## Using Hill Start Assist

1. Press the brake pedal to bring your vehicle to a complete standstill. Keep the brake pedal pressed.
2. If the sensors detect that your vehicle is on a slope, the system will turn on automatically.
3. When you remove your foot from the brake pedal, your vehicle will remain on the slope without rolling away for approximately two or three seconds. This hold time will automatically be extended if you are in the process of driving off.
4. Drive off in the normal manner. The brakes will be released automatically.

## Switching the System On and Off

**Note:** You can only switch the system on and off if your vehicle has a manual transmission.

**Note:** The system will remain on or off depending on how it was last set.

# Transmission

---

Your vehicle comes with this feature already enabled. If required, you can switch this feature off using the information display. See **General Information** (page 68).

## Four-Wheel Drive (If Equipped)

### PRINCIPLE OF OPERATION

This system is a proactive system. It has the ability to anticipate wheel slip and transfer torque to the rear wheels before slip occurs. Even when wheel slip is not present, the system is continuously making adjustments to the torque distribution, in an attempt to improve straight line and cornering behavior, both on and off road.

The system automatically turns on every time you switch the ignition on.

All components of the system are sealed and do not require maintenance.

### USING FOUR-WHEEL DRIVE

**Note:** When a system malfunction is present, a warning message will be displayed in the information display. See **Information Messages** (page 74). This means the system is not functioning correctly and has defaulted to front-wheel drive only. Have your vehicle checked by an authorized dealer.

**Note:** A message will be displayed in the information display when the system overheats and switches to front-wheel drive. This condition may occur if you operate your vehicle in extreme high load conditions or with excessive wheel slip, (i.e. deep sand). To resume four-wheel drive function as soon as possible, stop your vehicle in a safe location and switch the ignition off. After the system cools and normal four-wheel drive functionality resumes, a message will be displayed for approximately five seconds.

**Note:** If a warning message appears in the information display when using the spare tire, it should turn off after reinstalling the repaired or replaced road tire and you switch the ignition on.

**Note:** It is recommended that you reinstall the repaired tire or replace the tire as soon as possible. Major dissimilar tire sizes between the front and rear axles could cause system damage or default the system to front-wheel drive.

The system gives your vehicle some limited off-road capabilities. Operating your vehicle in conditions other than moderate sand, snow, mud or rough roads could subject it to excessive stress and heat which could result in system damage. This will not be covered by your vehicle warranty.



E142669

A graphic will be displayed in the information display to advise you of the power distribution between the front and rear wheels. The more the area is filled the more power is being distributed to that wheel.

### Driving in Special Conditions With Four-Wheel Drive

Four-wheel drive vehicles are suitable for driving on sand, snow, mud and rough roads and have operating characteristics that are somewhat different from conventional vehicles, both on and off the freeway.

**Note:** It may be useful to switch Traction control off. This allows for more wheel spin and engine torque in certain off road conditions or if your vehicle becomes stuck.

## Four-Wheel Drive (If Equipped)

When driving at slow speeds off road under high load conditions, use a low gear when possible. Low gear operation will maximize the engine and transmission cooling capability.

Under severe operating conditions, the air conditioning may cycle on and off to prevent the engine from overheating.

### Basic Operating Principles

- Drive slower in strong crosswinds which can affect the normal steering characteristics of your vehicle.
- When driving your vehicle on surfaces made slippery by loose sand, water, gravel, snow or ice proceed with care.

### If Your Vehicle leaves the Road

If your vehicle leaves the road, reduce your vehicle speed and avoid severe braking. When your vehicle speed has been reduced ease your vehicle back onto the road. Do not turn the steering wheel sharply while returning your vehicle to the road.

It may be safer to stay on the shoulder of the road and slow down gradually before returning to the road. You may lose control if you do not slow down or if you turn the steering wheel too sharply or abruptly.

It may be less risky to strike small objects, such as freeway reflectors, with minor damage to your vehicle rather than attempt a sudden return to the road which could cause your vehicle to slide sideways out of control or roll over. Remember, your safety and the safety of others should be your primary concern.

### Emergency Maneuvers

In an unavoidable emergency situation where a sudden sharp turn must be made, remember to avoid over-driving your vehicle (i.e. turn the steering wheel only as rapidly and as far as required to avoid the emergency). Excessive steering can result

in loss of vehicle control. Apply smooth pressure to the accelerator pedal or brake pedal when changes in vehicle speed are required. Avoid abrupt steering, acceleration and braking. This could result in an increased risk of vehicle roll over, loss of vehicle control and personal injury. Use all available road surface to bring your vehicle to a safe direction of travel.

In the event of an emergency stop, avoid skidding the tires and do not attempt any sharp steering wheel movements.

If your vehicle goes from one type of surface to another (i.e. from concrete to gravel) there will be a change in the way your vehicle responds to a maneuver (i.e. steering, acceleration or braking).

### Sand

When driving over sand, try to keep all four wheels on the most solid area of the trail. Avoid reducing the tire pressures but shift to a lower gear and drive steadily through the terrain. Apply the accelerator slowly and avoid excessive wheel slip.

Do not drive your vehicle in deep sand for an extended period of time. This will cause the system to overheat. A message will be displayed in the information display. See **Information Messages** (page 74).

To resume operation, switch the ignition off and allow the system to cool down for a minimum of 15 minutes. After the system has cooled down, a message will be displayed briefly in the information display. See **Information Messages** (page 74).

When driving at slow speeds in deep sand under high outside temperatures, use a low gear when possible. Low gear operation will maximize the engine and transmission cooling capability.

## Four-Wheel Drive (If Equipped)

Avoid driving at excessive speeds, this causes vehicle momentum to work against you and your vehicle could become stuck to the point that assistance may be required from another vehicle. Remember, you may be able to back out the way you came if you proceed with caution.

### Mud and Water

#### Mud

Be cautious of sudden changes in vehicle speed or direction when you are driving in mud. Even four-wheel drive vehicles can lose traction in slick mud. If your vehicle does slide, steer in the direction of the slide until you regain control of your vehicle.

After driving through mud, clean off residue stuck to rotating driveshafts and tires. Excess mud stuck on tires and rotating driveshafts can cause an imbalance that could damage drive components.

#### Water

If you must drive through high water, drive slowly. Traction or brake capability may be limited.

When driving through water, determine the depth and avoid water higher than the bottom of the wheel rims. If the ignition system gets wet, your vehicle may stall.

Once through water, always try the brakes. Wet brakes do not stop your vehicle as effectively as dry brakes. Drying can be improved by applying light pressure to the brake pedal while moving slowly.

**Note:** *Driving through deep water may damage the transmission. If the front or rear axle is submerged in water, the axle lubricant and power transfer unit lubricant should be checked and changed if necessary.*

### Driving on Hilly or Sloping Terrain

Although natural obstacles may make it necessary to travel diagonally up or down a hill or steep incline, you should always try to drive straight up or straight down.

**Note:** *Avoid turning on steep slopes or hills. A danger lies in losing traction, slipping sideways and possible vehicle roll over. Whenever driving on a hill, determine beforehand the route you will use. Do not drive over the crest of a hill without seeing what conditions are on the other side. Do not drive in reverse over a hill without the aid of an observer.*

When climbing a steep slope or hill, start in a lower gear rather than downshifting to a lower gear from a higher gear once the ascent has started. This reduces strain on the engine and the possibility of stalling.

If your vehicle stalls, do not try to turn around because this could cause vehicle roll over. It is better to reverse back to a safe location.

Apply just enough power to the wheels to climb the hill. Too much power will cause the tires to slip, spin or lose traction, resulting in loss of vehicle control.



E143949



## Four-Wheel Drive (If Equipped)

Descend a hill in the same gear you would use to climb up the hill to avoid excessive brake application and brake overheating. Do not descend in neutral. Disengage overdrive or move the transmission selector lever to a lower gear. When descending a steep hill, avoid sudden hard braking as you could lose control. The front wheels have to be turning in order to steer your vehicle.

Your vehicle has anti-lock brakes, therefore apply the brakes steadily. Do not pump the brake pedal.

### Driving on Snow and Ice

#### WARNING



If you are driving in slippery conditions that require tire chains or cables, then it is critical that you drive cautiously. Keep speeds down, allow for longer stopping distances and avoid aggressive steering to reduce the chances of a loss of vehicle control which can lead to serious injury or death. If the rear end of your vehicle slides while cornering, steer in the direction of the slide until you regain control of your vehicle.

**Note:** Excessive tire slippage can cause transmission damage.

Four-wheel drive vehicles have advantages over two-wheel drive vehicles in snow and ice but can skid like any other vehicle. Should you start to slide while driving on snowy or icy roads, turn the steering wheel in the direction of the slide until you regain control.

Avoid sudden applications of power and quick changes of direction on snow and ice. Apply the accelerator slowly and steadily when starting from a full stop.

Avoid sudden braking. Although a four-wheel drive vehicle may accelerate better than a two-wheel drive vehicle in snow and ice, it will not stop any faster as braking occurs at all four wheels. Do not become overconfident as to road conditions.

Make sure you allow sufficient distance between you and other vehicles for stopping. Drive slower than usual and consider using one of the lower gears. In emergency stopping situations, apply the brake steadily. As your vehicle has a four wheel anti-lock brake system, do not pump the brake pedal. See **Hints on Driving With Anti-Lock Brakes** (page 129).

### If Your Vehicle Gets Stuck In Mud or Snow

If your vehicle gets stuck in mud or snow, it may be rocked out by shifting between forward and reverse gears, stopping between shifts in a steady pattern. Press lightly on the accelerator in each gear.

**Note:** Do not rock your vehicle if the engine is not at normal operating temperature, damage to the transmission may occur.

**Note:** Do not rock your vehicle for more than a minute, damage to the transmission and tires may occur or the engine may overheat.

### Maintenance and Modifications

The suspension and steering systems on your vehicle have been designed and tested to provide predictable performance whether loaded or empty. For this reason, we strongly recommend that you do not make modifications such as adding or removing parts (i.e. lift kits or stabilizer bars) or by using replacement parts not equivalent to the original factory equipment.

## **Four-Wheel Drive (If Equipped)**

---

We recommend that you use caution when your vehicle has either a high load or device (i.e. ladder or luggage racks). Any modifications to your vehicle that raise the center of gravity may cause your vehicle to roll over when there is a loss of vehicle control.

Failure to maintain your vehicle correctly may void the warranty, increase your repair cost, reduce vehicle performance and operational capabilities and adversely affect you and your passenger's safety. We recommend you frequently inspect your vehicle's chassis components when your vehicle is subject to off road usage.

# Brakes

## GENERAL INFORMATION

### WARNING



The system does not relieve you of your responsibility to drive with due care and attention.

**Note:** Occasional brake noise is normal. If a metal-to-metal, continuous grinding or continuous squeal sound is present, the brake linings may be worn-out. If your vehicle has continuous vibration or shudder in the steering wheel while braking, have your vehicle checked by an authorized dealer.

**Note:** Brake dust may accumulate on the wheels, even under normal driving conditions. Some dust is inevitable as the brakes wear. See **Cleaning the Alloy Wheels** (page 196).

**Note:** Depending on applicable laws and regulations in the country for which your vehicle was originally built, your brake lamps may flash during heavy braking. Following this your hazard warning flashers may also flash when your vehicle comes to a stop.

Wet brakes result in reduced braking efficiency. Gently press the brake pedal a few times when driving from a car wash or standing water to dry the brakes.

## Emergency Brake Assist

Emergency brake assist detects when you brake heavily by measuring the rate at which you press the brake pedal. It provides maximum braking efficiency as long as you press the pedal. Emergency brake assist can reduce stopping distances in critical situations.

## Anti-lock Brake System

This system helps you maintain steering control and vehicle stability during emergency stops by keeping the brakes from locking.

## HINTS ON DRIVING WITH ANTI-LOCK BRAKES

**Note:** When the system is operating, the brake pedal will pulse and may travel further. Maintain pressure on the brake pedal. You may also hear a noise from the system. This is normal.

The anti-lock braking system will not eliminate the risks when:

- you drive too closely to the vehicle in front of you
- your vehicle is hydroplaning
- you take corners too fast
- the road surface is poor.

## PARKING BRAKE

### WARNING



Always set the parking brake fully and leave your vehicle with the transmission selector lever in position **P**.

**Note:** Do not press the release button while pulling the lever up.

To apply the parking brake:

1. Press the foot brake pedal firmly.
2. Pull the parking brake lever up to its fullest extent.

**Note:** If you park your vehicle on a hill and facing uphill, move the transmission selector lever to position **P** and turn the steering wheel away from the curb.

# Brakes

---

**Note:** *If you park your vehicle on a hill and facing downhill, move the transmission selector lever to **P** and turn the steering wheel toward the curb.*

To release the parking brake:

1. Press the brake pedal firmly.
2. Pull the lever up slightly.
3. Press the release button and push the lever down.

# Traction Control

---

## PRINCIPLE OF OPERATION

The traction control system helps avoid drive wheel spin and loss of traction.

If your vehicle begins to slide, the system applies the brakes to individual wheels and, when needed, reduces engine power at the same time. If the wheels spin when accelerating on slippery or loose surfaces, the system reduces engine power in order to increase traction.

## USING TRACTION CONTROL

Traction control forms part of the stability control system.

**Note:** *The system automatically turns on every time you switch the ignition on.*

In certain situations (e.g. stuck in snow or mud), turning the system off may be beneficial as this allows the wheels to spin with full engine power.

You can switch the system off and on using the information display. See **General Information** (page 68).

# Stability Control

## PRINCIPLE OF OPERATION

### Electronic Stability Program

#### WARNING



The system does not relieve you of your responsibility to drive with due care and attention.

### Stability Control Warning Lamp

While driving, it flashes when the system is operating. See **Warning Lamps and Indicators** (page 64).

## USING STABILITY CONTROL

**Note:** *The system automatically switches on every time you switch the ignition on.*

You can switch the system on and off using the information display. See **General Information** (page 68).

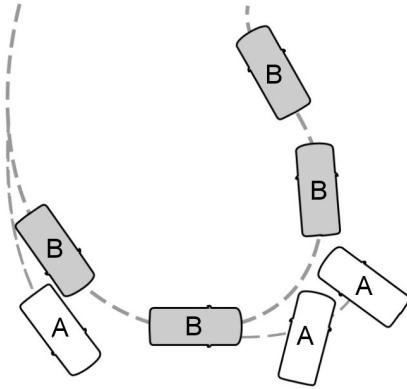

E72903

- A Without ESP
- B With ESP

The system supports stability when your vehicle starts to slide away from your intended path. This is performed by braking individual wheels and reducing engine torque as needed.

The system also provides an enhanced traction control function by reducing engine torque if the wheels spin when you accelerate. This improves your ability to pull away on slippery roads or loose surfaces, and improves comfort by limiting wheel spin in hairpin bends.

# Parking Aids

## PRINCIPLE OF OPERATION

### WARNINGS



The system does not relieve you of your responsibility to drive with due care and attention.



If your vehicle has a trailer tow module not approved by us, the system may not correctly detect obstacles.



The sensors may not detect objects in heavy rain or other conditions that cause disruptive reflections.



The sensors may not detect objects with surfaces that absorb ultrasonic waves.



The system does not detect obstacles moving away from your vehicle. They will only be detected shortly after they start to move toward your vehicle.



Take particular care when reversing with a tow ball arm or rear fitted accessories e.g. a bicycle carrier, as the rear parking aid will only indicate the distance from the bumper to the obstacle.



If you use a high pressure spray to wash your vehicle, only spray the sensors briefly from a distance not less than 8 inches (20 centimeters).

**Note:** If your vehicle has a tow ball arm, the system is switched off automatically when any trailer lamps (or lighting boards) are connected to the 13-pin socket via a trailer tow module we have approved.

**Note:** Keep the sensors free from dirt, ice and snow. Do not clean with sharp objects.

**Note:** The system may emit false tones if it detects a signal using the same frequency as the sensors or if your vehicle is fully laden.

**Note:** The outer sensors may detect the side walls of a garage. If the distance between the outer sensor and the side wall remains constant for three seconds, the tone will switch off. As you continue, the inner sensors will detect rearward objects.

## PARKING AID

### WARNINGS



To help avoid personal injury, read and understand the limitations of the system as contained in this section. Sensing is only an aid for some (generally large and fixed) objects when moving in reverse on a flat surface at parking speeds. Traffic control systems, inclement weather, air brakes and external motors and fans may also affect the function of the sensing system; this may include reduced performance or a false activation.



To help avoid personal injury, always use caution when in reverse and when using the sensing system.



This system is not designed to prevent contact with small or moving objects. The system is designed to provide a warning to assist you in detecting large stationary objects to avoid damaging your vehicle. The system may not detect smaller objects, particularly those close to the ground.



Certain add-on devices such as large trailer hitches, bike or surfboard racks and any device that may block the normal detection zone of the system, may create false beeps.

**Note:** Keep the sensors located on the bumper or fascia free from snow, ice and large accumulations of dirt. If the sensors are covered, the system's accuracy can be affected. Do not clean the sensors with sharp objects.

# Parking Aids

**Note:** *If your vehicle sustains damage to the bumper or fascia, leaving it misaligned or bent, the sensing zone may be altered causing inaccurate measurement of obstacles or false beeps.*

The system warns you of obstacles within a certain range of the bumper area. The system turns on automatically whenever you switch the ignition on. It becomes active when you press the parking aid button or move the transmission selector lever to reverse gear and your vehicle speed is below 8 mph (12 km/h).

When receiving a detection warning, the radio volume is reduced to a predetermined level. After the warning goes away, the radio volume returns to the previous level.

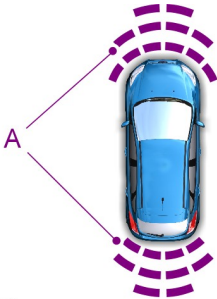

E130382

- A Coverage area of up to 31 inches (80 centimeters) from the front of your vehicle, up to 72 inches (183 centimeters) from the rear bumper and about 6–14 inches (15–35 centimeters) to the side of the front end of your vehicle.

The system sounds an audible warning when obstacles are near either bumper in the following manner:

- Objects detected by the front sensors are indicated by a high-pitched tone from the front speakers.
- Objects detected by the rear sensors are indicated by a lower pitched tone from the rear speakers. As your vehicle moves closer to the obstacle, the rate of the audible warning increases.
- The sensing system reports the obstacle which is closest to the front or rear of your vehicle. For example, if an obstacle is 24 inches (60 centimeters) from the front of your vehicle and at the same time, an obstacle is only 16 inches (40 centimeters) from the rear of your vehicle, the lower pitched tone sounds.
- An alternating warning sounds from the front and rear if there are objects at both bumpers that are closer than 12 inches (30 centimeters).
- If a stationary or receding object is detected further than 12 inches (30 centimeters) from the side of your vehicle, the tone sounds for only three seconds. Once the system detects an object approaching, the warning sounds again.

The system detects certain objects when the transmission selector lever is in reverse:

- and your vehicle is moving toward a stationary object at a speed of 3 mph (5 km/h) or less
- but your vehicle is not moving, and a moving object is approaching the rear of your vehicle at a speed of 3 mph (5 km/h) or less
- and your vehicle is moving at a speed of less than 3 mph (5 km/h) and a moving object is approaching the rear of your vehicle at a speed of less than 3 mph (5 km/h).



# Parking Aids

Press the button to switch the system off. It will remain off for the entire ignition cycle. For item location: See **At a Glance** (page 10).

## ACTIVE PARK ASSIST (IF EQUIPPED)

### WARNINGS



At all times you are responsible for controlling your vehicle, supervising the system and intervening if required.



You must observe that the selected space remains clear of obstructions at all times in the manoeuvre.



The system may not detect parked vehicles with overhanging loads, street furniture or other items. You must make sure that the selected space is suitable for parking.



Do not use the system if there is an overhanging item attached to your vehicle roof.



Do not use the system if a trailer is attached to your vehicle.



Do not use the system if a bike rack is attached to the back of your vehicle.



If interrupted before the manoeuvre is completed, the system will turn off. The steering wheel position will not indicate the true position of the steering and you will have to take control of your vehicle.



Make sure that your hands, arms and loose clothing do not get caught in the rotating steering wheel.

**Note:** After a tire change the system will go through a relearning procedure. During this time the system performance may deteriorate.

The system will detect a suitable parallel parking space and steer your vehicle into the space. The system controls the steering while you control the accelerator, transmission and brakes. You can stop the manoeuvre at any time by holding the steering wheel or pressing the active park assist switch. See **At a Glance** (page 10).

The system will visually and audibly instruct you throughout the manoeuvre to safely park your vehicle.

### Using the System

**Note:** The sensors may not detect objects in heavy rain or other conditions that cause disruptive reflections.

**Note:** The sensors may not detect objects with surfaces that absorb ultrasonic waves.

**Note:** The sensors may not detect the curb.

**Note:** If the traction control system is disabled active park assist will not be available.

The system may not align your vehicle correctly if:

- a spare tire or a significantly worn tire more than the other tires is used
- you use a tire size not recommended by us
- the tires skid
- the weather conditions are poor (heavy rain, snow, fog, etc).

Move forward at a maximum speed of 22 mph (35 km/h) and keep a passing distance between 1.3 - 6.6 feet (0.4 - 2 meters) to the parked vehicles or objects. Press the active park assist switch. See **At a Glance** (page 10). Use the direction indicator to select searching either to the left-hand side or right-hand side of your vehicle.

**Note:** If you do not make a selection the system will default to the passenger's side.

# Parking Aids

**Note:** The system will not offer a suitable parking space if it does not detect a safe distance to the other object. For example, vehicles parked too close on the opposite side.

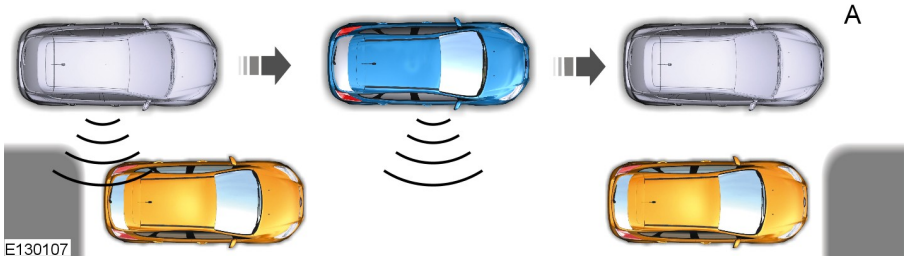

**Note:** You can disable the chimes using the information display. See **Personalized Settings** (page 73).

The information and entertainment display will inform you and a chime will be heard when a suitable space is found. To park your vehicle, follow the instructions on the information and entertainment display.

**Note:** The arrow symbols or graphics in the display indicate on which side of your vehicle the system will park. The display will also advise you when to select reverse gear.

Slow down and stop at approximately position **A**, then follow the system instructions.



## WARNING



You must take full control of your vehicle when the speed exceeds 6 mph (10 km/h) as the system is disabled.

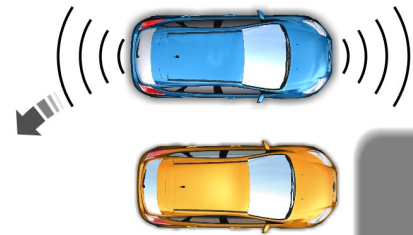

Cautiously move your vehicle backward using the accelerator and brake pedals. Parking aid warning tones will sound. Stop your vehicle when you hear a continuous tone.

You can take control of the manoeuvre by holding the steering wheel. If a message appears in the display, press the active park assist switch to resume. See **At a Glance** (page 10).

# Parking Aids

Move your vehicle forward. Stop your vehicle when you hear a continuous tone.

The display will indicate when the system has finished the manoeuvre.

## REAR VIEW CAMERA

### WARNINGS



The operation of the camera may vary depending on the ambient temperature, vehicle and road conditions.



The distances shown in the display may differ from the actual distance.



Do not place objects in front of the camera.

The camera is located on the liftgate near the handle.

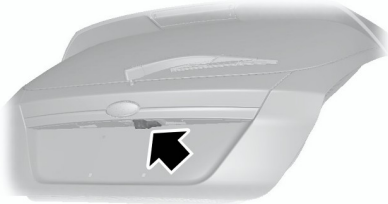

E147796

## Switching the Rear View Camera On

### WARNING



The camera may not detect objects that are close to your vehicle.

Switch the ignition and the audio unit on.

Press the parking aid switch in the instrument panel or move the transmission selector lever to reverse.

The image is displayed on the screen.

The lamp in the switch illuminates when the system is switched on.

The camera may not operate correctly in the following conditions:

- Dark areas.
- Intense light.
- If the ambient temperature increases or decreases rapidly.
- If the camera is wet, for example in rain or high humidity.
- If the camera's view is obstructed, for example by mud.

## Using the Display

### WARNINGS



Obstacles above the camera position will not be shown. Inspect the area behind your vehicle if necessary.



Marks are for general guidance only, and are calculated for vehicles in maximum load conditions on an even road surface.

The lines show the distance from the outer edge of the front tire plus two inches (51 millimeters) and the rear bumper.

# Parking Aids

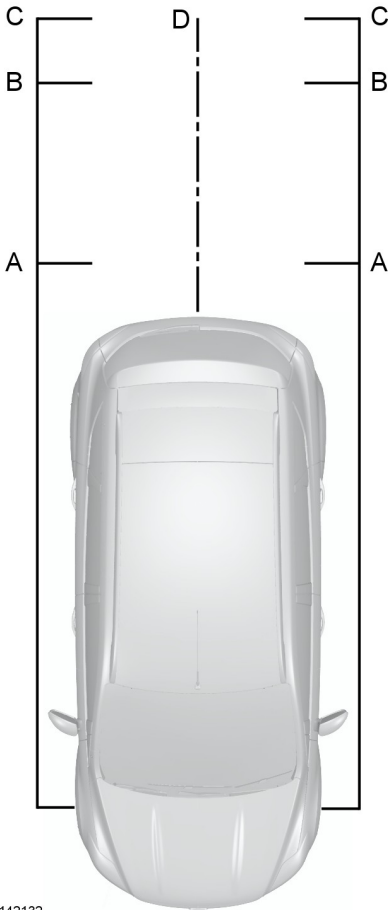

C Green - 24 - 35 inches (0.6 - 0.9 meter)

D Black - center line of the projected vehicle path

**Note:** The green line is extended from 35 inches (0.9 meter) up to a distance of 126 inches (3.2 meters).

**Note:** When reversing with a trailer, the lines on the screen are not shown. The camera will show your vehicle direction and not the trailer.

## Switching the Rear View Camera Off

**Note:** The system will automatically switch off once your vehicle speed has reached approximately 7 mph (12 km/h).

Press function button 4. For item location: See **Audio System** (page 214).

## Vehicles with Parking Aid

The display will additionally show a colored distance bar. This guide indicates the distance from the rear bumper to the detected obstacle.

These are color coded as follows:

- Green - 24 - 71 inches (0.6 to 1.8 meters).
- Amber - 12 - 24 inches (0.3 to 0.6 meter).
- Red - 12 inches (0.3 meter) or less.

E142132

A Red - up to 12 inches (0.3 meter)

B Amber - 12 - 24 inches (0.3 - 0.6 meter)

# Cruise Control

## PRINCIPLE OF OPERATION

Cruise control lets you maintain a set speed without keeping your foot on the accelerator pedal.

## USING CRUISE CONTROL

### WARNINGS



Do not use cruise control in heavy traffic, on winding roads or when the road surface is slippery. This could result in loss of vehicle control, serious injury or death.



When you are going downhill, your vehicle speed may increase above the set speed. The system will not apply the brakes. Change down a gear to assist the system in maintaining the set speed. Failure to do so could result in loss of vehicle control, serious injury or death.

**Note:** Cruise control will disengage if your vehicle speed decreases more than 10 mph (16 km/h) below your set speed while driving uphill.



E166821

The cruise control switches are located on the steering wheel.

## Switching Cruise Control On

Press and release **ON**.



The indicator will display in the instrument cluster.

## Setting a Speed

1. Accelerate to the desired speed.
2. Press and release **SET+**.
3. Take your foot off the accelerator pedal.

## Changing the Set Speed

- Press and hold **SET+** or **SET-**. Release the control when you reach the desired speed.
- Press and release **SET+** or **SET-**. The set speed will change in approximately 1 mph (2 km/h) increments.
- Press the accelerator or brake pedal until you reach the desired speed. Press and release **SET+**.

## Canceling the Set Speed

Pull **CAN** toward you and release, or tap the brake pedal. The system will not erase the set speed.

## Resuming the Set Speed

Pull **RES** toward you and release.

## Switching Cruise Control Off

**Note:** You will erase the set speed if you switch the system off.

Press and release **OFF** or switch the ignition off.

# Cruise Control

---

## USING ADAPTIVE CRUISE CONTROL

### WARNINGS



The system is not a crash warning or avoidance system. You must intervene if the system does not detect a vehicle in front of you.



When you use the system you are responsible for maintaining the correct distance and speed. Always pay attention to the traffic conditions and intervene when the system is not maintaining a suitable speed or distance.



The system does not relieve you of your responsibility to drive with due care and attention.



The system does not brake for slow or stationary vehicles, pedestrians, objects in the road, oncoming and crossing vehicles.



Do not use the system in poor visibility, specifically fog, heavy rain, spray or snow.



Do not use the system on icy or slippery roads.



Do not use the system when entering or leaving a freeway.

---

**Note:** Only use the system when conditions are favorable, for example on freeways and main roads with steady free flowing traffic.

**Note:** The radar sensor has a limited field of vision. In some situations it may detect a vehicle other than the one expected or not detect any vehicle at all.

**Note:** When you switch the system on, it is possible that you will hear some unusual sounds during automatic braking. This is normal and caused by the automatic braking system.

**Note:** Keep the front of your vehicle free from dirt, metal badges or objects. This includes vehicle front protectors and additional lights which may prevent the sensor from operating.

The system is designed to help you maintain a gap from the vehicle in front of you. If there is no vehicle in front of you the system will maintain a set speed. The system is intended to provide enhanced operation of your vehicle when following other vehicles which are in the same lane and traveling in the same direction.

The system is based on the use of a radar sensor which projects a beam directly forward of your vehicle. This beam will detect any vehicle ahead within the system's range.

The radar sensor is located behind the front grille.

# Cruise Control

## Detection Beam Issues

**A**

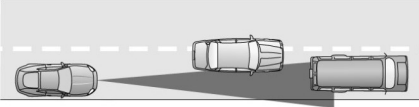

**B**

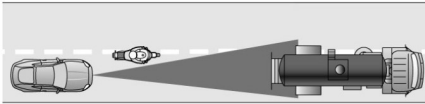

**C**

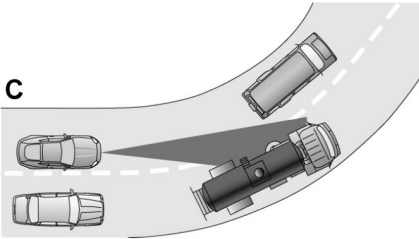

E71621

Detection issues can occur:

- With vehicles that edge into your lane that can only be detected once they have moved fully into your lane (**A**). Motorcyclists may be detected late, or not at all. (**B**)
- With vehicles in front of you when going into and coming out of a bend (**C**). The detection beam will not follow sharp curves in the road.

In these cases the system may brake late or unexpectedly. You should stay alert and intervene if necessary.

## Automatic Braking

### WARNINGS



You must take immediate action once alerted, as the adaptive cruise control braking will not be sufficient to keep a safe distance to the vehicle in front of you.



In some cases there may be no warning or the warning may be delayed. You should always apply the brakes when necessary.



When following a vehicle, the system will not automatically decelerate to a stop.

If required, the system will automatically brake for you to maintain the set gap between your vehicle and the one detected in front of you. This braking capacity is limited to approximately 30% of the total manual braking capacity to maintain smooth and comfortable cruising. If your vehicle needs to brake more heavily than this and you do not intervene by braking manually, an alarm will sound and a warning symbol will be shown in the display.

# Cruise Control

## Using the System

Use the steering wheel controls to operate the system.

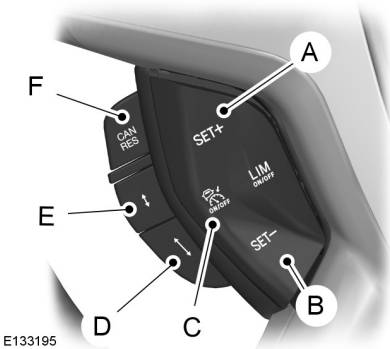

E133195

- A Set speed increase
- B Set speed decrease
- C On and off
- D Gap increase
- E Gap decrease
- F Cancel and resume

## Switching the System On

Press switch C. The system is set to standby mode.

## Setting a Speed

**Note:** The system must be in standby mode.

Press switch A or B to select your desired cruise speed. The speed is displayed in the information display and stored as the set speed.

## Changing the Set Speed

**Note:** Vehicle speed may be increased and decreased at intervals of 5 mph or 5 km/h depending on your unit of measure setting.

**Note:** If the system does not react to these changes the reason may be that the gap interval to the vehicle in front of you prevents an increase in speed.

Press switch A to increase or switch B to decrease the set speed until the desired set speed is shown in the information display. Your vehicle speed will gradually change to the selected speed.

## Setting the Vehicle Gap

**Note:** Use the appropriate gap setting in accordance with local traffic regulations.

**Note:** The gap setting is time dependent and therefore the distance will automatically adjust with your speed. For example on a gap setting of four bars, the time gap is 1.8 seconds. This will mean that at a speed of 62 mph (100 km/h), the distance to the vehicle in front of you will be maintained at 164 feet (50 meters).

**Note:** If you depress the accelerator for a short period of time, for example when overtaking, the system will temporarily switch off. It will switch back on when you release the accelerator pedal. A message will be shown in the display.

**Note:** The gap setting will remain unchanged each time you switch the ignition on.

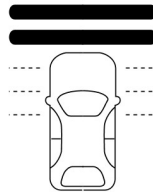

E82311



# Cruise Control

The distance between you and the vehicle detected in front of you is maintained by a variable setting. This setting is represented by horizontal bars displayed in the information display. Selecting one bar gives the smallest gap and selecting all bars gives the largest gap. These bars are shown empty when in standby mode and filled when the system is in use.

When the system does not detect a vehicle in front of you, you will only see your vehicle displayed in the information display below the bars. The system will maintain the set speed when conditions permit. The system also maintains the set gap and displays this in the information display.

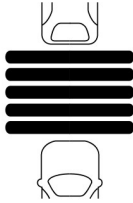

E82312

When the system detects a vehicle in front of you, it will be displayed above the horizontal bars.

This is a follow mode. The system will accelerate or decelerate as necessary to maintain the set gap. The selected gap will determine the acceleration behavior of the system.

Pull switch E to decrease the gap or switch D to increase the gap. The number of bars in the information display represents the set gap.

**Note:** *The recommended gap setting is four bars.*

## Standby Mode

**Note:** *You will cancel the system if you move the transmission selector lever to neutral or depress the clutch or accelerator pedal for a long period of time.*

Press the brake pedal or pull switch F to cancel the system. The system will return to standby mode allowing you full manual control of your vehicle. The memory will retain the set speed and gap setting.

Pull switch F again to resume. The system will resume with the previously set speed and gap setting if conditions permit.

## Switching the System Off

Press switch C.

**Note:** *This will not retain the stored speed.*

## Automatic Switch Off

**Note:** *A message will be shown in the display if the engine speed drops too low. It will advise you to change down a gear (manual transmission only). If you do not follow this recommendation then the system will automatically switch off.*

**Note:** *The system will not operate when traction control is off.*

The system is dependent on various other systems, for example anti-lock braking system and electronic stability program. When a safety system has a malfunction or is reacting to an emergency, the system will automatically switch off.

You will hear an audible tone and a message will be shown in the display. You must then intervene and adapt your driving and speed to vehicles in front of you.

An automatic switch off can occur if:

- Your vehicle speed falls below approximately 17 mph (25 km/h).
- The tires lose traction.
- The brake temperature is too high, for example when driving on mountainous or hilly roads.
- The engine speed is too low.
- The radar sensor is covered.
- You apply the parking brake.

# Cruise Control

## Forward Alert Function

### WARNINGS



Never wait for a crash warning. When driving you are responsible for maintaining the correct distance and speed, even when the system is used.



The system will only react to vehicles in front of you traveling in the same direction and will not react to slow or stationary vehicles.



Never drive in a manner to provoke the system. The system is designed to assist in emergencies only.



Warnings may be absent, triggered late or triggered unnecessarily due to detection beam issues. See

**Principle of Operation** (page 140).

**Note:** *The brake support system only reduces the crash speed if you brake immediately once alerted.*

**Note:** *If you depress the brake pedal quick enough, you will maintain full braking. This is regardless of how much force you apply to the pedal.*

**Note:** *Brake support prepares the braking system for rapid braking by gently applying the brake. You may notice a slight jerk.*

**Note:** *Crash alerts will only occur when you switch the system on. Brake support is always on and you can not turn it off.*

**Note:** *You can use the system with or without switching the adaptive cruise control system on.*

**Note:** *The system uses the same radar sensors as adaptive cruise control and therefore has the same limitations. See **Principle of Operation** (page 140).*

The system is designed to assist you by warning you of the risk of a crash with the vehicle in front of you.

The system is designed to alert you by warning chimes and a visual warning in the information display.

Brake support is turned on to enable full braking effectiveness and reduce the severity of a crash with the vehicle in front of you.

## Switching the System On and Off

You can switch the system on and off using the information display. See **General Information** (page 68).

**Note:** *When you switch the system off, a warning indicator will remain illuminated in the information display. See **Warning Lamps and Indicators** (page 64).*

**Note:** *The system status and settings will remain unchanged each time you switch the ignition on.*

## Adjusting the Warning Sensitivity

This will determine how early the system alerts you. You can adjust the sensitivity using the steering wheel controls. See **General Information** (page 68).

# Driving Aids

## BLIND SPOT MONITOR

### Blind Spot Information System

#### WARNINGS

 The system will not prevent a crash or contact with other vehicles or objects. It is designed to provide a warning to assist you in detecting vehicles in the blind spot zones. It will not detect obstacles, pedestrians, motorcyclists or cyclists.

 Do not use the system as a replacement for using the mirrors or looking over your shoulder before changing lanes. You should only use the system as an aid. It is not a replacement for careful driving.

The system is a convenience feature that assists you in detecting vehicles that may have entered the blind spot zone (A). The detection area is on both sides of your vehicle extending rearward from the exterior mirrors to approximately 10 feet (3 meters) beyond the rear bumper. The system is designed to alert you if other vehicles enter the blind spot zone when driving.

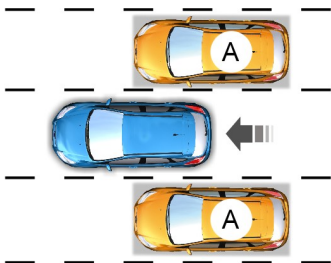

E124788

#### Using the System

The system displays a yellow warning indicator located in the exterior mirrors. It will dim when the ambient light decreases.



E124736

**Note:** Both warning indicators will illuminate briefly when you switch the ignition on to confirm that the system is operational.

**Note:** If your vehicle has an automatic transmission, the system only operates when you move the transmission selector lever to sport, drive or neutral.

The system only operates when your vehicle exceeds 6 mph (10 km/h). The system will temporarily switch off when you select reverse gear.

#### System Detection and Alerts

#### WARNINGS

 Do not place items such as bumper stickers in this area.

 Repairs to these areas using body filler will affect the performance of the system.

The system is designed to trigger the alert for vehicles that enter the blind spot zone from the rear or merge from the side. Vehicles that you pass or vehicles that enter the blind spot zone from the front, will only trigger the alert after the vehicle has remained in the blind spot zone for a short period of time.

**Note:** Vehicles that pass through the blind spot zone quickly (typically less than 2 seconds) will not trigger the alert.

The system consists of two radar sensors each located behind the rear wheels, hidden behind the bumpers.

# Driving Aids

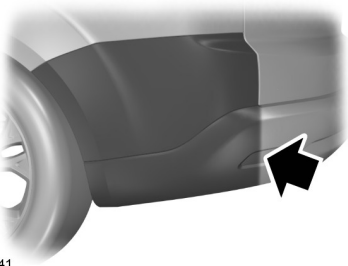

E124741

## Detection Limitations

There may be instances where the system will not always detect vehicles entering and exiting the blind spot zone.

Instances which may cause non-detection:

- Debris build up on the rear bumper panels in the area of the sensors.
- Certain maneuvering of vehicles entering and exiting the blind spot zone.
- Vehicles passing through the blind spot zone at high speed.
- Severe weather conditions.
- Several vehicles passing through the blind spot zone following each other closely.

## False Alerts

**Note:** *False alerts are temporary and will self correct.*

There may be certain instances when the system will alert with no vehicle present in the blind spot zone.

Circumstances where false alerts may occur:

- Road guardrails.
- Freeway concrete walls.
- Construction areas.
- Sharp turns around a building.

- Bushes and trees.
- Coming to a stop with a vehicle very close behind.

## Switching the System Off and On

You can switch the system off and on using the information display. See **Information Displays** (page 68).

When you switch the system off no further alerts will be received. The warning indicator in the instrument cluster will illuminate. See **Warning Lamps and Indicators** (page 64).

**Note:** *The system status will remain the same until you manually change it.*

## Detection Errors

**Note:** *The warning indicator in the exterior mirror will not illuminate.*

If the system senses a fault on either sensor, the warning indicator in the instrument cluster will illuminate and remain on. A message will be shown in the display to confirm the fault and indicate which sensor is affected.

## Blocked Sensor

### WARNINGS



Prior to the system recognizing a blocked condition and issuing a warning, the number of missed objects will increase.



The sensors may not detect vehicles in heavy rain or other conditions that cause disruptive reflections.

**Note:** *Keep the rear bumper area surrounding the sensors free from dirt, ice and snow.*

If a sensor becomes blocked the system performance may degrade. A blocked sensor message may be displayed.

# Driving Aids

The system will automatically return to normal operation after one of the following conditions have been met:

- Two other vehicles have been detected on both sides.
- You switch the ignition off and on.

If the sensor remains blocked after you have switched the ignition off and on, the system will detect the blockage again and alert you.

## Trailer Towing False Alerts

If your vehicle has a trailer tow module approved by us, the system will detect a connected trailer and turn off. A confirmation message will be shown in the information display. See **Information Messages** (page 74). The warning indicator in the instrument cluster will illuminate. See **Warning Lamps and Indicators** (page 64).

**Note:** *If your vehicle has a trailer tow module not approved by us, the system may not correctly detect a connected trailer. Switch the system off to avoid false alerts. See **Information Displays** (page 68).*

## SPEED LIMITER

### Principle of Operation

#### WARNING



When you are going downhill, your speed may increase above the set speed. The system will not apply the brakes but a warning will be given.

The system allows you to set a speed, to which your vehicle then becomes limited. The set speed will become the effective maximum speed of your vehicle, but with the option to temporarily exceed this limit if required.

## Using the System

**Note:** *The set speed limit can be intentionally exceeded for a short period of time if required, for example when overtaking.*

**The system is operated by adjustment controls mounted on the steering wheel.**



E1133198

- A Set speed increase
- B On and off
- C Set speed decrease
- D Cancel and resume

## Switching the System On and Off

Press switch B. The information display will prompt you to set a speed.

## Setting the Speed Limit

Use the cruise control switches to alter the maximum speed setting.

Press switch A or C to select your desired speed limit. The speed is displayed in the information display and stored as the set speed.

# Driving Aids

Pull switch D to cancel the limiter and place it in standby mode. The information display will confirm this has been turned off by showing the set speed crossed out.

Pull switch D again to resume the limiter. The information display will confirm this has been turned on by showing the set speed again.

## Intentionally Exceeding the Set Speed Limit

Depress the accelerator fully to temporarily turn the system off. The system will turn on once your vehicle speed drops below the set speed.

## System Warnings





If you accidentally exceed the set speed, it will flash in the information display and you will hear an audible warning chime.

If you intentionally exceed the set speed, it will flash in the information display.







## DRIVER ALERT

### Principle of Operation

#### WARNINGS

-  The system does not relieve you of your responsibility to drive with due care and attention.
-  At all times you are responsible for controlling your vehicle, supervising the system and intervening if required.
-  If the sensor becomes blocked the system may not function.
-  Take regular rest breaks as required and do not wait for the system to warn you if you feel tired.
-  Take rest breaks only where it is safe to do so.

#### WARNINGS

-  Certain driving styles and behavior may result in the system issuing a warning even if you are not feeling tired.
-  In cold and severe weather conditions the system may not function. Rain, snow, spray and large contrasts in lighting can all influence the sensor.
-  The system will not operate if the sensor cannot track the road lane markings.
-  The system may not operate in areas during roadwork construction.
-  The system may not operate on roads with sharp bends or narrow lanes.
-  Do not carry out windshield repairs in the immediate area surrounding the sensor.
-  If your vehicle has a suspension kit not approved by us, the system may not function correctly.

**Note:** *Keep the windshield free from obstructions such as bird droppings, insects and snow or ice.*

**Note:** *The system assists you when driving on fast main roads and freeways.*

**Note:** *The system calculates an alertness level at vehicle speeds above approximately 40 mph (65 km/h).*

The system automatically monitors your driving behavior.

The system is designed to alert you if it detects that you are becoming drowsy or if your driving deteriorates.

# Driving Aids

## Using Driver Alert

### Switching the System On and Off

**Note:** The system will remain on or off depending on how it was last set.

Switch the system on using the information display. See **Information Displays** (page 68).

The system will calculate your alertness level based upon your driving behavior in relation to the lane markings and other factors.

### System Warnings

**Note:** The system will not issue warnings below approximately 40 mph (65 km/h).

The warning system has two stages:

1. A temporary warning is issued to advise you to take a rest. This message only appears for a short time.
2. If you do not rest and the system continues to detect that your driving deteriorates, it will issue a further warning. This will remain in the information display until you cancel it. See **Information Messages** (page 74).

Press **OK** on the steering wheel control to remove the warning.

### System Display

When active the system will run automatically in the background and only issue warnings if required. You can view the status at any time using the information display. See **General Information** (page 68).

The alertness level is shown by six steps as a colored bar.

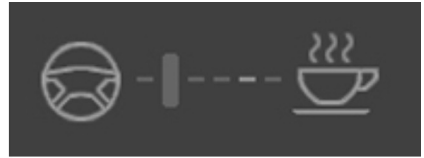

E131358

Alertness level is fine, no rest required.

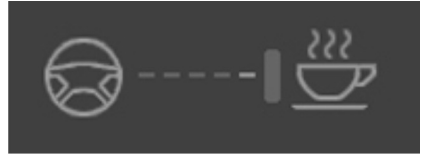

E131359

Alertness level is critical, indicating that you should take a rest as soon as it is safe to do so.

The status bar will travel from left to right as the calculated alertness level decreases. As the rest icon is approached the color turns from green to yellow and then finally red when a rest break must be taken.

- Green: No rest required.
- Yellow: First (temporary) warning.
- Red: Second warning.

Your alertness level will be shown in grey if:

- the camera sensor cannot track the road lane markings
- your vehicle speed drops below approximately 40 mph (65 km/h).

### Resetting the System

You can reset the system by:

- switching the ignition off and on
- stopping your vehicle and then opening and closing the driver's door.

# Driving Aids

## LANE KEEPING SYSTEM

### Lane Keeping Alert

#### Principle of Operation

##### WARNINGS



The system does not relieve you of your responsibility to drive with due care and attention.



At all times you are responsible for controlling your vehicle, supervising the system and intervening if required.



If the sensor becomes blocked the system may not function.



The sensor may incorrectly track lane markings such as other structures or objects. This can result in a false or missed warning.



In cold and severe weather conditions the system may not function. Rain, snow, spray and large contrasts in lighting can all influence the sensor.



The system will not operate if the sensor cannot track the road lane markings.



The system may not operate in areas during roadwork construction.



The system may not operate on roads with sharp bends or narrow lanes.



Do not carry out windshield repairs in the immediate area surrounding the sensor.



If your vehicle has a suspension kit not approved by us, the system may not function correctly.

**Note:** Keep the windshield free from obstructions such as bird droppings, insects and snow or ice.

**Note:** The system may assist you when driving on fast main roads and freeways.

**Note:** The system may not operate during hard braking or acceleration and when you are intentionally steering your vehicle.

**Note:** The system will operate with a minimum of one tracked lane marking.

**Note:** The system will only operate above vehicle speeds of approximately 40 mph (65 km/h).

The sensor is located behind the interior mirror. It continuously monitors conditions to alert you of unintentional lane drifting at high speeds.

The system will automatically detect and track the lane markings on the road. If your vehicle unintentionally drifts toward the road lane markings, a warning will be shown in the display. There is also a warning given in the form of a vibration felt through the steering wheel.

#### Using Lane Keeping Alert

##### Switching the System On and Off

**Note:** When you switch the system off, a warning indicator will remain illuminated in the information display. See **Warning Lamps and Indicators** (page 64).

**Note:** The system status and settings will remain unchanged when you switch the ignition on and off.



E132099

Switch the system on and off using the button on the direction indicator stalk.



# Driving Aids

Press the button twice to switch the system on. Press the button once to switch the system off.

## Setting the Steering Wheel Vibration Level

The system has three intensity levels which you can set using the information display. See **General Information** (page 68).

## Setting the System Sensitivity

You can adjust how quickly the system warns you of a dangerous situation. The system has two sensitivity levels which you can set using the information display. See **General Information** (page 68).

## System Warnings



E132651

A column of lane markings are displayed either side of the vehicle graphic.

The lane markings are color coded as follows:

- Green: The system is ready to warn you of any unintentional lane departure.
- Red: Your vehicle is approaching or is too close to the detected lane boundary. Take immediate safe action to reposition your vehicle.
- Gray: The relevant lane boundary will be suppressed.

Instances where a lane boundary may be suppressed:

- Lane markings on the road may not be detected by the sensor.
- You turn the direction indicator for that side of your vehicle on.
- If you apply direct steering, accelerate fast or brake hard.
- Your vehicle speed is outside the operating limits.
- If there is an anti-lock brake or stability control intervention.
- Narrow lane width.

If the lane markings in the display turn red or you feel a vibration through the steering wheel you must take immediate and safe action to align your vehicle. Correct any unintended lane drift immediately.

## Lane Keeping Aid

### Switching the System On and Off

**Note:** The system does not automatically turn on every time you switch the ignition on.

**Note:** When you switch the system on, this will automatically turn lane keeping alert on.



E132099

Switch the system on and off using the button on the indicator stalk.

Press the button three times to switch the system on. Press the button again to switch the system off.

# Driving Aids

## Setting the System Sensitivity

You can adjust how quickly the system intervenes in a dangerous situation. The system has two sensitivity levels which you can set using the information display. See **General Information** (page 68).

## System Warnings



E132651

A column of lane markings are displayed either side of the vehicle graphic.

The lane markings are color coded as follows:

- Green: The system is ready to warn you of any unintentional lane departure.
- Yellow: The system will automatically apply a steering torque to align your vehicle path and correct any unintended lane drift.
- Red: Your vehicle is approaching or is too close to the detected lane boundary. The steering wheel will give a vibration warning. Take immediate safe action to reposition your vehicle.

Instances where a lane boundary may be suppressed:

- Lane markings on the road may not be detected by the sensor.
- You turn the direction indicator for that side of your vehicle on.



- If you apply direct steering, accelerate fast or brake hard.
- Your vehicle speed is outside the operating limits.
- If there is an anti-lock brake or stability control intervention.
- Narrow lane width.

**Note:** You can override the system at any time during its operation by turning the steering wheel.

## TRAFFIC SIGN RECOGNITION

### Principle of Operation

#### WARNINGS

-  The system does not relieve you of your responsibility to drive with due care and attention.
-  At all times you are responsible for controlling your vehicle, supervising the system and intervening if required.
-  If the sensor becomes blocked the system may not function.

**Note:** In cold and severe weather conditions the system may not function. Rain, snow, spray and large contrasts in lighting can all prevent the sensor from functioning correctly.

**Note:** Do not carry out windshield repairs in the immediate area surrounding the sensor.

**Note:** If your vehicle has a suspension kit not approved by us, the system may not function correctly.

**Note:** Always fit Ford original parts when replacing headlamp bulbs. Other bulbs may reduce system performance.

# Driving Aids

**Note:** Keep the windshield free from obstructions such as bird droppings, insects and snow or ice.

**Note:** The system may not detect all traffic signs and may read signs incorrectly.

**Note:** The system is designed to automatically detect traffic signs meeting the Vienna convention.

**Note:** Traffic sign data provided by the navigation system contains information integrated to the data carrier release.

There is a sensor mounted behind the interior rear view mirror. It continuously monitors road signs to inform you of the current speed limit and overtaking regulations.

The system automatically detects recognisable traffic signs, such as:

- Speed limit signs.
- No overtaking signs.
- Speed limit cancellation signs.

When the system recognises a traffic sign, it will be shown in the display.

## Using the System

### Switching the System On and Off

**Note:** The system status and settings will remain unchanged during ignition cycles.

You can switch the system on and off using the information display. See **General Information** (page 68).

### Setting the System Speed Warning

The system has a number of speed warning levels which can be set using the information display. See **General Information** (page 68).

## System Display



E 132994

The system can display two traffic signs in parallel.

You can view the status at any time using the information display.

The system display is in four stages as follows:

1. All new recognizable traffic signs will appear brighter than the other traffic signs in the display.
2. After a predetermined time they will be shown normally.
3. After a predetermined distance they will be shown greyed out.
4. After another predetermined distance they will be deleted.

If the system detects a supplementary traffic sign, this sign is indicated as a box below the respective traffic sign. For example, when passing a reduced speed limit in wet road conditions sign.

If your vehicle has a navigation system, stored traffic sign data may influence the indicated speed limit value.

# Driving Aids

## ACTIVE CITY STOP

### Principle of Operation

#### WARNINGS

 The system does not relieve you of your responsibility to drive with due care and attention. Failure to do so could result in loss of vehicle control, personal injury or death.

 At all times you are responsible for controlling your vehicle, supervising the system and intervening if required. Failure to do so could result in loss of vehicle control, personal injury or death.

 Never look directly into the sensor with any type of object, there is a risk of eye injury.

 If the sensor becomes blocked the system may not function.

 You must run in the brake system to achieve full system performance. See **Breaking-In** (page 164).

 The system performance may vary depending on your vehicle and road conditions.

 The system will not react to vehicles driving in a different direction.

 The system will not react to cyclists, motorcyclists, people or animals.

 When the ignition is on the sensor will constantly transmit a laser beam.

 The system will not operate during harsh acceleration and steering.

 In cold and severe weather conditions the system may not function. Rain, snow, spray and ice can all influence the sensor.

#### WARNINGS

 Do not carry out windshield repairs in the immediate area surrounding the sensor.

 If your vehicle has a windshield not approved by us, the system may not function correctly.

 When the system is active, if the engine stops, the hazard warning flashers will turn on.

 The system may not function when driving around sharp curves.

**Note:** *Keep the windshield free from obstructions such as bird droppings, insects and snow or ice.*

**Note:** *Keep the hood free of ice and snow, otherwise the system may not function correctly.*

There is a sensor mounted behind the interior mirror. It continuously monitors conditions to decide when to intervene.

The system reduces the risk of low speed crashes into the rear of another vehicle. It will also help you reduce the impact damage or potentially avoid the crash completely.

The system operates at speeds below approximately 19 mph (30 km/h) by applying the brakes when the sensor detects that a crash is likely.

You must depress the brake pedal to obtain full braking force.

A message will be shown in the display when the system is braking or it applies the brakes automatically.

### Switching the System Off and On

**Note:** *The system is per default on.*

# Driving Aids

In certain situations it is advisable to disable the system, for example:

- Driving off road when objects may cover the windshield.
- Driving through a car wash facility.

You can switch the system off and on using the information display. See **General Information** (page 68).

## ECO MODE

This system assists you in driving more efficiently by constantly monitoring characteristics of gear changing, anticipation of traffic conditions and speeds while driving.

The value of these characteristics is represented by petals shown in the display, with five petals being the most efficient. The more efficiently you drive, the better the rating, and the better your vehicle's overall fuel economy.

**Note:** *These efficiency values do not result in a defined fuel consumption figure. It might vary as it is not only related to these driving habits, but also influenced by many other factors such as short trips and cold starts.*

**Note:** *Frequent short trips, where the engine does not fully warm up, will also increase fuel consumption*

The system is accessed using the information display control. See **General Information** (page 68).

## Type 1

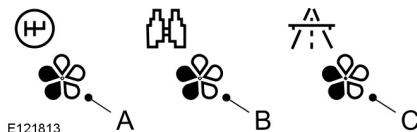

- A Gear shifting
- B Anticipation
- C Efficient speed

## Gear shifting

Use the highest drivable gear appropriate for the road conditions to improve fuel consumption.

## Anticipation

Adjust your vehicle speed and the distance to other vehicles to avoid the need for heavy braking or acceleration to improve fuel economy.

## Efficient speed

Reduce your cruising speed on open roads to improve economy. Higher speeds use more fuel.

## Type 2 and 3

The relevant information is shown in the display.

## Resetting Eco Mode







Reset the average fuel consumption by using the information display control.

**Note:** *New values may take a short time to calculate*

# Load Carrying

## GENERAL INFORMATION

### WARNINGS

-  Use load securing straps to an approved standard, e.g. DIN.
-  Make sure that you secure all loose items properly.
-  Place luggage and other loads as low and as far forward as possible within the luggage or loadspace.
-  Do not drive with the liftgate or rear door open. Exhaust fumes may enter your vehicle.
-  Do not exceed the maximum front and rear axle loads for your vehicle. See **Vehicle Identification Plate** (page 210).
-  Do not allow items to contact the rear windows.

## REAR UNDER FLOOR STORAGE

### Passenger Compartment Floor

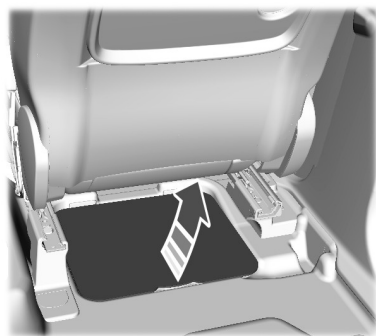

E159047

The under floor storage compartment is located behind the front passenger seat.

## Cargo Management System

The system is located in the floor of the cargo area. Lift the handle to open.

### Vehicles with Temporary Spare Wheel



E159408

### Vehicles with Temporary Mobility Kit

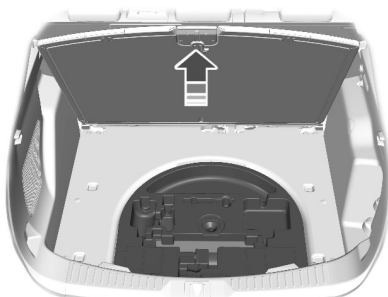

E159043

# Load Carrying

## Adjustable Load Floor

### Vehicles with Temporary Spare Wheel

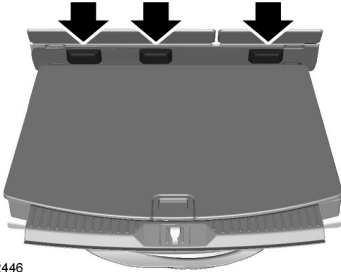

E142446

The front of the load floor can be placed either on (for high position) or below (for low position) the ledges behind the rear seats.

### Vehicles with Temporary Mobility Kit

The front of the load floor can be placed either on the ledge behind the rear seats (for high position) or on the black cargo insulator surface (for low position).

## LUGGAGE COVERS

### WARNINGS



Make sure that the posts are correctly latched in mounting features. The cover may cause injury in a sudden stop or crash if it is not securely installed.



Do not place any objects on the cargo shade. They may obstruct your vision or strike occupants of your vehicle in a sudden stop or crash.

Use the cargo shade to cover items in the cargo area of your vehicle.

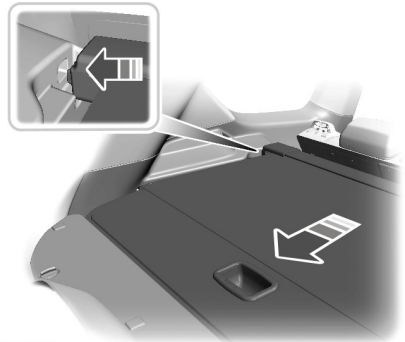

E159183

Insert the ends of the cargo shade into the mounting features located behind the rear seat on the rear trim panels to install the shade.

To operate the cargo shade:

1. Pull the rear edge of the cargo shade rearward until it clicks into place.
2. To close the cargo shade, tap on the rear edge and it will slide forward.

## LUGGAGE ANCHOR POINTS

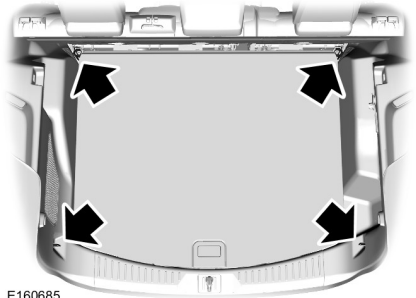

E160685

# Load Carrying

---

## Luggage Retention Nets

**Note:** *Your vehicle does not have luggage retention net anchor points fitted behind the first or second row seats.*

Make sure that you securely fasten the load. Check the tightness of the load before driving and at each fuel stop.

## ROOF RACKS AND LOAD CARRIERS

### WARNINGS



If you use a roof rack, the fuel consumption of your vehicle will be higher and you may experience different driving characteristics.



Read and follow the manufacturer's instructions when you are fitting a roof rack.



When loading the roof racks, we recommend you evenly distribute the load, as well as maintain a low center of gravity. Loaded vehicles, with higher centers of gravity, may handle differently than unloaded vehicles. Take extra precautions, such as slower speeds and increased stopping distance, when driving a heavily loaded vehicle.

---

The maximum recommended load, evenly distributed on the roof rack, is:

- 165 pounds (75 kilograms) for vehicles without a moonroof
- 132 pounds (60 kilograms) for vehicles with a moonroof.

**Note:** *Never place loads directly on the roof panel. The roof panel is not designed to directly carry a load.*

For correct roof rack system function, you must place loads directly on crossbars affixed to the roof rack side rails. When using the roof rack system, we recommend you use Ford Genuine Accessory crossbars designed specifically for your vehicle.



# Towing

## TOWING A TRAILER

### WARNINGS



Do not exceed 62 mph (100 km/h). Failure to take care may result in loss of vehicle control, serious personal injury or death.



The rear tire pressures must be increased by 3 psi (0.2 bar) above specification. See **Technical Specifications** (page 208). Failure to adhere to this warning could result in loss of vehicle control, serious personal injury or death.



Do not exceed the maximum gross train weight stated on your vehicle identification plate. See **Vehicle Identification Plate** (page 210). Failure to adhere to this warning could result in loss of vehicle control, serious personal injury or death.



Do not exceed the maximum permissible nose weight, e.g. vertical weight on the tow ball. See **Technical Specifications** (page 211). Failure to adhere to this warning could result in loss of vehicle control, serious personal injury or death.

Place loads as low as possible and central to the axle(s) of your trailer. If you are towing with an unladen vehicle, the load in your trailer should be placed toward the nose, within the maximum nose load, as this gives the best stability.

The stability of your vehicle to trailer combination is very much dependant on the quality of the trailer.

In high altitude regions above 3281 feet (1000 meters), the stipulated maximum permitted gross train weight must be reduced by 10% for every additional 3281 feet (1000 meters).

**Note:** *The electrical system is not suitable for towing trailers with more than one rear fog lamp.*

**Note:** *Not all vehicles are suitable or approved to have tow bars fitted. See an authorized dealer for further information.*

## Steep Gradients

### WARNING



The anti-lock braking system does not control the overrun brake on the trailer. Failure to take care may result in loss of vehicle control, serious personal injury or death.

Use a low gear when descending a steep downhill gradient.

## TOW BALL

### WARNINGS



When not in use, always transport the tow ball arm securely fastened in the luggage compartment.



Take special care when fitting the tow ball arm as the safety of your vehicle and the trailer depends on this.



Do not use any tools for mounting or dismantling the tow ball arm.



Do not modify the trailer coupling.



Do not disassemble or repair the tow ball arm.

# Towing

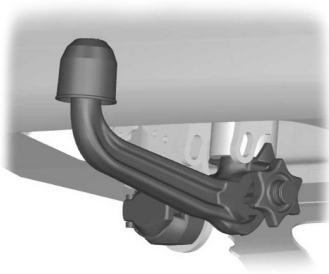

E71328

A 13-pin trailer socket and the tow ball arm seat are provided under the rear bumper. Turn the trailer socket down through 90 degrees until it engages in the end position.

## Unlocking the Tow Ball Arm Mechanism

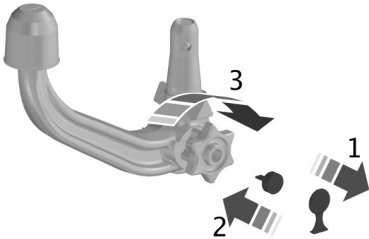

E71329

1. Remove the protecting cap.
2. Insert the key and turn it counterclockwise to unlock.
3. Hold the tow ball arm. Pull the handwheel out and turn it clockwise until it clicks.

**Note:** The red mark on the handwheel must align with the white dot on the tow ball.

4. Release the handwheel. The tow ball arm is unlocked.

## Inserting the Tow Ball Arm

### WARNING



The tow ball arm may only be inserted when completely unlocked.

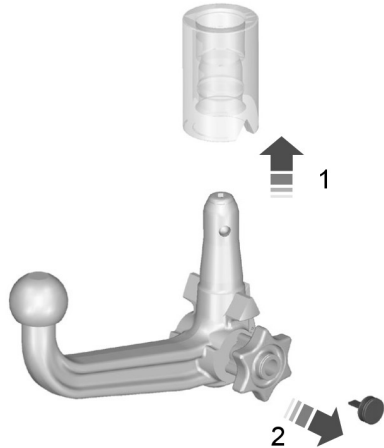

E71330

**Note:** Pull out the plug.

1. Insert the tow ball arm vertically and press it upward until it engages.

**Note:** Do not hold your hand near the handwheel.

**Note:** The green mark on the handwheel must align with the white dot on the tow ball.

2. Turn the key clockwise and remove the key to lock the tow ball.
3. Pull the protecting cap from the key bow and press it onto the lock.

# Towing

## Driving with a Trailer

### WARNING



If any of the below conditions cannot be met, do not use the tow bar and have it checked by an authorized dealer.

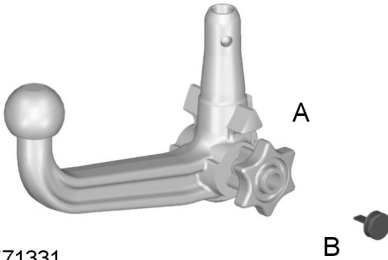

E71331

Before starting your journey, make sure that the tow ball arm is correctly locked. Check that:

- the green mark on the handwheel is aligned with the white dot on the tow ball
- the handwheel (A) is correctly fitted to the tow ball arm
- you have removed the key (B)
- the tow ball arm is securely positioned.

## Removing the Tow Ball Arm

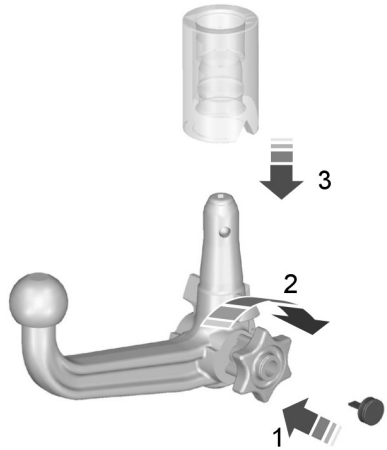

E71332

**Note:** *Unhitch the trailer.*

1. Remove the protecting cap. Insert the key and unlock.
2. Hold the tow ball arm. Pull the handwheel out, turn it clockwise against the stop.
3. Remove the tow ball arm.
4. Release the handwheel.

When unlocked in this way, the tow ball arm can be reinserted at any time.

## Driving without a Trailer

### WARNING



Never unlock the tow ball arm with the trailer attached.

# Towing

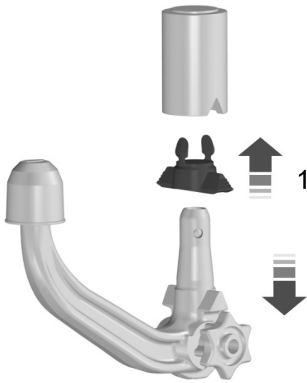

E94771

Remove the tow ball arm. Insert the plug into its seat (1).

## Maintenance

### WARNING



Remove the tow ball arm and protect the seat with the plug before steam cleaning your vehicle.

Keep the system clean. Periodically lubricate bearings, sliding surfaces, and locking balls with resin-free grease or oil and the lock with graphite.

In case of loss, replacement keys are available from the manufacturer by stating the number on the lock cylinder.

## TRAILER SWAY CONTROL

### WARNING



Turning off trailer sway control increases the risk of loss of vehicle control, serious injury or death. Ford does not recommend disabling this feature except in situations where speed reduction may be detrimental (such as hill climbing), the driver has significant trailer towing experience, and can control trailer sway and maintain safe operation.

**Note:** This feature does not prevent trailer sway, but reduces it once it begins.

**Note:** This feature cannot stop all trailers from swaying.

**Note:** In some cases, if vehicle speed is too high, the system may activate multiple times, gradually reducing vehicle speed.

This feature applies the vehicle brakes at individual wheels and, if necessary, reduces engine power. If the trailer begins to sway, the stability control light flashes. The first thing to do is slow the vehicle down, then pull safely to the side of the road and check for proper tongue load and trailer load distribution. See **Load Carrying** (page 156).

## TOWING POINTS

### WARNING



The towing eye has a left-hand thread. Turn it counterclockwise to install it. Make sure that the towing eye is fully tightened.

# Towing

## Front Towing Eye

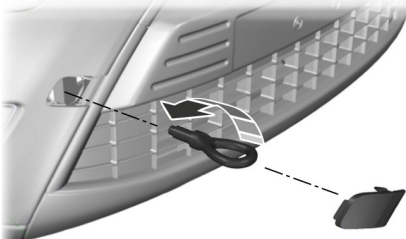

E99490

Space is provided in the spare wheel well. You must carry the towing eye in your vehicle at all times.

Remove the cover and install the towing eye.

## Rear Towing Eye

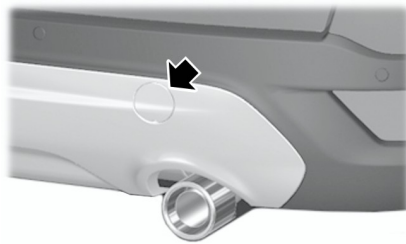

E152139

**Note:** *If your vehicle has a tow bar, you cannot install the towing eye at the rear of your vehicle. Use the tow bar to tow other vehicles.*

## TOWING THE VEHICLE ON FOUR WHEELS

### All Vehicles

#### WARNINGS



You must switch the ignition on when your vehicle is being towed.

#### WARNINGS



The brake and steering assistance will not operate unless the engine is running. Press the brake pedal harder and allow for increased stopping distances and heavier steering.



Too much tension in the tow rope could cause damage to your vehicle or the vehicle that is towing.



Do not use a rigid tow bar on the front towing eye.



When towing your vehicle you must select neutral.

Drive off slowly and smoothly without jerking the towed vehicle.

### Vehicles with Automatic Transmission

#### WARNINGS



If a speed of 12 mph (20 km/h) and a distance of 12 miles (20 kilometers) is to be exceeded the drive wheels must be lifted clear of the ground.



It is recommended not to tow with the drive wheels on the ground. However, if it is required to move your vehicle from a dangerous location, do not tow your vehicle faster than 12 mph (20 km/h) or further than 12 miles (20 kilometers).



Do not tow your vehicle backward.



In the event of a mechanical failure of the transmission the drive wheels must be lifted clear of the ground.



Do not tow your vehicle if the ambient temperature is below 32°F (0°C).

# Driving Hints

## BREAKING-IN

You need to break in new tires for approximately 300 miles (480 kilometers). During this time, your vehicle may exhibit some unusual driving characteristics.

Avoid driving too fast during the first 1000 miles (1600 kilometers). Vary your speed frequently and change up through the gears early. Do not labor the engine.

Do not tow during the first 1000 miles (1600 kilometers).

## COLD WEATHER PRECAUTIONS

The functional operation of some components and systems can be affected at temperatures below -13°F (-25°C).

## DRIVING THROUGH WATER

### WARNINGS



Drive through water in an emergency only and not as part of normal driving.



Engine damage can occur if water enters the air filter.

In an emergency, you can drive your vehicle through water to a maximum depth of 8 inches (200 millimeters) and at a maximum speed of 6 mph (10 km/h). You must take extra care when driving through flowing water.

When driving in water, maintain a low speed and do not stop your vehicle. After driving through water and as soon as it is safe to do so:

- Depress the brake pedal lightly to check that the brakes are functioning correctly.
- Check that the horn works.
- Check that your vehicle's lamps are fully operational.
- Check the power assistance of the steering system.

## FLOOR MATS



### WARNINGS



Always use floor mats that are designed to fit the foot well of your vehicle. Only use floor mats that leave the pedal area unobstructed. Only use floor mats that are firmly secured to retention posts so that they cannot slip out of position and interfere with the pedals or impair safe operation of your vehicle in other ways.



Pedals that cannot move freely can cause loss of vehicle control and increase the risk of serious personal injury.

# Driving Hints

---

## WARNINGS



Always make sure that the floor mats are properly attached to the retention posts in the carpet that are supplied with your vehicle. Floor mats must be properly secured to both retention posts to ensure mats do not shift out of position.



Never place floor mats or any other covering in the vehicle foot well that cannot be properly secured to prevent them from moving and interfering with the pedals or the ability to control the vehicle.



Never place floor mats or any other covering on top of already installed floor mats. Floor mats should always rest on top of vehicle carpeting surface and not another floor mat or other covering. Additional floor mats or any other covering will reduce the pedal clearance and potentially interfere with pedal operation.



Check attachment of floor mats on a regular basis. Always properly reinstall and secure floor mats that have been removed for cleaning or replacement.



Always make sure that objects cannot fall into the driver foot well while the vehicle is moving. Objects that are loose can become trapped under the pedals causing a loss of vehicle control.



Failure to properly follow floor mat installation or attachment instructions can potentially cause interference with pedal operation causing loss of control of vehicle.



To install floor mats, position the floor mat so that the eyelet is over the retention post and press down to lock in.



To remove the floor mat, reverse the installation procedure.

---

# Roadside Emergencies

## HAZARD WARNING FLASHERS



The hazard warning button is located on the instrument panel. Use it when your vehicle is creating a safety hazard for other motorists.

Press the button to turn on the hazard warning function, and the front and rear direction indicators will flash.

Press the button again to turn them off.

**Note:** *If used when the engine is not running, the battery will lose charge. There may be insufficient power to restart your engine.*

**Note:** *Depending on applicable laws and regulations in the country for which your vehicle was originally built, the hazard warning flashers may flash if you brake heavily.*

## FIRST AID KIT

Space is provided in the rear underfloor storage compartment. See **Rear Under Floor Storage** (page 156).

## WARNING TRIANGLE

Space is provided in the luggage compartment.

## FUEL SHUTOFF

### WARNING



Failure to inspect and, if necessary, repair fuel leaks after a collision may increase the risk of fire and serious injury. Ford Motor Company recommends that the fuel system be inspected by an authorized dealer after any collision.

In the event of a moderate to severe collision, this vehicle is equipped with a fuel pump shut-off feature that stops the flow of fuel to the engine. Not every impact will cause a shut-off.

Should your vehicle shut off after a collision, you may restart your vehicle by doing the following:

1. Turn the ignition off.
2. Turn the ignition to crank.
3. Turn the ignition off.
4. Turn the ignition on again to re-enable the fuel pump.

For vehicles equipped with a push button start system:

1. Press the **START/STOP** button to turn the ignition off.
2. Press the brake pedal and press the **START/STOP** button (crank attempt).
3. Remove your foot from the brake pedal and press the **START/STOP** button (ignition off).
4. Press the **START/STOP** button again to re-enable the fuel system.

## JUMP-STARTING THE VEHICLE

### WARNINGS



Do not use fuel lines, engine rocker covers or the intake manifold as grounding points.



Connect batteries with only the same nominal voltage.



Always use booster cables with insulated clamps and adequate size cable.

**Note:** *Do not disconnect the battery from your vehicle's electrical system.*



# Roadside Emergencies

## To Connect the Booster Cables

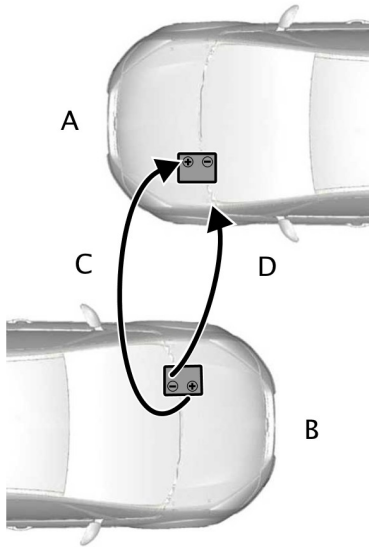

E102925

- A Flat battery vehicle
- B Booster battery vehicle
- C Positive connection cable
- D Negative connection cable

1. Position the vehicles so that they do not touch one another.
2. Switch off the engine and any electrical equipment.
3. Connect the positive (+) terminal of vehicle B with the positive (+) terminal of vehicle A (cable C).

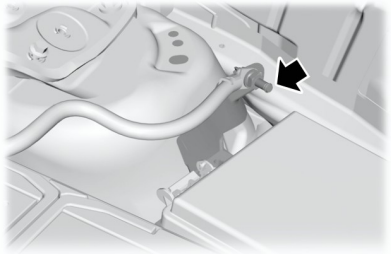

E152134

4. Connect the negative (-) terminal of vehicle B to the ground connection of vehicle A (cable D).

### WARNINGS



Do not connect directly to the negative (-) terminal of the flat battery.



Make sure that the cables are clear of any moving parts and fuel delivery system parts.

## To Start the Engine

1. Run the engine of vehicle B at a moderately high speed.
2. Start the engine of vehicle A.
3. Run both vehicles for a minimum of three minutes before disconnecting the cables.

### WARNING



Do not switch the headlamps on when disconnecting the cables. The peak voltage could blow the bulbs.

Disconnect the cables in the reverse order.

# Fuses

## FUSE BOX LOCATIONS

### Pre-Fuse Box

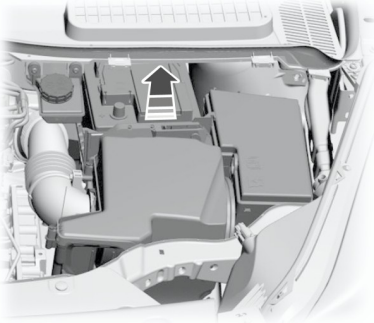

E152422

Your vehicle has a pre-fuse box located in the engine compartment attached to the positive battery post. This box contains several high current fuses. If replacement of these high current fuses is required, see an authorized dealer.

### Engine Compartment Fuse Box

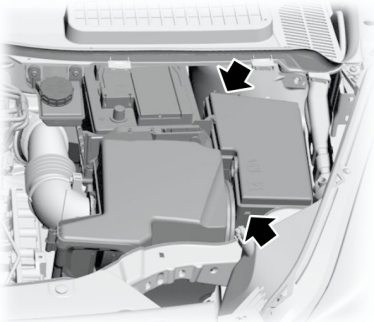

E152423

## WARNINGS



Always disconnect the battery before servicing high current fuses.

## WARNINGS



To reduce risk of electrical shock, always replace the cover to the engine compartment fuse box before reconnecting the battery or refilling fluid reservoirs.

The engine compartment fuse box has high-current fuses that protect your vehicle's main electrical systems from overloads.

When you disconnect and reconnect the battery, you will need to reset some features. See **Changing the 12V Battery** (page 184).

Lift the release lever at the rear of the cover to remove it.

### Passenger Compartment Fuse Box

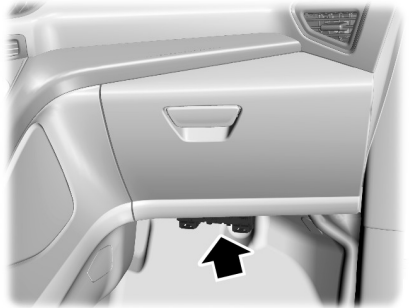

E159113

The fuse box is located below the glove box.

# Fuses

## Luggage Compartment Fuse Box

The fuse box is located in the luggage compartment behind the passenger side wheel well. Remove the fuse panel cover to gain access to the fuses.

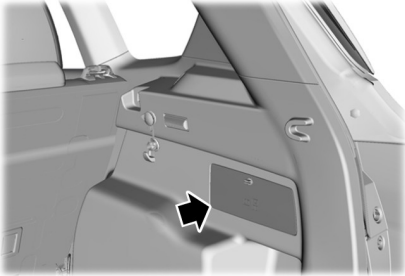

E152425

## FUSE SPECIFICATION CHART

### Engine Compartment Fuse Box

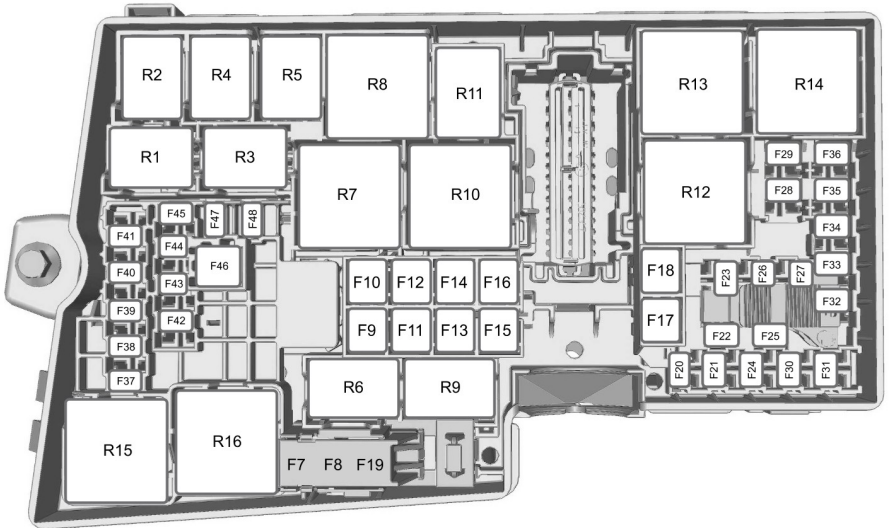

E157389

# Fuses

<b>Fuse/ Relay Number</b>	<b>Fuse Amp Rating</b>	<b>Protected Components</b>
F1	-	Not used
F2	-	Not used
F3	-	Not used
F4	-	Not used
F5	-	Not used
F6	-	Not used
F7	40A**	Anti-lock brake system, electronic stability program
F8	30A**	Electronic stability program
F9	20A**	Headlamp washer
F10	40A**	Heater blower motor
F11	30A**	Voltage quality module, body control module
F12	30A**	Powertrain control module
F13	30A**	Starter relay
F14	40A**	Heated windshield right-hand side
F15	20A**	Front cigar lighter, auxiliary power points
F16	40A**	Heated windshield left-hand side
F17	20A**	Auxiliary heater
F18	-	Not used
F19	5A*	Anti-lock brake system, electronic stability program
F20	15A*	Horn
F21	5A*	Stop light switch
F22	15A*	Battery monitor system
F23	5A*	Relay coils
F24	5A*	Lighting control
F25	-	Not used

# Fuses

<b>Fuse/ Relay Number</b>	<b>Fuse Amp Rating</b>	<b>Protected Components</b>
F26	5A*	Engine control relay coil feed (vehicles with a gasoline engine)
F26	15A*	Engine control relay coil feed (vehicles with a diesel engine), transmission control (vehicles with a diesel engine)
F27	15A*	Air conditioning clutch
F28	5A*	Adaptive cruise control (vehicles with start-stop)
F29	25A*	Rear window defroster
F30	-	Not used
F31	-	Not used
F32	15A*	Engine control module
F33	10A*	Engine control module
F34	10A*	Engine control module
F35	15A*	Engine control module
F36	5A*	Active grill shutters
F37	5A*	Passenger airbag deactivation indicator feed
F38	5A*	Engine control module, transmission control module
F39	5A*	Headlamps, headlamp leveling
F40	5A*	Electronic power assist steering
F41	20A*	Body control module
F42	15A*	Rear window wiper
F43	15A*	Headlamps
F44	5A*	Adaptive cruise control (vehicles without start-stop)
F45	10A*	Heated washer nozzle
F46	40A**	Autowipers
F47	-	Not used
F48	15A*	Diesel vaporizer
R1	-	Not used

# Fuses

<b>Fuse/ Relay Number</b>	<b>Fuse Amp Rating</b>	<b>Protected Components</b>
R2	Micro relay	Horn
R3	Micro relay	Diesel vaporizer relay
R4	-	Not used
R5	-	Not used
R6	-	Not used
R7	Power relay	Windshield defroster
R8	-	Not used
R9	Micro relay	Headlamp washer
R10	Mini relay	Starter relay
R11	Micro relay	Air conditioning clutch
R12	Power relay	Cooling fan
R13	Mini relay	Heater blower
R14	Mini relay	Engine control relay
R15	Power relay	Heated rear window
R16	Power relay	Ignition

\*Mini fuses \*\*Cartridge fuses

# Fuses

## Passenger Compartment Fuse Box

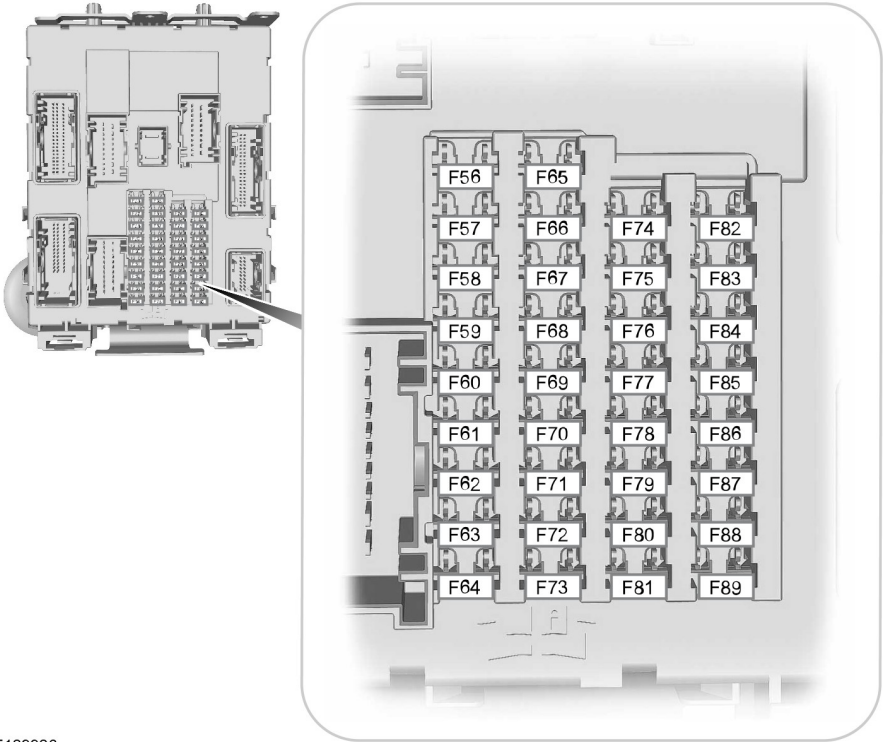

E129926

Fuse/ Relay Number	Fuse Amp Rating	Protected Components
56	20A	Fuel pump
57	-	Not used
58	-	Not used
59	5A	Passive anti-theft transceiver

# Fuses

<b>Fuse/ Relay Number</b>	<b>Fuse Amp Rating</b>	<b>Protected Components</b>
60	10A	Interior lamp, driver door switch pack, glove box illumination, overhead console switch bank
61	-	Not used
62	5A	Autowipers, auto-dimming mirror
63	10A	Adaptive cruise control (front sensing module)
64	-	Not used
65	10A	Liftgate release
66	-	Not used
67	7.5A	SYNC, multifunction display, global positioning system module
68	15A	Electric steering column lock
69	5A	Instrument cluster
70	-	Not used
71	10A	Heating control head (manual air conditioning), dual electronic automatic temperature control
72	7.5A	Steering wheel module
73	5A	Data link connector, battery backup sounder
74	15A	High beam headlamps
75	15A	Fog lamps
76	10A	Reversing lamp
77	20A	Washer pump
78	5A	Ignition switch, start button
79	15A	Audio unit, navigation DVD player, touch screen, hazard warning lamp switch, door lock switch
80	20A	Moonroof
81	5A	Radio frequency receiver, interior motion sensor
82	20A	Washer pump
83	20A	Central locking



# Fuses

Fuse/ Relay Number	Fuse Amp Rating	Protected Components
84	-	Not used
85	7.5A	Ignition switch
86	10A	Air bag module, occupant classification system, passenger air bag deactivation indicator
87	-	Not used
88	-	Not used
89	-	Not used

## Luggage Compartment Fuse Box

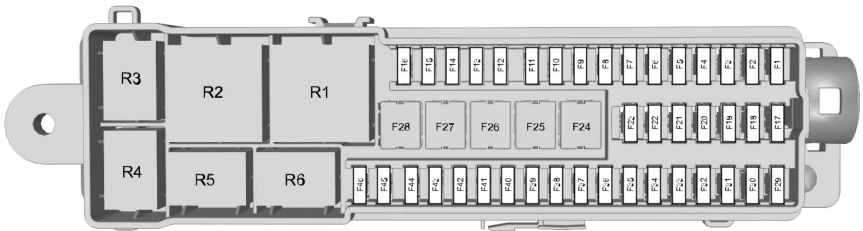

E129927

Fuse/ Relay Number	Fuse Amp Rating	Protected Components
F1	5A	Hands-free liftgate
F2	10A	Keyless vehicle module
F3	5A	Keyless vehicle door handles
F4	25A	Door control unit front left
F5	25A	Door control unit front right
F6	25A	Door control unit rear left

## Fuses

Fuse/ Relay Number	Fuse Amp Rating	Protected Components
F7	25A	Door control unit rear right
F8	-	Not used
F9	25A	Driver's seat motor
F10	-	Not used
F11	5A	Rear ignition relay coil feed
F12	10A	Climate control (vehicles with start-stop)
F13	5A	Instrument cluster (vehicles with start-stop)
F14	7.5A	Information and entertainment display, SYNC, global positioning system module (vehicles with start-stop)
F15	15A	Audio unit (vehicles with start-stop)
F16	-	Not used
F17	-	Not used
F18	-	Not used
F19	-	Not used
F20	-	Not used
F21	-	Not used
F22	-	Not used
F23	-	Not used
F24	30A	AC/DC auxiliary power points
F24	20A	Rear auxiliary power points
F25	25A	Power liftgate
F26	40A	Accessories, trailer tow module
F27	20A	Luggage compartment auxiliary power points
F28	-	Not used
F29	5A	Blind spot monitor, front camera sensor, adaptive cruise control, rear view camera with park assist, voltage quality module ignition signal

## Fuses

Fuse/ Relay Number	Fuse Amp Rating	Protected Components
F30	5A	Parking aid
F31	-	Not used
F32	5A	DC/AC auxiliary power point ignition signal
F33	-	Not used
F34	20A	Driver heated seat
F35	20A	Passenger heated seat
F36	-	Not used
F37	-	Not used
F38	-	Not used
F39	-	Not used
F40	-	Not used
F41	-	Not used
F42	-	Not used
F43	-	Not used
F44	-	Not used
F45	-	Not used
F46	10A	Blind spot monitor, front camera sensor, adaptive cruise control, rear view camera with park assist (vehicles with start-stop)
R1	Power relay	Ignition switch
R2	-	Not used
R3	-	Not used
R4	-	Not used
R5	-	Not used
R6	-	Not used

# Fuses

---

## CHANGING A FUSE

### WARNINGS



Do not modify the electrical system of your vehicle in any way. Have repairs to the electrical system and the replacement of relays and high current fuses carried out by an authorized dealer.



Switch the ignition and all electrical equipment off before attempting to change a fuse.



Always replace a fuse with one that has the specified amperage rating. Using a fuse with a higher amperage rating can cause severe wire damage and could start a fire.

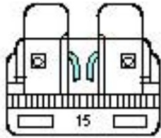

E142430

If electrical components in your vehicle are not working, a fuse may have blown. A break in the fuse wire will indicate a blown fuse. Check the appropriate fuses before replacing any electrical components.

# Maintenance

## GENERAL INFORMATION

Have your vehicle serviced regularly to help maintain its roadworthiness and resale value. There is a large network of Ford authorized repairers that are there to help you with their professional servicing expertise. Authorized repairers are best qualified to service your vehicle properly and expertly, with a wide range of highly specialized tools.

In addition to regular servicing, we recommend that you carry out the following checks.

### WARNINGS



Switch the ignition off before touching or attempting adjustment of any kind.



Do not touch the electronic ignition system parts after you have switched the ignition on or when the engine is running. The system operates at high voltage.



Keep your hands and clothing clear of the engine cooling fan. Under certain conditions, the fan may continue to run for several minutes after you have switched the engine off.



Make sure that you fit filler caps securely after carrying out maintenance checks.

## Daily Checks

- Exterior lamps.
- Interior lamps.
- Warning lamps and indicators.

## Check When Refueling

- Engine oil level. See **Engine Oil Check** (page 183).
- Brake fluid level.

- Washer fluid level. See **Washer Fluid Check** (page 184).
- Tire pressures (when cold). See **Technical Specifications** (page 208).
- Tire condition. See **Wheels and Tires** (page 197).

## Monthly Checks

- Engine coolant level (engine cold). See **Engine Coolant Check** (page 184).
- Pipes, hoses and reservoirs for leaks.
- Air conditioning operation.
- Parking brake operation.
- Horn operation.
- Tightness of lug nuts. See **Technical Specifications** (page 208).

## OPENING AND CLOSING THE HOOD

### Opening the Hood



E142457

1. Pull the hood release handle.

# Maintenance

---

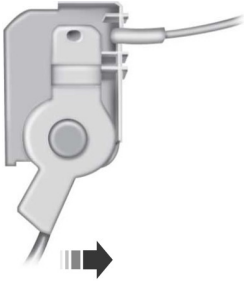

E142458

2. Move the catch to the right.

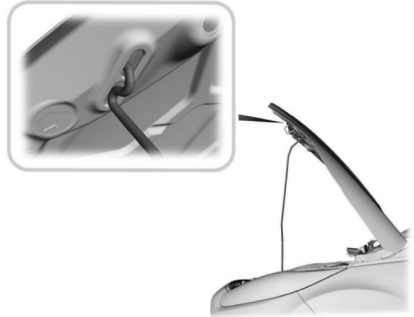

E87786

3. Open the hood and support it with the prop rod.

## Closing the Hood

1. Remove the prop rod from the catch and secure properly after use.
2. Lower the hood and allow it to drop from under its own weight for the last 8 - 11 inches (20 – 30 centimeters).

**Note:** *Make sure that you have closed the hood properly.*

# Maintenance

## UNDER HOOD OVERVIEW - 1.6L ECOBOOST (132KW/180PS) - SIGMA

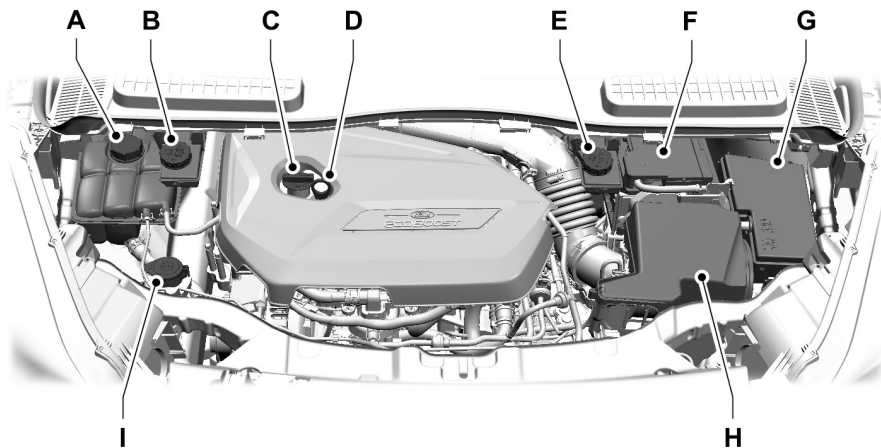

E158410

- A Engine coolant reservoir\*: See **Engine Coolant Check** (page 184).
- B Brake fluid reservoir (right-hand drive)\*: See **Brake Fluid Check** (page 184).
- C Engine oil filler cap\*: See **Engine Oil Check** (page 183).
- D Engine oil dipstick\*: See **Engine Oil Check** (page 183).
- E Brake fluid reservoir (left-hand drive)\*: See **Brake Fluid Check** (page 184).
- F Battery: See **Changing the 12V Battery** (page 184).
- G Engine compartment fuse box: See **Fuses** (page 168).
- H Air cleaner: No maintenance necessary.
- I Windshield and rear window washer fluid reservoir: See **Washer Fluid Check** (page 184).

\* The filler caps and the engine oil dipstick are colored for easy identification.

# Maintenance

## UNDER HOOD OVERVIEW - 2.0L DURATORQ-TDCI (DW) DIESEL

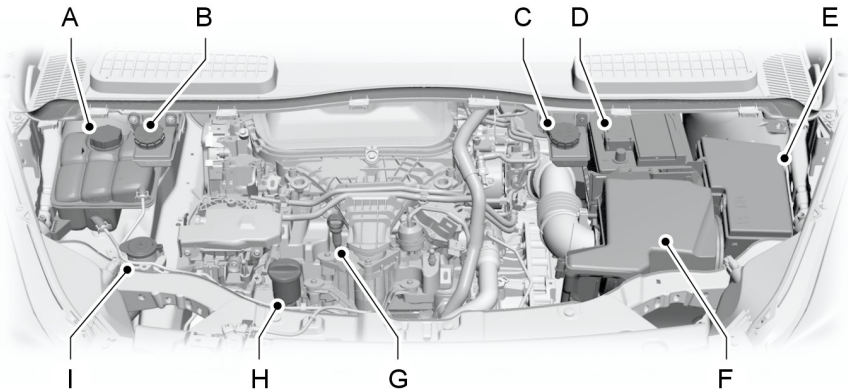

E152530

- A Engine coolant reservoir\*: See **Engine Coolant Check** (page 184).
- B Brake fluid reservoir (right-hand drive)\*: See **Brake Fluid Check** (page 184).
- C Brake fluid reservoir (left-hand drive)\*: See **Brake Fluid Check** (page 184).
- D Battery: See **Changing the 12V Battery** (page 184).
- E Engine compartment fuse box: See **Fuses** (page 168).
- F Air cleaner: No maintenance necessary.
- G Engine oil dipstick\*: See **Engine Oil Check** (page 183).
- H Engine oil filler cap\*: See **Engine Oil Check** (page 183).
- I Windshield and rear window washer fluid reservoir: See **Washer Fluid Check** (page 184).

\* The filler caps and the engine oil dipstick are colored for easy identification.



# Maintenance

## ENGINE OIL DIPSTICK - 1.6L ECOBOOST™

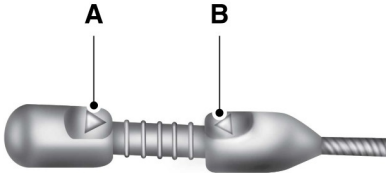

E146020

- A MIN
- B MAX

## ENGINE OIL DIPSTICK - 2.0L DURATORQ-TDCI (DW) DIESEL

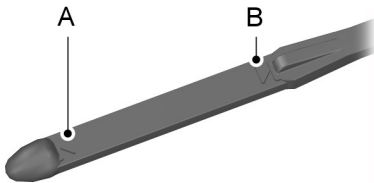

E95543

- A Minimum
- B Maximum

## ENGINE OIL CHECK

1. Make sure that your vehicle is on level ground.
2. Switch off the engine and wait 10 minutes for the oil to drain into the oil pan.

3. Remove the dipstick and wipe it with a clean, lint free cloth. Replace the dipstick and remove it again to check the oil level.

If the oil level is at the minimum mark, add oil immediately. See **Technical Specifications** (page 193).

**Note:** Check the oil level before starting the engine.



**Note:** Make sure that the oil level is between the minimum and the maximum marks.

**Note:** Do not use oil additives or other engine treatments. Under certain conditions, they may damage the engine.

**Note:** The oil consumption of new engines reaches its normal level after approximately 3000 miles (5000 kilometers).

## Adding Oil

### WARNINGS

-  Only add oil when the engine is cold. If the engine is hot, wait 10 minutes for the engine to cool down. Failure to take care may result in personal injury.
-  Do not remove the filler cap when the engine is running. Failure to take care may result in personal injury.

1. Remove the filler cap.
2. Add oil that meets Ford specifications. See **Technical Specifications** (page 193).
3. Replace the filler cap. Turn it until you feel a strong resistance.

**Note:** Do not add oil further than the maximum mark. Oil levels above the maximum mark may cause engine damage.

**Note:** Soak up any spillage with an absorbent cloth immediately.

# Maintenance

## ENGINE COOLANT CHECK

### WARNING



Do not allow the fluid to touch your skin or eyes. If this happens, rinse the affected areas immediately with plenty of water and contact your physician.

**Note:** Make sure that the level is between the **MIN** and the **MAX** marks.

**Note:** Coolant expands when it is hot. The level may therefore extend beyond the **MAX** mark.

If the level is at the **MIN** mark, add coolant immediately.

## Adding Engine Coolant

### WARNINGS



Only add coolant when the engine is cold. If the engine is hot, wait 10 minutes for the engine to cool down.



Do not remove the filler cap when the engine is running.



Do not remove the filler cap when the engine is hot. Wait for the engine to cool down.



Undiluted coolant is flammable and may ignite if splilt on a hot exhaust.

**Note:** In an emergency, you can add just water to the cooling system to reach a vehicle service station. Have the system checked by an authorized dealer as soon as possible.

**Note:** Prolonged use of incorrect dilution of the coolant can cause engine damage from corrosion, overheating or freezing.

**Note:** Do not add coolant further than the **MAX** mark.

1. Remove the filler cap. Any pressure will escape slowly as you unscrew the cap.

2. Add a 50/50 mixture of coolant and water using fluid that meets the Ford specifications. See **Technical Specifications** (page 193).
3. Replace the filler cap. Turn it until you feel a strong resistance.

## BRAKE FLUID CHECK

Fluid levels between the MIN and MAX lines are within the normal operating range; there is no need to add fluid. If the fluid levels are outside of the normal operating range, the performance of the system could be compromised; seek service from your authorized dealer immediately.

## WASHER FLUID CHECK

**Note:** The reservoir supplies the front and rear washer systems.

When adding fluid, use a mixture of washer fluid and water to help prevent freezing in cold weather and improve the cleaning capability. We recommend that you use only high quality washer fluid.

For information on fluid dilution, refer to the product instructions.

## CHANGING THE 12V BATTERY

### WARNING



For vehicles with start-stop the battery requirement is different. You must replace the battery with one of exactly the same specification.

**Note:** Where applicable you must reprogram the audio system using the keycode.

The battery is located in the engine compartment. See **Maintenance** (page 179).

# Maintenance

## CHECKING THE WIPER BLADES



E142463

Run the tip of your fingers over the edge of the blade to check for roughness.

Clean the wiper blades with washer fluid or water applied with a soft sponge or cloth.

## CHANGING THE WIPER BLADES

The wiper arms can be manually moved when the ignition is off. This allows for ease of blade replacement and cleaning under the blades.

1. Pull the wiper blade and arm away from the glass.

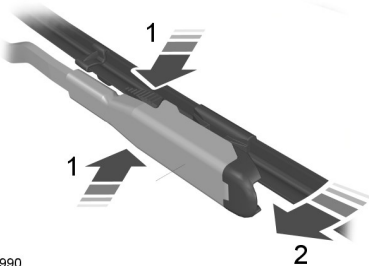

E129990

2. Press the locking buttons together.
3. Rotate and remove the wiper blade.
4. Install in the reverse order.

**Note:** Make sure that the wiper blade locks into place. Lower the wiper arm and blade back to the windshield. The wiper arms will automatically return to their normal position when the ignition is turned on.

To change the rear blades, do the following:

1. Lift the wiper arm.

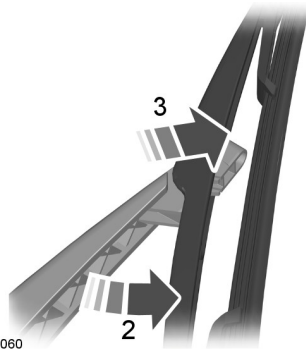

E130060

2. Slightly rotate the wiper blade from the wiper arm.
3. Disengage the wiper blade from the wiper arm.
4. Remove the wiper blade.
5. Install in the reverse order.

**Note:** Make sure that the wiper blade locks into place.

Replace wiper blades at least once per year for optimum performance.

Poor wiper quality can be improved by cleaning the wiper blades and the windshield.

# Maintenance

## REMOVING A HEADLAMP

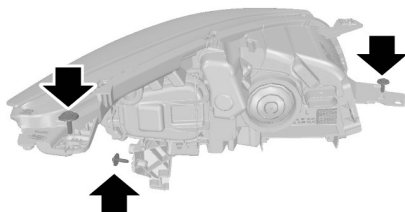

E159160

1. Make sure the lighting control is in the off position and open the hood.
2. Remove the three screws from the headlamp assembly.
3. Carefully pull the headlamp assembly as far as possible toward the front of your vehicle to disengage it from the lower fixing point.
4. Carefully lift the outer side of the headlamp and remove it.
5. Disconnect the electrical connector.

## CHANGING A BULB

### WARNINGS



Switch the lamps and the ignition off.



Let the bulb cool down before removing it.

**Note:** Only fit bulbs of the correct specification.

**Note:** The following instructions describe how to remove the bulbs. Fit replacements in the reverse order unless otherwise stated.

## Headlamp

### Type 1

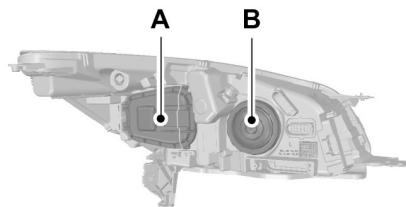

E159161

- A Low beam headlamp
- B High beam and daytime running lamp

## Headlamp High Beam

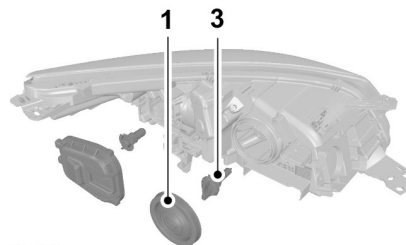

E159163

1. Remove the cover.
2. Disconnect the electrical connector.
3. Turn the bulb counterclockwise and pull it straight out to remove it.

**Note:** Do not touch the glass of the bulb.

# Maintenance

## Headlamp Low Beam

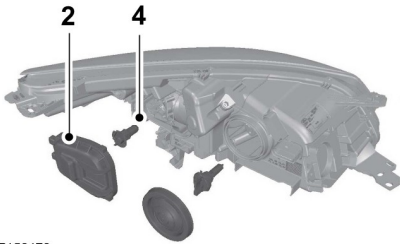

E159179

1. Release the metal retaining clip.
2. Remove the cover.
3. Disconnect the electrical connector.
4. Remove the bulb.

**Note:** Do not touch the glass of the bulb.

## Type 2

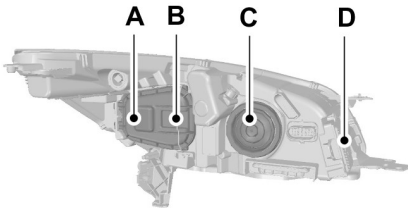

E159162

- A Low beam headlamp
- B High beam headlamp
- C Fixed bending light
- D Daytime running lamp and park position

## Headlamp High Beam

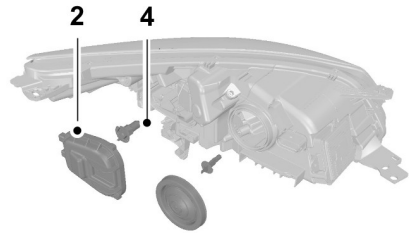

E159180

1. Release the metal retaining clip.
2. Remove the cover.
3. Disconnect the electrical connector.
4. Remove the bulb.

**Note:** Do not touch the glass of the bulb.

## Headlamp Fixed Bending Light Bulb

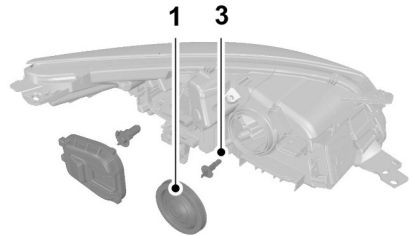

E159164

1. Remove the cover.
2. Disconnect the electrical connector.
3. Turn the bulb counterclockwise and pull it straight out to remove it.

**Note:** Do not touch the glass of the bulb.

## Direction Indicator, Front Fog Lamp and Position Lamp

**Note:** The position and direction indicator bulbs are not serviceable items, see an authorized dealer if they fail.

# Maintenance

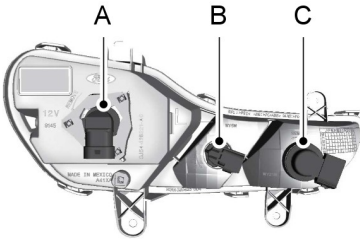

E142797

- A Fog lamp
- B Park lamp
- C Direction indicator lamp



E142798

1. Turn the steering wheel to full lock.
2. Remove the retaining clips from the front wheel splash shield to gain access to the lamp assembly.



E159629

3. Remove the bulb holder from the lamp assembly by turning it counterclockwise.
4. Disconnect the electrical connector.
5. Remove the bulb from the bulb holder by pulling it straight out.

## Side Repeater



E72263

1. Carefully remove the side repeater.

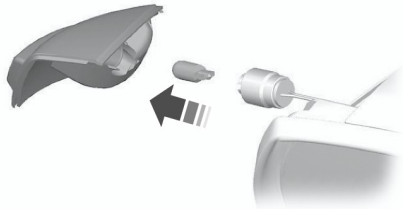

E72291

2. Remove the bulb holder.
3. Remove the bulb.

## Approach Lamp

**Note:** Position the mirror glass as far inward as possible.

# Maintenance



E72264

1. Insert a screwdriver into the gap between the mirror housing and the mirror glass and release the metal retaining clip.

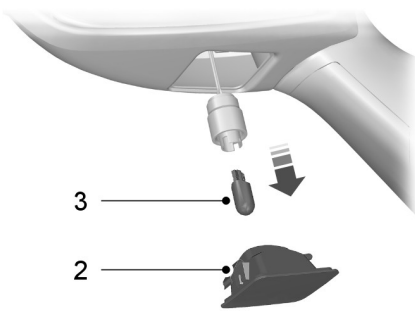

E72265

2. Remove the lamp.
3. Remove the bulb.

## Rear Lamps

### Type 1

#### *Direction Indicator, Tail and Brake Lamp*

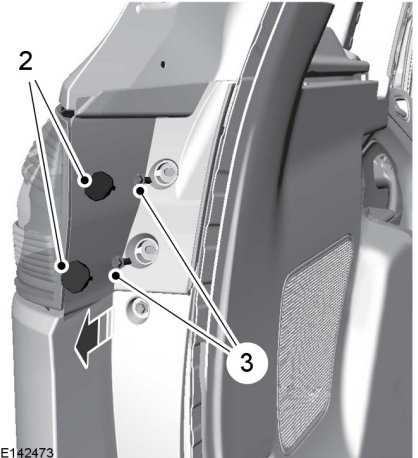

E142473

1. Make sure the lighting control is in the off position and open the liftgate.
2. Remove the two bolt covers using a standard flat tip screwdriver.
3. Remove the two bolts from the lamp assembly.
4. Gently pull the lamp assembly away from your vehicle.

### Type 2

#### *Direction Indicator*

Follow the same procedure as type 1 to remove the direction indicator bulb.

**Note:** *The tail and brake lamp bulbs are not serviceable items, see an authorized dealer if they fail.*

# Maintenance

## Reversing Lamp



E159417

1. Insert a suitable object to pry open the trim panel.

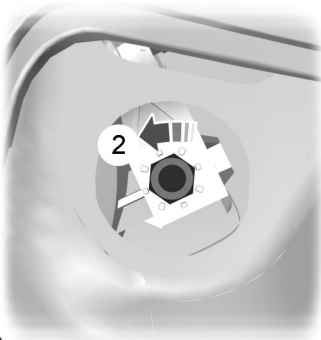

E99412

2. Remove the nut from the lamp assembly.
3. Gently pull the lamp assembly away from your vehicle.

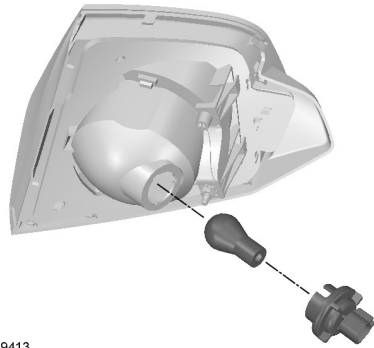

E99413

4. Gently press the bulb into the bulb holder, turn it counterclockwise and remove it.

## Rear Fog Lamp

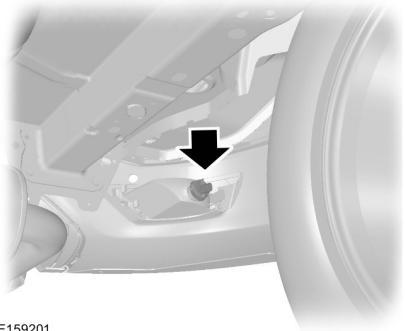

E159201

1. Disconnect the electrical connector.
2. Turn the bulb counterclockwise and pull it straight out to remove it.

## Central High Mounted Brake Lamp

These are not serviceable items, see an authorized dealer if they fail.



# Maintenance

## License Plate Lamp

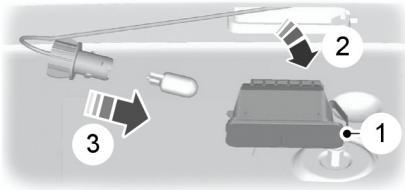

E72789

1. Carefully release the spring clip.
2. Remove the lamp.
3. Turn the bulb counterclockwise and remove it.

## Interior lamp

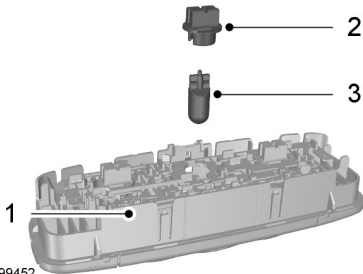

E99452

1. Carefully remove the lamp.
2. Turn the bulb holder counterclockwise and remove it.
3. Remove the bulb.

## Reading lamps

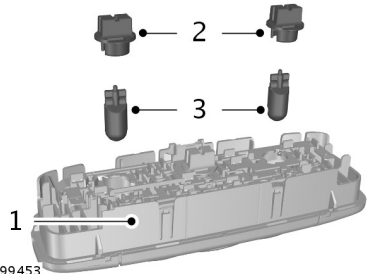

E99453

1. Carefully remove the lamp.
2. Turn the bulb holder counterclockwise and remove it.
3. Remove the bulb.

## Luggage Compartment Lamp, Footwell Lamp and Liftgate Lamp

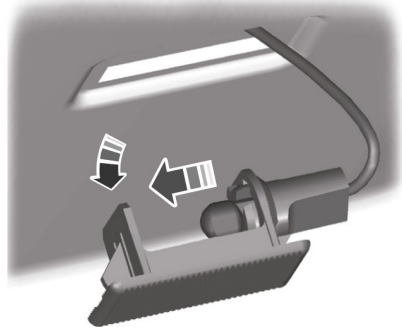

E72784

1. Carefully prize out the lamp.
2. Remove the bulb.

# Maintenance

## BULB SPECIFICATION CHART

Function	Trade number
Headlamps high beam (Halogen)	9005LL
* Headlamps high beam (HID)	H1
Headlamp low beam (Halogen)	H11LL
* Headlamp low beam (HID)	D3S
Sidemarkers - front	168
Parking lamp - front (HI Series)	WY5W
Parking lamp - front (Low Series)	194
Direction indicator lamp - front (HI Series)	WY21W
Direction indicator lamp - front (Low Series)	W21W
Fog lamps	H10 (9145)
Tail and brake lamp	3157K
Direction indicator lamp - rear	T20
Reversing lamp	921
License plate lamp	W5W
* High-mount brake lamp	LED
* Interior lamps	LED

\* To replace these lamps - see an authorized dealer.

To replace all instrument panel lamps - see an authorized dealer

# Maintenance

## TECHNICAL SPECIFICATIONS

### Vehicle Fluids

**Note:** Use fluids which meet the specifications or requirements defined. Use of other fluids may lead to damage which is not covered by your vehicle's warranty.

Item	Specification	Viscosity Grade	Recommended fluid
Engine oil - gasoline engines only	WSS-M2C948-B	5W-20	Castrol or Ford Engine Oil
Alternative engine oil - all gasoline engines	WSS-M2C913-C	5W-30	Castrol or Ford Engine Oil
Engine oil - diesel engines	WSS-M2C913-C	5W-30	Castrol or Ford Engine Oil
Engine coolant	WSS-M97B44-D	-	Motorcraft SuperPlus Antifreeze
Brake fluid	WSS-M6C65-A2 or ISO 4925 Class 6	-	Motorcraft or Ford DOT 4 LV High Performance Brake Fluid

The engine has been designed to be used with Castrol and Ford Engine Oil, which gives a fuel economy benefit while maintaining the durability of the engine.

Adding oil: If you are unable to find an oil that meets the specification defined by WSS-M2C913-C or WSS-M2C948-B (gasoline engines only), you must use SAE 5W-30 that meets the specification defined by ACEA A5/B5.

Using oils other than the one specified can result in longer engine cranking periods, reduced engine performance, reduced fuel economy and increased emission levels.

Castrol engine oil recommended.



# Maintenance

Variant	Item	Capacity in gallons (litres)
All	Windshield and rear window washer system - including headlamp washer	1.2 (4.5)
All	Windshield and rear window washer system - excluding headlamp washer	0.8 (3)
1.6L EcoBoost	Engine cooling system	1.7 (6.3)
2.0L Duratorq-TDCi (DW) Diesel	Engine cooling system	2.2 (8.5)
Vehicles with a gasoline engine	Fuel tank	13.2 (60)
Vehicles with a diesel engine	Fuel tank	13.2 (60)
1.6L EcoBoost	Engine lubrication system - including the oil filter	1 (3.8)
1.6L EcoBoost	Engine lubrication system - excluding the oil filter	0.8 (3)
2.0L Duratorq-TDCi (DW) Diesel	Engine lubrication system - including the oil filter	1.5 (5.7)
2.0L Duratorq-TDCi (DW) Diesel	Engine lubrication system - excluding the oil filter	1.4 (5.4)

## Engine Oil Adding Capacities

Engine	Capacity in gallons (litres)
1.6L EcoBoost	0.1 (0.5)
2.0L Duratorq-TDCi (DW) Diesel	0.4 (1.8)

# Vehicle Care

---

## CLEANING THE EXTERIOR

We recommend that you wash your vehicle regularly with a sponge and lukewarm water containing a neutral pH car shampoo.

Never use strong household detergents or soap, such as dish washing or laundry liquid. These products can discolor and can cause spotting on painted surfaces.

Never wash your vehicle when it is hot to the touch or during exposure to strong, direct sunlight.

Dry your vehicle with a chamois or soft terry cloth towel in order to eliminate water spotting.

Immediately remove items such as gasoline, diesel fuel, bird droppings and insect deposits as they can cause damage to your vehicle's paintwork and trim over time.

Suntan lotions and insect repellents can damage any painted surface. If these substances come in to contact with your vehicle, wash them off as soon as possible.

## Using a Car Wash

### WARNINGS



If you use a car wash with a waxing cycle, make sure that you remove the wax from the windshield.



Switch the heater blower off to prevent contamination of the fresh air filter.

---

Prior to using a car wash facility check the suitability of it for your vehicle.

Some car wash installations use water at high pressure. This could damage certain parts of your vehicle.

Remove any exterior accessories, including the antenna, before using an automatic car wash.

## Cleaning the Headlamps

### WARNINGS



Do not scrape the headlamp lenses or use abrasives, alcoholic solvents or chemical solvents to clean them.



Do not wipe the headlamps when they are dry.

---

## Cleaning the Chrome Trim

Do not use abrasives or chemical solvents. Use soapy water.

Do not apply cleaning product to hot surfaces.

Do not leave cleaning product on chrome surfaces longer than recommended.

Industrial-strength (heavy-duty) cleaners, or cleaning chemicals, may cause damage over a period of time.

## Underbody

Flush the complete underside of your vehicle frequently. Keep body and door drain holes free from packed dirt.

## Cleaning Plastic Exterior Parts

Use only approved products to clean plastic parts.

## REPAIRING MINOR PAINT DAMAGE

You should repair paintwork damage caused by stones from the road or minor scratches as soon as possible. A choice of products are available from an authorized dealer.

Remove particles such as bird droppings, tree sap, insect deposits, tar spots, road salt and industrial fallout before repairing paint chips.

# Vehicle Care

Always read and follow the manufacturer's instructions before using the products.

## CLEANING THE INTERIOR

**Note:** Do not allow air fresheners and hand sanitizers to spill on interior surfaces. If a spill occurs, wipe off immediately. Damage may not be covered by your warranty.

### Safety Belts

#### WARNINGS



Do not use abrasives, or chemical solvents to clean them.



Do not allow moisture to penetrate the safety belt retractor mechanism.

Clean them with interior cleaner or water applied with a soft sponge. Let them dry naturally, away from artificial heat.

### Instrument Cluster Screens, LCD Screens and Radio Screens

#### WARNING



Do not use abrasives, alcoholic solvents or chemical solvents to clean them.

### Rear Windows

#### WARNING



Do not use any abrasive materials to clean the interior of the rear windows.

**Note:** Do not install stickers or labels to the interior of the rear windows.

## CLEANING THE ALLOY WHEELS

**Note:** Do not apply a cleaning chemical to warm or hot wheel rims and covers.

**Note:** Industrial-strength (heavy-duty) cleaners, or cleaning chemicals, in combination with brush agitation to remove brake dust and dirt, could wear away the clear coat finish over a period of time.

**Note:** Do not use hydrofluoric acid-based or high caustic-based wheel cleaners, steel wool, fuels or strong household detergent.

**Note:** If you intend parking your vehicle for an extended period after cleaning the wheels with a wheel cleaner, drive your vehicle for a few minutes before doing so. This will reduce the risk of increased corrosion of the brake discs, brake pads and linings.

**Note:** Some automatic car washes may cause damage to the finish on your wheel rims and covers.

Alloy wheels and wheel covers are coated with a clear coat paint finish. To maintain their condition we recommend that you:

- Clean them weekly with the recommended wheel and tire cleaner.
- Use a sponge to remove heavy deposits of dirt and brake dust accumulation.
- Rinse them thoroughly with a pressurized stream of water when you have completed the cleaning process.

We recommend that you use Ford service wheel cleaner. Make sure that you read and follow the manufacturer's instructions.

Using other non-recommended cleaning products can result in severe and permanent cosmetic damage.

# Wheels and Tires

## GENERAL INFORMATION

A decal with tire pressure data is located in the driver's door opening.

Check and set the tire pressure at the ambient temperature in which you are intending to drive your vehicle and when the tires are cold.

**Note:** Check your tire pressures regularly to optimize fuel economy.

**Note:** Use only approved wheel and tire sizes. Using other sizes could damage your vehicle and will make the National Type Approval invalid.

**Note:** If you change the diameter of the tires from that fitted at the factory, the speedometer may not display the correct speed. Take your vehicle to an authorized dealer to have the engine management system reprogrammed.

**Note:** If you intend to change the size of the wheels from that fitted at the factory, check the suitability with an authorized dealer.

## TEMPORARY MOBILITY KIT

Your vehicle may not have a spare tire. Therefore you will have a temporary mobility kit which will only repair one damaged tire.

The kit is located in the spare wheel well.

### General Information

#### WARNINGS

 Depending on the type and extent of tire damage, some tires can only be partially sealed or not sealed at all. Loss of tire pressure can affect vehicle handling, leading to loss of vehicle control.

#### WARNINGS

 Do not use the kit on a previously damaged tire, for example when it has been driven under inflated. This could cause loss of vehicle control, personal injury or death.

 Do not use the kit on run flat tires. This could cause loss of vehicle control.

 Do not try to seal damage to the tire's sidewall. The tire could burst and cause loss of vehicle control, personal injury or death.

The kit seals most tire punctures [with a diameter of up to ¼ inch (six millimetres)] to temporarily restore mobility.

You must observe the following rules when using the kit:

- Drive with caution and avoid making sudden steering or driving maneuvers, especially if your vehicle is heavily loaded or you are towing a trailer.
- The kit will provide you with an emergency temporary repair, enabling you to continue your journey to the next vehicle or tire dealer, or to drive a maximum distance of 125 miles (200 kilometers).
- Do not exceed a maximum speed of 50 mph (80 km/h).
- Keep the kit out of the reach of children.
- Only use the kit when the ambient temperature is between -40°F (-40°C) and +158°F (+70°C).

### Using the Kit

#### WARNINGS

 Compressed air can act as an explosive or propellant which could cause serious personal injury.

# Wheels and Tires

## WARNINGS



Never leave the kit unattended while in use.



Do not keep the compressor operating for more than 10 minutes. This could cause loss of vehicle control or personal injury.

**Note:** *You must only use the kit for the vehicle with which it was supplied.*

- Park your vehicle at the roadside so that you do not obstruct the flow of traffic and so that you are able to use the kit without being in danger.
- Apply the parking brake, even if you have parked on a level road, to make sure that your vehicle will not move.
- Do not attempt to remove foreign objects like nails or screws penetrating the tire.
- Leave the engine running while the kit is in use, but not if your vehicle is in an enclosed or poorly ventilated area (e.g. inside a building). In these circumstances, switch the compressor on with the engine switched off.
- You must replace the sealant bottle with a new one before the expiry date (see top of bottle).
- Inform all other users of your vehicle that the tire has been temporarily sealed with the kit. Make them aware of the special driving conditions that must be observed.

## Inflating the Tire

### WARNINGS



Check the sidewall of the tire prior to inflation. If there are any cracks, bumps or similar damage, do not attempt to inflate the tire. This could cause personal injury.

## WARNINGS



Do not stand directly beside the tire while the compressor is operating. This could cause personal injury if the tire bursts.



Watch the sidewall of the tire. If any cracks, bumps or similar damage appears, switch the compressor off and let the air out by means of the pressure relief valve B. Do not continue driving with this tire. This could cause loss of vehicle control.



The sealant contains natural rubber latex. Avoid contact with skin and clothing. If this happens, rinse the affected areas immediately with plenty of water and consult a physician.



If the tire inflation pressure does not reach 1.8 bar (26 psi) within 10 minutes, the tire may have suffered excessive damage, making a temporary repair impossible. In this case, do not continue driving with this tire. This could cause loss of vehicle control.



Screwing the bottle onto the bottle holder will pierce the seal of the bottle. Do not unscrew the bottle from the holder as the sealant will escape, which could cause serious personal injury.



## Wheels and Tires

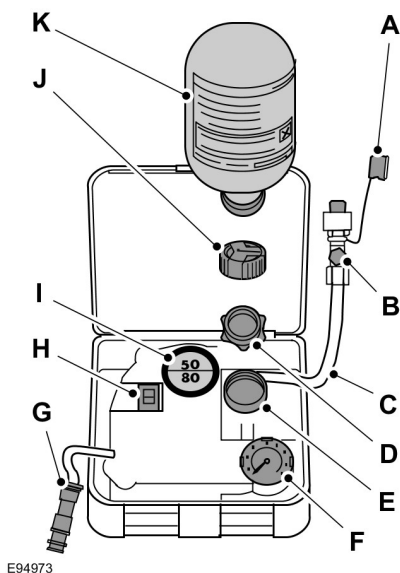

E94973

- A Protective cap
- B Pressure relief valve
- C Hose
- D Orange cap
- E Bottle holder
- F Pressure gauge
- G Power plug with cable
- H Compressor switch
- I Label
- J Bottle lid
- K Sealant bottle

1. Open the lid of the kit.

2. Peel off the label I showing the maximum permissible speed of 50 mph (80 km/h) from the casing and attach it to the instrument panel in the driver's field of view. Make sure the label does not obscure anything important.
3. Take the hose C and the power plug with cable G out of the kit.
4. Unscrew the orange cap D and the bottle lid J.
5. Screw the sealant bottle K clockwise into the bottle holder E fully tight.
6. Remove the valve cap from the damaged tire.
7. Detach the protective cap A from the hose C and screw the hose C firmly onto the valve of the damaged tire.
8. Make sure that the compressor switch H is in position 0.
9. Insert the power plug G into the cigar lighter socket or auxiliary power point. See **Auxiliary Power Points** (page 102).
10. Start the engine.
11. Move the compressor switch H to position 1.
12. Inflate the tire for no longer than 10 minutes to an inflation pressure of minimum 1.8 bar (26 psi) and a maximum of 3.5 bar (51 psi). Move the compressor switch H to position 0 and check the current tire pressure with pressure gauge F.

**Note:** When pumping in the sealant through the tire valve, the pressure may rise up to 6 bar (87 psi) but will drop again after about 30 seconds.

**Note:** After you have switched the compressor off, you may hear air escaping from the damaged tire. This is normal and can be ignored provided that the specified minimum tire pressure has been reached.

# Wheels and Tires

---

13. Remove the power plug G from the cigar lighter socket or auxiliary power point.
14. Quickly unscrew the hose C from the tire valve and replace the protective cap A. Fasten the valve cap again.

**Note:** *Some residual sealant fluid may drip or spray out of hose C while you are disconnecting it. This is normal.*

15. Leave the sealant bottle K in the bottle holder E.
16. Make sure the kit, the bottle lid and the orange cap are stored safely, but still easily accessible in your vehicle. The kit will be required again when you check the tire pressure.
17. Immediately drive approximately two miles (three kilometers) so that the sealant can seal the damaged area.

## WARNING



If you experience heavy vibrations, unsteady steering behavior or noises while driving, reduce your speed gradually and stop your vehicle as soon as it is safe to do so. Recheck the tire and its pressure. If the tire pressure is less than 1.3 bar (19 psi) or if there are any cracks, bumps or similar damage visible, do not continue driving with this tire. This could cause loss of vehicle control.

---

## Checking the Tire Pressure

### WARNING



Before driving, make sure the tire is adjusted to the recommended inflation pressure. See **Technical Specifications** (page 208). Monitor the tire pressure until the sealed tire is replaced.

1. Stop your vehicle after driving approximately two miles (three kilometers). Check, and where necessary, adjust the pressure of the damaged tire.
2. Attach the kit and read the tire pressure from the pressure gauge F.
3. If the pressure of the sealant-filled tire is 1.3 bar (19 psi) or more, adjust it to the specified pressure. See **Technical Specifications** (page 208).
4. Follow the inflation procedure once again to top up the tire.
5. Check the tire pressure again from the pressure gauge F. If the tire pressure is too high, deflate the tire to the specified pressure using the pressure relief valve B.
6. Once you have inflated the tire to its correct tire pressure, move the compressor switch H to position 0, remove the power plug G from the socket, unscrew the hose C, fasten the valve cap and replace the protective cap A.
7. Leave the sealant bottle K in the bottle holder E and store the kit away safely in its original location.
8. Drive to the nearest tire specialist to get the damaged tire replaced. Before the tire is removed from the rim, inform your tire dealer that the tire contains sealant. You must renew the sealant bottle K and hose C as soon as possible once used.

**Note:** *Remember that this kit only provides temporary mobility. Regulations concerning tire repair after usage of the kit may differ from country to country. You should consult a tire specialist for advice.*

Empty sealant bottles can be disposed of together with normal household waste. Return remains of sealant to an authorized dealer or dispose of it in compliance with local waste disposal regulations.

# Wheels and Tires

## TIRE CARE



E70415

To make sure the front and rear tires of your vehicle wear evenly and last longer, we recommend that you swap the tires from front to rear and vice versa at regular intervals of between 3000 and 6000 miles (5000 and 10000 kilometers).

### WARNING



Do not scrub the sidewalls of the tires when you are parking.

If you have to mount a curb, do so slowly and approach it with the wheels at right-angles to the curb.

Examine the tires regularly for cuts, foreign objects and uneven wear of the tread. Uneven wear could mean that the wheel alignment is outside specification.

Check the tire pressures (including the spare) when cold, every two weeks.

## USING WINTER TIRES

### WARNING



When you use winter tires on your vehicle, you must make sure that you use the correct lug nuts.

If winter tires are used, you must make sure that you use the correct tire pressures. See **Technical Specifications** (page 208).

## USING SNOW CHAINS

### WARNINGS



Do not exceed 30 mph (50 km/h).



Do not use snow chains on snow-free roads.



Only fit snow chains to specified tires. See **Technical Specifications** (page 208).



If your vehicle has wheel trims, remove them before fitting snow chains.

**Note:** *The anti-lock braking system will continue to operate normally.*

Only use small link snow chains.

Only use snow chains on the front wheels.

### Vehicles with Stability Control

When stability control is on, your vehicle may exhibit some unusual driving characteristics. To reduce this, switch traction control off. See **Using Stability Control** (page 132).

## CHANGING A ROAD WHEEL

### Lug Nuts

You can obtain a replacement locking lug nut key and replacement locking lug nuts from an authorized dealer using the reference number certificate.

### Vehicles with a Spare Wheel

If the spare wheel is exactly the same type and size as the other fitted road wheels, you can replace the existing road wheel with the spare wheel and continue to drive in the normal manner.

# Wheels and Tires

If the spare wheel is different to the other road wheels, it will carry a yellow label with the appropriate speed limit.

Refer to the following information before changing the road wheel.

## WARNINGS



Drive the shortest possible distances.



Do not fit more than one spare wheel on your vehicle at any one time.



Do not carry out any tire repairs on a spare wheel.



Do not drive through an automatic car wash.



If you are unsure what type of spare wheel you have do not exceed 50 mph (80 km/h).



Only fit snow chains to specified tires. See **Technical Specifications** (page 208).



The ground clearance of your vehicle may be reduced. Take care when parking next to a curb.

**Note:** Your vehicle may exhibit some unusual driving characteristics.

## Vehicle Jack

### WARNINGS



The vehicle jack supplied with your vehicle should only be used when changing a wheel in emergency situations.

## WARNINGS



Before using the vehicle jack, check that it is not damaged or deformed and that the thread is lubricated and free from foreign matter.



Never place anything between the jack and the ground, or the jack and your vehicle.

**Note:** Vehicles with a temporary mobility kit do not have a vehicle jack or a wheel brace.

It is recommended to use a workshop type hydraulic jack for changing between summer and winter tires.

**Note:** Use a jack with a minimum lifting capacity of 1.5 tonnes and a lifting plate with a minimum diameter of 3.1 inches (80 millimeters).

## Vehicles without a Temporary Mobility Kit

Your vehicle jack, wheel brace, screw-in towing eye and wheel trim remover are located in the spare wheel well.

## Jacking and Lifting Points

### WARNING



Use only the specified jacking points. If you use other positions, you may damage the body, steering, suspension, engine, braking system or the fuel lines.

# Wheels and Tires

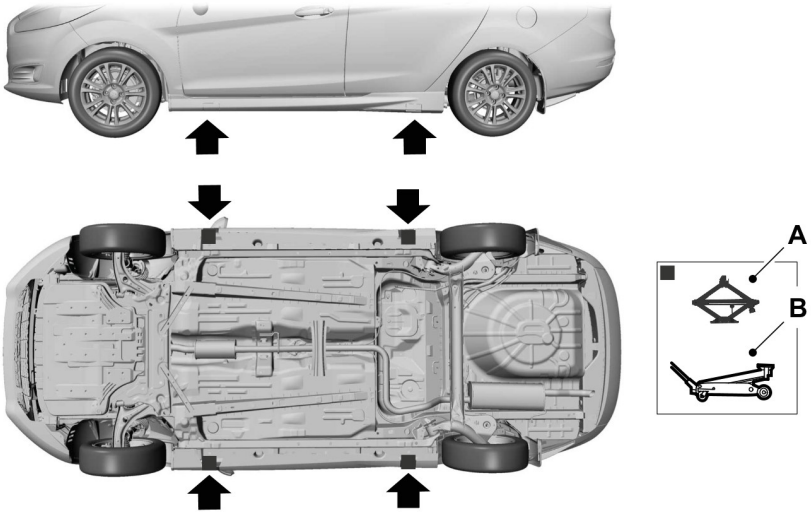

E92658

- A Emergency use only
- B Maintenance

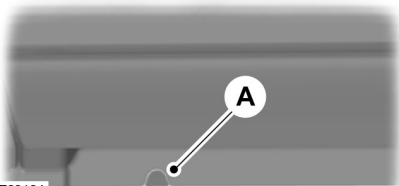

E93184

Indentations in the sills show the location of the jacking points.



E142553

# Wheels and Tires



E93020

**Note:** You can use the wheel brace to raise and lower the jack.

## Assembling the Wheel Brace

### Type One

#### WARNING

 The screw-in towing eye has a left-hand thread. Turn it counterclockwise to install it. Make sure that the towing eye is fully tightened.



E122502

Insert the screw-in towing eye into the wheel brace.

### Type Two



E159432

**Note:** When jacking your vehicle, you will need to rotate the wheel brace 180 degrees, pivot the wheel brace back to the original position before rotating again.

### Using the Wheel Brace as a Jack Handle

1. Attach the wheel brace to the jack horizontally.
2. Rotate the wheel brace 180 degrees.
3. Return the wheel brace to the original position and repeat as necessary.

## Removing the Wheel Trim

### Type One

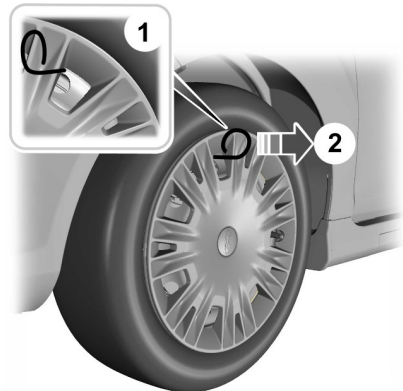

E122314

1. Insert the wheel trim remover.
2. Remove the wheel trim.

# Wheels and Tires









**Note:** Make sure that you pull the wheel trim remover at right angles to the trim.

## Type Two

Insert the flat end of the wheel brace between the rim and the trim and carefully remove the trim.

## Removing a Road Wheel

### WARNINGS

-  Park your vehicle in such a position that neither the traffic nor you are hindered or endangered.
-  Set up a warning triangle.
-  Make sure that your vehicle is on firm, level ground with the wheels pointing straight ahead.
-  Switch the ignition off and apply the parking brake.
-  If your vehicle has a manual transmission, select first or reverse gear. If it has an automatic transmission, select park.
-  Have the passengers leave your vehicle.
-  Secure the diagonally opposite wheel with an appropriate block or wheel chock.
-  Do not work underneath your vehicle when it is supported only by a jack.
-  Make sure that the jack is vertical to the jacking point and the base is flat on the ground.

**Note:** The spare wheel is located under the floor cover in the luggage compartment.

1. Install the locking lug nut key.

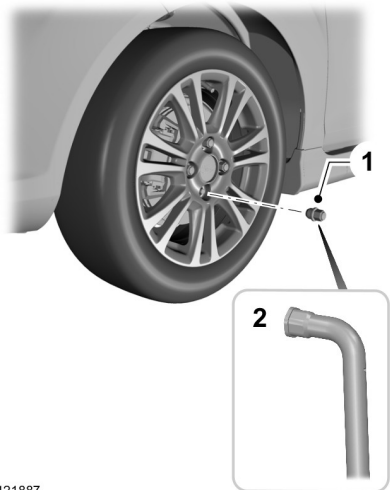



E 121887

2. Slacken the lug nuts.
3. Jack up your vehicle until the tire is clear of the ground.
4. Remove the lug nuts and the wheel.

**Note:** Do not lay alloy wheels face down on the ground, this will damage the paint.

## Installing a Road Wheel

### WARNINGS

-  Make sure that the arrows on directional tires point in the direction of rotation when your vehicle is moving forward. If you have to fit a spare wheel with the arrows pointing in the opposite direction, have the tire refitted in the correct direction by an authorized dealer.
-  Use only approved wheel and tire sizes. Using other sizes could damage your vehicle and will make the National Type Approval invalid. See **Technical Specifications** (page 208).

# Wheels and Tires

## WARNINGS

 Do not fit run flat tires on vehicles that were not originally fitted with them. See an authorized dealer for more details about compatibility.

## WARNINGS

 Do not install alloy wheels using lug nuts designed for use with steel wheels.

 Lug nuts are subject to change. You must make sure that you use only the specific lug nuts and wheels supplied for your vehicle. If in doubt see an authorized dealer.

 Make sure there is no lubrication (grease or oil) on the threads or the surface between the wheel lugs and nuts. This can cause the lug nuts to loosen while driving.

**Note:** *The lug nuts of alloy wheels and spoked steel wheels can also be used for the steel spare wheel for a short time (maximum two weeks).*

**Note:** *Make sure the wheel and hub contact surfaces are free from foreign matter.*

**Note:** *Make sure that the cones on the lug nuts are against the wheel.*

1. Install the wheel.
2. Install the lug nuts finger tight.
3. Install the locking lug nut key.

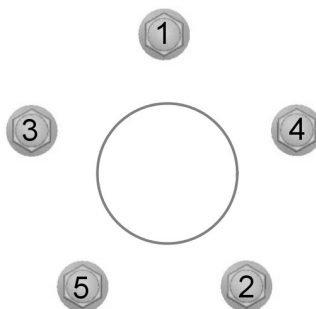

E154985

4. Partially tighten the lug nuts in the sequence shown.
5. Lower your vehicle and remove the jack.
6. Fully tighten the lug nuts in the sequence shown. See **Technical Specifications** (page 208).
7. Install the wheel trim using the ball of your hand.

## WARNING

 Have the lug nuts checked for tightness and the tire pressure checked as soon as possible.

## Stowing the Flat Tire

1. Unblock the wheels.
2. Place the flat tire on the luggage compartment floor.



# Wheels and Tires

3. Locate the cargo tie-down near the seatback. Push the loop of the retainer strap through the tie-down. Thread the other end through the loop.



E142906

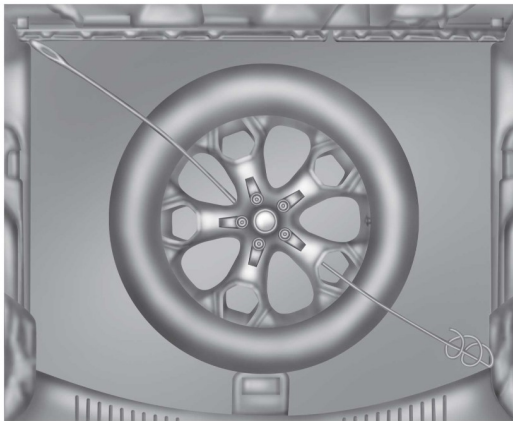

E142985

4. Weave the retainer strap through the wheel openings.
5. Locate the front cargo tie-down at the opposite corner of the luggage compartment. Thread the retainer strap through the tie-down and pull it tight.

# Wheels and Tires

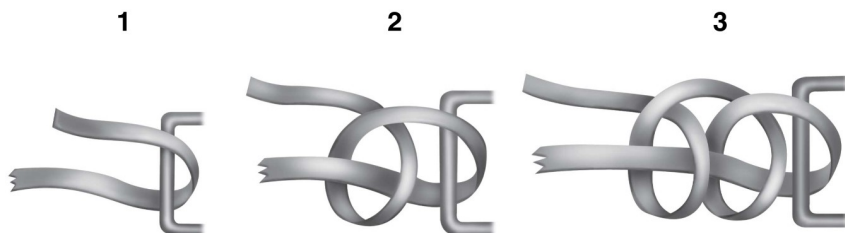

E143746

6. Secure by tying two half hitch knots.

## TECHNICAL SPECIFICATIONS

### Lug Nut Torque

Wheel type	lb-ft (Nm)
All	100 (135)

### Tire Pressures (Cold Tires)

#### Up to 50 mph (80 km/h)

Variant	Tire size	Normal load		Full load	
		Front	Rear	Front	Rear
		psi (bar)	psi (bar)	psi (bar)	psi (bar)
Temporary spare wheel when it differs from the other fitted wheels	155/70 R17	60 psi (4.2 bar)	60 psi (4.2 bar)	60 psi (4.2 bar)	60 psi (4.2 bar)

# Wheels and Tires

## Up to 100mph (160 km/h)

Variant	Tire size	Normal load		Full load	
		Front	Rear	Front	Rear
		psi (bar)	psi (bar)	psi (bar)	psi (bar)
All engines	235/55 R17 *	35 psi (2.4 bar)	35 psi (2.4 bar)	35 psi (2.4 bar)	41 psi (2.8 bar)
All engines	235/50 R18	33 psi (2.3 bar)	33 psi (2.3 bar)	35 psi (2.4 bar)	41 psi (2.8 bar)
All engines	235/45 R19	33 psi (2.3 bar)	33 psi (2.3 bar)	35 psi (2.4 bar)	41 psi (2.8 bar)

\*Only fit snow chains to specified tires.

## Continuous Speed in Excess of 100mph (160 km/h)

Variant	Tire size	Normal load		Full load	
		Front	Rear	Front	Rear
		psi (bar)	psi (bar)	psi (bar)	psi (bar)
All engines	235/55 R17	35 psi (2.4 bar)	35 psi (2.4 bar)	36 psi (2.5 bar)	41 psi (2.8 bar)
All engines	235/50 R18	33 psi (2.3 bar)	33 psi (2.3 bar)	36 psi (2.5 bar)	41 psi (2.8 bar)
All engines	235/45 R19	33 psi (2.3 bar)	33 psi (2.3 bar)	36 psi (2.5 bar)	41 psi (2.8 bar)

# Capacities and Specifications

## VEHICLE IDENTIFICATION PLATE

**Note:** Your vehicle identification plate design may vary to that shown.

**Note:** The information shown on the vehicle identification plate is dependent upon market requirements.

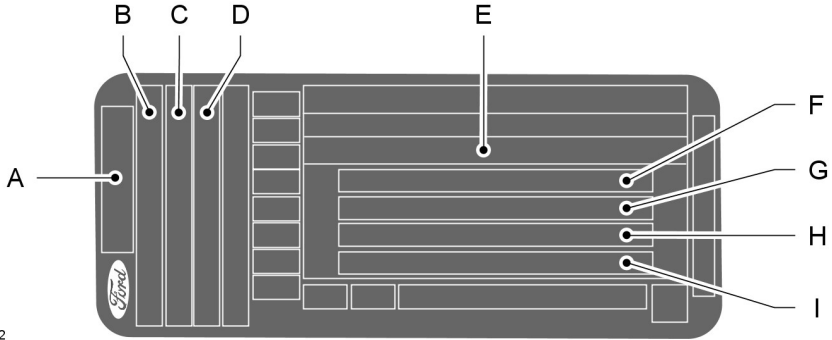

E135662

- A Model
- B Variant
- C Engine designation
- D Engine power and emission level
- E Vehicle identification number
- F Gross vehicle weight
- G Gross train weight
- H Maximum front axle weight
- I Maximum rear axle weight

Your vehicle identification number and maximum weights are shown on a plate, located at the bottom of the lock side of the right-hand door aperture.

# Capacities and Specifications

## VEHICLE IDENTIFICATION NUMBER

The vehicle identification number is stamped into the floor panel on the right-hand side, beside the front seat. It is also shown on the left-hand side of the instrument panel.

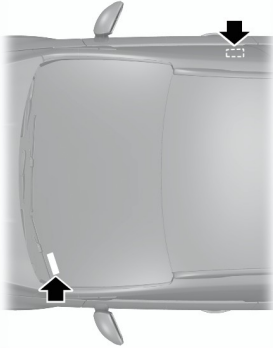

E87496

## TECHNICAL SPECIFICATIONS

### Vehicle Dimensions

Dimension description	Dimension in inches (mm)
Maximum length	178 (4524)
Overall width including exterior mirrors	82 (2086)
Overall height - EC curb weight	66 - 67 (1680 - 1702)
Wheelbase	106 (2690)
Front track	61 - 62 (1554 - 1574)
Rear track	61 - 62 (1554 - 1574)

# Capacities and Specifications

## Towing Equipment Dimensions

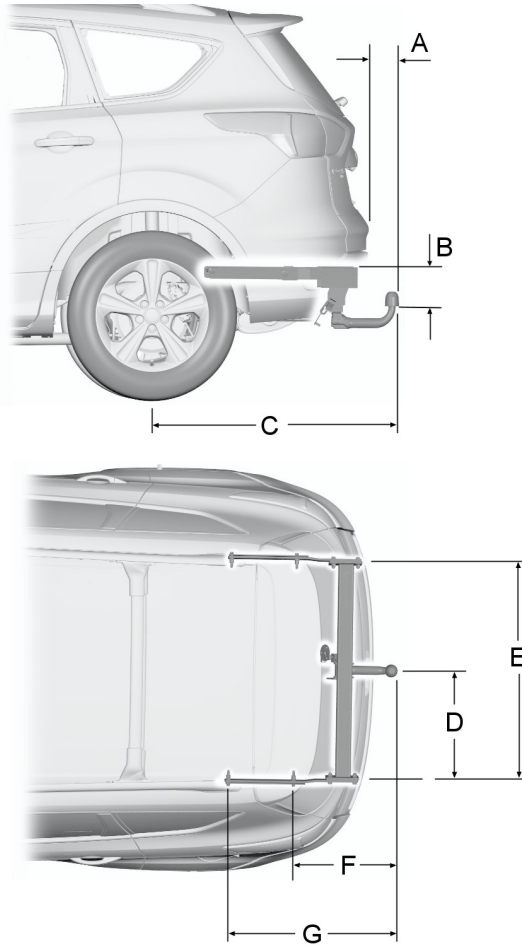

E152457

# Capacities and Specifications

---

<b>Item</b>	<b>Dimension description</b>	<b>Dimension in inches (mm)</b>
A	Bumper – end of tow ball	4 (100)
B	Attachment point – center of tow ball	4 (104)
C	Wheel center – center of tow ball	39 (985)
D	Center of tow ball – side member	20 (517)
E	Distance between side members	41 (1035)
F	Center of tow ball – center 1. attachment point	18 (449)
G	Center of tow ball – center 2. attachment point	29 (749)

## Maximum Permissible Nose Weight

<b>lb (kg)</b>
220 (100)

# Audio System

## GENERAL INFORMATION

### Radio Frequencies and Reception Factors

Radio reception factors	
Distance and Strength	The further you travel away from an FM station, the weaker the signal and the weaker the reception.
Terrain	Hills, mountains, tall buildings, bridges, tunnels, freeway overpasses, parking garages, dense tree foliage and thunderstorms can interfere with the reception.
Station overload	When you pass near a radio transmission tower, a stronger signal can override a weaker signal and can cause interference in the audio system.

### CD and CD Player Information

**Note:** *CD units play commercially pressed 4.75-inch (12 centimeter) audio compact discs only. Due to technical incompatibility, certain recordable and re-recordable compact discs may not function correctly when used in Ford CD players.*

**Note:** *Do not insert CDs with homemade paper (adhesive) labels into the CD player as the label may peel and cause the CD to become jammed. You should use a permanent felt tip marker rather than adhesive labels on your homemade CDs. Ballpoint pens may damage CDs. Please contact an authorized dealer for further information.*

**Note:** *Do not use any irregularly shaped discs or discs with a scratch protection film attached.*

Always handle discs by their edges only. Clean the disc with an approved CD cleaner only. Wipe it from the center of the disc toward the edge. Do not clean in a circular motion.

Do not expose discs to direct sunlight or heat sources for extended periods.

### MP3 and WMA Track and Folder Structure

Audio systems capable of recognizing and playing MP3 and WMA individual tracks and folder structures work as follows:

- There are two different modes for MP3 and WMA disc playback: MP3 and WMA track mode (system default) and MP3 and WMA folder mode.
- MP3 and WMA track mode ignores any folder structure on the MP3 and WMA disc. The player numbers each MP3 and WMA track on the disc (noted by the .mp3 or .WMA file extension) from T001 to a maximum of T255. The maximum number of playable MP3 and WMA files may be less depending on the structure of the CD and exact model of radio present.



# Audio System

---

- MP3 and WMA folder mode represents a folder structure consisting of one level of folders. The CD player numbers all MP3 and WMA tracks on the disc (noted by the .mp3 or .WMA file extension) and all folders containing MP3 and WMA files, from F001 (folder) T001 (track) to F253 T255.
- Creating discs with only one level of folders helps with navigation through the disc files.

If you are burning your own MP3 and WMA discs, it is important to understand how the system reads the structures you create. While various files may be present, (files with extensions other than mp3 and WMA), only files with the .mp3 and WMA extension are played; other files are ignored by the system. This enables you to use the same MP3 and WMA disc for a variety of tasks on your work computer, home computer and your in-vehicle system.

In track mode, the system displays and plays the structure as if it were only one level deep (all .mp3 files play, regardless of being in a specific folder). In folder mode, the system only plays the .mp3 files in the current folder.

## **AUDIO UNIT - VEHICLES WITH: AM/FM/CD**

### **WARNING**



Driving while distracted can result in loss of vehicle control, accident and injury. We strongly recommend that you use extreme caution when using any device or feature that may take your focus off the road. Your primary responsibility is the safe operation of your vehicle. We recommend against the use of any handheld device while driving and encourage the use of voice-operated systems when possible. Make sure you are aware of all applicable local laws that may affect the use of electronic devices while driving.

---

# Audio System

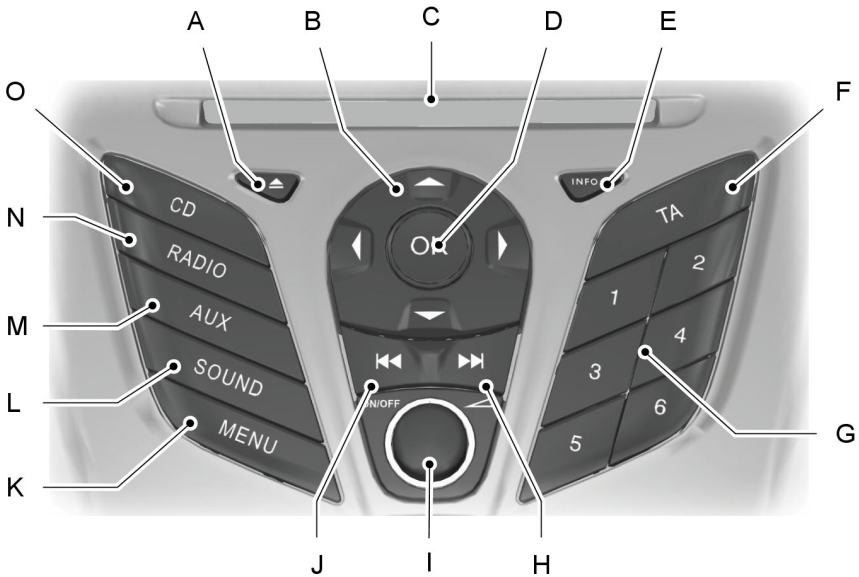

E130324

- A **Eject:** Press the button to eject a CD.
- B **Cursor arrows:** Press a button to scroll through on-screen choices.
- C **CD slot:** Where you insert a CD.
- D **OK:** Press the button to confirm on-screen selections.
- E **INFO:** Press the button to access radio, CD, USB and iPod information.
- F **TA:** Press the button to turn traffic announcements on or off and cancels announcements during an active announcement.
- G **Numeric keypad:** Press the button to recall a previously stored station. To store a favorite station press and hold until the sound returns.
- H **Seek up:** Press the button to go to the next station up the radio frequency band or the next track on a CD.
- I **On, Off and Volume:** Press the button to switch the audio system on or off. Turn the dial to adjust the volume.
- J **Seek down:** Press the button to go to the next station down the radio frequency band or the previous track on a CD.

# Audio System

---

- K **MENU:** Press the button to access different audio system features.
- L **SOUND:** Press the button to adjust the sound settings for bass, treble, middle, balance and fade.
- M **AUX:** Press the button to access the AUX and SYNC features, it will also cancel the menu or list browsing.
- N **RADIO:** Press the button to select different radio bands, it will also cancel the menu or list browsing.
- O **CD:** Press the button to change source to CD, it will also cancel the menu or list browsing.

## Sound Button

This will allow you to adjust the sound settings (for example bass, middle and treble).

1. Press the **SOUND** button.
2. Use the up and down arrow buttons to select the required setting.
3. Use the left and right arrow buttons to make the necessary adjustment. The display indicates the level selected.
4. Press the **OK** button to confirm the new settings.

## Waveband Button

Press the **RADIO** button to select from the wavebands available.

You can use the selector to return to radio reception when you have been listening to another source.

Alternatively, press the left arrow button to display the available wavebands. Scroll to the required waveband and press **OK**.

## Station Tuning Control

### Seek Tuning

Select a waveband and briefly press one of the seek buttons. The unit will stop at the first station it finds in the direction you have chosen.

## Manual Tuning

1. Press the **MENU** button.
2. Select **RADIO** mode and then **MANUAL TUNE**.
3. Use the left and right arrow buttons to tune down or up the waveband in small increments or press and hold to increment quickly, until you find a station you want to listen to.
4. Press **OK** to continue listening to a station.

## Scan Tuning

Scan allows you to listen to a few seconds of each station detected.

1. Press the **MENU** button.
2. Select **RADIO** mode and then **SCAN**.
3. Use the seek buttons to scan up or down the selected waveband.
4. Press **OK** to continue listening to a station.

## Station Preset Buttons

This feature allows you to store your favorite stations, they can be recalled by selecting the appropriate waveband and pressing one of the preset buttons.

1. Select a waveband.
2. Tune to the station required.

# Audio System

3. Press and hold one of the preset buttons. A progress bar and message will appear. When the progress bar completes the station has been stored. The audio unit will also mute momentarily as confirmation.

You can repeat this on each waveband and for each preset button.

**Note:** *When you drive to another part of the country, stations that broadcast on alternative frequencies and are stored on preset buttons, may be updated with the correct frequency and station name for that area.*

## Autostore Control

**Note:** *This will store up to a maximum of the six strongest signals available, either from the AM or the FM waveband and overwrite the previously stored stations. You can also store stations manually in the same way as other wavebands.*

- Press and hold the **RADIO** button.
- When the search is complete, sound is restored and the strongest signals are stored on the autostore presets.

## Traffic Information Control

Many stations that broadcast on the FM waveband have a TP code to signify that they carry traffic program information.

## Turning Traffic Announcements On and Off

Before you can receive traffic announcements, you must press either the **TA** or **TRAFFIC** button. A TA display will appear to show the feature is switched on.

If you are already tuned to a station that broadcasts traffic information, **TP** will also be displayed. Otherwise the unit will search for a traffic program.

When traffic information is broadcast, it will automatically interrupt normal radio or CD playback and **Traffic announcement** will appear in the display.

If a non-traffic station is selected or recalled using a preset button, the audio unit will remain on that station unless **TA** or **TRAFFIC** is turned off, then on again.

**Note:** *If traffic announcement is on and you select a preset or manual tune to a non traffic announcement station no traffic announcement will be heard.*

**Note:** *When you are listening to a non traffic announcement station and turn traffic announcement off and on again a TP seek will occur.*

## Traffic Announcement Volume

Traffic announcements interrupt normal broadcasts at a preset minimum level that is usually louder than normal listening volumes.

To adjust the preset volume:

- Use the volume control to make the necessary adjustment during an incoming traffic announcement broadcast. The display will show the level selected.

## Ending Traffic Announcements

The audio unit will return to normal operation at the end of each traffic announcement. To end the announcement prematurely, press **TA** or **TRAFFIC** during the announcement.

**Note:** *If you press TA or TRAFFIC at any other time it will switch all announcements off.*

## Automatic Volume Control

When available, automatic volume control adjusts the volume level to compensate for engine noise and road speed noise.

# Audio System

1. Press the **MENU** button and select **AUDIO** or **AUDIO SETTINGS**.
2. Select **AVC LEVEL** or **ADAPTIVE VOL**.
3. Use the left or right arrow button to adjust the setting.
4. Press the **OK** button to confirm your selection.
5. Press the **MENU** button to return.

## News Broadcasts

Your audio unit may interrupt normal reception to broadcast news bulletins from stations on the FM waveband, radio data system or other enhanced network linked stations.

The display will indicate there is an incoming announcement, during news broadcasts. When the audio unit interrupts for a news broadcast the preset volume level will be the same as traffic announcements.

1. Press the **MENU** button.
2. Select **AUDIO** or **AUDIO SETTINGS**.
3. Scroll to **NEWS** and turn on or off with the **OK** button.
4. Press the **MENU** button to return.

## Alternative Frequencies

The majority of programs that broadcast on the FM waveband have a program identification code, it can be recognized by audio units.

When your vehicle moves from one transmission area to another with the alternative frequencies tuning switched on, this function will search for the strongest station signal.

Under certain conditions, alternative frequencies tuning may temporarily disrupt normal reception.

When selected, the unit continually evaluates signal strength and if a better signal becomes available, the unit will switch to that alternative. It mutes while it checks a list of alternative frequencies and if necessary, it will search once across the selected waveband for a genuine alternative frequency.

It will restore radio reception when it finds one or if one is not found, the unit will return to the original stored frequency.

When selected, **AF** will be shown in the display.

1. Press the **MENU** button.
2. Select **AUDIO** or **AUDIO SETTINGS**.
3. Scroll to **ALTERNATE FREQ** or **ALTERNATIVE FREQ** and turn on or off with the **OK** button.
4. Press the **MENU** button to return.

## Regional Mode

Regional mode controls the behavior of alternative frequencies switching between regionally related networks of a parent broadcaster. A broadcaster may run a fairly large network across a large part of the country. At various times of the day this large network may be broken down into a number of smaller regional networks, typically centered on major towns or cities. When the network is not split into regional variants, the whole network carries the same programming.

Regional mode ON: This prevents random alternative frequency switches when neighboring regional networks are not carrying the same programming.

Regional mode OFF: This allows a larger coverage area if neighboring regional networks are carrying the same programming, but can cause random alternative frequency switches if they are not.

1. Press the **MENU** button.

# Audio System

---

2. Select **AUDIO** or **AUDIO SETTINGS**.
3. Scroll to **RDS REGIONAL** and turn on or off with the **OK** button.
4. Press the **MENU** button to return.

## **AUDIO UNIT - VEHICLES WITH: AM/FM/CD/DIGITAL AUDIO BROADCAST (DAB) RADIO/SYNC**

### **WARNING**



Driving while distracted can result in loss of vehicle control, accident and injury. We strongly recommend that you use extreme caution when using any device or feature that may take your focus off the road. Your primary responsibility is the safe operation of your vehicle. We recommend against the use of any handheld device while driving and encourage the use of voice-operated systems when possible. Make sure you are aware of all applicable local laws that may affect the use of electronic devices while driving.

---

# Audio System

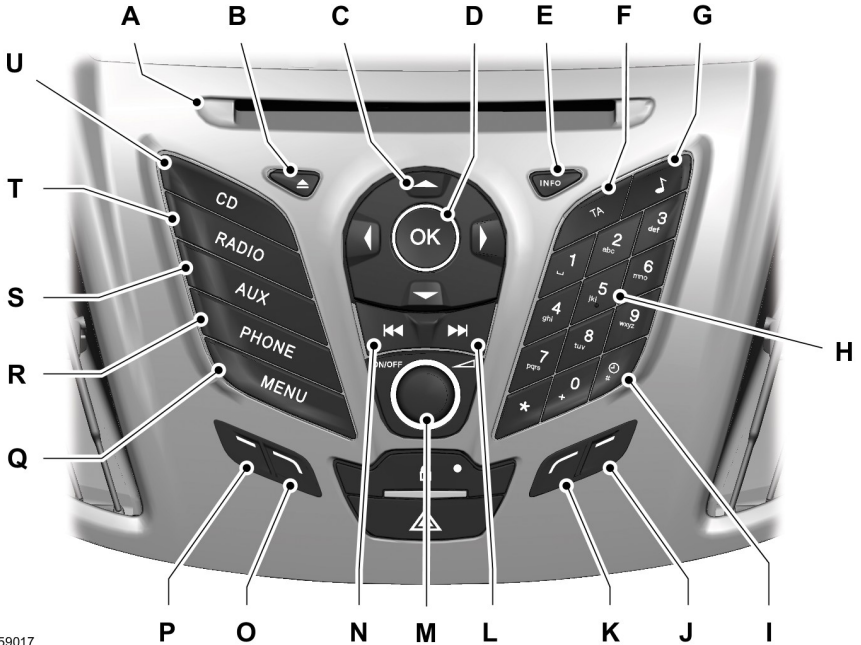

E159017

- A **CD slot:** Where you insert a CD.
- B **Eject:** Press the button to eject a CD.
- C **Cursor arrows:** Press a button to scroll through on-screen choices.
- D **OK:** Press the button to confirm on-screen selections.
- E **INFO:** Press the button to access radio, CD, USB and iPod information.
- F **TA:** Press the button to turn traffic announcements on or off and cancels announcements during an active announcement.
- G **SOUND:** Press the button to adjust the sound settings for bass, treble, middle, balance and fade.
- H **Numeric keypad:** Press the button to recall a previously stored station. To store a favorite station press and hold until the sound returns.
- I **Clock:** Press the button to select clock setup.

# Audio System

---

- J **Function button 4:** Press the button to select different functions of the audio system depending on which mode (i.e. radio or CD) you are in.
- K **Function button 3:** Press the button to select different functions of the audio system depending on which mode (i.e. radio or CD) you are in.
- L **Seek up:** Press the button to go to the next station up the radio frequency band or the next track on a CD.
- M **On, Off and Volume:** Press the button to switch the audio system on or off. Turn the dial to adjust the volume.
- N **Seek down:** Press the button to go to the next station down the radio frequency band or the previous track on a CD.
- O **Function button 2:** Press the button to select different functions of the audio system depending on which mode (i.e. radio or CD) you are in.
- P **Function button 1:** Press the button to select different functions of the audio system depending on which mode (i.e. radio or CD) you are in.
- Q **MENU:** Press the button to access different audio system features.
- R **PHONE:** Press the button to access the phone feature of the SYNC system by pressing **PHONE** then **MENU**.
- S **AUX:** Press the button to access the AUX and SYNC features, it will also cancel the menu or list browsing.
- T **RADIO:** Press the button to select different radio bands, it will also cancel the menu or list browsing.
- U **CD:** Press the button to change source to CD, it will also cancel the menu or list browsing.

## Sound Button

This will allow you to adjust the sound settings (for example bass, middle and treble).

1. Press the sound button.
2. Use the up and down arrow buttons to select the required setting.
3. Use the left and right arrow buttons to make the necessary adjustment. The display indicates the level selected.
4. Press the **OK** button to confirm the new settings.

## Waveband Button

Press the **RADIO** button to select from the wavebands available.

You can use the selector to return to radio reception when you have been listening to another source.

Alternatively, press the left arrow button to display the available wavebands. Scroll to the required waveband and press **OK**.



# Audio System

---

## Station Tuning Control

### Seek Tuning

Select a waveband and briefly press one of the seek buttons. The unit will stop at the first station it finds in the direction you have chosen.

### Manual Tuning

1. Press function button 2.
2. Use the left and right arrow buttons to tune down or up the waveband in small increments or press and hold to increment quickly, until you find a station you want to listen to.
3. Press **OK** to continue listening to a station.

### Scan Tuning

Scan allows you to listen to a few seconds of each station detected.

1. Press function button 3.
2. Use the seek buttons to scan up or down the selected waveband.
3. Press function button 3 again or **OK** to continue listening to a station.

### Station Preset Buttons

This feature allows you to store your favorite stations, they can be recalled by selecting the appropriate waveband and pressing one of the preset buttons.

1. Select a waveband.
2. Tune to the station required.
3. Press and hold one of the preset buttons. A progress bar and message will appear. When the progress bar completes the station has been stored. The audio unit will also mute momentarily as confirmation.

You can repeat this on each waveband and for each preset button.

**Note:** *When you drive to another part of the country, stations that broadcast on alternative frequencies, and are stored on preset buttons, may be updated with the correct frequency and station name for that area.*

### Autostore Control

**Note:** *This will store up to a maximum of the 10 strongest signals available, either from the AM or the FM waveband, and overwrite the previously stored stations. You can also store stations manually in the same way as other wavebands.*

- Press and hold the **RADIO** button.
- When the search is complete, sound is restored and the strongest signals are stored on the autostore presets.

### Traffic Information Control

Many stations that broadcast on the FM waveband have a TP code to signify that they carry traffic program information.

### Turning Traffic Announcements On and Off

Before you can receive traffic announcements, you must press either the **TA** or **TRAFFIC** button. A TA display will appear to show the feature is switched on.

If you are already tuned to a station that broadcasts traffic information, **TP** will also be displayed. Otherwise the unit will search for a traffic program.

When traffic information is broadcast, it will automatically interrupt normal radio or CD playback and **Traffic announcement** will appear in the display.

If a non-traffic station is selected or recalled using a preset button, the audio unit will remain on that station unless **TA** or **TRAFFIC** is turned off, then on again.

# Audio System

---

**Note:** If traffic announcement is on and you select a preset or manual tune to a non traffic announcement station no traffic announcement will be heard.

**Note:** When you are listening to a non traffic announcement station and turn traffic announcement off and on again a TP seek will occur.

## Traffic Announcement Volume

Traffic announcements interrupt normal broadcasts at a preset minimum level that is usually louder than normal listening volumes.

To adjust the preset volume:

- Use the volume control to make the necessary adjustment during an incoming traffic announcement broadcast. The display will show the level selected.

## Ending Traffic Announcements

The audio unit will return to normal operation at the end of each traffic announcement. To end the announcement prematurely, press **TA** or **TRAFFIC** during the announcement.

**Note:** If you press **TA** or **TRAFFIC** at any other time it will switch all announcements off.

## Automatic Volume Control

When available, automatic volume control adjusts the volume level to compensate for engine noise and road speed noise.

1. Press the **MENU** button and select **AUDIO** or **Audio settings**.
2. Select **Adaptive vol**.
3. Use the left or right arrow button to adjust the setting.
4. Press the **OK** button to confirm your selection.
5. Press the **MENU** button to return.

## News Broadcasts

Your audio unit may interrupt normal reception to broadcast news bulletins from stations on the FM waveband, radio data system or other enhanced network linked stations.

The display will indicate there is an incoming announcement, during news broadcasts. When the audio unit interrupts for a news broadcast the preset volume level will be the same as traffic announcements.

1. Press the **MENU** button.
2. Select **AUDIO** or **Audio settings**.
3. Scroll to **News** and turn on or off with the **OK** button.
4. Press the **MENU** button to return.

## Alternative Frequencies

The majority of programs that broadcast on the FM waveband have a program identification code, it can be recognized by audio units.

When your vehicle moves from one transmission area to another with the alternative frequencies tuning switched on, this function will search for the strongest station signal.

Under certain conditions, however, alternative frequencies tuning may temporarily disrupt normal reception.

When selected, the unit continually evaluates signal strength and, if a better signal becomes available, the unit will switch to that alternative. It mutes while it checks a list of alternative frequencies and if necessary, it will search once across the selected waveband for a genuine alternative frequency.

It will restore radio reception when it finds one or if one is not found, the unit will return to the original stored frequency.

# Audio System

---

When selected, AF will be shown in the display.

1. Press the **MENU** button.
2. Select **AUDIO** or **Audio settings**.
3. Scroll to **Alternat. frequency** or **ALTERNATIVE FREQ.** and turn on or off with the **OK** button.
4. Press the **MENU** button to return.

## Regional Mode

Regional mode controls the behavior of alternative frequencies switching between regionally related networks of a parent broadcaster. A broadcaster may run a fairly large network across a large part of the country. At various times of the day this large network may be broken down into a number of smaller regional networks, typically centered on major towns or cities. When the network is not split into regional variants, the whole network carries the same programming.

**Regional mode on:** This prevents random alternative frequency switches when neighboring regional networks are not carrying the same programming.

**Regional mode off:** This allows a larger coverage area if neighboring regional networks are carrying the same programming, but can cause random alternative frequency switches if they are not.

1. Press the **MENU** button.
2. Select **AUDIO** or **Audio settings**.
3. Scroll to **RDS regional** and turn on or off with the **OK** button.
4. Press the **MENU** button to return.

## AUDIO UNIT - VEHICLES WITH: DIGITAL AUDIO BROADCAST (DAB) RADIO/NAVIGATION SYSTEM/SYNC

### WARNING



Driving while distracted can result in loss of vehicle control, accident and injury. We strongly recommend that you use extreme caution when using any device or feature that may take your focus off the road. Your primary responsibility is the safe operation of your vehicle. We recommend against the use of any handheld device while driving and encourage the use of voice-operated systems when possible. Make sure you are aware of all applicable local laws that may affect the use of electronic devices while driving.

---

# Audio System

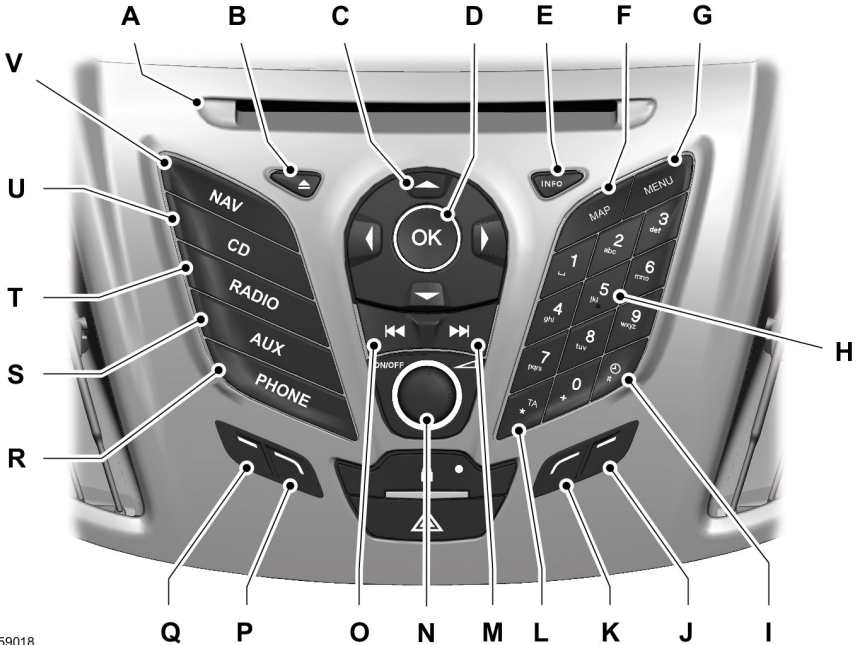

E159018

- A **CD slot:** Where you insert a CD.
- B **Eject:** Press the button to eject a CD.
- C **Cursor arrows:** Press a button to scroll through on-screen choices.
- D **OK:** Press the button to confirm on-screen selections.
- E **INFO:** Press the button to access radio, CD, USB and iPod information.
- F **MAP:** Press the button to access map features.
- G **MENU:** Press the button to access different audio system features.
- H **Numeric keypad** Press the button to recall a previously stored station. To store a favorite station press and hold until the sound returns.
- I **Clock:** Press the button to select clock setup.
- J **Function button 4:** Press the button to select different functions of the audio system depending on which mode (i.e. radio or CD) you are in.

# Audio System

---

- K **Function button 3:** Press the button to select different functions of the audio system depending on which mode (i.e. radio or CD) you are in.
- L **TA:** Press the button to turn traffic announcements on or off and cancels announcements during an active announcement.
- M **Seek up:** Press the button to go to the next station up the radio frequency band or the next track on a CD when in CD mode. In phone mode, use the button to end a phone call. An incoming call can be rejected.
- N **On, Off and Volume:** Press the button to switch the audio system on or off. Turn the dial to adjust the volume.
- O **Seek down:** Press the button to go to the next station down the radio frequency band or the previous track on a CD, When in CD mode. In phone mode use the button to begin a phone call. An incoming phone call can be accepted.
- P **Function button 2:** Press the button to select different functions of the audio system depending on which mode (i.e. radio or CD) you are in.
- Q **Function button 1:** Press the button to select different functions of the audio system depending on which mode (i.e. radio or CD) you are in.
- R **PHONE:** Press the button to access the phone feature of the SYNC system by pressing **PHONE** then **MENU**.
- S **AUX:** Press the button to access the AUX and SYNC features, it will also cancel the menu or list browsing.
- T **RADIO:** Press the button to select different radio bands, it will also cancel the menu or list browsing.
- U **CD:** Press the button to change source to CD, it will also cancel the menu or list browsing.
- V **NAV:** Press the button to access the navigation system.

## Sound Button

This will allow you to adjust the sound settings (for example bass, middle and treble).

1. Press the sound button.
2. Use the up and down arrow buttons to select the required setting.
3. Use the left and right arrow buttons to make the necessary adjustment. The display indicates the level selected.
4. Press the **OK** button to confirm the new settings.

## Waveband Button

Press the **RADIO** button to select from the wavebands available.

You can use the selector to return to radio reception when you have been listening to another source.

Alternatively, press the left arrow button to display the available wavebands. Scroll to the required waveband and press **OK**.

# Audio System

---

## Station Tuning Control

### DAB Service Linking

**Note:** *This feature does not automatically turn on every time you switch the ignition on.*

**Note:** *Service linking allows cross-referencing to other corresponding frequencies of the same station, for example FM and other DAB ensembles.*

**Note:** *The system will automatically change to another corresponding station if the current one becomes unavailable, for example when leaving the coverage area.*

Switching DAB service linking on and off. See **General Information** (page 214).

### Seek Tuning

Select a waveband and briefly press one of the seek buttons. The unit will stop at the first station it finds in the direction you have chosen.

### Manual Tuning

1. Press function button 2.
2. Use the left and right arrow buttons to tune down or up the waveband in small increments or press and hold to increment quickly, until you find a station you want to listen to.
3. Press **OK** to continue listening to a station.

### Scan Tuning

Scan allows you to listen to a few seconds of each station detected.

1. Press function button 3.
2. Use the seek buttons to scan up or down the selected waveband.
3. Press function button 3 again or **OK** to continue listening to a station.

## Station Preset Buttons

This feature allows you to store your favorite stations, they can be recalled by selecting the appropriate waveband and pressing one of the preset buttons.

1. Select a waveband.
2. Tune to the station required.
3. Press and hold one of the preset buttons. A progress bar and message will appear. When the progress bar completes the station has been stored. The audio unit will also mute momentarily as confirmation.

You can repeat this on each waveband and for each preset button.

**Note:** *When you drive to another part of the country, stations that broadcast on alternative frequencies, and are stored on preset buttons, may be updated with the correct frequency and station name for that area.*

## Autostore Control

**Note:** *This will store up to a maximum of the 10 strongest signals available, either from the AM or the FM waveband, and overwrite the previously stored stations. You can also store stations manually in the same way as other wavebands.*

**Note:** *You must select either **FM AST** or **AM AST** to use this function.*

- Press and hold the **RADIO** button.
- When the search is complete, sound is restored and the strongest signals are stored on the autostore presets.

## Traffic Information Control

Many stations that broadcast on the FM waveband have a TP code to signify that they carry traffic program information.

# Audio System

---

## Turning Traffic Announcements On and Off

Before you can receive traffic announcements, you must press either the **TA** or **TRAFFIC** button. A TA display will appear to show the feature is switched on.

If you are already tuned to a station that broadcasts traffic information, **TP** will also be displayed. Otherwise the unit will search for a traffic program.

When traffic information is broadcast, it will automatically interrupt normal radio or CD playback and Traffic announcement will appear in the display.

If a non-traffic station is selected or recalled using a preset button, the audio unit will remain on that station unless **TA** or **TRAFFIC** is turned off, then on again.

**Note:** *If traffic announcement is on and you select a preset or manual tune to a non traffic announcement station no traffic announcement will be heard.*

**Note:** *When you are listening to a non traffic announcement station and turn traffic announcement off and on again a TP seek will occur.*

## Traffic Announcement Volume

Traffic announcements interrupt normal broadcasts at a preset minimum level that is usually louder than normal listening volumes.

To adjust the preset volume:

- Use the volume control to make the necessary adjustment during an incoming traffic announcement broadcast. The display will show the level selected.

## Ending Traffic Announcements

The audio unit will return to normal operation at the end of each traffic announcement. To end the announcement prematurely, press **TA** or **TRAFFIC** during the announcement.

**Note:** *If you press TA or TRAFFIC at any other time it will switch all announcements off.*

## Automatic Volume Control

When available, automatic volume control adjusts the volume level to compensate for engine noise and road speed noise.

1. Press the **MENU** button and select **AUDIO**.
2. Select **Adaptive vol.**
3. Use the left or right arrow button to adjust the setting.
4. Press the **OK** button to confirm your selection.
5. Press the **MENU** button to return.

## Digital Signal Processing

### Digital Signal Processing Occupancy

This feature takes into account the differences in distance from the various speakers in your vehicle to each seat. You must select the correct sitting position for the audio to be correctly set.

### Digital Signal Processing Equalizer

Select the music category that most suits your listening preference. The audio output will change to enhance the particular style of music chosen.

### Changing the Digital Signal Processing Settings

1. Press the **MENU** button.
2. Select **AUDIO** or **Audio settings**.

# Audio System

---

3. Scroll to the required digital signal processing function.
4. Use the up and down arrow buttons to select the required setting.
5. Press the **OK** button to confirm your selection.
6. Press the **MENU** button to return.

## News Broadcasts

Your audio unit may interrupt normal reception to broadcast news bulletins from stations on the FM waveband, radio data system or other enhanced network linked stations.

The display will indicate there is an incoming announcement, during news broadcasts. When the audio unit interrupts for a news broadcast the preset volume level will be the same as traffic announcements.

1. Press the **MENU** button.
2. Select **AUDIO** or **Audio settings**.
3. Scroll to **News** and turn on or off with the **OK** button.
4. Press the **MENU** button to return.

## Alternative Frequencies

The majority of programs that broadcast on the FM waveband have a program identification code, it can be recognized by audio units.

When your vehicle moves from one transmission area to another with the alternative frequencies tuning switched on, this function will search for the strongest station signal.

Under certain conditions, however, alternative frequencies tuning may temporarily disrupt normal reception.

When selected, the unit continually evaluates signal strength and, if a better signal becomes available, the unit will switch to that alternative. It mutes while it checks a list of alternative frequencies and if necessary, it will search once across the selected waveband for a genuine alternative frequency.

It will restore radio reception when it finds one or if one is not found, the unit will return to the original stored frequency.

When selected, AF will be shown in the display.

1. Press the **MENU** button.
2. Select **AUDIO** or **Audio settings**.
3. Scroll to **Alternat. frequency** or **ALTERNATIVE FREQ.** and turn on or off with the OK button.
4. Press the **MENU** button to return.

## Regional Mode

Regional mode controls the behavior of alternative frequencies switching between regionally related networks of a parent broadcaster. A broadcaster may run a fairly large network across a large part of the country. At various times of the day this large network may be broken down into a number of smaller regional networks, typically centered on major towns or cities. When the network is not split into regional variants, the whole network carries the same programming.

Regional mode on: This prevents random alternative frequency switches when neighboring regional networks are not carrying the same programming.

Regional mode off: This allows a larger coverage area if neighboring regional networks are carrying the same programming, but can cause 'random' alternative frequency switches if they are not.

1. Press the **MENU** button.



# Audio System

---

2. Select **AUDIO** or **Audio settings**.
3. Scroll to **RDS regional** and turn on or off with the **OK** button.
4. Press the **MENU** button to return.

**Note:** An integrated multi function display is situated above the unit. This shows important information regarding control of your system. Additionally, there are various icons placed around the display screen which light up when a function is active (for example CD, Radio or Aux.)

## **AUDIO UNIT - VEHICLES WITH: DIGITAL AUDIO BROADCAST (DAB) RADIO/SYNC/SONY AM/FM/CD**

### **WARNING**



Driving while distracted can result in loss of vehicle control, accident and injury. We strongly recommend that you use extreme caution when using any device or feature that may take your focus off the road. Your primary responsibility is the safe operation of your vehicle. We recommend against the use of any handheld device while driving and encourage the use of voice-operated systems when possible. Make sure you are aware of all applicable local laws that may affect the use of electronic devices while driving.

---

# Audio System

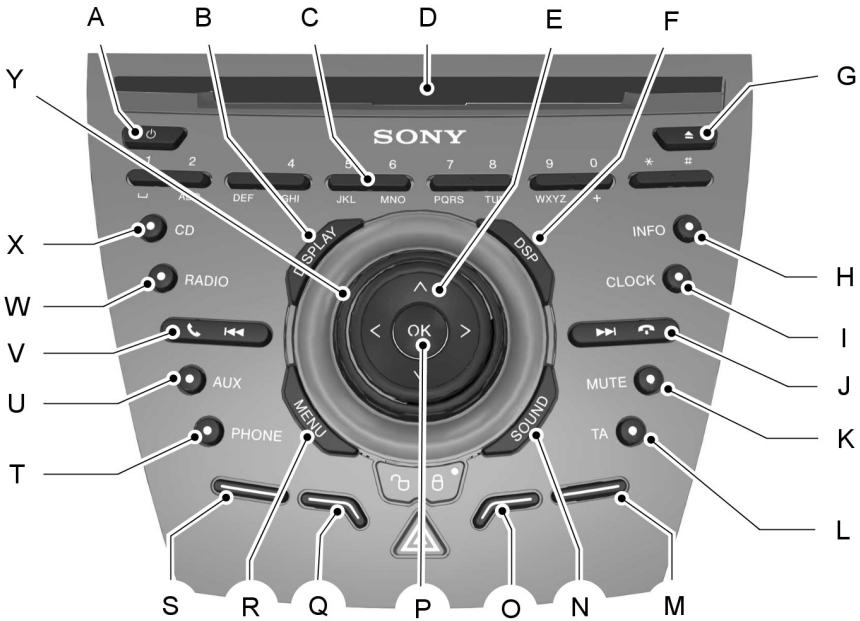

E129074

- A **On, Off:** Press the button to switch the audio system on or off.
- B **DISPLAY:** Press the button to turn on the display into idle mode.
- C **Numeric keypad:** Press the button to recall a previously stored station. To store a favorite station press and hold until the sound returns. In CD mode, press a number to select a track. In phone mode, use the buttons to dial a phone number.
- D **CD slot:** Where you insert a CD.
- E **Cursor arrows:** Press the button to scroll through on-screen choices.
- F **Digital signal processing:** Press the button to access the digital signal processing functions.
- G **Eject:** Press the button to eject a CD.
- H **INFO:** Press the button to access radio, CD, USB and iPod information.
- I **CLOCK:** Press the button to access the clock functions.

# Audio System

---

- J **Seek up:** Press the button to go to the next station up the radio frequency band or the next track on a CD when in CD mode. In phone mode, use the button to end a phone call. An incoming call can be rejected.
- K **MUTE:** Press the button to turn the sound off, press again to turn the sound on.
- L **TA:** Press the button to turn traffic announcements on or off and cancels announcements during an active announcement.
- M **Function button 4:** Press the button to select different functions of the audio system depending on which mode (i.e. radio or CD) you are in.
- N **SOUND:** Press the button to adjust the sound settings for bass, treble, middle, balance and fade.
- O **Function button 3:** Press the button to select different functions of the audio system depending on which mode (i.e. radio or CD) you are in.
- P **OK:** Press the button to confirm on-screen selections.
- Q **Function button 2:** Press the button to select different functions of the audio system depending on which mode (i.e. radio or CD) you are in.
- R **MENU:** Press the button to access different audio system features.
- S **Function button 1:** Press the button to select different functions of the audio system depending on which mode (i.e. radio or CD) you are in.
- T **PHONE:** Press the button to access the phone feature of the SYNC system by pressing **PHONE** then **MENU**. See separate manual.
- U **AUX:** Press the button to access the AUX and SYNC features, it will also cancel the menu or list browsing.
- V **Seek down:** Press the button to go to the next station down the radio frequency band or the previous track on a CD, When in CD mode. In phone mode use the button to begin a phone call. An incoming phone call can be accepted.
- W **RADIO:** Press the button to select different radio bands, it will also cancel the menu or list browsing.
- X **CD:** Press the button to change source to CD, it will also cancel the menu or list browsing.
- Y **Volume:** Turn the dial to adjust the volume.

# Audio System

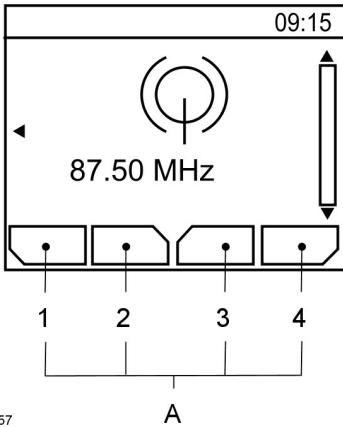

E104157

- A Descriptions for function buttons 1-4

Function buttons 1 to 4 are context dependent, and change according to the current unit mode. The description for the current function displays in the screen.

## Sound Button

This will allow you to adjust the sound settings (for example bass, middle and treble).

1. Press the **SOUND** button.
2. Use the up and down arrow buttons to select the required setting.
3. Use the left and right arrow buttons to make the necessary adjustment. The display indicates the level selected.
4. Press the **OK** button to confirm the new settings.

## Waveband Button

Press the **RADIO** button to select from the wavebands available.

You can use the selector to return to radio reception when you have been listening to another source.

Alternatively, press the left arrow button to display the available wavebands. Scroll to the required waveband and press **OK**.

## Station Tuning Control

### DAB Service Linking

**Note:** The system does not automatically turn on every time you switch the ignition on.

**Note:** Service linking allows cross-referencing to other corresponding frequencies of the same station, for example FM and other DAB ensembles.

**Note:** The system will automatically change to another corresponding station if the current one becomes unavailable, for example when leaving the coverage area.

Switching DAB service linking on and off. See **General Information** (page 68).

## Seek Tuning

Select a waveband and briefly press one of the seek buttons. The unit will stop at the first station it finds in the direction you have chosen.

## Manual Tuning

1. Press function button 2.
2. Use the left and right arrow buttons to tune down or up the waveband in small increments or press and hold to increment quickly, until you find a station you want to listen to.
3. Press **OK** to continue listening to a station.

## Scan Tuning

Scan allows you to listen to a few seconds of each station detected.

# Audio System

1. Press function button 3.
2. Use the seek buttons to scan up or down the selected waveband.
3. Press function button 3 again or **OK** to continue listening to a station.

## Station Preset Buttons

This feature allows you to store your favorite stations, they can be recalled by selecting the appropriate waveband and pressing one of the preset buttons.

1. Select a waveband.
2. Tune to the station required.
3. Press and hold one of the preset buttons. A progress bar and message will appear. When the progress bar completes the station has been stored. The audio unit will also mute momentarily as confirmation.

You can repeat this on each waveband and for each preset button.

**Note:** *When you drive to another part of the country, stations that broadcast on alternative frequencies, and are stored on preset buttons, may be updated with the correct frequency and station name for that area.*

## Autostore Control

**Note:** *This will store up to a maximum of the 10 strongest signals available, either from the AM or the FM waveband, and overwrite the previously stored stations. You can also store stations manually in the same way as other wavebands.*

**Note:** *You must select either **FM AST** or **AM AST** to use this function.*

- Press and hold the **RADIO** button.
- When the search is complete, sound is restored and the strongest signals are stored on the autostore presets.

## Traffic Information Control

Many stations that broadcast on the FM waveband have a TP code to signify that they carry traffic program information.

## Turning Traffic Announcements On and Off

Before you can receive traffic announcements, you must press either the **TA** or **TRAFFIC** button. A TA display will appear to show the feature is switched on.

If you are already tuned to a station that broadcasts traffic information, **TP** will also be displayed. Otherwise the unit will search for a traffic program.

When traffic information is broadcast, it will automatically interrupt normal radio or CD playback and Traffic announcement will appear in the display.

If a non-traffic station is selected or recalled using a preset button, the audio unit will remain on that station unless **TA** or **TRAFFIC** is turned off, then on again.

**Note:** *If traffic announcement is on and you select a preset or manual tune to a non traffic announcement station no traffic announcement will be heard.*

**Note:** *When you are listening to a non traffic announcement station and turn traffic announcement off and on again a TP seek will occur.*

## Traffic Announcement Volume

Traffic announcements interrupt normal broadcasts at a preset minimum level that is usually louder than normal listening volumes.

To adjust the preset volume:

- Use the volume control to make the necessary adjustment during an incoming traffic announcement broadcast. The display will show the level selected.

# Audio System

---

## Ending Traffic Announcements

The audio unit will return to normal operation at the end of each traffic announcement. To end the announcement prematurely, press **TA** or **TRAFFIC** during the announcement.

**Note:** If you press **TA** or **TRAFFIC** at any other time it will switch all announcements off.

## Automatic Volume Control

When available, automatic volume control adjusts the volume level to compensate for engine noise and road speed noise.

1. Press the **MENU** button.
2. Select **AUDIO** or **AUDIO SETTINGS**.
3. Select **AVC LEVEL** or **ADAPTIVE VOL**.
4. Use the left or right arrow button to adjust the setting.
5. Press the **OK** button to confirm your selection.
6. Press the **MENU** button to return.

## Digital Signal Processing

### Digital Signal Processing Occupancy

This feature takes into account the differences in distance from the various speakers in your vehicle to each seat. You must select the correct sitting position for the audio to be correctly set.

### Digital Signal Processing Equalizer

Select the music category that most suits your listening preference. The audio output will change to enhance the particular style of music chosen.

### Changing the Digital Signal Processing Settings

1. Press the **MENU** button.

2. Select **AUDIO** or **AUDIO SETTINGS**.
3. Scroll to the required digital signal processing function.
4. Press the **OK** button.
5. Use the up and down arrow buttons to select the required setting.
6. Press the **OK** button to confirm your selection.
7. Press the **MENU** button to return.

## News Broadcasts

Your audio unit may interrupt normal reception to broadcast news bulletins from stations on the FM waveband, radio data system or other enhanced network linked stations.

The display will indicate there is an incoming announcement, during news broadcasts. When the audio unit interrupts for a news broadcast the preset volume level will be the same as traffic announcements.

1. Press the **MENU** button.
2. Select **AUDIO** or **AUDIO SETTINGS**.
3. Scroll to **NEWS** and turn on or off with the **OK** button.
4. Press the **MENU** button to return.

## Alternative Frequencies

The majority of programs that broadcast on the FM waveband have a program identification code, it can be recognized by audio units.

When your vehicle moves from one transmission area to another with the alternative frequencies tuning switched on, this function will search for the strongest station signal.

Under certain conditions, however, alternative frequencies tuning may temporarily disrupt normal reception.

# Audio System

When selected, the unit continually evaluates signal strength and, if a better signal becomes available, the unit will switch to that alternative. It mutes while it checks a list of alternative frequencies and if necessary, it will search once across the selected waveband for a genuine alternative frequency.

It will restore radio reception when it finds one or if one is not found, the unit will return to the original stored frequency.

When selected, AF will be shown in the display.

1. Press the **MENU** button.
2. Select **AUDIO** or **AUDIO SETTINGS**.
3. Scroll to **ALTERNAT FREQ.** or **ALTERNATIVE FREQ.** and turn on or off with the **OK** button.
4. Press the **MENU** button to return.

## Regional Mode

Regional mode controls the behavior of alternative frequencies switching between regionally related networks of a parent broadcaster. A broadcaster may run a fairly large network across a large part of the country. At various times of the day this large network may be broken down into a number of smaller regional networks, typically centered on major towns or cities. When the network is not split into regional variants, the whole network carries the same programming.

Regional mode ON: This prevents random alternative frequency switches when neighboring regional networks are not carrying the same programming.

Regional mode OFF: This allows a larger coverage area if neighboring regional networks are carrying the same programming, but can cause 'random' alternative frequency switches if they are not.

1. Press the **MENU** button.
2. Select **AUDIO** or **AUDIO SETTINGS**.
3. Scroll to **RDS REGIONAL** and turn on or off with the **OK** button.
4. Press the **MENU** button to return.

## AUDIO UNIT - VEHICLES WITH: DIGITAL AUDIO BROADCAST (DAB) RADIO/NAVIGATION SYSTEM/SYNC/SONY AM/FM/CD

### WARNING



Driving while distracted can result in loss of vehicle control, crash and injury. We strongly recommend that you use extreme caution when using any device that may take your focus off the road. Your primary responsibility is the safe operation of your vehicle. We recommend against the use of any handheld device while driving and encourage the use of voice-operated systems when possible. Make sure you are aware of all applicable local laws that may affect the use of electronic devices while driving.

**Note:** *An integrated multi function display is situated above the unit. This shows important information regarding control of your system. Additionally, there are various icons placed around the display screen which light up when a function is active (for example CD, Radio or Aux.)*

# Audio System

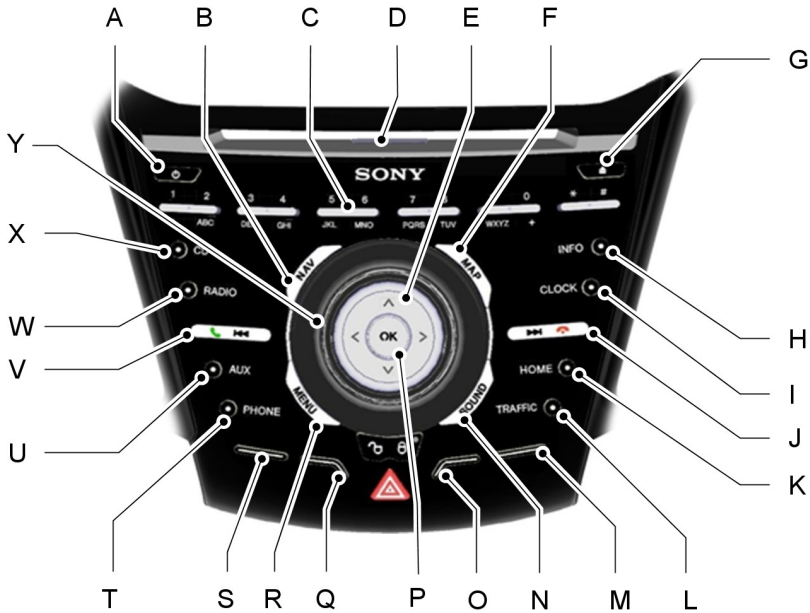

E156660

- A **On, Off:** Press the button to switch the audio system on or off.
- B **NAV:** Press the button to access the navigation system.
- C **Numeric keypad:** Press the button to recall a previously stored station. To store a favorite station press and hold until the sound returns. In CD mode, press a number to select a track. In phone mode, use the buttons to dial a phone number.
- D **CD slot:** Where you insert a CD.
- E **Cursor arrows:** Press the button to scroll through on-screen choices.
- F **MAP:** Press the button to access map features.
- G **Eject:** Press the button to eject a CD.
- H **INFO:** Press the button to access radio, CD, USB, iPod and Navigation information. If Navigation has been selected, pressing this button will show details of your current location or journey.
- I **CLOCK:** Press the button to access the clock functions.



# Audio System

---

- J **Seek up:** Press the button to go to the next station up the radio frequency band or the next track on a CD when in CD mode. In phone mode, use the button to end a phone call. An incoming call can be rejected.
- K **HOME:** Press the button to access the address menu, to start navigating to your home address or to change your home address.
- L **TRAFFIC:** Press the button to turn traffic announcements on or off and cancel an active announcement. If Navigation has been selected, pressing this button takes you to the traffic menu.
- M **Function button 4:** Press the button to select different functions of the audio system depending on which mode (i.e. radio or CD) you are in.
- N **SOUND:** Press the button to adjust the sound settings for bass, treble, middle, balance and fade.
- O **Function button 3:** Press the button to select different functions of the audio system depending on which mode (i.e. radio or CD) you are in.
- P **OK:** Press the button to confirm on-screen selections.
- Q **Function button 2:** Press the button to select different functions of the audio system depending on which mode (i.e. radio or CD) you are in.
- R **MENU:** Press the button to access different audio system features.
- S **Function button 1:** Press the button to select different functions of the audio system depending on which mode (i.e. radio or CD) you are in.
- T **PHONE:** Press the button to access the phone feature of the SYNC system by pressing **PHONE** then **MENU**. See separate manual.
- U **AUX:** Press the button to access the AUX and SYNC features, it will also cancel the menu or list browsing.
- V **Seek down:** Press the button to go to the next station down the radio frequency band or the previous track on a CD, when in CD mode. In phone mode use the button to begin a phone call. An incoming phone call can be accepted.
- W **RADIO:** Press the button to select different radio bands, it will also cancel the menu or list browsing.
- X **CD:** Press the button to change source to CD, it will also cancel the menu or list browsing.
- Y **Volume:** Turn the dial to adjust the volume.

# Audio System

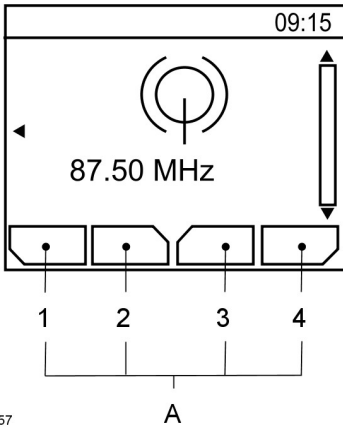

E104157

- A Descriptions for function buttons 1-4

Function buttons 1 to 4 are context dependent, and change according to the current unit mode. The description for the current function displays in the screen.

## Sound Button

This will allow you to adjust the sound settings (for example bass, middle and treble).

1. Press the **SOUND** button.
2. Use the up and down arrow buttons to select the required setting.
3. Use the left and right arrow buttons to make the necessary adjustment. The display indicates the level selected.
4. Press the **OK** button to confirm the new settings.

## Waveband Button

Press the **RADIO** button to select from the wavebands available.

You can use the selector to return to radio reception when you have been listening to another source.

Alternatively, press the left arrow button to display the available wavebands. Scroll to the required waveband and press **OK**.

## Station Tuning Control

### DAB Service Linking

**Note:** The system does not automatically turn on every time you switch the ignition on.

**Note:** Service linking allows cross-referencing to other corresponding frequencies of the same station, for example FM and other DAB ensembles.

**Note:** The system will automatically change to another corresponding station if the current one becomes unavailable, for example when leaving the coverage area.

Switching DAB service linking on and off. See **General Information** (page 68).

### Seek Tuning

Select a waveband and briefly press one of the seek buttons. The unit will stop at the first station it finds in the direction you have chosen.

### Manual Tuning

1. Press function button 2.
2. Use the left and right arrow buttons to tune down or up the waveband in small increments or press and hold to increment quickly, until you find a station you want to listen to.
3. Press **OK** to continue listening to a station.

### Scan Tuning

Scan allows you to listen to a few seconds of each station detected.

# Audio System

1. Press function button 3.
2. Use the seek buttons to scan up or down the selected waveband.
3. Press function button 3 again or **OK** to continue listening to a station.

## Station Preset Buttons

This feature allows you to store your favorite stations, they can be recalled by selecting the appropriate waveband and pressing one of the preset buttons.

1. Select a waveband.
2. Tune to the station required.
3. Press and hold one of the preset buttons. A progress bar and message will appear. When the progress bar completes the station has been stored. The audio unit will also mute momentarily as confirmation.

You can repeat this on each waveband and for each preset button.

**Note:** *When you drive to another part of the country, stations that broadcast on alternative frequencies, and are stored on preset buttons, may be updated with the correct frequency and station name for that area.*

## Autostore Control

**Note:** *This will store up to a maximum of the 10 strongest signals available, either from the AM or the FM waveband, and overwrite the previously stored stations. You can also store stations manually in the same way as other wavebands.*

**Note:** *You must select either **FM AST** or **AM AST** to use this function.*

- Press and hold the **RADIO** button.
- When the search is complete, sound is restored and the strongest signals are stored on the autostore presets.

## Traffic Information Control

Many stations that broadcast on the FM waveband have a TP code to signify that they carry traffic program information.

## Turning Traffic Announcements On and Off

Before you can receive traffic announcements, you must press either the **TA** or **TRAFFIC** button. A TA display will appear to show the feature is switched on.

If you are already tuned to a station that broadcasts traffic information, **TP** will also be displayed. Otherwise the unit will search for a traffic program.

When traffic information is broadcast, it will automatically interrupt normal radio or CD playback and Traffic announcement will appear in the display.

If a non-traffic station is selected or recalled using a preset button, the audio unit will remain on that station unless **TA** or **TRAFFIC** is turned off, then on again.

**Note:** *If traffic announcement is on and you select a preset or manual tune to a non traffic announcement station no traffic announcement will be heard.*

**Note:** *When you are listening to a non traffic announcement station and turn traffic announcement off and on again a TP seek will occur.*

## Traffic Announcement Volume

Traffic announcements interrupt normal broadcasts at a preset minimum level that is usually louder than normal listening volumes.

To adjust the preset volume:

- Use the volume control to make the necessary adjustment during an incoming traffic announcement broadcast. The display will show the level selected.

# Audio System

---

## Ending Traffic Announcements

The audio unit will return to normal operation at the end of each traffic announcement. To end the announcement prematurely, press **TA** or **TRAFFIC** during the announcement.

**Note:** If you press **TA** or **TRAFFIC** at any other time it will switch all announcements off.

## Automatic Volume Control

When available, automatic volume control adjusts the volume level to compensate for engine noise and road speed noise.

1. Press the **MENU** button.
2. Select **AUDIO** or **AUDIO SETTINGS**.
3. Select **AVC LEVEL** or **ADAPTIVE VOL**.
4. Use the left or right arrow button to adjust the setting.
5. Press the **OK** button to confirm your selection.
6. Press the **MENU** button to return.

## Digital Signal Processing

### Digital Signal Processing Occupancy

This feature takes into account the differences in distance from the various speakers in your vehicle to each seat. You must select the correct sitting position for the audio to be correctly set.

### Digital Signal Processing Equalizer

Select the music category that most suits your listening preference. The audio output will change to enhance the particular style of music chosen.

### Changing the Digital Signal Processing Settings

1. Press the **MENU** button.

2. Select **AUDIO** or **AUDIO SETTINGS**.
3. Scroll to the required digital signal processing function.
4. Press the **OK** button.
5. Use the up and down arrow buttons to select the required setting.
6. Press the **OK** button to confirm your selection.
7. Press the **MENU** button to return.

## News Broadcasts

Your audio unit may interrupt normal reception to broadcast news bulletins from stations on the FM waveband, radio data system or other enhanced network linked stations.

The display will indicate there is an incoming announcement, during news broadcasts. When the audio unit interrupts for a news broadcast the preset volume level will be the same as traffic announcements.

1. Press the **MENU** button.
2. Select **AUDIO** or **AUDIO SETTINGS**.
3. Scroll to **NEWS** and turn on or off with the **OK** button.
4. Press the **MENU** button to return.

## Alternative Frequencies

The majority of programs that broadcast on the FM waveband have a program identification code, it can be recognized by audio units.

When your vehicle moves from one transmission area to another with the alternative frequencies tuning switched on, this function will search for the strongest station signal.

Under certain conditions, however, alternative frequencies tuning may temporarily disrupt normal reception.

# Audio System

When selected, the unit continually evaluates signal strength and, if a better signal becomes available, the unit will switch to that alternative. It mutes while it checks a list of alternative frequencies and if necessary, it will search once across the selected waveband for a genuine alternative frequency.

It will restore radio reception when it finds one or if one is not found, the unit will return to the original stored frequency.

When selected, **AF** will be shown in the display.

1. Press the **MENU** button.
2. Select **AUDIO** or **AUDIO SETTINGS**.
3. Scroll to **ALTERNAT FREQ.** or **ALTERNATIVE FREQ.** and turn on or off with the **OK** button.
4. Press the **MENU** button to return.

## Regional Mode

Regional mode controls the behavior of alternative frequencies switching between regionally related networks of a parent broadcaster. A broadcaster may run a fairly large network across a large part of the country. At various times of the day this large network may be broken down into a number of smaller regional networks, typically centered on major towns or cities. When the network is not split into regional variants, the whole network carries the same programming.

**Regional mode ON:** This prevents random alternative frequency switches when neighboring regional networks are not carrying the same programming.

**Regional mode OFF:** This allows a larger coverage area if neighboring regional networks are carrying the same programming, but can cause random alternative frequency switches if they are not.

1. Press the **MENU** button.

2. Select **AUDIO** or **AUDIO SETTINGS**.
3. Scroll to **RDS REGIONAL** and turn on or off with the **OK** button.
4. Press the **MENU** button to return.

## DIGITAL AUDIO

**Note:** *Coverage differs from region to region and will influence the quality of reception. It is broadcast nationwide, regionally and locally.*

The system allows you to listen to Digital Audio Broadcast (DAB) radio stations.

The following formats are supported:

- DAB
- DAB+
- DMB-Audio.

## Ensembles

**Note:** *When you tune from one ensemble to another, it can take a while until the system synchronizes to the other ensemble. The audio mutes during synchronization.*

Stations are grouped within ensembles. Each ensemble can consist of several different stations.

When listening to a station, you can also display the ensemble name if required by pressing function button 2. The station name displays below the ensemble name.

## Selecting Radio Band

DAB1 and DAB2 operate in the same way. You can store up to 10 different presets on each band.

1. Press the **RADIO** button.
2. Press the left arrow button to display the available wavebands.
3. Select **DAB1** or **DAB2**.

# Audio System

---

## Station Tuning Control

**Note:** *When you reach the first or last station within an ensemble, further tuning will skip to the next ensemble. There may be a delay during this change and the audio will briefly mute.*

Press the **RADIO** button and select **DAB1** or **DAB2**. Both preset banks operate in the same way and can store up to 10 different preset stations.

## Seek Tuning

1. Select a station.
2. Press a seek button. The radio will stop at the first station it finds in the direction chosen.

## Radio Station List

**Note:** *Only the stations in the current ensemble are shown in the display.*

This feature displays all the available stations in a list.

1. Select a station.
2. Press function button 1.
3. Press the up and down arrow buttons to navigate to your required station.
4. Press **OK** to confirm your selection.

## Manual Tuning

1. Select a station.
2. Press function button 2.
3. Press the left and right arrow buttons to tune up or down the waveband in small increments. Press and hold to move through the waveband quickly.
4. Press **OK** to confirm your selection.

## Scan Tuning

This feature allows you to listen to the first few seconds of each station while searching through a waveband.

1. Select a station.
2. Press function button 3.
3. Press a seek button to begin the scan.
4. Press function button 3 or **OK** to continue listening to the currently tuned station.

## Station Preset Buttons

**Note:** *Stations stored on preset buttons may not always be available if you have left the coverage area. The audio will mute when this happens.*

This feature allows you to store up to 10 favorite stations from any ensemble in each preset bank. They can be recalled by selecting the digital waveband and pressing one of the preset buttons.

1. Select a station.
2. Press and hold one of the preset buttons. A progress bar and message will appear. When the progress bar completes the station has been stored. The audio unit will also mute momentarily as confirmation.

## Radio Text

**Note:** *Extra information may not always be available.*

You can display extra information such as artist name, news, etc. To turn this on, select a station and press function button 4.

## Service Linking

**Note:** *If a digital station has no corresponding FM station, the audio will mute when attempting to switch.*

**Note:** *When linked to a corresponding FM station, an FM symbol displays below the station name.*

# Audio System

If you leave the coverage area of a frequency, this feature allows the system to switch automatically to a corresponding frequency, e.g. from Digital to FM.

You can switch this feature on and off using the information display. See **General Information** (page 68).

## AUXILIARY INPUT JACK

### WARNINGS



Driving while distracted can result in loss of vehicle control, crash and injury. We strongly recommend that you use extreme caution when using any device that may take your focus off the road. Your primary responsibility is the safe operation of your vehicle. We recommend against the use of any hand-held device while driving and encourage the use of voice-operated systems when possible. Make sure you are aware of all applicable local laws that may affect the use of electronic devices while driving.



For safety reasons, do not connect or adjust the settings on your portable music player while your vehicle is moving.



Store the portable music player in a secure location, such as the center console or the glove box, when your vehicle is moving. Hard objects may become projectiles in a collision or sudden stop, which may increase the risk of serious injury. The audio extension cable must be long enough to allow the portable music player to be safely stored while your vehicle is moving.



E149149

The auxiliary input jack allows you to connect and play music from your portable music player through your vehicle speakers. You can use any portable music player designed for use with headphones. Your audio extension cable must have male 1/8th-inch (3.5 millimeter) connectors at each end.

1. Switch off the engine, radio and portable music player. Set the parking brake and put the transmission in position **P**.
2. Plug the extension cable from the portable music player into the auxiliary input jack.
3. Switch the radio on. Select either a tuned FM station or a CD.
4. Adjust the volume as desired.
5. Switch your portable music player on and adjust its volume to half its maximum level.
6. Press **AUX** until **LINE** or **LINE IN** appears in the display. You should hear music from your device even if it is low.
7. Adjust the volume on your portable music player until it reaches the volume level of the FM station or CD. Do this by switching back and forth between the AUX and FM or CD controls.

# Audio System

## USB PORT



E142604

The USB port allows you to plug in media playing devices, memory sticks and charge devices (if supported). See **SYNC™** (page 247).

## AUDIO TROUBLESHOOTING

Audio unit display	Rectification
PLEASE CHECK CD	General error message for CD fault conditions, such as cannot read the CD, data-CD inserted, etc. Make sure the disc is loaded correct way up. Clean and re-try, or replace disc with known music disc. If error persists contact your dealer.
CD DRIVE MALFUNCTION	General error message for CD fault conditions such as possible mechanism fault.
CD DRIVE HIGH TEMP	Ambient temperature too hot – unit will not work until it has cooled down.



## GENERAL INFORMATION

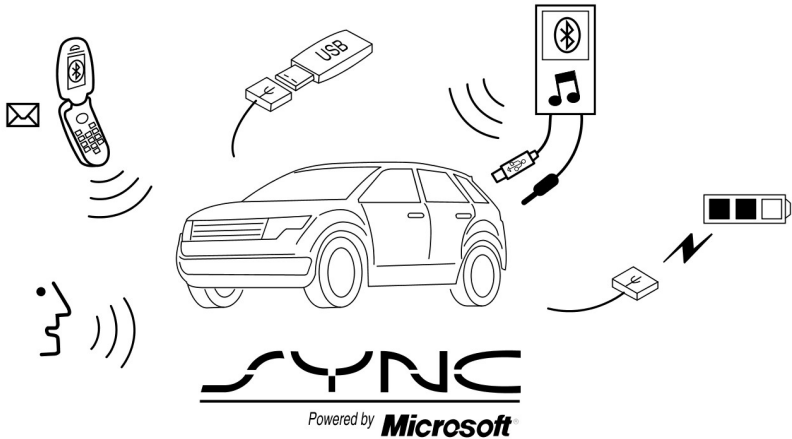

E142598

SYNC is an in-vehicle communications system that works with your Bluetooth-enabled cell phone and portable media player.

This allows you to:

- make and receive calls
- access and play music from your media player
- use emergency assistance
- access phonebook contacts and music using voice commands
- stream music from your connected cell phone
- select pre-defined text messages

- use the advanced voice recognition system
- charge your USB device (if your device supports this).

Make sure that you review your device's manual before using it with SYNC.

### Support

For further support see an authorized dealer. For more information visit the regional Ford website.

## Safety Information

### WARNING



Driving while distracted can result in loss of vehicle control, crash and injury. We strongly recommend that you use extreme caution when using any device that may take your focus off the road. Your primary responsibility is the safe operation of your vehicle. We recommend against the use of any handheld device while driving, encourage the use of voice-operated systems when possible and that you become aware of applicable country and local laws that may affect use of electronic devices while driving.

When using SYNC:

- Do not operate playing devices if the power cords or cables are broken, split or damaged. Carefully place cords and cables where they cannot be stepped on or interfere with the operation of pedals, seats, compartments or safe driving abilities.
- Do not leave playing devices in your vehicle during extreme conditions as it could cause them damage. Refer to your device's manual for further information.
- Do not attempt to service or repair the system. See an authorized dealer.

## Privacy Information

When a cell phone is connected to SYNC, the system creates a profile that is linked to that cell phone. The system creates the profile to offer you more mobile features and to operate more efficiently. Among other things, this profile may contain data about your phonebook, text messages (read and unread) and call history. This will include the history of calls when your cell phone was not connected to the system. If you connect a media player, the system creates and retains an index of

supported media content. The system also records a short development log of approximately 10 minutes of all recent system activity. The log profile and other system data may be used to improve the system and help diagnose any problems that may occur.

The cell phone profile, media player index and development log will remain in the system unless deleted. They are generally accessible in your vehicle only when you connect your cell phone or media player. If you no longer plan to use the system or your vehicle, we recommend you complete a master reset to erase all stored information. See **Information Displays** (page 68).

Special equipment is required to access system data. Access to your vehicle's SYNC module is also required. We will not access the system data for any purpose other than as described without consent. Examples where system data can be accessed are for a court order, where required by law enforcement, other government authorities or other third parties acting with lawful authority. Other parties may seek to access the information independently of us. Further privacy information is available. See **SYNC™ Applications and Services** (page 261).

## USING VOICE RECOGNITION

This system helps you control many features using voice commands. This allows you to keep your hands on the steering wheel and focus on what is around you.

### Helpful Hints

Make sure the interior of your vehicle is as quiet as possible. Wind noise from open windows and road vibrations may prevent the system from correctly recognizing spoken commands.

Before giving a voice command, wait for the system announcement to finish followed by a single beep. Any command spoken prior to this does not register with the system.

Speak naturally, without long pauses between words.

You can interrupt the system at anytime while it is speaking by pressing the voice button. You can also cancel a voice session at any time by pressing and holding the voice button.

## Initiating a Voice Session



Press the voice button. A list of available commands will appear in the display.

Say	If You Want To
"Bluetooth Audio"	Stream audio from your cell phone.
"Cancel"	Cancel the requested action.
"Line in"	Access the device connected to the auxiliary input jack.
"Phone"	Make calls.
"SYNC"	Return to the main menu.
"USB"	Access the device connected to your USB port.
"Voice settings"	Adjust the level of voice interaction and feedback.
"Help"	Hear a list of voice commands available in the current mode.

## System Interaction and Feedback

The system provides feedback through audible tones, prompts, questions and spoken confirmations depending on the situation and your chosen level of interaction. You can customize the voice recognition system to provide more or less instruction and feedback.

The default setting is to a higher level of interaction in order to help you learn to use the system. You can change these settings at any time.

## Adjusting the Interaction Level



Press the voice button. Say "Voice settings" when prompted, then any of the following:

When You Say	The System
"Interaction Mode Advanced"	Provides less audible interaction and more tone prompts.
"Interaction Mode Standard"	Provides more detailed interaction and guidance.

The system defaults to the standard interaction mode.

# SYNC™

Confirmation prompts are short questions the system asks when it is not sure of your request or when there is more than one possible response to your request. For example, the system may ask if the

command phone is correct.

Press the voice button to change the confirmation prompt setting. Say "Voice settings" when prompted, then any of the following:

When You Say	The System
"Confirmation Prompts Off"	Makes a best guess from the command. You may still occasionally be asked to confirm settings.
"Confirmation Prompts On"	Clarifies your voice command with a short question.

The system creates suggestion lists when it has the same confidence level of several options based on your voice commands. When turned on, you may be prompted with as many as four possibilities for clarification.

For example, say "one" after the tone to call John Doe at home. Say "two" after the tone to call Johnny Doe on mobile. Say "three" after the tone to call Jane Doe at home.

The same logic applies to media content. For example say, "one" after the tone to play John Doe. Say "two" after the tone to play Johnny Doe. Say "three" after the tone to play Jane Doe.

When You Say	The System
"Media Candidate Lists Off"	Makes a best guess from the media suggestion list. You may still occasionally be asked questions.
"Media Candidate Lists On"	Clarifies your voice command for media suggestions.
"Phone Candidate Lists Off"	Makes a best guess from the cell phone suggestion list. You may still occasionally be asked questions.
"Phone Candidate Lists On"	Clarifies your voice command for cell phone suggestions.

## Changing the Voice Settings

You can change the voice settings using the information and entertainment display.

1. Press the **MENU** button.

2. Select **SYNC-Settings**.
3. Select **Voice Settings**.

## USING SYNC™ WITH YOUR PHONE

Hands-free calling is one of the main features of SYNC. While the system supports a variety of features, many are dependent on your cell phone's functionality.

At a minimum, most cell phones with Bluetooth wireless technology support the following functions:

- Answering an incoming call.
- Ending a call.
- Using privacy mode.
- Dialing a number.
- Redialing.
- Call waiting notification.
- Caller ID.

Other features such as text messaging using Bluetooth and automatic phonebook download are cell phone dependent features. To check your cell phone's compatibility, refer to your device's manual or visit the regional Ford website.

### Pairing a Cell Phone For the First Time

**Note:** *You must switch the ignition and radio on.*

**Note:** *To scroll through the menus, press the up or down arrows on your audio system.*

Wirelessly pairing your cell phone with the system allows you to make and receive hands-free calls.

1. Make sure the Bluetooth feature on your cell phone is switched on before starting the search. Refer to your device's manual if necessary.
2. Press the **PHONE** button. When the audio display indicates that no phones are paired, select the option to add.

3. When a message to begin pairing appears in the audio display, search for SYNC on your cell phone to start the pairing process.
4. When prompted on your cell phone's display, enter the six-digit PIN provided by the system in the audio display. The display indicates when the pairing is successful.

Depending on your cell phone's capability and your market, the system may prompt you with questions such as setting the current cell phone as the primary cell phone (the cell phone the system automatically tries to connect with first when you switch the ignition on), downloading your phonebook, etc.

### Pairing Subsequent Cell Phones

**Note:** *You must switch the ignition and radio on.*

**Note:** *To scroll through the menus, press the up or down arrows on your audio system.*

1. Make sure the Bluetooth feature on your cell phone is switched on before starting the search. Refer to your device's manual if necessary.
2. Press the **PHONE** button.
3. Select the option for Bluetooth devices.
4. Press the **OK** button.
5. Select the option to add. This starts the pairing process.
6. When a message to begin pairing appears in the audio display, search for SYNC on your device to start the pairing process.
7. When prompted on your cell phone's display, enter the six-digit PIN provided by the system in the audio display. The display indicates when the pairing is successful.

The system may prompt you with questions such as setting the current cell

phone as the primary cell phone, downloading your phonebook, etc.

## Cell Phone Voice Commands

<b>"Phone"</b>	
"Call <name>" <sup>1</sup>	"Go to privacy"
"Call <name> at home" <sup>1</sup>	"Hold"
"Call <name> at work" <sup>1</sup>	"Join"
"Call <name> in office" <sup>1</sup>	"Menu" <sup>2,4</sup>
"Call <name> on cell" <sup>1</sup>	"Phonebook <name>" <sup>2</sup>
"Call <name> on other" <sup>1</sup>	"Phonebook <name> at home" <sup>2</sup>
"Call history incoming" <sup>2</sup>	"Phonebook <name> in office" <sup>2</sup>
"Call history missed" <sup>2</sup>	"Phonebook <name> at work" <sup>2</sup>
"Call history outgoing" <sup>2</sup>	"Phonebook <name> on cell" <sup>2</sup>
"Connections" <sup>2</sup>	"Phonebook <name> on other" <sup>2</sup>
"Dial" <sup>1,3</sup>	-

<sup>1</sup> You do not need to say "phone" prior to these commands.

<sup>2</sup> These commands are not available until your cell phone information has completely downloaded using Bluetooth.

<sup>3</sup> See **Dial** table.

<sup>4</sup> See **Menu** table.

## Phonebook Commands

When you ask the system to access a phonebook name, number, etc., the requested information appears in the audio display. Press the voice button and say "call" to call the contact.

# SYNC™

---

"Dial"
"112" (one-one-two), etc.
"700" (seven hundred)
"800" (eight hundred)
"900" (nine hundred)
"Pound", (#)
"Number <0-9>"
"Asterisk" (*)
"Clear" (deletes all entered digits)
"Delete" (deletes one digit)
"Plus"
"Star"

**Note:** To exit dial mode, press and hold the phone button or any button on the audio unit.

"Menu"
"(Phone) connections"
"(Phone) settings (message) notification off"
"(Phone) settings (message) notification on"
"(Phone) settings (set) phone ringer"
"(Phone) settings (set) ringer 1"
"(Phone) settings (set) ringer 2"
"(Phone) settings (set) ringer 3"
"(Phone) settings (set) ringer off"
"Phone name"
"Text message inbox"

Words in parenthesis are optional and do not have to be spoken for the system to understand the command.

## Making a Call

1. Press the voice button and when prompted say "call <name>" or "dial" followed by a number.
2. When the system confirms the number, say "dial" again to initiate the call.

To erase the last spoken digit, say "delete" or press the left arrow button on the audio unit. To erase all spoken digits, say "clear" or press and hold the left arrow button on the audio unit.

To end the call, press the end call button on the steering wheel or select the end call option in the audio display and press **OK**.

## Receiving a Call

When receiving a call, you can:

- Answer the call by pressing the accept call button on the steering wheel or by selecting the accept call option in the audio display. Press the **OK** button.
- Reject the call by pressing the reject call button on the steering wheel or by selecting the reject call option in the audio display. Press the **OK** button.
- Ignore the call by doing nothing.

## Cell Phone Options During an Active Call

During an active call, you have extra menu features which become available such as putting a call on hold, joining calls, etc.

To access this menu, choose one of the options available at the bottom of the audio display or select the option for more.

When You Select	You Can
Mic. off	Turn your vehicle's microphone off. To turn the microphone on, select the option again.
Privacy	Switch a call from an active hands-free environment to your cell phone for a more private conversation. When selected, the audio display will indicate the call is private.
Hold	Put an active call on hold. When selected, the audio display will indicate the call is on hold.
Dial a number	Enter numbers using the audio system numeric keypad, for example numbers for passwords.
Join Calls	Join two separate calls. The system supports a maximum of three callers on a multi-party or conference call. 1. Select the option for more. 2. Access the desired contact through the system or use voice commands to place the second call. Once actively in the second call, select the option for more.



When You Select	You Can
	3. Scroll to the option to join calls and press the <b>OK</b> button.
Phonebook	Access your phonebook contacts. 1. Select the option for more. 2. Scroll to the option for phonebook and press the <b>OK</b> button. 3. Scroll through your phonebook contacts. 4. Press the <b>OK</b> button again when the desired selection appears in the audio display. 5. Press the <b>OK</b> button or dial button to call the selection.
Call History	Access your call history log. 1. Select the option for more. 2. Scroll to the option for call history appears and press the <b>OK</b> button. 3. Scroll through your call history options (incoming, outgoing or missed). 4. Press the <b>OK</b> button again when the desired selection appears in the audio display. 5. Press the <b>OK</b> button or dial button to call the selection.

## Accessing Features Through the Cell Phone Menu

You can access your call history, phonebook, sent text messages as well as access cell phone and system settings.

You can also access advanced features such as emergency assistance.

1. Press the **PHONE** button to enter the cell phone menu.
2. Select one of the options available.

When You Select	You Can
Dial a number	Dial a number using the audio system numeric keypad.
Redial	Redial the last number called (if available). Press the <b>OK</b> button to select.
Phonebook <sup>1</sup>	Access your downloaded phonebook. 1. Press the <b>OK</b> button to confirm and enter. You can use the options at the bottom of the screen to quickly access an alphabetical category. You can also use the letters on the keypad to jump in the list. 2. Scroll through your phonebook contacts. 3. Press the <b>OK</b> button again when the desired selection appears in the audio display. 4. Press the <b>OK</b> button or dial button to call the selection.

When You Select	You Can
Call History <sup>1</sup>	Access any previously dialed, received or missed calls. 1. Press the <b>OK</b> button to select. 2. Scroll to select either incoming calls, outgoing calls or missed calls. Press the <b>OK</b> button to make your selection. 3. Press the <b>OK</b> button or dial button to call the selection. The system attempts to automatically re-download your phonebook and call history each time your cell phone connects to the system. You must turn on the auto download feature if your cell phone supports it.
Speed Dial	Select one of 10 speed dial entries. To set a speed dial entry, go to the phonebook and press and hold one of the numbers on the audio system numeric keypad.
Text message <sup>1</sup>	Send, download and delete text messages.
BT Devices	Access the option for Bluetooth device menu listings (add, connect, set as primary, on or off, delete).
Phone settings <sup>1</sup>	View various settings and features on your cell phone.
Emergency Assistance	Turn the SYNC emergency assistance feature on or off.

<sup>1</sup> This is a cell phone dependent feature.

## Text Messaging

**Note:** *This is a cell phone dependent feature.*

The system allows you to receive, send, download and delete text messages. The system can also read incoming text messages to you so that you do not have to take your eyes off the road.

### Receiving a Text Message

**Note:** *Your cell phone must support downloading text messages using Bluetooth to receive incoming text messages.*

**Note:** *Only one recipient is allowed per text message.*

When a new message arrives, an audible tone sounds and the audio display indicates you have a new message.

You have these options:

- Select the listen option to have the system read the message to you.
- Select the view option to open the text message. Select the ignore option or do nothing and the message goes into your text message inbox. Once selected, you have the ability to have the message read out to you, to view other messages or to select the more option.

- Press the voice button and say "Read text message".
- Select the more option and use the arrow buttons to scroll through further options. Choose from the following:
  - **Reply to sender:** Press the **OK** button to access and then scroll through the list of pre-defined messages to send.
  - **Call sender:** Press the **OK** button to call the sender of the message.
  - **Forward msg:** Press the **OK** button to forward the message to anyone in your phonebook or call history. You can also choose to enter a number.
- **Delete** allows you to delete current text messages from the system (not your cell phone). The audio display indicates when all your text messages have been deleted.
- **More** allows you to delete all messages or to manually trigger a download of all unread messages from your cell phone.

When you select the option to send a text message, a list of pre-defined messages appear in the audio display.

### **Sending a Text Message**

1. Select the send option when the desired selection is highlighted in the audio display.
2. Select the confirmation option when the contact appears and press the **OK** button again to confirm when the system asks if you would like to send the message. Each text message is sent with a pre-defined signature.

**Note:** *You can send text messages either by choosing a contact from the phonebook and selecting the text option from the audio display or by replying to a received message in the inbox.*

### **Sending, Downloading and Deleting Your Text Messages**

1. Press the **PHONE** button.
2. Select the text messaging option, then press the **OK** button.

A list of all available text messages appears.

You can choose from the following options:

- **New** allows you to send a new text message based on a pre-defined set of 15 messages.
- **View** allows you to read the full message and in addition provides the option to have the message read out to you by the system. To go to the next message select the more option. This allows you to reply to the sender, call the sender or forward the message.

### **Accessing Your Cell Phone Settings**

These are cell phone dependent features. Your cell phone settings allow you to access and adjust features such as your ringtone, text message notification, modify your phonebook and set up automatic download.

1. Press the **PHONE** button.
2. Scroll until the phone settings option appears, then press the **OK** button.
3. Scroll to select from the following options:

When You Select	You Can
Set as master	If this option is checked, the system will use this cell phone as the master when there is more than one cell phone paired to the system. This option can be changed for all paired cell phones (not only for the active one) using the Bluetooth devices menu.
Phone Status	See the cell phone name, provider name, cell phone number, signal level and battery level. When done, press the left arrow button to return to the cell phone status menu.
Set ringtone	Select which ringtone sounds during an incoming call (one of the system's or your cell phone's). 1. Press the <b>OK</b> button to select and scroll to hear each ringtone. 2. Press the <b>OK</b> button to select. If your cell phone supports in-band ringing, your cell phone's ringtone sounds when you choose the cell phone ringtone option.
Text msg notify	Have the option of hearing an audible tone to notify you when a text message arrives. 1. Press the <b>OK</b> button to turn the audible tone on or off.
Phonebook pref.	Modify the contents of your phonebook, e.g. add, delete, download. Press the <b>OK</b> button to select and scroll between: <b>Add contacts:</b> Press the <b>OK</b> button to add more contacts from your phonebook. Push the desired contacts on your cell phone. Refer to your device's manual on how to push contacts. <b>Delete:</b> Press the <b>OK</b> button to delete the current phonebook and call history. When a message asking you to delete appears, select the option to confirm. The system takes you back to the menu for phone settings. <b>Download now:</b> Press the <b>OK</b> button to select and download your phonebook to the system. <b>Auto-download:</b> Check or uncheck this option to automatically download your phonebook each time your cell phone connects to the system. Downloading times are cell phone dependent and quantity dependent. When automatic download is switched on, any changes, additions or deletions saved in the system since your last download are deleted.

# SYNC™

When You Select	You Can
	<p>When automatic download is switched off, your phonebook will not be downloaded when your cell phone connects to the system.</p> <p>Your phonebook, call history and text messages can only be accessed when your paired cell phone is connected to the system.</p>

## Bluetooth Devices

This menu provides access to your Bluetooth devices. Use the arrow buttons to scroll through the menu options. It allows you to add, connect and delete devices and set a cell phone as primary.

## Bluetooth Devices Menu Options

1. Press the **PHONE** button.
2. Scroll until the Bluetooth device option appears, then press the **OK** button.
3. Scroll to select from the following options:

When You Select	You Can
Add	<p>Pair additional cell phones to the system.</p> <ol style="list-style-type: none"> <li>1. Select the option to add to start the pairing process.</li> <li>2. When a message to begin pairing appears in the audio display, search for <b>SYNC</b> on your cell phone. Refer to your device's manual if necessary.</li> <li>3. When prompted on your cell phone's display, enter the six-digit PIN provided by the system in the audio display. The display indicates when the pairing is successful.</li> <li>4. When the option to set the cell phone as the primary cell phone appears, select either yes or no.</li> <li>5. Depending on the functionality of your cell phone, you may be asked extra questions (for example, if you would like to download your phonebook). Select either yes or no to confirm your response.</li> </ol>
Delete	<p>Delete a paired cell phone.</p> <p>Select the delete option and confirm when the system asks to delete the selected device. After deleting a cell phone from the list, the cell phone can only be connected again by repeating the full pairing process.</p>
Master	<p>Set a previously paired cell phone as your primary cell phone.</p> <p>Select the master option to confirm the primary cell phone.</p>

When You Select	You Can
	The system attempts to connect with the primary cell phone every time you switch the ignition on. When a cell phone is selected as primary, it appears first in the list and is marked with an asterisk.
Conn.	Connect a previously paired cell phone. You can only have one cell phone connected at a time to use the cell phone functionality. When another cell phone is connected, the previous cell phone will be disconnected from the telephone services. The system allows you to use different Bluetooth devices for the cell phone functionality and the Bluetooth audio music playback feature at the same time. Select this option to connect to the selected previously paired cell phone.
Discon.	Disconnects the selected cell phone. Select this option and confirm when asked to. After disconnecting a cell phone, it can be connected again without repeating the full pairing process.

## System Settings

1. Press the **MENU** button.

2. Select the SYNC settings option, then press the **OK** button.

When You Select	You Can
Bluetooth on	Check or uncheck this option to turn the Bluetooth interface of the system on or off. Select this option then press the <b>OK</b> button to change the option's status.
Set defaults	Return to the factory default settings. This selection does not erase your indexed information (phonebook, call history, text messages and paired devices). Select this option and confirm when <b>Set defaults?</b> appears in the audio display.
Master reset	Completely erase all information stored on the system (phonebook, call history, text messages and paired devices) and return to the factory default settings. Select this option and confirm when <b>Master reset?</b> appears in the audio display. The display indicates when complete and the system takes you back to the <b>SYNC-Settings</b> menu.
Install on SYNC	Install applications or software updates you have downloaded.

When You Select	You Can
	Select this option and confirm when <b>Install on SYNC</b> appears in the audio display. There must be a valid SYNC application or update available on the USB thumb drive in order to finish an installation successfully.
System info	Display the system's version numbers as well as its serial number. Press the <b>OK</b> button to select.
Voice settings	The voice settings submenu contains various options. See <b>Using Voice Recognition</b> (page 248).
Browse USB	Browse the actual menu structure of the connected USB device. Press the <b>OK</b> button and use the up or down arrows to scroll through the folders and files. Use the left or right arrows to enter and leave a folder. Media content can be directly selected for playback from this menu.
Emergency assistance	You can turn the emergency assistance feature on or off. See <b>SYNC™ Applications and Services</b> (page 261).

## SYNC™ APPLICATIONS AND SERVICES

1. Press the **MENU** button to enter the system's menu.
2. Scroll until **SYNC-Apps** is selected, then press **OK**.

A list of available applications will be shown. Each application might have its own specific settings.

### SYNC Emergency Assistance

#### WARNINGS



For this feature to work, your cell phone must have Bluetooth and be compatible with the system.



Always place your cell phone in a secure location inside your vehicle. Failure to do so may cause serious injury to someone or damage the cell phone which could prevent this feature from working correctly.

#### WARNINGS



Unless the feature setting is switched on prior to a crash, the system will not attempt to place an emergency call which could delay the response time, potentially increasing the risk of serious injury or death. Do not wait for the system to make an emergency call if you can do it yourself. Dial emergency services immediately to avoid a delayed response time. If you do not hear emergency assistance within five seconds of the crash, the system or cell phone may be damaged or non-functional.

**Note:** Before selecting this feature, you must read the emergency assistance privacy notice later in this section for important information.

**Note:** When you turn this feature on or off, that setting will apply for all paired cell phones. If you have turned this feature off and a previously paired phone connects when you switch the ignition on, either a voice message plays, a display message or icon is shown or both.

**Note:** Every cell phone operates differently. While this feature works with most cell phones, some cell phones may experience difficulties using this feature.

**Note:** Make sure you are familiar with the information regarding airbag deployment. See **Supplementary Restraints System** (page 26).

In the event of a crash which deploys an airbag or triggers the fuel pump shut off, the system may contact emergency services by dialing 112 (the wireless emergency number that works in most European countries) through a paired and connected cell phone. For more information about the system and emergency assistance visit the regional Ford website.

## Switching Emergency Assistance On and Off

1. Press the **PHONE** button to enter the cell phone menu.
2. Select the emergency assistance option and press **OK**.
3. Select the option you require and press **OK**.

## Display Options

If you turn this feature on, a confirmation message will be shown in the display.

If you turn this feature off, a dialog will be shown in the display which allows you to set a voice reminder.

Off with voice reminder provides a display and voice reminder when your cell phone connects and your vehicle starts.

Off without voice reminder provides a display reminder only without a voice reminder when your cell phone connects.

To make sure that emergency assistance works correctly:

- The system must have power and be working correctly at the time of the crash and during feature activation and use.
- The feature must be switched on prior to a crash.
- You must have a cell phone connected to the system.
- In certain countries it may be necessary to have a valid and registered SIM card with credit in order to place and maintain an emergency call.
- A connected cell phone must have the ability to make and maintain an outgoing call at the time of the crash.
- A connected cell phone must have adequate network coverage, battery power and signal strength.
- Your vehicle must have battery power.

**Note:** This feature will only work in a European country or region where SYNC emergency assistance can call the local emergency services. Visit the regional Ford website for details.

## In the Event of a Crash

**Note:** Not every crash will deploy an airbag or trigger the fuel pump shut off (which may turn on emergency assistance). However, if emergency assistance is triggered the system tries to contact the emergency services. If a connected cell phone is damaged or loses connection to the system, it searches for and tries to connect to any available previously paired cell phone. The system will then attempt to dial 112.



Before making a call:

- If the call has not been cancelled and a successful call is made, an introductory message is played first for the emergency operator. This is followed by hands-free communication between your vehicle's occupants and the operator.
- The system provides a short window of time (approximately 10 seconds) to cancel the call. If the call is not cancelled the system will attempt to dial 112.
- The system plays a message letting you know that it will attempt to make an emergency call. You can cancel the call by selecting the relevant icon in the display or by pressing the hang up button on your cell phone.

During a call:

- Emergency assistance uses your vehicle GPS or cellular network information when available to determine the most appropriate language to use. It will alert the emergency operator of the crash and deliver the introductory message. This may include your vehicle GPS coordinates.
- The language the system uses to interact with the occupants of your vehicle may differ from the language used to deliver information to the emergency operator.
- After the delivery of the introductory message the voice line will open so that you can speak hands-free with the emergency operator.
- When the line is connected, you must be prepared to provide your name, phone number and location information immediately.

**Note:** While information is being provided to the emergency operator, the system will play a message letting you know it is sending important information. It will then let you know when the line is open to start hands-free communication.

**Note:** During an emergency assistance call, an emergency priority screen will be displayed which contains vehicle GPS coordinates when available. These coordinates match the information provided to the emergency operator in the introductory message.

**Note:** The emergency operator may also receive information from the cellular network such as cell phone number, cell phone location and cell phone carrier name independent from SYNC emergency assistance.

Emergency assistance may not work if:

- Your cell phone or emergency assistance hardware has been damaged in the crash.
- The vehicle battery or the system has no power.
- Your cell phone is thrown from your vehicle during a crash.
- You do not have a valid and registered SIM card with credit in your cell phone.
- You are in a European country or region where the SYNC emergency assistance call cannot be placed. Visit the regional Ford website for details.

### **Important Information About the Emergency Assistance Feature**

Emergency assistance does not currently call emergency services in the following markets: Albania, Belarus, Bosnia and Herzegovina, Macedonia, Netherlands, Ukraine, Moldova and Russia.

Visit the regional Ford website for latest details.

## Emergency Assistance Privacy Notice

When you turn emergency assistance on, it may disclose to emergency services that your vehicle has been in a crash involving the deployment of an airbag or activation of the fuel pump shut off. This feature has the capability to disclose your location information to the emergency operator or other details about your vehicle or crash to provide the most appropriate emergency services.

If you do not want to disclose this information, do not turn the feature on.

## USING SYNC™ WITH YOUR MEDIA PLAYER

You can access and play music from your media player through your vehicle's speaker system using the system's media menu or voice commands. You can also sort and play your music by specific categories such as artists, albums, etc.

SYNC is capable of hosting nearly any media player including: iPod®, Zune™, Plays from device players, and most USB drives. SYNC also supports audio formats such as MP3, WMA, WAV and ACC.

## Connecting Your Media Player to the USB Port

**Note:** *If your media player has a power switch, make sure that the device is turned on.*

### To Connect Using Voice Commands

1. Plug the device into your vehicle's USB port.
2. Press the voice button and when prompted, say "USB".

3. You can now play music by saying any of the appropriate voice commands. Refer to the media voice commands.

### To Connect Using the System Menu

1. Plug the device into your vehicle's USB port.
2. Press the **AUX** button until an initializing message appears in the display.
3. Depending on how many media files are on your connected device, an indexing message may appear in the display. When indexing is complete, the screen returns to the **Play** menu.

Press **Browse**. Now you can scroll through the list:

- **Play all.**
- **Playlists.**
- **Songs.**
- **Artists.**
- **Albums.**
- **Genres.**
- **Browse USB.**
- **Reset USB.**
- **Exit.**

## What is Playing?

At any time during playback, you can press the voice button and ask the system what is playing. The system reads the metadata tags (if populated) of the track being played.

## Media Voice Commands



Press the voice button and when prompted say "USB", and then any of the following:

# SYNC™

<b>"USB"</b>	
"Pause"	
"Play"	"Repeat off"
"Play album <name>" <sup>1,2</sup>	"Repeat on"
"Play All"	"Search album <name>" <sup>1,2</sup>
"Play artist <name>" <sup>1,2</sup>	"Search artist <name>" <sup>1,2</sup>
"Play genre <name>" <sup>1,2</sup>	"Search genre <name>" <sup>1</sup>
"Play next folder" <sup>3</sup>	"Search song <name>" <sup>1</sup>
"Play next track"	"Search track <name>" <sup>1,2</sup>
"Play playlist <name>" <sup>1,2</sup>	"Shuffle off"
"Play previous folder" <sup>3</sup>	"Shuffle on"
"Play previous track"	"Similar music"
"Play song <name>" <sup>1</sup>	"What's playing?"
"Play track <name>" <sup>1,2</sup>	

<sup>1</sup> <name> is a dynamic listing, meaning that it could be the name of any desired group, artist, song, etc.

<sup>2</sup> Voice commands which are not available until indexing is complete.

<sup>3</sup> Voice commands which are only available in folder mode.

<b>Voice Command Guide</b>	
"Search genre" or "Play genre"	The system searches all the data from your indexed music and if available, begins to play the chosen type of music. You can only play genres of music which are present in the genre metadata tags that you have on your media player.
"Similar music"	The system compiles a playlist and then plays similar music to what is currently playing from the USB port using indexed metadata information.
Search or Play, "Artist", "Track, or "Album"	The system searches for a specific artist, track or album from the music indexed through the USB port.

The system is also capable of playing music from your cell phone via Bluetooth.

To switch the Bluetooth audio on use the **AUX** or **Source** button or press the voice button and when prompted say "Bluetooth audio", then any of the following:

<b>"Bluetooth Audio"</b>
"Connections"
"Pause"
"Play"
"Play next track"
"Play previous track"

## Media Menu Features

The media menu allows you to select how to play your music (by artist, genre, shuffle, repeat, etc.) and to find similar music or reset the index of your USB devices.

1. Press **AUX** to select USB playback and then **Options** to enter the **Media** menu.
2. Scroll to cycle through:

When You Select	You Can
Shuffle playlist and Repeat track	Choose to shuffle or repeat your music. Once these selections are turned on, they will remain on until turned off.
Similar music	You can play similar types of music to the current playlist from the USB port. The system uses the metadata information of each track to compile a playlist. The system then creates a new list of similar tracks and will then begin playing. Each track must have the metadata tags populated for this feature. With certain playing devices, if your metadata tags are not populated, the tracks will not be available in voice recognition, play menu or similar music. However, if you place these tracks onto your playing device in mass storage device mode they are available in voice recognition, Play menu browsing and Similar Music. Unknowns are placed into any unpopulated metadata tag.
Reset SYNC USB	Resets the USB index. After the new indexing is complete you can choose what to play from the USB song library.

## Accessing Your USB Song Library

This menu allows you to select and play your media files by artist, album, genre, playlist, track or even to browse what is on your USB device.

1. Make sure that your device is plugged into your vehicle's USB port and is turned on.
2. Press **AUX** to select USB playback and then **Browse**.

If there are no media files to access, the display indicates there is no media. If there are media files, you have the following options to scroll through and select from:

When You Select	You Can
Play all	Play all indexed media files from your playing device one at a time in numerical order. Press <b>OK</b> to select. The first track title appears in the display.
Playlists	Access your playlists (from formats such as .ASX, .M3U, .WPL or .MTP). 1. Press <b>OK</b> to select.

# SYNC™

When You Select	You Can
	2. Scroll to select the desired playlist, then press <b>OK</b> .
Songs	Search for and play a specific track which has been indexed. 1. Press <b>OK</b> to select. 2. Scroll to select the desired track, then press <b>OK</b> .
Artists	Sort all indexed media files by artist. Once selected, the system lists and then plays all artists and tracks alphabetically. 1. Press <b>OK</b> to select. 2. Scroll to select the desired artist, then press <b>OK</b> .
Albums	Sort all indexed media files by albums. 1. Press <b>OK</b> to select. 2. Scroll to select the desired albums, then press <b>OK</b> .
Genres	Sort indexed music by genre (category) type. 1. Press <b>OK</b> to select. 2. Scroll to select the desired genre, then press <b>OK</b> .
Browse USB	Browse all supported media files on your media player connected to the USB port. You can only view media files which are compatible with SYNC, other files saved are not visible. 1. Press <b>OK</b> to select. 2. Scroll to browse indexed media files on your flash drive, then press <b>OK</b> .
Reset USB	Resets the USB index. After the new indexing is complete you can choose what to play from the USB song library.

You can use the buttons at the bottom of the audio display to quickly jump to a certain alphabetical category. You can also use the letters on the numeric keypad to jump in the list.

## Bluetooth Devices and System Settings

You can access these menus using the audio display. See **Using SYNC™ With Your Phone** (page 251).

## SYNC™ TROUBLESHOOTING

Your SYNC system is easy to use. However, should questions arise, please refer to the tables below.

To check your cell phone's compatibility, visit the regional Ford website.

<b>Cell Phone Issues</b>		
<b>Issue</b>	<b>Possible Cause</b>	<b>Possible Solution</b>
A lot of background noise during a phone call.	The audio control settings on your cell phone may be affecting SYNC performance.	Refer to your device's manual regarding audio adjustments.
During a call, I can hear the other person but they cannot hear me.	Possible cell phone malfunction.	Try turning your cell phone off, resetting it or removing the battery, then trying again. Make sure that the microphone for SYNC is not set to off.
SYNC is not able to download my phonebook.	This is a cell phone-dependent feature. Possible cell phone malfunction.	Check your cell phone's compatibility. Try turning your cell phone off, resetting it or removing the battery, then trying again. Try pushing your phonebook contacts to SYNC by selecting the option to add. You must switch your cell phone on and the automatic phonebook download feature on SYNC.
The system says "Phonebook downloaded" but my phonebook in SYNC is empty or is missing contacts.	Limitations on your cell phone's capability.	Try pushing your phonebook contacts to SYNC by selecting the option to add. If the missing contacts are stored on your SIM card, try moving them to your cell phone's memory. Remove any pictures or special ring tones associated with the missing contact. You must switch your cell phone on and the automatic phonebook download feature on SYNC.
I am having trouble connecting my cell phone to SYNC.	This is a cell phone-dependent feature. Possible cell phone malfunction.	Check your cell phone's compatibility. Try turning your cell phone off, resetting it or removing the battery, then trying again. Try deleting your device from SYNC and deleting SYNC from your device, then trying again. Always check the security and auto accept prompt settings relative to the SYNC Bluetooth connection on your cell phone. Update your cell phone's firmware.

# SYNC™

Cell Phone Issues		
Issue	Possible Cause	Possible Solution
		Turn off the auto download setting.
Text messaging is not working on SYNC.	This is a cell phone-dependent feature. Possible cell phone malfunction.	Check your cell phone's compatibility. Try turning your cell phone off, resetting it or removing the battery, then trying again.
Audible text messages do not work on my cell phone.	This is a cell phone limitation. This is a cell phone-dependent feature.	Your cell phone must support downloading text messages through Bluetooth to receive incoming text messages. Access the text messaging menu of SYNC to see if the feature is supported by your cell phone. Press the <b>PHONE</b> button and then scroll and select the option for text messaging, then press <b>OK</b> . Because each cell phone is different refer to your device's manual for the specific cell phone being paired. In fact, there can be differences between cell phones due to brand, model, service provider and software version.

USB and Media Issues		
Issue	Possible Cause	Possible Solution
I am having trouble connecting my device.	Possible device malfunction.	Try turning the device off, resetting it or removing the battery, then trying again. Make sure you are using the manufacturer's cable. Make sure the USB cable is correctly inserted into the device and your vehicle's USB port.



# SYNC™

<b>USB and Media Issues</b>		
<b>Issue</b>	<b>Possible Cause</b>	<b>Possible Solution</b>
		Make sure that the device does not have an auto-install program or active security settings.
SYNC does not recognize my device when I start my vehicle.	This is a device limitation.	Make sure you are not leaving the device in your vehicle during very hot or cold temperatures.
Bluetooth audio does not stream.	This is a device-dependent feature. The device is not connected.	Make sure the device is connected to SYNC and that you have pressed play on your device.
SYNC does not recognize music that is on my device.	Your music files may not contain the correct artist, song title, album or genre information. The file may be corrupted. The song may have copyright protection which does not allow it to play.	Make sure that all song details are populated. Some devices require you to change the USB settings from mass storage to media transfer protocol class.
When my iPhone or iPod Touch is connected through the USB and Bluetooth Audio at the same time, I sometimes do not hear any sound.	This is a device limitation.	From the iPhone or iPod Touch music now playing screen, select the audio device airplay icon at the very bottom of your iPhone or iPod Touch screen. To listen to the iPhone or iPod Touch through Bluetooth Audio, select SYNC. To listen to the iPhone or iPod Touch through USB, select Dock Connector.

<b>Voice Command Issues</b>		
<b>Issue</b>	<b>Possible Cause</b>	<b>Possible Solution</b>
SYNC does not understand what I am saying.	You may be using the wrong voice commands. You may be speaking too soon or at the wrong time.	Review the cell phone voice commands and the media voice commands at the beginning of their respective sections. Refer to the audio display during an active voice session, you will find a list of voice commands there. The microphone for the system is either in your rear view mirror or in the headliner just above the windshield.
SYNC does not understand the name of a song or artist.	You may be using the wrong voice commands. You may not be saying the name exactly as it is saved. The system may not be reading the name the same way you are saying it.	Review the media voice commands at the beginning of the media section. Say the song or artist exactly as it is saved. If you say "Play Artist Prince" the system does not play music by Prince and the Revolution or Prince and the New Power Generation. Make sure you are saying the complete title such as "California remix featuring Jennifer Nettles". If the songs are saved in capital letters, you have to spell them. LOLA requires you to say "L-O-L-A". Do not use special characters in the title as the system does not recognize them.
SYNC does not understand or is calling the wrong contact when I want to make a call.	You may be using the wrong voice commands. You may not be saying the name exactly as it is saved. Contacts in your phonebook may be very short and similar or they may contain special characters. Your phonebook contacts may be saved in capital letters.	Review the cell phone voice commands at the beginning of the cell phone section. Make sure you are saying the name exactly as it is saved. For example, if a contact is saved as Joe Wilson, say "Call Joe Wilson". The system works better if you list full names such as "Joe Wilson" rather than "Joe". Do not use special characters such as 123 or ICE as the system does not recognize them. If the contacts are saved in capital letters, you have to spell them. JAKE requires you to say "Call J-A-K-E".

# SYNC™

Voice Command Issues		
Issue	Possible Cause	Possible Solution
		You can also use the cell phone and media suggestion lists to get a list of possible suggestions when the system cannot fully understand you. See <b>Using Voice Recognition</b> (page 248).
The SYNC voice control system is having trouble recognizing foreign names stored on my cell phone.	Foreign names are spoken using the currently selected language for SYNC.	SYNC applies the phonetic pronunciation rules of the selected language to the contact names stored on your cell phone. Helpful Hint: You can select your contact manually. Press <b>PHONE</b> select the option for phonebook and then contact name. Press the soft-key option to hear it. SYNC will read the contact name to you, giving you some idea of the pronunciation it is expecting.
The SYNC voice control system is having trouble recognizing foreign tracks, artists, albums, genres and playlist names from my media player or USB flash drive.	Foreign names are spoken using the currently selected language for SYNC.	SYNC applies the phonetic pronunciation rules of the selected language to the names stored on your media player or USB flash drive. It is able to make some exceptions for very popular artist names (for example, U2) such that you can always use the English pronunciation for these artists.
Voice prompts are electronically generated and the pronunciation of some words may not be accurate for my language.	SYNC uses text-to-speech voice prompt technology.	SYNC uses a synthetically-generated voice rather than pre-recorded human voice.

# SYNC™

<b>Voice Command Issues</b>		
<b>Issue</b>	<b>Possible Cause</b>	<b>Possible Solution</b>
		SYNC offers several new voice control features for a wide range of languages. Dialing a contact name directly from the phonebook without pre-recording (for example, "call John Smith") or selecting a track, artist, album, genre or playlist directly from your media player (for example, "play artist Madonna).
My previous bluetooth voice control system allowed me to control the radio, CD, and climate control systems. Why can I not control these systems with SYNC?	The focus of SYNC is to control your mobile devices and the content stored on them.	SYNC offers significant capability above and beyond the previous system such as. Dialing a contact name directly from the phonebook without pre-recording (for example, "call John Smith") or selecting a track, artist, album, genre or playlist directly from your media player (for example, "play artist Madonna).

<b>General</b>		
<b>Issue</b>	<b>Possible Cause</b>	<b>Possible Solution</b>
The language selected for the instrument cluster and information and entertainment display (radio, CD, menu settings, etc.) does not match the SYNC language (phone, USB, Bluetooth audio, voice control and voice prompts).	A language not supported by SYNC is currently selected for the instrument cluster and information and entertainment display.	SYNC only supports four languages in a single module for text display, voice control and voice prompts. The four languages in each bundle are selected based upon the most popular languages spoken in the country where your vehicle is sold. If the selected language is not available, SYNC will remain in the current active language. SYNC offers several new voice control features for a wide range of languages. Dialing a contact name directly from the phonebook without pre-recording (for example, "call John Smith") or selecting a track, artist, album, genre or playlist directly from your media player (for example, play artist Madonna).

# Navigation

## Using Navigation

### WARNINGS



The indicated maximum speed may not be applicable to your vehicle. It is always your responsibility to control your vehicle, supervise any system and obey the correct speed limit. Failure to do so could result in loss of vehicle control.



The front glass on the liquid crystal display may break if hit with a hard object. If the glass breaks, do not touch the liquid crystalline material. In case of contact with the skin, wash immediately with soap and water.

**Note:** Do not switch the ignition on or attempt to start the engine while the software is updating.

**Note:** Do not clean the unit with solvents or aerosol cleaning agents. Use only a damp cloth.

**Note:** The navigation SD card must be in the SD card slot to operate the navigation system. If you need a replacement SD card, see an authorized dealer.

**Note:** The SD card slot is spring-loaded. To remove the SD card, push the card in and release it. Do not attempt to remove the card without first pushing it in. This could cause damage.



E129900

Your navigation system is comprised of two main features, destination mode and map mode.

## Road Safety

### WARNING



Driving while distracted can result in loss of vehicle control, crash and injury. We strongly recommend that you use extreme caution when using any device that may take your focus off the road. Your primary responsibility is the safe operation of your vehicle. We recommend against the use of any handheld device while driving and encourage the use of voice-operated systems when possible. Make sure you are aware of all applicable local laws that may affect the use of electronic devices while driving.

**Note:** You are ultimately responsible for the safe operation of your vehicle and must evaluate whether it is safe to follow route suggestions. Navigation features are provided only as an aid. Driving decisions based on observations of local conditions and existing traffic regulations must be observed. Do not follow route suggestions if they would result in an unsafe or illegal maneuver, an unsafe situation, or if you would be directed into an area that you consider unsafe. Maps used by this system may be inaccurate due to errors, changes in roads, traffic or driving conditions.

## Safety Information

If detailed viewing of route instructions is necessary, pull off the road when it is safe to do so and park your vehicle.

# Navigation

---

## Route Options Menu

You can choose up to three different types of route:

- **Fast:** Uses the fastest route possible.
- **Short:** Uses the shortest distance possible.
- **Eco:** Uses the most fuel efficient route.

You can select **Always ask** to make sure that you are always given the choice of route option for your journey.

### Driver

#### Leisurely

This option will prioritize the route for a leisurely drive to the destination.

#### Normal

This option will prioritize the route for a normal drive to the destination.

#### Fast

This option will prioritize the route for a fast drive to the destination.

## Eco Settings

### Trailer

Use this feature to change the economy settings of your journey relating to whether or not you are towing a trailer and if so the size of trailer being towed.

### Roof Box

Use this feature to change the economy settings of your journey relating to the use of a roof box.

### Dynamic

When switched on, and if the unit is receiving a valid traffic message channel signal, the route will be automatically updated to take into account real time traffic incidents or congestion.

**Note:** *This feature can be useful in avoiding delays or hold ups on journeys.*

### Freeway

When switched on the system will look for freeways on your route and automatically update your route distance and timings.

**Note:** *This feature can be useful in avoiding delays or hold ups on journeys.*

### Ferries and Car Trains

When switched on the system will look for ferry crossings and car train facilities on your route and automatically update your route distance and timings.

### Toll

When switched on the system will look for toll roads on your route and automatically update your route distance and timings.

### Seasonal Roads

When switched on the system will look for seasonal roads on your route and automatically update your route distance and timings.

**Note:** *This feature can be useful in avoiding delays or hold ups on journeys.*

### Toll Sticker

When switched on the system will automatically select toll roads and update your route distance and timings.

## Information

Press the information button to view details of your current location or journey.

## Setting Your Navigation Preferences

Select settings for the system to take into account when planning your route. Press **MENU** and select the navigation option.

# Navigation

When You Select	You Can
Route	Avoid freeways, toll roads, ferries and car trains when planning your route. Have the system always select the shortest distance, fastest time or most economical route.
Destination input	Enter your destination details (for example enter city names, enter street names or pick a place from a map).
Traffic	Choose how you want the system to handle traffic problems along your route. Automatic: Have the system reroute you to avoid traffic incidents that develop and impact the current route (no notification is provided). Manual: Have the system always provide a traffic alert notification for traffic incidents along the planned route. You have a choice to accept or ignore the notification before the route deviation is made.
Home address	See the location on the map currently stored as the home position. Only one entry from the address book can be saved as the home address.
Last destinations	Access a history of previous destinations entered in the system. A detailed display will show the complete stored information including an overview map. Select the required repeat destination from the list.
Favorites	Save the current location to your favorites.
Points of interest	See points of interest displayed on the map and this can be turned on or off. There are about 56 subcategories of points of interest that can be selected to be displayed on the map one at a time.
Tour planning	Enter a number of different destinations and select the order in which you wish to visit them. You can also modify an existing tour or recall a previous tour. The system will automatically calculate and display your chosen journey.
Store position	Store and name your current position.
Route options	Store and name your current position.
Special functions	Select GPS and system information or a demonstration of the system functionality.

# Navigation

When You Select	You Can
Assistance options	Customize display information for your journey (for example signs, lanes and speed limits).
Personal data	Edit and delete personal data (for example your home address).
Reset all settings	Reset the navigation settings.

## Route Displays

### Map Display

Press **MAP** to view map mode. This view will show your current location with your vehicle in the center shown as an arrow surrounded by a circle. The arrow will face in the direction of travel.

The information on the top line gives the name of the current road, or the next road to take if a turn is approaching.

You can change the way the map is displayed by altering the zoom and orientation settings. Press the relevant function buttons to change the map scale and using the left and right arrow buttons zoom in or out. The current map scale is shown on the display.

Map scale settings may be set between 0.05 miles to 500 miles or 50 meters to 500 kilometers, with an auto setting to the far left. The auto setting continuously changes the map scale according to the road type being driven.

### Junction Zoom

This feature will automatically increase the zoom on the map display at times when you are required to make a turn, or perform more complex maneuvers. Shortly after the zoom scale will return to the previous level.

Select the auto option to turn on junction zoom.

### Navigation Display

After commencing a navigation route, the default screen is the main navigation screen.

Once an active route is underway, guidance will be given by on-screen information and voice prompts. Whichever audio source you wish to leave the unit in, basic turn by turn and distance information will remain on the screen in the form of a graphic inset. You do not need to leave the unit on the main navigation screen when you are navigating a route. Press **MAP** at any time to return to the main navigation screen. Slightly more detailed information on your route may be available via the main navigation screen if required.

### Hazard Spot Warning

The system supports a hazard spot warning feature which informs you with visible and audible feedback about hazardous traffic areas. The system does not automatically turn on every time you switch the ignition on. You can switch the system on and off using the information display. See **Information Displays** (page 68).

### Navigation Map Updates

Annual navigation map updates are available for purchase through an authorized dealer. You need to specify the make and model of your vehicle to determine if there is an update available.



# Navigation

---

## Type Approvals



SD Logo is a trademark.

The navigation software is based in part on the work of the FreeType team © 2006

The navigation software is based in part on the work of the independent JPEG Group.





# Appendices

## ELECTROMAGNETIC COMPATIBILITY

### WARNINGS

 Your vehicle has been tested and certified to legislations relating to electromagnetic compatibility (72/245/EEC, UN ECE Regulation 10 or other applicable local requirements). It is your responsibility to make sure that any equipment you have fitted complies with applicable local legislations. Have any equipment fitted by an authorized dealer.

### WARNINGS

-  The radio frequency transmitter equipment (e.g. cellular telephones, amateur radio transmitters etc.) may only be fitted to your vehicle if they keep to the parameters shown in the table below. There are no special provisions or conditions for installations or use.
-  Do not mount any transceiver, microphones, speakers, or any other item in the deployment path of the airbag system.
-  Do not fasten antenna cables to original vehicle wiring, fuel pipes and brake pipes.
-  Keep antenna and power cables at least 4 inches (10 centimeters) from any electronic modules and airbags.

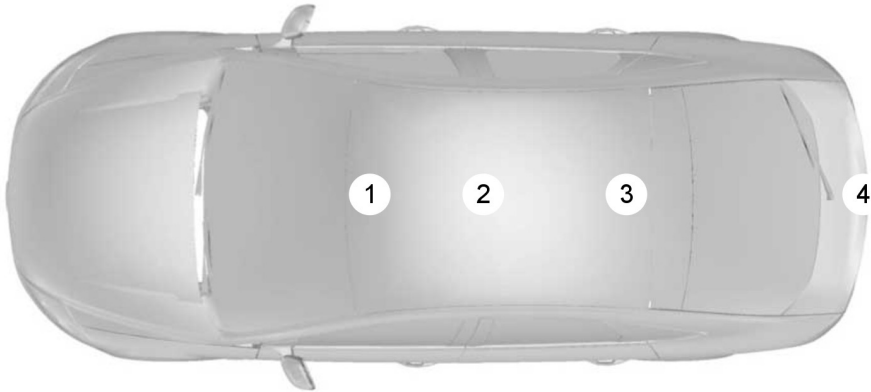

E85998

Frequency Band MHz	Maximum output power Watt (Peak RMS)	Antenna Positions
1 – 30	50 W	3, 4
30 – 54	50 W	1, 2, 3
68 – 87.5	50 W	1, 2, 3

# Appendices

Frequency Band MHz	Maximum output power Watt (Peak RMS)	Antenna Positions
142 – 176	50 W	1, 2, 3
380 – 512	50 W	1, 2, 3
806 – 940	10 W	1, 2, 3
1200 – 1400	10 W	1, 2, 3
1710 – 1885	10 W	1, 2, 3
1885 – 2025	10 W	1, 2, 3

**Note:** After the installation of radio frequency transmitters, check for disturbances from and to all electrical equipment in your vehicle, both in the standby and transmit modes.

Check all electrical equipment:

- with the ignition ON
- with the engine running
- during a road test at various speeds.

Check that electromagnetic fields generated inside your vehicle cabin by the transmitter installed do not exceed applicable human exposure requirements.

## END USER LICENSE AGREEMENT

### SYNC® End User License Agreement (EULA)

- You have acquired a device ("DEVICE") that includes software licensed by Ford Motor Company and its affiliates ("FORD MOTOR COMPANY") from an affiliate of Microsoft Corporation ("MS"). Those installed software products of MS origin, as well as associated media, printed materials,

and "online" or electronic documentation ("MS SOFTWARE") are protected by international intellectual property laws and treaties. The MS SOFTWARE is licensed, not sold. All rights reserved.

- The MS SOFTWARE may interface with and/or communicate with, or may be later upgraded to interface with and/or communicate with additional software and/or systems provided by FORD MOTOR COMPANY. The additional software and systems of FORD MOTOR COMPANY origin, as well as associated media, printed materials, and "online" or electronic documentation ("FORD SOFTWARE") are protected by international intellectual property laws and treaties. The FORD SOFTWARE is licensed, not sold. All rights reserved.

# Appendices

---

- The MS SOFTWARE and/or FORD SOFTWARE may interface with and/or communicate with, or may be later upgraded to interface with and/or communicate with additional software and/or systems provided by third party software and service suppliers. The additional software and services of third party origin, as well as associated media, printed materials, and "online" or electronic documentation ("THIRD PARTY SOFTWARE") are protected by international intellectual property laws and treaties. The THIRD PARTY SOFTWARE is licensed, not sold. All rights reserved.
- The MS SOFTWARE, FORD SOFTWARE and THIRD PARTY SOFTWARE hereinafter collectively and individually will be referred to as "SOFTWARE".

**IF YOU DO NOT AGREE TO THIS END USER LICENSE AGREEMENT ("EULA") DO NOT USE THE DEVICE OR COPY THE SOFTWARE. ANY USE OF THE SOFTWARE, INCLUDING BUT NOT LIMITED TO USE ON THE DEVICE, WILL CONSTITUTE YOUR AGREEMENT TO THIS EULA (OR RATIFICATION OF ANY PREVIOUS CONSENT).**

**GRANT OF SOFTWARE LICENSE:** This EULA grants you the following license:

- You may use the SOFTWARE as installed on the DEVICE and as otherwise interfacing with systems and/or services provide by or through FORD MOTOR COMPANY or its third party software and service providers.

## **Description of Other Rights and Limitations**

- **Speech Recognition:** If the SOFTWARE includes speech recognition component(s), you should understand that speech recognition is an inherently statistical process and that recognition errors are inherent in the process. Neither FORD MOTOR COMPANY nor its suppliers shall be liable for any damages arising out of errors in the speech recognition process.
- **Limitations on Reverse Engineering, Decompilation and Disassembly:** You may not reverse engineer, decompile, or disassemble nor permit others to reverse engineer, decompile or disassemble the SOFTWARE, except and only to the extent that such activity is expressly permitted by applicable law notwithstanding this limitation.
- **Limitations on Distributing, Copying, Modifying and Creating Derivative Works:** You may not distribute, copy, make modifications to or create derivative works based on the SOFTWARE, except and only to the extent that such activity is expressly permitted by applicable law notwithstanding this limitation.
- **Single EULA:** The end user documentation for the DEVICE and related systems and services may contain multiple EULAs, such as multiple translations and/or multiple media versions (e.g., in the user documentation and in the software). Even if you receive multiple EULAs, you are licensed to use only one (1) copy of the SOFTWARE.

# Appendices

---

- **SOFTWARE Transfer:** You may permanently transfer your rights under this EULA only as part of a sale or transfer of the DEVICE, provided you retain no copies, you transfer all of the SOFTWARE (including all component parts, the media and printed materials, any upgrades, and, if applicable, the Certificate(s) of Authenticity), and the recipient agrees to the terms of this EULA. If the SOFTWARE is an upgrade, any transfer must include all prior versions of the SOFTWARE.
- **Termination:** Without prejudice to any other rights, FORD MOTOR COMPANY or MS may terminate this EULA if you fail to comply with the terms and conditions of this EULA.
- **Security Updates/Digital Rights Management:** Content owners use the WMDRM technology included in your DEVICE to protect their intellectual property, included copyrighted content. Portions of the SOFTWARE on your DEVICE use WMDRM software to access WMDRM-protected content. If the WMDRM software fails to protect the content, content owners may ask Microsoft to revoke the SOFTWARE's ability to use WMDRM to play or copy protected content. This action does not affect unprotected content. When your DEVICE downloads licenses for protected content, you agree that Microsoft may include a revocation list with the licenses. Content owners may require you to upgrade the SOFTWARE on your DEVICE to access their content. If you decline an upgrade, you will not be able to access content that requires the upgrade.
- **Consent to Use of Data:** You agree that MS, Microsoft Corporation, FORD MOTOR COMPANY, third party software and systems suppliers, their affiliates and/or their designated agent may collect and use technical information gathered in any manner as part of product support services related to the SOFTWARE or related services. MS, Microsoft Corporation, FORD MOTOR COMPANY, third party software and services suppliers, their affiliates and/or their designated agent may use this information solely to improve their products or to provide customized services or technologies to you. MS, Microsoft Corporation, FORD MOTOR COMPANY, third party software and systems suppliers, their affiliates and/or their designated agent may disclose this information to others, but not in a form that personally identifies you.
- **Internet-Based Services Components:** The SOFTWARE may contain components that enable and facilitate the use of certain Internet-based services. You acknowledge and agree that MS, Microsoft Corporation, FORD MOTOR COMPANY, third party software and service suppliers, their affiliates and/or their designated agent may automatically check the version of the SOFTWARE and/or its components that you are utilizing and may provide upgrades or supplements to the SOFTWARE that may be automatically downloaded to your DEVICE.
- **Additional Software/Services:** The SOFTWARE may permit FORD MOTOR COMPANY, third party software and service suppliers, MS, Microsoft Corporation, their affiliates and/or their designated agent to provide or make available to you SOFTWARE updates,

# Appendices

---

supplements, add-on components, or Internet-based services components of the SOFTWARE after the date you obtain your initial copy of the SOFTWARE ("Supplemental Components").

If FORD MOTOR COMPANY or third party software and services suppliers provide or make available to you Supplemental Components and no other EULA terms are provided along with the Supplemental Components, then the terms of this EULA shall apply.

If MS, Microsoft Corporation, their affiliates and/or their designated agent make available Supplemental Components, and no other EULA terms are provided, then the terms of this EULA shall apply, except that the MS, Microsoft Corporation or affiliate entity providing the Supplemental Component(s) shall be the licensor of the Supplemental Component(s).

FORD MOTOR COMPANY, MS, Microsoft Corporation, their affiliates and/or their designated agent reserve the right to discontinue without liability any Internet-based services provided to you or made available to you through the use of the SOFTWARE.

- **Links to Third Party Sites:** The MS SOFTWARE may provide you with the ability to link to third party sites through the use of the SOFTWARE. The third party sites are not under the control of MS, Microsoft Corporation, their affiliates and/or their designated agent. Neither MS nor Microsoft Corporation nor their affiliates nor their designated agent are responsible for (i) the contents of any third party sites, any links contained in third party sites, or any changes or updates to third party sites, or (ii) webcasting or any other form of transmission received from any third party sites. If the SOFTWARE provides links to third party sites, those links are provided to you only as a convenience, and the inclusion of any link does not imply an endorsement of the third party site by MS, Microsoft Corporation, their affiliates and/or their designated agent.
- **Obligation to Drive Responsibly:** You recognize your obligation to drive responsibly and keep attention on the road. You will read and abide with the DEVICE operating instructions particularly as they pertain to safety and assumes any risk associated with the use of the DEVICE.

## **UPGRADES AND RECOVERY MEDIA:**

If the SOFTWARE is provided by FORD MOTOR COMPANY separate from the DEVICE on media such as a ROM chip, CD ROM disk(s) or via web download or other means, and is labeled "For Upgrade Purposes Only" or "For Recovery Purposes Only" you may install one (1) copy of such SOFTWARE onto the DEVICE as a replacement copy for the existing SOFTWARE, and use it in accordance with this EULA, including any additional EULA terms accompanying the upgrade SOFTWARE.

# Appendices

---

## **INTELLECTUAL PROPERTY RIGHTS:**

All title and intellectual property rights in and to the SOFTWARE (including but not limited to any images, photographs, animations, video, audio, music, text and "applets" incorporated into the SOFTWARE), the accompanying printed materials, and any copies of the SOFTWARE, are owned by MS, Microsoft Corporation, FORD MOTOR COMPANY, or their affiliates or suppliers. The SOFTWARE is licensed, not sold. You may not copy the printed materials accompanying the SOFTWARE. All title and intellectual property rights in and to the content which may be accessed through use of the SOFTWARE is the property of the respective content owner and may be protected by applicable copyright or other intellectual property laws and treaties. This EULA grants you no rights to use such content. All rights not specifically granted under this EULA are reserved by MS, Microsoft Corporation, FORD MOTOR COMPANY, third party software and service providers, their affiliates and suppliers. Use of any on-line services which may be accessed through the SOFTWARE may be governed by the respective terms of use relating to such services. If this SOFTWARE contains documentation that is provided only in electronic form, you may print one copy of such electronic documentation.

**EXPORT RESTRICTIONS:** You acknowledge that the SOFTWARE is subject to U.S. and European Union export jurisdiction. You agree to comply with all applicable international and national laws that apply to the SOFTWARE, including the U.S. Export Administration Regulations, as well as end-user, end-use and destination restrictions issued by U.S. and other governments. For additional information, see <http://www.microsoft.com/exporting/>.

**TRADEMARKS:** This EULA does not grant you any rights in connection with any trademarks or service marks of FORD MOTOR COMPANY, MS, Microsoft Corporation, third party software or service providers, their affiliates or suppliers.

**PRODUCT SUPPORT:** Product support for the SOFTWARE is not provided by MS, its parent corporation Microsoft Corporation, or their affiliates or subsidiaries. For product support, please refer to FORD MOTOR COMPANY instructions provided in the documentation for the DEVICE. Should you have any questions concerning this EULA, or if you desire to contact FORD MOTOR COMPANY for any other reason, please refer to the address provided in the documentation for the DEVICE.

**No Liability for Certain Damages:** EXCEPT AS PROHIBITED BY LAW, FORD MOTOR COMPANY, ANY THIRD PARTY SOFTWARE OR SERVICES SUPPLIERS, MS, MICROSOFT CORPORATION AND THEIR AFFILIATES SHALL HAVE NO LIABILITY FOR ANY INDIRECT, SPECIAL, CONSEQUENTIAL OR INCIDENTAL DAMAGES ARISING FROM OR IN CONNECTION WITH THE USE OR PERFORMANCE OF THE SOFTWARE. THIS LIMITATION SHALL APPLY EVEN IF ANY REMEDY FAILS OF ITS ESSENTIAL PURPOSE. IN NO EVENT SHALL MS, MICROSOFT CORPORATION AND/OR THEIR AFFILIATES BE LIABLE FOR ANY AMOUNT IN EXCESS OF U.S. TWO HUNDRED FIFTY DOLLARS (U.S. \$250.00).

- THERE ARE NO WARRANTIES OTHER THAN THOSE THAT MAY EXPRESSLY BE PROVIDED FOR YOUR NEW VEHICLE.

# Appendices

---

## Adobe

Contains Adobe® [Flash® Player] or [AIR®] technology by Adobe Systems Incorporated. This [Licensee Product] contains [Adobe® Flash® Player] [Adobe® AIR®] software under license from Adobe Systems Incorporated, Copyright ©1995-2009 Adobe Macromedia Software LLC. All rights reserved. Adobe, Flash and AIR are trademarks of Adobe Systems Incorporated.

## End User Notice

### **Microsoft® Windows® Mobile for Automotive Important Safety Information**

This system Ford SYNC™ contains software that is licensed to Manufacturer FORD MOTOR COMPANY by an affiliate of Microsoft Corporation pursuant to a license agreement. Any removal, reproduction, reverse engineering or other unauthorized use of the software from this system in violation of the license agreement is strictly prohibited and may subject you to legal action.

**Read and follow instructions:** Before using your Windows Automotive-based system, read and follow all instructions and safety information provided in this end user manual ("User's Guide"). Not following precautions found in this User's Guide can lead to an accident or other serious consequences.

**Keep User's Guide in vehicle:** When kept in the vehicle, the User's Guide will be a ready reference for you and other users unfamiliar with the Windows Automotive-based system. Please make certain that before using the system for the first time, all persons have access to the User's Guide and read its instructions and safety information carefully.

## WARNING



Operating certain parts of this system while driving can distract your attention away from the road, and possibly cause an accident or other serious consequences. Do not change system settings or enter data non-verbally (using your hands) while driving. Stop the vehicle in a safe and legal manner before attempting these operations. This is important since while setting up or changing some functions you might be required to distract your attention away from the road and remove your hands from the wheel.

## General Operation

**Voice Command Control:** Functions within the Windows Automotive-based system may be accomplished using only voice commands. Using voice commands while driving allows you to operate the system without removing your hands from the wheel.

**Prolonged Views of Screen:** Do not access any function requiring a prolonged view of the screen while you are driving. Pull over in a safe and legal manner before attempting to access a function of the system requiring prolonged attention. Even occasional short scans to the screen may be hazardous if your attention has been diverted away from your driving task at a critical time.

**Volume Setting:** Do not raise the volume excessively. Keep the volume at a level where you can still hear outside traffic and emergency signals while driving. Driving while unable to hear these sounds could cause an accident.



# Appendices

---

## **Use of Speech Recognition Functions:**

Speech recognition software is inherently a statistical process which is subject to errors. It is your responsibility to monitor any speech recognition functions included in the system and address any errors.

**Navigation Features:** Any navigation features included in the system are intended to provide turn by turn instructions to get you to a desired destination. Please make certain all persons using this system carefully read and follow instructions and safety information fully.

**Distraction Hazard:** Any navigation features may require manual (non-verbal) setup. Attempting to perform such set-up or insert data while driving can seriously distract your attention and could cause an accident or other serious consequences. Stop the vehicle in a safe and legal manner before attempting these operations.

**Let Your Judgment Prevail:** Any navigation features are provided only as an aid. Make your driving decisions based on your observations of local conditions and existing traffic regulations. Any such feature is not a substitute for your personal judgment. Any route suggestions made by this system should never replace any local traffic regulations or your personal judgment or knowledge of safe driving practices.

**Route Safety:** Do not follow the route suggestions if doing so would result in an unsafe or illegal maneuver, if you would be placed in an unsafe situation, or if you would be directed into an area that you consider unsafe. The driver is ultimately responsible for the safe operation of the vehicle and therefore, must evaluate whether it is safe to follow the suggested directions.

**Potential Map Inaccuracy:** Maps used by this system may be inaccurate because of changes in roads, traffic controls or driving conditions. Always use good judgment and common sense when following the suggested routes.

**Emergency Services:** Do not rely on any navigation features included in the system to route you to emergency services. Ask local authorities or an emergency services operator for these locations. Not all emergency services such as police, fire stations, hospitals and clinics are likely to be contained in the map database for such navigation features.

## **TeleNav Software End User License Agreement**

Please read these terms and conditions carefully before you use the TeleNav Software. Your use of the TeleNav Software indicates that you accept these terms and conditions. If you do not accept these terms and conditions, do not break the seal of the package, launch, or otherwise use the TeleNav Software.

TeleNav may revise this Agreement and the privacy policy at any time, with or without notice to you. You agree to visit <http://www.telenav.com> from time to time to review the then current version of this Agreement and of the privacy policy.

### **1. Safe and Lawful Use**

You acknowledge that devoting attention to the TeleNav Software may pose a risk of injury or death to you and others in situations that otherwise require your undivided attention, and you therefore agree to comply with the following when using the TeleNav Software: (a) observe all traffic laws and otherwise drive safely; (b) use your own personal judgment while driving. If you feel that a route suggested by the TeleNav Software instructs you to perform an unsafe or illegal maneuver,

# Appendices

---

places you in an unsafe situation, or directs you into an area that you consider to be unsafe, do not follow such instructions; (c) do not input destinations, or otherwise manipulate the TeleNav Software, unless your vehicle is stationary and parked; (d) do not use the TeleNav Software for any illegal, unauthorized, unintended, unsafe, hazardous, or unlawful purposes, or in any manner inconsistent with this Agreement; (e) arrange all GPS and wireless devices and cables necessary for use of the TeleNav Software in a secure manner in your vehicle so that they will not interfere with your driving and will not prevent the operation of any safety device (such as an airbag).

You agree to indemnify and hold TeleNav harmless against all claims resulting from any dangerous or otherwise inappropriate use of the TeleNav Software in any moving vehicle, including as a result of your failure to comply with the directions above.

## **2. Account Information**

You agree: (a) when registering the TeleNav Software, to provide TeleNav with true, accurate, current, and complete information about yourself, and (b) to inform TeleNav promptly of any changes to such information, and to keep it true, accurate, current and complete.

## **3. Software License**

Subject to your compliance with the terms of this Agreement, TeleNav hereby grants to you a personal, non-exclusive, non-transferable license (except as expressly permitted below in connection with your permanent transfer of the TeleNav Software license), without the right to sublicense, to use the TeleNav Software (in object code form only) in order to access and use the TeleNav Software. This license shall terminate upon

any termination or expiration of this Agreement. You agree that you will use the TeleNav Software only for your personal business or leisure purposes, and not to provide commercial navigation services to other parties.

### **3.1 License Limitations**

You agree not to do any of the following: (a) reverse engineer, decompile, disassemble, translate, modify, alter or otherwise change the TeleNav Software or any part thereof; (b) attempt to derive the source code, audio library or structure of the TeleNav Software without the prior express written consent of TeleNav; (c) remove from the TeleNav Software, or alter, any of TeleNav's or its suppliers' trademarks, trade names, logos, patent or copyright notices, or other notices or markings; (d) distribute, sublicense or otherwise transfer the TeleNav Software to others, except as part of your permanent transfer of the TeleNav Software; or (e) use the TeleNav Software in any manner that (i) infringes the intellectual property or proprietary rights, rights of publicity or privacy or other rights of any party, (ii) violates any law, statute, ordinance or regulation, including but not limited to laws and regulations related to spamming, privacy, consumer and child protection, obscenity or defamation, or (iii) is harmful, threatening, abusive, harassing, tortuous, defamatory, vulgar, obscene, libelous, or otherwise objectionable; and (f) lease, rent out, or otherwise permit unauthorized access by third parties to the TeleNav Software without advanced written permission of TeleNav.

# Appendices

---

## **4. Disclaimers**

To the fullest extent permissible pursuant to applicable law, in no event will TeleNav, its licensors and suppliers, or agents or employees of any of the foregoing, be liable for any decision made or action taken by you or anyone else in reliance on the information provided by the TeleNav Software. TeleNav also does not warrant the accuracy of the map or other data used for the TeleNav Software. Such data may not always reflect reality due to, among other things, road closures, construction, weather, new roads and other changing conditions. You are responsible for the entire risk arising out of your use of the TeleNav Software. For example but without limitation, you agree not to rely on the TeleNav Software for critical navigation in areas where the well-being or survival of you or others is dependent on the accuracy of navigation, as the maps or functionality of the TeleNav Software are not intended to support such high risk applications, especially in more remote geographical areas.

TELENAV EXPRESSLY DISCLAIMS AND EXCLUDES ALL WARRANTIES IN CONNECTION WITH THE TELENAV SOFTWARE, WHETHER STATUTORY, EXPRESS OR IMPLIED, INCLUDING ALL WARRANTIES WHICH MAY ARISE FROM COURSE OF DEALING, CUSTOM OR TRADE AND INCLUDING, BUT NOT LIMITED TO, THE IMPLIED WARRANTIES OF MERCHANTABILITY, FITNESS FOR A PARTICULAR PURPOSE AND NON-INFRINGEMENT OF THIRD PARTY RIGHTS WITH RESPECT TO THE TELENAV SOFTWARE. Certain jurisdictions do not permit the disclaimer of certain warranties, so this limitation may not apply to you.

## **5. Limitation of Liability**

TO THE EXTENT PERMITTED UNDER APPLICABLE LAW, UNDER NO CIRCUMSTANCES SHALL TELENAV OR ITS LICENSORS AND SUPPLIERS BE LIABLE TO YOU OR TO ANY THIRD PARTY FOR ANY INDIRECT, INCIDENTAL, CONSEQUENTIAL, SPECIAL OR EXEMPLARY DAMAGES (INCLUDING IN EACH CASE, BUT NOT LIMITED TO, DAMAGES FOR THE INABILITY TO USE THE EQUIPMENT OR ACCESS DATA, LOSS OF DATA, LOSS OF BUSINESS, LOSS OF PROFITS, BUSINESS INTERRUPTION OR THE LIKE) ARISING OUT OF THE USE OF OR INABILITY TO USE THE TELENAV SOFTWARE, EVEN IF TELENAV HAS BEEN ADVISED OF THE POSSIBILITY OF SUCH DAMAGES.

NOTWITHSTANDING ANY DAMAGES THAT YOU MIGHT INCUR FOR ANY REASON WHATSOEVER (INCLUDING, WITHOUT LIMITATION, ALL DAMAGES REFERENCED HEREIN AND ALL DIRECT OR GENERAL DAMAGES IN CONTRACT, TORT (INCLUDING NEGLIGENCE) OR OTHERWISE), THE ENTIRE LIABILITY OF TELENAV AND OF ALL OF TELENAV'S SUPPLIERS SHALL BE LIMITED TO THE AMOUNT ACTUALLY PAID BY YOU FOR THE TELENAV SOFTWARE. SOME STATES AND/OR JURISDICTIONS DO NOT ALLOW THE EXCLUSION OR LIMITATION OF INCIDENTAL OR CONSEQUENTIAL DAMAGES, SO THE ABOVE LIMITATIONS OR EXCLUSIONS MAY NOT APPLY TO YOU.

## **6. Arbitration and Governing Law**

You agree that any dispute, claim or controversy arising out of or relating to this Agreement or the TeleNav Software shall be settled by independent arbitration involving a neutral arbitrator and administered by the American Arbitration Association in the County of Santa Clara, California. The arbitrator shall apply the

# Appendices

---

Commercial Arbitration Rules of the American Arbitration Association, and the judgment upon the award rendered by the arbitrator may be entered by any court having jurisdiction. Note that there is no judge or jury in an arbitration proceeding and the decision of the arbitrator shall be binding upon both parties. You expressly agree to waive your right to a jury trial.

This Agreement and performance hereunder will be governed by and construed in accordance with the laws of the State of California, without giving effect to its conflict of laws provisions. To the extent judicial action is necessary in connection with the binding arbitration, both TeleNav and you agree to submit to the exclusive jurisdiction of the courts of the County of Santa Clara, California. The United Nations Convention on Contracts for the International Sale of Goods shall not apply.

## **7. Assignment**

You may not resell, assign, or transfer this Agreement or any of your rights or obligations, except in totality, in connection with your permanent transfer of the TeleNav Software, and expressly conditioned upon the new user of the TeleNav Software agreeing to be bound by the terms and conditions of this Agreement. Any such sale, assignment or transfer that is not expressly permitted under this paragraph will result in immediate termination of this Agreement, without liability to TeleNav, in which case you and all other parties shall immediately cease all use of the TeleNav Software. Notwithstanding the foregoing, TeleNav may assign this Agreement to any other party at any time without notice, provided the assignee remains bound by this Agreement.

## **8. Miscellaneous**

### **8.1**

This Agreement constitutes the entire agreement between TeleNav and you with respect to the subject matter hereof.

### **8.2**

Except for the limited licenses expressly granted in this Agreement, TeleNav retains all right, title and interest in and to the TeleNav Software, including without limitation all related intellectual property rights. No licenses or other rights which are not expressly granted in this Agreement are intended to, or shall be, granted or conferred by implication, statute, inducement, estoppel or otherwise, and TeleNav and its suppliers and licensors hereby reserve all of their respective rights other than the licenses explicitly granted in this Agreement

### **8.3**

By using the TeleNav Software, you consent to receive from TeleNav all communications, including notices, agreements, legally required disclosures or other information in connection with the TeleNav Software (collectively, "Notices") electronically. TeleNav may provide such Notices by posting them on TeleNav's Website or by downloading such Notices to your wireless device. If you desire to withdraw your consent to receive Notices electronically, you must discontinue your use of the TeleNav Software.

### **8.4**

TeleNav's or your failure to require performance of any provision shall not affect that party's right to require performance at any time thereafter, nor shall a waiver of any breach or default of this Agreement constitute a waiver of any subsequent breach or default or a waiver of the provision itself.

# Appendices

## 8.5

If any provision herein is held unenforceable, then such provision will be modified to reflect the intention of the parties, and the remaining provisions of this Agreement will remain in full force and effect

## 8.6

The headings in this Agreement are for convenience of reference only, will not be deemed to be a part of this Agreement, and will not be referred to in connection with the construction or interpretation of this Agreement. As used in this Agreement, the words "include" and "including" and variations thereof, will not be deemed to be terms of limitation, but rather will be deemed to be followed by the words "without limitation".

## 9. Other Vendors Terms and Conditions

The TeleNav Software utilizes map and other data licensed to TeleNav by third party vendors for the benefit of you and other end users. This Agreement includes end-user terms applicable to these companies (included at the end of this Agreement), and thus your use of the TeleNav Software is also subject to such terms. You agree to comply with the following additional terms and conditions, which are applicable to TeleNav's third party vendor licensors:

### *NavTeq End User License Agreement*

#### **END USER TERMS**

The content provided ("Data") is licensed, not sold. By opening this package, or installing, copying, or otherwise using the Data, you agree to be bound by the terms of this agreement. If you do not agree to the terms of this agreement, you are not permitted to install, copy, use, resell or transfer the Data. If you wish to reject the terms of this agreement, and have not

installed, copied, or used the Data, you must contact your retailer or NAVTEQ North America, LLC ("NT") within thirty (30) days of purchase for a refund of your purchase price. To contact NT, please visit [www.navteq.com](http://www.navteq.com).

The Data is provided for your personal, internal use only and may not be resold. It is protected by copyright, and is subject to the following terms (this "End User License Agreement") and conditions which are agreed to by you, on the one hand, and NAVTEQ North America, LLC ("NT") and its licensors (including their licensors and suppliers) on the other hand.

The Data for areas of Canada includes information taken with permission from Canadian authorities, including: © Her Majesty the Queen in Right of Canada, © Queen's Printer for Ontario, © Canada Post Corporation, GeoBase®.

NT holds a nonexclusive license from the United States Postal Service ® to publish and sell ZIP+4 ® information.

© United States Postal Service ® 2009. Prices are not established, controlled or approved by the United States Postal Service ® The following trademarks and registrations are owned by the USPS: United States Postal Service, USPS, and ZIP+4.

The Data for Mexico includes certain Data from Instituto Nacional de Estadística y Geografía.

#### **TERMS AND CONDITIONS**

**License Limitations on Use:** You agree that your license to use this Data is limited to and conditioned on use for solely personal, noncommercial purposes, and not for service bureau, timesharing or other similar purposes. Except as otherwise set forth herein, you agree not to otherwise

# Appendices

reproduce, copy, modify, decompile, disassemble or reverse engineer any portion of this Data, and may not transfer or distribute it in any form, for any purpose, except to the extent permitted by mandatory laws.

**License Limitations on Transfer:** Your limited license does not allow transfer or resale of the Data, except on the condition that you may transfer the Data and all accompanying materials on a permanent basis if: (a) you retain no copies of the Data; (b) the recipient agrees to the terms of this End User License Agreement; and (c) you transfer the Data in the exact same form as you purchased it by physically transferring the original media (e.g., the CD-ROM or DVD you purchased), all original packaging, all Manuals and other documentation. Specifically, Multi-disc sets may only be transferred or sold as a complete set as provided to you and not as a subset thereof.

**Additional License Limitations:** Except where you have been specifically licensed to do so by NT in a separate written agreement, and without limiting the preceding paragraph, your license is conditioned on use of the Data as prescribed in this agreement, and you may not (a) use this Data with any products, systems, or applications installed or otherwise connected to or in communication with vehicles capable of vehicle navigation, positioning, dispatch, real time route guidance, fleet management or similar applications; or (b) with, or in communication with, including without limitation, cellular phones, palmtop and handheld computers, pagers, and personal digital assistants or PDAs.

## WARNING



This Data may contain inaccurate or incomplete information due to the passage of time, changing circumstances, sources used and the nature of collecting comprehensive geographic Data, any of which may lead to incorrect results.

**No Warranty:** This Data is provided to you "as is", and you agree to use it at your own risk. NT and its licensors (and their licensors and suppliers) make no guarantees, representations or warranties of any kind, express or implied, arising by law or otherwise, including but not limited to, content, quality, accuracy, completeness, effectiveness, reliability, fitness for a particular purpose, usefulness, use or results to be obtained from this Data, or that the Data or server will be uninterrupted or error free.

**Disclaimer of Warranty:** NT AND ITS LICENSORS (INCLUDING THEIR LICENSORS AND SUPPLIERS) DISCLAIM ANY WARRANTIES, EXPRESS OR IMPLIED, OF QUALITY, PERFORMANCE, MERCHANTABILITY, FITNESS FOR A PARTICULAR PURPOSE OR NON-INFRINGEMENT. Some States, Territories and Countries do not allow certain warranty exclusions, so to that extent the above exclusion may not apply to you.

**Disclaimer of Liability:** NT AND ITS LICENSORS (INCLUDING THEIR LICENSORS AND SUPPLIERS) SHALL NOT BE LIABLE TO YOU IN RESPECT OF ANY CLAIM, DEMAND OR ACTION, IRRESPECTIVE OF THE NATURE OF THE CAUSE OF THE CLAIM, DEMAND OR ACTION ALLEGING ANY LOSS, INJURY OR DAMAGES, DIRECT OR INDIRECT, WHICH MAY RESULT FROM THE USE OR POSSESSION OF THIS DATA; OR FOR ANY LOSS OF PROFIT, REVENUE, CONTRACTS

# Appendices

---

OR SAVINGS, OR ANY OTHER DIRECT, INDIRECT, INCIDENTAL, SPECIAL OR CONSEQUENTIAL DAMAGES ARISING OUT OF YOUR USE OF OR INABILITY TO USE THIS DATA, ANY DEFECT IN THIS DATA, OR THE BREACH OF THESE TERMS OR CONDITIONS, WHETHER IN AN ACTION IN CONTRACT OR TORT OR BASED ON A WARRANTY, EVEN IF NT OR ITS LICENSORS HAVE BEEN ADVISED OF THE POSSIBILITY OF SUCH DAMAGES. Some States, Territories and Countries do not allow certain liability exclusions or damages limitations, so to that extent the above may not apply to you.

**Export Control:** You agree not to export from anywhere any part of the Data or any direct product thereof except in compliance with, and with all licenses and approvals required under, applicable export laws, rules and regulations, including but not limited to the laws, rules and regulations administered by the Office of Foreign Assets Control of the U.S. Department of Commerce and the Bureau of Industry and Security of the U.S. Department of Commerce. To the extent that any such export laws, rules or regulations prohibit NT from complying with any of its obligations hereunder to deliver or distribute Data, such failure shall be excused and shall not constitute a breach of this Agreement.

**Entire Agreement:** These terms and conditions constitute the entire agreement between NT (and its licensors, including their licensors and suppliers) and you pertaining to the subject matter hereof, and supersedes in their entirety any and all written or oral agreements previously existing between us with respect to such subject matter.

**Severability:** You and NT agree that if any portion of this agreement is found illegal or unenforceable, that portion shall be severed and the remainder of the Agreement shall be given full force and effect.

**Governing Law:** The above terms and conditions shall be governed by the laws of the State of Illinois, without giving effect to (i) its conflict of laws provisions, or (ii) the United Nations Convention for Contracts for the International Sale of Goods, which is explicitly excluded. You agree to submit to the personal jurisdiction of the State of Illinois for any and all disputes, claims and actions arising from or in connection with the Data provided to you hereunder.

**Government End Users:** If the Data is being acquired by or on behalf of the United States government or any other entity seeking or applying rights similar to those customarily claimed by the United States government, this Data is a "commercial term" as that term is defined at 48 C.F.R. ("FAR") 2.101, is licensed in accordance with this End User License Agreement, and each copy of Data delivered or otherwise furnished shall be marked and embedded as appropriate with the following "Notice of Use", and be treated in accordance with such Notice:

## NOTICE OF USE

CONTRACTOR  
(MANUFACTURER/SUPPLIER)

NAME:

## NAVTEQ

CONTRACTOR  
(MANUFACTURER/SUPPLIER)

ADDRESS:

**425 West Randolph Street, Chicago, IL  
60606.**

# Appendices

---

This Data is a commercial item as defined in FAR 2.101

and is subject to the End User License Agreement under

which this Data was provided.

© 2011 NAVTEQ. All rights reserved.

If the Contracting Officer, federal government agency, or any federal official refuses to use the legend provided herein, the Contracting Officer, federal government agency, or any federal official must notify NAVTEQ prior to seeking additional or alternative rights in the Data.

Wi-Fi hotspot data provided by JiWire, © 2013 JiWire.

## **Gracenote® Copyright**

CD and music-related data from Gracenote, Inc., copyright© 2000-2007 Gracenote. Gracenote Software, copyright © 2000-2007 Gracenote. This product and service may practice one or more of the following U.S. Patents #5,987,525, #6,061,680, #6,154,773, #6,161,132, #6,230,192, #6,230,207, #6.240,459, #6,330,593 and other patents issued or pending. Some services supplied under license from Open Globe, Inc. for U.S. Patent: #6,304,523.

Gracenote and CDDB are registered trademarks of Gracenote. The Gracenote logo and logotype, and the "Powered by Gracenote™" logo are trademarks of Gracenote.

## **Gracenote® End User License Agreement (EULA)**

This device contains software from Gracenote, Inc. of 2000 Powell Street Emeryville, California 94608 ("Gracenote").

The software from Gracenote (the "Gracenote Software") enables this device to do disc and music file identification and obtain music-related information, including name, artist, track, and title information ("Gracenote Data") from online servers ("Gracenote Servers"), and to perform other functions. You may use Gracenote Data only by means of the intended End User functions of this device.

This device may contain content belonging to Gracenote's providers. If so, all of the restrictions set forth herein with respect to Gracenote Data shall also apply to such content and such content providers shall be entitled to all of the benefits and protections set forth herein that are available to Gracenote.

You agree that you will use the content from Gracenote ("Gracenote Content"), Gracenote Data, the Gracenote Software, and Gracenote Servers for your own personal, non-commercial use only. You agree not to assign, copy, transfer or transmit the Gracenote Content, Gracenote Software or any Gracenote Data (except in a Tag associated with a music file) to any third party. YOU AGREE NOT TO USE OR EXPLOIT GRACENOTE CONTENT, GRACENOTE DATA, THE GRACENOTE SOFTWARE, OR GRACENOTE SERVERS, EXCEPT AS EXPRESSLY PERMITTED HEREIN.

You agree that your non-exclusive licenses to use the Gracenote Content, Gracenote Data, the Gracenote Software, and Gracenote Servers will terminate if you violate these restrictions. If your licenses terminate, you agree to cease any and all use of the Gracenote Content, Gracenote Data, the Gracenote Software, and Gracenote Servers. Gracenote, respectively, reserve all rights in Gracenote Data, the Gracenote Software, and the Gracenote Servers and Gracenote Content, including all ownership rights. Under no circumstances will either Gracenote



# Appendices

become liable for any payment to you for any information that you provide, including any copyrighted material or music file information. You agree that Gracenote may enforce its respective rights, collectively or separately, under this agreement against you, directly in each company's own name.

Gracenote uses a unique identifier to track queries for statistical purposes. The purpose of a randomly assigned numeric identifier is to allow Gracenote to count queries without knowing anything about who you are. For more information, see the web page at [www.gracenote.com](http://www.gracenote.com) for the Gracenote Privacy Policy.

THE GRACENOTE SOFTWARE, EACH ITEM OF GRACENOTE DATA AND THE GRACENOTE CONTENT ARE LICENSED TO YOU "AS IS". NEITHER GRACENOTE MAKES ANY REPRESENTATIONS OR WARRANTIES, EXPRESS OR IMPLIED, REGARDING THE ACCURACY OF ANY GRACENOTE DATA FROM THE GRACENOTE SERVERS OR GRACENOTE CONTENT. GRACENOTE COLLECTIVELY AND SEPARATELY RESERVE THE RIGHT TO DELETE DATA AND/OR CONTENT FROM THE COMPANIES' RESPECTIVE SERVERS OR, IN THE CASE OF GRACENOTE, CHANGE DATA CATEGORIES FOR ANY CAUSE THAT GRACENOTE DEEMS SUFFICIENT. NO WARRANTY IS MADE THAT EITHER GRACENOTE CONTENT OR THE GRACENOTE SOFTWARE OR GRACENOTE SERVERS ARE ERROR-FREE OR THAT THE FUNCTIONING OF THE GRACENOTE SOFTWARE OR GRACENOTE SERVERS WILL BE UNINTERRUPTED. GRACENOTE IS NOT OBLIGATED TO PROVIDE YOU WITH ANY ENHANCED OR ADDITIONAL DATA TYPES THAT GRACENOTE MAY CHOOSE TO PROVIDE IN THE FUTURE AND IS FREE TO DISCONTINUE ITS ONLINE SERVICES AT ANY TIME. GRACENOTE DISCLAIMS ALL

WARRANTIES EXPRESS OR IMPLIED, INCLUDING, BUT NOT LIMITED TO, IMPLIED WARRANTIES OF MERCHANTABILITY, FITNESS FOR A PARTICULAR PURPOSE, TITLE, AND NON-INFRINGEMENT. NEITHER GRACENOTE WARRANTS THE RESULTS THAT WILL BE OBTAINED BY YOUR USE OF THE GRACENOTE SOFTWARE OR ANY GRACENOTE SERVER. IN NO CASE WILL GRACENOTE BE LIABLE FOR ANY CONSEQUENTIAL OR INCIDENTAL DAMAGES OR FOR ANY LOST PROFITS OR LOST REVENUES FOR ANY REASON WHATSOEVER.

© Gracenote 2007.

FCC ID: KMHSYNG2

IC: 1422A-SYNG2

This device complies with Part 15 of the FCC Rules and with RSS-210 of Industry Canada. Operation is subject to the following two conditions: (1) This device may not cause harmful interference, and (2) this device must accept any interference received, including interference that may cause undesired operation.

## WARNING



Changes or modifications not expressly approved by the party responsible for compliance could void the user's authority to operate the equipment. The term "IC" before the radio certification number only signifies that Industry Canada technical specifications were met.

The antenna used for this transmitter must not be co-located or operating in conjunction with any other antenna or transmitter.



# Index

## 4

### 4WD

See: Four-Wheel Drive.....124

## A

### A/C

See: Climate Control.....87

About This Manual.....5

Protecting the Environment.....5

### ABS

See: Brakes.....129

### ABS driving hints

See: Hints on Driving With Anti-Lock  
Brakes.....129

### Accessories

See: Replacement Parts  
Recommendation.....8

### ACC

See: Using Adaptive Cruise Control.....140

Active City Stop.....154

Principle of Operation.....154

Switching the System Off and On.....154

Active Park Assist.....135

Using the System.....135

Adjusting the Steering Wheel.....43

### Air Conditioning

See: Climate Control.....87

Air Vents.....87

Center.....87

Center Console.....88

Side.....88

### Alarm

See: Anti-Theft Alarm.....40

Ambient Lighting.....55

Anti-Theft Alarm.....40

Alarm System.....40

Arming the Alarm.....41

Disarming the Alarm.....42

Full and Reduced Guard.....41

Triggering the Alarm.....41

Appendices.....280

At a Glance.....10

Front Exterior Overview.....10

Instrument Panel Overview.....12

Rear Exterior Overview.....15

Vehicle Interior Overview.....11

Audible Warnings and Indicators.....67

Automatic Transmission Warning

Chime.....67

Headlamps On Warning Chime.....67

Key in Ignition Warning Chime.....67

Parking Brake On Warning Chime.....67

Audio Control.....43

Type 1.....44

Type 2.....44

Audio System.....214

General Information.....214

Audio Troubleshooting.....246

Audio unit - Vehicles With:

AM/FM/CD/Digital Audio Broadcast

(DAB) Radio/SYNC.....220

Alternative Frequencies.....224

Automatic Volume Control.....224

Autostore Control.....223

News Broadcasts.....224

Regional Mode.....225

Sound Button.....222

Station Preset Buttons.....223

Station Tuning Control.....223

Traffic Information Control.....223

Waveband Button.....222

Audio unit - Vehicles With:

AM/FM/CD.....215

Alternative Frequencies.....219

Automatic Volume Control.....218

Autostore Control.....218

News Broadcasts.....219

Regional Mode.....219

Sound Button.....217

Station Preset Buttons.....217

Station Tuning Control.....217

Traffic Information Control.....218

Waveband Button.....217

# Index

Audio unit - Vehicles With: Digital Audio Broadcast (DAB) Radio/Navigation System/SYNC/Sony AM/FM/CD.....	237
Alternative Frequencies.....	242
Automatic Volume Control.....	242
Autostore Control.....	241
Digital Signal Processing.....	242
News Broadcasts.....	242
Regional Mode.....	243
Sound Button.....	240
Station Preset Buttons.....	241
Station Tuning Control.....	240
Traffic Information Control.....	241
Waveband Button.....	240
Audio unit - Vehicles With: Digital Audio Broadcast (DAB) Radio/Navigation System/SYNC.....	225
Alternative Frequencies.....	230
Automatic Volume Control.....	229
Autostore Control.....	228
Digital Signal Processing.....	229
News Broadcasts.....	230
Regional Mode.....	230
Sound Button.....	227
Station Preset Buttons.....	228
Station Tuning Control.....	228
Traffic Information Control.....	228
Waveband Button.....	227
Audio unit - Vehicles With: Digital Audio Broadcast (DAB) Radio/SYNC/Sony AM/FM/CD.....	231
Alternative Frequencies.....	236
Automatic Volume Control.....	236
Autostore Control.....	235
Digital Signal Processing.....	236
News Broadcasts.....	236
Regional Mode.....	237
Sound Button.....	234
Station Preset Buttons.....	235
Station Tuning Control.....	234
Traffic Information Control.....	235
Waveband Button.....	234
Autolamps.....	50
Automatic Climate Control.....	89
Mono Mode.....	91
Switching Mono Mode Back On.....	91
Switching Mono Mode Off.....	91
Temperature Control.....	90
Automatic High Beam Control.....	51
Manually Overriding the System.....	52
Setting the System Sensitivity.....	52
Switching the System On.....	52
Automatic Transmission.....	119
Emergency Park Position Release Lever.....	121
Hints on Driving with an Automatic Transmission.....	121
Selector Lever Positions.....	119
Sport Mode and Manual Shifting.....	120
Autowipers.....	46
Auxiliary Heater.....	95
Fuel Operated Heater.....	95
Auxiliary Input Jack.....	245
Auxiliary Power Points.....	102
12 Volt DC Power Point.....	102
AC Power Point.....	102
Location.....	102
<b>B</b>	
Blind Spot Monitor.....	145
Blind Spot Information System.....	145
Bonnet Lock	
See: Opening and Closing the Hood.....	179
Brake Fluid Check.....	184
Brakes.....	129
General Information.....	129
Breaking-In.....	164
Bulb Specification Chart.....	192
<b>C</b>	
Capacities and Specifications.....	210
Technical Specifications.....	211
Car Wash	
See: Cleaning the Exterior.....	195
Catalytic Converter.....	115
Driving with a Catalytic Converter.....	115

# Index

Changing a Bulb.....	186	Coolant Check	
Approach Lamp.....	188	See: Engine Coolant Check.....	184
Central High Mounted Brake Lamp.....	190	Cornering Lamps.....	54
Headlamp.....	186	Cruise Control.....	45
Interior lamp.....	191	Principle of Operation.....	139
License Plate Lamp.....	191	Cruise control	
Luggage Compartment Lamp, Footwell		See: Using Cruise Control.....	139
Lamp and Liftgate Lamp.....	191	Cup Holders.....	104
Reading lamps.....	191		
Rear Lamps.....	189	<b>D</b>	
Side Repeater.....	188	Data Recording.....	7
Changing a Fuse.....	178	Daytime Running Lamps.....	51
Changing a Road Wheel.....	201	Diesel Particulate Filter.....	109
Assembling the Wheel Brace.....	204	Regeneration.....	110
Installing a Road Wheel.....	205	Digital Audio.....	243
Jacking and Lifting Points.....	202	.....	243
Lug Nuts.....	201	Direction Indicators.....	54
Removing a Road Wheel.....	205	DPF	
Removing the Wheel Trim.....	204	See: Diesel Particulate Filter.....	109
Stowing the Flat Tire.....	206	Driver Airbag.....	26
Vehicle Jack.....	202	.....	26
Vehicles with a Spare Wheel.....	201	Driver Alert.....	148
Changing the 12V Battery.....	184	Principle of Operation.....	148
Changing the Wiper Blades.....	185	Using Driver Alert.....	149
Checking the Wiper Blades.....	185	Driving Aids.....	145
Child Safety.....	17	Driving Hints.....	164
Child Safety Locks.....	22	Driving Through Water.....	164
Electric Child Safety Locks.....	22	.....	164
Manual Child Safety Locks.....	22		
Child Seat Positioning.....	17	DRL	
Cleaning the Alloy Wheels.....	196	See: Daytime Running Lamps.....	51
Cleaning the Exterior.....	195		
Cleaning Plastic Exterior Parts.....	195	<b>E</b>	
Cleaning the Chrome Trim.....	195	Eco Mode.....	155
Cleaning the Headlamps.....	195	Resetting Eco Mode.....	155
Underbody.....	195	Type 1.....	155
Using a Car Wash.....	195	Type 2 and 3.....	155
Cleaning the Interior.....	196	Electromagnetic compatibility.....	280
Instrument Cluster Screens, LCD Screens		End User License Agreement.....	281
and Radio Screens.....	196	SYNC® End User License Agreement	
Rear Windows.....	196	(EULA).....	281
Safety Belts.....	196	Engine Coolant Check.....	184
Climate Control.....	87	Adding Engine Coolant.....	184
Principle of Operation.....	87	Engine Immobilizer	
Clock.....	73	See: Passive Anti-Theft System.....	40
Type 1.....	73	Engine Oil Check.....	183
Type 2.....	73	Adding Oil.....	183
Cold Weather Precautions.....	164		

# Index

Engine Oil Dipstick - 1.6L EcoBoost™.....	183
Engine Oil Dipstick - 2.0L Duratorq-TDCi (DW) Diesel.....	183
Event Data Recording See: Data Recording.....	7
Exterior Mirrors.....	58
Fold-Away Exterior Mirrors.....	59
Power Exterior Mirrors.....	58
<b>F</b>	
Fastening the Safety Belts.....	23
Using Safety Belts During Pregnancy.....	23
First Aid Kit.....	166
Flat Tire Inflation See: Temporary Mobility Kit.....	197
Floor Mats.....	164
Fog Lamps - Front See: Front Fog Lamps.....	52
Fog Lamps - Rear See: Rear Fog Lamps.....	53
Four-Wheel Drive.....	124
Principle of Operation.....	124
Front Fog Lamps.....	52
Fuel and Refueling.....	113
Technical Specifications.....	118
Fuel Burning Heater See: Auxiliary Heater.....	95
Fuel Consumption.....	117
Calculating Fuel Economy.....	118
Filling the Tank.....	117
Fuel Consumption See: Technical Specifications.....	118
Fuel Quality - Diesel.....	114
Long-Term Storage.....	114
Fuel Quality - Gasoline.....	114
Long-Term Storage.....	114
Fuel Shutoff.....	166
Fuse Box Locations.....	168
Engine Compartment Fuse Box.....	168
Luggage Compartment Fuse Box.....	169
Passenger Compartment Fuse Box.....	168
Pre-Fuse Box.....	168
Fuses.....	168
Fuse Specification Chart.....	169
Engine Compartment Fuse Box.....	169
Luggage Compartment Fuse Box.....	175
Passenger Compartment Fuse Box.....	173
<b>G</b>	
Gauges.....	63
Engine Coolant Temperature Gauge.....	64
Fuel Gauge.....	64
Information Display.....	63
General Information on Radio Frequencies.....	29
Global Opening and Closing.....	61
Global Closing.....	61
Global Opening.....	61
<b>H</b>	
Handbrake See: Parking Brake.....	129
Hazard Warning Flashers.....	166
Headlamp Exit Delay.....	50
Headlamp Leveling.....	53
Recommended Headlamp Leveling Switch Positions.....	53
Headlamp Washers.....	48
Head Restraints.....	96
Adjusting the Head Restraint.....	97
Heated Seats.....	100
Heated Windows and Mirrors.....	94
Heated Exterior Mirror.....	94
Heated Rear Window.....	94
Heated Windshield.....	94
Heating See: Climate Control.....	87
Hill Start Assist.....	122
Switching the System On and Off.....	122
Using Hill Start Assist.....	122

# Index

Hints on Controlling the Interior	
Climate.....	91
Cooling the Interior Quickly.....	92
General Hints.....	91
Heating the Interior Quickly.....	92
Maximum Cooling Performance in Instrument Panel or Instrument Panel and Footwell Positions.....	94
Recommended Settings for Cooling .....	93
Recommended Settings for Heating.....	92
Side Window Defogging in Cold Weather.....	93
Vehicle Stationary for Extended Periods During Extreme High Ambient Temperatures.....	93
Hints on Driving With Anti-Lock Brakes.....	129
Hood Lock See: Opening and Closing the Hood.....	179
<b>I</b>	
Ignition Switch.....	105
Information Display Control.....	45
Multimedia Controls.....	45
Information Displays.....	68
General Information.....	68
Information Messages.....	74
Active City Stop.....	74
Airbag.....	74
Alarm.....	75
Automatic High Beam Control.....	75
Battery and Charging System.....	75
Blind Spot Monitor and Cross Traffic Alert System.....	76
Child Power Lock.....	76
Climate Control.....	77
Cruise Control and Adaptive Cruise Control (ACC).....	77
Doors.....	78
Driver Alert.....	77
Engine.....	79
Hill Start Assist.....	79
Keyless Vehicle.....	79
Lane Keeping Aid.....	80
Lighting.....	80
Maintenance.....	81
Message Indicator.....	74
Occupant Protection.....	81
Parking Aid.....	82
Parking Brake.....	82
Power Steering.....	83
Starting System .....	84
Start-Stop.....	83
Towing.....	84
Traction Control.....	86
Transmission and Four-Wheel Drive.....	85
Installing Child Seats.....	19
Attaching a Child Seat with Top Tethers.....	21
Booster Seats.....	20
Child Seats for Different Mass Groups.....	19
ISOFIX Anchor Points.....	21
Top Tether Anchor Points.....	21
Instrument Cluster.....	63
Instrument Lighting Dimmer.....	50
Interior Lamps.....	54
Front Interior Lamp .....	55
Rear Interior Lamp.....	55
Interior Mirror.....	59
Auto-Dimming Mirror.....	59
Introduction.....	5

# Index

## J

Jump-Starting the Vehicle.....	166
To Connect the Booster Cables.....	167
To Start the Engine.....	167

## K

Keyless Entry.....	37
Disabled Keys.....	38
General Information.....	37
Locking and Unlocking the Doors with the Key Blade.....	39
Locking Your Vehicle.....	37
Passive Key.....	37
Unlocking Your Vehicle.....	38
Keyless Starting.....	105
Failure to Start.....	106
Fast Restart.....	107
Starting Your Vehicle.....	106
Stopping the Engine When Your Vehicle is Moving.....	107
Stopping the Engine When Your Vehicle is Stationary.....	107
Switching the Ignition On (Accessory Mode).....	106
Keys and Remote Controls.....	29
Knee Airbag.....	27

## L

Lane Keeping System.....	150
Lane Keeping Aid.....	151
Lane Keeping Alert.....	150
Lighting Control.....	49
Headlamp Flasher.....	50
High Beam.....	49
Lighting.....	49
General Information.....	49
Load Carriers	
See: Roof Racks and Load Carriers.....	158
Load Carrying.....	156
General Information.....	156

Locking and Unlocking.....	32
Locking and Unlocking the Doors from Inside.....	33
Locking and Unlocking the Doors with the Key.....	33
Locking the Doors Individually with the Key.....	33
Power Door Locks.....	32
Power Liftgate.....	33
Remote Control.....	32
Locks.....	32
Luggage Anchor Points.....	157
Luggage Retention Nets.....	158
Luggage Covers.....	157
Lug Nuts	
See: Changing a Road Wheel.....	201

## M

Maintenance.....	179
General Information.....	179
Technical Specifications.....	193
Manual Climate Control.....	88
Manual Liftgate.....	34
Closing the Liftgate.....	34
Opening the Liftgate.....	34
Manual Seats.....	98
Adjusting the Height of the Driver's Seat.....	98
Adjusting the Lumbar Support.....	98
Moving the Seat Backward and Forward.....	98
Recline Adjustment.....	98
Manual Transmission.....	119
Selecting Reverse Gear.....	119
Message Center	
See: Information Displays.....	68
Mirrors	
See: Heated Windows and Mirrors.....	94
See: Windows and Mirrors.....	57
Mobile Communications Equipment.....	8
Moonroof.....	60
Bounce-Back.....	60
Opening and Closing the Moonroof.....	60
Opening and Closing the Sunscreen.....	60
Venting the Moonroof.....	61



# Index

## N

Navigation.....	275
Hazard Spot Warning.....	278
Information.....	276
Navigation Map Updates.....	278
Road Safety.....	275
Route Options Menu.....	276
Setting Your Navigation Preferences.....	276
Type Approvals.....	279
Using Navigation.....	275

## O

Oil Check	
See: Engine Oil Check.....	183
Opening and Closing the Hood.....	179
Closing the Hood.....	180
Opening the Hood.....	179
Overhead Console.....	104

## P

Parking Aid.....	133
Parking Aids.....	133
Principle of Operation.....	133
Parking Brake.....	129
Passenger Airbag.....	27
.....	27
Switching the Passenger Airbag Off.....	27
Switching the Passenger Airbag On.....	27
Passive Anti-Theft System.....	40
Arming the Engine Immobilizer.....	40
Coded Keys.....	40
Disarming the Engine Immobilizer.....	40
Principle of Operation.....	40
PATS	
See: Passive Anti-Theft System.....	40
Personalized Settings.....	73
Measure Units.....	73
Switching Chimes Off.....	73
Power Door Locks	
See: Locking and Unlocking.....	32
Power Liftgate.....	35
Closing the Liftgate.....	36
Hands-Free Feature.....	36
Programming the Liftgate.....	36

Power Seats.....	99
10-Way.....	99
Power Lumbar.....	100
Power Windows.....	57
Accessory Delay.....	58
Bounce-Back.....	57
One-Touch Down.....	57
One-Touch Up.....	57
Window Lock.....	57

## R

Rear Fog Lamps.....	53
Rear Seat Armrest.....	101
Rear Seats.....	100
Folding the Seatback.....	100
Recline Adjustment.....	100
Unfolding the Seatback.....	100
Rear Under Floor Storage.....	156
Adjustable Load Floor.....	157
Cargo Management System.....	156
Passenger Compartment Floor.....	156
Rear View Camera.....	137
Switching the Rear View Camera Off.....	138
Switching the Rear View Camera On.....	137
Using the Display.....	137
Vehicles with Parking Aid.....	138
Rear View Camera	
See: Rear View Camera.....	137
Rear Window Wiper and Washers.....	47
Rear Window Washer.....	48
Rear Window Wiper.....	47
Refueling.....	116
Remote Control.....	29
Changing the Remote Control Battery.....	29
Remote Control with a Folding Key	
Blade.....	29
Remote Control without a Folding Key	
Blade.....	30
Reprogramming the Unlocking	
Function.....	29
Removing a Headlamp.....	186
Repairing Minor Paint Damage.....	195

# Index

Replacement Parts	
Recommendation.....	8
Collision Repairs.....	8
Scheduled Maintenance and Mechanical Repairs.....	8
Warranty on Replacement Parts.....	8
Replacing a Lost Key or Remote Control.....	31
Roadside Emergencies.....	166
Roof Racks and Load Carriers.....	158
Running-In	
See: Breaking-In.....	164
Running Out of Fuel.....	114
Refilling with a Portable Fuel Container.....	115
<b>S</b>	
Safety Belt Height Adjustment.....	24
Safety Belt Minder.....	24
Rear Safety Belt Minder.....	24
Switching the Safety Belt Minder Off.....	24
Safety Belts.....	23
Safety Precautions.....	113
Seat Back Trays.....	104
Seats.....	96
Security.....	40
Side Airbags.....	28
Side Curtain Airbags.....	28
Sitting in the Correct Position.....	96
Snow Chains	
See: Using Snow Chains.....	201
Speed Control	
See: Cruise Control.....	139
Speed Limiter.....	147
Principle of Operation.....	147
Using the System.....	147
Stability Control.....	132
Principle of Operation.....	132
Starter Switch	
See: Ignition Switch.....	105
Starting a Diesel Engine.....	109
Cold or Hot Engine.....	109
Failure to Start.....	109
Starting a Gasoline Engine.....	108
Cold or Hot Engine.....	108
Engine Idle Speed after Starting.....	109
Failure to Start.....	109
Flooded Engine.....	108
Starting and Stopping the Engine.....	105
General Information.....	105
Start-Stop.....	111
To Re-Start the Engine.....	112
To Stop the Engine.....	111
Using Start-Stop.....	111
Steering Wheel Lock.....	107
Vehicles with Keyless Starting.....	108
Vehicles without Keyless Starting.....	107
Steering Wheel.....	43
Storage Compartments.....	104
Sunroof	
See: Moonroof.....	60
Sun Visors.....	59
Illuminated Vanity Mirror.....	60
Supplementary Restraints System.....	26
Principle of Operation.....	26
Switching Off the Engine.....	110
Vehicles With a Turbocharger.....	110
Symbols Glossary.....	5
SYNC™ Applications and Services.....	261
In the Event of a Crash.....	262
Switching Emergency Assistance On and Off.....	262
SYNC Emergency Assistance.....	261
SYNC™.....	247
General Information.....	247
SYNC™ Troubleshooting.....	268
<b>T</b>	
Technical Specifications	
See: Capacities and Specifications.....	210
Temporary Mobility Kit.....	197
Checking the Tire Pressure.....	200
General Information.....	197
Inflating the Tire.....	198
Using the Kit.....	197
Tire Care.....	201
Tire Inflation When Punctured	
See: Temporary Mobility Kit.....	197
Tire Repair Kit	
See: Temporary Mobility Kit.....	197

# Index

Tires	
See: Wheels and Tires.....	197
Tow Ball.....	159
Driving with a Trailer.....	161
Driving without a Trailer.....	161
Inserting the Tow Ball Arm.....	160
Maintenance.....	162
Removing the Tow Ball Arm.....	161
Unlocking the Tow Ball Arm	
Mechanism.....	160
Towing a Trailer.....	159
Steep Gradients.....	159
Towing Points.....	162
Towing the Vehicle on Four	
Wheels.....	163
All Vehicles.....	163
Vehicles with Automatic	
Transmission.....	163
Towing.....	159
Traction Control.....	131
Principle of Operation.....	131
Traffic Sign Recognition.....	152
Principle of Operation.....	152
Using the System.....	153
Trailer Sway Control.....	162
Transmission.....	119
Transmission	
See: Transmission.....	119
Trip Computer.....	73
All Value.....	73
Average Fuel.....	73
Fuel Used.....	73
Resetting the Trip Computer.....	73
Trip Odometer.....	73
<b>U</b>	
Under Hood Overview - 1.6L EcoBoost	
(132kW/180PS) - Sigma.....	181
Under Hood Overview - 2.0L	
Duratorq-TDCi (DW) Diesel.....	182
Unique Driving Characteristics.....	111
USB Port.....	246
Using Adaptive Cruise Control.....	140
Automatic Braking.....	141
Automatic Switch Off.....	143
Changing the Set Speed.....	142
Detection Beam Issues.....	141
Forward Alert Function.....	144
Setting a Speed.....	142
Setting the Vehicle Gap.....	142
Standby Mode.....	143
Switching the System Off.....	143
Switching the System On.....	142
Using the System.....	142
Using Cruise Control.....	139
Switching Cruise Control Off.....	139
Switching Cruise Control On.....	139
Using Four-Wheel Drive.....	124
Driving in Special Conditions With	
Four-Wheel Drive.....	124
Using Snow Chains.....	201
Vehicles with Stability Control.....	201
Using Stability Control.....	132
.....	132
Using SYNC™ With Your Media	
Player.....	264
Accessing Your USB Song Library.....	267
Bluetooth Devices and System	
Settings.....	268
Connecting Your Media Player to the USB	
Port.....	264
Media Menu Features.....	266
Media Voice Commands.....	264
What is Playing?.....	264
Using SYNC™ With Your Phone.....	251
Accessing Features Through the Cell Phone	
Menu.....	255
Accessing Your Cell Phone Settings.....	257
Bluetooth Devices.....	259
Cell Phone Options During an Active	
Call.....	254
Cell Phone Voice Commands.....	252
Making a Call.....	254
Pairing a Cell Phone For the First	
Time.....	251
Pairing Subsequent Cell Phones.....	251
Receiving a Call.....	254
Text Messaging.....	256
Using Traction Control.....	131

# Index

Using Voice Recognition.....	248	Warning Triangle.....	166
Helpful Hints.....	248	Washer Fluid Check.....	184
Initiating a Voice Session.....	249	Washers	
System Interaction and Feedback.....	249	See: Cleaning the Exterior.....	195
Using Winter Tires.....	201	See: Wipers and Washers.....	46
<b>V</b>		Wheel Nuts	
Vehicle Care.....	195	See: Changing a Road Wheel.....	201
Vehicle Identification Number.....	211	Wheels and Tires.....	197
Vehicle Identification Plate.....	210	General Information.....	197
Ventilation		Technical Specifications.....	208
See: Climate Control.....	87	Windows and Mirrors.....	57
Vents		Windshield Washers.....	47
See: Air Vents.....	87	Windshield Wipers.....	46
VIN		Intermittent Wipe.....	46
See: Vehicle Identification Number.....	211	Speed dependent wipers (if	
Voice Control.....	45	equipped).....	46
<b>W</b>		Winter Tires	
Warning Lamps and Indicators.....	64	See: Using Winter Tires.....	201
Anti-Lock Braking System Warning		Wipers and Washers.....	46
Lamp.....	64		
Automatic High Beam Lamp.....	64		
Battery Warning Lamp.....	64		
Blind Spot Monitor Indicator.....	64		
Brake System Warning Lamp.....	64		
Cruise Control Indicator.....	65		
Direction Indicator.....	65		
Engine Oil Warning Lamp.....	65		
Engine Warning Lamps.....	65		
Fasten Safety Belt Warning Lamp.....	66		
Front Airbag Warning Lamp.....	66		
Front Fog Lamps Indicator.....	66		
Frost Warning Lamp.....	66		
Glow Plug Indicator.....	66		
Headlamp and Parking Lamp			
Indicator.....	66		
High Beam Indicator.....	66		
Information Indicator.....	66		
Lane Keeping System Indicator.....	66		
Low Fuel Level Warning Lamp.....	66		
Rear Fog Lamps Indicator.....	66		
Shift Indicator.....	66		
Stability Control Off Indicator.....	67		
Stability Control Warning Lamp.....	67		
Start-Stop Indicator.....	67		



