



PostBase

Mailing System



Operator Manual
Reference Guide

About this Manual

Please read this manual before installing and using the Post-Base mailing system. Please keep this manual near the system for quick reference.

Further documents

The **Installation instructions** (flyer) and the **First steps** manual which were supplied with your mailing system contain all relevant information on installing, commissioning and handling the PostBase mailing system.

Information on available product variants and country-specific particularities can be found in the **Addendum to the Operator Manual** (if available in your country).

This manual covers all configurations and equipment options of the PostBase mailing system. Functions that are only available for particular system configurations are marked by an additional note, e.g. (optional).

Functions or information that are not available in all countries are identified as *not available in all countries*.

As currency, Euros are used exemplarily.

PostBase

In this manual, the product name appears in its plain form 'PostBase'.

The following keywords and signs identify the safety tips in this manual:



Warning! indicates a potential hazard that may result in injury.



Caution! indicates a potential hazard that may result in damage to the mailing system or impair the franking process.



Caution! indicates an automatic machine operation that may result in the user being startled.

The following symbols and text features are used in this manual:

- Bullets precede instructions.
- Dashes precede list items.

Menu names and options from the operating menu are written in small capitals, e.g. MENU.



A tip offers advice or additional suggestions for improving the operation.

About this Manual	2
1 Safety tips	7
2 A short description of the PostBase	9
2.1 PostBase franking machine – overview	9
2.2 Feeder – overview (<i>optional</i>)	11
2.3 Things worth knowing about PostBase	12
3 Installation	15
Step 1: Unpacking and checking the contents of the package	15
Step 2: Assembling PostBase	16
Step 3: Connecting PostBase	20
Step 4: Installing PostBase	21
Step 5: Setting up PostBase	22
Step 6: Installing the feeder (<i>optional</i>)	23
4 The basics of operation	29
4.1 Turning the PostBase on / off	29
4.2 Standby	30
4.3 Adjusting the display inclination	30
4.4 Setting up the label dispenser (<i>optional</i>)	31
4.5 Setting up the catch tray	32
4.6 Screen elements and operation philosophy	33
4.6.1 The touch screen	33
4.6.2 The Home screen	35
4.6.3 The Product calculation menu	36
4.6.4 The Menu	37
4.6.5 Lists	38
4.6.6 Adjustment menus	38
4.6.7 Pop-up windows	40
4.6.8 Procedures (wizards)	40
4.7 Test print	41
5 Setting the franking imprint	44
5.1 Postage / product	45
5.1.1 Setting a product via shortcut	45
5.1.2 Setting postage manually (<i>not in all countries</i>)	46
5.1.3 Setting mailing data	46
5.1.4 Weighing the mail piece	47
5.1.4.1 Normal weighing	47
5.1.4.2 Changing the weighing mode (<i>only if 'Differential weighing' is available</i>)	48
5.1.4.3 Differential weighing (<i>optional</i>)	49

5.2	Advertising imprints _____	51
5.3	Imprint offset <i>(not in all countries)</i> _____	52
5.4	Date <i>(not in all countries)</i> _____	53
6	Franking _____	54
6.1	Changing the user _____	54
6.2	Changing the account _____	55
6.3	Positioning and franking letters _____	56
6.3.1	Hand feed tray _____	56
6.3.2	Sealer <i>(optional)</i> _____	57
6.3.3	Feeder <i>(optional)</i> _____	60
6.3.3.1	Preparing the letter stack and setting up the feeder _____	60
6.3.3.2	Switch on / off seal function _____	62
6.3.3.3	Setting letter thickness _____	62
6.3.3.4	Positioning and franking letters in stack _____	63
6.3.3.5	Using the batch counter _____	64
6.4	Franking labels <i>(optional)</i> _____	66
6.5	Displaying and clearing down the item counter _____	68
6.6	Controlling PostBase via PC software – ‘Connected’ mode _____	68
7	Displaying and printing registers _____	69
8	Download postage _____	70
9	Special functions _____	71
9.1	Advert Only _____	71
9.2	Print Numbers _____	72
9.3	Feed Only / Count mail pieces _____	74
9.4	Seal Only <i>(optional)</i> _____	75
10	Advanced settings & system information _____	76
10.1	System information _____	76
10.2	Display brightness _____	76
10.3	Tone signals _____	77
10.4	Account administration _____	78
10.4.1	Switch account administration on / off _____	78
10.4.2	Display account information _____	79
10.4.3	Set one account to zero _____	79
10.4.4	Set all accounts to zero _____	79
10.5	Standby time _____	80
10.6	Auto Off _____	80

10.7	Meter type (<i>not in all countries</i>)	81
10.8	User interface language	82
10.9	Setting up the connection with the data center	83
10.10	View / change contact information	84
10.11	Access control / PIN	85
10.12	Auto Postage Download	86
10.13	Remote Services	88
10.14	Change ZIP / postal code (<i>not in all countries</i>)	88
11	Maintenance and care	89
11.1	Cleaning the PostBase mailing system	89
11.2	Changing the ink cartridges	90
11.3	Aligning ink cartridges	95
11.4	Cleaning the print system	96
11.4.1	Starting automatic print system cleaning	96
11.4.2	Cleaning ink cartridges by hand	97
11.5	Print system: displaying filling level	98
11.6	Replacing the transport brush	99
11.7	Feeder (<i>optional</i>)	101
11.7.1	Filling with sealing liquid	101
11.7.2	Adjust moistening level	104
11.7.3	Cleaning / changing the moistening sponge	105
11.7.4	Cleaning / changing the moistening brush	109
11.8	Sealer (<i>optional</i>)	111
11.8.1	Cleaning	111
11.8.2	Checking the liquid level and filling 'sealit' sealing liquid	112
11.8.3	Replacing felts	113
12	Tips for troubleshooting	116
12.1	Error messages and help	116
12.2	Removing letter jams in the franking machine	124
12.3	Removing letter jams in the feeder	125
12.4	Correcting the moistening felt position on the rocker (<i>sealer</i>)	126
12.5	Cleaning the sensors of the PostBase	127
12.6	Cleaning the sensors of the feeder	129
12.7	Removing / inserting the security device	130
12.8	Manually ejecting the ink cartridges	132
12.9	Calibrating the touch screen	133
13	Decommissioning and disposing of the franking machine	134

Appendix

Overview of symbols _____	135
Technical Data _____	140
Declaration of conformity _____	144
License _____	145
Security Declaration for data usage _____	147
United States Patents _____	147
FCC Compliance Statement _____	147
External USB modem (<i>optional</i>) _____	148
Index _____	149
Customer Support / Warranty _____	159

1 Safety tips

PostBase is a digital mailing system with ink-jet print technology for franking mail. PostBase complies with the pertinent safety regulations for office information equipment.

Please observe the following tips for your own safety:

Prevention of electrical hazards

- Operate the PostBase only on a grounded single-phase power socket. Make sure your office power supply conforms to the power requirements indicated on the serial number plates.
- Make sure the sockets for connecting the mailing system are close by and easily accessible at all times.
- Unplug the plugs in case of an emergency. Call the Customer Support.
- Take special care that no foreign objects penetrate the system's interior.
- Be extremely careful when handling liquids.
- When filling with sealing liquid, make sure not to wetten any parts connected to the mains.
- Unplug the plugs prior to cleaning the PostBase mailing system.

Prevention of mechanical hazards

- Keep long hair, fingers, loose clothing pieces, neck ties, shawls, jewelry and the like away from moving machine parts.
- Do not remove any parts of the housing.
- Do not remove any equipment related to safety or protection. Do not make them inoperative or unable to function.

Accessories and consumables

- We recommend to use only approved FP equipment and FP original parts. The manufacturer FP has established reliability, safety and applicability. The manufacturer cannot assess the reliability, safety and applicability for products not approved by FP, and therefore not vouch for such products.
- Use the supplied power and connection cables or cables that have been approved by Francotyp-Postalia. Make sure that cables are not damaged.
- Ingestion of the ink can be hazardous. Avoid contact with the eyes. Keep the ink cartridges away from children. Further instructions for use are enclosed with the ink cartridges.
- We recommend to use only the batteries provided by Francotyp-Postalia. The manufacturer FP has established reliability, safety and applicability. Observe the instructions enclosed with the battery for correct use and disposal.

General safety tips

- Install the PostBase mailing system according to the instructions.
- Do not use attached parts like the weighing platform, label compartment, display, drawer, ... as 'handles' during transport. The best way to handle the components is to hold them at the lower part of the housing at the clearances on both sides.
- When you move the PostBase from a cold environment (i.e. below 10 °C / 50°F): Unpack the PostBase and wait at least 2 hours before connecting the PostBase. The PostBase requires this period to adapt to the ambient conditions. Any condensation evaporates.
- Use the 'Feeder PostBase' only with the PostBase franking machine. It is not possible to operate the feeder without the PostBase franking machine.
- Have maintenance and repair work done only by qualified personnel authorized by Francotyp-Postalia. Otherwise, your warranty may become void.
- Do not be startled while positioning letters. Letter transport will start after a short delay.

2 A short description of the PostBase

2.1 PostBase franking machine – overview

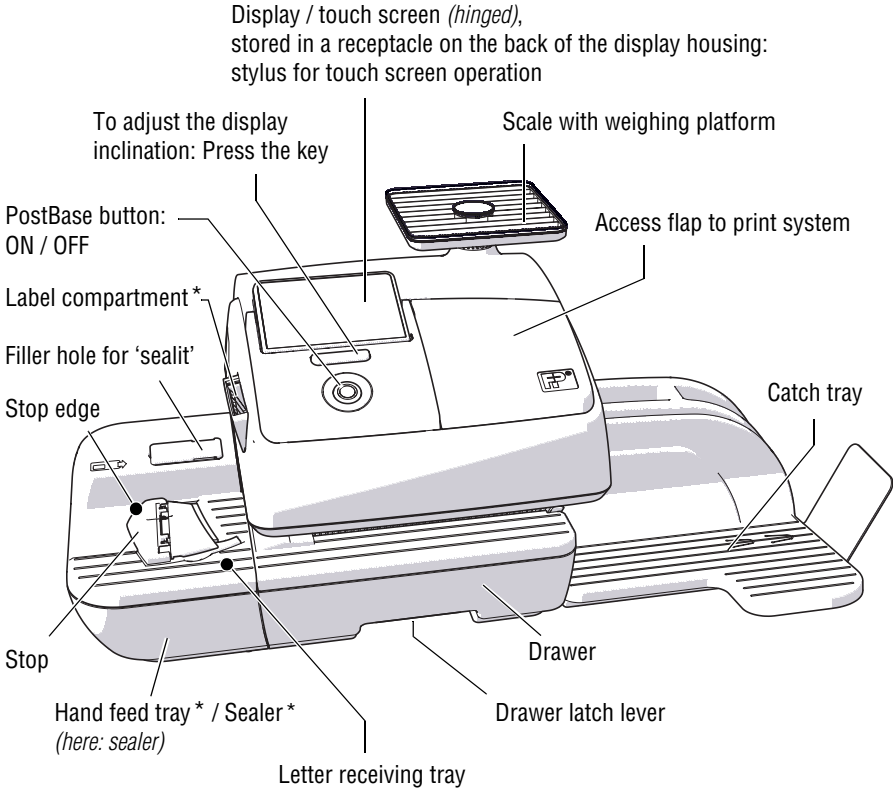

* optional / not all product variants

Franking machine – rear view

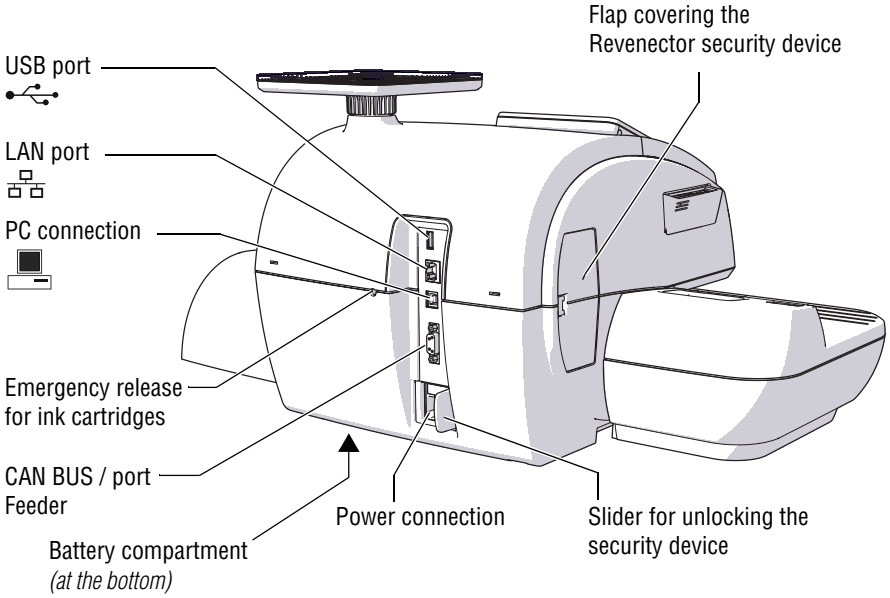

2.2 Feeder – overview *(optional)*

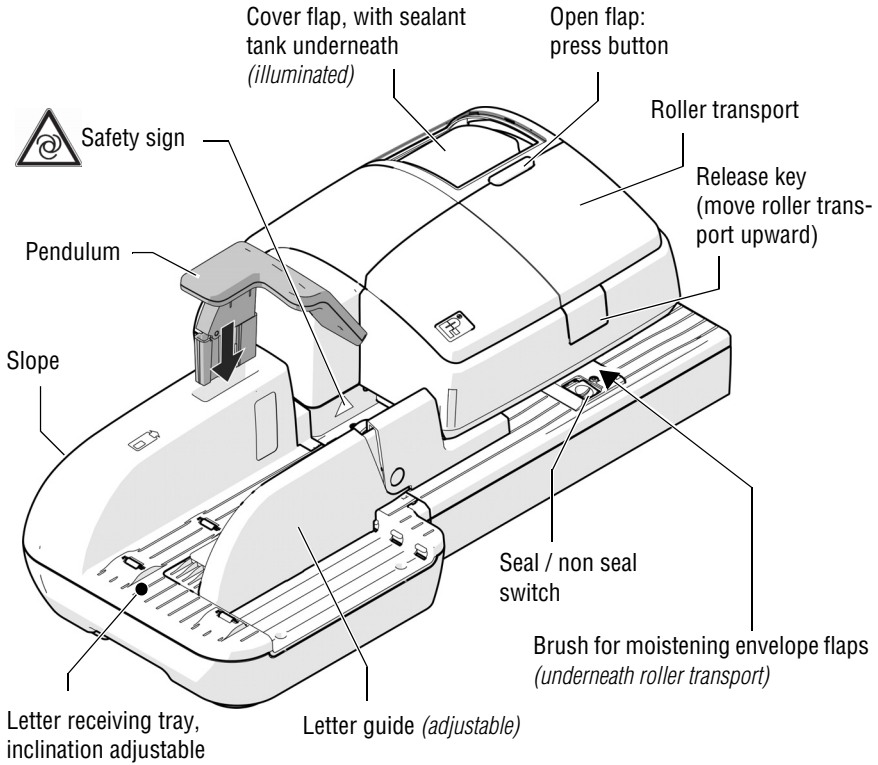

Feeder – rear view

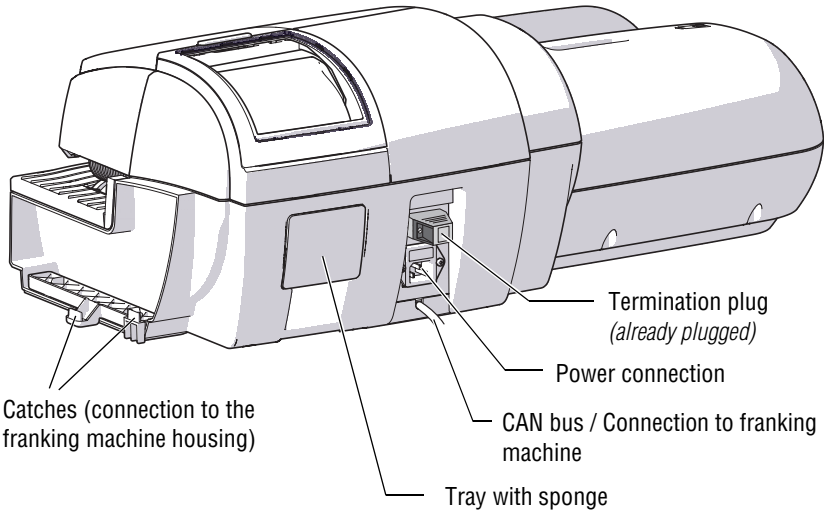

(View without pendulum)

2.3 Things worth knowing about PostBase

PostBase is a digital mailing system featuring a touch screen and ink-jet print technology.

Modular design

In its basic version, the mailing system consists of the PostBase franking machine with integrated scale, a hand feed tray and a letter catch tray.

This basic version can easily be extended with optional components.

<i>Franking</i>	<p>To frank a letter, simply position it with the side to be printed on facing up – PostBase will seize the letter and frank it, after which it is exited to the right side ready for dispatch.</p> <p>Franking is possible on mail pieces made of ink-absorbing material – postcards to 10 mm (0.4") thick letters in ISO B4 format – and special self-adhesive labels.</p>
<i>Letters as advertising medium</i>	<p>In addition to printing postage, you can print custom advertisements of your choice and text messages on every mail piece you send <i>(not available in all countries)</i>.</p>
<i>Download postage</i>	<p>Load postage from the data center directly into your franking machine – fast, easy and, if need be, 24 hours a day <i>(not available in all countries)</i>.</p>
<i>Flexible and up to date</i>	<p>The PostBase franking machine ensures you are always using the current postal rates. Whether new postage rates or new adverts – the data center loads current data directly into your franking machine.</p>
<i>Access control</i>	<p>The PostBase franking machine can be protected against unauthorized use via a PIN.</p>
<i>Additional functions</i>	<p>The PostBase mailing system offers a range of convenient additional functions. Among these are:</p> <ul style="list-style-type: none"> – Scale. The space saving, integrated scale quickly and reliably determines the weight for letters and parcels. The determined weight directly affects the product settings. – Shortcut function for frequently used postal products. – Account function for separate registration and billing of postage costs. – Print lists of register states and loading report. – Variable imprint offset for changing the franking imprint position on the envelope <i>(not available in all countries)</i>.

Options

The following features are available for functionality extension:

- **Label dispenser** to print self-adhesive labels, for large or thick mail pieces or for envelopes that are not suited for ink-jet printing.
- **Feeder.** Automatic feeder with sealer for the PostBase. The letters are separated from the stack, optionally moistened and sealed, and fed to the PostBase franking machine.
- **Sealer.** Manually pass the open envelope through the sealer. The moistened flap will be closed in the PostBase during subsequent franking. *(Not available in all countries.)*
- **Differential weighing.** A special weighing mode of the integrated scale that helps you save time when weighing and franking large amounts of similar mail pieces.
- **Controlling PostBase via PC software.** FP offers software for controlling and administration of the franking machine via PC, e.g. Navigator, RemoteOne, ReportOne, MailOne *(not available in all countries).*

3 Installation

Step 1: Unpacking and checking the contents of the package



Warning! Do not start operating PostBase if parts are damaged or missing. Please contact the Customer Support.



Caution! Carry out the steps exactly in the given order. Also, consult the installation instructions (fold-out).

- Unpack the packages.
- Check that the contents of the packages are complete and free from any damage.



Keep the packing. Use it again when you need to transport PostBase or send it in to the Customer Support.

Scope of delivery

- PostBase franking machine
- Hand feed tray (*not all product variants*)
- Catch tray with stop
- Weighing platform (*version as ordered*)
- Power cable
- USB cable
- Ethernet cable
- Ink cartridge set
- Franking labels
- ‘First steps’ manual
- Installation instructions (flyer).

Optional, only when ordered separately

- Sealer
- External USB modem incl. modem cable (*not available in all countries*)
- Feeder incl. slope, pendulum, power cable, termination plug, replacement sponge holder with sponge
- ‘sealit’ sealing liquid.

Step 2: Assembling PostBase



Caution! When you move PostBase from a cold environment (i.e. below 10 °C / 50 °F): Unpack the PostBase and wait at least 2 hours before connecting PostBase. PostBase requires this period to adapt to the ambient conditions.

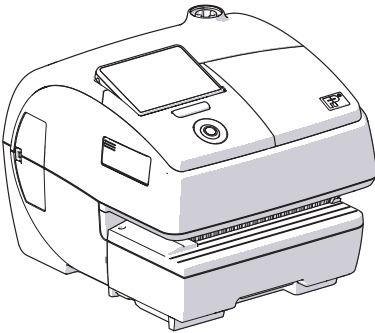

- Choose an installation site with the following ambient conditions:
 - room temperature: 15 °C to 35 °C (59 °F to 95 °F)
 - no direct sunlight
 - power socket in the immediate vicinity
 - network connection with internet access

or

 - telephone socket for modem connection in the immediate vicinity (*not in all countries*).
- Place PostBase on a firm, level, low vibration and horizontal base.



Caution! Do not connect and install the feeder until step 6. Prior to this, the PostBase franking machine has to be installed completely. Otherwise, the feeder will not be recognized and the mailing system will not work.

PostBase with hand feed tray

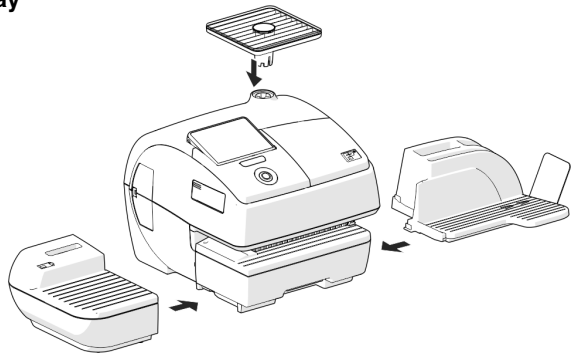

PostBase with sealer

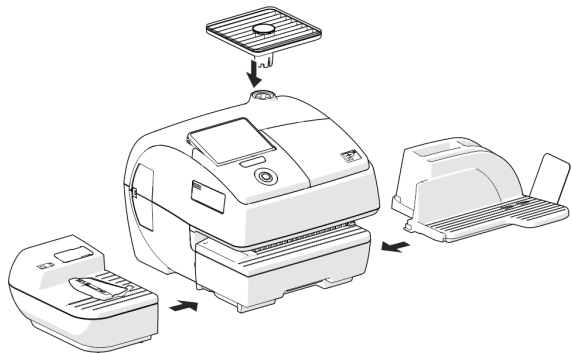

Details on how to assemble the modules can be found on the following pages.

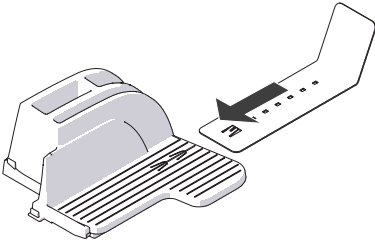

Catch tray: attaching the stop

- Attach the stop to the catch tray: Slide the stop into the guides on the catch tray bottom.

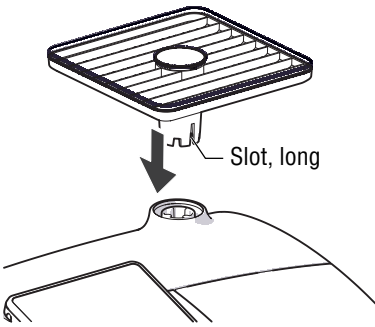

Mounting the weighing platform

- Hold the weighing platform such that the long slot in the weighing platform foot points to the front.
- Place the weighing platform onto the scale receptacle from above. The long slot of the weighing platform must slide in the counterpart on the scale receptacle.
- Press down slightly on the weighing platform with your flat hand.

Mounting catch tray and feeding device

- Place the respective attachment next to the franking machine (see overviews on previous page).
- Slightly lift the franking machine on the side on which you wish to mount the attachment. The bottom side of the housing features slots where the attachments are fastened.
- Push the respective attachment underneath the franking machine such that the catches on the attachment engage in the slots.
- Put the franking machine carefully down.

Sealer: filling 'sealit' sealing liquid

- Swing the filler hole lid aside.

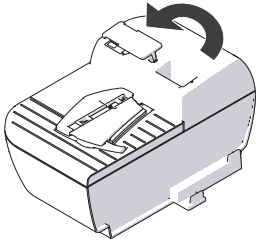

- Fill the sealer with 'sealit' sealing liquid.
- Check the liquid level.
The liquid level in the sealer should roughly reach to the 'max' mark.

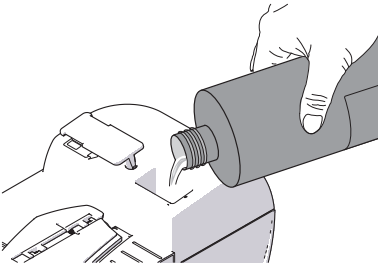

- Swing the filler hole lid back on.
- If necessary: dry the sealer outside.

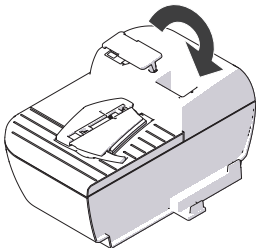

Step 3: Connecting PostBase



Warning! Use the power and connection cables provided with the PostBase or approved by Francotyp-Postalia. Make sure that cables are not damaged. Connect PostBase only to a grounded single-phase power socket. Make sure your office power supply conforms to the power requirements indicated on the serial number plates.

Make sure the socket for connecting PostBase is close by and easily accessible at all times.

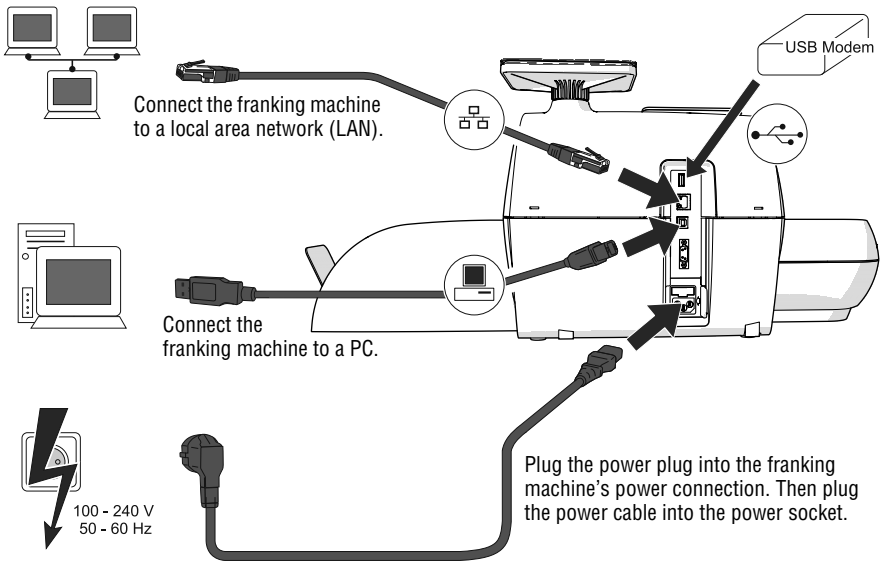

Step 4: Installing PostBase

PostBase button

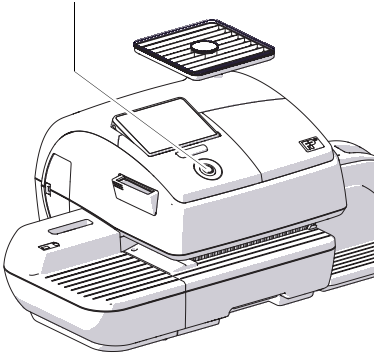

- Turn PostBase on: Press the PostBase button.

The display lighting and button illumination switch on. PostBase performs a self test and then starts the installation procedure.

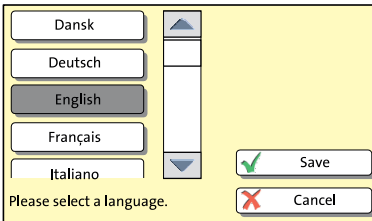

- Follow the instructions on the display.

PostBase will guide you step by step through the installation procedure:

- Select language
- Set connection parameters
- Enter repository PIN (R-PIN)
- Software update
- Insert cartridges
- Load postage / contact server.

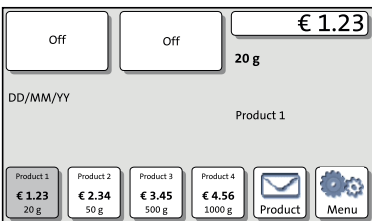

Installation is complete.



For information on handling the touch screen and an overview of screen elements, please read chapter 4.6.

Step 5: Setting up PostBase

You can now configure the system settings.
Refer to the Reference Guide, chapter “Advanced settings & system information”.



PIN protection



Cost account feature



Auto Postage Download *(not in all countries)*



Tone signals



Display settings



Language



Standby time



Auto Off

Step 6: Installing the feeder (optional)



Caution! Prior to connecting and installing the feeder, the PostBase franking machine has to be installed completely. Otherwise, the PostBase will not recognize the feeder and the mailing system will not work.

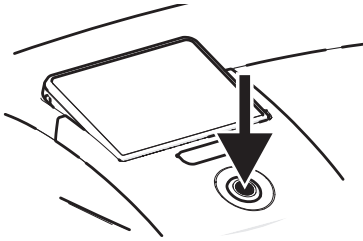

- Turn the franking machine off: Press the PostBase button for three seconds.

Assembling the feeder

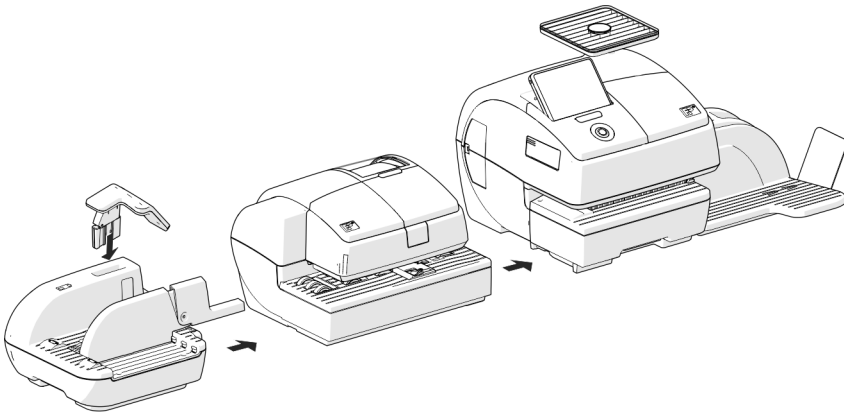

Connecting the feeder

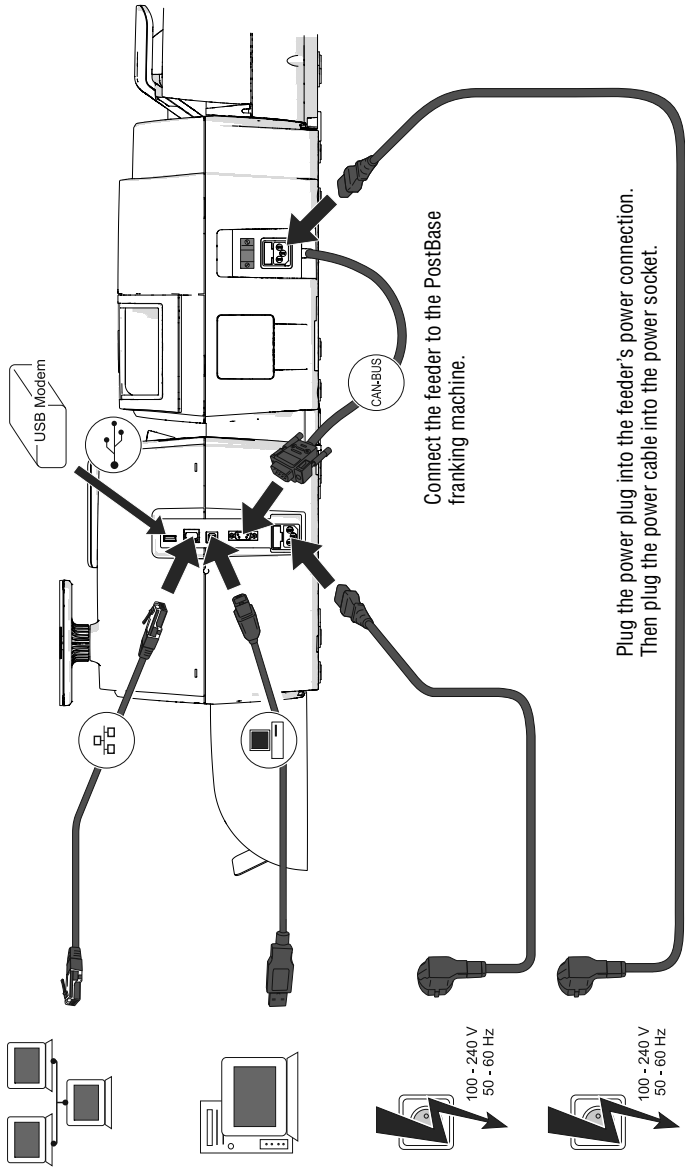

Filling with sealing liquid



Warning! Be extremely careful when handling liquids. If you fill the sealant tank, make sure not to wetten any parts connected to the mains. If this should happen, immediately pull the power plugs. Have the PostBase mailing system checked by the Customer Support before using it again.

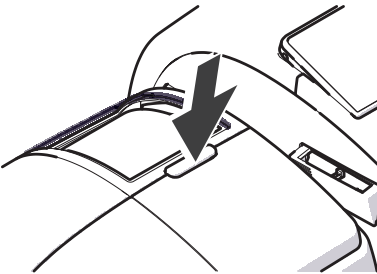

- Open the flap by pressing the release button.

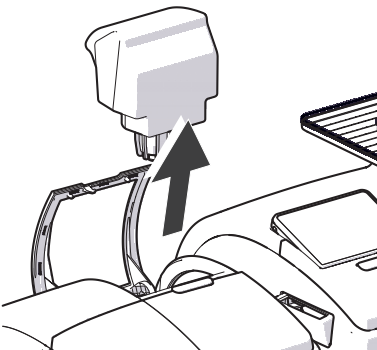

- Remove sealant tank out of the housing and put it at a safe place.

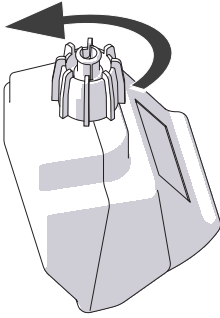

- Unscrew sealant tank cover.

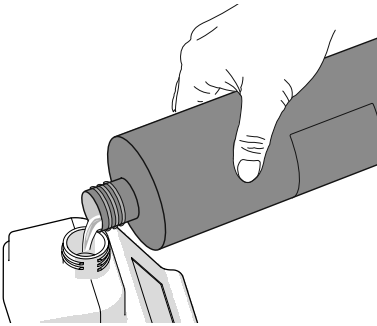

- Fill the sealant tank with 'sealit' sealing liquid.

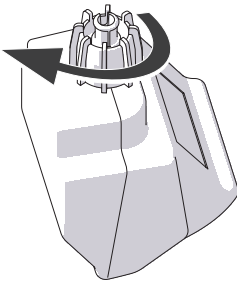

- Place sealant tank screw cover and tighten.
- Turn sealant tank upside down in a non-dangerous area (e.g. over a sink) to check if the cover is well sealed.

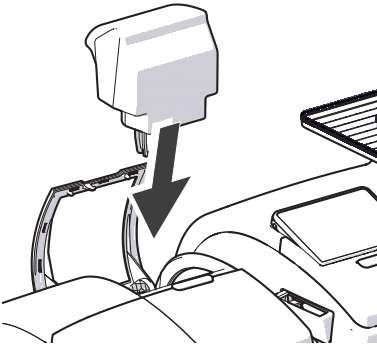

- Insert sealant tank into the housing with the cover downward.

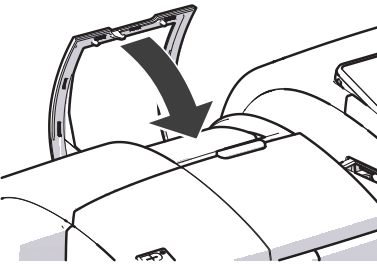

- Close the flap.

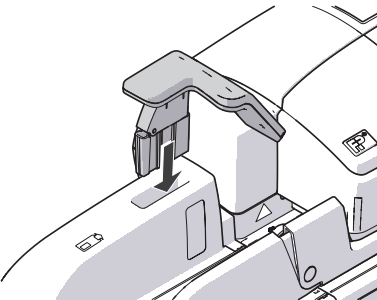

Attach the pendulum

- Insert the base of the pendulum into the fixture of the slope.
- Press down on the pendulum until it clicks into place.

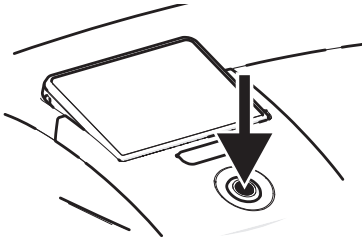

Turning on

- Turn the franking machine back on: Press the PostBase button.

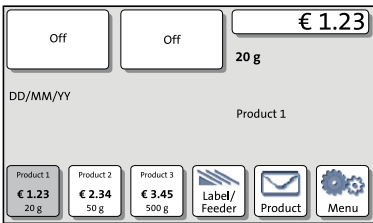

After rebooting, the PostBase mailing system with feeder is ready for use.



With the LABEL / FEEDER button, feature 'batch processing' is accessible.

4 The basics of operation

In this chapter you will learn about the basic functions of the PostBase mailing system and how to handle the touch screen.

4.1 Turning the PostBase on / off

The franking machine can remain connected to mains all the time to ensure it is always ready for use. Use the PostBase button to turn the franking machine ON and OFF.

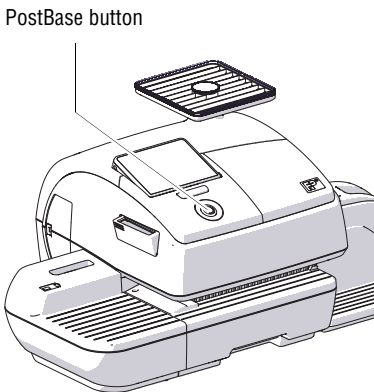

Turning on

- Press the PostBase button.

The display lighting and button illumination switch on. The PostBase performs a self test and then displays the Home screen.

Depending on the setting, you are prompted to choose a user and enter the PIN.

Turning off

- At any time, press the PostBase button for **three seconds** to turn the franking machine off.

The PostBase will complete any current actions and then switches off. The display light and PostBase button illumination go out and the touch screen is deactivated.

Disconnecting the PostBase from mains



Caution! Make sure to always turn the PostBase off with the PostBase button before disconnecting the PostBase from mains. Never pull the power plug or separate the power supply in any other way before the printing system has reached its sealed position. This is the only way to prevent drying up and to ensure a permanently high print quality.

- Press the PostBase button for three seconds to turn the franking machine off. The display goes out.
- Unplug the power cable from the socket.

4.2 Standby

The PostBase franking machine will go to standby automatically if it is not used for some time.

The display is dark and the PostBase button is illuminated in standby. The touch function is inactive.

You can 'wake up' PostBase by briefly pressing the PostBase button.

4.3 Adjusting the display inclination

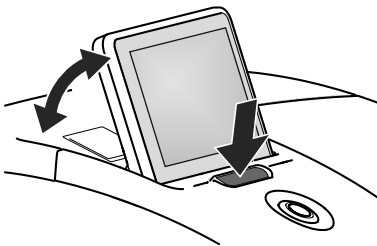

- Press the key below the display and set the display in the desired position. The adaptation mechanism features several catches.
- Release the key.

4.4 Setting up the label dispenser (optional)



Caution! We recommend to use only labels that have been approved by Francotyp-Postalia. The manufacturer FP has established reliability, safety and applicability. The manufacturer cannot assess the reliability, safety and applicability for products not approved by FP, and therefore not vouch for such products

We can ensure correct label processing only when you comply with this.

Folding the label compartment in and out

To fold the label compartment in or out:

- Press on the knurled surface until you hear a click, then release.

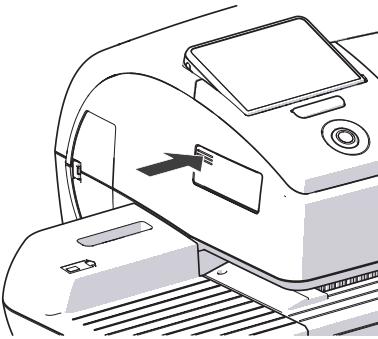

Inserting labels

- Remove package band from the package of labels.
- Insert the complete package (50 labels) in the label dispenser:
 - The side to be printed on faces up.
 - Insert the package of labels in direction of the imprinted arrow as far as it will go.

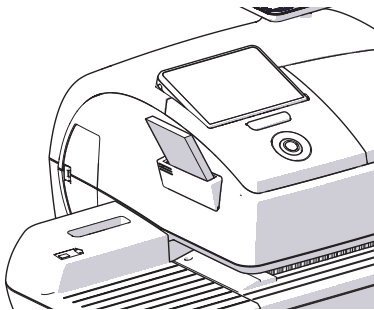

4.5 Setting up the catch tray

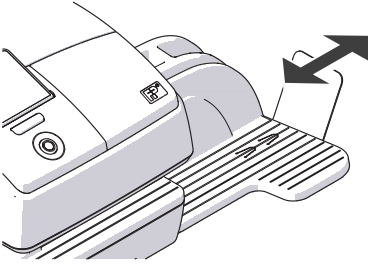

- The catch tray can be adapted to different envelope sizes by displacing the catch bracket. The stop features several catches for the most common sizes.

4.6 Screen elements and operation philosophy

This chapter covers the user interface of the PostBase franking machine. You will learn how to operate the touch screen, the screen elements and the menus, window types and symbols.

4.6.1 The touch screen

The touch screen is active when the display is lit. To operate the touch screen, simply touch the screen elements with your finger.

General operation philosophy

You briefly touch the desired screen element (in the example: the postage button) with your finger. PostBase performs the corresponding action.

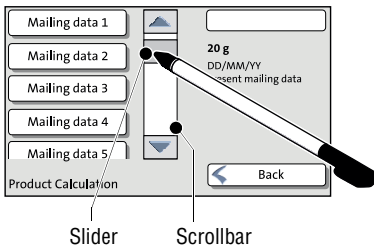
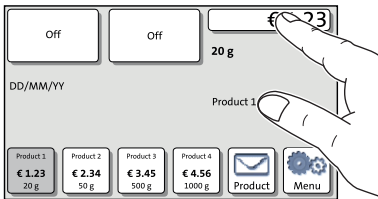

You can operate scrollbars with the arrow buttons or by touching the slider and moving it. The setting is updated when you lift your finger off.



You can also use the supplied stylus instead of your finger. The stylus is stored in a receptacle on the back of the display.

Buttons

You distinguish buttons from the screen background by a shadow. They can have various states, depending on the function:



Button can be pressed / is active.



Button is selected / passive.



Confirmation: Button is being pressed.



Button is deactivated / cannot be pressed.

Standard buttons

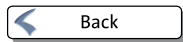

The term 'standard button' refers to buttons like for example SAVE, CANCEL, BACK or CONTINUE.

Depending on the function, the button label can differ. The CANCEL / BACK button (if available) is always located in the bottom right corner of the screen and goes back one step / level.

4.6.2 The Home screen

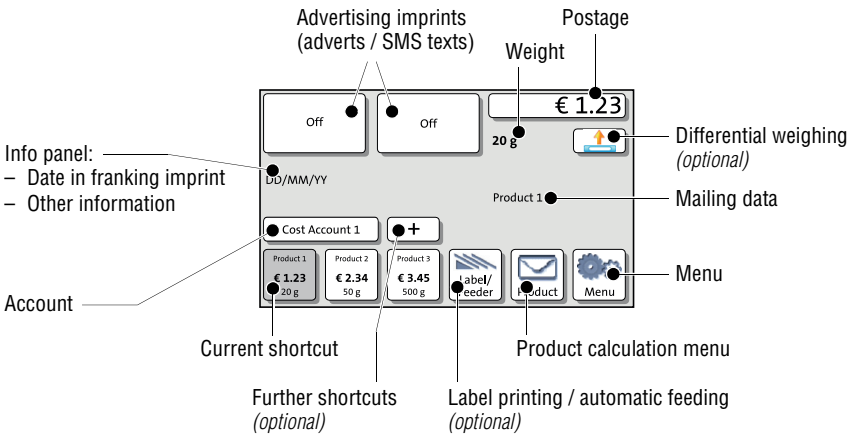

The Home screen appears after the machine was turned on and the start routine has been successfully completed. It displays the current franking settings. The postage appears only when all required product details are selected and the set weight exceeds 0 g (0 oz).

In the Home screen

- you have access to all franking imprint settings
- you frank your mail pieces
- you can weigh your mail pieces
- you can open the Menu.
- current settings are displayed.

Operation philosophy

A function can be edited or selected by simply touching its button. Depending on the respective function, the PostBase opens a list, an adjustment menu or a menu offering further options. In the chapters to follow, you will be introduced to each of the menu and window types and their operation.

4.6.3 The Product calculation menu

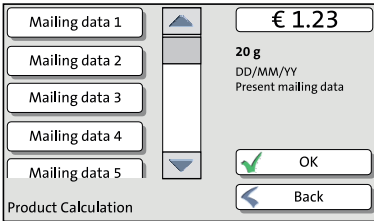

Calling up the Product calculation menu

By pressing the PRODUCT button the product calculation menu is opened. Here, you set the product for the franking imprint.

The left area of the display shows the available mailing data.

You can scroll the list with the scroll bar if more than four options are available.

The right area of the product calculation menu shows the current settings:

- the postage
- the weight
- the date
- the selected mailing data.

The postage and the OK button only appear if all necessary mailing data were selected and the displayed weight exceeds 0 g (0 oz).

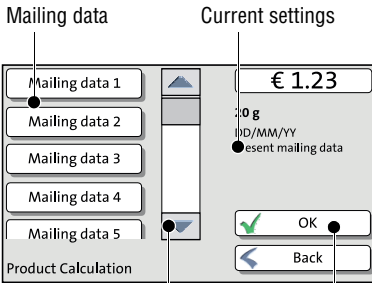

Other mailing data:
scroll with scroll bar

Accept current
settings and return
to Home screen

Selecting mailing data

By pressing the respective buttons, you select mailing data. The PostBase guides you through the postage calculation process step by step.

Press OK to accept the current settings and to return to the Home screen.

Deselecting mailing data

With the BACK button, the mailing data can be deleted step by step from the current product settings.

Returning to the Home screen

- OK** With the OK button, you set the current selected mailing data for franking and return to the Home screen.
- BACK** Pressing the BACK button repeatedly deletes the mailing data step by step. By pressing the button again after having deselected all mailing data you will cancel the product selection. The product set last remains set in the Home screen.

4.6.4 The Menu

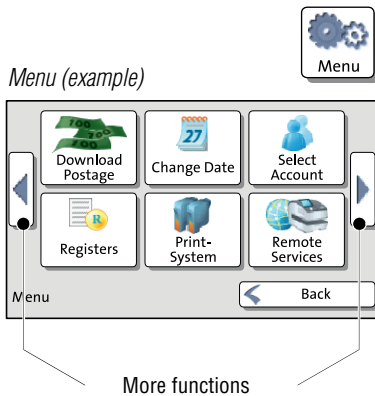

Use the MENU button to open the Menu. From this Menu you can access the administration functions, the system settings, and service functions.

Use the arrow buttons to scroll to the next page and back in the Menu.

4.6.5 Lists

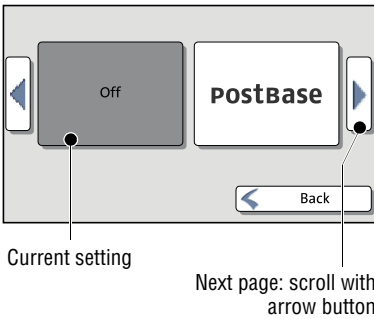

Lists (e.g. for adverts, SMS texts) offer all available settings in list form.

Use the arrow buttons to scroll forward or backward.

Press the respective button to select one of the provided settings and return to the Home screen.

4.6.6 Adjustment menus

A separate menu each opens for editing and selecting settings. There are three types: Lists, input via keypad, and input according to the counter principle.

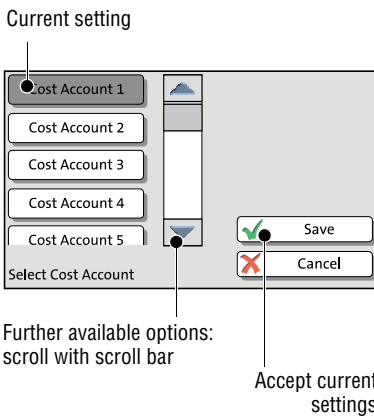

Lists

The left area of the display shows the available settings. The current setting is shown with a dark background. You can scroll the list with a scroll bar if more than four options are available.

Press SAVE to accept the current settings and to quit the adjustment menu.

Press CANCEL to discard your changes and to quit the adjustment menu.

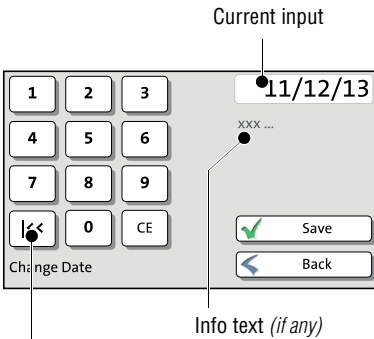

Button assigned acc. to function
(here: reset to current date)

Input via keypad

Use the keypad in the left area of the display to input values. The top right text box indicates your input.

The keypad is always matched to the respective situation: The button labels change accordingly, depending on whether you must type figures or figures and letters.

The bottom left button is assigned a special function matched to the current operation, e.g. change between small and capital letters. The info text informs of special features and gives additional hints.

Press CE to clear input.

Press SAVE to accept the current settings and to quit the adjustment menu.

Press BACK to discard your changes and to quit the adjustment menu.

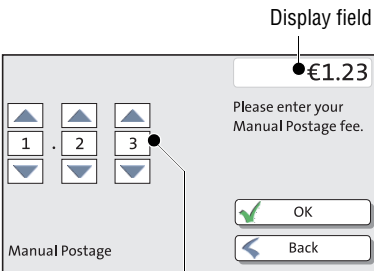

Setting an amount with
the arrow buttons

Input using the counter principle

PostBase may require you to enter values via a counter principle.

Use the arrow buttons to increase or decrease the figure in each digit until the desired amount is displayed in the top right text box.

Press OK to accept the current settings.

4.6.7 Pop-up windows

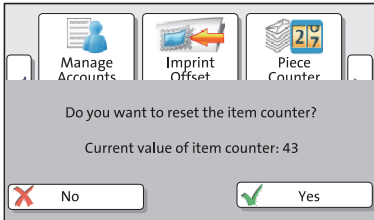

For some settings, a window covering parts of the current window opens (pop-up window). The pop-up prompts you for an action. Messages and the batch processing feature also appear as a pop-up.

Some pop-up messages feature auto-confirmation, i.e. they automatically close after some time.

4.6.8 Procedures (wizards)

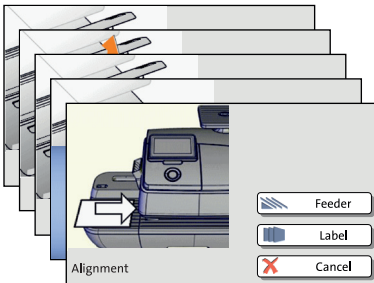

For more complex settings, e.g. when setting up connection data, the PostBase opens a 'procedure', guiding you through all necessary actions step by step. Different window types are used, depending on requirements.

Press CONTINUE to accept the current settings and to go to the next step.

You can press BACK to return to previous steps.

Pressing BACK at the beginning of the procedure will discard all settings and close the procedure.

4.7 Test print

Using a test print, you can assess the settings for the franking imprint as well as the print quality.



Test print (example)

According to postal regulations, test prints are marked as such. Never post test imprints.

Setting a test imprint



The way you set the test print may differ from the approach described here, depending on requirements by the respective postal service. In that case, please refer to the country-specific addendum to the Operator Manual.

- Set the desired parameters for the franking imprint (advert, SMS text etc.).
- Press the **PRODUCT** button in the Home screen.
- Set the desired product.



Once all necessary mailing data are set, you can perform a test print. The **TEST PRINT PRODUCT** option is shown at the end of the additional services list.

- Choose **TEST PRINT PRODUCT**.

PostBase prompts you to position a letter.

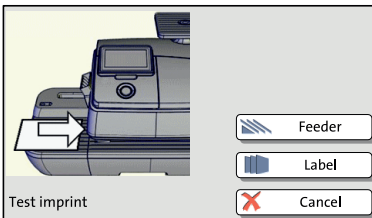

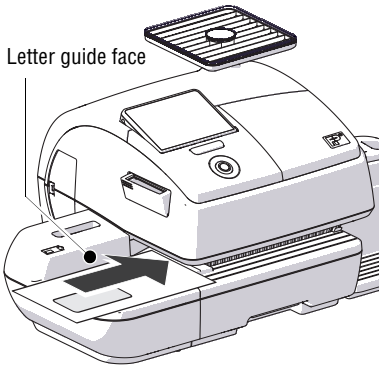

Printing the test print on an envelope

- Insert an empty envelope (or a postcard) in the hand feed tray:
 - side to be printed face up
 - the top edge must touch the letter guide face.
- Push the envelope in direction of the arrow.

PostBase takes up the envelope, prints the test print and discharges the envelope to the right.

Printing the test print on a label *(optional)*

- Choose LABEL to print the test print on a label.

PostBase prints the test print on a label and discharges the label to the right.

Positioning an envelope at the feeder *(optional)*

- Position an envelope on the feeder:
 - side to be printed face up
 - the top edge must touch the letter guide face.

Or, if an envelope has already been positioned:

- Choose FEEDER.

PostBase seizes the envelope, prints the test print and discharges the envelope to the right.

Checking the print quality

Make sure the PostBase always provides clean and legible franking imprints.

- Check the print quality. There must not be any offsets, blurred or blank spots. Pay special attention to the data matrix symbol (if any).



This illustration shows a perfect imprint (*example; the actual appearance of the imprint depends on the specifications of your national postal service*).

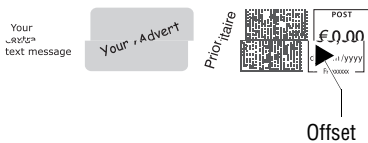

When there are offsets / shifts in the imprint:

- Align the ink cartridges. Read the chapter “Aligning ink cartridges” in the Reference Guide.



When there are blurred or blank spots in the imprint:

- Clean print system. Read the chapter “Cleaning the print system” in the Reference Guide.

5 Setting the franking imprint

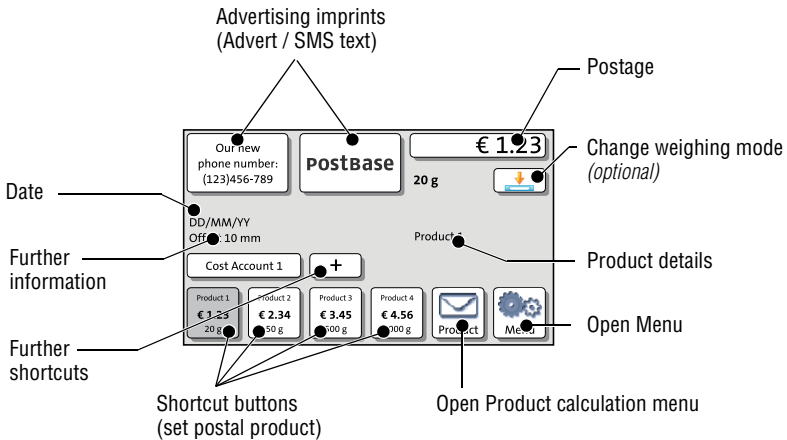

This chapter describes the required settings for franking and additional possible advertising imprints.

Set up the franking imprint by selecting the product and other settings in the Home screen:

- Postage / postal product (see chapter 5.1)
- Advert imprints (see chapter 5.2)
- Date (see chapter 5.4).

Refer to chapter 5.3 on how to use the ‘imprint offset’ function to laterally displace the franking imprint position (*not available in all countries*).

Detailed information on the franking imprint of your postal service can be found in the country-specific addendum (*if available*).



For information on how to use PC software from Francotyp-Postalia (e.g. Navigator, MailOne) to set the franking imprint, please refer to the manual provided with the software.

5.1 Postage / product

PostBase sets the postage, i.e. the price for the postal product using the chosen mailing data (destination, type, mail piece dimensions and additional services if applicable), in conjunction with the displayed weight.

Use the **shortcut** to fast and easily set up a product. For this purpose, please refer to the next chapter.

5.1.1 Setting a product via shortcut

You can directly view and retrieve up to four products in the Home screen at the touch of a button. Optionally, there are up to 20 shortcuts available which you can access via the **+** button. The franking machine comes ex factory with typical postal products stored as shortcuts. Upon activation of a new rate table, the shortcuts will be erased and re-programmed.

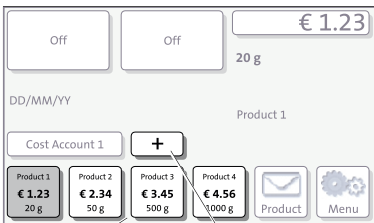

Shortcut buttons

More shortcuts

- Press the desired shortcut button.

If necessary:

- Weigh the mail piece.

The product with the related postage is set for franking.

Further shortcuts *(optional)*

Optionally, PostBase offers up to 20 shortcuts.

- In the Home screen, press the **+** button.

PostBase opens a list with all available shortcuts.



For details on how to save products as shortcuts via PC software (e.g. Navigator, MailOne), please refer to the manual provided with the software.

5.1.2 Setting postage manually *(not in all countries)*

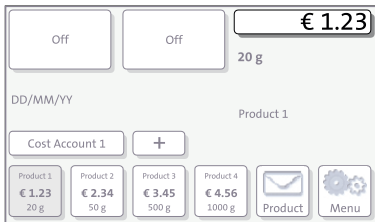

In the Home screen:

- Press the postage button.

PostBase opens the Product calculation menu.

- Select appropriate option from the list.
PostBase opens the window where you can set the postage.

- Enter the desired postage and confirm.
- Confirm with OK.

The postage is set.

5.1.3 Setting mailing data

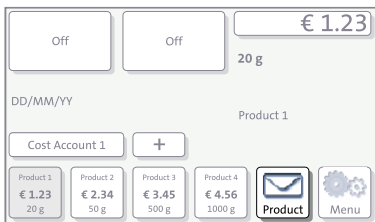

In the Home screen:

- Press the PRODUCT button.

PostBase opens the Product calculation menu.

Selecting mailing data

PostBase prompts you for all required details regarding the mail piece.

- Select the respective desired setting by pressing the button.

The selected mailing data appear to the right in the display.

The postage appears as soon as all necessary mailing data have been selected and the displayed weight exceeds 0 g (0 oz).

When the desired product is set:

- Press OK to return to the Home screen.

5.1.4 Weighing the mail piece

PostBase offers two weighing modes:

Normal weighing – PostBase determines the weight of every mail piece you place on the weighing platform (see chapter 5.1.4.1)

Differential weighing (*optional*) – You can place letter stacks on the scale. PostBase determines the weight when you remove a letter from the weighing platform.

You can order the optional function 'Differential weighing' from Francotyp-Postalia.

If 'Differential weighing' is available, the current weighing mode is displayed on the button next to the weight.

For details on how to change the weighing mode, please read chapter 5.1.4.2.

For using the 'Differential weighing' feature, please read chapter 5.1.4.3.

5.1.4.1 Normal weighing



Caution! Please observe the following notes on handling the scale:

- Please heed the designated maximum weight of the scale (depending on PostBase variant / equipment).
- The scale only determines a new weight if it was emptied before. Therefore, always empty the weighing platform prior to putting on a mail piece for weighing.
- The scale only determines a new weight if the letter transport is not running. Wait until letter transport stops prior to putting on a mail piece for weighing.
- When weighing large mail pieces, make sure they do not touch the housing as it would distort the results.

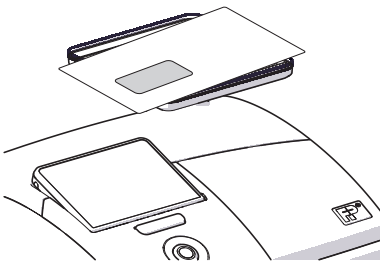

- In the Home screen, place the mail piece on the weighing platform.

A beep signals that the scale has determined the mail piece's weight.

The weight determined by the scale is now set. PostBase sets the postage based on the displayed weight and the selected mailing data.

5.1.4.2 Changing the weighing mode *(only if 'Differential weighing' is available)*

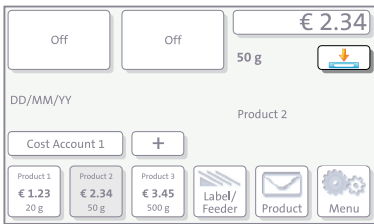

- In the Home screen, press the button next to the weight.

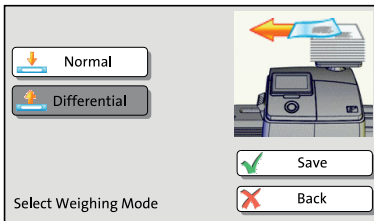

- Select the weighing mode: COMMON or DIFFERENTIAL.
- SAVE the shown setting to return to the Home screen.

The weighing mode is set. The button in the Home screen shows the corresponding icon.

5.1.4.3 Differential weighing (optional)



Caution! Please observe the following notes on handling the scale:

- Please heed the designated maximum weight of the scale (depending on PostBase variant / equipment).
- The scale only determines a new weight if the letter transport is not running. Wait until letter transport stops prior to putting on a mail piece for weighing.
- When weighing large mail pieces, make sure they do not touch the housing as it would distort the results.

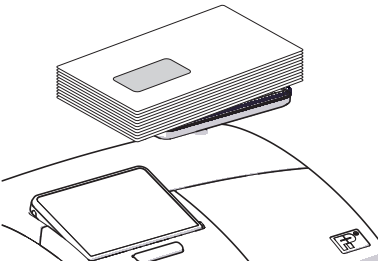

In the Home screen:

- Place the letter stack or a box with letters on the weighing platform.

Two short beeps indicate that the scale has recognized that a load was placed on the platform.

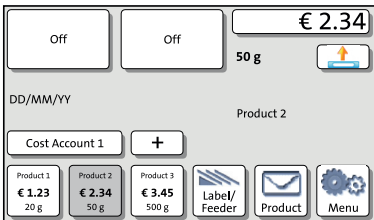

For now, the previous weight and the previous postage value are still displayed.

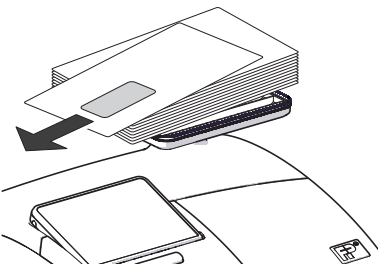

- Remove one letter from the stack or from the box.

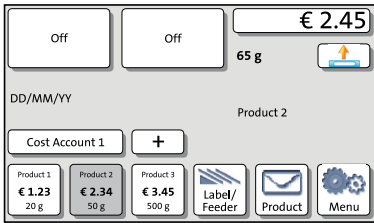

- PostBase determines the change in weight and calculates the postage value.
- Frank the letter as usual.
- Handle the remaining letters in the same way.

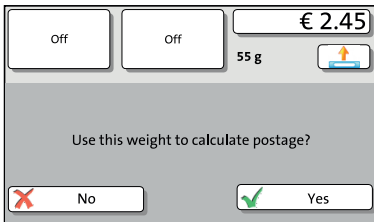

When you empty the weighing platform PostBase asks you if the set weight is to be used.

- Acknowledge with YES to frank the last letter of the stack.

Or

- Press NO to discard the displayed weight (e.g. because you removed the empty box last). PostBase does not determine a postage value.

5.2 Advertising imprints

The PostBase can print up to two advertising imprints of your choice on your mail pieces. Advertising imprints may be:

- Graphical adverts
- Text messages / SMS texts (*not in all countries*).

You can print advertising imprints in any order.

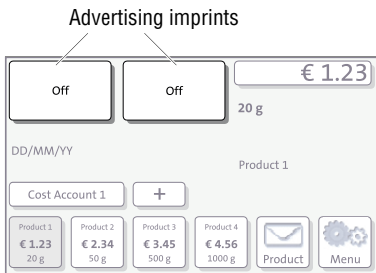

To set the advertising imprint

In the Home screen:

- Press one of the advertising imprint buttons.

You see a list with all available advertising imprints.

- Chose the desired advertising imprint.

The PostBase returns to the Home screen. The advertising imprint is set for franking.

- Set the second advertising imprint in the same manner.



You can enter and change SMS texts with PC software (e.g. Navigator, MailOne) which you can order from Francotyp-Postalia. For details on how to enter text and manage adverts on the PC, please read the manual provided with the software.

5.3 Imprint offset *(not in all countries)*

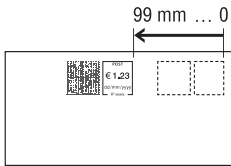

PostBase prints the franking imprint at a fixed offset (approx. 1 cm / 0.4") from the right mail piece edge. You can increase this offset and thus shift the franking imprint to the left by adjusting the imprint offset. If an imprint offset is set, it appears in the info panel in the Home screen.

To set the imprint offset

In the Home screen:

- Press the MENU button.

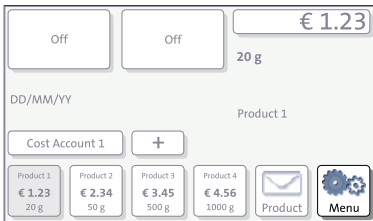

- Select IMPRINT OFFSET.

PostBase opens the adjustment menu for the imprint offset.

- Type the desired offset value.
- SAVE the displayed imprint offset.

The imprint offset for franking imprint is set and remains effective until it is changed – even if the machine is switched off.

The info panel in the Home screen shows the currently set imprint offset.

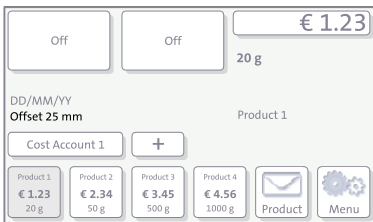

5.4 Date *(not in all countries)*

The date for the franking imprint is set automatically to the current date by the system clock. You can forward the date for the franking imprint.

The PostBase rejects invalid input, e.g. a franking date too far in the future or redating.

The currently set date is displayed the info panel in the Home screen.

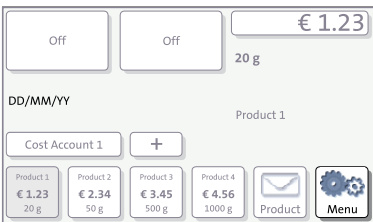

Setting the franking date

- In the Home screen: Press the MENU button.



- Select CHANGE DATE.
- Type the date.
- SAVE the displayed date.

The new franking date is set. The info panel in the Home screen shows the current setting.



You can press the |<< button to reset the franking date to the current date.

Franking without date *(not in all countries)*

In the CHANGE DATE menu:

- Clear the displayed date with CE.
- SAVE the setting.

6 Franking

This chapter covers how to set up accounts to register the postage used, how you place letters on the hand feed tray, how to use the feeder and sealer, and how to frank selfadhesive labels which can be stuck onto the mail piece. Also, the counter function available for franking is described.

Please refer to chapter 5 on page 44 for further information on how to set franking imprint parameters.

6.1 Changing the user

You can set up a user-specific access control for the PostBase.

If enabled, you are prompted to select a user and enter the corresponding PIN during startup. PostBase loads the corresponding user profile. Among other things, the following settings are stored in the user profile:

- name
- PIN
- budgets
- allocated account(s) and the standard account
- allow / block postage download.

On how to set up and manage users, please refer to the manual of the PC software.

PostBase button

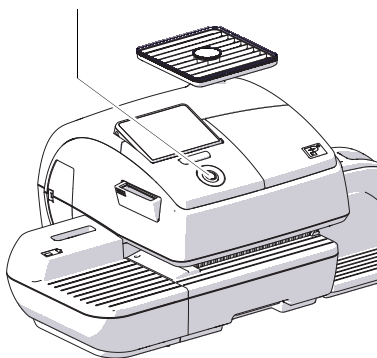

Changing the user

- In the Home screen, **briefly** press the PostBase button.
- In the list, press the button of the desired user.
- Enter the PIN.

PostBase loads the user profile and then shows the Home screen.

6.2 Changing the account

When you enable the Account function, you must always specify an account to frank. The currently set account is displayed left in the info panel of the Home screen.

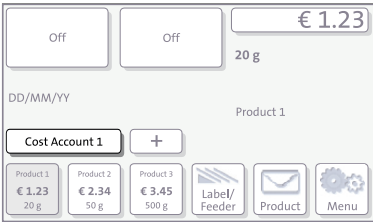

Changing the account

In the Home screen:

- Press the COST ACCOUNT... button.

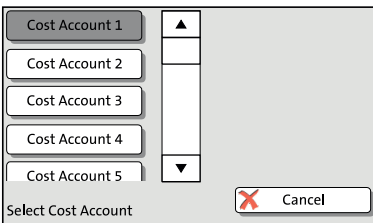

The PostBase opens a list with all available accounts. You see the account names and numbers. The currently set account is shown in black (in the example: 'Cost Account 1').

- Press the button of the desired account.

PostBase sets this account and returns to the Home screen.



If users are enabled, only those accounts allocated to the currently set user are available in the list.

6.3 Positioning and franking letters

6.3.1 Hand feed tray

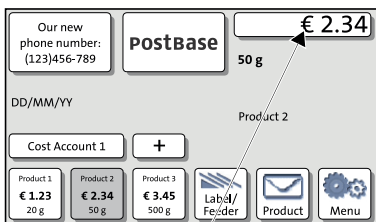

PostBase is ready for franking

You can feed mail pieces to frank when the Home screen displays a postage.

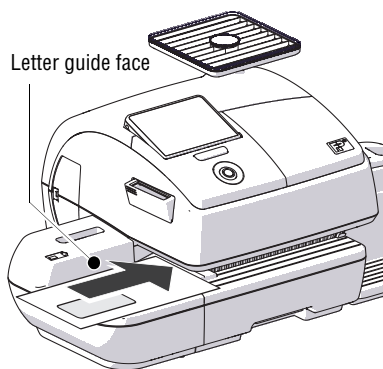

- To position the letter on the hand feed tray:
 - side to be printed face up (address field is visible)
 - the top edge must touch the letter guide face.
- Push the letter in direction of the arrow and release it.

The PostBase takes up the letter, prints and discharges the franked letter to the right into the catch tray.

You can feed more letters one by one while the letter transport is running.

6.3.2 Sealer (optional)

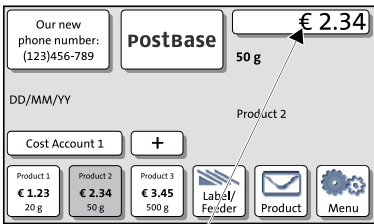

PostBase is ready for franking

You can feed mail pieces to frank when the Home screen displays a postage.



Moistening the envelope flap

- Hold the letter with the open flap facing down.
- Engage the letter at the sealer in arrow direction.

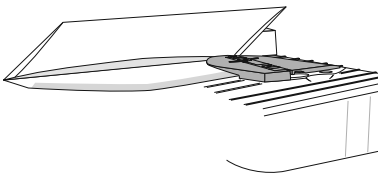

The illustration shows the correct letter position in the sealer:

- the flap is beneath the stop
- the stop edge is exactly in the flap groove.



- Guide the letter through the sealer with an arched motion as shown in the illustration.

This will pass the gummed flap edge along the moistening felt and moisten it.

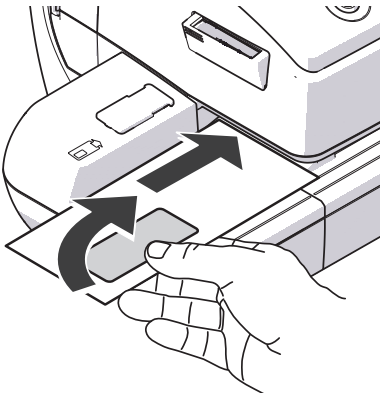

- Align the letter top edge with the franking machine letter guide and push in the letter in arrow direction.

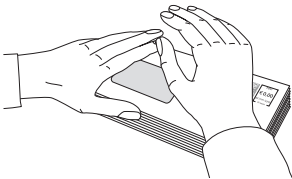

Sealing moistened envelope flaps

We recommend that you firmly press on the envelope flaps after franking to make sure the envelopes are firmly sealed.

- Stroke your hand firmly over the envelope's / letter stack's flap area.

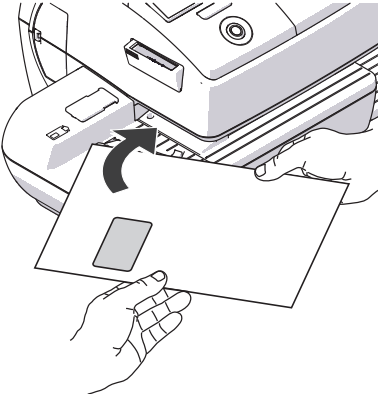

Large-sized mail pieces

You best guide large-sized mail pieces with both hands during moistening. You should support the mail piece only slightly as soon as the franking machine has started feeding it.

6.3.3 Feeder (optional)

6.3.3.1 Preparing the letter stack and setting up the feeder



Caution! If PostBase is ready to frank, letter transport starts as soon as a letter is positioned on the feeder.



This is how you avoid letters being unintentionally fed: Simply open the MENU on the touch screen. The letter sensor is then inactive. You can now take your time to set up the feeder.

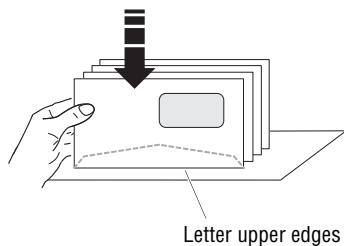

Prepare letter stack

- Arrange the letter stack so that all envelope flaps are face down.
- Make sure the letters are flush at their upper sides: Loosen letter stack with the upper edge on a level base and shake smooth.

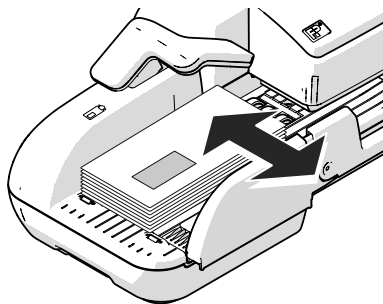

Position letter guide

- Position a letter stack:
 - side to be printed face up (address field is visible)
 - the top edge must touch the letter guide face
 - observe the maximum stack height of 55 mm (2.2").
- Move the letter guide so that the letter guide rests against the letter stack.

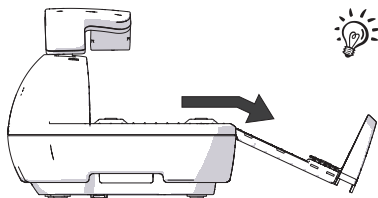

For large letters to be franked large side first:

- Pull out the letter guide until you can fold it down.

Using the pendulum

When franking bent or thin letters in stack, we recommend using the 'pendulum'. It presses down the letters so that the sensors can recognise them.

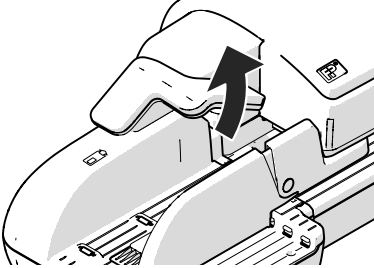

- Raise the pendulum.

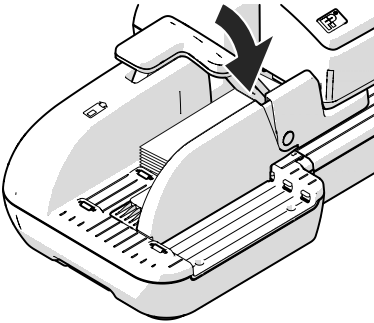

- Position the letter stack.
- Lower the pendulum.

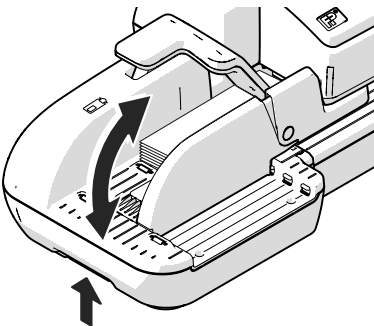

Adjust the slope inclination

- Unlock the letter receiving tray by pressing the release key on the bottom left.
- Raise or lower the slope and let go of the release key to lock the slope into position.

6.3.3.2 Switch on / off seal function

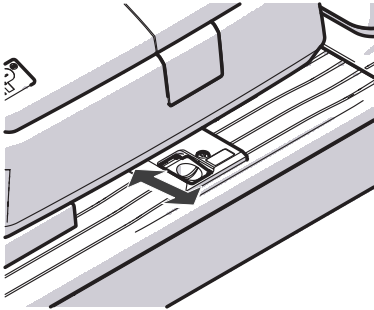

If the letters (up to 7 mm / 0.3") are to be sealed:

- Set the switch to the rear position (**seal**). Sealing is switched on, the sealant tank is illuminated.

If you do not want to seal letters or if they are already sealed:

- Set the switch to the front position (**non-seal**).

Sealing is switched off, the sealant tank illumination is off.

6.3.3.3 Setting letter thickness

For reliable results, make use of the 'thick letters' feature when franking letters with a thickness of 6 - 10 mm (0.24" - 0.4") with the feeder.

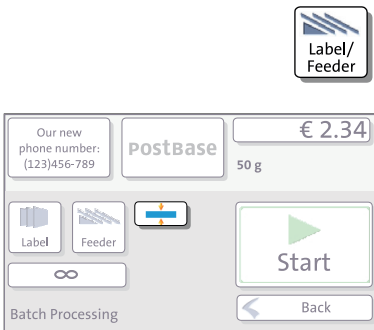

- In the Home screen, press the LABEL/ FEEDER button.

PostBase opens the 'Batch Processing' pop-up.

- In the pop-up, press the button next to the FEEDER button.

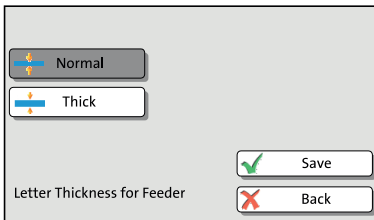

- Select NORMAL or THICK, according to the letters you wish to frank.
- SAVE the setting. The current setting is shown on a dark background.

When 'thick letters' is activated, PostBase processes letters much slower. Make sure to switch back to NORMAL to achieve the best performance.

6.3.3.4 Positioning and franking letters in stack

When the feeder is set up (see chapters 6.3.3.1 to 6.3.3.3) and the desired franking imprint is set (see chapter 5), you can start batch processing. You can also set the number of letters to be franked prior to starting batch processing. Refer to chapter "Using the batch counter" on page 64.



Caution! If PostBase is ready to frank, letter transport starts as soon as a letter is positioned on the feeder.

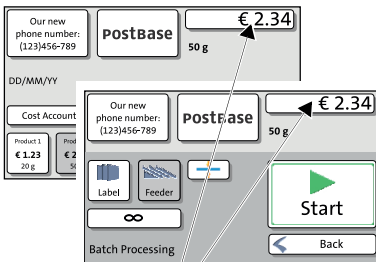

PostBase is ready for franking

You can start batch processing in the Home screen as well as in the 'Batch Processing' pop-up by simply feeding a letter stack.

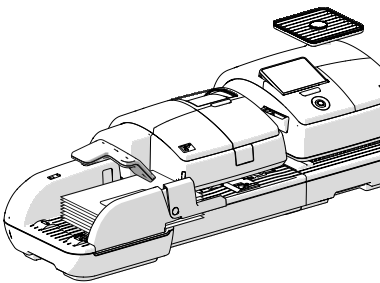

- Raise the pendulum.
- Position the prepared letter stack:
 - side to be printed face up (address field is visible)
 - the top edge must touch the letter guide face
 - observe the maximum stack height of 55 mm (2.2").
- Lower the pendulum (if necessary).

PostBase feeds the letters one by one, prints, and places the franked letters in the catch tray.

You can interrupt batch processing with the STOP button.

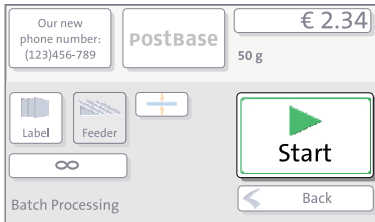

Interrupt / continue batch processing ...

After an interruption or when there are already letters in the feeder:

- In the Home screen, press the LABEL/ FEEDER button.

PostBase opens the 'Batch Processing' pop-up.

- Press the START-button.

You process **single letters** in the same manner. Simply position a single letter / a postcard instead of a letter stack on the feeder.

6.3.3.5 Using the batch counter

The batch counter provides you with the possibility to define the number of mail pieces to be franked in advance. You can use this function to have a precise number of mail pieces ready for dispatch.



Caution! If PostBase is ready to frank, letter transport starts as soon as a letter is positioned on the feeder.



When the Home screen displays the desired settings for franking:

- In the Home screen, press the LABEL/ FEEDER button.

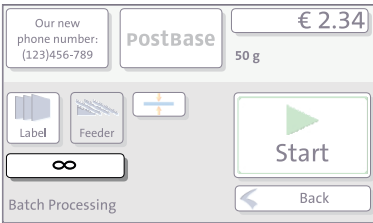

- In the pop-up, press the button below the FEEDER button.

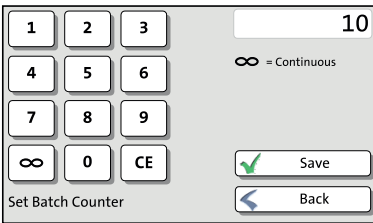

- Enter the amount of letters you want to frank.

Or:

Enable continuous operation with the  button.

- SAVE the setting.

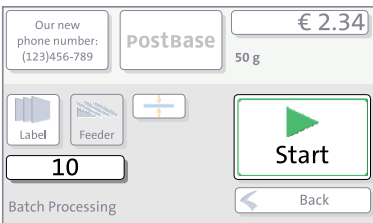

- Position the prepared letter stack.
For details on how to set up the feeder and position letter stacks, please read pages 60 to 64.

PostBase feeds the letters one by one, prints, and places the franked letters in the catch tray. The counter displays the number of letters still to be franked. You can interrupt batch processing with the STOP button.

6.4 Franking labels *(optional)*

With the optional label dispenser, PostBase can frank self-adhesive labels, which you can order from Francotyp-Postalia.



Caution! We recommend to use only labels that have been approved by Francotyp-Postalia. The manufacturer FP has established reliability, safety and applicability. The manufacturer cannot assess the reliability, safety and applicability for products not approved by FP, and therefore not vouch for such products

We can ensure correct label processing only when you comply with this.



Caution! Always mind that you do not position letters on the feeder that you do not want to frank right away. The feeder starts letter transport even if LABEL is selected in the 'Batch Processing' pop-up.

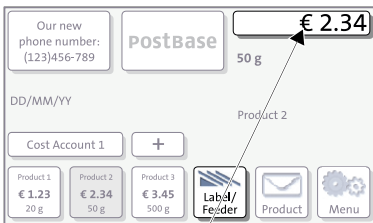

The PostBase is ready for franking

Frank a label

- In the Home screen, press the LABEL/ FEEDER button.

PostBase opens a pop-up.

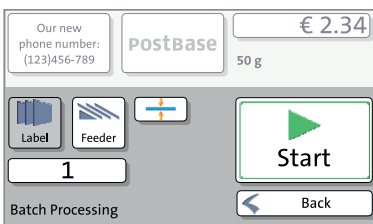

- Press the LABEL button.
- Press the START button.

PostBase prints a label.

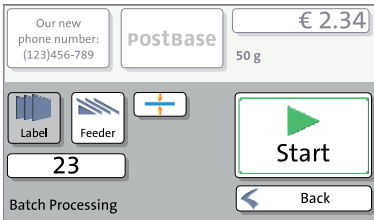

Franking several identical labels

- In the Home screen, press the LABEL/ FEEDER button.

PostBase opens a pop-up.

- Press the LABEL button.
- Set the batch counter to the desired number of labels (see chapter 6.3.3.5).
- Press the START button.

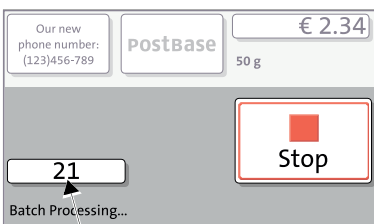

Labels yet to be printed

PostBase prints the number of labels you have set. The counter displays the number of labels still to be franked. You can interrupt processing with the STOP button.

6.5 Displaying and clearing down the item counter

Apart from the counter for franking imprints in the register and the account counters, the PostBase features an item counter for franking imprints you can use as you like. The item counter counts all franking imprints. Independently of other counter functions you can reset this item counter to zero or use it as a daily or job counter.



In the Home screen:

- Press the MENU button.
- Select PIECE COUNTER.

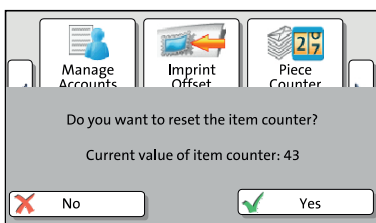

The PostBase opens a pop-up displaying the number of franked mail pieces since last resetting the piece counter.

- YES deletes the displayed number.
- Press NO to return to the MENU without clearing the item counter.

6.6 Controlling PostBase via PC software – ‘Connected’ mode

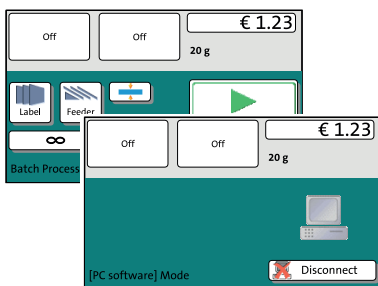

When PostBase is connected to a PC via FP software (e.g. Navigator, MailOne), a corresponding pop-up is shown. Access to the Menu and imprint settings is blocked while in ‘Connected’ mode.

Cancel ‘Connected’ mode

- Press DISCONNECT.

The connection between PostBase and the PC is disconnected. Menu and imprint settings are accessible via touch screen.



For information on how to use the PC software from Francotyp-Postalia, please refer to the manual provided with the software or the integrated help feature.

7 Displaying and printing registers

The PostBase franking machine saves important parameters and information on used postage in registers. You can view and print the register states.



- Open the MENU.
- Choose REGISTERS.

Registers	
Descending	€81.85
Postage Used	€18.15
Control Total	€100.00
Total Items	20
Last Amount	€100.00
Last Date	DD/MM/YYYY 03:26:19 PM
<input type="button" value="Print"/> <input type="button" value="Back"/>	

The REGISTER displays the current register states.

Printing registers

- Press the PRINT button.
- Load an empty envelope / postcard to print the register report.

Or:

- Press the LABEL button (*optional*).

PostBase prints the register report on a label.

Or:

- Press the FEEDER button (*optional*).
- Load an empty envelope / postcard to print the register report.

The registers store the following information:

DESCENDING	Available postage (= credit)
POSTAGE USED	Total value of all franking imprints performed
CONTROL TOTAL	Sum total of all loaded sums
TOTAL ITEMS	Number of all franking imprints performed
LAST AMOUNT	Last amount loaded
LAST DATE	Date of last postage loading

8 Download postage

To load postage you connect to the data center with your franking machine and call the desired amount. Billing occurs according to your contract with the postal service. Refer also to the country-specific addendum (if available) in case there is further information on the loading process.

If users are enabled, postage download might not be available. In that case, please contact the system administrator.



Loading postage

- Make sure all settings for communication with the data center are correct.
- Open the MENU.
- Choose DOWNLOAD POSTAGE.
- Accept the amount to be loaded.

Or

Type the desired amount.

- Confirm the amount displayed with LOAD POSTAGE and continue.

To load the displayed sum:

- Confirm the security prompt with YES.

PostBase will then establish a connection to the data center. Loading continues automatically. Please stand by. Data exchange may take some time.

The new residual amount is indicated when loading ends.

- Use REPORT to view and print the loading report.

9 Special functions

9.1 Advert Only

With the special function 'Advert Only', you can print advertising imprints (graphical adverts and text messages) that are stored in your PostBase Mailing System.



- Open the MENU.
- Choose SPECIAL FUNCTIONS.
- Choose ADVERT ONLY.

Set advertising imprint
advert / text message

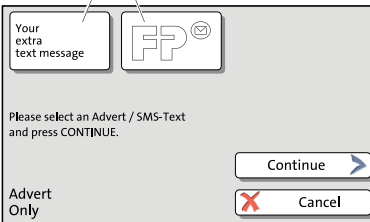

PostBase opens the 'Advert Only' menu.

The two advertising imprint buttons on the upper left show the print image for this special function. You can assign each one of these buttons either an advert or a text message (SMS).

- Press the one of the advertising imprint buttons.

PostBase opens a list of all available advertising imprints.

- Press the button of the desired advertising imprint.

PostBase returns to the 'Advert Only' menu. The advertising imprint button shows the selected imprint.

- Set the second advertising imprint in the same way.

When both buttons show the desired imprints:

- Confirm with CONTINUE.

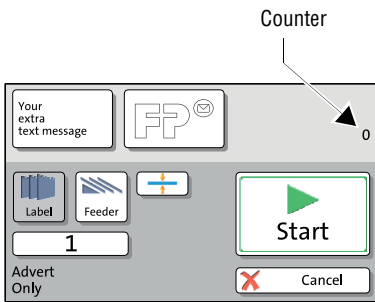

You can start printing. Proceed exactly as when franking:

- Position an envelope / a postcard on the hand feed tray.

Or

- Start label printing.

Or

- Use the feeder.



For detailed information on feeding letters, batch processing with the feeder and label printing, please read chapter 6.

The 'Advert Only' special function has its own counter. PostBase shows the number of imprints on the upper right side of the display. When quitting the 'Advert Only' function, the counter is reset to '0'.

9.2 Print Numbers

With the special function 'Print Numbers', you can print a 6-digit consecutive number vertically on your mail. You can set any start number and choose the direction of counting (ascending or descending).



- Open the MENU.
- CHOOSE SPECIAL FUNCTIONS.
- CHOOSE PRINT NUMBERS.

PostBase opens the 'Print Numbers' menu.

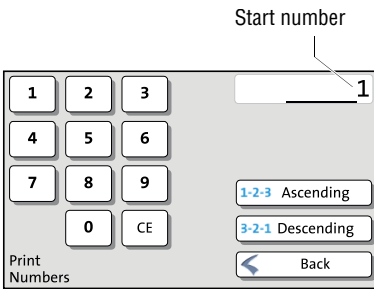

Setting the start number

- Enter the desired start number.
You can choose any number between 1 and 999999.

Setting the direction of counting

When the desired start number is displayed:

- Press the button for the desired direction of counting (Ascending or Descending).

PostBase applies start number and direction of counting.

You can start printing numbers. Proceed exactly as when franking:

- Position an envelope / a postcard on the hand feed tray.

Or

- Start label printing.

Or

- Use the feeder.

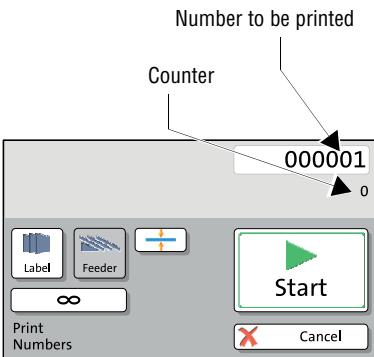

For detailed information on feeding letters, batch processing with the feeder and label printing, please read chapter 6.

During processing, PostBase shows the next number to be printed in the upper right corner of the display.

The 'Print Numbers' special function has its own counter. PostBase shows the number of imprints below the number to be printed. When quitting the 'Print Numbers' function, the counter is reset to '0'.

9.3 Feed Only / Count mail pieces

With the special function 'Feed Only', you can process mail without printing. In this way, you can count mail pieces and prepare your bulk mail for dispatch in counted stacks.



- Open the MENU.
- CHOOSE SPECIAL FUNCTIONS.
- CHOOSE FEED ONLY.

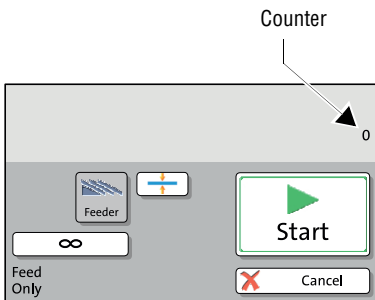

- Position letter stack on the feeder / start letter transport.

When stack processing with the automatic feeder for the 'Feed Only' special function, proceed exactly as when franking mail. For detailed information, please read chapter 6.3.3.

The 'Feed Only' special function has its own counter. PostBase shows the number of transported mail pieces on the upper right side of the display. When quitting the 'Feed Only' function, the counter is reset to '0'.



The 'Feed Only' special function is also available when working without feeder. You then have to position mail pieces individually on the hand feed tray.

9.4 Seal Only (optional)

With the special function 'Seal Only', you can seal and count letters without printing (up to 7 mm / 0.3"). This special function is only available on PostBase systems with feeder. Please heed the mail piece specifications on page 143.



- Open the MENU.
- CHOOSE SPECIAL FUNCTIONS.
- CHOOSE SEAL ONLY.
- On the feeder, switch on the seal function: Set the switch to the position **seal** (see also chapter 6.3.3.2, page 62).
- Position letter stack on the feeder / start letter transport.

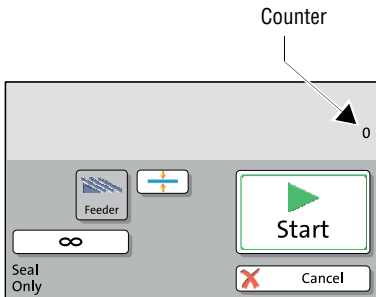

When stack processing with the automatic feeder for the 'Seal Only' special function, proceed exactly as when franking mail. For detailed information, please read chapter 6.3.3.

The 'Seal Only' special function has its own counter. PostBase shows the number of transported mail pieces on the upper right side of the display. When quitting the 'Seal Only' function, the counter is reset to '0'.

10 Advanced settings & system information

10.1 System information

You can view a list of all major system parameters (e.g. software version, rate table).



- Open the MENU.
- Choose SYSTEM INFORMATION.

PostBase displays the system information.

10.2 Display brightness

You can adapt the display brightness to fine-tune the gray scales and increase the legibility of the displayed texts.



- Open the MENU.
- Choose DISPLAY BRIGHTNESS.

PostBase opens the adjustment menu for display brightness.

- Use the BRIGHTER / DARKER buttons to achieve the desired setting. You can press the buttons multiple times to increase / decrease display brightness further.

Or

- Choose DEFAULT to reset display brightness to the factory setting.

You can monitor the changes immediately in the display. Alter the settings until you can easily read the display.

- SAVE the setting shown.

10.3 Tone signals

PostBase confirms certain actions with a beep. A series of tone signals indicates an error. You can restrict the scope of audible signals to warnings or turn off the audible signals altogether.



- Open the MENU.
- Choose SOUND SIGNALS.

PostBase opens the adjustment menu for tone signals. The current setting is shown on a dark background.

- Select the desired setting.
- SAVE the setting shown.

Sound signals – possible settings and their meaning:

ON	Tone signals in case of errors. Confirmation beep of the scale when weighing is finished.
OFF	No tone signals.
ONLY ERRORS	Tone signals in case of errors.

10.4 Account administration

If user management is enabled via PC software, the account administration features are only available to the administrator.

10.4.1 Switch account administration on / off



Switching on

- Open the MENU.
- Choose MANAGE ACCOUNTS.
- Confirm the prompt with CONTINUE.

The account function is enabled.



Switching off

- Open the MENU.
- Choose MANAGE ACCOUNTS.
- Select DEACTIVATE.



Caution! Any data stored in the accounts will be lost.

If the account function has been used, i.e. data is stored in any account:

- Confirm the security prompt with YES.

The account function is disabled.



While the account administration is disabled, the settings stored in the user profiles lie idle.

10.4.2 Display account information



- Open the MENU.
- Choose MANAGE ACCOUNTS.
- Select SHOW LIST.

PostBase displays a list of all accounts containing the respective number and value of franked letters.

10.4.3 Set one account to zero



- Open the MENU.
- Choose MANAGE ACCOUNTS.
- Select CLEAR ONE ACCOUNT.
- Select the account you want to set to zero and CONTINUE.
- Confirm the security prompt with YES.

All account information (postage and number of franking imprints) of the selected account is deleted.

10.4.4 Set all accounts to zero



- Open the MENU.
- Choose MANAGE ACCOUNTS.
- Select CLEAR ALL ACCOUNTS.
- Confirm the security prompt with YES.

All account information (postage and number of franking imprints) is deleted.

10.5 Standby time

The PostBase franking machine will go to standby automatically if it is not used for some time. The standby time is the time between your last operation and the time PostBase automatically goes to standby.



- Open the MENU.
- Choose STANDBY TIME.

PostBase opens the standby adjustment menu.

- Type the desired time.
- SAVE the specified standby time.

10.6 Auto Off

The PostBase franking machine switches off automatically if it is not used for some time. The Auto Off time is the time between your last operation and the time PostBase automatically switches off.



- Open the MENU.
- Choose AUTO OFF.

PostBase opens the adjustment menu.

- Type the desired time.
- SAVE the specified Auto Off time.

10.7 Meter type *(not in all countries)*

The meter type setting defines whether PostBase displays and prints the postage in the 00.00 or 00.000 format.



- Open the MENU.
- Select DECIMAL METER MODE.

The current setting is shown on a dark background.

- Select the desired setting.
- SAVE the displayed setting.

Decimal Meter Mode – possible settings and their meaning:

0.00	Displays and prints the postage in integer cents.
0.000	Displays and prints the postage in tenths of cents.

10.8 User interface language

The PostBase user interface supports multiple languages.



- Open the MENU.
- Choose LANGUAGE.

PostBase opens the language adjustment menu. The current setting is shown on a dark background.

- Choose the desired language.

The user interface language changes immediately.

- SAVE the shown setting.

The new language will remain selected until you change the language again.

10.9 Setting up the connection with the data center

Set the respective connection parameters during commissioning. You should verify and, if necessary, correct the settings if changes were made to your system configuration.

In case of problems, please contact your network administrator.



- Open the MENU.
- Choose MANAGE CONNECTION.

PostBase shows the current connection settings.

Changing the settings

- Press CHANGE.
- Simply follow the instructions on the display. The PostBase successively prompts you to specify all necessary details.

When finished, PostBase displays the current connection configuration.

- If everything is correct: SAVE.

10.10 View / change contact information

Important contact information is stored in your franking machine at the factory. You can view the contact information and edit the phone number that is used to contact the data center.



View contact information

- Open the MENU.
- Choose CONTACT INFORMATION.

PostBase displays the stored phone numbers and URLs.

Change the data center phone number



Caution! Change the phone number only when instructed to do so by Francotyp-Postalia. A wrong phone number can cause troubles, e.g. during postage loading.

- Choose CHANGE.

PostBase opens the adjustment menu where you can edit the phone number.

- Type the phone number.
- SAVE the setting shown.



You can insert blanks to arrange the display of the number more clearly. These blanks do not affect the dialling procedure.

10.11 Access control / PIN

PostBase can be protected against unauthorized use via a PIN. With the PC software, you can set up a user-specific access control for the PostBase. Please refer to the manual of the PC software. In the PostBase menu, the PIN function is then only accessible with the administrator PIN.



Enable access control

- Open the MENU.
- Choose MANAGE PIN.
- Confirm the prompt with CONTINUE.

PostBase opens the access control adjustment menu.

- Enter a PIN and CONTINUE.
- Enter the PIN a second time to confirm.
- SAVE the PIN.

The PIN is set. Each time you start up PostBase, you have to enter it to get access.

Disable access control



Caution! If you disable access control, all users will be deleted without prior warning.



- Open the MENU.
- Choose MANAGE PIN.
- Confirm the prompt with CONTINUE.

Access control is disabled.

10.12 Auto Postage Download

The 'Auto Postage Download' feature facilitates keeping track of the remaining postage. When enabled, PostBase will warn you once the remaining postage reaches the preset threshold and will give you the opportunity to load postage.



Enable 'Auto Postage Download' function

- Open the MENU.
- Choose AUTO POSTAGE DOWNLOAD.
- Confirm the prompt with CONTINUE.
- Enter the desired threshold and SAVE.

Auto Postage Download is enabled.

Performing Auto Postage Download

When the remaining postage reaches the threshold, PostBase opens an appropriate screen with the following options:

- CHANGE the displayed load amount, then load postage.

Or:

- LOAD the displayed amount directly.

Or:

- CANCEL the procedure to load postage later.



Change threshold

- Open the MENU.
- Choose AUTO POSTAGE DOWNLOAD.
- To CHANGE the threshold (option is already selected), choose CONTINUE.
- Enter the new threshold.
- SAVE the setting.



Disable 'Auto Postage' function

- Open the MENU.
- Choose AUTO POSTAGE DOWNLOAD.
- Select TURN OFF and CONTINUE.
- Confirm the security prompt with YES.

Auto Postage Download is disabled.

10.13 Remote Services

With the 'Remote Services' function, PostBase connects to the FP server and checks for updates (e.g. a new rate table, new machine software). Diagnostic data is also exchanged with the FP server.



- Open the MENU.
- Choose REMOTE SERVICES.

PostBase starts the update procedure. It takes some time to establish the connection and to exchange data. Please stand by.

10.14 Change ZIP / postal code *(not in all countries)*

You must inform Francotyp-Postalia of the new location of your PostBase if you wish to operate the PostBase at another location (e.g. after a relocation).



- Open the MENU.
- Select CHANGE ZIP.
- Follow the instructions in the display.

Re-authorization starts. It takes some time to establish the connection and to exchange data. Please stand by.

11 Maintenance and care

Have your PostBase mailing system cleaned and serviced regularly by an authorized Service staff. This guarantees long-term, trouble-free operation. Ask about our low-cost care and maintenance agreement.

You can do the following work yourself:

- Clean housing exterior
- Change / align ink cartridges
- Clean print system
- Replace the transport brush
- Filling with sealing liquid (*feeder / sealer*)
- Clean / replace moistening sponge (*feeder*)
- Clean / replace moistening brush (*feeder*)
- Clean / replace rocker with moistening felt (*sealer*)
- Replace absorption felt (*sealer*).

Only when prompted by Francotyp-Postalia: start the 'Temp. Calibration' service function.

11.1 Cleaning the PostBase mailing system



Warning! Disconnect the power plug before cleaning the PostBase franking machine.



Warning! Handle liquids with care. Make sure that no objects can reach the interior of the franking machine. If this happens nevertheless: Have the franking machine checked by the Customer Support before using it again.

PostBase button

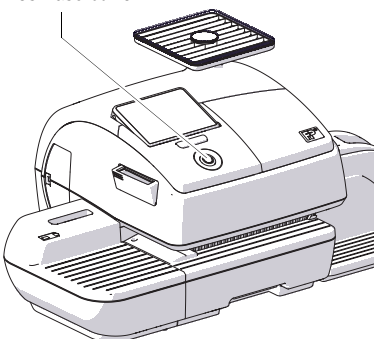

Cleaning the mailing system

- Turn off the mailing system.
- Pull the power plugs of the franking machine and of all peripherals such as the feeder out of the wall socket.
- Clean dirt from the housing with a slightly damp cloth. You can also use a commercially available dishwashing detergent.

11.2 Changing the ink cartridges

The PostBase franking machine monitors the filling level in the ink cartridges and issues a message when they must be replaced.

We recommend that you always have a new FP cartridge kit in stock.

We recommend also cleaning the contacts in the cartridge holder each time you replace the cartridge. For this purpose, use the special 'clean & renew' cleaning kit for ink-jet print systems from Francotyp-Postalia.



Warning! Ingestion of the ink can be damaging to your health. Avoid contact with the eyes. Keep the ink cartridges out of the reach of children. Further instructions for use are enclosed with the ink cartridges.



Caution! Heed the following hints to avoid damage to the print system:

- Do not yank the cartridge flap open. Run the CHANGE CARTRIDGES function from the PRINT SYSTEM menu. The flap then opens by itself.
- We recommend to use only approved FP equipment and FP original parts. The manufacturer FP has established reliability, safety and applicability. The manufacturer cannot assess the reliability, safety and applicability for products not approved by FP, and therefore not vouch for such products.
- Make sure to always replace both ink cartridges. Always use brand new ink cartridges.



Caution! There are ink residues on the old cartridges.

- Make sure not to soil yourself, your clothes or any objects.
- Use a mat to deposit the ink cartridges.

Changing the ink cartridges

The PostBase will prompt you to replace the cartridges when they are depleted.

- Confirm the message.
- Open the MENU.
- Choose PRINT SYSTEM.
- Choose CHANGE CARTRIDGES.



The exchange procedure starts. The PostBase moves the ink cartridges to the exchange position and opens the flap.



Caution! Do not lean on the flap or PostBase might lock the flap and move the ink cartridges into idle position again.

- Follow the instructions on the display.

The required steps are described in detail below.

Removing the ink cartridges

After the PostBase has unlocked the flap:

- Unlock the ink cartridges:
At the knurled handles, push the ink cartridges down and slightly forward.

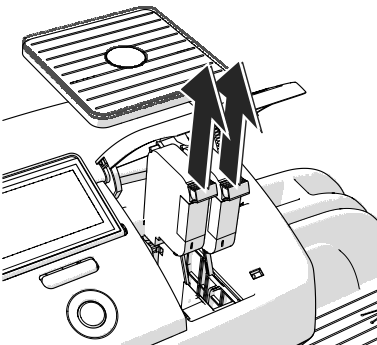
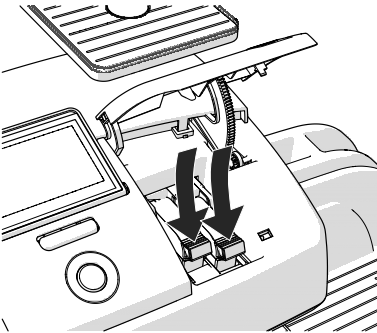

- Take **both** ink cartridges upward and out of the socket.

Inserting new ink cartridges



Caution! Insert ink cartridges only when they have adapted to the ambient temperature of the franking machine (e.g. after storage in the basement or transport in a cold car). Otherwise, correct calibration will be impossible.

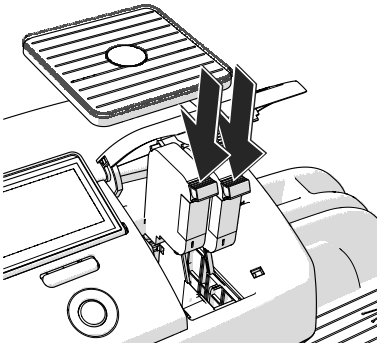

- Take the new ink cartridges out of the packing.
- Remove the nozzle protection from the ink cartridges.
For details, please refer to the instruction leaflet that comes with the ink cartridges.
- Hold the ink cartridges so the contacts are facing to the rear of the franking machine.
- Insert the ink cartridge into the socket.
- Push the ink cartridge all the way down. You can feel the ink cartridge engage.
- Insert the second ink cartridge in the same way.

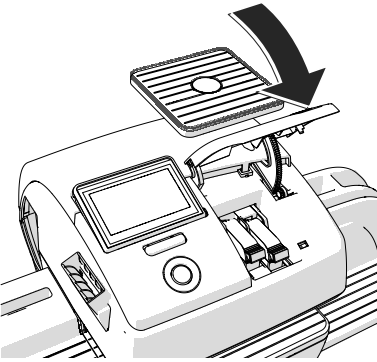

- Close the flap of the print system by pushing it down on the lower right corner.

Calibration

After cartridge exchange, the ink cartridges are calibrated. You can monitor the progress in the display. Please be patient until calibration is complete.

Cleaning

After calibration, the ink cartridges will be cleaned. Cleaning is performed automatically.

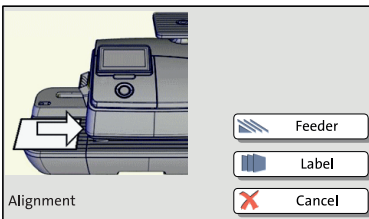

Aligning ink cartridges

The PostBase continues by aligning the ink cartridges and prompts you to place a letter.

- Place an empty envelope for the test print.

Test print (example)

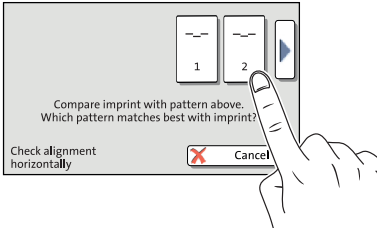
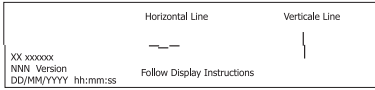

The PostBase prints a test print with each a horizontal and vertical line pattern (similar to the example on the left).

- Compare the horizontal line on the test print with the line patterns in the display.
- Press the button that shows the line pattern best matching that of the test print. In the example, this is button number “2”.



- Compare the vertical line on the test print with the line patterns in the display.

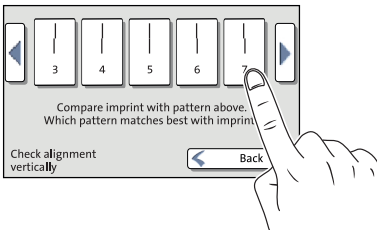

- Press the button that shows the line pattern best matching that of the test print. In the example, this is button number “7”.

The PostBase analyses your entries.

New test print required

When an offset of the horizontal and/or vertical line was found the PostBase adjusts the ink cartridges accordingly and prompts you to perform another test print.

- Place an empty envelope for another test print.
- Repeat the adjustment procedure as described above.

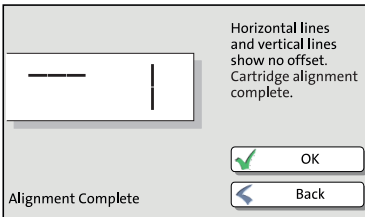

You may have to repeat the adjustment procedure several times.

Adjustment OK

When no offset of the horizontal and vertical line was found a message appears.

- Quit the procedure with OK.

11.3 Aligning ink cartridges

You must align the ink cartridges when there are shifts in the franking imprints. Alignment will ensure your imprints are free of shifts.



Starting the alignment procedure

- Open the MENU.
- Choose PRINT SYSTEM.
- Choose ALIGNMENT in the submenu.

The PostBase starts the alignment procedure. Follow the instructions on the display.

For a detailed description of the procedure, please refer to pages 93 / 95.

11.4 Cleaning the print system

11.4.1 Starting automatic print system cleaning

You should start automatic print system cleaning only if the quality of the imprint is not good enough (e.g. blank spots in the imprint after longer periods out of use).



Cleaning

- Open the MENU.
- Choose PRINT SYSTEM.
- Choose CLEANING in the submenu.

A message informs you about the cleaning process in progress.

- Check the quality of the imprint with a test print (see page 41).

Intensive cleaning

You should start intensive cleaning if normal cleaning fails to improve the print quality to your satisfaction.



- Open the MENU.
- Choose PRINT SYSTEM.
- Choose INTENSIVE CLEANING in the submenu.

A message informs you about the cleaning process in progress.

- Check the quality of the imprint with a test print (see page 41).



In case of stubborn soiling, even intensive cleaning may be unable to improve the print quality as desired. In such cases, you can manually clean the cartridges (see page 97).

11.4.2 Cleaning ink cartridges by hand



Caution! Inexpert cleaning can damage the ink cartridges and render them useless. Heed the following hints to avoid damage to the print system:

- In case of print quality issues, always run the cleaning functions of the franking machine accessible from the MENU first. Read chapter 11.4.1 on page 96.
- You should manually clean the ink cartridges in exceptional cases only where intensive cleaning fails to restore the normal print quality.
- For cleaning, make sure to use a soft, lint free cloth moistened with demineralized water. Small fibers could clog the nozzles. Too hard or dry cloths could scratch the nozzle plate. Such scratches make the ink cartridge useless because they prevent the ink-jet from being correctly positioned during printing.
- Never use any chemical cleansers either.



Move the ink cartridges into the change position.

- Open the MENU.
- Choose PRINT SYSTEM.
- Choose CHANGE CARTRIDGES in the submenu.

Removing the cartridges

- Remove one cartridge as usual (see page 91).

Cleaning

- Moisten a lint free cloth with demineralized water.



You can also use distilled water or normal tap water if demineralized water is not at hand. The minerals contained in tap water could, however, leave residues in the print head.



For best cleaning results, use FP contact cleaner and cleaning cloths contained in the clean & renew cleaning kit offered by Francotyp-Postalia.

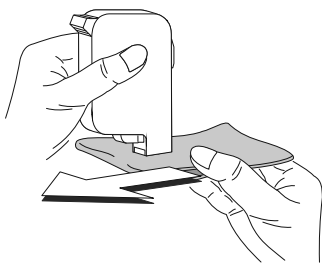

- Hold the cartridge as shown in the picture. The nozzles must point downwards!
- Slowly and carefully wipe the print head with the cloth in the direction of the arrow. Repeat this action several times.

The water will blend with ink residues and clean the nozzles.

- Reinsert the cartridge.
- Remove the second cartridge and clean it in the same manner.
- Reinsert the cartridge.
- Close the flap of the print system.
- Align the cartridges (see chapter 11.3, page 95).

11.5 Print system: displaying filling level



- Open the MENU.
- Choose PRINT SYSTEM.
- Choose INFORMATION in the submenu.

The PostBase displays the filling level of the ink cartridges.

11.6 Replacing the transport brush

When imprints on thin letters or labels appear compressed, the transport brush needs to be replaced.



Caution! Make sure not to soil yourself, your clothes or any objects. Use a mat to deposit the drawer.



Caution! As long as the print system is in printing position, the drawer is locked. Do not pull out the drawer by force. Wait until the print system moves into idle position, then remove the drawer.

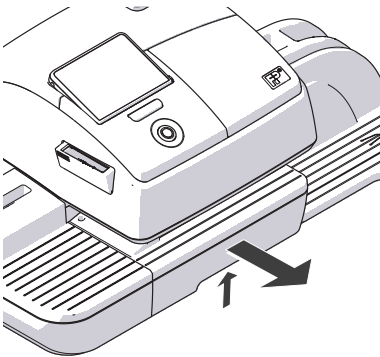

- Unlock the drawer by pushing the drawer latch lever upward.
- Pull the drawer to the front and out of the housing.
- Deposit the drawer on a mat.

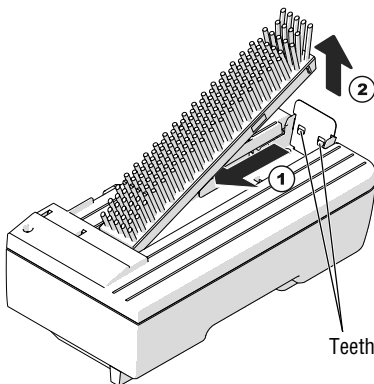

Remove worn-out transport brush

The transport brush is held in the brush carrier by two teeth on the right side.

- Grab the bristles, pull the worn-out transport brush to the left and pull it upwards out of the brush carrier.

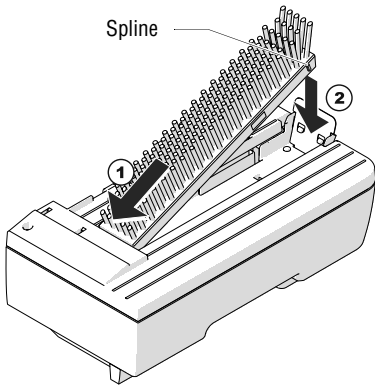

Insert new transport brush

- Insert the new transport brush into the brush carrier with the spline facing the front.
- Push down the brush on the right side until it locks into place beneath the two teeth.

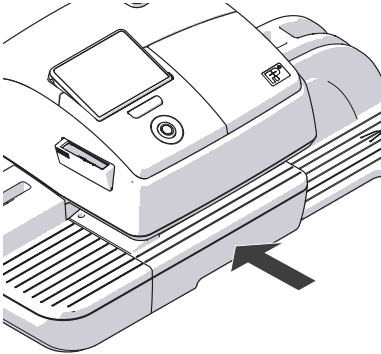

- Push the drawer back in all the way. Make sure it engages properly on both sides.

PostBase is ready for operation again.

11.7 Feeder (optional)

11.7.1 Filling with sealing liquid

We recommend using the 'sealit' sealing liquid. This special sealing liquid is available from Francotyp-Postalia.



Warning! Switch off the PostBase mailing system and all components connected to it prior to topping up sealing liquid.



Warning! Be extremely careful when handling liquids. If you fill the sealant tank, make sure not to wetten any parts connected to the mains. If this should happen, immediately pull the power plugs. Have the PostBase mailing system checked by the Customer Support before using it again.

PostBase button

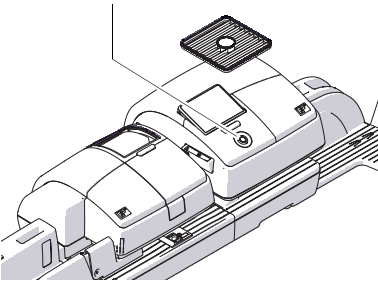

- Switch off the mailing system.

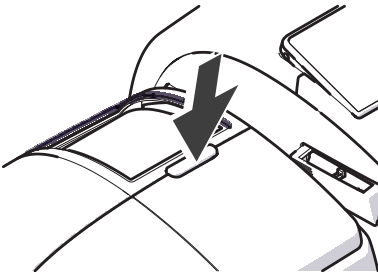

- Open the flap by pressing the release button.

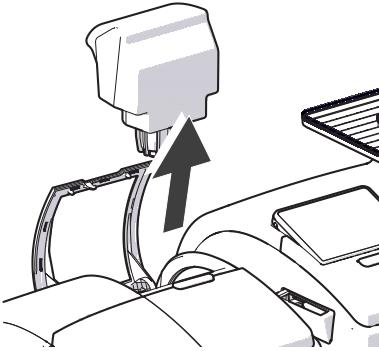

- Remove sealant tank out of housing.

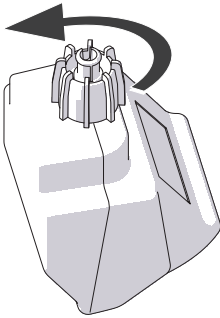

- Unscrew sealant tank cover.
- Fully empty sealant tank and, if necessary, clean it.

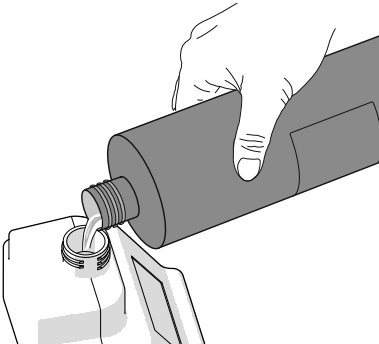

- Fill the sealant tank with 'sealit' sealing liquid.

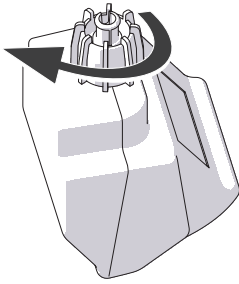

- Place sealant tank screw cover and tighten.
- Turn sealant tank upside down in a non-dangerous area (e.g. over a sink) to check if the cover is well sealed.

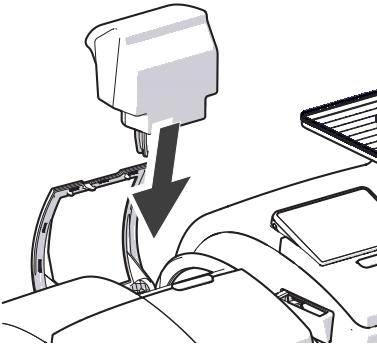

- Insert sealant tank into the housing with the cover downward.

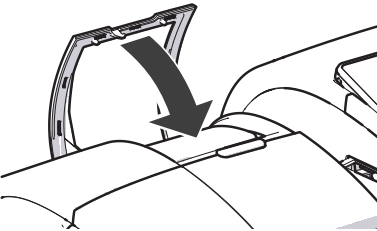

- Close the flap.

11.7.2 Adjust moistening level

With the help of the supplied spacer ring, the moistening level can be adapted to the letters accordingly. Depending on the position of the spacer ring, moistening of the envelope flaps can be reduced or increased.



Warning! Switch off the PostBase mailing system and all components connected to it prior to adjusting the moistening level.

PostBase button

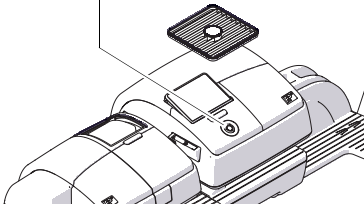

- Switch off the mailing system.
- Remove sealant tank out of the housing (for further information see chapter 11.7.1 on page 101).

At the rear of feeder:

- Carefully pull out to the back the sealant tray (see page 106).

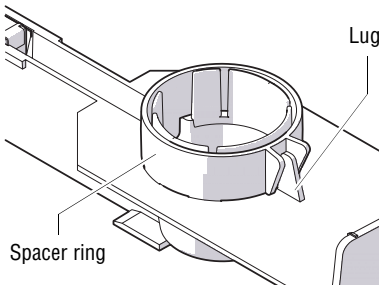

Normal moistening

With this setting, you achieve best results in most cases.

- Position the spacer ring so that the teeth are facing down and the lug on the tray is placed between the guides. The teeth have to nip into the cut-outs of the tray.

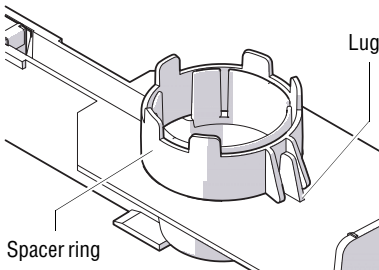

Reduce moistening

- Position the spacer ring so that the teeth are facing up and the lug on the tray is placed between the guides.

- Insert the sealant tray into the housing until it clicks into place (see page 107).
- Insert sealant tank into the housing with the cover downward. Close the flap (see page 103).

11.7.3 Cleaning / changing the moistening sponge

The sponge for moistening the envelope flaps should be cleaned regularly (e.g. always after weekend). Check the condition of the sponge and replace it if exhausted. We recommend always keeping a new sponge in reserve.



Warning! Switch off the PostBase mailing system and all components connected to it prior removing the sealant tank and changing the sponge.



Warning! Be extremely careful when handling liquids. If you fill the sealant tank, make sure not to wetten any parts connected to the mains. If this should happen, immediately pull the power plugs. Have the PostBase mailing system checked by the Customer Support before using it again.

PostBase button

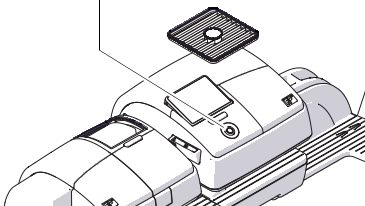

- Switch off the mailing system.

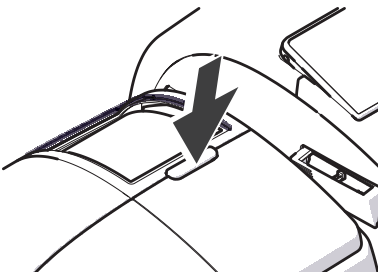

- Open the flap by pressing the release button.

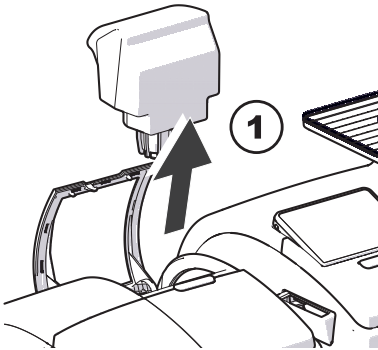

- Remove sealant tank out of the housing and put it at a safe place.

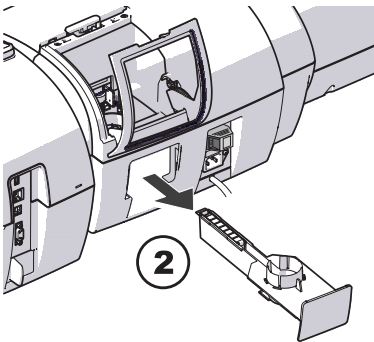

At the rear of feeder:

- Carefully pull out to the back the sealant tray.
- Empty sealant tray.

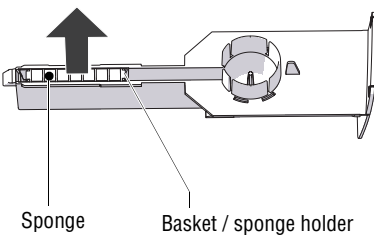

- Lift the basket with the sponge out of the tray.
- Clean sponge or replace with a new one.
- Put a new sponge (with basket / sponge holder) into sealing liquid before inserting it, and let soak completely. The flaps are thus correctly moistened from the first letter on.

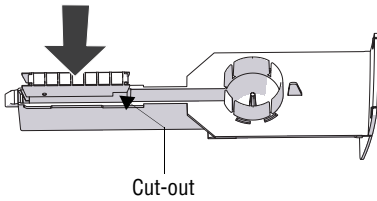

- Carefully insert the basket with sponge into the tray until basket and tray are flush. Mind the position of the cut-out.

Checks:

Basket on the extreme left

Basket flushed on top

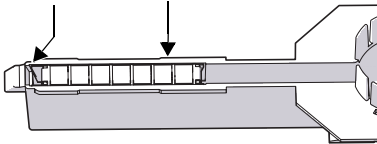

- Check if the basket is correctly seated: It must rest on the extreme left in the tray and close on top in a flushed manner.

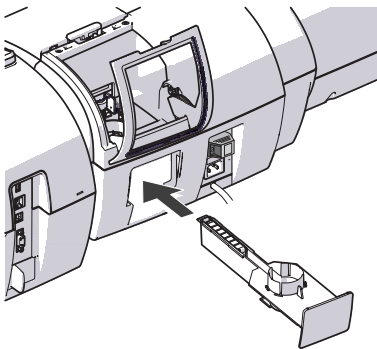

- Insert the complete tray into the housing until it clicks into place.
- Check if the sponge is correctly seated. It should be directly below the moistening felt and brush.

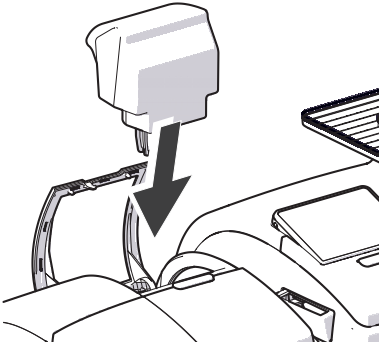

- If necessary: Fill 'sealit' sealing liquid into sealant tank. Check for leakages. (For further information see chapter 11.7.1.)
- Insert sealant tank into the housing with the cover downward.

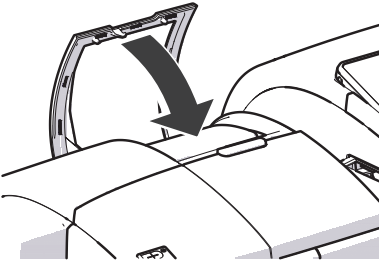

- Close the flap.

11.7.4 Cleaning / changing the moistening brush

PostBase button

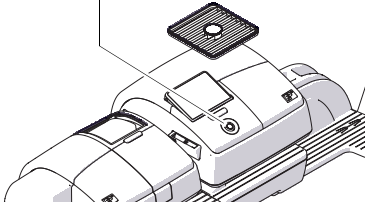

- Switch off the mailing system.

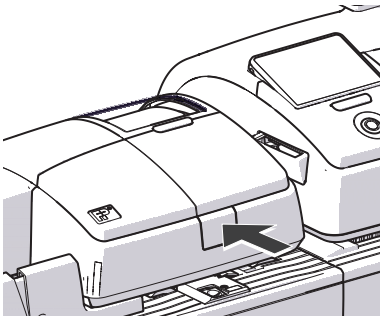

- Open roller transport by pressing on release key.

Roller transport moves upward.

Now you have access to the moistening brush beneath the roller support.

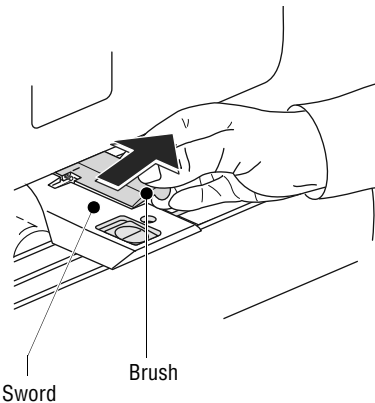

On both sides, the brush is provided with pins that are snapped in clips on the sword.

- Slightly lift the brush and pull it off the sword in the direction of the arrow.

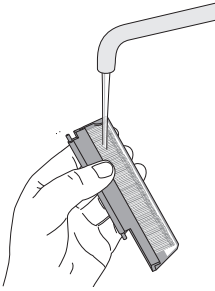

- Clean brush or replace with a new one.
- Moisten a new brush before inserting it.

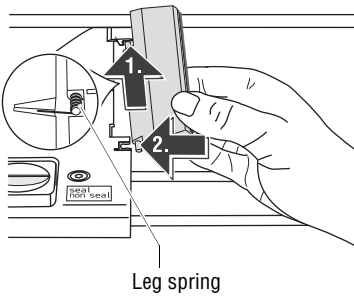

- Hold the brush as shown in the figure.
 - The bristles must face down.
 - One leg of the leg spring is located in the brush groove and the other leg in the sword slot.
- Put the rear pin into the clip of the sword as indicated by the arrow.
- Then carefully snap the front pin into the clip of the sword.

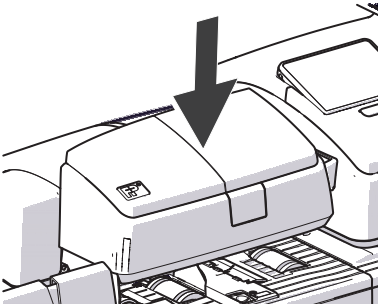

- Push the roller transport powerfully down until it locks into place.

11.8 Sealer *(optional)*

11.8.1 Cleaning

To remove glue residues the sealer should be cleaned once a month.

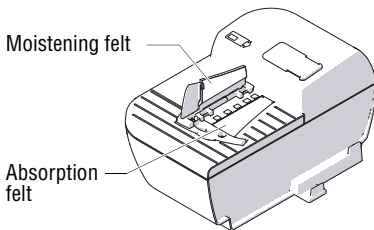
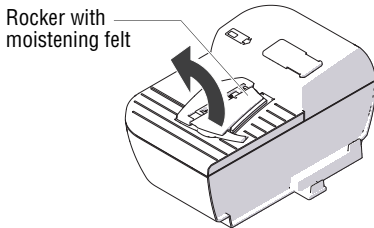

- Separate the sealer from the franking machine:
Slightly lift the franking machine on the left side and pull the sealer away to the left.
- Swing up the rocker with the moistening felt.
- Thoroughly rinse absorption and moistening felts under running water.
- Wipe the housing with a damp cloth. You can also use a commercially available liquid soap.
- Fill 'sealit' sealing liquid (see page 112).
- Dry the sealer.
- Connect the sealer to the franking machine.

11.8.2 Checking the liquid level and filling 'sealit' sealing liquid

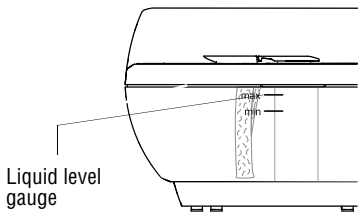

- Check the liquid level in the sealer regularly.

Make sure the sealer is always filled at least to the 'min' mark to prevent the felts from drying up. When felts with glue residues dry up they harden to the point of becoming prematurely useless.

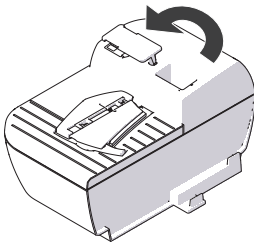

Filling 'sealit' sealing liquid

We recommend using the 'sealit' sealing liquid. This special sealing liquid is available from Francotyp-Postalia.

- Swing the filler hole lid aside.

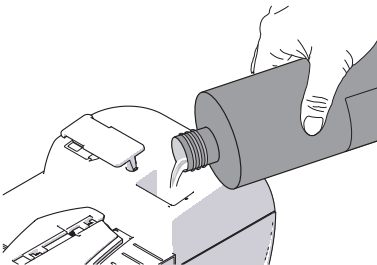

- Fill the sealer with 'sealit' sealing liquid.
- Check the liquid level.
The liquid level in the sealer should roughly reach to the 'max' mark.

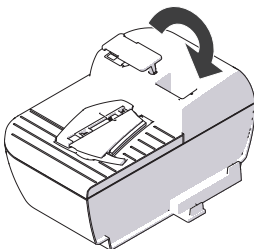

- Swing the filler hole lid back on.
- If necessary: dry the sealer outside.

11.8.3 Replacing felts

- Separate the sealer from the franking machine:
Slightly lift the franking machine on the left side and pull the sealer away to the left.
- Empty the liquid reservoir.

Removing the rocker with moistening felt

- Slightly tilt the rocker and pull it off in an obliquely upward direction.

Rocker with moistening felt

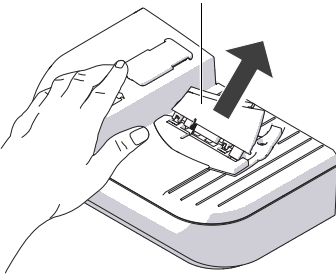

Removing the absorption felt

- Grip the absorption felt with pliers or tweezers and pull it out upwards.

Absorption felt

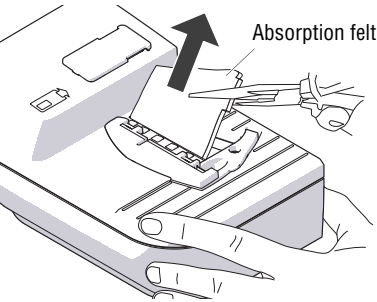

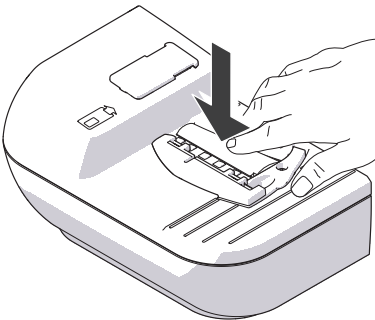
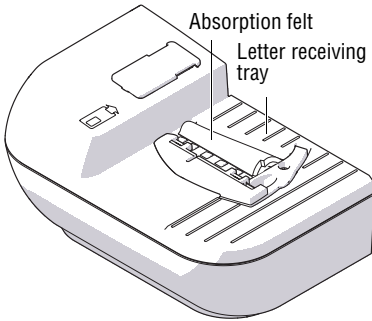
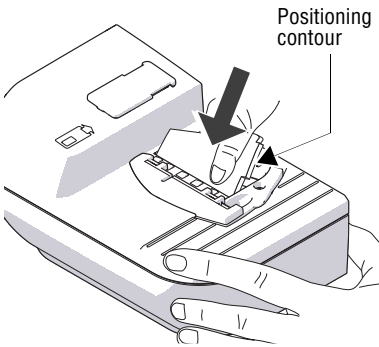

Installing the absorption felt

- Install a new absorption felt as shown in the illustration. The felt should be halfway in the sealer.
- Bend the upper part of the felt to the right and push it beneath the letter receiving tray until it reaches the stop in the contour.
- Evenly push the arched absorption felt with your hand into the liquid reservoir. Make sure that the felt is correctly seated, in particular at the edges. The stop in the positioning contour must fit precisely in the opening of the letter receiving tray.
- As a final measure, stroke with your finger over the felt repeatedly to eliminate any irregularities.

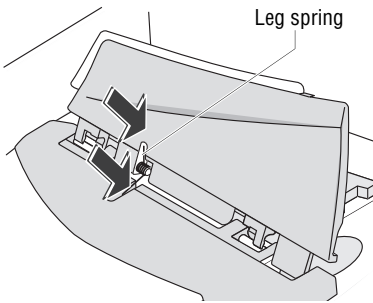

Installing the rocker with moistening felt

The rocker features two clips that engage on the two bolts at the sealer.

- Fit the new rocker such that one leg of the leg spring is located in the rocker groove and the other leg in the sealer slot.

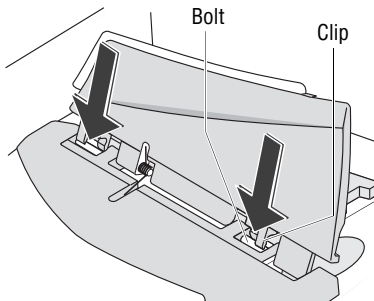

- Hold sealer in place, and exerting moderate pressure, push the rocker onto the sealer such that the two clips engage on the bolts.

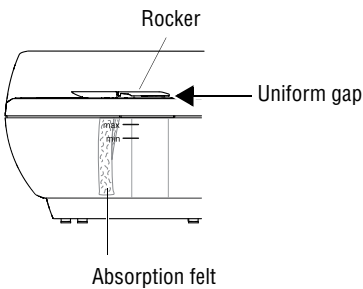

Check

- Check the correct seat:
 - The absorption felt must be perpendicularly suspended in the liquid reservoir. Its lower edge should roughly reach the bottom.
 - The gap between rocker and sealer housing must be uniform. (The rocker must neither jut out nor touch the housing.)
- Fill 'sealit' sealing liquid (see page 112).
- Connect the sealer to the franking machine.

12 Tips for troubleshooting

12.1 Error messages and help

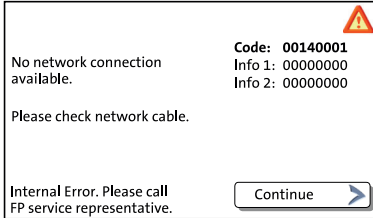

An error message appears on the display in case of an error or handling error. An additional beep may also indicate an error.

Make sure to carefully read the error message. You will be given hints on the error cause and what you can do to remedy it.

A symbol indicates the error group (e.g. 'communication error'). For an overview of error group symbols, refer to page 139.

You can correct many minor errors and issues occurring during PostBase operation yourself.



Please contact the Customer Support if you cannot remedy an error by means of the display information and the hints given in the present Operator Manual.

Issue	Possible cause and remedy
... when franking	
Franking not possible	No product / postage set because – mailing data are incomplete or – weight value is missing. Check product settings (<i>see chapter 5.1</i>).
	No credit left in franking machine. Please load postage (<i>see chapter 8</i>).
	Maximum postage value for franking exceeded. Please contact the system administrator.
	Credit of the current user is too low. Have the system administrator assign new credit.

Issue	Possible cause and remedy
Imprints are compressed (thin letters / labels)	Replace the transport brush (<i>see chapter 11.6</i>).
Label franking: – separation error – jam	<p>The labels used were not well suited. We recommend to use only labels that have been approved by Francotyp-Postalia.</p> <hr/> <p>Labels stick to one another. Take the labels out of the dispenser. Slacken / fan the label stack and reinsert it.</p> <hr/> <p>Internal problem of label print function. Call the Customer Support.</p>
Letter jam	On how to clear a letter jam, please see <i>chapter 12.2</i> .
Letter transport fails to start	<p>PostBase does not show the Home screen. Return to the Home screen and try again.</p> <hr/> <p>Sensor does not recognize letter. Position the letter again.</p>
PostBase signals a jam although no letters are in the letter path	The sensors (light barriers) are soiled. Clean the sensors (<i>see chapter 12.5</i>).
Print quality: Blank spots	Clean print system (<i>see chapter 11.4</i>).
Print quality: Offsets / shifts in the franking imprint	Align the ink cartridges (<i>see chapter 11.3</i>).
Weighing: no weight is determined for the letter on the scale	<p>The weighing platform was still occupied when another letter was placed on it. The franking machine can determine a new weight only if the scale has been emptied beforehand. Empty the weighing platform. Place the letter.</p> <hr/> <p>Letter transport is still running. Wait until letter transport stops prior to putting on a mail piece for weighing.</p>

Issue	Possible cause and remedy
<p><i>(Continued)</i> Weighing: no weight is determined for the letter on the scale</p>	<p>The scale operates in the 'Differential weighing' mode. The weight is determined upon removing the mail piece from the weighing platform (<i>see chapter 5.1.4.3</i>).</p> <hr/> <p>Either PostBase does not recognize the scale, or the scale is defective. Call the Customer Support.</p> <hr/> <p>The weight is too low or the scale is overloaded. Use scale for mail pieces of the permitted weight range only.</p>
<p>... general errors</p>	
<p>Accounts are missing</p>	<p>The current user is not allowed to frank on the desired account. Please contact the system administrator.</p>
<p>Blank display</p>	<p>Check whether the power cable is plugged in correctly and the PostBase is turned on.</p> <hr/> <p>PostBase is in standby. Press the PostBase button briefly.</p>
<p>Display fails to react when touched</p>	<p>Turn off the PostBase. Calibrate touch screen (<i>see chapter 12.9</i>).</p>
<p>Functions are missing in the display (e.g. advertising imprint)</p>	<p>The currently set product may allow only one / no advertising imprint(s). Generally, unavailable functions are blanked out.</p>
<p>Lost PIN (administrator PIN)</p>	<p>Select LOST PIN. Follow the prompts in the display.</p>
<p>Lost PIN (user PIN)</p>	<p>Please contact the system administrator.</p>
<p>No users available</p>	<p>When deactivating access control, all users are deleted. Create new users with the PC software.</p>

Issue	Possible cause and remedy
Scale: no confirmation beep	Adjust tone signals (<i>see chapter 10.3</i>).
User PIN is not accepted	Did you select the correct user? Press BACK. Select the correct user.
	Contact the system administrator.
... postage download	
Desired amount cannot be loaded	Impermissible amount. Change amount and repeat loading.
Function not available	The current user is not authorized to access this function. Please contact the system administrator.
Postage download procedure aborts	The PostBase fails to establish connection to the data center. Check connection configuration (<i>see chapter 10.9</i>). Check data center phone number (<i>see chapter 10.10</i>). Data center issue. Try again later.
... when using special functions	
Advert Only: adverts / text messages are not printed on the expected position on the letter	Imprint offset is active. Deactivate the imprint offset or set a suitable value (<i>see chapter 5.3</i>).
Print Numbers: the number is not printed on the expected position on the letter	Imprint offset is active. Deactivate the imprint offset or set a suitable value (<i>see chapter 5.3</i>).
Seal Only: letters are transported, but not sealed	On the feeder, check if the sealing function is switched on. Set the switch to the rear position (seal). <i>See chapter 6.3.3.2.</i>

Issue	Possible cause and remedy
... basic settings, maintenance and care	
Drawer cannot be opened	<p>The drawer is locked while the print system is in print position.</p> <p>Wait until the print system retreats into idle position and try again.</p>
Ink cartridges are not detected	<p>Ink cartridges are not fitted correctly. Remove ink cartridges and insert them once again.</p> <hr/> <p>Wrong ink cartridges inserted. Observe the specifications (<i>see page 141</i>).</p> <hr/> <p>Contacts of the print system are soiled. Use the 'clean and renew' FP cleaning kit for ink-jet print systems to clean the contacts.</p> <hr/> <p>Ink cartridges are defective. Call the Customer Support.</p>
Print system cleaning fails to improve the print quality	<p>Ink cartridges heavily soiled or dried up. Repeat cleaning: Function 'Intensive Cleaning'.</p> <p>If you cannot solve the problem: Clean ink cartridges by hand (<i>see chapter 11.4.2</i>).</p>

Issue	Possible cause and remedy
... with automatic feeding / sealing (<i>feeder</i>)	
Envelopes are not properly sealed	<p>Rub powerfully with your hand over the letter stack once in the area of the flaps.</p>
	<p>Moistening sponge and brush are dried because the sealant tank was empty over a longer period of time. Remove sponge and let it soak up completely (<i>see chapter 11.7.3</i>).</p>
	<p>Sponge is dirty or worn. Clean or replace the sponge (<i>see chapter 11.7.3</i>).</p>
	<p>Brush is dirty or worn. Clean or replace the brush (<i>see chapter 11.7.4</i>).</p>
	<p>You have used unsuited envelopes. Only use envelopes that are suited for sealing by machine. Observe specifications (<i>see page 143</i>).</p>
	<p>Adjust the moistening level (<i>see chapter 11.7.2</i>).</p> <p>Use the special 'sealit' sealing liquid available from Francotyp-Postalia.</p>
Envelopes are not sealed	<p>Sealing is disabled. Set the switch to the 'seal' position (<i>see chapter 6.3.3.2</i>).</p> <p>Sealant tank is empty. Fill more 'sealit' sealing liquid (<i>see chapter 11.7.1</i>).</p>
Jam	<p>On how to clear a letter jam, please read <i>chapters 12.2 and 12.3</i>.</p>
Letters are not correctly fed	<p>When processing thick letters (>6 mm / 0.24"), use the 'thick letters' function (<i>see page 62</i>).</p> <p>Adjust the slope inclination (<i>see page 61</i>).</p>
Letter transport does not start	<p>PostBase does not display the Home screen / the 'Batch Processing' pop-up (<i>see chapter 6.3.3.4</i>).</p>

Issue	Possible cause and remedy
Letter transport is stopped / batch processing was interrupted	<p>Jam. Carefully read the displayed information. On how to clear a letter jam, please read <i>chapters 12.2 and 12.3.</i></p> <hr/> <p>The batch counter is turned on. After the pre-set number of mail pieces have been processed, PostBase will automatically stop (<i>see chapter 6.3.3.5</i>).</p>
PostBase signals a jam although no letters are in the letter path	<p>The sensors (light barriers) are soiled. Clean the sensors (<i>see chapters 12.5 and 12.6</i>).</p>
... with manual sealing (<i>sealer</i>)	
Envelopes are not properly sealed	<p>Stroke your hand firmly over the envelope's / letter stack's flap area.</p> <hr/> <p>Use the special 'sealit' sealing liquid available from Francotyp-Postalia.</p>
Envelope flaps are not moistened properly	<p>Felts are soiled / dried out. Clean sealer (<i>see chapter 11.8.1</i>). Fill 'sealit' sealing liquid (<i>see chapter 11.8.2</i>).</p> <hr/> <p>Moistening felt is worn. Replace rocker with moistening felt (<i>see chapter 11.8.3</i>).</p> <hr/> <p>Absorption felt is worn. Replace absorption felt (<i>see chapter 11.8.3</i>).</p> <hr/> <p>Moistening felt incorrectly seated in the rocker. Correct moistening felt position (<i>see chapter 12.4</i>).</p> <hr/> <p>Absorption felt incorrectly seated in the sealer. Surface is curved. Check and if necessary correct absorption felt position in the sealer (<i>see page 115</i>).</p>

Issue	Possible cause and remedy
... during installation	
Blank display	Check whether the power cable is plugged in correctly and the PostBase is turned on.
Delivery is incomplete / damaged	Do not start operating the PostBase. Call the Customer Support.
Error during installation procedure	<p>An error message with troubleshooting information appears.</p> <p>If necessary:</p> <ul style="list-style-type: none"> • Turn off the PostBase (<i>see chapter 4.1</i>). Wait one minute. • Turn the PostBase on again. <p>The installation procedure restarts.</p> <p>Make sure that the Connection Configuration is set correctly (<i>see chapter 10.9</i>).</p>
Other errors ...	If you cannot remedy an error yourself, please call the Customer Support.

12.2 Removing letter jams in the franking machine



Caution! Make sure not to soil yourself, your clothes or any objects. Use a mat to deposit the drawer.



Caution! As long as the print system is in printing position, the drawer is locked. Do not pull out the drawer by force. Wait until the print system moves into idle position, then remove the drawer.

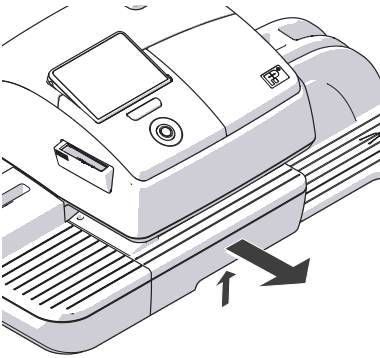

- Unlock the drawer by pushing the drawer latch lever upward.
- Pull the drawer to the front out of the housing.
- Deposit the drawer on a mat.
- Carefully remove jammed letters.

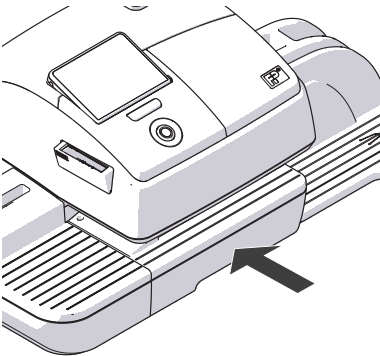

- Push the drawer back in all the way. Make sure it engages properly on both sides.

PostBase is ready for operation again.

12.3 Removing letter jams in the feeder



Warning! Keep long hair, fingers, loose clothing pieces, neck ties, shawls, jewelry and the like away from moving machine parts.

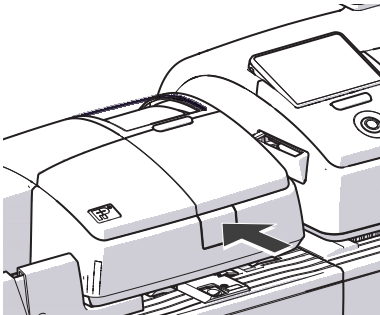

- Release roller transport by pressing on release key.

Roller transport moves upward.

- Carefully remove jammed letters.

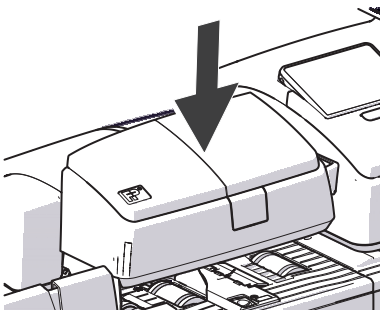

- Press roller transport powerfully down until it clicks into place.

The PostBase is ready for operation again.

12.4 Correcting the moistening felt position on the rocker (sealer)

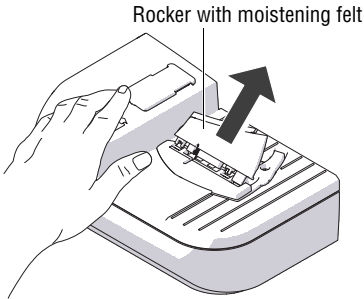

- Slightly tilt the rocker and pull it off in an obliquely upward direction.

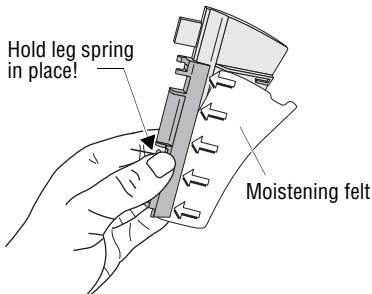

Caution! Make sure to always hold the leg spring on the pin with one hand while positioning the moistening felt. This will prevent the leg spring from jamming or jumping out.

- Push the long moistening felt side fully underneath the clamping strip such that
 - the felt's recesses are perfectly aligned with the rocker stop edge and
 - both moistening felt outer edges uniformly project over the rocker edge by approximately 1 - 2 mm (0.04 - 0.08"). See illustration.

Moistening felt correctly positioned:

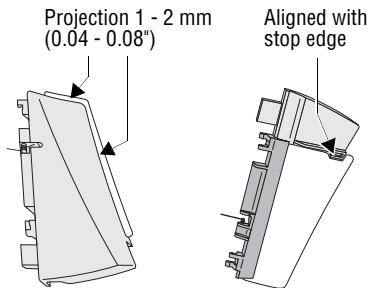

- Carefully displace the moistening felt in the clamping strip if necessary.
- Reattach the rocker on the sealer (see page 115).

12.5 Cleaning the sensors of the PostBase

Over time, paper dust may settle on the franking machine's sensors and cause problems with recognizing positioned letters. We recommend cleaning the sensors in the PostBase once a month to ensure optimal results. You can order a special cleaning kit from Francotyp-Postalia.



Caution! Make sure not to soil yourself, your clothes or any objects. Use a mat to deposit the drawer.



Caution! As long as the print system is in printing position, the drawer is locked. Do not pull out the drawer by force. Wait until the print system moves into idle position, then remove the drawer.

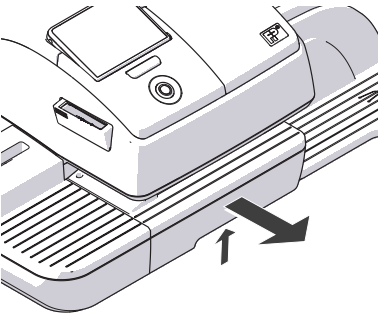

- Unlock the drawer by pushing the drawer latch lever upward.
- Pull the drawer to the front and out of the housing.
- Deposit the drawer on a mat.

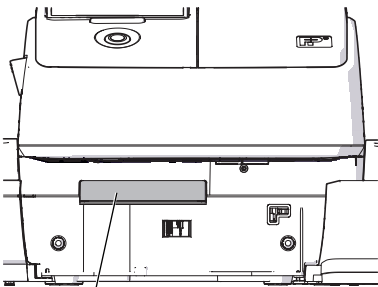

Sensors

- Apply cleaning solution to the cleaning cloth.
- Clean the sensors by wiping them repeatedly with the cleaning cloth.

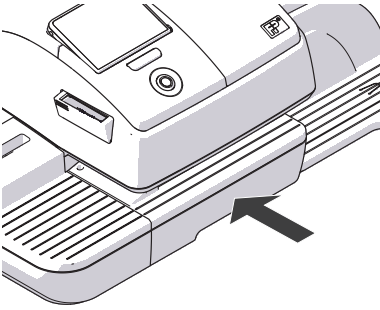

- Push the drawer back in all the way. Make sure it engages properly on both sides.

The PostBase is ready for operation again.

12.6 Cleaning the sensors of the feeder

Over time, paper dust may settle on the feeder's sensors and cause problems with recognizing positioned letters. We recommend cleaning the sensors in the feeder once a month to ensure optimal results. You can order a special cleaning kit from Francotyp-Postalia.

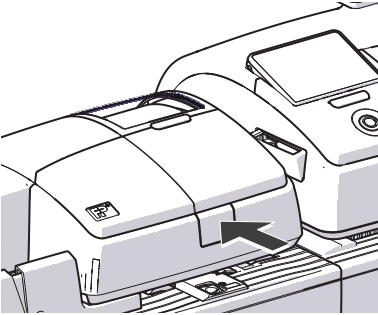

- Switch off the PostBase mailing system.
- Release roller transport by pressing on release key.

Roller transport moves upward.

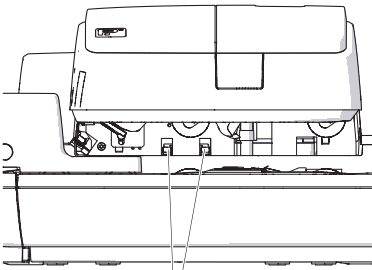

Sensors

- Apply cleaning solution to the cleaning cloth.
- Clean the sensors by wiping them repeatedly with the cleaning cloth.

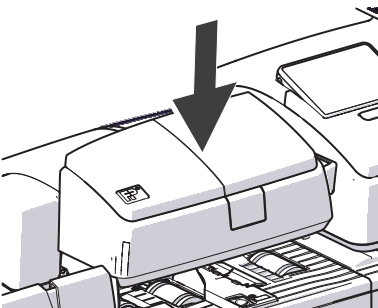

- Press roller transport powerfully down until it clicks into place.

12.7 Removing / inserting the security device



Caution! Remove the security device in exceptional cases only, e.g. if you need to send in the franking machine to the Customer Support. The connector of the security device is designed for a maximum of 30 connection cycles (removal / insertion).



Caution! When the franking machine or the security device was in a cold environment (i.e. below 10 °C / 50 °F) before: Wait for at least two hours before connecting and commissioning the PostBase franking machine. The franking machine needs this time to adapt to the ambient conditions. Any condensation evaporates.

Removing the security device

- Turn the PostBase off.

The PostBase will complete any current actions and then switches off. The display light and PostBase button illumination go out.

- Unplug the power plug from the wall socket.
- Unplug the power cable from the power connection of the franking machine.
- Press the clip catch on the cover of the security device slot in the direction of the arrow and remove the cover.

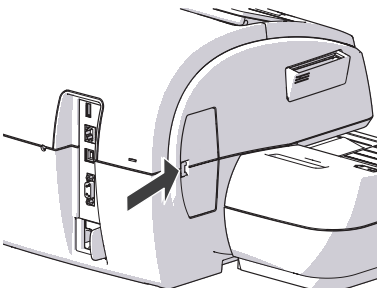

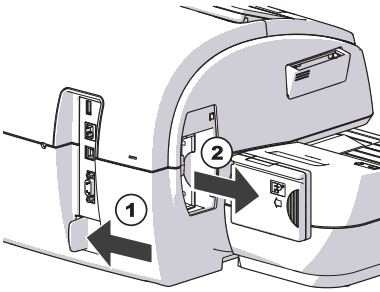

- Push the white slider next to the power socket on the PostBase in the direction of the arrow **and hold it**. The catch retracts and allows access to the security device.
- Remove the security device out of its mounting.
- Release the white slider.

Inserting the security device

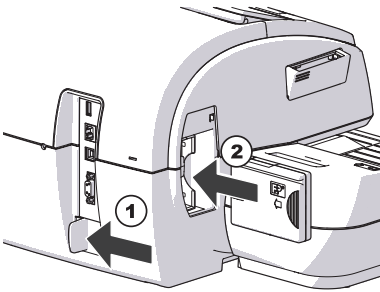

- Push the white slider next to the power socket on the PostBase in the direction of the arrow **and hold it**. The catch allows access to the security device mounting.
- Insert the security device as shown in the picture and push it all the way into the mounting. You can feel it engage.
- Release the white slider.
- Close the cover of the security module slot again.
- Reconnect the power cable.

You can now use the PostBase franking machine again.

12.8 Manually ejecting the ink cartridges

If need be, the ink cartridges can be removed without the franking machine running (e.g. in case the franking machine is defective and is to be send to the Customer Support).

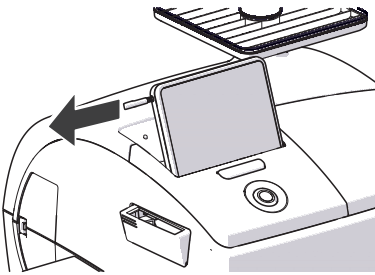

- Take the stylus from its carrier behind the display.
- If necessary, turn the PostBase off.

The PostBase will complete any current actions and then switches off. The display light and PostBase button illumination go out.

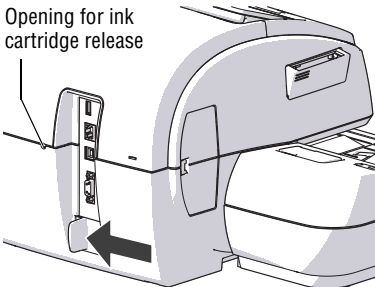

- Unplug the power plug from the wall socket.
- Unplug the power cable from the power connection of the franking machine.
- Push the white slider next to the power socket on the PostBase in the direction of the arrow **and hold it**, thus allowing the manual removal of the ink cartridges.

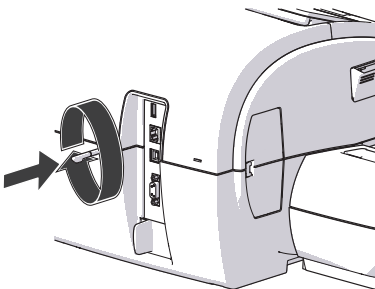

- Insert the stylus in the opening in the back of the franking machine.
- Rotate the stylus clockwise until the flap opens.
- Remove the ink cartridges as usual (see page 91).

12.9 Calibrating the touch screen



- Turn on the PostBase.

As soon as the screen displays PostBase logo:

- **Touch the display and keep your finger on it** until the calibration procedure starts.
- Follow the instructions on the display: Touch the points where the red circle symbol appears.

The PostBase will continue its start routine.
The display is now calibrated.

13 Decommissioning and disposing of the franking machine

To ultimately decommission the PostBase franking machine, you must correctly unsubscribe all postal services. PostBase will guide you through all required decommissioning steps in a dialog. We are pleased to assist if required. Please contact the Customer Support.

In case of a rented or leased franking machine, please make sure to always contact the Customer Support.



Caution! Run the 'Withdraw machine' function only if you really want to decommission the PostBase. Commissioning the franking machine after decommissioning is only possible by calling a service technician at extra costs.



- Make sure PostBase is ready to connect to the data center.
- Run the MENU function WITHDRAW MACHINE.
- Follow the instructions on the display. Make sure to carefully read the information!
- For disposal of the franking machine, please contact the Customer Support.

Overview of symbols

Menu functions



Postage download



Display register report



Set franking date *(not in all countries)*



Print system



Print system information (display filling level)



Clean print system



Align cartridges



Replace cartridges



Calibrate cartridges



Change account



Remote Services / synchronize with data server



Account administration
(show list, set accounts to zero, switch account function on / off)



Special functions



Print advert only



Feed only



Seal only



Print numbers only



Imprint offset *(not in all countries)*



Auto postage download / set threshold



Display / clear down piece counter



Adjust display brightness



Brighter



Default



Darker



Display system info



Change ZIP code / place of posting *(not in all countries)*



Change language



Display / edit connection configuration (network / modem)



Withdraw machine *(not in all countries)*



Set tone signals



Edit standby time



Edit 'Auto Off' time



Configure access control / PIN



Display contact information / change data center phone number



Set meter type *(not in all countries)*

Standard buttons



Open product calculation menu



Open Menu



Start franking / automatic feeder



Frank labels / print register on labels



OK / Finished / Confirm / Save



Cancel



Continue



Back



Edit / Change



'Differential weighing' mode on



'Differential weighing' mode off / normal weighing mode



Feeder: 'thick letters' mode on



Feeder: 'thick letters' mode off / normal mode



Start label printing / automatic feeding



Stop label printing / automatic feeding

Error categories



General error



Printing plate error



Account error



Automatic feeder error



Print system error



Scale error



Label dispenser error



Jam



Security device error



Communication error with the PC



Postage calculation error



Communication error with FP infrastructure.

Technical Data

Dimensions

– Length	310 mm (12.2") – <i>housing</i>
	146 mm (5.7") – <i>hand feed tray / sealer</i>
	385 mm (15.2") – <i>feeder</i>
	280 mm (11") – <i>slope</i>
	320 mm / 445 mm (12.6" / 17.5") – <i>catch tray min / max</i>
– Width	345 mm (13.6")
	390 mm (15.4") – <i>with slope</i>
– Height	300 mm (11.8") – <i>with weighing platform</i>

Weight

8.9 kg (19.6 lb) – <i>franking machine</i>
0.6 kg (1.3 lb) – <i>hand feed tray</i>
0.6 kg (1.3 lb) – <i>sealer</i>
7.3 kg (16.1 lb) – <i>feeder</i>
2.6 kg (5.7 lb) – <i>slope</i>
0.9 kg (2 lb) – <i>catch tray</i>

Power connection

– franking machine	100 - 240 V / 2.0 A / 50 - 60 Hz
– feeder	100 - 240 V / 2.0 A / 50 - 60 Hz

Power consumption

– franking machine	80 W, Energy Star
	< 1 W (switched off)
	< 7 W (standby)
– feeder	80 W

Battery

3,6 V / 2 Ah / 20 mA order no. 90.4701.8004.00

Display

TFT, 480 x 272 pixels, with touch panel, backlit

Print system

– Print technology	ink-jet, 2 ink cartridges
– Printing area	max. 185 mm x 25 mm (7.3" x 1")
– Print resolution	≥ 300 dpi

Performance	According to machine configuration / country version: up to 85 letters/min <i>(Varies depending on envelope size / content, imprint length, machine state and operating mode.)</i>
Noise emission	< 60 dB(A) franking machine (stand alone) < 70 dB(A) franking machine with feeder
Operating conditions	+15 °C to +35 °C (59 °F to 95 °F) Only use in closed rooms Do not expose to direct sunlight Rel. humidity 15 % to 80 % non-condensing
Weighing area	3 g to 7000 g (0.1 oz to 15 lb) (depending on machine configuration)

Ink cartridges

Ink cartridges	FP cartridge kit for PostBase
Operating and storage conditions	+15 °C to +35 °C (59 °F to 95 °F) Use in closed rooms only Do not expose to direct sunlight Relative humidity 20 % to 70 %, non-condensing



Safety data sheet for users available at <http://www.francotyp.com/en/mail-management/material-safety-data-sheets-msds.html>.

Subject to short-term modification.

Mail piece specifications

Format (length x width)	<u>PostBase (stand-alone):</u> 127 mm x 89 mm up to 253 mm x 353 mm (5" x 3.5" up to 9.96" x 13.89") <u>PostBase with feeder:</u> 152 mm x 101 mm up to 253 mm x 353 mm (6" x 4" up to 9.96" x 13.89")
Thickness	<u>Franking without usage of sealing function:</u> Up to 10 mm (0.4") <u>Using the feeder's sealing function:</u> Up to 7 mm (0.3")
Material	Ink-absorbent material (suitable for ink-jet printing) No dark paper No glossy coating on the surface to frank No bubble-foil material No corrugated board No extremely fibrous paper on which the data matrix symbol could smear
Labels	Self-adhesive labels for PostBase

Subject to short-term modification.

Envelope specifications for automatic sealing (*feeder*)

Material Envelopes must be suitable for sealing by machine. The flap must be at the envelope's long side.

Sealing area Sufficient closure can only be achieved with continuous sealing area.

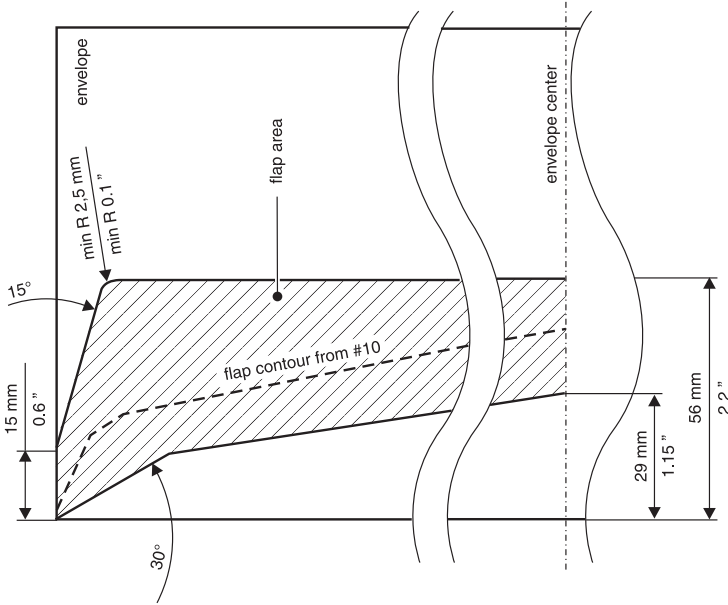

Subject to short-term modification.

EC DECLARATION OF CONFORMITY FOR ELECTRICAL PRODUCTS

(According to Annex III B of the Low Voltage Directive)

Manufacturer: Francotyp-Postalia GmbH

Address: Triftweg 21-26, 16547 Birkenwerder, Germany

herewith declares that the Franking System, consisting of:

**PostBase,
PostBase Feeder**

.....
(Type or Model designation)

which this declaration refers to, is in accordance with:

The conditions of the Low Voltage Directive 2006/95/EC
and the EMC Directive 2004/108/EC.

This product is in conformity with following harmonized standards:

IEC 60950-1: 2006 + A1: 2010

EN 55022: 12.2010, Class B

EN 55024: 11.2010

EN 61000-3-2: 2006 + A1: 2009 + A2: 2009

EN 61000-3-3: 09.2008

July 18, 2013

.....
(Date of issue)

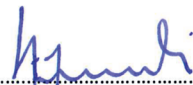

Hans Szymanski
Managing Director



Uwe Hübler
Head of R&D Hardware

(Legally binding signatures for the company)

License

This is a copy of the current LICENSE file inside the CVS repository.

```
LICENSE ISSUES
=====
```

```
The OpenSSL toolkit stays under a dual license, i.e. both the conditions of
the OpenSSL License and the original SSLeay license apply to the toolkit.
See below for the actual license texts. Actually both licenses are BSD-style
Open Source licenses. In case of any license issues related to OpenSSL
please contact openssl-core@openssl.org.
```

```
OpenSSL License
-----
```

```
/* =====
 * Copyright (c) 1998-2011 The OpenSSL Project. All rights reserved.
 *
 * Redistribution and use in source and binary forms, with or without
 * modification, are permitted provided that the following conditions
 * are met:
 *
 * 1. Redistributions of source code must retain the above copyright
 * notice, this list of conditions and the following disclaimer.
 *
 * 2. Redistributions in binary form must reproduce the above copyright
 * notice, this list of conditions and the following disclaimer in
 * the documentation and/or other materials provided with the
 * distribution.
 *
 * 3. All advertising materials mentioning features or use of this
 * software must display the following acknowledgment:
 * "This product includes software developed by the OpenSSL Project
 * for use in the OpenSSL Toolkit. (http://www.openssl.org/)"
 *
 * 4. The names "OpenSSL Toolkit" and "OpenSSL Project" must not be used to
 * endorse or promote products derived from this software without
 * prior written permission. For written permission, please contact
 * openssl-core@openssl.org.
 *
 * 5. Products derived from this software may not be called "OpenSSL"
 * nor may "OpenSSL" appear in their names without prior written
 * permission of the OpenSSL Project.
 *
 * 6. Redistributions of any form whatsoever must retain the following
 * acknowledgment:
 * "This product includes software developed by the OpenSSL Project
 * for use in the OpenSSL Toolkit (http://www.openssl.org/)"
 *
 * THIS SOFTWARE IS PROVIDED BY THE OpenSSL PROJECT ``AS IS'' AND ANY
 * EXPRESSED OR IMPLIED WARRANTIES, INCLUDING, BUT NOT LIMITED TO, THE
 * IMPLIED WARRANTIES OF MERCHANTABILITY AND FITNESS FOR A PARTICULAR
 * PURPOSE ARE DISCLAIMED. IN NO EVENT SHALL THE OpenSSL PROJECT OR
 * ITS CONTRIBUTORS BE LIABLE FOR ANY DIRECT, INDIRECT, INCIDENTAL,
 * SPECIAL, EXEMPLARY, OR CONSEQUENTIAL DAMAGES (INCLUDING, BUT
 * NOT LIMITED TO, PROCUREMENT OF SUBSTITUTE GOODS OR SERVICES;
 * LOSS OF USE, DATA, OR PROFITS; OR BUSINESS INTERRUPTION)
 * HOWEVER CAUSED AND ON ANY THEORY OF LIABILITY, WHETHER IN CONTRACT,
 * STRICT LIABILITY, OR TORT (INCLUDING NEGLIGENCE OR OTHERWISE)
 * ARISING IN ANY WAY OUT OF THE USE OF THIS SOFTWARE, EVEN IF ADVISED
 * OF THE POSSIBILITY OF SUCH DAMAGE.
 * =====
 *
```

```

* This product includes cryptographic software written by Eric Young
* (eay@cryptsoft.com). This product includes software written by Tim
* Hudson (tjh@cryptsoft.com).
*
*/

```

```

Original SSLeay License
-----

```

```

/* Copyright (C) 1995-1998 Eric Young (eay@cryptsoft.com)
* All rights reserved.
*
* This package is an SSL implementation written
* by Eric Young (eay@cryptsoft.com).
* The implementation was written so as to conform with Netscapes SSL.
*
* This library is free for commercial and non-commercial use as long as
* the following conditions are aheared to. The following conditions
* apply to all code found in this distribution, be it the RC4, RSA,
* lhash, DES, etc., code; not just the SSL code. The SSL documentation
* included with this distribution is covered by the same copyright terms
* except that the holder is Tim Hudson (tjh@cryptsoft.com).
*
* Copyright remains Eric Young's, and as such any Copyright notices in
* the code are not to be removed.
* If this package is used in a product, Eric Young should be given attribution
* as the author of the parts of the library used.
* This can be in the form of a textual message at program startup or
* in documentation (online or textual) provided with the package.
*
* Redistribution and use in source and binary forms, with or without
* modification, are permitted provided that the following conditions
* are met:
* 1. Redistributions of source code must retain the copyright
* notice, this list of conditions and the following disclaimer.
* 2. Redistributions in binary form must reproduce the above copyright
* notice, this list of conditions and the following disclaimer in the
* documentation and/or other materials provided with the distribution.
* 3. All advertising materials mentioning features or use of this software
* must display the following acknowledgement:
* "This product includes cryptographic software written by
* Eric Young (eay@cryptsoft.com)"
* The word 'cryptographic' can be left out if the rouines from the library
* being used are not cryptographic related :-).
* 4. If you include any Windows specific code (or a derivative thereof) from
* the apps directory (application code) you must include an acknowledgement:
* "This product includes software written by Tim Hudson (tjh@cryptsoft.com)"
*
* THIS SOFTWARE IS PROVIDED BY ERIC YOUNG ``AS IS'' AND
* ANY EXPRESS OR IMPLIED WARRANTIES, INCLUDING, BUT NOT LIMITED TO, THE
* IMPLIED WARRANTIES OF MERCHANTABILITY AND FITNESS FOR A PARTICULAR PURPOSE
* ARE DISCLAIMED. IN NO EVENT SHALL THE AUTHOR OR CONTRIBUTORS BE LIABLE
* FOR ANY DIRECT, INDIRECT, INCIDENTAL, SPECIAL, EXEMPLARY, OR CONSEQUENTIAL
* DAMAGES (INCLUDING, BUT NOT LIMITED TO, PROCUREMENT OF SUBSTITUTE GOODS
* OR SERVICES; LOSS OF USE, DATA, OR PROFITS; OR BUSINESS INTERRUPTION)
* HOWEVER CAUSED AND ON ANY THEORY OF LIABILITY, WHETHER IN CONTRACT, STRICT
* LIABILITY, OR TORT (INCLUDING NEGLIGENCE OR OTHERWISE) ARISING IN ANY WAY
* OUT OF THE USE OF THIS SOFTWARE, EVEN IF ADVISED OF THE POSSIBILITY OF
* SUCH DAMAGE.
*
* The licence and distribution terms for any publically available version or
* derivative of this code cannot be changed. i.e. this code cannot simply be
* copied and put under another distribution licence
* [including the GNU Public Licence.]
*/

```

Security Declaration for data usage

Product Description: PostBase Mailing Machine

The PostBase Mailing Machine is connected to the user's local network through an Ethernet interface to share data with the Francotyp-Postalia Data Center using both the local network and a suitable available internet connection provided by the user.

Francotyp-Postalia guarantees that the PostBase Mailing Machine does not utilize, transmit, or sort any data from the user's network which is not relevant for the operation of this equipment.

United States Patents

Following patents and applications for patents, designs and trademarks are reserved for the franking machine PostBase™.

US 5671146, US 5699415, US 5790768, US 6247774, US 6594648, US 6625741, US 6629084, US 6698953, US 6733194, US 6739245, US 6771179, US 6853986, US 6953234, US 6954149, US 7043631, US 7343359, US 7437756, US 7606264, US 7610501, US 7694010, US 7724905, US 7996884, US 8091979, US11/099364, US11/229466, US11/642122, US12/034768, US12/036558, US12/201100, US12/252679, US12/336852, US12/427038, US13/251454, US13/286389, US13/194373, US29/405873, US29/405874, US29/405875, US29/405876, US85/405623, US85/390545

An update is published on our website.

FCC Compliance Statement

This device complies with FCC Part 15, Subpart B, Class B.

External USB modem *(optional)*

USB Modem 51.0052.3147.00:

This Class B digital apparatus complies with Canadian ICES-003.

This product meets the applicable Industry Canada technical specifications.

The RINGER EQUIVALENCE NUMBER (REN) for the USB modem is 0.006.

The Ringer Equivalence Number (REN) is an indication of the maximum number of devices allowed to be connected to a telephone interface.

The termination of an interface may consist of any combination of devices subject only to the requirement that the sum of the RENs of all the devices not exceed five.

A

- Absorption felt *111, 113, 114, 115*
 - installing *114*
 - removing *113*
- Access control *13, 85*
 - switch on / off *85*
- Account *35, 55*
 - change *55*
- Account function *13, 78*
 - switch off *78*
 - switch on *78*
- Addendum to the Operator Manual *2*
- Adjusting the display inclination *30*
- Adjustment menu *38*
- Advert *35, 44, 51*
 - print advert / text only *71*
 - print separately *71*
 - setting *51*
- Advert Only *71*
- After-sales service. See *Customer Support*
- Auto Off *80*
- Auto Postage Download *86*
 - change threshold *87*
 - disable *87*
 - enable *86*
- Automatic feeder. See *Feeder*
- Available postage *69*

B

- Basket *106*
- Batch counter *64*
- Batch processing *28, 63, 65, 122*
 - continue *64*
 - interrupt *63*
 - start *63*
- Battery compartment *10*
- Battery, permissible type *140*
- Blank spots in franking imprint *43*
- Brush *11*
 - change *109*
 - clean *109*
- Buttons *34*

C

- Calibrate ink cartridges *89*
- Cartridges. See *Ink cartridges*
- Catch tray *9*
 - adapting to envelope format *32*
- Change ink cartridges *90*
- Clean
 - contacts (print system) *90*
 - housing *89*
 - moistening brush (feeder) *109*
 - moistening sponge (feeder) *105*
 - print system *96*
 - sealer *111*
 - sensors (feeder) *129*
 - sensors (franking machine) *127*
- clean & renew *90, 98*
- Connect
 - feeder *20, 24*
 - franking machine *20*
 - PC *20*
 - USB modem *20*
- 'Connected' mode *68*
- Connection
 - feeder *10*
 - franking machine *12*
- Connection to data center *83*
- Contact information *84*
- Correcting errors *116*
 - causes and remedies *116*
 - See also *Errors*
- Count mail pieces *74*
- Counter
 - Advert Only *72*
 - Feed Only *74*
 - item counter (franking imprints) *68*
 - Print Numbers *73*
 - Seal Only *75*
- Counting (without printing) *74*
- Cover flap (sealant tank) *11*
- Credit *69*
- Customer Support *159*

D

Data center

- change phone number *84*
- display phone numbers *84*
- set up connection *83*

Date *44*

- in franking imprint *35, 53*
- setting *53*

Decimal Meter Mode *81*Declaration of conformity *144*Decommissioning *134*Differential weighing *14, 49*Display *9*

- adjust brightness *76*
- adjust inclination *9, 30*

Disposal *134*Download postage *70*Drawer *9*

- latch lever *9*

EEnvelopes *142, 143*

- for automatic sealing *143*
- for franking *142*

Error messages *116*

Errors

- during installation *123*
- general *118*
- in basic settings *120*
- maintenance and care *120*
- postage download *119*
- when franking *116*
- when using special functions *119*
- with automatic feeding *121*
- with manual sealing *122*

FFCC Compliance Statement *147*Feed Only *74*Feeder *11, 14, 15*

- adjust letter guide *60*
- adjust slope inclination *61*
- adjusting *60*
- clean sensors *129*

connect *10, 20, 24*filling with sealing liquid *101*install *23*overview *11*position letters in stack *60, 63*processing single letters *64*start *63*switch on/off seal function *62*use *60*use pendulum *61*

Felts

See also Absorption felt

See also Moistening felt

correct seat *115, 126*replacing *113*Filler hole (sealer) *19, 112*

Filling level

feeder *101*ink cartridges *98*sealer *112*

Filling sealit sealing liquid

feeder *101*sealer *112*First steps manual *2*Forward dating *53*Franking *54*labels *66*letters (feeder) *60*letters (hand feed tray) *56*letters (sealer) *57*Franking imprint *44*example *44*setting *44***H**Hand feed tray *9*install *17*Home screen *35*functions *35*operation philosophy *35*

I

- Imprint offset *13, 44, 52*
 - See also Offsets / shifts in the franking imprint
 - setting *52*
- Ink cartridges *141*
 - align *95*
 - calibrate *89*
 - change *90*
 - clean (automatic) *96*
 - clean (by hand) *97*
 - filling level *98*
 - installing *92*
 - remove manually *132*
 - removing *91*
- Installation *8*
 - feeder *23*
 - hand feed tray *17*
 - PostBase *21*
 - sealer *17*
- Installation instructions (flyer) *2*
- Item counter
 - See also Counter
 - reset *68*
 - show *68*

K

- Keypad *39*

L

- Label *13, 14*
 - frank *66*
 - insert *31*
- Label compartment *9*
 - fold in/out *31*
- LAN port *10, 20*
- Language, change *82*
- Large letters
 - adjusting feeder *60*
 - sealing (PostBase with sealer) *59*
- Latch lever (drawer) *9*
- Letter guide *11, 60*
- Letter guide face *42, 56*
- Letter receiving tray *9, 11*

Letter stack

- positioning *60, 63*
- prepare *60*

Letter thickness *62***Letters**

- position (feeder) *60, 63, 64*
- position (hand feed tray) *56*
- position (sealer) *57*
- sealing (PostBase with feeder) *62*

License *145***List** *38***Load**

- Auto Postage Download *86*
- machine software *88*
- postage credit *70*
- rate table *88*

M**Machine software**

- show version *76*
- update *88*

Mail piece specifications *142***Mailing data** *35*

- deselecting *36*
- selecting *36, 46*

MailOne *14, 44, 45, 51***Menu** *35, 37*

- access *37*
- overview of symbols *135*

Meter type *81***Metering.** See **Franking****Modem (external, USB)** *15*

- connection *20*
- set up connection *83*
- technical specifications *148*

Moistening *11*

- adjust *104*
- changing moistening brush *109*
- changing moistening sponge *105*
- cleaning moistening brush *109*
- cleaning moistening sponge *105*

Moistening felt *111, 113, 126*

- correct seat *126*
- installing *115*
- removing *113*

N

- Navigator *14, 44, 45, 51*
- Numbers
 - print numbers only *72*

O

- Offsets / shifts
 - in the franking imprint *43*
- ON / OFF *9*
- Operating conditions *141*
- Operation philosophy *33*
- Overview *9*
 - feeder *11*
 - franking machine *9*

P

- Patents (USA) *147*
- PC connection *10, 20*
- PC software *51*
 - MailOne *14*
 - Navigator *14*
 - RemoteOne *14*
 - ReportOne *14*
- Pendulum *11, 61*
 - attach *27*
 - use *61*
- Phone number
 - change data center phone number *84*
 - view *84*
- PIN
 - enter during startup *29*
 - set *85*
- Place of posting, change *88*
- Pop-up windows *40*
- Postage *44*
 - display in the Home screen *35*
 - display in the product calculation menu *36*
 - set *45*
 - set manually *46*
 - set via shortcut *45*
- Postage download *70*
 - Auto Postage Download *86*
 - general notes *70*
- Postage used *69*

- Postal product *35*
 - set *36*
 - set via shortcut *45*
- PostBase
 - clean sensors *127*
 - disconnecting from mains *30*
 - feeder *11, 14*
 - modular design *12*
 - overview *9*
 - sealer *14*
 - short description *9*
 - turning off *29*
 - turning on *29*
 - withdraw *134*

- PostBase button *9, 54*
- Power connection *10, 12, 20, 24*

- Print Numbers *72*
 - set direction of counting *73*
 - set start number *73*

- Print quality
 - checking *43*
 - good *43*
 - poor (blank spots) *43, 117*
 - poor (offset) *43, 117*

- Print system *98*
 - cleaning *96*
 - cleaning the contacts *90*
 - filling level *98*
 - intensive cleaning *96*

- Procedures *40*
- Product calculation menu *35, 36*
 - calling up *36*
 - cancelling *37*
 - exit / quitting *36, 37*

R

- Rate table *88*
 - show version *76*
 - update *88*
- Ready for franking *56, 57, 63, 66*
- Re-authorization, Postal code
 - change *88*
- Register *69*
 - printing *69*
 - show *69, 70*

RemoteOne 14
 Remove letter jam
 in the feeder 125
 in the franking machine 124
 REN 148
 Report (postage download) 70
 ReportOne 14
 Ringer Equivalence Number 148
 Rocker with moistening felt 111, 113, 126
 installing 115
 removing 113
 Roller transport 11

S

Safety tips 2, 7
 Scale 9, 13, 141
 Scrollbar 33
 Seal letters (without printing) 75
 Seal Only 75
 Seal / non seal switch 11, 62
 Sealant tank 11
 open cover flap 11, 101
 topping up sealing liquid 101
 Sealer 9, 14, 15, 111
 cleaning 111
 filler hole 9
 filling sealit sealing liquid 112
 install 17
 replacing felts 113
 Sealing liquid
 topping up (feeder) 101
 topping up (sealer) 112
 sealit 15, 101
 see also Sealing liquid
 Security device 10
 installing 130
 removing 130
 unlock 10
 Shortcut 13, 35, 45
 display in the Home screen 35
 save 45
 use 45
 Slider 33
 Slope 11
 adjust inclination 61

SMS text 35, 44
 enter / edit 51
 print separately 71
 setting 51
 Software version, show 76
 Sound signals 77
 Spacer ring 104
 Special functions 71
 Specifications for mail pieces 142
 for automatic sealing 143
 Sponge 12
 change 105
 cleaning 105
 Sponge holder 106
 Standby 30
 Standby time 80
 Stylus for touch screen operation 9
 Symbols (overview) 135
 error categories 139
 menu functions 135
 standard buttons 138
 System information, display 76

T

Technical data 140
 envelope specifications for sealing 143
 ink cartridges 141
 mail piece specifications 142
 PostBase mailing system 140
 scale 141
 USB modem (optional) 148
 Test print 41, 93
 Text message. See SMS text
 Thick letters 62
 Tone signals 77
 Touch screen 9, 33
 adjust brightness 76
 adjust inclination 30
 calibrate 133
 Transport brush
 insert 100
 remove 99
 Tray 12
 Turning off 9, 29, 30
 Turning on 9, 29

U

- USB modem *20*
 - REN (Ringer Equivalence Number) *148*
 - technical specifications *148*
- USB port *10, 20*
- User *54*
 - change *54*
 - user profile *54*

W

- Warranty *159*
- Weighing
 - differential weighing *49*
 - normal weighing *47*
- Weighing mode
 - change *44, 48*
- Weighing platform *9*
- Weight
 - display in the Home screen *35*
 - display in the product calculation menu *36*
- Withdraw machine *134*

Z

- Zero imprint. See Test print
- ZIP code, change *88*

Customer Support

Every PostBase mailing system is thoroughly checked before leaving the factory. Should any faults occur with your PostBase mailing system in spite of our extensive quality control, please contact Francotyp-Postalia help line.

fp-francotyp.com

Warranty

For warranty information, refer to the country-specific addendum to the Operator Manual (*if available in your country*).

51.0052.3810.00 Rev. 04

2014-09 / xxx / helbig.berlin



PostBase

Mailing system



Addendum to the Operator Manual
| USA |

What you need to know

This addendum complements the PostBase Mailing System Operator Manual.

This document solely covers the country-specific particularities with handling the PostBase mailing system. You will find information about

- the Home screen
- the meter imprint for carrying by the U.S. Postal Service
- special imprints (Correction, Redate, ...)
- possible equipment versions of the mailing system
- the US customer service.

Further documents

The **Installation instructions** (flyer) and the **First steps** manual which were supplied with your mailing system contain all relevant information on installing, commissioning and handling the PostBase mailing system.

The **PostBase Operator Manual** (Reference Guide) contains a complete description of the mailing system and all optional components and features.

For basic information on handling the PC software for PostBase, please read the **User Manual RemoteOne / ReportOne**.

Please observe the instructions on intended use and the safety instructions in the PostBase Operator Manual.

Contents

What you need to know	2
1 The Home screen	4
2 The USPS meter imprint	5
3 Special imprints and functions	6
3.1 Postage correction	6
3.2 Redate	7
3.3 Reply Mail metering	9
4 Additional technical specification	10
4.1 PostBase – variants and equipment	10
4.2 Additional Technical Data	11
4.3 The Security Device (PSD)	11
5 Glossary	12
6 Index	13
7 Service	15

1 The Home screen

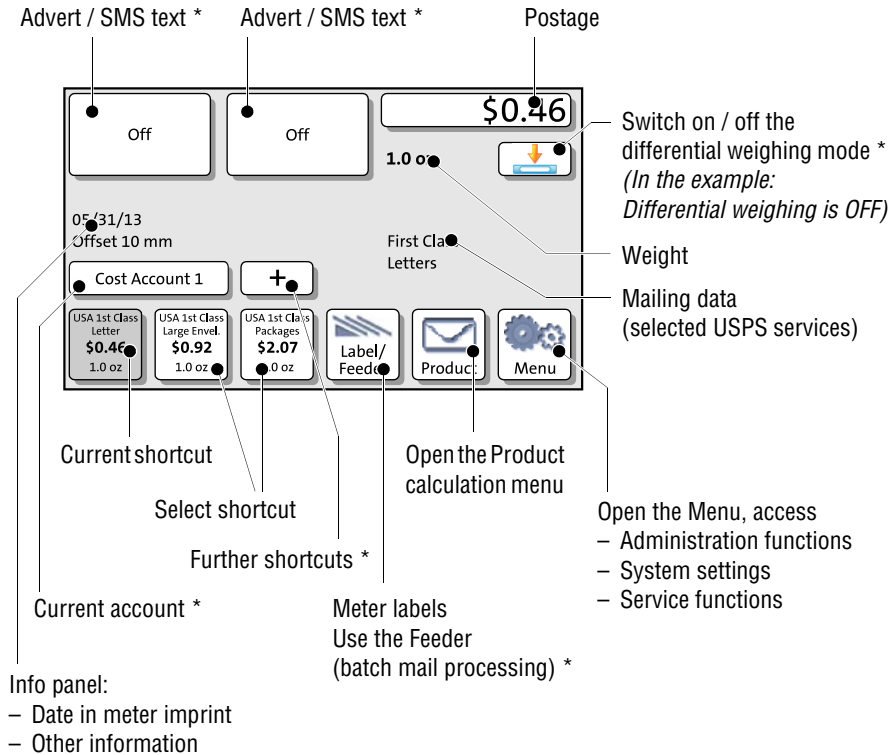

PostBase 20 – additional shortcut instead of Label/Feeder button:

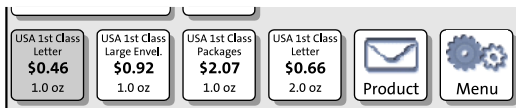

The Home screen appears after the PostBase was turned on and the start routine has been successfully completed. Depending on the settings, you may have to select a user and enter the PIN.

* Availability depending on PostBase variant / equipment.

2 The USPS meter imprint

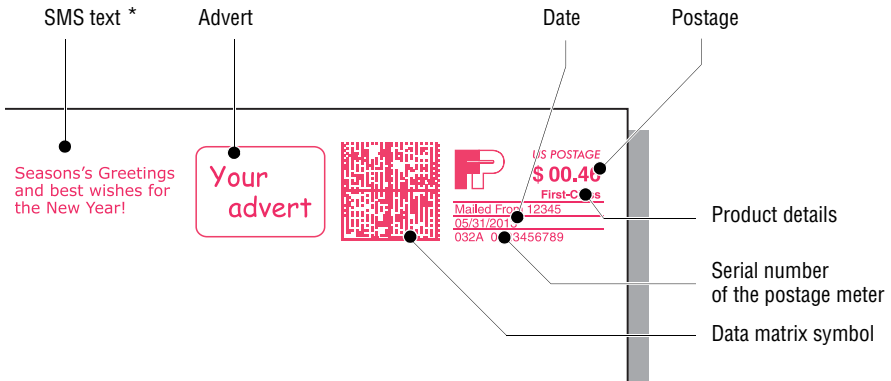

The illustration shows an example of a meter imprint for a First-Class letter with two advertising imprints (an SMS text/text message and a graphical advert/logo).

For details on how to set the meter imprint, please read the PostBase Reference Guide.

Particularities for metering mail pieces for dispatch by the USPS, e.g. correction of incorrect meter imprints, are described in the following chapters.

To check the settings for metering and the imprint quality, choose TEST PRINT PRODUCT in the Product calculation menu. The TEST PRINT PRODUCT option is shown at the end of the additional services list.

Test imprints always show the postage value '\$ 00.00' (zero imprint) and the data matrix code is overprinted with the indication 'VOID'.

* Availability depending on PostBase variant / equipment.

3 Special imprints and functions

3.1 Postage correction

You can correct faulty meter imprints on an already metered letter. The correction print must always be printed on the non-address side of the mail piece.

If you have metered a postage value which is too low, print a correction with the missing amount on the non-address side of the mail piece.



Setting the CORRECTION imprint

In the Home screen:

- Press the **PRODUCT** button.

PostBase opens the Product calculation menu.

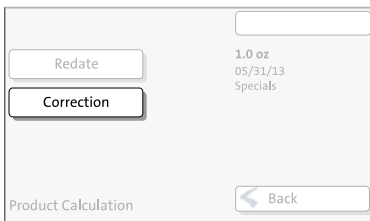

- Select **SPECIALS**.
- Select **CORRECTION**.

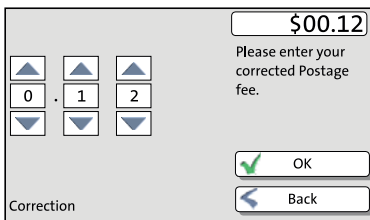

PostBase opens the Correction menu.

- Set the amount to be imprinted on the mail piece in addition to the postage value already metered.

Use the arrow buttons to increase or decrease the figure in each digit until the desired amount is displayed in the top right text box.

- Confirm the displayed correction amount with **OK**.
- Press **OK** to accept the displayed product setting and to return to the Home screen.

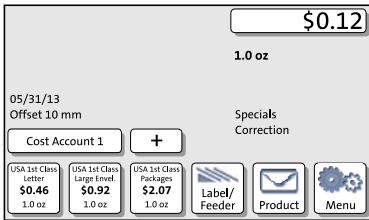

Print postage correction

The Home screen shows the current settings for the correction imprint. You can change the settings (e.g. date, imprint offset) in the same way as with a regular meter imprint.

- Position the mail piece the non-address side face up.



PostBase prints the correction imprint.



When printing the postage correction, advertising imprints are not available.

3.2 Redate

If the meter imprint shows an incorrect date, you can print a correction with the correct date on the non-address side of the already metered mail piece.



Setting the REDATE imprint

In the Home screen:

- Press the **PRODUCT** button.
- PostBase opens the Product calculation menu.

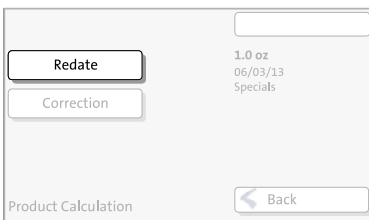

- Select **SPECIALS**.
- Select **REDATE**.
- Press **OK** to accept the displayed product setting and to return to the Home screen.

The Home screen shows the current settings for the redate imprint. You can change the settings (e.g. imprint offset) in the same way as with a regular meter imprint.



Setting the date

- Open the MENU.
- Select CHANGE DATE.
- Type the date.
- Press SAVE to set the date.

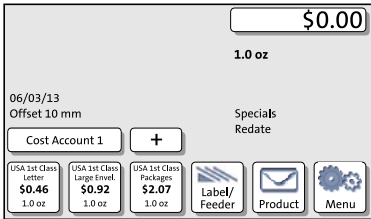

Print redate

When the Home screen shows the desired settings for the redate imprint:

- Position the mail piece the non-address side face up.



PostBase prints the redate imprint.



When printing the redate imprint, advertising imprints are not available.

3.3 Reply Mail metering

You can meter reply mail. When metering reply mail, PostBase prints a normal meter imprint without date.

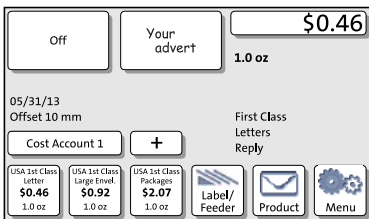
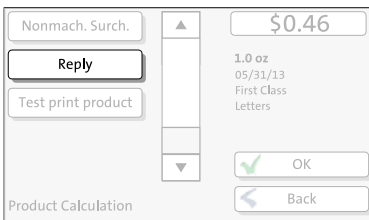

Setting the Reply Mail meter imprint

In the Home screen:

- Press the PRODUCT button.
- PostBase opens the Product calculation menu.
- Select the mailing data for the reply mail as usual.
- In the additional services list, select REPLY.
- When the desired product is set, press OK to return to the Home screen.

Meter reply mail

The Home screen shows the current settings for the reply mail meter imprint. You can change the settings (e.g. advertising imprints, imprint offset) in the same way as with a regular meter imprint.

When the Home screen shows the desired settings for the reply mail meter imprint:

- Position the reply envelopes / cards as usual.

PostBase prints the reply mail meter imprint.

4 Additional technical specification

4.1 PostBase – variants and equipment

	PostBase 20	PostBase 30	PostBase 45	PostBase 65	PostBase 85
Hand feed tray	●	●	●	●	●
Catch tray (adjustable)	●	●	●	●	●
Feeder with sealer	—	—	○	○	○
Manual sealer	○	○	○	○	○
Label dispenser	—	●	●	●	●
Integrated postage scale	●	●	●	●	●
Weighing range, maximum	5 lbs	5 lbs	10 lbs	15 lbs	15 lbs
Differential weighing	—	○	●	●	●
Speed (letters per minute)	20	30	45	65	85
Interfaces: USB, Ethernet/LAN, CAN bus	●	●	●	●	●
External analog modem (USB)	—	○	○	○	○
Access control via PIN	●	●	●	●	●
Remote services (download postage, rate change, ...)	●	●	●	●	●
Department accounts – standard	5	5	20	50	50
– optional	—	10/20/50/ 100/200	50/100/ 200	100/200	200
Shortcuts for USPS products	●	●	●	●	●
Advertisement memories	3	12	20	30	30
SMS-text messages, user-defined	—	8	10	12	12
Decimal meter	●	●	●	●	●
Low ink warning	●	●	●	●	●
Auto-daylight saving time	●	●	●	●	●
Using FP Portal	●	●	●	●	●
Connection to RemoteOne, ReportOne, MailOne	—	●	●	●	●

Subject to short-term modification.

4.2 Additional Technical Data

Type of Equipment	Stand-alone equipment (Desk-top)
Class of Equipment	Class I
Connection to Supply	Pluggable type A
Type of Power System	TN, IT
Mobility	Moveable equipment
Pollution Degree	2

FCC Compliance Statement

This device complies with FCC Part 15, Subpart B, Class B.

4.3 The Security Device (PSD)

The Revenector Security Device (PSD) used in your PostBase mailing system was authorized according to specifications of the United States Postal Service following an internationally valid practice. To commensurate to this standard the cryptographic keys used by the PSD have to be updated or exchanged after a specified period of time. Please, make sure that the mailing system contacts the Server at least once a year (e.g. by loading postage with the value of '\$0'), even if the system may not be in use. Otherwise the Security Device may disable itself and will have to be exchanged with costs for reconnecting the mailing system.

5 Glossary

FP Portal	Via a PC or a laptop, you can access the essentials for your PostBase mailing system, e.g. a complete overview of your data, updates, and the shop with accessories and consumables.
Meter imprint	<p>Metering mail for carrying by U.S. Postal Service.</p> <p>When metering, PostBase prints among other things the indicia, the postage value, the date and the machine identification on the envelope. Details on the product (e.g. First-Class) appear below the postage.</p> <p>The meter imprint can also comprise advert imprints (advert and/or text message).</p>
PIN	<p>Personal Identification Number.</p> <p>The PostBase mailing system can be protected against unauthorized use via a PIN.</p>
RemoteOne	<p>RemoteOne is a user-friendly PC application enabling you to set up, maintain and use the PostBase mailing system (<i>only PostBase 30/45/65/85</i>).</p> <p>RemoteOne enables you to perform your mailing system's basic functions directly on your computer. In addition to its ease of use, RemoteOne offers an extended functionality, e.g. entering / editing text messages and setting your frequently used postal products as shortcuts.</p>
ReportOne	<p>In addition to RemoteOne's entire functionality, ReportOne offers easy to handle administration and report features (<i>only PostBase 30/45/65/85</i>).</p>
Test print product (Zero imprint)	<p>Invalid meter imprint with the postage value \$00.00 and the indication 'VOID' printed over the data matrix. This feature enables you to check the settings for the meter imprint and the print quality.</p> <p>Test prints are not logged in the postage registers.</p>

6 Index

A

Account 4
 select 4
 Advert 4, 5

C

Correction
 imprint (example) 7
 position a mail piece 7
 print 7
 set imprint 6

D

Data matrix 5
 Date 5
 in meter imprint 4
 in redate imprint 8
 Differential weighing mode ON / OFF 4

E

Equipment (standard / option) 10

H

Home screen 4

M

Memory. See Shortcut
 Menu 4
 Meter imprint 12
 USPS (example) 5

P

PIN 12
 Postage 5
 correction 6
 display in the Home screen 4
 PostBase 20 10
 PostBase 30 10

PostBase 45 10
 PostBase 65 10
 PostBase 85 10
 Product calculation menu, open 4
 PSD 11

R

Redate 7
 imprint (example) 8
 position a mail piece 8
 print 8
 set date 8
 set imprint 7
 RemoteOne 12
 Reply Mail 9
 imprint (example) 9
 meter 9
 position reply envelopes / cards 9
 set imprint 9
 ReportOne 12

S

Security Device (PSD) 11
 Serial number (postage meter) 5
 Service (contact) 15
 Shortcut 4
 display in the Home screen 4
 select 4
 show further shortcuts 4
 SMS text 4, 5

T

Technical Data (in addition to PostBase
 Reference Guide) 11
 Test print product 5, 12

V

Variants 10
 VOID 5

Z

Zero imprint 5, 12

7 Service



**FP Mailing Solutions
Francotyp-Postalia, Inc.
140 N. Mitchell Court, Suite 200
Addison, IL 60101-5629**

Customer Service (800) 341-6052

www.fp-usa.com

51.0052.3830.00 Rev. 05

2014-02 / xxx / helbig berlin