



1980 Airstream/Argosy
Owner's Manual

1980 Airstream/Argosy Trailer Owner's Manual



Introduction

An Airstream or Argosy travel trailer offers you excellence in travel luxury and mobility. This owner's manual is your key to carefree travel fun. It contains information necessary to avoid problems. Consult it when you have a question about your new trailer. It has been designed to aid you in knowing your trailer better. All information, illustrations and specifications contained in this literature are based on the latest product information available at the time of publication approval. The right is reserved to make changes at any time without notice. Should you trade or sell your trailer, please leave the manual with it. Make this your year for carefree vacations.

Note: If and when new materials and production techniques are developed which can improve the quality of its product or material substitutions are necessary due to availability, Airstream reserves the right to make such changes.

Contents

Warranty and Service	2
Explanation of Airstream/Argosy Warranty	3
Wally Byam Stores	5
Tow Car Equipment	6
Electric Brakes	7
Hydraulic Disc Brakes	9
Loading	12
Tires	22
Hitching Up	25
Towing Tips	28
Overnight Stop	31
Extended Stay	32
Winter Trailering	34
Storage and Winterizing	35
Exterior Identifications	36
Exterior	42
Floor Plans	45
Interior	55
L.P.G. System	69
Refrigerator	71
Microwave Oven	75
Range and Oven	77
Furnace	79
Water Heater	82
Water System	83
Drain and Waste System	86
Electrical System	89
Battery	91
Electrical Outlet Locations	92
Electrical Wiring Diagrams	94
Electrical Trouble Shooting	110
Specifications	111
Pre-Travel Check List	114
Lubrication and Maintenance	115
Maintenance Record	116
Index	117

Warranty and Service

The Airstream Certified Performance

Checkout, or C.P.C., is an exclusive Airstream program. Before leaving the factory, each and every vital part of the trailer is tested for performance. Each test is signed and certified by an inspector. After the trailer arrives on your dealer's lot, all of these vital parts and systems are again tested. When you take delivery of your new trailer, a factory trained expert personally gives you a complete check-out.

C.P.C. does not stop here. After you have traveled with your trailer for 1000 miles (or 60 days, whichever comes first) you can make an appointment with any one of the Airstream/Argosy dealers for still another check-out of your trailer. At that time, a specified list of performance checks on your trailer equipment will be conducted and any deficiencies you have experienced since taking delivery will be corrected.

Please contact your dealer if you need service. Major service under your Airstream/Argosy Limited Warranty is available through our nationwide network of factory trained specialists at Airstream/Argosy Certified Dealer Service Centers. An up to date list of Dealer Service Centers has been provided with your new trailer. This list is current as of the date of publication. Occasionally dealerships change or new dealers are added who may not appear on this list. For this reason, it is suggested that you contact your local dealer from time to time and bring your list up to date. He can also provide you with additional copies if you need them. **All centers operate on an appointment basis for the utmost efficiency.**

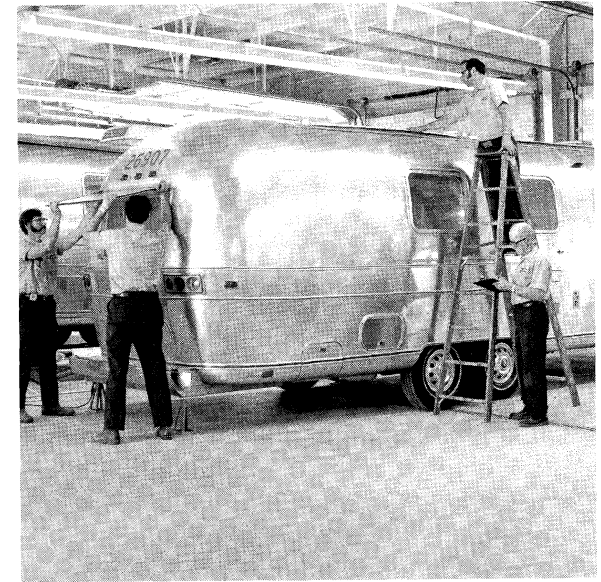

When you require service from a Caravan Service Center or a Certified Dealer Service Center, please contact the service manager for an appointment, and kindly inform him if you are unable to keep the appointment date or wish to change it.

Service may be arranged at Caravan Service Center by contacting the service manager at:

Caravan Service Center
15939 Piuma Avenue
Cerritos, California 90701
(213) 860-4411

Caravan Service Center
419 W. Pike Street
Jackson Center, Ohio 45334
(513) 596-6111

Explanation of Airstream/Argosy Limited Warranty

The Airstream/Argosy Limited Warranty is detailed in a separate folder.

EXCLUSIONS:

Normal Wear

Items such as tires, water heater flints, water purifier packs, curtains, upholstery, floor coverings, window, door and vent seals will show wear or may even wear out within the one year warranty period depending upon the amount of usage, weather, and atmospheric conditions.

Accident

We can all recognize damage caused by accident because it is visible, and we strongly urge our dealers and customers to inspect the trailer upon receipt of delivery for any damage caused by accident while being delivered to the dealer, or while it is on the dealer's lot. Damage of this nature becomes the dealer's or customer's responsibility upon acceptance of delivery, unless Airstream is notified and the damage is verified by the person making the delivery.

Abuse

Lack of customer care and/or improper maintenance will result in early failure for which Airstream cannot be held responsible.

Exposure

Not unlike a car, the steel parts of a trailer can and will rust if subjected to prolonged exposure to moisture, salt air, or corrosive air-borne

pollutants without repainting. Aluminum oxidizes when unprotected under similar conditions, and refinery chemicals of a sulfurous nature are harmful to finishes if not washed off periodically. Extremely hot or direct sunlight will deteriorate rubber and fade curtains and upholstery. Conditions of this nature, although they may be normal for the area, are beyond Airstream's control and become the responsibility of the owner.

Although it is our obligation to correct a rain or plumbing leak within the terms of the limited warranty, it is the owner's responsibility to use reasonable, prudent care to minimize foreseeable secondary damage, such as a delaminated floor, stained upholstery, carpeting, drapes, etc.

Overload

Damage due to loading, either beyond capacity or to cause improper towing because of improper balance, is beyond Airstream's responsibility. The Airstream trailer is engineered to properly handle the gross vehicle load rating on the certification label. Load distribution has a definite effect upon the towing characteristics and attitudes of the trailer. Level hitch installations are a necessity, and very important on a tandem axle trailer. There are limits to the amount of load that can be safely transported depending upon speed and road conditions, and reasonable cause to believe these factors have been exceeded could void the Airstream warranty. For additional information on the loading of your trailer, consult your Owner's Manual or gross vehicle weight rating plate.

The Airstream axle is manufactured to a tolerance of 1° camber and 1/8" toe-in. These tolerances will only change if the trailer is subjected to abuse, such as dropping off a sharp berm, striking a curb, or hitting a deep hole in the road. Such damage would be considered as resulting from an accident which risks are not covered under the warranty. Abnormal tire wear and/or wheel alignment resulting from such damage is not covered under the terms of the warranty.

Caution: Your Airstream may be equipped with the optional Excella-Vac brake system which brings all of the advantages of full disc braking to travel trailers. It is extremely important to note, however, that Excella-Vac uses an entirely different system for controlling brake operation. It is not compatible in any way with the old electric brake control system. If you do not use the control system designed for use with the Excella-Vac disc brakes, the terms of your Airstream Limited warranty will be void with respect to any damages incurred as a result of the use of a noncompatible system. In addition, many advantages of the exclusive Airstream disc brakes will be lost if the Excella-Vac control system is not used.

Wally Byam Stores

To make trailering more enjoyable, there are Wally Byam Stores established at the majority of Airstream/Argosy dealers. All Airstream/Argosy dealers have the opportunity of purchasing for you the necessary equipment which would enable you to enjoy your new trailer to the utmost. The Wally Byam Stores authorized dealerships stretch from coast to coast, and these dealers stock hundreds of items which are tested and approved by travel experts. Be sure and get an accessories catalog from your dealer.

The following is a list of equipment we recommend:

1. First Aid Kit
2. Flashlight
3. Emergency Road Warning Triangle
4. Crosstypc Lug Wrench for Trailer Wheels
5. Pop Rivets (3 sizes)
6. Pop Rivet Gun
7. Battery Booster Cables
8. Tire Gauge (up to 100 pounds P.S.I.)
9. Hitch Ball Lube
10. Small Bi-Directional Spirit Level
11. Heavy-Duty Turn Signal Flasher
12. Four Stabilizing Jacks
13. Leveling Ramps
14. Wheel Chocks
15. Spare Tire and Wheel for Single Axle Trailers
16. One 50 ft. and one 25 ft. length of 5/8" High Pressure Water Hose

17. Y-Connection with Cap
18. 5 Gal. Water Jug
19. Quick Disconnect Garden Hose Coupling
20. One 10 ft. or 20 ft. Sewer Hose
21. One Thetford Sewer Hose Adapter — Straight or Elbow
22. One Elbow Sewer Hose Outlet
23. Two 2½" to 3¾" Adjustable Hose Clamps
24. One Thetford Plastic Cap with Hose Drain
25. One 1/2 Gal. Holding Tank Cleaner and Deodorizer
26. 50 ft. Electric Cord #12-3 wire
27. 20 ft. Electric Cord #10-3 wire, 30 amp capacity
28. One Service Cord Adapter 30-15 amp
29. Spare 20, 40, and 50 amp Cartridge Fuses
30. Spare Light Bulbs
31. Electrical Contact Cleaner (Spra-Kleen)

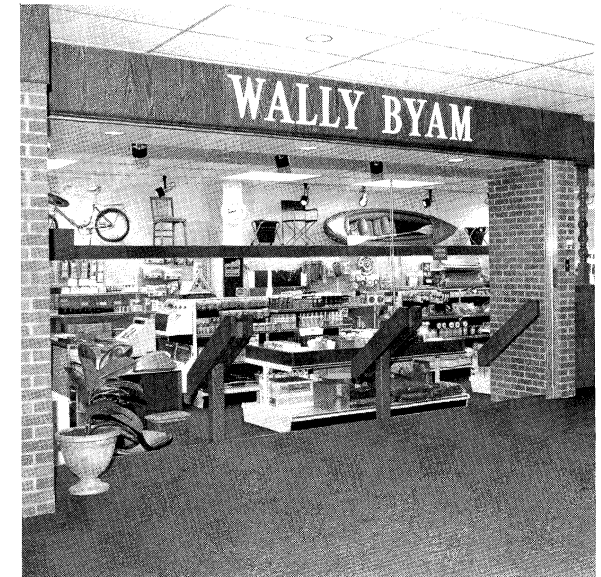

Tow Car Equipment

If you plan to buy a new car to tow your trailer, we suggest that you include in your purchase the trailer towing options offered by most automobile manufacturers. These include such things as heavy duty alternator and radiator, heavy duty springs and shock absorbers, automatic transmission cooler, heavy duty fan and flasher unit and others, depending on the make of the vehicle.

Transmissions may be manual or automatic, but an automatic transmission may prolong your car's engine life and generally does a better job of controlling engine loads than the average driver using a manual shift.

Having adequate power is very important when considering the purchase of a new car or the trailer towing capability of your present one. Emission controls that are required by the Federal Government have reduced overall engine power. To determine generally what the tow capability of your car is, divide the total weight of your trailer by the cubic inch displacement of your automobile engine. This ratio should be between 10 and 20 pounds of trailer weight per cubic inch of engine displacement. For example, with a 31' Airstream weighing 6500 pounds totally loaded for travel and a vehicle with 350 cubic inch displacement engine, divide 6500 by 350 giving a value of 18.5 pounds of trailer weight per cubic inch engine displacement. This vehicle should have adequate power for towing the trailer. Obviously, total car performance such as maximum speed up grades and acceleration is lessened when towing a trailer.

Remember that engine power is only one indication of the car's towing capabilities; the axle ratio and cooling capabilities certainly must be considered. We suggest you review the owner's manual of your present car and discuss your automobile towing capabilities with your Airstream/Argosy dealer and your automobile dealer.

Inspect your vehicle's hitch regularly for loose bolts or nuts, cracked welds, loose ball mounts, worn parts, etc.

New trailerists often carry more food and other supplies than really needed. Remember that every item you take along is one more thing to stow and adds weight to the total load you must pull. Consolidate items in shelves, lockers, and in the refrigerator. It is better to have one full and one empty locker than two half empty ones. Special care must be taken not to overload the front and rear ends of the trailer.

See tire section for correct tire sizes and pressures for your trailer and load on pages 22-23.

Electric Brakes

The Kelsey Hayes Brakes are operated by 12 volt current from your car and **must be hooked up so that you have an integral system with your car brakes.** To prevent problems and insure satisfactory braking action, install a Kelsey Hayes Controller (or equivalent) and selective resistor in line with the controller in you car.

A Kelsey Hayes Controller (or equivalent) installed in your car will synchronize the trailer brakes with your car brakes. It is designed to apply the trailer brakes with your car brakes.

The controller handle adjustment affects the rate of application of the trailer brakes. This adjustment has no bearing on the maximum braking capacity of the trailer brakes. Because of the wide variety of towing vehicles and trailers it is necessary to balance the trailer brakes with the towing vehicle brakes to provide for a safe, comfortable stop. This adjustment should be made to provide for a slight lead of the trailer brakes over the tow vehicle brakes. Turning the handle clockwise will decrease the rate of application of the trailer brakes, while counter-clockwise will increase the rate of application. When the desired setting is reached, the controller will hold the adjustment, but may be varied at any time by rotating the handle as described above. After this adjustment, there should be no sensation of the trailer pushing the car during a stop, nor should there be an excessive sensation of the trailer pulling the car during a stop.

A selective resistor to match the weight of your trailer to the controller should be installed

on the fire wall of your engine compartment. It should be correctly adjusted during installation. However, if you wish to change the action of your brakes proceed as follows:

The selective resistor adjustment affects the maximum braking capacity of the trailer brakes. Because of the variety of axle loadings, the rated load capacity of the brakes may exceed the load on the trailer axle.

When a resistor is installed on the towing vehicle and a setting is made according to the chart on page 8, check the initial trailer brake application with the controller fully applied. If the setting is correct, the controller full "on" position should provide firm braking action just short of skidding on dry pavement. Follow the chart and change the setting to achieve greater or less braking, as required.

Due to normal brake lining wear, the brakes and the controller setting should be checked and readjusted, if necessary, during the trailer manufacturer's recommended inspection intervals. Normally, it is not necessary to reset the selective resistor unless there are major changes in the trailer loading. Note: Brake lining adjustment should be periodically checked (fully) to be sure trailer brakes are in the same adjustment as the automobile's.

Properly set, these adjustments will provide for safe comfortable stops. They will also help assure optimum brake and tire life for both the tow vehicle and the trailer.

In **the event of an accidental separation of the tow car and trailer, the breakaway switch**

will set and lock the trailer brakes for a sufficient length of time to stop the trailer. The switch is activated when the small pin in the front of the unit is pulled out by the wire attached to it and to the car. **This pin should be pulled out, lubricated with light household oil and replaced every 90 days.**

To prevent corrosion within the breakaway switch, pull the switch's pin straight forward and spray the inside of the switch through the hole with an electric contact cleaner (such as Spra-Kleen) and reinsert pin. A drop of light household oil on the groove near the base of pin will allow pin to operate freely. **When the trailer is connected to the tow car, the break-away switch loop should be attached to the permanent frame of your hitch.** When disconnecting trailer from tow car, remove wire loop from the frame, **do not remove pin from switch, because this will apply the trailer brakes. Caution: Do not use break-away switch for parking brake.**

We recommend that your brake system be checked and adjusted by a Certified Service Center. However, in emergencies, to adjust brakes:

1. Remove the small rubber plug at the base of the backing plate on the brake drum.
2. Jack the wheel so that you can spin it by hand. Tighten the brakes (using a brake adjusting tool or a screwdriver that has been bent to a 90° angle) until the wheel is locked, then back off until you have a free spinning wheel, which will be approximately 8 notches.
3. Repeat this operation with all trailer wheels.

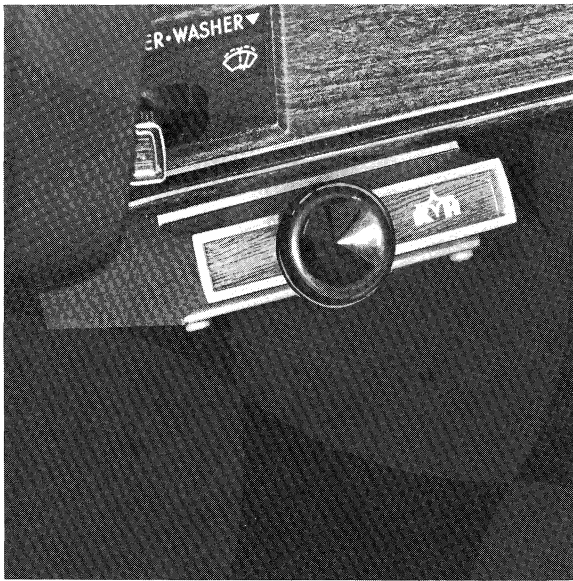

Trailer Brake Controller

Brake Adjustment

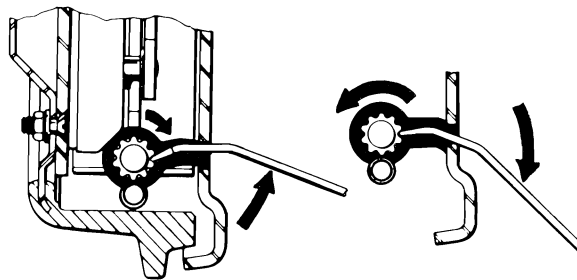
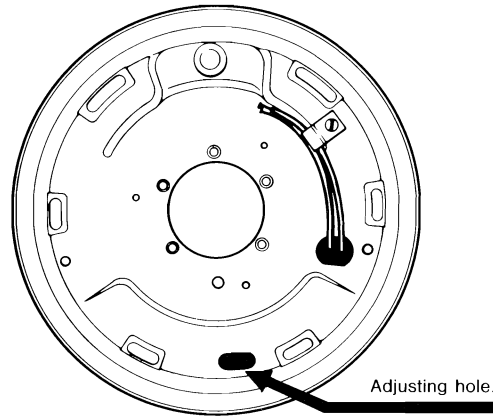

To tighten, turn clockwise.

To loosen, turn counterclockwise.

Selective Resistor Settings

All settings shown are for 12 volt electric brakes, using tow vehicle with 12 volt system.

MODEL	TRAILER WT. (lbs.)
24 Ft.	3,000 - 3,500
28 Ft.	4,500 - 5,200

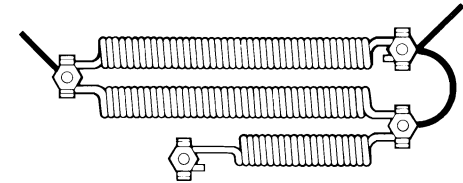

20 Ft.	(None required above 2,500)	2,000 - 2,500
24 Ft.		3,500 - 4,000
25 Ft.		3,500 - 4,000
28 Ft.		5,200 - 6,000
31 Ft.		5,200 - 6,000

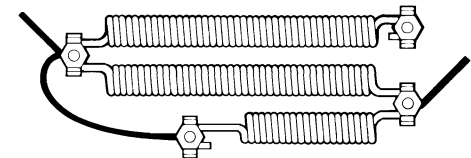

24 Ft.		4,000 - 4,500
25 Ft.	(None required above 5,200)	4,000 - 5,200
28 Ft.		6,000 - 7,100
31 Ft.		6,000 - 7,100

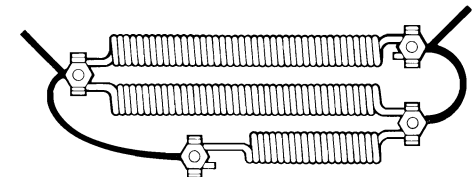

Hydraulic Disc Brakes

The optional **disc brake system**, available on 28' and 31' Airstream /Argosy models, is operated by 12 volt negative ground current and engine vacuum from your tow vehicle. The brake controller and trailer disc brakes improve brake balance, braking control, reliability, and reduce brake fade from high speed stops or frequent brake application.

Disc brake components consist of a controller, power brake booster, brake release valve, disc brake calipers, and hub and rotor. Tow vehicle's and trailer's vacuum lines, brake hoses and brake lines should be checked periodically for abrasion and signs of leakage at fittings.

The **brake controller** (Fig 1), designed for use with your Excella-Vac disc brake system, must be installed in your tow vehicle for proper brake operation. **It is extremely important to note that Excella-Vac uses an entirely different system for controlling brake operation. It is not compatible in any way with the old electric brake control system. If you do not use the control system designed for use with the Excella-Vac disc brakes, the terms of your Airstream/Argosy Limited warranty will be voided with respect to any damages incurred as a result of the use of a noncompatible system. In addition, many advantages of the exclusive Airstream disc brakes will be lost if the Excella-Vac control system is not used.** The brake controller is activated automatically when you apply the brakes of the tow vehicle. Trailer brakes may be applied manually, independent from your tow vehicle brake system, by moving the controller's lever to the right.

A **trailer brake sensitivity lever** located on the top of the controller (See Photo) provides adjustments to balance the trailer brakes with your tow vehicle's brakes without the need for a selective resistor. It is designed to balance the trailer brakes with your car brakes. Balanced brakes provide smooth braking action without premature skidding of tires on either trailer or tow vehicle during heavy braking.

Move the sensitivity lever away from you to increase or toward you to decrease the effectiveness of your trailer brakes. When first installed set the adjustment to the maximum setting, then reduce setting as required to obtain smooth braking.

There are **two indicator lights** on your controller. During brake application, the green light glows indicating normal system operation. The intensity of the green light increases as braking effort increases. A red light will glow if the brake electrical wiring is faulty. Loss of electrical input to your controller will be indicated by neither light glowing when brakes are applied.

Do not use a selective resistor.

A **vacuum line assembly** furnished in your disc brake tow vehicle kit must be installed in your tow vehicle, which provides vacuum to the power brake booster assembly located on your trailer. (See Fig. 2) Vacuum is supplied to the trailer by coupling the trailer vacuum hose to the tow vehicle vacuum connector. To couple, push knurled coupling sleeve forward, firmly insert trailer's vacuum hose fitting and pull

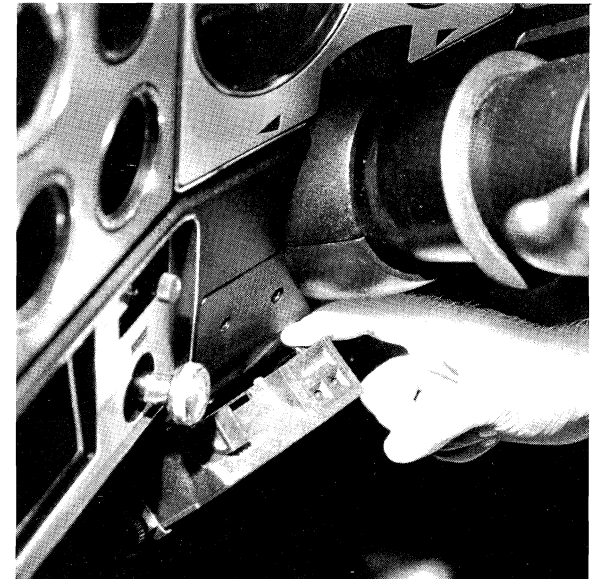

Fig. 1 - Brake Controller

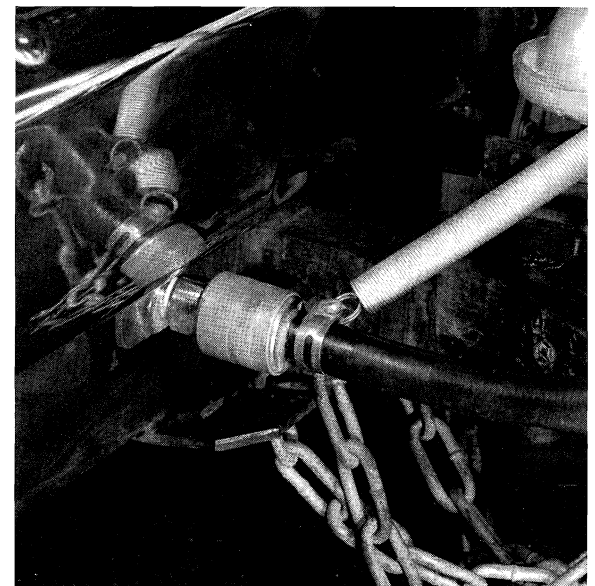

Fig. 2 - Trailer Vacuum Hose Connection

sleeve back. Check for proper locking by firmly pulling trailer's hose fitting.

To disconnect, push knurled coupling forward and pull hose fitting free. Store the hose by sliding the fitting down over the storage pin located on the front of the tongue. Never allow the hose to rest on the ground. This can cause contaminants to get on the fitting and be drawn into the actuator mechanism.

Important: A coupling plug must be inserted in the tow vehicle's vacuum connector when the trailer is disconnected. Operating your engine without the plug will result in a vacuum leak. This may result in engine misfiring, or inoperative vacuum boosted accessories (brakes, emissions, etc.) Extended operation may cause engine damage. An extra plug is supplied in the kit.

The **power brake booster** (Fig. 3) located in the trailer tongue supplies hydraulic pressure to the disc brake calipers. The fluid level in the booster's master cylinder reservoir should be checked twice a year. If necessary, add fluid to bring level to within 1/4 inch of the top of the reservoir. With disc brakes, fluid level can be expected to fall as the brake pads wear. Only brake fluid conforming to DOT 3 should be used. Use only fresh brake fluid that has been in a tightly closed container to avoid contamination from foreign matter or moisture. Periodically check actuator breather. Replace element if dirty.

When the **trailer vacuum hose** (Fig. 4) is disconnected from the tow vehicle, the trailer brakes are automatically applied. This provides

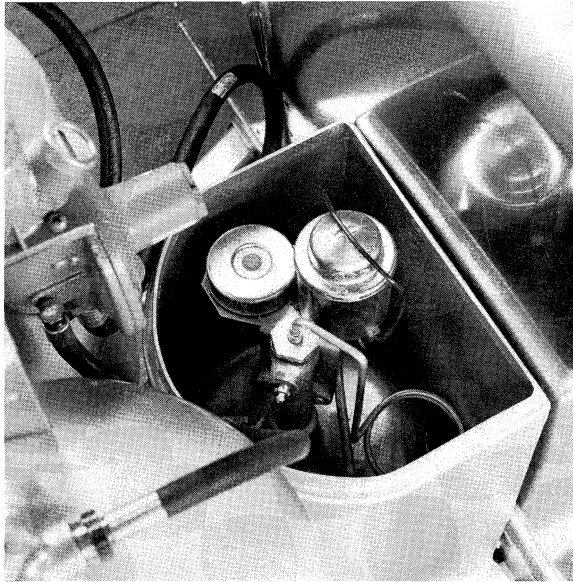

Fig. 3 - Power Brake Actuator and Breather

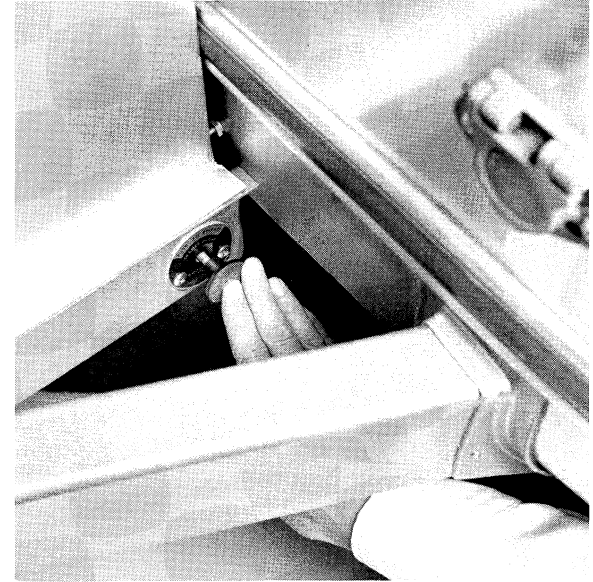

Fig. 5 - Brake Release Knob

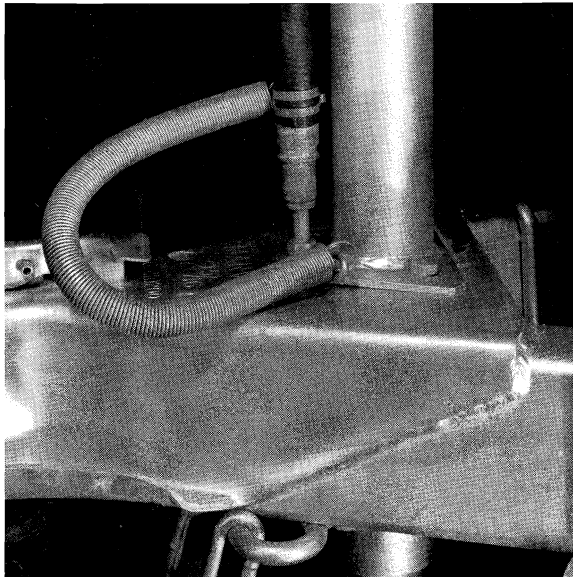

Fig. 4 - Trailer Vacuum Hose Storage

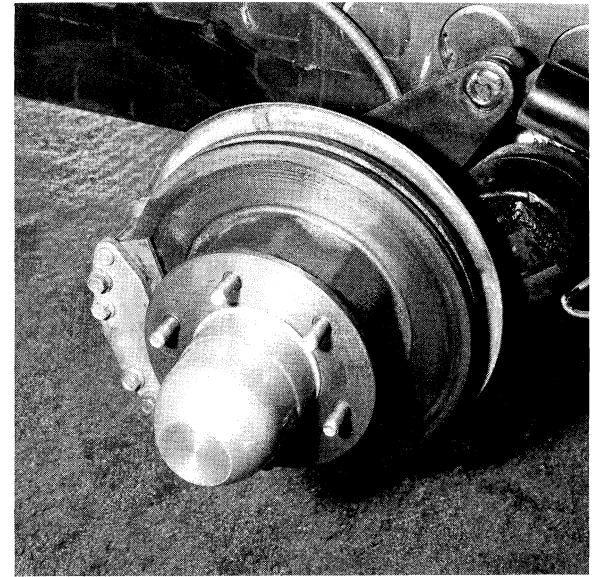

Fig. 6 - Disc Brake Calipers, Hub and Rotor

breakaway protection should the trailer break away from the tow vehicle. Brakes engaged by a disconnected supply line can be disengaged by pushing and holding knob. (Fig. 5) on brake release valve for 10 seconds. Blocking or chocking wheels is necessary when parking your trailer. **Do not use trailer brakes as parking brakes** by disconnecting the trailer vacuum line.

The self-adjusting **disc brake calipers** (Fig. 6) should be inspected for wear any time the wheels are removed for tire rotation, wheel bearing maintenance, etc. The lining will need replacement if there is evidence of brake fluid leakage or if there is less than 1/16" between the liner and liner's steel backing plate. See your Airstream dealer for all trailer braking service.

Additional information on the Brake System is available in the Service Manual.

Loading

Over all the years Airstream has been building trailers we have rarely found an instance where people have overloaded their trailer. Because it can happen we are giving you instructions for weighing your trailer. We are also providing you with an alternate method of determining the weight of your trailer without the use of scales. The following weight information and form will help you determine the actual weight of your trailer, with all its options and variable weights, and how much personal cargo weight can be added, staying within the weight ratings of your trailer.

Per Federal regulations, your trailer is placarded on the front roadside area with a gross vehicle weight rating (G.V.W.R.) and a gross axle weight rating (G.A.W.R.). The gross vehicle weight rating is the maximum the trailer can weigh when it is being towed. The gross axle weight rating is the maximum load that can be on each axle when the trailer is being towed.

The **Dura-Torque axle** is designed to last the life of your trailer without service, except for lubrication of the wheel bearings. **Under no circumstances should welding be done on or near the axle.**

The diagrams on the following page illustrates the use of scales in determining (1) your trailer's total weight, (2) weight on axle assemblies and (3) weight on tongue.

The allowable personal cargo, and placement within the trailer, may be determined by the following methods.



Federal Placard

Before weighing trailer **add all trailer's variable weights** which are full water tank, LPG tanks and water heater.

Note: The variable weights of the main and auxiliary holding tanks are not used because, under typical usage, if the water tank is full, there is storage capacity in the holding tanks. As the water tank is emptied, the holding tanks are filled.

Remove personal cargo which includes food, clothing, kitchen utensils, etc. from trailer. Your trailer is now ready for weighing.

The **trailer's total weight** is determined by placing the trailer, without tow vehicle, on a scale. This weight indicates your trailer's total weight without personal cargo. The allowable

1980 Airstream/Argosy Service Manual

For most owners, the Owner's Manual provides the answers for normal use and maintenance of their trailer. But some owners, who are mechanically inclined, want detailed information on all systems, equipment and basic construction. For these people we have made available a copy of the same Service Manual provided to our Certified Service Centers. The Airstream/Argosy Service Manual includes illustrated parts lists, procedures for maintenance and adjustments, service operations, removal and installation for components, including options for all 1980 Airstream and Argosy models.

The 1980 Airstream/Argosy Service Manual will be available in September, 1979. To receive your copy, fill in the order form and mail to:

Airstream
419 W. Pike Street
Jackson Center, Ohio 45334
or
Airstream
15939 Piuma Avenue
Cerritos, California 90701

Please send me the 1980 Airstream/Argosy Service Manual price \$50.00* per copy, to the following address:

Name _____

Address _____

City _____ State _____ Zip _____

Enclosed \$50.00 check or money Please send C.O.D.
order payable to Airstream

- * Ohio Purchasers - Add 4 ½ % Sales Tax
- * California Purchasers - Add 6% Sales Tax

The Exclusive Caravanner Travel Trailer Insurance Plan

When you own a quality product, such as your Airstream or Argosy Travel Trailer, it makes sense to protect your investment with a quality insurance program that has been specifically designed to provide maximum protection for your Airstream or Argosy Travel Trailer.

Caravanner Insurance Inc. was founded in 1964 for the sole purpose of developing the best possible insurance policy for Airstream and Argosy Travel Trailer owners. Today we offer both Airstream and Argosy owners superior benefits and service from coast to coast. No one knows your trailer better than Caravanner. Airstream/Argosy insurance is our only business.

Insurance is a unique service because "NOTHING HAPPENS UNTIL A LOSS OCCURS." That is when you need the expertise of Caravanner Insurance Inc. and our "knowledge of the product" to provide you with the fastest, most efficient claims service available anywhere in the U.S., Canada or Mexico.

Call Toll Free (800) 421-8560

Protect your investment.

Please rush information on these exclusive Airstream money-saving programs:

- Caravanner Airstream Travel Trailer Insurance Plan
- Airstream Owner's Association Accident Insurance Program
- Argosy Travel Trailer Insurance Plan

Name _____

Address _____

City _____ State _____ Zip _____

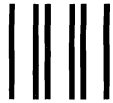

NO POSTAGE
NECESSARY
IF MAILED
IN THE
UNITED STATES

BUSINESS REPLY MAIL

FIRST CLASS PERMIT NO. 3922 PASADENA, CA

POSTAGE WILL BE PAID BY ADDRESSEE

Caravanner Insurance, Inc.

P.O. Box 7037
101 W. Walnut
Pasadena, CA 91108

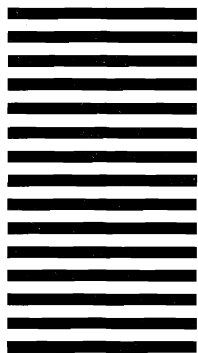

1980 Airstream/Argosy Service Manual Card

Trailer Weighing

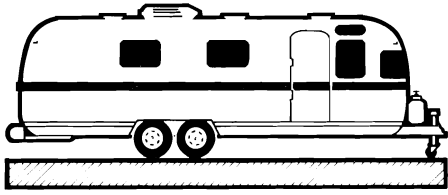

1. Trailer's Total Weight
(cannot exceed G.V.W.R.)

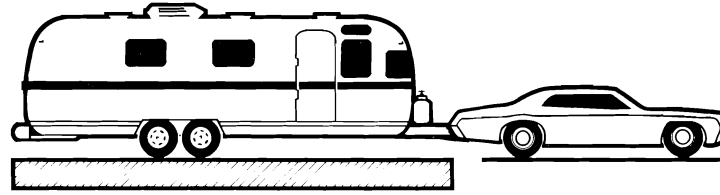

2. Trailer's Weight
on Axle Assemblies
(cannot exceed G.A.W.R.)

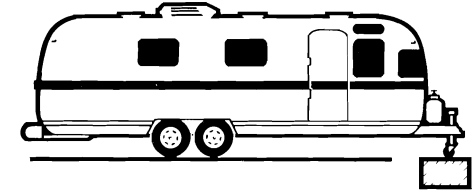

3. Weight on
Trailer's Tongue
Tongue Weight

personal cargo that you add to your trailer **shall not exceed** the difference between the Gross Vehicle Weight Rating (G.V.W.R.) and this weight. Example: if the G.V.W.R. rating on the placard is 7100 lbs. and the trailer's total weight is 6100 lbs., your personal cargo may not exceed 1000 lbs. (7100 - 6100 = 1000).

The **allowable personal cargo**, determined above, must be distributed in your trailer in such a manner that the **Gross Axle Weight Rating** (G.A.W.R.) is not exceeded.

To determine this, it is necessary to load all of your allowable personal cargo (example above 1000 lbs. total) and variable weights. Then hitch trailer to tow vehicle with load equalizing hitch properly adjusted, see the diagram on page 25.

Place trailer on scale with both axles only on scale [see (2) above]. If the weight on the axles exceeds the axle system G.A.W.R. then some

of the personal cargo must be redistributed forward in order to place some of this weight on the tongue.

The **tongue weight** should be between 10%-16% of the trailer's weight **but must not exceed 1,000 lbs.** Some tow vehicle manufacturers may restrict the amount of tongue load to a lower value. To determine tongue load, unhitch tow vehicle and place tongue hitch post on scale, see (3). The trailer must be properly loaded, as determined above, with your allowable personal cargo and variable weights.

A **scale which has a lower weight limit than your tongue load**, such as a bathroom scale, may be used to check the tongue weight by using the following method (see illustration).

Place a piece of wood of approximately the same thickness as the bathroom scales on the ground in line with the trailer hitch jack as shown. It should be so spaced that a short piece of pipe or other round piece will lay exactly one foot from the center line of the jack extension. Place the scales so that another round piece can be exactly two feet from the center line of the jack extension in the other direction. Place a 4 x 4 on the two round pieces and screw the jack extension down on the top of the 4 x 4 until the tongue of the trailer is supported by it. Multiply the scale reading by three. This will be the tongue weight of your trailer. If you exceed the capacity of the bathroom scales, increase the two foot dimension to three or four or more feet but always multiply the scale reading by the total number of feet between the wood and scales.

Caution: Be sure trailer is level when you read scales.

An alternate method for determining the weight of your trailer, without the use of scales, is by using the following information and form.

Before you fill in the blank form that pertains to your trailer, please read the sample form, page 16, to see what type of information will be needed.

First enter the model length, type of beds, and type of bathroom of your trailer on the first line (i.e. **31 Ft. Twin Rear Bath**).

Column A

Column A represents the Total Maximum Personal Cargo weight that can be added to your trailer. Personal Cargo includes food supplies, clothing, other personal items, etc. Find the Factory Weight of your trailer, Chart A-1, page 18 and enter it across from ITEM 1 Column A (Factory Weight = weight without options and variable weights (i.e. **4691 lbs.**).

Next fill in the total weights of the options and variable weights with which your trailer is equipped. This information is on Charts B and C, pages 20, 21. Add all of the weights together and this total becomes ITEM 2, Column A (i.e. **832 lbs.**). Next add ITEM 1 and ITEM 2. This becomes ITEM 4, Column A (i.e. **5523 lbs.**). This is the sum total of your trailer's Factory Weight plus the Options and Variable Weights.

Next enter in ITEM 5, Column A (i.e. **7100 lbs.**), your trailer's Gross Vehicle Weight Rating (G.V.W.R.). This information is on the placard located on the front road side area of your trailer which corresponds to information on Chart A, page 18. The Gross Vehicle Weight Rating is the maximum the trailer can weigh when it is being towed. Next subtract ITEM 4, Column A from ITEM 5, Column A; this amount indicates the Total Maximum Personal Cargo that can be added to your trailer (i.e. **1577 lbs.**). Under no circumstances shall the G.V.W.R. be exceeded.

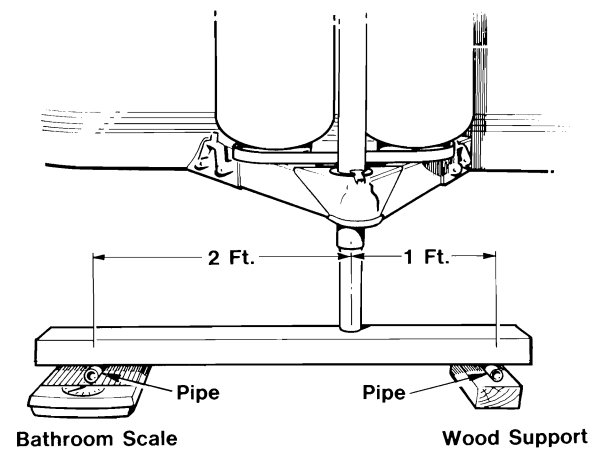

Tongue Weight

Column B

Column B represents the Recommended Personal Cargo that can be added to your trailer's tongue. Find the Factory Tongue Weight of your trailer and enter it in ITEM 1 Column B (Factory Tongue = weight without options and variable weights (i.e. **622 lbs.**). This information is on Chart A-1 page 18. Column B has + weight and - weight. Due to the location of optional items within the trailer, their weight will either have a + weight or - weight effect on the tongue. If the option is behind the axle system, or rear of trailer, it will tend to have a - weight, or lifting effect on the tongue; if the option is forward of the axle system or the front of the trailer, it will have a + weight or loading effect on the tongue. Next fill in + weights or - weights of the options and variable weights with which your trailer is equipped, indicated in the Tongue Weight Columns on Chart B or C.

Next total both the + weight (i.e. **162 lbs.**) and - weight (i.e. **22 lbs.**) columns and find the difference between the two columns; this becomes ITEM 2 Column B (i.e. **+ 140 lbs.**). Next add ITEM 1 Column B and ITEM 2 Column B; this becomes ITEM 4 (i.e. **762 lbs.**). This is the total of your trailer's Factory Tongue Weight, plus the weight of the Options and Variable Weights on the tongue. Next enter in ITEM 5 Column B 12 ½ % of your trailer's G.V.W.R. (i.e. **.125 x 7100 = 887.5**), this information is located on Chart A page 18.

Next subtract ITEM 4 Column B from ITEM 5 Column B and the amount indicates the amount of Recommended Personal Cargo that can be added to your trailer's tongue (i.e. **125.5 lbs.**).

The maximum tongue load must not exceed 1000 pounds. Some tow vehicles may restrict the amount of tongue load to a lower value. The tongue load is a total of the weight in ITEM 4 Column B plus your personal cargo.

Column C

Column C represents the Maximum Personal Cargo that can be added to your trailer's axle system. Find the Factory Axle Weight of your trailer and enter it in ITEM 1 Column C (i.e. **4069 lbs.**—Factory Axle Weight = weight without options and variable weights). This information is on Chart A-1 page 18. Next fill in the axle system weights of the options and variable weights with which your trailer is equipped from the Axle System columns on Chart B or C, page 20, 21. Add all of the weights together and this total becomes ITEM 2, Column C (i.e. **692 lbs.**).

Next calculate 34% of ITEM 5 Column B (i.e. **.34 x 887.5 = 301.75**). This becomes ITEM 3 Column C and represents the amount of tongue weight that is transferred to the trailer's axle system when properly hitched with a load equalizing hitch assembly. (The remaining 66% is transferred to the tow vehicle.) Next add ITEM 1 Column C, ITEM 2 Column C, and ITEM 3 Column C,; this becomes ITEM 4 Column C (i.e. **5062.75 lbs.**). This is the sum total of your trailer's Factory Axle Weight, the weight of the Options and Variable Weights on the axle system; and 34% of the tongue weight. Next enter in ITEM 5 Column C, the sum of your trailer's Gross Axle Weight Rating (G.A.W.R.-i.e. **3200 + 3200 = 6400 lbs.**).

This information is on the placard on the front roadside area of your trailer which corresponds to information on Chart A-1 page 18.

The Gross Axle Weight Rating is the maximum load that can be carried on the axle system when the trailer is being towed. Next subtract ITEM 4 Column C from ITEM 5 Column C. The remainder is the amount of total Maximum Personal Cargo that can be added to your trailer's axle system (i.e. **1,337.25 lbs.**).

Under no circumstances shall the G.A.W.R. be exceeded.

Sample Form

Model: <i>Excelsa 11-31 Ft. Twin-Rear Bath</i>	Column A		Column B			Column C	
	Maximum Personal Cargo Total (includes axle systems & tongue)		Recommended Personal Cargo on Tongue			Maximum Personal Cargo on Axle System	
Factory Weight (without options and variable weights)	Item 1	<i>4691</i>					
Factory Axle Weight (without options and variable weights)	----->					Item 1	<i>4069</i>
Factory Tongue Weight (without options and variable weights)	----->		Item 1		<i>622</i>		
Options:			+ Weight	- Weight			
Air Conditioner	<i>139</i>		<i>28</i>			<i>111</i>	
Auxiliary Main Step	<i>13</i>		<i>6</i>			<i>7</i>	
B.A.L. Jacks	<i>48</i>		<i>4</i>			<i>44</i>	
Bunk Bed (each)							
Entertainment Group	<i>10</i>		<i>9</i>			<i>1</i>	
L-Front Lounge							
Microwave Oven							
Refrigerator RM-100 (25 Ft. Twin and Double)							
Space Locker							
Spare Tire Bracket	<i>13</i>		<i>10</i>			<i>3</i>	
Spare Tire	<i>52</i>		<i>40</i>			<i>12</i>	
T.V. Antenna							
Window – Double Pane							
Window – Vista View	<i>26</i>		<i>15</i>			<i>11</i>	
Variable Weights:							
Water Heater	<i>50</i>			<i>22</i>		<i>72</i>	
Water Tank	<i>425</i>		<i>0</i>			<i>425</i>	
L.P.G. (tank and liquid)	<i>56</i>		<i>50</i>			<i>6</i>	
Item 2 Total	<i>832</i>		<i>+162</i>	<i>-22</i>	<i>=140</i>	<i>692</i>	<i>692</i>
Item 3 34% of Item 5 Column B	----->						<i>301.75</i>
Item 4 Items 1 & 2 Total	<i>5523</i>		Add Items 1 & 2	<i>762</i>	Add Items 1,2,3	<i>5062.75</i>	
Item 5 G.V.W.R.	<i>7100</i>		Enter 12½% G.V.W.R.	<i>887.5</i>	G.A.W.R.	<i>6400.00</i>	
Enter Item 4 and subtract from Item 5	<i>6523</i>			<i>-762.0</i>		<i>-5062.75</i>	
Maximum Personal Cargo	<i>1577</i>						
Recommended Personal Cargo on Tongue	----->					<i>125.5</i>	
Maximum Personal Cargo on Axle System	----->						<i>1,337.25</i>

Blank Form

	Column A		Column B			Column C	
	Maximum Personal Cargo Total (includes axle systems & tongue)		Recommended Personal Cargo on Tongue			Maximum Personal Cargo on Axle System	
Model:							
Factory Weight (without options and variable weights)	Item 1					Item 1	
Factory Axle Weight (without options and variable weights)	----->		----->			----->	
Factory Tongue Weight (without options and variable weights)	----->		Item 1				
Options:			+ Weight	- Weight			
Air Conditioner							
Auxiliary Main Step							
B.A.L. Jacks							
Bunk Bed (each)							
Entertainment Group							
L-Front Lounge							
Microwave Oven							
Refrigerator RM-100 (25 Ft. Twin and Double)							
Space Locker							
Spare Tire Bracket							
Spare Tire							
T.V. Antenna							
Window – Double Pane							
Window – Vista View							
Variable Weights:							
Water Heater							
Water Tank							
L.P.G. (tank and liquid)							
Item 2	Total	----->	+	-	=	----->	
Item 3	34% of Item 5 Column B	----->	----->	----->	----->	----->	
Item 4	Items 1 & 2 Total			Add Items 1 & 2		Add Items 1,2,3	
Item 5	G.V.W.R.			Enter 12½% G.V.W.R.		G.A.W.R.	
Enter Item 4 and subtract from Item 5				↓		↓	
Maximum Personal Cargo							
Recommended Personal Cargo on Tongue		----->					
Maximum Personal Cargo on Axle System		----->					

Chart A-1: Weights and Ratings - Excella II Models

Model		Gross Vehicle Weight Rating G.V.W.R.	Factory Weight Without Options or Variable Weights	Allowable Additional Total Weight Incl. Personal Cargo*	Gross Axle Weight Rating G.A.W.R. (Axle System)	Factory Axle Weight (Axle System)	Allowable Additional Weight (Axle System)	Factory Tongue Weight Without Options or Variable Weights
25 Ft.	T	5800	4244	1556	5200	3575	1625	669
	D	5800	4212	1588	5200	3608	1592	604
28 Ft.	T	7100	4443	2657	6400	3821	2579	622
	D	7100	4504	2596	6400	3854	2546	650
31 Ft. Rear Bath	T	7100	4691	2409	6400	4069	2331	622
	D	7100	4762	2338	6400	4112	2288	650
31 Ft. Center Bath	T	7100	4795	2305	6400	4189	2211	606
	D	7100	4785	2315	6400	4179	2221	606

* Allowable additional weight includes all options and accessories, L.P.G., water, waste, food supplies, clothing, or other personal cargo, etc.

T-Twin Bed Models
D-Double Bed Models

Chart A-2: Weights and Ratings - International, Argosy, Caravelle, Minuet

Model		Gross Vehicle Weight Rating G.V.W.R.	Factory Weight Without Options or Variable Weights	Allowable Additional Total Weight Incl. Personal Cargo*	Gross Axle Weight Rating G.A.W.R. (Axle System)	Factory Axle Weight (Axle System)	Allowable Additional Weight (Axle System)	Factory Tongue Weight Without Options or Variable Weights
20 Ft.		3500	2539	961	3000	2230	770	309
22 Ft.		3800	2799	1001	3300	2550	750	249
24 Ft.		4500	3317	1183	4000	2970	1030	347
25 Ft.	T	5800	3956	1844	5200	3342	1858	614
	D	5800	3926	1874	5200	3372	1828	554
28 Ft.	T	7100	4143	2957	6400	3572	2828	571
	D	7100	4200	2900	6400	3603	2797	597
31 Ft. Rear Bath	T	7100	4485	2615	6400	3914	2486	571
	D	7100	4552	2548	6400	3955	2445	597
31 Ft. Center Bath	T	7100	4612	2488	6400	4029	2371	583
	D	7100	4603	2497	6400	4020	2380	583

*Allowable additional weight includes all options and accessories, L.P.G., water, waste, food supplies, clothing, or other personal cargo, etc.

T-Twin Bed Models
D-Double Bed Models

CHART B: 20, 22, 24, 25 FT. MODELS

Optional Equipment & Variable Weights	Total Weight	20'		22'		24'		25 Twin		25 Double		
		Axle System	Tongue	Axle System	Tongue	Axle System	Tongue	Axle System	Tongue	Axle System	Tongue	
Air Conditioner	10,000 BTU	113	114	-1	109	4	105	8	NA	NA	NA	NA
	13,5000	139	NA	NA	NA	NA	NA	NA	129	10	129	10
Auxiliary Main Step	13	NA	NA	NA	NA	NA	NA	NA	7	6	7	6
B.A.L. Jacks	48	42	6	42	6	42	6	43	5	43	5	
Bunk Bed	45	48	-3	48	-3	48	-3	48	-3	48	-3	
Entertainment Group	10	2.5	7.5	2	8	2	8	4	6	4	6	
L.P.G. 7 gal. Steel Tanks & Liquid	56	9	47	8	48	8	48	STD		STD		
L.P.G. 7½ gal. Alum. Tank & Liquid*	-16	-3	-13	-3	-13	-2	-14	-2	-14	-2	-14	
L.P.G. 10 gal. Alum. Tanks & Liquid*	10	NA	NA	NA	NA	NA	NA	1	9	1	9	
Microwave Oven	66	NA	NA	NA	NA	NA	NA	NA	NA	NA	NA	
Refrigerator RM-100	71	NA	NA	NA	NA	NA	NA	51	20	51	20	
Space Locker	20	NA	NA	NA	NA	NA	NA	20	0	20	0	
Spare Tire Bracket	13	3	10	3	10	3	10	3	10	3	10	
Spare Tire & Wheel	51	12	40	12	40	12	40	13	39	13	39	
T.V. Antenna	Manual	5	4	1	4	1	4	1	2	3	2	3
Water Tank - Liquid Only		215	70	145	60	155	60	155	NA	NA	NA	NA
		425	NA	NA	NA	NA	NA	NA	425	0	425	0
Water Heater - Liquid Only	50	65	-15	42	8	72.5	22.5	65	-15	64	-14	
Windows - Double Pane	Variable	NA	NA	NA	NA	NA	NA	39	14	40	13	
Windows - Vista View	Variable	NA	NA	NA	NA	NA	NA	4	3	9	7	
Excella Vac Disc Brakes	Variable	NA	NA	NA	NA	NA	NA	NA	NA	NA	NA	

Liquid weights indicate full container.
NA - Not Available

* - Difference in weight from std. unit.

CHART C: 28 FT. REAR BATH, 31 FT. REAR BATH & CENTER BATH

Optional Equipment & Variable Weights	Total Weight	28 Twin		28 Double		31 Twin Rear Bath		31 Double Rear Bath		31Twin Center Bath		31 Double Center Bath	
		Axle System	Tongue	Axle System	Tongue	Axle System	Tongue	Axle System	Tongue	Axle System	Tongue	Axle System	Tongue
Air Conditioner 13,500 BTU	139	129	10	129	10	111	28	111	28	111	28	111	28
Auxiliary Main Step	13	7	6	7	6	7	6	7	6	7	6	7	6
B.A.L. Jacks	48	43	5	43	5	44	4	44	4	44	4	44	4
Bunk Bed	45	49	-4	49	-4	50	-5	50	-5	NA		NA	
Entertainment Group	10	2	8	2	8	1	9	1	9	1	9	1	9
L-Front Lounge	80	NA		NA		11	69	11	69	11	69	11	69
L.P.G. 7 gal. Steel Tanks & Liq.	56	STD		STD		STD		STD		STD		STD	
L.P.G. 7 ½ gal. Alum. Tanks & Liq.*	-16	-1	-15	-1	-15	-1	-15	-1	-15	-1	-15	-1	-15
L.P.G. 10 gal. Alum. Tanks & Liq. *	10	2	8	2	8	3	7	3	7	3	7	3	7
Microwave Oven	66	55	11	55	11	58	8	58	8	58	8	58	8
Refrigerator RM-100 *T	71	51	20	51	20	51	20	51	20	51	20	51	20
Space Locker	20	22	-2	22	-2	22	-2	22	-2	NA		NA	
Spare Tire Bracket	13	3	10	3	10	3	10	3	10	3	10	3	10
Spare Tire & Wheel	52	12	40	12	40	12	40	12	40	12	40	12	40
T.V. Antenna	Manual	5	2	3	2	3	2	3	2	3	2	3	2
	Electric	13	6	7	6	7	6	7	6	7	6	7	6
Water Tank - Liquid Only	425	425	0	425	0	425	0	425	0	425	0	425	0
Water Heater - Liquid Only	50	69	-19	69	-19	72	-22	72	-22	61	-11	61	-11
Windows - Double Pane*	Variable	42	11	42	11	53	15	53	15	55	13	55	13
Windows - Vista View	Variable	9	7	9	7	11	15	11	15	23	13	23	13
Excella Vac-Disc Brakes*	Variable	31	27	31	27	31	27	31	27	31	27	31	27

Liquid weights indicate full container.
NA - Not Available

* - Difference in weight from std. unit.
T - Std. in Excella II trailers

Tires

Your trailer is equipped at the factory with name brand trailer tires. Airstream/Argsoy dealers cannot make adjustments to tires. This must be done by a dealer who handles that particular brand. If you ever have tire problems, check the local telephone directory for the nearest dealer.

To get the maximum performance from your tires check the air pressure often, but only when the tires are cool. Never bleed out air immediately after driving. Recommended tire pressures vary with models, tire type and size. For specific pressures refer to the table, page 23.

It is also important to periodically check on the tightness of lug nuts. They should be tightened to a torque of 90-95-ft.-lbs. on both the steel and forged aluminum wheels. Care should be taken at all times when handling the forged aluminum wheel because of possible damage to its appearance.

In a warm climate, park out of the sun whenever possible. In desert regions use the tire covers to prevent ultra-violet deterioration to tires.

To change a tire with a jack, see the label affixed to the underbelly just to the rear of the wheels. This indicates the proper jack placement. On tandem axle models a flat tire may be changed without the aid of a jack. Drive the unit up a ramp 8" wide, 6" high and about 3 feet long at the base (see photo).

All tire, wheel, hub and drum assemblies are dynamically balanced at the factory. **Be sure to rebalance the tire, wheel, hub and drum**

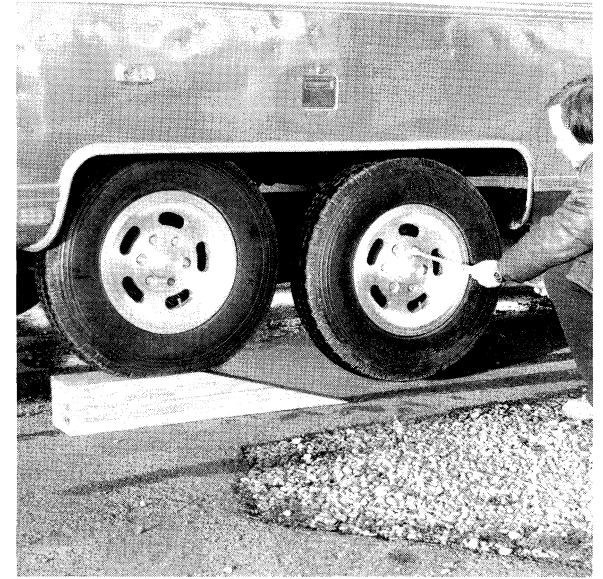

Tire Changing

assemblies each time a tire is changed or rotated.

In an emergency remove the flat tire. The independent suspension of the Dura-Torque Axle allows a four wheel unit to be safely towed on three wheels for a short distance (100 miles maximum) and only at a low speed (30 MPH). Be especially cautious in crossing holes or dips in the road. Under these circumstances, it is good practice to set your rear view mirrors so that you can observe your tires at all times.

Tire Load and Inflation Pressure Notes

1. Tire inflation pressure may increase as much as 6 pounds per square inch (PSI) when hot.
2. Cold tire inflation pressure: after vehicle has been inoperative for 3 hours or more, or driven less than 1 mile.

Tire Rotation

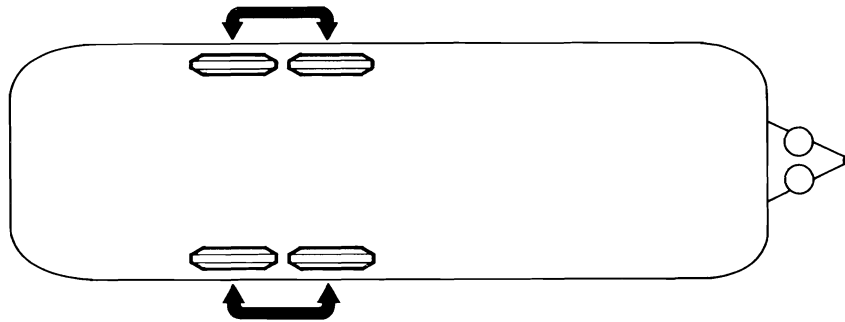

Radial

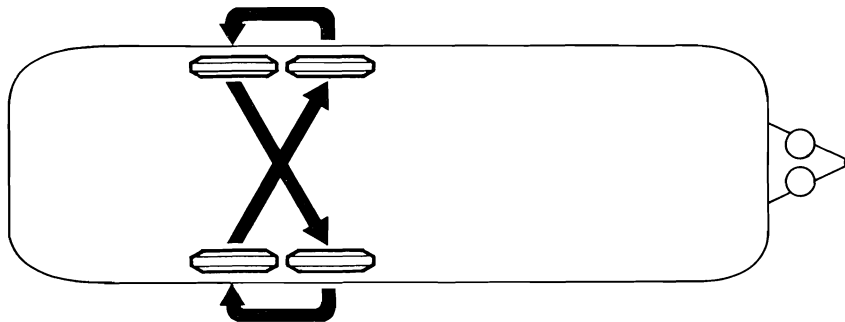

Bias Belted

Tips on Tire Care

Any tire, no matter how well constructed, may fail in use as a result of punctures, impact damage, improper inflation or other conditions resulting from use. Tire failures may create a risk of property damage or personal injury. To reduce the risk of tire failure we strongly recommend the following.

1. CHECK the pressure in your tires, including your spare, at least monthly when the tires are cool (after the vehicle has been stopped three hours and then driven less than one mile). Do not reduce pressure when tires are hot; use a tire gauge to check pressure and maintain it at the recommended level.
2. NEVER overload your tires. The maximum load carrying capability of your tires is molded on the sidewall of the tire.
3. CHECK your tires frequently for scrapes, bulges, separations, cuts or snags resulting from use. See your tire dealer immediately if any such condition is discovered.
4. NEVER operate your vehicle in excess of lawful speeds or the maximum speeds justified by driving conditions, or in excess of speeds recommended for the tire you are using.
5. MAKE every effort to avoid running over objects that may damage the tire through impact or cutting, such as chuckholes, glass, metal, etc.
6. NEVER drive on smooth tires. Tires should be removed when 2/32nds inch of tread depth remains. In most states it is illegal to drive with less than 2/32nds inch remaining tread depth.

Tire Inflation Pressure (PSI) Cold Inflation

Model	7.00 x 15 Load Range C	7.00 x 15 XC Steel Radial Tires	7.75 x 15 ST Load Range C
20', 22' Single axle			35 PSI
24' Dual			40 PSI
25' Dual axle	35 PSI	35 PSI	
28', 31' Dual axle	40 PSI	45 PSI	

*N.R. Not recommended by tire manufacturer

Hitching Up

Hitching up your trailer is something that will become almost second nature with practice. The following section includes proper hitch load distribution and a procedure for hitching up.

The electric jack is strongly recommended for anyone who, for any reason, should not physically exert himself. Available as an option, the electric jack makes hitching and unhitching a much easier operation.

Equalizing Hitch Load Distribution

When a trailer is hitched up properly to a tow vehicle, with a load equalizing hitch, approximately 1/3 of the trailer's tongue weight will be on the trailer's axles and 2/3 will be transferred to the tow vehicle. 1/3 of this weight transfer will be carried by the front wheels and 1/3 by the rear wheels of the tow vehicle (see diagram). Thus, the tire loading of each wheel on the tow vehicle will be increased by 1/6 of the trailer's tongue weight. The tire air pressure of the tow vehicle should be increased to compensate for this additional weight. Refer to the vehicle's owners manual for this information.

The tongue weight should be approximately 10% to 16% of the trailer's total weight but **must not exceed 1000 lbs.** and under no condition exceed the hitch rating. Your hitch rating information should be provided to you by your hitch installer.

Steps for Hitching up

Jack up the trailer hitch until there is clearance for the **hitch ball** to slide under, remove safety pin and raise the **locking lever**. Back the car

Equalizing Hitch Load Distribution

Proper Installation

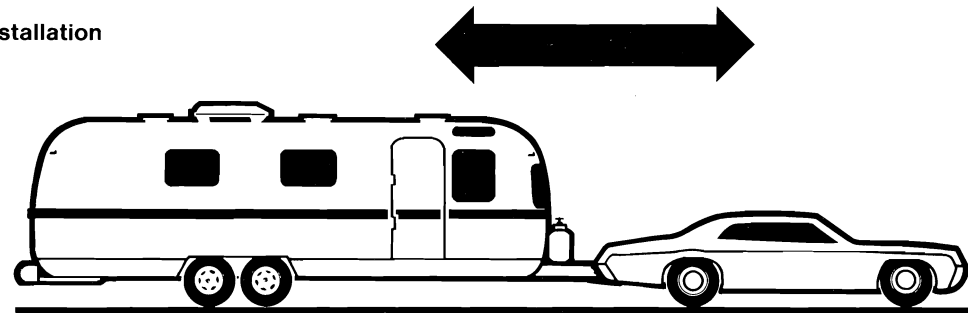

Percentage of Tongue Load distributed to car and/or trailer wheels.

34%

33%

33%

Hitch High

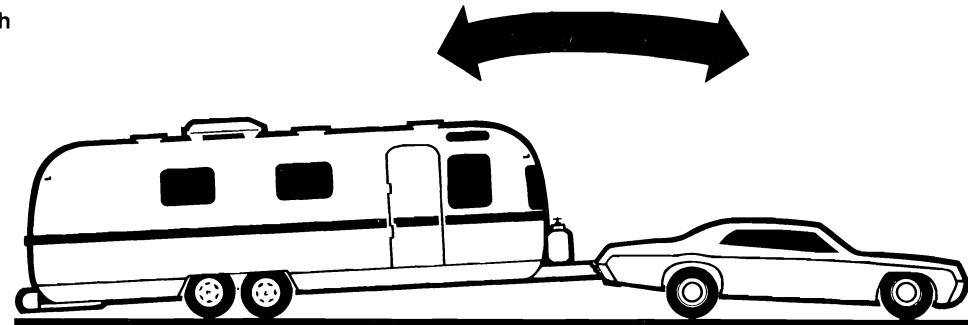

40 to 50%

-20 to +20%

40 to 70%

Hitch Low

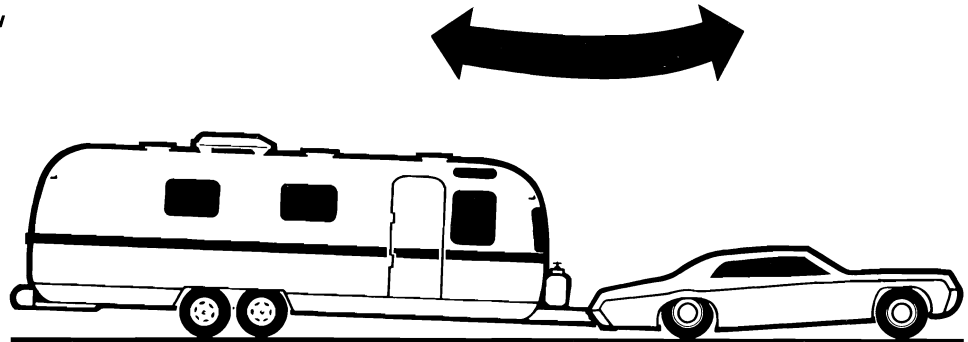

0 to 20%

60 to 90%

-10 to +20%

straight back to the hitch. (See Fig. 2.) This can best be accomplished through the use of prearranged hand signals with the help of another person, but if you are hitching up by yourself we recommend the use of a **hook-up view mirror**.

Lower the trailer hitch onto the hitch ball; then close the locking lever and insert safety pin. (See Fig. 3.)

Now raise the trailer and car to the full height of the hitch jack (See Fig. 7) and then attach the **leveling bars**. (See Fig. 4, 5, & 6) Lower the car and trailer (See Fig. 7). The hitch ball should be level to slightly higher. Readjust leveling bars until this condition is correct, by increasing or decreasing length of chain engaged in "A" frame saddle bracket. Shorter chain raises hitch ball, longer chain lowers it. A level condition will result in the best balance for towing and steering control as the weight equalizing hitch distributes the hitch load. A low hitch ball increases tailwagging tendencies by lowering the nose of the trailer thus changing the center of support for the trailer and reducing the weight on the front wheels of the car. With proper hitch installation and hitching up, the bar should have a noticeable amount of deflection or bending. (See Fig. 8.) A little practice with your rig will teach you how far to pull up the bar, and you may wish to mark the chain links that match your rig. Always choose level ground for checking correct hook-up. For further information see hitch manufacturer's literature.

Note: If your car is equipped with adjustable load leveling air shocks, you must load the car first with typical luggage and passengers and bring it back to level. Then attach the trailer and adjust the load leveling bars. Otherwise the air shocks on

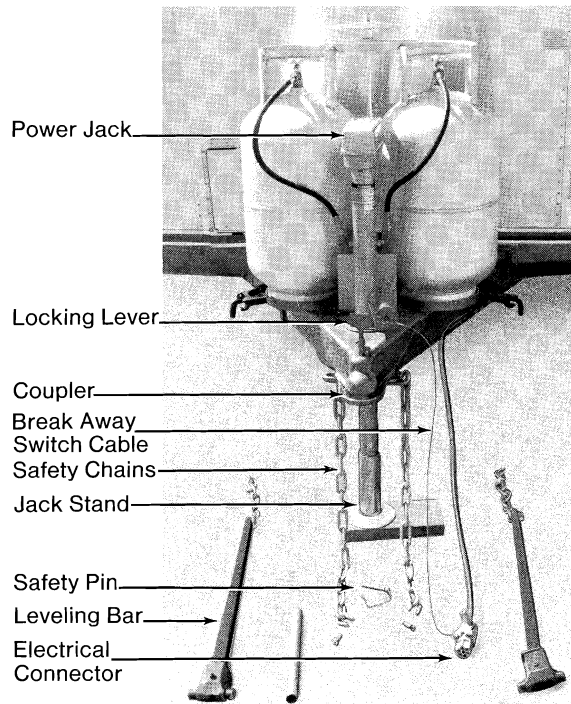

Fig. 1 - Hitching Up Equipment

your car will overload the rear wheels. Do not use air shocks to level car and trailer after hitching up.

The hitch ball on your car should be installed at a height of 19½" to the top of the hitch ball, measured when the car is loaded to pull 25', 28', and 31' models and 16½" to pull 20', 22' and 24' models. Plug in the electrical connector cord (See Fig. 9) and check running, directional, brake lights, and back up.

If your trailer is equipped with electric brakes, attach the break-away switch cable to welded portion of hitch, or car's frame (See Fig. 11). If it has hydraulic disc brakes, remove plug from tow vehicle's vacuum coupling and insert trailer's vacuum line (See Fig. 12). To couple,

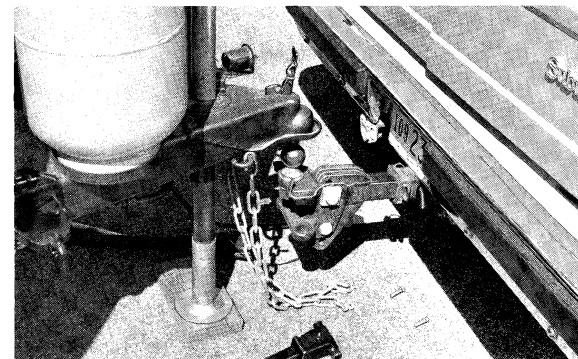

Fig. 2 - Hitching Up

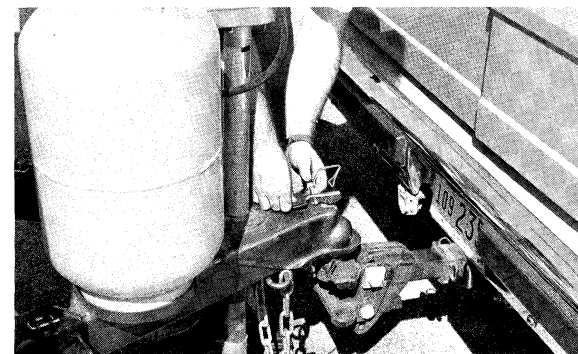

Fig. 3

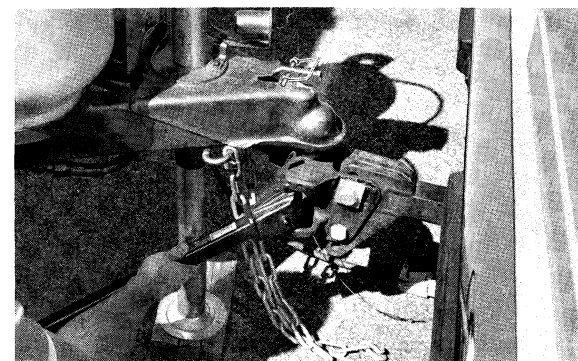

Fig. 4

push knurled coupling sleeve forward, firmly insert trailer's vacuum hose fitting and pull sleeve back. Check for proper locking by firmly pulling trailer's hose fitting.

Attach the safety chains (see Fig. 10) to the welded portion of the hitch or the car's frame,

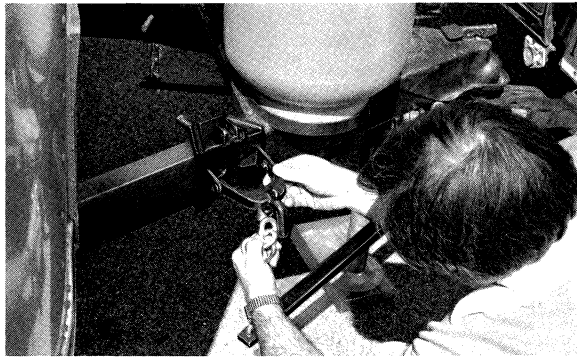

Fig. 5

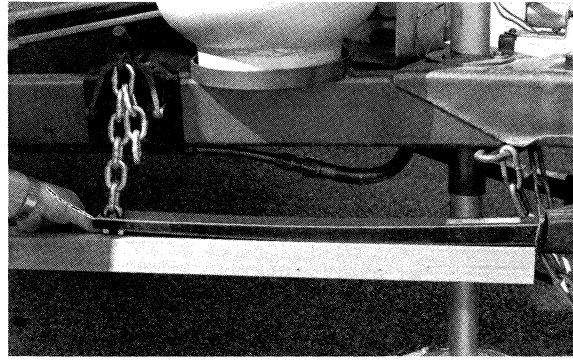

Fig. 8

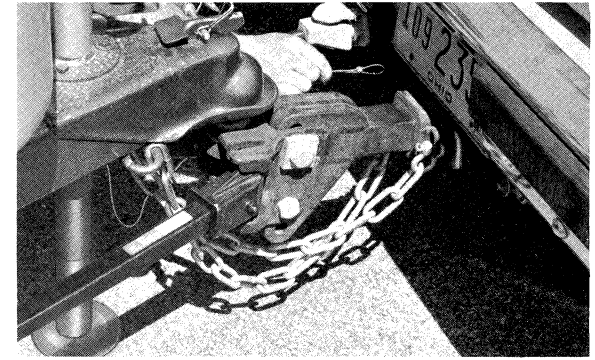

Fig. 11

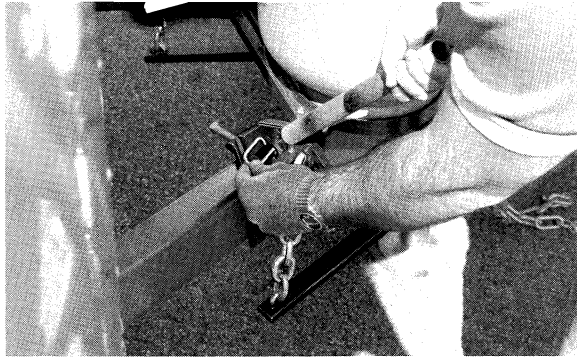

Fig. 6

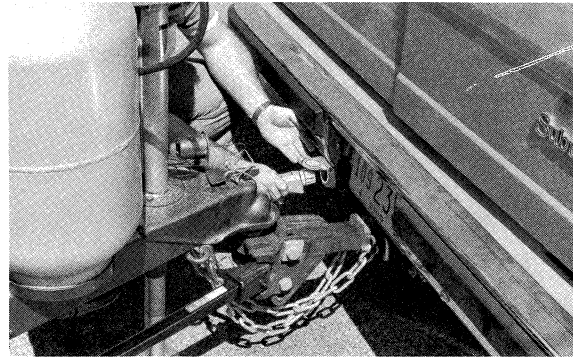

Fig. 9

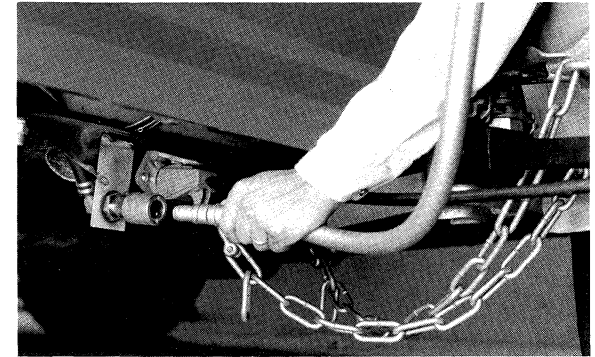

Fig. 12

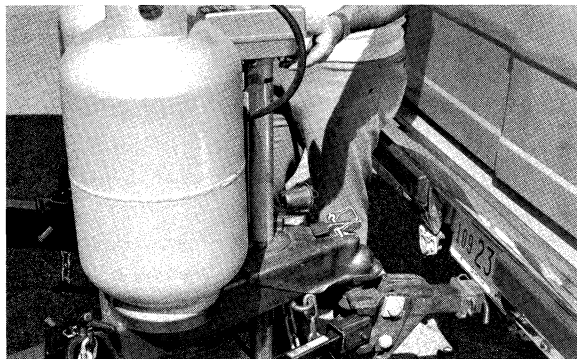

Fig. 7



Fig. 10



Fig. 13

but never to the removable ball mount. Cross the safety chains under the hitch.

Retract the hitch jack completely for maximum ground clearance. Remove the jack pad (See Fig. 13), and stow in the car's trunk, along with leveling jack and other gear used when

stopped. Never tow your trailer with the jack down. Check that the fold-away step is up and that the main door is completely closed and locked for towing. If it is not locked the constant vibration of travel may cause it to open with possible damage.

Move the rig ahead about 50 feet and test the trailer brakes, then check the ground for forgotten objects. Regularly check the condition of your tires, air pressure, and the tightness of the lug bolts. For specific tire pressures refer to page 23.

Towing Tips

We want every owner to be a safe and courteous driver.

A few hours of towing practice in a large empty supermarket lot will make pulling your trailer over the road much easier. Line out two corners for left and right turns. You may also use these corners to practice backing and parking. **Observe that the tracks made by the trailer wheels are distinctly different from those made by the car.** Studying this will make it easier for you to correct mistakes. Truck or trailer type fender or door grip rear view mirrors are a must for maximum visibility and in most states they are required by law.

After thoroughly inspecting your hitch, brakes and tires you should be ready to tow. Check traffic, signal that you are about to pull away, and start slowly. Look often in your mirrors, and observe the action of the trailer, then carefully move into the proper lane of traffic. Remember that the trailer wheels will not follow the path of the car's wheels, therefore, **wider turns are necessary when turning to the left or to the right.**

On freeways or expressways try to pick the lane you want, and stay in it. Always maintain plenty of space between you and the car ahead, at least the length of the car plus trailer, for every ten miles per hour. Remember that in order to pass another vehicle, you will need longer to accelerate. You must also allow for the length of the trailer when returning to the right hand lane.

On a two lane road, cars will be lining up behind you because you travel at a lower

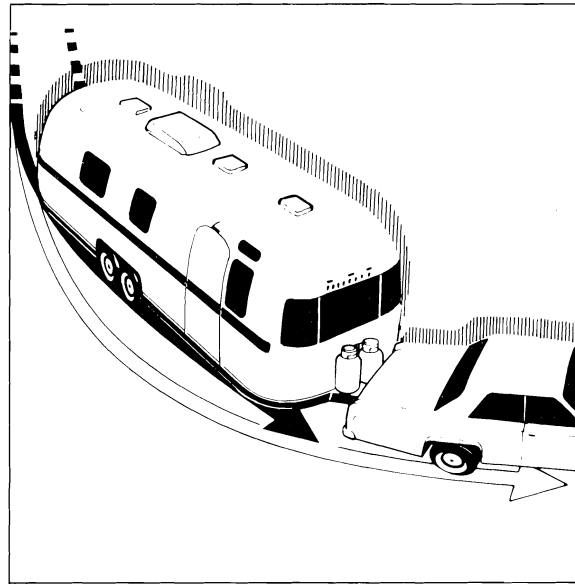

Tracking

speed. It is both courteous and sensible to signal, pull onto the shoulder, and let them pass. Your trailer is designed to be towed easily at any legal speed, so if you are not careful you may be inclined to forget it is there.

The **brake controller** is activated when you apply the brakes of the tow vehicle. Your car brakes will automatically apply the trailer brakes first when properly adjusted. This will help keep your car and trailer in a straight line and make you stop as if you were driving the car alone.

Note: The tow vehicle's engine must be warm (near operating temperature) to insure maximum braking, with vacuum operated hydraulic brakes.

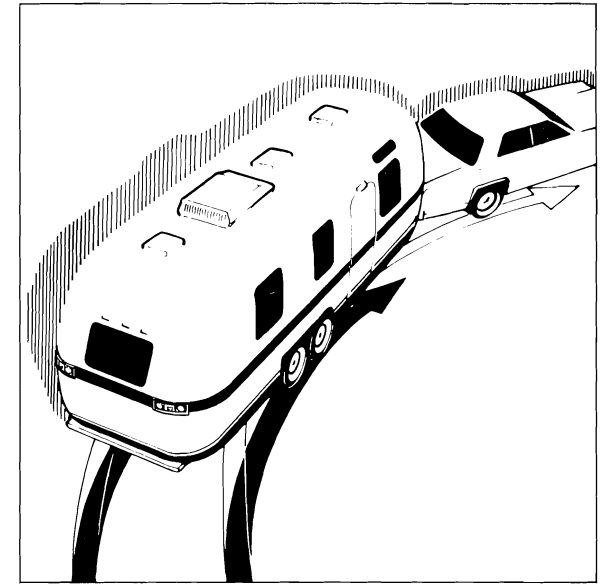

When trailering, you might encounter a temporary cooling system overload during severe conditions — such as hot days when pulling on a long grade, when slowing down after higher-speed driving, or driving long idle periods in traffic jams. If the hot indicator light comes on or the temperature gauge indicates overheat and you have your air conditioning turned on, turn it off. Pull over in a safe place and put on your emergency brake. Don't turn off the engine. Increase the engine idle speed. Lift the engine hood and check for fluid leaks at the radiator hoses, radiator or radiator overflow outlet. Check to see that all drive belts are intact and the fan is turning. If you have a problem, have it fixed at the next opportunity. If there is no problem, the light should go off or temperature should come down within one

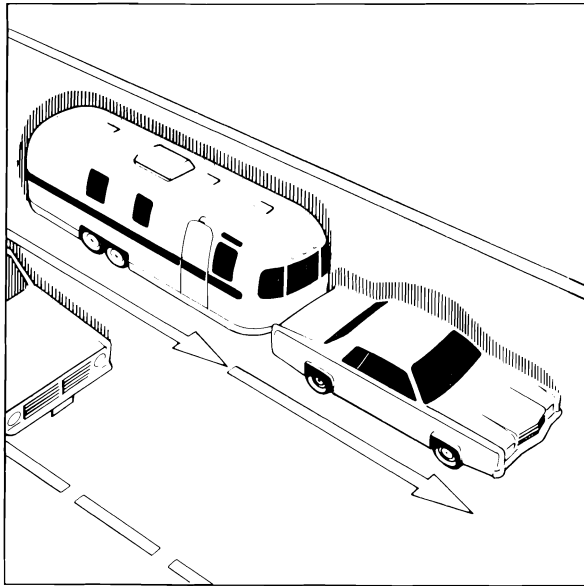

Passing

minute. Proceed on the highway a little slower. Ten minutes later resume normal driving.

Caution: Never open a radiator cap when the car is hot! Check the car coolant level when the car is cool.

When going downhill in dry weather, down shift so that engine compression will slow the whole rig down. Take dips and depressions in the road slowly and do not resume normal driving speeds until you are sure that the trailer wheels are clear of the dip.

On slippery pavement do not use engine drag to help slow down as this may cause the rear wheels of the car to skid. On icy pavement drive slowly and if you feel the car is skidding,

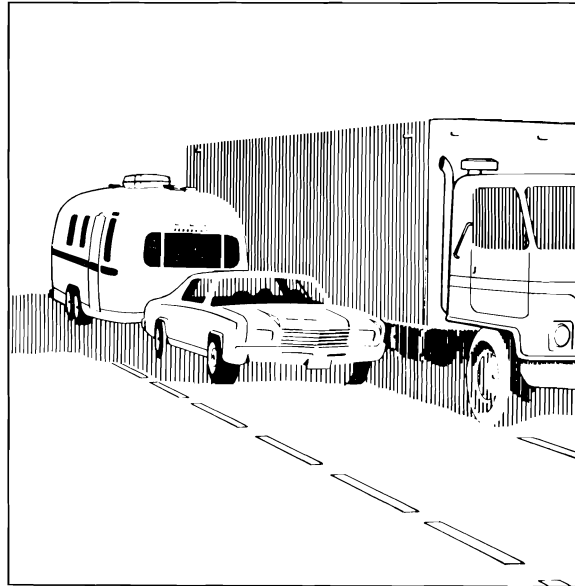

gently apply the trailer brakes only. This will bring the car and trailer back into a single line. Chains do not help trailer wheels.

When driving in mud and sand let the momentum carry the rig through. Apply power gently and use as little as possible. Stay in the tracks of the vehicle ahead and keep the car in the highest possible gear. If you get stuck it is best to tow out both car and trailer together without unhitching.

If you have to tow long distance over bad roads, the stones and gravel thrown back by your tires will dent and scratch the aluminum finish of your trailer. To prevent this, use masking tape to secure heavy sheets of cardboard to the lower front end of the trailer.

Despite the best hitch, you will notice that whenever a large bus or truck overtakes your rig the displaced air first pushes the trailer rear slightly to the right and then affects the front. It may be necessary to steer very slightly, momentarily, toward the bus or truck, to help compensate for the sway induced by the passing vehicle. Do not apply the vehicle brakes, as this can tend to exaggerate the situation. You may find, however, that briefly applying the trailer brakes with your manual control will help eliminate sway.

When stopping on a hill or slope, leaving your car in gear is not enough for standstill-safety. **Check the trailer wheels** to be double sure. Do not use trailer brakes as parking brakes.

Backing Up

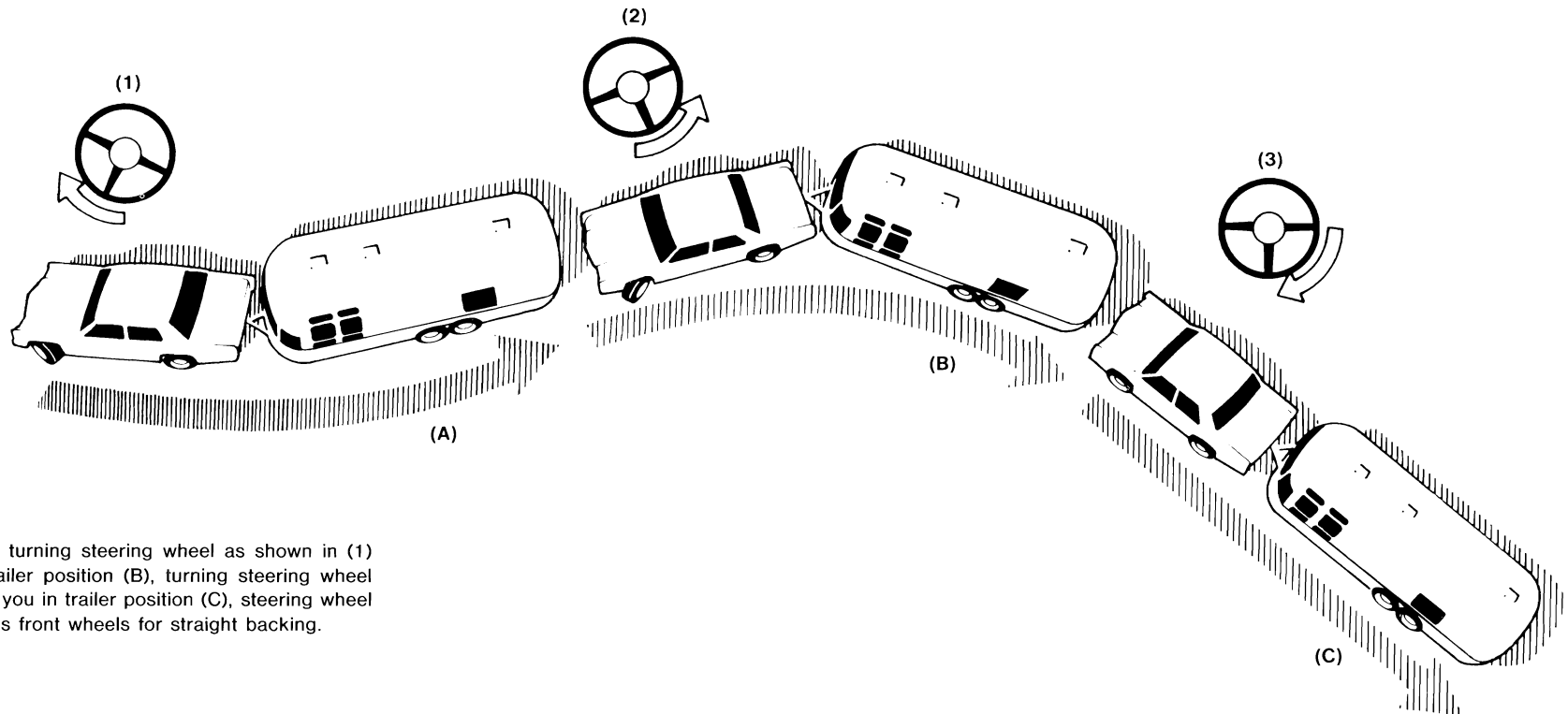

Position (A) start, turning steering wheel as shown in (1) will put you in trailer position (B), turning steering wheel shown in (2) puts you in trailer position (C), steering wheel position (3) returns front wheels for straight backing.



Indicates steering directions

In backing up, the important thing to remember is to **do everything slowly** and to correct immediately if you see the trailer turning the wrong way. Concentrate on the rear of the trailer. With your car and trailer in a straight line, back up slowly and turn the bottom of the steering wheel in the direction you want the

trailer to go. Watch out the window or in the mirror until the rear of the trailer is pointing in the desired direction. Then turn the steering wheel in the opposite direction. Your car will be following the trailer in an arc. Straighten the car and trailer by turning the steering wheel more

sharply, then when they are in line, straighten the steering wheel. **Always try to back to your left because the visibility is much better.** (See illustration.) When you don't make it on the first try it is usually much easier to pull forward to your original position and start over.

Overnight Stop

Airstream and Argosy owners have parked virtually every place imaginable from filling stations to farm lands. In time you will develop a knack for spotting wonderful little roadside locations by turning off the main highway and exploring.

There are many modern trailer parks including State, County and Federal parks with good facilities, where you may obtain hookups of electrical, water and sewer connections. Directories are published which describe in detail these parks and tell what is available in the way of services and hookups.

On overnight or weekend trips, chances are you will not use up the capacity of the sewage holding tank, deplete the water supply or run down the battery which supplies the 12 volt current.

On a longer trip, when you have stayed where sewer connections and utility hook-ups, were not available, it will be necessary for you to stop from time to time to dispose of the waste in the holding tank and replenish the water supply. Many gas stations (chain and individually owned) have installed **sanitary dumping stations** for just this purpose. Booklets are available which list these dumping stations.

When stopping for the night your Airstream is built to be safely parked in any spot that is relatively level and where the ground is firm. **Your facilities are with you, you are self-contained.** Unless the car is needed for transportation, it is not necessary to unhitch.

Try to pick as level a parking spot as possible. **Stabilizing jacks or blocks** probably won't be required for an overnight stay; however if you put the jack pad on the hitch jack and run the hitch jack down to take the weight off the car's springs this will provide some stability. If you must park on a slope, **park facing downhill**; it is easier to level the trailer this way.

All you need to do to enjoy the self-contained luxury of your Airstream is to:

1. Light the water heater and refrigerator pilots if required. See pages 69-82 for complete details on LPG system and gas operated appliances.
2. Turn on the range gas supply and light the pilot.

Before moving on, check your campsite, both for cleanliness and also to be sure you haven't left anything behind, turn off the gas supply petcock to the range and make sure everything is properly stowed. Use your Pre-Travel Check List on page 114 and you are ready for more travel adventure.

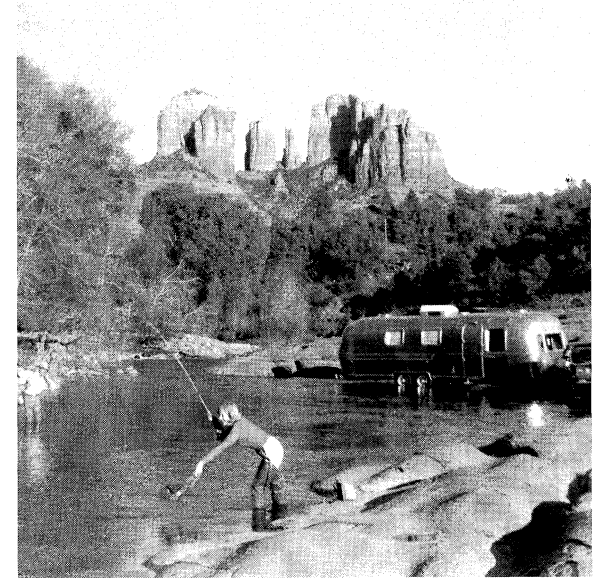

Extended Stay

Making a long trip in your Airstream or Argosy is not very different from making a weekend excursion. Since everything you need is right at hand you are at home wherever you go. When packing for an extended trip take everything you need, but only what you need.

When you plan to stay in the same place for several days, weeks, or months, you will want your trailer to be as level and steady as possible. Check the attitude with a small spirit level set on the inside work counter or the trailer hitch "A-Frame". (See Fig. 1.) If a correction is necessary then **you must level from side to side first**. This can be done easily by backing the trailer up one or more 2"x6" boards. (See Fig. 2.) We do not recommend placing tires in a hole for leveling.

Level from front to rear by disconnecting the hitch from the car, putting the jack pad under the hitch jack and adjusting the jack up or down until you are level. Block or chock the wheels to keep the trailer from rolling. Use **stabilizing jacks** at all four corners as shown in the diagram to the right, to eliminate the natural spring action of the axles. If you have optional **B.A.L. stabilizing jacks** (Fig. 3) use the wrench provided to lower the units.

Note: Whenever the trailer must be lifted with a jack as when changing a tire or leveling on very rough terrain, **always place the lifting jack under the main frame rail**. A label is provided to indicate the proper position for the jack. **Never use stabilizing jacks to lift the trailer.**

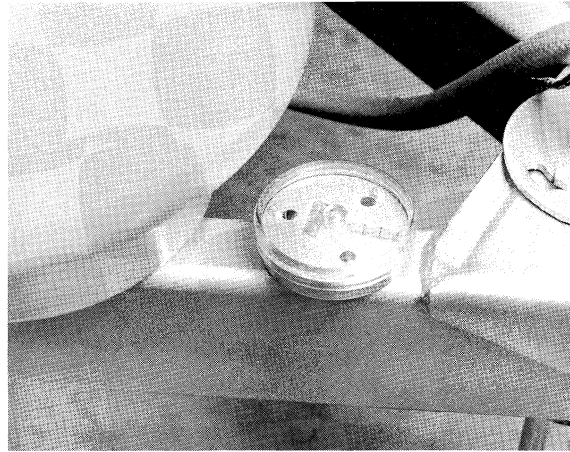

Fig. 1 - Spirit Level

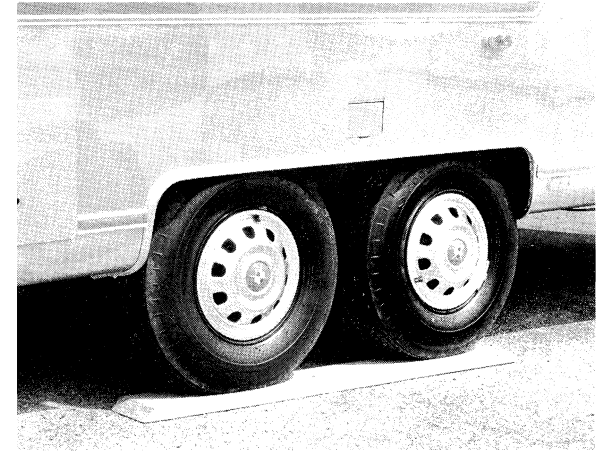
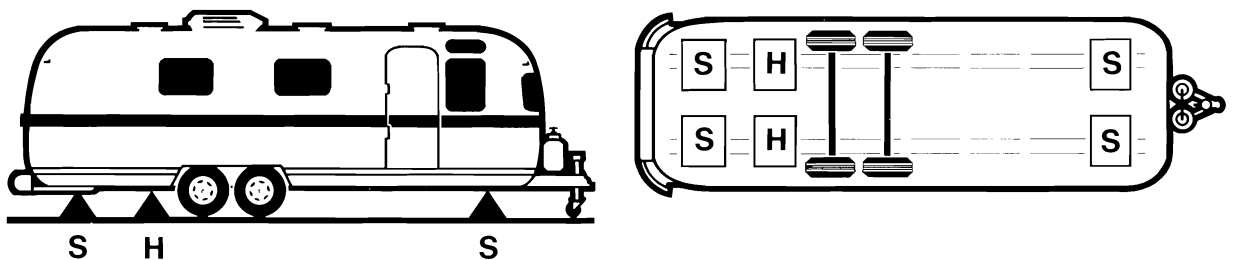
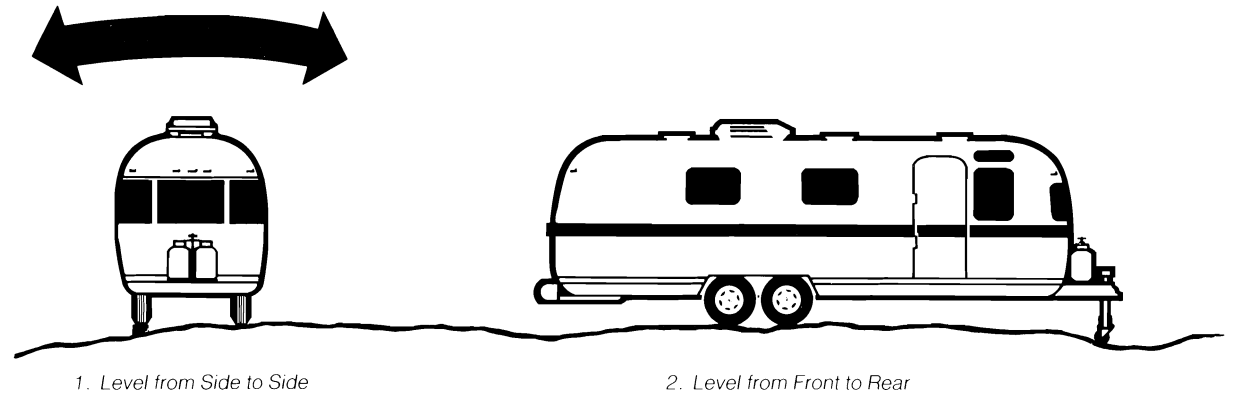

Fig. 2 - Trailer Leveling



H - Hydraulic Jack Positions
S - B.A.L. Stabilizing Jack

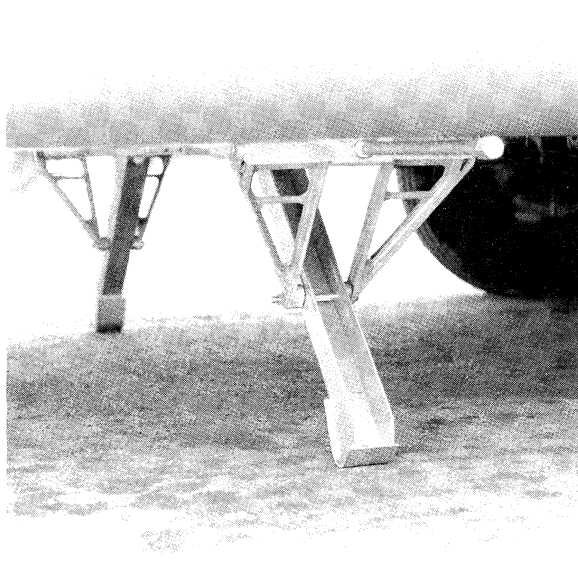

Fig. 3 - B.A.L. Stabilizing Jack

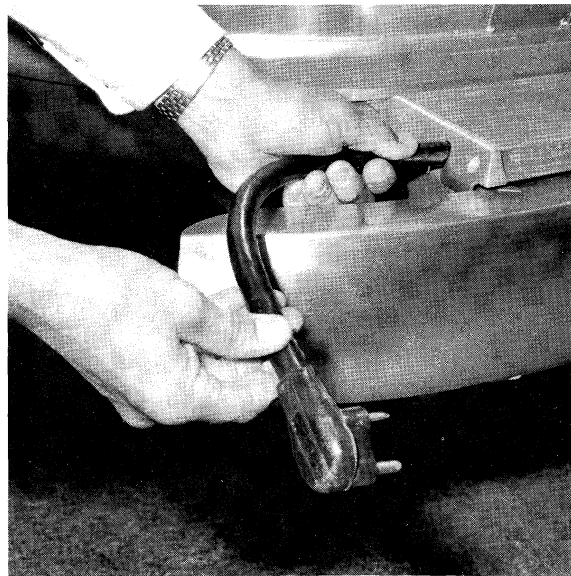

Fig. 5 - 120 Volt Electrical Cable

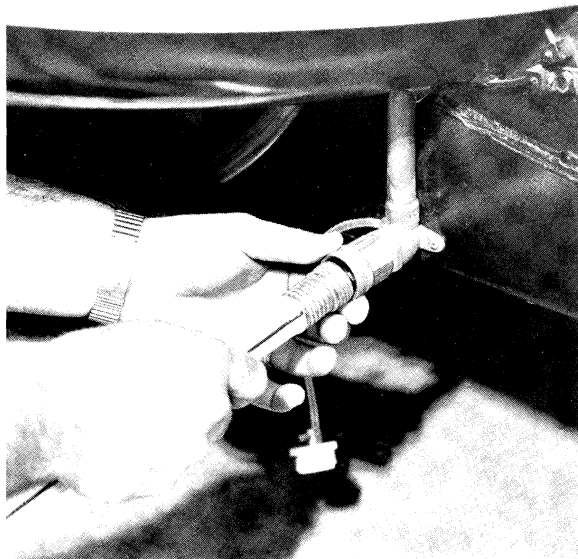

Fig. 4 - City Water Hook-Up

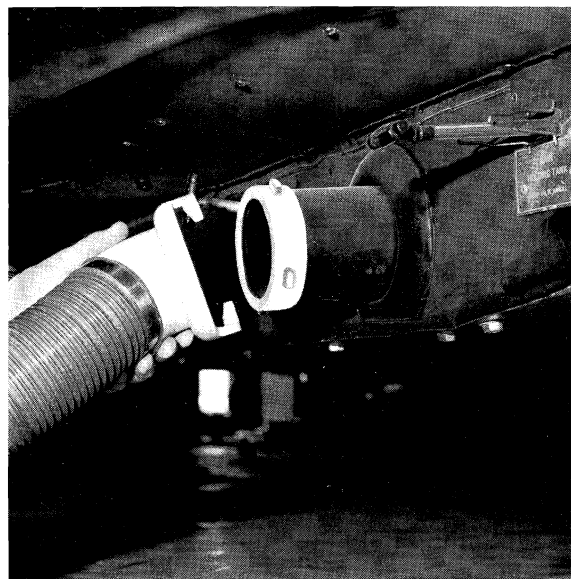

Fig. 6 - Waste Drain Hose Hook-Up

Hook up to water (see Fig. 4) by attaching a $\frac{1}{2}$ " minimum high pressure water hose to the city water service.

Plug the **electrical cable** (See Fig. 5), which is stored in the bumper storage compartment into the **city power service**. Be sure you have the wire grounded and have the proper polarity. See page 89 for details.

Hook your **waste drain hose** (see Fig. 6) into the **sewer disposal facility** and attach to the drain outlet in your trailer. For details on this procedure refer to page 86.

Turn on gas supply; light the range and oven pilots, light the water heater, refrigerator and furnace pilots. See pages 69-82 for complete details on L.P.G. system and gas operated appliances.

When you stay for extended periods where electric or water hook-ups are not available, you must make regular checks on the condition of your 12 volt battery and the contents of your water tank. Try to conserve electricity. You can recharge your battery by hooking up the car/trailer electrical connector and running the car engine at a fast idle. 45 minutes per day should provide about 3-4 hours of power. Carry drinking water in a clean bucket to refill your tank. When your waste tank nears capacity, move to a dumping location.

Winter Trailering

Traveling in an Airstream or Argosy during the cold winter months can be one of the most exhilarating experiences in all trailering. When we speak of cold, we are talking about temperatures of zero to -10 degrees. Trailers properly outfitted with dual-pane windows have been cold-soaked at -20 degrees with no adverse effects and with no real discomfort. Optional dual-pane windows, (not available in Caravelle and Minuet models), improve the efficiency of the heating system.

There are of course certain precautions which must be taken as you would in your own home in low temperatures.

1. There should be heat in the trailer at all times.*
2. You must have a plentiful supply of propane gas.
3. If your stay is longer than overnight, then you should endeavor to have 110 V electricity available. The battery (fully charged) will not last more than about 10 hours in zero weather. Of course you can always run your car to recharge the battery and normally the battery will attain sufficient power to run another 3-4 hours by running your engine for approximately 45 minutes to one hour at fast idle. For more detailed information on the battery see page 91.
4. Minimize use of electricity if 110 volt power sources is not available.

* Some states do not allow L.P.G. to be turned on while moving. While traveling in these states it will be necessary to take other precautions to prevent freezing of the water and waste drain systems. (See "Storage and Winterizing") Additionally, L.P.G. should always be shut off as a safety precaution when gasoline is added to the tow vehicle.

5. Heat is also provided around the water and holding tanks. This heat is supplied by your furnace. Heat from your optional roof air conditioner heat strip is not sufficient to prevent your tanks from freezing.
6. Leave cabinet doors, bed doors and wardrobe doors slightly open at night to allow circulation of air around all furniture components.
7. For extended stays in cold weather, insulate the water line outside the trailer.

You should remember that low temperatures in combination with high winds cause an equivalent chill temperature much below what your thermometer is reading. For instance, with an outside temperature of zero degrees and the wind velocity of 10 miles per hour, the equivalent chill temperature is minus 20 degrees F. Whenever possible, experienced winter campers try to park their trailer so it heads into prevailing winds. Use trees and other natural barriers as wind breaks. Be sure to check all tires before setting out. There should be plenty of tread left on each one for safety and maximum traction.

It is also important to **guard against excessive humidity** inside your trailer during winter camp-outs. When windows and window frames fog up or "sweat", it means that there is too much moisture in the air. Moisture comes from water vapor, and water vapor is the direct result of water evaporating. Many things such as baths and showers, boiling foods, washing dishes, mopping the floor, washing clothes, even breathing, contribute to evaporation. The inside air can only absorb so much of this moisture before it becomes saturated. At this

point, it can hold no more, and any additional water vapor condenses back to liquid water in the form of droplets on any available cool solid surface. Temperature has a direct effect on the air's saturation point. Cold air holds less moisture than warm air. For this reason, the air immediately adjacent to cold outside walls and windows cools down and causes water vapor to condense and form moisture droplets even though warmer inside surfaces are still dry.

The best way to keep condensation under control is to reduce moisture producing activities. It is also important to provide adequate ventilation and keep the air circulating as much as possible. Use your exhaust fans to remove moisture before water vapor mixes with the air. Open windows slightly once in awhile, while operating fans to bring in drier outside air and aid in overall air circulation. In extremely cold weather, when outside ventilation is not practical, it may be necessary to use a small de-humidifier to aid in reducing condensation.

Storage and Winterizing

When storing your trailer for short or long periods use the same precautions as you would in your own home in regard to perishables, ventilation and rain protection. In addition, for prolonged storage periods, flush out all the drain lines and the holding tanks. Also, drain the entire water system including the water heater and the water storage tank. Instructions for draining the water system are explained in the following paragraphs on winterizing.

Twice a year or after a long storage period, we suggest you take your unit in for a check-up and cleaning of the gas operated appliances.

The main consideration in winterizing is to guard against freezing damage to the hot and cold water systems, the waste drain system (including the traps), the waste-holding tanks, the water heater and the battery. To completely winterize your trailer, follow this procedure:

1. Level the trailer from side to side and front to rear. Open all faucets.
2. Turn the water pump switch to the ON position to expel water from the storage tank.
3. Open all drain valves. See page 85 for location.
4. While the water is draining from the system, open and flush the toilet flushing valve. Depress hand spray lever while holding the spray head down inside the bowl. Depress hand spray thumb button on the telephone shower head while holding down inside the tub and drain all

- water from the flexible hose. Unscrew the heads on both spray units and store.
5. After all all water has been removed from the storage tank, turn the pump switch OFF.
 6. Remove exhaust hose from water pump.
 7. Disconnect the water pump inlet connection, and with check valve removed, turn the pump by hand until all the water is expelled (belt driven pumps only).
 8. Lower the front of the trailer as far as the jack will allow until water ceases to drain, then crank the jack up as high as it will go and let any remaining water drain out the rear drain valves on models so equipped.
 9. Pour a cup of approved* nontoxic antifreeze into the lavatory, sink, and tub drains to prevent trap freeze-up.
 10. Be sure to open the waste-holding tank drain valves and drain and flush the tanks thoroughly. **(This is very important as the sewage in the tanks, if frozen, could seriously damage the tanks.)**
 11. Remove the cartridge of the water purifier and leave the purifier valve in the open position.
 12. Remove the batteries from your trailer and store in a cool dry place where there is no danger of freezing. It is very important for optimum life of a battery to check it periodically and to keep it fully charged.
 13. Remove any items (food, cosmetics, etc.) from trailer interior that might be damaged by freezing — or might damage the trailer if containers break.

* Approved and listed by a recognized testing authority such as UL (Underwriter Lab).

For additional winterizing protection add a nontoxic antifreeze (approved for drinking water systems) to the water lines using the following procedure:

1. Reconnect all lines except the hose to the pump inlet port. Close all drain valves (see step No. 3).
2. Attach a length of hose to the pump inlet port. This piece of hose should be long enough for the free end to be inserted into and reach the bottom of the antifreeze container.
3. Dilute the antifreeze solution in accordance with the manufacturer's instructions.
4. Open all water faucets.
5. Insert hose length into the antifreeze container, turn the pump switch on, and run the water pump until the antifreeze solution fills all water lines and the water heater. Flush toilet, work hand spray while holding down in bowl. Work hand shower spray while holding down in tub.
6. Shut off the pump and close all faucets.
7. Disconnect the hose length from pump inlet fitting and reconnect water system inlet line.

Note: If you wish to bypass your water heater in order to cut down on the amount of antifreeze necessary, you may purchase a kit for this purpose from a Wally Byam Store.

Exterior Identification

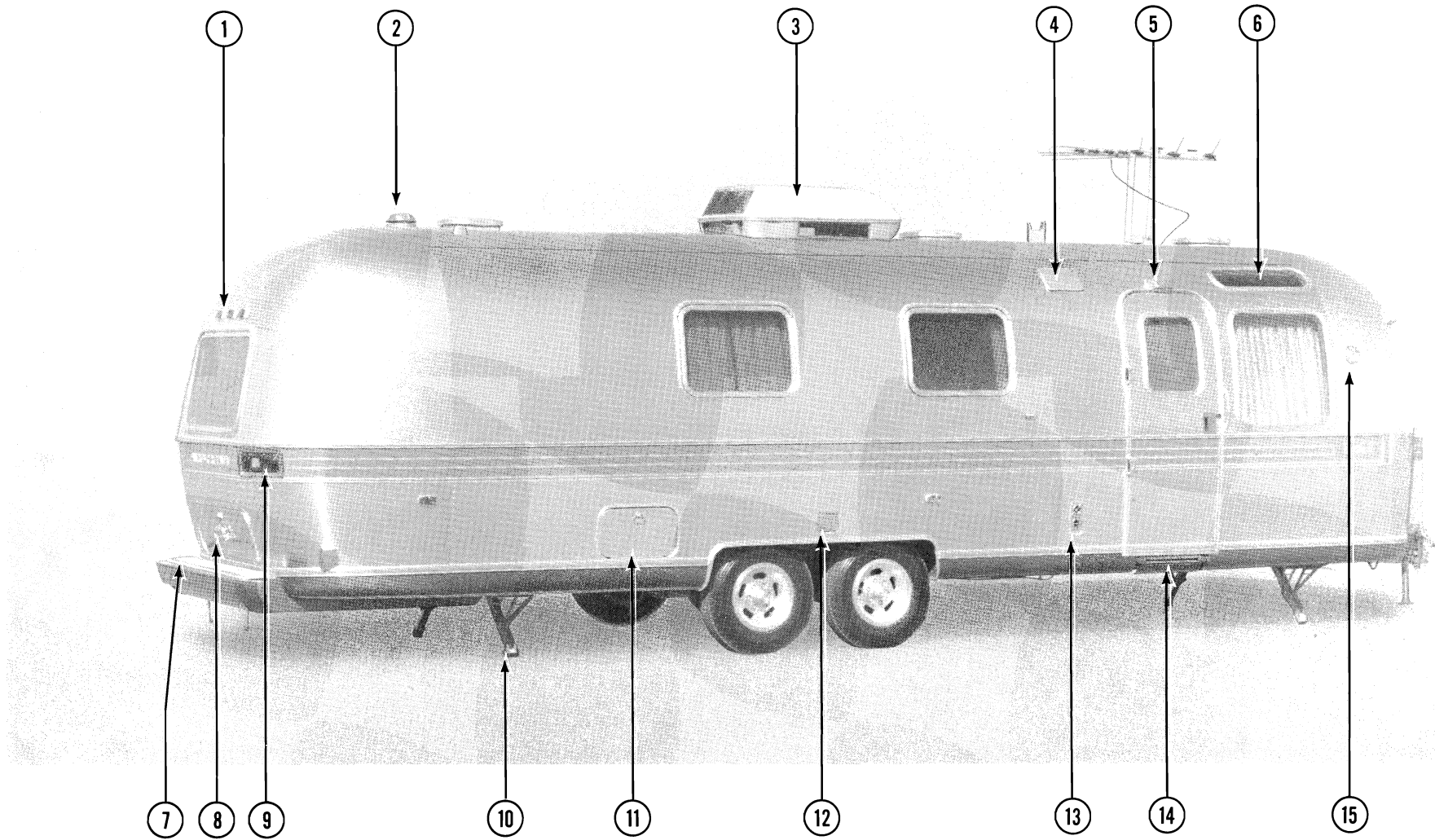

Excella II - Curbside

No.	Description	Page No.
1.	Cluster lights	112
2.	Bathroom exhaust fan	68
3.	Air conditioner (optional)	62-65
4.	Range exhaust vent (optional)	78
5.	Main door light	112
6.	Vista view window (optional)	43
7.	Electrical inlet (city)	33, 89
8.	License plate light	112
9.	Stop, tail, turn, and backing lights	112
10.	B.A.L. stabilizing jacks (optional)	32
11.	Side access door	—
12.	120 volt outlet	89
13.	Furnace vent	79
14.	Main door step	43
15.	Exterior light	112
16.	Electric jack	25
17.	L.P.G. tanks and regulator	69

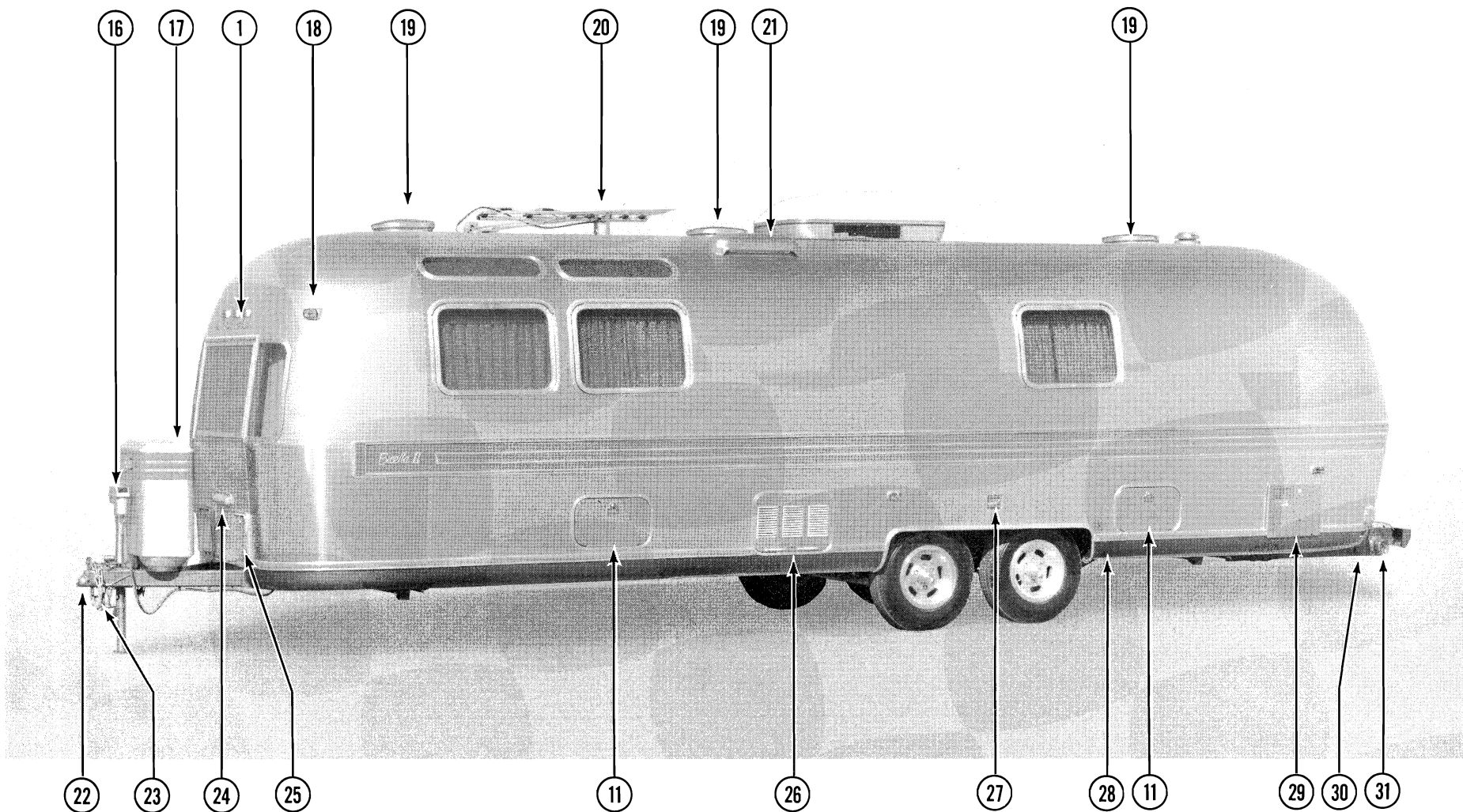

Excella II - Roadside

No.	Description	Page No.
18.	Clearance light	112
19.	Roof vent	66
20.	T.V. antenna (optional)	44
21.	Refrigerator vent	74
22.	Coupler	26
23.	Safety chains	26
24.	Univolt vent	—
25.	Battery compartment	91
26.	Refrigerator access door	71
27.	Water inlet (tank)	83
28.	Waste outlet (center bath)	86
29.	Water heater access panel	82
30.	Water inlet (city)	83
31.	Waste outlet (rear bath)	86

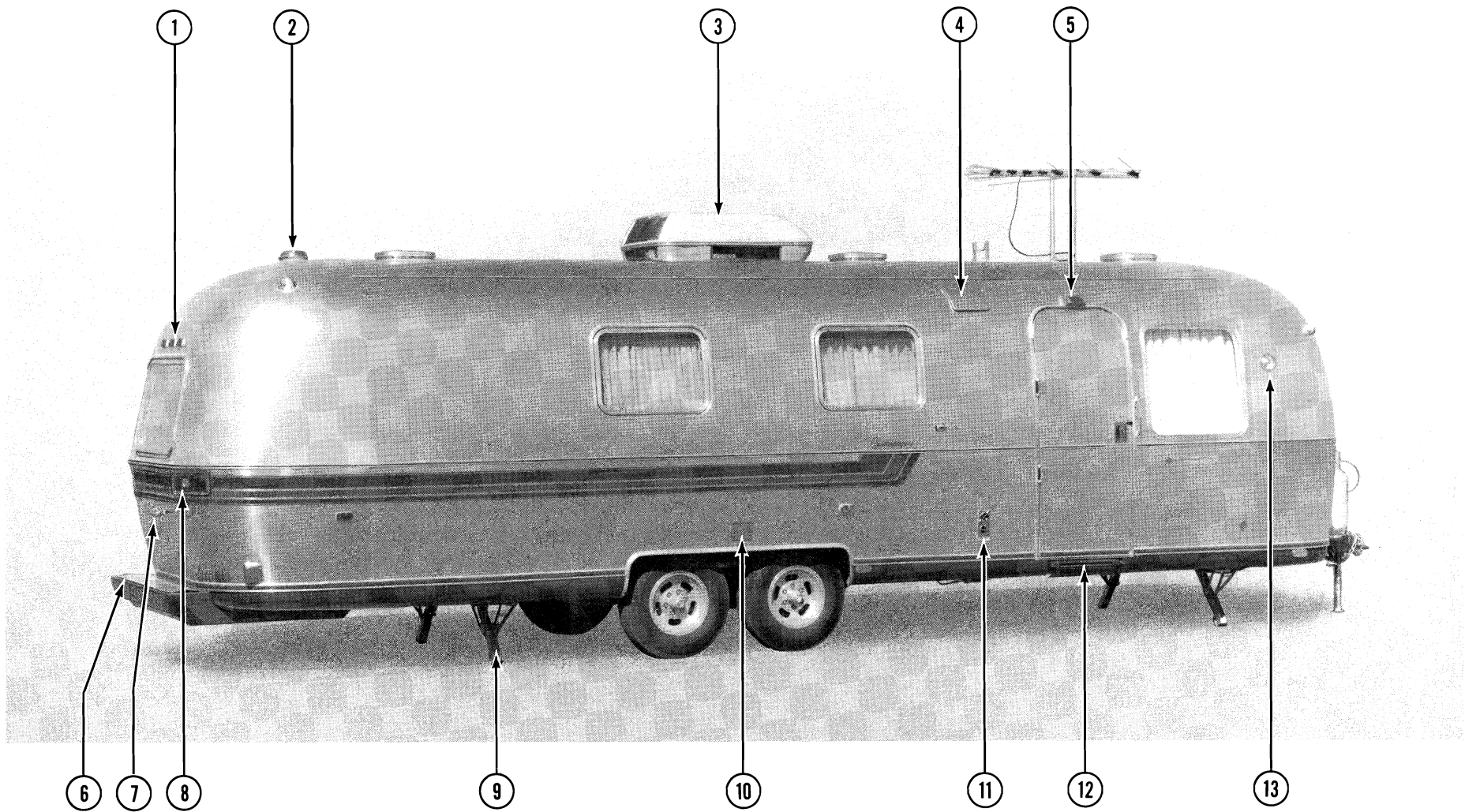

International, Argosy - Curbside

No.	Description	Page No.	No.	Description	Page No.
1.	Cluster lights	112	6.	Electrical inlet (city)	33, 89
2.	Bathroom exhaust fan	68	7.	License plate light	112
3.	Air conditioner (optional)	62-65	8.	Stop, tail, turn, and backing lights	112
4.	Range exhaust vent (optional)	78	9.	B.A.L. stabilizing jacks (optional)	32
5.	Main door light	112	10.	120 volt outlet	89
			11.	Furnace vent	79
			12.	Main door step	43
			13.	Exterior light	112
			14.	Electric jack	25
			15.	L.P.G. tanks and regulator	69
			16.	Clearance light	112
			17.	Roof vent	66

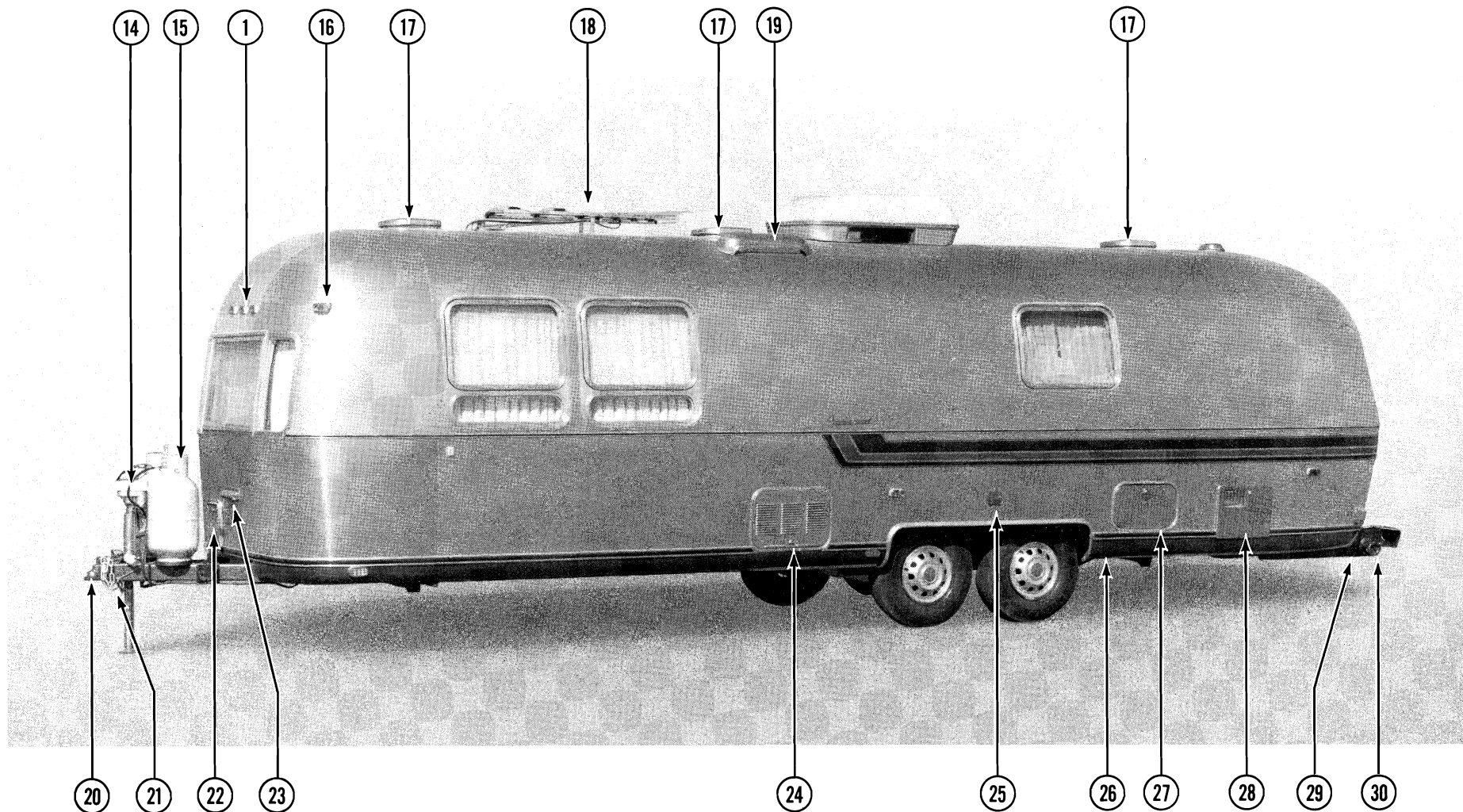

International, Argosy - Roadside

No.	Description	Page No.		Page No.
18.	T.V. antenna (optional)	44	23.	Univolt vent —
19.	Refrigerator vent.	74	24.	Refrigerator access door 71
20.	Coupler	26	25.	Water inlet (tank). 83
21.	Safety chains	26	26.	Waste outlet (center bath). 86
22.	Battery compartment	91	27.	Side access door —
			28.	Water heater access panel 82
			29.	Water inlet (city) 83
			30.	Waste outlet (rear bath). 86

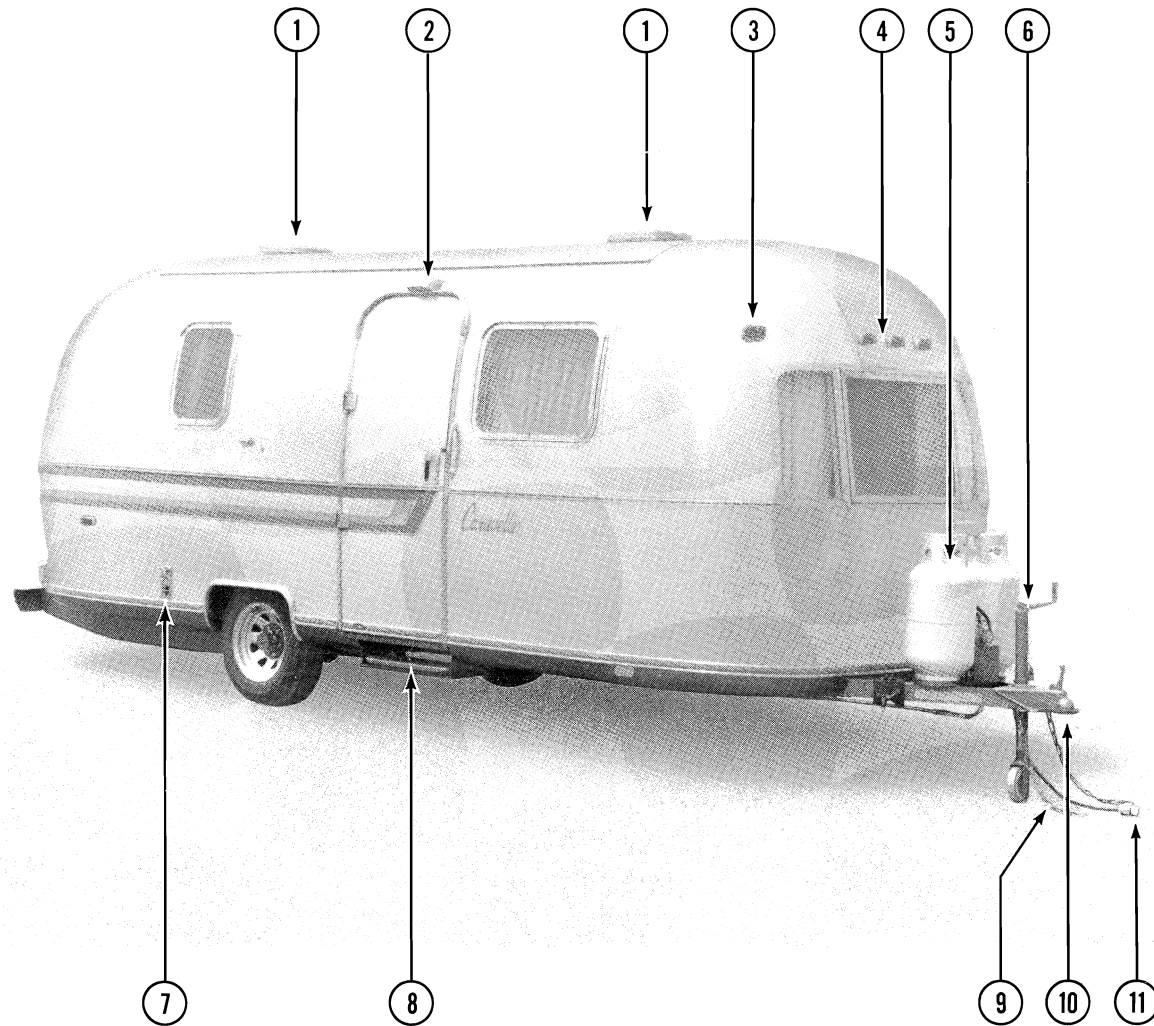

Caravelle, Minuet - Curbside

No.	Description	Page No.			
1.	Roof vent	66	4.	Cluster light	112
2.	Main door light	112	5.	L.P.G. tanks and regulator	69
3.	Clearance light	112	6.	Manual jack	—
			7.	Furnace vent	79
			8.	Main door step	43
			9.	Safety chains	26
			10.	Coupler	26
			11.	Electrical connector - towing	26

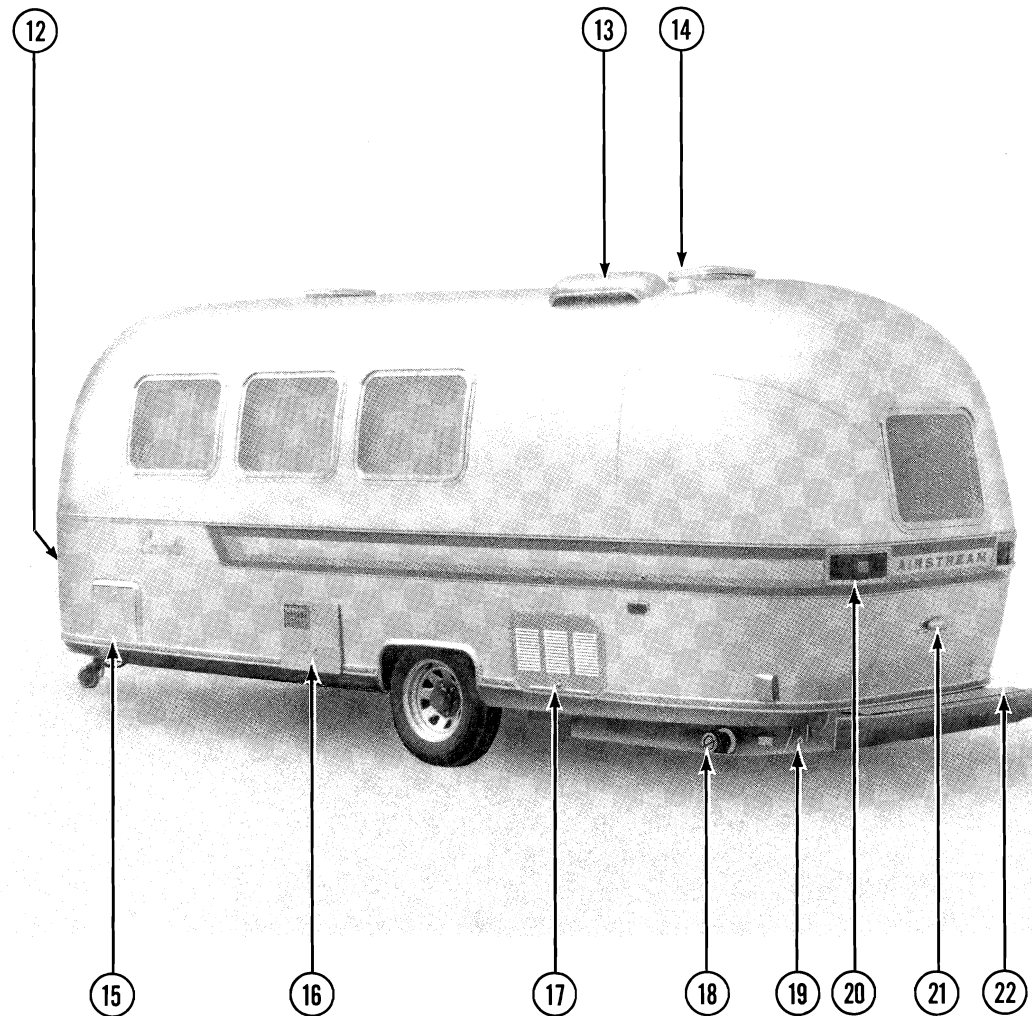

Caravelle, Minuet - Roadside

No.	Description	Page No.
12.	Water inlet (tank)	83
13.	Refrigerator vent	74
14.	Bathroom exhaust fan	68
15.	Battery compartment	91
16.	Water heater access door	82
17.	Refrigerator access door	71
18.	Waste outlet	86
19.	Water inlet (city)	83
20.	Stop, tail, turn, and backing light	112
21.	License plate light	112
22.	Electrical inlet (city)	33, 89

Exterior

The clear Plasticoat finish applied to the outer surfaces of Excella II, International, and Caravelle models has been specifically formulated by Airstream to provide maximum protection for the shiny aluminum surface. The Plasticoat formula includes special plasticizers used to keep the coating flexible so that it can cope with aluminum's high coefficient of expansion. This flexibility, however, results in a surface coat which is of necessity somewhat softer than automotive acrylic lacquer finishes. For this reason, **abrasive polishes or cleaning solvents such as automatic dishwasher detergents or acid etch cleaners are too strong and should never be used.** These same precautions and the following instructions should also be used to clean the enamel finish on all painted models.

Always clean your trailer in the shade or on a cloudy day when the aluminum skin is cool. Oil, grease, dust and dirt may be removed by washing with any mild nonabrasive soap or detergent. Cleaning should be followed by a thorough clean water rinse. Spots and streaks may be prevented by drying the unit with a chamois or a soft cloth. **When washing or polishing your trailer, always wipe "with" the grain of the metal.**

After cleaning and drying, a good grade of nonabrasive automotive paste or liquid wax will increase the life of the finish, especially in coastal areas where the finish is exposed to salt air or in polluted industrial areas. It will also protect the shell from minor scratches and make subsequent cleaning easier. Wax should normally be applied every three to six months.

The first application should not be sooner than 90 days after purchase to allow acrylic finish to cure.

It is important to remove sap, seeds, gum, resin, asphalt, etc., as soon as possible after they appear by washing and rewaxing. Sunlight and time will bake-harden these materials making them almost impossible to remove without heavy buffing. If asphalt remains on the trailer after washing, use a small amount of kerosene on a rag and wipe the spots individually, being careful not to scratch the finish.

For small areas of damage to the plasticoat finish, or where oxidation is beginning to occur, remove all traces of the coating with a good grade of lacquer solvent and then thoroughly clean the aluminum with an aluminum cleaner. Respray the area with clear plasticoat lacquer.

All items needed for these minor repairs to the exterior shell are available at Wally Byam Stores. For extensive refinishing we recommend that you contact an Airstream/Argosy Dealer Certified Service Center or Caravan Service Center. Small areas of damage to the enamel finish on painted models can be retouched with aerosol spray paint in the matching colors. Spray paint is available through your local Airstream/Argosy dealer.

To keep your trailer looking new, paint the "A" frame, L.P.G. tanks, and rear frame periodically.

It is recommended that the caulking and sealant used in external seams and joints such as end shell segments and around window frames, light bezels, beltline and rubrail molding, etc., be checked regularly. If this material has dried out and becomes cracked or checked, or if a portion has fallen out, it should be replaced with fresh material to prevent possible rain leaks. Caulking and sealing material is available from your Airstream/Argosy dealer.

Each time you connect the **7-way electrical connector** check for dirt and corrosion. Keep the contacts clean with "Spra-Kleen."

It is important that the main door be completely closed and locked during towing. If it is not locked, the constant vibration of travel may cause it to open with possible damage.

For your security the lock has been designed as a dead bolt. For this reason never try to shut the door when the striker is in the locked position. The door is properly closed when the handle is firm. If the door is difficult to open, push in to release the latch. When the door swings fully open it will automatically latch against the side of the trailer.

The **screen door** secures to the main door by means of a slide bolt type latch. It can be operated independently by releasing the slide bolt and swinging the screen door away from the main door. A second slide bolt is provided to secure the screen door to the frame when closed.

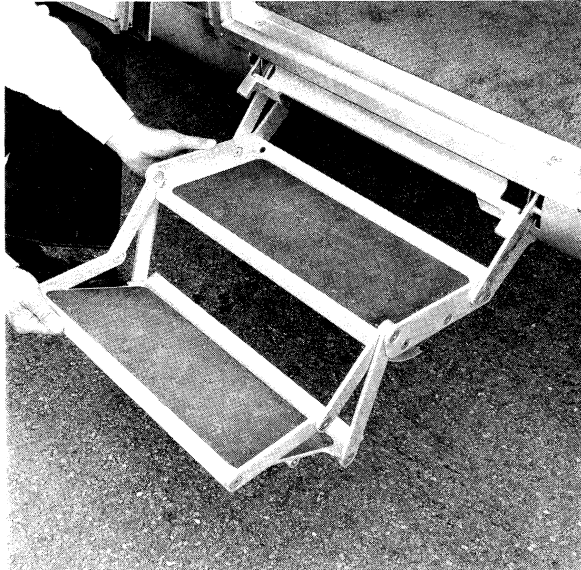

Fig. 1 - Fold-Away Step

To operate the **fold-away step** used on 25', 28', and 31' models (See Fig. 1) just press down on either side of the latch bar and the step will automatically drop into position. To stow the step simply lift the front edge and then push it up under the trailer to its stowed position.

The optional **extension step** available with fold away step (See Fig. 1) is permanently attached to the main step and when needed it is simply flipped out. To operate the step installed on all 20', 22', and 24' models, simply grasp the front edge, lift up and pull the step toward you until it stops.

Never travel with step lowered or extended.



Fig. 2 - Caravelle/Minuet Step

The **exterior windows** in your trailer are of heat strengthened safety plate glass. The standard windows are single pane clear glass. **Dual pane windows and those tinted a solar gray are optional on some models.** To open swing out windows, release the two lever locks at the bottom, pull the two side operator handles toward the center and pull down until the window is in the desired position (See Fig. 3) then place the operators into one of the five positioning recesses in the frame. To close: pull the two side operator handles toward the center and slowly lift until window is closed. To secure, turn the two lock handles until the lock pawls are in the vertical position, then press the handles downward as far as they will go. Clean your trailer windows the same way you clean the windows in your house. Clean the seals with a damp cloth or mild detergent every three



Fig. 3 - Window Operation

to six months taking care not to use strong solvents as they will damage the seals. A coat of natural silicone lubricant applied after the seal has dried will keep it flexible. Spread the lubricant evenly with a brush or finger, working it into the surface. This is a good practice for all rubber seals in your trailer. For replacement of a damaged window contact an Airstream/Argosy Dealer Certified Service Center or Caravan Service Center.

Your plastic **screens** are easy to maintain. Just clean occasionally with a damp cloth.

Note: They will melt at the point of contact if touched by a cigarette.

Vista view windows, optional on some models, allow for interior lighting while maintaining privacy. They are equipped with integral shades.

Optional **awnings** give shade during trips and rallies. They are easy to operate and can be installed by your dealer.

The aluminum construction of your trailer creates a radio-shield and you will need outside antennas for good reception. This can be accomplished by a whip radio antenna or T.V. antenna with an auto coupler.

The **auto coupler** (optional) enables you to utilize your T.V. antenna for AM-FM radio reception.

A telescoping whip radio antenna (optional) is available for the optional 12-volt AM-FM radio and should be professionally installed next to the front window roadside of your trailer on a swivel mount.

The controls for the optional **T.V. antenna** are in the ceiling directly below the antenna. To raise the antenna, turn hand crank clockwise until it stops. Then turn on T.V. set and select channel. While watching picture, reverse the handle approximately 1/2 turn, push handle up toward the ceiling, hold in that position and rotate antenna. If you hit a stop in rotation before the picture is clear, reverse rotation. You may have to readjust when changing channels. To close, reverse the direction of cranking. Before traveling, check outside that the antenna is folded and pointed straight forward.

The optional **motorized T.V. antenna** has a control panel located on the curbside wall just forward of fixed window. A two position rocker type switch is pushed, the antenna raises to the full "up" position then starts to turn in a

clockwise direction. When the strongest signal point is reached, antenna rotation is stopped by pushing the bottom portion of the switch rocker to bring it to the center or "off" position. Counter clockwise rotation and antenna lowering are accomplished by pushing the rocker bottom portion all the way in. A green light on the switch panel indicates when antenna is in motion. The antenna must be fully stowed to travel.

Floor Plans

20 Ft. - Caravelle, Minuet

No.	Description	Page No.
1.	Water inlet-city	83
2.	120 volt circuit breaker panel	90
3.	Waste outlet	86
4.	Water heater	82
5.	Air conditioner (optional)	62-65
6.	Water pump	83
7.	Battery	91
8.	12 volt distribution panel	106
9.	Univolt	89
10.	Water inlet-tank	83
11.	Electrical inlet-city	89
12.	Toilet	87-88
13.	Range exhaust hood (optional)	78
14.	Furnace	79
15.	Range and oven	77
16.	Sink	65
17.	Refrigerator	71
18.	Monitor II control panel (optional)	108
19.	Table	58
20.	L.P.G. tanks and regulator	69
21.	Hitch	25

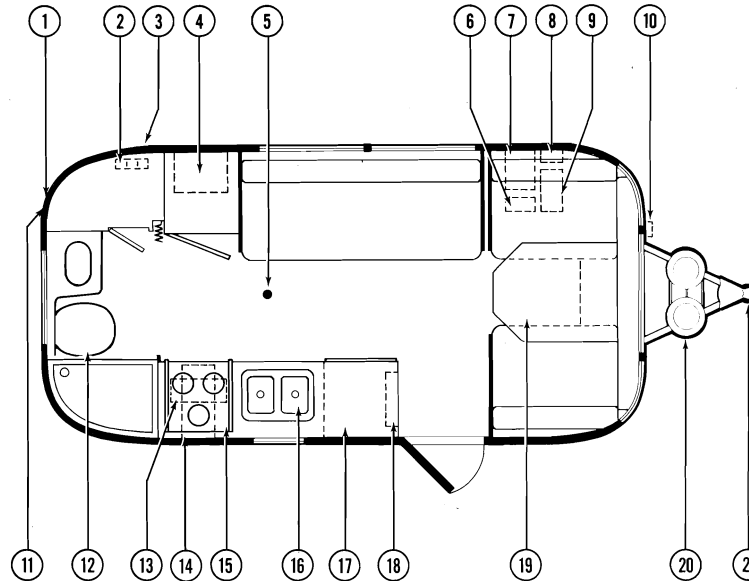

22 Ft. - Caravelle, Minuet

No.	Description	Page No.
1.	Water inlet-city	83
2.	120 volt circuit breaker panel	90
3.	Waste outlet	86
4.	Refrigerator	71
5.	Air conditioner (optional)	62-65
6.	Water heater	82
7.	Univolt	89
8.	Battery	91
9.	12 volt distribution panel	106
10.	Water pump	83
11.	Water inlet-tank	83
12.	Electrical inlet-city	89
13.	Toilet	87-88
14.	Furnace	79
15.	Sink	65
16.	Range exhaust hood (optional)	78
17.	Range and oven	77
18.	Monitor II control panel (optional)	108
19.	Table	58
20.	L.P.G. tanks and regulator	69
21.	Hitch	25

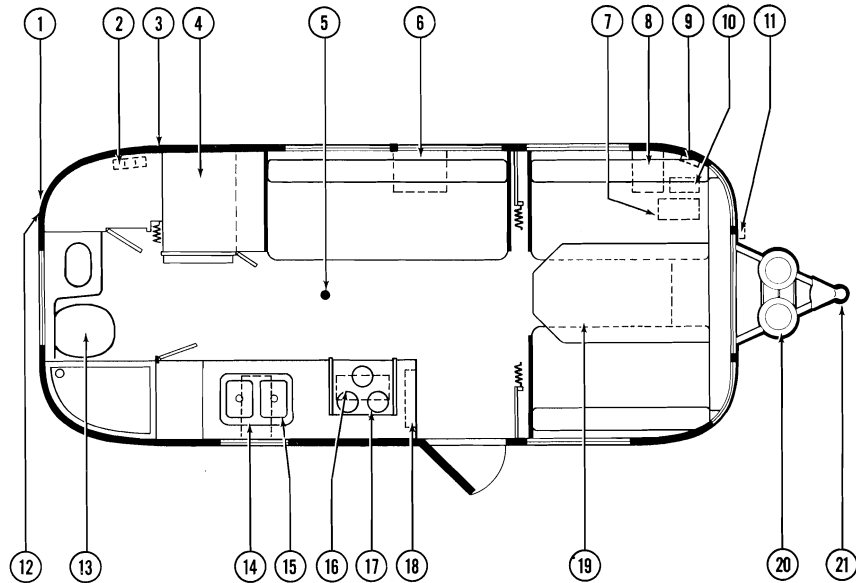

24 Ft. Twin and Double - Caravelle, Minuet

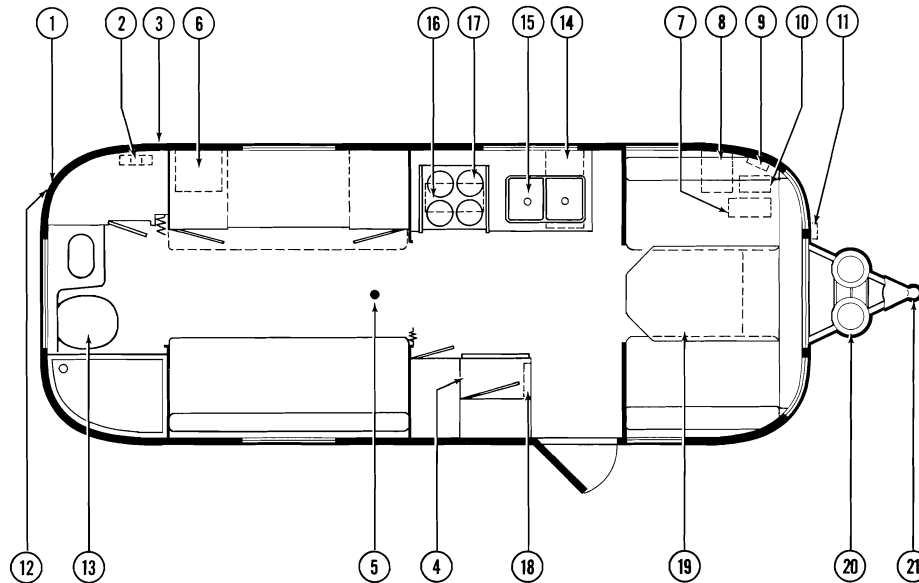

No.	Description	Page No.
1.	Waste outlet	86
2.	Water inlet-city	83
3.	Water pump	83
4.	Water heater	82
5.	Bed light	66
6.	Water inlet-tank	83
7.	Range and oven	77
8.	Water filter	84
9.	Sink	65
10.	Furnace	79
11.	Stereo AM/FM radio/tape (optional)	61
12.	Front lounge	57
13.	Battery	91
14.	Univolt	89
15.	12 volt distribution panel	107
16.	Electrical inlet-city	89
17.	120 volt circuit breaker panel	90
18.	Toilet	87-88
19.	Air conditioner (optional)	62-65
20.	Central control panel w/clock (optional)	109
21.	Refrigerator	71
22.	Table	58
23.	Power brake booster (optional)	10
24.	L.P.G. tanks and regulator	69
25.	Hitch	25

25 Ft. Twin (Rear Bath) - Excella II

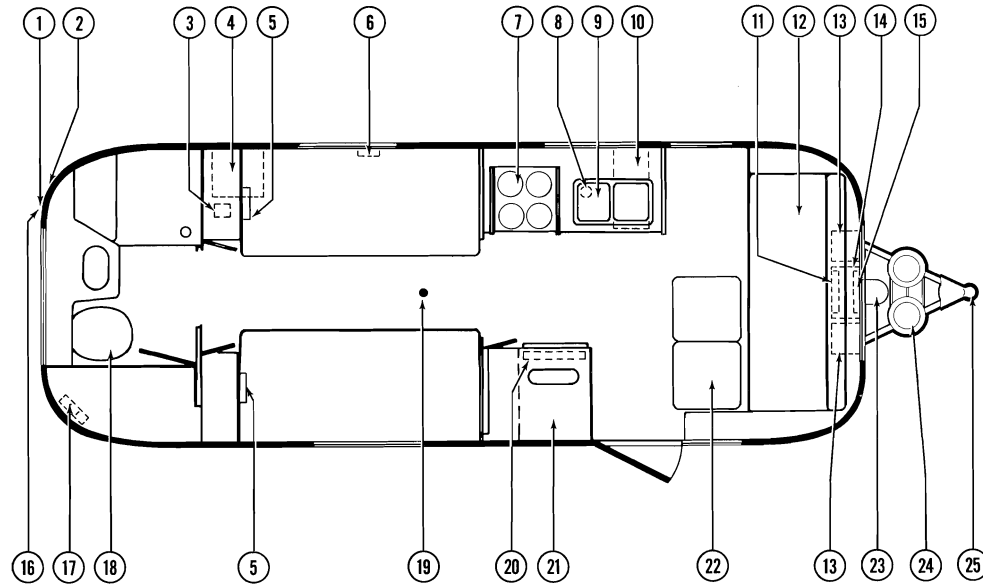

25 Ft. Double (Rear Bath) - Excella II

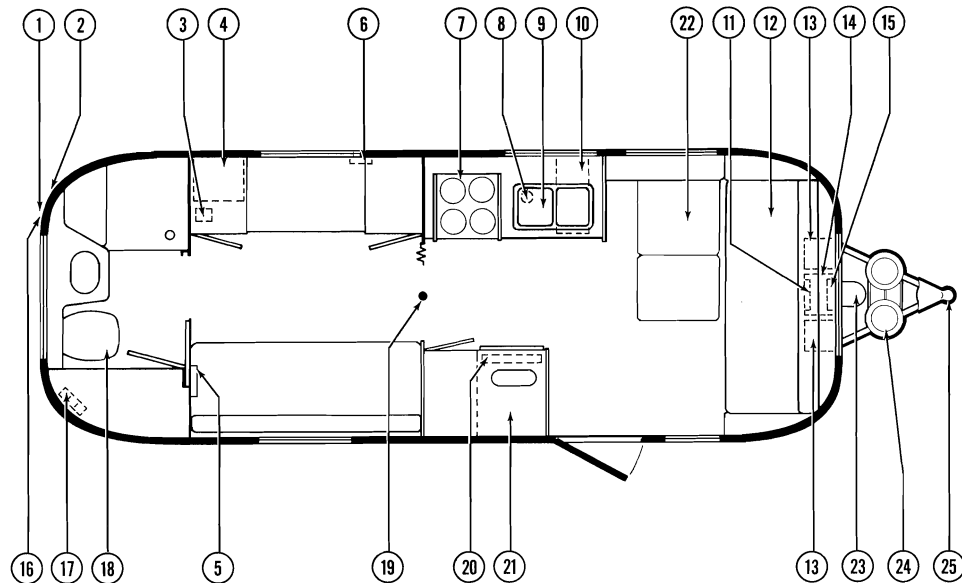

28 Ft. Twin (Rear Bath) - Excella II

No. Description	Page No.
1. Electrical inlet-city	89
2. Waste outlet	86
3. Water inlet-city	83
4. Toilet	87-88
5. Water heater	82
6. Water pump	83
7. Bed light	66
8. Water inlet-tank	83
9. Central control panel w/clock (optional)	109
10. Refrigerator	71
11. Front Lounge	57
12. Table	58
13. Univolt	89
14. Stereo AM/FM radio/tape (optional) .	61
15. Battery	91
16. 12 volt distribution panel	107
17. 120 volt circuit breaker panel	90
18. Air conditioner (optional)	62-65
19. Sink	65
20. Water filter	84
21. Range and oven	77
22. Furnace	79
23. Power brake booster (optional)	10
24. L.P.G. tanks and regulator	69
25. Hitch	25

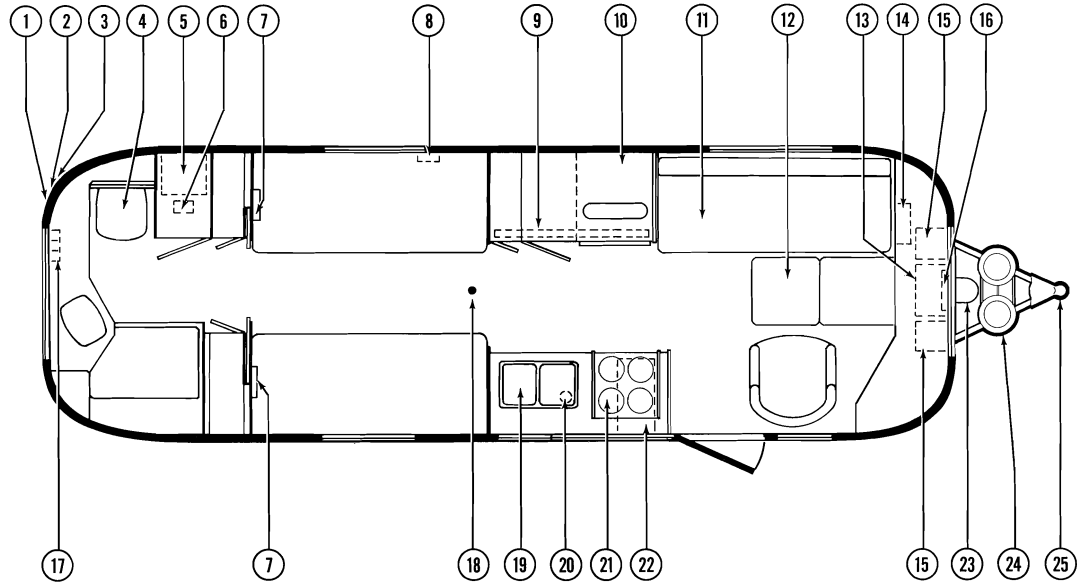

28 Ft. Double (Rear Bath) - Excella II

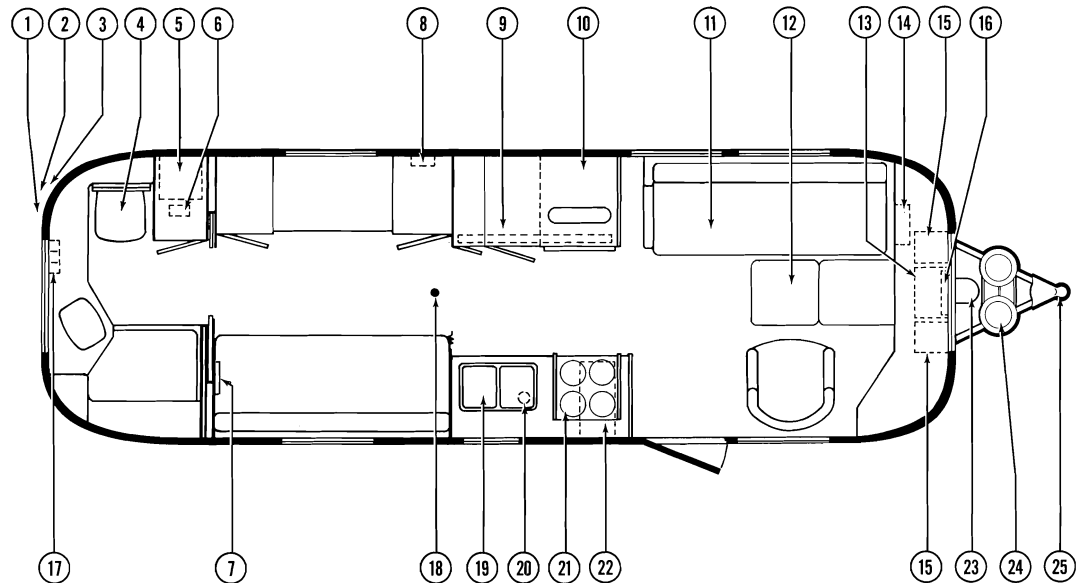

No.	Description	Page No.
1.	Electrical inlet-city	89
2.	Water inlet-city	83
3.	120 volt circuit breaker panel	90
4.	Waste outlet	86
5.	Water pump	83
6.	Water inlet-tank	83
7.	Central control panel w/clock (optional)	109
8.	Refrigerator	71
9.	Front Lounge	57
10.	Table	58
11.	Univolt	89
12.	Stereo AM/FM radio/tape (optional)	61
13.	Battery	91
14.	12 volt distribution panel	107
15.	Toilet	87-88
16.	Water heater	82
17.	Air conditioner (optional)	62-65
18.	Sink	65
19.	Water filter	84
20.	Range and oven	77
21.	Furnace	79
22.	Power brake booster (optional)	10
23.	L.P.G. tanks and regulator	69
24.	Hitch	25

31 Ft. Twin (Center Bath) - Excella II

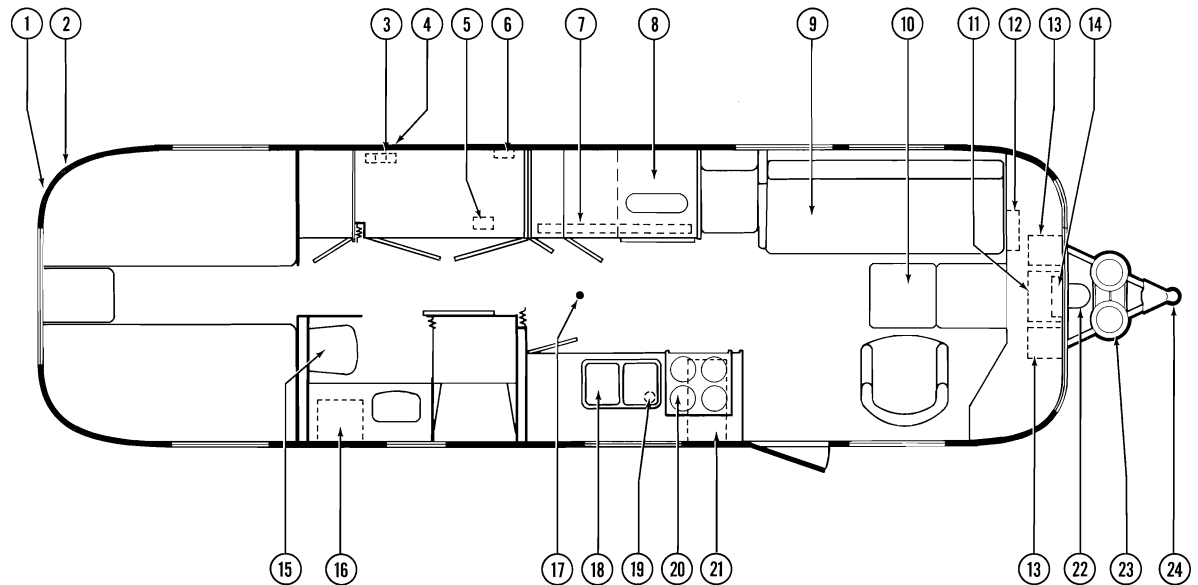

31 Ft. Double (Center Bath) - Excella II

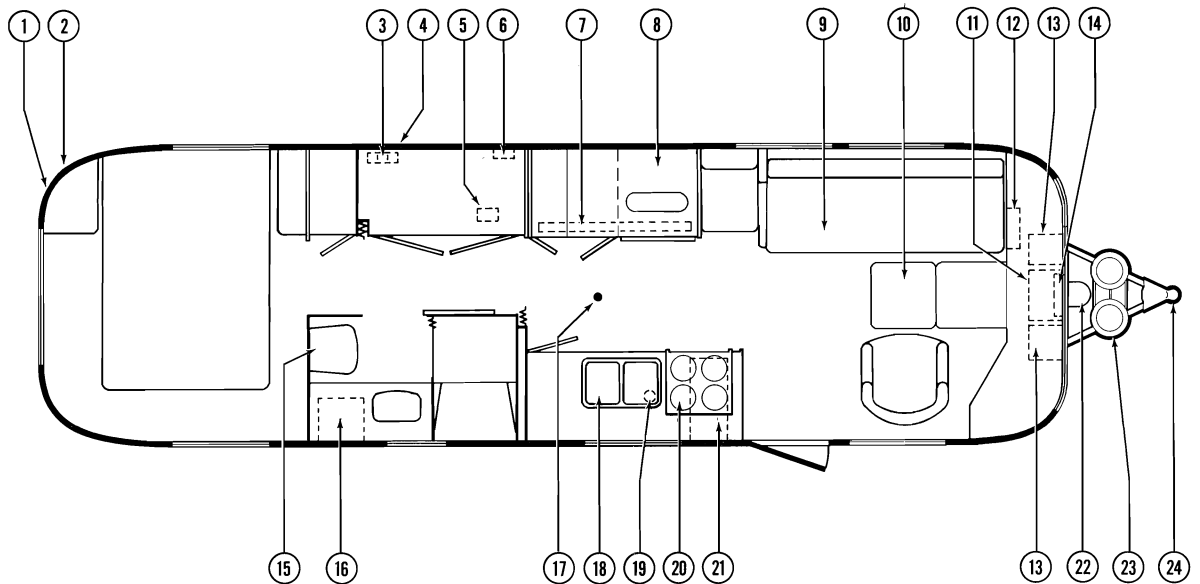

31 Ft. Twin and Double (Rear Bath) - Excella II

No.	Description	Page No.
1.	Waste outlet	86
2.	Electrical inlet-city	89
3.	Water inlet-city	83
4.	Toilet	87-88
5.	Water heater	82
6.	Water pump	83
7.	Bed light	66
8.	Water inlet-tank	83
9.	Central control panel w/clock (optional)	109
10.	Refrigerator	71
11.	Front Lounge	57
12.	Table	58
13.	Univolt	89
14.	Stereo AM/FM radio/tape (optional)	61
15.	Battery	91
16.	12 volt distribution panel	107
17.	120 volt circuit breaker panel	90
18.	Air conditioner (optional)	62-65
19.	Sink	65
20.	Water filter	84
21.	Range and oven	77
22.	Furnace	79
23.	Power brake booster (optional)	10
24.	L.P.G. tanks and regulator	69
25.	Hitch	25

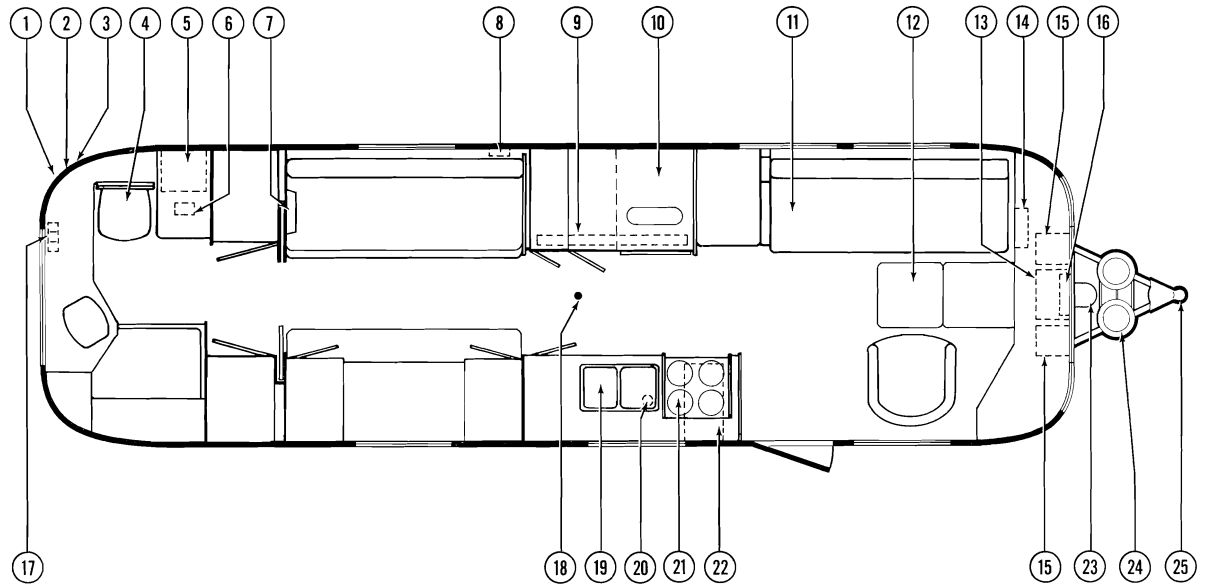

No.	Description	Page No.
1.	Waste outlet	86
2.	Water inlet-city	83
3.	Water pump	83
4.	Water heater	82
5.	Bed light	66
6.	Water inlet-tank	83
7.	Range and oven	77
8.	Water filter (optional)	84
9.	Sink	65
10.	Furnace	79
11.	Stereo AM/FM radio/tape (optional)	61
12.	Front Lounge	57
13.	Battery	91
14.	Univolt	89
15.	12 volt distribution panel	107
16.	Electrical inlet-city	89
17.	120 volt circuit breaker panel	90
18.	Toilet	87-88
19.	Air conditioner (optional)	62-65
20.	Central control panel (optional)	109
21.	Refrigerator	71
22.	Table	58
23.	Digital clock (optional)	60
24.	Power brake booster (optional)	10
25.	L.P.G. tanks and regulator	69
26.	Hitch	25

25 Ft. Twin (Rear Bath) - International, Argosy

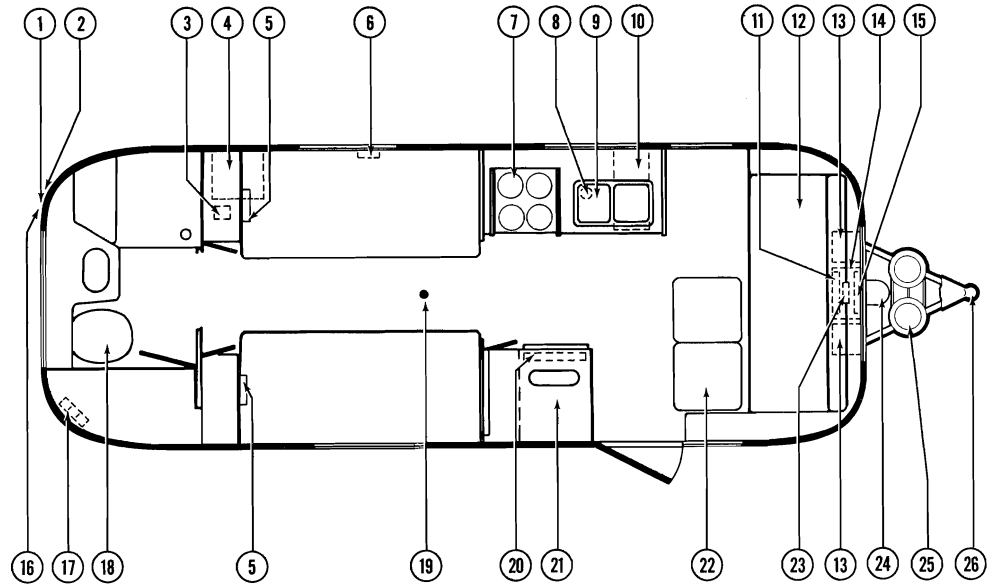

25 Ft. Double (Rear Bath) - International, Argosy

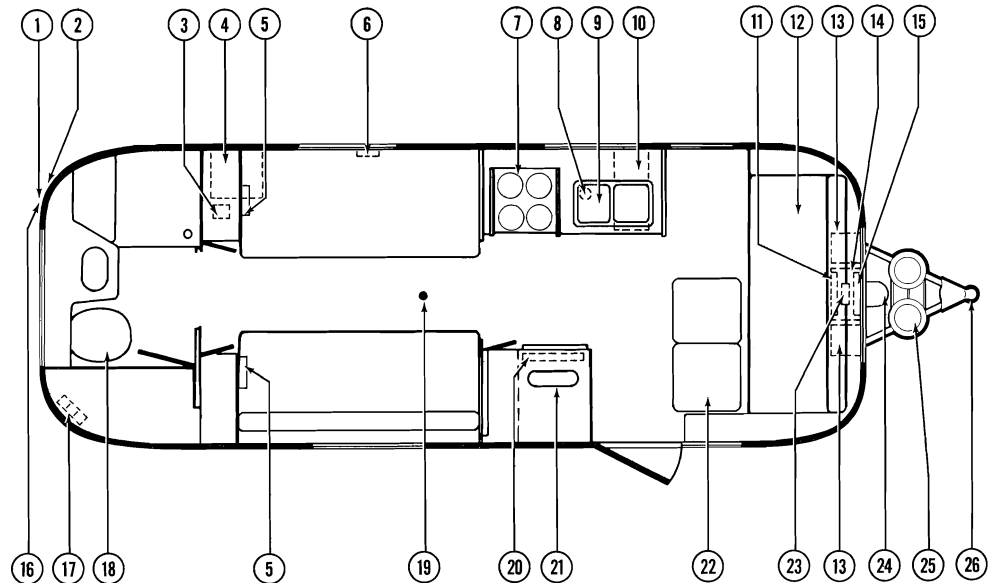

No.	Description	Page No.
1.	Electrical inlet-city	89
2.	Waste outlet	86
3.	Water inlet-city	83
4.	Water pump	83
5.	Water heater	82
6.	Bed light	66
7.	Water inlet-tank	83
8.	Central control panel (optional)	109
9.	Refrigerator	71
10.	Front Lounge	57
11.	Table	58
12.	Univolt	89
13.	Stereo AM/FM radio/tape (optional)	61
14.	Battery	91
15.	12 volt distribution panel	107
16.	120 volt circuit breaker panel	90
17.	Toilet	87-88
18.	Air conditioner (optional)	62-65
19.	Sink	65
20.	Water filter (optional)	84
21.	Range and oven	77
22.	Furnace	79
23.	Digital clock (optional)	60
24.	Power brake booster (optional)	10
25.	L.P.G. tanks and regulator	69
26.	Hitch	25

28 Ft. Twin and Double (Rear Bath) - International, Argosy

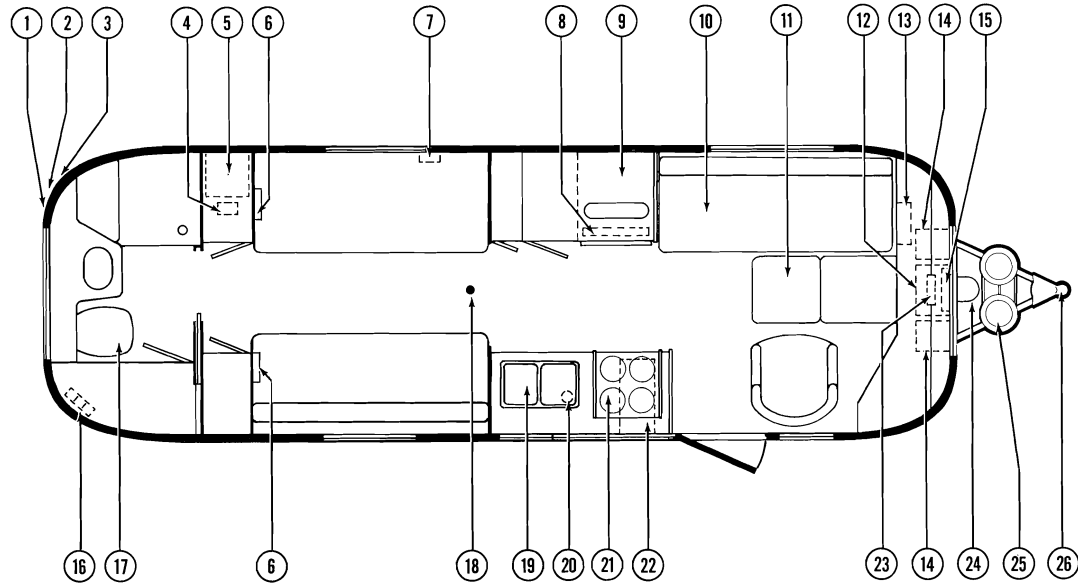

31 Ft. Twin and Double (Rear Bath) - International, Argosy

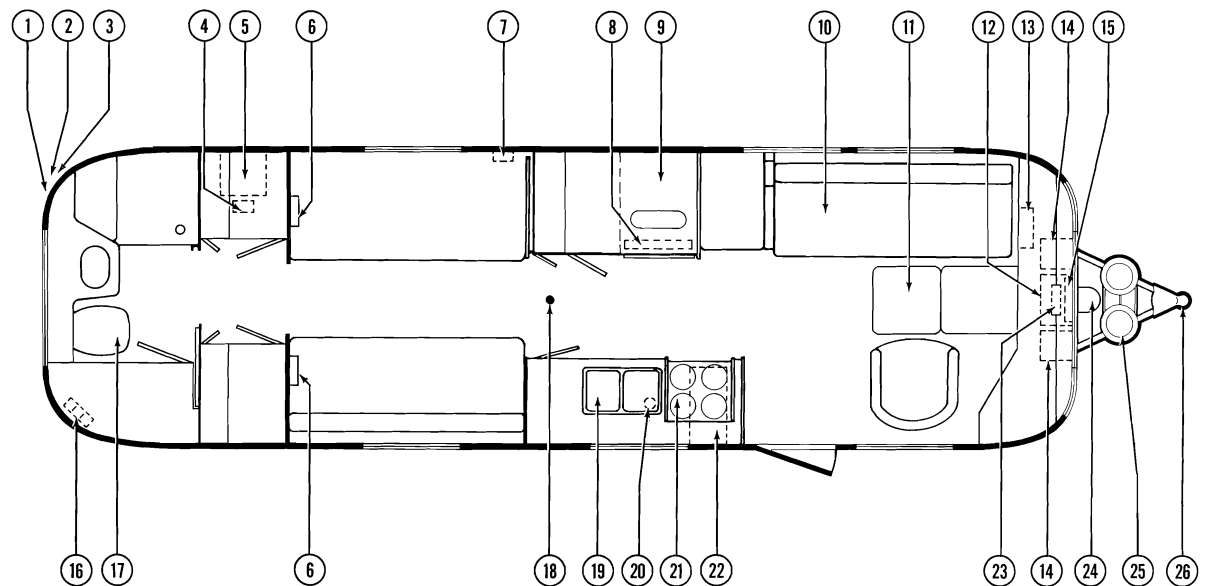

No.	Description	Page No.
1.	Electrical inlet-city	89
2.	Water inlet-city	83
3.	120 volt circuit breaker panel	90
4.	Waste outlet	86
5.	Water pump	83
6.	Water inlet-tank	83
7.	Central control panel (optional)	109
8.	Refrigerator	71
9.	Front Lounge	57
10.	Table	58
11.	Univolt	89
12.	Stereo AM/FM radio/tape (optional)	61
13.	Battery	91
14.	12 volt distribution panel	107
15.	Toilet	87-88
16.	Water heater	82
17.	Air conditioner (optional)	62-65
18.	Sink	65
19.	Water filter (optional)	84
20.	Range and oven	77
21.	Furnace	79
22.	Digital clock (optional)	60
23.	Power brake booster (optional)	10
24.	L.P.G. tanks and regulator	69
25.	Hitch	25

31 Ft. Twin (Center Bath) - International, Argosy

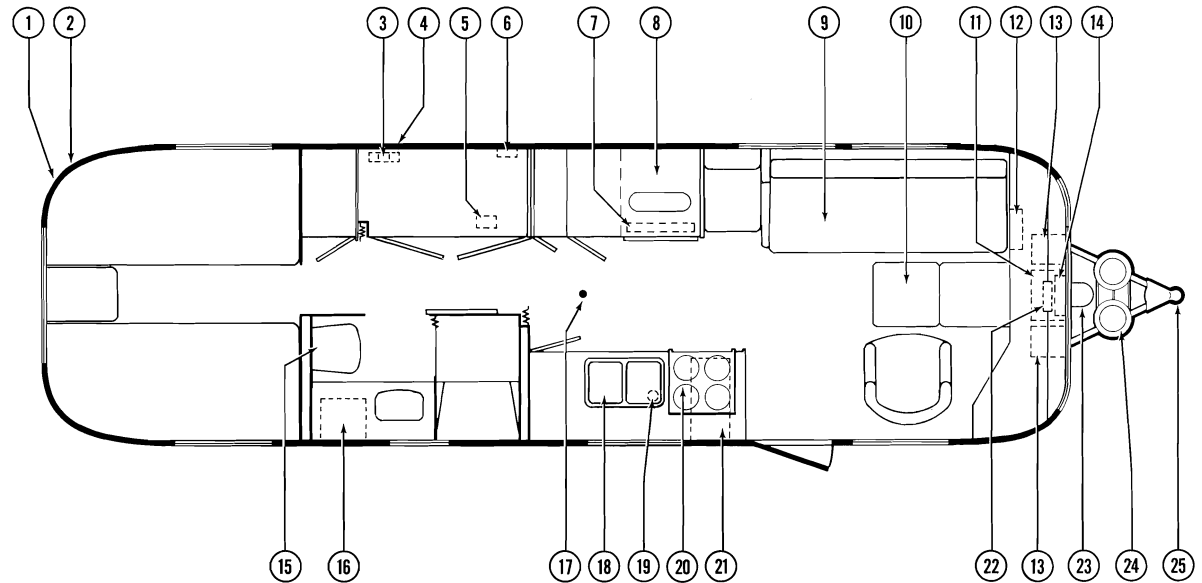

31 Ft. Double (Center Bath) - International, Argosy

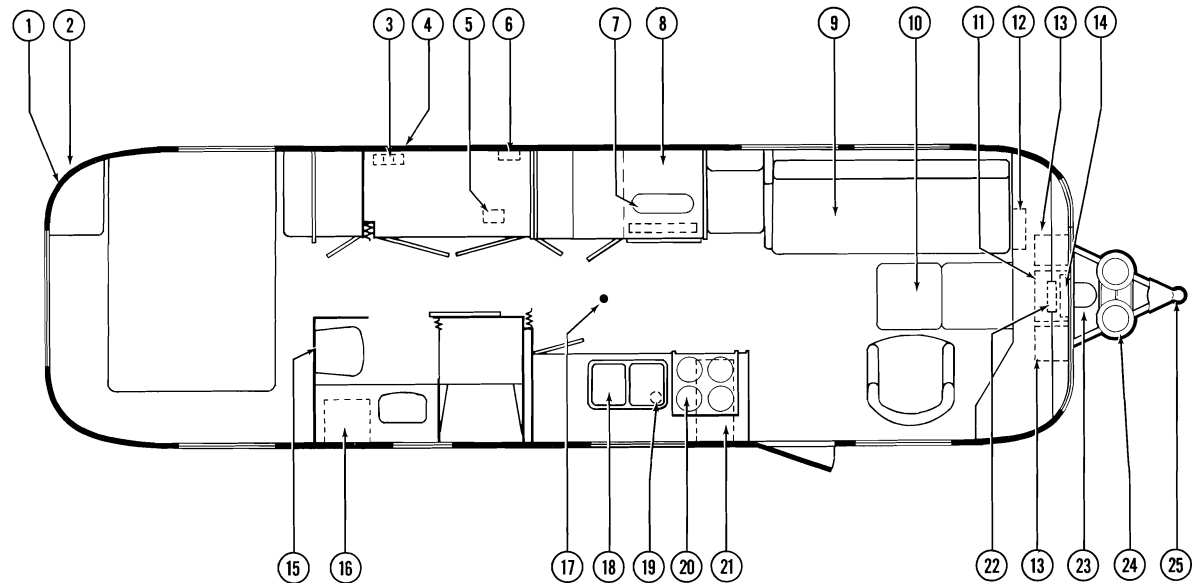

Interior

The interior of all Airstream/Argosy trailers has been designed for comfort, convenience, durability and appearance. How you use it and how you take care of it naturally depends on you. However, if you learn to operate the interior components and take care of them and the trailer properly, this knowledge will add to your pleasure as well as the long life of your trailer.

Following is a list of upholstery materials used in 1980 Airstream/Argosy trailers. All materials should be professionally dry cleaned to remove any overall soiled condition. These materials may be spot cleaned, however, using the cleanability code instructions as listed.

Fabric Name	Cleaning Code
Whitney Aqua	WS
Tristan Copen	WS
Wagner Navy	WS
Milwaukee Cream	W
Donegal Bronze	W
Chapman Parsley	W
Chapman Canyon	W
Wicker Green	W
Husky Cork	WS
Amherst Teal	W
Whitney Celedon	WS
Veronica Brass	S
Ny-Crest Fawn	S
Kenilworth Navy	WS
Ventura Henna	WS
Casablanca R	S
Ultra/R	S
Trafalgar Hearth	WS
Racine Optical	S
Racine Hunter	S
Racine Brick	S



Cleanability Codes

Code W-S

Fabric Care. Spot clean this fabric either with a mild solvent or a water-based cleaning agent. When using a solvent or dry cleaning product follow instructions carefully and clean only in a well ventilated room. Avoid any product which contains highly toxic carbon tetrachloride. You may also use an upholstery shampoo product or the foam from a mild detergent. With either method, pre-test small area before proceeding. Use a professional furniture cleaner when an overall soiled condition is reached.

Code S

Fabric Care. Spot clean, using a mild, water-free solvent or dry cleaning product. Carefully follow instructions on such product. Clean only in a well-ventilated room. Avoid any product containing carbon tetrachloride which is highly toxic. Pre-test small area before proceeding. Use a professional furniture cleaner when an overall soiled condition is reached.

Code W

Fabric Care. Spot clean, using the foam only from a water-based cleaning agent, such as mild detergent or non-solvent upholstery shampoo product. Apply foam with a soft brush in a circular motion. Vacuum when dry. Pre-test small area before proceeding. Use a professional furniture cleaner when an overall soiled condition is reached. The above code was designed by the manufacturer of the fabric.

CAUTION: Never remove cushion cover for separate dry-cleaning or washing. Any tumble cleaning method can destroy the backing, shrink or otherwise damage upholstery fabric.

Smoking Warning

Keep your furniture and family safe from fires caused by careless smoking. Do not smoke when drowsy. Remove immediately any flowing ash or a lighted cigarette which falls on furniture.

Smoldering smoking material can cause upholstered furniture fires.

All drapery materials and mattress covers must be professionally dry cleaned.

Use the following procedure to remove drapery panels for cleaning.

1. Front lounge, both roadside and curbside — unsnap the dot fasteners holding the lower and the upper front and rear corners to the outer wall. Slide drapery panels to the rear until they are completely free of both tracks.
2. Front wrap around drapes — first remove rearmost lounge panels; see step 1 above. Unsnap dot fastener holding the corners of the curbside and roadside wraparound panels to the outer trailer walls. Slide the drapery panels to the rear until they are completely free of upper tracks. Continue to slide to the rear until they are also free of lower tracks.
3. Side bedroom windows, both roadside and curbside - unsnap the dot fasteners holding the lower and upper front and rear corner to

the outer wall. Remove drapery panels by sliding them clear of both upper and lower track.

On some models the dot fastener may be held to the end of the track with a screw and must be removed before removing drapes. After replacing drapes, reinstall any dot fasteners which have been removed.

The carpet can be cleaned with any good commercial carpet cleaner, or with a detergent and water. **Be careful not to soak the carpet with water, however.**

The counter areas around the sink are of a high-pressure laminate and can be cleaned with soap and water, or you can use a common cleaning solvent on tough spots. Be sure no abrasive cleaner is used as there is the possibility it could scratch the surface. A protective pad should always be placed under hot utensils.

The walls can be cleaned with any vinyl cleaner or with any mild household detergent and water. But, again, no abrasives.

The high-pressure laminate wood of the wardrobes and cabinets may be waxed, if desired, or may be cleaned simply with a damp cloth.

See the bathroom section for cleaning and maintenance suggestions for the ABS plastic surfaces.



Fig. 1 - Lounge Into Bed

To convert the lounge into a bed, grasp the front edge of the seat, (See Fig. 1), lift up slightly and pull lounge assembly out until it stops and the lounge back is in a horizontal position. (See Fig. 2). Place bolster filler strip in position between lounge back and trailer wall (See Fig. 3) (not necessary with 5th Avenue Lounge).

To return bed to lounge position, remove bolster strip, push lounge back toward wall until seat back is in upright position. Pull seat back forward to provide access, and store bolster strip behind.

An optional **space locker** attached to the roof lockers is available for additional storage space for bedding, etc. in the bedroom.



Fig. 2

All the cabinet drawers are removable allowing you storage flexibility and ease of packing and unpacking. Wardrobe catches are self-locking.

When attaching wall hung improvements, like hooks for clothing, bookshelves and extra towel racks, secure with half-inch No. 8 sheet metal screws ~~(#444)~~ with flat binder heads, make holes in the aluminum inner walls with a small drill bit (No. 30).

The **bunk beds** (optional), located in the bedroom, serve as the back bolster for the bed when not in use. In order to place bunk into sleeping position:

1. Depress latch located on the center back side of the bolster.

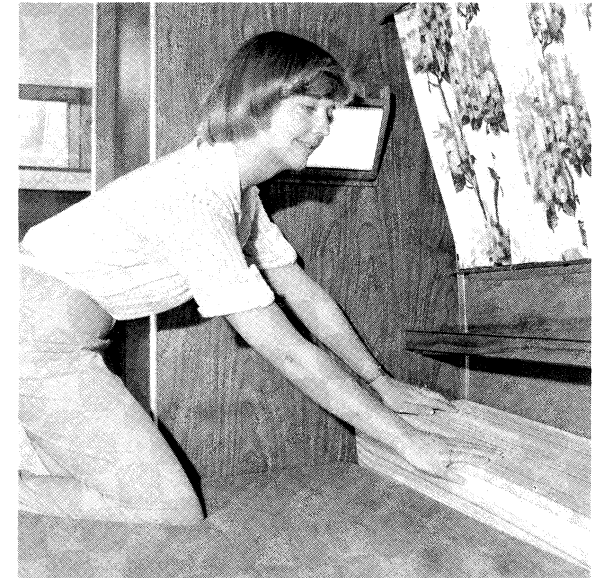

Fig. 3

2. With latch depressed pull on on fabric loop located on the center front bottom of bolster. This will allow bolster filler to hinge down.
3. Bring bolster filler up to horizontal position and attach both straps to bracket on ceiling.

To lower bunk:

1. Release straps.
2. Rotate bolster filler into latched position.
3. Lower bolster down against wall.

Make beds in the usual way, using fitted sheets 3/4 bed size.

To make fixed twin beds, lift mattress slightly, pull it away from the wall and then tuck bedding along wall.

A fold up table comes as standard equipment with all models. The table is located in the front credenza under the front window in 28' and 31' models with side pull out lounge. It is located in the roadside credenza in all 25' Excella models, and all 28' and 31' models when a front pull-out lounge is installed. In all 25' International models, 20', 22', and 24' Caravelle and Minuet models, the table is in the curbside credenza just forward the main door.

On models with **table in curbside credenza**, it will be necessary to slide table rearward to clear the pull out lounge before opening.

To open the table, lift into a horizontal position (See Fig. 1), and pull the folding leg down until it locks in position (See Fig. 2.) To extend the table lift the table and leg slightly off the floor and pull the extension and leg out as far as they will go. Release the catch on the extension table leaf and rotate it over onto the extension (See Fig. 3.) By raising the leg the entire table can be moved from side to side for your seating comfort.

To stow simply reverse the procedure and drop the table to the wall.



Fig. 1 - Fold-Up Table-Opening



Fig. 2



Fig. 1 - Sliding Table - Opening



Fig. 2



Fig. 3



Fig. 3

The **optional Solid State Central Control Panel**, with digital clock used in Excella II models is located above the refrigerator and refrigerator cabinet. The control panel without digital clock used as an option in International and Argosy models is located in the rooflocker above the refrigerator. Both panels contain the necessary instrumentation to monitor your trailer's systems.

The **panel display** button lights up the diode indicator lights. The AC power light indicates that you are operating on 120V AC.

The **battery condition tester lights** indicate whether the trailer batteries are in good, fair, weak or bad condition. When they show weak or bad condition, you should take every reasonable step to conserve power by using as few lights as possible and switching off appliances. The battery should be charged as soon as practical with the tow vehicle charging system or by connection to 120 volt power.

The charging system in your trailer is much like the charging system in your car. The univolt package performs a similar function to the car alternator by constantly recharging your battery as power is used. It is important to remember, however, that if the total current draw is greater than the univolt's capacity to recharge, your battery may become discharged even though the univolt is attempting to keep it charged. In this event, it will be necessary to reduce current usage.



Solid State Central Control Panel - Excella II

The LP monitoring gauges on the Excella II panels show the amount of LP gas in your bottles.

The **water pump switch**, when on, also lights the indicator light. On trailers without a Central Control Panel, this switch is located in the galley area. For a complete discussion of the pump, please refer to page 83.

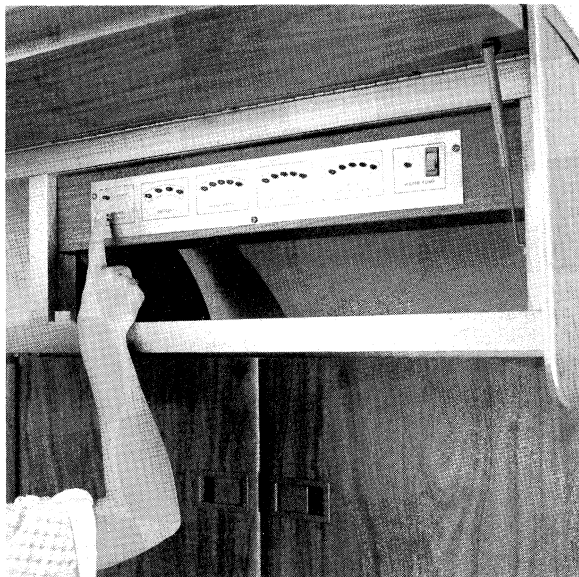

Control Panel - International, Argosy

The **water tank, main holding tank** and **auxiliary holding tank indicator lights** show the amount of liquid in their respective tanks. Measurements are made by means of a series of electronically controlled probes located at various levels in each tank. The gauge lights will indicate in one of the five positions (see diagram).

The **power-on light** will glow automatically when you are hooked up to city power. This light and the polarity warning light (See page 89) are your checks on a proper 120 volt connection.

The **“Monitor II” control panel** offered as an option in Caravelle and Minuet models is located on the galley rooflocker end panel adjacent to the main door. This panel monitors your battery, fresh water and waste water

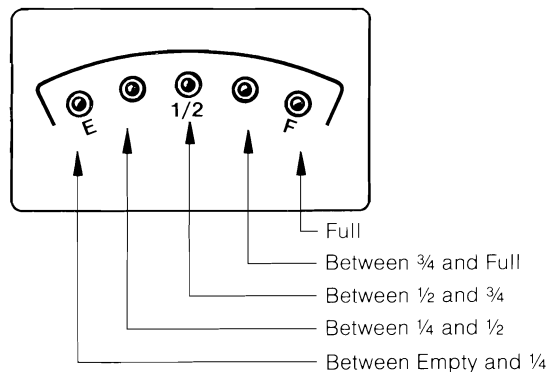

Water Tank and Holding Tank Gauges

systems. The battery condition gauge is activated by the “battery” switch and shows the battery’s state of charge. The amount of fluid in the “Fresh water”, “gray” or waste water and “holding” or sewage tanks will be indicated simultaneously when you push the “test” button. The “pump” switch is used to turn your water pump on and off.

Accumulation of oxides, dirt, etc. on the probes may result in inaccurate readings. In this case, empty the tank, remove probes and scrape clean. Apply sealant to thread area only and replace probes. Care must be taken to keep the probes free of sealant.

The **electronic digital clock** optional in Excella II, International, and Argosy models, operates at all times whether you are on self-



Monitor II Control Panel

contained battery power or hooked up to 120 volt city power.

To operate the clock, push display switch to ON. To set correct time, push set switch to SET MINUTES and then to SET HOURS.

To conserve electricity, the display switch may be turned OFF. (See Fig. 1) The correct time is held in memory until the display is turned back on. If, when the display is turned back on, the time shown is incorrect, there has likely been a power interruption.

After some time you may experience what appears to be a malfunction in the set switch; that is, the displays may not turn on at all or they may “rapid fire.” This is caused by dust on the switch contacts and is easily corrected by moving the switch back and forth 10-20 times.



Fig. 1 - Electronic Digital Clock

Optional Motorola AM-FM Stereo Radio and Combination Motorola Stereo AM-FM Radio with 8 Track Stereo Tape Player Operating Instructions

1. Switch power on by pressing POWER button to "in" position. Switch power off by pressing POWER button again, releasing it to "out" position.
2. Turn SELECT control to desired mode of operation (AM, FM, FM STEREO, FMLC, or TAPE) NOTE: FMLC position is useful only in strong FM signal areas, especially where many FM stations may tend to interfere with each other. FMLC position minimizes this type of interference. For best FM reception under normal conditions the "FM STEREO" position should be used. The "FM" position is useful in fringe areas to lock receiver into monaural mode, thus eliminating stereo threshold noise.

3. Turn TUNING control to select desired station.
4. VOLUME . . . Turn VOLUME control to right to increase volume and left to decrease volume.
5. BALANCE (Left-to-right) . . . Turn BALANCE control either right or left as required for desired left and right sound level.
6. FADER (Front-to-Rear) . . . Turn FADER control either right or left as required for desired front and rear sound level.
7. BASS . . . Turn BASS control either right or left as required for desired bass response.
8. TREBLE . . . Turn TREBLE control either right or left as required for desired treble response.
9. NOISE FILTER . . . Press NOISE FILTER button to "in" position to reduce annoying noise during reception.
10. STEREO INDICATOR LIGHT (FM STEREO ONLY) . . . The indicator light will go on automatically when selected FM station is broadcasting Stereo. The light is not on when monaural broadcasts are being received, or when a stereo signal drops below a predetermined level. The radio is designed to reproduce weak stereo signals monaurally to provide more noise free reception. When the signal increases beyond the threshold level, the stereo indicator will light again.

Tape Deck Operation (8 Track)

Insert tape cartridge into slot (behind hinged panel, see Fig. 2) to a fully seated position to switch tape deck on. Receiver SELECT switch must be in TAPE position to operate tape deck.

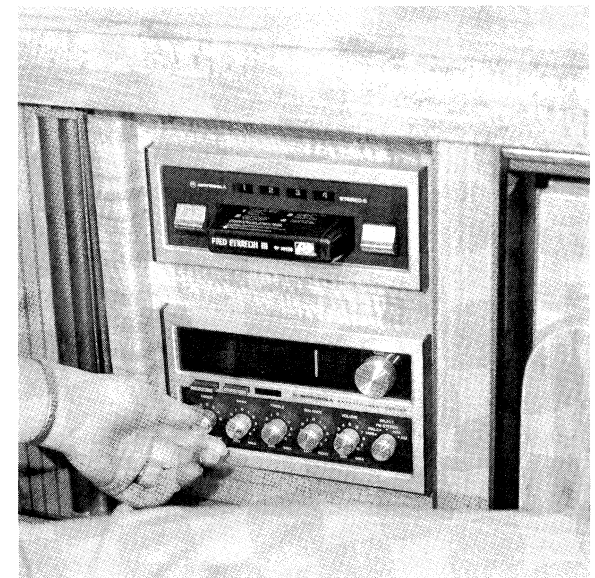

Fig. 2 - Stereo Tape and AM/FM Radio

Retracting tape cartridge approximately one inch from seated position or removing tape cartridge completely switches tape deck off.

The program indicator lights indicate which tape program is playing.

When REPEAT button is in "IN" position, the tape deck will continue playing the same program that is playing until another program is selected or button is released to "OUT" position.

Press and release PROGRAM button to position tape deck pick-up head to the next program on the tape. NOTE: If PROGRAM selector feature is not used the four programs will play in sequence except when "REPEAT" button is in "REPEAT" position. The tape deck will play continuously in this manner until tape cartridge is pulled out from its seated position.

Tape Deck Operation (Cassette)

With select switch in TAPE position, the player is automatically turned on when the cassette is inserted and seated. To insert cassette, hold cassette with exposed tape surface facing right, and place cassette into slot. Then guide it in gently with fingers until cassette snaps into place. Cassette will now play continuously until ejected. Each cassette has two program tracks (side one and side two). To change from one track to the other, momentarily depress the Program change button. If allowed to play continuously the player will automatically reverse at the end of the program and play the second track.

To eject the cassette, depress "EJECT" button. The cassette will protrude for easy removal.

An illuminated arrow will appear to the right of the toggle lever when playing tapes. The arrows indicate the forward or reverse direction of the tape and which track is playing. If the cassette has been inserted with Side One upwards and the right arrow lights, this indicates that the program on Side One is playing. Depressing the Program change button will cause the left arrow to illuminate and will mean Side Two is playing. These arrows also indicate in which direction the toggle lever should be moved in order to move the tape Fast Forward or Rewind.

FAST FORWARD . . . To rapidly advance tape (Fast Forward) to another portion of the program, press the toggle lever in the direction of the illuminated arrow. The lever will lock and remain in this position until you return it to the center position. The unit will then begin playing the tape at its advanced position. If end of tape is reached while in the Fast Forward mode, the lever will automatically return to the center position and the tape unit will begin playing the start of the 2nd program track.

FAST REVERSE . . . To rapidly rewind tape (Fast Reverse) in order to repeat the program material, press the toggle lever in the direction opposite to the direction indicated by the illuminated arrow. Returning the lever to the center position will again place the tape in the playing mode and the recorded program will repeat. If the start of the tape is reached, the lever will automatically return to center position and the entire program will repeat.

Store tapes and cassettes in a cool area with open end down. Protect tapes from dust and direct sunlight.

In time, oxide from recording tape will accumulate on the tape head and capstan shaft which can cause tape hiss and erratic operation. The more often the player is used, the more often it should be cleaned.

Clean the head with a cotton swab moistened with isopropyl alcohol. **Do not use carbon tetrachloride.**

To clean the capstan shaft, first turn on the motor by depressing the motor switch (next to or in front of the capstan shaft) with the eraser end of a pencil. Use a cotton swab moistened with alcohol on the shaft.

The fuse for the radio, or radio/tape is located behind the unit. To gain access to the fuse, carefully pry off the metalized plastic front bezel of radio unit. Remove four attaching screws and slide unit out.

The **Armstrong or Coleman air conditioner** can be used for cooling or heating (heat strip optional on some models) your trailer or for air circulation only.

Operating Instructions - Armstrong:

To operate for cooling:

1. Make sure you are connected to 120V AC supply. Close doors, windows and ventilators.
2. Set thermostat to "COOL" position and set thermostat indicator to your desired comfort level.
3. Set system switch (located at ceiling cover of air conditioner) to your preferred speed setting.

Note: The air conditioner will not operate until speed selection is made. The recommended cooling speeds for various outdoor temperature ranges are:

Hi-Cool	70-120
Med-Cool	60-110
Lo-Cool	50-100

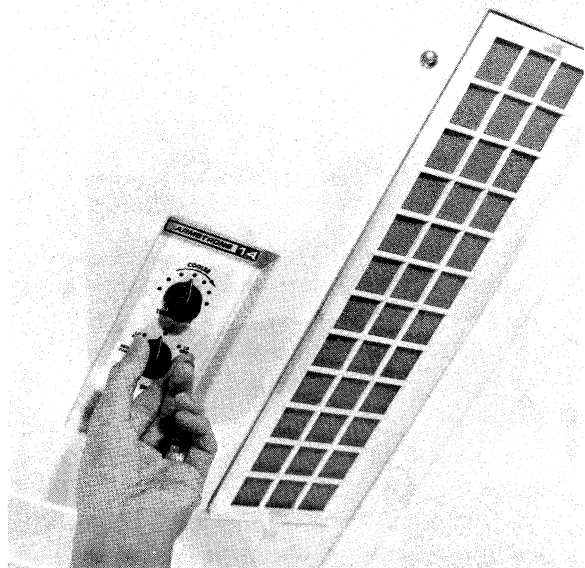

Air Conditioner Controls - Armstrong

To operate for heating:

1. Set wall thermostat to "HEAT" position and set thermostat indicator to your desired comfort level.
2. Set system switch to your preferred speed setting. We suggest MED or LO speed.

Note: The heater will not operate until speed selection is made.

CAUTION: Water and holding tanks are warmed by furnace only. Heat from air conditioner is not sufficient to keep these tanks from freezing in cold weather.

To use for air circulation, set wall thermostat to "OFF" position and system switch to any of the three speed selections. To shut unit off, set system switch to "OFF" position.

Shut unit off to clean or replace filters. Clean both filters with vacuum cleaner once a week. Once a month, remove filters and wash in warm soapy water.

Operating Instructions - Coleman:

General Information

Your unit is operated totally from the control panel on the inside ceiling assembly. There are three (3) controls on the control panel, they are as follows:

1. The **temperature control** regulates the "on" and "off" temperature setting at which the compressor or heater (if you have the Elec-A-Heat model) will operate.
2. The **small lever** regulates the volume of air that your air conditioning unit will be handling during the fan only, cooling or heating, (if you have the Elec-A-Heat model) cycle. In the "up position" high air volume and in the "down position" low air volume.
3. The **selector switch** positions the desired mode (Off, Heat, Fan Only, and Cooling).

Your Coleman RV air conditioner unit incorporates a unique air damper control which regulates the volume of air being circulated in the trailer as well as several other things related to your personal comfort. First, the blower recirculates air throughout the trailer to keep you comfortable. In addition, the air being circulated is completely filtered by non-allergic natural fiber filters while the unit is in operation. Second, it conditions the air to the temperature that is most comfortable for you.

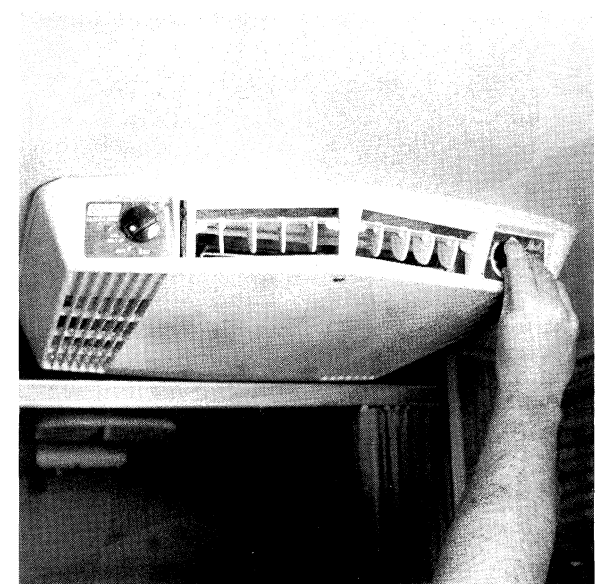

Air Conditioner Controls - Coleman

To operate for cooling:

1. Set the left hand selector switch to the "Cooling" position of the dial. The fan will run continuously and filter the air while keeping the air circulating throughout the trailer. Setting the air volume lever at "Hi" will give you the greatest volume of air circulation, and is recommended to provide fastest "cool down" of the trailer.
2. Set the temperature control, right hand knob, to the temperature level that is the most comfortable for you. The compressor will automatically turn on when the temperature of the air entering the air conditioner rises a few degrees above the setting you have selected and automatically turns off the compressor when the temperature of the air entering the air conditioner drops a few degrees

below this setting. The air conditioner will keep cycling the compressor ON and OFF in this fashion until you change the selector switch to another mode of operation. During this time, both the air recirculating system and the refrigerant system will be in operation to provide you with filtered dehumidified, cold air in the volume you desire.

Operation of damper (Small lever)

When relative humidity conditions are high, set air damper at either medium or high setting. In high humidity conditions **we do not** recommend operation of the air conditioner at the full "Lo Air Volume" position, which may cause excessive sweating at ceiling plate location.

Operation during cooler nights (Cooling)

It is important when temperatures drop in the evening or during the night below 75°F. that the thermostat (Temperature Control) be set at about midway between "COLDER" and "WARMER". When the setting is at "COLDEST" it may cause freezing or icing-up of the cooling coil (Evaporator) and stop cooling. During the heat of the day reset temperature control to any desired cooling position.

Note: Should icing-up have occurred it is necessary to let the coil defrost before normal operation is possible. Run unit on "Fan Only" position. If increased or full air flow is observed, the coil should be clear of ice.

To operate for heating:

1. Set the selector switch (left hand knob as you face the unit) to the "Heat" position. The fan will automatically start circulating air continuously.
2. Set the temperature control to the temperature level that is the most comfortable for you. The heater will automatically turn on when the temperature of the air entering the air conditioner drops below this setting a few degrees and automatically turns off when the temperature of the air entering the air conditioner rises a few degrees above the temperature setting you have selected. The air conditioner will keep cycling the heat on and off in this fashion until you change the selector switch to another mode of operation.

Note: The trailer temperature must be below 80°F. for the heater to operate.

3. You can regulate the air volume and resulting air temperature change with the lever and in conjunction with closing the louvers partially. Fully open louvers will throw the prewarmed air toward the back and front for efficient circulation and faster warm-up of the vehicle. **Note:** Although the air temperature is lower the same amount of heating capacity is produced, regardless of louver position. Hottest air is produced when lever is in full down position.

Note: Elect-A-Heat is intended to take the chill out of the indoor air when the air is a few degrees too cool for comfort. When properly sized, the Elect-A-Heat is an effective "chill chaser". **It is not a substitute for a furnace. In freezing weather, it will not keep water and holding tanks from freezing.**

To operate for air recirculation only

1. Set the selector switch to the "Fan Only" positions on the left hand dial. The fan will run continuously and filter the air without either cooling or heating the air. To obtain a lower or higher volume of circulating air, simply lower or raise the air volume lever. This will close or open the damper in the air conditioning unit to give you almost unlimited control over the volume of air being recirculated in your trailer.

Owner's Maintenance:

Cleaning and changing the filters.

The air filters are located in the interior ceiling shroud and are accessible for changing and/or cleaning as follows:

1. Remove the two (2) screws from bottom of the ceiling shroud.
2. Pull down on ceiling shroud at end opposite the control knobs; filters can then be removed for changing or cleaning.
3. Replace filters and "snap" ceiling plate back into its original position and reinstall screws.

Note: Make sure that supply wire and thermostat cap tube are routed clear of the spring "legs" to avoid snagging of these items when ceiling plate is pulled down for filter servicing.

Your filters provide a vital function to proper operation of your air conditioning system. If the filters are not cleaned at regular intervals, they become partially plugged with lint, dirt, grease, etc. Then it will be possible to severely damage the operating components of your air conditioner.

We recommend that you remove the filters and clean them at least every two weeks that the unit is in operation. The filters can be easily cleaned with soap and water and rinsed clean, or by using a garden hose to remove the contamination. Dry the filter carefully and reinstall in the air conditioner.

IMPORTANT: Do not operate your air conditioner for extended periods of time without the filters installed.

If replacement filters are necessary, the filters can be purchased from Airstream/Argosy Certified Service Centers. You should carry spare filters at all times for installation in the ceiling shroud, if your old filters become torn or deteriorate from the effect of smog, aerosol sprays, etc.

Electrical problems

Note: All electrical work and/or inspection should be performed only by qualified service personnel. Contact your nearest Airstream/Argosy Certified Service Center if electrical problems arise.

Check Points For Service Person:

Failure to start or failure to cool air are sometimes problems with air conditioning units. The Coleman RV air conditioner is designed to operate on 115 volt electrical power. If the compressor on you unit fails to start, check with your Airstream/Argosy Service Center to determine that the proper sized extension cord is being used for the distance covered from the utility outlet to your trailer. The required minimum wire size is #12 AWG for lengths up to 25 feet (larger size if longer).

If your unit continues to trip off the circuit breaker, have an electrician check the starting amperage and running amperage on the unit. The amperage figures for your particular unit by model number are shown in the specification table at the front of this booklet. If the circuit breaker trip off continues, and the electrical consumption is normal, it will require replacement of the faulty circuit breaker.

If all electrical power to the air conditioner is normal but neither the fan or compressor run, the electrical plug on the back of the selector switch junction box should be checked for a secure connection.

On the heating-cooling air conditioner models, if all electrical power to the unit is normal and the fan runs but you never get any heated air, then the electrical plug to the heating unit should be checked for a secure connection. If this does not correct the malfunction, the heating thermostat or limit switch may be faulty.

CAUTION: SHOCK HAZARD, Do not service while unit is running. Disconnect power to unit.

Lubrication

The blower drive motor on some units may include oiling cups at the top. There is no requirement to oil these journals under normal operating conditions. However, if you desire to lubricate your unit, use only SAE 20 non-detergent type oil. Do not over oil; three to four drops in each oil hole once a year is sufficient.

Stainless steel sinks cannot be harmed by boiling water. However, salt, mustard, mayonnaise and ketchup can cause pitting. Stubborn stains will yield to paste made of water and slightly abrasive household cleaner. Be sure to work in the direction of the polish-lines on the steel, to keep the original finish. Fingerprints are sometimes a problem. They can be minimized by applying a cleaner that leaves a film of thin wax: simply wipe it on and remove the excess with a dry cloth. After this, fingerprints can be wiped off with a soft dry cloth, or one moistened with a little wax cleaner. The surface should always be washed before wax is applied. Regular cleaning will prevent build-up of scale and film. Ordinary soaps or detergents are best for routine cleaning of the stainless steel sinks. Rinse thoroughly with warm water and wipe dry with a cloth to avoid streaks and spots.

For further information on galley equipment refer to page 71 for the refrigerator and page 77 for the range and oven.

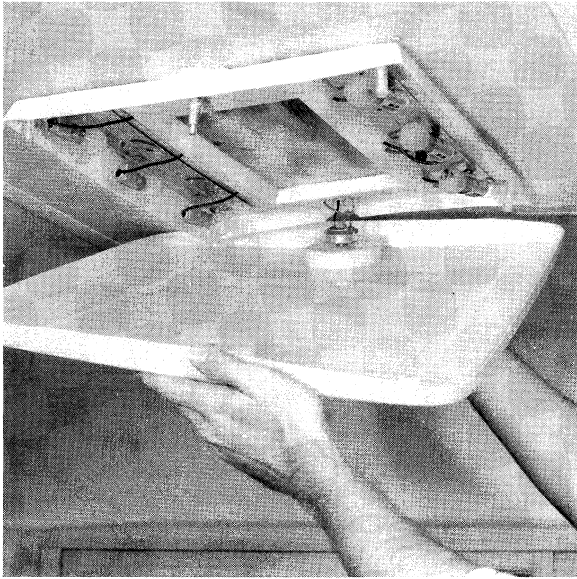

Ceiling Light Fixture

Ceiling light fixtures are incorporated with the ceiling fresh air vents in Excella II models. To operate the lights turn the control knob clockwise; first position 2 lights, second position 4 lights, third position 6 lights, fourth position off. If optional florescent lighting is installed, the light switch will be in the ceiling near the light.

To remove the lens and replace the bulbs or florescent tubes, pull knob from light switch shaft and remove nut (bulbs only). Remove the screw from the vent control handle and remove handle. (Knob on light assemblies without vent.) Remove 4 screws attaching lens to vent frame, this will release the lens. To replace, reverse removal procedure.

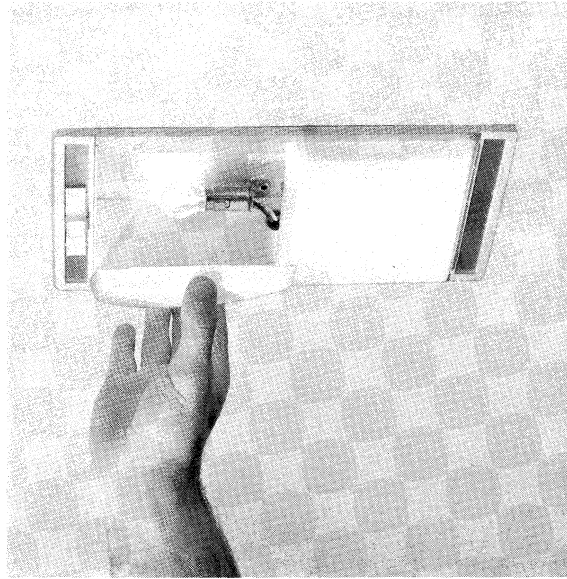

Galley, Vanity, Bath, Bed-Light

The **fresh air vents** are operated by a control handle. Turning clockwise will raise the vent and at the maximum extension, vents with fans will automatically turn on. For maximum air without fan, open until fan starts and back up just enough to turn fan off. Turning counterclockwise will close the vent. Screens should be removed for periodic cleaning.

Galley, vanity, bathroom and bed lights, gently squeeze lens and pull down to remove. These lights are operated by a sliding switch on the end of the light frame.

The optional **NuTone Food Center** (not available in some models) allows you to operate several appliances with just one built-in power unit. The food center is equipped with three attachments, mixer, blender, and knife



Nu-Tone Appliance Center

sharpener. Other appliance attachments are available.

Your power unit was oiled at the time of manufacture but a storage period may have permitted oil to drain back into the reservoir. Before using it for the first time, please run the power unit for one to two minutes to insure lubrication . . . before attaching an appliance. At intervals of from one to two months, depending on the amount of use, a few drops of ordinary household oil should be placed around the motor shaft opening.

The unit will warm up in proportion to the length of time it's run and the load it carries. If you run it unusually long or hard, give it a rest before putting it to work again.

The **mixer** was designed for convenience and efficient operation. The bowl rests on a turntable directly connected to power unit. The motor, not the beater, turns the bowl — automatically keeps it revolving during mixing, regardless of the consistency of the batter. This feature eliminates hand-turning the bowl. And, while the bowl revolves automatically, the beater turns in the opposite direction. This 'counter-motion' feature helps prevent lumpy, incomplete mixing.

To operate the mixer:

1. Place turntable in position on the power unit.
2. Lock the turntable in place by pressing the locking lever clockwise.
3. Place the mixing bowl on the turntable.
4. Push the beater blade into the beater head. Blade will 'click' when it's locked in position.
5. Insert beater head shaft into center tube of bowl. Place it in one of six positions until it snaps into turntable.
6. Turn dial to desired speed.

Note: To remove beater head, turn counter-clockwise, and lift it out of mixing bowl. If the turntable should become locked to power unit and cannot be easily removed, insert beater head and turn it counter-clockwise.

The **blender** makes meal preparation and entertaining less work and more fun. It performs, quickly and easily the time consuming and tiring tasks of grating, chopping, shredding and mincing; it even liquifies solids and blends them to perfection.

To operate the blender:

1. Place blender in position on power unit, and turn clockwise to lock securely in place. **Never attempt to place blender or any other attachment in position while power unit is running.**
2. Put food in blender. Turn dial to desired speed. Or . . .
3. When adding solids, cover, then turn dial to desired speed. Remove insert from lid. Add food through opening while blades are in motion.
4. To remove contents from blender, use a long-handled rubber bottle and jar scraper or a wooden spoon or fork. Don't use a metal spatula or spoon.

The **knife sharpener** will allow you to sharpen your knives in just seconds.

To operate the knife sharpener:

1. Place sharpener in power unit; turn clockwise to lock in position. Be sure sharpening stone is on left as you face the knife sharpener.
2. Turn control dial to speed 3. Be sure knife is clean and dry.
3. Place heel of knife blade into guide slot next to sharpening stone (left or right). Hold knife firmly by the handle and draw it slowly toward you with cutting edge against stone. Allow weight of the knife and the guide slot to apply necessary pressure and positioning.
4. Repeat operation, alternating to left and right side of stone with each stroke, until desired sharpness is obtained.



Bathroom

Don't sharpen knives with an irregular edge such as serrated, scalloped, fluted, corrugated or hollow edges . . . and don't sharpen scissors. **Don't clean sharpener while attached to power unit. Be sure speed control dial is turned "off" before attaching or removing sharpener.**

The lavatory bowl, counter top, tub or shower pan in your bathroom are made of a special ABS long-wearing, light weight, high strength plastic material. **When cleaning, use soap or detergent only — never use scouring powder.** Always re wax the ABS plastic surfaces after each heavy cleaning with a good grade paste wax (without solvents or cleaners). The wax will protect the surfaces from discoloration and stains. When you first

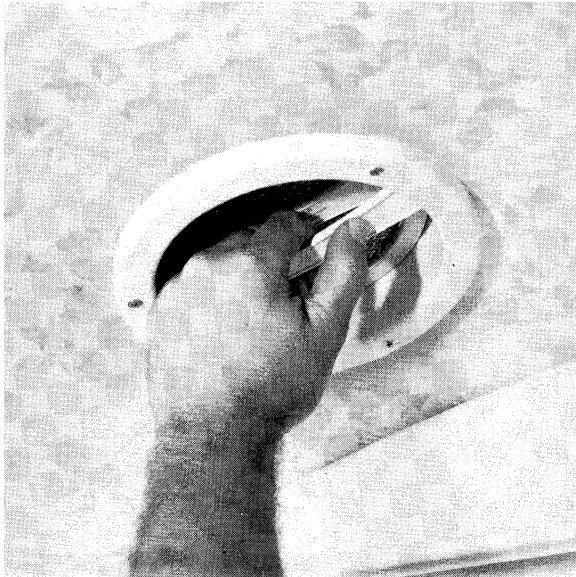

Bathroom Exhaust Fan

purchase your trailer, Airstream recommends that you give all ABS plastic surfaces a heavy coating of paste wax. This will assure easier cleaning and lasting beauty.

The **bathroom exhaust fan** is in the bathroom ceiling and is operated by pushing up on the handle running across the fan opening and turning on the switch located at the fan or on the rear wall above the sink. To shut the fan off, shut off switch and pull the handle back down.

The **telephone shower head** is designed to give maximum flexibility in usage and provides for water saving techniques when using your trailer on self-containment. It can be held in the hand and moved about the body. Normally the best water conservation procedure is to wet the entire body and then turn the water off with the push button at the shower head. Apply soap, lather thoroughly, then rinse the soap off. The telephone shower head is also used to fill the tub for taking a bath. When you have finished using the shower be sure to shut the water off at the faucet. The push button is intended as a shower convenience only and should not be used as a water shut-off.

L.P.G. System

Your trailer is equipped with two tanks for LPG (Liquid Petroleum Gas). LPG burns with a clean blue flame. There are two basic types of LPG in common usage: **Butane and Propane.**

Butane is widely used where temperatures are normally above freezing the year round and Propane is used when subfreezing temperatures are common, since Butane freezes at 32° as compared to -40° for Propane. **All of the orifices in your LPG appliances are of the universal type which will burn either fuel.**

How long a full tank of gas will last is dependent on usage. In cold weather when you are using the furnace, large amounts of hot water, and are doing extensive cooking, you will naturally use more than you will in warm weather when you may do limited cooking. On the average, with normal cooking and other appliance use, you can probably count on two to three weeks service from each tank.

Some models are equipped with an **optional automatic gas regulator.** Both tanks are connected to this regulator. When the gas is turned on, it is drawn from only one tank at a time. When the tank being used is depleted the regulator automatically switches to the full tank. An indicator on the regulator knob points toward the tank which was being used to give you a visual reminder when one tank is empty. Note: The tank in use is not completely empty until the red warning flag is fully visible in the indicator window. The empty tank can be removed for refilling without disturbing the tank being used. Simply close the tank valve, disconnect the empty tank and have it refilled.

The vent at the bottom of the regulator must be kept free of any obstruction. Inspect the vent opening regularly.

The LPG gas bottles are securely mounted on the front "A" frame of your trailer. **If these bottles must be removed for service or replacement,** it is important that they be reinstalled correctly in order to prevent any possibility of their falling off or becoming dislodged during travel. The following step by step procedure gives you the proper method of removing and installing these bottles:

1. Turn the knob on your automatic regulator so the arrow points to the tank opposite the one to be removed. Shut off the gas valve on the bottle to be removed. If your trailer does not have an automatic regulator, shut off the gas valve at both bottles.
2. Disconnect the rubber gas line at the bottle to be removed. (This fitting has a left hand thread and turns in the opposite direction to most threaded fittings).
3. Turn the large clamping "T" handle counterclockwise until the hold down bracket is loose enough to remove the bottle. If your trailer is equipped with an optional gas bottle protective shroud, the "T" handle must be removed and then remove the shroud before removing the bottle.

Do Not Remove The Center Hold Down Rod.

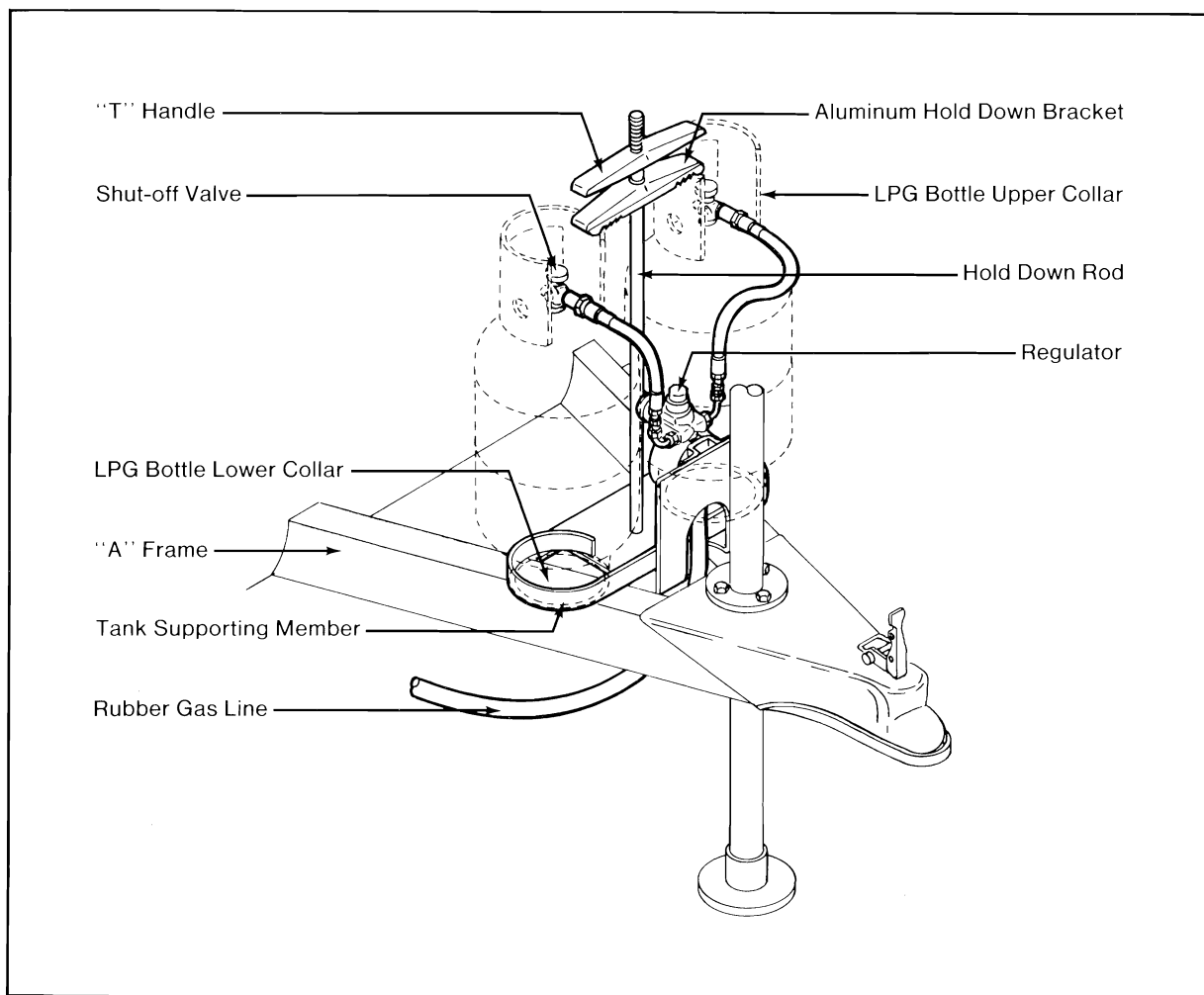

Fig. 1

To install:

1. Place the bottle in position on the "A" frame and bottle crossmember so that the lower collar fits inside the circular bracket welded to the "A" frame. The open gap in the upper collar faces forward. Reattach rubber gas lines.
2. Place the cast aluminum hold down bracket in a position so that it rests on the upper collar of both bottles with the collar rims engaged in the grooves on the underside of the bracket. If your trailer is equipped with an optional Gas Bottle Protective Shroud, it should be positioned over the bottles next. Make sure the Hold Down Rod projects up through the hole in shroud center bracket.
3. Replace the "T" handle and tighten down until the bottles are held firmly in place.
4. Turn on gas shut-off valves and test all fittings with a soap suds or detergent solution and watch for bubbles.

If you have allowed both tanks to run out, air may have gotten into the lines. In this event, the air must be forced out through the lines by gas pressure before you will be able to light the pilots. Hold a match to the pilot of the appliance closest to the tanks until it lights and stays lit. Then move to the next closest, etc. For more complete appliance operating instructions, refer to page 71-82.

Close the shutoff valves on the gas tanks if you smell LP-gas, or if appliance pilot light fails to stay on. Contact an LP gas company service man to correct the problem.

Additional information on the LPG system is available in the Service Manual.

Refrigerator

Your trailer is equipped with either an **A.G.A. approved Dometic or Norcold gas electric refrigerator**. These are the finest refrigerators available for trailer use and will give you many years of faithful service.

For best operation of these refrigerators it is important to level your trailer. Continued off-level operation may permanently damage the cooling unit. When parking try to avoid having a strong wind blowing directly against the vent outlet for most efficient operation.

OPERATING INSTRUCTIONS, DOMETIC

Controls for both gas and electric operation are located inside the food storage compartment, at the bottom of the unit, and in the outside access compartment. (See Fig. 1.)

For gas operation, follow these instructions (See Fig. 1.):

1. Open refrigerator door, all controls for gas operation are located at bottom of unit.
2. To start the refrigerator turn the valve knob (A) to gas position. The gas valve is now open and the electric circuits are not in use. Set thermostat knob (C) to setting No. 4.
3. Pull knob (D) of the automatic pilot, and keep it out for 15 seconds. Press in knob (E) of the piezo lighter. The pressing may have to be repeated.
4. After the burner is lit, which will be seen through reflector window (F), keep the knob (D) pulled outward for an additional 15 seconds.
5. Release the knob (D) and check that the burner is operating.

If the burner is not operating, repeat the lighting procedure.

After a replacement of a gas bottle or a long shut-off period the gas lines are likely to be filled with air. In such cases the lighting procedure has to be repeated until the air is pushed out of the lines and the gas has reached the burner.

As soon as the required cold temperature inside the cabinet is reached, the thermostat cuts the burner main flame to the by-pass flame sufficient to keep the safety valve open during gas operation. During electric operation the thermostat cycles the flow of the electrical current to maintain the set temperature.

Incorporated in the burner bracket is an automatic flame failure device which allows gas to pass only when the burner is lighted, keeping the thermocouple hot. Should the flame be blown out, the thermocouple will cool and the device will cut off the flow of gas to the burner.

The refrigerator is fitted with a piezo lighter which does not require flint.

For 120V Electric Operation, follow these instructions.

1. Open refrigerator door and outside access compartment door. Outside access doors are opened by removing sheet metal screw from top center, then turning the latch handle 1/4 turn counterclockwise.
2. Make sure the electrical cord is plugged into the 120 volt outlet located in the refrigerator outside access compartment.

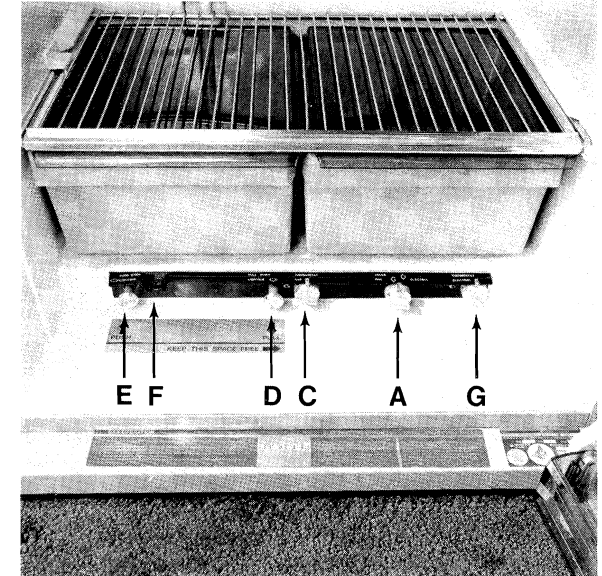

Fig. 1 - Controls Inside Dometic Refrigerator

3. To start the refrigerator turn the valve knob (A) to the off position.
4. Press knob (A) in, until it stops, then turn to electric position.
5. Turn the electric thermostat knob (G) to setting No. 4. To increase cooling, go to higher setting. To decrease, go to lower setting.

For best operation even during extended stays in parks your unit should be periodically run on gas.

The refrigerator has automatic thermostatic control of the temperature in the food storage space. The gas thermostat (C) controls the temperature during gas operation, while the electric thermostat (G) controls the temperature during electric operation. **Be sure to make the temperature setting on the correct thermostat.**

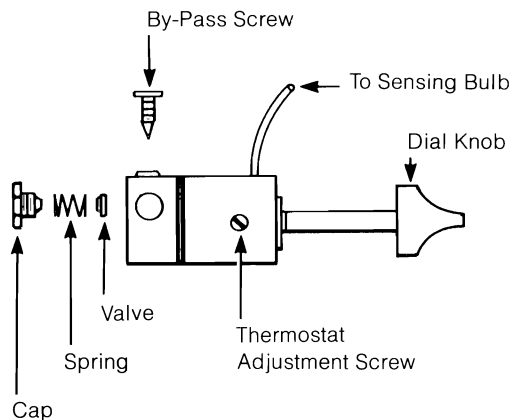

Fig. 2 - Dometic Thermostat

Your Dometic RM100 model incorporates a unique, **fully automatic defrosting device** for the general food storage compartment, which eliminates the necessity for manual defrosting at frequent intervals normally associated with most conventional refrigerators in the medium size range. Furthermore, the time interval of each defrosting cycle, and the frequency, have been so arranged that during defrosting there is no noticeable effect upon the temperature of the foods stored in the refrigerator, and the frozen food storage conditions can be maintained at all times in the frozen storage compartment.

The following are some trouble shooting tips for emergency use only. They relate to gas operation and should normally be done by the dealer.

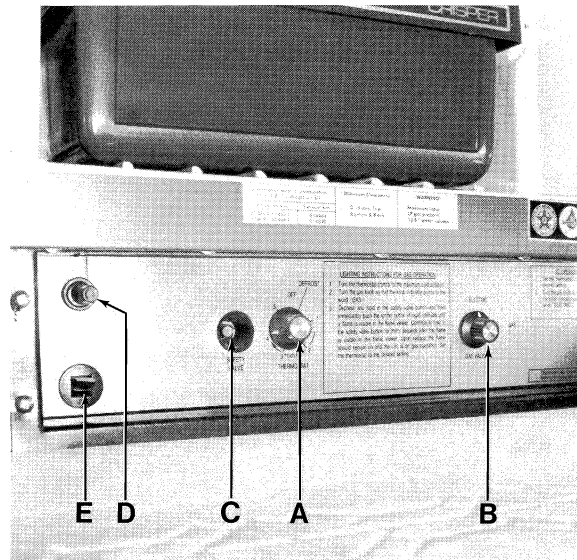

Fig. 3 - Controls Inside Norcold Refrigerator

Problem: Flame goes out. The thermostat is out of adjustment. To adjust it, turn the dial to "zero". If the flame does not go down to the "low" by-pass setting, follow this procedure (See Fig. 2.):

1. Unscrew the large cap screw at the rear of the thermostat and remove the valve. Clean the seat and valve, and replace.
2. If procedure (1) does not correct the problem, adjust the set screw out (in counterclockwise direction) until the flame goes down to the "low" position.

If the flame keeps going out when the dial is turned to (O), remove and clean the by-pass screw which is located as shown in Fig. 2.

Problem: Burner does not light. Remove and clean the burner barrel, and/or check the gas supply.

OPERATING INSTRUCTIONS, NORCOLD

It is important that when the vehicle is parked or stopped for any length of time it must be properly leveled. Level the freezer plate using a small pocket level and adjust the vehicle so that the freezer plate is level in each direction.

Normal installation of the refrigerator is such that the freezer plate is parallel to the vehicle floor. If this is evident then leveling the vehicle will automatically level the refrigerator and cooling performance will be satisfactory.

While the refrigerator must be level when the vehicle is stopped, performance during transit is not normally affected.

It must be noted, however, that a prolonged travel either up or down hill will initiate a defrost cycle as the washing motion in this case can not prevent liquid traps and blockage.

The combination gas and electric models employ the same refrigeration system. The gas controls are independent of the electric and the electric completely independent of the gas.

One thermostat controls the desired cooling temperature on both heat sources . . . gas or 120 AC.

The electric and gas control are so designed that single operation of the refrigerator on either of the heat sources is assured. It is not possible to operate the unit on both gas and electric simultaneously.

GAS OPERATION as follows: (See Fig. 3)

1. Turn the thermostat (A) to the maximum cold or full clockwise position.
2. Turn the operational selector knob (B) so that the knob indicator is pointing to the word "GAS".
3. Depress and hold in the safety valve button (C) while at the same time pushing the ignitor button (D) at rapid intervals until a flame is visible in the flame viewer (E). On initial start up the lighting procedure must be repeated until the air in the line has been replaced by gas.
4. Continue holding the safety valve button (C) in the depressed position for approximately 15 to 30 seconds after the flame is visible. Upon release the flame should remain on and the unit is on gas operation.

The gas regulator located in the manifold system reduces the pressure from the propane tank(s), usually 12 to 13 inch (2.98kPa-3.23kPa) water column, to the Norcold operating design pressure . . . 8.5 inch (2.11kPa) water column for Models 776EG2 and 778EG2 and 10.5 inch (2.61kPa) water column on Model 774EG2. If the regulator is not properly adjusted cooling performance will be decreased. Adjustment of this regulator should be done only by an authorized Service Center.

The safety valve is designed so that should any loss of flame occur through blow out or other reasons it will interrupt the gas flow preventing any danger of explosion. It is controlled by means of a thermocouple that is position in the flame. As long as a flame is detected by the

thermocouple the valve is held open. Upon flame failure, the valve closes shutting off the gas flow.

Replacement of this valve or its thermocouple should only be done by an authorized Service Center.

The thermostat on the Norcold refrigerator control both the gas and electric operation thereby eliminating the necessity of resetting each time a different power source is employed.

At the maximum cold setting the thermostat valve remains open and the gas flows at the maximum pressure. At the minimum cold setting the valve is closed and the unit will operate at the bypass flow pressure of 2 to 3 inch (.498kPa - .747kPa) water column, or just enough to maintain the burner at a low flame.

Between the maximum and minimum extremes is a numbered section of the thermostat dial over which controlled temperatures may be obtained. The higher the number the colder the setting. Once the temperature in the refrigerator cabinet has reached the point of the thermostat setting the thermostat valve closes and the unit operates on low fire until once again the thermostat calls for cooling.

Replacement of the thermostat should only be done by an authorized Service Center.

The pressure tap tee is a part of the manifold assembly and serves as a point for servicemen to monitor the gas pressure being introduced into the burner.

ELECTRIC OPERATION ON AC

The refrigerator incorporates a single cartridge heater having a resistance type element for AC operation.

For AC OPERATION (See Fig. 3) set the thermostat (A) to the maximum cold setting. Turn the operational selector knob (B) so that the knob indicator is pointing directly to the word "ELECTRIC". The refrigerator should now operate on AC.

IMPORTANT

If after a period of time, (usually 2 to 4 hours) the refrigerator does not appear to be functioning or a cooling performance loss is noted check the following:

1. Make sure the AC supply cord is plugged into the electrical outlet provided and that the vehicle is connected to the proper voltage and frequently supply of 120 V.A.C., 60 Hertz.
2. Check that the circuit breakers are not tripped.
3. Make sure the instructions governing electrical operation have been properly followed.
4. Check the thermostat and make certain that it is the full clockwise or maximum cold setting.

If after checking all of the above the refrigerator does not cool have a service man check the heater for continuity. This may be done with the unit plugged in using a watt meter or when unplugged using an ohmmeter.

On gas refrigerators, the flue will require occasional cleaning because an obstruction in the flue can reduce or stop flue draft. Flue obstructions can cause odors outside refrigerator, slow freezing and higher cabinet temperatures. To clean, it will be necessary to gain access to the back of the cabinet. It is recommended that you contact your Authorized Airstream/Argosy Dealer for this operation.

When cleaning, remove all food and clean the interior and all other plastic parts with warm water, and mild detergents. **Never use abrasive or caustic cleansing powders, polishes, cleaning paste, gasoline, turpentine or other solvent type cleaners.** Use a damp cloth for cleaning and finish with a soft dry cloth.

When the refrigerator is to be out of operation for some time, always leave the door slightly open or place a pie tin of barbecue charcoal on the shelf.

Additional information on the refrigerator is available in the Service Manual.

Microwave Oven

Airstream/Argosy dealers cannot service or make adjustments to the optional portable oven. This must be done by an authorized Litton Industries service agency. If you ever have problems with the oven check the list of authorized service agents. This list is packed in your microwave oven.

To operate your Litton microwave oven:

1. Open door by pushing down door release.
2. Place food in oven.
3. Select cook* or defrost**
4. Close door — cooking or defrosting cycle begins when oven door is closed.
Microwave oven may be opened at any point to check food even if time is left on the dial.
5. Always turn timer back to "OFF" when food is taken out.

- * For fast cooking of food when recipe calls for "MICROWAVE".
- ** Provides convenience for defrosting frozen foods. When microwaves first contact the outer section of the food, heat is created and conducted toward the center. Without automatic defrosting there is danger of overheating the outside of the food before the center is hot. In extreme cases, the outside of the food could be cooking before the center is defrosting. Automatic defrosting alternates "defrost cycles" and "rest cycles." The rest cycles allow heat to be conducted toward the center providing an evenly defrosted food.

NOTE: Never operate the microwave oven unless the shelf is in place. The steam that is present during cooking and the moisture on the inside of your microwave oven are normal and nothing to worry about. The moisture is caused by the steam from the cooking food hitting a cool oven surface.

Never operate your microwave oven unless the removable shelf is in place. The shelf may be cleaned in the dishwasher.

Please read your cooking guide carefully. It will help you learn about your new Litton Electronic Oven quickly.

Your microwave oven is portable and can be removed for use in your home when your trailer is not in use.

IMPORTANT

Safety and Maintenance Instructions

Litton microwave ovens are one of the safest kitchen appliances. Each Litton microwave oven meets all safety standards set by the U.S. Dept. of Health, Education and Welfare. Look for the safety seal and UL tested label on your oven. However, it is important for you as a user to observe certain precautions and care in utilizing your Litton oven for maximum performance and safety. The door on your oven has been carefully designed to contain the microwave energy; therefore, it is important that you observe the following:

1. Do not attempt to operate this oven with the door open since open-door operation can result in harmful exposure to



Microwave Oven

- microwave energy. It is important not to defeat or temper with the safety interlocks.
2. Do not place any object between the oven front face and the door or allow soil or cleaner residue to accumulate on sealing surfaces.
 3. Do not operate the oven if it is damaged. It is particularly important that the oven door close properly and that there is no damage to the: a. Door (bent). b. Hinges and latches (broken or loosened). c. Door seals and sealing surfaces.
 4. The oven should not be adjusted or repaired by anyone except properly qualified service personnel.
 5. Remember that it requires considerable electrical power to operate the microwave oven (15 amps). Operation of other 120 volt appliances should be kept at a minimum when operating the oven.

Your new oven requires very little maintenance except for cleaning. Do not allow grease, soil or splatter to build up on the door seal to the oven cavity. Use only mild detergent, water and soft cloth to clean the door surface and the interior surfaces. Odors can be eliminated by boiling a solution of one cup of water and several tablespoons of lemon juice in the oven for 5-7 minutes. Litton maintains trained service technicians in all principal metropolitan areas. It is suggested that these authorized service agencies be utilized for proper repair and adjustment of your oven.

The Litton **Micro-Browner® Steak Grill** allows you to brown and sear steaks, hamburgers and chops, fry eggs, grill a cheese sandwich.

To operate your Magic Chef microwave oven:

Airstream dealers cannot service or make adjustments to your optional Magic Chef Microwave Oven. This must be done by an authorized Magic Chef agency. If you need to have service work done on your oven, check the list of agencies provided with trailer.

To operate your oven, first open the oven door by pulling up on the door latch then select the cooking mode on the mode dial, Bake, Broil, etc. Place your food in the oven, close the door, making sure it latches tightly. Set the timer dial for the desired time and the oven does the rest. You should always make sure the timer is turned back to **OFF** when you remove the food.

Your oven shuts off automatically when you open the door. Never tamper with the door interlock switch or operate the oven with the door open. If the door becomes damaged so that it will not close properly, have it repaired before attempting to operate your oven.

Do not allow grease to build up inside your oven or on the door seal. Use a mild detergent and water to clean the inside surfaces. Don't use abrasive cleaners as they can scratch the surface.

Range and Oven

Your trailer is equipped with a Magic Chef **gas range and oven**. The following are some hints on how to keep them operating at their best.

NOTE: The range gas line shut-off valve, located on the lower exterior of the trailer below the range, must be turned off when towing the trailer, when changing the gas tank, or if the gas supply is turned off for any reason. Be sure oven and top pilot (on models so equipped) lights have been relighted as soon as range shut-off valve is turned on. If the range has not been operating for a long time, a longer waiting period for ignition of the pilot may be necessary due to air in the gas lines.

To light the pilots (models with oven and top pilot):

1. Be sure all valves are in the "OFF" position. The oven thermostat dial should be in the "PILOTS OFF" position.
2. Turn on main gas supply to range.
3. Depress and turn the thermostat dial to the "OFF" position.
4. Lift main cook top panel and light top burner pilot with a match.
5. Open oven door and light pilot with a match. A small flame will be noted at the top of the pilot burner.

To light top burners (on models without top burner pilot)

1. Be sure gas supply line valve is in open position. This valve is located on the lower exterior of the trailer below the range.
2. Place burning match over burner, press burner knob in and slowly turn knob counterclockwise until burner ignites.

3. Continue to turn burner knob clockwise until desired flame is established.

The oven thermostat control knob (See Fig. 2) is combined with the constant oven and top burner pilot shut-off (on models so equipped). For normal use: turn only between "OFF" and "BROIL". When traveling, turn to "PILOTS OFF". Relight only when you want to use the range, by turning from "PILOTS OFF" to "OFF" and lighting oven pilot with a match.

Range Top Section

The range is equipped with orifices for use with L.P. gas only. The flame will be approximately 1/2 inch long. Do not attempt to adjust gas to burner. The orifices have no readjustment.

Top burners have pre-set air openings and need no adjustment.

Top burner pilot adjustment (on models so equipped):

Adjust top pilot so that tip of flame is just over the edge of inner cone. Top burner pilot adjustment screw can be reached by removing the thermostat knob (See Fig. 2.) Burners should light within 4 seconds. If lighting is difficult, check height of pilot.

Warning: Never allow the top cover to be closed while the range is in operation, as this could extinguish the flame and permit gas to escape into the trailer.



Fig. 1 - Range and Oven

Oven Section

The thermostat on your oven does not have a by-passing setting. It will cycle off and on at all temperature settings except broil. No by-pass adjustment is necessary. There are no oven pilot adjustments on the thermostat. Control has been factory preset for use on L.P. gas. No field adjustment is necessary. The air shutter has been adjusted at the factory, however, it may require additional adjustment when used at high altitudes.

To adjust main oven burner air shutter:

Open air shutter to the full open position where you have a blowing condition. Begin closing the shutter slowly. When you reach the correct adjustment, blowing will stop. Burner should have a sharp blue flame approximately 3 inches long.

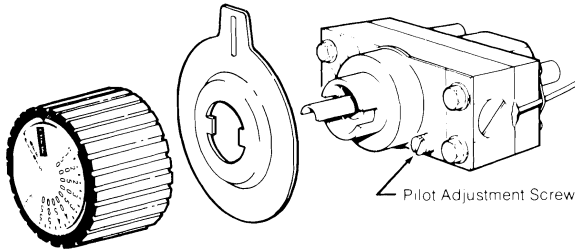

Fig. 2 - Oven Thermostat

Important: Your oven is equipped with a **safety ignition** that requires a minimum of 30 seconds to operate after turning the oven control knob on. The oven pilot may be slow in lighting due to air in the gas lines.

Cleaning Instructions:

1. The main top has been hinged from the back so that it can be raised or removed for cleaning around the top burners.
2. When cleaning the top burner heads, care should be taken that all ports are opened up with a toothpick afterwards.
3. Spill-over or spotting in the oven or broiler are more easily cleaned when removed promptly after they occur.
4. An orange flame indicates dirt or dust getting into burner—clean burners.

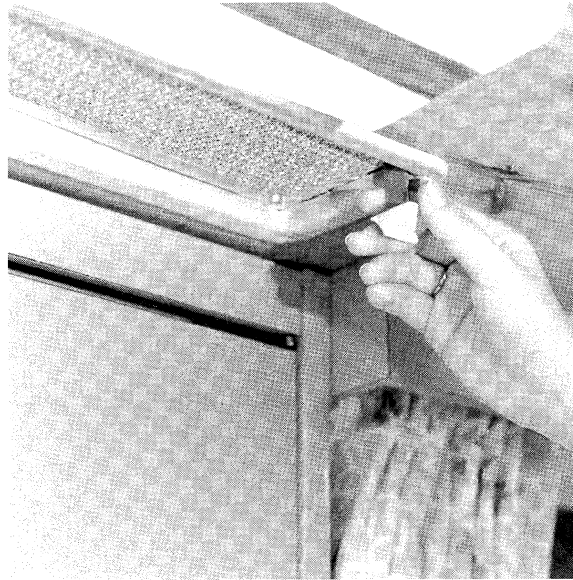

Fig. 3 - Range Exhaust Hood

Never wash porcelain when warm. Never use cleaning powder containing grit or acid. When oven bottom is replaced after cleaning and servicing, be sure that it is locked in place.

WARNING: Range or oven burners should never be used to heat the trailer.

The range exhaust hood (Optional on Caravelle and Minuet models) vents cooking heat and smoke from the trailer. To operate, push back on lever, located under the galley rooflocker at the end of the vent filter or down on lever located inside galley rooflocker. This will open the shutter. If your trailer is equipped with the optional fan, this will also turn on the switch. Clean the filter at least every six months

with warm water and detergent. To remove the filter, remove the screws that secure it to the housing and let it drop out while supporting it with your hand. Keep the vent housing clean of grease and dirt by frequent washing.

Additional information on the Range and Oven is available in the Service Manual.

Furnace

The furnace installed in your trailer is an American Gas Association approved Suburban or Duo Therm unit with pilot or optional electronic ignition designed specifically for travel trailers. It has a sealed combustion system with a dual blower for maximum air circulation. One blower circulates room air while the other draws in air for combustion. The louvered heat registers control warm air flow while cold air returns through the galley cabinet toe kick opening.

The heat duct system also circulates warm air around the holding tanks, and water tank, a vital feature when operating in below freezing weather.

The Suburban furnace is thermostatically controlled. When the thermostat calls for heat, the blower starts and only after it has reached nearly full speed will the burner light. After the temperature set on the thermostat is reached the blower will continue to run for a short time removing most of the remaining heat from the furnace as well as forcing the combustion gases from the heat exchanger. To turn the furnace off for an extended period of time, turn the thermostat and the gas valve to their "OFF" positions. The gas shut-off valve is outside the trailer below the furnace. Turn handle until it is perpendicular to gas line. Operating instructions are printed inside the furnace door.

Trouble-free operation of the Suburban furnace will depend on your adherence to recommended operating procedures and precautions. Regular preventive maintenance is important.

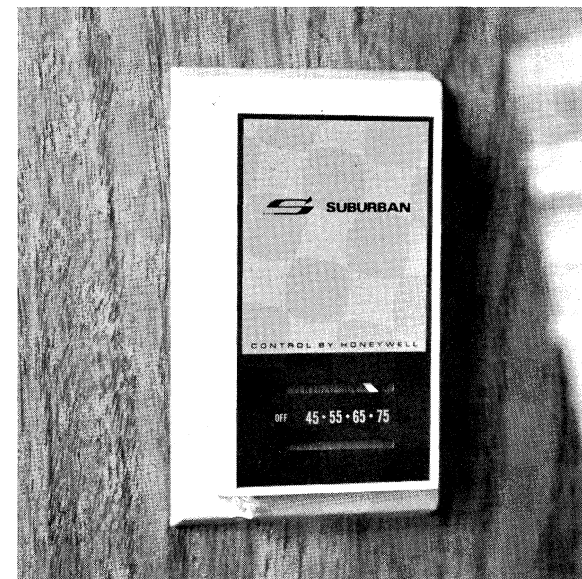

Furnace Thermostat

Recommendations and instructions are covered under "Maintenance and Cleaning" on page 81. Corrections of possible malfunctions presented here will be helpful in an emergency situation, but servicing should be done by a dealer. One note of caution regarding flue gases: they are vented from the furnace to the outside of the trailer through a vent in the outside wall. **Do not in any way obstruct this vent by placing clothing or other flammable material on the vent assembly.** Check it often to make certain it does not become clogged.

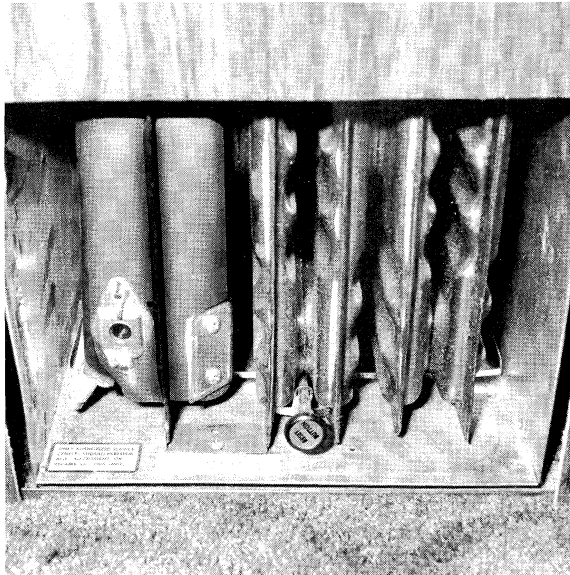

Furnace - Manual Ignition

Operating Instructions, Suburban Furnace (Electronic Ignition):

1. To light the furnace, turn the manual valve to the "off" position and wait 5 minutes with blower running. (Set thermostat above actual temperature to operate blower.)
2. After 5 minutes, set the thermostat to the "off" position.
3. Open manual valve. (Correct operating characteristics depend on this valve being positioned fully open, handle parallel with gas line. Never attempt to operate with valve partially closed.)
4. Set thermostat on desired temperature.
5. If burner does not light, set thermostat on "off" and repeat steps 1 thru 5.
6. If after 3 tries and no ignition, go to shut down and determine cause. Do not attempt to light burner with matches.

To shut down

1. Turn manual valve to the "off" position, perpendicular to gas line.
2. Set thermostat on "off".

Operating Instructions, Suburban Furnace (Manual Ignition):

Set the thermostat to the "OFF" position, unlatch the furnace door and open it. Turn the manual gas valve on the lower exterior of trailer below furnace to on (handle parallel with gas line). Remove the lighter hole cover, depress the reset button and hold it in. Light the pilot. After the pilot is lit, keep the reset button depressed for thirty seconds. Release the reset button and the pilot should remain lit. If the pilot goes out, repeat the above steps keeping the reset button depressed for a longer period of time. The pilot may not light immediately due to the presence of air in the gas line. It may be necessary to hold the reset button in for a minute or more before the pilot ignites. Replace the lighter hole cover as soon as the pilot is lit, close the front access door and set the thermostat. If the furnace has just gone out, turn the manual gas valve off and wait 5 minutes before attempting to relight the pilot.

Differences in pressure between the room air and the outside air may cause a strong draft to come through the heater once the lighter hole cover is removed. Opening a window or the temperature will have no effect on furnace operation once the lighter hole cover has been replaced.

Caution: The air shutter adjustment cover must be tightly secured for proper operation of the heater.

Operating Instructions, Duo Therm Furnace (Manual Ignition):

Important - Failure to follow the lighting instructions exactly may result in damage to the unit.

1. Set thermostat to highest setting. Remove front panel.
2. Turn gas valve knob inside furnace cabinet on left hand side facing furnace to "off" position. Wait 5 minutes.
3. Reset thermostat to "off" setting.
4. Turn gas valve knob to "pilot" position. Open pilot lighting door. Depress gas valve knob and light pilot with a match. Close pilot lighting door.

Note: On the initial lighting the pilot may not light immediately due to air in the gas line. If such is the case, it may be necessary to hold the reset button "in" for a minute or more before the pilot lights.

5. When the pilot continues to burn, hold the reset button in for approximately 30 seconds or until the pilot remains lighted when the reset button is released. **If pilot goes out, repeat steps 2 and 4, allowing longer time before releasing gas valve knob.**
6. Turn gas valve knob to full "on" position. Correct operation of the unit depends on this valve being in the full "on" position. Never attempt to operate the unit with valve partially closed.
7. Replace furnace front panel.
8. Set thermostat at desired temperature. Furnace will now operate automatically.

For Complete Shut-Down Press Valve Dial And Turn To "Off". Set Thermostat To "Off" Setting.

If your fuel supply is depleted the main burner will go into lockout. To reset the lockout, turn gas valve to "OFF" and set thermostat to "OFF". Wait 5 minutes and return to operation.

Adjustment of main burner (Primary air): Set the furnace into operation by advancing the thermostat and allow to run until it reaches near-maximum operating temperature. Observe the main burners through the burner observation window. The flame should be without a trace of yellow and be "sitting" on the burner. As the furnace was tested at the factory before shipment, it may be found that the primary air is already in proper adjustment. However, adjustments may vary from one location to another due to differences in elevation and in characteristics of the fuel gases.

If the flame burns yellow or "lifts" off the burner, it needs adjustment. Take out the screws retaining the rectangular cover plate and lift the plate off.

Inside the opening is a threaded rod with the visible end slotted to receive a screwdriver. By turning the rod you will adjust the position of the main burner air shutter. This air shutter should be adjusted to the point where a hard blue flame is present at the burner. Replace the cover and check to be certain that the flame is still hard blue. **Caution: The primary air adjustment cover plate must be in place for proper operation of the furnace.**

Note: If burner is allowed to operate in yellow condition, "soot" will accumulate on vent cap and in radiators. This should not be allowed to occur.

When the humidity is high inside your trailer and you wish to remove moisture, open a roof vent and turn on a vent or open a window slightly for cross ventilation.

The most common cause of pilot operated furnace failure is pilot outage, the inability of the pilot to stay lit unless the reset button is depressed. The trouble is usually in the thermocouple, which is located inside the cover plate near the pilot light. Check to see that the end of the thermocouple lead is screwed firmly into the safety valve and that the joint is clean.

The furnace can be used to circulate air during hot weather by shutting off the gas valve and turning the thermostat up higher than the temperature in the trailer. Return the thermostat to "OFF" setting whenever the furnace is not in use.

Additional information on the Furnace is available in the Service Manual.

Maintenance and Cleaning

We recommend that the furnace be inspected and thoroughly cleaned by a qualified service agency before each heating season. This would include the combustion chamber, the main burner, the blower assembly, and all control parts. A careful inspection of all gaskets should be made and if any gaskets show signs of leakage or deterioration, they should be replaced.

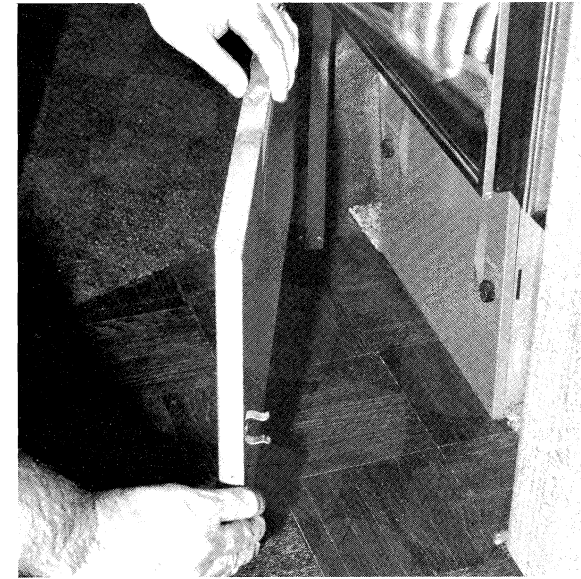

Furnace Access Door

Cleaning of the chamber and main burner will be required if the unit has been allowed to operate with a high yellow flame. The yellow flame is due to incomplete combustion (lack of air) and will deposit a soot formation inside the chamber and on the main burner.

To clean the chamber, main burner, blower assembly and controls, the chamber assembly must be pulled from the furnace. (See instructions for removing chamber.)

The furnace is equipped with an oiled, sealed motor and requires no oiling.

Water Heater

The Atwood-Bowen Gas Water Heater is equipped with an LP gas pressure regulator control with a 100% shut-off safety valve which shuts off the gas supply if the pilot flame is extinguished or the water temperature becomes excessively hot. **It is lighted and serviced from the outside through a hinged access panel.**

Procedure for lighting or relighting:

1. **Be sure the water heater is filled with water.** To fill, connect hose to city water supply or turn on water pump. Turn on galley or lavatory hot water faucet and allow water to run until all air is expelled.
2. Turn gas supply line valve, on the lower exterior of the trailer below the water heater, to the "ON" position (valve handle parallel with gas line).
3. Turn Lighting Control dial "A" to "Pilot" position and hold against stop while lighting pilot burner. Allow pilot to burn approximately one half minute before releasing dial.
4. Turn dial to "ON" position. If pilot does not remain lit, repeat operation allowing longer period before releasing dial.
5. Position temperature lever "B" to desired comfort.
6. To shut down the water heater, turn the gas cock knob to the "OFF" position.

If the **pilot flame** does not have a small orange tip, the pilot is not getting enough gas. The flame should be about $\frac{1}{4}$ inch in vertical height when the water in the tank is cold and the burner is off, $\frac{1}{4}$ to $\frac{3}{8}$ inch in horizontal length when the tank is warm.

A large orange flame indicates excessive gas supply, which will result in short pilot life and early replacement. The pilot has been properly adjusted at the factory and should operate with a blue, orange tipped flame enveloping the pilot thermocouple. The flame is adjusted by using pilot gas adjustment screw (C). **Turning this screw clockwise reduces** the flow of gas to the pilot (blue flame) and counter-clockwise, the gas supply will increase (orange flame).

All fuels depend upon air (oxygen) to give them proper burning characteristics. A yellow, smoking flame indicates a lack of air and a noisy hard blue flame indicates too much air. The air shutter slides back and forth along the burner tube and is held in place by a small shutter adjustment screw (D). Loosen the screw for adjustment. A good method of adjusting the air shutter is to slide the shutter to the right until yellow tipping occurs on the main burner flame (not the pilot) and then slowly slide the shutter to the left until all signs of yellow tipping are gone. When proper adjustment has been obtained, tighten the screw holding the air shutter. The outside access door must be kept locked for proper operation.

NOTE: If you wish to bypass your water heater in order to cut down on the amount of antifreeze necessary when winterizing (see page 35), you may purchase a kit for this purpose from a Wally Byam Store.

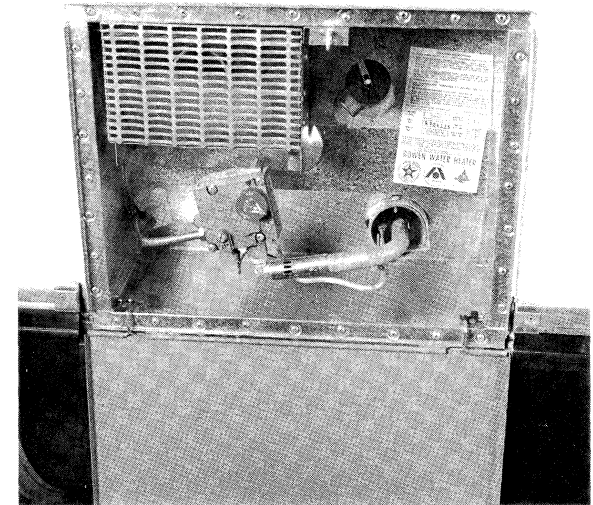

Water Heater Access Panel

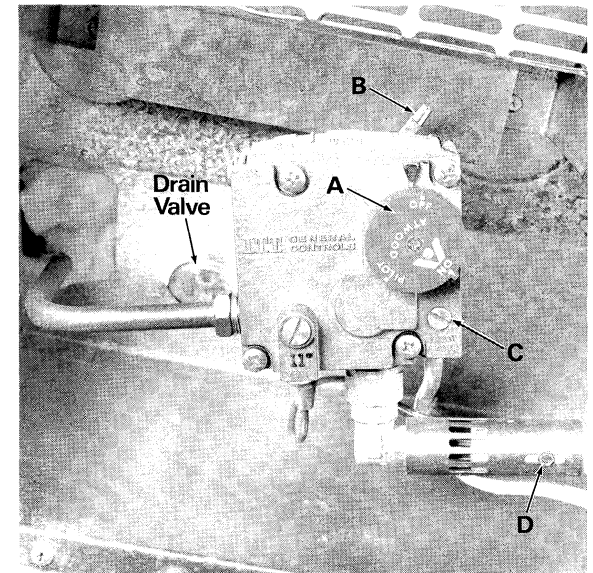

Water Heater Controls and Drain Valve

Water System

The trailer water system provides full service both when the trailer is self-contained or when city water is available. Water heater capacity is 6 gallons. The water tank stores clean fresh water for all your needs.

When self-contained, the water pump should be turned on. The switch is located on the Central Control Panel in the refrigerator roof locker or on the wall above the galley or under the galley rooflocker of your trailer. With the water pump switch on, the water pump will run whenever a faucet is opened, and will shut off when the faucet is closed.

Note: The water pump must be turned off when hooked up to city water supply and when you leave your Airstream unattended.

The **water pump and filter** are adjacent to the water heater in the bathroom cabinet on 28' and 31' T&D, rear bath models in the roadside bedroom wardrobe on 25' T&D models, in the roadside double wardrobe on 31' center bath and in the roadside front corner on all Caravalle and Minuet models. The filter screen should be cleaned periodically to prevent accumulation of dirt and sand. To remove the screen, disconnect the rubber hoses from both ends, separate the screen housing, remove the screen, clean and replace.

For city water supply, connect a ½" minimum high pressure hose to city water supply and to the water inlet fitting (see Figs. 1 and 2), see floor plan illustrations on pages 45-53 for locations. Turn the water on and slowly open

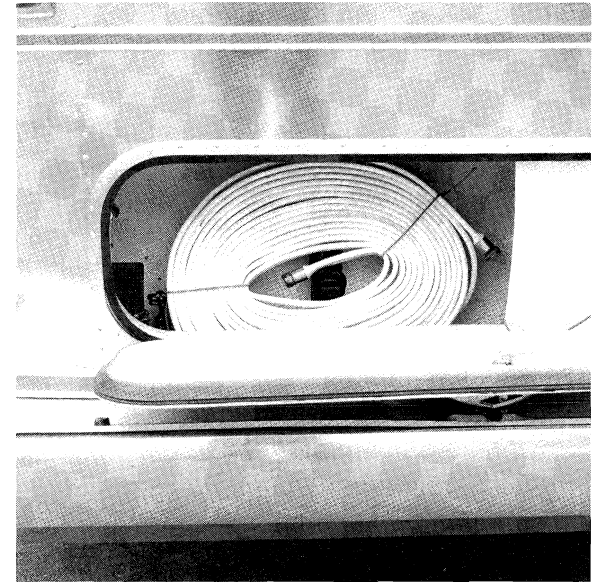

Fig. 1 - Water Hose Storage

an inside faucet until the water flows free of air. The system will now be ready for use. If you are staying for some time where city water is available, you may want to drain the water storage tank. To drain the tank, open faucets and turn the water pump switch on until the tank is empty. Be sure to refill the tank with fresh water before departing. The system has check valves in the water lines to protect the water tank while you are connected to the city water supply.

The **water tank** is located under the floor between the axles on Excella II, International, and Argosy models and on the floor in the front of the trailer on Caravalle and Minute models. To fill the water storage tank, open the filler spout (See Fig. 3, page 84) on the exterior wall above the center of the roadside wheel well on

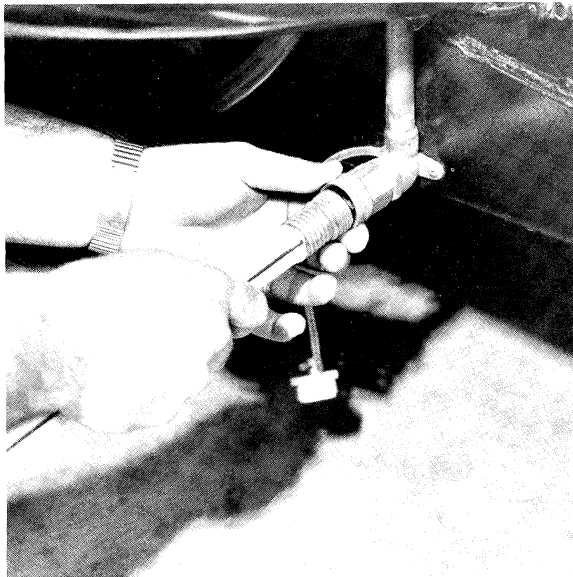

Fig. 2 - City Water Hook-Up

Excella II, International and Argosy models and in the front roadside corner on Caravelle and Minuet models, and fill with a hose or a bucket. Close and lock the spout and the water system is ready for use.

To clean the tank, pour some bicarbonate of soda into the filler spout with several gallons of water and allow to stand for a minimum of four hours. Then flush the tank out by opening a faucet, allowing the water pump to drain the system. Then refill with fresh drinking water. If the water tank must be cleaned further, the following procedure is recommended.

1. Prepare a sodium hypochlorite solution using potable water and household bleach (5 ¼ to 6%) in the ratio of ¼ cup of bleach to 1 gallon of water. (Common household bleaches are Purex and Clorox.)

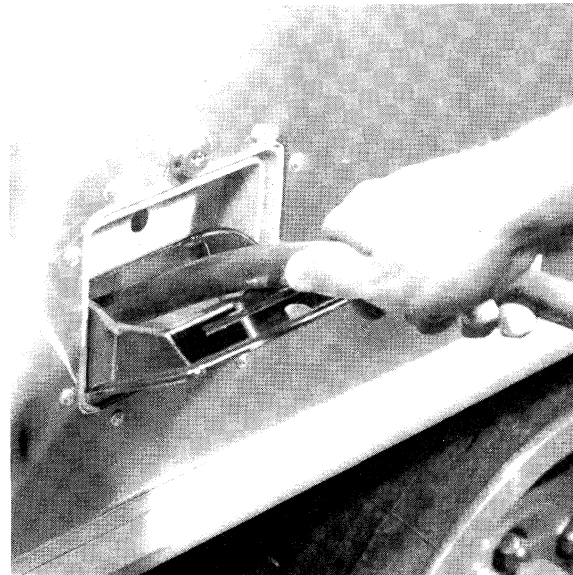
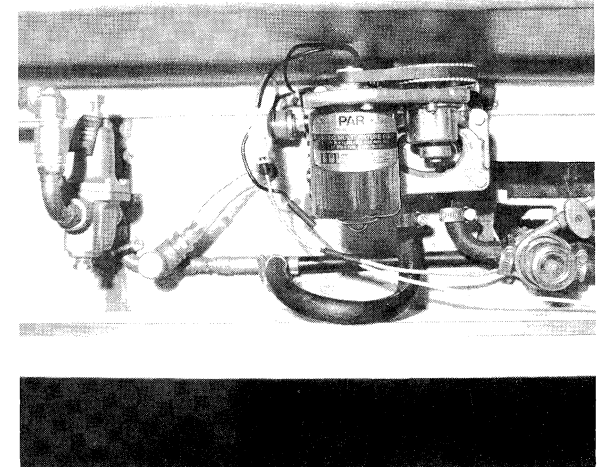

Fig. 3 - Water Tank Fill Spout

2. Pour 1 gallon of hypochlorite solution for each 15 gallons of capacity into the empty water tank.
3. Add enough potable water to completely fill the water system.
4. Allow closed system to stand for three hours.
5. Drain the hypochlorite solution from the system and refill with potable water.
6. Excessive hypochlorite taste or odor remaining in the water system is removed by rinsing the system with a vinegar solution mixed in the ratio of 1 quart of vinegar to 5 gallons of water.
7. Drain the system and flush with fresh drinking water.
8. Drain the system and refill with fresh drinking water.



ITT - Water Pump and Filter

The **optional Everpure QC-2 Water Filter** is located under the galley sink. It will remove even very fine dirt and colloidal matter, and eliminates most chlorine, phenol and similar distasteful odors and tastes, while delivering sparkling taste-free water for drinking and cooking. The filter is connected to the cold water galley drinking faucet only. The filter will also remove iron and sulphur provided the water supply is chlorinated. Super-chlorination will precipitate the iron and sulphur which will then be removed by the QC-2 Filter. To purify any questionable water, fill the Everpure Chlorine Disinfectant Dispenser with liquid bleach and add 1/6 ounce (one teaspoonful) per 10 gallons of water in the water tank. The

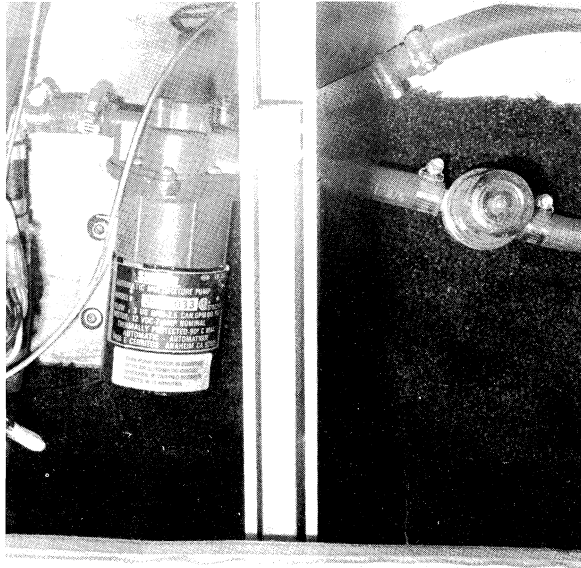

Shurflo - Water Pump and Filter

water will remain sparkling clear even to the end of the filter pack life, however as the minute pores slowly fill up with impurities the flow rate will be gradually reduced. When it becomes too slow for convenience, the cartridge can be very simply changed. Follow the instructions on the cartridge. We advise keeping a spare cartridge at all times.

To remove used cartridge:

1. Shut off water by lifting valve handle counterclockwise as far as possible.
2. Turn colored ring all the way to the left. Ring will drop about 5/8".
3. Lift cartridge slightly and turn it further to the left until it can be disengaged.
4. Lower cartridge to disengage it from ring. Discard used cartridge.

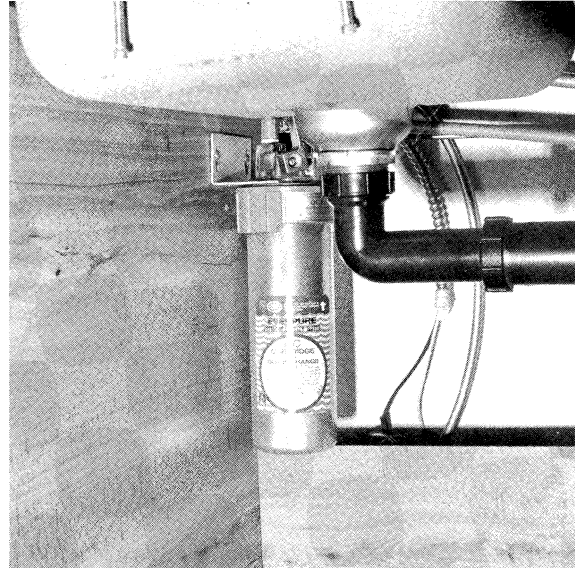

Everpure Water Filter

To install new cartridge:

1. With colored ring in lowered position (turned all the way to the left), orient lug on cartridge with cutout under label on ring.
2. Insert cartridge straight up into ring as far as it will go. Holding colored ring steady, turn cartridge as far to the right as possible, without forcing.
3. Then turns colored ring far to right to drive cartridge up into head.
4. To lock ring in place and turn water on, move valve handle down. Be sure handle leg engages ring locking-lug.

The **water pressure regulator** protects the plumbing inside your trailer. Regardless of the variation in city water pressure, the pressure at the faucet is kept constant.

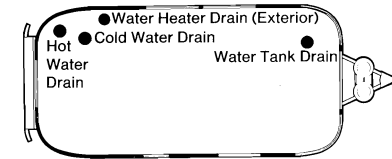

20 Ft. and 22 Ft. Models

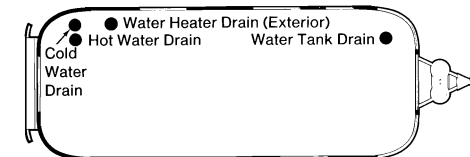

24 Ft. Models

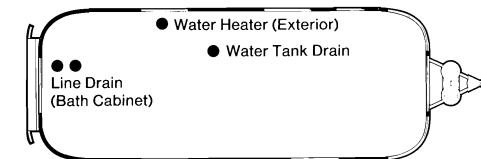

25 Ft. Rear Bath Models

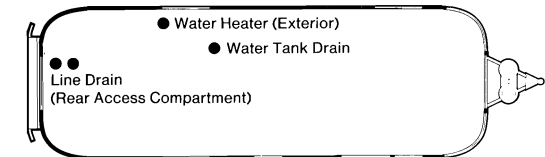

28 Ft. and 31 Ft. Rear Bath Models

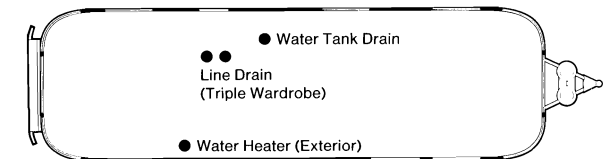

31 Ft. Center Bath Models

● Drain Valve Locations

The water system has built-in drain valves to protect it from winter freezing. For complete details see Storage and Winterizing, page 35.

Drain and Waste System

Your trailer has a drain and waste system that includes waste holding tanks made from molded plastic, free from corrosion problems, with trouble free dump valves. The **main holding tank** enables you to use the toilet for several days away from disposal facilities. The waste water from the sink, shower, bath and lavatory drains into the **auxiliary holding tank**. Each tank has its own dump valve, however, both tanks drain through a common outlet. Therefore you need to make only one connection when hooking up in a trailer park with sewer facilities.

When the toilet will no longer drain, the main holding tank is full and must be emptied. Watch this closely, because **when the tank is full, sewage cannot be emptied from the toilet bowl.** In models with a central control panel, check the main holding tank gauge. The auxiliary holding tank must be emptied when the gauge on the central control panel indicates full.

On 28 and 31 ft. rear bath models the **dump valves** are located in the rear trunk compartment. The main holding tank dump valve is located on the roadside and the auxiliary holding tank dump valve is located on the curbside. (See illustration.) On 31' center bath models the dump valves are located on the roadside, just behind the rear wheels, on the main frame rail. The main holding tank dump valve is located aft of the sewage outlet. On the 25' T&D the main holding tank dump valve is located under the rear bumper storage compartment and the auxiliary holding tank dump valve is located next to the sewage outlet on the roadside main frame rail just forward of

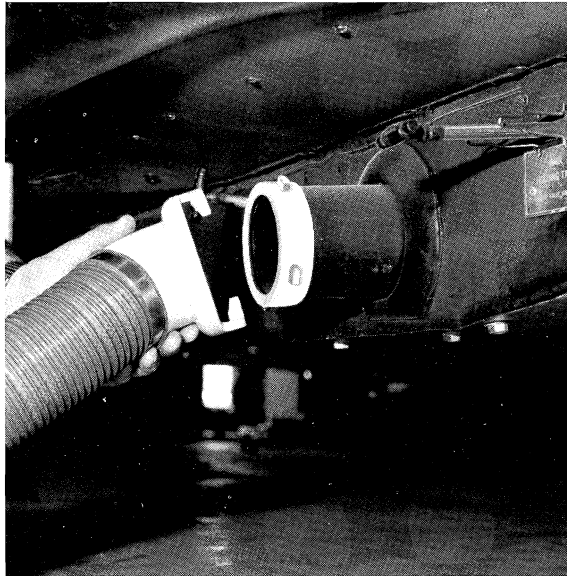
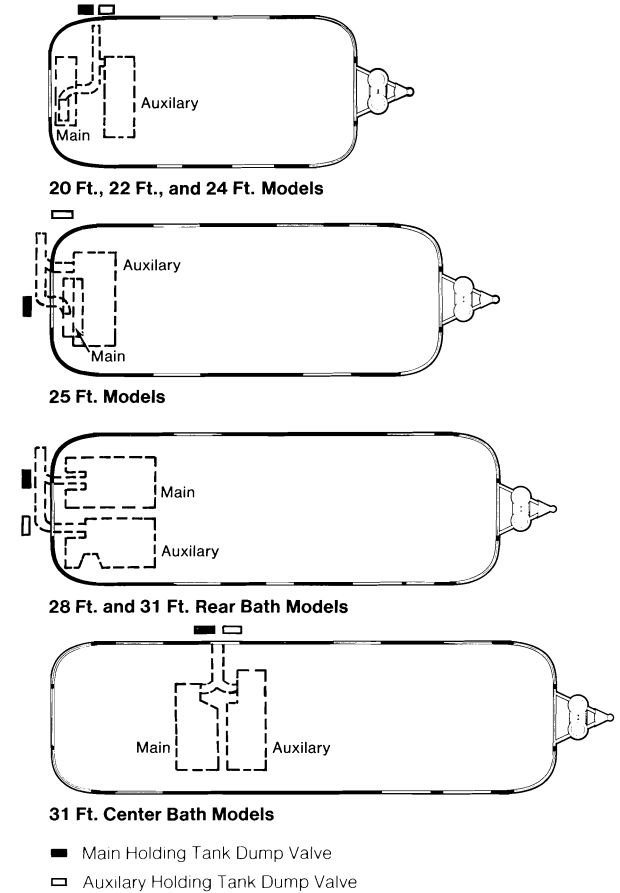

Fig. 1 - Waste Drain Hose Hook-Up

the bumper. On Caravelle and Minuet models, the dump valves are located under the rear roadside corner of the trailer.

To empty one or both tanks attach the sewer hose by pressing the bayonet fitting onto the dump valve outlet and rotate clockwise until it feels solid and secure. (See Figure 1) Attach the outlet end of the hose to the sewage outlet, making sure that the hose is placed so it will drain completely. The dump valves have two wire loops that lock the handle in the closed position. To unlock push outward on the wire loops and they will snap loose, permitting you to open the valve. Pull the dump valve handle as far as it will go and wait until the tank is drained. When dumping, the main holding tank should be dumped first; then the auxiliary holding tank. This will help to rinse out the sewer line with auxiliary holding tank water.



Holding Tank Dump Valve Locations

The main holding tank must be flushed out until all paper and waste material is removed. Close the dump valve and refill the tank with clean water and repeat until clean.

On 28 and 31 ft. rear bath models, a convenient fitting for flushing the holding tank is in the center of the rear trunk compartment.

Replace the plug after using the fitting. The sewer hose is stored in the rear bumper compartment. Rinse out the sewer line before storing.

When in a park and connected to a sewer outlet, keep the main holding tank dump valve closed and empty the tank ever few days or whenever it becomes almost full. **Only by sending a large volume of liquid through the main holding tank at a time will toilet paper and other solids completely wash away.**

This practice will avoid the accumulation of solids in the main holding tank which could lead to an unpleasant cleaning job. Should solids accumulate and close the dump valve, fill the tank about half full with water; then tow the trailer for a few miles. The turbulence and surging of the water will usually dissolve the solids into suspension so the tank can be drained. If your trailer is equipped with the auxiliary holding tank, keep the auxiliary tank valve open when connected to a sewer outlet.

The foot pedal **operated Aqua Magic** toilet employs a sliding self-cleaning positive seal blade. Odors cannot escape from the holding tank into the trailer. The unit uses less than 2 quarts of water for automatic flush. A special feature is the second pedal attached to the main foot pedal which, when pressed by itself, allows fresh water through either the fill rim or hand spray without opening the slide valve.

When conserving water, use the hand spray in the following way:

1. Hold the hand spray in ready position over bowl.
2. Depress thumb button and step on the foot pedal, which sprays water and dumps the contents at the same time.
3. Spray bowl clean.
4. Release foot pedal, shutting off water flow.
5. If you wish to refill bowl with water for next use, depress small foot pedal until water reaches desired level.

When using automatic flush:

1. Step on main foot pedal, and this will automatically open the slide valve and drop the waste into holding tank.
2. Hold pedal down until water begins to swirl. This fills rim storage and rinses the bowl.
3. Release the foot pedal. This will close the valve blade and stop fresh water from flowing. The bowl will refill automatically.

If you are certain to empty your holding tank every few days, you can use the toilet on automatic flush. It uses very little water and the tank will provide for the requirements of two adults from 2 to 4 days.

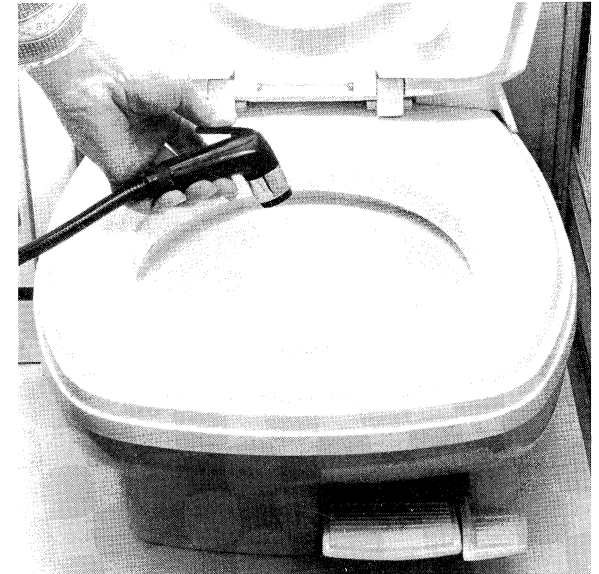

Toilet Hand Spray

Whenever water is scarce, the optional hand spray flush makes it possible to stay a week or longer in areas where you cannot empty the holding tank. In flushing for urine only, first, wet the bowl with fresh water, and again after use. Starting with a dry bowl takes more water for the final rinse. To flush for urine and solid matter: spray just enough water in the dry bowl to provide for floating the paper and solids. After use, rinse down the sides with the hand spray and empty the bowl. Hold the slide valve open and spray and rinse the lower surfaces. Even if it appears clean, quickly spray it one more time, then release the pedal and it is ready for the next use.



Fig. 1 - Aqua Magic IV

The **Aqua Magic IV** is equipped with two operating levers located on the right side of the toilet when facing the unit. To flush, pull the black lever forward (clockwise) until rinse clears bowl, release lever slowly. Movement of the flush lever opens the waste valve and allows waste to pass into the holding tank. Water fill is activated simultaneously with flush lever (black). The lever should be held open for several seconds to allow adequate flush water coverage of bowl to develop. The water fill lever (white) can be operated independently of flush lever (black) if more than the normal 2'' automatic bowl refill water is desired.



Fig. 2

There are certain items that should never be put into the toilet or tank. Facial and other similar tissues: because they have wet strength and do not dissolve easily. Toilet paper, especially white, dissolves well after a period of traveling.

Use only trailer sewage tank deodorizers. Antifreeze, ammonias, alcohols and acetones may cause damage to the tank, valve parts, tank fittings, and drain hose. For protection against freezing, use recommended fluids (see Winterizing, page 35).

Some state and federal parks prohibit draining sink and bath waters into the ground, although this is done in the wilderness. Your auxiliary holding tank will hold this water until you are at a dump area.

The **auxiliary holding tank should be flushed out periodically** to wash away sediments that may accumulate on the bottom of the tank. To flush, close dump valve, fill tank with water and then release dump valve. This volume of water will wash sediment away.

Additional information on the Drain and Waste System is available in the Service Manual.

Electrical System

The exclusive **Airstream Univolt System** enables you to use the lights and appliances whether operating on self-contained battery power or hooked up to 120 volt city power. This combination unit is designed for protection from damage up to and including a dead short. The 12 Volt light bulbs give off the same light as regular house-hold bulbs, so that when operating on self-contained battery power, everything works normally except the 120 volt convenience outlets and electrical operation of the refrigerator.

Convenience outlets for 120 volts and 12 volts are located throughout the interior of the trailer, see diagrams pages 92-100.

Exterior outlets for 120V are located on the curbside exterior wall, between the wheels, above the wheel well. (See Fig. 1.) (There is no exterior outlet provided on 20' models.)

When operating with city power, make very certain that the service is 120 volt and not 220 volt. Open the bumper storage compartment lid, uncoil only the needed amount of cord and plug it into the city power source. Before closing the lid, carefully place the cord in the opening provided for it.

The univolt system is a transformer designed to maintain constant output voltages regardless of the variances that occur in city power systems. The transformer design eliminates the need for complex electronic sensing systems to charge the battery, minimizing the possibility of failures and greatly increasing its overall reliability.

When the three pronged plug can be used, there will be no problems with proper polarity or grounding. In some older parks and other locations where three pronged outlets are not available, certain precautions to insure proper grounding and polarity must be taken. These precautions are listed below:

1. Attach the three pronged plug to a two pronged adapter. The third conductor line of this adapter has a short wire lead which must be grounded.
2. For proper grounding connect the short ground lead to a grounded outlet box or to a cold water pipe. When no water pipe is available, drive a metal rod two feet into the ground and attach the ground lug to it thus providing the unit with proper grounding.
3. Check the polarity light (see Fig. 2). If it is on, pull the plug, turn it over and reinsert. The light will now be out.

The **polarity warning light** may occasionally glow when the three wire system is in use, but your trailer is properly grounded, and in this case you may ignore the light.

To operate self-contained, simply disconnect the power supply cable.

The **stop and turn signal monitor**, optional on some models, is mounted on the front roadside of the trailer. It monitors the functions of the rear tail light, stop, and turn signal lamps. The uppermost window is for curbside and lower roadside. They light up if vehicle lights are on, get brighter if the stop light is operated, and flash if turn signal is working.

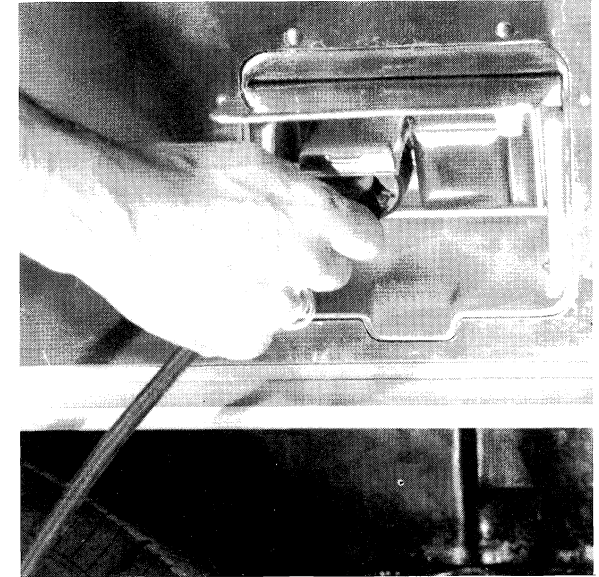

Fig. 1 - 120 Volt Exterior Outlet

The monitor is not electrically operated. It is connected to the respective lamp by means of fiber optics.

When your trailer is hooked up to 120 volt A.C. the **univolt system automatically charges the trailer batteries** and, if it is hooked up, your automobile battery as well. The speed and degree of charge depends on how much power is used for lights and appliances, as only the surplus goes to charging the battery. (Please refer to the specifications section for more information on power consumption.) If you are making an extended stay, then you should (if it is available) **keep your trailer hooked up to 120 volt current.**

Whenever possible, use the automatic built-in charger of the univolt system for charging. The charging circuit automatically controls the current, reducing it as the battery increases in charge. At service stations, make certain they give your battery a slow charge because quick charges will drastically shorten the life of the battery as will allowing repeated complete discharges.

The **low voltage fuse panel** is located on the center front wall of all 25', 28', and 31' trailers above the univolt. On models with a front lounge, it will be behind the lounge. On models with a front credenza, it is behind the folding table. In all 20', 22', and 24' models, the fuse panel is in the front roadside corner beneath the corner window.

On 28' T&D and all 31' rear bath models the **120 volt circuit breaker panel** is accessible in the bathroom cabinet to the right of the sink facing rear. On 25' T&D models, it is located in the cabinet to the left of the toilet. On 31' center bath models, it is located in the roadside triple wardrobe. In 20', 22', and 24' models, the 120V circuit breakers are located in the roadside bathroom wardrobe.

While you are connected to the 120 volt receptacle, the wiring is protected by circuit breakers in the breaker panel. In the event of failure of a 120 volt circuit, check your circuit breakers first. If a breaker continues to trip after you have reset it several times, your circuit may be overloaded with appliances or there may be a short in the circuit. If lessening the load does not solve the problem consult an Airstream/Argosy Service Center.

The 12V Univolt System is protected by a series of fuses (see illus., pages 106-107). Trouble with the electrical system is extremely unlikely, but if it should occur we recommend that you contact your nearest Certified Service Center for repairs. We have included a troubleshooting chart to be used in emergencies only. Details of electric motor amperage, light bulb size, and fuse and circuit breaker ratings are shown on the chart in the specifications section on pages 111-113.

When being towed, the 12 volt battery in your trailer is receiving a constant charge from the car's generator or alternator through the **Seven Way Connector**. The charge rate is controlled by your automobile's voltage regulator. It is important to keep the seven way connector clean: one method is to use "Spray-Kleen".

Additional information on the Electrical System is available in the Service Manual.

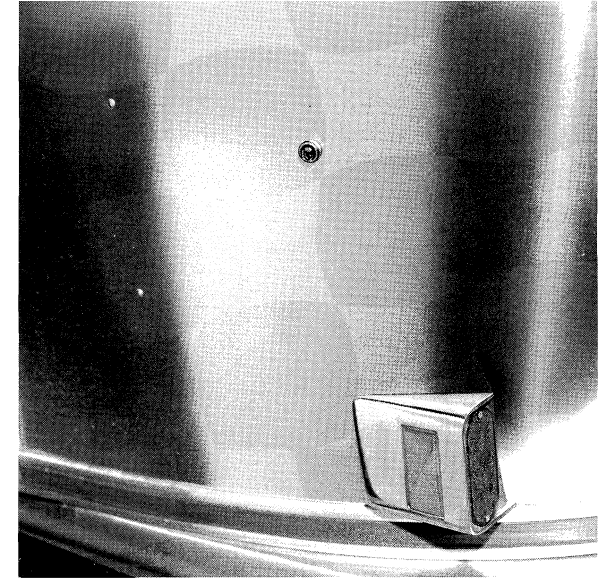

Fig. 2 - Polarity Warning Light

Battery

A normal battery can discharge by itself in 30 to 45 days when not in use, therefore, **it is necessary to periodically check the battery and charge it as is necessary.** We suggest checking the battery at least every two weeks in freezing weather. The temperature at which a battery will freeze depends on the condition of its charge. As an example, a fully charged battery with a specific gravity of 1.265 will not freeze until the electrolyte temperature drops to -71.3°F, while a discharge battery will freeze at +19°F. The following table shows the freezing points of batteries at various specific gravity readings, temperature corrected 80°F.

1.265	-71.3°F
1.250	-62°F
1.200	-16°F
1.150	+5°F
1.100	+19°F

Note: Do not add water to a battery in freezing temperatures unless the vehicle will be put to use at once, otherwise, the added water may freeze. Neglect is expensive. Care costs little. Check your batteries regularly.

Maintain a clean battery top and check terminals and cables for tightness and cleanliness. A dirty battery will dissipate its charge through surface contamination. Clean battery top with a damp cloth and dry thoroughly.

The terminals should be tight and free of corrosion. To clean terminals, neutralize with a solution of baking soda, rinse in clear water, and dry.

To insure maximum battery capacity on both charge and discharge, the battery terminals and the inside portion of the cable connector should be scraped or brushed until both of these surfaces are shiny bright. The cable connectors should then be reconnected to the battery and tightened. The complete assembly, battery post and cable connector should be coated with a heavy bodied mineral grease, petroleum grease or a petroleum jell.

Important: Reconnect the battery cables to the correct battery posts. The black cable should be connected to the negative (-) post and the red cable to the (+) post. The polarity of your tow vehicle must also be negative (-) ground since it must always match the trailer. Most tow vehicles are negative grounded, but always check your vehicle owner's manual to be sure.

Add water to cells as necessary. Check the electrolyte level at least once a month. When you are traveling steadily and for an extended period of time, or you are in climates above 90°F check the electrolyte level about every two weeks. Do not fill battery above the split ring in filler opening. **Do not measure specific gravity immediately** after adding water. The water must mix with the electrolyte by charging or by driving a few miles.

Caution: The gases generated within a storage battery cell may be ignited by an open flame or spark in the vicinity of the battery. Do not use a match or flame to provide light for checking the level of the water.

During the winter the battery should be removed from the trailer and stored in a cool, dry place, where there is no danger of freezing. It should be kept full of water, cleaned and charged monthly. A battery which is allowed to completely lose its charge will never regain its original power, or a full charge.

The battery is located in an exterior compartment curbside of the tongue on all 25, 28 and 31 ft. models. If optional 2nd battery is installed, it will be located in a similar compartment, roadside of the tongue. On all 20, 22, and 24 ft. models, the battery is located in the front roadside corner.

Slide the battery out onto the opened compartment door for service and removal.

For battery service or replacement, go to any service station or dealer who sells and services the make battery installed in your trailer. Original equipment batteries are rated for 105 amp. hours at 80°F.

Electrical Outlet Locations

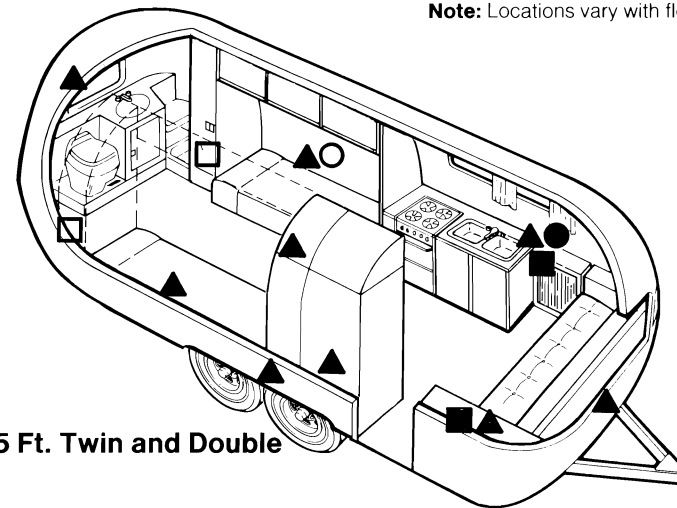
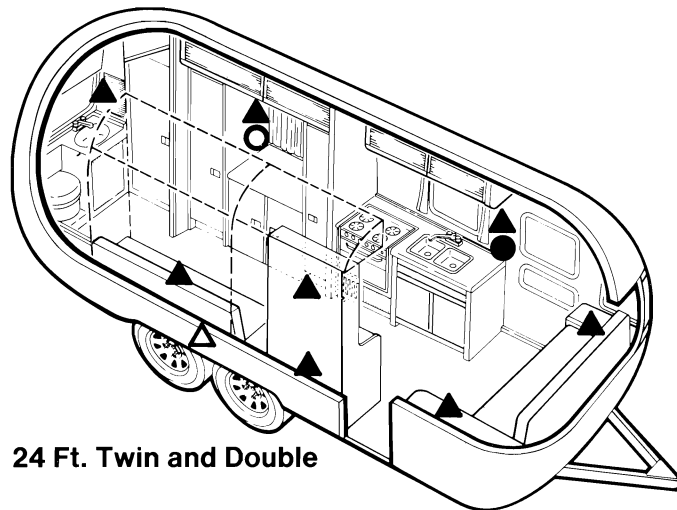
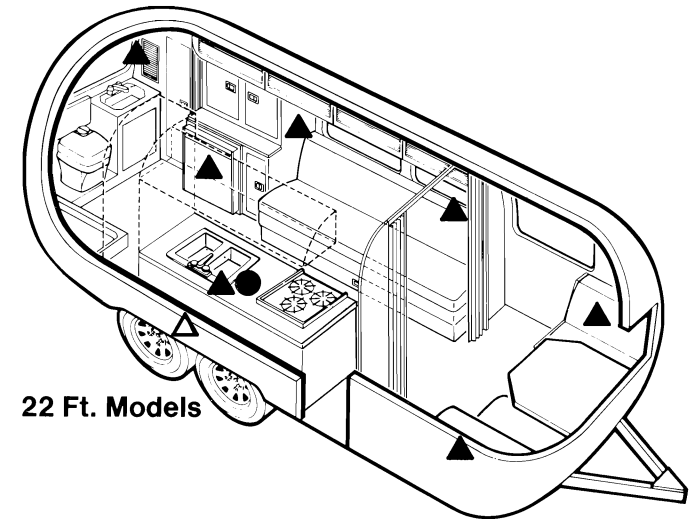
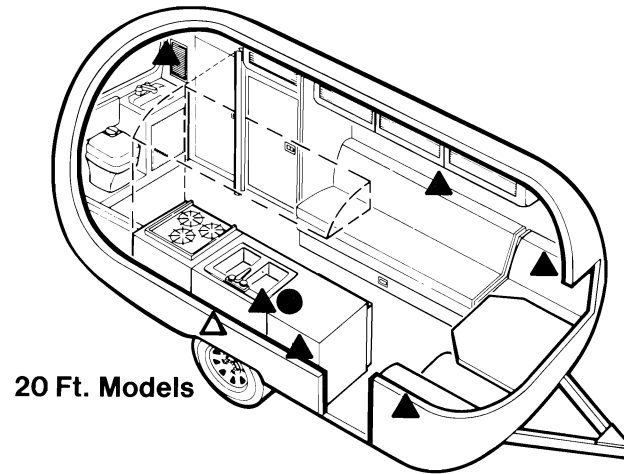

Note: Locations vary with floor plan and options ordered.

▲ 120 V (standard)

□ Telephone Inlet (optional)

● 12 V w/T.V. Jack (standard w/T.V. antenna)

△ 120 V (optional)

■ Telephone Jack (optional)

○ 12 V w/T.V. Jack (optional)

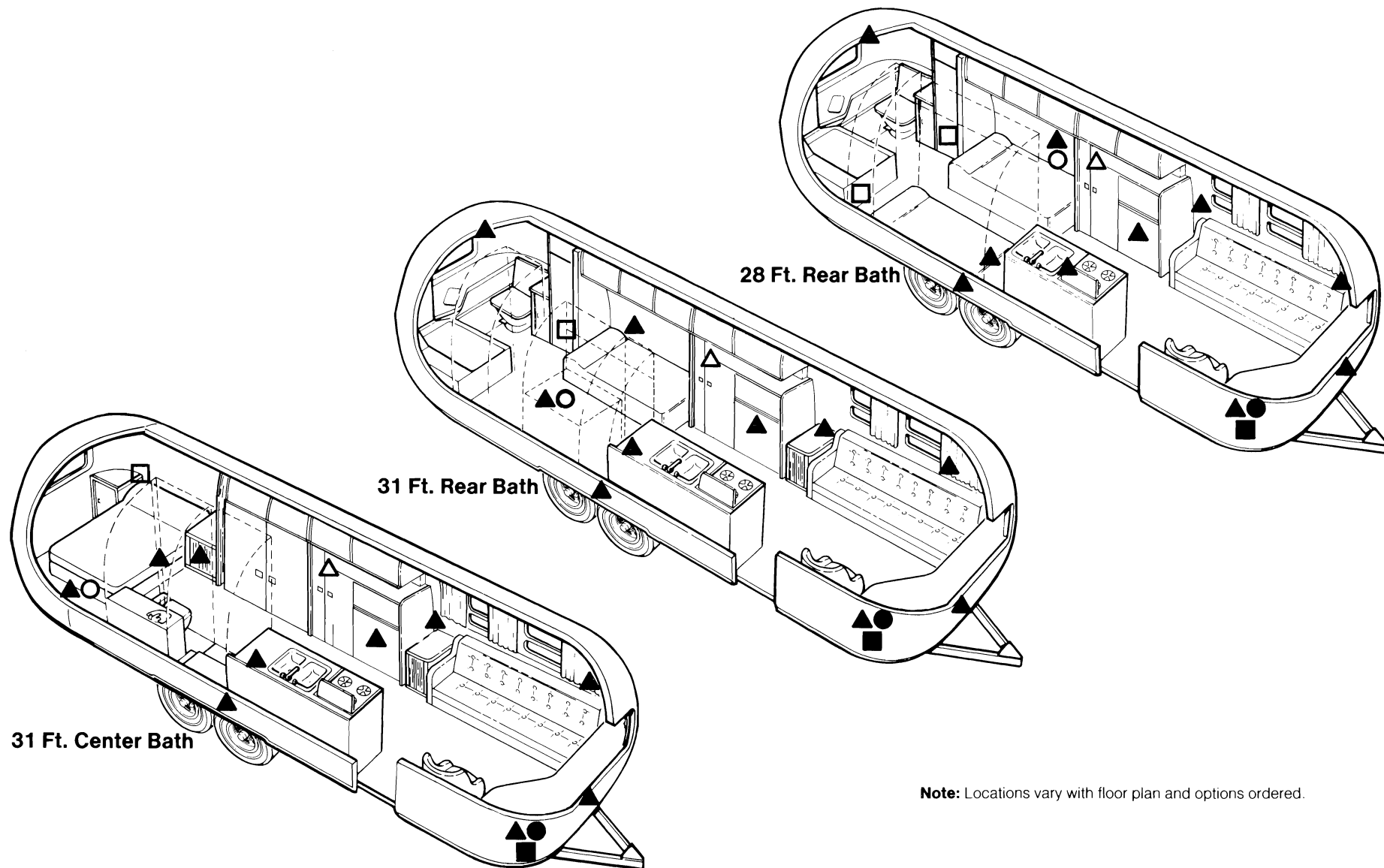

Note: Locations vary with floor plan and options ordered.

- ▲ 120 V (standard)
- △ 120 V (optional)
- Telephone Inlet (optional)
- Telephone Jack (optional)
- 12 V w/T.V. Jack (standard w/T.V. antenna)
- 12 V w/T.V. Jack (optional)

Electrical Wiring Diagrams

120 Volt Distribution System - 20 Ft. Models

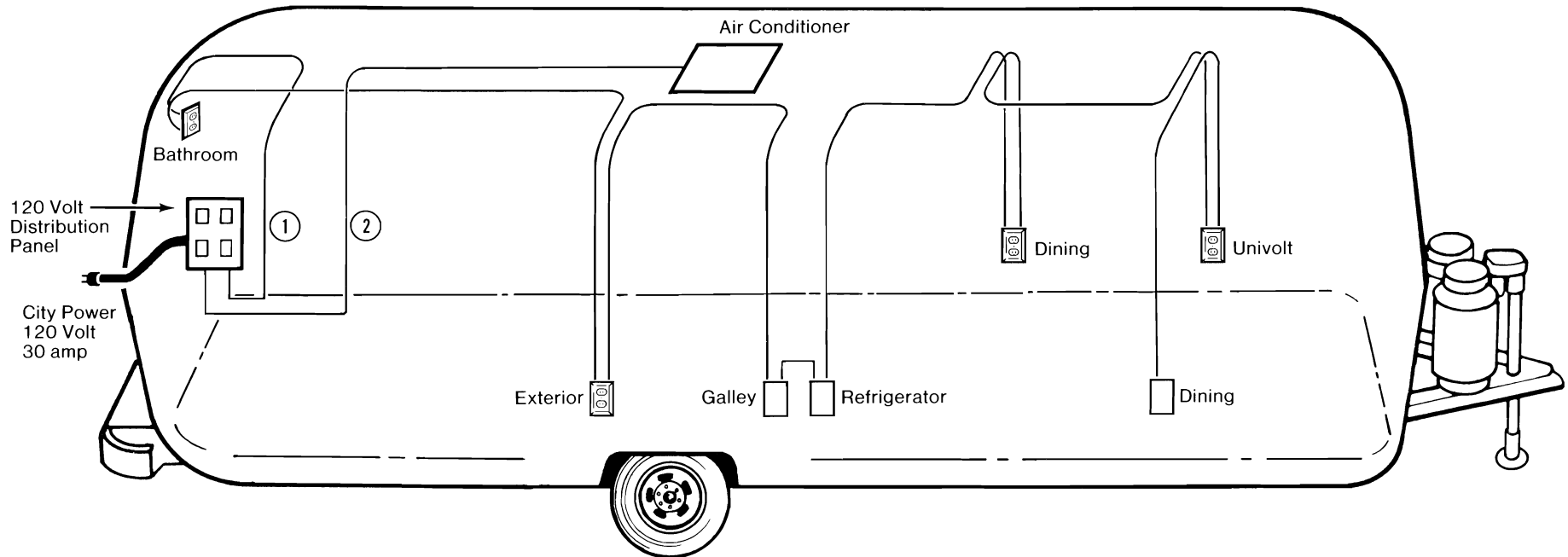

- ① Appliance Circuit 20 amp
- ② Air Conditioner 20 amp

120 Volt Distribution System - 22 Ft. Models

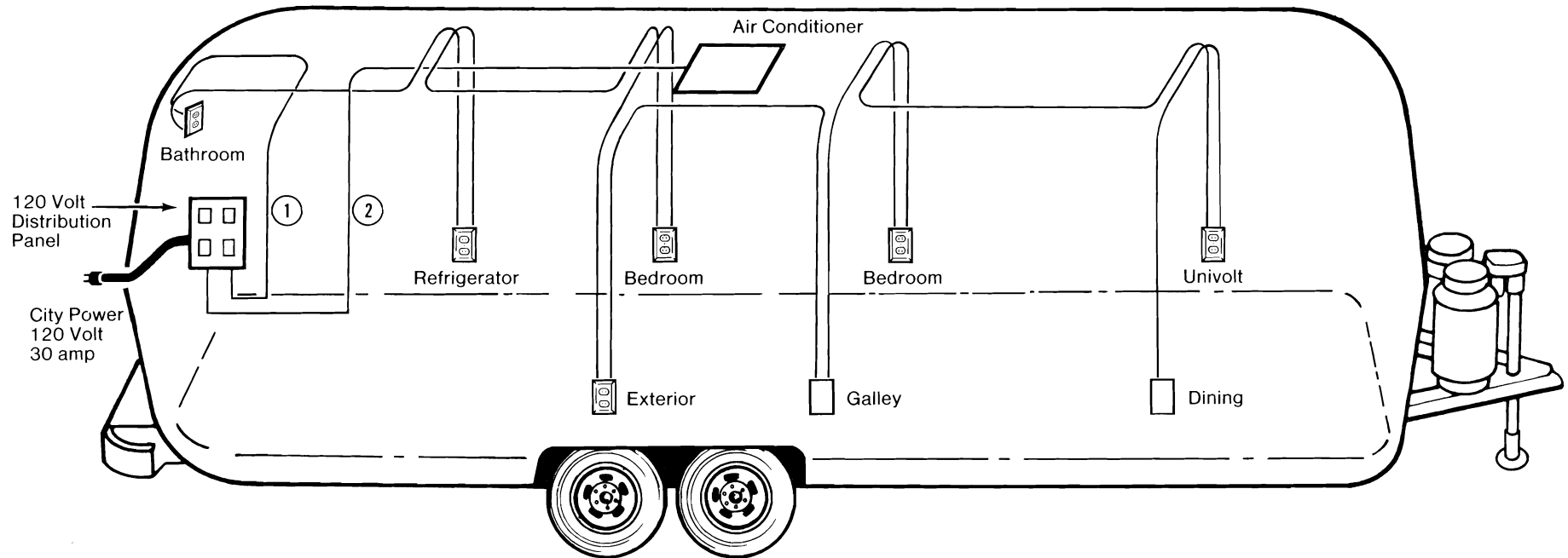

① Appliance Circuit 20 amp

② Air Conditioner 20 amp

120 Volt Distribution System - 24 Ft. Twin and Double

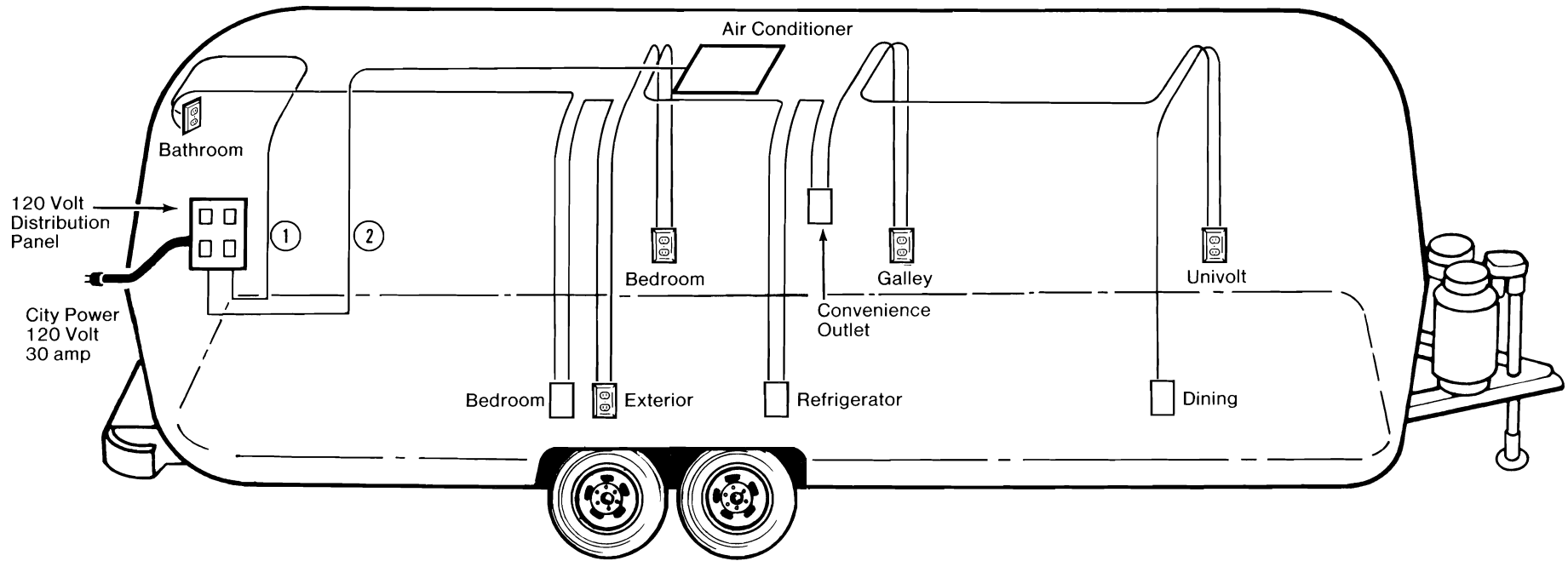

-
- ① Appliance Circuit 20 amp
 - ② Air Conditioner 20 amp

120 Volt Distribution System - 25 Ft. Twin and Double

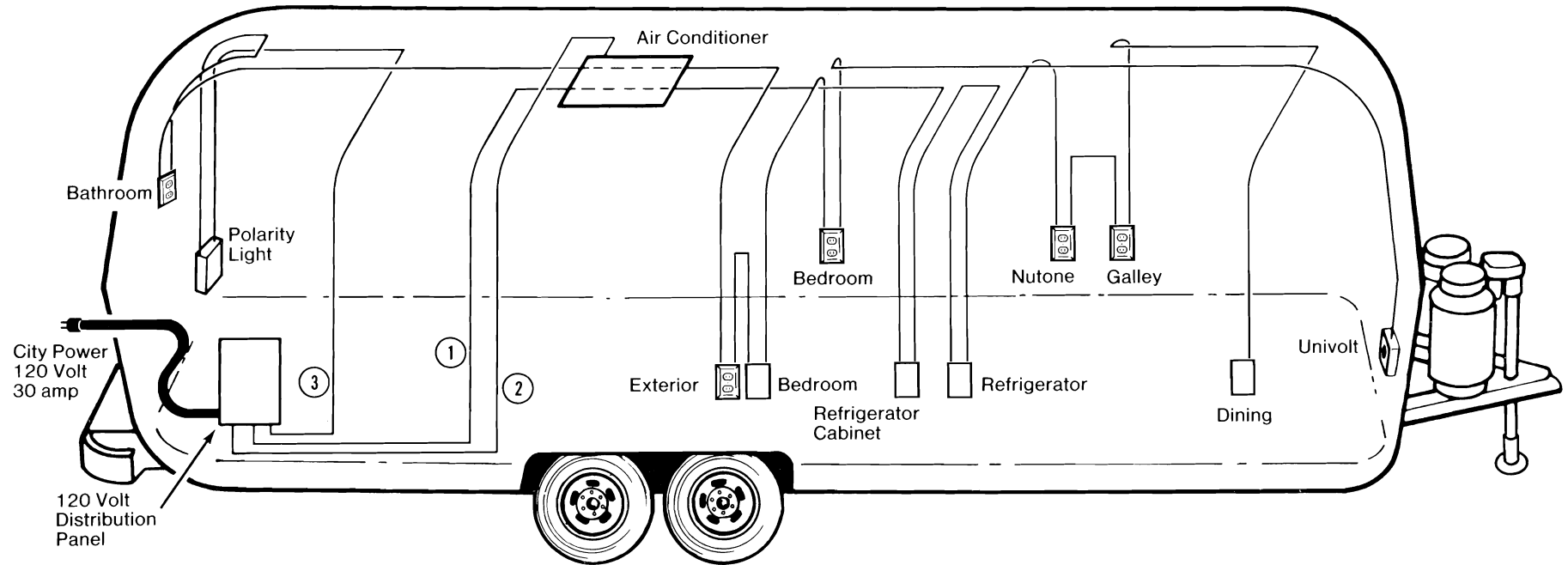

-
- ① Appliance Circuit 20 amp
 - ② Air Conditioner 20 amp
 - ③ General Circuit 15 amp

120 Volt Distribution System - 28 Ft. and 31 Ft., Rear Bath

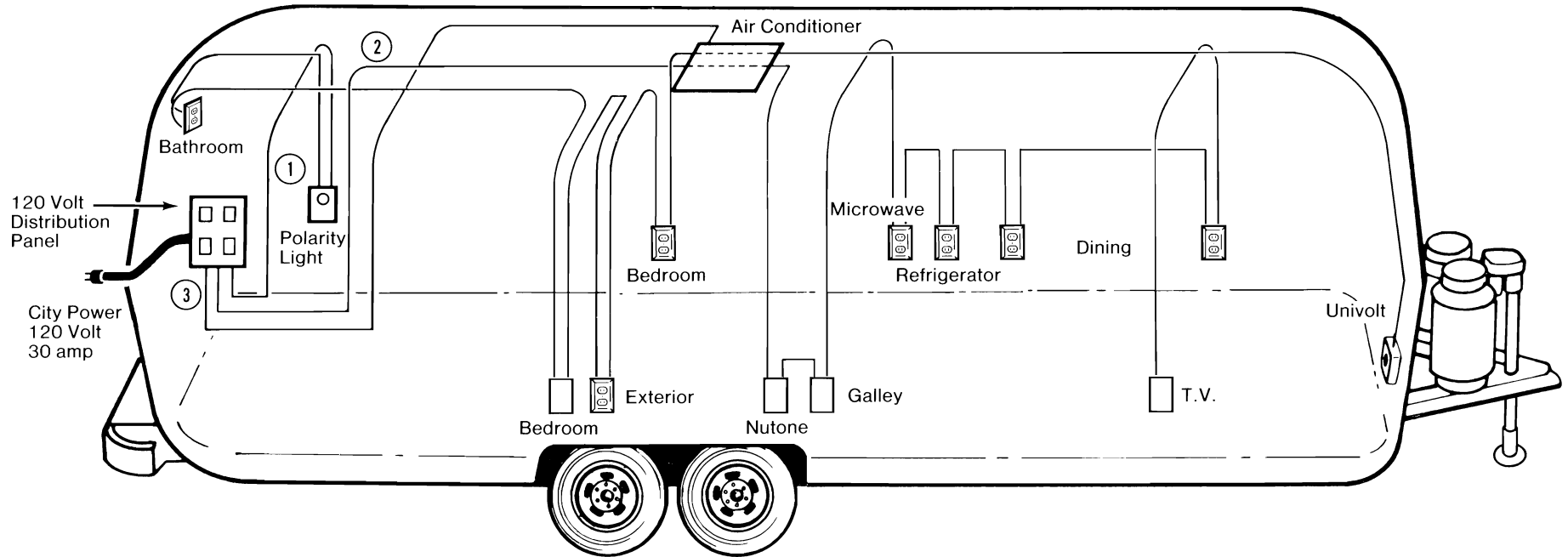

-
- ① General Circuit 15 amp
 - ② Appliance Circuit 20 amp
 - ③ Air Conditioner 20 amp

120 Volt Distribution System - 31 Ft. Center Bath, Twin

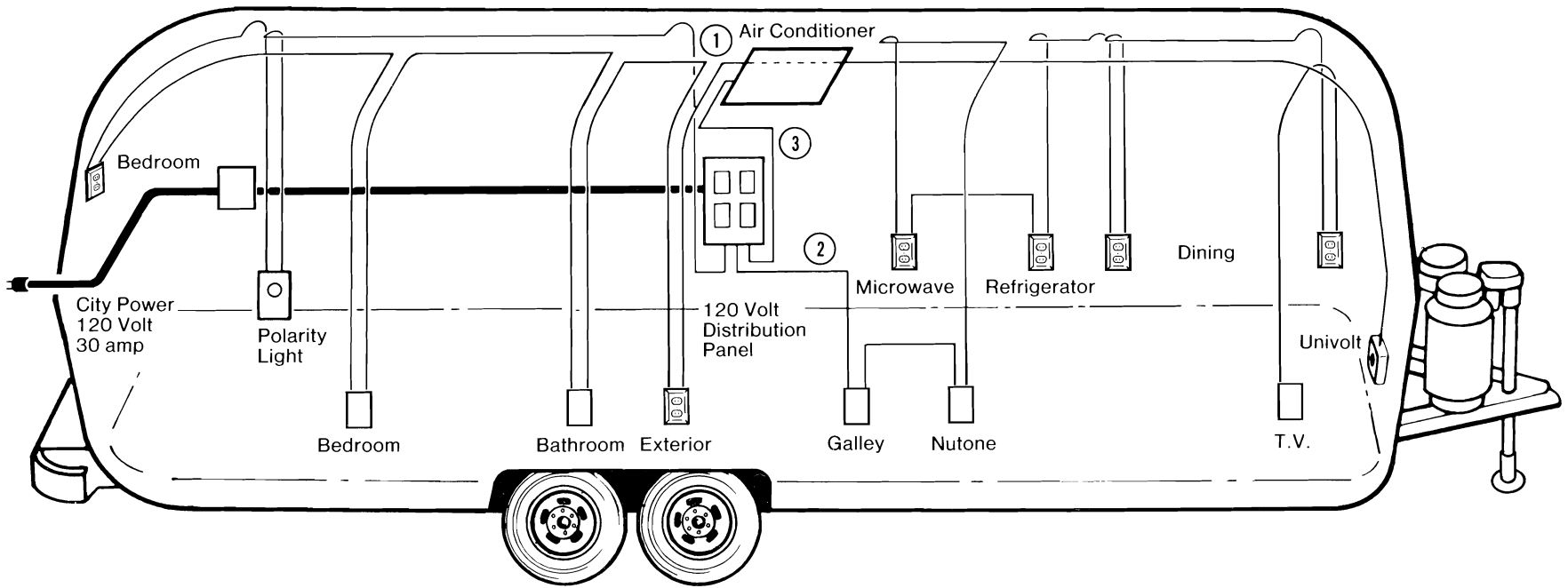

- ① General Circuit 15 amp
- ② Appliance Circuit 20 amp
- ③ Air Conditioner 20 amp

120 Volt Distribution System - 31 Ft. Center Bath, Double

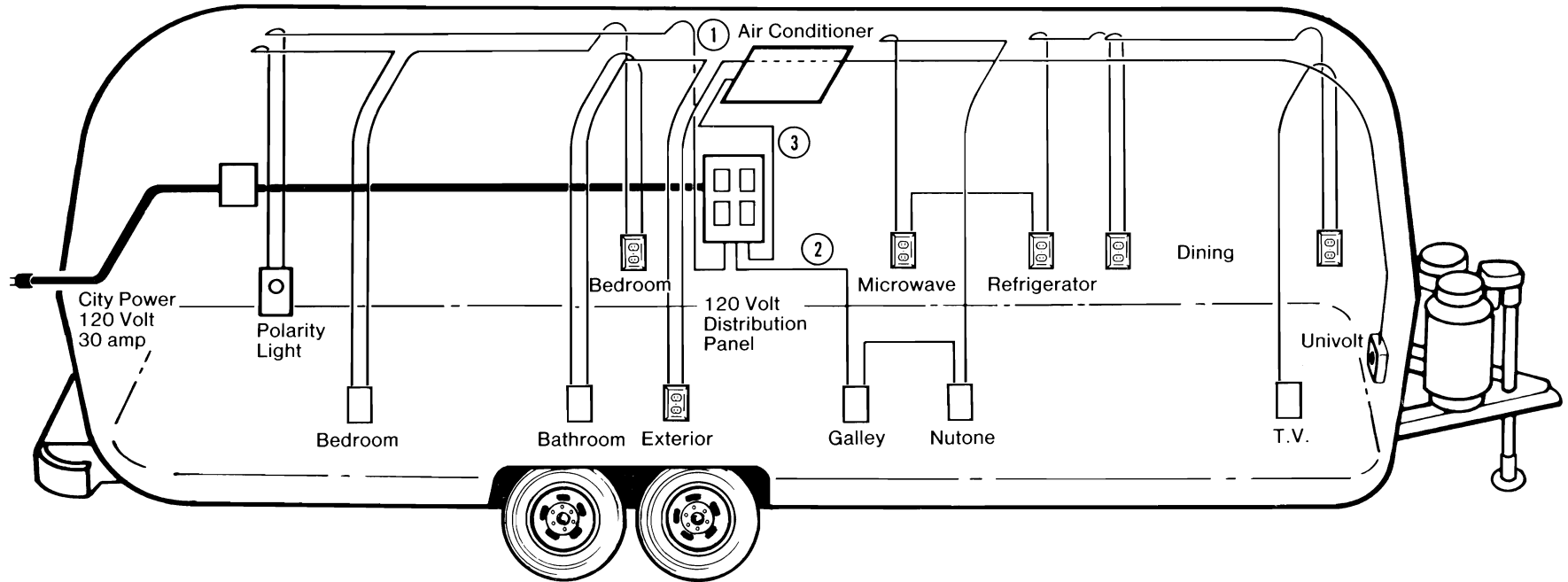

- ① General Circuit 15 amp
- ② Appliance Circuit 20 amp
- ③ Air Conditioner 20 amp

12 Volt Interior - Caravelle, Minuet

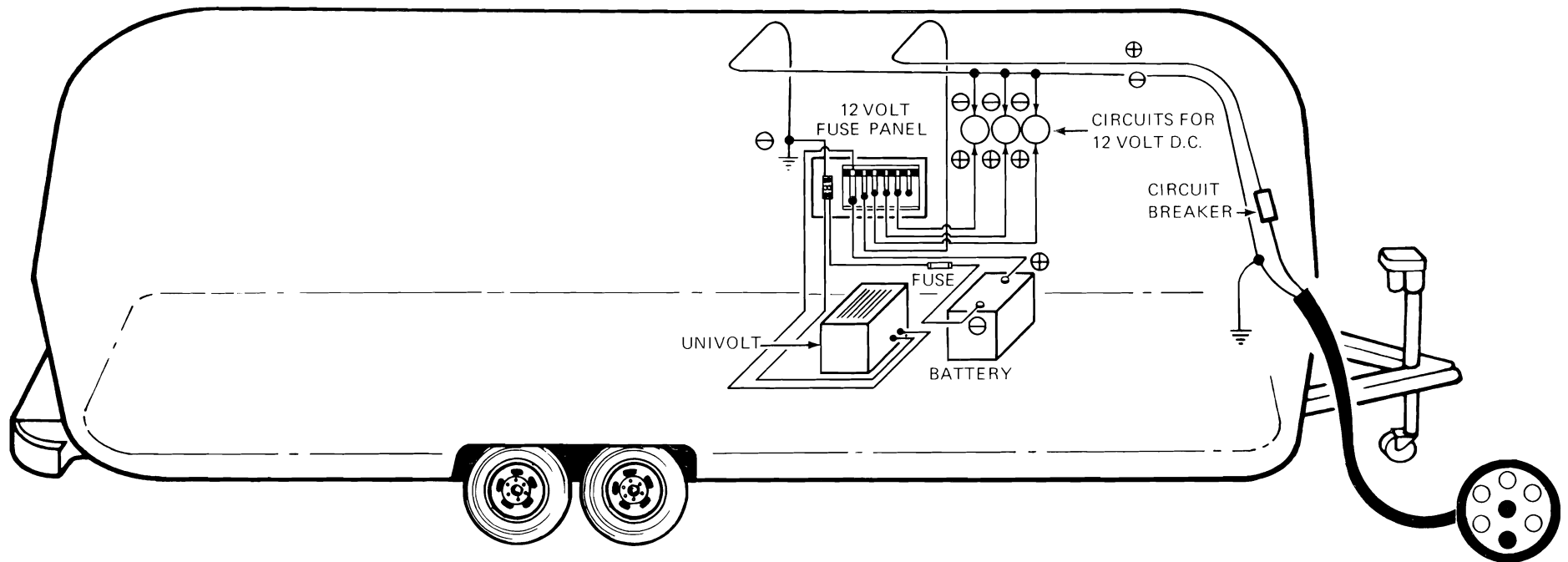

Wiring Color Code

BLUE - Main Charge Line (BLACK - Canada)

WHITE - Ground Line

*Univolt converts 120 volts AC to 12 volts DC

12 Volt Interior - Excella II, International, Argosy

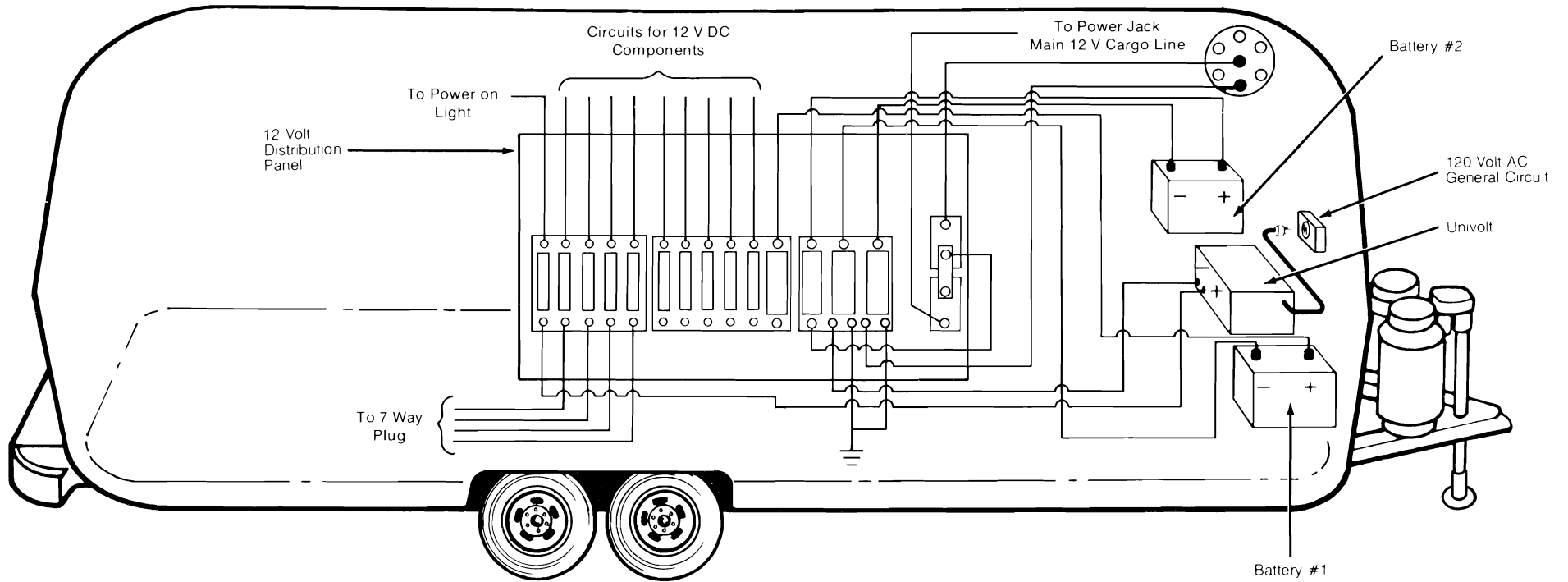

Wiring Color Code

BLUE - Main Charge Line (BLACK - Canada)

WHITE - Ground Line

*Univolt converts 120 volts AC to 12 volts DC

12 Volt Exterior

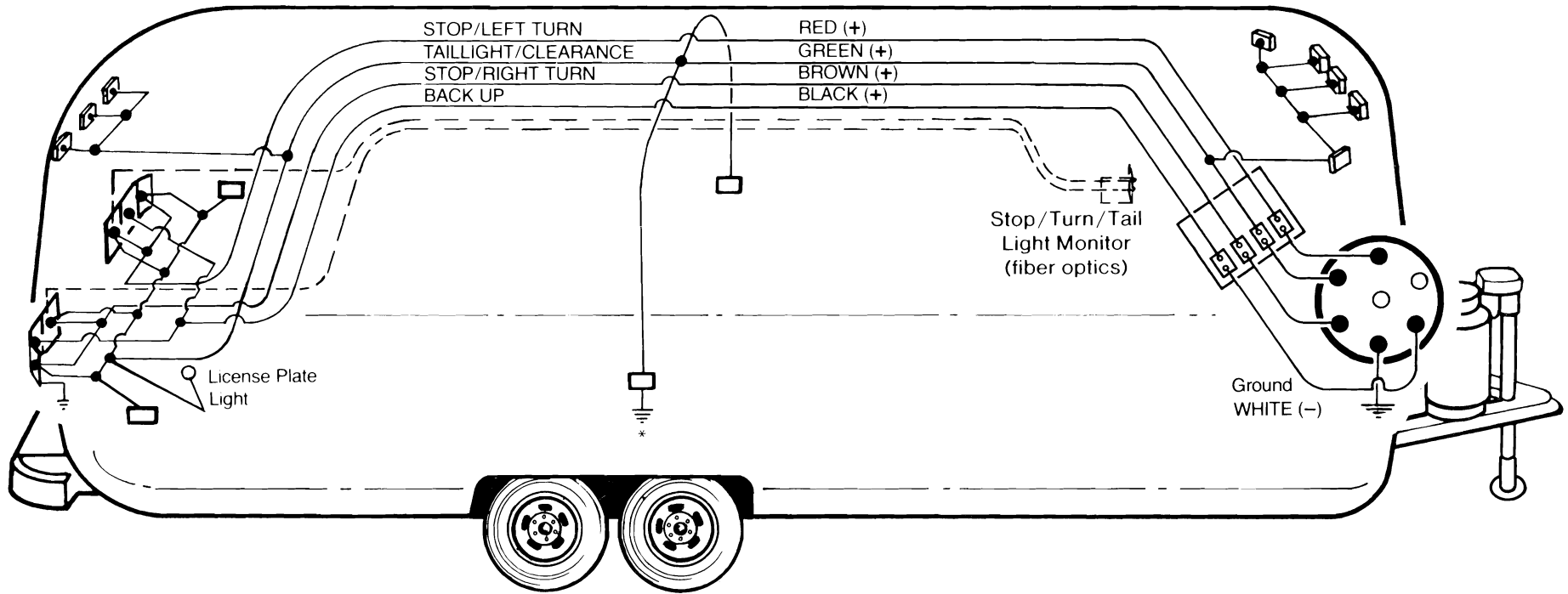

Wiring Color Code

RED - Stop/Left Turn
GREEN - Taillight/Clearance
BROWN - Stop/Right Turn
BLACK - Back Up (YELLOW - Canada)
WHITE - Ground

*All lamp assemblies are grounded to exterior skin.

Main Charge Circuit and Brake Circuit - Caravelle and Minuet

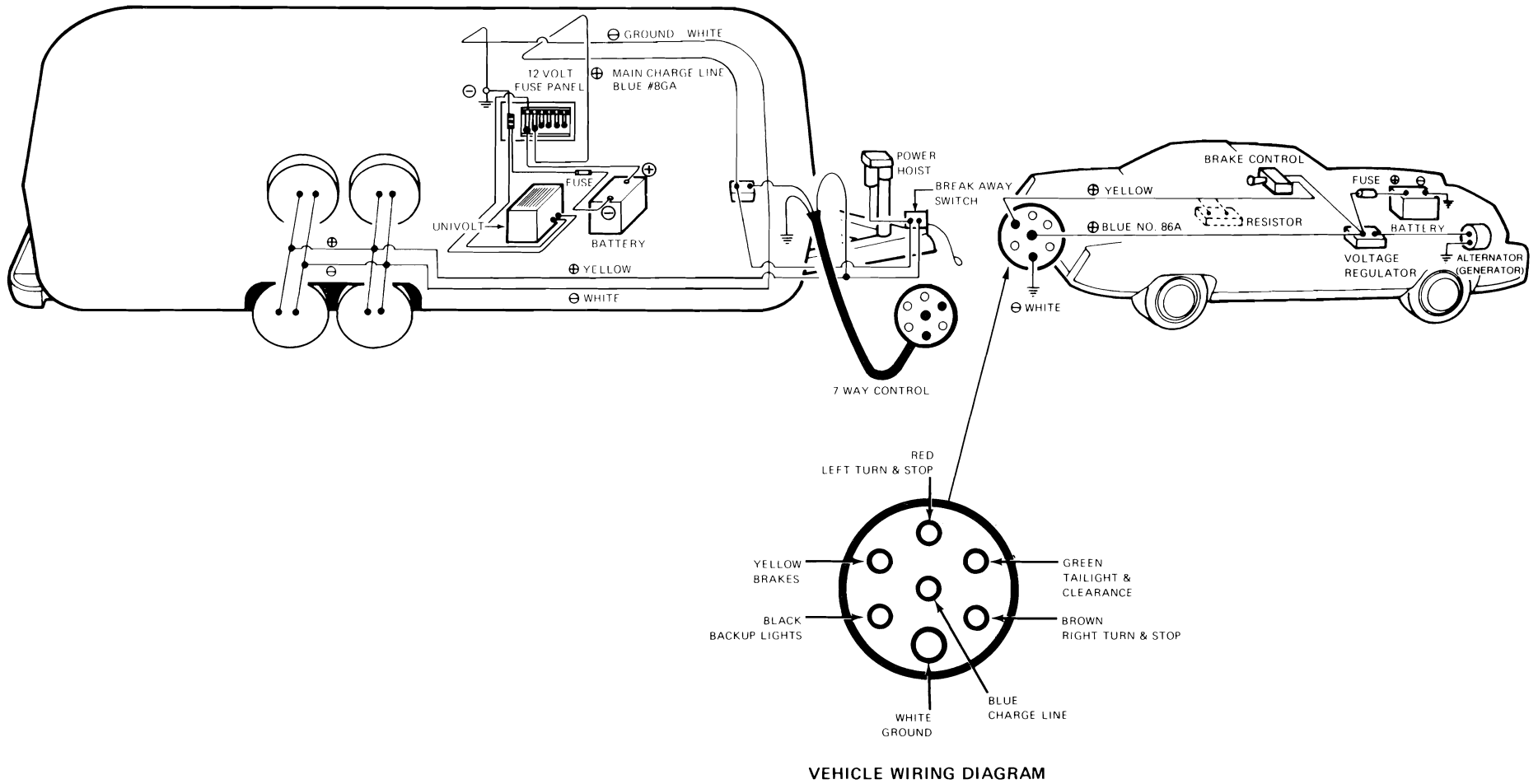

Wiring Color Code

BLUE - Main Charge Line (BLACK - Canada)

WHITE - Ground Line

YELLOW - Brake Line (BLUE - Canada)

Main Charge Circuit and Brake Circuit - Excella II, International, Argosy

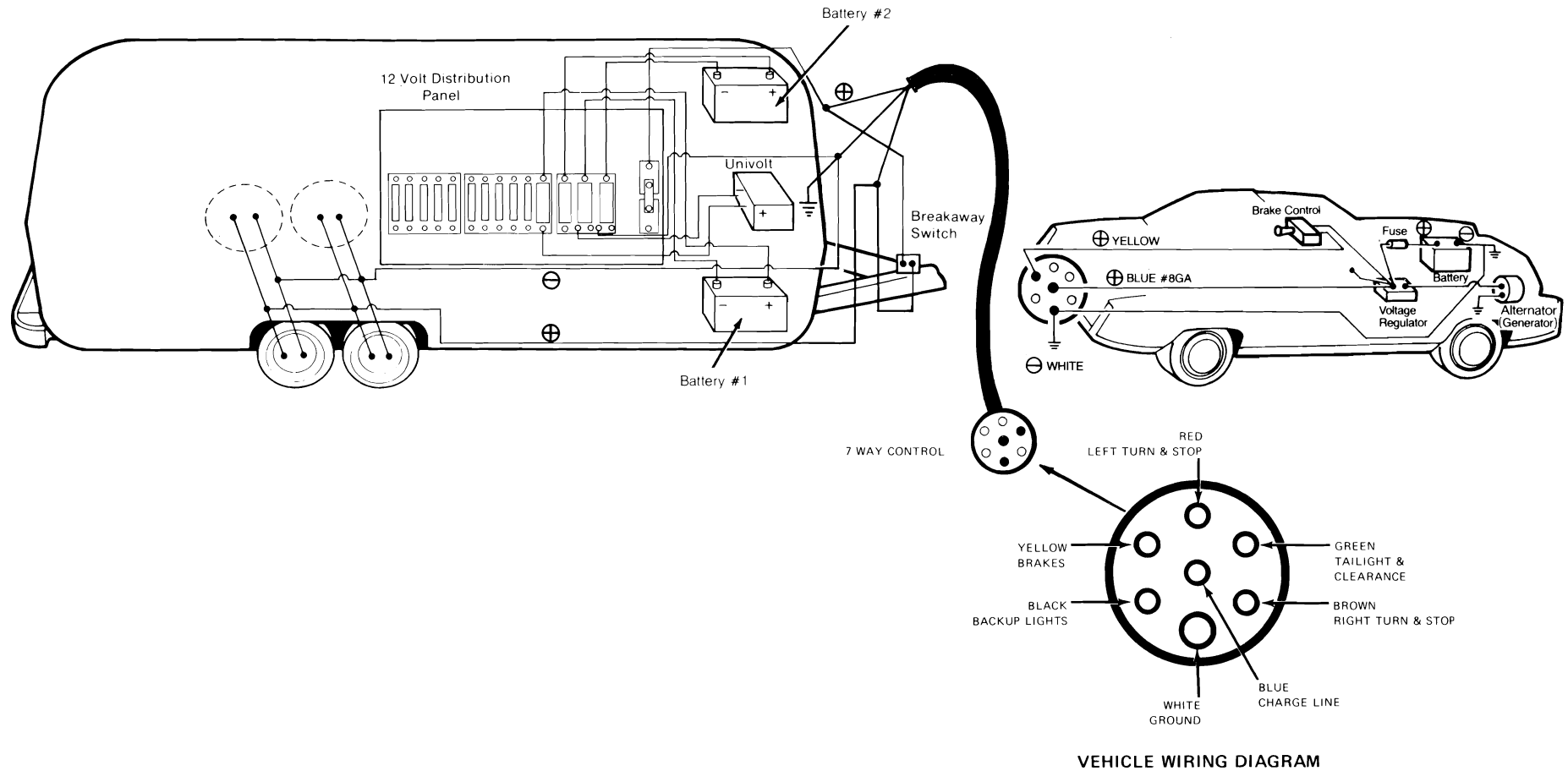

Wiring Color Code

BLUE - Main Charge Line (BLACK - Canada)

WHITE - Ground Line

YELLOW - Brake Line (BLUE - Canada)

12 Volt Fuse Panel — Caravelle, Minuet

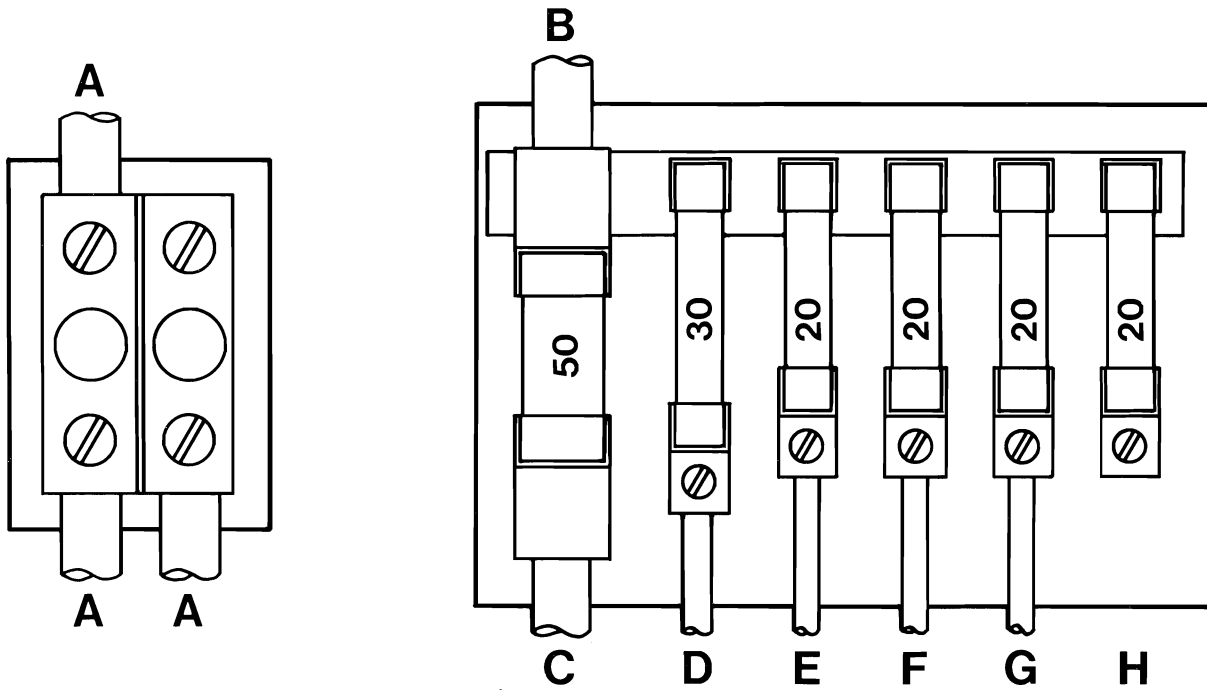

- A — Battery, Univolt & Harness - Ground
- B — Univolt - Pos.
- C — Battery - Pos.
- D — Main Charge Wire - Blue
- E — Circuit #1 - Purple
- F — Circuit #2 - Yellow
- G — Circuit #3 - Pink
- H — Circuit #4 - Option

12 Volt Fuse Panel — Excella II, International, Argosy

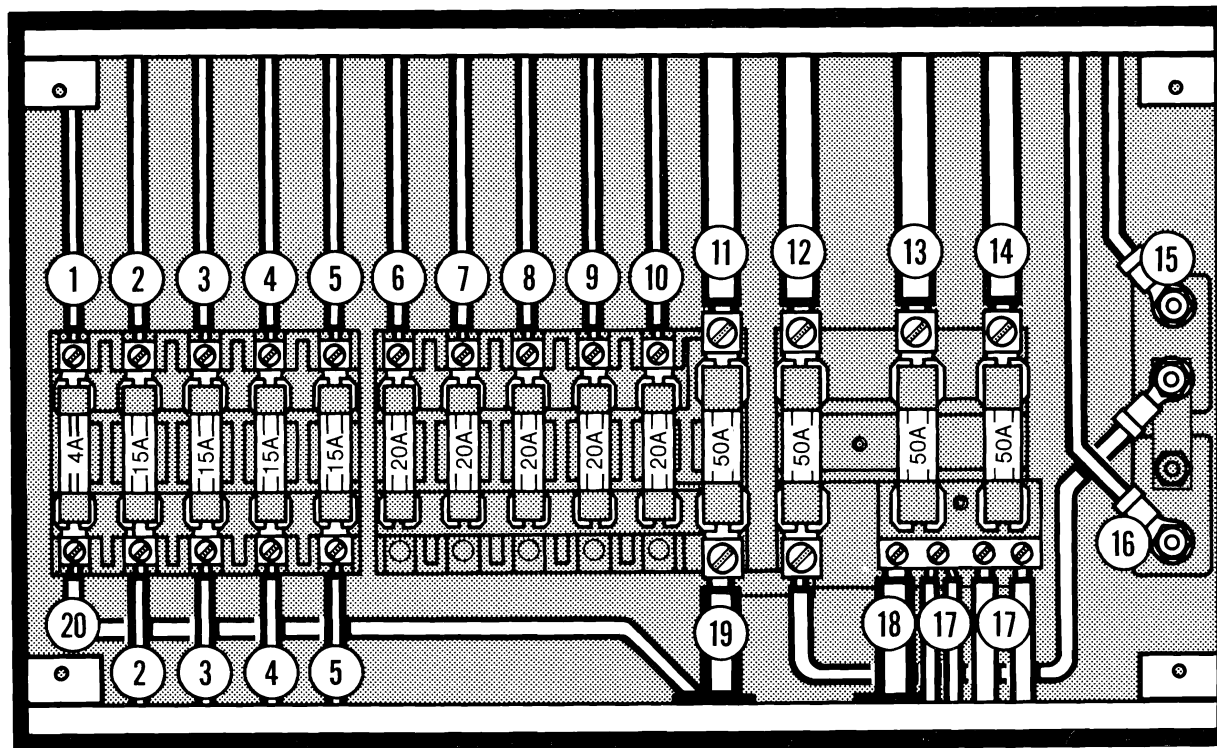

No.	Description
1	Power on, Gray
2	Back up light, Black
3	Clearance and tail light, Green
4	Left turn and stop light, Red
5	Right turn and stop light, Brown
6	Circuit No. 5, Blue
7	Circuit No. 4, Brown
8	Circuit No. 3, Pink
9	Circuit No. 2, Yellow
10	Circuit No. 1, Purple
11	Battery No. 1, positive Red
12	Battery No. 2, positive Red
13	Battery No. 1, negative Black
14	Battery No. 2, negative Black
15	Main 12 volt charge, Blue (Black Can.)
16	Power jack, Orange
17	Ground, White
18	Univolt, negative
19	Univolt, positive
20	Power on, White

Solid State Central Control System Panel - Caravelle, Minuet

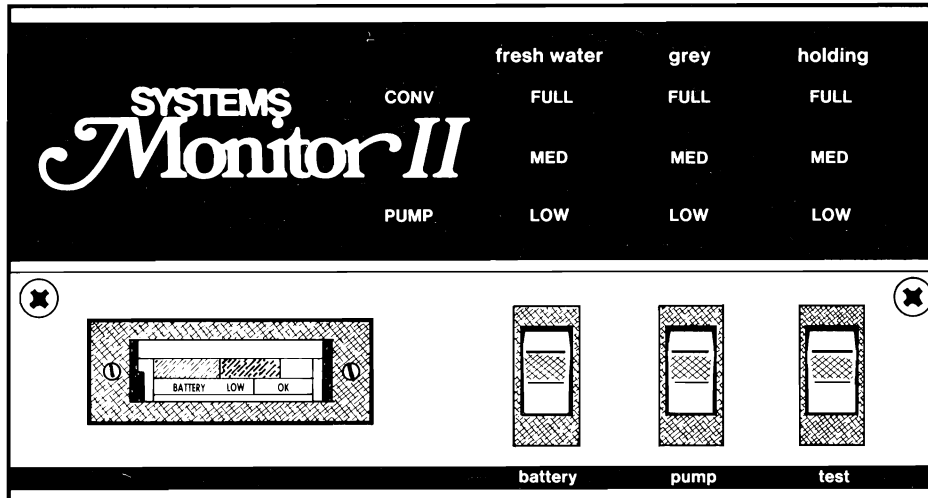

Wire Color Legend

Wire Color	Description
RED/BLUE	Positive
WHITE/BLACK	Negative
YELLOW	Fresh Water HIGH
VIOLET	Fresh Water MED.
BLUE	Fresh Water LOW
WHITE	Fresh Water GRD.
PINK	Grey Water HIGH
GREY	Grey Water MED.
BLACK	Grey Water LOW
WHITE	Grey Water GRD.
GREEN	Holding Tank HIGH
RED	Holding Tank MED.
BROWN	Holding Tank LOW
WHITE	Holding Tank GRD.
RED/YELLOW	Pump

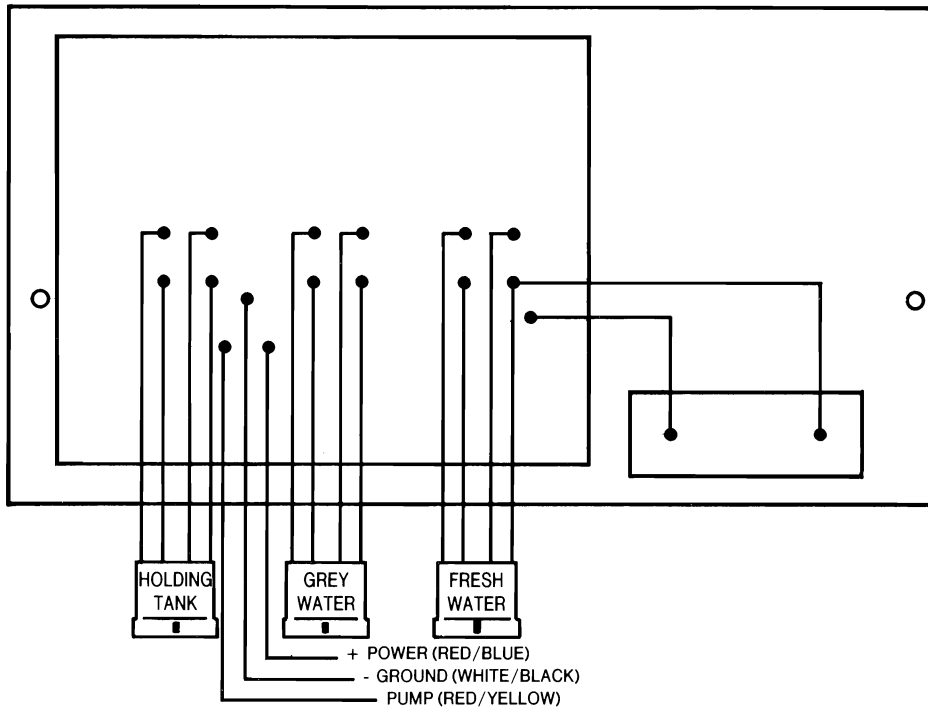

Solid State Central Control System Panel - Excella II, International, Argosy

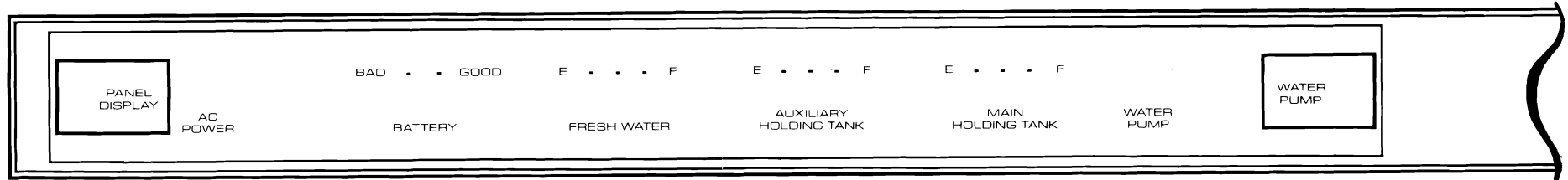

Excella II — Control Panel

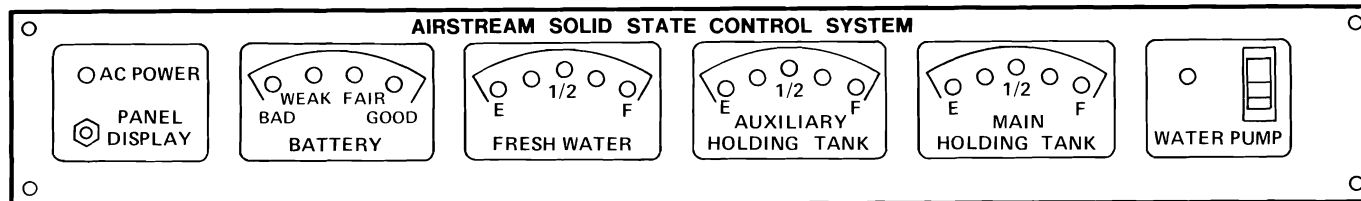

International, Argosy — Control Panel

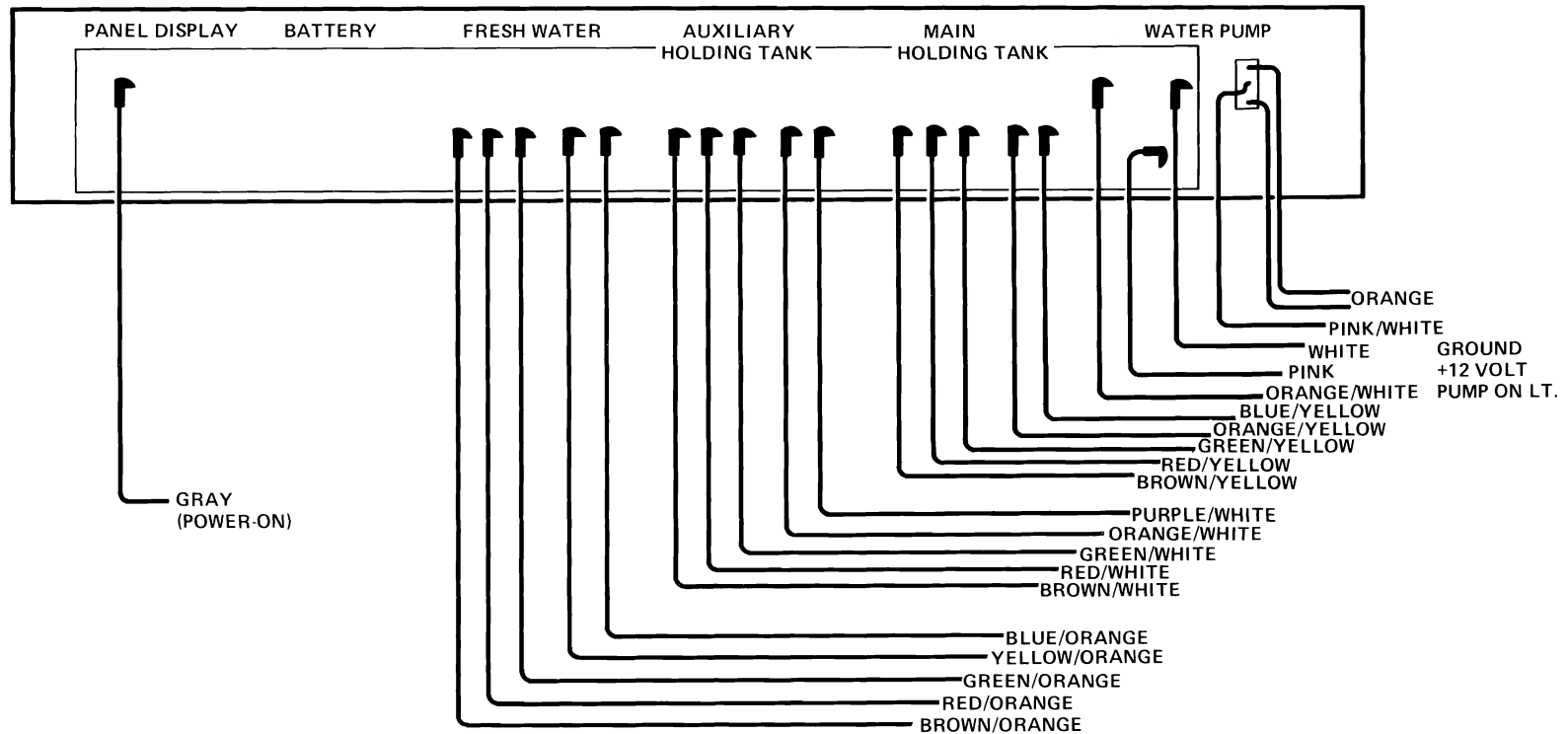

Electrical Trouble Shooting

Additional electrical trouble shooting information is available in the Service Manual.

Symptom	Possible Cause	Remedy
No 12-volt power (Lights, appliances do not work)	<ol style="list-style-type: none">1. Input line and/or battery not connected2. Discharged trailer battery3. Trailer battery on wrong polarity	<ol style="list-style-type: none">1. Make necessary connections2. Charge battery3. See Item 7
Blown fuse	<ol style="list-style-type: none">4. Overloaded circuit (over 50 amps)5. Electrical short6. Shorted battery7. Battery terminals not properly connected to UNIVOLT + and - terminals	<ol style="list-style-type: none">4. Turn off switches to reduce load. Replace blown UNIVOLT fuse.5. Find blown fuse in UNIVOLT and identify circuit. From wiring diagrams, check the circuit for defective wiring, lamps or motors.6. Replace battery and fuse.7. Make proper connections; replace fuse.
Dim lights or sluggish fan motor	<ol style="list-style-type: none">8. 25 - or 50 - cycle power (some foreign countries)9. Discharged battery (when operating without 120 - volt line)10. Battery is low on water	<ol style="list-style-type: none">8. Use 60 - cycle power9. Charge battery10. Add distilled water to battery
UNIVOLT will not charge battery	<ol style="list-style-type: none">11. Input line not connected12. Battery not connected (or polarity reversed)13. Bad battery14. Too many lights and appliances in use15. Fuse blown	<ol style="list-style-type: none">11. Connect input line12. Connect battery to UNIVOLT (Check polarity)13. Replace battery14. Reduce electrical load15. Replace fuse

Specifications

Exterior Dimensions

Caravelle and Minuet

Width	7 ft. 3 in.
Height (shell)	8 ft. 2 ¼ in.
Height (to closed vent)	8 ft. 5 in.
Height (vent open)	8 ft. 7 ¼ in.
Height (top of T.V. antenna - folded)	8 ft. 9 ¼ in.
Height (top of air conditioner)	9 ft. 3 in.
Ground Clearance	8 ¼ in.

Exterior Dimensions

Excella II, International, Argosy

Width	7 ft. 11 ½ in.
Height (shell)	8 ft. 5 ¼ in.
Height (to closed vent)	8 ft. 7 in.
Height (vent open)	8 ft. 10 ¾ in.
Height (top of T.V. antenna - folded)	9 ft. ¼ in.
Height (top of air conditioner)	9 ft. 5 ¾ in.
Ground Clearance	8 ½ in.

Capacities

Appliance	Capacity
Main Holding Tank — 25 Ft.	14 gal.
Main Holding Tank — 28 and 31 Ft. Rear Bath	20 gal.
Main Holding Tank — 31 Ft. Center Bath	25 gal.
Main Holding Tank — Caravelle and Minuet	12 gal.
Auxiliary Holding Tank — 25 Ft.	13 gal.
Auxiliary Holding Tank — 28 and 31 Ft. Rear Bath	16 gal.
Auxiliary Holding Tank — Center Bath	25 gal.
Auxiliary Holding Tank — Caravelle and Minuet	15 gal.
Water Tank — 25, 28 and 31 Ft. Models	50 gal.
Water Tank — Caravelle and Minuet	28 gal.
Water Heater — All	6 gal.

Specifications listed herein are those which are designed to be in your trailer. There may be some small differences in the capacities of individual trailers.

Light and Appliance Amperage — Caravelle and Minuet

Light and Appliance Amperage — 25 Ft., 28 Ft. and 31 Ft. Models

Item	Lamp Number	Amperage
Water Pump	—	5.5 max.
Ceiling Fan	—	3.5
Bathroom Exhaust Fan	—	3.5
Range Exhaust Fan	—	3.5
Furnace Fan	—	2.8
Reading Lights:		
Living Room	1141	1.44 each bulb
Bedroom	1141	1.44 each bulb
Main Door Light	1141	1.44 each bulb
Ceiling Light (2 Bulbs):		
Living Room, Galley	1141	1.44 each bulb
Bedroom, Bathroom	1141	1.44 each bulb
Galley and Vanity Lights under Roof Locker	1141	1.44 each bulb
Clearance & Cluster Lights	1895	.3 each bulb
Stop & Turn Signal	1156	2.1
Tail Light	1157	2.1 stop, .6 tail
License Plate Light	89	.6
Backup Lights	1156	2.1
Battery		72 amp hrs. at 80°F

Item	Lamp Number	Amperage
Water Pump	Excella II	7.0 max.
Water Pump	Int., Argosy	5.5 max.
Ceiling Fan	—	3.5
Bathroom Exhaust Fan	—	3.5
Range Exhaust Fan	—	3.5
Furnace Fan	—	5.0
Reading Lights:		
Living Room	1141	1.44 each bulb
Bedroom	1141	1.44 each bulb
Main Door Light	1141	1.44 each bulb
Exterior Light	1156	2.1
Ceiling Light (6 Bulbs):		
Living Room, Galley	1141	1.44 each bulb
Bedroom, Bathroom	1141	1.44 each bulb
Galley and Vanity Lights under Roof Locker	1141	1.44 each bulb
Trunk Lights:		
Service Center, Trunk	67	.6 each bulb
Clearance & Cluster Lights	1895	.3 each bulb
Stop & Turn Signal	1156	2.1
Tail Light	1157	2.1 stop, .6 tail
License Plate Light	89	.6
Backup Lights	1156	2.1
Battery		105 amp hrs. at 80°F

Fuses and Circuit Breakers — Caravelle and Minuet

Circuit	Location	Rating
Main Breaker	120 volt panel	30 amp
General Circuit	120 volt panel	20 amp (GFI)
Air Conditioner	120 volt panel	20 amp C.B. (man. resetting)
Charge Line from Car	Univolt	AGU 30 amp fuse
Low Voltage Circuits	Univolt	SFE 20 amp fuse
Trailer Battery Fuse (+)	Univolt	AGU 50 amp fuse
Radio, Radio/Tape	Radio, Radio/Tape	IAG 5 amp fuse
Water Pump Fuse	Water Pump	*

Fuses and Circuit Breakers — 25 Ft., 28 Ft. and 31 Ft. Models

Circuit	Location	Rating
Main Breaker	120 volt panel	30 amp
General Circuit	120 volt panel	15 amp
Appliance Circuit	120 volt panel	20 amp
Air Conditioner	120 volt panel	20 amp
Charge Line from Car	Univolt	30 amp mini breaker
Low Voltage Circuits	Univolt	SFE 20 amp fuse
Trailer Battery Fuse (+)	Univolt	AGU 50 amp fuse
Trailer Battery Fuse (-)	Univolt	AGU 50 amp fuse
Power On Circuit	Univolt	SFE 4 amp fuse
Radio, Radio/Tape	Radio, Radio/Tape	IAG 5 amp fuse
Water Pump	Excella II	6 ¼ SLO-BLO
Water Pump	Int., Argosy	*

*Water pump is thermal protected internally.

Pre-Travel Check List

Interior

1. Turn off water pump switch.
2. Check battery water level.
3. Close windows and vents.
4. Turn off gas to range & oven.
5. Lock all interior cabinet doors.
6. Lock refrigerator door.
(Seal containers first.)
7. Hold down or stack securely, all loose, hard and sharp objects.
8. Fasten sliding & foldette doors.
9. Drain toilet bowl.
10. Turn off interior lights.
11. Secure and lock the Main door.
12. Pull up or retract step.

Exterior

1. Disconnect and stow:
 - a) electrical hook-up cord
 - b) sewer-hook-up hose. (flush out)
 - c) water-hook-up hose.
2. Turn off gas line shut-off valve to appliances.
3. Remove and stow leveling jacks and wheel chocks.
4. Check hitch: it must be properly attached.
5. Check safety chains and breakaway switch cable. (electric brakes)
6. Fully retract jack. Remove and stow jack stand.
7. Check clearance and stop lights.
8. Check lug nuts. (See page 22)
9. Check tires, for correct pressure
(See page 23)
10. Check that T.V. antenna is pointed forward and dipoles closed.
11. Adjust car mirrors.
12. Pull forward some 50 ft., test brakes, and check site for forgotten objects and cleanliness.

Home

1. Leave house key with your neighbor.
2. Store valuables and important papers in a safe place.
3. Discontinue newspaper, milk and other deliveries.
4. Ask the Post Office to hold your mail for you.
5. Arrange with the Telephone Company for discontinued or 'Vacation Service'.
6. Arrange care for your pets.
7. Have your lawn, garden and house plants cared for.
8. Lock all windows and doors securely. Keep shades open for a lived-in look.
9. Cover all food to keep out mice and insects.
10. Eliminate all fire hazards. Place matches in a tin box or glass jar.
11. Store oil, gasoline and other inflammables properly.
12. Destroy all newspapers, magazines and oily rags.
13. Notify police.

Personal

14. Automobile insurance to cover you and your family fully.
15. Avoid cash. Use travelers checks and credit cards.
16. Confirm reservations.
17. Have sunglasses for everyone.
18. Pack cameras and films.
19. Make a check list of clothing for everyone, and toilet articles.

Motoring Essentials

1. Display car and trailer registration properly.
2. Carry driver's license. In Canada you will need a non-resident liability insurance card.
3. In Mexico you must have special auto insurance.
4. Carry an extra set of ignition and truck keys in a separate pocket, or in your wallet.
5. Keep an operating flashlight with fresh batteries in the glove compartment.
6. Pack the trunk so that you can reach the tools and spare tire without completely unpacking.
7. Keep sharp or hard articles securely packed wherever they may be.
8. Do not pack things in the passenger seating area, you need maximum space for comfort.
9. Wear easy-wash, drip-dry traveling clothes.
10. Do not make your vacation trips a mileage marathon! Stop and relax frequently.
11. Carry a first aid kit.
12. Carry your pet's dish, food, leash and health and registration papers.

Lubrication and Maintenance

Your Airstream or Argosy is without a doubt the finest engineered travel trailer ever to be mass produced. Every design feature and component has been chosen with the thought

in mind of giving you thousands of miles of trouble-free operation. By adhering to the following minimum maintenance schedule and

the additional exterior and interior maintenance suggestions you will enjoy all of the pleasure you dream of from your trailer . . . and more.

Item	Every 1,000 miles or 30 days	Every 5,000 miles or 90 days	Every 10,000 miles or 6 months	Procedure
All Exterior Door Locks	X			Lubricate by shooting in dry graphite.
Axle				None, except wheel bearings.
Battery	X			Check water level.
Brake Fluid (Hydraulic Brakes)		X		Remove reservoir cover. Add Dot 3 fluid.
Brakes			X	Inspect and replace as necessary.
Break Away Switch		X		Pull pin and lubricate with light household oil.
Entrance Door Hinges	X			Lubricate with light household oil.
Hitch Ball Latch	X			Lubricate with engine motor oil.
Hitch Jack (Manual)	X			Lubricate with light household oil (put oil can spout up under handle, and allow oil to run down post).
LPG Hold Down Knob	X			Lubricate with light household oil.
Main Door Step		X		Lubricate moving parts.
Range Exhaust Hood	X			Clean fan blades and wash filter.
Refrigerator Flue Cleaning		X		See page 74.
Roof Vent Elevator Screws	X			Lubricate with light household oil.
Strike Pocket on Main Door	X			Coat with paraffin.
Tires	X			Check for foreign objects. Air pressure — page 23.
T.V. Antenna	X			Lubricate exterior moving parts with silicon spray or WD40.
Water Pump		X		Check belt for wear and proper tension (where applicable).
Wheel Bearings			X	Clean, repack, and adjust.
Wheel Lug Bolts		X*		Check for tightness.
Window Seals/Door Seals		X		Clean with mild detergent and coat with "Slipicone"
7-Way Plugs and Receptacle		X		Clean contacts and coat with "SPRA-KLEEN".

Note: If and when new materials and production techniques are developed which can improve the quality of its product, Airstream reserves the right to make such changes.

*Note: On new trailers check lug bolts every 200 miles for the first 1,000 miles.

Maintenance Record

Date	Mileage	Address	Dealer	Service Performed	Remarks

Index

- Air Conditioner 62-65
- Aluminum Shell 42
- AM/FM Stereo 61
- Amperage Chart 112-113
- Automatic Gas Regulator 69
- Axle 12
- Backing 30
- Ball (Hitch) 25
- Battery 91
- Battery Condition Tester 59
- Beds 57
- Brake Controller 7
- Brakes (Electric) 7-8
- Brakes (Hydraulic Disc) 9-11
- Bulbs (Replacement) 112
- Bunk Beds 57
- Capacities 111
- Caravanner Insurance (tear out page)
- Car Connector 26, 90, 104-105
- Cargo Capacity 12, 25
- Ceiling Fans 66, 68
- Ceiling Vents 66
- Central Control Panel 59-60, 108-109
- Certified Service Centers 2
- Check Lists 114
- Circuit Breakers (120 V) 90
- City Power 89
- Clock 60
- Defrosting 72
- Drainage System 86-88
- Drain Valve Locations 85
- Dump Valves 86
- Electrical Connector 26, 90, 104-105
- Electrical Inlet 89
- Electrical Outlet Locations 92-93
- Electrical Panels 59-60, 106-109
- Electrical System 89
- Electrical Troubleshooting 110
- Electrical Wiring Diagrams 94-109
- Electric Jack (Hitch) 25
- Equipment List 5
- Explanation of Airstream/Argosy Limited Warranty 3
- Extended Stay 32
- Extension Step 43
- Exterior 42
- Exterior Identification 36-41
- Factory Service 2
- Fan Switch 68
- Filter (Air Conditioner) 63-65
- Filter (Water) 83, 84
- Flat Tires 22
- Floor Plans 45-53
- Fold-Away Step 43
- Furnace 79
- Fuses and Circuit Breakers 113
- Fuse Panel (12 V) 90, 106-107
- Gas (LPG) System 69
- Gas Tank 69
- Grounding 89, 91
- Hitch 25
- Hitch Ball Height 26
- Hitching Up 25
- Holding Tanks 86
- Home Check List 114
- Interior Check List 114
- Interior Maintenance 55-56
- Jacking Trailer 32
- Leveling 32
- Leveling Bars 26
- Light Bulb Replacement 66, 112
- L.P.G. System 69
- Load Charts 16-21
- Loading 12-21
- Low Voltage Distribution Panel 106-107
- Lubrication and Maintenance 115
- Maintenance Record 116
- Microwave Oven 75
- Motoring Check List 114
- Nutone Food Center 66
- Oven 77
- Oven Cleaning 78
- Overheating 28-29
- Overnight Stop 31
- Personal Check List 114
- Pilot Adjustment:
 - Furnace 81
 - Oven 77
 - Range 77
 - Refrigerator 71, 73
 - Water Heater 82
- Power On 60
- Polarity Light 89, 90
- Pre-Travel Check List 114
- Radio 61
- Range 77
- Range Exhaust Hood 78
- Refrigerator 71
- Regulator (LPG) 69
- Repair Centers 2
- Removing Moisture 34, 81
- Self-Contained (Drainage) 86
- Self-Contained (Electrical) 89
- Service Centers 2
- Seven Way Connector 90
- Sewer Connection 86
- Shower Head 68
- Sink Maintenance 65
- Specifications 111
- Stabilizing Jack Positions 32
- Stereo Tape Player 61, 62
- Storage and Winterizing 35
- Switches: Lights 66
- Table 58
- Tank (Sewage) 86
- Tank (Water) 83
- Telephone Jacks 92-93
- Telephone Shower Head 68
- Tires 22
- Tire Pressures 23
- Tire Rotation 23
- Toilet 87-88
- Tow Car Equipment 6
- Towing Tips 28
- Trailer Storage 35
 - Trailer Weight Information 12-21
- Trouble Shooting:
 - Electrical 110
 - Refrigerator 72
 - Water Systems 83
- TV Antenna 44
- TV Jacks 92-93
- Univolt 89
- Utility Connection 33
- Vents 66
- Vista View Windows 43
- Wally Byam Stores 5
- Warranty 2-3
- Warranty and Service 2
- Water Drainage
 - Procedure 35, 86
- Water Drain Valves 35, 85
- Water Filter (Water Pump) 83
- Water Heater 82
- Water Inlet 83-84
- Water Level Indicator 60
- Water Pressure Regulator 85
- Water Pump 83
- Water Purifier (Everpure) 84, 85
- Water System 83
- Water Tank 83
- Weight: HP Ratio 6
- Windows 43
- Winter Trailing 34
- Winterizing 35
- Wiring Diagrams 94-109
- Wiring, 12 V Exterior 103
- Wiring, 12 V Interior 101, 102
- Wiring, Main Charge
 - Circuit 91, 104, 105

NOTES

