



Contents A - Z

OWNER'S MANUAL MINI COUNTRYMAN



**COOPER
COOPER S
COOPER S ALL4
JOHN COOPER
WORKS**

Congratulations on your new MINI!

This Owner's Manual should be considered a permanent part of this vehicle. It should stay with the vehicle when sold to provide the next owner with important operating, safety and maintenance information.

We wish you an enjoyable driving experience.

© 2012 Bayerische Motoren Werke
Aktiengesellschaft
Munich, Germany

Reprinting, including excerpts, only with the
written consent of BMW AG, Munich.
US English VI/12

Printed on environmentally friendly paper,
bleached without chlorine, suitable for recycling.

CONTENTS

The fastest way to find information on a particular topic or item is by using the index, refer to page 188.

- 4 Notes
- 7 Reporting safety defects

AT A GLANCE 9

- 10 Cockpit
- 16 Radio

CONTROLS 21

- 22 Opening and closing
- 34 Adjustments
- 41 Transporting children safely
- 45 Driving
- 55 Controls overview
- 64 Technology for driving comfort and safety
- 76 Lamps
- 81 Climate
- 86 Practical interior accessories

DRIVING TIPS 95

- 96 Things to remember when driving

ENTERTAINMENT 107

- 108 Radio MINI Boost CD

COMMUNICATIONS 119

- 120 Telephone

MOBILITY 133

- 134 Refueling
- 136 Wheels and tires
- 145 Engine compartment
- 149 Maintenance
- 151 Care
- 155 Replacing components
- 165 Giving and receiving assistance
- 169 Indicator and warning lamps

REFERENCE 183

- 184 Technical data
- 188 Everything from A to Z

NOTES

USING THIS OWNER'S MANUAL

We have tried to make all the information in this Owner's Manual easy to find. The fastest way to find specific topics is to refer to the detailed index at the back of the manual. If you wish to gain an initial overview of your vehicle, you will find this in the first chapter.

Should you wish to sell your MINI at some time in the future, remember to hand over this Owner's Manual to the new owner; it is an important part of the vehicle.

Additional sources of information

Should you have any other questions, your MINI dealer will be glad to advise you at any time.

You can find more information about the MINI, for example on its technology, on the Internet at www.MINI.com.

SYMBOLS USED



Indicates precautions that must be followed precisely in order to avoid the possibility of personal injury and serious damage to the vehicle. ◀



Indicates information that will assist you in gaining the optimum benefit from your vehicle and enable you to care more effectively for your vehicle. ◀



Refers to measures that can be taken to help protect the environment. ◀

◀ Marks the end of a specific item of information.

"..." Identifies radio display texts used to select individual functions.

>...< Verbal instructions to use with the voice operation system.

>>...<< Identifies the answers generated by the voice operation system.

Symbols on vehicle components



Indicates that you should consult the relevant section of this Owner's Manual for information on a particular part or assembly.

VEHICLE EQUIPMENT

The manufacturer of your MINI is the Bayerische Motoren Werke Aktiengesellschaft, BMW AG.

This Owner's Manual describes all models as well as all production, country and special equipment that is offered in the model range. Equipment is also described that is not available because of, for example, selected options or country version. This also applies to safety related functions and systems. For equipment and models that are not described in this Owner's Manual, please see the supplementary Owner's Manuals that are provided.

STATUS OF THIS OWNER'S MANUAL AT TIME OF PRINTING

The high level of safety and quality of the MINI vehicles is ensured through continuous development. In rare cases, there may be differences between the description and the vehicle.

FOR YOUR SAFETY

Maintenance and repair



Advanced technology, e.g. the use of modern materials and high-performance electronics, requires specially adapted maintenance and repair methods. Therefore, have the necessary work on your MINI only carried out by a MINI dealer or a workshop that has specially trained personnel working in accordance with

the specifications of the MINI manufacturer. If this work is not carried out properly, there is a danger of subsequent damage and related safety hazards. ◀

Parts and accessories

 For your own safety, use genuine parts and accessories approved by the manufacturer of the MINI.

When you purchase accessories tested and approved by the manufacturer of the MINI and Original MINI Parts, you simultaneously acquire the assurance that they have been thoroughly tested by the manufacturer of the MINI to ensure optimum performance when installed on your vehicle.

The manufacturer of the MINI warrants these parts to be free from defects in material and workmanship.

The manufacturer of the MINI will not accept any liability for damage resulting from installation of parts and accessories not approved by the manufacturer of the MINI.

The manufacturer of the MINI cannot test every product made by other manufacturers to verify if it can be used on a MINI safely and without risk to either the vehicle, its operation, or its occupants.

Original MINI Parts, MINI Accessories and other products approved by the manufacturer of the MINI, together with professional advice on using these items, are available from all MINI dealers.

Installation and operation of accessories that have not been approved by the manufacturer of your MINI, such as alarms, radios, amplifiers, radar detectors, wheels, suspension components, brake dust shields, telephones, including operation of any mobile phone from within the vehicle without using an externally mounted antenna, or transceiver equipment, for instance, CBs, walkie-talkies, ham radios or similar accessories, may cause extensive damage to the vehicle, compromise its safety, interfere with the vehicle's electrical system or affect the validity of

the MINI Limited Warranty. See your MINI dealer for additional information. ◀

 Maintenance, replacement, or repair of the emission control devices and systems may be performed by any automotive repair establishment or individual using any certified automotive part. ◀

California Proposition 65 warning

California law requires us to issue the following warning:

 Engine exhaust and a wide variety of automobile components and parts, including components found in the interior furnishings in a vehicle, contain or emit chemicals known to the State of California to cause cancer and birth defects and reproductive harm. In addition, certain fluids contained in vehicles and certain products of component wear contain or emit chemicals known to the State of California to cause cancer and birth defects or other reproductive harm.

Battery posts, terminals and related accessories contain lead and lead compounds. Wash your hands after handling.

Used engine oil contains chemicals that have caused cancer in laboratory animals. Always protect your skin by washing thoroughly with soap and water. ◀

SERVICE AND WARRANTY

We recommend that you read this publication thoroughly.

Your MINI is covered by the following warranties:

- ▷ New Vehicle Limited Warranty
- ▷ Rust Perforation Limited Warranty
- ▷ Federal Emissions System Defect Warranty
- ▷ Federal Emissions Performance Warranty
- ▷ California Emission Control System Limited Warranty

Detailed information about these warranties is listed in the Service and Warranty Information Booklet for US models or in the Warranty and Service Guide Booklet for Canadian models.

Your vehicle has been specifically adapted and designed to meet the particular operating conditions and homologation requirements in your country and continental region in order to deliver the full driving pleasure while the vehicle is operated under those conditions. If you wish to operate your vehicle in another country or region, you may be required to adapt your vehicle to meet different prevailing operating conditions and registration requirements. You should also be aware of any applicable warranty limitations or exclusions for such country or region. In such a case, please contact Customer Relations for further information.

Maintenance

Maintain the vehicle regularly to sustain road safety, operational reliability and the New Vehicle Limited Warranty.

Specifications for required maintenance measures:

- ▷ MINI Maintenance System
- ▷ Service and Warranty Information Booklet for US models
- ▷ Warranty and Service Guide Booklet for Canadian models

If the vehicle is not maintained according to these specifications, this could result in serious damage to the vehicle. Such damage is not covered by the MINI New Vehicle Limited Warranty.

DATA MEMORY

A variety of electronic components in your vehicle include data storage devices, which store technical information on the condition of your vehicle, events and errors, either temporarily or permanently. In general, this technical information documents the condition of a component, a module, a system or the surroundings:

- ▷ Operating conditions of system components, e.g., fill levels.
- ▷ Status messages regarding the vehicle and of its individual components, such as wheel rpm/vehicle speed, response delay, lateral acceleration.
- ▷ Malfunctions and defects in the major system components, such as the lights and brakes.
- ▷ Responses of the vehicle in special driving situations, such as the deployment of an airbag, the utilization of stability control systems.
- ▷ Environmental conditions, such as temperature.

These data are exclusively of a technical nature and are used for the detection and correction of errors, as well as the optimization of vehicle functions. Motion profiles of traveled routes can not be deduced from these data. If services are required, such as repair services, service processes, warranty claims and quality assurance, then this technical information can be read out by employees of service departments, including the manufacturer, from the event and error data storage devices by using special diagnostic equipment. There, if necessary, you will receive further information. After remedying an error, the information in the error memory is deleted or progressively overwritten.

When using the vehicle, situations are conceivable in which this technical data, in conjunction with other information, such as accident reports, vehicle damage, witness statements, etc. - possibly with the assistance of an expert - could be traced to particular individuals. Additional functions that are agreed upon contractually with the customer, such as vehicle tracking in case of emergency, permit the transmission of certain vehicle data from the vehicle.

REPORTING SAFETY DEFECTS

For US customers

The following applies only to vehicles owned and operated in the US.

If you believe that your vehicle has a defect that could cause a crash or could cause injury or death, you should immediately inform the National Highway Traffic Safety Administration, NHTSA, in addition to notifying MINI of North America, LLC, P.O. Box 1227, Westwood, New Jersey 07675-1227, Telephone 1-800-831-1117.

If NHTSA receives similar complaints, it may open an investigation, and if it finds that a safety defect exists in a group of vehicles, it may order a recall and remedy campaign. However, NHTSA cannot become involved in individual problems between you, your dealer, or MINI of North America, LLC.

To contact NHTSA, you may call the Vehicle Safety Hotline toll-free at 1-888-327-4236 (TTY: 1-800-424-9153); go to <http://www.safercar.gov>; or write to: Administrator, NHTSA, 400 Seventh Street, SW., Washington, DC 20590. You can also obtain other information about motor vehicle safety from <http://www.safercar.gov>

For Canadian customers

Canadian customers who wish to report a safety-related defect to Transport Canada, Defect Investigations and Recalls, may telephone the toll-free hotline 1-800-333-0510. You can also obtain other information about motor vehicle safety from <http://www.tc.gc.ca/roadsafety>.



WATCH ME.

AT A GLANCE

CONTROLS

DRIVING TIPS

ENTERTAINMENT

COMMUNICATIONS

MOBILITY

REFERENCE

COCKPIT









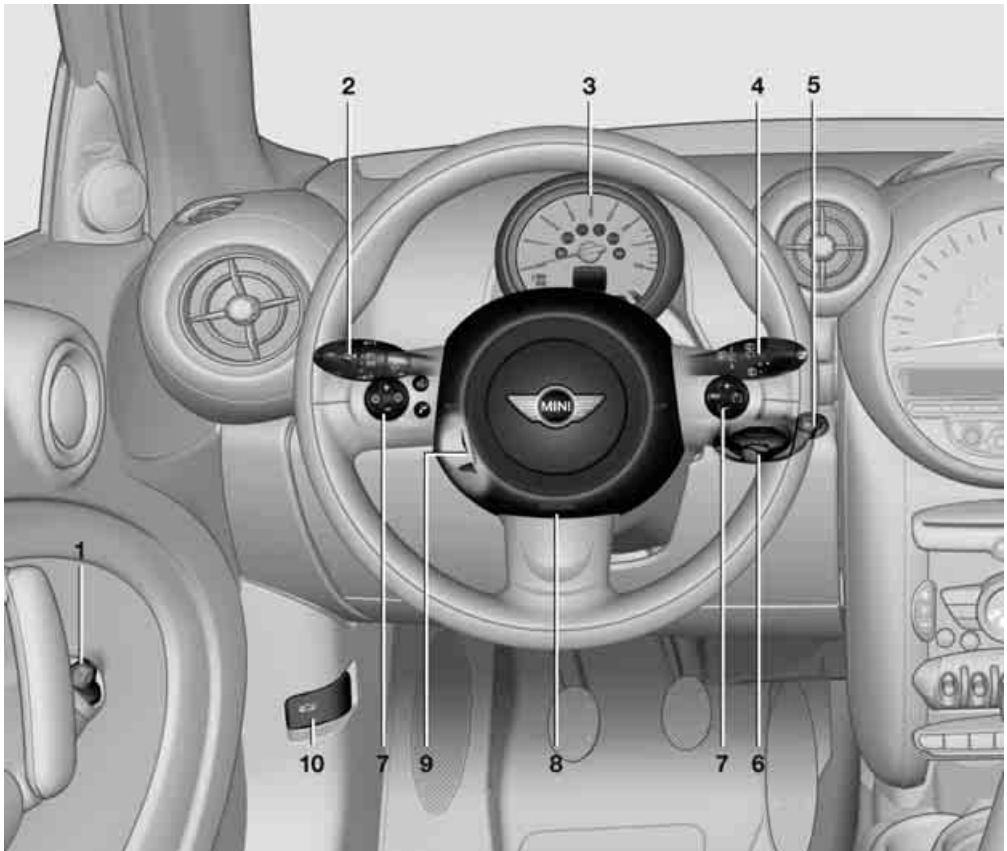











VEHICLE EQUIPMENT

In this chapter, all production, country, and optional equipment that is offered in the model

range is described. Equipment is also described that is not available because of, for example, selected options or country version. This also applies to safety related functions and systems.

AROUND THE STEERING WHEEL



- 1 Adjusting the exterior mirrors in and out 39
- 2  Parking lamps 76
-  Low beams 76
-  Automatic headlamp control 76
Adaptive Light Control 78
-  Turn signals 50
-  High beams 78
-  Headlamp flasher 50
-  Roadside parking lamps 78
-  Computer 56
- 3 Tachometer 12
-  Instrument lighting 79
-  TRIP O.D. Resetting the trip odometer 55
- 4  Wiper system 51
- 5  Switching the ignition on/off and starting/stopping the engine 45
- 6 Ignition lock 45
- 7 Buttons on steering wheel, right
-  Resuming cruise control 53
-  Storing speed and accelerating or decelerating
-  Activating/deactivating cruise control 53
- left side
-  Increasing or reducing volume
-  Telephone
Accepting and ending a call, starting dialing of selected phone number and redialing if no phone number is selected
-  Activating/deactivating voice activation system
-  Changing the radio station
-  Selecting a music track
-  Scrolling through the redial list
- 8 Horn: the entire surface
- 9 Adjusting the steering wheel 40
- 10 Releasing the hood 146

DISPLAYS

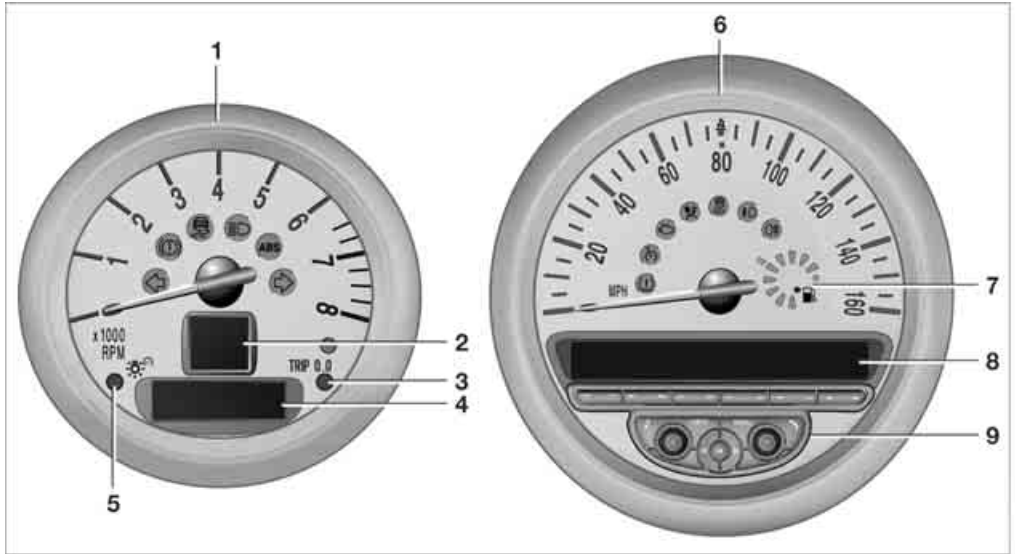

- 1 Tachometer 55
with indicator and warning lamps 13
- 2 Display for
 - ▷ Current vehicle speed 55
 - ▷ Indicator and warning lamps 13
- 3 Resetting the trip odometer 55
- 4 Display for
 - ▷ Position of automatic transmission 47
 - ▷ Computer 56
 - ▷ Date of next scheduled service, and remaining distance to be driven 61
 - ▷ Odometer and trip odometer 55
 - ▷ Initializing the Flat Tire Monitor 68
 - ▷ Resetting the Tire Pressure Monitor 70
 - ▷ Settings and information 57
 - ▷ Personal Profile settings 22

- 5 Instrument lighting 79
- 6 Speedometer
with indicator and warning lamps 13
- 7 Fuel gauge 55
- 8 Radio display 16
- 9 Radio 16

INDICATOR AND WARNING LAMPS

The concept

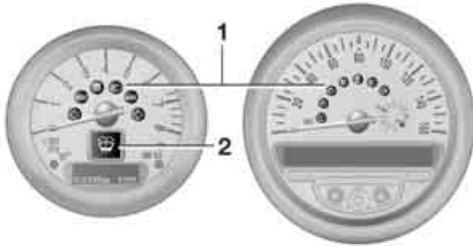

Indicator and warning lamps can light up in various combinations and colors in indicator area **1** or **2**.

Some lamps will be tested for proper functioning when the engine is started or the ignition is switched on and will therefore light up briefly.

What to do in case of a malfunction

A list of all indicator and warning lamps, as well as notes on possible causes of malfunctions and on how to respond, can be found starting on page [169](#).

AROUND THE CENTER CONSOLE

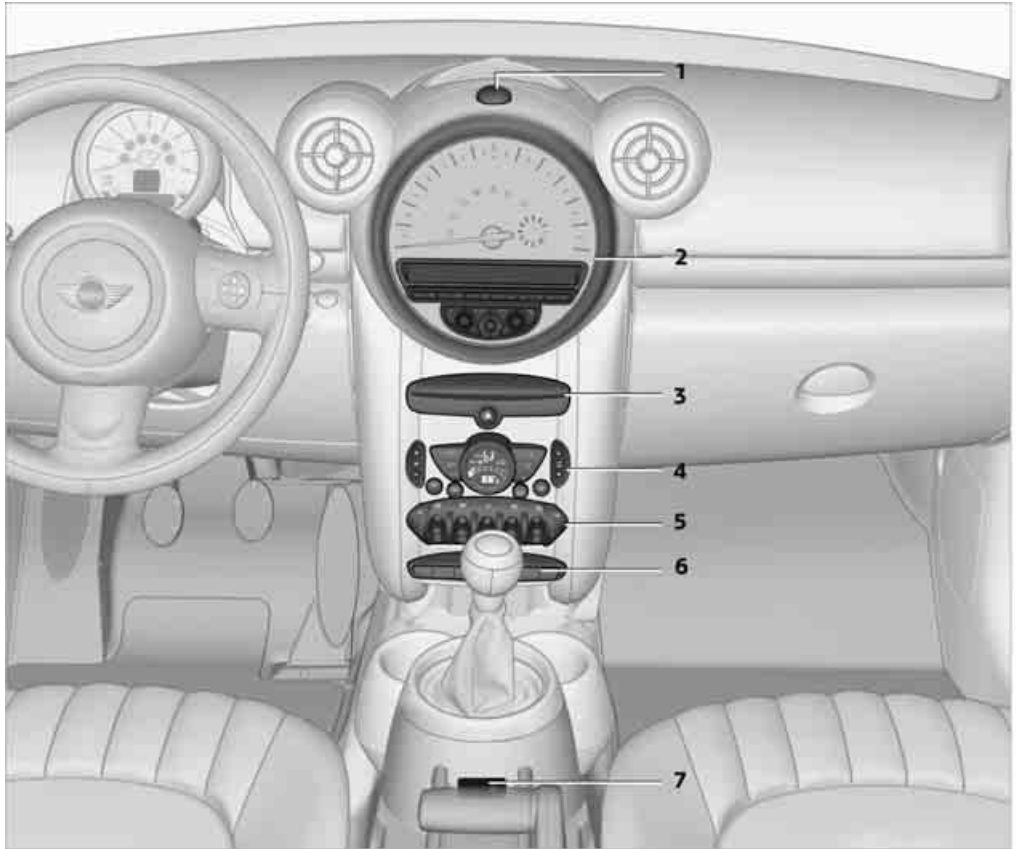

1 Hazard warning flashers

2 Speedometer with radio 12

3 CD slot

4 Air conditioner or automatic climate control 81



Temperature



Recirculated-air mode



Air distribution for air conditioner



Air distribution to the windshield



Air distribution to the upper body area



Air distribution to the footwell

AUTO

Automatic air distribution and flow rate

MAX

Maximum cooling

A/C

Cooling function



Defrosting windows

 Rear window defroster

 Windshield heating

 Air flow rate

5 Switches in the center console

 Seat heating [37](#)

 Power windows, front [32](#)

 Power windows, rear [32](#)

 Central locking system, inside [26](#)

6 Buttons in the center console

 Front fog lamps [79](#)

 Safety switch for power windows in rear passenger compartment [33](#)

SPORT Sport button [67](#)

 Driving stability control systems
Dynamic Stability Control DSC [65](#)
Dynamic Traction Control DTC [66](#)

7 AUX-In connection USB audio interface [115](#)

AROUND THE HEADLINER

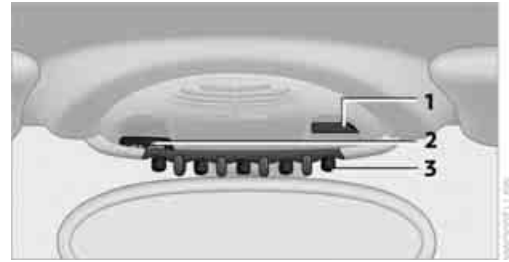

1 Microphone for voice activation system and for telephone in hands-free mode

2 Indicator/warning lamp for front passenger airbags [74](#)

3  Reading lamps [80](#)

 Ambient lighting [80](#)

 Glass roof, electric [31](#)

 Interior lamps [79](#)

RADIO

VEHICLE EQUIPMENT

In this chapter, all production, country, and optional equipment that is offered in the model

range is described. Equipment is also described that is not available because of, for example, selected options or country version. This also applies to safety related functions and systems.

RADIO MINI BOOST CD

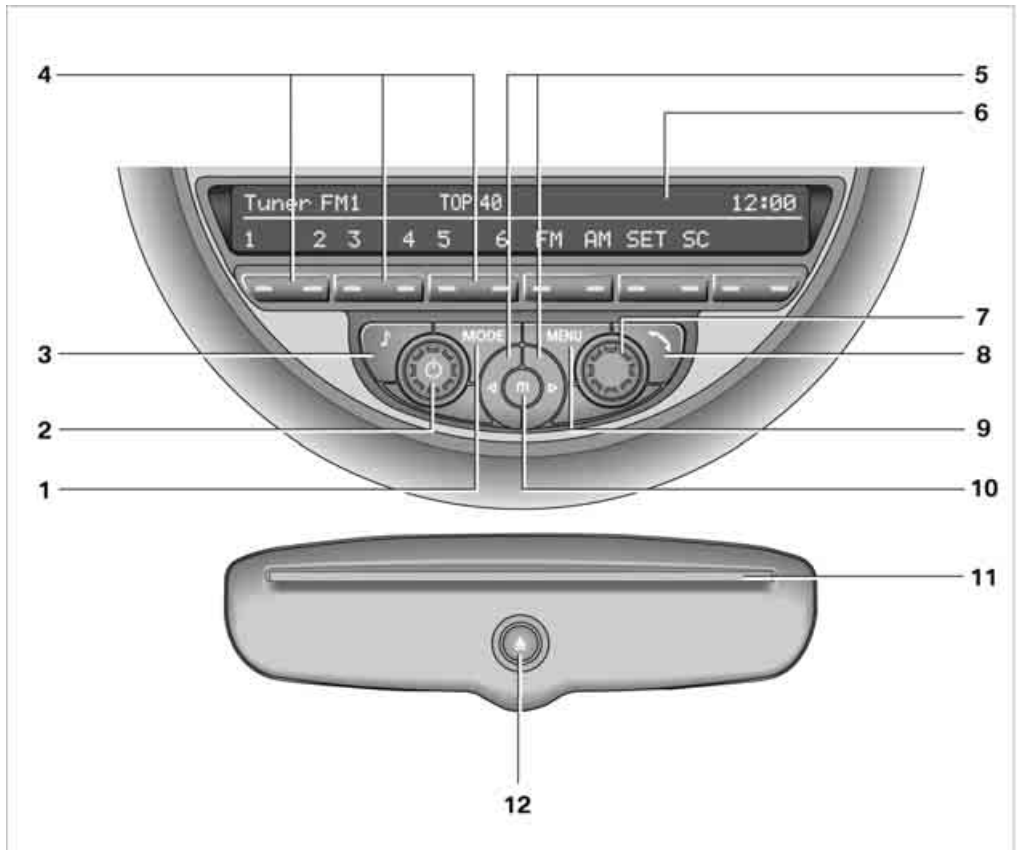

- 1 Selecting audio sources
- 2 On/off, loudspeaker controls
- 3 Accessing settings
 - ▷ Speed-dependent volume
 - ▷ Tone setting
- 4 Function buttons to confirm the menu items displayed above
- 5 Changing stations, tracks
 - ▷ Changing stations
 - ▷ Changing tracks on the CD player
- 6 Display
- 7 Selecting functions
 - ▷ Turn: to select menu items or set values
 - ▷ Press: to confirm selection or store settings
- 8 Establishing/ending voice connections
- 9 Calling up settings menu
- 10 Selecting frequency manually
- 11 CD slot
- 12 Ejecting a CD

Menu navigation

Radio and telephone functions can be called up by using the buttons on the radio and menus.

Calling up settings menu

Press the **MENU** button

- ▷ Settings
- ▷ MINI phone numbers
- ▷ Telephone

Calling up the audio menu

Press the **MODE** button

- ▷ Radio
- ▷ HD Radio
- ▷ Satellite radio
- ▷ CD player
- ▷ External audio device, e.g., MP3 player
- ▷ USB audio interface

Selecting a menu item

Menu items can be selected by using the knob on the right, the **MODE** button or function buttons.

Using the knob on the right

1. Turn knob, arrow **2**, to mark a menu item, for example, "CONFIG".

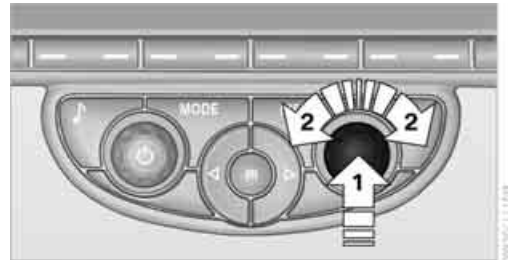

2. Press the knob, arrow **1**, to confirm a highlighted function.

Using function buttons



Press the button.

To carry out a function that is shown on the display, press the button that is below on the left or right.

If only a single function is displayed, press the button in the center.









Depiction in the Owner's Manual

Function buttons that can be pressed on the left or right are provided with an arrow on each side.

For example, press the  button on the left.

Menu items that are to be selected are displayed in quotes, for example "CONFIG".

Symbols on the display

Symbol	Function
	Function is selected
	Function is activated
	Function is deactivated
	Exit menu, one menu back
 	Displaying other menu items
	Scroll display, list contains more than two inputs
	Changing to parent directory

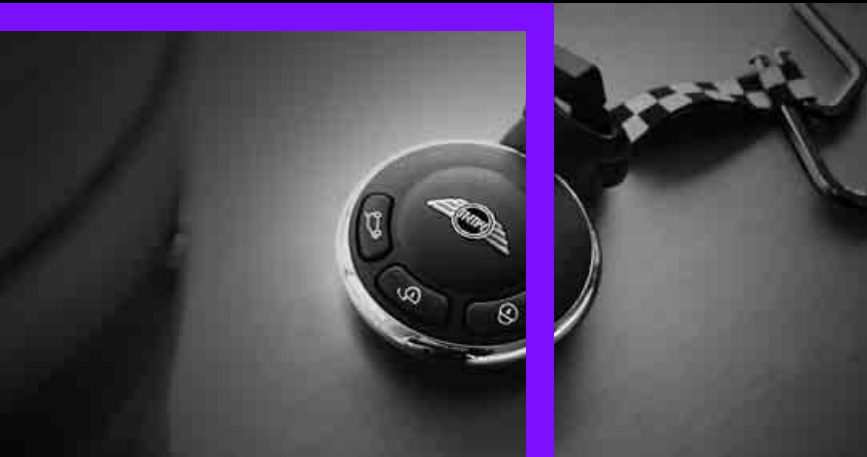

HANDLE ME.

AT A GLANCE

CONTROLS

DRIVING TIPS

ENTERTAINMENT

COMMUNICATIONS

MOBILITY

REFERENCE

OPENING AND CLOSING

VEHICLE EQUIPMENT

In this chapter, all production, country, and optional equipment that is offered in the model range is described. Equipment is also described that is not available because of, for example, selected options or country version. This also applies to safety related functions and systems.

KEYS/REMOTE CONTROLS

Buttons on the remote control

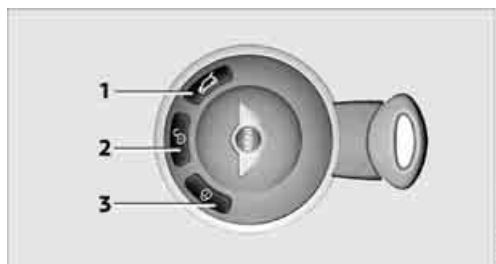

- 1 Opening the tailgate
- 2 Unlocking
- 3 Locking

General information

Each remote control contains a rechargeable battery that is recharged when it is in the ignition lock while the car is being driven. You should therefore use each remote control at least twice a year to maintain the charge status. In vehicles equipped with Comfort Access, the remote control contains a replaceable battery, page 31.

If more than one remote control unit is used, the settings called up and implemented depend on which remote control is recognized when the car is unlocked, refer to Personal Profile, page 22.

In addition, information about service requirements is stored in the remote control, refer to Service data in the remote control, page 149.

New remote controls

Your MINI dealer can supply new remote controls as additional units or as replacements in the event of loss.

Integrated key

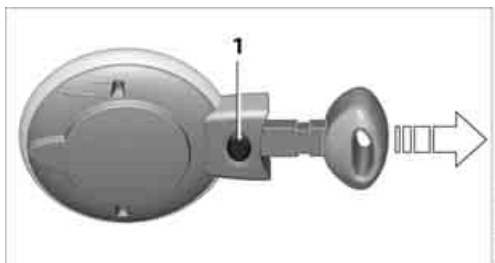

Press button 1 to release the key.

The integrated key fits the following locks:

- ▷ Driver's door, page 26

PERSONAL PROFILE

The concept

The functions of your MINI can be set individually. By means of Personal Profiles, most of these settings are stored for the remote control currently in use. When you unlock the car, the remote control is recognized and the settings stored for it are called up and implemented.

This means that your settings will be activated for you, even if in the meantime your car was used by someone else with another remote control and the corresponding settings.

Individual settings are stored for a maximum of three remote controls.

Personal Profile settings

For more information on specific settings, refer to the specified pages.

- ▷ Response of the central locking system when the car is being unlocked 23
- ▷ Automatic locking of the vehicle 27
- ▷ Triple turn signal activation 50
- ▷ Settings for the displays in the speedometer and tachometer:
 - ▷ 12 h/24 h mode of the clock Formats and units of measure 59
 - ▷ Date format, refer to Formats and units of measure 59
 - ▷ Units of measure for fuel consumption, distance covered/remaining distances and temperature, refer to Formats and units of measure 59
- ▷ Light settings:
 - ▷ Pathway lighting 77
 - ▷ Daytime running lights 77
- ▷ Automatic climate control: activating/deactivating the AUTO program, setting the temperature, air volume and air distribution 83
- ▷ Entertainment:
 - ▷ Last entertainment source
Radio MINI Boost CD:
Audio volume, starting on 108
Tone 109

CENTRAL LOCKING SYSTEM

The concept

The central locking system is ready for operation whenever the driver's door is closed.

The system simultaneously engages and releases the locks on the following:

- ▷ Doors
- ▷ Tailgate
- ▷ Fuel filler flap

Operating from outside

- ▷ Via the remote control
- ▷ Using the door lock
- ▷ In cars with Comfort Access, via the door handles on the driver's and passenger's sides

The remote control can also be used to switch on/off the welcome lamps and interior lamps. The alarm system is also activated or deactivated, page 28.

Operating from inside

Button for central locking system, page 26.

In the event of a sufficiently severe accident, the central locking system unlocks automatically. In addition, the hazard warning flashers and interior lamps come on.

OPENING AND CLOSING: FROM OUTSIDE



Persons or animals in a parked vehicle could lock the doors from the inside. Take the key with you when you leave the vehicle so that the vehicle can be opened from the outside. ◀

Using the remote control

Unlocking

Press the  button.

The welcome lamps and interior lamps come on.

Unlocking mode

You can also set which parts of the car are unlocked. The setting is stored for the remote control in use.

1. Switch on the ignition, refer to page 45.
2. Press the button in the turn signal indicator as often as necessary until "SET/INFO" is displayed.



3. Press and hold the button until the display changes.
4. Press the button as often as necessary until the symbol and "SET" are displayed.



5. Press and hold the button until the display changes.
6. Press the button repeatedly until the display shows the illustrated symbol, arrow.

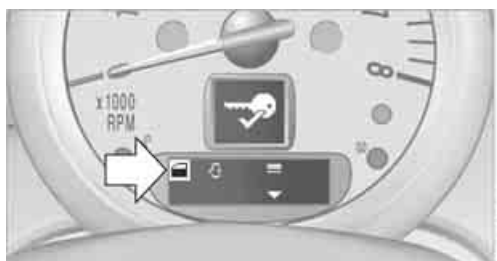

7. Press and hold the button until the display changes.

8. Press the button to select:



Press the button once to unlock only the driver's door and the fuel filler flap.

Press the button twice to unlock the entire vehicle.



Press the button once to unlock the entire vehicle.

9. Press and hold the button until the display changes. The setting is stored for the remote control currently in use.

Convenient opening

Press and hold the  button.

The power windows are opened and the glass roof is tilted.



Convenient closing is not possible by means of the remote control. ◀

Locking

Press the  button.



Do not lock the vehicle from the outside if there is any person inside, because the vehicle cannot be unlocked from inside without special knowledge. ◀

Setting confirmation signals

To have the vehicle confirm when it has been locked or unlocked.

1. Switch on the ignition, refer to page 45.
2. Press the button in the turn signal indicator as often as necessary until "SET/INFO" is displayed.



3. Press and hold the button until the display changes.
4. Press the button as often as necessary until the symbol and "SET" are displayed.



5. Press and hold the button until the display changes.
6. Press the button to select, arrow:
 - ▷ Confirmation signal during unlocking
 - ▷ Confirmation signal during locking

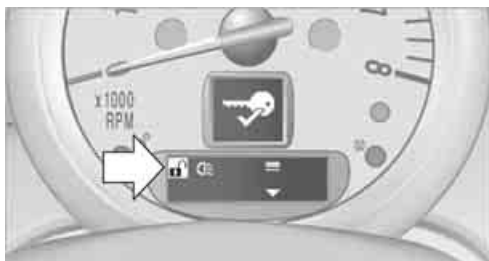

7. Press and hold the button until the display changes.

8. Press the button to select:

- ▷ The hazard warning flashers light up during unlocking/locking.
- ▷ An acoustic signal sounds during unlocking/locking.
- ▷ The hazard warning flashers light up and an acoustic signal sounds during unlocking/locking.
- ▷ **off**
The function is deactivated.

9. Press and hold the button until the display changes. The setting is stored.

Switching on interior lamps

While the car is locked:

Press the button.

You can also use this function to locate your vehicle in parking garages, etc.

Unlocking tailgate

Press the button for approx. 1 second and then release it.

When it is opened, the tailgate swings out and up toward the rear. Make sure that adequate clearance is available before opening. To prevent accidentally locking yourself out, do not place the key down in the cargo area. If the tailgate was locked before opening, it will be locked again after it is closed. Before and after each trip, check that the tailgate has not been inadvertently unlocked. ◀

Malfunctions

The remote control may malfunction due to local radio waves. If this occurs, unlock and lock the car at the door lock with the integrated key. If the car can no longer be locked with a remote control, the battery in the remote control is discharged. Use this remote control during an extended drive; this will recharge the battery, page 22.

For US owners only

The transmitter and receiver units comply with part 15 of the FCC/Federal Communications Commission regulations. Operation is governed by the following:

FCC ID:
LX8766S
LX8766E
LX8CAS

Compliance statement:

This device complies with part 15 of the FCC Rules. Operation is subject to the following two conditions:

- ▷ This device must not cause harmful interference, and
- ▷ this device must accept any interference received, including interference that may cause undesired operation.

 Any unauthorized modifications or changes to these devices could void the user's authority to operate this equipment. ◀

Using the door lock

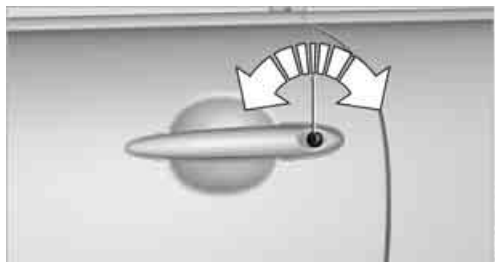

You can set which parts of the car are unlocked, page 23.

Depending upon the equipment, it is possible that only the driver's side door is unlocked or locked using the door lock.

 Do not lock the vehicle from the outside if there is any person inside, because the vehicle cannot be unlocked from inside without special knowledge. ◀

Locking doors and tailgate together

To lock all doors, the fuel filler flap, and the tailgate together:

- ▷ With the doors closed, press the interior central locking button, page 26, to lock the vehicle.
- ▷ Unlocking and opening the driver or passenger door, page 26.

Lock the vehicle.

- ▷ Lock the driver's door with the integrated key via the door lock, or
- ▷ press the safety lock button on the passenger's door and close the door from the outside.

Manual operation

In the event of an electrical malfunction, the driver's door can be unlocked or locked by turning the integrated key in the door lock to the end positions.

OPENING AND CLOSING: FROM INSIDE

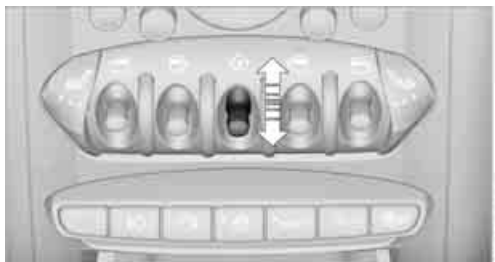

The switch locks or unlocks the doors and tailgate when the doors are closed, but the anti-theft system is not activated. The fuel filler flap remains unlocked.

Unlocking and opening

- ▷ Either unlock the doors together using the switch for the central locking system and then pull the door handle above the armrest or

- ▷ pull on the door handle of either door twice: the first time unlocks the door, the second time opens it.

Locking

- ▷ Press the switch or
- ▷ press down the safety lock button of a door. To prevent you from being locked out, the open driver's door cannot be locked using the lock button.

 Persons or animals in a parked vehicle could lock the doors from the inside. Take the key with you when you leave the vehicle so that the vehicle can be opened from the outside. ◀

Automatic locking

You can also set the situations in which the car locks. The setting is stored for the remote control in use.

1. Switch on the ignition, refer to page 45.
2. Press the button in the turn signal indicator as often as necessary until "SET/INFO" is displayed.







3. Press and hold the button until the display changes.

4. Press the button as often as necessary until the symbol and "SET" are displayed.

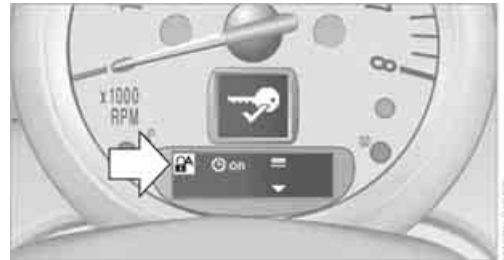



5. Press and hold the button until the display changes.
6. Press the button repeatedly until the display shows the illustrated symbol, arrow.



7. Press and hold the button until the display changes.
8. Press the button to select:
 - ▷  **on**
The central locking system automatically locks the vehicle after some time if no door has been opened.
 - ▷  **on**
The central locking system automatically locks the vehicle as soon as you drive off.
 - ▷  **→**
The central locking system automatically locks the vehicle after some time if no door has been opened, or as soon as you drive off.
 - ▷ **off**
The central locking system remains unlocked.
9. Press and hold the button until the display changes. The setting is stored.

TAILGATE

 To avoid damage, make sure there is sufficient clearance before opening the tailgate. ◀

 While driving, sharp objects or objects with edges may strike against the rear window and damage the heating element for the rear window. Assure that there are no objects with sharp edges near the rear window. ◀

Opening

 In some market-specific versions, the tailgate cannot be unlocked using the remote control unless the vehicle is unlocked first. Only drive with the tailgate fully closed; otherwise, the tail lamps will be obscured and driving safety will be compromised. ◀



Press the top side of the MINI emblem, arrow, or  button on the remote control for approx. 1 second and then release it. The tailgate is unlocked.

Closing

 Make sure that the closing path of the tailgate is clear; otherwise, injuries may occur. ◀

 Take the remote control with you and do not put it into the luggage compartment: otherwise, the remote control can be locked in the vehicle when the tailgate is closed. ◀



The handle recesses on the interior trim panel of the tailgate make it easier to pull it down.

ALARM SYSTEM

The concept

The alarm system, when activated, reacts if:

- ▷ A door, the engine compartment lid or the tailgate is opened
- ▷ There is movement inside the car
- ▷ The car's inclination changes, for instance if an attempt is made to jack it up and steal the wheels or to raise it prior to towing it away
- ▷ There is an interruption in the power supply from the battery

The alarm system briefly indicates unauthorized entry or tampering by means of:

- ▷ An acoustic alarm
- ▷ Switching on the hazard warning flashers

Arming and disarming

General information

Whenever the car is locked or unlocked, the alarm system is armed or disarmed.

Door lock with armed alarm system

Because of the design, unlocking the door lock may trigger the alarm in some countries.

To turn off the alarm, unlock the vehicle using the remote control or switch on the ignition.

Tailgate with armed alarm system

Even when the alarm system is armed, you can open the tailgate by means of the  button on the remote control.

When you subsequently close the tailgate it is again locked and monitored.

Panic mode

You can activate the alarm system if you find yourself in a dangerous situation.

Press the  button for at least two seconds.

Switching off the alarm:

Press any button.

Switching off an alarm

- ▷ Unlock the car with the remote control.
- ▷ Insert the key fully into the ignition lock.
- ▷ In cars with Comfort Access, press the button on the door lock.

Display on the revolution counter

When the system is armed, all LEDs pulse. After approx. 16 minutes one LED flashes.

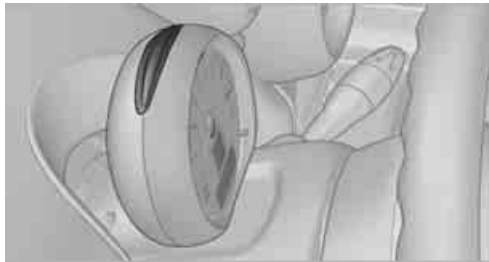

- ▷ LEDs pulse or LED flashes: system is armed.
- ▷ One LED flashes at short intervals: Doors, the hood or the tailgate are not properly closed. Even if these are not closed fully, the remaining items are deadlocked and the LEDs pulse after approx. 10 seconds for approx. 16 minutes. Afterwards, one LED flashes. The interior movement detector is not activated.

- ▷ LEDs go out after the vehicle is unlocked: No attempt was made to tamper with the car.
- ▷ LEDs flash after unlocking until the key is inserted in the ignition, but for no longer than approx. 5 minutes: an attempt was made to tamper with the vehicle.

Tilt alarm sensor

The vehicle's inclination is monitored. The alarm is triggered, for instance, if an attempt is made to steal the vehicle's wheels or tow it away.

Interior movement detector

Before the interior movement detector can operate correctly, the windows and glass roof must be closed.

Avoiding false alarms

The tilt alarm sensor and the interior movement detector can be switched off together.

This prevents false alarms, e.g. in the following situations:

- ▷ In duplex garages
- ▷ When being transported on car-carrying trains, ferries or trailers
- ▷ If pets are to remain inside the car

Switching off the tilt alarm sensor and interior movement detector

- ▷  Press the button on the remote control twice in succession.
- ▷ Lock the vehicle twice with the integrated key.

LEDs flash in short succession for approx. 2 seconds.

The tilt alarm sensor and the interior movement detector are switched off until the car is next unlocked and locked.

COMFORT ACCESS

The concept

Access to the vehicle is possible without the use of the remote control. All you need to do is wear the remote control close to your body, e.g. in your jacket pocket. The vehicle automatically detects the remote control within the immediate vicinity or in the passenger compartment.

Comfort Access supports the following functions:

- ▷ Unlocking/locking the vehicle
- ▷ Convenient closing
- ▷ Unlocking the tailgate separately
- ▷ Starting the engine

Functional requirements

- ▷ There are no external malfunction sources in the vicinity.
- ▷ For locking, the remote control must be outside of the vehicle.
- ▷ The vehicle cannot be locked or unlocked again until after approx. 2 seconds.
- ▷ The engine can only be started if the remote control is in the vehicle.
- ▷ The doors and tailgate must be closed to be able to operate the windows and glass roof.

Comparison to standard remote controls

The indicated function can be operated by pressing the buttons or via Comfort Access.

Instructions on opening and closing are found starting on page 22.

- ▷ If you notice a brief delay while opening or closing the windows or glass roof, the system is checking whether a remote control is inside the vehicle. Repeat the opening or closing procedure, if necessary. ◀

Unlocking



Press button 1.

Depending on the setting, refer to Unlocking mode on page 23, only the driver's door or the entire vehicle is unlocked.

- ▷ Press the button again to lock the vehicle again. ◀

Convenient opening with the remote control, refer to page 24.

Locking

Press button 1.

For Convenient closing, press and hold button 1. In addition, the windows and the glass sunroof are closed.

Unlocking the tailgate separately

Press the top side of the MINI emblem.

- ▷ If the vehicle detects that a remote control has been accidentally left inside the locked vehicle's cargo area after the tailgate is closed, the tailgate will reopen slightly. The hazard warning flashers flash and an acoustic signal sounds. ◀

Windows and glass roof, electric

If the engine is switched off, you can still operate the windows and glass sunroof so long as a door or the tailgate has not been opened.

If the doors and tailgate are closed again and the remote control is located inside the vehicle, the windows and the glass sunroof can be operated again.

Insert the remote control into the ignition lock to be able to operate the windows or glass roof when the engine is switched off and the doors are open.

Switching on radio readiness

Switch on radio readiness by pressing the Start/Stop button, page 45.

 Do not depress the brake or the clutch; otherwise, the engine will start. ◀

Starting the engine

The engine can be started or the ignition can be switched on when a remote control is inside the vehicle. It is not necessary to insert a remote control into the ignition lock, page 45.

Switching off the engine in cars with automatic transmission

The engine can only be switched off when the selector lever is in position P, page 47.

To switch the engine off when the selector lever is in position N, the remote control must be in the ignition lock.

Before driving a vehicle with automatic transmission into a car wash

1. Insert remote control into ignition lock.
2. Depress the brake.
3. Move the selector lever to position N.
4. Switch off the engine.

The vehicle can roll.

Malfunction

Comfort Access may malfunction due to local radio waves.

If this happens, open or close the vehicle via the buttons on the remote control or using the integrated key.

Insert the remote control into the ignition lock and start the engine.

Warning lamps



The warning lamp lights up when an attempt is made to start the engine: the engine cannot be started. The remote control is not inside the vehicle or is malfunctioning. Take the remote control with you inside the vehicle or have it checked. If necessary, insert another remote control into the ignition lock.



The warning lamp lights up when the engine is running: the remote control is no longer inside the vehicle. After the engine is switched off, the engine can only be restarted within approx. 10 seconds.



The indicator lamp lights up: replace the battery in the remote control.

Replacing the battery

The remote control for Comfort Access contains a battery that will need to be replaced from time to time.

1. Remove the cover.



2. Insert the new battery with the plus side facing up.
 3. Press the cover on to close.
-  Take the old battery to a recycling center or to your MINI dealer. ◀

GLASS ROOF, ELECTRIC



To prevent injuries, exercise care when closing the glass roof and keep it in your field of vision until it is shut. Take the key with you when you leave the car;

otherwise, children could operate the roof and possibly injure themselves. ◀

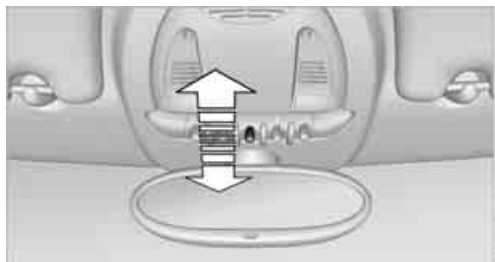

Tilting

- ▷ Press the switch backward to the resistance point and hold it there.
Both glass roofs are tilted.
Releasing the switch stops the movement.
- ▷ With the ignition switched on, press the switch backward beyond the resistance point.
Both closed roofs are tilted fully.
Pressing again stops the movement.

Opening, closing

With the ignition switched on and the glass sunroof tilted, press the switch backward and hold it there.

The front glass roof opens.

The rear glass roof is closed.

Releasing the switch stops the movement.

The glass roof can be closed in the same way by pressing the switch forward.

The front glass roof remains in a tilted position.

The rear glass roof is tilted. Pressing on the switch again closes both roofs completely.

Convenience operation via door lock or Comfort Access, refer to page 24 and 30.

Roller sunblind

The roller sunblind can be opened and closed independently of the glass roof.

Following interruptions in electrical power supply

After a power failure, there is a possibility that the glass roof can only be tilted. In this case, have the system initialized. The manufacturer of your MINI recommends that you have this work done by your MINI dealer.

WINDOWS



To prevent injuries, exercise care when closing the windows.

Take the remote control with you when you leave the car; otherwise, children could operate the electric windows and possibly injure themselves. ◀



If, after a window is opened and closed several times in close succession, the window can only be closed and not opened, the system is overheated. Let the system cool for several minutes with the ignition switched on or the engine running. ◀

Opening, closing

Front window

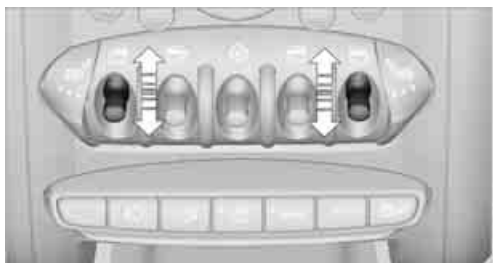

- ▷ Press the switch downward.
The window opens until you release the switch.
- ▷ Push the switch downward.
As of radio readiness, the windows will open automatically. Push the switch again to stop the opening movement.

To open the window a crack, press the switch down twice in quick succession.

The window can be closed in the same way by pressing the switch up.

Rear window

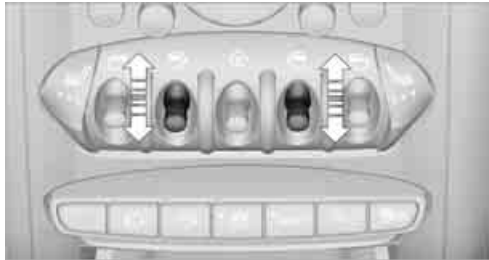

- ▷ Press the switch downward. The window opens until you release the switch.
- ▷ Push the switch downward. As of radio readiness, the windows will open automatically. Push the switch again to stop the opening movement.

The window can be closed in the same way by pressing the switch up.

After switching off the ignition

When the ignition is switched off, the windows can still be operated for approx. 1 minute as long as no door is opened.

! Take the key with you when you leave the car; otherwise, children could operate the electric windows and possibly injure themselves. ◀

Pinch protection system

If the closing force rises beyond a predefined threshold during closing, the system will stop moving the window prior to lowering it again slightly.

! Even though there is the pinch protection system, always ensure that the window's travel path is clear; otherwise, the safety system might fail to detect certain kinds of obstructions, such as thin objects, and the window would continue closing.

Do not install any accessories that might interfere with window movement. Otherwise, the pinch protection system could be impaired. ◀

Closing without pinch protection

If there is an external danger, or if ice on the windows, etc., prevents you from closing the windows normally, the window can be closed manually.

1. Press the switch upward and hold it there. Pinch protection is limited and the window reopens slightly if the closing force exceeds a certain value.
2. Press the switch upward again within approx. 4 seconds and hold it there. The window closes without pinch protection.

Safety switch

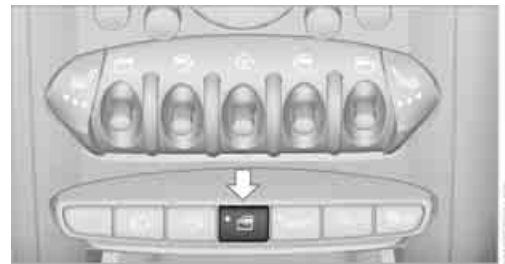

With the safety switch, you can prevent the rear windows from being opened or closed via the switches in the rear passenger area, by children, for example.

Press the button, arrow.

The LED lights up when this safety feature is activated.

! Always press the safety switch when children ride in the rear, otherwise uncontrolled closing of the windows could lead to injuries. ◀

ADJUSTMENTS

VEHICLE EQUIPMENT

In this chapter, all production, country, and optional equipment that is offered in the model range is described. Equipment is also described that is not available because of, for example, selected options or country version. This also applies to safety related functions and systems.

SITTING SAFELY

The ideal sitting position can make a vital contribution to relaxed, fatigue-free driving. In conjunction with the safety belts, the head restraints and the airbags, the seated position has a major influence on your safety in the event of an accident. To ensure that the safety systems operate with optimal efficiency, we strongly urge you to observe the instructions contained in the following section.

For additional information on transporting children safely, refer to page 41.

Airbags



Always maintain an adequate distance between yourself and the airbags. Always grip the steering wheel on the rim, with your hands in the 3 o'clock and 9 o'clock positions, to minimize the risk of injury to the hands or arms in the event of the airbag being deployed.

No one and nothing should come between the airbags and the seat occupant.

Do not use the cover of the front airbag on the front passenger side as a storage area. Ensure that the front passenger is correctly seated, e.g. that no feet or legs are propped against the dashboard. Otherwise, leg injury could result if the front airbag suddenly deployed.

Make sure that passengers keep their heads away from the side airbag and do not lean against the cover of the head airbag, otherwise

injuries can occur when the airbags are triggered. ◀

Even if you follow all the instructions, injuries resulting from contact with airbags cannot be fully excluded, depending on the circumstances. The ignition and inflation noise may provoke a mild hearing loss in extremely sensitive individuals. This effect is usually only temporary.

For airbag locations and additional information on airbags, refer to page 73.

Head restraint

A correctly adjusted head restraint reduces the risk of neck injury in the event of an accident.



Adjust the head restraint in such a way that its center is at approx. ear level.

Otherwise, there is an increased risk of injury in the event of an accident. ◀

Head restraints, refer to page 36.

Safety belt

Before every drive, make sure that all occupants wear their safety belts. Airbags complement the safety belt as an additional safety device, but they do not represent a substitute.

Number of safety belts



Never allow more than one person to wear a single safety belt. Never allow infants or small children to ride in a passenger's lap.

Make sure that the belt in the lap area sits low across the hips and does not press against the abdomen. The safety belt must not rest against the throat, run across sharp edges, pass over hard or fragile objects or be pinched. Fasten the safety belt so that it is pulled taut across the lap and shoulder, fitting the body snugly without any twists. Otherwise, the belt could slide over the hips in the event of a frontal collision and injure the abdomen. Avoid wearing bulky cloth-

ing and regularly pull the belt in the upper-body area taut; otherwise, its restraining effect could be impaired. ◀

Safety belts, refer to page 37.

SEATS

Note before adjusting

! Never attempt to adjust your seat while the vehicle is moving. The seat could respond with unexpected movement, and the ensuing loss of vehicle control could lead to an accident.

On the front passenger seat as well, do not incline the backrest too far to the rear while the vehicle is being driven; otherwise, there is a danger in the event of an accident of sliding under the safety belt, eliminating the protection normally provided by the belt. ◀

Comply with the instructions on head restraint height on page 36 and on damaged safety belts on page 39.

Seat adjustment, front

! Observe the instructions on page 35 to ensure the best possible personal protection. ◀



Longitudinal direction

Pull the lever, arrow 1, and slide the seat into the desired position, arrows 2.

After releasing the lever, move the seat slightly forward or back so that it engages properly.

Height

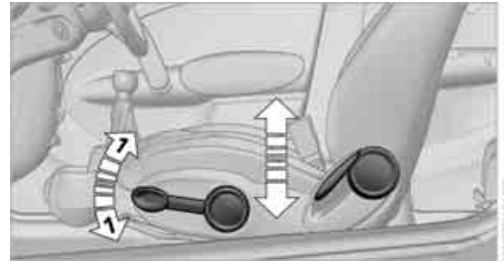

Pull up or push down the lever repeatedly, arrows 1, until the desired height is reached.

Backrest



Pull lever, arrow 1, and apply weight to or remove weight from the backrest as needed.

Lumbar support

You can also adjust the contour of the backrest to obtain additional support in the lumbar region.

The upper hips and spinal column receive supplementary support to help you maintain a relaxed, upright sitting position.



Turn the wheel to increase or decrease the curvature.

Seat adjustment, rear

⚠ Do not adjust rear seats while the vehicle is moving; otherwise, passengers could be injured.

Make sure that the locking devices of the rear seats engage properly. Otherwise the restraining effect of the safety belts during an accident could be reduced. ◀

Longitudinal adjustment

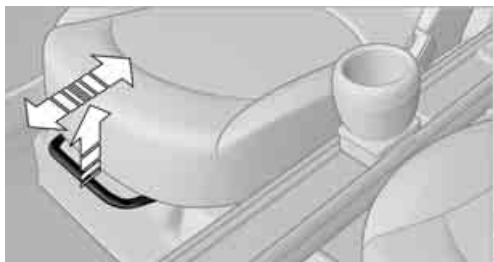

1. Pull the lever and slide the seat into the desired position.
2. Release the lever and move the seat slightly forward or back so that it engages properly.

Backrest

Adjusting backrest angle, refer to page 98.

HEAD RESTRAINTS

Correctly adjusted head restraint

A correctly adjusted head restraint reduces the risk of neck injury in the event of an accident.

⚠ Correctly adjust the head restraints of all occupied seats; otherwise, there is an increased risk of injury in an accident. ◀

Height

Adjust the head restraint so that its center is approximately at ear level.

Height adjustment

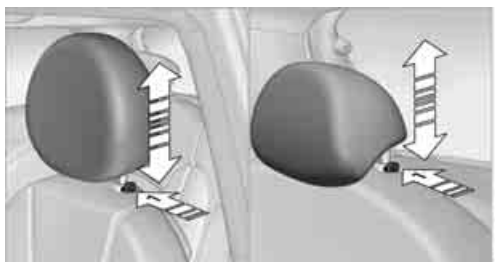

To raise: pull up.

To lower: press the button, arrow 1, and slide the head restraint down.

Removing

Only remove a head restraint if no one will be sitting on the seat in question.

⚠ Reinstall the head restraint before transporting passengers, as otherwise the head restraint cannot provide its protective function. ◀

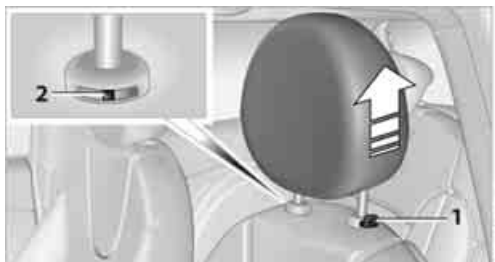

Front

1. Pull up as far as it will go.
2. Fold the backrest back slightly.
3. Press button **1** and pull the head restraint out as far as it will go.
4. Also press button **2** with a suitable tool and completely remove the head restraint.
5. Fold back the backrest.

Rear

1. Pull up as far as it will go.
2. Fold the backrest forward slightly.
3. Press button **1** and pull the head restraint out completely.
4. Also press button **2** with a suitable tool and completely remove the head restraint.
5. Fold rear seat backrest back into position.

SEAT HEATING

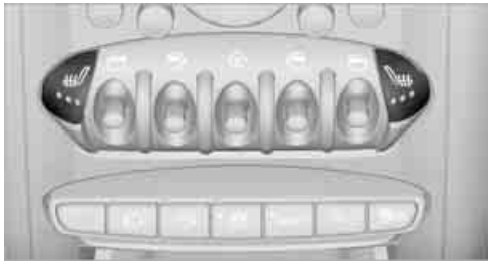

Switching on

Press once for each temperature level. Three LEDs indicate the highest temperature.

If you continue driving within the next 15 minutes, the seat heating is automatically activated at the previously set temperature.

The temperature is lowered or the heating is switched off entirely to reduce the drain on the battery.

The LEDs stay lit.

Switching off

Press button longer.

SAFETY BELTS



Observe the instructions on page **35** to ensure the best possible personal protection. ◀

Before every drive, make sure that all occupants wear their safety belts. Airbags complement the safety belt as an additional safety device, but they do not represent a substitute.

Front and rear seats



Closing

Make sure you hear the lock engage in the belt buckle.

The upper belt anchor is suitable for adults of any stature as long as the seat is adjusted properly, page **35**.

Opening

1. Grasp the belt firmly.
2. Press the red button in the buckle.
3. Guide the belt into its reel.

Height adjustment for rear safety belt tongues

When the outer rear seats are unoccupied, the safety belt tongues can be slid back to the cargo area trim panel with a clasp to prevent noise.

Back seat: center belt

The belt buckle marked with the word CENTER is designed exclusively for the middle passenger.

If the center safety belt is used in the back, the backrests must be locked, see page 99; otherwise the safety belt will not have a restraining effect.

Belt take-up on headliner

The take-up for the safety belt is on the headliner.



- 1 Opening for safety belt
- 2 Receptacle for small belt latch

Remove small belt latch from the take-up 3. Guide both belt latches downwards.

Fastening

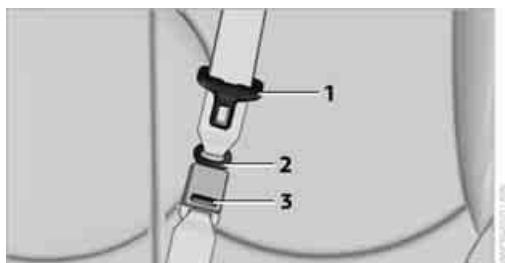

Insert safety belt with small belt latch 2 into the small belt buckle 3.

Opening

Press red button on small belt buckle 3 with belt latch 1.

If the center belt is locked:

Press red button 3 with the belt latch of the left outside belt.

Buckle belt

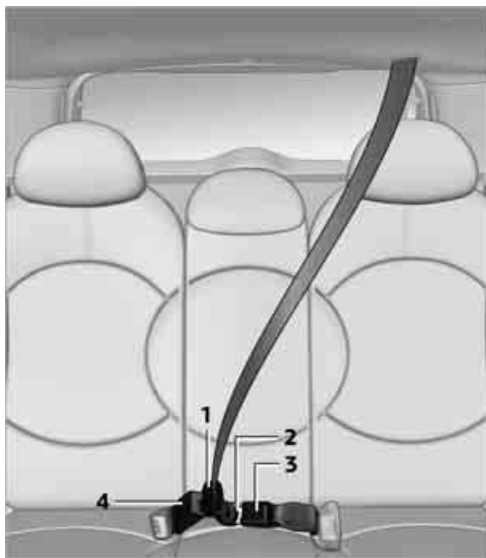

- 1 Large belt latch
- 2 Small belt latch
- 3 Small belt buckle
- 4 Large belt buckle

The belt latch 1 must be inserted into the belt buckle 4. Make sure you hear the lock engage in the belt buckle.

 Insert the belt latch into the belt buckle so that the safety belt is properly attached when a person is buckled in, and is not twisted. ◀

Stow away the center belt

If the center seat is not occupied, then insert the belt buckles **3** and **4** into the corresponding holders, arrows.

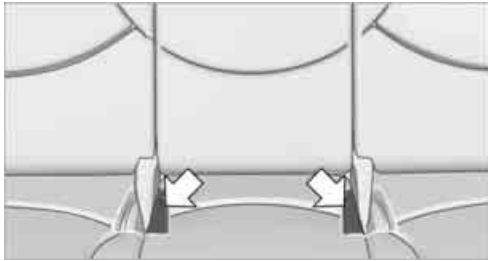

Guide belt latches to the belt take-ups on the headliner, refer to page **38**, and insert them in the provided take-ups.

Safety Belt Reminder

Front seats



The indicator lamps come on and an acoustic signal sounds. Check whether the safety belt has been fastened correctly. The Safety Belt Reminder is issued when the driver's safety belt has not been fastened. The Safety Belt Reminder is also activated at road speeds above approx. 5 mph or 8 km/h if the front passenger's safety belt has not been fastened, if objects are placed on the front passenger seat, or if driver or front passenger unfasten their safety belts.



Damage to safety belts



If the safety belts are damaged or stressed in an accident: have the safety belt system and its seat-belt tensioners replaced and the belt anchors checked. Have this work carried out only by a MINI dealer or by a workshop that has specially trained personnel working in accordance with the specifications of the MINI manufacturer; otherwise, correct operation of these safety systems is not ensured. ◀

MIRRORS

Exterior mirrors



The mirror on the passenger's side is more curved than the driver's mirror. The objects seen in the mirror are closer than they appear. Do not gauge your distance from traffic behind you on the basis of what you see in the mirror; otherwise, there is an increased risk of an accident. ◀



- 1 Adjusting the left or right exterior mirror
- 2 Tilting mirrors in and out

To adjust electrically

1. Choose a mirror, and also turn the button to position **1**.
2. To adjust the mirror, tilt the button into the desired direction forward, back, left or right.

Manual adjustment

If there is, for example, an electrical failure, press on the edges of the mirror glass.

Tilting mirrors in and out

Turn the knob beyond the pressure point in direction **2**. The mirrors can be folded in at road speeds up to approx. 20 mph/30 km/h.

This can be beneficial in narrow streets, for example, or for moving mirrors that were folded in by hand back out into their correct positions.

Automatic heating

At external temperatures below a certain limit, both exterior mirrors are automatically heated while the engine is running or the ignition switched on.

Interior rearview mirror

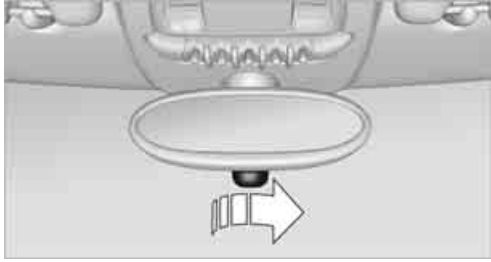

To reduce glare from vehicles behind you when you are driving at night:

Turn the knob.

Interior and exterior mirrors, automatic dimming feature

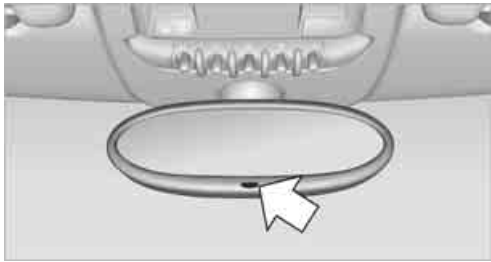

It is controlled by two photosensors:

- ▷ Inside the interior rearview mirror, arrow.
- ▷ On the back of the mirror.

For proper function:

- ▷ Keep the photosensors clean.
- ▷ Do not cover the area between the interior rearview mirror and the windshield.
- ▷ Do not place stickers or decals on the windshield in front of the mirror.

STEERING WHEEL

Adjustments

 Do not adjust the steering wheel position while the car is in motion; otherwise, there is a risk of accident due to an unexpected movement. ◀

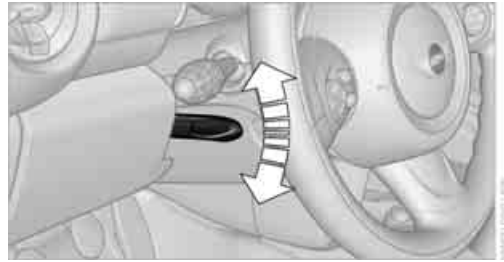

1. Fold the lever down.
2. Move the steering wheel to the preferred distance and angle to suit your seated position.
3. Swing the lever back up.

 Do not use force to swing the lever back up; otherwise, the mechanism will be damaged. ◀

TRANSPORTING CHILDREN SAFELY

VEHICLE EQUIPMENT

In this chapter, all production, country, and optional equipment that is offered in the model range is described. Equipment is also described that is not available because of, for example, selected options or country version. This also applies to safety related functions and systems.

THE RIGHT PLACE FOR CHILDREN

 Do not leave children unattended in the vehicle; otherwise, they could endanger themselves and/or other persons by opening the doors, for example. ◀

Children should always sit in the rear

Accident research has shown that the safest place for children is on the rear seat.

 Only transport children under the age of 13 or smaller than 5 ft/150 cm in the rear in a child restraint system suitable for their age, weight and size. Otherwise, there is an increased risk of injury in the event of an accident. ◀

Children 13 years of age or older must be buckled in with a safety belt as soon as there no longer is any child restraint system that is appropriate for their age, size and weight.

Exception for front passenger seat

Front passenger airbags

 Should it be necessary to use a child restraint system on the front passenger seat, the front and side airbags must be deactivated. Otherwise, there is an increased risk of injury to the child if the airbags deploy, even if the child is seated in a child restraint system. ◀

For more information on automatic deactivation of the front passenger airbags, refer to page 73.

CHILD RESTRAINT SYSTEMS, INSTALLATION

Before installing a child restraint system on the rear seats, move the seat as far back as possible.

5-seater: adjust the inclination of the center backrest to the respective outer backrest.

After the child restraint system has been installed on the respective rear seat, move the backrest forward so that it rests lightly against the child restraint system, refer to Rear seat backrests on page 98.

 Observe the child restraint system manufacturer's instructions when selecting, installing and using child restraint systems. Otherwise, the protective effect may be diminished. ◀

On the front passenger seat

 After installing a child restraint system on the front passenger seat, make sure that the front, side, and knee airbags for the front passenger are deactivated; otherwise, there is an increased risk of injury if the airbags deploy. ◀

Seat position

Before installing a child restraint system, move the front passenger seat as far back and up as possible to obtain the best possible position for the belt. Do not change the seat position after this.

Child seat security



All rear safety belts and the safety belt for the front passenger can be prevented from being pulled out in order to secure child restraint systems.

Locking the safety belt

1. Secure the child restraint system with the belt.
2. Pull the belt strap all the way out.
3. Allow the belt strap to retract and pull it taut against the child restraint system.

The safety belt is locked.

Unlocking the safety belt

1. Open the belt buckle.
2. Remove the child restraint system.
3. Allow the safety belt strap to retract all the way.

Center belt: unlocking additional belt buckle **3**, see page **38**.

Guide safety belt to the take-up on the headliner.

LATCH CHILD RESTRAINT FIXING SYSTEM

LATCH: Lower Anchors and Tethers for Children.

 To install and use the LATCH child restraint system, follow the operating and safety instructions provided by the manufacturer of the system; otherwise, the protective function of the seat may be compromised. ◀

Anchor points for LATCH anchors

Before installing the child seat, pull the belt out of the area for the child restraint fixing system.

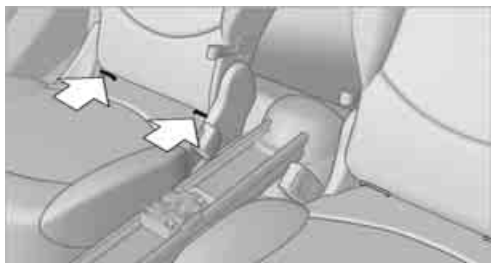

The mounts for the lower LATCH anchors are located at the points indicated by the arrows.

 Make sure that both lower LATCH anchors are properly engaged and that the child restraint system rests firmly against the seat backrest; otherwise, the protective function of the seat may be compromised. ◀

Child restraint system with tether strap

 Use the tether strap anchors to secure child restraint systems only; otherwise, the anchors could be damaged. ◀

4-seater

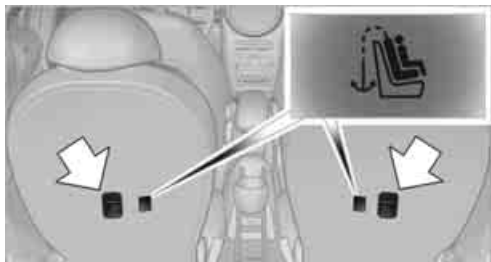

The child restraint anchor fittings, see arrows, are located behind the back of the rear seats.

5-seater

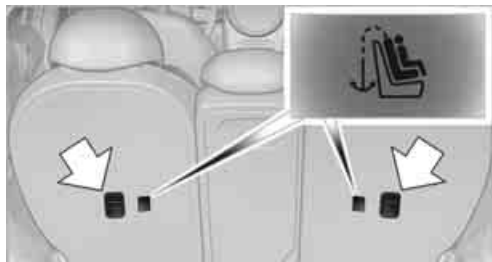

The child restraint anchor fittings for the two outer seats, see arrows, are located behind the back of the rear seats.

The child restraint anchor fitting for the center seat is located under the luggage-compartment sill, position 4 in picture center seat.

Placement of the tether strap

! Make sure the upper tether strap does not run over sharp edges and is not twisted as it passes to the top anchor. Otherwise, the strap will not properly secure the child restraint system in the event of an accident. ◀

Outer seats:



- 1 Direction of travel
- 2 Head restraint
- 3 Rear cargo well
- 4 Tether strap hook
- 5 Anchor
- 6 Seat backrest
- 7 Tether strap of the child restraint system

Center seat:

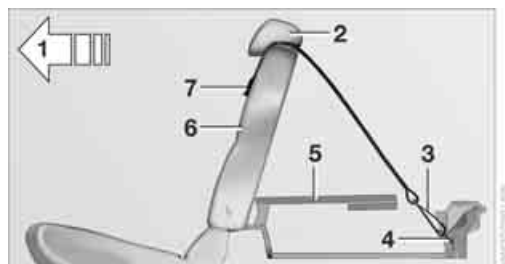

- 1 Forward driving direction
- 2 Head rest
- 3 Attaching clip
- 4 Child restraint anchor fitting
- 5 Load area floor
- 6 Seat back
- 7 Strap of the child restraint system

Attaching upper tether strap to the attachment point

1. Slide the head restraint upward.
2. Center seat: fold the load area floor backwards
3. Guide the tether strap between the head restraint holders.
4. Attach the tether strap to the anchor using the hook.
5. Push the head restraint into its lowermost position.
6. Pull the tether strap tight.

SECURING DOORS AND WINDOWS

Rear doors

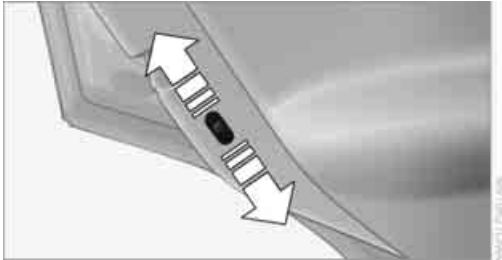

Slide down the safety lever on the rear doors.

The door can now be opened from the outside only.

Safety switch for power windows

The rear power windows are blocked and cannot be operated from the rear. Press safety switch, refer to page [33](#).

DRIVING

VEHICLE EQUIPMENT

In this chapter, all production, country, and optional equipment that is offered in the model range is described. Equipment is also described that is not available because of, for example, selected options or country version. This also applies to safety related functions and systems.

IGNITION LOCK

Inserting the key into the ignition lock

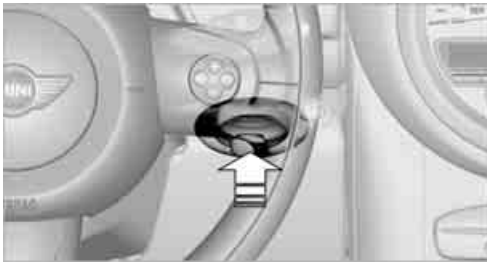

Insert the key all the way into the ignition lock.

Radio readiness

Individual electrical consumers can operate.

Removing the key from the ignition lock

Press in the key briefly. It is ejected slightly.

At the same time:

- ▷ The ignition is switched off if it was on beforehand.

Automatic transmission

The key can only be removed if the selector lever is in position P: interlock.

START/STOP BUTTON



Press the Start/Stop button to switch radio readiness or the ignition on and off. Do not depress the brake or clutch while doing so.

- ▷ If the Start/Stop button is pressed while the clutch is depressed in the manual transmission or the brake pedal is depressed in the automatic transmission, the engine starts. ◀

Radio readiness

Individual electrical consumers can operate. The time and external temperature are displayed in the tachometer.

Radio readiness is switched off automatically:

- ▷ When the key is removed from the ignition lock
- ▷ When using Comfort Access by pressing the button on the door handle or the  button on the remote control, refer to Locking on page 30
- ▷ After a certain has elapsed

Ignition on

Most indicator and warning lamps in indicator area 1, page 13, light up for varying lengths of time.

- ▷ When the engine is off, switch off the ignition and any unnecessary electrical consumers in order to preserve the battery. ◀

Radio readiness and ignition off

All indicator and warning lamps in the displays go out.

The ignition switches off automatically if the driver's door is opened. Pressing the Start/Stop button again switches the ignition back on.

The ignition is not switched off in situations such as the following:

- ▷ The clutch or brake is depressed
- ▷ The low beams are switched on

STARTING THE ENGINE

 Do not allow the engine to run in enclosed areas; otherwise, inhalation of the noxious exhaust gases can lead to loss of consciousness and death. Exhaust gases contain carbon monoxide, an odorless and colorless, but highly toxic gas. Never leave an unattended vehicle with the engine running; otherwise, such a vehicle represents a potential safety hazard.

Before leaving the car while the engine is running, place the transmission in neutral or move the selector lever to position P and forcefully apply the parking brake to prevent the car from moving. ◀

 Avoid frequent starting in quick succession or repeated start attempts in which the engine does not start. Otherwise, the fuel is not burned or inadequately burned and there is a danger of overheating and damaging the catalytic converter. ◀

Do not let the engine warm up with the vehicle at a standstill. Move off immediately at a moderate engine speed.

When starting the engine, do not depress the accelerator pedal.



Manual transmission

Key in ignition lock or inside vehicle with Comfort Access, refer to page 30.

1. Depress the brake.
2. Depress the clutch.
3. Press the Start/Stop button.

Automatic transmission

Key in ignition lock or inside vehicle with Comfort Access, refer to page 30.

1. Depress the brake.
2. Shift the selector lever into position P or N.
3. Press the Start/Stop button.

The starter operates automatically for a certain time, and stops automatically as soon as the engine has started.

SWITCHING OFF THE ENGINE

 Always take the key with you when you leave the vehicle.

When parking, apply the parking brake forcefully; otherwise, the vehicle could begin to roll. Secure the vehicle on steep upward and downward slopes, for example, turn the steering wheel towards the curb. ◀

Manual transmission

1. With the car at a standstill, press the Start/Stop button.
2. Shift into first gear or reverse.
3. Forcefully apply the parking brake.

Automatic transmission

1. With the car at a stop, move the selector lever to position P.
2. Press the Start/Stop button.
3. Forcefully apply the parking brake.

Before driving into a car wash

By following these steps, the vehicle is able to roll:

1. Place the remote control, even with Comfort Access, in the ignition lock.
2. Depress the brake.
3. Move the selector lever to position N.
4. Switch off the engine.

PARKING BRAKE

The parking brake is primarily intended to prevent the vehicle from rolling while parked; it brakes the rear wheels.

In addition, follow the instructions on page 46 under Switching off the engine.

Applying

The lever locks in position automatically.

Releasing



Pull upward slightly, press the button, arrow, and guide the lever down.

! In exceptional cases, if the parking brake has to be used to slow or stop the car, do not pull the lever up too hard. In doing so, continuously press the button of the parking brake lever.

Otherwise, excessive force could lead to over-braking and loss of traction, i.e. fishtailing, at the rear axle. ◀

MANUAL TRANSMISSION

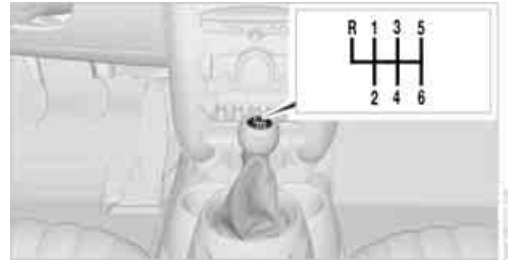

! When shifting into 5th or 6th gear, press the gearshift lever to the right. Otherwise, the engine could be damaged if you inadvertently shift into 3rd or 4th gear. ◀

Reverse gear

Select this only when the vehicle is stationary. When the gearshift lever is pressed to the left, a slight resistance has to be overcome.

AUTOMATIC TRANSMISSION WITH STEPTRONIC

In addition to the fully automatic mode, you can shift gears manually using Steptronic, page 49.

Parking the vehicle

! To prevent the vehicle from rolling, always select position P and apply the parking brake before leaving the vehicle with the engine running. ◀

Removing the key

To remove the key from the ignition lock, first move the selector lever into position P and then switch off the engine: interlock. Remove the key from the ignition lock, refer to page 45.

Selector lever positions

P R N D M/S + -

Displays in the tachometer



P R N D S M1 to M6

The selector lever position is displayed, or the current gear in the manual mode.

Changing selector lever positions

- ▷ The selector lever can only be moved out of position P when the ignition is switched on or the engine is running.
- ▷ Before moving the lever away from P or N with the vehicle stationary, first depress the brake; otherwise, the selector lever will refuse to move: shiftlock.



To prevent the vehicle from creeping after you select a driving position, depress the brake until you are ready to start. ◀

A lock prevents accidental shifting into selector lever positions R and P.

Overriding the selector lever lock



Press the button on the front of the selector lever, arrow.

P Park

Select this only when the vehicle is stationary. The front wheels are blocked.

R Reverse

Select this only when the vehicle is stationary.

N Neutral

Select this when you are in a car wash, for example. The vehicle can roll.

D Drive, automatic position

Position for normal vehicle operation. All forward gears are selected automatically.

Under normal operating conditions, the fuel consumption is lowest when driving in position D.

Kickdown

Kickdown enables you to achieve maximum performance.

Depress the accelerator pedal beyond the full-throttle resistance point.

Sport program and manual mode M/S



Move the selector lever from position D to the left into the M/S shifting slot:

The Sport program is activated and DS is displayed. This position is recommended for a performance-oriented driving style.

To deactivate the Sport program or manual mode M/S, move the selector lever to the right into position D.

Shifting with the selector lever

Push the selector lever forward or pull it back to activate manual operation. Steptronic shifts the gear.

- ▷ Pull the selector lever in the + direction. Transmission shifts up.
- ▷ Push the selector lever in the – direction. Transmission shifts down.

The selected gear is displayed in the tachometer, e.g. M1.

To use the automatic mode again, move the selector lever to the right into position D.

Upshifts and downshifts are executed only when they will result in a plausible combination of engine and vehicle speed; thus, for example, a downshift that would cause the engine to overrev will not be executed by the system. The selected gear is displayed briefly, followed by the current gear.

Shifting on the steering wheel

With the selector lever in position D, automatic drive, you can shift gears using the shift paddles on the steering wheel. The transmission automatically switches to manual mode.

If you do not shift gears with the shift paddles or accelerate for a certain amount of time, the transmission automatically returns to D, automatic drive.



- ▷ Pull one of the shift paddles. Transmission shifts up.
- ▷ Push one of the shift paddles. Transmission shifts down.

M1 through M6 are displayed in the tachometer.

Manually releasing the selector lever lock

Should the selector lever refuse to move out of position P even though the ignition is switched on, the brake is depressed and the button on the selector lever is pressed, the selector lever lock can be overridden:

1. Unclip the sleeve of the selector lever.
2. Pull the sleeve up over the selector lever until the sleeve is inside out. Disconnect the cable connector if necessary.

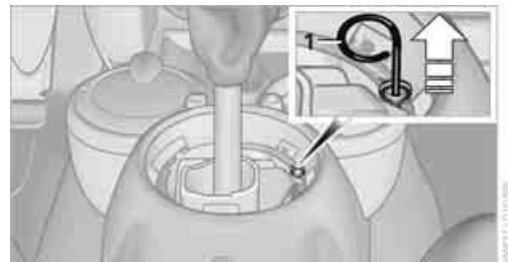

3. Insert extractor hook 1 into the loop on the passenger's side.

 The extractor hook is in the onboard document holder or in the pouch for the tire-changing set, page 162. ◀

4. Pull the loop up.
5. Move the selector lever into the desired position by pressing the button on the front of the selector lever.

 Before manually unlocking the selector lever lock, firmly set the parking brake to prevent the vehicle from rolling away. ◀

TURN SIGNALS/ HEADLAMP FLASHER

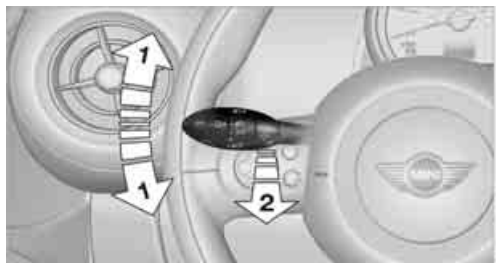

- 1 Turn signal
- 2 Headlamp flasher

Using turn signals

Press the lever beyond the resistance point.
To turn off manually, press the lever to the resistance point.

 Unusually rapid flashing of the indicator lamp indicates that an indicator bulb has failed. ◀

Signaling a turn briefly

Press the lever as far as the resistance point for as long as you wish to signal a turn.

Triple turn signal activation

Press the lever as far as the resistance point.
You can set whether the turn signal flashes once or three times.

1. Switch on the ignition, refer to page 45.
2. Press the button in the turn signal indicator as often as necessary until "SET/INFO" is displayed.



3. Press and hold the button until the display changes.
4. Press the button as often as necessary until the symbol and "SET" are displayed.



5. Press and hold the button until the display changes.
6. Press the button repeatedly until the display shows the illustrated symbol, arrow.

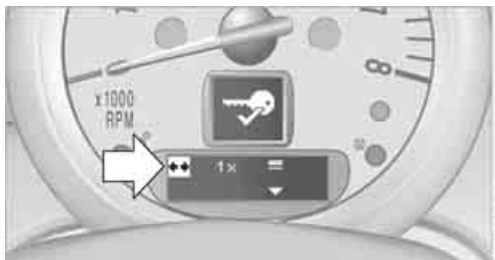

7. Press and hold the button until the display changes.

8. Press the button to select:
 - ▷ 1 ×
Brief indication of a turn.
 - ▷ 3 ×
Triple turn signal.
9. Press and hold the button until the display changes. The setting is stored.

WIPER SYSTEM

 Do not turn on the wipers when they are frozen; otherwise, the wiper blades and the windshield wiper motor may be damaged. ◀

 Do not use the windshield wipers when the windshield is dry; otherwise the wiper blades may wear out faster or be damaged. ◀



- 1 Switching on wipers
- 2 Switching off wipers or brief wipe
- 3 Activating/deactivating intermittent wipe or rain sensor
- 4 Cleaning windshield and headlamps

Switching on wipers

Press the lever upward, arrow 1.

The lever automatically returns to its initial position when released.

Normal wiper speed

Press once.

The system switches to intermittent operation when the vehicle is stationary.

Fast wiper speed

Press twice or press beyond the resistance point. The system switches to normal speed when the vehicle is stationary.

Intermittent wipe or rain sensor

If the car is not equipped with a rain sensor, the intermittent-wipe time is preset.

If the car is equipped with a rain sensor, the time between wipes is controlled automatically and depends on the intensity of the rainfall. The rain sensor is mounted on the windshield, directly in front of the interior rearview mirror.

Activating intermittent wipe or rain sensor

Press button, arrow 3.



This symbol is displayed in the tachometer.

 Deactivate the rain sensor before entering an automatic car wash. Failure to do so could result in damage caused by undesired wiper activation. ◀

Adjusting the sensitivity of the rain sensor

1. Switch on the ignition, refer to page 45.
2. Press the button in the turn signal indicator as often as necessary until "SET/INFO" is displayed.



3. Press and hold the button until the display changes.

- Press the button as often as necessary until the symbol and "SET" are displayed.



- Press and hold the button until the display changes.



- Press the button to select the desired sensitivity.
- Wait, or press and hold the button until the display changes. The settings are stored.

Deactivating intermittent wipe or rain sensor

Press the button again, arrow 3.

Brief wipe

Press the lever downward once, arrow 2.

Cleaning windshield and headlamps

Pull the lever, arrow 4.

Washer fluid is sprayed onto the windshield and the wipers are operated briefly.

When the vehicle lighting system is switched on, the headlamps are cleaned at regular and appropriate intervals.

In cars equipped with an alarm system, the headlamps cannot be cleaned when the hood is open.

⚠ Do not use the washers when the washer fluid reservoir is empty; otherwise, you will damage the washer pump.

Only use the washers if the hood has been completely closed; otherwise, the headlamp washer system may be damaged. Do not use the washers if there is any danger that the fluid will freeze on the windshield. If you do, your vision could be obscured. For this reason, use antifreeze. ◀

Window washer nozzles

The window washer nozzles are heated automatically while the engine is running or the ignition is switched on.

Rear window wiper

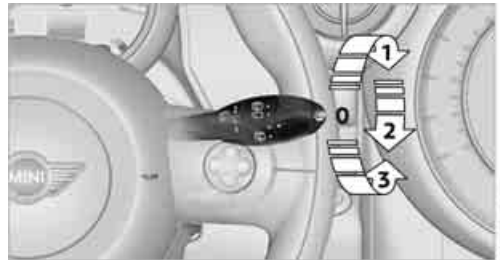

0 Rear wipers parked

1 To switch on intermittent wipe :

Turn the cap to level 1.

Operation is continuous in reverse gear.

The rear wiper does not move if the cap is in interval stage 1 before the ignition is switched on.

Cleaning the rear window

2 To clean the rear window during intermittent wipe :

Turn the cap further to level 2 and hold it there.

3 To clean the rear window when wipers are parked :

Turn the cap to level 3 and hold it there.

 Do not use the washers when the washer fluid reservoir is empty; otherwise, you will damage the washer pump. ◀

WASHER FLUID

 Washer fluid is flammable. Keep it away from ignition sources, only store it in the closed, original container, and keep out of reach of children; otherwise, there is a danger of injury. Comply with the instructions on the container. ◀

Washer fluid reservoir

 Only refill washer fluid that contains anti-freeze when the engine is cool, to avoid contact with hot engine parts. Otherwise, fluid spills constitute a fire hazard and a risk to personal safety. ◀



Fill with water and, if required, with a washer antifreeze, according to manufacturer's recommendations.

 Mix the water and antifreeze before filling the washer fluid reservoir to make sure the correct concentration is maintained. ◀

Capacity

Approx. 4.2 US quarts/4 liters.

CRUISE CONTROL

The concept

Cruise control is available at vehicle speeds of at least approx. 20 mph or 30 km/h. The car then stores and maintains the speed that you specify using the button on the steering wheel.

 Do not use cruise control when driving at constant speed is prevented by adverse conditions, e.g. winding roads, dense traffic or poor road conditions due to, e.g. snow, rain, ice or loose surfaces. Otherwise, you could lose control of the vehicle and cause an accident as a result. ◀

Activating



- 1 Maintaining, storing and increasing speed
- 2 Activating/deactivating cruise control
- 3 Maintaining, storing and decreasing speed
- 4 Resuming cruise control

Indicator lamp in the speedometer lights up. The cruise control system is ready and can be activated.

Activating/deactivating cruise control

Press button 2.

The system is automatically deactivated if:

- ▷ Braking takes place
- ▷ The clutch is engaged
- ▷ The transmission is set on N
- ▷ The stability control system is on

Cruise control is not deactivated by depressing the accelerator pedal. Once the accelerator

pedal is released, the stored speed is achieved again and maintained.

The stored speed is cleared when the ignition is switched off.

Maintaining current speed

Press button **1**.

The system maintains and stores the current vehicle speed.

If, on a downhill grade, the engine braking effect is not sufficient, the controlled speed may be exceeded. On uphill grades vehicle speed may drop if the engine output is insufficient.

Increasing speed

Press button **1** repeatedly until the desired speed is reached. Every time you press the button, the speed increases by approx. 1 mph or 1 km/h.

Accelerating using the button

Press and hold button **1**.

The vehicle accelerates without pressure on the accelerator pedal. After the button is released, the driving speed is maintained and stored.

Decreasing speed

Press button **3** repeatedly until the desired speed is reached.

The functions here are the same as for increasing the speed or accelerating, except that the speed will be decreased.

Resuming a speed stored beforehand

Press button **4**.

The last speed stored is achieved again and maintained.

The stored speed is cleared when the ignition is switched off.

Display on tachometer



Selected speed is displayed briefly.

▶ If --- mph or --- km/h is displayed briefly in the tachometer, the conditions necessary for operation may not be fulfilled. ◀

Malfunction



The warning lamp in the tachometer lights up if the system fails.

CONTROLS OVERVIEW

VEHICLE EQUIPMENT

In this chapter, all production, country, and optional equipment that is offered in the model range is described. Equipment is also described that is not available because of, for example, selected options or country version. This also applies to safety related functions and systems.

FUEL GAUGE

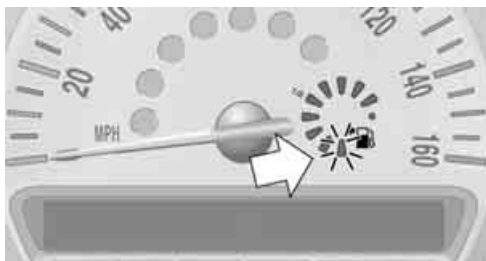

Fuel tank capacity

Approx. 12.4 US gal/47 liters.

You will find information on refueling on page 134.

If the tilt of the vehicle varies for a longer period, when you are driving in mountainous areas, for example, the indicator may fluctuate slightly.

The arrow next to the gas pump symbol of the fuel gauge points toward the side of the vehicle with the fuel filler flap.

Reserve

Once the fuel level has fallen to the reserve zone of approx. 2.1 US gal/8 liters, the remaining indicator lamps change from orange to red, arrow. The tachometer displays the remaining cruising range. A warning lamp lights up when the remaining range is less than approx. 30 miles/50 km.



If the range displayed is less than 30 miles/50 km, be sure to refuel; otherwise, engine functions are not guaranteed and damage may occur. ◀

With a dynamic driving style, e.g. rapid cornering, engine functions are not always assured.

TACHOMETER



Never operate the engine with the needle in the red overspeed zone of the gauge. In this range, the fuel supply is interrupted to protect the engine.

Displays in tachometer

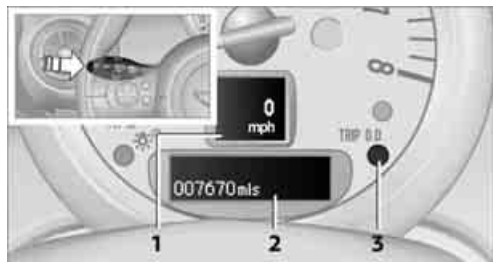

- 1 Current vehicle speed
- 2 Odometer in kilometers, trip recorder, external temperature, time
- 3 Resetting the trip odometer

Press button on turn signal indicator to call up information in the display area 2.

The following information is displayed sequentially:

- ▷ Trip odometer
- ▷ Time
- ▷ External temperature

Trip odometer

To display trip recorder:
Briefly press button **3**.

Resetting the trip odometer:
While the trip recorder is displayed and the ignition is switched on, press button **3**.

Time

To set time, see page [62](#).

External temperature, external temperature warning

When the displayed temperature sinks to approx. +37 °F /+3 °C, a signal sounds and a warning lamp lights up. There is an increased risk of black ice.

 Even at temperatures above +37 °F /+3 °C ice can form. Therefore, drive carefully, e.g. on bridges and sections of road in the shade; otherwise, there is an increased accident risk. ◀

Units of measure

Select the respective units of measure, miles or km for the odometer as well as °F or °C for the external temperature, page [59](#).

COMPUTER

Displays in the tachometer



Press the button in the turn signal lever repeatedly to call up various items of information.

The following information is displayed sequentially:

- ▷ Cruising range
- ▷ Average fuel consumption
- ▷ Current fuel consumption
- ▷ Average speed

To set the corresponding units of measure, refer to Formats and units of measure on page [59](#).

Cruising range

Displays the estimated cruising range available with the remaining fuel. The range is calculated on the basis of the way the car has been driven over the last 18 miles/30 km and the amount of fuel currently in the tank.

 If the range displayed is less than 30 miles/50 km, be sure to refuel; otherwise, engine functions are not guaranteed and damage could occur. ◀

Average fuel consumption

Calculated for the time the engine has been running.

To reset average fuel consumption: press the button in the turn signal lever for approx. 2 seconds.

Current fuel consumption

Displays the current fuel consumption to allow you to see whether your current driving style is conducive to fuel economy with minimum exhaust emissions.

Average speed

Periods with the vehicle parked and the engine switched off are not included in the calculations of average speed.

To reset average speed: press the button in the turn signal lever for approx. 2 seconds.

Display in Radio MINI Boost CD

To call up information

1. Press the **MENU** button.

2.  Press the button.



Fuel consumption

Displayed according to average consumption, for example, for the entire trip, a portion of the trip, or after every time that you fill the tank. Average consumption for the time that the engine is running.

To start the calculation for fuel consumption:

1.  Press the button.

2.  Press the button.





The previous display is reset to zero and the system starts with the new calculation for average fuel consumption.

Average speed

The average speed for a trip can be displayed. Average speed is determined for the time that the engine is running.

To start the calculation for average speed:

1.  Press the button.
2.  Press the button.



The previous display is reset to zero and the system starts with the new calculation for average speed.

Cruising range

By using the "RANGE" function, the distance is displayed that can likely still be driven with the available amount of fuel given the mode of driving over the last 18 miles/30 km.

SETTINGS AND INFORMATION









Operating principle





Certain settings and information are only available when the ignition is switched on, the vehicle is at a standstill and the doors are closed.



1 Button for:

- ▷ Selecting display
- ▷ Setting values
- ▷ Confirming selected display or set values
- ▷ Calling up computer information 56

Symbol	Function
 	Adjusting rain sensor 51
 	Calling up Check Control 62
 	Displaying vehicle check 63
 	Initializing the Flat Tire Monitor 68 Resetting the Tire Pressure Monitor 70

Symbol	Function
 	Setting formats and units of measure, resetting to factory settings 60
 	Adjusting settings <ul style="list-style-type: none"> ▷ Confirmation signals when locking and unlocking the vehicle 24 ▷ Response during unlocking procedure 23 ▷ Automatic locking 27 ▷ Pathway lighting 77 ▷ Daytime running lights 77 ▷ Triple turn signal activation 50
	Exiting the menu

Exiting displays



1. Press the button in the turn signal lever repeatedly until "HOME" is displayed.
2. Press the button for a longer period.

Displays are also exited if no entries are made for approx. 8 seconds.

Next setting or item of information



1. While in a setting or information item, press the button in the turn signal indicator repeatedly until "NEXT" is displayed.
2. Press the button for a longer period.

The display changes directly to the next setting or item of information.

FORMATS AND UNITS OF MEASURE

To set the formats and units of measure. The settings are stored for the remote control currently in use, refer also to Personal Profile on page 22.

1. Switch on the ignition, refer to page 45.
2. Press the button in the turn signal indicator as often as necessary until "SET/INFO" is displayed.



3. Press and hold the button until the display changes.
4. Press the button as often as necessary until the symbol and "SET" are displayed.



5. Press and hold the button until the display changes.
6. Press the button repeatedly until the display shows the illustrated symbol, arrow.

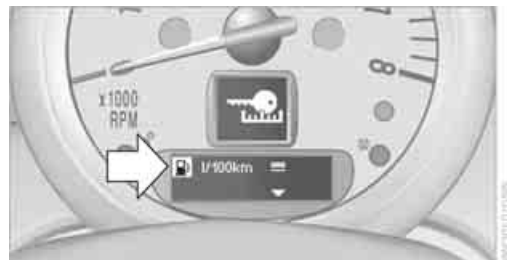

- ▶  Fuel consumption: l/100 km, mpg, km/l

- ▷ Distance covered: miles, km
 - ▷ Temperature: °F, °C
7. Press and hold the button until the display changes.
 8. Press the button to change the format or the measurement units.
 9. Press and hold the button until the display changes.
The settings are stored.

Resetting to factory settings

The settings for formats and units of measure can be reset to the factory settings. The settings are stored for the remote control currently in use, refer also to Personal Profile on page 22.

1. Press the button in the turn signal indicator as often as necessary until "SET/INFO" is displayed.



2. Press and hold the button until the display changes.
3. Press the button as often as necessary until the symbol and "SET" are displayed.



4. Press and hold the button until the display changes.

5. Press the button as often as necessary until "RESET" is displayed.



6. Press and hold the button until the display changes to the first setting.
The settings are reset.

In Radio MINI Boost CD

Settings

You can set the radio individually:

1. Press the **MENU** button.
2. Press the button.



- ▷ "DIST"
Change units of measurement for distance.
 - ▷ "LANG"
Select language for display text.
 - ▷ "CONSUM"
Change units of measurement for average consumption.
 - ▷ "TEMP"
Change units of measurement for external temperature.
3. Select desired menu item and press button.

SERVICE REQUIREMENTS



The remaining driving distance and the date of the next scheduled service are briefly displayed immediately after you start the engine or switch on the ignition.

 The extent of service work required can be read out from the remote control by your MINI dealer. ◀

Displaying vehicle check

For certain maintenance operations, you can view the respective distance remaining or due date individually in the tachometer.

1. Switch on the ignition, refer to page 45.
2. Press the button in the turn signal indicator as often as necessary until "SET/INFO" is displayed.



3. Press and hold the button until the display changes.

4. Press the button repeatedly until the corresponding symbol and "SERVICE- INFO" are displayed.















5. Press and hold the button until the display changes.
6. Press the button to display the individual service items, refer to the following information.

Possible displays

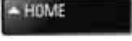

1 Button for selecting information

Symbol	Function
 m/s 10000 12/2014	Engine oil
 m/s 10000	Front brakes



Symbol	Function
 	Rear brakes
 	Road worthiness test
 	Vehicle check
 	Brake fluid
 	Exit display 59
 	Next setting or item of information 59

More information on the MINI Maintenance System can be found on page [149](#).

CLOCK

Setting the time



Radio MINI Boost CD:

1. Press the **MENU** button.
2.  Press the button.
3.  Press the button.
4. Select the desired menu item, "FORMAT", "HRS" or "MIN", and then press the button.
5. Turn the knob on the right to set values.
6. Press the knob on the right to store values.
7.  Press the button to exit setting values.

DATE

Setting date

Radio MINI Boost CD:

1. Press the **MENU** button.
2.  Press the button.
3.  Press the button.
4. Select the desired menu item "DD", "MM" or "YY".
5. Turn the knob on the right to set values.
6. Press the knob on the right to store values.
7.  Press the button to exit setting values.

CHECK CONTROL

The concept

The Check Control monitors vehicle functions and alerts you to any malfunctions in the sys-

tems monitored. Check Control messages involve indicator or warning lamps in the displays and, in some circumstances, an acoustic signal.



Indicator and warning lamps can light up in various combinations and colors in the indicator areas 1 and 2.

What to do in case of a malfunction

The meaning of each lamp in the event of a malfunction and tips on how to respond are listed starting on page 169.

Hiding Check Control messages

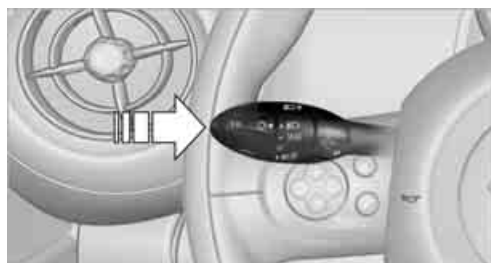

Press the button in the turn signal lever.

- ▷ Some Check Control messages are displayed until the malfunctions have been rectified. They cannot be hidden. If several malfunctions occur at the same time, they are displayed in succession.
- ▷ Other Check Control messages are automatically hidden after approx. 20 seconds, but remain stored.

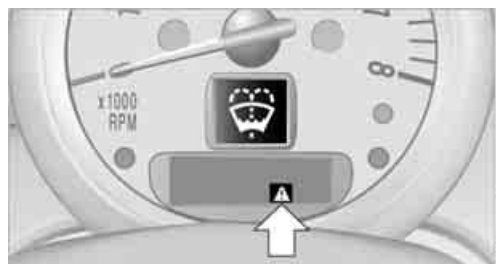

The  symbol indicates that Check Control messages have been stored. Check Control messages can be viewed whenever it is convenient.

Viewing stored Check Control messages

Stored Check Control messages can only be displayed if the driver's door is closed.

1. Press the button in the turn signal indicator as often as necessary until "SET/INFO" is displayed.
 2. Press and hold the button until the display changes.
 3. Press the button repeatedly until the corresponding symbol and "CHECK INFO" appear in the display.
- 
4. Press and hold the button. If there are no Check Control messages, then "CHECK OK" is displayed. If a Check Control message has been stored, the corresponding message is displayed.
 5. Press the button to display any other messages.

TECHNOLOGY FOR DRIVING COMFORT AND SAFETY

VEHICLE EQUIPMENT

In this chapter, all production, country, and optional equipment that is offered in the model range is described. Equipment is also described that is not available because of, for example, selected options or country version. This also applies to safety related functions and systems.

PARK DISTANCE CONTROL PDC

The concept

PDC assists you with parking in reverse. Acoustic signals warn you of the presence of an object behind the vehicle. The measurement is carried out by four ultrasonic sensors in the rear bumper.



An acoustic warning sounds when an object is approx. 24 in/60 cm from the corner sensors or approx. 5 ft/1.50 m from the center sensors. PDC is a parking aid that can indicate objects when they are approached slowly, as is usually the case when parking. Avoid approaching an object at high speed; otherwise, physical circumstances may lead to the system warning being issued too late. ◀

Automatic mode

With the engine running or the ignition switched on, the system is activated automatically after approx. 1 second when you engage reverse gear or move the automatic transmission selector lever to position R. Wait this short period before driving.

Acoustic signals

As the distance between vehicle and object decreases, the intervals between the tones become shorter. If the distance to the nearest object falls to below roughly 1 ft/30 cm, then a continuous tone sounds.

If the distance remains constant, e.g. when driving parallel to a wall, the acoustic signal stops after approx. 3 seconds.

Adjustments

The volume of the acoustic signals can be set, refer to page 108.

Malfunction



Indicator lamp lights up. PDC has failed. Have the system checked.

To avoid this problem, keep the sensors clean and free of ice or snow in order to ensure that they will continue to operate effectively. When using a high-pressure cleaner, do not direct the jet toward the sensors for lengthy periods and only spray from a distance of at least 4 in/10 cm.

System limitations



Even with PDC, final responsibility for estimating the distance between the vehicle and any obstructions always remains with the driver. Sensors, too, have blind spots in which objects cannot be detected. Moreover, ultrasonic detection can reach its physical limits with objects such as trailer tow bars and couplings, thin and wedge-shaped objects, etc. Low objects already indicated, such as curbs, may enter the sensors' blind spots before or after a continuous audible signal is given. Higher, protruding objects, such as wall ledges, may not be detectable. Therefore, always drive cautiously; otherwise, there is a risk of personal injury or

property damage. Loud sound sources outside or inside the car can drown out the PDC signal. ◀

DRIVING STABILITY CONTROL SYSTEMS

Your MINI has a number of systems that help to maintain the vehicle's stability even in adverse driving conditions.

 The laws of physics cannot be repealed, even with driving stability control systems. An appropriate driving style always remains the responsibility of the driver. Therefore do not reduce the additional safety margin by engaging in hazardous driving thereby running the risk of an accident. ◀

Antilock Brake System ABS

ABS prevents locking of the wheels during braking. Safe steering response is maintained even during full braking. Active safety is thus increased.

Braking safely, refer to page 97.

ABS is operational every time you start the engine.

Cornering Brake Control CBC

Driving stability and steering characteristics are further enhanced while braking in turns or during a lane change.

Electronic brake-force distribution EBV

The system controls the brake pressure in the rear wheels to ensure stable braking behavior.

Brake Assist

Rapidly depressing the brake causes this system to automatically develop maximum braking force. Thus, the system helps keep braking distance to a minimum. At the same time, all the benefits provided by ABS are exploited.

Do not reduce the pressure on the brake for the duration of the full braking application.

Dynamic Stability Control DSC

The concept

DSC prevents the driving wheels from losing traction when you pull away from rest or accelerate.

DSC also detects unstable driving conditions such as when the vehicle's rear end fishtails or the vehicle is sliding on its front wheels. In these cases, DSC helps the vehicle maintain a safe course within physical limits by reducing engine output and through braking actions at the individual wheels.

Every time that the engine is started, DSC is ready to operate.

Deactivating DSC



Press the button until the DSC OFF indicator lamp on the speedometer is on and DSC OFF is displayed on the tachometer. DSC is deactivated. Stabilizing and propulsion promoting actions are no longer executed.

When driving with snow chains or to 'rock free' in snow, it can be helpful to switch off DSC for a brief period.

To increase vehicle stability, activate DSC again as soon as possible.

Activating DSC

Press the button again: the DSC indicator lamps in the display elements go out.

For better control



The indicator lamp on the tachometer is flashing:

DSC controls the driving and braking forces.



The indicator lamp DSC OFF on the speedometer is on and DSC OFF is displayed on the tachometer:

DSC is deactivated.

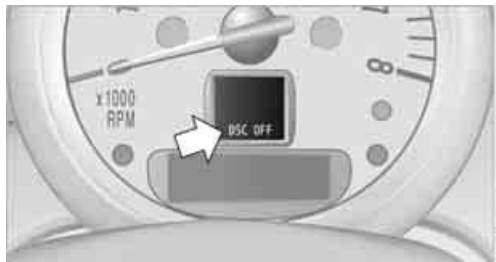

Dynamic Traction Control DTC

The concept

DTC is a type of DSC that is propulsion optimized for special road conditions such as uncleared snowy roads. The system ensures maximum propulsion though with restricted driving stability. You therefore need to drive with suitable caution.

In the following exceptional situations, it can be useful to briefly activate DTC:

- ▷ When driving on snow-covered inclines, in slush, or on uncleared snowy roads
- ▷ When rocking the vehicle free, driving out of deep snow or on loose surfaces
- ▷ When driving with snow chains

Activating DTC



Press the button; the indicator lamp DSC OFF on the speedometer comes on and TRACTION is displayed on the tachometer. The Dynamic Stability Control DSC is deactivated; the Dynamic Traction Control DTC is activated.

For better control



The indicator lamp on the tachometer is flashing:

DTC controls the driving and braking forces.



The indicator lamp on the speedometer is on and TRACTION is displayed on the tachometer:

DTC is activated.

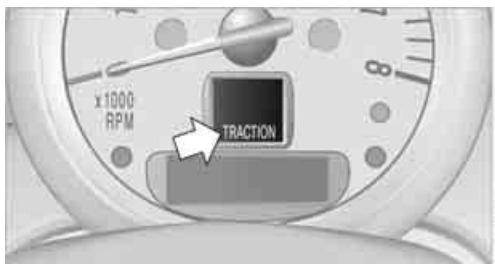

Deactivating DTC

Press button again, the indicator lamp DSC OFF on the speedometer and TRACTION on the tachometer go out.

Deactivating both DTC and DSC



Press the button for at least 3 seconds; the indicator lamp DSC OFF on the speedometer comes on and DSC OFF is displayed on the tachometer. The Dynamic Traction Control DTC and Dynamic Stability Control DSC are both deactivated. There will be no more stabilizing interventions.

Interventions (differential lock) in braking occur to improve propulsion when drive wheels are rotating unevenly, even when DSC is deactivated.

Activating DSC

Press the button again: the indicator lamps go out.

Hill Assist

Hill Assist aids you in comfortably driving off on inclines. It is not necessary to use the parking brake for this.

1. Hold the MINI with the brake.
2. Release the brake and immediately drive off.

Hill Assist holds the car in place for approx. 2 seconds after the brake is released.

 Depending on the load and gradient, the vehicle can roll backward slightly during this period. After you release the brake, immediately start driving since the Hill Assist only holds the vehicle for about 2 seconds, and it will start to roll backward. ◀

ALL4 all-wheel drive system

ALL4 is the all-wheel drive system of your MINI. The combined effects of ALL4 and DSC further optimize the traction and dynamic driving characteristics. The ALL4 all-wheel drive system variably distributes the drive force to the front and rear axle depending on the driving situation and prevailing road conditions.

SPORT BUTTON

Pressing the button causes your MINI to respond even more sportily.

- ▷ Engine responds more spontaneously to movements of the accelerator.
- ▷ Steering response is more direct.
- ▷ Cooper S, John Cooper Works: the engine sounds more sporty in coasting mode.

With automatic transmission:

- ▷ More rapid gear shifting in Sport program.

Activating the system



Press the button.
The LED lights up.

SPORT is briefly displayed in the tachometer.

Deactivating the system

- ▷ Press the button again.
- ▷ Switch off the engine.

FLAT TIRE MONITOR FTM

The concept

The system does not measure the actual inflation pressure in the tires.

The system detects a pressure loss in a tire by comparing the rotational speeds of the individual wheels while moving.

In the event of a pressure loss, the diameter and therefore the rotational speed of the corresponding wheel change. This is detected and reported as a flat tire.

Functional requirement

The system must have been initialized while the tire inflation pressure was correct; otherwise, reliable signaling of a flat tire is not ensured.

Initialize the system after every correction of the tire inflation pressure and after every tire or wheel change.

System limitations

 Sudden serious tire damage caused by external influences cannot be indicated in advance. ◀

A natural, even pressure loss in all four tires cannot be detected. Therefore, check the tire inflation pressure regularly.

In the following situations, the system could be delayed or malfunction:

- ▷ System has not been initialized
- ▷ Driving on snowy or slippery road surface
- ▷ Performance-oriented style of driving: slip in the drive wheels, high lateral acceleration
- ▷ Snow chains are attached

Initializing the system

The initialization process adopts the set inflation tire pressures as reference values for the detection of a flat tire. Initialization is started by confirming the inflation pressures.

Do not initialize the system when driving with snow chains.

Using the button in the turn signal lever

1. Start the engine, but do not start driving.
2. Press the button in the turn signal indicator as often as necessary until "SET/INFO" is displayed.



3. Press and hold the button until the display changes.
4. Press the button repeatedly until the corresponding symbol and "RESET" are displayed.



5. Press and hold the button until the display changes.
6. Start driving.
Initialization is completed while the car is on the move, without any feedback.

 The initialization is completed during driving, which can be interrupted at any time. When driving resumes, the initialization is continued automatically. ◀

Indication of a flat tire

 The warning lamps come on in yellow and red. An acoustic signal also sounds.



There is a flat tire or a major loss in tire inflation pressure.

1. Reduce speed and stop the vehicle with caution. Avoid sudden braking and steering maneuvers.
2. Check whether the vehicle is equipped with normal tires or with run-flat tires.

Run-flat tires, refer to page 143, are identified by a circular symbol containing the letters RSC on the tire sidewall.

 If the vehicle is not equipped with run-flat tires, do not continue driving; continuing to drive can result in serious accidents. ◀

When a flat tire is reported, the Dynamic Stability Control DSC is activated.

Actions in the event of a flat tire

Normal tires

1. Identify the damaged tire.

To do so, check the inflation pressure in all four tires.

The inflation pressure display of the Mobility Kit, page 160, can be used for this purpose.

If the inflation pressure in all four tires is correct, the Flat Tire Monitor might not have been initialized. The system must then be initialized.

If it is not possible to identify the damaged tire, contact your MINI dealer

2. Use the Mobility Kit to remedy the flat tire on the damaged wheel, refer to page 159.

Run-flat tires

You can continue driving with a damaged tire at speeds up to 50 mph or 80 km/h.

Continued driving with a flat tire

When driving with a damaged tire:

1. Avoid sudden braking and steering maneuvers.
2. Do not exceed a speed of 50 mph or 80 km/h.
3. At the next opportunity, check the air pressure in all four tires.

If the inflation pressure in all four tires is correct, the Flat Tire Monitor might not have been initialized. The system must then be initialized.

Possible driving distance with complete loss of tire inflation pressure:

The distance it is possible to drive depends on the load and the stress on the vehicle while driving.

With an average load, it may be possible to drive for approx. 50 miles/80 km.

When driving with damaged tires, the handling characteristics change, e.g. the vehicle will skid sooner when braking, braking distances will be longer, or self-steering response will change. Adapt your driving style accordingly. Avoid turning abruptly and driving over obstacles such as curbs, potholes, etc.

Since the possible driving distance depends to a considerable degree on the strain exerted on the vehicle while driving, it can be shorter or, with a gentle driving style, can also be longer, depending on the speed, road condition, external temperature, vehicle load, etc.

 Drive cautiously and do not exceed a speed of 50 mph/80 km/h.

A loss of tire inflation pressure results in a change in the handling characteristics, e.g. reduced lane stability during braking, a longer braking distance and altered self-steering properties. ◀

 Vibrations or loud noises while driving can indicate final failure of the tire. Reduce your speed and bring the vehicle to a stop; otherwise, pieces of tire may come off, which

could result in an accident. Do not continue driving and contact your MINI dealer. ◀

TIRE PRESSURE MONITOR TPM

The concept

Measuring the inflation pressure in the four mounted tires. The system notifies you if there is a significant loss of pressure in one or more tires.

Functional requirement

The system must have been reset while the inflation pressure was correct; otherwise, reliable signaling of a flat tire is not ensured.

Always use wheels with TPM electronics to ensure that the system will operate properly.

Reset the system again after each correction of the tire inflation pressure and after every tire or wheel change.

System limitations

 Sudden, serious tire damage caused by external influences cannot be indicated in advance. ◀

The system does not operate correctly if it has not been reset. For example, a flat tire may be indicated despite correct tire inflation pressures.

The system is inactive and cannot indicate a flat tire:

- ▷ If a wheel without TPM electronics is mounted
- ▷ Interference with TPM by other systems or devices with the same transmission frequency.

Resetting system

Reset the system again after each correction of the tire inflation pressure and after every tire or wheel change.

1. Start the engine, but do not start driving.
2. Press the button in the turn signal indicator as often as necessary until "SET/INFO" is displayed.



3. Press and hold the button until the display changes.
4. Press the button repeatedly until the symbol for Tire Pressure Monitor and "ACTIVE" are displayed.

The Tire Pressure Monitor can be reset by selecting "RESET".



5. Press and hold the button until "RESETTING" is displayed.



6. Start driving.
After driving a few minutes, the set inflation pressures in the tires are accepted as the tar-

get values to be monitored. The system reset is completed during your drive, and can be interrupted at any time. When driving resumes, the reset is continued automatically. The indicator lamp goes out after the system reset is completed.

Message with low tire inflation pressure



The warning lamps come on in yellow and red. An acoustic signal also sounds.



▷ There is a flat tire or substantial loss in tire pressure in the displayed tire.

- ▷ The system was not reset after a wheel change and thus issues a warning based on the inflation pressures initialized last.
- 1. Reduce speed and stop the vehicle with caution. Avoid sudden braking and steering maneuvers.
- 2. Check whether the vehicle is equipped with normal tires or with run-flat tires.

Run-flat tires, refer to page 143, are identified by a circular symbol containing the letters RSC on the tire sidewall.

When a low inflation pressure is reported, the Dynamic Stability Control DSC is activated.

Actions in the event of a flat tire

Normal tires

1. Identify the damaged tire.

To do so, check the inflation pressure in all four tires. The inflation pressure display of the Mobility Kit, page 160, can be used for this purpose.

If the inflation pressure is correct in all four tires, then the Tire Pressure Monitor may not have been reset. The system must then be reset.

If it is not possible to identify the damaged tire, contact your MINI dealer.

2. Use the Mobility Kit to remedy the flat tire on the damaged wheel, refer to page 160.

The use of tire sealant, e.g. Mobility Kit, can damage the TPM wheel electronics. In this case, have the electronics checked and replaced if necessary at your earliest opportunity.

Run-flat tires

You can continue driving with a damaged tire at speeds up to 50 mph/80 km/h.



If the vehicle is not equipped with run-flat tires, do not continue driving; continuing to drive can result in serious accidents. ◀

Continued driving with a flat tire

When driving with a damaged tire:

1. Avoid sudden braking and steering maneuvers.
2. Do not exceed a speed of 50 mph or 80 km/h.
3. At the next opportunity, check the air pressure in all four tires.

If the inflation pressure is correct in all four tires, then the Tire Pressure Monitor may not have been reset. The system must then be reset.

Possible driving distance with complete loss of tire inflation pressure:

The distance it is possible to drive depends on the load and the stress on the vehicle while driving.

With an average load, it may be possible to drive for approx. 50 miles/80 km.

When driving with damaged tires, the handling characteristics change, e.g. the vehicle will skid sooner when braking, braking distances will be longer, or self-steering response will change. Adapt your driving style accordingly. Avoid turning abruptly and driving over obstacles such as curbs, potholes, etc.

Since the possible driving distance depends to a considerable degree on the strain exerted on the vehicle while driving, it can be shorter or, with a gentle driving style, can also be longer,

depending on the speed, road condition, external temperature, vehicle load, etc.

 Drive cautiously and do not exceed a speed of 50 mph/80 km/h.

A loss of tire inflation pressure results in a change in the handling characteristics, e.g. reduced lane stability during braking, a longer braking distance and altered self-steering properties. ◀

 Vibrations or loud noises while driving can indicate complete failure of the tire.

Reduce your speed and bring the vehicle to a stop; otherwise, pieces of tire may come off, which could result in an accident. Do not continue driving and contact your MINI dealer. ◀

Malfunction

 The small warning lamp flashes in yellow and then lights up continuously; the larger warning lamp lights up in yellow. No flat tire can be detected.

Display in the following situations:

- ▷ Wheel without TPM electronics is mounted: If need be, have it checked by your MINI dealer.
- ▷ Malfunction: Have the system checked
- ▷ TPM was unable to complete the resetting procedure; reset the system again.

 The small warning lamp flashes in yellow and then lights up continuously; the larger warning lamp lights up in yellow. No flat tire can be detected.

Display in the following situation:

- ▷ Interference due to systems or devices that use the same radio frequency: The system automatically reactivates once it is outside of the field of interference.

Declaration according to NHTSA/ FMVSS 138 Tire Pressure Monitoring Systems

Each tire, including the spare, should be checked monthly when cold and inflated to the

inflation pressure recommended by the vehicle manufacturer on the vehicle placard or tire inflation pressure label. If your vehicle has tires of a different size than the size indicated on the vehicle placard or tire inflation pressure label, you should determine the proper tire inflation pressure for those tires. As an added safety feature, your vehicle has been equipped with a tire pressure monitoring system TPMS that illuminates a low tire pressure telltale when one or more of your tires are significantly underinflated.

Accordingly, when the low tire pressure telltale illuminates, you should stop and check your tires as soon as possible, and inflate them to the proper pressure. Driving on a significantly underinflated tire causes the tire to overheat and can lead to tire failure. Underinflation also reduces fuel efficiency and tire tread life, and may affect the vehicle's handling and stopping ability. Please note that the TPMS is not a substitute for proper tire maintenance, and it is the driver's responsibility to maintain correct tire pressure, even if underinflation has not reached the level at which the TPMS low tire pressure telltale illuminates.

The TPMS malfunction indicator is combined with the low tire pressure telltale. When the system detects a malfunction, the telltale will flash for approximately one minute and then remain continuously lit. This sequence will continue upon subsequent vehicle startups as long as the malfunction exists. When the malfunction indicator is illuminated, the system may not be able to detect or signal low tire pressure as intended. TPMS malfunctions may occur for a variety of reasons, including the installation of replacement or alternate tires or wheels on the vehicle that prevent the TPMS from functioning properly. Always check the TPMS malfunction telltale after replacing one or more tires or wheels on your vehicle to ensure that the replacement or alternate tires and wheels allow the TPMS to continue to function properly.

AIRBAGS



The following airbags are located under the marked covers:

- 1 Front airbags
- 2 Knee airbag

- 3 Side airbags in backrests
- 4 Head airbags at the front and rear

Protective action

 Observe the instructions on page 34 to ensure the best possible personal protection. ◀

The front airbags help protect the driver and front passenger by responding to frontal impacts in which safety belts alone cannot provide adequate restraint. When needed, the head and side airbags help provide protection in the event of side impact. The relevant side airbag supports the side upper body area. The head airbag supports the head.

The airbags are designed to not be triggered in every type of collision, e.g. not in minor accidents, certain rollover situations or rear impacts.

 Do not apply adhesive materials to the cover panels of the airbags, cover them or modify them in any other way.

Keep the dashboard and window on the passenger side free from obstruction, i.e. do not cover it with adhesive film or coverings, and do not affix any holders such as for a navigation device or a mobile phone.

Do not attach seat covers, cushions or other objects not specifically approved for seats with integral side airbags to the front seats. Do not hang items of clothing such as coats or jackets over the backrests. Do not attempt to remove the airbag retention system from the vehicle. Do

not modify the individual components of the system or its wiring in any way. This includes the upholstery in the center of the steering wheel, on the instrument panel, the doors, and the roof pillars as well as the sides of the headliner. Do not attempt to remove or dismantle the steering wheel. ◀

 Do not touch the individual components immediately after the system has been triggered, because there is a danger of burns.

Have the testing, repair, removal, and disposal of airbag generators executed only by your MINI dealer or a workshop that has the required explosives licenses.

Otherwise, unprofessional attempts to service the system could lead to failure in an emergency or undesired airbag activation, either of which could result in personal injury. ◀

Warning notices and information about the airbags can also be found on the sun visors.

Automatic deactivation of the front passenger airbags

The presence of a passenger in the front passenger seat is detected by measuring the resistance of the human body. The system correspondingly

activates or deactivates the front, side, and knee airbags for the front passenger.

 Make sure that the front passenger's feet remain in the footwell; otherwise, it is not possible to guarantee the function of the front passenger airbags. ◀

The indicator lamp above the interior rearview mirror shows the current status of the front passenger airbags, deactivated or activated, refer to Status of front passenger airbags below.

 Before transporting a child on the front passenger seat, read the safety information and follow the instructions under Transporting children safely, page 41. ◀

Malfunction of the automatic deactivation

When teenagers and adults assume certain sitting positions, this can cause the front, side, and knee airbags to deactivate. The indicator lamp for the front passenger airbags lights up when this occurs. In such cases, the passenger should change his or her sitting position so that the front passenger airbags are activated and the indicator lamp goes out. If the desired airbag status cannot be achieved by changing the sitting position, transport the relevant passenger on a rear seat.

- ▷ Do not attach covers, cushions, ball mats or other items to the front passenger seat unless they are specifically recommended by the manufacturer of your MINI.
- ▷ Do not place items on the front passenger seat.
- ▷ Do not place items under the seat which could press against the seat from below.

Status of front passenger airbags



The indicator lamp for the front passenger airbags shows the functional status of the front passenger's front, side, and knee airbags in accordance with whether and how the front passenger seat is occupied. The indicator lamp shows whether the front passenger airbags are activated or deactivated.

- ▷ The indicator lamp lights up when a child in a specially designated child restraint system is properly detected on the seat or the seat is unoccupied.

The front, side, and knee airbags for the front passenger are not activated.

 Most child seats are detected by the system. This particularly applies to child seats that were required by NHTSA at the time of manufacture of the vehicle. After installing a child seat, check that the indicator lamp for the front passenger airbags lights up. It indicates that the child seat has been detected and that the front passenger airbags are deactivated. ◀

- ▷ The indicator lamp does not come on as long as a person of sufficient size and in a correct sitting position is detected on the seat. The front, side, and knee airbags for the front passenger are activated.

Operational readiness of airbag system



As of radio readiness, page 45, the warning lamp lights up briefly to indicate that the entire airbag system and the belt tensioners are operational.

Airbag system malfunction

- ▷ The warning lamp does not come on when radio readiness is switched on.
- ▷ The warning lamp stays lit continuously.

 In the event of a fault in the airbag system, have it checked without delay; otherwise, there is the risk that the system will not function as intended even if a severe accident occurs. ◀

LAMPS

VEHICLE EQUIPMENT

In this chapter, all production, country, and optional equipment that is offered in the model range is described. Equipment is also described that is not available because of, for example, selected options or country version. This also applies to safety related functions and systems.

PARKING LAMPS/LOW BEAMS

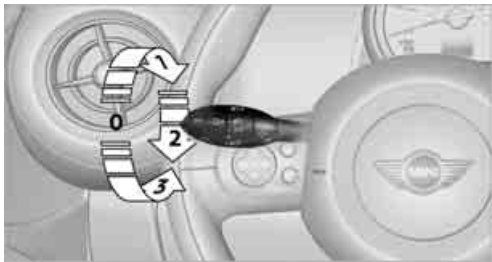

- 0** Lamps off / daytime running lights
- 1** Parking lamps and daytime running lights
- 2** Low-beam headlamps and welcome lamps
- 3** Automatic headlamp control, daytime running lights, welcome lamps, and Adaptive Light Control

When you open the driver's door with the ignition switched off, the exterior lighting is automatically switched off if the light switch is in position **0**, **2** or **3**.

Switch on the parking lamps if necessary, switch position **1**.

Parking lamps

Turn the light switch to position **1**. The front, rear and side vehicle lighting is switched on.

Activation of lights on one side of the vehicle for parking, page [78](#).

 The parking lamps will discharge the battery. Therefore, do not leave them on for unduly long periods of time; otherwise, the battery might not have enough power to start the engine. ◀

Low beams

Turn the light switch to position **2**. The low beams come on when the ignition is on.

Automatic headlamp control

When the switch is in position **3**, the low beams are switched on and off automatically depending on ambient light conditions, e.g. in a tunnel, in twilight, or if there is precipitation. Adaptive Light Control is active.

The headlamps may also come on when the sun is sitting low on a blue sky.

When driving into tunnels with bright overhead lights, there may be a delay before the headlamps come on.

The low beams remain switched on independent of the ambient lighting conditions when you switch on the fog lamps.

If the daytime running lights are activated, page [77](#), the low beams are always switched on with the light switch in position **3** and the ignition on. The exterior lamps are automatically switched off after the vehicle is parked.

 The automatic headlamp control cannot serve as a substitute for your personal judgment in determining when the lamps should be switched on in response to ambient lighting conditions. For example, the system cannot detect fog or hazy weather. To avoid safety risks, you should respond to these kinds of low-visibility situations by switching the headlamps on manually. ◀

Welcome lamps

If you leave the light switch in the low beam or automatic headlamp control position when you switch off the ignition, the parking lamps and interior lamps come on for a certain time as soon as the vehicle is unlocked.

Pathway lighting

If you activate the headlamp flasher after switching off the ignition with the lamps switched off, the low beams come on and remain on for a certain time.

The setting is stored for the remote control in use, refer to Personal Profile, page 22.

Setting the duration or deactivating the function

1. Switch on the ignition, refer to page 45.
2. Press the button in the turn signal indicator as often as necessary until "SET/INFO" is displayed.



3. Press and hold the button until the display changes.
4. Press the button as often as necessary until the symbol and "SET" are displayed.



5. Press and hold the button until the display changes.
6. Press the button repeatedly until the display shows the illustrated symbol.

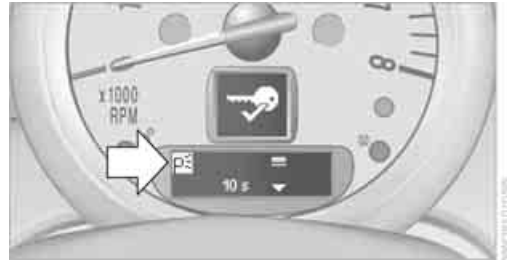

7. Press and hold the button until the display changes.
8. Press the button to select:
 - ▷ 0 s
The function is deactivated.
 - ▷ 10 s ... 240 s
Select the corresponding period, e.g., 40 seconds.
9. Press the button for a longer period.
The setting is stored.

Daytime running lights

The light switch can remain in the lamps off, parking lamps or automatic headlamp control position.

In the lamps off position, the exterior lighting is automatically switched off after the vehicle is parked. In the parking lamps position, the parking lamps will stay on after the ignition is switched off.

Switch on the parking lamps separately if needed.

Activating/deactivating daytime running lights

The setting is stored for the remote control in use, refer to Personal Profile, page 22.

1. Switch on the ignition, refer to page 45.
2. Press the button in the turn signal indicator as often as necessary until "SET/INFO" is displayed.



3. Press and hold the button until the display changes.
4. Press the button as often as necessary until the symbol and "SET" are displayed.



5. Press and hold the button until the display changes.
6. Press the button repeatedly until the display shows the illustrated symbol, arrow.

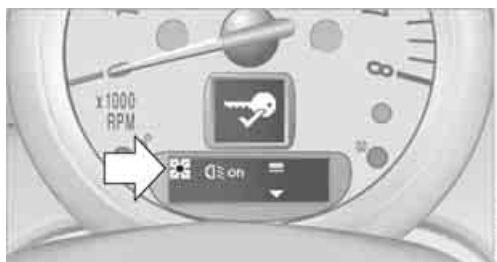

7. Press and hold the button until the display changes.
8. Press the button to select:



Daytime running lights activated.

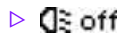

Daytime running lights deactivated.

9. Press the button for a longer period. The setting is stored.

ADAPTIVE LIGHT CONTROL

The concept

Adaptive Light Control is a variable headlamp control system that enables better illumination of the road surface. Depending on the steering angle and other parameters, the light from the headlamp follows the course of the road.

Activating Adaptive Light Control

With the ignition switched on, turn the light switch to position 3, refer to page 76.

Standstill function: to avoid blinding oncoming traffic, the Adaptive Light Control does not pivot toward the driver's side when the vehicle is at a standstill.

In reverse, the Adaptive Light Control is not activated.

Malfunction

A message is displayed.

The Adaptive Light Control is malfunctioning or failed. Have the system checked as soon as possible.

HIGH BEAMS/ ROADSIDE PARKING LAMPS

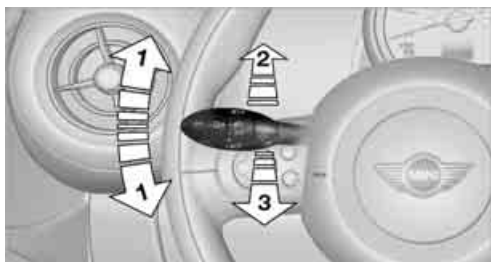

- 1 Turn signals/roadside parking lamps
- 2 Switching on high beams

3 Switching off high beams/headlamp flasher

Roadside parking lamps, left or right

The vehicle can be illuminated on one side for parking. Comply with local regulations when doing so.

Switching on

After parking the vehicle, press and hold the lever up or down, arrow 1.

 The roadside parking lamps drain the battery. Therefore, do not leave them on for unduly long periods of time; otherwise, the battery might not have enough power to start the engine. ◀

Switching off

Press the lever up or down to the pressure point.

FRONT FOG LAMPS



Press the button to switch the lamps on and off.

Front fog lamps

The parking lamps or low beams must be switched on for the fog lamps to operate. The green indicator lamp lights up when the fog lamps are switched on.

Depending on your vehicle's equipment, the fog lamps are switched off when you activate the headlamp flasher or switch on the high beams.

 If the automatic headlamp control is activated, the low beams will come on automatically when you switch on the fog lamps. ◀

INSTRUMENT LIGHTING

You can adjust the brightness of the instrument lighting only when the parking lamps or the low beams are on.

The intensity of the brightness changes up to a predetermined end point, and then decreases.



Adjusting brightness

- ▷ Briefly press button: brightness changes in stages.
- ▷ Press and hold the button. Brightness changes in a continuous manner.

INTERIOR LAMPS

The interior lamps, the footwell lamps, the entry lamps, and the cargo area lamp are controlled automatically.

 To reduce the drain on the battery, a short while after the ignition is switched off, refer to Start/Stop button on page 45, all lights in the vehicle's passenger compartment are switched off. ◀

Switching interior lamps on/off manually

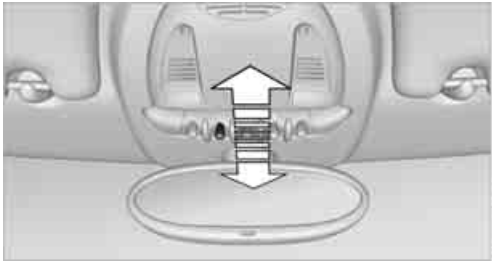

To switch the interior lamps on/off.

Press the switch.

To switch off the interior lamps permanently, press the switch for about 3 seconds.

Reading lamps

Reading lamps are provided in the front and rear adjacent to the interior lamps.

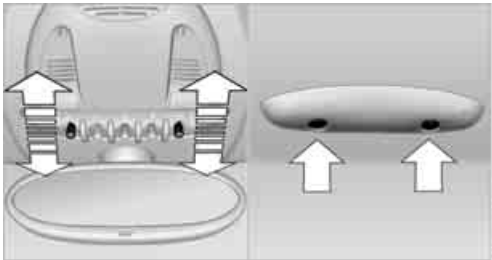

To switch the reading lamps on and off.

In the front: press the switch.

In the rear: press the button.

Ambient lighting

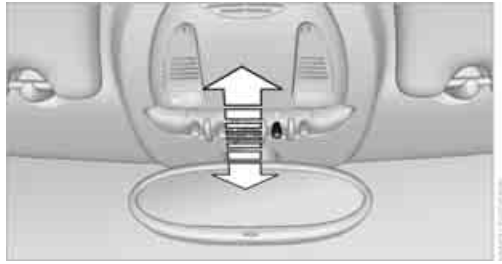

The color and brightness of the ambient lighting can be changed.

- ▷ Press the switch forward. The color changes in stages.
- ▷ Press the switch toward the rear. The brightness changes in stages.

Intermediate settings and colors are possible.

- ▶ For a continuous color change in the ambient lighting, press and hold the switch forward for longer than 10 seconds. ◀

CLIMATE

VEHICLE EQUIPMENT

In this chapter, all production, country, and optional equipment that is offered in the model range is described. Equipment is also described

that is not available because of, for example, selected options or country version. This also applies to safety related functions and systems.

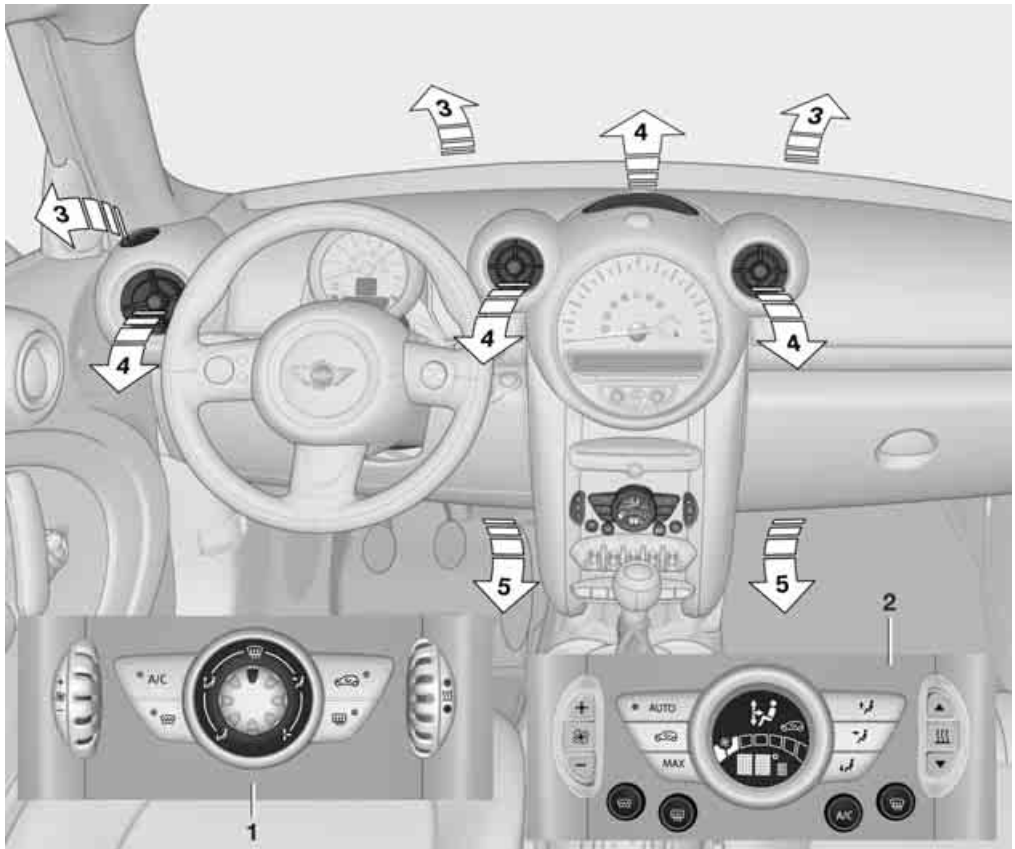

Equipment versions

Depending on your vehicle's equipment, your MINI contains an air conditioner or an automatic climate control.

- 1 Air conditioner [82](#)
- 2 Automatic climate control [83](#)

Air vents

- 3 Airflow directed toward the windshield and side windows
- 4 Air to the upper body area, draft-free ventilation
- 5 Air to the footwell

AIR CONDITIONER

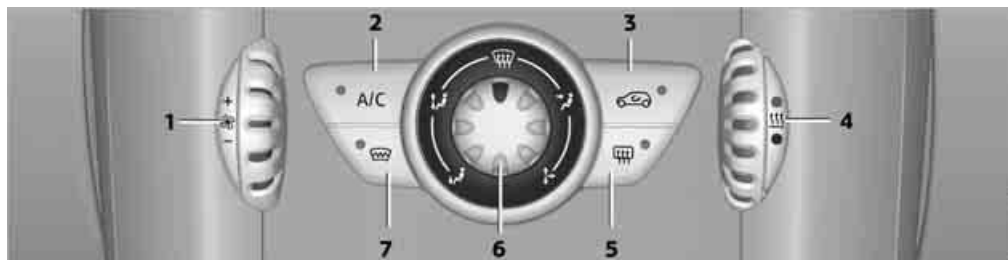

- | | |
|-------------------------------------------------------------------------------------------------------------------------------------------------------|-------------------------------------------------------------------------------------------------------------------------------------|
| <ul style="list-style-type: none"> 1 Air flow rate 2 Cooling function 3 Recirculated-air mode 4 Temperature | <ul style="list-style-type: none"> 5 Rear window defroster 6 Air distribution 7 Windshield heating |
|-------------------------------------------------------------------------------------------------------------------------------------------------------|-------------------------------------------------------------------------------------------------------------------------------------|

Air flow rate

 Adjust the air flow rate. The higher the rate, the more effective the heating or cooling will be.

The air flow rate is lowered or switched off entirely to reduce the drain on the battery.

Switching the system on/off

Turn the air flow rate rotary switch to 0. Blower and air conditioner are completely switched off and the air supply is cut off.

Set any desired air flow rate to switch on the air conditioner.

Cooling function

 When the cooling function is on, the air is cooled, dried, then reheated according to the temperature setting. The passenger compartment can only be cooled while the engine is running.

The cooling function helps prevent condensation on the windows or removes it quickly.

Depending on the weather, the windshield may fog over briefly when the engine is started.

 To cool the air more quickly and intensely when the external temperature is high, you can switch on the recirculated-air mode. ◀

Recirculated-air mode

 If the air outside the car has an unpleasant odor or contains pollutants, shut off the supply to the interior of the car temporarily. The system then recirculates the air currently within the vehicle.

If the windows fog in recirculated-air mode, switch off the recirculated-air mode and increase the air volume if necessary. Ensure that air can flow onto the windshield.

 The recirculated-air mode should not be used over an extended period of time; otherwise, the air quality in the passenger compartment will deteriorate continuously. ◀

Temperature

 Turn upward, red, to increase the temperature.

Turn downward, blue, to decrease the temperature.

Rear window defroster

 The defroster is switched off automatically after a certain time.

The rear window heating is lowered or switched off entirely to reduce the drain on the battery.

Air distribution



Direct the flow of air to the windows , to the upper body area or to the footwell . Intermediate settings are possible.

Windshield heating



The windshield heating is switched off automatically after a short time.

The front window heating is lowered or switched off entirely to reduce the drain on the battery.

Defrosting windows and removing condensation

1. Set air flow rate to the maximum level.
2. Set air distribution to position . Condensation is removed from the windows more quickly when the cooling function is also activated.
3. Set to the highest temperature, red.
4. Deactivate recirculated-air mode.
5. Turn on windshield heating if necessary.
6. Turn on rear window defroster if necessary.

Microfilter

The microfilter captures dust and pollen. The microfilter is changed by your MINI dealer during routine maintenance work.

AUTOMATIC CLIMATE CONTROL



- | | |
|----------------------------|------------------------------------------------|
| 1 Air flow rate, manual | 6 Temperature |
| 2 AUTO program | 7 Defrosting windows and removing condensation |
| 3 Recirculated-air mode | 8 Cooling function |
| 4 Maximum cooling | 9 Rear window defroster |
| 5 Air distribution, manual | 10 Windshield heating |

Comfortable interior climate

AUTO program **2** offers the ideal air distribution and air flow rate for almost all conditions, refer to AUTO program below. All you need to do is select an interior temperature which is comfortable for you.

The following sections inform you in detail about how to adjust the settings.

Most settings are stored for the remote control currently in use, refer also to Personal Profile settings on page [23](#).

Air flow rate, manual



Press the – button to reduce air flow. Press the + button to increase it.

You can reactivate the automatic mode for the air flow rate with the AUTO button.

The air flow rate is lowered or switched off entirely to reduce the drain on the battery. The display remains the same.

Switching the system on/off

Reduce the air flow by pressing the – button repeatedly until the system is switched off. All displays go out.

Press the AUTO button to switch the automatic climate control back on.

AUTO program



The AUTO program adjusts the air distribution to the windshield and side windows, toward the upper body area and into the footwell for you. The air flow rate and your temperature specifications will be adapted to outside influences in accordance with seasonal changes, e.g. sunlight.

The cooling function is automatically switched on along with the AUTO program.

The program is switched off if the air distribution is manually adjusted or if the button is pressed again.

Recirculated-air mode



If the air outside the car has an unpleasant odor or contains pollutants, shut off the supply to the interior of the car temporarily. The system then recirculates the air currently within the vehicle.

If condensation starts to form on the inside window surfaces, press the AUTO button or switch off the recirculated-air mode and, if necessary, increase the air flow rate. Ensure that air can flow onto the windshield.



The recirculated-air mode should not be used over an extended period of time;

otherwise, the air quality in the passenger compartment will deteriorate continuously. ◀

Maximum cooling



The automatic climate control switches to the lowest temperature, high airflow and the recirculated-air mode.

For maximum cooling, open the air vents for the upper body area.

The air is cooled as quickly as possible:

- ▷ For an outside temperature of more than 32 °F / 0 °C
- ▷ While the motor is running.

Air distribution, manual



The flow of air is directed to the windows, to the upper body area or to the footwell as selected.

You can switch the automatic air distribution back on by pressing the AUTO button.

Temperature



Set the desired temperature individually.

The automatic climate control achieves this temperature as quickly as possible regardless of the season, using maximum cooling or heating power if necessary, and then maintains it.



If you switch between different temperature settings in quick succession, the automatic climate control does not have enough time to achieve the set temperature. ◀

Rear window defroster



The defroster is switched off automatically after a certain time. Depending on your vehicle's equipment, the upper wires serve as an antenna and are not part of the rear window defroster.

Defrosting windows and removing condensation



Quickly removes ice and condensation from the windshield and front side windows.

For this purpose, also switch on the cooling function. The windshield heating is switched on automatically.

Windshield heating



The windshield heating is switched off automatically after a certain time.

Cooling function



When the cooling function is on, the air is cooled, dried, then reheated according to the temperature setting. The passenger compartment can only be cooled while the engine is running.

The cooling function helps prevent condensation on the windows or removes it quickly.

Depending on the weather, the windshield may fog over briefly when the engine is started. The recirculated-air mode may be switched on automatically.

When the AUTO button is pressed, the cooling function switches on automatically.

Microfilter/activated-charcoal filter

The microfilter captures dust and pollen. The activated-charcoal filter provides additional protection by filtering gaseous pollutants from the outside air. Your MINI dealer replaces this combined filter as a standard part of your scheduled maintenance.

You can call up further information in the service requirements display, page 61.

VENTILATION

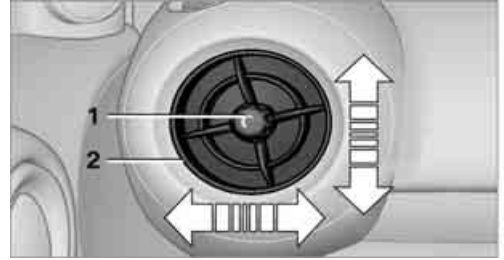

- 1 Knob for continuous opening and closing
- 2 Jet for direction of air flow

Opening/closing

Turn the knob.

Direction of air flow

Swivel the entire jet.

PRACTICAL INTERIOR ACCESSORIES

VEHICLE EQUIPMENT

In this chapter, all production, country, and optional equipment that is offered in the model range is described. Equipment is also described that is not available because of, for example, selected options or country version. This also applies to safety related functions and systems.

INTEGRATED UNIVERSAL REMOTE CONTROL

The concept

By using the Integrated universal remote control, up to 3 functions of remote controlled devices, e.g., garage door openers or lighting systems, can be operated. As a result, the universal remote control can replace up to 3 different remote controls. To operate, the buttons on the rearview mirror must be programmed with the desired functions. For programming, the remote control for each device is needed.

 To prevent possible damage or injury, before programming or using the integrated universal remote control, always inspect the immediate area to make certain that no people, animals or objects are within the travel range of the device.

Comply also with the safety instructions supplied with the original hand-held transmitter. ◀

Before selling the vehicle, delete the stored functions as a safety precaution, page.

Checking compatibility

 Depending on your vehicle's equipment, the glove compartment can be ventilated and, if the cooling function is switched on, can also be cooled.

For additional information, please contact your MINI dealer or call: 1-800-355-3515.

A list of compatible remote controls is available on the Internet at www.homelink.com.

HomeLink is a registered trademark of Johnson Controls, Inc.

Operating elements on the rearview mirror



- 1 LED
- 2 Memory buttons
- 3 Hand-held transmitter

Programming

General information

1. Switch on ignition.
2. Initial startup:

Press and hold the right and left buttons on the rearview mirror for approx. 20 seconds until the LED on the rearview mirror starts flashing quickly. All the programming for the buttons on the rearview mirror is deleted.
3. Hold the original hand-held transmitter at a distance of approx. 1 in/2.5 cm to 3 in/8 cm from the buttons on the rearview mirror. The required distance depends on the hand-held transmitter.
4. Press both the desired function on the remote and the button to be programmed on the rearview mirror at the same time. The LED flashes slowly at first.

- As soon as the LED flashes rapidly, release both buttons. The quick flashing indicates that the button on the rearview mirror has been programmed.

If the LED does not flash rapidly after approx. 60 seconds, alter the distance between the rearview mirror and hand-held transmitter and repeat this step. Several attempts at different distances may be necessary. Wait at least 15 seconds before each attempt.

Canada: if the programming was interrupted by the hand-held transmitter, press and hold the memory button and press the button on the hand-held transmitter for 2 seconds and release several times.

- To program other functions on other buttons, repeat steps 3 to 5.

You can operate the system with the engine running or with the ignition switched on.

Special features of hopping-code transmitter systems

If the device cannot be operated after being programmed repeatedly, then check if the device to be operated is equipped with a hopping-code system. In addition, check in the operating instructions for the device or press the programmed button on the rearview mirror for a longer period of time. If the LED on the rearview mirror first flashes quickly and then is on for 2 seconds, then the device is equipped with a hopping-code system. The flashing and the LED being on repeats itself for approx. 20 seconds.

In addition, for devices with hopping-code systems, the integrated universal remote control and the device must be synchronized.

Information about synchronizing can be found in the operating instructions for the device to be set.

Programming will be easier with the aid of a second person.

Synchronizing:

- Park your vehicle within the range of the remote-controlled device.
Do not exceed the 164 ft/50 m range of the remote-controlled device.
- Program the particular button on the rearview mirrors as described.
- Find and press the button for synchronizing the device to be set. There remain approx. 30 seconds for the next step.
- Press and hold the programmed button on the rearview mirror for approx. 3 seconds and then release. Repeat this step, possibly up to three times, to complete the synchronization. After the synchronization is completed, the programmed function is implemented.

To reprogram individual buttons

- Switch on ignition.
- Press and hold the button to be programmed on the rearview mirror.
- As soon as the LED on the rearview mirror starts flashing slowly, hold the hand-held transmitter of the device to be operated approx. 1 in/2.5 cm to 3 in/8 cm from the buttons on the rearview mirror. The required distance depends on the hand-held transmitter.
- Press and also hold the button with the desired function on the hand-held transmitter.
- As soon as the LED on the rearview mirror starts blinking faster, release both buttons. The quick flashing indicates that the button on the rearview mirror has been programmed. The device can now be operated using the button on the rearview mirror.
Canada: if the LED is not flashing rapidly after 60 seconds, change the distance and repeat the step or, if the programming was interrupted by the hand-held transmitter, press and hold the memory button and

press the button on the hand-held transmitter for 2 seconds and release several times.

Operation

 Before using the integrated universal remote control, always inspect the immediate area to make certain that no people, animals or objects are within the travel range of the device.

Comply also with the safety instructions supplied with the original hand-held transmitter. ◀

The device, for example a garage door, can be operated while the engine is running or when the ignition is on by using the button on the rearview mirror. In addition, while within the reception range of the device, press the button until the function is deleted. The LED on the rearview mirror is constantly on while the signal is being transmitted.

Deleting stored functions

Press and hold the right and left buttons on the rearview mirror for approx. 20 seconds until the LED on the rearview mirror starts flashing quickly. All stored functions are deleted. The functions can not be deleted individually.

DIGITAL COMPASS

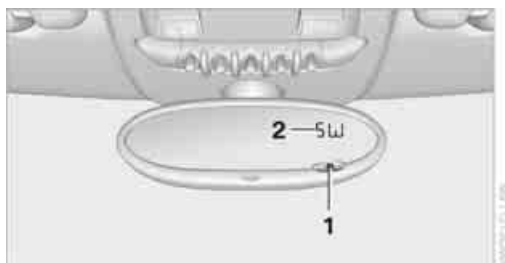

- 1 Setting button on the back of the mirror
- 2 Display

The cardinal or ordinal direction in which the vehicle is moving is shown on the display.

Operating principle

By pressing the setting button with a thin, sharp object, e.g., a pen or a similar object, various functions can be called up. The following setting options are displayed one after the other, depending on how long the setting button is pressed down:

- ▷ Quick press: display switches on/off
- ▷ 3 to 6 seconds: compass zone setting
- ▷ 6 to 9 seconds: compass calibration
- ▷ 9 to 12 seconds: left/right-hand drive setting
- ▷ 12 to 15 seconds: setting the language

Setting the compass zones

Set the appropriate compass zone on your vehicle so that the compass operates properly; see world map with compass zones.

To set the compass zones, press the setting button for approx. 3-4 seconds. The number of the compass zones that have been set are shown on the display.

To change the zone setting, quickly press the setting button as often as necessary until the number of the compass zone for your location is displayed.

The compass is again ready to use after approx. 10 seconds.

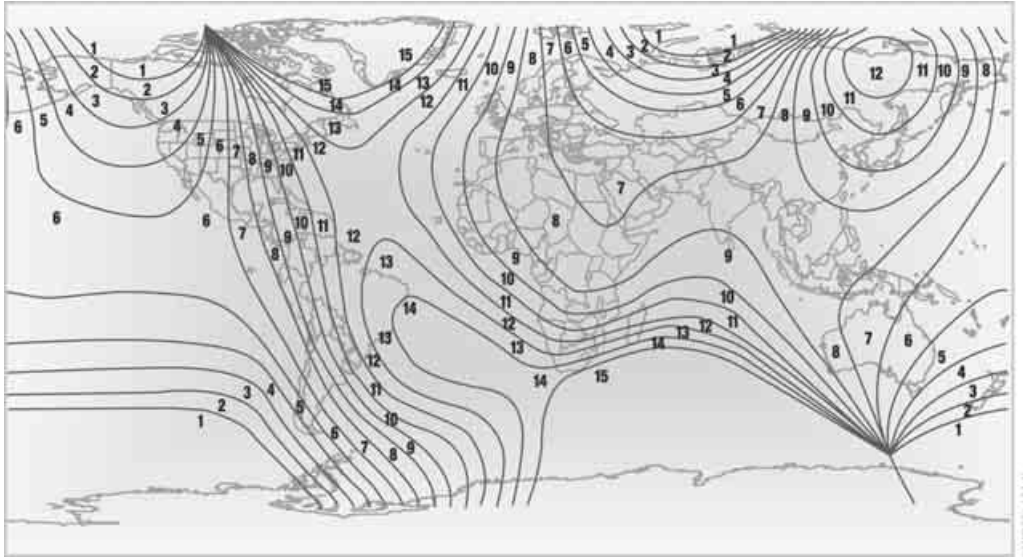

Calibrating the digital compass

The digital compass must be calibrated in the following situations:

- ▷ The incorrect cardinal direction is displayed.
- ▷ The direction that is displayed does not change even though the driving direction changes.
- ▷ Not all cardinal directions are displayed.

Procedure

1. Make sure that there are no large metal objects or overhead power lines near your vehicle, and that you have enough space to drive in circles.
2. Set the compass zone that currently applies.
3. Press the setting button approx. 6-7 seconds to call up C. Then drive in a complete circle at a maximum speed of 4 mph/7 km/h.
If the calibration is successful, the C will be replaced by the directions.

Setting right/left-hand drive

Your digital compass is already set to right-hand drive or left-hand drive at the factory, depending upon your vehicle.

Setting the language

You can set the language on the display:

Press the setting button for approx. 12-13 seconds. Briefly press the setting button again to switch between English "E" and German "O".

The setting is automatically stored after approx. 10 seconds.

GLOVE COMPARTMENT

Opening



Pull the handle to open the cover.
The light in the glove compartment comes on.

Closing

Fold cover up.

 To prevent injury in the event of an accident, close the glove compartment after use while the vehicle is being driven. ◀

Ventilation

Depending on your vehicle's equipment, the glove compartment can be ventilated and, if the cooling function is switched on, can also be cooled.

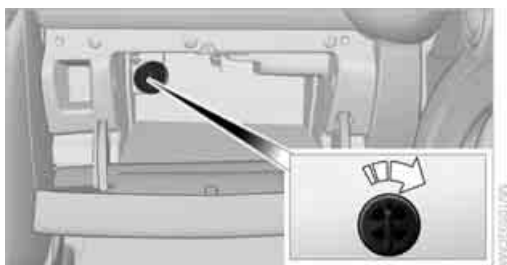

Opening

Rotate the switch in the direction of the arrow.

Closing

Rotate the switch in the opposite direction of the arrow until it is in the vertical position.

Depending on the temperature setting of the air conditioner or the automatic climate control, high temperatures may result in the glove compartment.

CONNECTION FOR EXTERNAL AUDIO DEVICE

You can connect an external audio device such as a CD or MP3 player and play audio tracks over the vehicle's speaker system, refer to the Entertainment chapter, page 115.

CENTER ARMREST

The center armrest between the front seats contains either a compartment or the cover for the snap-in adapter, see page 130.

In the center armrest between the back seats, there is a storage compartment.

Opening

Press the button, arrow, and lift the cover.

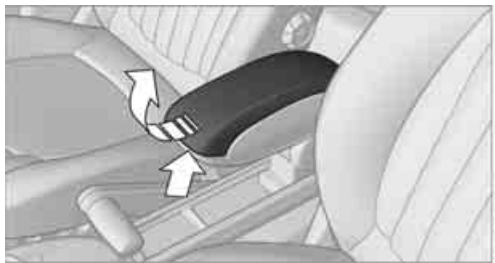

Center armrest rear

Removing

The center armrest in the rear can be removed to increase the amount of storage room.

1. Turn handwheel counterclockwise until it reaches the stop, arrow 1.



2. Push center armrest in the base plate gently towards the back, arrow 2.
3. Raise the armrest in front and swing out.

Installing

1. Insert center armrest in the back into the rear recess of the base plate, arrow 1.



2. Push to rear and swing down in front, arrow 2.
 3. Push center armrest in the base plate forward.
 4. Tighten handwheel by turning clockwise.
- Ensure that the center armrest engages properly when it is installed; otherwise, it may be damaged, for example, during braking maneuvers.

STORAGE COMPARTMENTS

! Do not put any unsecured objects into the interior of the vehicle; otherwise these may endanger the occupants, e.g., during braking and evasive maneuvers. ◀

! Do not use the instrument panel as a shelf, for example with non-slip mats; otherwise, it could be damaged. ◀

In the vehicle interior

Depending on your vehicle's equipment, you will find storage compartments in the front and rear doors and in the center console. Pockets are provided on the backrest rear panels of the front seats.

Center Rail

Various accessory parts can be attached to the Center Rail and installed in different positions.

▶ Do not use accessory parts near the hand brake; otherwise these could be damaged when the hand brake lever is operated.

In addition, do not position accessory parts directly behind the center armrest on the rail; otherwise they could be damaged upon opening the center armrest. ◀

Smartphone holder

The upper part of the smartphone holder can be rotated by 360°.

When installing in the front of the rail, ensure that there is sufficient space, e.g., away from the seat; otherwise, damage may be caused when rotating.

1. Pull the lever 1 up to unlock the mounts.

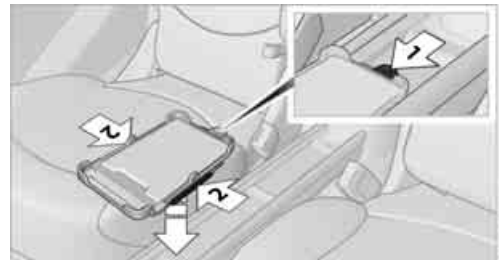

2. First install the smartphone on the Center Rail with the mounts 2.
3. To secure, push lever 1 down. Ensure that the lever can lock it properly.

When connecting a smartphone to the USB audio interface, see page 115, guide the connection cable under the smartphone holder.

Base plate

On the base plate, various accessories can be attached, such as cup holders, holders for sunglasses and cell phone holders.

Inserting base plate

The lever **3** can be locked in three positions.

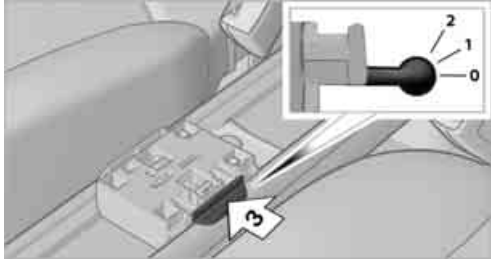

- 0** Locking
- 1** Sliding along the rail
- 2** Inserting base plate

For inserting, move the lever into position **2**.

Sliding and locking

1. Push lever **3** into position **1**.
2. Slide the base plate.
3. Push the lever **3** down, into position **0**, and lock the base plate in place.

 Lock the base plate in place before driving; otherwise, injuries may result in the event of an accident. ◀

Example: cupholder

Put cupholder in the back between the rear seats and push in.

Installing cupholder

1. Lock base plate in place if necessary, refer to Sliding and locking.
2. Pull the lever **6** up to unlock the mounts.

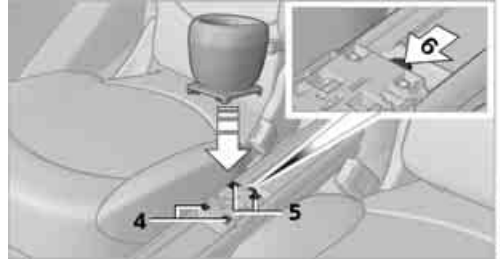

3. First insert the cupholder into the front mounts **4** and then snap it into the rear mounts **5**.

 Make sure that the lever **6** is situated opposite the mount **4**. ◀

Clothes hooks

There are clothes hooks on the grab handles in the rear passenger compartment.

 Items of clothing hung from the hooks must not obstruct the driver's view. Do not hang heavy objects from the hooks; otherwise, they could endanger the car's occupants, e.g. in case of heavy braking or sudden swerving. ◀

In the cargo area

Depending on your vehicle's equipment, you have the following storage options:

- ▷ Storage compartment under the flat load floor
- ▷ Bag holder on the support for the cargo area cover

CUPHOLDERS AND ASHTRAY



Cupholders

⚠ Use lightweight, nonbreakable containers and do not transport hot beverages. Otherwise, there is an increased risk of injury in the event of an accident. ◀

⚠ Do not push unsuitable containers forcibly into the cupholder. Otherwise, you may damage it. ◀

Additional cupholders can be attached to the Center Rail in the rear passenger compartment.

Ashtray

The ashtray is located in one of the cupholders in the center console.

Emptying

Remove the entire ashtray.

Lighter

With the engine running or the ignition switched on, press in the cigarette lighter.

The lighter can be pulled out as soon as it pops back out.

⚠ Hold or touch the hot cigarette lighter by the knob only. Holding or touching it in other areas could result in burns.

When leaving the car, always remove the key so that children cannot operate the cigarette lighter and burn themselves. ◀

CONNECTING ELECTRICAL APPLIANCES

In your MINI, when the engine is running or if the ignition is switched on, you can use electrical devices such as flashlights, car vacuum cleaners, etc., up to approx. 140 watts at 12 volts, as long as one of the following sockets is available. Avoid damaging the sockets by attempting to insert plugs of unsuitable shape or size.

Cigarette lighter socket

Remove the lighter or cover from the socket.

Sockets

In the rear passenger compartment

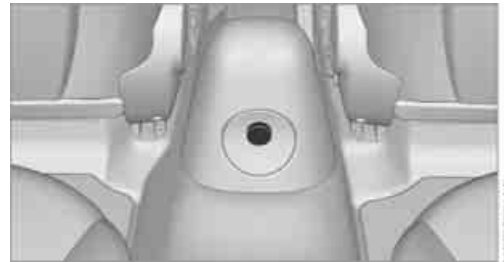

Pull out the cover.

In the cargo area



Pull out the cover.



DRIVE ME.

AT A GLANCE

CONTROLS

DRIVING TIPS

ENTERTAINMENT

COMMUNICATIONS

MOBILITY

REFERENCE

THINGS TO REMEMBER WHEN DRIVING

VEHICLE EQUIPMENT

In this chapter, all production, country, and optional equipment that is offered in the model range is described. Equipment is also described that is not available because of, for example, selected options or country version. This also applies to safety related functions and systems.

BREAK-IN PERIOD

Moving parts need breaking-in time to adjust to each other. Please follow the instructions below in order to achieve the optimal service life and economy of operation for your vehicle.

Engine and differential

Always obey all official speed limits.

Up to 1,200 miles/2,000 km

Drive at varying engine and road speeds, but do not exceed the following:

- ▷ Gasoline engine
4,500 rpm or 100 mph/160 km/h

Avoid full-throttle operation and use of the transmission's kickdown mode.

After driving 1,200 miles/2,000 km

Engine and vehicle speeds can be gradually increased.

Tires

Due to technical factors associated with their manufacture, tires do not achieve their full traction potential until after an initial break-in period. Therefore, drive cautiously during the first 200 miles/300 km.

Brake system

Brakes require an initial break-in period of approx. 300 miles/500 km to achieve optimized contact and wear patterns between brake pads and rotors. Drive cautiously during this break-in period.

Clutch

The function of the clutch reaches its optimal level only after a distance driven of approx. 300 miles/500 km. During this break-in period, engage the clutch gently.

Following part replacement

The same break-in procedures should be observed if any of the components mentioned above have to be renewed in the course of the vehicle's operating life.

GENERAL DRIVING NOTES

Ground clearance

 When driving, ensure that there is sufficient ground clearance, such as when entering underground parking garages, driving over curbs or when driving in winter; otherwise damage to the vehicle may result. ◀

Closing tailgate

 Only drive with the tailgate closed. Failure to do so may endanger passengers or other road users or may damage the vehicle in the event of an accident or a braking and evasive maneuver. In addition, exhaust gas may flow into the passenger compartment. ◀

If special circumstances make it absolutely necessary to drive with the tailgate open:

1. Close all windows and the glass sunroof.
2. Switch off recirculated-air mode and switch the airflow control of the air conditioner or automatic climate control to high, refer to page 82 or 84.

Hot exhaust system

 As in all vehicles, extremely high temperatures are generated on the exhaust system. Do not remove the heat shields installed adjacent to various sections of the exhaust system, and never apply undercoating to them. When driving, standing at idle and while parking, take care to avoid possible contact between the hot exhaust system and any highly flammable materials such as hay, leaves, grass, etc. Such contact could lead to a fire, with the risk of serious personal injuries and property damage. Do not touch hot exhaust tail pipes. Otherwise, there is a risk of burns. ◀

Hydroplaning

 When driving on wet or slushy roads, reduce road speed. If you do not, a wedge of water can form between tires and road surface. This situation, known as hydroplaning, can cause partial or complete loss of tire contact with the road surface, so that the car cannot be steered or braked properly. ◀

The risk of hydroplaning increases with declining tread depth on the tires, refer also to Tread depth on page 142.

Driving through water

 Drive through water on the road only if it is not deeper than 1 ft/30 cm, and then only at walking speed at the most. Otherwise, the vehicle's engine, the electrical systems and the transmission may be damaged. ◀

Parking brake on inclines

 On inclines, do not hold the vehicle with the clutch; use the parking brake. Otherwise, greater clutch wear will result. ◀

For information on driving off using Hill Assist, refer to page 67.

Braking safely

Your MINI is equipped with ABS. If you are in a situation which requires full braking, it is best to brake using maximum brake pressure. Since the vehicle maintains steering responsiveness, you can still avoid possible obstacles with a minimum of steering effort.

The pulsation of the brake pedal, together with the sound of hydraulic regulation, indicates that ABS is functioning properly.

Objects in the movement range of the pedals

 Keep floor mats, carpet, and other objects out of the movement range of the pedals; otherwise, they may inhibit the function of the pedals during driving. Do not place additional floor mats onto an existing one or onto other objects. Only use floor mats that have been approved for the vehicle and can be appropriately fastened. Make sure that the floor mats are securely fastened again after they have been removed, e.g. for cleaning. ◀

Driving in wet conditions

When roads are wet or there is heavy rain, briefly exert gentle pressure on the brake pedal every few miles. Monitor traffic conditions to ensure that this maneuver does not endanger other road users. The heat generated in this process helps dry the pads and rotors to ensure that. Then full braking force will be immediately available when it is needed.

Hills

 To prevent overheating and the resulting reduced efficiency of the brake system, drive long or steep downhill gradients in the gear in which the least braking is required. Even light but consistent brake pressure can lead to high temperatures, brake wear and possibly even brake failure. ◀

You can increase the engine's braking effect by shifting down, all the way to first gear if necessary. This strategy helps you avoid placing excessive loads on the brake system. Downshifting in manual mode of the automatic transmission, page 49.

 Never drive with the clutch held down, with the transmission in neutral or with the engine switched off; otherwise, engine braking action will not be present or there will be no power assistance to the brakes or steering. Never allow floor mats, carpets or any other objects to protrude into the area around the pedals; otherwise, pedal function could be impaired. ◀

Corrosion on brake rotors

When the vehicle is driven only occasionally, during extended periods when the vehicle is not used at all, and in operating conditions where brake applications are less frequent, there is an increased tendency for corrosion to form on rotors, while contaminants accumulate on the brake pads. This occurs because the minimum pressure which must be exerted by the pads during brake applications to clean the rotors is not reached.

Should corrosion form on the brake rotors, the brakes will tend to respond with a pulsating effect that even extended application will fail to cure.

When the vehicle is parked

Condensation forms while the automatic climate control is in operation, and then exits under the vehicle. Traces of condensed water under the vehicle are therefore normal.

In the MINI Cooper S, the coolant pump may continue to run for some time after the engine is switched off. This will generate noise in the engine compartment.

CARGO LOADING

 To avoid loading the tires beyond their approved carrying capacity, never overload the vehicle. Overloading can lead to overheating and increases the rate at which damage develops inside the tires. The ultimate result can assume the form of a sudden blowout. ◀

 Avoid fluid spills in the cargo area as they could damage the vehicle. ◀

EXPANDING CARGO AREA

Cargo area cover

 Do not place any objects on the cover; otherwise, they could endanger the car's occupants, e.g. in the case of braking or sudden swerving, or they may damage the cover. ◀

When you open the tailgate, the roll-up cover is raised.

To load bulky luggage, the cover can be removed.

1. Unhook the lift straps from the tailgate.
2. Lift the cover slightly, arrow 1, and pull it rearward out of the bracket, arrow 2.

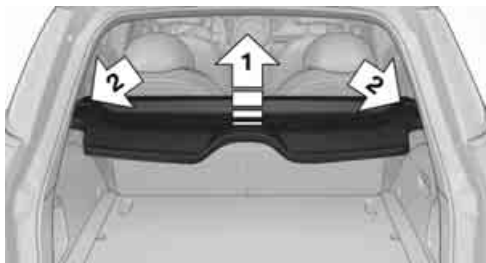

Rear seat backrest

 Before folding down the rear seat backrests, ensure that the range of motion for the backrests is unobstructed. Particularly with a folded down middle section, ensure that there is no one within the range of motion of the backrest and that no one reaches into that region. Otherwise, injury or damage can result. ◀

 To ensure that the safety systems continue to provide optimized protection, observe the safety belt information on page 37. ◀

5 seater: the rear seat back is divided in the following proportions: 40-20-40.

 When the outer rear seat backs are folded down, no one may sit in the middle position. ◀

If necessary, remove the third head restraint, refer to Removing head restraints, page 36. Open the center belt and insert in the take-up on the headliner, see page 38.

Expand the cargo area by raising the rear seat backrests to a steeper angle.

The backrests can be adjusted as needed in 10 stages between a comfort position and a transport position or can be folded down.

In the comfort position, the backrests are as far back as possible; in the transport position, they are in an approximately vertical position.

Before installing a child restraint system, observe the instructions starting on page 41.



1. Hold on to the backrest near the top, for example on the headrest, and pull on the loop, arrow.
2. Lock backrest in the desired position or fold down.

Folding the backrests back into position

 When folding the backrest, ensure that the lock properly engages. Otherwise, for example during braking and avoidance maneuvers, cargo can be thrown into the interior and endanger the occupants. ◀

 If the rear seat backrests are positioned at a steeper angle, do not install child restraint systems in the rear of the vehicle as their protective features may be ineffective. ◀

When backrests are folded back from the folded-down position, they lock in the transport position.

To set the desired backrest angle or a comfortable position, pull the loop forward and adjust the backrest.

Cargo area privacy screen

Between the cargo area and the rear seat backrest, there is a cargo area privacy screen. It can be folded down and used as a loading platform.

 When the rear seat backrests are folded down, do not fold the privacy screen upright. In an accident, cargo could fold down the privacy screen and damage it. ◀

Folding down the privacy screen

1. If necessary, remove the cargo area cover, refer to page 98.
2. Fold the privacy screen up and to the rear, arrow 1.

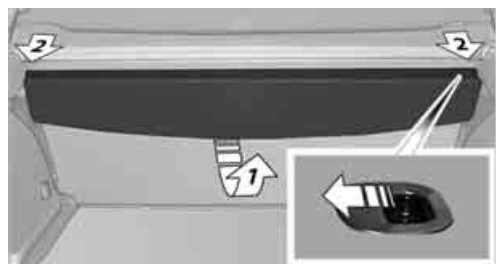

3. Release the locking mechanisms on the left and right sides, arrows 2.
4. Grasp the outer sides of the privacy screen and guide it downward.

 Do not exceed the maximum load of 330 lbs/150 kg of the privacy screen when it is in folded down into the loading platform position; otherwise, damage may occur. ◀

Folding the privacy screen forward

1. Fold down rear seat backrests.
2. Unlock privacy screen, see above.
3. Grasp the outer sides of the privacy screen and guide it forward onto the folded-down rear seat backrests.

Removing

1. Removing cargo area cover, page 98.
2. Fold the privacy screen up and to the rear and unlock it, refer to Folding the privacy screen forward.
3. Remove it from the guides on the cargo area floor, arrows, and remove the privacy screen.



Flat load floor

 Do not exceed a maximum load of 330 lbs/150 kg on the load floor; otherwise, damage may result. ◀

Access to the storage space

Under the load floor, there is storage space, e.g., for the cargo net.

1. Reach into the recess, arrow 1, at the back edge of the load floor.

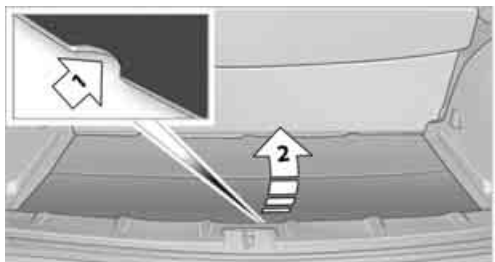

2. Lift up load floor behind and fold forwards, arrow 2.

Before closing the tailgate, put the load floor back on the cargo area floor.

Removing

If necessary, the load floor can be removed.

1. Fold load floor together.
2. Pull the load floor back slightly out of the take-up.
3. Then take it out toward the top.

The folded together load floor can be placed into the luggage compartment.

Cargo net

 Ensure that the cargo net is firmly attached; otherwise, injuries may occur. ◀

Before installing

1. Remove the pouch with the cargo net from the storage compartment under the pull-out floor panel in the cargo area.
2. Remove the cargo net from the pouch, then unroll and unfold it.

After use, fold the cargo net together, roll it back up in the same way, and place it in the pouch so that it can be stowed under the floor panel again. When doing so, make sure that hooks and tensioning buckles do not rest against the rod elements.

3. Unfold the cargo net until the rod elements snap into place.

Installing behind the front seats

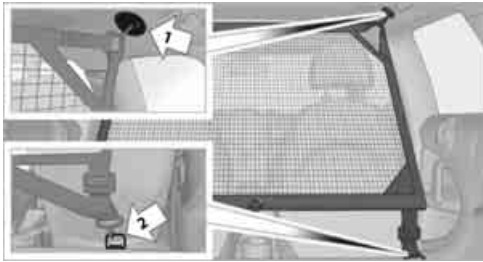

1. If necessary, remove the cargo area cover.
2. Fold down the rear seat backrests, refer to Expanding cargo area.
3. Insert each cargo net mounting pin all the way into its respective front mount in the headliner, arrow 1, and push it forward.
4. Attach the hook, arrow 2, at the bottom of each retaining strap to the respective eye on the vehicle floor.
5. Lash the cargo net securely. To do so, tighten the retaining straps at the tensioning buckles.

Removing

When removing and stowing the cargo net, proceed in the reverse sequence.

To fold closed, press the release button, arrow.

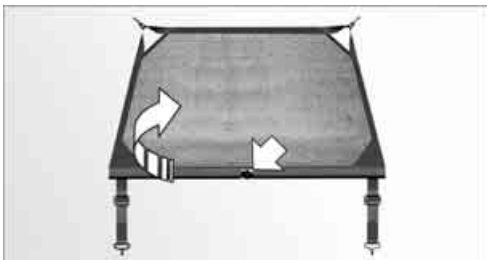

Bag holders

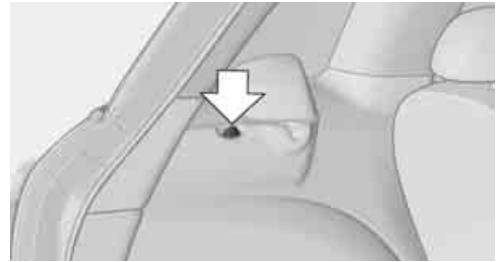

Holders on the left and right side of the support for the cargo area cover, arrow, e.g. for hanging shopping bags or storage bags.

! Only hang light shopping bags or suitable items on the holders. Otherwise, this may create a hazard due to flying objects, for example in the event of braking and evasive maneuvers.

Transport heavy luggage only if it is appropriately secured in the cargo area. ◀

Determining cargo limit

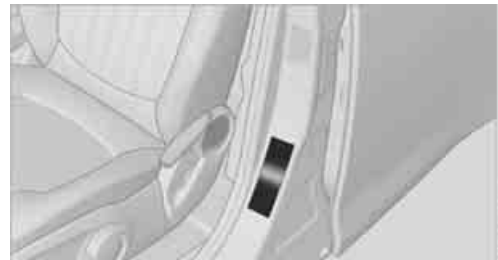

1. Locate the following statement on your vehicle's placard:

! The combined weight of occupants and cargo should never exceed XXX kg or YYY lbs. Otherwise, this could damage the vehicle and produce unstable vehicle operating conditions. ◀

2. Determine the combined weight of the driver and passengers that will be riding in your vehicle.
3. Subtract the combined weight of the driver and passengers from XXX pounds or YYY kilograms.

4. The resulting figure equals the available amount of cargo and luggage load capacity. For example, if the XXX amount equals 1,400 lbs and there will be four 150 lb- passengers in your vehicle, the amount of available cargo and luggage load capacity is 650 lbs:
1,400 lbs minus 750 lbs = 650 lbs.
5. Determine the combined weight of luggage and cargo being loaded on the vehicle. That weight may not safely exceed the available cargo and luggage load capacity calculated in step 4.
6. If your vehicle will be towing a trailer, part of the load from your trailer will be transferred to your vehicle. Consult the manual for transporting a trailer to determine how this may reduce the available cargo and luggage load capacity of your vehicle.

Load

4-seater:

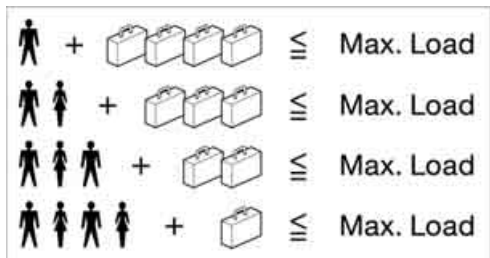

5-seater:

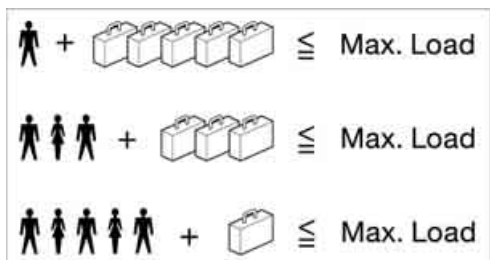

The permissible load is the sum of the occupants' weights and the weight of the cargo. The greater the weight of the occupants, the less cargo/luggage can be transported.

Stowing cargo

- ▷ Position heavy objects as low and as far forward as possible, ideally directly behind the rear seat backrests.
- ▷ Cover sharp edges and corners.
- ▷ For very heavy cargo when the rear seat is not occupied, secure each safety belt in the respective opposite buckle.
- ▷ Do not stack higher than the top edge of the backrests.
- ▷ Use the cargo net, refer to page 100. Ensure that no objects can penetrate through the net.

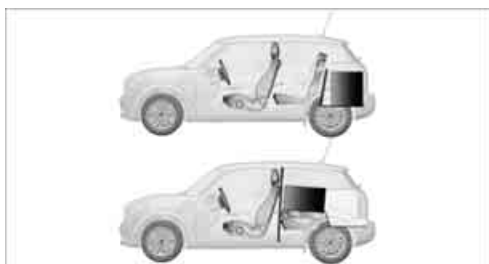

Securing cargo

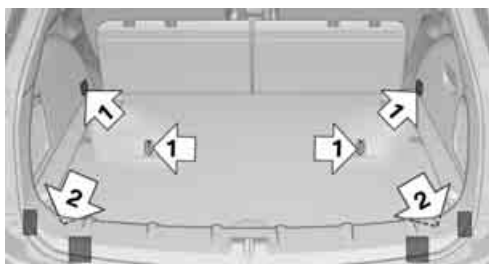

- ▷ Secure smaller and lighter items using retaining or draw straps.
- ▷ Heavy-duty cargo straps for securing larger and heavier objects are available at your MINI dealer.
- ▷ These cargo straps are fastened using eight securing eyes.

Two of them are located on the side wall, arrows 1, of the cargo area.

Two of them are located on the rear wall, arrows 2, of the cargo area.

To use the lower lashing eyes, raise or remove the pull-out floor panel.

Comply with the information enclosed with the load-securing devices.

! Always position and secure the cargo as described above, so that it cannot endanger the car's occupants, for example if sudden braking or swerves are necessary.

Do not exceed the approved gross vehicle weight and axle loads, page 186; otherwise, the vehicle's operating safety is no longer assured and the vehicle will not be in compliance with the construction and use regulations.

Heavy or hard objects should not be carried loose inside the car, since they could be thrown around, for example as a result of heavy braking, sudden swerves, etc., and endanger the occupants. Do not secure cargo using the fastening points for the tether strap, page 42; they may become damaged. ◀

ROOF-MOUNTED LUGGAGE RACK

A special rack system is available as an option for your MINI. Your MINI dealer will be glad to advise you. Comply with the installation instructions supplied with the rack system.

Loading roof-mounted luggage rack

Because roof racks raise the vehicle's center of gravity when loaded, they have a major effect on vehicle handling and steering response. You should therefore always remember not to exceed the approved roof load capacity, the approved gross vehicle weight or the axle loads when loading the rack.

You can find more information under Weights in the technical specifications.

The roof load must be distributed uniformly and should not be too large in area. Heavy items should always be placed at the bottom.

When loading, make sure that there is sufficient space for the movement of the glass roof.

Fasten roof-mounted cargo correctly and securely to prevent it from shifting or falling off during the trip.

Drive smoothly. Avoid sudden acceleration and braking maneuvers, and take corners gently.

REAR LUGGAGE RACK

A special rear-mounted luggage rack is available as an optional accessory. It does not require a trailer hitch.

Please comply with the precautions included with the installation instructions.

Mounting points



The mounting points are located under the covers in the bumper.

Remove the covers, refer to page 167.

Loading rear luggage rack

When loading, make sure that you do not exceed the approved gross vehicle weight and axle loads.

You can find more information under Weights in the technical specifications.

SAVING FUEL

General information

Your vehicle incorporates numerous technologies for reducing fuel consumption and emissions.

Fuel consumption depends on a number of different factors. Fuel consumption and environmental pollution are affected by various actions, the manner of driving and regular maintenance.

Remove unnecessary cargo

Additional weight increases fuel consumption.

Remove attached parts no longer in use

Attached parts on the vehicle affect its aerodynamics and increase fuel consumption.

Closing windows

Open windows increase air resistance and therefore fuel consumption.

Check tire inflation pressure regularly

Check and, if necessary, correct tire inflation pressure at least twice a month and before starting on a long trip.

Low inflation pressure increases rolling resistance and thus leads to greater fuel consumption and tire wear.

Drive off immediately

Do not wait for the engine to warm up while the vehicle remains stationary. Start driving right away, but at moderate engine speeds. This is the fastest way for the cold engine to reach its operating temperature.

Think ahead while driving

Avoid unnecessary acceleration and braking. By maintaining a suitable distance to the vehicle driving ahead.

Looking-ahead and smooth driving reduces fuel consumption.

Avoid high engine speeds

Use first gear only for driving off. In second and higher gears, accelerate smoothly to a suitable engine and road speed. In doing so, avoid high engine speeds and shift up early.

When you reach your desired traveling speed, shift to the highest suitable gear and drive at constant speed.

As a rule: driving at low engine speeds lowers fuel consumption and reduces wear.

Coasting

When approaching a red traffic light, take your foot off the accelerator and let the car roll to a stop in the highest gear possible.

On a downhill gradient, take your foot off the accelerator and let the vehicle coast in a suitable gear.

Fuel supply is shut off automatically when the vehicle is coasting.

Switch off the engine during lengthy stops

Switch off the engine when stopping for lengthy periods, e.g. at traffic lights, railroad crossings or in traffic jams.

Switch off any features that are not currently required

Features such as air conditioning, seat heaters and the rear window defroster require a great deal of energy and result in greater fuel consumption, especially in city driving and during Stop & Go operation. For this reason, switch off these features if they are not really needed.

Have the vehicle serviced

Have your vehicle serviced regularly to achieve good economy and a long vehicle life. The manufacturer of your MINI recommends having the vehicle serviced by a MINI dealer. Also note the MINI Maintenance System, page 149.

DRIVING ON POOR ROADS

Your MINI with ALL4 drive is at home on any type of street or road. It combines an all-wheel drive system with the advantages of a normal passenger car.



Do not drive on unpaved terrain, as otherwise the vehicle may be damaged. ◀

When you are driving on poor roads, there are a few points which you should strictly observe for your own safety, for that of your passengers, and for the safety of the vehicle:

- ▷ Familiarize yourself with the vehicle before beginning to drive and do not take risks under any circumstances.
- ▷ Adapt your speed to road conditions. The steeper and rougher the road surface is, the lower the speed should be.
- ▷ When driving on very steep uphill or downhill grades, make sure in advance that the engine oil and coolant levels are close to the maximum mark, refer to page 146.
- ▷ While driving, watch carefully for obstacles such as rocks or holes. Try to avoid these obstacles whenever possible.
- ▷ Make sure that the undercarriage does not touch the ground, for example on hilltops and bumpy roads. The ground clearance of the vehicle is a maximum of approx. 6.0 in/ 15 cm. Please note that the ground clearance can vary depending on loading and the driving conditions of the vehicle.
- ▷ Only drive through road surface water up to a maximum water depth of 1 ft/30 cm and only at walking speed; do not remain stationary.
- ▷ After driving through water at low speed, lightly press the brake pedal several times to dry the brakes and to prevent the braking effect from being reduced by wetness.
- ▷ Depending on the condition of the surface, it may be practical to briefly activate DTC, refer to DTC Dynamic Traction Control on page 66.
- ▷ If the drive wheels spin on one side, depress the accelerator pedal sufficiently so that the driving stability control systems can distribute the drive forces to the individual wheels.

After driving on poor roads, please observe the following points to maintain the driving safety of the vehicle:

- ▷ Clean the coarsest dirt from the body.
- ▷ Clean mud, snow, ice, etc. from the wheels and tires and check the tires for damage.

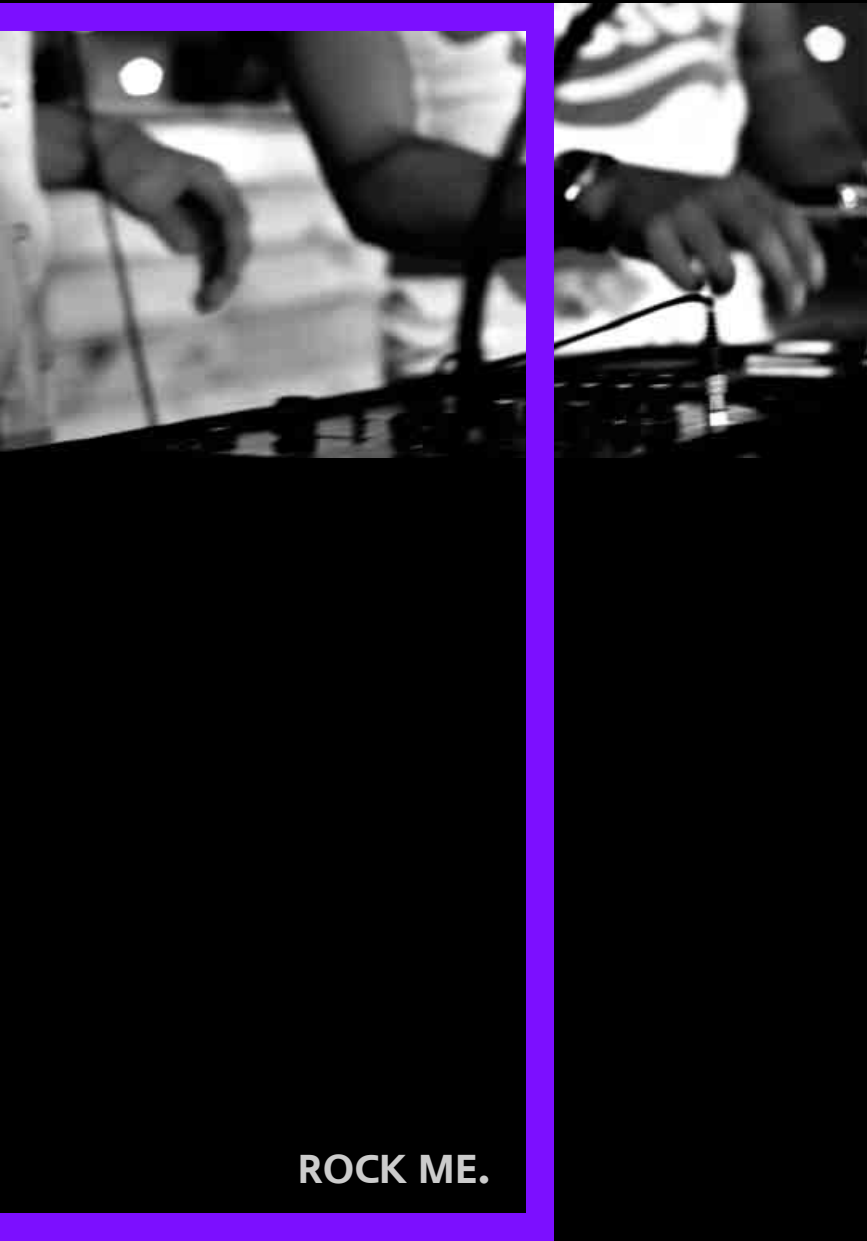

ROCK ME.

AT A GLANCE

CONTROLS

DRIVING TIPS

ENTERTAINMENT

COMMUNICATIONS

MOBILITY

REFERENCE

RADIO MINI BOOST CD

VEHICLE EQUIPMENT

In this chapter, all production, country, and optional equipment that is offered in the model range is described. Equipment is also described that is not available because of, for example, selected options or country version. This also applies to safety related functions and systems.

SWITCHING RADIO ON/OFF



Press the left rotary knob. The radio selects the last set audio source:

▷ Radio

- ▷ HD Radio
- ▷ Satellite radio
- ▷ CD
- ▷ External audio device
- ▷ USB audio interface.

Listening to the radio when the ignition is switched off

After switching off the radio readiness, the radio functions are available for approx. 20 minutes.

To do so, switch the radio on again.

 To spare the battery, ensure that the radio is switched off when leaving the vehicle. ◀

ADJUSTING VOLUME



Turn left rotary knob. The setting is stored for the remote control in use.

 As soon as you make a phone call using the hands-free device, the radio will automatically be muted. ◀

Setting the volume for the PDC and gong

You can raise or lower the audio signals for the PDC or gong with respect to the volume of the

audio sources.

The audio signals have a set minimum and maximum volume, below which they can not fall and above which they can not go.

 Set the audio source to a high volume to be able to better set the volume of the audio signals. ◀

1. Press the  button.

2.  Press the button if necessary.

3.  Press the button.

or

 Press the button.

4. Select the desired volume and press the knob on the right.

Setting the speed-dependent volume

The speed-dependent volume controls automatically increases the volume as the speed of the vehicle increases. You can set different levels for increasing the volume.

1. Press the  button.

2.  Press the button if necessary.

3.  Press the button.



4. Select the desired volume and press the knob on the right.

Setting the volume for external audio devices

Your radio has the option of connecting an external audio device, e.g., an MP3 player, and playing it over the loudspeakers in the vehicle. You can set the volume by using the radio.

Connecting an external device, refer to page 115.

To adjust the volume of an external audio device to the radio:

1. Press the **MODE** button.
2.  Press the button.
3.  Press the button.
4. Select the desired volume and press the knob on the right.

SETTING TONE CONTROLS

You can select between the following settings:

- ▷ Bass: bass adjustment.
- ▷ Treble: treble adjustment.
- ▷ Balance: volume distribution left/right.
- ▷ Fader: volume distribution front/back.

The tone settings are set for all audio sources at once.

Setting the bass, treble and balance



1. Press the  button.
2. Select the desired tone setting and press the knob on the right.



3. Select the desired volume and press the knob on the right.

Resetting tone settings

The tone settings are reset to the middle values.

1. Press the  button.
2.  Press the button.

TIME

Setting the time, date and time format

You can set the time, date and time format, refer to page 62.



RADIO

Your radio is designed for the reception of FM and AM signals.

Listening to the radio

1. Switch on the radio, refer to page 108.
2. If necessary, press the **MODE** button.



3.  Press the button.
4.  Press the corresponding button as often as necessary until the desired wavelength band is selected.
 - ▷ AM: AM and AMA
 - ▷ FM: FM1/FM2 and FMA

Selecting a station

The setting is stored for the remote control in use.

Next station

Press the  ...  button.

The next available station is selected.

Selecting stations by changing the frequency

1. Press the  button.
2. Press the button each time to enter a desired frequency.



Or, by using the knob on the right:

1. Press the **M** button.
2. Turn the knob on the right until the desired frequency is reached.

Automatically updating strongest stations

FM AM

Press the corresponding button until "Autostore" is displayed.

Several seconds may go by until the stations are stored and one of the stations can be heard.

If you do not wish to use the Autostore feature, you can store six stations of your choice in the FMA or AMA memory levels. ◀

Playing and selecting stations, scan

You can listen to all the receivable stations for approx. 10 seconds.

SET SC

Press the button.

Interrupting the scan and selecting a station:

SET SC

Press the button.

When a traffic information station is selected, only traffic information broadcasts will be played.

Storing and recalling stations

Memory presets

Your radio can store 30 stations:

- ▷ FM1, FM2: six stations each of your choice
- ▷ AM: six stations each of your choice
- ▷ FMA/AMA: the six strongest stations automatically

Storing a station

1. **FM AM**
Press the corresponding button as often as necessary until the desired frequency range is selected.
2. Select station.

3. **1 2 5 6**
Press and hold the desired button until the station can again be heard after a short interruption. The memory level and the selected button are shown on the display, e.g.:



Recalling stored stations

1. **FM AM**
Press the corresponding button as often as necessary until the desired wave-length band is selected.
2. **1 2 5 6**
Press the desired button.

Using the knob on the right:

Turn the knob on the right as long as necessary until the desired station has been reached.

RDS – Radio Data System

The Radio Data System transmits additional information in the FM frequency range. RDS stations have the following features:



- ▷ When there are good reception conditions, then the station names are displayed.
- ▷ Additional information can be shown on the display, e.g., text messages from the station.
- ▷ Over RDS, some stations transmit the type of the received program, PTY. At the option of the station, this can be shown briefly on the display, e.g., messages, NEWS. Using PTY, warnings regarding catastrophes can also be displayed, e.g., "ALARM".

Switching RDS on/off

1. **SET SC**
Press the button.
2. **RDS**
Press the button.

The name of the current station is displayed if this station broadcasts RDS information.

Displaying the program type

1.  Press the button.
2.  Press the button.

HD RADIO™ RECEPTION

Many radio stations transmit analog and digital signals. If a digital radio network is available, these stations can be received digitally and thus with improved sound quality.



License conditions

HD Radio™ technology is manufactured under U.S. and Foreign Patents licensed from iBiquity Digital Corp. HD Radio™ and the HD and HD Radio logos are proprietary trademarks of iBiquity Digital Corp.

Activating/deactivating digital radio reception

1. Press the **MODE** button.



2.  Press the button.
3.  Press the button.
4.  Press the button.

"HD": a station is received digitally.

"(HD)": a station is broadcasting digital signals; digital radio reception is, however, switched off.

For some stations, the digital signals are not broadcast simultaneously with the analog signals. If you are in an area where the selected station can not be continuously received digitally, then the playback switches between analog and digital reception. As a result, the reception can be interrupted and then resume from time to time. In this type of situation, it is suggested that digital radio reception be turned off.

Selecting programs from a digital station

Some stations broadcast several programs. To select one of these programs:

1. Press the ◀ ... ▶ button as often as necessary until the desired digital station is displayed.
If a station broadcasts several programs, then, e.g., "HD1" is displayed.



2.  Press the button.
3. Select the desired program.
Up to eight programs per station can be selected, "HD1" to "HD8".

Displaying additional information

For digital stations, additional information about the current track is displayed, e.g., the name of the artist.

1.  Press the button.

The information is displayed.

Operation indicators

Acquiring

A search for digital stations is being conducted.

No Signal

No digital station has been found.

SATELLITE RADIO

You can receive more than 100 different channels with higher audio quality.

The channels are offered in defined packages. To receive the channels of your choice, you have to activate the package.

-  You may experience signal drops and muting events related to this new technology. ◀

Activating or deactivating channels

1. Press the **MODE** button.



2.  Press the button.



3.  Press the button.
4. Select the desired category.



The channels are displayed.

✓ This symbol indicates the current channel.



Activating

1. Turn the knob on the right to select a channel that is not yet activated.
2. Press the knob on the right to confirm a channel.

A phone number and the electronic serial number, ESN, are displayed. When activating, the electronic serial number is required.

3. To activate the channels:
Dial the phone number.

Deactivating

1. Press the **MODE** button.



2.  Press the button.



3.  Press the button for a longer period.

A phone number and the electronic serial number, ESN, are displayed. For deactivating, the electronic serial number is required.

4. To deactivate channels:
Dial the phone number.

Selecting and storing a channel

1. Press the **MODE** button.



2.  Press the button.



3.  Press the button.
4. Select the desired category.





5. Select desired channel.



To display all the channels:

-  Press the button.

To store a channel:

1.  Press the button.
2.  Press the button as often as necessary until the desired memory level, SAT 1 or SAT 2, is reached.
3.  Press and hold the desired button until the channel can again be heard after a short interruption.

Changing to the current channel



Press the button.

Additional information

The name of the channel and additional information about the current track is displayed, e.g., the name of the artist.

1. Select the desired channel.



Press the button.



Changing channels using buttons

Press the ◀ ... ▶ button for the corresponding direction.

The next activated channel is recalled.

Search function

1. Press and hold the ◀ ... ▶ button for the corresponding direction.
The activated channels are shown, one after another, on the display.
2. Release the button to select the displayed channel.

Notes

When there is a signal blockage or the transmission is suspended momentarily for more than 4 seconds, a message appears on the Control Display.

-  Service may be interrupted or unavailable for specific reasons such as environmental or topographic conditions and others that Satellite Radio cannot directly control. Signals may not be available under tunnels, in parking garages, next to tall buildings, nearby

trees with dense foliage, nearby mountains or other possible strong sources of radio interference.

Service should resume normally after the source of signal unavailability has been cleared. ◀

CD PLAYER

Starting the CD player

Some time may pass until the CD player starts.

1. Switch on the radio, refer to page 108.
2. Insert the CD with the printed side up into the CD slot.

If there is already a CD in the CD slot:

1. Switch on the radio, if necessary.
2. Press the **MODE** button.
3.  Press the button.

Changing the music track

Skipping tracks

Press the ◀ ... ▶ button as often as necessary until the desired track is reached.

Using the knob on the right:
Turn the knob on the right until the desired track has been reached.

Fast forward/reverse

1. Press and hold the ◀ ... ▶ button.
The track can be heard but is distorted.
2. To cancel the fast forward/reverse, release the button.

Random order



Press the button.

To terminate the random generator:



Press the button.

Playing a track and selecting, scan



Press the button.

To cancel the scan and select a track:



Press the button.

Selecting MP3 music tracks

The CD player can also play CDs with compressed audio data, such as MP3 and WMA.

Selecting a track

1. Press button.
2. Use the knob on the right to select the desired folder.
 - ▶ : press the knob on the right to open a folder
 - ▶ : press the knob on the right to close a folder
3. Select additional folders if you wish.
4. Select the desired track and press the knob on the right.

You can browse through the folders during playback.

To change to the current track:



Press the button.

Track display

You can call up any input information about the current music track:

1. Press button.
2. Press button.

Ejecting the CD out of the CD player

Press the button.

The CD is partially ejected from the CD slot.

Operation indicators

- ▶ "Insert CD"
The CD slot is empty.
- ▶ "Error CD"
The CD can not be read or is defective.
- ▶ "Temp. CD"
The operating temperature is too high.

Notes



CD players are laser products of Class 1. Do not operate if the cover is damaged; otherwise, serious injury to eyes may result.

Do not use CDs with after-market labels; otherwise, the labels can loosen as a result of the heat generated during playback and possibly cause irreparable damage to the system.

Only use round CDs with a standard diameter of 4.7 in/12 cm and do not play CDs with adapters, e.g., single CDs; otherwise, the CDs or the adapters may jam and it may not be possible to eject them.

Do not use combined CD/DVDs, e.g., DVD^{Plus}; otherwise, the CD/DVD may jam and it may not be possible to eject it. ◀

General malfunctions

The CD players are optimized for operation in vehicles. They may be more sensitive to defective CDs than players for stationary use.

If a CD can not be played, first check if the CD is properly inserted.

Humidity

If there is high humidity, the CD or the focusing lens for the laser beam may get fogged up and playing the CD may temporarily not be possible.

Malfunctions with individual CDs

If there are malfunctions with individual CDs, then they may be due to the following causes.

CDs that you burned yourself

Potential problems with home-burned CDs are, for example, inconsistent data generation and

burning processes, as well as low quality or excessive aging of the blanks that are used.

Only write on the upper surface of CDs with a writing instrument that is suitable for the purpose.

Damaged CDs

Avoid finger prints as well as dust, scratches and moisture.

Store CDs in sleeves.

Do not expose CDs to a temperature greater than 122 °F / 50 °C, high humidity or direct sunlight.

CDs with copy protection

CDs are often provided with copy protection from the manufacturer. This can result in CDs not playing or playing back in only a limited fashion.

Care

If necessary, clean the reflecting side of the CD with a commercially available cleaning cloth by wiping in a straight line from the center outwards.

USB AUDIO INTERFACE

- ▷ iPods/iPhones or USB devices such as MP3 players and USB memory sticks: connection via the USB audio interface.
- ▷ iPhone/mobile phone music players: connection using a snap-in adapter, refer to page 130.
- ▷ Only one iPod/iPhone can be connected to the vehicle. Output from an iPod/iPhone to the USB audio interface is only possible if there is no iPhone in the snap-in adapter.
- ▷ Popular audio files, such as MP3, AAC and M3U playlists, PLS and WPL, can be played. Depending on the audio file, proper playback can not be ensured in every case, such as for bit rates greater than 256 kbit/s.
- ▷ Music tracks with integrated Digital Rights Management (DRM) cannot be played.

Because of the large number of audio devices on the market, it can not be ensured that every device will properly operate in the vehicle. Additional information may be found at www.mini.com/connectivity or at a MINI dealer.

File systems

Popular FAT file systems for USB devices are supported. The manufacturer of your MINI recommends the FAT 32 format.

Connecting

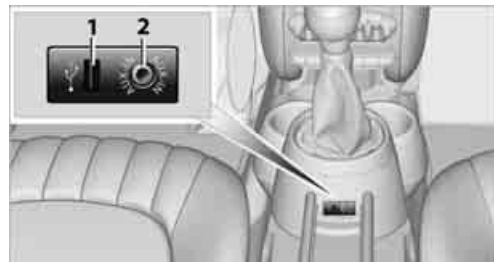

- 1 USB interface
- 2 Connection for audio playback:
TRS connector 1/8"/3.5 mm

Apple iPod/iPhone

Use the special cable adapter for Apple iPods/iPhones to produce the connection. The cable adapter is required for a proper connection. For further information, contact your MINI dealer or check on the Internet at www.mini.com/connectivity

To have audio playback over the vehicle speakers, connect the iPod with the USB interface and the connection for the audio playback.

The iPod/iPhone's menu structure is supported by the USB audio interface.

USB device

For audio playback over the vehicle speakers, connect the USB device to the USB interface.

After first connecting

Track information is transferred to the vehicle. The time required is dependent on the USB device and on the number of tracks.

The data from up to four USB devices or for approx. 20,000 tracks can be stored in the vehicle.

Starting audio playback

iPod

1. Press the **MODE** button.
2.  Press the button.

USB device

1. Press the **MODE** button.
2.  Press the button.

Changing music tracks

Skipping tracks

It is possible to skip tracks within the selected folder.

Press the ◀ ... ▶ button as often as necessary until the desired track is reached.

Using the knob on the right:
Turn the knob on the right until the desired track has been reached.

Fast forward/reverse

1. Press and hold the ◀ ... ▶ button.
The track can be heard but is distorted.
2. To cancel the fast forward/reverse, release the button.

Random order

1.  Press the button.

The current track is played to the end. Then the tracks in the current folder are played back in random order.

To terminate the random generator:

1.  Press the button.

Selecting a track

Depending on the connected device, a track can be selected from the following categories.

- ▷ "LIST": playlists.
 - ▷ "GEN": music type.
 - ▷ "ART": artist.
 - ▷ "ALB": album.
1. Select the desired category.
 2. Use the knob on the right to select the desired folder as needed.
 - ▷ + : press the knob on the right to open a folder
 - ▷ - : press the knob on the right to close a folder
 3. Select additional folders if you wish.
 4. Select the desired track and press the knob on the right.

You can browse through the folders during playback.

To change to the current track:

1.  Press the button.

Track display

You can call up any input information about the current music track:

1.  Press button.

Adjusting the iPod volume

The volume of the iPod can be lower or higher than the audio sources for the radio.

To adjust the volume of the iPod to the volume of the other audio sources:

1.  Press the button.
2. Select the desired volume and press the knob on the right.

Notes

- ▷ The USB audio interface supplies the connected audio devices with power, provided that this is supported by the audio device. For this reason, audio devices are not to be connected to a receptacle in the vehicle during operation.
- ▷ Do not expose audio devices to extreme ambient conditions, for example, very high temperatures; refer to the operating instructions for the audio device.
- ▷ Do not connect any devices, e.g. fans or lamps, to the USB audio interface.
- ▷ Do not connect USB hard drives.



CONNECT ME.

AT A GLANCE

CONTROLS

DRIVING TIPS

ENTERTAINMENT

COMMUNICATIONS

MOBILITY

REFERENCE

TELEPHONE

VEHICLE EQUIPMENT

In this chapter, all production, country, and optional equipment that is offered in the model range is described. Equipment is also described that is not available because of, for example, selected options or country version. This also applies to safety related functions and systems.

OVERVIEW

The concept

Mobile phones can be connected to the vehicle through Bluetooth.

Bluetooth® is a registered trademark of Bluetooth® SIG, Inc.

Your MINI is equipped with a mobile phone preparation package. After a suitable mobile phone is paired with the vehicle once, the mobile phone can be controlled via the radio, the buttons on the steering wheel, and by voice.

It may be necessary for some functions to be activated by the mobile phone provider.



Only make entries when traffic conditions permit. Do not hold the mobile phone in your hand while you are driving; use the hands-free system instead. If you do not observe this precaution, your being distracted can endanger vehicle occupants and other road users. ◀

Snap-in adapter

The snap-in adapter, refer to page 130, makes it possible to:

- ▷ Accommodate the mobile phone.
- ▷ Recharge its battery.
- ▷ Connect it to an external antenna of the vehicle.

This assures a better network connection and constant sound quality.

A mobile phone that is connected to the vehicle should not be operated via the mobile phone keypad; otherwise, malfunctions may occur.

Suitable mobile phones

Precise information as to which mobile phones are supported by the hands-free device can be found at www.mini.com/connectivity.

Notes

Do not expose your mobile phone to extreme ambient conditions, for example, very high temperatures; otherwise, functions on your mobile phone may not work. Follow the operating instructions for your mobile phone.

Mobile phone operation over the radio

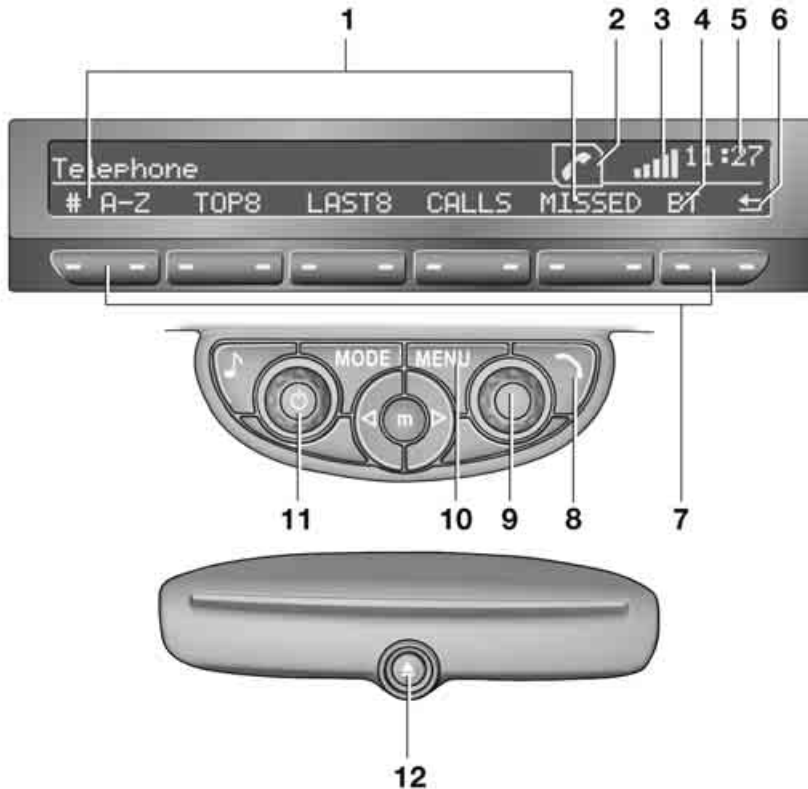

To open the menu shown above, refer to page 126.

1 Making and receiving phone calls 125

- ▷ "#": dial phone number
- ▷ "A-Z": phone book
- ▷ "TOP8": most frequently dialed phone numbers
- ▷ "LAST8": last phone numbers dialed
- ▷ "CALLS": accepted calls
- ▷ "MISSED": missed calls

2 Marking to select a function

3  Reception of the mobile phone network: Display depends upon signal strength.

4 Pairing a new mobile phone, delete pairing data of a mobile phone, or switching Bluetooth on/off 122

5 Time

6 Backspace

7 Function buttons for confirming the functions displayed above them

8 Redialing, answering a call, starting to dial, ending a call, and switching to the phone menu

9 Selecting and confirming function

- ▷ Turn: to select a function or number
- ▷ Press: to activate a function or number



10 Switching displays 126

- ▷ "PHONE": telephone
- ▷ "COMP": computer
- ▷ "CONFIG": adjusting
- ▷ "MINI": MINI contact

11 Radio on/off, volume

- ▷ Press: switching radio on/off
- ▷ Turn: adjusting volume 125

12 Ejecting CD

Symbols on the display	Meaning
	Roaming active
	Placing a telephone call using the hands-free system

PAIRING/UNPAIRING MOBILE PHONE

Overview

The pairing data of four mobile phones can be stored simultaneously in the vehicle. When the engine is running or the ignition is switched on, each paired mobile phone is automatically detected as soon as it is present in the passenger compartment.





Requirements

- ▷ Suitable mobile phone, refer to page 120.
- ▷ Mobile phone operational.
- ▷ Bluetooth activated in vehicle, refer to page 122, and in the mobile phone.
- ▷ Bluetooth presets in the mobile phone are required, e.g. connection not confirmed or visible, refer to Owner's Manual for the mobile phone.
- ▷ A number with at least 4 and at most 16 digits has been established as the Bluetooth passkey. Only required once for pairing.
- ▷ Ignition switched on.

Activating/deactivating Bluetooth link

Bluetooth is not permitted everywhere. Comply with all safety guidelines and regulations.

To deactivate the Bluetooth connection:

1. Press the **MENU** button.
2.  Press the button.
3.  Press the button.
4.  Press the button.
5.  Press the button.

To reactivate the Bluetooth connection:

1.  Press the button.



2.  Press the button.

Pairing and connecting

 Only pair the mobile phone when the vehicle is stopped; otherwise, inattention may lead to endangerment of passengers or other road users. ◀

Switching on ignition

1. Insert the remote control as far as possible into the ignition lock.
2. Switch on the ignition; to do so, press the Start/Stop button without stepping on the brake or clutch pedal.

Preparation on the radio display

3. Press the **MENU** button.



4.  Press the button.



5.  Press the button.



6.  Press the button.



Turn the right rotary knob to display the Bluetooth name of your vehicle on the display.

Preparation with mobile phone

- Other operations must be performed on the mobile phone and differ depending on the type of mobile phone, refer to Owner's Manual for the mobile phone, e.g. under Connecting or pairing Bluetooth device. The Bluetooth name of the vehicle appears on the mobile phone display.
- Select the Bluetooth name of the vehicle on the mobile phone display.

Pairing

The mobile phone or the radio display will prompt you to enter the same Bluetooth passkey.

Depending on the mobile phone, you have approx. 30 seconds to enter the Bluetooth passkey using the mobile phone and the radio display.

If the Bluetooth passkey can be entered using the radio, then the following appears on the display:



- Enter the Bluetooth passkey using the number buttons of the mobile phone.

-  Press the button to enter the Bluetooth passkey using the radio.



- Using the function buttons 0-9, enter the same Bluetooth passkey that was entered into the mobile phone.

To delete the last digit:

-  Press the button.

-  Press the button to confirm the Bluetooth passkey.

The following display will appear after a few seconds:



-  Press the button if necessary.

The following display will appear after the mobile phone is paired:



If pairing was successful, the mobile phone appears at the top of the list of mobile phones. If the pairing was not successful: What to do if..., refer to page 124.

To repeat the pairing procedure:



-  Press the button.
- Repeat steps 6 to 13.

If the pairing procedure was not successful repeated times:

- ▷ Suitable mobile phones can be found at: www.mini.com/connectivity
- ▷ E-mail: mini.assistance@askminiusa.com
- ▷ Hotline, also refer to page 130.

To display the number for the Hotline:



HELP
- - Press the button.

Turn the right knob to show the phone number for the Hotline and the required information for the pairing procedure on the display.

Following the initial pairing

- ▷ The mobile phone is detected/connected in the vehicle within a short period of time when the engine is running or radio readiness is switched on.
- ▷ After identification, phone book entries are imported from the mobile phone and/or SIM card of the telephone, depending on the telephone.
- ▷ Specific settings may be necessary in some mobile phones, e.g. authorization or a secure connection, refer to the Owner's Manual for the mobile phone.

Connecting a particular mobile phone

The connected mobile phone is identified with the following symbol in the radio display: ✓
To change the sequence of mobile phones in the list:

1. Press the **MENU** button.
2. **PHONE**
- - Press the button.



3. **BT**
- - Press the button.



4. Turn the right rotary knob until the display shows the mobile phone whose position in the list is to be changed.
5. **PRI0+**
- - Press the button the number of times required to reach the desired position.

Unpairing mobile phone

1. Switch off mobile phone.
2. Press the **MENU** button.
3. **PHONE**
- - Press the button.
4. **BT**
- - Press the button.



5. Turn the right rotary knob to show the desired mobile phone on the radio display.
6. **DELETE**
- - Press the button.
7. **YES**
- - Press the button to acknowledge the message displayed.

What to do if...

For information on suitable mobile phones, refer to page 120.

The mobile phone could not be paired or connected.

- ▷ Is Bluetooth activated in the vehicle and in the mobile phone? Activate Bluetooth in the vehicle and in the mobile phone.
- ▷ Do the Bluetooth passkeys on the mobile phone and the vehicle match? Enter the same passkey on the mobile phone and via the radio.
- ▷ A multi-digit passkey may be required.
- ▷ Is the passkey input taking longer than 30 seconds? Repeat the pairing procedure.
- ▷ Are too many Bluetooth devices connected to the mobile phone? If so, delete the connections with other devices on the mobile phone.
- ▷ Is the mobile phone in power economy mode or does it only have a small amount of battery charge remaining? Charge the mobile phone in the snap-in adapter or via a charging cable.

- ▷ Depending on the mobile phone, it may only be possible to connect one device to the vehicle. Unpair the connected device from the vehicle and only pair and connect one device.
- ▷ Is the mobile phone no longer responding? Switch the mobile phone off and back on again. Repeat the pairing procedure.
- ▷ Delete connection to the mobile phone and, if necessary, to the radio and try again.

Is the mobile phone no longer responding?

- ▷ Switch the mobile phone off and back on again. Repeat the pairing procedure.
- ▷ Is the ambient temperature too high or too low? Do not subject your mobile phone to extreme ambient temperatures.

Phone book entries are not displayed, not all of them are displayed, or they are displayed incompletely.

- ▷ The transfer of phone book entries has not yet completed.
- ▷ It is possible that only the phone book entries of the mobile phone or the SIM card are transferred.
- ▷ It may not be possible to display phone book entries with special characters.
- ▷ The number of phone book entries to be stored is too high.
- ▷ The data volume of the phone book entry is too great, e.g. due to additionally stored information such as notes? Reduce the data volume.

The telephone connection quality is low.

- ▷ Depending on the mobile phone, it is possible to adjust the strength of the Bluetooth signal.
- ▷ Insert the mobile phone into the snap-in adapter or place it in the vicinity of the center console.
- ▷ Adjust the volume of the microphone and speaker separately.

If you have gone through all items in the list and still cannot activate the desired function please contact the Hotline or your MINI dealer.

OPERATION

Overview

The following functions can be operated using the radio:

- ▷ Accepting/refusing a call
- ▷ Dialing phone numbers
- ▷ Dialing a phone number from the phone book
- ▷ Dialing a stored phone number, e.g., from a list of accepted calls
- ▷ Ending a call

When the ignition is switched off and radio readiness switched on, e.g. after removal of the infrared remote control, an ongoing conversation can be continued for a maximum of 25 minutes using the hands-free system.

Adjusting volume

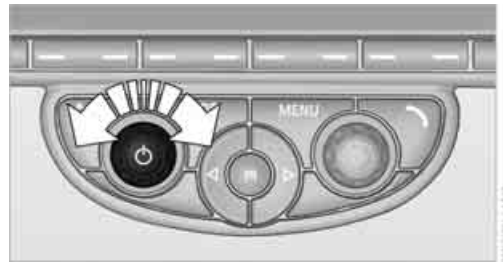

Turn the knob until the desired volume is reached.

The volume for incoming calls and call volume can be adjusted independently of each other.

The setting is stored for the remote control currently in use.

Incoming call

Receiving calls

If the phone number of the caller is stored in the phone book and the phone number is transmitted, then the name of the entry is displayed.

Accepting a call

Press the  button on the radio or on the steering wheel.

Alternative:



Rejecting a call



Ending a call

Press the  button on the radio or on the steering wheel.

Alternative:



Entering phone numbers



Dialing a number

1. Press the **MENU** button.



2.  Press the button



3.  Press the button.
4. Enter the desired phone number using the 0-9 buttons.
To delete the last digit:
 Press the button.
5. Press the  button on the radio or on the steering wheel.



Alternative:

Press the right rotary knob to dial the phone number.

For your phone number to be displayed to the person you are calling, the display of phone numbers must be enabled by your service provider.

Keypad dialing

Use keypad dialing to gain access to network services or to control devices, e.g. to remotely access an answering machine. This requires the DTMF code.

This function is available if a connection has been established and the call is being made using the hands-free system.

1.  Press the button.



2. Enter the desired code using the 0-9 buttons.
3.  If needed, press and hold the button on the right or left side to enter special characters.

Dialing a phone number from the phone book or from phone numbers stored in a list

Phone numbers dialed, incoming calls, and phone book entries are stored in lists when the mobile phone is connected to the vehicle via Bluetooth. If the caller is entered in the phone book, then the name of the entry is displayed instead of the phone number. Select the desired name from the list and establish the connection.

There are five available lists:

- ▷ "A-Z"
The entries of the phone book, the SIM card, or the mobile phone, composed of a name and phone number, are sorted alphabetically.

- ▷ "TOP8"
The eight most frequently dialed numbers are automatically stored in the Top 8 list.
- ▷ "LAST8"
The last eight phone numbers you have dialed are stored automatically. The phone number dialed last appears at the top of the list.
- ▷ "CALLS"
The phone numbers of the last eight accepted calls are stored. This requires the phone number of the caller to have been transmitted.
- ▷ "MISSED"
The phone numbers of the last eight calls that were not accepted are stored. This requires the phone number of the caller to have been transmitted.

Dialing a phone number from the phone book

The A-Z list is available for phone book entries. If entries with different names, but the same phone number are transferred from the mobile phone to the vehicle, only one entry is displayed.



The displays of the phone book entries on the radio display can differ from the displays on the mobile phone display, e.g. sequence of the first and last names.

1. Press the **MENU** button.



2.  Press the button.



3.  Press the button.
  The arrows indicate that additional letters can be displayed. Turn the right rotary knob to display additional letters.

4. Turn the right rotary knob to select the first letters of the desired entry.

5.  Press the button if so desired.

The phone number is dialed.

To display all entries:

1. Turn the right rotary knob to select the first letters of the desired entry and press the right rotary knob.
2. Turn the right rotary knob to select the desired entry and press the right rotary knob.



The phone number is dialed.

The phone number can also be dialed using the buttons on the steering wheel or radio:



Press the  button.

Editing and dialing a phone number from the phone book

The phone number of an entry can be edited before a call. This change is not stored in the phone book.

1. Select an entry.
2.  Press the button.
3.  Press the button to delete a digit.
4. Enter additional digits using the 0-9 buttons.
5. Press the right rotary knob to dial the phone number.

Dialing a phone number from the phone book using buttons on the steering wheel

1. Press and hold the  button to display the telephone menu.
2. Use the arrow buttons on the steering wheel to scroll through the phone book.
3. Press and hold the  button to dial the phone number.

Dialing a phone number stored in a list

To select an entry and establish a connection:

1. Press the **MENU** button.
2.  Press the button.



3.  Press the desired button to select one of the four lists.
4. Turn the right rotary knob to select an entry and press the right rotary knob to dial the phone number.

Deleting an individual entry

1. Select the desired entry from the list.
2.  Press the button.

Displaying call duration

To display the duration during a call:

-  Press the button.

Hands-free system

General information

Calls being conducted using the hands-free system can be continued using the mobile phone and vice versa.

From the mobile phone to the hands-free system

Calls that have been initiated from outside the Bluetooth range of the vehicle can be continued using the hands-free system if the ignition is switched on.

Depending on the mobile phone, the call is automatically switched to hands-free mode.

If the switch does not occur automatically, then follow the instructions that appear on the dis-

play of the mobile phone, also refer to the Owner's Manual for the mobile phone.

From hands-free system to mobile phone

Calls being conducted using the hands-free system can also be continued using the mobile phone if so desired, depending on the mobile phone.

At this point, follow the instructions that appear on the display of the mobile phone, also refer to the Owner's Manual for the mobile phone.

OPERATION BY VOICE

The concept

- ▷ The mobile phone can be operated without removing your hand from the steering wheel.
- ▷ In many cases, the entry process is supported by means of announcements or questions.
- ▷ >...< Verbal instructions to use with the voice activation system.
- ▷ >>...<< Identifies the answers generated by the voice activation system.

Voice commands

Activating voice activation system

1. Briefly press the  button on the steering wheel.

An acoustic signal indicates that commands can be spoken aloud. Display on the radio:



2. Say the command.

Finishing voice input

Press the  button on the steering wheel briefly

or
 ›Cancel‹.

Possible commands

Having possible commands read aloud

Press the  button on the steering wheel.

 ›Help‹.

Possible commands are read aloud.

Each digit can be spoken individually or combined into a sequence to accelerate the entry process.

Using alternative commands

There are often a number of commands to run a function, e.g.:



 ›Dial name‹ or ›Name‹.

Example: dialing phone numbers

1. Briefly press the  button on the steering wheel.
2. ›Dial number‹
3. The system replies: ››Please say the number‹‹
4. For example: ›123 456 7890‹
5. The system replies: ››123 456 7890. Continue?‹‹
6. ›Dial‹
System replies: ››Dialing number‹‹

Calling

Dialing phone numbers

1.  ›Dial number‹.
2. Say the phone number.
3.  ›Dial‹.

The connection to the desired subscriber is established.

Correcting phone number

Digit sequences can be deleted after the system has repeated the digits.

 ›Correct number‹.

The command can be repeated as often as necessary.

Deleting phone number

 ›Delete‹.

All digits entered up to this point are deleted.

Redialing

 ›Redial‹.

Voice phone book

Depending on how the vehicle is equipped, it may be necessary to set up a separate voice telephone book.

Depending on the equipment you have, the entries are imported from the mobile phone's memory or have to be entered independently of it. In this case, phone numbers stored in the mobile phone cannot be accessed by voice or stored in the mobile phone by voice.

Storing the entry

1.  ›Save name‹.
2. Say the name aloud. Do not exceed a speaking duration of about 2 seconds.
3. Say the phone number after being prompted to do so by the system.
4. ›Save‹.

Deleting the entry

1.  ›Delete name‹.
2. Say the name when prompted.
3. Confirm prompt with ›Yes‹.

Deleting all entries

1. ›Delete phonebook‹.
The dialog for deleting phone book is opened.
2. Confirm prompt with ›Yes‹.
3. Confirm repeated prompt with ›Yes‹.

Reading and selecting the entries

1. ›Read phonebook‹.
The dialog for reading phone book is opened.
2. ›Dial number‹ when the desired entry is read aloud.

Selecting an entry

1. ›Dial name‹.
2. Say the name when prompted.
3. Confirm prompt with ›Yes‹.

Adjusting volume

Turn knob during announcement.

- ▷ The volume is stored for the remote control currently in use.
- ▷ The changed volume remains the same, even if the volume of other audio sources is changed.

Notes

Do not use the voice operation system to initiate an emergency call. In stressful situations, the voice and vocal pitch can change. This can unnecessarily delay the establishment of a telephone connection.

Ambient conditions

- ▷ Say the commands, numbers and letters smoothly and with normal volume, emphasis and speed.
- ▷ Always say the commands in the language of the system.
- ▷ Keep doors, windows, glass sunroof/panoramic sunroof, or convertible top closed to avoid noise interference.

- ▷ Avoid ambient noise in the vehicle while speaking.

MINI CONTACT

When the ignition is on, several dealer phone numbers can be displayed.

- ▷ "Road Assist": Roadside service, if you require assistance in the event of a flat tire.
- ▷ "Service": MINI dealer, for example if you need to make a service appointment.
- ▷ "Cust Relat": MINI Hotline for information about your vehicle.

Displaying phone numbers

1. Press the **MENU** button.

2.  Press the button.



3. Turn the right rotary knob until the desired phone number is displayed.

SNAP-IN ADAPTER

The concept

The snap-in adapter makes it possible to do the following:

- ▷ Accommodate the mobile phone.
- ▷ Recharge its battery.
- ▷ Connect to the outside antenna of the vehicle.

This assures a better network connection and constant sound quality.

General information

Detailed information on snap-in adapters that compatibly support mobile phone functions can be found at your MINI dealer.

Do not expose your mobile phone to extreme ambient conditions, for example, very high temperatures; otherwise, functions on your mobile phone may not work. Follow the operating instructions for your mobile phone.

Installation location

In the center armrest.

Inserting snap-in adapter

1. Press the button and remove the cover.

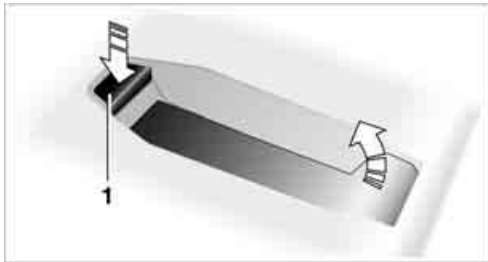

2. Insert the snap-in adapter at the front, arrow 1, and press downward, arrow 2, until it clicks into place.



Inserting mobile phone

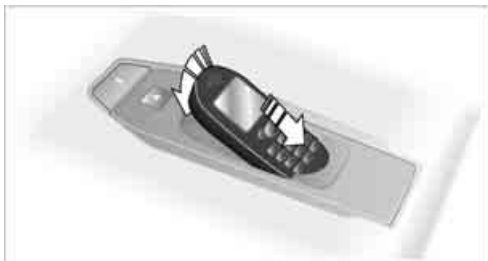

1. Depending on the mobile phone, it may be necessary to remove the protective cap of the antenna connector and from the USB connection of the mobile phone.
2. Push the mobile phone with the buttons facing upward toward the electrical connections and press down until it engages.

Removing mobile phone

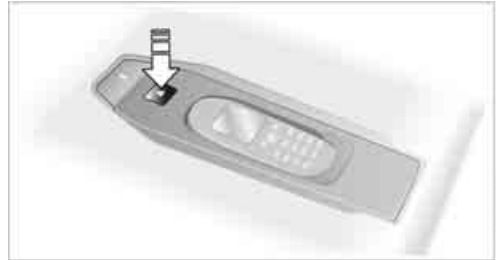

Press the button and remove the mobile phone.



MOVE ME.

AT A GLANCE

CONTROLS

DRIVING TIPS

ENTERTAINMENT

COMMUNICATIONS

MOBILITY

REFERENCE

REFUELING

VEHICLE EQUIPMENT

In this chapter, all production, country, and optional equipment that is offered in the model range is described. Equipment is also described that is not available because of, for example, selected options or country version. This also applies to safety related functions and systems.

GENERAL INFORMATION

 Switch off the engine before refueling; otherwise, fuel cannot be added to the tank and a message will be displayed. ◀

 Take all precautionary measures and observe all applicable regulations when handling fuel. Do not carry any spare fuel containers in your vehicle. They can develop a leak and cause an explosion or cause a fire in the event of an accident. ◀

FUEL FILLER FLAP

Opening

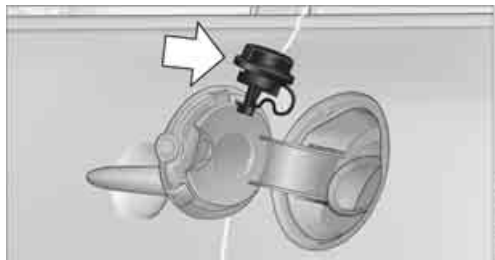

1. Open the fuel filler flap.
2. Turn the fuel cap counterclockwise.
3. Place the fuel cap in the bracket attached to the fuel filler flap.

Closing

Fit the cap and turn it clockwise until you clearly hear a click.

 Do not pinch the band attached to the cap; otherwise, the cap cannot be closed properly and fuel vapors can escape. A message will be displayed if the fuel cap is loose or missing. ◀

Manually releasing the fuel filler flap

In the event of an electrical malfunction, you can manually release the fuel filler flap:



1. Open cargo area trim panel, arrow 1.
2. Pull the green knob with the gas pump symbol, arrow 2.

The fuel filler flap opens.

Observe the following when refueling

 Take all precautionary measures and observe all applicable regulations when handling fuel; otherwise, there is a danger of personal injury and property damage. ◀

When refueling, insert the filler nozzle completely into the filler pipe. Avoid lifting the filler nozzle while filling the tank, as that would lead to

- ▷ premature pump shutoff
- ▷ reduced efficiency of the fuel-vapor recovery system.

The fuel tank is full when you top off twice after the first time that the fuel pump nozzle clicks off.

 Do not overfill the fuel tank; otherwise, overflowing fuel can cause damage to the environment and the vehicle. ◀

Fuel tank capacity

 If the range displayed is less than 30 miles/50 km, be sure to refuel; otherwise, engine functions are not guaranteed and damage may occur. ◀

Approx. 12.3 US gal/47 liters, including the reserve capacity of 2.1 US gal/8 liters.

If the engine can no longer be started because of an empty fuel tank, add at least 1.3 US gal/ 5 liters of fuel. If the vehicle is at an angle, a larger amount of fuel may be necessary.

FUEL SPECIFICATIONS

Gasoline

For optimum fuel efficiency, the gasoline should be free of sulfur or as low in sulfur as possible.

Fuels that are labeled at the pump as containing metal may not be used.

 Do not fill the tank with leaded gasoline or gasoline that contains metal additives, such as manganese or iron; otherwise, long term damage to the catalytic converter or other components may result. ◀

Fuels with a maximum ethanol content of up to 10%, that is, E10, can be used.

The ethanol should meet the following quality standards:

US: ASTM 4806-xx

CAN: CGSB-3.511-xx

xx: Always observe currently valid standards.

 Do not fill the tank with E85, i.e. fuel containing 85% ethanol, nor with FlexFuel. Otherwise, the engine and fuel supply system will be damaged. ◀

The engine is knocking regulated. Therefore, different grades of gasoline can be used for refueling.

Recommended gasoline grades

The manufacturer of your MINI recommends:

- ▷ AKI 91.
- ▷ John Cooper Works: AKI 93.

Minimum quality

The manufacturer of your MINI recommends AKI 89.

 Do not use any gasoline below the specified minimum fuel grade. Otherwise, the engine could be damaged. ◀

If you use gasoline with this minimum AKI rating, the engine may produce knocking sounds when starting at high external temperatures. This has no effect on the engine life.

 The use of poor quality fuels may result in harmful engine deposits or damage. Additionally, problems relating to driveability, starting and stalling, especially under certain environmental conditions such as high ambient temperatures and high altitudes, may occur.

If driveability problems are encountered, we recommend switching to a high quality gasoline brand and a higher octane grade - AKI number - for a few tankfuls. To avoid harmful engine deposits, it is highly recommended to purchase gasoline from BP or Top Tier retailers.

Failure to comply with these recommendations may result in a need for unscheduled maintenance. ◀

MINI recommends BP fuels 

WHEELS AND TIRES

VEHICLE EQUIPMENT

In this chapter, all production, country, and optional equipment that is offered in the model range is described. Equipment is also described that is not available because of, for example, selected options or country version. This also applies to safety related functions and systems.

TIRE INFLATION PRESSURES

Information for your safety

It is not merely the tires' service life, but also driving comfort and, to a great extent, driving safety that depend on the condition of the tires and the maintenance of the specified tire pressure.

Checking pressure

 Check the tire inflation pressure regularly and correct it, if necessary: at least twice a month and before starting long trips. If you fail to observe this precaution you may be driving on tires with incorrect tire pressures, a condition that can not only compromise your vehicle's driving stability, but also lead to tire damage and the risk of an accident. Do not drive with deflated, i.e. flat tires, except when using run-flat tires. A flat tire will seriously impair your vehicle's handling and braking response. Attempts to drive on a flat tire can lead to loss of control over the vehicle. ◀

Check the tire inflation pressures only on cold tires. This means after a maximum of 1.25 miles/ 2 km driving or when the vehicle has been parked for at least 2 hours. When tires are warm, the tire inflation pressure is higher.

 After adjusting the tire inflation pressure, reinitialize the Flat Tire Monitor, page 68, or reset the Tire Pressure Monitor, page 70. ◀

Pressure specifications

The tables below provide all the correct inflation pressures for the specified tire sizes at ambient temperature.

 The tire inflation pressures apply to the tire sizes approved and the tire brands recommended by the manufacturer of your MINI. Your MINI dealer will be glad to advise you. ◀

For correct identification of the right tire inflation pressures, observe the following:

- ▷ Tire sizes for your vehicle
- ▷ Maximum allowable driving speed

Tire inflation pressures for driving up to 100 mph or 160 km/h

For normal driving up to 100 mph or 160 km/h and to achieve optimum driving comfort, adjust pressures to the respective tire inflation pressures listed on the following pages in the columns for traveling speeds up to a maximum of 100 mph or 160 km/h.

These tire inflation pressures can also be found on the driver's side door pillar when the driver's door is open.



 The maximum permitted speed for these tire inflation pressures is 100 mph or 160 km/h. Do not exceed this speed; otherwise, tire damage and accidents may occur. ◀



Tire inflation pressures for driving above 100 mph or 160 km/h



In order to drive at maximum speeds in excess of 100 mph or 160 km/h, adjust pressures to the respective tire inflation pressures listed on the following pages in the columns for traveling speeds including those exceeding 100 mph or 160 km/h. Otherwise, tire damage and accidents could occur. ◀

Observe all national and local maximum speed limits; otherwise, violations of the law could occur.

Tire inflation pressures MINI Cooper Countryman

Tire size	Tire pressures in bar/psi			
	Speeds up to a max. of 100 mph/160 km/h		Speeds including those exceeding 100 mph/160 km/h	
All pressure specifications in the table are indicated in bar/psi for cold tires. Cold = ambient temperature				
	195/60 R 16 89 H M+S			
	205/55 R 17 91 H M+S			
	205/55 R 17 91 H M+S RSC	2.2/32	2.2/32	2.4/35
	205/55 R 17 91 V RSC			
	225/45 R 18 91 V RSC			
225/40 R 19 89 V RSC				

More details on the permissible load and weights can be found on page [186](#).

Tire inflation pressures MINI Cooper S Countryman / Cooper S ALL4 Countryman

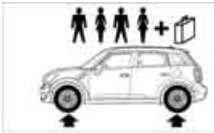
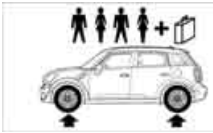
Tire size	Tire pressures in bar/psi			
	Speeds up to a max. of 100 mph/160 km/h		Speeds including those exceeding 100 mph/160 km/h	
All pressure specifications in the table are indicated in bar/psi for cold tires. Cold = ambient temperature				
	195/60 R 16 89 H M+S			
	205/55 R 17 91 H M+S			
	205/55 R 17 91 H M+S RSC	2.2/32	2.2/32	2.6/38
	205/55 R 17 91 V RSC			2.6/38
	225/45 R 18 91 V RSC			
225/40 R 19 89 V RSC				

More details on the permissible load and weights can be found on page [186](#).

MINI Countryman John Cooper Works tire inflation pressures

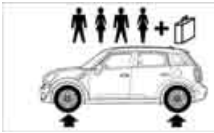
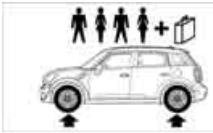
Tire size	Tire pressures in bar/psi			
	Speeds up to a max. of 100 mph/160 km/h		Speeds including those exceeding 100 mph/160 km/h	
<p>All pressure specifications in the table are indicated in bar/psi for cold tires. Cold = ambient temperature</p>				
	195/60 R 16 89 H M+S Std			
	205/55 R 17 91 H M+S RSC			
	205/55 R 17 91 H M+S A/S RSC	2.4/35	2.4/35	2.6/38
	225/45 R 18 91 V RSC			
225/40 R 19 89 V RSC				

More details on the permissible load and weights can be found on page [186](#).

TIRE IDENTIFICATION MARKS

Knowledge of the labeling on the side of the tire makes it easier to identify and choose the right tires.

Tire size

e.g.	225/45	R	17	91	V
Nominal width in mm					
Aspect ratio in %					
Radial belt construction					
Rim diameter in inches					
Load rating, (not on ZR tires)					
Speed code letter, (before the R on ZR tires)					

Speed letter

Q = up to 100 mph/160 km/h

T = up to 118 mph/190 km/h

H = up to 131 mph/210 km/h

V = up to 150 mph/240 km/h

W = up to 167 mph/270 km/h

Y = up to 186 mph/300 km/h

Tire Identification Number

Tires with DOT codes meet the guidelines of the US Department of Transportation.

DOT code:

Uniform Tire Quality Grading

For instance: DOT xxxx xxx 1012

Manufacturer's code for tire make					
tire size and tire design					
Tire age					

Quality grades can be found where applicable on the tire sidewall between tread shoulder and maximum section width. For example:

Tread wear 200 Traction AA

Temperature A

DOT Quality Grades

Tread wear

Traction AA A B C

Temperature A B C



All passenger car tires must conform to Federal Safety Requirements in addition to these grades. ◀

Tread wear

The tread wear grade is a comparative rating based on the wear rate of the tire when tested under controlled conditions on a specified government test course. For example, a tire graded 150 would wear one and one-half (1 ½) times as well on the government course as a tire graded 100. The relative performance of tires depends upon the actual conditions of their use, however, and may depart significantly from the norm due to variations in driving habits, service practices and differences in road characteristics and climate.

Traction

The traction grades, from highest to lowest, are AA, A, B, and C.

Those grades represent the tire's ability to stop on wet pavement, as measured under controlled conditions on specified government test surfaces of asphalt and concrete. A tire marked C may have poor traction performance.



The traction grade assigned to this tire is based on straight-ahead braking traction tests, and does not include acceleration, cornering, hydroplaning, or peak traction characteristics. ◀

Temperature

The temperature grades are A, the highest, B, and C, representing the tire's resistance to the generation of heat and its ability to dissipate heat when tested under controlled conditions on a specified indoor laboratory test wheel. Sustained high temperature can cause the material of the tire to degenerate and reduce tire life, and excessive temperature can lead to sudden tire

failure. The grade C corresponds to a level of performance which all passenger car tires must meet under the Federal Motor Vehicle Safety Standard No. 109. Grades B and A represent levels of performance on the laboratory test wheel that exceed the minimum required by law.



The temperature grade for this tire is established for a tire that is properly inflated and not overloaded. Excessive speed, underinflation, or excessive loading, either separately or in combination, can cause heat buildup and possible tire failure. ◀

RSC - run-flat tires

You will recognize run-flat tires by a circular symbol containing the letters RSC on the side of the tire, page 143.

M+S

Winter and all-season tires. These have better winter properties than summer tires.

XL

Designation for specially reinforced tires.

TIRE CONDITION

Inspect your tires regularly for tread wear, signs of damage and for foreign objects lodged in the tread. Check the tread depth.

Tread depth

The tread depth should not drop below 0.12 in/3 mm, although, for example, European legislation only specifies a minimum tread depth of 0.063 in/1.6 mm. At tread depths below 0.12 in/3 mm there is an increased risk of high-speed hydroplaning, even when only small amounts of water are present on the road surface.

Winter tires

When winter tires wear down past a tread depth of 0.16 in/4 mm, they become perceptibly less

suitable for winter conditions. In the interest of safety, new tires should be installed.

Minimum tread depth

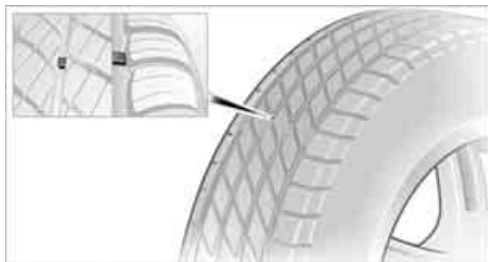

Wear indicators in the base of the tread groove are distributed around the tire's circumference; the letters TWI, for Tread Wear Indicator, on the tire's sidewalls identify tires that incorporate these wear indicators. If the tire tread has been driven down to the wear indicators, a tread depth of 0.063 in/1.6 mm has been reached.

Tire damage

Driving over rough or damaged road surfaces, as well as debris, curbs, and other obstacles can cause serious damage to wheels, tires, and suspension parts. This is more likely to occur with low-profile tires, which provide less cushioning between the wheel and the road. Be careful to avoid road hazards and reduce your speed, especially if your vehicle is equipped with low-profile tires.

Unusual vibrations encountered during normal vehicle operation can indicate tire failure or some other vehicle defect. This can, for example, be caused by driving over curbs. The same applies to any other abnormal road behavior, such as pulling severely to the right or left.



In these cases, reduce speed immediately and have wheels and tires thoroughly checked. To do so, drive carefully to the nearest MINI dealer or a specialized tire shop that has specially trained personnel working in accordance with the specifications of the MINI manufacturer. If necessary, have the vehicle towed there.

Otherwise, tire damage can be extremely dangerous for vehicle occupants and other road users. ◀

Tire age

The manufacturing date of tires is contained in the tire coding:
DOT ... 1012 means that the tire was manufactured during the 10th week of 2012.

For various reasons, such as the development of brittleness, the manufacturer of your MINI recommends tire replacement after no more than 6 years, regardless of the actual wear of the tires.

RUN-FLAT TIRES



The symbol identifying run-flat tires is a circle with the letters RSC on the sidewall. Run-flat tires comprise a conditionally self-supporting tire and a special rim. The reinforcement in the sidewalls ensures that the tire can continue to be used subject to certain restrictions, even if depressurized.

For information on continuing to drive with a flat tire, refer to Indication of a flat tire, page 69.

NEW WHEELS AND TIRES

 Have new wheels and tires mounted only by your MINI dealer or a specialized tire shop that has specially trained personnel working in accordance with the specifications of the MINI manufacturer. If this work is not carried out

properly, there is a danger of subsequent damage and related safety hazards. Make sure that the new wheels are balanced. ◀

Retreaded tires

 The manufacturer of your MINI recommends that you avoid using retreaded tires, as this could impair driving safety. The causes for this include potentially different tire casing structures and often wide variations in tire age, which can result in a limited service life. ◀

Correct wheels and tires

 The manufacturer of your MINI recommends mounting only wheels and tires that it has specifically approved for use on your particular model. Although other wheels and tires may theoretically have the same dimensions, variations in factors such as manufacturing tolerances can result in contact between tire and bodywork, ultimately leading to serious accidents. The manufacturer of your MINI cannot evaluate non-approved wheels and tires to determine if they are suited for use, and therefore cannot ensure the operating safety of the vehicle if they are mounted. ◀

Your MINI dealer will be glad to inform you about the correct wheel and tire combination for your vehicle.

The correct combination of wheels and tires is also necessary to ensure reliable operation of various vehicle systems such as ABS and DSC.

To maintain good handling and vehicle response, use only tires of a single brand and tread configuration. After a tire has been damaged, mount the previous wheel and tire combination again as soon as possible.

Wheels with Tire Pressure Monitor TPM electronics

When mounting new tires or changing over from summer to winter tires, or vice versa, only use wheels with TPM electronics; otherwise, the Tire Pressure Monitor may not be able to detect a

puncture, refer to page 71. Your MINI dealer will be glad to advise you.

Recommended tire brands

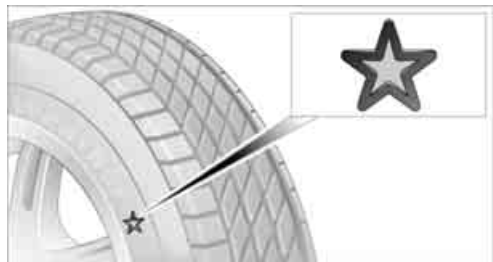

For each tire size, the manufacturer of your MINI recommends certain tire brands. They are marked with a clearly visible MINI designation on the sidewall of the tire.

When properly used, these tires meet the highest standards in terms of safety and handling characteristics.

Run-flat tires

When mounting new tires or changing over from summer to winter tires and vice versa, mount run-flat tires for your own safety. Keep in mind that no space-saver spare tire is available in the event of a flat. Your MINI dealer will be glad to advise you.

Special characteristics of winter tires

The manufacturer of your MINI recommends the use of winter tires on snowy roads or if temperatures drop below 45 °F / +7 °C. Although all-season M+S tires provide better winter traction than summer tires, they generally fail to provide the same levels of cold-weather performance as winter tires.

Pay attention to speed



Always comply with the speed limit for the winter tires mounted on your car; failure to do so could result in tire damage and accidents. ◀

If the car is capable of speeds higher than that permitted for the winter tires, a label stating the maximum permitted speed for the mounted tires must be displayed in your field of view. This label is available at your tire dealer or MINI dealer.

Storage

Always store wheels and tires in a cool, dry place with as little exposure to light as possible.

Always protect tires against all contact with oil, grease and fuels.

Do not exceed the maximum tire inflation pressure indicated on the side wall of the tire.

Swapping wheels among the axles

Depending on the individual use, front and rear tires may exhibit different wear and tear.

In order to maintain an even wear and tear, the wheels may be rotated between the axles. Your MINI dealer will be glad to advise you.

Always check the inflation pressure after the tire rotation, if necessary change the pressure.

SNOW CHAINS

Only certain types of fine-link snow chains have been tested by the manufacturer of your MINI, classified as road-safe and recommended. Contact your MINI dealer for more details.

Only attach snow chains in pairs to the front wheels with the following tires.

▷ 195/60 R 16 M+S

Observe the manufacturer's instructions when mounting snow chains. Do not exceed a speed of 30 mph or 50 km/h.



Do not initialize the Flat Tire Monitor if snow chains are mounted; otherwise, the instrument might issue an incorrect reading. When driving with snow chains, it can be useful to briefly deactivate DSC or activate DTC, refer to page 66. ◀

ENGINE COMPARTMENT

VEHICLE EQUIPMENT

In this chapter, all production, country, and optional equipment that is offered in the model range is described. Equipment is also described that is not available because of, for example, selected options or country version. This also applies to safety related functions and systems.

GENERAL INFORMATION

 Never attempt to perform any service or repair operations on your vehicle without the required professional technical training. If you do not know how to follow the specified instructions, then have the work carried out by your MINI dealer. If this work is not carried out properly, there is a danger of subsequent damage and related safety hazards. ◀

IMPORTANT PARTS OF THE ENGINE COMPARTMENT

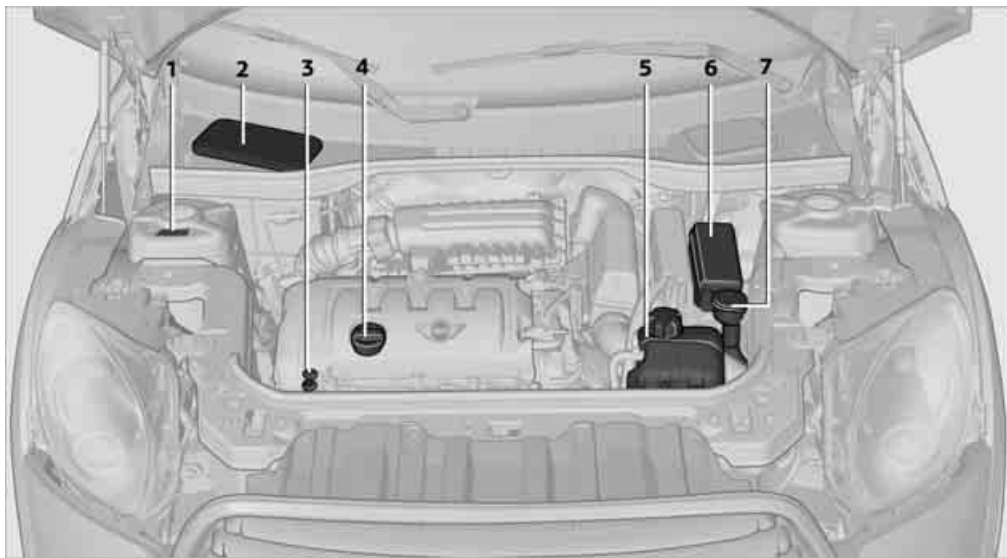

- | | | | |
|---|----------------------------------------------|---|-----------------------------------------------------------------------------------------|
| 1 | Vehicle identification number | 5 | Coolant expansion tank 148 |
| 2 | Battery, under the cover 166 | 6 | Engine compartment fuse box 164 |
| 3 | Engine oil dipstick 146 | 7 | Reservoir for washer fluid for the headlamp and window washer system 53 |
| 4 | Engine oil filler neck 147 | | |

HOOD

Releasing



Pull the lever.

! Do not clean the windshield and headlamps if the hood is unlocked as this may damage the headlamp washer system. ◀

Opening



! To avoid damage, make sure that the wiper arms are against the windshield before you open the hood. ◀

Press the release handle and open the hood.

Closing



Close the hood from a height of approx. 16 in/ 40 cm with momentum. It must be clearly heard to engage.

! If you notice any signs while driving your vehicle that the hood is not completely closed, stop at once and close it securely. Make sure that the closing path of the hood is clear; otherwise, injuries may result. ◀

ENGINE OIL

Engine oil consumption depends on driving style and operating conditions, e.g., with a very sporty driving style, the engine oil consumption is significantly increased.

Therefore, check the engine oil level regularly after each refueling.

Checking engine oil level

1. With the vehicle's engine at normal operating temperature, i.e. after uninterrupted driving for at least 6 miles/10 km, park the vehicle on a level surface.
2. Switch off the engine.
3. Pull the dipstick out after approx. 5 minutes and wipe it off with a lint-free cloth, paper towel or similar material.
4. Carefully push the dipstick all the way into the guide tube and pull it out again. The oil level should be between the two marks on the dipstick.

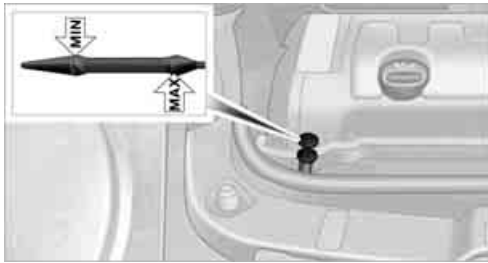

The oil quantity corresponding to the difference between the two marks on the dipstick is 1 US quart/1 liter.

! Do not fill beyond the upper mark on the dipstick. Excess oil will damage the engine. ◀

Adding engine oil

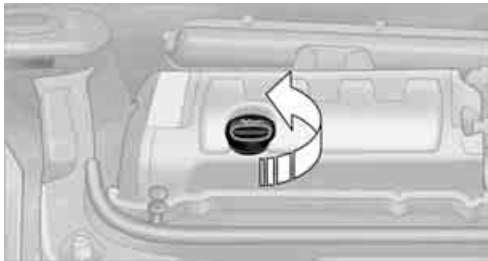

Do not add the maximum quantity of 1 US quart/1 liter of engine oil until the oil level has dropped to just above the lower mark on the dipstick, page 146.

! Add oil within the next 30 miles/50 km; otherwise, the engine could be damaged. ◀

! If too much motor oil is added, immediately have the vehicle checked; otherwise, damage to the engine may result. ◀

! Keep oils, grease, etc. out of the reach of children and comply with the warnings on the containers. Otherwise, health hazards may result. ◀

Oil types for refilling

Notes

! Do not use oil additives as this could result in engine damage. ◀

! When choosing oil, ensure that it belongs to one of the SAE viscosity classes 0W-40, 0W-30, 5W-40 and 5W-30; otherwise, malfunctions and damage to the engine may result. ◀

The engine oil quality is critical for the life of the engine.

Some types of oil may not be available in every country.

Approved oil types

Gasoline engines

BMW High Performance SAE 5W-30

BMW Longlife-01

BMW Longlife-01 FE

Additional information on approved types of oil can be found at a MINI dealer.

Alternative oil types

If the approved engine oils are not available, up to 1 US quart/1 liter of another oil with the following specification may be used:

Gasoline engines

API SM or higher specifications

Oil change

Only MINI dealers are to perform oil changes.

MINI RECOMMENDS 

COOLANT

Coolant consists of half water and half additive. Not all commercially available additives are suitable for your MINI. Your MINI dealer knows which additives are suitable and will be glad to advise you.

 Only use suitable additives; otherwise, engine damage may result. Because additives are harmful to your health, it is important to follow the instructions on the containers. ◀

 Comply with the appropriate environmental protection regulations when disposing of coolant additives. ◀

Coolant temperature

If the coolant, and therefore the engine, should overheat, then a warning lamp will go on, refer to page 172.

Checking coolant level

 Do not add coolant to the cooling system when the engine is hot. Escaping coolant can cause burns. ◀

Do not open the hood until the engine has cooled down.



The coolant level is correct if it is between the Min and Max markings.

Topping off

1. Turn the cap of the expansion tank a little counterclockwise to allow any accumulated pressure to escape, then continue turning to open.
2. Slowly fill to the correct fluid level; do not overfill.
3. Close by turning the cap.

Have the reason for the coolant loss eliminated as soon as possible.

MAINTENANCE

VEHICLE EQUIPMENT

In this chapter, all production, country, and optional equipment that is offered in the model range is described. Equipment is also described that is not available because of, for example, selected options or country version. This also applies to safety related functions and systems.

MINI MAINTENANCE SYSTEM



The MINI Maintenance System supports the preservation of the traffic and operating safety of your MINI. The objective is to optimize efforts with respect to minimal vehicle maintenance costs.

If and when you come to sell your MINI, a comprehensive record of servicing will prove a significant benefit.

Condition Based Service CBS

Sensors and special algorithms take the different driving conditions of your MINI into account. Condition Based Service uses this to determine the current and future service requirements. By letting you define a service and maintenance regimen that reflects your own individual requirements, the system builds the basis for trouble-free driving.

In the tachometer, you can have the remaining times or distances for selected maintenance

tasks and any legally prescribed dates displayed, page 61.

Service data in the remote control

Your vehicle continuously stores service-requirement information in the remote control while you are driving. Your MINI dealer can read out this data from the remote control unit, and propose an optimized maintenance approach. Whenever you take your car in for servicing you should therefore hand your MINI dealer the remote control unit that you last used.

 Make sure that the date in the tachometer is always set correctly, page 62; otherwise, the effectiveness of Condition Based Service CBS is not assured. ◀

Service and Warranty Information Booklet for US models and Warranty and Service Guide Booklet for Canadian models

Please consult your Service and Warranty Information Booklet for US models and Warranty and Service Guide Booklet for Canadian models for additional information on service requirements.

 The manufacturer of the MINI recommends that you have service and repair operations performed at your MINI dealer. Take the time to ensure that these service procedures are confirmed by entries in your vehicle's Service and Warranty Information Booklet for US models and Warranty and Service Guide Booklet for Canadian models. These entries verify that your vehicle has received the specified regular maintenance. ◀

SOCKET FOR ON-BOARD DIAGNOSIS OBD

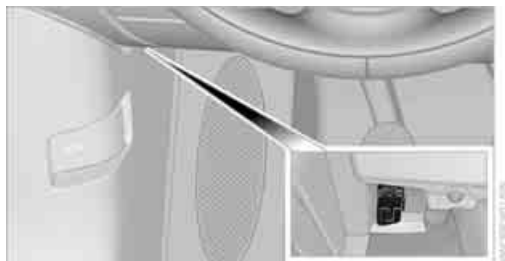

The primary components that make up the emissions can be checked by a device via the OBD socket.

Data memory

Your vehicle displays data about the operation, malfunctions, and user settings. These data are stored in the vehicle and can be partly stored in the remote control; the data can be read by suitable devices, in particular at your MINI dealer. The data read out are used for supporting the service processes and repair or for optimization and development of vehicle functions.

EMISSIONS



The warning lamps come on. The vehicle is producing higher emissions. You can continue your journey, but moderate your speed and exercise due caution.



Have the car checked as soon as possible.

Under certain circumstances, one of the lamps will flash or light up continuously. This indicates excessive misfiring or a malfunction in the engine. If this happens, reduce your speed and visit the nearest MINI dealer as soon as possible. Severe misfiring can quickly lead to serious damage of emissions-related components, especially the catalytic converter. In addition, mechanical engine components can become damaged.



If the fuel cap is not properly tightened, the OBD system may conclude that fuel vapors are escaping, causing an indicator to light up. If the fuel cap is then tightened, the indicator should go out within a few days.

CARE

VEHICLE EQUIPMENT

In this chapter, all production, country, and optional equipment that is offered in the model range is described. Equipment is also described that is not available because of, for example, selected options or country version. This also applies to safety related functions and systems.

CAR-CARE PRODUCTS

Regular cleaning and care helps to maintain the value of your MINI.

The manufacturer of your MINI recommends using manufacturer-approved products to clean and care for your vehicle.

Your MINI dealer would be pleased to advise you on cleaning and care products and services for your MINI.

 The ingredients of original MINI Care Products have been tested, and the products have been tested in the laboratory and in practice. They offer optimum care and protection for your vehicle. ◀

 Do not use any cleansers containing alcohol or solvents as these may cause damage. ◀

 Cleaning agents may contain hazardous or health-damaging substances. Follow the warning and hazard instructions on the packaging. For interior cleaning, always open the doors or windows of the vehicle.

Do not use any products that are not intended for cleaning the vehicle. ◀

EXTERNAL CARE

Washing your vehicle

 Especially during the winter months the vehicle should be frequently washed. Dirt and road salt can damage the vehicle. ◀

 After washing the vehicle, apply the brakes briefly to dry them; otherwise, water can reduce braking efficiency over the short term and the brake rotors can corrode. ◀

Car washes

Preference should be given to cloth car washes.

 Do not use automatic high-pressure car washes; otherwise, water may drip into the vehicle around the windows. ◀

Before driving into the car wash, check if the system is suitable for your MINI. Observe the following points:

- ▷ Vehicle dimensions, page 185
 - ▷ If necessary: fold in the outside mirrors, page 39
 - ▷ Maximum permissible tire width
-  Avoid car washes with tracks higher than 4 in/10 cm; otherwise, the chassis could be damaged. ◀
- Preparations for driving into the car wash:
- ▷ Unscrew the rod antenna.
 - ▷ Deactivate the rain sensor to prevent unintentional wiping.
 - ▷ Deactivate rear window wiper and protect it from damage. Ask the car wash operator about measures that can be taken to protect the wipers.
 - ▷ Remove additional attachments, e.g. spoilers or telephone antennas, if there is a possibility that they could be damaged.
 - ▷ Insert the remote control into the ignition lock.

Automatic transmission

Before driving into the car wash, make sure that the vehicle can roll:

1. Place the remote control, even with Comfort Access, in the ignition lock.
2. Move the selector lever to position N.
3. Release the parking brake.
4. Switch off the engine.
5. Insert the remote control in the ignition lock so that the vehicle can roll.

Steam jets/high-pressure washers

 When using steam jets or high-pressure washers, make sure that you maintain sufficient distance from the vehicle and do not exceed a maximum temperature of 140 °F / 60 °C.

If the distance is too close, the pressure too high, or the temperature too high, parts of the vehicle can be damaged, or water can penetrate.

Observe the operating instructions for high-pressure washers. ◀

 Do not spray sensors such as the Park Distance Control with high-pressure washers for a long time and maintain the greatest possible distance of approx. 1 ft/30 cm from them. ◀

Manual washing

Use a great deal of water and, if necessary, car shampoo when washing your car by hand. Clean the vehicle with a sponge or a washing brush applying a slight amount of pressure.

 Before cleaning the windshield, deactivate the rain sensor or turn off the ignition to prevent unintentional wiping. ◀

 Observe local regulations regarding washing vehicles by hand. ◀

Headlamps

Do not wipe dry and do not use abrasive or corrosive cleaning agents. Remove dirt and contamination, such as insects, by soaking with

shampoo and then washing with plenty of water.

Do not remove accumulated ice and snow with an ice scraper; use window deicers instead.

Windows

Clean the outside and inside of the windows and mirrors with a window cleaner.

 Do not clean the mirrors with cleaners containing quartz. ◀

Wiper blades

Clean with soapy water and change regularly to prevent the formation of streaks.

 Wax, preservatives and dirt on the windows cause streaks when the windshield wipers are on, and can cause premature wear of the wiper blades and interfere with the rain sensor. ◀

Paintwork, care

Regular care helps your vehicle retain its value and protects the paint from the long-term effects of aggressive substances.

Environmental influences in areas with increased air pollution or natural contaminants, such as tree sap or pollen, can affect the vehicle paintwork. It is therefore important to adjust the frequency and extent of vehicle care correspondingly.

Immediately remove any particularly aggressive substances, such as fuel that has overflowed, oil, grease, brake fluid, or bird droppings; otherwise, paint damage can be caused.

Removing paintwork damage

 Depending on the severity of the damage, immediately repair stone damage or scratches to prevent rusting. ◀

The manufacturer of the MINI recommends repairing paint damage professionally according to factory specifications with original MINI paints.

Preservation

Preservation is necessary when water no longer beads on the clean paint surface. To preserve the paint, only use preservatives that contain carnauba or synthetic waxes.

Rubber seals

Only treat with water or rubber care products.

 Do not use silicon sprays or other silicon-containing care products on rubber seals; otherwise, noise and damage could occur. ◀

Chrome parts

Carefully clean vehicle parts such as the radiator grill and door handles with copious quantities of water and, if necessary, a shampoo additive, especially when contaminated with road salt. For additional treatment, use chrome polish.

Light alloy wheels

The system produces brake dust that collects on the light alloy wheels. Clean them regularly with acid-free wheel cleaner.

 Do not use aggressive, acid-containing, highly alkaline, or abrasive cleansers or steam jets hotter than 140 °F /60 °C as they may cause damage. ◀

External sensors

 Keep the outside sensors on the vehicle such as the Park Distance Control clean and ice-free to ensure that they function properly. ◀

INTERNAL CARE

Upholstery/fabrics

Regularly use a vacuum cleaner to remove surface dirt.

In case of serious spots such as liquid stains, use a soft sponge or lint-free microfiber cloth and suitable interior cleaners. Observe the instructions on the packaging.

 Clean upholstery up to the seams. Do not rub forcefully. ◀

 Velcro fasteners on pants or other items of clothing can damage seat covers. Make sure that all Velcro fasteners are closed. ◀

Leather/leather coverings

 The leather processed by the manufacturer of your MINI is a high-quality natural product. Light variations in the grain is one of the typical properties of natural leather. ◀

Dust and road grit in the pores and folds of the leather have an abrasive effect, leading to increased wear and causing the leather surface to become brittle prematurely. Use a cloth or vacuum cleaner to remove dust on a regular basis.

Especially when the leather has a light color, it should be cleaned regularly since it tends to get heavily soiled.

Treat the leather twice a year using a leather lotion since dirt and grease will gradually attack the leather's protective layer.

Carpets/floor mats

 Keep floor mats, carpet, and other objects out of the movement range of the pedals; otherwise, they may inhibit the function of the pedals during driving.

Do not place additional floor mats onto an existing one or onto other objects.

Only use floor mats that have been approved for the vehicle and can be appropriately fastened. Make sure that the floor mats are securely fastened again after they have been removed, e.g. for cleaning. ◀

Floor mats can be removed to be cleaned.

If the carpets are very dirty, clean with a microfiber cloth and water or an interior cleaner.

When doing so, rub forward and back in the driving direction; otherwise, the carpet may become matted.

Interior plastic parts

These include:

- ▷ Plastic surfaces
- ▷ Lamp glass
- ▷ Display panes
- ▷ Mat parts

Only clean with water and, if necessary, solvent-free plastic cleaners.

 Do not use solvents such as alcohol, lacquer thinner, cold cleaners, fuel, or similar, as these will damage the surfaces. ◀

Decorative strips

Only clean decorative strips and fine wood parts with damp cloths. Wipe dry with a soft cloth.

Safety belts

Dirty belt straps impede the reeling action and thus have a negative impact on safety.

 Do not clean chemically, as this may destroy the webbing. ◀

Displays

To clean displays, such as the radio or display elements, use an anti-static microfiber cloth.

 Avoid pressing too hard when cleaning the display as this can cause damage. ◀

 Do not use chemical or abrasive household cleaning agents. Keep fluids of any kind away from the device. Surfaces or electrical components may otherwise become corroded or damaged. ◀

CD/DVD drives

 Do not use cleaning CDs as this could damage parts of the drive. ◀

VEHICLE STORAGE

If you park your vehicle longer than three months, ask your MINI dealer to advise you.

REPLACING COMPONENTS

VEHICLE EQUIPMENT

In this chapter, all production, country, and optional equipment that is offered in the model range is described. Equipment is also described that is not available because of, for example, selected options or country version. This also applies to safety related functions and systems.

WIPER BLADES

! Do not place windshield wipers on the windshield if wiper blades are not installed; otherwise, the windshield may be damaged. ◀

Changing the front wiper blades

1. Fold out the wiper arm and hold it.

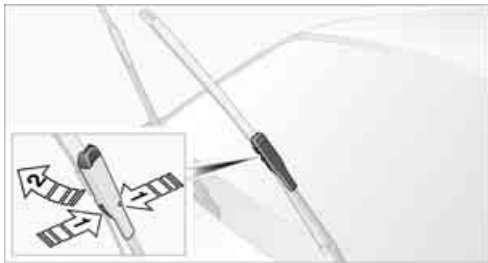

2. Press together the locking spring, arrows 1, and fold out the wiper blade, arrow 2.
3. Pull the wiper blade forward and out of the catch mechanism.
4. Press the new wiper blade into the fixture until it engages audibly.

! To avoid damage, make sure that the wiper arms are against the windshield before you open the hood. ◀

Changing the rear wiper blade

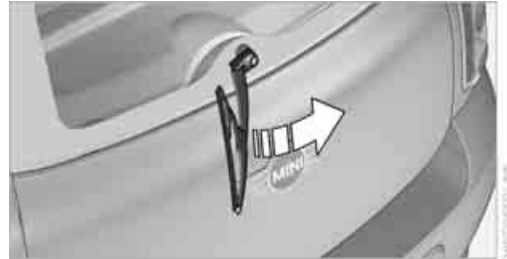

1. Fold out the wiper arm and hold it.
2. Rotate the wiper blade toward the back as far as it will go, arrow.
3. Press the wiper blade against the limit and thus out of the mounting.
4. Press the new wiper blade into the fixture until it engages audibly.

LAMPS AND BULBS

Lamps and bulbs make an essential contribution to vehicle safety. They should, therefore, be handled carefully. The manufacturer of your MINI recommends having your MINI dealer perform any work that you do not feel competent to perform yourself or that is not described here.

▶ Never touch the glass of new bulbs with your bare fingers, as even minute amounts of contamination will burn into the bulb's surface and reduce its service life. Use a clean tissue, cloth or something similar, or hold the bulb by its base. ◀

You can obtain a selection of replacement bulbs at your MINI dealer.

! Only replace bulbs after they have cooled down; otherwise, you may burn your fingers. ◀

! When working on electrical systems, always begin by switching off the consumer in question; otherwise, short circuits

could result. To avoid possible injury or equipment damage when replacing bulbs, observe any instructions provided by the bulb manufacturer. ◀

Caring for headlamps, refer to page 152.

▶ For any bulb replacement not described below, contact a MINI dealer or a workshop that has specially trained personnel working in accordance with the specifications of the MINI manufacturer. ◀

▶ For checking and adjusting headlamp aim, please contact your MINI dealer. ◀

Light-emitting diodes LEDs

Light-emitting diodes installed behind translucent lenses serve as the light sources for many of the controls and displays in your vehicle. These light-emitting diodes are related to conventional laser diodes, and legislation defines them as Class 1 light-emitting diodes.

⚠ Do not remove the covers or expose the eyes directly to the unfiltered light source for several hours; otherwise, this could cause irritation of the retina. ◀

Headlamp glass lens

In cool or humid weather, condensation may occur on the interiors of the headlamps. During trips with the headlamps on, the condensation disappears after a short time. The headlamps do not need to be changed.

Do not remove the condensation from headlamps, despite driving with lights on, and if condensation increases, e.g., because of water droplets, have this checked by your MINI dealer.

Xenon lamps

The service life of these bulbs is very long and the probability of failure very low, provided that they are not switched on and off an excessive number of times. If a xenon lamp fails nevertheless, switch on the fog lamps and continue the journey with great care, provided that local legislation does not prohibit this.

⚠ Work on the xenon lighting system, including lamp replacement, is only to be carried out only by your MINI dealer. Due to high voltage, there is a risk of fatal injury if work on the xenon lamps is carried out improperly. ◀

Halogen low beams and high beams

H13 bulb, 60/55 watts

⚠ The H13 bulb is pressurized. Therefore, wear safety glasses and protective gloves. Otherwise, there is a risk of injury if the bulb is damaged. ◀

⚠ Be careful when installing the cover; otherwise, leaks could occur and cause damage to the headlamp system. ◀

Accessing the lamp from the engine compartment

The low-beam/high-beam bulb can be changed from the engine compartment.

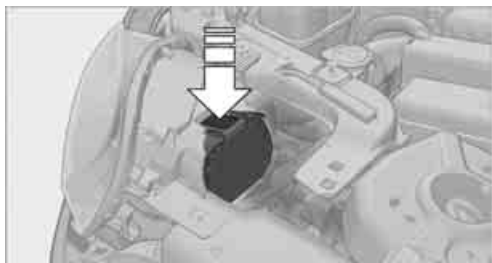

Removing the cover:

1. Press the tab.
2. Flip open the cover and take it out of the holder.

Follow the same steps in reverse order to reattach the cover.

Replacing the bulb

1. Turn the lamp counterclockwise, arrow 1, and remove it, arrow 2.

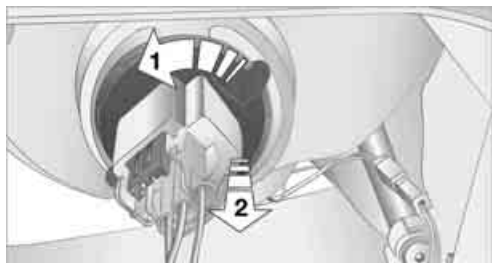

2. Push on the catch, arrow 1, and disconnect the connector, arrow 2.

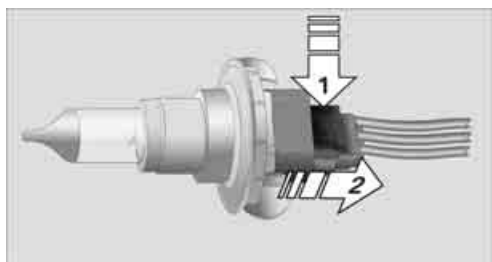

3. To insert the new bulb and replace the cover, proceed in reverse order.

Turn signals, parking lamps, roadside parking lamps, and fog lamps

Accessing the lamps via the wheel well

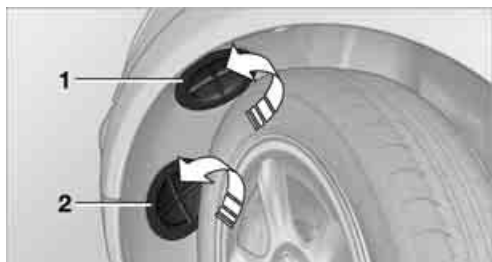

- 1 Turn signal
- 2 Parking/roadside parking/fog lamps

Replacing a turn signal bulb

21 watt bulb, P21W, if necessary PY 21 W

1. Turn in the wheel.
2. Remove cover 1.
To do so, turn the cover counterclockwise.
3. Remove the inside cover.
To do so, turn the cover counterclockwise.



4. Unscrew the bulb counterclockwise.

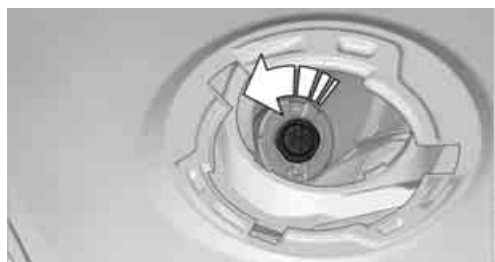

5. To insert the new bulb and replace the covers, proceed in reverse order.

Replacing a parking/roadside parking lamp bulb

5 watt bulb, W 5 W

1. Turn in the wheel.
2. Remove cover 2.
To do so, turn the cover counterclockwise.

3. Unscrew the upper bulb counterclockwise.



4. To insert the new bulb and replace the cover, proceed in reverse order.

Replacing a fog lamp bulb

H8 bulb, 35 watts

1. Turn in the wheel.
2. Remove cover **2**.
To do so, turn the cover counterclockwise.
3. Pull the cable connector.
4. Unscrew the lower bulb counterclockwise.



5. To insert the new bulb and replace the cover, proceed in reverse order.

Side turn signals

5 watt bulb, W 5 W

1. Open hood.

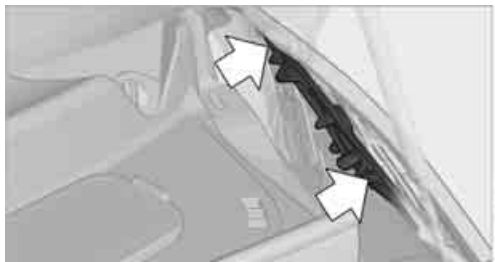

2. Squeeze clamping clip, arrows, and remove bulb holder.
3. Unscrew bulb counterclockwise and replace.
4. To insert the new bulb and replace the cover, proceed in reverse order.

Side marker lamps

Have these bulbs replaced by your MINI dealer.

Tail lamps

Bulb P 21 W

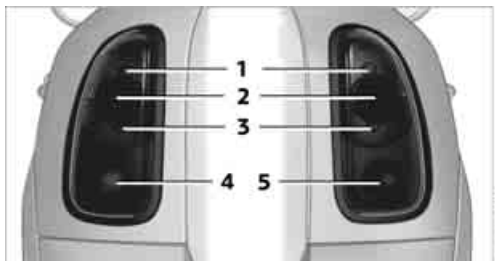

- 1 Brake/tail lamp
- 2 Turn signal
- 3 Brake/tail lamp
- 4 Backup lamps
- 5 Backup lamps

Changing

All bulbs are integrated in a central bulb holder.

1. Switch off the light and remove the infrared remote control from the ignition lock.
2. Push the cover panel out from the rear of the cargo area side trim panel and remove it.



3. Open emergency release for the fuel filler flap, see page 134, and then push to the side with the foam insert. Ensure that the emergency release is not damaged.
4. Disengage the bulb holder by pressing down on the clamping clip, arrow 1.

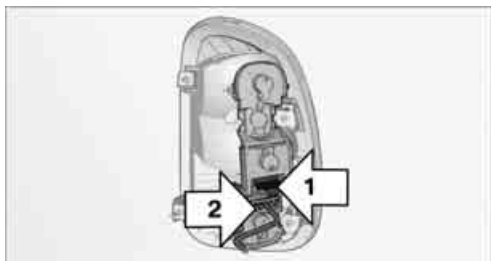

5. Take out bulb holder and pull out cable, arrow 2.
6. Exerting gentle pressure, turn bulb to the left and remove.
7. To insert the new bulb and install the bulb holder, proceed in reverse order. Ensure that the lamp holder engages in all the fasteners.
8. Put foam insert in its original position and install the emergency fuel flap release.
9. Install cover.

License plate lamps

5 watt bulb, C 5 W



1. Using a screwdriver, push the lamp to the left in the tab of the lamp housing, arrow 1.
2. Remove the lamp, arrow 2.
3. Replace the bulb.
4. Insert the lamp.

Center brake lamp

This lamp uses LED technology for operation. In the event of a malfunction, contact your MINI dealer or a workshop that has specially trained personnel working in accordance with the specifications of your MINI manufacturer.

REPAIRING A FLAT TIRE



Safety measures in the event of a breakdown:

Park the vehicle as far as possible from moving traffic and switch on the hazard warning flashers.

Turn the steering wheel until the front wheels are in the straight-ahead position and engage the steering wheel lock. Engage the parking brake and shift into 1st or reverse gear or place the selector lever in position P.

All passengers should be outside the vehicle and in a safe place, e.g. behind a guardrail.

Erect a warning triangle or warning flasher at the appropriate distance if necessary. Comply with all safety guidelines and regulations. ◀

In the event of a flat tire, different procedures should be followed depending on the equipment included in your vehicle:

- ▷ MINI Mobility Kit, refer to the following section
- ▷ Run-flat tires, page 143

MINI Mobility Kit

The Mobility Kit is located under the left front seat.

Preparations

Use of the MINI Mobility Kit may be ineffective if the tire puncture measures approx. 1/8 in/4 mm or more. Contact the nearest MINI dealer if the tire cannot be made drivable with the Mobility Kit.

Do not remove foreign bodies which have penetrated the tire if possible.

- ▷ Follow the instructions on using the Mobility Kit found on the compressor and the sealant bottle. ◀

Remove the adhesive label for the speed limit from the sealant bottle and affix it to the steering wheel.

Sealant and compressor



- 1 Sealant bottle and adhesive label with speed limit
- 2 Filling hose

- ▷ Note the use-by date on the sealant bottle. ◀

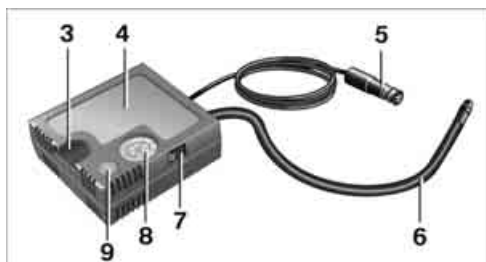

- 3 Holder for the sealant bottle
- 4 Compressor
- 5 Plug and cable for the socket in the vehicle interior, page 93
- 6 Connection hose to connect the compressor and sealant bottle or the compressor and wheel
- 7 On/off switch
- 8 Pressure gauge for indicating the tire inflation pressure
- 9 Release button for reducing the tire inflation pressure

Connector, cable and connection hose are stored in the compressor housing.

Using the Mobility Kit

To repair a tire puncture with the Mobility Kit, proceed as follows:

- ▷ Filling the tire with sealant.
- ▷ Distributing the sealant.
- ▷ Correct the tire inflation pressure.

Filling the tire with sealant.

- ⚠ Proceed in the specified order; otherwise, sealant may emerge under high pressure. ◀

1. Shake the sealant bottle.
2. Pull the connecting hose 6 completely out of the compressor housing and screw it onto the connector of the sealant bottle. Make sure that the hose is not kinked.
3. Insert the sealant bottle on the compressor housing in an upright position.

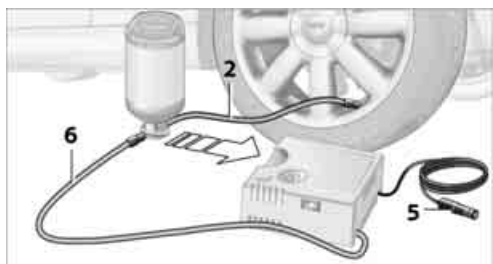

4. Unscrew the dust cap from the valve of the defective wheel and screw the filling hose 2 of the sealant bottle onto the valve.
5. Ensure that the compressor is switched off.
6. Insert the plug 5 into the lighter socket/ power socket in the vehicle interior, page 93.
7. With the engine running: Switch on the compressor and let run for about 3 to 8 minutes in order to add the sealant and to achieve an inflation pressure of about 1.8 bar/26 psi.

 When adding sealant, the filling pressure can temporarily increase up to about 5 bar/73 psi. Do not switch off the compressor during this phase. ◀

 Do not run the compressor for longer than 10 minutes; otherwise, the device will overheat and possibly be damaged. ◀

8. Switch off the compressor.

If an inflation pressure of 1.8 bar/26 psi is not reached:

1. Unscrew the filling hose 2 from the wheel and drive the vehicle forward and backward approx. 33 ft/10 m to distribute the liquid sealant in the tire evenly.
2. Inflate the tire again with the compressor.

 If an inflation pressure of 1.8 bar/26 psi still cannot be reached, then the tire is too heavily damaged. Please contact the nearest MINI dealer. ◀

Stowing Mobility Kit

1. Unscrew filler hose 2 of the sealant bottle from the wheel.
2. Unscrew connecting hose of the compressor 6 from the sealant bottle.
3. Connect the filler hose 2 of the sealant bottle to the unoccupied connection on the sealant bottle. This prevents the rest of the sealant from escaping from the bottle.
4. Wrap the empty sealant bottle in suitable material to avoid dirtying the cargo area.
5. Stow Mobility Kit back in the vehicle.

Distributing the sealant.

Immediately drive approx. 3.1 miles/5 km so that the sealant evenly distributes itself.

 Do not exceed speeds of 50 mph/ 80 km/h.

If possible, do not drop below 10 mph/ 20 km/h. ◀

Correct the tire inflation pressure.

1. After driving approx. 3.1 miles/5 km or ten minutes, stop at a suitable location.
2. Screw the connection hose 6 of the compressor directly onto the tire valve.
3. Insert the plug 5 into the power socket in the vehicle interior.
4. Adjust tire pressure to 1.8 bar/26 psi. With the engine running:
 - ▷ To increase the inflation pressure: switch on the compressor. To check the current inflation pressure, switch off the compressor.
 -  Do not run the compressor for longer than 10 minutes; otherwise, the device will overheat and possibly be damaged. ◀
 - ▷ To decrease the inflation pressure: press the release button 9.

 If the tire cannot maintain the inflation pressure, drive the vehicle again, refer to Distributing the sealant. Then repeat steps 1 to 4.

If an inflation pressure of 1.8 bar/26 psi still cannot be reached, then the tire is too heavily damaged. Contact your nearest MINI dealer. ◀

Driving on

 Do not exceed the permitted maximum speed of 50 mph/80 km/h; doing so may result in an accident. ◀

Replace the defective tire as soon as possible and have the new wheel/tire assembly balanced.

Have the Mobility Kit refilled.

CHANGING WHEELS

The pouch with the wheel changing kit is stored under the flat load floor.

It includes:

- ▷ Vehicle jack
- ▷ Reversible ratchet
- ▷ Wheel stud wrench
- ▷ Extractor hook for wheel center cover
- ▷ Chock

Preparing for a wheel change

 Observe the safety precautions regarding flat tires on page 159. ◀

 Additional safety measures when changing tires:

Only change the tire when parked on a surface that is level, firm and not slippery.

The vehicle or the jack could slip sideways on soft or slippery support surfaces, such as snow, ice, flagstones, etc.

Do not use a wooden block or similar object as a support base for the jack, as this would prevent it from extending to its full support height and reduce its load-carrying capacity.

Do not lie under the vehicle or start the engine

when the vehicle is supported by the jack; otherwise, there is a risk of fatal injury. ◀

1. Place the foldable chock behind the front wheel on the other side of the vehicle or in front of the wheel if the vehicle is on an incline. If the wheel is changed on a surface with a more severe slope, take additional precautions to secure the vehicle from rolling.
2. Uncover the lug bolts if necessary.
3. Loosen the lug bolts by a half turn.

Jacking up the vehicle

 The vehicle jack is designed for changing wheels only. Do not attempt to raise another vehicle model with it or to raise any load of any kind. To do so could cause accidents and personal injury. ◀

1. Place the jack at the jacking point closest to the wheel.

The jack base must be perpendicular to the surface beneath the jacking point.

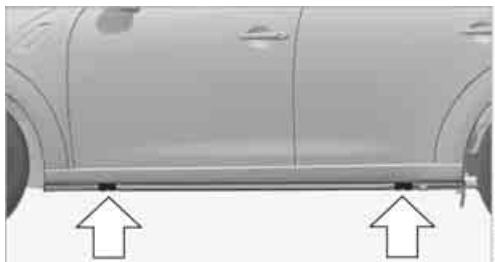

2. Slide reversible ratchet onto the fixture on the jack, arrow 1.



3. As you ratchet up the jack, place the jack head onto the lifting point on the body, arrow 2.
4. Jack the vehicle up until the wheel you are changing is raised off the ground.

Mounting the wheel

1. Unscrew the lug bolts and remove the wheel.
2. Remove accumulations of mud or dirt from the mounting surfaces of the wheel and hub. Clean the lug bolts.
3. Lift the new wheel into place.
4. Screw at least two lug bolts finger-tight into opposite bolt holes.
5. Screw in the remaining bolts.
6. Tighten all the lug bolts firmly in a diagonal pattern.
7. Lower the vehicle.
8. Remove the jack.

Tightening the lug bolts

Tighten the lug bolts in a diagonal pattern.

 Immediately have the wheels checked with a calibrated torque wrench to ensure that the lug bolts are firmly seated. Otherwise, incorrectly tightened lug bolts can present a safety hazard. ◀

Tightening torque: 103.3 lb ft or 140 Nm.

Replace the defective tire as soon as possible and have the new wheel/tire assembly balanced.

VEHICLE BATTERY

Maintenance

The battery is maintenance-free; that is, the electrolyte will last for the life of the battery when the vehicle is operated in a temperate climate.

If you have any questions regarding your battery, please contact your MINI dealer.

Battery replacement

 Only use vehicle batteries that have been approved for your vehicle by the manufacturer; otherwise, the vehicle could be damaged and systems or functions may not be fully available. ◀

After a battery replacement, have the battery registered on the vehicle by your MINI dealer to ensure that all convenience functions are fully available and, if necessary, the corresponding Check Control messages are no longer displayed.

Charging the battery

Note

 Do not connect battery chargers to the sockets installed in the vehicle at the factory; otherwise you may cause damage to the battery. ◀

Only charge the battery in the vehicle when the engine is off. Connections, refer to Jump-starting on page 165.

General information

To guarantee the full service life of the battery, ensure that the battery is always properly charged.

It may be necessary to charge the battery in the following situations:

- ▷ If frequent short trips are taken.
- ▷ If the vehicle is frequently parked for more than a month.

Disposal

 After replacing old batteries, return the used batteries to your MINI dealer or to a recycling center. Maintain the battery in an upright position for transport and storage. Always secure the battery against tipping over during transport. ◀

Power failure

After a temporary power loss, some equipment may not be fully functional and may require initialization. Individual settings are also lost and must be reprogrammed:

- ▷ Time and date
These values must be updated, page 62.
- ▷ Radio
In some cases, stations may have to be stored again, page 110.
- ▷ Glass sunroof, electric
It may only be possible to tilt the sunroof, if applicable. The system must be initialized. Contact your nearest MINI dealer.

In the vehicle interior

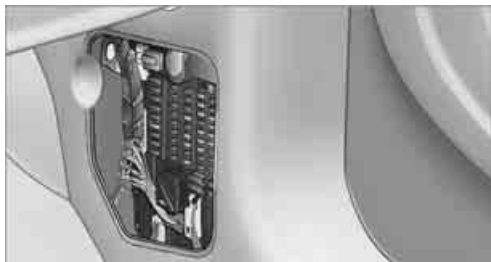

On the right side of the footwell.

Opening the cover

Press out at the recess.

FUSES

 Do not attempt to repair a blown fuse or replace it with a fuse of a different color or Ampere rating. To do this could cause a fire in the vehicle resulting from a circuit overload. Have fuses replaced by your MINI dealer. ◀

A fuse assignment diagram is located on the inside of the fuse box cover panels.

In the engine compartment



Opening the cover

Press the latch.

GIVING AND RECEIVING ASSISTANCE

VEHICLE EQUIPMENT

In this chapter, all production, country, and optional equipment that is offered in the model range is described. Equipment is also described that is not available because of, for example, selected options or country version. This also applies to safety related functions and systems.

ROADSIDE ASSISTANCE

Roadside Assistance is available by phone 24 hours a day in many countries. You can obtain assistance there in the event of a vehicle breakdown.

FIRST AID POUCH

Some of the articles contained in the first aid pouch have a limited service life. Therefore, check the expiration dates of the contents regularly and replace any items in good time, if necessary.



The first aid pouch is located on the rear cargo well by the left side trim panel or under the pull-out floor panel.

WARNING TRIANGLE

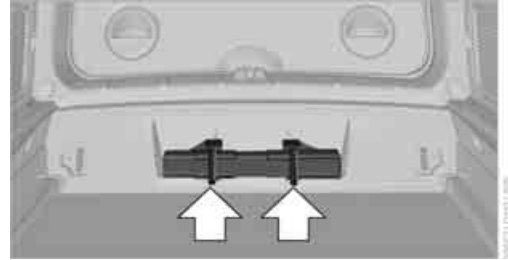

In the cargo area under the loading sill.

To remove, open the two clasps.

JUMP-STARTING

If the car's own battery is flat, your MINI's engine can be started by connecting two jumper cables to another vehicle's battery. You can also use the same method to help start another vehicle. Only use jumper cables with fully-insulated clamp handles.

 Do not touch any electrically live parts when the engine is running, or a fatal accident may occur. Carefully adhere to the following sequence, both to prevent damage to one or both vehicles, and to guard against possible personal injuries. ◀

Preparation

1. Check whether the battery of the other vehicle has a voltage of 12 volts and approximately the same capacitance in Ah. This information can be found on the battery.
2. Switch off the engine of the support vehicle.
3. Switch off any consumers in both vehicles.

 There must not be any contact between the bodies of the two vehicles; otherwise, there is a danger of shorting. ◀

Connecting jumper cables

 Connect the jumper cables in the correct order, so that no sparks which could cause injury occur. ◀

1. Open the battery cover in the engine compartment to access the positive terminal of your MINI.

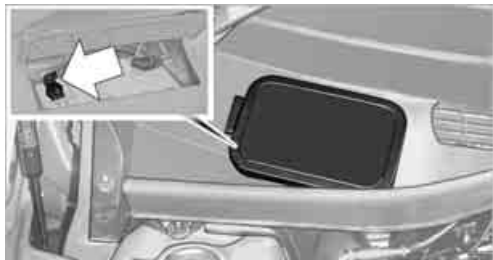

2. Release the tabs on the left and right sides of the positive terminal cover, arrows 1, and lift the cover to open, arrow 2.

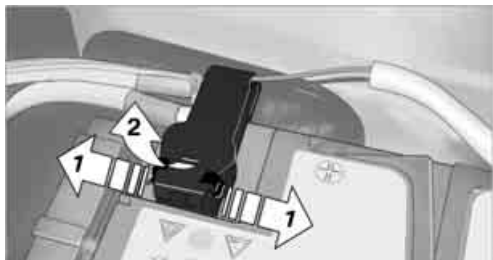

3. Attach one terminal clamp of the plus/+ jumper cable to the positive terminal of the battery or to a starting-aid terminal of the vehicle providing assistance.
4. Attach the second terminal clamp of the plus/+ jumper cable to the positive terminal of the battery or a starting-aid terminal of the vehicle to be started.
5. Attach one terminal clamp of the minus/- jumper cable to the negative terminal of the battery or to an engine or body ground of the assisting vehicle.

Body ground in MINI:

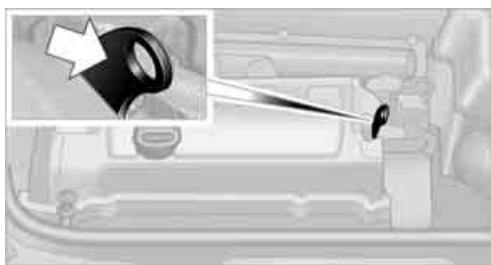

6. Attach the second terminal clamp of the minus/- jumper cable to the negative terminal of the battery or to the engine or body ground of the vehicle to be started.

Starting the engine

1. Start the engine of the donor vehicle and allow it to run for a few minutes at slightly increased idle speed.
2. Start the engine of the vehicle to be started in the usual manner.
If the first start attempt is not successful, wait a few minutes before another attempt in order to allow the discharged battery to recharge.
3. Let the engines run for a few minutes.
4. Disconnect the jumper cables by reversing the above connecting sequence.

If necessary, have the battery checked and recharged.

 Never use spray fluids to start the engine. ◀

TOW-STARTING, TOWING AWAY

 Observe applicable laws and regulations for tow-starting and towing. ◀

 Do not transport any passengers other than the driver in a vehicle that is being towed. ◀

Using a tow fitting

The screw-in tow fitting must always be carried in the car. It can be screwed in at the front or at the right rear.

Depending upon the vehicle features, the tow fitting is located

- ▷ under the right or left front seat.
- ▷ in the pouch for the tire-changing set in the luggage compartment.

 Use only the tow fitting provided with the vehicle and screw it all the way in. Use the tow fitting for towing on paved roads only. Avoid lateral loading of the tow fitting, e.g. do not lift the vehicle by the tow fitting. Otherwise, the tow fitting and the vehicle could be damaged. ◀

Access to screw thread

Press sideways on the cover, vehicle outer side. This will push out the opposite side of the cover, which can then be removed.

Front

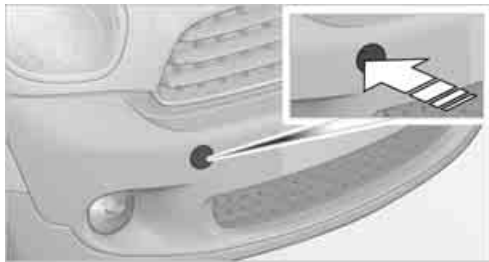

Rear



Being towed

 Make sure that the ignition is switched on, refer to page 45; otherwise, the low beams, tail lamps, turn signals, and windshield wipers may be unavailable. Do not tow the vehicle with just the rear axle raised, as this would allow the steering to turn. ◀

There is no power assist while the engine is off. Thus, braking and steering will require increased effort.

Switch on the hazard warning flashers, depending on local regulations.

Manual transmission

Gearshift lever in neutral position.

Automatic transmission

 Tow vehicles with automatic transmission only with a tow truck or with the front wheels lifted; otherwise, the transmission can be damaged. ◀

Towing methods

 Do not lift vehicle by tow fitting or body and chassis parts, otherwise damage may result. ◀

With towbar

 The towing vehicle must not be lighter than the towed vehicle; otherwise, it may be impossible to maintain control. ◀

The tow fittings used should be on the same side on both vehicles. Should it prove impossible to

avoid mounting the tow bar at an angle, please observe the following:

- ▷ Clearance and maneuvering capability will be sharply limited during cornering.
- ▷ The tow bar will generate lateral forces if it is attached offset.

 Only attach the tow bar to the tow fittings, as attachment to other vehicle parts can lead to damage. ◀

With tow rope

When starting off in the towing vehicle, make sure that the tow rope is taut.

 To avoid jerking and the associated stresses on vehicle components when towing, always use nylon ropes or nylon straps. Attach the tow rope to the tow fittings only, as attaching it to other parts of the vehicle could result in damage. ◀

With tow truck: vehicles without ALL4 all-wheel drive

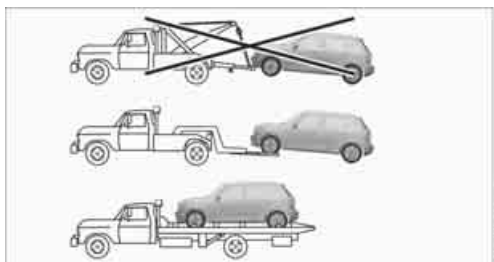

Have the MINI Countryman transported by a tow truck with a so-called lift bar or on a flat bed.

With tow truck: vehicles with ALL4 all-wheel drive

 Do not have your vehicle with ALL4 all-wheel drive towed with the front or rear axle raised individually; otherwise, the wheels may lock and the transfer case may be damaged. ◀

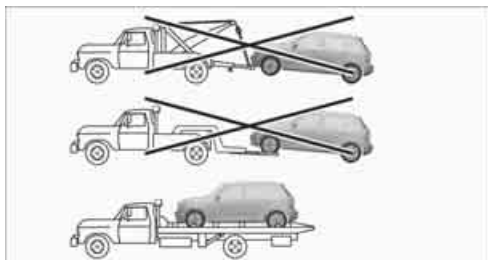

Only have your MINI Countryman transported on a flat bed.

Tow-starting

Avoid tow-starting the vehicle whenever possible; instead, jump-start the engine, page 165. Vehicles with a catalytic converter should only be tow-started when the engine is cold, vehicles with an automatic transmission cannot be tow-started at all.

1. Switch on hazard warning flashers, comply with local regulations.
2. Switch on the ignition, page 45.
3. Shift into 3rd gear.
4. Have the vehicle tow-started with the clutch completely depressed and then slowly release the clutch. After the engine starts, immediately depress the clutch completely again.
5. Stop at a suitable location, remove the tow bar or rope and switch off the hazard warning flashers.
6. Have the vehicle checked.

INDICATOR AND WARNING LAMPS





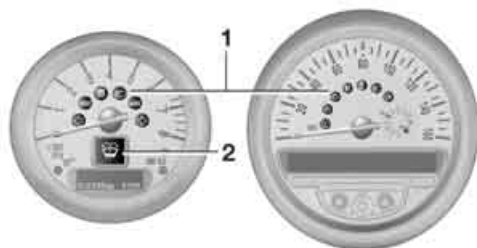

VEHICLE EQUIPMENT











In this chapter, all production, country, and optional equipment that is offered in the model range is described. Equipment is also described that is not available because of, for example, selected options or country version. This also applies to safety related functions and systems.







THE CONCEPT













Indicator and warning lamps can light up in various combinations and colors in indicator area 1 or 2. Refer to the table for information on causes and how to react. Note whether a lamp lights up alone or in combination with another. Some lamps can light up in different colors. Corresponding distinctions are made in the text.











1	2	Cause	What to do
		Turn signals	
		High beams/headlamp flasher switched on	
		Fog lamps switched on	
		Rear fog lamp switched on	
		Fasten safety belts	Fasten your safety belt, refer also to page 39.
		Indication in US models Parking brake applied	Release the parking brake.











1	2	Cause	What to do
		Indication in Canadian models Parking brake applied	Release the parking brake.
		External temperature warning	Drive cautiously, refer also to page 56.
		Lights up briefly: Approx. 2.1 US gal/8 liters of fuel are still in the tank	
		Remains on: Cruising range is no more than 30 miles/50 km, page 55	
		Engine refuses to start	Depress the brake or clutch in order to start the engine, page 45.
		Ignition switched on and driver's door open	Switch off the ignition, page 45, or close the driver's door.
		Lamps still on	
		Roadside parking lamps on	
		Door open	
		Hood open	
		Fuel cap missing or loose	Make sure that the fuel cap is correctly positioned and close it until it audibly clicks. Do not jam the strap between the fuel cap and the vehicle.















1	2	Cause	What to do
		Window washer fluid level too low	Add washer fluid as soon as possible, page 53.
		Lights up in red: Service due	Arrange a service appointment. Check service requirements, page 149.
		Lights up in yellow: The next time that the Start/Stop button is pressed, the engine starts, possibly even without a foot on the brakes or without depressing the clutch	
		Remote control malfunctioning or, in cars with Comfort Access, not detected	The engine cannot be started. Have the remote control checked, if necessary.
		Remote control battery is discharged	Use the remote control for a longer journey or, in cars with Comfort Access, replace the battery.
		Belt tensioners and/or airbag system failed	Have the system checked immediately. Fasten the safety belts anyway.
		Power steering failed	You can continue your journey, but moderate your speed and exercise due caution. Steering response will be markedly different. Have the system checked without delay.







1	2	Cause	What to do
	Lights up in red: Engine malfunction		Stop the car and switch off the engine. You cannot continue your journey. Contact your MINI dealer.
	Lights up in yellow: Full engine power no longer available		You can continue your journey, but moderate your speed and exercise due caution. Have the engine checked as soon as possible.
 	Indicator lamp 1 flashes: Engine malfunction under high load. High engine load will result in damage to the catalytic converter		You can continue your journey, but moderate your speed and exercise due caution. Have the vehicle checked without delay.
	Indicator lamp 1 comes on: Engine malfunction with adverse effect on exhaust emissions		You can continue your journey, but moderate your speed and exercise due caution. Have the car checked as soon as possible.
	Lights up in red: Engine overheating		Carefully bring the car to a stop, switch off the engine and allow it to cool down. Do not open the hood; otherwise, there is a risk of injury from scalding. Contact your MINI dealer.
	Lights up in yellow: Engine too hot		Continue driving at more moderate speed so that the engine can cool down. Have the engine checked without delay if the situation reoccurs.



1	2	Cause	What to do
		<p>Lights up in red:</p> <p>Battery is no longer being charged. Alternator malfunction</p>	Switch off all unnecessary electrical consumers. Have the battery checked without delay.
		<p>Lights up in yellow:</p> <p>Battery charge level very low, battery aged or not securely connected</p>	Charge it by taking a longer drive or by using an external charger. Possibly automatic switch-off of power consuming devices. Have the battery checked as soon as possible.
	BRAKE	<p>Indication in US models</p> <p>Parking brake applied</p>	
		<p>Indication in Canadian models</p> <p>Parking brake applied</p>	
	ABS BRAKE 	<p>Indication in US models</p> <p>Lights up in red:</p> <p>Brake fluid level too low</p>	Braking action is reduced, stop with care. Contact your nearest MINI dealer.
	  	<p>Indication in Canadian models</p> <p>Lights up in red:</p> <p>Brake fluid level too low</p>	Braking action is reduced, stop with care. Contact your nearest MINI dealer.
	ABS BRAKE 	<p>Indication in US models</p> <p>Brake pads worn</p>	Have the condition of the brake pads checked without delay.









1	2	Cause	What to do
 		Indication in Canadian models Brake pads worn	Have the condition of the brake pads checked without delay.
ABS BRAKE 		Indication in US models Vehicle electronics failed	You cannot continue your journey. Contact your MINI dealer.
  		Display in Canadian models Vehicle electronics failed	You cannot continue your journey. Contact your MINI dealer.
		Lights up in red: ▶ Starter failed or ▶ Ignition malfunctioning. Engine restart only possible when brake is depressed or ▶ Lighting system failed. Low beams/tail lamps and brake lamps still operational. All other lamps failed	Have the system in question checked without delay. The engine cannot be restarted. Depress the brake to start the engine again.
		Lights up in yellow: ▶ Control of the brake lamps failed or ▶ fuel supply malfunctioning ▶ Drive malfunctioning	You can continue your journey, but moderate your speed and exercise due caution. Have the system in question checked without delay. You can continue your journey, but moderate your speed and exercise due caution. Transmission limp-home program active with restricted range of gears. Have the system checked immediately.







1	2	Cause	What to do
		Flashing: Dynamic Stability Control DSC or Dynamic Traction Control DTC is controlling drive and braking forces, refer also to page 65	
		Dynamic Traction Control DTC is activated, refer also to page 66	
		The Dynamic Stability Control DSC and Dynamic Traction Control DTC are deactivated, refer also to page 65	Driving stability limited during acceleration and cornering. Driving style must be adjusted.
		The Dynamic Stability Control DSC and Dynamic Traction Control DTC have failed.	Driving stability limited during acceleration and cornering. You can continue your journey, but moderate your speed and exercise due caution. Have the system checked as soon as possible.
ABS BRAKE 		Indication in US models The driving stability control systems, including ABS and the Tire Pressure Monitor, have failed, refer also to page 65	Reduced braking and driving stability. Drive cautiously and think well ahead. Avoid braking with full force, driving on rough tracks, and depressing the accelerator pedal to full throttle or kickdown position. Have the system checked immediately.
ABS BRAKE 		Indication in US models The driving stability control systems, including ABS, ALL4 all-wheel drive, and the Tire Pressure Monitor, have failed, refer also to page 65	Reduced braking and driving stability. Drive cautiously and think well ahead. Avoid braking with full force, driving on rough tracks, and depressing the accelerator pedal to full throttle or kickdown position. Have the system checked immediately.

1	2	Cause	What to do
   	 	<p>Display in Canadian models</p> <p>The driving stability control systems, including ABS and the Flat Tire Monitor or the Tire Pressure Monitor, have failed, refer also to page 65</p>	<p>Reduced braking and driving stability. Drive cautiously and think well ahead. Avoid braking with full force, driving on rough tracks, and depressing the accelerator pedal to full throttle or kickdown position. Have the system checked immediately.</p>
   	 	<p>Display in Canadian models</p> <p>The driving stability control systems, including ABS, ALL4 all-wheel drive, and the Flat Tire Monitor or the Tire Pressure Monitor, have failed, refer also to page 65</p>	<p>Drive cautiously and think well ahead. Avoid braking with full force, driving on rough tracks, and depressing the accelerator pedal to full throttle or kickdown position. Have the system checked immediately.</p>
 		<p>ALL4 all-wheel drive has failed.</p>	<p>Continued driving is possible. Drive cautiously and think well ahead. Avoid rough track driving, full-throttle operation, and use of the transmission's kickdown mode. Have the system checked immediately.</p>
 		<p>ALL4 all-wheel drive and DSC have failed.</p>	<p>Continued driving is possible. Drive cautiously and think well ahead. Avoid rough track driving, full-throttle operation, and use of the transmission's kickdown mode. Have the system checked immediately.</p>

1	2	Cause	What to do
		Vehicles with Flat Tire Monitor	
		<p>Light up in yellow and red:</p> <ul style="list-style-type: none"> ▷ Tire damage ▷ Flat Tire Monitor not initialized 	<p>Carefully bring the car to a stop. Observe the information starting on page 68.</p> <p>Initialize Flat Tire Monitor, page 68.</p>
		<p>Light up in yellow:</p> <p>Flat Tire Monitor failed. Punctures are not indicated</p>	<p>Have the system checked.</p>
		Vehicles with Tire Pressure Monitor	
		<p>Light up in yellow and red:</p> <p>There is a flat tire or significant tire pressure loss, e.g. in the front right tire</p>	<p>Carefully bring the car to a stop. Observe the information starting on page 70.</p>
		Vehicles with Tire Pressure Monitor	
		<p>Light up in yellow:</p> <p>Tire Pressure Monitor not initialized</p> <p>The small lamp flashes yellow and then stays on, the large lamp lights up in yellow:</p> <ul style="list-style-type: none"> ▷ Wheel mounted without TPM electronics ▷ The TPM is temporarily malfunctioning due to other systems or devices using the same radio frequency. 	<p>Check the inflation pressure and reset the system, page 71.</p> <p>Have the system checked.</p>

1	2	Cause	What to do
 	<p>Vehicles with Tire Pressure Monitor</p> <hr/> <p>The small lamp flashes yellow and then stays on, the large lamp lights up in yellow:</p>	<ul style="list-style-type: none"> ▶ Tire Pressure Monitor failed. Punctures are not indicated ▶ Wheel mounted without TPM electronics 	<p>Have the system checked.</p> <p>Have the system checked.</p>
	<p>Lights up in red:</p>	<ul style="list-style-type: none"> ▶ Transmission limp-home program active with restricted range of gears, possibly with reduced acceleration ▶ Gears can be engaged without depressing the brake ▶ Automatic selector lever locked <hr/> <p>Lights up in yellow:</p>	<p>You can continue your journey, but moderate your speed and exercise due caution. Have the system checked without delay.</p> <p>Always depress the brake to engage a gear.</p> <p>Manually releasing the selector lever lock, page 49.</p> <hr/> <p>Have the system checked as soon as possible.</p> <p>Manually releasing the selector lever lock, page 49.</p> <p>To engage a gear while the vehicle is at a standstill, always depress the brake. Before leaving the vehicle, move the selector lever to position P and switch off the engine.</p>

1	2	Cause	What to do
	 <p>Lights up in red: Transmission overheating</p>	<p>Bring the car to a stop and move the selector lever to position P. Allow the transmission to cool down. You can continue your journey, but moderate your speed and exercise due caution. Have the system checked if the situation reoccurs.</p>	
	<p>Lights up in yellow: Transmission too hot</p>	<p>Avoid high engine loads. You can continue your journey, but moderate your speed and exercise due caution.</p>	
	 <p>Selector lever position P not engaged. Vehicle not prevented from rolling</p>		
	 <p>Selector lever position P not engaged. Ignition cannot be switched off</p>	<p>Engage selector lever position P when you wish to switch off the ignition, page 45.</p>	
	 <p>Cruise control system failed</p>	<p>Have the system checked.</p>	
	 <p>Park Distance Control failed</p>	<p>Have the system checked.</p>	
	 <p>Bulb of exterior lighting system failed</p>	<p>Have the exterior lighting checked as soon as possible.</p>	
	 <p>Low-beam headlamp or fog lamp failed</p>	<p>Have the lamps checked as soon as possible.</p>	
	 <p>High-beam headlamp failed</p>	<p>Have the high-beam headlamps checked.</p>	
	 <p>Rear fog lamp failed</p>	<p>Have the rear fog lamp checked.</p>	

1	2	Cause	What to do
		Adaptive Light Control has failed	
		Coolant level too low	Add coolant immediately, page 148.
		Engine oil pressure too low	Stop immediately and switch off the engine. You cannot continue your journey. Contact your MINI dealer.
	Lights up in red:	Service appointment overdue	Arrange a service appointment. Check service requirements, page 61.
	Lights up in yellow:	Service due	Arrange a service appointment. Check service requirements, page 61.
		No service due	
		Set speed limit exceeded	
		Time and date no longer correct	Set the time and date, page 62.

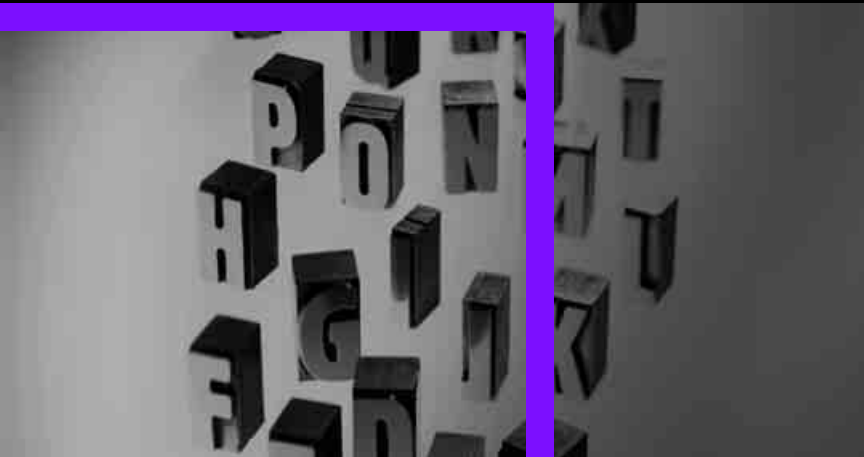

FIND ME.

AT A GLANCE

CONTROLS

DRIVING TIPS

ENTERTAINMENT

COMMUNICATIONS

MOBILITY

REFERENCE

TECHNICAL DATA

VEHICLE EQUIPMENT

In this chapter, all production, country, and optional equipment that is offered in the model range is described. Equipment is also described

that is not available because of, for example, selected options or country version. This also applies to safety related functions and systems.

ENGINE DATA

		Cooper	Cooper S	John Cooper Works
Displacement	cu in/ cm ³	97.5/1,598	97.5/1,598	97.5/ 1,598
Number of cylinders		4	4	4
Maximum power output	hp	121	181	208
At engine speed	rpm	6,000	5,500	6,000
Maximum torque with overboost	lb ft/ Nm	114/155 –	177/240 192/260	207/280 221/300
At engine speed with overboost	rpm	4,250 –	1,600-5,000 1,730-4,500	1,900-5,000 2,100-4,500
Overboost briefly raises the maximum torque at high rates of acceleration, e.g. when passing.				

DIMENSIONS

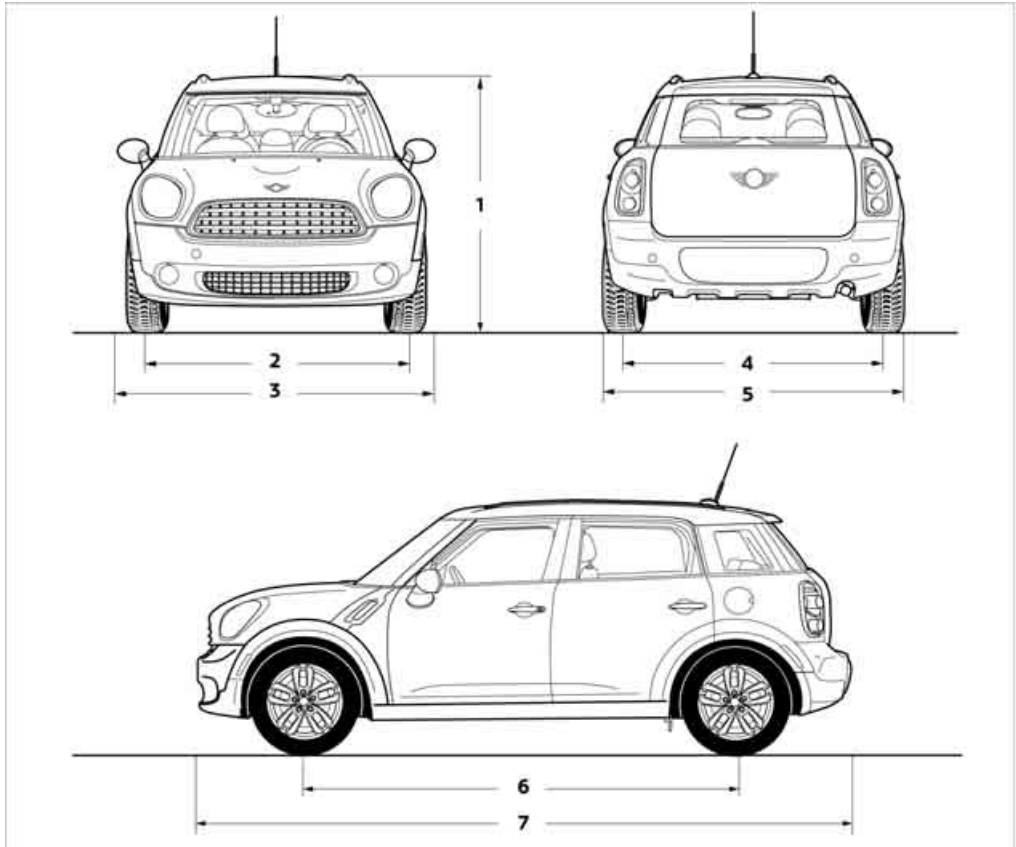

		Cooper	Cooper S	John Cooper Works
1	Vehicle height without roof antenna	61.5/1,561	61.5/1,561	61.5/1,561
2	Track, front	60/1,525	60/1,525	60.1/1,527
3	Vehicle width, with outside mirror	78.5/1,995	78.5/1,995	78.6/1,996
4	Track, rear	61.1/1,551	61.1/1,551	61.2/1,554
5	Vehicle width, without outside mirror	70.4/1,789	70.4/1,789	70.4/1,789

		Cooper	Cooper S	John Cooper Works
6	Wheelbase	102.2/2,595	102.2/2,595	102.2/2,596
7	Vehicle length	161.7/4,108	161.8/4,110	163.2/4,144
All dimensions in in/mm. Minimum turning radius dia.: 38.1 ft/11.6 m.				

WEIGHTS

		Cooper	Cooper S	
Curb weight, ready for travel, with all optional extras				
▷	Manual transmission	lbs/kg	2,954/1,340	3,053/1,385
▷	Automatic transmission	lbs/kg	3,020/1,370	3,097/1,405
Approved gross weight				
▷	Manual transmission	lbs/kg	3,858/1,750	3,990/1,810
▷	Automatic transmission	lbs/kg	3,924/1,780	4,034/1,830
Approved front axle load				
▷	Manual transmission	lbs/kg	2,050/930	2,127/965
▷	Automatic transmission	lbs/kg	2,116/960	2,172/985
Approved rear axle load		lbs/kg	1,918/870	1,918/870
Approved roof load capacity		lbs/kg	165/75	165/75
Cargo area capacity		cu ft/ liters	12.4 - 41.3/ 350 - 1,170	12.4 - 41.3/ 350 - 1,170

		Cooper S ALL4	John Cooper Works	
Curb weight, ready for travel, with all optional extras				
▷	Manual transmission	lbs/kg	3,208/1,455	3,263/1,480
▷	Automatic transmission	lbs/kg	3,252/1,475	3,307/1,500
Approved gross weight				

		Cooper S ALL4	John Cooper Works
▷ Manual transmission	lbs/kg	4,101/1,860	4,156/1,885
▷ Automatic transmission	lbs/kg	4,145/1,880	4,200/1,905
Approved front axle load			
▷ Manual transmission	lbs/kg	2,183/990	2,183/990
▷ Automatic transmission	lbs/kg	2,227/1,010	2,227/1,010
Approved rear axle load	lbs/kg	2,017/915	2,072/940
Approved roof load capacity	lbs/kg	165/75	165/75
Cargo area capacity	cu ft/ liters	12.4 - 41.3/ 350 - 1,170	12.4 - 41.3/ 350 - 1,170

Never exceed either the approved axle loads or the gross vehicle weight.

CAPACITIES

	US gal/US quarts	Liters	Notes
Fuel tank	12.4/-	approx. 47	Fuel grade: page 135
including reserve of	2.1/-	approx. 8	
Window washer system incl. headlamp washer system	-/4.2	approx. 4	For more details: page 53

EVERYTHING FROM A TO Z

INDEX

A

ABS Antilock Brake System [65](#)
 Accepting a call [125](#)
 Accessories, see Vehicle equipment [4](#)
 Acknowledgment signals for locking/unlocking vehicle [24](#)
 Activated-charcoal filter for automatic climate control [85](#)
 Adaptive Light Control [78](#)
 Adding engine oil [147](#)
 Additives
 – coolant [148](#)
 – engine oil [147](#)
 Adjusting temperature inside the car, refer to Air conditioner [82](#)
 Adjusting temperature inside the car, refer to Automatic climate control [83](#)
 Airbags [73](#)
 – sitting safely [34](#)
 – warning lamp [75](#)
 Air conditioner [81](#)
 Air conditioning mode
 – air conditioner [82](#)
 – automatic climate control [83](#)
 – ventilation [85](#)
 Air distribution
 – automatic [84](#)
 – individual [83](#)
 – manual [83](#)
 Air flow rate [82, 84](#)
 – air conditioning system [82](#)
 – automatic climate control [84](#)
 – heating, ventilation [82](#)
 Airing, refer to Ventilation [85](#)
 Air outlets, refer to Air vents [81](#)
 Air pressure, checking, refer to Tire inflation pressure [136](#)

Air recirculation, refer to Recirculated-air mode [82, 84](#)
 Air supply
 – air conditioner [82](#)
 – automatic climate control [83](#)
 – ventilation [85](#)
 Air vents [81](#)
 AKI, refer to Fuel grade [135](#)
 Alarm system [28](#)
 ALL4 all-wheel drive system [67](#)
 All-season tires, refer to Winter tires [144](#)
 All-wheel drive, refer to ALL4 [67](#)
 Ambient air, refer to Recirculated-air mode [82, 84](#)
 Ambient lighting [80](#)
 Antenna, care [151](#)
 Antifreeze
 – coolant [148](#)
 – washer fluid [53](#)
 Antilock Brake System ABS [65](#)
 Anti-theft alarm system, refer to Alarm system [28](#)
 Approved axle loads, refer to Weights [186](#)
 Approved engine oils [147](#)
 Approved gross vehicle weight, refer to Weights [186](#)
 Armrest, refer to Center armrest [90](#)
 Ashtray [93](#)
 Assistant systems, refer to – Dynamic Stability Control DSC [65](#)
 Audio device, external [90](#)

Automatic
 – air distribution [84](#)
 – air flow rate [84](#)
 – cruise control [53](#)
 – headlamp control [76](#)
 Automatic climate control [81](#)
 – automatic air distribution [84](#)
 Automatic station search [109](#)
 Automatic station storage [110](#)
 Automatic transmission with Steptronic [47](#)
 – interlock [48](#)
 – overriding selector lever lock [49](#)
 – shiftlock [48](#)
 – sport program [49](#)
 AUTO program for automatic climate control [84](#)
 Auto radio, refer to Radio MINI Boost CD [108](#)
 AUX-In, refer to External audio device [90](#)
 AUX-In connection [108](#)
 Average fuel consumption [56](#)
 – setting the units [59](#)
 Average speed [57](#)
 Axle loads, refer to Weights [186](#)

B

Background lighting, refer to Ambient lighting [80](#)
 Backrests, refer to Seats [35](#)
 Backup lamps
 – replacing bulb [158, 159](#)
 Band-aids, refer to First aid pouch [165](#)
 Bar, refer to Tow-starting, towing away [167](#)

- Base plate for telephone or mobile phone
 - refer to Snap-in adapter 130
 - Battery 163
 - disposal 31, 163
 - jump-starting 165
 - temporary power failure 164
 - Battery renewal
 - remote control 31
 - Being towed 167
 - Belts, refer to Safety belts 37
 - Belt tensioner, refer to Safety belts 37
 - Beverage holders, refer to Cupholders 93
 - Black ice, refer to External temperature warning 56
 - Blower, refer to Air flow rate 82, 84
 - Bluetooth, activating/deactivating 122
 - Bottle holders, refer to Cupholders 93
 - Brake Assist 65
 - Brake fluid, refer to Service requirements 61
 - Brake lamps
 - replacing bulbs 159
 - Brake pads, breaking in 96
 - Brake rotors 98
 - brakes 96
 - breaking in 96
 - Brakes
 - ABS 65
 - breaking in 96
 - MINI Maintenance System 149
 - parking brake 47
 - service requirements 61
 - Brakes, refer to Braking safely 97
 - Brake system 96
 - breaking in 96
 - disc brakes 98
 - MINI Maintenance System 149
 - Breakdown service, refer to Roadside Assistance 165
 - Breaking in the clutch 96
 - Break-in period 96
 - Bulb changing, refer to Lamps and bulbs 155
 - Button for starting the engine 45
 - Buttons on the steering wheel 11
- C**
- California Proposition 65 warning 5
 - Call ending 126
 - Calling, refer to Phone numbers, dialing 126
 - Can holders, refer to Cupholders 93
 - Capacities 187
 - Car battery, refer to Vehicle battery 163
 - Car care 151
 - Care 151
 - car-care products 151
 - car washes 151
 - CD/DVD drives 154
 - high-pressure washers 152
 - leather 153
 - manual washing 152
 - upholstery and fabrics 153
 - windows 152
 - wiper blades 152
 - Cargo, securing 102
 - Cargo area 98
 - capacity 186
 - Comfort Access 30
 - lamp 79
 - opening from outside 28
 - trunk lid, refer to Tailgate 28
 - Cargo area, expanding 98
 - Cargo area lamp 79
 - Cargo area lid, refer to Tailgate 28
 - Cargo area partition net, refer to Cargo net 100
 - Cargo loading 101
 - securing cargo 102
 - stowing cargo 102
 - vehicle 98
 - Cargo net 100
 - Car key, refer to Keys/remote controls 22
 - Carpets, care 153
 - Car phone
 - installation location, refer to Center armrest 90
 - Car phone, refer to Telephone 120
 - Car wash
 - before driving in 47
 - Car wash, care 151
 - Car washes 151
 - Catalytic converter, refer to Hot exhaust system 97
 - CD player 113
 - changing the track 113
 - fast forward/reverse 113
 - playing a track 114
 - random order 113
 - volume 108
 - Center armrest 90
 - Center brake lamp 159
 - Center console, refer to Around the center console 14
 - Center Rail 91
 - Center Rail, refer to Storage compartments 91
 - Central locking system 23
 - Comfort Access 30
 - from inside 26
 - from outside 23
 - setting unlocking behavior 23
 - Changing bulbs 155
 - Changing wheels 162
 - Charging the battery 163
 - Chassis number, refer to Engine compartment 145
 - Check Control 62
 - Child restraint fixing system LATCH 42

- Child restraint systems [41](#)
 - Child-safety locks [44](#)
 - Child seats [41](#)
 - Chrome parts, care [153](#)
 - Chrome parts, refer to
 - Care [151](#)
 - Cigarette lighter [93](#)
 - Cleaning headlamps [52](#)
 - washer fluid [53](#)
 - Clock
 - setting time [62](#)
 - 12 h/24 h mode [59](#)
 - Closing
 - from inside [26](#)
 - from outside [23](#)
 - Clothes hooks [92](#)
 - Cockpit [10](#)
 - Cold start, refer to Starting the engine [46](#)
 - Comfort Access [30](#)
 - replacing the battery [31](#)
 - what to observe before entering a car wash [31](#)
 - Comfort area, refer to Around the center console [14](#)
 - Compartment for remote control, refer to Ignition lock [45](#)
 - Compass [88](#)
 - Compressed audio files [113](#)
 - Computer [56](#)
 - Condensation, refer to When the vehicle is parked [98](#)
 - Condition Based Service CBS [149](#)
 - Configuring settings, refer to Personal Profile [22](#)
 - Connecting vacuum cleaner, refer to Connecting electrical appliances [93](#)
 - Consumption, refer to Average fuel consumption [56](#)
 - Controls and displays [10](#)
 - Convenience operation
 - windows [24](#)
 - Convenient access, refer to Comfort Access [30](#)
 - Convenient start, refer to Starting the engine [46](#)
 - Coolant [148](#)
 - checking level [148](#)
 - filling [148](#)
 - temperature [148](#)
 - Cooling, maximum [84](#)
 - Cooling fluid, refer to Coolant [148](#)
 - Copyright [2](#)
 - Cornering light, refer to Adaptive Light Control [78](#)
 - Cruising range [56, 57](#)
 - Cupholders [93](#)
 - Curb weight, refer to Weights [186](#)
 - Current fuel consumption [57](#)
- D**
- Dashboard, refer to Cockpit [10](#)
 - Dashboard instruments, refer to Displays [12](#)
 - Dashboard lighting, refer to Instrument lighting [79](#)
 - Data [184](#)
 - capacities [187](#)
 - dimensions [185](#)
 - engine [184](#)
 - weights [186](#)
 - Data memory [150](#)
 - Date
 - setting [62](#)
 - Daytime running lights [77](#)
 - DBC Dynamic Brake Control, refer to Brake Assist [65](#)
 - Deactivating front passenger airbags [73](#)
 - Deadlocking, refer to Locking [24](#)
 - Defect
 - door lock [26](#)
 - Defective
 - fuel filler flap [134](#)
 - Defogging windows [83, 85](#)
 - Defrosting windows [83, 85](#)
 - Defrosting windows and removing condensation
 - air conditioner [83](#)
 - automatic climate control [85](#)
 - Defrosting windshield, refer to Defrosting windows [83, 85](#)
 - Defrost position, refer to Defrosting windows [83, 85](#)
 - Differential, breaking in [96](#)
 - Digital compass [88](#)
 - Digital radio, refer to HD Radio [111](#)
 - Dimensions [185](#)
 - Dipstick, engine oil [146](#)
 - Directional indicators, refer to Turn signals [50](#)
 - Displacement, refer to Engine data [184](#)
 - Display lighting, refer to Instrument lighting [79](#)
 - Displays [12](#)
 - instrument panel [12](#)
 - Displays, care [154](#)
 - Displays and controls [10](#)
 - Disposal
 - of coolant [148](#)
 - remote control battery [31](#)
 - vehicle battery [163](#)
 - Distance remaining to service, refer to Service requirements [61](#)
 - Distance warning, refer to Park Distance Control PDC [64](#)
 - Door key, refer to Integrated key/remote control [22](#)
 - Door lock [26](#)
 - Door lock, confirmation signals [24](#)
 - Doors, manual operation [26](#)
 - DOT Quality Grades [141](#)
 - Drinks holders, refer to Cupholders [93](#)
 - Drive-off assistant, refer to Hill Assist [67](#)
 - Driving dynamics control, refer to Sport button [67](#)
 - Driving lamps, refer to Parking lamps/low beams [76](#)

Driving notes [96](#)
 Driving off on inclines, refer to Hill Assist [67](#)
 Driving stability control systems [65](#)
 Driving through water [97](#)
 Driving tips, refer to Driving notes [96](#)
 Dry air, refer to Cooling function [85](#)
 DSC Dynamic Stability Control [65](#)
 DTC Dynamic Traction Control [66](#)
 Dynamic Brake Control DBC, refer to Brake Assist [65](#)
 Dynamic Stability Control DSC [65](#)
 Dynamic Traction Control DTC [66](#)

E

Eject button [114](#)
 Electrical malfunction
 – door lock [26](#)
 – fuel filler flap [134](#)
 Electronic brake-force distribution [65](#)
 Electronic Stability Program ESP, refer to Dynamic Stability Control DSC [65](#)
 Emergency operation, refer to Manual operation
 – door lock [26](#)
 – fuel filler flap [134](#)
 – transmission lock, automatic transmission [49](#)
 Emergency services, refer to Roadside Assistance [165](#)
 Ending a call [126](#)
 Engine
 – breaking in [96](#)
 – data [184](#)
 – overheated, refer to Coolant temperature [148](#)
 – speed [184](#)
 – starting, Comfort Access [30](#)

Engine compartment [145](#)
 Engine coolant, refer to Coolant [148](#)
 Engine oil
 – additives, refer to Approved engine oils [147](#)
 – alternative oil types [147](#)
 – approved engine oils [147](#)
 – capacity [147](#)
 – checking level [146](#)
 – dipstick [146](#)
 – intervals between changes, refer to Service requirements [61](#)
 – MINI Maintenance System [149](#)
 Engine oil level, checking [146](#)
 Engine output, refer to Engine data [184](#)
 Engine starting, refer to Starting the engine [46](#)
 ESP Electronic Stability Program, refer to Dynamic Stability Control DSC [65](#)
 Exhaust system, refer to Hot exhaust system [97](#)
 Exterior mirrors [39](#)
 – adjusting [39](#)
 – automatic dimming feature [40](#)
 – automatic heating [40](#)
 – folding in and out [39](#)
 External audio device [90](#), [108](#)
 External care [151](#)
 External temperature display
 – change units of measure [59](#)
 – in the onboard computer [59](#)
 External temperature warning [56](#)
 Eyes
 – for tow-starting and towing away [167](#)
 – for tying down loads [102](#)

F

Failure messages, refer to Check Control [62](#)
 Failure of an electrical consumer [164](#)
 Fastening safety belts, refer to Safety belts [37](#)
 Fast forward
 – CD [113](#)
 Fault messages, refer to Check Control [62](#)
 Faulty
 – tire [69](#)
 Filter
 – microfilter/activated-charcoal filter for automatic climate control [85](#)
 – microfilter for air conditioner [83](#)
 Fine wood, care [154](#)
 First aid pouch [165](#)
 Fixture for remote control, refer to Ignition lock [45](#)
 Flash when locking/unlocking [24](#)
 Flat load floor [100](#)
 Flat tire
 – run-flat tires [143](#)
 – Tire Pressure Monitor TPM [70](#)
 Flat Tire Monitor FTM [68](#)
 – indicating a flat tire [69](#)
 – initializing the system [68](#)
 – snow chains [68](#)
 – system limits [68](#)
 Flat tires, refer to Tire condition [142](#)
 Floor mats, care [153](#)
 Floor plate, refer to Flat load floor [100](#)
 Fog lamps
 – replacing bulb [157](#)
 Folding rear seat backrest [98](#)
 Footbrake, refer to Braking safely [97](#)
 Footwell lamps [79](#)
 For your own safety [4](#)

Four-wheel drive, refer to
ALL4 67

Front airbags 73

Front fog lamps 79

– indicator lamp 169

– replacing bulb 157

Front seat adjustment 35

Frost on windows, refer to

Defrosting windows 83, 85

FTM, refer to Flat Tire

Monitor 68

Fuel 135

– fuel tank volume 187

– gauge 55

– high-quality brands 135

– quality 135

– specifications 135

Fuel clock, refer to Fuel

gauge 55

Fuel consumption display

– average fuel consumption 56

Fuel display, refer to Fuel

gauge 55

Fuel filler flap 134

– releasing in the event of

electrical malfunction 134

Fuses 164

G

Garage door opener, refer to

Integrated universal remote
control 86

Gasoline

– refer to Average fuel
consumption 56

Gasoline, refer to Required
fuel 135

Gasoline display, refer to Fuel
gauge 55

Gear indicator

– automatic transmission with
Steptronic 48

Gear shifting

– automatic transmission 48

– manual transmission 47

Gearshift lever

– automatic transmission with
Steptronic 48

– manual transmission 47

General driving notes 96

Glass roof, electric 31

– convenience operation 24

– opening, closing 32

– remote control 24

– tilting 32

Glove compartment 90

Gong

– volume 108

Grills, refer to Air vents 81

Gross vehicle weight, refer to

Weights 186

H

Halogen lamps

– replacing bulb 156

Handbrake, refer to Parking

brake 47

Hands-free system 14, 128

Hazard warning flashers 14

HD Radio 111

Head airbags 73

Headlamp control,

automatic 76

Headlamp flasher 50

– indicator

lamp 11, 82, 85, 169

Headlamp glass lens 156

Headlamps

– replacing bulb 156

Headlamps, care 152

Head Light, refer to Adaptive

Light Control 78

Head restraints 36

– sitting safely 34

Heated

– mirrors 40

– rear window 82, 84

– seats 37

Heating 81

– mirrors 40

– rear window 82, 84

– seats 37

Heavy loads, refer to Stowing
cargo 102

Height, refer to

Dimensions 185

Height adjustment

– seats 35

– steering wheel 40

High beams 78

– headlamp flasher 78

– indicator lamp 82, 85, 169

– replacing bulb 156

High water, refer to Driving
through water 97

Hill Assist 67

Hills 97

Holders for cups 93

Homepage 4

Hood 146

Horn 10

Hot exhaust system 97

Hydroplaning 97

I

IBOC, refer to HD Radio 111

Ice warning, refer to External
temperature warning 56

Ignition 45

– switched off 46

– switched on 45

Ignition key, refer to

Integrated key/remote
control 22

Ignition key position 1, refer to
Radio readiness 45

Ignition key position 2, refer to
Ignition on 45

Ignition lock 45

Imprint 2

Incoming call 125

Indicator and warning lamps **13, 169**
 – Tire Pressure Monitor TPM **71**
 Indicator lighting, refer to Instrument lighting **79**
 Individual air distribution **83**
 Individual settings, refer to Personal Profile **22**
 Inflation pressure monitoring, refer to Tire Pressure Monitor TPM **70**
 Initializing
 – Flat Tire Monitor FTM **68**
 – glass roof, electric **32**
 Initializing the
 – compass, see Calibration **89**
 Instrument lighting **79**
 Instrument panel, refer to Cockpit **10**
 Instrument panel, refer to Displays **12**
 Integrated key **22**
 Integrated universal remote control **86**
 Interior lamps **79**
 – remote control **25**
 Interior rearview mirror **40**
 – automatic dimming feature **40**
 Interlock **48**
 Intermittent mode of the wipers **51**
 Internal care **153**
 Internet page **4**

J

Jacking points **162**
 Jets, refer to Window washer nozzles **52**
 Jumpering, refer to Jump-starting **165**
 Jump-starting **165**

K

Key, refer to Keys/remote controls **22**
 Keyless-Go, refer to Comfort Access **30**
 Keyless opening and closing, refer to Comfort Access **30**
 Key Memory, refer to Personal Profile **22**
 Keypad dialing **126**
 Kickdown **48**
 – automatic transmission with Steptronic **48**
 Knock control **135**

L

Lamps, refer to Parking lamps/ Low beams **76**
 Lamps and bulbs, replacing bulbs **155**
 Lashing eyes, refer to Securing cargo **102**
 LATCH child restraint fixing system **42**
 Leather care **153**
 LEDs light-emitting diodes **156**
 Length, refer to Dimensions **185**
 License plate lamp
 – bulb replacement **159**
 Light
 – automatic headlamp control **76**
 Light alloy wheels, care **153**
 Light-emitting diodes LEDs **156**
 Lighter **93**
 – socket **93**
 Lighting
 – lamps and bulbs **155**
 – of the instruments **79**
 – of vehicle, refer to Lamps **76**
 Light switch **76**
 Limit **180**

Listening to test, scan
 – radio MINI Boost CD **110**
 Load **101**
 Load securing equipment, refer to Securing cargo **102**
 Lock buttons of doors, refer to Locking **27**
 Locking
 – adjusting confirmation signal **24**
 – from inside **27**
 – from outside **24**
 – without remote control, refer to Comfort Access **30**
 Locking and unlocking doors
 – confirmation signals **24**
 – from inside **26**
 – from outside **23**
 Longlife oils
 – approved motor oils **147**
 Low beams **76**
 – automatic **76**
 – replacing bulb **156**
 Lower back support, refer to Lumbar support **35**
 Luggage compartment
 – doors, refer to Tailgate **28**
 Luggage compartment partition net, refer to Cargo net **100**
 Luggage rack, refer to Roof-mounted luggage rack **103**
 Lumbar support **35**

M

M+S tires, refer to Winter tires **144**
 Maintenance, refer to Service and Warranty Information Booklet for US models and Service Guide Booklet for Canadian models
 Maintenance system **149**
 Malfunction warnings, refer to Check Control **62**
 Manual air distribution **83**

Manual mode
 – automatic transmission with Steptronic 49

Manual operation
 – door lock 26
 – fuel filler flap 134
 – transmission lock, automatic transmission 49

Manual station search 109

Manual transmission 47

Manual washing 152

Master key, refer to Integrated key/remote control 22

Maximum cooling 84

Maximum speed
 – with winter tires 144

Medical assistance, refer to First aid pouch 165

Microfilter
 – for air conditioner 83
 – for automatic climate control 85
 – MINI Maintenance System 149

Microfilter/activated-charcoal filter
 – MINI Maintenance System 149

Microphone for telephone 14

MINI Internet page 4

MINI Maintenance System 149

Mirror dimming feature 40

Mirrors 39
 – exterior mirrors 39
 – heating 40
 – interior rearview mirror 40

Mobile phone
 – adjusting volume 125
 – connecting, refer to Mobile phone, pairing 122
 – installation location, refer to Center armrest 90
 – pairing 122
 – What to do if.... 124

Mobility Kit 160

Modifications, technical, refer to For your own safety 4

Monitoring system for tire pressures, refer to Flat Tire Monitor 68

MP3 113

Multifunctional steering wheel, refer to Buttons on the steering wheel 11

Multifunction switch
 – refer to Turn signals/headlamp flasher 50
 – refer to Wiper system 51

Music tracks
 – playing a track 114
 – random order 113

N

Neck support, refer to Head restraints 36

Nets, refer to Storage compartments 91

New tires 143

Number of cylinders, refer to Engine data 184

Number of safety belts 34

Nylon rope, refer to Tow rope 168

O

OBd socket, refer to Socket for On-Board Diagnosis 150

Octane ratings, refer to Fuel specifications 135

Odometer 56

Oil, refer to Engine oil 146

Oil consumption 146

Oil level 146

Oil types 147

Old batteries, refer to Disposal 163

Opening and closing
 – Comfort Access 30
 – from inside 26
 – from outside 23
 – using the door lock 26
 – using the remote control 23

Opening and unlocking
 – from inside 26

Outlets
 – refer to Ventilation 85

Outlets, refer to Air vents 81

Output, refer to Engine data 184

Outside-air mode
 – automatic climate control 84

Overheated engine, refer to Coolant temperature 148

P

Paintwork, care 152

Park Distance Control PDC 64

Parking
 – vehicle 46

Parking aid, refer to Park Distance Control PDC 64

Parking brake 47

Parking lamps, replacing bulb 157

Parking lamps/low beams 76

Parts and accessories, see Vehicle equipment 4

Pathway lighting 77

PDC
 – volume 108

Personal Profile 22

Phone numbers
 – dialing 126

Pinch protection system
 – windows 33

Plastic parts, care 154

Playing a track, scan
 – CD 114

Pollen
 – refer to Microfilter/activated-charcoal filter for automatic climate control 85
 – refer to Microfilter for air conditioner 83

Power failure 164

Power window
 – safety switch 33

Power windows 32

Power windows, refer to
Windows **32**
Pressure, tires **136**
Pressure monitoring, tires **68**
– Flat Tire Monitor **68**
Pressure monitoring of tires,
refer to Tire Pressure Monitor
TPM **70**
Protective function, refer to
Pinch protection system
– windows **33**
PTY **111**
Puncture
– Flat Tire Monitor **68**

R

Radio
– HD Radio **111**
Radio key, refer to Integrated
key/remote control **22**
Radio MINI Boost CD
– playing stations **110**
– recalling stations **110**
– satellite radio **111**
– searching stations **109**
– storing stations **110**
– switching on/off **108**
– tone control **109**
– volume **108**
Radio position, refer to Radio
readiness **45**
Radio readiness **45**
– switched off **46**
– switched on **45**
Rain sensor **51**
Range, refer to Cruising
range **56**
RDS **110**
Reading lamps **80**
Rear fog lamp
– indicator lamp **169**
Rear lamps
– bulb replacement **159**
Rear lamps, refer to Tail
lamps **158**

Rear-mounted luggage
rack **103**
Rear seat backrest, folding **98**
Rear seats
– adjusting **36**
– folding down the
backrests **98**
Rearview mirror
– compass **88**
Rearview mirror, refer to
Mirrors **39**
Rear window
– windshield wiper **52**
Rear window defroster **82, 84**
Rear window safety switch **33**
Reception
– quality **110**
– radio station **109**
Recirculated-air mode **82, 84**
Recirculation of air, refer to
Recirculated-air
mode **82, 84**
Reclining seat, refer to
Backrest **35**
Refueling **134**
Rejecting a call **126**
Releasing
– hood **146**
Remote control **22**
– battery renewal **31**
– Comfort Access **30**
– garage door opener **86**
– malfunctions **25, 31**
– service data **149**
– tailgate **25**
Replacement remote
control **22**
Replacing bulbs, refer to
Lamps and bulbs **155**
Replacing tires, refer to New
wheels and tires **143**
Reporting safety defects **7**
Reserve warning, refer to Fuel
gauge **55**
Reservoir for washer
systems **53**

Reset, resetting tone
settings **109**
Restraint systems
– for children **41**
– refer to Safety belts **37**
Reverse
– CD **113**
Reverse gear
– automatic transmission with
Steptronic **48**
– manual transmission **47**
Roadside Assistance **165**
Roadside parking lamps **79**
– replacing bulb **157**
Road worthiness test, refer to
Service requirements **61**
Roof load capacity **186**
Roof-mounted luggage
rack **103**
Rope, refer to Tow-starting,
towing away **168**
RSC Run-flat System
Component, refer to Run-flat
tires **143**
Rubber parts, care **153**
Run-flat System Component
RSC, refer to Run-flat
tires **143**
Run-flat tires **143**
– flat tire **69**
– Flat Tire Monitor **69**
– tire inflation pressure **136**
– tire replacement **143**
– winter tires **144**

S

Safety belt
– number **34**
Safety Belt Reminder **39**
Safety belts **37**
– center belt **38**
– damage **39**
– indicator lamp **39**
– reminder **39**
– sitting safely **34**
Safety belts, care **154**

- Safety systems
 - airbags [73](#)
 - Antilock Brake System ABS [65](#)
 - driving stability control systems [65](#)
 - Dynamic Stability Control DSC [65](#)
 - safety belts [37](#)
- Safety tires, refer to Run-flat tires [143](#)
- Satellite radio [111](#)
 - activating [112](#)
- Scan, listening to test
 - radio MINI Boost CD [110](#)
- Screw thread for tow fitting [167](#)
- Searching
 - CD player [113](#)
 - radio [109](#)
- Searching for a music track
 - CD [113](#)
- Seat adjustment
 - mechanical [35](#)
 - rear [36](#)
- Seats [35](#)
 - adjusting the seats [35](#)
 - heating [37](#)
 - sitting safely [34](#)
- Securing the vehicle
 - from inside [26](#)
 - from outside [23](#)
- Selector lever
 - automatic transmission with Steptronic [48](#)
- Selector lever lock
 - automatic transmission with Steptronic, refer to Shiftlock [48](#)
 - overriding manually [49](#)
- Selector lever positions
 - automatic transmission with Steptronic [48](#)
- Service, refer to Roadside Assistance [165](#)
- Service car, refer to Roadside Assistance [165](#)
- Service data in the remote control [149](#)
- Service Interval Display, refer to Condition Based Service CBS [149](#)
- Service requirement display, refer to Condition Based Service CBS [149](#)
- Service requirements [61](#)
- Settings
 - clock, 12 h/24 h mode [59](#)
- Settings and information [57](#)
- Setting the date [109](#)
- Setting the time format [109](#)
- Setting tone controls [109](#)
- Shifting gears
 - automatic transmission with Steptronic [49](#)
 - manual transmission [47](#)
- Shiftlock
 - automatic transmission, refer to Changing selector lever positions [48](#)
- Shift paddles [49](#)
- Side airbags [73](#)
- Side marker lamps, replacing bulbs [158](#)
- Side turn signal
 - replacing bulb [158](#)
- Side windows, refer to Windows [32](#)
- Signal horn, refer to Horn [10](#)
- Sitting safely [34](#)
 - airbags [34](#)
 - safety belts [34](#)
 - with head restraint [34](#)
- Size, refer to Dimensions [185](#)
- Sliding/tilt sunroof
 - refer to Glass roof, electric [31](#)
- Slot for remote control [45](#)
- Smokers' package, refer to Ashtray [93](#)
- Snap-in adapter
 - inserting/removing [130](#)
 - use [120](#)
- Snap-in adapter, refer to Center armrest storage compartment [90](#)
- Snow chains [144](#)
- Socket, refer to Connecting electrical appliances [93](#)
- Socket for On-Board Diagnosis OBD [150](#)
- Special oils, refer to Approved engine oils [147](#)
- Speed [184](#)
 - with winter tires [144](#)
- Speed-dependent volume [108](#)
- Speedo, refer to Speedometer [12](#)
- Speedometer [12](#)
- Split rear seat backrest, refer to Expanding the cargo area [98](#)
- Sport button [67](#)
- Stability control, refer to Driving stability control systems [65](#)
- Start/Stop button [45](#)
 - starting the engine [46](#)
 - switching off the engine [46](#)
- Starting, refer to Starting the engine [46](#)
- Starting assistance, refer to Jump-starting [165](#)
- Starting the CD player [113](#)
- Starting the engine [46](#)
- Start/Stop button [45](#)
- Start-off assistance, refer to
 - DSC [65](#)
 - Hill Assist [67](#)
- Stations, refer to Radio MINI Boost CD [110](#)
- Status of this Owner's Manual at time of printing [4](#)
- Steering wheel [40](#)
 - adjustment [40](#)
 - buttons on steering wheel [11](#)
 - lock [45](#)
 - shift paddles [49](#)

Steptronic, refer to Automatic transmission with Steptronic [47](#)
 Storage area
 – cargo area [98](#)
 Storage compartments [91](#)
 Storage space
 – storage compartments [91](#)
 Storing the vehicle [154](#)
 Storing tires [144](#)
 Stowage, refer to Storage compartments [91](#)
 Summer tires, refer to Wheels and tires [136](#)
 Switches, refer to Cockpit [10](#)
 Switching off
 – engine [46](#)
 Switching off the engine [46](#)
 – Start/Stop button [45](#)
 Switching on
 – CD player [108, 113](#)
 – radio MINI Boost CD [108](#)
 Switching the cooling function on and off [85](#)
 Symbols [4](#)

T

Tachometer [55](#)
 Tailgate [28](#)
 – Comfort Access [30](#)
 – opening/closing [28](#)
 – opening from outside [28](#)
 – unlocking with remote control [25](#)
 Tail lamp, refer to Tail lamps [158](#)
 – replacing bulb [158](#)
 Tail lamps [158](#)
 Tank volume, refer to Capacities [187](#)
 Technical data [184](#)
 Technical modifications [4](#)
 Telephone [120](#)
 – hands-free system [128](#)
 – installation location, refer to Center armrest [90](#)
 – voice commands [128](#)
 Temperature display
 – setting the units [59](#)
 Temperature of coolant, refer to Coolant temperature [148](#)
 Temperature setting
 – air conditioner [82](#)
 – automatic climate control [84](#)
 Tempomat, refer to Cruise control [53](#)
 Tensioning straps, refer to Securing cargo [102](#)
 Third brake lamp, refer to Center brake lamp [159](#)
 Three-point safety belt [37](#)
 Tightening the lug bolts
 – torque [163](#)
 Tightening torque, refer to Tightening lug bolts [163](#)
 Time
 – setting [109](#)
 Tire failure
 – Flat Tire Monitor [69](#)
 – indicator/warning lamp [69](#)
 – MINI Mobility Kit [160](#)
 – run-flat tires [69](#)
 – Tire Pressure Monitor [70](#)
 Tire inflation pressure [136](#)
 – loss [69](#)
 Tire pressure monitoring, refer to Flat Tire Monitor [68](#)
 Tire Pressure Monitor TPM [70](#)
 – limitations of system [70](#)
 – resetting system [70](#)
 – warning lamp [71](#)
 Tire Quality Grading [141](#)
 Tires
 – age [143](#)
 – breaking in [96](#)
 – changing, refer to Changing wheels [162](#)
 – condition [142](#)
 – damage [142](#)
 – inflation pressure [136](#)
 – inflation pressure loss [71](#)
 – minimum tread depth [142](#)
 – new tires [143](#)
 – pressure monitoring, refer to Flat Tire Monitor [68](#)
 – pressure monitoring, refer to Tire Pressure Monitor TPM [70](#)
 – puncture [69](#)
 – size [141](#)
 – wear indicators, refer to Minimum tread depth [142](#)
 – winter tires [144](#)
 – with emergency operation properties [143](#)
 Tires with emergency operation properties, refer to Run-flat tires [143](#)
 Tires with safety features, refer to Run-flat tires [143](#)
 Tone
 – middle setting [109](#)
 Torque [184](#)
 – lug bolts [163](#)
 Tow bar [167](#)
 Tow fitting [167](#)
 – screw thread [167](#)
 Tow fittings for tow-starting and towing away [167](#)
 Towing [166](#)
 – car with automatic transmission [167](#)
 – methods [167](#)
 Tow rope [168](#)
 Tow-starting [166](#)

TPM, refer to Tire Pressure Monitor **70**

Track width, refer to
Dimension **185**

Traction control, refer to
– Dynamic Stability Control
DSC **65**

Transmission
– automatic transmission with
Steptronic **47**
– manual transmission **47**
– overriding selector lever lock
for automatic transmission
with Steptronic **49**

Transporting children safely **41**

Transport securing devices,
refer to Securing cargo **102**

Tread depth, refer to Minimum
tire tread **142**

Trip-distance counter, refer to
Trip odometer **56**

Triple turn signal activation **50**

Trip odometer **56**

Turning circle, refer to
Dimensions **185**

Turn signal **50**
– front, replacing bulb **157**
– indicator lamp **12**
– rear, replacing bulb **158**
– side, replacing bulb **158**

Tying down loads, refer to
Cargo loading **102**

U

Uniform Tire Quality Grading
UTQR **141**

Units
– average fuel consumption **59**
– temperature **59**

Universal garage door opener,
refer to Integrated universal
remote control **86**

Universal remote control **86**

Unlatching, refer to
Unlocking **30**

Unlocking
– from inside **26**
– from outside **23**
– setting unlocking
behavior **23**
– tailgate **30**
– without remote control, refer
to Comfort Access **30**

Upholstery, care **153**

USB audio interface **115**

V

Vehicle
– battery **163**
– breaking in **96**
– cargo loading **98**
– dimensions **185**
– identification number, refer
to Engine compartment **145**
– parking **46**
– storage **154**
– weight **186**

Vehicle jack
– jacking points **162**

Ventilation
– air conditioner **85**

Ventilation, refer to Climate
control **81**

Vents, refer to Air vents **81**

Vents, refer to Ventilation **85**

Voice commands
– telephone **128**

Voice phone book **129**

Volume
– gong **108**
– mobile phone **125**
– PDC **108**
– setting speed-
dependent **108**

Volume of cargo area **186**

W

Warning and indicator
lamps **13, 169**

Warning messages, refer to
Check Control **62**

Warning triangle **165**

Washer/wiper system
– washer fluid **53**

Washer fluid **53**
– capacity of reservoir **53**

Washer fluid reservoir **53**

Waste tray, refer to Ashtray **93**

Waterfall lighting, refer to
Ambient lighting **80**

Water on roads, refer to
Driving through water **97**

Wear indicators in tires, refer to
Minimum tread depth **142**

Weights **186**

Welcome lamps **77**

Wheelbase, refer to
Dimensions **185**

Wheels, new **143**

Wheels and tires **136**

Width, refer to
Dimensions **185**

Windows **32**
– closing **32**
– convenience operation **24**
– opening **32**
– pinch protection system **33**
– safety switch **33**

Window washer, refer to
Washer fluid **53**

Window washer reservoir,
refer to Washer fluid
– volume, refer to
Capacities **187**

Window washer system **51**
– washer fluid **53**
– washer jets **52**

Windshield
– cleaning **52**
– defrosting and removing
condensation **83, 85**

Windshield wiper blades,
 changing 155
Windshield wipers, refer to
 Wiper system 51
Winter tires 144
– storage 144
Wiper blade replacement 155
Wiper system 51
WMA 113
Work in the engine
 compartment 146

X

Xenon lamps
– replacing bulb 156



01 40 2 914 828 ue

DRIVE ME.