



SkyEcho 2

Installation and Pilot's Guide



UAV-1002156-001

ECCN 7A994



Page 1 | 33

© 2019 uAvionix Corporation. All rights reserved.

uAvionix Corporation
300 Pine Needle Lane
Bigfork, MT 59911

<http://www.uavionix.com>

support@uavionix.com

Except as expressly provided herein, no part of this guide may be reproduced, transmitted, disseminated, downloaded or stored in any storage medium, for any purpose without the express written permission of uAvionix. uAvionix grants permissions to download a single copy of this guide onto an electronic storage medium to be viewed for personal use, provided that the complete text of this copyright notice is retained. Unauthorized commercial distribution of this manual or any revision hereto is strictly prohibited.

uAvionix® is a registered trademark of uAvionix Corporation, and may not be used without express permission of uAvionix.

1 Revision History

Revision	Date	Comments
A	8/8/18	Pre-transmit release of SE2. ADS-B only
B	8/28/18	Mode C/S Bearingless Targets, DoCC Approval
C	9/11/18	User feedback corrections
D	12/24/18	FLARM Functionality
E	02/09/19	Regional Setting
F	05/21/19	Removal of Mode C/S Bearingless Targets
G	10/26/19	Firmware Update Procedures / Removal of FlarmBridge
H	12/12/19	Review for AIC publication

2 Warnings / Disclaimers

All device operational procedures must be learned on the ground.

Received traffic information is to be used as an aid to situational awareness and is merely supplemental and advisory in nature.

uAvionix is not liable for damages arising from the use or misuse of this product.

This equipment is classified by the United States Department of Commerce's Bureau of Industry and Security (BIS) as Export Control Classification Number (ECCN) 7A994.

These items are controlled by the U.S. Government and authorized for export only to the country of ultimate destination for use by the ultimate consignee or end-user(s) herein identified. They may not be resold, transferred, or otherwise disposed of, to any other country or to any person other than the authorized ultimate consignee or end-user(s), either in their original form or after being incorporated into other items, without first obtaining approval from the U.S. government or as otherwise authorized by U.S. law and regulations.

3 Limited Warranty

uAvionix SkyEcho products are warranted to be free from defects in material and workmanship for one year from purchase. For the duration of the warranty period, uAvionix, at its sole option, will repair or replace any product which fails in normal use. Such repairs or replacement will be made at no charge to the customer for parts or labor, provided that the customer shall be responsible for any transportation cost.

This warranty does not apply to cosmetic damage, consumable parts, damage caused by accident, dropping, abuse, misuse, water, fire or flood, damage caused by unauthorized servicing, or product that has been modified or altered.

IN NO EVENT SHALL UAVIONIX BE LIABLE FOR ANY INCIDENTAL, SPECIAL, INDIRECT OR CONSEQUENTIAL DAMAGES, WHETHER RESULTING FROM THE USE, MISUSE OR INABILITY TO USE THE PRODUCT OR FROM DEFECTS IN THE PRODUCT. SOME STATES DO NOT ALLOW THE EXCLUSION OF INCIDENTAL OR CONSEQUENTIAL DAMAGES, SO THE ABOVE LIMITATIONS MAY NOT APPLY TO YOU.

Warranty Service

Warranty repair service shall be provided directly by uAvionix.

4 Contents

1	Revision History	3
2	Warnings / Disclaimers	4
3	Limited Warranty	5
5	Introduction	8
5.1	Features	9
5.2	Regulatory Compliance.....	10
5.2.1	CAA CAP 1391 Declaration	10
6	Specifications	12
7	Limitations	13
7.1	Installation	13
8	Equipment Installation and Configuration.....	16
8.1	Mounting.....	16
8.2	Connections	17
8.3	Installation Setup.....	17
8.3.1	Connecting to the SkyEcho2 via Wi-Fi.....	17
8.3.2	1090ES Transmit.....	20
8.3.3	Receiver Mode	20
8.3.4	Region	21
8.3.5	Aircraft Address Programming (ICAO Address)	21
8.3.6	Call Sign	21
8.3.7	Emitter Category	22
8.3.8	VFR Squawk.....	23
8.3.9	ADS-B IN Capability	24
8.3.10	Air/Ground Threshold Speed VSO (knots).....	24
8.3.11	Aircraft Length and Width in Meters.....	24
8.3.12	GPS Antenna Offsets	25

UAV-1002156-001

ECCN 7A994



Page 6 | 33

8.4 Update and Confirm Configuration 25

9 Normal Operation..... 26

9.1 Battery Pack / Charging 26

9.2 Power On/Off 26

9.3 Indicators..... 26

9.4 Electronic Flight Bag Application 27

9.5 Transmit Control..... 28

10 Firmware Update Procedure..... 28

10.1 Configuration Setup 28

10.1.1 Connecting to the SkyEcho 2 via Wi-Fi..... 28

10.2 Update Transceiver Software 30

10.3 Wi-Fi Firmware..... 32

11 Contact uAvionix 33

5 Introduction

The SkyEcho 2 is a portable ADS-B transceiver. It incorporates the following into a single portable Electronic Conspicuity Device (ECD):

- 1090MHz ADS-B traffic receiver
- Secondary receiver which is selectable between 978 MHz UAT ADS-B or 868 MHz FLARM
- 1090 MHz Class A0 transmitter limited to 20W.
- Precision WAAS GPS meeting the performance requirements of TSO-C199 Class B
- Barometer
- Wi-Fi support for interface to EFB applications and support function

SkyEcho 2 is designed to meet the performance requirements of United Kingdom (UK) Civil Aviation Authority (CAA) Electronic Conspicuity (EC) CAP 1931, version 2, dated April 11, 2018.



EC devices are intended for voluntary carriage on registered and non-registered UK Annex II aircraft, non-complex EASA aircraft of <5700kg MTOM and for gliders and balloons (including those covered under ELA 1 and ELA 2) within uncontrolled UK airspace.



An EC device must not transmit on 1090Mhz at the same time as a Mode S transponder *enabled*¹ for Extended Squitter (aka ADS-B Out), and it doesn't replace the need for a transponder when required by airspace/flight rules. If a Mode S ES enabled (ADS-B Out) transponder is fitted and working then the EC device must have transmission switched off.



An internal geofence prevents SkyEcho 2 from transmission within North America. Within North America, receive functionality is supported.

¹ A Mode S ES *capable* transponder is ADS-B *enabled* if it has been connected to a GNSS position source.

5.1 Features

The SkyEcho 2 performs the following functions:

- 1090ES ADS-B 1090MHz reception
 - Receives ADS-B In data from aircraft equipped with 1090 MHz Extended Squitter transmitters.
- 978MHz UAT reception (Selectable Option)
 - Receives ADS-B In data from aircraft equipped with 978 MHz UAT transmitters. Receives Flight Information Services (FIS) and Traffic Information Services (TIS) compliant with UAT where available.
- FLARM® Receiver (Selectable Option)
 - For customers with participating EFB applications, there is an ability to choose FLARM reception capability. Two options exist:
 - FLARM Compatible Proximity Warnings – With this feature, the EFB will alert the user to the proximity nearby FLARM equipped aircraft. This option is presented as a bearingless target. This option requires no FLARM license.
 - FLARM Reception – With this feature, the EFB will present the location of FLARM equipped aircraft on the moving map. This option requires a FLARM license acquired through each EFB application.
 - For a list of compatible EFB's, visit <http://www.uavionix.com>
- 1090ES transmission (1090 MHz)
 - Transmits ADS-B Out data on the 1090 MHz frequency.
- SBAS GPS reception
 - High precision SBAS GPS meeting performance requirements of TSO-C199, transmitting a Source Integrity Level (SIL) value

of 1, ensuring ATC and airborne avionics can receive and trust the GPS position being transmitted.

- Barometric Altimeter for pressure altitude
- Traffic correlation
 - Traffic information is correlated to provide a coherent view of nearby aircraft.
- GDL 90 output (via Wi-Fi)
 - Traffic, ownship GPS, barometric pressure, and FIS/TIS data are translated to standard GDL 90 format for Wi-Fi transmission to compatible situational display applications.
- Wi-Fi EFB connection
 - The GDL 90 data is transmitted over the built-in Wi-Fi interface for reception by standards compliant with Electronic Flight Bag (EFB) applications.
- Integrated rechargeable battery
 - The integrated rechargeable battery provides 12 hours of continuous use. The battery is recharged through USB-C connection, which can also provide power to SkyEcho 2 directly when connected to a USB power source.

5.2 Regulatory Compliance

The SkyEcho 2 meets the Minimum Operational Performance Standards of DO-260B Class A0 with the output power limited to 20W and the SBAS GNSS receiver meets the performance requirements of TSO-C199.

5.2.1 CAA CAP 1391 Declaration

An EC device that operates using ADS-B at 1090MHz must have a Declaration of Capability and Conformance (DoCC) from the manufacturer before you can legally use it on board an aircraft. The pilot in command of the aircraft is responsible for ensuring that the EC device has a valid declaration.

Reference number	Issue number	Manufacturer	Type number	Category
------------------	--------------	--------------	-------------	----------

UAV-1002156-001

ECCN 7A994



UK.CAA.DoCC.000007	Issue 0	uAvionix Inc	SkyEcho 2	Intermediate
--------------------	---------	--------------	-----------	--------------

Please refer to the CAA EC Web page for more information:

<https://www.caa.co.uk/General-aviation/Aircraft-ownership-and-maintenance/Electronic-Conspicuity-devices/>

6 Specifications

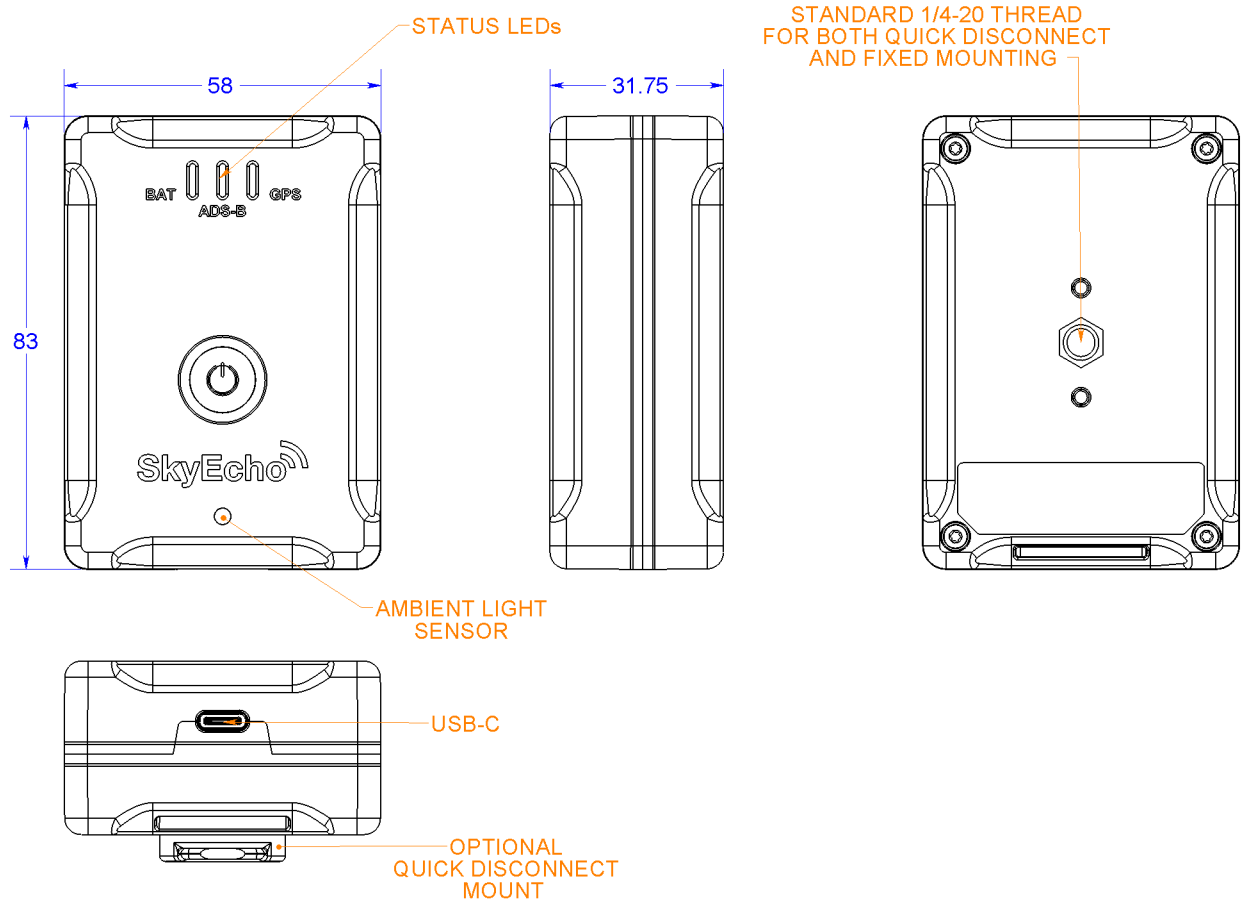

UAV-1002156-001

ECCN 7A994



Specification	Value
Input Power	5V USB 500mW
Size	58x83x32mm
Weight	120grams
SIL/SDA	1/0 (CAP 1391 Requirement)
Operating Temp	-45 to 80°C
Transmitter	
Frequency	1090MHz ±1MHz
Transmit Power	20W Nominal
Spectral Performance	DO-260B
Receiver	
MTL 1090MHz	-88dBm
1090 Dynamic Range	-87 to 0dBm
MTL 978MHz	-99dBm
978 Dynamic Range	-99 to 10dBm
SBAS GPS	
Augmentation	SBAS
Sensitivity	-167dBm
Altimeter	
Range	-1000 to 60,000ft
Interfaces	
	WIFI
Control	GDL 90
Ownship	GDL 90
Battery	
	Internal 12-hour operating life

7 Limitations

7.1 Installation

SkyEcho 2 is a completely self-contained portable device with no required installation for external antenna, power source, or physical installation into the aircraft.

Transmission and reception performance are affected by antenna placement within the aircraft and is subject to airframe shadowing. Best performance is achieved when the SkyEcho 2 is placed vertically orientated on the aircraft window mounted with the suction cup mount in a forward or side facing window with clear line of sight visibility in the direction of travel and clear visibility to the sky for GPS reception.

UAV-1002156-001

ECCN 7A994



Modifications and use outside of intended scope

This device has been designed and tested to conform to all applicable standards in the original form and when configured with the components shipped with the device. It is not permissible to modify the device, use the device for any use outside of the intended scope, or use the device with any antenna other than the one shipped with the device.

Important Pilot Advisory Note Regarding Safety of Radio Frequency Energy

Safe use of this device requires care as to the placement of the antenna. Place the antenna at least 4cm away from any part of your body or that of other cabin occupants. To stop all RF emissions, remove power from the equipment or configure the equipment for receive mode only. Retain these instructions with your maintenance logs/files and for future reference.

FCC RF Radiation Exposure Statement

This equipment complies with FCC RF radiation exposure limits (Table 1 of 47Pt1 (i) 1.1310) set forth for a Public/Uncontrolled environment.

Mode-S Extended Squitter (ES) Enabled Transponders

According to CAP1391, if an aircraft has an operating Mode-S ES Enabled (ADS-B Out) transponder fitted, the SkyEcho transmitter must be deactivated. Receive functionality may still be used. Deactivation of the transmitter is accomplished by removing device power or disabling the transmit capability via the configuration settings. These regulations are subject to change. Please be informed of the most current regulations at:

<https://www.caa.co.uk/General-aviation/Aircraft-ownership-and-maintenance/Electronic-Conspicuity-devices/>

Proximity to other equipment

Mount the SkyEcho 2 so that it does not compromise the operation of any other proximate communication or navigation antenna or system. It may be possible to hear transmissions through installed audio equipment, such as headsets.

UAV-1002156-001

ECCN 7A994



Altimeter Cross Check

The reported altitude must be cross-checked against the aircraft's altimeter during pre-flight.

Harmful Interference

It is the responsibility of the pilot to ensure that the transceiver causes no harmful interference to other onboard equipment and systems.

Configurable Options

Accessing or altering configurable options not intended to be operated during flight by the pilot in command, as this may cause pilot distraction.

See and Avoid

The SkyEcho 2 is intended to be an aid to 'see and avoid'. Manoeuvres to regain adequate separation should not be based on alerts issued by this device or connected applications alone.

Approvals

Approvals do not cover adaptations to the aircraft necessary to accommodate ancillary equipment such as power provisions, mounting devices or external antennas, such items must still be approved under existing minor modification/change processes applicable to the aircraft.

Warning: This transceiver is to be used to improve pilot situational awareness only and as a navigational aid. It is not intended for use in IFR flight conditions. uAvionix is not responsible for the transceiver's end use and will not be held liable for any events occurring from its use or misuse.

Usage Outside of the United Kingdom

Transmit functionality is currently approved for use only in the United Kingdom. If flying outside of the UK, configure the device for receive functionality only or consult your local regulator for approval.

8 Equipment Installation and Configuration

This section describes the installation and configuration of the SkyEcho 2 and related accessories in the aircraft, including mounting, wiring, and connections.

8.1 Mounting

SkyEcho 2 is approved as a portable ECD. SkyEcho 2 should be placed vertically orientated on an aircraft window with the optional suction cup mount with line of sight and visibility in the direction of travel and to the sky for the internal GPS. Installation location can significantly impact the receive and transmit range of the device.



8.2 Connections

1. Connect a USB-C cable to the USB-C port in order to provide direct power or to charge the battery. While the device is charging, a blue BAT LED will remain lit. When the device has completed charging the blue LED will extinguish.
2. Care should be taken to make sure all devices are secure and will not interfere with pilot visibility or aircraft operation.

8.3 Installation Setup

Configuration of the SkyEcho 2 is accomplished by logging on to the device directly from a computer or mobile device using the SkyEcho 2 internal Wi-Fi hotspot. No additional application is necessary.

8.3.1 Connecting to the SkyEcho2 via Wi-Fi

1. To connect to the SkyEcho 2, power on SkyEcho 2 and join a device to the wireless network SSID named SKYECHO-XXXX using the procedure for your device. This procedure is identical to joining any other public or private Wi-Fi on your chosen device.
2. If required, enter **uavionix** as the WPA password for the secure Wi-Fi network, then tap join. Note: *The No Internet Connection* message is normal when connected to SkyEcho 2.

3. Open any browser on your computer/mobile device that is connected to your SkyEcho via the Wi-Fi link and type in 192.168.4.1

The following landing page should load:

This page will show the SkyEcho status.

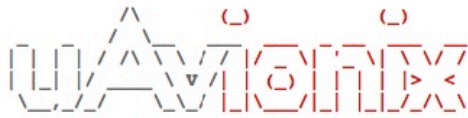

Wi-Fi Version: 0.2.19RC-SkyEcho [Update](#)
ADS-B Version: 2.6.9 [Update](#)
SSID: SkyEcho_5DA9
Clients Connected: 2

[SkyEcho Setup](#)
[WiFi Settings](#)

Current Status

ICAO Address	000000
Callsign	*****
GPS Fix	3D
GPS Sats	5
Position	51.68344, -0.6964751
GNSS Altitude	715 ft
Pressure Altitude	1407 ft
NIC	6
NACp	8

Click on “SkyEcho Setup” to configure SkyEcho with your aircraft information.

A configuration page similar to the following should load:

ADS-B Setup

 Configuration loaded.

Setup

1090ES Transmit:	<input type="checkbox"/> Enable	Receiver Mode:	<input checked="" type="radio"/> UAT <input type="radio"/> FLARM <input type="radio"/> 1090ES
Region:	<input checked="" type="radio"/> UK/EU <input type="radio"/> AUS		
ICAO Address (hex):	<input type="text" value="000000"/>	Callsign:	<input type="text" value="*****"/>
FLARM ID (hex):	<input type="text"/>	Ownship Filter:	<input type="checkbox"/> Filter ADS-B <input type="checkbox"/> Filter FLARM
Emitter Category:	<input type="text" value="Light"/>	VFR Squawk:	<input type="text" value="7000"/>
ADS-B In Capability:	<input type="checkbox"/> 1090ES <input type="checkbox"/> UAT	V _{so} (knots):	<input type="text" value="10"/>
Aircraft Length:	<input type="text" value="L ≤ 15 m"/>	Aircraft Width:	<input type="text" value="W ≤ 23 m"/>
Lateral GPS Offset:	<input type="text" value="Center"/>	Longitudinal GPS Offset (m):	<input type="text" value="0"/>

Apply

Reset to defaults

[Main Page](#)

For proper operation the following parameters must be configured:

- 1090ES Transmit
- Receiver Mode
- ICAO Address (hex)
- Call Sign
- FLARM ID (hex)
- Ownship Filter ADS-B Out / FLARM Out
- Emitter Category
- VFR Squawk
- ADS-B In Capability
- Air/Ground Threshold Speed (V_{so})
- Aircraft Length
- Aircraft Width
- Lateral GPS Offset
- Longitudinal GPS Offset

After configuration of your parameters click on “Apply” to save.

ADS-B Setup

 Configuration loaded.

Setup

1090ES Transmit:	<input type="checkbox"/> Enable	Receiver Mode:	<input checked="" type="radio"/> UAT <input type="radio"/> FLARM <input type="radio"/> 1090ES
Region:	<input checked="" type="radio"/> UK/EU <input type="radio"/> AUS		
ICAO Address (hex):	<input type="text" value="000000"/>	Callsign:	<input type="text" value="*****"/>
FLARM ID (hex):	<input type="text"/>	Ownship Filter:	<input type="checkbox"/> Filter ADS-B <input type="checkbox"/> Filter FLARM
Emitter Category:	<input type="text" value="Light"/>	VFR Squawk:	<input type="text" value="7000"/>
ADS-B In Capability:	<input type="checkbox"/> 1090ES <input type="checkbox"/> UAT	V _{so} (knots):	<input type="text" value="10"/>
Aircraft Length:	<input type="text" value="L ≤ 15 m"/>	Aircraft Width:	<input type="text" value="W ≤ 23 m"/>
Lateral GPS Offset:	<input type="text" value="Center"/>	Longitudinal GPS Offset (m):	<input type="text" value="0"/>

[Main Page](#)

8.3.2 1090ES Transmit

This setting configures SkyEcho 2 for transmission. Select the checkbox to enable transmission. (Note: Transmit functionality is currently approved for use only in the United Kingdom. If flying outside of the UK, configure the device for receive functionality only or consult your local regulator for approval.)

Deselect the checkbox to disable transmission.

8.3.3 Receiver Mode

The SkyEcho 2 contains dual receivers. The primary receiver is configured for 1090MHz ADS-B. The secondary receiver can be configured for either 978MHz UAT ADS-B, or FLARM® Reception. Only one option can be selected.

When selecting UAT, SkyEcho 2 will be able to receive 978MHz UAT ADS-B weather and traffic information.

UAV-1002156-001

ECCN 7A994



When selecting FLARM, encrypted FLARM data is received and transmitted to the EFB application for processing. Specific FLARM functionality (proximity warnings or FLARM target depiction) is dependent upon the EFB functionality implemented.

8.3.4 Region

Settings for either UK/Europe or Australia are preset by selecting the appropriate checkbox to the region in which you will operate. Note FLARM reception is not applicable to Australia.

8.3.5 Aircraft Address Programming (ICAO Address)

The ICAO address is a 24-bit number issued to the aircraft by the registration authority of the aircraft. These addresses are usually written as a 6-digit hexadecimal number, although you may also encounter one written as an 8-digit octal number. The SkyEcho 2 understands the hexadecimal format, so you must first convert an octal number to hexadecimal before entering. Sometimes this value is referred to as Mode S code. In the UK to find the ICAO address of the aircraft you will be flying go to <https://siteapps.caa.co.uk/g-info/>

Refer to UK CAA guidance for using 24-bit addresses with EC devices at the following URL:

<https://www.caa.co.uk/General-aviation/Aircraft-ownership-and-maintenance/Electronic-Conspicuity-devices/>

8.3.6 Call Sign

CALL SIGN is an 8-digit code that corresponds to the tail number of the aircraft. (0-9, A-F). The value should be entered without dashes: G-ABCD should be entered as GABCD.

8.3.7 FLARM ID

If you have a separate FLARM transmitting device in the aircraft, you can enter its allocated FLARM ID code here. This in conjunction with the Ownship Filter function (see next para) will stop your EFB self alarming from your own transmission.

8.3.8 Ownship Filter ADS-B / FLARM

If you have either an Extended Squitter (ES) enabled Mode S transponder (aka ADS-B Out) fitted to your aircraft or you have enabled 1090ES transmit (ADS-B Out) on your SkyEcho 2, you can select ADS-B Ownship Filter to stop your EFB self alarming or displaying a 'ghost' of your own aircraft. This requires that you also set the correct Mode S/ADS-B hex code for your aircraft. Similarly, if you have a FLARM transmitting device in your aircraft, you can filter out its transmissions to stop your EFB self alarming or 'ghosting' based on this transmission. As with ADS-B, you must first set your FLARM ID code to enable this filter.

8.3.9 Emitter Category

To assist ATC tracking of aircraft, an aircraft category is transmitted. Select the aircraft category that most closely matches the aircraft. Note EC devices are not approved for all emitter categories. EC devices are intended for voluntary carriage on registered and non-registered UK Annex II aircraft, non-complex EASA aircraft of <5700kg MTOM and for gliders and balloons (including those covered under ELA 1 and ELA 2) within uncontrolled UK airspace.

Emitter Category can be set as follows:

Emitter Category	Description
Light Airplane	Any airplane with a maximum takeoff weight less than 15,500 pounds. This includes very light aircraft (light sport aircraft) that do not meet the requirements of US 14 CFR Section 103.1.
Small Airplane	Any airplane with a maximum takeoff weight greater than or equal to 15,500 pounds but less than 75,000 pounds.
Large Airplane	Any airplane with a maximum takeoff weight greater than or equal to 75,000 pounds but less than 300,000 pounds that does not qualify for the high vortex category.

Emitter Category	Description
Large Airplane with High Vortex	Any airplane with a maximum takeoff weight greater than or equal to 75,000 pounds but less than 300,000 pounds that has been determined to generate a high wake vortex. Currently, the Boeing 757 is the only example.
Heavy Airplane	Any airplane with a maximum takeoff weight greater than or equal to 300,000 pounds.
Highly Maneuverable Airplane	Any airplane, regardless of weight, which can maneuver in excess of 5 G's and maintain true airspeed above 400 knots.
Rotorcraft	Any rotorcraft regardless of weight.
Glider / Sailplane	Any glider or sailplane regardless of weight.
Lighter than Air	Any lighter than air (airship or balloon) regardless of weight.
Parachute	Any parachute / skydiver.
Ultralight Vehicle	A vehicle that meets the requirements of US 14 CFR Section 103.1. Light sport aircraft should not use the ultralight emitter category unless they meet US 14 CFR Section 103.1.
Emitter Category	Description
UAV	Any unmanned aerial vehicle or unmanned aircraft system regardless of weight
Space	Any spacecraft or trans-atmospheric vehicle.
Surface Vehicle - Emergency	Any ground vehicle in operation at an airport providing emergency services.
Surface Vehicle - Service	Any ground vehicle in operation at an airport NOT providing emergency services.
Point Obstacle	Point obstacle including tethered balloons.
Cluster Obstacle	Cluster obstacle.
Line Obstacle	Line obstacle.

8.3.10 VFR Squawk

The SkyEcho 2 transmits a squawk code. Note that this is in a different Downlink Format field from your aircraft transponder and will be recognized UAV-1002156-001

by ATC as originating from an EC device; it cannot be interrogated. Enter the standard VFR squawk code (7000) in the SkyEcho 2 setup page. Set squawks as instructed by ATC on your aircraft's transponder during flight. There is no need to alter the squawk set in your SkyEcho which can remain on the VFR squawk.

8.3.11 ADS-B IN Capability

This selection is applicable for ground stations providing TIS-B functionality. Any selection here is not applicable in the UK. See 8.3.3 for receiver settings.

8.3.12 Air/Ground Threshold Speed VSO (knots)

This parameter allows the SkyEcho 2 to automatically switch between airborne and ground modes, which affects reception by other ADS-B receivers. Enter the stall airspeed (in kts) of the aircraft in landing configuration. (0-999 knots).

8.3.13 Aircraft Length and Width in Meters

Note that air/ground behavior for ADS-B is established as per FAA RTCA DO-260B and is dependent upon the emitter category selected.

On the ground, ADS-B transmits encoded aircraft size information which is used by ATC to identify taxiing routes and potential conflicts. Enter the length and width (wingspan) (meters) fields and the appropriate size codes will be calculated for transmission.

Enter the Aircraft Length in Meters

$L \leq 15$	$55 < L \leq 65$
$15 < L \leq 25$	$65 < L \leq 75$
$25 < L \leq 35$	$75 < L \leq 85$
$35 < L \leq 45$	$L > 85$
$45 < L \leq 55$	

Enter the Aircraft Width (wing span) in Meters

$W \leq 72.5$

$72.5 < W \leq 80$

8.3.14 GPS Antenna Offsets

The GPS antenna offset is used in conjunction with the length and width to manage taxiway conflicts. A typical GPS does not report the geographic position of the center of the aircraft, or even the tip of the nose of the aircraft; instead, it usually reports the location of the actual GPS antenna (not the GPS receiver). In normal flight operation this distinction is of no importance at all, but if ADS-B is used to manage taxiway conflicts, a significant offset in antenna position could mean that the aircraft footprint is not in the same place as the ADS-B reported position. Although the GPS Antenna Offset is primarily intended for position correction on large transport aircraft, General Aviation aircraft can also have a significant offset. For example, if the aircraft has a long tail boom and the GPS antenna is on top of the tail, the GPS position could be 4 meters or more from the nose of the aircraft.

Enter the GPS Antenna Offset Lateral from Roll axis (Meters)

0	Right 2
Left 2	Right 4
Left 4	Right 6
Left 6	

Enter the GPS Antenna Offset Longitudinal from Aircraft nose (Meters)

0 to 60 Meters in 2 Meter increments

8.4 Update and Confirm Configuration

1. After entering the correct information for all fields press Apply. You should receive a message confirming the configuration at the top of the screen.

UAV-1002156-001

ECCN 7A994



2. Programming of the SkyEcho 2 is complete. You can disconnect your computer or mobile device from the Wi-Fi hotspot.

9 Normal Operation

9.1 Battery Pack / Charging

The integrated battery pack needs to be fully charged before use.

Connect the USB-C cable to the connector on the bottom of the SkyEcho 2 in order to charge the battery. The BLUE LED will remain lit during charging, and will extinguish when the battery is fully charged.

9.2 Power On/Off

Press and hold the momentary power switch for approximately 3 seconds to power the SkyEcho 2 on.

Press and hold the momentary power switch for approximately 3 seconds to power the SkyEcho 2 off.

9.3 Indicators

There are a 3 LEDs visible through the top cover of SkyEcho 2.

LED	Color	On
BAT	Blue	Battery Charging
BAT	Red	Battery Low (<33%)
BAT	Yellow	Battery 33%-66%
BAT	Green	Battery > 66%
ADS-B	Off	ADS-B receive only
ADS-B	Green (blinking)	ADS-B transmit/receive
GPS	Red	No GPS Lock
GPS	Yellow	2D GPS Lock
GPS	Green	3D GPS Lock

9.4 Electronic Flight Bag Application

Launch your GDL 90 compatible Electronic Flight Bag (EFB) application. Not all EFB applications support FLARM functionality.

Configure your EFB as necessary to access the device. Refer to your EFB instructions or EFB support team for configuration instructions.

Traffic and flight information should begin streaming to the application when in range.

Illustration: ForeFlight, SkyDemon, and EasyVFR displaying ADS-B traffic and weather from SkyEcho 2 is shown below.

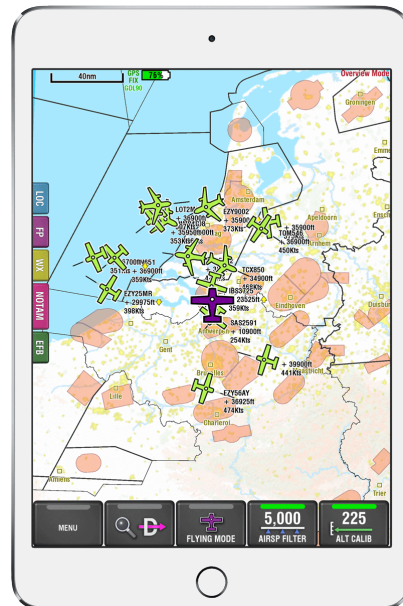

UAV-1002156-001

ECCN 7A994



Altitude must be pre-flight cross-checked by comparing the aircraft's altimeter with the GPS altitude displayed on the EFB application.

9.5 Transmit Control

According to UK CAP1391 regulations, EC device transmission must be deactivated when used on an aircraft with an Extended Squitter (ES) ADS-B Out Enabled Transponder in use. Note: a Mode S transponder is ADS-B **enabled** only when it is connected to a compatible GNSS source, which can be either internal or external to the transponder.

10 Firmware Update Procedure

10.1 Configuration Setup

Configuration of the SkyEcho 2 is accomplished by logging on to the device directly from a computer or mobile device using the SkyEcho 2 internal Wi-Fi hotspot. No additional application is necessary.

The following are procedures for updating the SkyEcho 2 firmware. You may be provided with one or two files to update, corresponding to the procedures below.

- Save the provided firmware file(s) to an accessible location on your computer or tablet prior to joining the SkyEcho 2 Wi-Fi hotspot.

10.1.1 Connecting to the SkyEcho 2 via Wi-Fi

1. To connect to the SkyEcho 2, power on SkyEcho 2 and join a device to the wireless network SSID named SKYECHO-XXXX using the procedure for your device. This procedure is identical to joining any other public or private Wi-Fi on your chosen device.

2. If required, enter **uavionix** as the WPA password for the secure Wi-Fi network, then tap join. Note: *The No Internet Connection* message is normal when connected to SkyEcho 2.

3. Open any browser on your computer/mobile device that is connected to your SkyEcho 2 via the Wi-Fi link and type in 192.168.4.1

The following landing page should load:

This page will show the SkyEcho 2 status.



Wi-Fi Version: 0.2.19RC-SkyEcho [Update](#)
ADS-B Version: 2.6.9 [Update](#)
SSID: SkyEcho_5DA9
Clients Connected: 2

[SkyEcho Setup](#)
[WiFi Settings](#)

Current Status

ICAO Address	000000
Callsign	*****
GPS Fix	3D
GPS Sats	5
Position	51.68344, -0.6964751
GNSS Altitude	715 ft
Pressure Altitude	1407 ft
NIC	6
NACp	8

10.2 Update Transceiver Software

Follow this procedure if you were given a Transceiver Software (*.uav) update file.

1. Click on the “ADS-B Version” Update Link:



2. Click on “Choose File”, navigate to the Transceiver Software firmware file (.uav), select it and click “Update.”

Ping Update

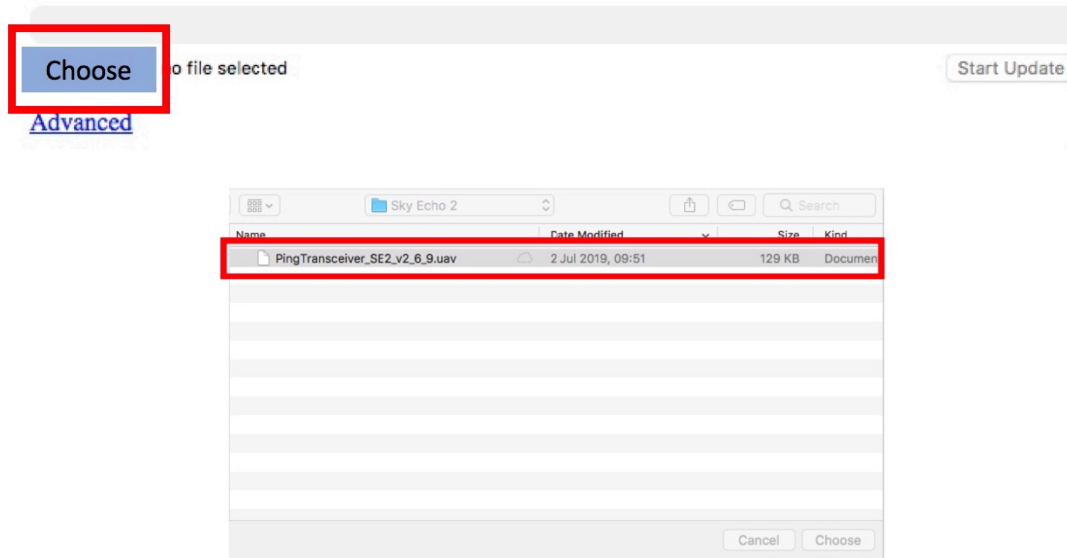

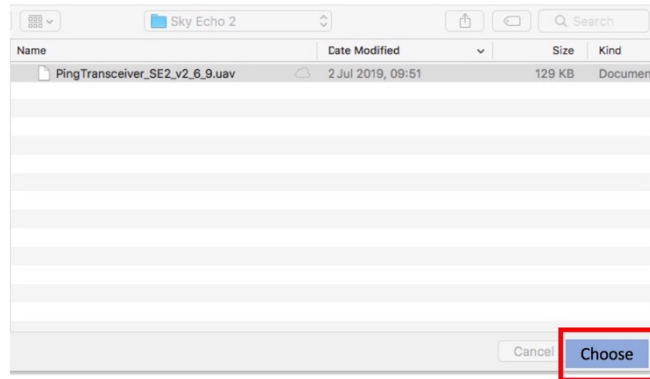

Ping Update



3. The system will update. You will see the following screen for a few seconds.

Update Ping ADS-B

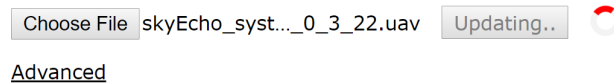

4. When complete, the following screen will appear:

Update success, device 1 restarting

[Return to status page](#)

5. Manually power off, then power back on SkyEcho 2 to reboot.

10.3 Wi-Fi Firmware

Follow these instructions if you were given Wi-Fi update firmware (*.bin).

1. **Reconnect to the SkyEcho 2 hotspot as described above.**
2. Open a web browser and navigate to 192.168.4.1
3. Click on the “Wi-Fi Version” Update Link:



6. Click on “Choose File”, navigate to the Wi-Fi firmware file (.bin), select it and click “Update.”

ESP32 Update

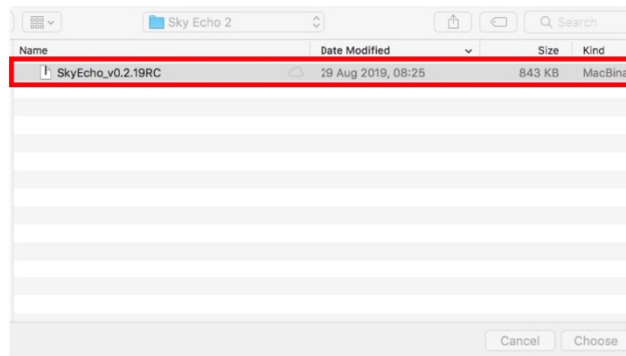
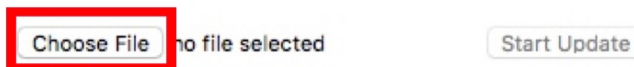

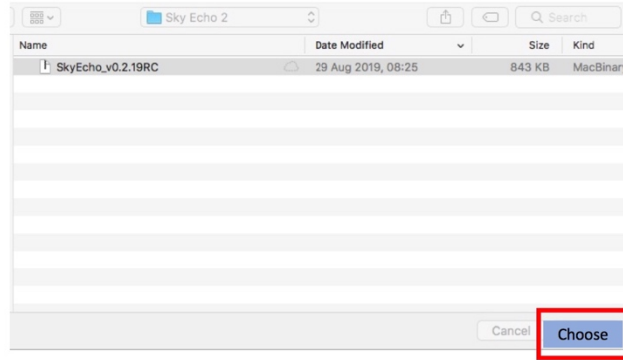

ESP32 Update



7. The system will update.
8. When complete, go back to the main page to confirm both ADS-B and Wi-Fi versions match the files delivered.
9. Reboot the SkyEcho 2 by manually turning power off, then back on

Contact uAvionix

For additional questions or support please visit <http://uavionix.com/support>