

TASCAM

D01219420D

DP-32SD

Digital Multitrack Recorder

OWNER'S MANUAL

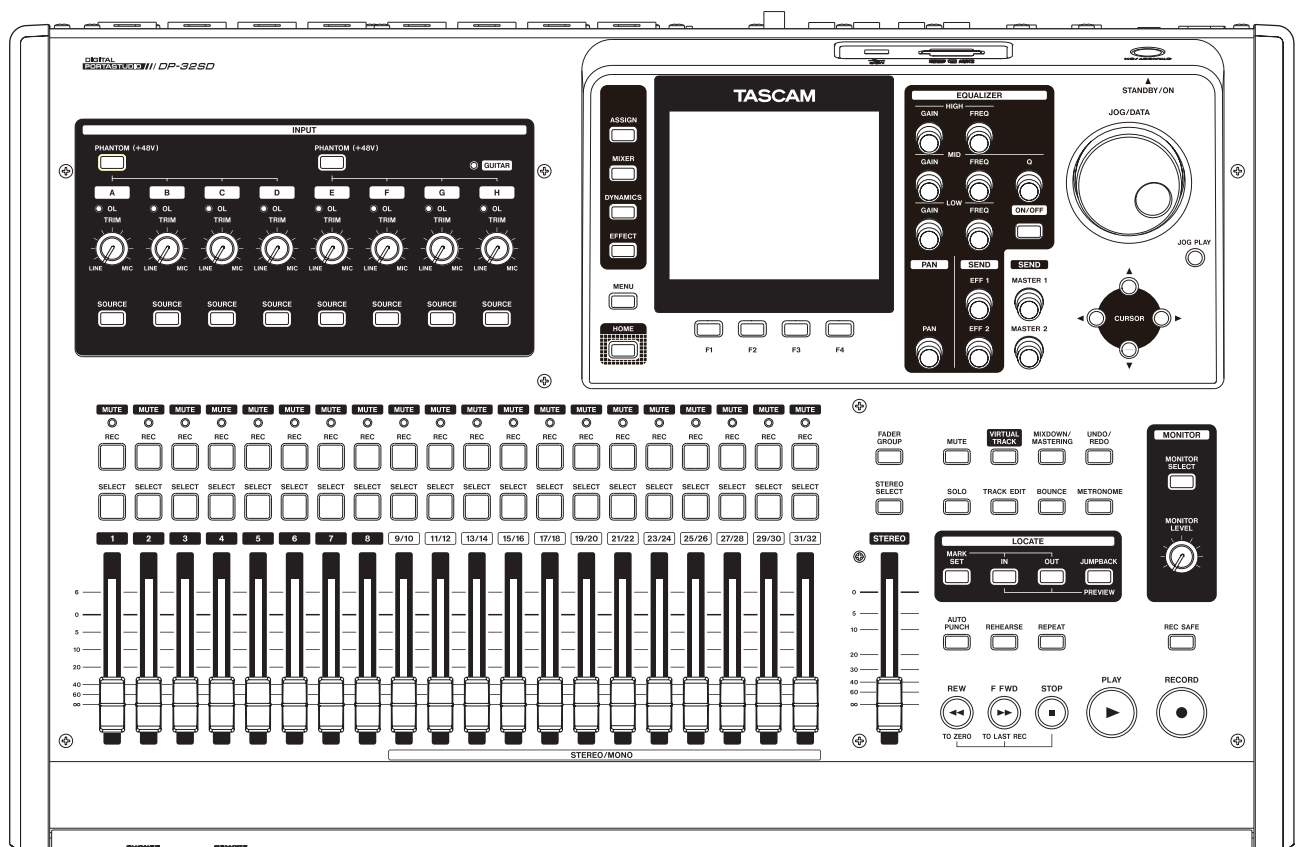

IMPORTANT SAFETY PRECAUTIONS

For U.S.A.

This equipment complies with Part 15 of FCC Rules. Operation is subject to the following two conditions:

- 1) This device may not cause interference and
- 2) This device must accept any interference, including interference that may cause undesired operation of the device.

INFORMATION TO THE USER

This equipment has been tested and found to comply with the limits for a Class B digital device, pursuant to Part 15 of the FCC Rules. These limits are designed to provide reasonable protection against harmful interference in a residential installation. This equipment generates, uses, and can radiate radio frequency energy and, if not installed and used in accordance with the instruction manual, may cause harmful interference to radio communications. However, there is no guarantee that interference will not occur in a particular installation. If this equipment does cause harmful interference to radio or television reception, which can be determined by turning the equipment off and on, the user is encouraged to try to correct the interference by one or more of the following measures.

- a) Reorient or relocate the receiving antenna.
- b) Increase the separation between the equipment and receiver.
- c) Connect the equipment into an outlet on a circuit different from that to which the receiver is connected.
- d) Consult the dealer or an experienced radio/TV technician for help.

CAUTION

Changes or modifications to this equipment not expressly approved by TEAC CORPORATION for compliance could void the user's authority to operate this equipment.

WARNING: TO PREVENT FIRE OR SHOCK HAZARD, DO NOT EXPOSE THIS APPLIANCE TO RAIN OR MOISTURE.

For Canada

THIS CLASS B DIGITAL APPARATUS COMPLIES WITH CANADIAN ICES-003.CET

APPAREIL NUMERIQUE DE LA CLASSE B EST CONFORME A LA NORME NMB-003 DU CANADA.



This product complies with the European Directives request and the other Commission Regulations.

IMPORTANT SAFETY INSTRUCTIONS

- 1 Read these instructions.
- 2 Keep these instructions.
- 3 Heed all warnings.
- 4 Follow all instructions.
- 5 Do not use this apparatus near water.
- 6 Clean only with dry cloth.
- 7 Do not block any ventilation openings. Install in accordance with the manufacturer's instructions.
- 8 Do not install near any heat sources such as radiators, heat registers, stoves, or other apparatus (including amplifiers) that produce heat.
- 9 Do not defeat the safety purpose of the polarized or grounding-type plug. A polarized plug has two blades with one wider than the other. A grounding type plug has two blades and a third grounding prong. The wide blade or the third prong are provided for your safety. If the provided plug does not fit into your outlet, consult an electrician for replacement of the obsolete outlet.
- 10 Protect the power cord from being walked on or pinched particularly at plugs, convenience receptacles, and the point where they exit from the apparatus.
- 11 Only use attachments/accessories specified by the manufacturer.
- 12 Use only with the cart, stand, tripod, bracket, or table specified by the manufacturer, or sold with the apparatus. When a cart is used, use caution when moving the cart/apparatus combination to avoid injury from tip-over.



- 13 Unplug this apparatus during lightning storms or when unused for long periods of time.
- 14 Refer all servicing to qualified service personnel. Servicing is required when the apparatus has been damaged in any way, such as power-supply cord or plug is damaged, liquid has been spilled or objects have fallen into the apparatus, the apparatus has been exposed to rain or moisture, does not operate normally, or has been dropped.

- The apparatus draws nominal non-operating power from the AC outlet with its POWER or STANDBY/ON switch not in the ON position.
- The mains plug is used as the disconnect device, the disconnect device shall remain readily operable.
- Caution should be taken when using earphones or headphones with the product because excessive sound pressure (volume) from earphones or headphones can cause hearing loss.
- If you are experiencing problems with this product, contact TEAC for a service referral. Do not use the product until it has been repaired.

CAUTION

- Do not expose this apparatus to drips or splashes.
- Do not place any objects filled with liquids, such as vases, on the apparatus.
- Do not install this apparatus in a confined space such as a book case or similar unit.
- The apparatus should be located close enough to the AC outlet so that you can easily grasp the power cord plug at any time.
- If the product uses batteries (including a battery pack or installed batteries), they should not be exposed to sunshine, fire or excessive heat.
- CAUTION for products that use replaceable lithium batteries: there is danger of explosion if a battery is replaced with an incorrect type of battery. Replace only with the same or equivalent type.

Safety Information

■ CAUTIONS ABOUT BATTERIES

This product uses batteries. Misuse of batteries could cause a leak, rupture or other trouble. Always abide by the following precautions when using batteries.

- Never recharge non-rechargeable batteries. The batteries could rupture or leak, causing fire or injury.
- When installing batteries, pay attention to the polarity indications (plus/minus (+/-) orientation), and install them correctly in the battery compartment as indicated. Putting them in backward could make the batteries rupture or leak, causing fire, injury or stains around them.
- When you store or dispose batteries, isolate their terminals with insulation tape or something like that to prevent them from contacting other batteries or metallic objects.
- When throwing used batteries away, follow the disposal instructions indicated on the batteries and the local disposal laws.
- Do not use batteries other than those specified. Do not mix and use new and old batteries or different types of batteries together. The batteries could rupture or leak, causing fire, injury or stains around them.
- Do not carry or store batteries together with small metal objects. The batteries could short, causing leak, rupture or other trouble.
- Do not heat or disassemble batteries. Do not put them in fire or water. Batteries could rupture or leak, causing fire, injury or stains around them.
- If the battery fluid leaks, wipe away any fluid on the battery case before inserting new batteries. If the battery fluid gets in an eye, it could cause loss of eyesight. If fluid does enter an eye, wash it out thoroughly with clean water without rubbing the eye and then consult a doctor immediately. If the fluid gets on a person's body or clothing, it could cause skin injuries or burns. If this should happen, wash it off with clean water and then consult a doctor immediately.
- The unit power should be off when you install and replace batteries.
- Remove the batteries if you do not plan to use the unit for a long time. Batteries could rupture or leak, causing fire, injury or stains around them. If the battery fluid leaks, wipe away any fluid on the battery compartment before inserting new batteries.
- Do not disassemble a battery. The acid inside the battery could harm skin or clothing.

■ For European Customers

Disposal of electrical and electronic equipment

- All electrical and electronic equipment should be disposed of separately from the municipal waste stream via designated collection facilities appointed by the government or the local authorities.
- By disposing of the electrical and electronic equipment correctly, you will help save valuable resources and prevent any potential negative effects on human health and the environment.
- Improper disposal of waste equipment can have serious effects on the environment and human health as a result of the presence of hazardous substances in electrical and electronic equipment.
- The crossed out wheeled dust bin symbol indicates that electrical and electronic equipment must be collected and disposed of separately from household waste.



- The return and collection systems are available to the end users. For more detailed information about disposal of old electrical and electronic equipment, please contact your city office, waste disposal service or the shop where you purchased the equipment.

■ For China



“環境保護使用年限”

产品有毒有害物质或元素的名称及含量

机种	品名	铅 (Pb)	汞 (Hg)	镉 (Cd)	六价铬 (Cr6+)	多溴联苯 (PBB)	多溴二苯醚 (PBDE)
DP-32SD	1 CHASSIS部份	○	○	○	○	○	○
	2 PCB Assy部份	×	○	○	○	○	○
	3 线材部份	○	○	○	○	○	○
	4 附属品部份	×	○	○	○	○	○
	5 SEAL部份	○	○	○	○	○	○
	6 包装部份	○	○	○	○	○	○

○：表示该有毒有害物质在该部件所有均质材料中的含量均在 GB/T26572 标准规定的限量要求以下。

×：表示该有毒有害物质至少在该部件的某一均质材料中的含量超出 GB/T26572 标准规定的限量要求。
(针对现在代替技术困难的电子部品及合金中的铅)

1 – Introduction	7	5 - Song Management	28
Features.....	7	Note for customers using both DP-32SD and DP-24 units.....	28
Items included with the product	7	Editing names	28
Conventions used in this manual	7	Loading a song	28
Trademarks.....	8	Creating a new song.....	29
Precautions for placement and use	8	Saving a song	29
Beware of condensation	8	Viewing song information.....	30
Cleaning the unit	8	Copying songs	30
About SD cards.....	8	Erasing songs	30
Precautions for use.....	8	Protecting songs.....	31
Using the TEAC Global Site.....	8	Deleting unnecessary audio data from a song.....	31
About TASCAM customer support service	8	Changing a song name	32
2 - Quick Guide.....	9	6 - Basic Recording.....	33
Playback and mixing	9	Selecting the input sources	33
Preparation.....	9	Assigning inputs	33
Listening to the demo song	10	Setting the track type.....	33
Recording and mastering	10	Assigning inputs to mono tracks.....	33
Creating a new song.....	11	Assigning inputs to stereo tracks	33
Connecting and setting the input sources.....	11	Assigning inputs to a stereo bus	33
Setting the guitar as the recording source for TRACK 1	12	Checking assignments	34
Adjusting and monitoring the input level.....	12	Canceling assignments.....	34
Recording a guitar to TRACK 1	12	Using phantom power.....	34
Playing back the recording.....	12	Monitoring	34
Recording a guitar to TRACK 2	13	Monitor selection.....	34
Recording a vocal to TRACK 3.....	13	OL indicators and level meters	34
Mixing the tracks.....	14	Peak hold display	35
Mastering a recording	15	Mixer screen settings	35
Shutting down.....	16	Using the input equalizer.....	35
3 – Names and Functions of Parts	17	DIGITAL TRIM setting (track only).....	36
Top panel.....	17	Sending signals to internal/external effects	36
Display area.....	18	Enabling insert effects.....	36
Operation buttons.....	19	Setting the stereo position.....	37
Front panel.....	20	Changing the signal phase.....	37
Rear panel.....	21	Checking the fader level.....	37
Home screen	21	Setting levels sent to stereo buses	37
Menu structure	22	Solo.....	37
Navigating screens.....	23	Muting tracks	37
Function button assignments	23	Rehearsing a recording	38
Navigation examples	23	Making the first recording.....	38
4 – Preparation.....	24	Multitrack recording.....	38
Inserting and removing SD cards	24	Arming tracks for recording	38
Inserting an SD card.....	24	Adjusting track pan and level settings.....	38
Removing the card	24	Input selection and assignment.....	38
About write-protected SD cards.....	24	Setting input levels.....	39
Powering the unit.....	24	Recording.....	39
Starting up & shutting down.....	25	Undoing an operation	39
Starting up the unit.....	25	Undo feature settings.....	39
Shutting down	25	Undoing the last operation (single undo).....	39
Setting the date and time.....	26	Undoing older operations (multiple undo).....	40
Preparing an SD card for use	26	7 - Recorder Functions.....	41
Recorder modes	26	Punching in and out	41
Connecting other equipment	27	Using a footswitch to punch in/out	41
Front panel	27	Setting the footswitch.....	41
Rear panel.....	27	Bouncing tracks.....	41
Adjusting the display	27	Using the bounce function.....	42
		Checking the bounce result.....	42
		Direct location function	42

Contents

Locating a specified time directly	42
Locating a specified bar/beat directly	43
Location marks	43
Setting a location mark.....	43
Skipping to location marks.....	43
Deleting a location mark.....	43
Returning to zero or the last recording position.....	43
Fast forwarding and rewinding	43
Cueing with the JOG/DATA dial.....	43
Jogging while viewing a waveform	43
Jogging while listening to audio.....	44
Repeat playback.....	44
Setting IN/OUT points	44
Using repeat playback.....	44
Jumpback playback	44
Previewing cue points	45
Automatic punching in and out.....	45
Setting punch-in/out points	45
Checking punch-in/out points.....	46
Rehearsing with automatic punching.....	46
Recording with automatic punching.....	46
Checking takes.....	47
Virtual tracks.....	47
Recording to virtual tracks.....	47
Assigning virtual tracks.....	47
8 - Track Editing	48
Overview of track editing	48
Editing points	48
Basic editing procedures	48
Explanation of items	48
COPY/PASTE.....	49
COPY/INSERT	49
MOVE/PASTE.....	50
MOVE/INSERT.....	50
OPEN (Insert Silence).....	50
CUT (Remove Part)	50
SILENCE (Erase Part).....	51
CLONE TRACK (duplicate track)	51
CLEAN OUT (delete track)	51
9 - Using Internal Effects	52
Dynamic effects.....	52
Inserting a dynamic effect	52
Adjusting dynamic effects	52
Guitar effects	52
Inserting a guitar effect	52
Adjusting guitar effects	53
Loading guitar effect settings	53
Saving guitar effects in the library	53
Send effects	53
Using send effects.....	53
Adjusting send effects.....	53
Loading send effect settings.....	53
Saving send effects in the library	53
10 - Mixing Down and Mastering Songs	54
Mixing down tracks.....	54
Levels and balance	54
Fader group.....	54
Stereo position (panning).....	54
Track equalizer	54
Send effects.....	55
Creating a master file	55
Setting the start and end points	55
Creating a master file.....	55
Exiting Mixdown mode.....	56
Checking the master file	56
Ending master file checking.....	56
Using the mastering tools	56
Mastering procedures	56
Using the mastering equalizer	57
Using mastering compression	57
Using normalize.....	58
Exiting Mastering mode	58
11 - Various Other Functions.....	59
Metronome	59
Tuner function	59
PREFERENCE menu settings	60
Setting automatic power saving	60
Setting automatic monitoring	60
Setting the song name format.....	61
Restoring the initial preference settings	61
Viewing information.....	61
12 - SD Card Management.....	62
Quick formatting an SD card	62
Full formatting an SD card.....	63
13 - Exchanging Data with a Computer.....	64
Operating system requirements	64
Connecting to a computer	64
Disconnecting	65
Track import and export	65
Importing tracks.....	65
Exporting tracks.....	66
Deleting files from the AudioDepot folder	66
14 - Troubleshooting.....	67
15 - Messages	68
General messages.....	68
16 - Specifications	71
Ratings.....	71
Input/output ratings	71
Analog audio input/output ratings.....	71
Control input/output ratings.....	71
Audio performance.....	71
Operating requirements	71
Dimensional drawings.....	72
General	72
Block diagram	73
Level diagram.....	74

Thank you very much for purchasing the TASCAM DP-32SD Digital Multitrack Recorder.

Before connecting and using the unit, please take time to read this manual thoroughly to ensure you understand how to properly set up and connect the unit, as well as the operation of its many useful and convenient functions. After you have finished reading this manual, please keep it in a safe place for future reference.

You can also download the Owner's Manual from the TEAC Global Site (<http://teac-global.com/>).

Features

This unit uses SD cards for multitrack recording of up to 8 tracks and playback of up to 32 tracks simultaneously. Multiple tracks can be mixed down to a stereo master file using the built-in mixer functions. Master files created this way can be transferred to a computer connected by USB. Moreover, since transferring data between the unit and a computer is possible, you can copy tracks and master files, and back up song files to a computer.

- 32-track Digital Multitrack Recorder that uses SD cards as recording media
- Supports SDHC standard for high-capacity SD cards of up to 32GB
- Multitrack recorder functions include simultaneous 8-track recording and 32-track playback (44.1/48kHz, 16/24-bit)
- Stereo/mono track type selection function makes changing track allocation easy
- 20 track faders and 1 master fader for level adjustment (all 45 mm)
- Each track has independent **SELECT** and **REC** buttons
- +48V phantom power supported mic input
- 8 balanced mic/line inputs (XLR/TRS combo jacks)
- INPUT H supports high-impedance guitar input (6.3mm (1/4") phone jack)
- Large TFT color display with excellent visibility (3.5-inch)
- Independent 3-band equalizers for each input and playback track
- Mixing down to a dedicated master file possible
- Mastering effects that can be used during mix downs of master files
- Reverb and various other effects that can be adjusted independently for each playback track
- Automatic punch in/out
- Track bouncing
- COPY INSERT, COPY PASTE, MOVE INSERT, MOVE PASTE, OPEN, CUT, SILENCE, CLONE TRACK and CLEAN OUT track editing functions
- Undo and redo functions, including 10-level history setting option
- Location to marks
- Tuner and metronome
- Song data and WAVE files can be copied and backed up to a computer connected by USB 2.0
- Punch in/out and other functions can be assigned to and controlled by a TASCAM RC-3F footswitch (sold separately)

Items included with the product

This product includes the following items.

Take care when opening the package to avoid damaging the items. Keep the packing materials for transportation in the future.

Please contact the store where you purchased this unit if any of these items are missing or have been damaged during transportation.

- Main unit 1
- AC adaptor (TEAC PS-P1220E) 1
- SD memory card (inserted into the unit) 1
- Owner's Manual (this manual)..... 1

The warranty is included at the end of this manual.

CAUTION

Always use the included TEAC PS-P1220E AC adaptor with this unit. Moreover, do not use the included AC adaptor with other equipment. Doing so could cause malfunction, fire or electric shock.

Conventions used in this manual

Conventions used in this manual are as follows.

- Names of buttons, controls, etc. of this unit appear like this: **MENU**.
- Text displayed on the LCD display appears like this: MENU.
- The four buttons beneath the LCD display (**F1** to **F4**) are function buttons. The functions displayed at the bottom of each screen are sometimes shown after the button names in parentheses.
Example: **F1** (TIME LINE) button, **F4** (▶) button.
- "SD memory card" is abbreviated as "SD card".
- Text displayed on a computer monitor appears like this: OK.
- Additional information is introduced in the following styles when needed: TIP, NOTE, and CAUTION.

TIP

Useful hints when using the unit.

NOTE

Explanation of actions in special situations, supplementary explanations, etc.

CAUTION

Instructions that should be followed to avoid injury, damage to the unit or other equipment, and loss of data.

Product registration

Customers in the USA, please visit the following TASCAM website to register your TASCAM product online.

<https://tascam.com/us/>

1 – Introduction

Trademarks

- TASCAM and PORTASTUDIO are trademarks of TEAC Corporation, registered in the U.S. and other countries.
- SDHC Logo is a trademark of SD-3C, LLC.



- Microsoft, Windows, Windows XP, Windows Vista, Windows 7 and Windows 8 are either registered trademarks or trademarks of Microsoft Corporation in the United States and/or other countries.
- iMac, Mac OS and OS X are trademarks of Apple Inc.
- Pentium and Intel are trademarks of Intel Corporation in the U.S. and/or other countries.
- Other company names, product names and logos in this document are the trademarks or registered trademarks of their respective owners.

Any data, including, but not limited to information, described herein are intended only as illustrations of such data and/or information and not as the specifications for such data and/or information. TEAC Corporation disclaims any warranty that any use of such data and/or information shall be free from infringement of any third party's intellectual property rights or other proprietary rights, and further, assumes no liability of whatsoever nature in the event of any such infringement, or arising from or connected with or related to the use of such data and/or information.

This product is designed to help you record and reproduce sound works to which you own the copyright, or where you have obtained permission from the copyright holder or the rightful licensor. Please use the product appropriately. Under no circumstances will TEAC Corporation be responsible for the consequences of any illegal copying performed using the recorder.

Precautions for placement and use

- The operating temperature should be between 5°C and 35°C (41°F and 95°F).
- Do not install in the following types of places. Doing so could degrade the sound quality and/or cause malfunctions.
 - Places with significant vibrations or that are otherwise unstable
 - Near windows or other places exposed to direct sunlight
 - Near heaters or other extremely hot places
 - Extremely cold places
 - Places with bad ventilation or high humidity
 - Very dusty locations
- Make sure that the unit is mounted in a level position for correct operation.
- Do not place any object on the unit for heat dissipation.
- Avoid installing this unit on top of any heat-generating electrical device such as a power amplifier.

Beware of condensation

If the unit is moved from a cold to a warm place, or used after a sudden temperature change, there is a danger of condensation; vapor in the air could condense on the internal mechanism, making correct operation impossible. To prevent this, or if this occurs, let the unit sit for one or two hours at the new room temperature before using.

Cleaning the unit

Use a dry soft cloth to wipe the unit clean. Do not clean the unit with a chemically treated cloth or substances such as thinner and alcohol. This could damage the surface or change the color of the unit.

About SD cards

This unit uses SD cards for recording and playback.

SD cards that meet SD/SDHC standards and are at least 512 MB can be used with this unit.

A list of SD cards that have been confirmed for use with this unit can be found on our web site. Please access to a product page of this product from the TEAC Global Site (<http://teac-global.com>) to find the list or contact the TASCAM customer support service.

Precautions for use

SD cards are delicate media. In order to avoid damaging a card or the card slot, please take the following precautions when handling them.

- Do not leave them in extremely hot or cold places.
- Do not leave them in extremely humid places.
- Do not let them get wet.
- Do not put things on top of them or twist them.
- Do not hit them.
- Do not remove or insert an SD card when the power is ON.

Using the TEAC Global Site

You can download updates for this unit from the TEAC Global Site: <http://teac-global.com/>

In the TASCAM Downloads section, select the desired language to open the Downloads website page for that language.

A list of SD cards that have been confirmed for use with this unit can be found on our web site. Please access to a product page of this product from the TEAC Global Site (<http://teac-global.com>) to find the list or contact the TASCAM customer support service.

About TASCAM customer support service

TASCAM products are supported and warrantied only in their country/region of purchase.

To receive support after purchase, on the TASCAM Distributors list page of the TEAC Global Site (<http://teac-global.com/>), search for the local company or representative for the region where you purchased the product and contact that organization. When making inquiries, the address (URL) of the shop or web shop where it was purchased and the purchase date are required. Moreover, the warranty card and proof of purchase might also be necessary.

Playback and mixing

In this section, we will play back the demo song on the included SD card.

When this unit is purchased new, an SD card with the demo song on it is already inserted in the unit, but we will start by explaining how to insert an SD card using the procedures below.

Preparation

1. Insert the included SD card into the SD card slot on the rear panel. Be careful not to forcibly insert the card in the wrong direction. Doing so could damage the SD card slot or the SD card.

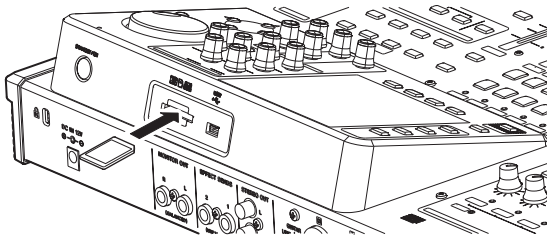

2. Connect the supplied AC adaptor (TEAC PS-P1220E) to the **DC IN 12V** jack on the rear panel.

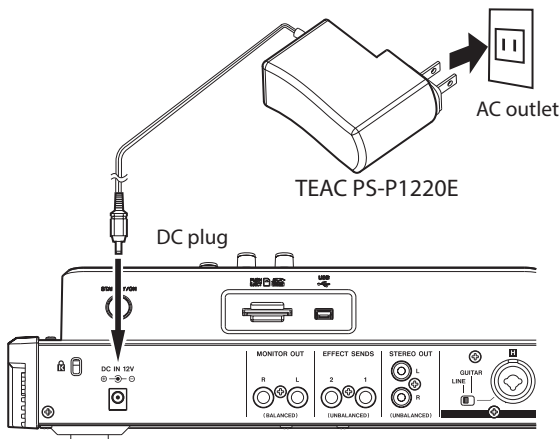

CAUTION

Always use the included TEAC PS-P1220E AC adaptor. Use of a different adapter could cause malfunction, fire or electric shock.

3. Connect headphones to the **PHONES** jack on the front panel.

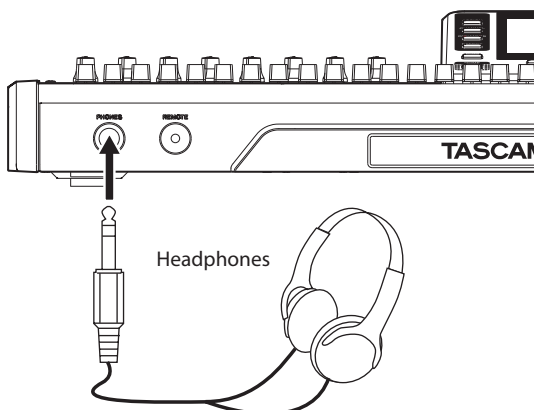

4. Press and hold the **STANDBY/ON** button for a few seconds on the rear panel to turn the power ON. When the unit starts, the Home screen opens on the display.

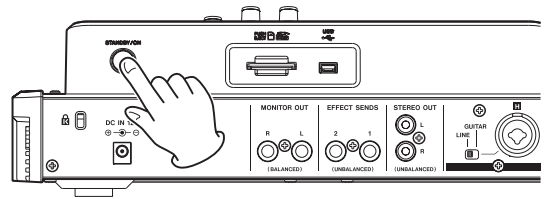

Start-up screen

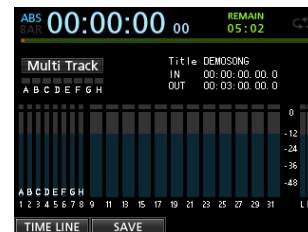

Home screen

CAUTION

- Do not remove or insert an SD card when the power is ON. Always turn the power off (put in standby) before removing or inserting an SD card.
- When the power is ON, do not disconnect the power cord or otherwise interrupt the power to the unit. Doing so will cause all settings made since the last time you saved to be lost. If the power is interrupted while an SD card is being accessed, all recorded songs and data on the card could be damaged beyond recovery.
- Before turning the power ON, minimize the headphones volume and the volume on any monitoring system connected to this unit.

TIP

By connecting an amplifier or powered speakers to the **MONITOR OUT** jacks, you can monitor using speakers.

2 - Quick Guide

Listening to the demo song

The included SD card in the unit contains a demo song. We will use this demo song to practice listening to and mixing a recording.

1. Press the **HOME** button to open the Home screen.

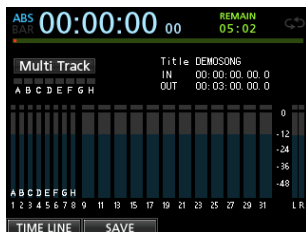

2. When the recorder is stopped, press the **MENU** button to open the MENU screen.

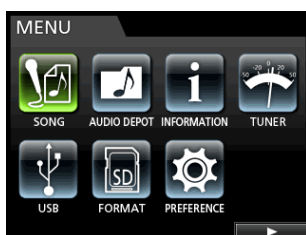

3. Use the **JOG/DATA** dial or the **CURSOR** (▲/▼/◀/▶) buttons to select (highlight green) **SONG**, and then press the **F4** (▶) button.

The **SONG LIST** screen opens.

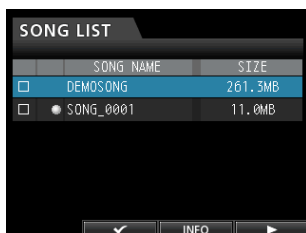

4. Use the **JOG/DATA** dial or the **CURSOR** (▲/▼) buttons to select **DEMO SONG**, and then press the **F4** (▶) button to open a menu list.



5. Use the **JOG/DATA** dial or the **CURSOR** (▲/▼) buttons to select **LOAD**, and then press the **F4** (▶) button.

The **SONG LOAD** pop-up window appears.

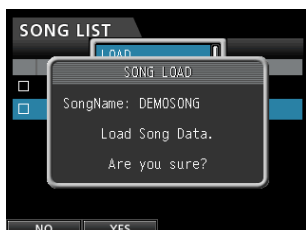

6. Press the **F2** (YES) button to load the demo song.
The demo song is loaded and the window closes, but the **SONG LIST** screen remains open.

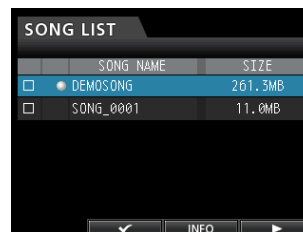

7. Press the **HOME** button to return to the Home screen.
8. Press the **PLAY** (▶) button, and raise the levels of the track and **STEREO** faders and the **MONITOR LEVEL** knob to listen to the demo song.

The **STEREO** fader adjusts the overall volume of the mixer output. When the **STEREO** fader is at 0dB the overall level is neither increased nor decreased.

Use the track faders to adjust the balance of the tracks.

Use the **MONITOR LEVEL** knob to adjust the final monitoring volume.

9. Press the **MIXER** button to open the Mixer screen.



10. Press a **SOURCE** buttons to select an input (A-H) or press a **SELECT** button to select a track to be set. Then use the **PAN** knob to set the stereo position of that input or track. Repeat for other inputs and tracks.

TIP

- Press the **STOP** (■) and **REW** (◀◀) buttons at the same time to use the **TO ZERO** function to return to the beginning of the song (**ZERO** point).
- If you press the wrong button and open a different screen, you can press the **HOME** button to return to the Home screen at any time.

Recording and mastering

In this section we will practice multitrack recording.

Here we will explain how to connect electric guitars to **INPUT H** and external microphones to **INPUT B**.

In the following example, we will explain how to record an electric guitar rhythm part to track 1 and a lead guitar part to track 2. Then, we will use an external microphone to record vocals to track 3. Finally, we will mix down the tracks to stereo.

We will assume that you have already followed the instructions in the previous section, and that you have connected headphones or other monitoring equipment, started the unit and inserted an SD card.

Creating a new song

1. When the recorder is stopped, press the **MENU** button to open the MENU screen.



2. Use the **JOG/DATA** dial or the **CURSOR** (▲/▼/◀/▶) buttons to select (highlight green) **SONG**, and then press the **F4** (▶) button.

The **SONG LIST** screen opens.

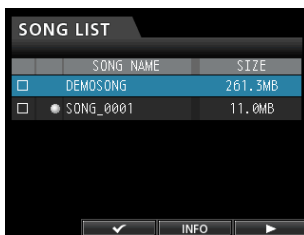

3. Press the **F4** (▶) button to open the menu list and then use the **JOG/DATA** dial or the **CURSOR** (▲/▼) buttons to select **CREATE**.

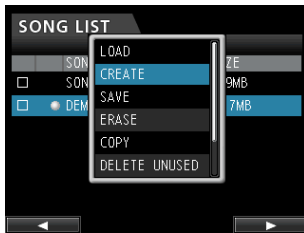

4. Press the **F4** (▶) button to open the **SONG CREATE** pop-up window.

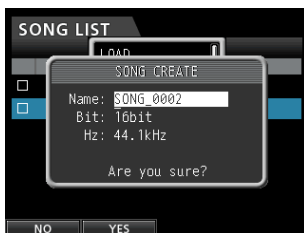

The created song is given the name **SONG_0002**.

5. Change the name (title) of the song if necessary in the **Name** item. (See "Editing names" on page 28.)
6. Use the **CURSOR** (▲/▼) buttons to move the cursor (highlighted blue) to select **Bit** (bit rate) or **Hz** (sampling frequency), and then use the **JOG/DATA** dial to set it as desired.

7. Press the **F2** (YES) button.

The currently loaded song is saved and a new song is created.

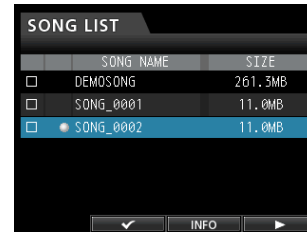

8. Press the **HOME** button to return to the Home screen.

Connecting and setting the input sources

1. Connect an electric guitar to the **MIC/LINE INPUTS H** jack on the rear panel.

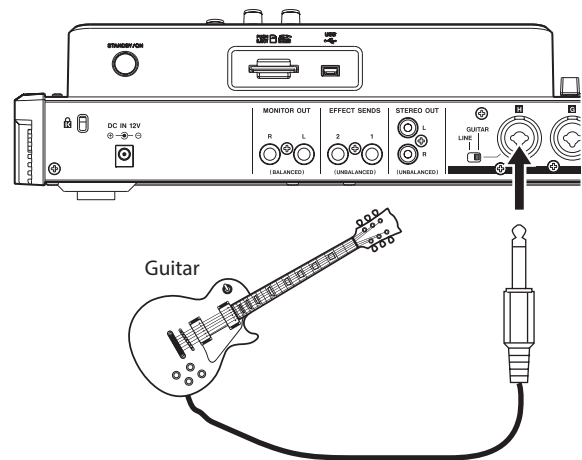

2. Set the **LINE-GUITAR** switch on the rear panel to **GUITAR**.

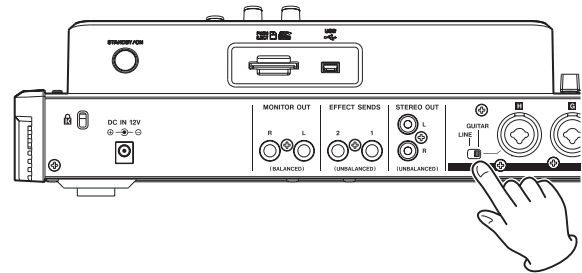

The **GUITAR** indicator lights.

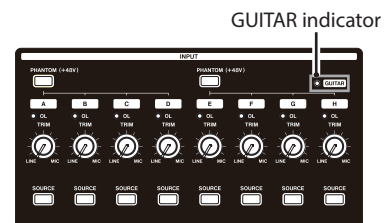

Now the guitar is the input source for **INPUT H**.

TIP

When connecting an electric-acoustic guitar with a built-in preamp or an active-type electric guitar, or when using an effects pedal, for example, between the guitar and this unit, set the **LINE-GUITAR** switch to **LINE** on the rear panel.

2 - Quick Guide

Setting the guitar as the recording source for TRACK 1

When you press the **ASSIGN** button to open the Assign screen, the default screen setting for the recording source is **A (INPUT A)** for TRACK 1, **B (INPUT B)** for TRACK 2, **C (INPUT C)** for TRACK 3, and so on for tracks 4 to 8 (**D** to **H**). (See “Assigning inputs” on page 33.)

Since initially **INPUT H** is set only as the recording source for TRACK 8, you must change the TRACK 1 recording source.

Follow these procedures to change the recording source of TRACK 1.

1. Press the **ASSIGN** button to open the Assign screen.

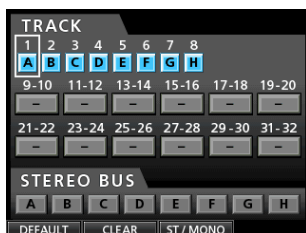

2. Use the **CURSOR** (**▲/▼/◀/▶**) buttons or press the **SELECT** button for TRACK 1 to move the cursor (frame) on the Assign screen with TRACK 1.
3. Use the **JOG/DATA** dial or the **SOURCE** button for **INPUT H** to set the recording source of TRACK 1 to H.

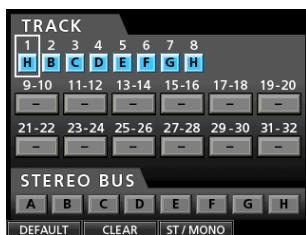

3. Use the **TRIM** knob for **INPUT H** to adjust the guitar input level. Set the **TRIM** knob so that the **OL** indicator for **INPUT H** does not light even when the loudest sound to be recorded is input.

If the **OL** indicator continues to light even when the **TRIM** knob is turned down, the guitar signal itself is too loud. In this case, lower the output level on the guitar.

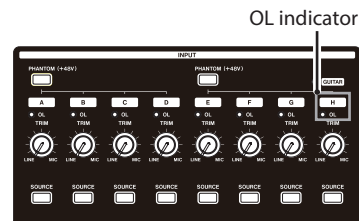

When you play the guitar, level meter 1 (TRACK 1) shows the input level on the display.

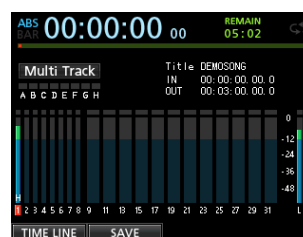

When you raise the fader for TRACK 1, the **STEREO** fader and the **MONITOR LEVEL** knob, you will be able hear the sound of the guitar through the headphones (or monitoring system), and the **L** and **R** level meters will move.

NOTE

- You can use the **PAN** knob for TRACK 1 on the Mixer screen to set the stereo position for monitoring.
- If the **REC** button for TRACK 1 is not lit, you will not be able to hear the guitar sound that is being input.

Adjusting and monitoring the input level

1. Press the **HOME** button to return to the Home screen.

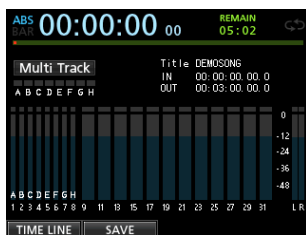

2. Press the **REC** button for TRACK 1.
The **REC** button flashes and the unit enters recording standby.

Recording a guitar to TRACK 1

1. Press the **RECORD** (**●**) button to start recording and play the guitar.
The **REC** button for TRACK 1 stops flashing and lights steadily when recording.
2. After you finish your performance, press the **STOP** (**■**) button to stop recording.
The recorded file is saved in the folder of the currently loaded song.
3. Press the **REC** button for TRACK 1 so the **REC** button becomes unlit.

Playing back the recording

1. To return to the beginning of the song (ZERO point), press and hold the **STOP** (**■**) button and press the **REW** (**◀◀**) (**TO ZERO**) button.
2. Press the **PLAY** (**▶**) button to play back the recording on TRACK 1.

- Use the fader for TRACK 1 and the **STEREO** fader to adjust the playback monitoring level. Use the **MONITOR LEVEL** knob to adjust the final monitoring volume.

TIP

Use the **PAN** knob for TRACK 1 on the Mixer screen to set the stereo position of the track signal.

Recording a guitar to TRACK 2

Next, you can listen to the rhythm guitar on TRACK 1 as you play the lead guitar part and record it on TRACK 2.

Follow these procedures to change the recording source of TRACK 2.

- Press the **ASSIGN** button to open the Assign screen.

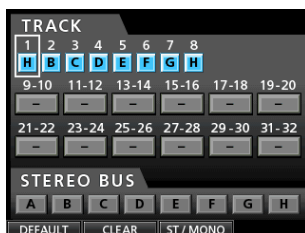

We want to record the lead guitar sound from **INPUT H** to TRACK 2, but **INPUT B** is assigned to TRACK 2 by default.

- Use the **CURSOR** (**▲/▼/◀/▶**) buttons or press the **SELECT** button for TRACK 2 to move the cursor (frame) on the Assign screen to TRACK 2.

Use the **JOG/DATA** dial or press the **SOURCE** button for **INPUT H** to set the TRACK 2 recording source to H.

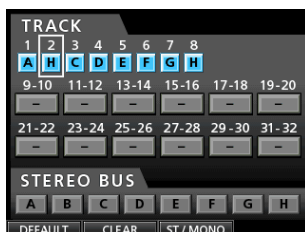

- Press the **HOME** button to return to the Home screen.

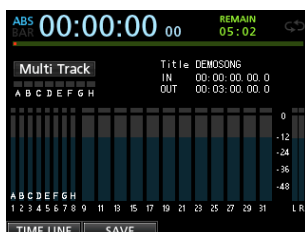

- Press the **REC** button for TRACK 2.

Its **REC** indicator blinks and the unit enters recording standby.

When you play the guitar, the input level is shown by the **ℳ** level meter (TRACK 2).

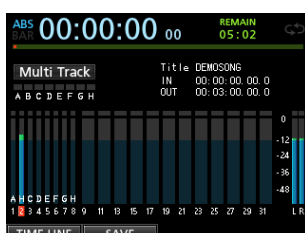

- Return to the beginning of the song (ZERO point) and start playback of the recorded rhythm guitar to practice the lead guitar part along with the recording.

Raise the fader for TRACK 2 to hear the input guitar signal along with the TRACK 1 playback signal through your headphones or monitoring system.

- As necessary, use the TRACK 1, 2 and **STEREO** faders and **MONITOR LEVEL** knob to adjust the monitoring level and balance and the PAN knob to adjust the stereo positions.
- Return to the beginning of the song, press the **RECORD** (**●**) button to start recording, and play the lead guitar part.

The **RECORD** (**●**) button lights red and the **REC** indicator for TRACK 2 stops flashing and stays lit while recording.

- After you finish your performance, press the **STOP** (**■**) button to stop recording.

The recorded file is saved in the folder of the currently loaded song.

- Press the **REC** button for TRACK 2 so the **REC** button becomes unlit.

Recording a vocal to TRACK 3

- Press the **ASSIGN** button to open the Assign screen.

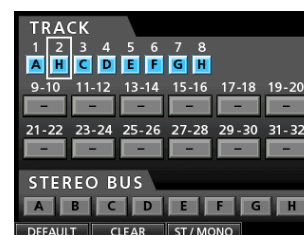

- Use the **CURSOR** (**▲/▼/◀/▶**) buttons or press the **SELECT** button for TRACK 3 to move the cursor (frame) on the Assign screen to TRACK 3.

Use the **JOG/DATA** dial or press the **SOURCE** button for **INPUT B** to set the TRACK 3 recording source to B.

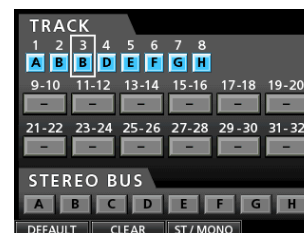

- Press the **HOME** button to return to the Home screen.

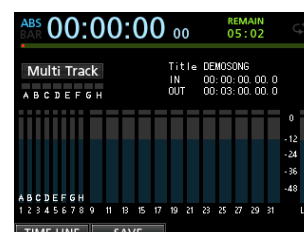



- Press the **REC** button for TRACK 3.

The **REC** indicator blinks and the unit enters recording standby.

2 - Quick Guide

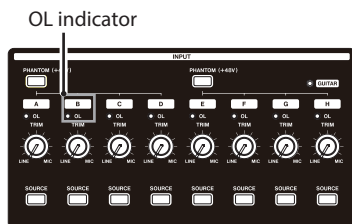
- Use the **TRIM** knob for **INPUT B** to adjust the input level suitably for the mic. Set the **TRIM** knob so that the **OL** indicator for **INPUT B** does not light even when the loudest sound to be recorded is input.



When you input a sound through an external microphone, the input level is shown by the  level meter.

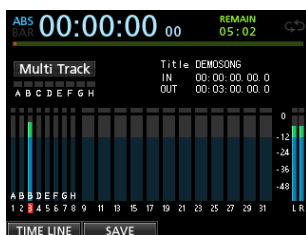

When you raise the fader for **TRACK 3**, the **STEREO** fader and the **MONITOR LEVEL** knob, you can hear the sound of the mic input through the headphones.

NOTE

If the **OL** indicator continues to light even when the **TRIM** knob is turned down, the mic signal itself is too loud. In this case, move the mic further away from the sound source or lower the volume of the sound source.

- Return to the beginning of the song, start playback of the recorded rhythm and lead guitar parts, and practice singing along with the recording.
You can hear the playback of the recorded guitar parts on tracks 1 and 2 along with the vocal on your headphones.
- As necessary, use the **TRACK 1, 2, 3** and **STEREO** faders and the **MONITOR LEVEL** knob to adjust the monitoring level and balance and the **PAN** knob to adjust the stereo positions.
- Return to the beginning of the song, press the **RECORD** (●) button to start recording, and then sing along with the recording.

The **RECORD** (●) button lights red, and the **REC** indicator for **TRACK 3** stops flashing and stays lit while recording.

- After you finish your performance, press the **STOP** (■) button to stop recording.
The recorded file is saved in the folder of the currently loaded song.
- Press the **REC** button for **TRACK 3** so that the **REC** button becomes unlit.

Mixing the tracks

Once you have finished your recording, you are ready to mix down and create a master file.

- Use the faders for **TRACKS 1 to 3** to balance their levels. Use the **STEREO** fader to adjust the overall level.
- Press the **MIXER** button to open the Mixer screen.

Press the **SELECT** buttons for **TRACKS 1 to 3** to select the track to be adjusted and then use the **PAN** knob to set its stereo position.



- Set the **IN** point.
The interval from the **IN** point to the **OUT** point will be used for the master file.
Play back the song, press and hold the **MARK SET** button and press the **IN** button at the point where you want to start the master file.
The position where you press the button is set as the **IN** point, which is where the mix down will start.
- Set the **OUT** point.
Play back the song, press and hold the **MARK SET** button and press the **OUT** button where you want to end the master file.
The position where you press the button is set as the **OUT** point, which is where the mix down will end.

TIP

You can also press and hold the **MARK SET** button and press the **IN** or **OUT** button to set the **IN** or **OUT** point when playback is stopped.

- Press the **MIXDOWN/MASTERING** button.
The recorder switches to **Mixdown** mode and the display returns to the Home screen.

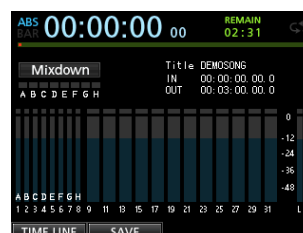

NOTE

When in **Mixdown** mode, **Mixdown** appears in the upper left of the Home screen.

- Press the **RECORD (●)** button.
Master file recording starts.
Recording stops automatically when the OUT point is reached.

NOTE

- The IN and OUT points must be at least 4 seconds apart. If the interval is shorter than 4 seconds, the message **I/O Too Short** will appear and the Recorder mode cannot switch to Mixdown mode.
- During recording, you can use the track faders to adjust the levels of the tracks and the overall level.
- You can also use the equalizer or reverb effect while recording a master file. (See "Send effects" on page 53 and "Track equalizer" on page 54.)
- You can mute unwanted tracks so that they are not recorded to the master file. (See "Muting tracks" on page 37.)

Mastering a recording

You can adjust the sound of the master file to your liking. This process is called mastering.

■ Checking the master file

- When in Mixdown mode, press the **MIXDOWN/MASTERING** button to open the Mastering screen.
The recorder switches to Mastering mode and the display returns to the Home screen.



NOTE

- When in Mastering mode, Mastering appears on the upper left corner of the Home screen.
 - If a master file does not exist, the recorder mode cannot switch to Mastering mode.
 - If the recorder is in Multi Track mode, press the **MIXDOWN/MASTERING** button to switch to Mixdown mode, and then press the **MIXDOWN/MASTERING** button again to switch to Mastering mode.
- In this mode, press the **PLAY (▶)** button to listen to the master file that you have created.

NOTE

- Confirm that both the EQ and COMP items are set to OFF. If either is set to ON, the sound heard will be affected by the equalizer and/or compressor. (See "Using the mastering equalizer" on page 57 and "Using mastering compression" on page 57.)
- In Mastering mode, the **STEREO** fader cannot be used to adjust the level.

■ Applying equalization

In this example, we will use the equalizer on the master file to reduce high frequencies and increase low frequencies slightly.

- When in Mastering mode, press the **F1 (EQ)** button to open the EQUALIZER screen.

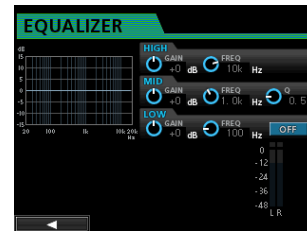

- Turn the EQ HIGH GAIN knob left to lower the HIGH GAIN knob on the screen to "-2dB". This reduces the high frequencies.
- Next turn the EQ MID GAIN knob left to lower the MID GAIN to "-2dB". This reduces the mid frequencies.
- Next, turn the EQ LOW GAIN knob right to raise the LOW GAIN knob on the screen to "+6dB". This increase the low frequencies.
- Press the ON/OFF button to the right of the LOW knobs to turn the equalizer ON.

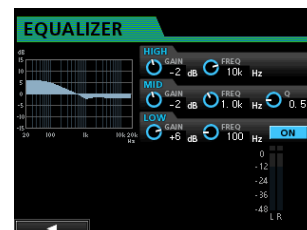

- Press the **F1 (◀)** button to return to the Mastering screen.
- Press the **PLAY (▶)** button to listen to the master file with equalization.

■ Applying compression

Use the compressor on the master file to adjust the dynamics and loudness of the entire song.

- When in Mastering mode, press the **F2 (COMP)** button to open the COMP MULTI screen.



- Press the **F3 (LIBRARY)** button to open the library list.

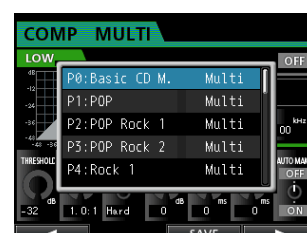

2 - Quick Guide

- Use the **JOG/DATA** dial to select (highlight blue) an item in the list and then press the **F4 (▶)** button to load a suitable setting from the library.

The library list closes.

TIP

You can also adjust the parameters on the **COMP MULTI** screen using the **CURSOR** buttons and **JOG/DATA** dial. (See "Using mastering compression" on page 57.)

- Press the **F4 (ON)** button to turn the compressor on. The OFF icon changes to ON.

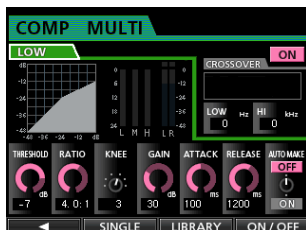

- Press the **F1 (◀)** button to return to the Mastering screen.
- Press the **PLAY (▶)** button on the Mastering screen to listen to the master file with compression.

NOTE

If the EQ item is set to ON on the EQUALIZER screen, the effect of the equalizer on the sound will also be heard.

■ Normalizing

Normalizing maximizes the volume of the master file without changing the dynamic range.

- When in Mastering mode, press the **F4 (NORM)** button to open the NORMALIZE screen.

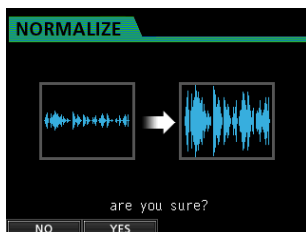

- Press the **F2 (YES)** button to perform the normalization.
- Press the **F1 (◀)** button to return to the Mastering screen.

■ Re-recording the master file

Re-record the master file with equalization and compression applied to create a new master file.

- When in Mastering mode, press the **RECORD (●)** button.
- This will record over the master file and create a new master file with equalization and compression applied.

Shutting down

Turn the unit off when you are done using it.

- Press the **HOME** button to open the Home screen.

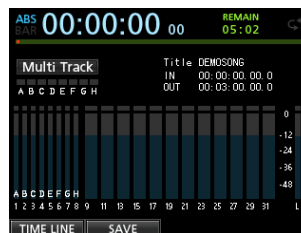

- Press and hold the **STANDBY/ON** button on the rear panel until **DIGITAL PORTASTUDIO** appears on the display.



When the unit completes its automatic shutdown procedure, which includes keeping a record of various information about operations that have been performed until now, the power turns off (enters standby mode).

Always use the procedure above to turn the power off properly.

CAUTION

When the power is ON, do not disconnect the power cord or otherwise interrupt the power to the unit. Doing so will cause all settings made since the last time you saved to be lost. If the power is interrupted while an SD card is being accessed, all recorded songs and data on the card could be damaged beyond recovery.

3 – Names and Functions of Parts

Top panel

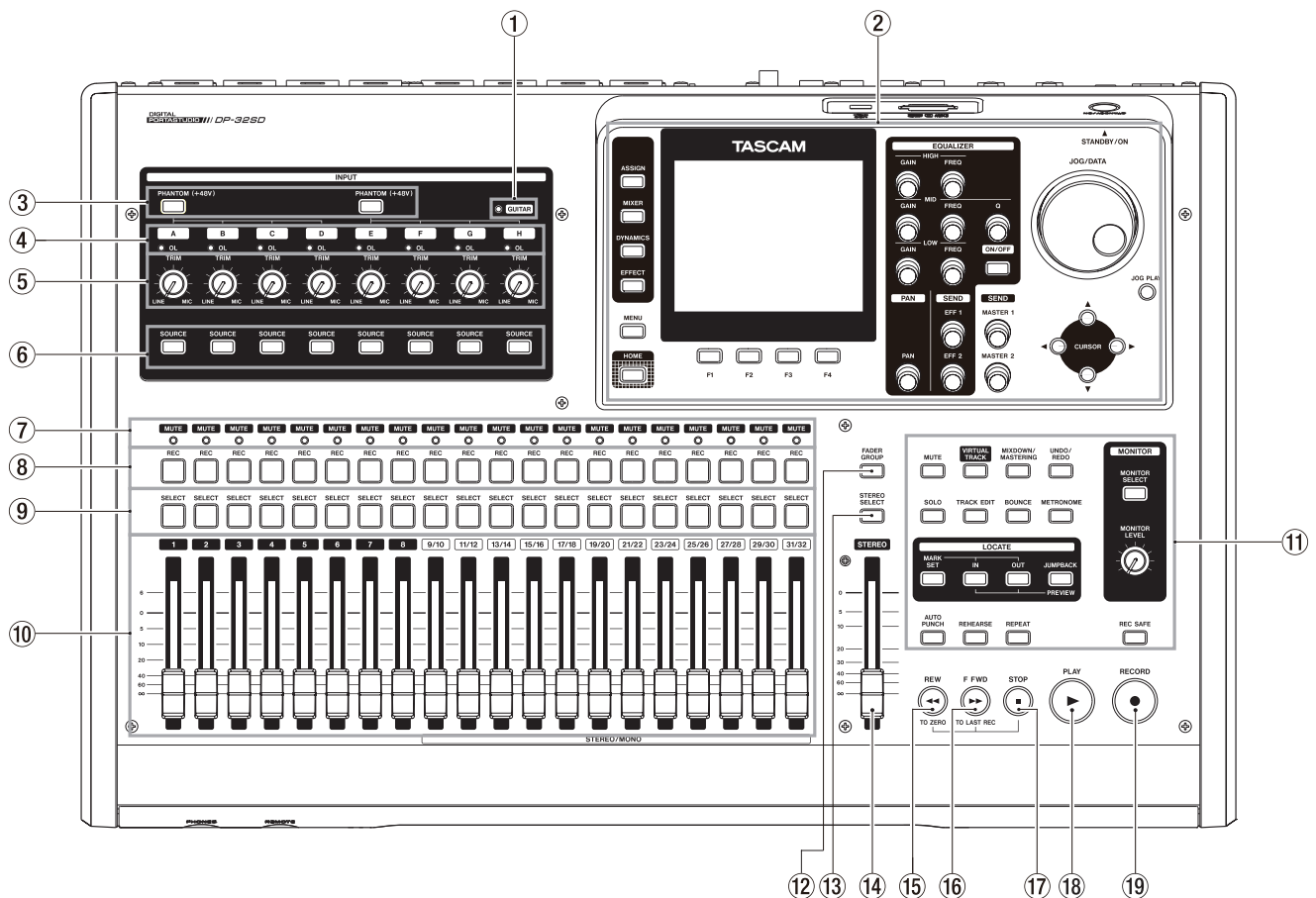

① GUITAR indicator

This indicator lights when the **LINE-GUITAR** switch on the rear panel is set to **GUITAR**.

② Display area

While viewing the screen, use the **JOG/DATA** dial or the **CURSOR** (▲/▼/◀/▶) buttons to, for example, return to the Home screen, open the **MENU** screen, assign input signals to tracks and change parameters for each input and track. (See “Display area” on page 18.)

③ PHANTOM (+48V) buttons/indicators

Use these buttons to turn phantom power on/off for **MIC/LINE INPUTS A-D** and **E-H** on the rear panel.

The **PHANTOM** indicators light when phantom power is turned on for each set of inputs.

When the **GUITAR** indicator is lit, even if phantom (+48V) power is **ON** (indicator lit) for **E-H**, **INPUT H** will not receive phantom power.

CAUTION

- Use the **STEREO** fader to lower the output volume of the unit before turning phantom power on or off. Depending on the microphone, a loud noise could occur, possibly damaging equipment and harming people’s hearing.
- Do not connect or disconnect a microphone when phantom power is turned on.
- Turn phantom power on only when using a condenser microphone that requires phantom power.
- Do not supply phantom power to an unbalanced dynamic microphone.

- Supplying phantom power to some types of ribbon microphones could break them. Do not supply phantom power to a ribbon microphone if you are in doubt.

④ OL indicators (A-H)

These indicators light when the input source signal is too loud.

⑤ TRIM knobs (A-H)

Use these knobs to adjust input levels. (See “Making the first recording” on page 38.)

⑥ SOURCE buttons/indicators

When you press one of these buttons, the corresponding input (**INPUT A** to **H**) is selected as the input source (and its button lights).

Operation of mixer controls and other functions affect the selected input.

These buttons are also used to assign input sources to tracks. (See “Assigning inputs” on page 33.)

⑦ MUTE (solo) indicators

These indicators light when a track is muted or soloed. When the **SOLO** button is not lit, it indicates the track is muted.

When the **SOLO** button is lit, it indicates the track is soloed.

3 – Names and Functions of Parts

⑧ REC buttons/indicators

Use these buttons to enable (arm) or disable recording for each track.

To monitor a track's input sound through headphones or a monitoring system, press the **REC** button for the corresponding track.

When recording is enabled for a track, the **REC** button flashes when the recorder is stopped, and lights during recording. (See "Making the first recording" on page 38 and "Multitrack recording" on page 38.)

⑨ SELECT buttons/indicators

When you press one of these buttons, the corresponding track (1 to 31/32) is selected as the current channel (its button lights).

The mixer and other functions affect the current channel.

These buttons are also used for the following purposes.

- To assign an input source to a track (See "Assigning inputs" on page 33.)
- To assign effects to an input (See "Inserting a guitar effect" on page 52.)
- To select tracks in a fader group

⑩ TRACK faders (1–31/32)

Use these faders to adjust the monitoring level of each track's playback signal or input signal assigned to the track. (See "Levels and balance" on page 54.)

⑪ Operation buttons

Use these buttons to activate/deactivate functions or make settings. (See "Operation buttons" on page 19.)

⑫ FADER GROUP button/indicator

Press to set a fader group.

The button lights when in use. (See "Fader group" on page 54.)

⑬ STEREO SELECT button/indicator

When the Assign screen is open, you can press to move the cursor from the **TRACK** display area to the **STEREO BUS** display area, and set the input for the stereo bus. (See "Assigning inputs to a stereo bus" on page 33.)

⑭ STEREO fader

Use this fader to adjust the stereo signal level output from the **STEREO OUT** jacks and **PHONES** jack. Use this fader also to adjust the recording level when bouncing or mixing down tracks.

⑮ REW (◀◀) (TO ZERO) button

When stopped or playing back, press and hold this button to rewind. Rewinding is at a fixed 10x speed.

Press briefly to jump to the previous mark.

Press and hold the **STOP (■)** button and press to locate the beginning of the song (00:00:00:00 = ZERO point). (See "Returning to zero or the last recording position" on page 43.)

⑯ F FWD (▶▶) (TO LAST REC) button

When stopped or playing back, press and hold this button to fast-forward. Fast-forwarding is at a fixed 10x speed.

Press briefly to jump to the next mark.

Press and hold the **STOP (■)** button and press to locate the last recording position (LAST REC point). (See "Returning to zero or the last recording position" on page 43.)

⑰ STOP (■) button

Use this button to stop playback, recording and fast-forwarding/rewinding. Press at the same time as you press the **REW (◀◀) (TO ZERO)** button or **F FWD (▶▶) (TO LAST REC)** button to locate the beginning of the song (00:00:00:00 = ZERO point) or the last recording position (LAST REC point). (See "Returning to zero or the last recording position" on page 43.)

⑱ PLAY (▶) button/indicator

Press to start playback.

During recording, press to stop recording and start playback (punch out).

During playback or recording, the **PLAY (▶)** button lights.

⑲ RECORD (●) button/indicator

Press to start recording.

This button lights during recording. During playback, if you press this button when a track **REC** button is flashing, recording to that track will begin (punch in). (See "Automatic punching in and out" on page 45.)

Display area

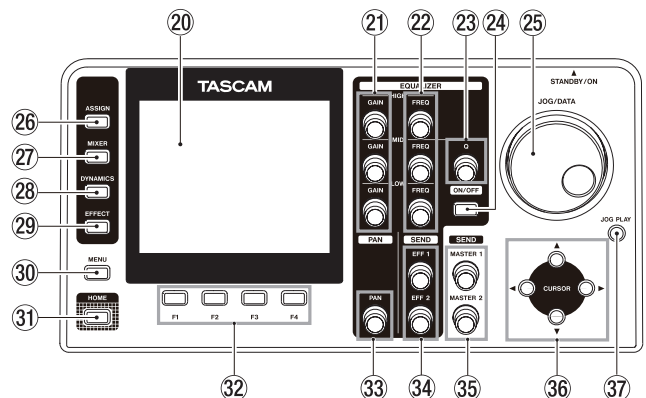

⑳ Color display

This 3.5-inch TFT display with 320x240 resolution shows various types of information.

NOTE

The display is produced with extremely high-precision manufacturing technologies. More than 99.99% of the pixels operate to specification. Less than 0.01% of the pixels may occasionally misfire or appear as red or black dots. This is not a malfunction.

㉑ GAIN (HIGH/MID/LOW) knobs

Use these knobs to adjust the equalizer gain of each band. (See "Using the input equalizer" on page 35.)

㉒ FREQ (HIGH/MID/LOW) knobs

Use these knobs to adjust the center frequency of each equalizer band. (See "Using the input equalizer" on page 35.)

㉓ Q knob

Use this knob to adjust the width of the MID equalizer band. (See "Using the input equalizer" on page 35.)

㉔ EQUALIZER ON/OFF button

Use this button to turn the equalizer on and off. (See "Using the input equalizer" on page 35.)

3 – Names and Functions of Parts

25 JOG/DATA dial

When the Home screen is open, you can use this dial for transport jog operations. (See “Cueing with the JOG/DATA dial” on page 43.)

Use this dial to change parameter values and select items when using menus.

26 ASSIGN button/indicator

Use this button to set the track type for tracks 9/10–31/32 and set (assign) the input (**INPUT A to H**) for each track. When you press this button, the Assign screen opens. The input signal of the assigned input source becomes the recording source. (See “Assigning inputs” on page 33.)

27 MIXER button/indicator

Press to open the Mixer screen.

On this screen, you can adjust the settings for the selected input (**INPUT A to H**) or track (including **GROUP**) that is selected. (See “Bouncing tracks” on page 41.)

28 DYNAMICS button/indicator

Pressing this button opens a screen to adjust the settings for the effects applied to the inputs (**INPUT A to H**). (See “Dynamic effects” on page 52.)

29 EFFECT button/indicator

Pressing this button opens a screen to make adjustments to the effects. (See “Guitar effects” on page 52 and “Send effects” on page 53.)

30 MENU button

Press to open the **MENU** screen. (See “Menu structure” on page 22.)

31 HOME button

Press to open the Home screen. (See “Home screen” on page 21.)

32 F1 to F4 (function) buttons

The functions of these buttons depend on the currently open screen. The functions currently assigned to the **F1** to **F4** buttons are shown at the bottom of the screen.

33 PAN knob

Use this knob to adjust the stereo position of the track's playback signal or the input signal assigned to that track. (See “Stereo position (panning)” on page 54.)

34 SEND EFF 1/EFF 2 knobs

Use these knobs to adjust the amount of track signal output to the **EFFECT SENDS** jacks.

Use the **SEND EFF 1** knob also to adjust the amount of track signal sent to the internal effects. (See “Sending signals to internal/external effects” on page 36.)

35 SEND MASTER 1/MASTER 2 knobs

Use these knobs to adjust the amount of master track signal output to the **EFFECT SENDS** jacks.

Use the **SEND MASTER 1** knob also to adjust the amount of master track signal sent to the internal effects. (See “Sending signals to internal/external effects” on page 36.)

36 CURSOR (▲/▼/◀/▶) buttons

Use these buttons to move the cursor on the screen.

37 JOG PLAY button

Press to switch to Search mode.

Operation buttons

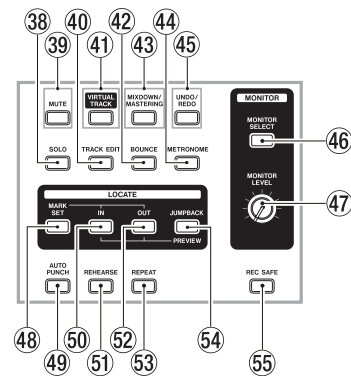

38 SOLO button/indicator

Press to switch to Solo mode (the button lights). (See “Solo” on page 37.)

39 MUTE button/indicator

Press to switch to Mute mode (the button lights). (See “Muting tracks” on page 37.)

40 TRACK EDIT button

Press to open the **TRACK EDIT** screen. (See “Overview of track editing” on page 48.)

41 VIRTUAL TRACK button/indicator

Press to open the **VIRTUAL TRACK** screen. (See “Virtual tracks” on page 47.)

42 BOUNCE button/indicator

Press to switch to Bounce recording mode (the button lights). (See “Bouncing tracks” on page 41.)

43 MIXDOWN/MASTERING button/indicator

Press to cycle through the Multi Track, Mixdown and Mastering modes. Mastering mode is only available when there is a master track. (See “Mixing down tracks” on page 54, “Creating a master file” on page 55, “Checking the master file” on page 56 and “Using the mastering tools” on page 56.)

NOTE

The current mode is shown on the Home screen.

44 METRONOME button/indicator

Press to set the metronome.

The button flashes in time with the set tempo. (See “Metronome” on page 59.)

45 UNDO/REDO button/indicator

Press to undo the immediately previous action (single undo) or to cancel the last undo (redo). (See “Undoing an operation” on page 39.)

After a single or multiple undo, the **UNDO/REDO** button lights, showing that an operation has been undone.

46 MONITOR SELECT button

Press to open the **MONITOR SELECT** pop-up window on the Home screen. (See “Monitor selection” on page 34.)

47 MONITOR LEVEL knob

Use this knob to adjust the level of the signals output from the **MONITOR OUT** jacks.

48 MARK SET button

During recording or playback, press to set a mark manually. (See “Setting a location mark” on page 43.)

3 – Names and Functions of Parts

49 AUTO PUNCH button/indicator

Press to turn automatic punching on and off.

When auto punch is on, **Auto Punch** appears on the Home screen. (See “Automatic punching in and out” on page 45.)

50 IN button

Press to locate the IN point.

Press and hold the **MARK SET** button and press to set the IN point.

Press and hold the **JUMPBACK (PREVIEW)** button and press this to start pre-roll playback up to the current position where it stops. (See “Previewing cue points” on page 45.)

51 REHEARSE button/indicator

Use this button to turn Rehearse mode on and off. In addition to auto punch in/out, you can also use the Rehearse mode for ordinary recording. (See “Rehearsing a recording” on page 38.)

52 OUT button

Press to locate the OUT point.

Press and hold the **MARK SET** button and press to set the OUT point.

Press and hold the **JUMPBACK (PREVIEW)** button and press this to start post-roll playback from the current position for a set amount of time, then return to the current position and stop. (See “Previewing cue points” on page 45.)

53 REPEAT button/indicator

Press to this button to turn Repeat Playback mode on and off. (See “Using repeat playback” on page 44.)

54 JUMPBACK (PREVIEW) button

Press to rewind a set number of seconds from the current position and start playback. (See “Jumpback playback” on page 44.)

55 REC SAFE button

Press to disable recording on all tracks.

Front panel

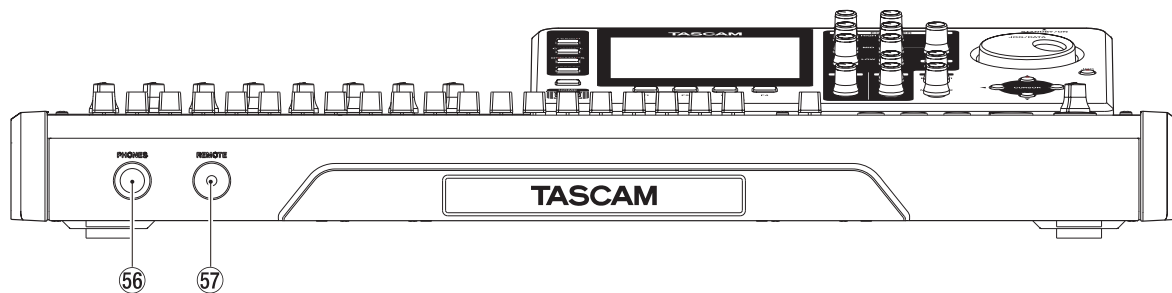

56 PHONES jack

Use this standard stereo jack to connect stereo headphones.

Use the **MONITOR LEVEL** knob on the top panel to adjust the volume output from this jack.

57 REMOTE jack (2.5mm TRS)

Connect a TASCAM RC-3F footswitch (sold separately) here to remotely control a variety of operations, including punching in and out (starting and stopping recording).

CAUTION

Before connecting headphones, use the **MONITOR LEVEL** knob on the top panel to set to the volume to minimum. A loud noise could occur, which might result in damage to equipment and people's hearing.

3 – Names and Functions of Parts

Rear panel

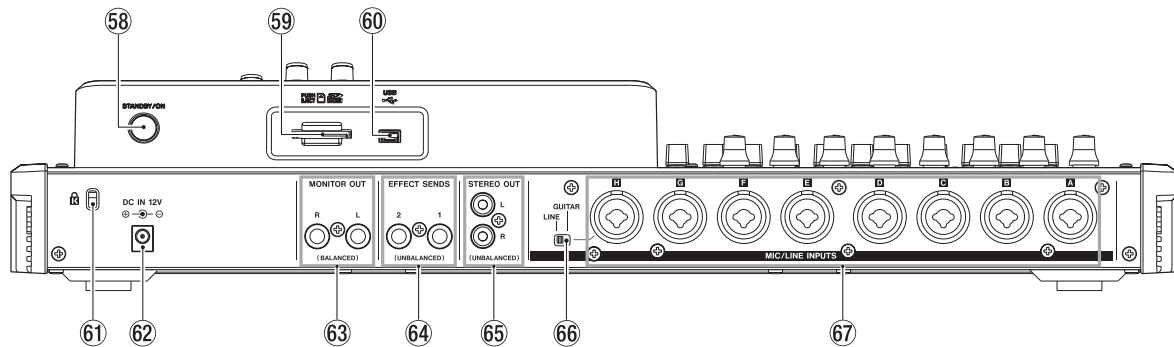

58 STANDBY/ON button

When the power is OFF (in standby), press and hold this to turn the power on. When the power is ON, press and hold this button to turn the power off (put in standby). (See “Starting up & shutting down” on page 25.)

59 SD card slot

Insert an SD card into this slot.

60 USB port

Use the USB cable to connect with a USB port on a computer. (See “Connecting to a computer” on page 64.)

CAUTION

Always connect the unit directly to a computer. Do not use a USB hub.

61 Kensington lock attachment hole

62 DC IN 12V jack

Connect the supplied TEAC PS-P1220E AC adaptor.

63 MONITOR OUT jacks (standard balanced TRS)

These jacks output the signal selected using the **MONITOR SELECT** button on the top panel. These are standard balanced jacks.

64 EFFECT SENDS jacks (standard unbalanced TS)

These jacks output the signal for effect sends 1 and 2.

65 STEREO OUT jacks (unbalanced RCA)

These jacks output the stereo bus signal.

66 LINE-GUITAR switch

Set this switch according to the input source of the **MIC/LINE INPUT H**. When connecting an electric guitar, electric bass or similar instrument directly, set this switch to **GUITAR**. When connecting a digital instrument or other audio equipment, set it to **LINE**.

67 MIC/LINE INPUTS A-H jacks (balanced)

These are balanced analog XLR/TRS combo jacks for microphone and line level input.

- XLR (1: GND, 2: HOT, 3: COLD)
- TRS (Tip: HOT, Ring: COLD, Sleeve: GND)

Home screen

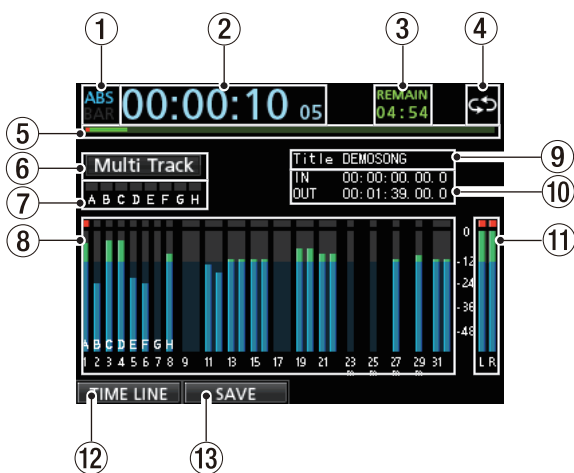

Home screen with track level meters

1 Counter mode

Shows the currently selected time counter mode: **ABS** or **BAR**.

2 Recorder time counter

Shows the elapsed time from the start of the song.

3 REMAIN time

Shows the remaining recordable time (hours: minutes) on the SD card.

4 Repeat playback icon

When the unit is in Repeat Playback mode, the icon appears.

5 Playback position

Shows the current playback position.

6 Recorder mode

Shows the current recorder mode: **Multi Track**, **Bounce**, **Mixdown** or **Mastering**.

The following items are also shown here: **Rehearsal**, **Auto Punch** and **Search**.

7 INPUT A to H overload indicators

If the input signal of any **INPUT A** to **H** source is too loud, the corresponding indicator lights.

3 – Names and Functions of Parts

⑧ Track section Level meters

When level meters appear, they show input signal levels during recording and playback signal levels during playback.



Home screen with timeline

Timeline

When the timeline appears, it shows the current playback position and which tracks have recordings.

- ⑨ **Song name**
Shows the song name during playback.
- ⑩ **IN/OUT point time**
Press and hold the **MARK SET** button and press the **IN** or **OUT** button to display the set IN or OUT point.
- ⑪ **Stereo level meters**
Shows the signal level output from the **STEREO OUT** jacks.
- ⑫ **TIMELINE/METER function**
When the level meters are shown in the track section, press the **F1 (TIMELINE)** button to shown the timeline.
When the timeline is shown in the track section, press the **F1 (METER)** button to shown the level meters.
- ⑬ **SAVE function**
Press the **F2 (SAVE)** button to open the **SONG SAVE** pop-up window.

Menu structure

Press the **MENU** button to open the **MENU** screen.

The menu contains the following items.

Menu item	Function	Reference
SONG	Song loading, saving and creation, and other song-related operations	Page 28
AUDIO DEPOT	Import and export WAV files	Page 65
INFORMATION	View information about songs, files, and the system	Page 61
TUNER	Tune instruments	Page 59
USB	Make USB settings	Page 64
FORMAT	Format SD cards	Page 62
PREFERENCE	Auto Power Save setting	Page 60
	Contrast (LCD adjustment)	Page 27
	Brightness (LCD adjustment)	
	Backlight(LCD adjustment)	
	Foot SW Right assignment	Page 41
	Foot SW Center assignment	
	Foot SW Left assignment	
	Undo History(Switch between Level 1 and Level 10)	Page 39
	Jump Back (JUMP time setting)	Page 44
	Auto Monitor setting	Page 60
	Preview Time setting	Page 45
	Peak Hold setting	Page 35
Song Name Type (switch between DATE and WORD)	Page 61	
Date/Time (system time setting)	Page 26	
Initialize (restore default settings)	Page 61	

Navigating screens

After using the **MENU** button or a dedicated button to open a screen, follow the guidelines below to use the functions on the screen.

These examples show basic operation procedures, but the actual assignments of the function buttons (**F1** to **F4** buttons) depend on the screen.

- Use the **JOG/DATA** dial or the **CURSOR** (▲/▼/◀/▶) buttons to select (highlight green) the desired item.

This example shows the **MENU** screen with the **SONG** item selected.



This is an example of the **MENU** screen. The **SONG** item is selected on this screen.

Function button assignments

The assignments of the function buttons (**F1** to **F4**) are shown at the bottom of the screen above the buttons themselves.

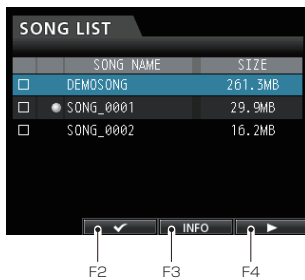

“✓” above the **F2** button shows that “✓” is assigned to the **F2** button when using this screen.

In this manual, the function assigned to a function button is shown in parentheses, for example, “**F2** (✓) button”.

In this way, “**INFO**” is assigned to the **F3** button, and “▶” is assigned to the **F4** button.

When an item has a menu, “▶” appears on the right side, and the **F4** (▶) button is used to open it.

In the menu, you can press the **F1** (◀) button to return to the previous screen.

Navigation examples



In this menu, use the **JOG/DATA** dial or the **CURSOR** (▲/▼) buttons to select **LOAD**, and then press the **F4** (▶) button to load the song.

- When the cursor (highlighted blue) is on a setting value, use the **JOG/DATA** dial to change the value.

To select an item, use the **CURSOR** (▲/▼) buttons.

This example shows the **PREFERENCE** screen.

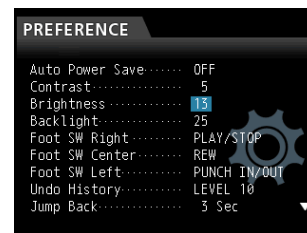

Use the **JOG/DATA** dial to change the value.

Move the cursor (highlighted blue) up or down.

- To move left or right, use the **CURSOR** (◀/▶) buttons.

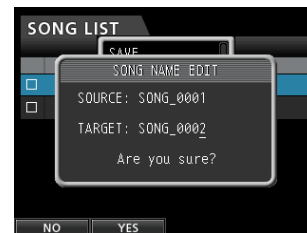

- Press the **HOME** button to return to the Home Screen.

4 – Preparation

Inserting and removing SD cards

Inserting an SD card

Insert the SD card into the SD card slot on the rear panel as shown in the illustration until it clicks into place.

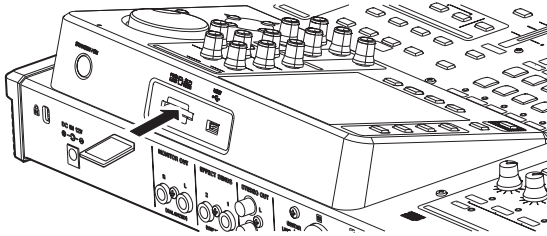

NOTE

An SD card is already in the SD card slot when the unit is shipped from the factory. If you want to use this card to record and play tracks, there is no need to reinsert it.

Removing the card

Push the loaded card in gently to eject it.

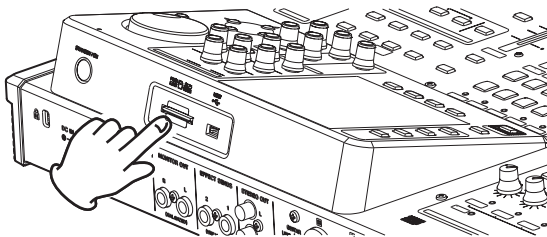

CAUTION

- Always turn the power off (put in standby) before removing an SD card.
- If you remove or insert an SD card when the power is on, recorded data could be lost permanently.
- SD and SDHC cards that are at least 512 MB in size can be used.
- A list of SD cards that have been confirmed for use with this unit can be found on our web site. Please access to a product page of this product from the TEAC Global Site (<http://teac-global.com>) to find the list or contact the TASCAM customer support service.

About write-protected SD cards

SD cards have write-protect (lock) switches.

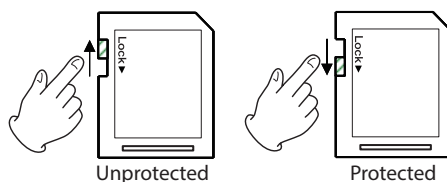

When the protect switch is in the LOCK position, files cannot be recorded or edited on the card. Slide the switch away from the LOCK position if you want to record, erase or otherwise change files on a card.

Powering the unit

As shown in the illustration, connect the included TEAC PS-P1220E AC adaptor to the DC IN 12V jack.

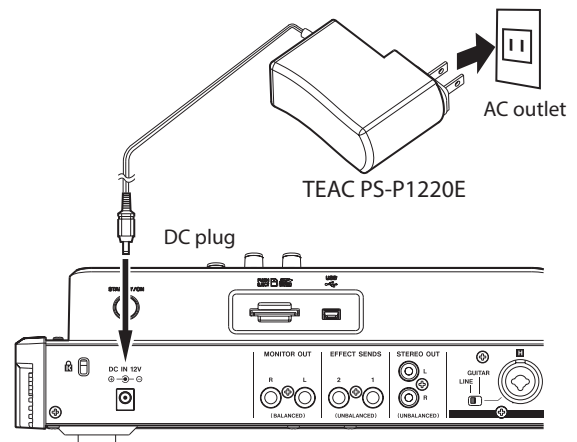

CAUTION

- Always use the included TEAC PS-P1220E AC adaptor. Use of a different adapter could cause malfunction, fire or electric shock.
- Be sure to use the included TEAC PS-P1220E AC adaptor to supply power to this unit. Power cannot be supplied to this unit by USB.

Starting up & shutting down

CAUTION

- Turn down the volume of any sound monitoring system connected to the unit before starting up or shutting down the unit.
- Do not use headphones when starting up or shutting down the unit. A loud noise could cause damage to your headphones or your ears.

Starting up the unit

Press and hold the **STANDBY/ON** button on the rear panel for a few seconds.

When the unit starts, the startup screen opens briefly followed by the Home screen.



Start-up screen

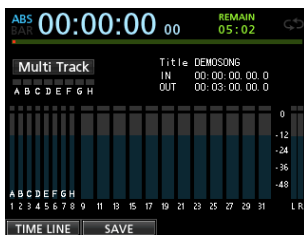

Home screen

When the unit starts up, it defaults to multitrack mode, regardless of the mode used last before shutting down.

Shutting down

Make the following preparations before shutting down the unit.

- Stop the recorder. (The unit cannot be shut down during recording and other operations.)
- Return to the Home screen.
- If the unit is connected to a computer, disconnect the USB cable after performing the necessary procedure on the computer to disconnect the unit.

After making these preparations, press and hold the **STANDBY/ON** button on the rear panel until the following screen opens.



The power turns off (enters standby) after the unit completes its shutdown process, which includes saving various information from your session.

CAUTION

When the power is ON, do not disconnect the power cord or otherwise interrupt the power to the unit. Doing so will cause all settings made since the last time you saved it to be lost. If the power is interrupted while an SD card is being accessed, all recorded songs and data on the card could be damaged beyond recovery.

NOTE

When the power is turned off (put in standby), the currently loaded song is saved. When the power is turned on again, the last song used is reloaded in the same state it was when the power was turned off (put in standby). You can even undo and redo previous operations.

4 – Preparation

Setting the date and time

Using its internal clock, this unit remembers the date and time when a song or file is recorded.

1. When the recorder is stopped, press the **MENU** button to open the MENU screen.
2. Use the **JOG/DATA** dial or the **CURSOR** (▲/▼/◀/▶) buttons to select (highlight green) **PREFERENCE**, and then press the **F4** (▶) button.

The **PREFERENCE** screen opens.

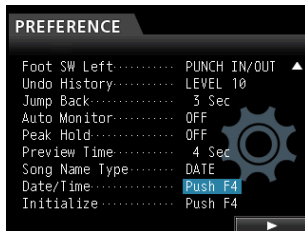

3. Use the **CURSOR** (▲/▼) buttons to select (highlight blue) **Date/Time**, and then press the **F4** (▶) button. The **DATE/TIME** screen opens.

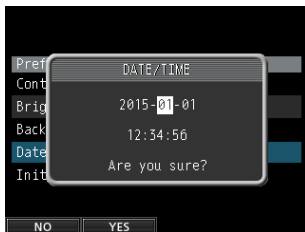

4. Use the **CURSOR** (◀/▶) buttons to move the cursor (highlighted blue) to the desired item, and then use the **JOG/DATA** dial to change the value.
5. After making the settings, press the **F2** (YES) button to return to the Home screen.

NOTE

- The time indication stops while the time is being set.
- You can automatically add the date to file names by setting the **Song Name Type** to **DATE** in the **PREFERENCE** menu.

Preparing an SD card for use

In order to use an SD card in this unit, you must format it first.

CAUTION

The included SD card is already formatted, so formatting it is not necessary. Formatting the supplied SD card will erase the demo song stored on it.

1. Confirm that the SD card is loaded and turn the power on.
2. An "Invalid Card" pop-up warning appears when a new SD card or an SD card formatted for use with another device is inserted in the unit.
3. You can also reformat a card in this unit at any time. (See "Quick formatting an SD card" on page 62 and "Full formatting an SD card" on page 63.)
To close the pop-up message, press the **F1** button.

Recorder modes

This unit has four modes.

Multi Track

Use to operate the unit as a multitrack recorder.

Bounce

Use to bounce tracks. (See "Bouncing tracks" on page 41.)

Mixdown

Use to mix down tracks to create a master file. (See "Mixing down tracks" on page 54 and "Creating a master file" on page 55.)

Mastering

Use to play back the master files that you have created and apply effects and tailor them to suit your preferences (mastering). (See "Checking the master file" on page 56 and "Using the mastering tools" on page 56.)

When the unit starts up, it defaults to multitrack mode, regardless of the mode used last before shutting down.

When in any mode other than multitrack mode, many of the onscreen operations are unavailable.

In this manual, explanations are given for multitrack mode unless otherwise noted.

Connecting other equipment

This section shows examples of how to connect other devices to this unit.

Precautions before making connections

- Turn off (put in standby) this unit and all devices that you will connect beforehand.
- Supply power to all the devices from the same line. When using a power strip, for example, use one with a cable that has a high electric current capacity in order to minimize power voltage variations.

Front panel

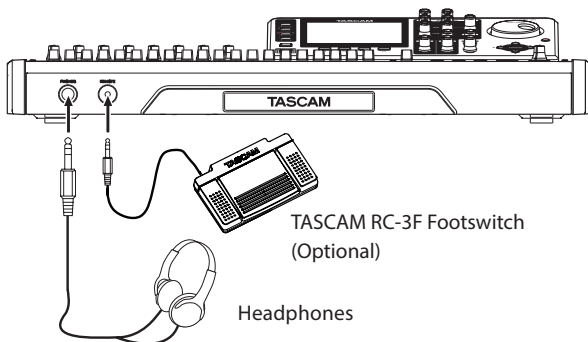

Rear panel

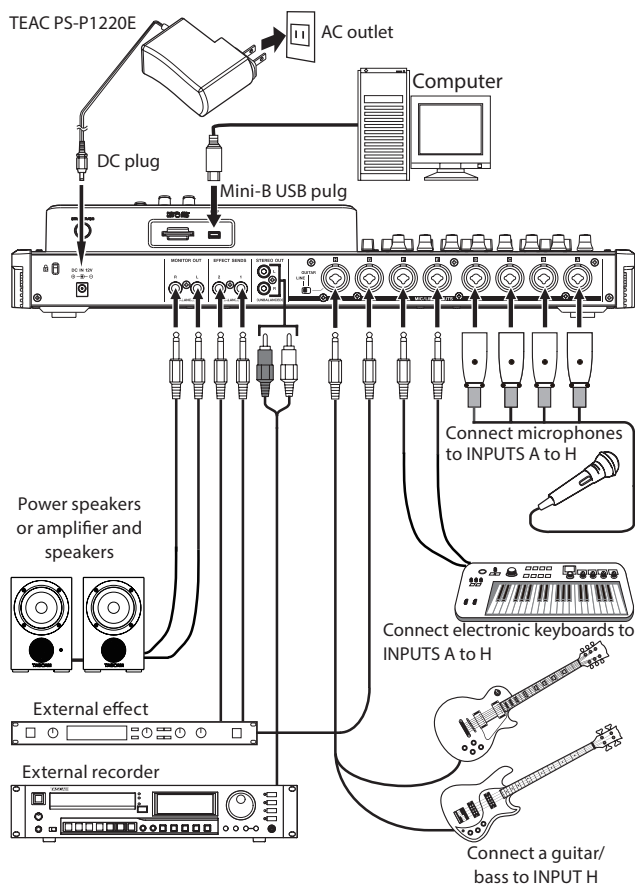

CAUTION

- Do not connect a dynamic microphone using an unbalanced connection when phantom power is on. Doing so could break it.
- Do not connect or disconnect a microphone when phantom power is on. Doing so could cause a loud noise and damage the equipment.
- Before turning phantom power on or off, turn down the output volume using the **MONITOR LEVEL** knob, **STEREO** fader and external monitor monitoring system. Depending on the microphone, a loud noise could occur, resulting in harm to equipment and hearing.

NOTE

- Before producing any sound, minimize the output volume using the **MONITOR LEVEL** knob and external monitoring system. Loud noise could occur, resulting in harm to equipment and hearing.
- Recorder functions cannot be used when the unit is connected to a computer via USB.

TIP

When connecting an electric-acoustic guitar with a built-in preamp or an active-type electric guitar, or when using an effects pedal, for example, between the guitar and this unit, set the **LINE-GUITAR** switch on the rear panel to **LINE**.

Adjusting the display

You can adjust the contrast, brightness and backlight level of the display.

Follow these procedures to adjust the contrast.

1. When the recorder is stopped, press the **MENU** button to open the **MENU** screen.
2. Use the **JOG/DATA** dial or the **CURSOR** (▲/▼/◀/▶) buttons to select (highlight green) **PREFERENCE**, and then press the **F4** (▶) button.

The **PREFERENCE** screen opens.



3. Use the **CURSOR** (▲/▼) buttons to select **Contrast**, and then use the **JOG/DATA** dial to adjust it.
 - Contrast range: 1 – 25 (default: 5)
 - Brightness range: 1 – 25 (default: 13)
 - Backlight range: 1 – 25 (default: 25)
4. After making the settings, press the **HOME** button to return to the Home screen.

5 - Song Management

This unit manages data in units called "songs". Ordinarily, each project should have its own "song" file. The first step is to load an existing song that you want to use or create a new song.

The audio data for the recorded multitrack (TRACKS 1 to 31/32) and the master file are saved in the song.

This chapter covers basic operations, including procedures for loading songs and creating new songs, as well as explains various song management functions.

Note for customers using both DP-32SD and DP-24 units

Before using a song created on a DP-24 with a DP-32SD, always backup the song data or copy the song. When a song created on a DP-24 is loaded on a DP-32SD, the song data is overwritten in DP-32 format, making it unusable by a DP-24.

Please check TEAC Global Site (<http://teac-global.com/>) for a DP-24 firmware update that enables compatibility with DP-32 format songs.

Editing names

You can edit the name of a song in a pop-up window when creating (SONG CREATE), saving (SONG SAVE) and copying (SONG COPY) the song. You can also edit the name of a song by opening the SONG NAME EDIT pop-up window.

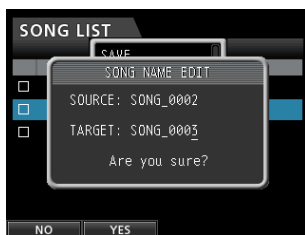

SONG NAME EDIT screen

Use the following controls to edit names.

- Use the **CURSOR** (◀/▶) buttons to move the cursor. The character at the cursor position (underlined) is the one that can be edited.
- Use the **JOG/DATA** dial to change the characters at the cursor (underline) position. You can input a maximum of 15 characters, including ordinary symbols, numerals and English upper and lower case letters.
- After inputting or editing the name, press the **F2** (YES) button to save the edited name.

Loading a song

Follow these procedures to load the song you want.

1. When the recorder is stopped, press the **MENU** button to open the MENU screen.
2. Use the **JOG/DATA** dial or the **CURSOR** (▲/▼/◀/▶) buttons to select (highlight green) **SONG**, and then press the **F4** (▶) button.

The SONG LIST screen opens.

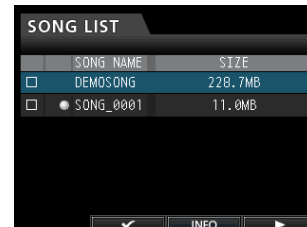

NOTE

- The ● icon appears next to the currently loaded song.
 - A lock icon appears next to any protected song.
3. Use the **JOG/DATA** dial or the **CURSOR** (▲/▼) buttons to select the desired song, and then press the **F4** (▶) button to open the menu.



4. Use the **JOG/DATA** dial or the **CURSOR** (▲/▼) buttons to select **LOAD**, and then press the **F4** (▶) button again. The SONG LOAD pop-up window appears.

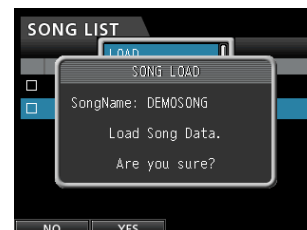

5. Press the **F2** (YES) button to load the selected song.

NOTE

If you press the **F1** (NO) button, the pop-up window disappears from the SONG LIST screen.

6. Once the song is loaded, the pop-up window disappears from the SONG LIST screen.
7. Press the **HOME** button to return to the Home screen.

Creating a new song

Follow these procedures to create a new song.

1. When the recorder is stopped, press the **MENU** button to open the MENU screen.
2. Use the **JOG/DATA** dial or the **CURSOR** (**▲/▼/◀/▶**) buttons to select (highlight green) **SONG**, and then press the **F4** (**▶**) button.

The **SONG LIST** screen opens.

3. Press the **F4** (**▶**) button to open the menu.

Use the **JOG/DATA** dial or the **CURSOR** (**▲/▼**) buttons to select **CREATE** from the menu, and then press the **F4** (**▶**) button.



4. Press the **F4** (**▶**) button to open the **SONG CREATE** pop-up window.

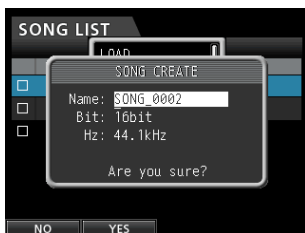

The created song will automatically be given a name according to the **Song Name Type** setting in the **PREFERENCE** menu.

5. Change the song name in the **Name** item if you want. (See "Editing names" on page 28.)

TIP

You can edit the name of a song later by selecting **NAME EDIT** from the **SONG** screen. You can also edit the song name when saving the song.

6. Align the cursor with **Bit** and turn the **JOG/DATA** dial to set the bit rate. (Default: 16bit)
7. Align the cursor with **Hz** and turn the **JOG/DATA** dial to set the sampling frequency. (Default: 44.1kHz)
8. Press the **F2** (**YES**) button to save the currently loaded song and create a new song.

NOTE

If you press the **F1** (**NO**) button, the pop-up window disappears from the **SONG LIST** screen.

9. Once the song is created, the pop-up window disappears from the **SONG LIST** screen.
10. Press the **HOME** button to return to the Home screen.

Saving a song

This unit automatically saves the current song during shutdown and when loading another song. You can also save a song at any time using the following procedure.

1. When the recorder is stopped, press the **MENU** button to open the MENU screen.
2. Use the **JOG/DATA** dial or the **CURSOR** (**▲/▼/◀/▶**) buttons to select (highlight green) **SONG**, and then press the **F4** (**▶**) button.

The **SONG LIST** screen opens.

3. Press the **F4** (**▶**) button to open the menu.

Use the **JOG/DATA** dial or the **CURSOR** (**▲/▼**) buttons to select **SAVE** from the menu, and then press the **F4** (**▶**) button.

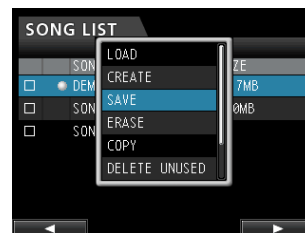

4. Press the **F4** (**▶**) button to open the **SONG SAVE** pop-up window.

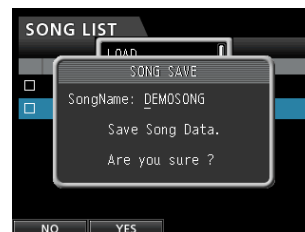

5. Change the song name in the **SongName** item if you want. (See "Editing names" on page 28.)
To save without changing the name, just press the **F2** (**YES**) button.
6. Once the song is saved, the pop-up window disappears from the **SONG LIST** screen.
7. Press the **HOME** button to return to the Home screen.

TIP

The **SAVE** item, which is one of the **SONG LIST** menu items, can also be selected using the **F2** (**SAVE**) button on the Home screen.

5 - Song Management

Viewing song information

You can check the song file format, song name (title), time/date, and song size.

1. Press the **MENU** button to open the **MENU** screen.
2. Use the **JOG/DATA** dial or the **CURSOR** (**▲/▼/◀/▶**) buttons to select (highlight green) **SONG**, and then press the **F4** (**▶**) button.

The **SONG LIST** screen opens.

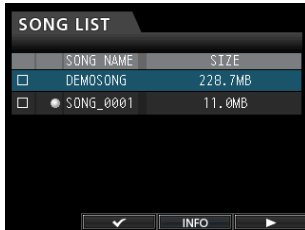

3. Press the **F3** (**INFO**) button to cycle through the song information shown in the following order: **SIZE**, **SAMPLE RATE**, **SAMPLE BIT**, and **DATE**.

Copying songs

You can copy songs.

1. When the recorder is stopped, press the **MENU** button to open the **MENU** screen.
2. Use the **JOG/DATA** dial or the **CURSOR** (**▲/▼/◀/▶**) buttons to select (highlight green) **SONG**, and then press the **F4** (**▶**) button.

The **SONG LIST** screen opens.

3. Select (highlight blue) a song you want to copy.

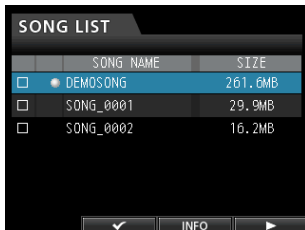

4. Next, press the **F4** (**▶**) button to open the menu. Use the **JOG/DATA** dial or the **CURSOR** (**▲/▼**) buttons to select **COPY** from the menu, and then press the **F4** (**▶**) button.

A confirmation pop-up message appears.

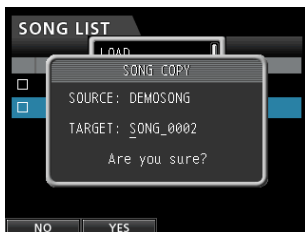

5. Change the song name as you want and press the **F2** (**YES**) button.

NOTE

To cancel copying, press the **F1** (**NO**) button instead of the **F2** (**YES**) button.

6. When copying completes, the pop-up window disappears from the **SONG LIST** screen.

Erasing songs

You can erase a single song or multiple songs at once. You might want to erase unneeded songs if the SD card starts to run out of space.

1. When the recorder is stopped, press the **MENU** button to open the **MENU** screen.
2. Use the **JOG/DATA** dial or the **CURSOR** (**▲/▼/◀/▶**) buttons to select (highlight green) **SONG**, and then press the **F4** (**▶**) button.

The **SONG LIST** screen opens.

3. Select (highlight blue) the song you want to erase and then press the **F2** (**✓**) button. To erase multiple songs, check all the songs you want to erase.

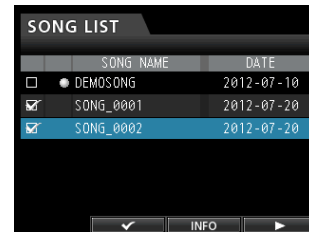

NOTE

To remove a check **✓** from a box, press the **F2** (**✓**) button again while the song is selected (highlighted blue).

4. Next, press the **F4** (**▶**) button to open the menu. Use the **JOG/DATA** dial or the **CURSOR** (**▲/▼**) buttons to select **ERASE** from the menu, and then press the **F4** (**▶**) button. A confirmation pop-up message appears.

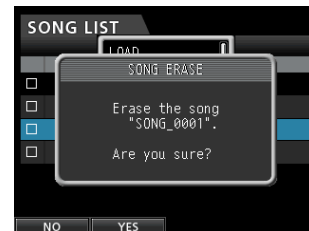

5. Press the **F2** (**YES**) button to perform the erase.

NOTE

To cancel erasing a song, press the **F1** (**NO**) button instead of the **F2** (**YES**) button.

6. When erasing a song completes, the pop-up window disappears from the **SONG LIST** screen.

NOTE

The **MUSIC** folder must always have at least one song in it. Therefore, one song will be automatically created when you insert or format a card.

Protecting songs

If you protect a song, editing, recording and erasing that song will be prevented.

1. When the recorder is stopped, press the **MENU** button to open the MENU screen.
2. Use the **JOG/DATA** dial or the **CURSOR (▲/▼/◀/▶)** buttons to select (highlight green) **SONG**, and then press the **F4 (▶)** button.
The **SONG LIST** screen opens.
3. Select (highlight blue) the song you want to protect and then press the **F2 (✓)** button. To protect multiple songs, select all songs you want to protect.

NOTE

To remove a check ✓ from a box, press the **F2 (✓)** button again while the song is selected (highlighted blue).

4. Next, press the **F4 (▶)** button to open the menu. Use the **JOG/DATA** dial or the **CURSOR (▲/▼)** buttons to select the **PROTECT** item from the menu, and then press the **F4 (▶)** button.
The song protect function is enabled for the selected song.

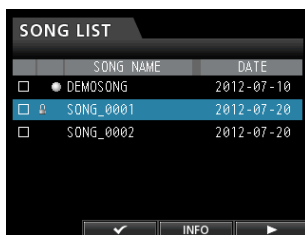

5. When protecting a song completes, the pop-up window disappears from the **SONG LIST** screen.

NOTE

- In a song list used to copy, erase or perform other functions, lock icons will appear next to protected songs.
- If you try to perform a prohibited operation (edit, record or erase) on a protected song, a **SONG PROTECTED** message will appear and the operation will be prevented.
- To remove protection from a song, follow the same procedure above, unchecking songs that you want to unlock in step 3.

Deleting unnecessary audio data from a song

In addition to audio data for a track, a song may also contain "unused" audio data. When a track is overwritten in this unit, the overwritten audio data is not erased, but remains on the SD card. Audio data that has been completely overwritten is "unused" audio data.

As shown in the illustration, if old audio data is not completely overwritten by new audio data, old audio data cannot be deleted.

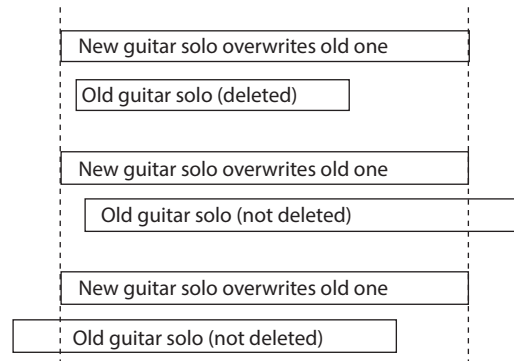

"Unused" old audio data in any virtual track that has not been assigned to a physical track can also be deleted. (See "Virtual tracks" on page 47.)

Follow these procedures to delete "unused" audio data and create room on the SD card for additional storage (this operation cannot be undone).

1. When the recorder is stopped, press the **MENU** button to open the MENU screen.
2. Use the **JOG/DATA** dial or the **CURSOR (▲/▼/◀/▶)** buttons to select (highlight green) **SONG**, and then press the **F4 (▶)** button.
The **SONG LIST** screen opens.
3. Select (highlight blue) the song that contains unnecessary audio data and then press the **F2 (✓)** button. To erase multiple songs, select all songs you want to erase.

NOTE

To remove a check ✓ from a box, press the **F2 (✓)** button again while the song is selected (highlighted blue).

4. Next, press the **F4 (▶)** button to open the menu. Use the **JOG/DATA** dial or the **CURSOR (▲/▼)** buttons to select **DELETE UNUSED** from the menu, and then press the **F4 (▶)** button.
A confirmation message appears.

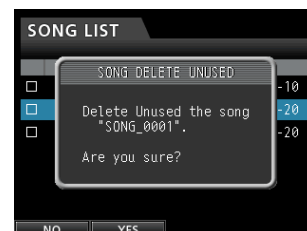

5 - Song Management

5. Press the **F2 (YES)** button.

The unnecessary audio data is deleted from the song(s).

When the deletion of unnecessary data completes, the pop-up window disappears from the **SONG LIST** screen.

NOTE

To cancel the deletion of unnecessary data, press the **F1 (NO)** button instead of the **F2 (YES)** button.

CAUTION

This operation deletes all unused audio data from the selected songs and cannot be undone. Therefore, if you think you might use this audio data later, back up the data to a computer before using the **DELETE UNUSED** command. (See "Connecting to a computer" on page 64.)

Changing a song name

1. When the recorder is stopped, press the **MENU** button to open the **MENU** screen.
2. Use the **JOG/DATA** dial or the **CURSOR (▲/▼/◀/▶)** buttons to select (highlight green) **SONG**, and then press the **F4 (▶)** button.
The **SONG LIST** screen opens.
3. Select (highlight blue) the song with the name that you want to change.

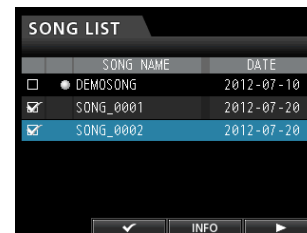

4. Next, press the **F4 (▶)** button to open the menu. Use the **JOG/DATA** dial or the **CURSOR (▲/▼)** buttons to select **NAME EDIT** from the menu, and then press the **F4 (▶)** button.

Now you can change the song name.

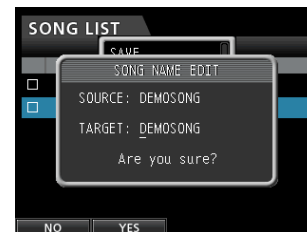

5. Change the song name as you want and press the **F2 (YES)** button.

NOTE

To cancel changing a song name, press the **F1 (NO)** button instead of the **F2 (YES)** button.

6. Once the song name is changed, the pop-up window disappears from the **SONG LIST** screen.

Selecting the input sources

This unit is equipped with eight inputs (**INPUTS A to H**), and each of them has a standard XLR/TRS combo jack.

In addition to microphones and line level instruments, you can connect guitars to the **INPUT H** jack. When connecting a guitar, set the **LINE-GUITAR** switch on the rear panel to **GUITAR**.

TIP

When connecting an electric-acoustic guitar with a built-in preamp or an active-type electric guitar, or when using an effects pedal, for example, between the guitar and this unit, set the **LINE-GUITAR** switch on the rear panel to **LINE**.

Assigning inputs

When using this unit, "assigning inputs" means setting the recording source for each track to **INPUT A to H** on the Assign screen.

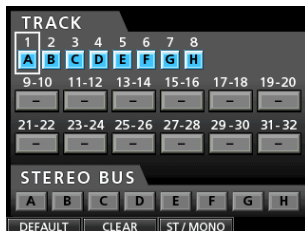

Assign screen

NOTE

- By default, the recording sources of tracks 1 to 8 are assigned to inputs A to H, in that order.
- Assignments are saved when you save a song or turn the unit off. Likewise, assignments are loaded when you load a song.

This unit can simultaneously record a maximum of eight tracks. You can assign one input source to multiple tracks simultaneously, but you cannot assign multiple input sources to the same track. You can also assign an input source to a direct stereo bus.

Setting the track type

You can set tracks 9/10–31/32 to be used as either stereo or mono tracks. By default, they are all stereo tracks. Change these settings on the Assign screen.

1. When the recorder is stopped, press the **ASSIGN** button to open the Assign screen.
2. Use the **STEREO SELECT** button of each track or the **CURSOR (▲/▼/◀/▶)** buttons to move the cursor to a track that you want to change.
3. Press the **F3 (ST/MONO)** button to change the type of the selected track.
4. If you want to change the type of other tracks, repeat steps 2 and 3.
5. After selecting all the tracks that you want to change, press the **F4 (▶)** button.

A "Erase selected tracks. Are you sure?" pop-up message appears.

6. Press the **F2 (YES)** button to change all the tracks at once.

CAUTION

When the track type is changed, the audio for that track is cleared, so the track will have no audio signal. If you make a mistake, however, you can undo this operation to restore the track type and audio on it. (See "Undoing an operation" on page 39.)

NOTE

- When the track type is changed, the input assignment is cleared, so you should make assignments now.
- If you set track 9/10 as a mono track, it will become track 9, for example. Likewise, if 31/32 is set to mono, it will become track 31. (The even numbered track is skipped.)

Assigning inputs to mono tracks

1. When the recorder is stopped, press the **ASSIGN** button to open the Assign screen.
2. Use the **SELECT** button of each track or the **CURSOR (▲/▼/◀/▶)** buttons to move the cursor to the mono track to which you want to assign a recording source.
3. Press the **SOURCE** button of the desired input (A to H) or turn the **JOG/DATA** dial to set the input source of each mono track.
4. After making the settings, press the **ASSIGN** button or the **HOME** button to return to the Home screen.

Assigning inputs to stereo tracks

Stereo tracks are always recorded simultaneously. You cannot record to a single track of a stereo track pair.

1. When the recorder is stopped, press the **ASSIGN** button to open the Assign screen.
2. Use the **SELECT** button of each track or the **CURSOR (▲/▼/◀/▶)** buttons to move the cursor to the stereo track to which you want to assign a recording source.
3. Press the **SOURCE** button of the desired input (A to H) or turn the **JOG/DATA** dial to set the input source of each stereo track.

Options: A/A, A/B, B/B, C/C, C/D, D/D, E/E, E/F, F/F, G/G, G/H, and H/H
4. After making the settings, press the **ASSIGN** button or the **HOME** button to return to the Home screen.

NOTE

- You can assign a single input source to multiple tracks by keeping the **SOURCE** button of the desired input (A to H) pressed and pressing the **SELECT** buttons of multiple tracks.
- However, you cannot assign multiple input sources to the same track.

Assigning inputs to a stereo bus

To use an external effect device, assign the inputs (A to H) that are connected to the outputs of the effect (EFFECT RETURN) to a stereo bus to return the effect signal to that stereo bus. You can also assign inputs to stereo buses during mixdown, allowing you to mix up to 8 input signals with the playback tracks.

1. When the recorder is stopped, press the **ASSIGN** button to open the Assign screen.

6 - Basic Recording

- Use the **STEREO SELECT** button or the **CURSOR** (▲/▼/◀/▶) buttons to move the cursor to the **STEREO BUS** display area.
- Use the **CURSOR** (◀/▶) buttons to move the cursor to the stereo bus to which you want to assign the input source.
- Press the **SOURCE** button of the desired input (**INPUT A** to **H**) or turn the **JOG/DATA** dial to set the input source to the stereo bus.
- After making the settings, press the **ASSIGN** button or the **HOME** button to return to the Home screen.

Checking assignments

You can check the current assignment on the Assign screen. The assigned input source name (A to H) is shown on the level meter display area of each track on the Home screen.

NOTE

When the power is turned off, the current song is saved and all song-related settings are stored (except when the song protection function is enabled).

The next time you turn the power on, all stored settings will be restored.

Canceling assignments

When the Assign screen is open, pressing the **F1** (DEFAULT) button restores the default track type and assignment settings. On this screen, pressing the **F2** (ALL CLEAR) button clears all assignment settings.

Using phantom power

When connecting a condenser microphone that requires phantom power, press the **PHANTOM (+48V)** for **INPUTS A** to **D** or **INPUTS E** to **H** when the recorder is stopped to turn phantom power on or off.

When you turn phantom power on, the **PHANTOM (+48V)** button lights and phantom power is supplied to the XLR jacks of **INPUTS A** to **D** and/or **INPUTS E** to **H**.

When the **GUITAR** indicator is lit, however, **INPUT H** will not receive phantom power even if phantom (+48V) power is on (indicator lit) for **E-H**.

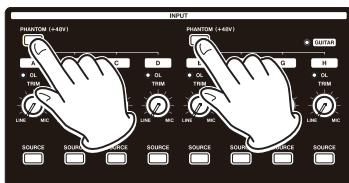

CAUTION

- Turn the **STEREO** fader down before turning phantom power on or off. Depending on the microphone, a loud noise could occur, resulting in harm to the equipment and hearing.
- Do not connect or disconnect a microphone when phantom power is on. This could cause a loud noise that might damage the equipment.
- Turn phantom power on only when using a condenser microphone that requires phantom power.

- Do not supply phantom power to an unbalanced dynamic microphone. Doing so could cause a malfunction.
- Supplying phantom power to some types of ribbon microphones could cause a malfunction. Do not supply phantom power to a ribbon microphone if you are in doubt.

Monitoring

Monitoring is an important element in the recording and mastering process. You can use an external monitoring system (such as a self-powered monitor speakers, an amplifier equipped with speakers) or headphones to monitor the sound of this unit.

Use the **MONITOR LEVEL** knob to adjust the level of the monitoring system.

Monitor selection

Besides the stereo bus, this unit allows you to monitor the bounce bus (see "Bouncing tracks" on page 41) or Effect Send 1 or 2.

With Effect Send monitoring, you can monitor the signal being sent to an effect.

- When the Home screen is open, press the **MONITOR SELECT** button to open the **MONITOR SELECT** menu.

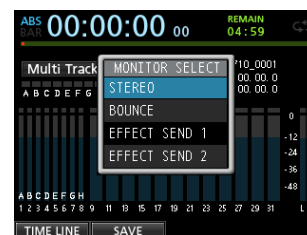

- Use the **JOG/DATA** dial or the **CURSOR** (▲/▼) buttons to select the signal to monitor.

STEREO (default)

Select to monitor the stereo signal of the stereo bus.

BOUNCE

Select to monitor the stereo signal of the bounce bus.

EFFECT SEND 1

Select to monitor the mono signal of Effect Send 1.

EFFECT SEND 2

Select to monitor the mono signal of Effect Send 2.

- After selecting the signal source to monitor, press the **MONITOR SELECT** button to return to the Home screen.

OL indicators and level meters

You can check the audio signal levels of this unit with the **OL** indicators and the onscreen level meters for **INPUTS A** to **H**.

The level meters allow the signal levels to be observed and can be used to confirm whether signals are being input into the unit. For example, if the level meters assigned to inputs A to H on the Home screen are moving, this means that signals are being input into the unit even if you cannot hear anything when monitoring.

As shown below, if a red line appears at the top of a level meter, the level is too high (it stays on screen for a while before automatically disappearing). If the level is too loud, the sound

might be distorted, so lower the level until the red line  stops appearing.

If an **OL** indicator lights, the signal from the input source might be too loud and/or the **TRIM** knob might be set too high.

If the **OL** indicator lights even though the **TRIM** knob is set to the **LINE** position, the input source signal is too loud, so lower the volume of the input source.

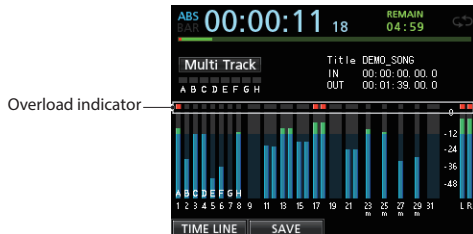

Overload indicators (A to H)

The overload indicators for inputs **A** to **H** on the display show input level (**A** to **H**) overloads.

Use the **TRIM** knobs of **INPUTS A** to **H** or the output volume controls of the input sources to reduce their input levels if overloads occur.

Track level meters (1 to 31/32)

These level meters show either the playback signal levels or the input signal levels of the corresponding tracks. The signal levels shown by the track level meters depend on the operating conditions as shown below.

REC button	Transport status	Level meters
Unlit	Playback	Show playback signal levels
Flashing (recording standby)	Playback (Automatic monitoring ON)	Show track playback signal levels
	Playback (Automatic monitoring OFF)	Show input and playback signal levels
Flashing (recording standby)	Stopped	Show input signal levels
Lit (recording)	Recording	Show input signal levels

NOTE

- When playback signal levels are shown, they cannot be adjusted because they are the levels of the recorded signals. When input signal levels are shown, you can adjust the levels with the **TRIM** knobs of **INPUT A** to **H**.

Stereo level meter (L, R)

This meter shows the output level of this unit's stereo bus. Adjust this level with the **STEREO** fader.

Peak hold display

Using the peak hold function, you can set how long peak levels are shown on the level meters on the Home Screen and other screens.

- When the recorder is stopped, press the **MENU** button to open the **MENU** screen.

- Use the **JOG/DATA** dial or the **CURSOR** (**▲/▼/◀/▶**) buttons to select **PREFERENCE**, and then press the **F4** (**▶**) button.

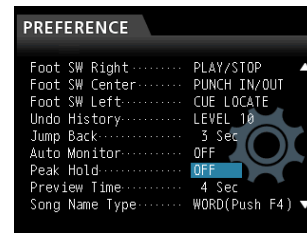

- Use the **CURSOR** (**▲/▼**) buttons to select the **Peak Hold** item, and then use the **JOG/DATA** dial to change the setting.

Option	Function
OFF (default)	Peak value is not shown.
1 Sec	Peak value is shown for about one second.
KEEP	In mastering mode, the peak value is cleared when you locate a new time. In all other modes, press the F3 [PEAK CLEAR] button to clear the peak value.

- After making the settings, press the **HOME** button to return to the Home screen.

TIP

When you are unable to monitor the meters continuously (when playing, for example), use the **KEEP** setting to check the highest level so far.

Mixer screen settings

Press the **SOURCE** button for an input or press the **SELECT** button for a track to adjust its EQ and other settings.

Using the input equalizer

INPUTS A to **H** and tracks 1 to 31/32 have independent 3-band EQs (equalizers).

CAUTION

The effect of the input equalizer will be recorded. If you plan to make EQ adjustments during mixdown, turn input equalizers **OFF** and turn track equalizers **ON**.

Adjust the equalizer settings on the Mixer screen.

- Press the **MIXER** button to open the Mixer screen.



- Press the **SOURCE** button of an **INPUT (A** to **H)** or the **SELECT** button of a track to open the Mixer screen with the corresponding equalizer.

6 - Basic Recording

- Press the **EQUALIZER ON/OFF** button to the right of the **LOW FREQ** knob to turn the equalizer on/off.

The equalizer parameters are as follows.

	GAIN	FREQ
HIGH	Setting range: ±12 dB (Default: 0 dB)	Setting range: 1.7 kHz to 18 kHz (Default: 10 kHz)
MID	Setting range: ±12 dB (Default: 0 dB)	Setting range: 32 Hz to 18 kHz (Default: 1.0 kHz)
LOW	Setting range: ±12 dB (Default: 0 dB)	Setting range: 32 Hz to 1.6 kHz (Default: 100 Hz)

Use track **SELECT** buttons to select desired tracks.

Use **INPUT SOURCE** buttons to select desired inputs.

Use **HIGH**, **MID** and **LOW GAIN** knobs to adjust the gain of each band.

Use the **HIGH**, **MID** and **LOW FREQ** knobs to adjust the center frequency of each band.

Use the **MID Q** knob to set the resonance (width) of the **MID FREQ** band.

Setting range: 0.25 to 16 (Default: 0.5)

NOTE

- The "Q" value is the center frequency of the equalizer divided by the bandwidth. A high Q value reduces the range of the cut or boost applied to the frequencies. Depending on the equalizer setting, the graph at the top of the screen changes.
 - If you press the **F1 (EQ FLAT)** button, all the settings shown on the open Mixer screen will be restored to their default values.
- After making the settings, press the **HOME** button to return to the Home screen.

DIGITAL TRIM setting (track only)

Depending on the playback sound, EQ boosting could cause distortion (digital clipping). If this happens, use the **DIGITAL TRIM** to lower the playback level before the EQ.

- Use the **CURSOR (▲/▼/◀/▶)** buttons to move the cursor to the **DIGITAL TRIM** display area.



- Turn the **JOG/DATA** dial to set the value.
Setting range: -42dB to +6dB (Default: 0dB)

Sending signals to internal/external effects

This unit has two external effect sends (**EFF 1** and **EFF 2**) and a send for the internal effects (**INSERT EFFECT**).

You can adjust send levels for each track. For details about the built-in send effects, see "Send effects" on page 53.

Follow these procedures to enable use of these effects.

- Use the **CURSOR (▲/▼/◀/▶)** buttons to move the cursor to the **SEND EFF 1/EFF 2** area.



- Turn the **JOG/DATA** dial to enable the effect.

Options: OFF (default), PRE, POST

PRE

This sends the track pre-fader signal to the effect send bus. The effect send signal level is not affected by the track fader.

POST

This sends the track post-fader signal to the effect send bus. The effect send signal level is affected by the track fader.

- Use the **SEND EFF 1/EFF 2** knobs to adjust the external send levels.

Setting range: 0 to 127 (Default: 0)

- Use the **SEND MASTER 1/MASTER 2** knobs to adjust the internal send levels.

Setting range: 0 to 127 (Default: 0)

Enabling insert effects

This unit has dynamic and guitar effects that can be used as insert effects. For details about these effects, see "Dynamic effects" on page 52 and "Guitar effects" on page 52.

- Use the **CURSOR (▲/▼/◀/▶)** buttons to move the cursor to the **INSERT EFFECT** area.



- Turn the **JOG/DATA** dial to enable/disable the insert effect.

Options

OFF: **INSERT EFFECT** indicator unlit (default)

ON: **INSERT EFFECT** indicator lit

Setting the stereo position

Use the **PAN** parameter to set the stereo position. The full left value is **L63**, and the full right value is **R63**. The center position is shown by **C**.

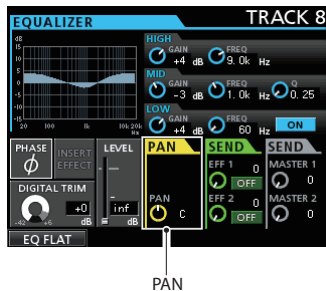

Turn the **PAN** knob to adjust the stereo position.
Setting range: L63 to C to R63 (Default: C)

Changing the signal phase

When the phase is inverted due to mic wiring or another reason, use the **PHASE Ø** item to correct the phase.

- Use the **CURSOR** (▲/▼/◀/▶) buttons to move the cursor to the **PHASE Ø** area.



- Turn the **JOG/DATA** dial to change the signal phase.

Options:

- PHASE Ø unlit (default): Normal phase
- PHASE Ø lit: Inverted phase

Checking the fader level

You can check the level of a track with the **LEVEL** item of the Mixer screen. You cannot, however, select this item and adjust the level of a track directly on this display.

NOTE

The fader level indicator shows the actual fader level. When playing back a track, by default, the positions of the faders (physical faders) on the top panel and the fader level indicators match, but control using a fader group could cause them to differ. In this case, when you move a physical fader, the fader level indicator will respond to and match the physical fader value, and thereafter the physical fader will control the level again.

CAUTION

In such cases, a sudden level change could occur.

Setting levels sent to stereo buses

You can adjust the levels sent to stereo buses independently for each input (**INPUT A** to **H**).

- Use the **CURSOR** (▲/▼/◀/▶) buttons to move the cursor to the **LEVEL** area.

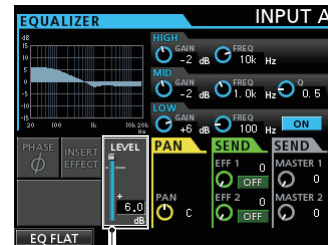

- Turn the **JOG/DATA** dial to adjust the level.
Setting range: inf to +6.0dB

Solo

Press the **SOLO** button to enable Solo mode. The **SOLO** button lights when this mode is active.

In Solo mode, the **REC** button of each track works as a **SOLO** button, so you can monitor the signal of the desired track.

When Solo mode is active, only tracks that have lit **REC** buttons can be heard. All other tracks are muted.

- When the Home screen is open, press the **SOLO** button to enable Solo mode.
 In Solo mode, the **SOLO** button is lit.
- Press the **REC** button for the track you want to solo. (You can solo multiple tracks at the same time.)
 When Solo mode is activated, the **MUTE** indicator of the track whose **REC** button was pressed lights.

■ To cancel soloing

In Solo mode, press the **SOLO** button or the **REC** button of the soloed track.

When Solo mode is deactivated, the **MUTE** indicators of soloed tracks turn off.

Muting tracks

- Press the **MUTE** button to enter Mute setting mode.
 In Mute setting mode, the **MUTE** button lights.
- Press the **REC** button for a track that you want to turn muting on/off.
 When muted, the **MUTE** indicator of that track lights.

■ To cancel muting

Press the **MUTE** button to enter Mute setting mode.

Press the **REC** button of a muted track to unmute it (and turn its **MUTE/SOLO** indicator off).

NOTE

If you solo a muted track, you can hear its sound, but its muted status is retained. So, it will be muted again when you end soloing.

6 - Basic Recording

Rehearsing a recording

This unit has a recording rehearsal function, so you can rehearse without actually recording.

The rehearsal function is especially useful for auto punch recording and other recording operations. (See "Automatic punching in and out" on page 45.)

In a rehearsal mode, monitoring and other recording operations are the same as during actual recording, but input signals are not recorded.

To rehearse, press the **REHEARSE** button so that the button lights.

When you record in Rehearsal mode, the **RECORD (●)** button flashes instead of becoming lit.

After finishing your rehearsal, press the **REHEARSE** button to cancel Rehearsal mode.

Making the first recording

Before beginning the following recording procedures, connect a recording source (such as a microphone or guitar) to an input, assign that input as the recording source for the track, and prepare your monitoring equipment.

1. Press the **REC** button of the track that you want to record on.
The **REC** button flashes red and the unit enters recording standby.

A maximum of eight tracks can be recorded simultaneously. When the **REC** buttons of eight tracks are flashing, the other **REC** buttons become inoperative.

2. Set the recording level.

Use the **TRIM** knobs of **INPUTS A** to **H** to adjust the input level.

When doing this, adjust the levels appropriately by checking the **OL** indicators above and to the left of the **TRIM** knobs.

At the same time, confirm that the sound heard from the headphones or monitoring system is not distorted, and that no effects have been applied to the sound unintentionally.

NOTE

The level meter of tracks that have input sources assigned to them show input levels after the application of INPUT equalizer.

OL indicators light if inputs are too loud.

If an **OL** indicator stays lit even when you lower the **TRIM** knob for that input, lower the input source signal level.

3. Press the **REHEARSE** button to activate Rehearsal mode.

In Rehearsal mode, **Rehearsal** appears in the upper left corner of the Home screen.

4. Press the **RECORD (●)** button.

Rehearsal starts, the **RECORD (●)** button flashes, and the **PLAY (▶)** button lights.

The **REC** button of tracks set to be recorded keep flashing because they are not being recorded.

5. After rehearsing your recording, press the **STOP (■)** button.

6. Press the **REHEARSE** button to exit Rehearsal mode.

Rehearsal disappears from the upper left corner of the Home screen.

7. Press the **RECORD (●)** button.

Recording starts, and the **RECORD (●)** and **PLAY (▶)** buttons light.

The **REC** buttons of the tracks being recorded stop flashing and stay lit.

8. After finishing your recording, press the **STOP (■)** button.
9. If you want to check part of a recording, use the **REW (◀◀)** (**TO ZERO**) button, for example, to move (locate) to it.

TIP

*Use the **TO LAST REC** function to move to the last recording position and the **TO ZERO** function to return to the start of the song (00:00:00). For more information about the rewind/fast-forward and locate functions, see "Returning to zero or the last recording position" on page 43.*

10. Press the **PLAY (▶)** button to play back the recorded tracks.
Use the track and **STEREO** faders to adjust the playback level.

Use the **MONITOR LEVEL** knob or the volume control on your monitoring system to set the final monitoring volume.

Use the **PAN** knob on the Mixer screen to set the stereo position of each track.

NOTE

- For each track, the **PAN** knob on the Mixer screen and the track fader control the recorded track's playback output signal or the monitoring sound of the input signal. They do not control the signal being recorded to the track.
- If you are not satisfied with the recorded sound, repeat the procedure above from the beginning.

Multitrack recording

You can record new audio to different tracks while playing back already recorded tracks.

Arming tracks for recording

- Press the **REC** buttons of the already recorded tracks to turn off their **REC** buttons if they are lit.
- Press the **REC** buttons of the tracks on which you want to record to put them into recording standby (the **REC** buttons start flashing).

Adjusting track pan and level settings

Use the track faders and **PAN** knobs on the Mixer screen of the already recorded tracks to adjust their levels and stereo positions that will be used when monitoring their playback signals while making the new recording.

Input selection and assignment

Use the procedures described earlier in this chapter to assign input sources to the recording tracks.

Setting input levels

After making the settings, press the **PLAY (▶)** button to start playback.

Just as though you were recording, you can monitor the sound of the already recorded tracks being played back and the input sources on the tracks for recording, allowing you to check the monitoring balance and volume.

Recording

Press the **RECORD (●)** button to start recording to another track while monitoring the playback signal.

Undoing an operation

This unit allows you to undo an operation or recording that was not successful or satisfactory. Many ordinary operations, including editing and recording, can be canceled (undone).

This unit has two types of undo functions. Single undo can be performed by a simple button press, while multiple undo allows you to return to a specific past operation and undo the operations that occurred after it.

You can use the undo functions for the following types of operations.

- Track editing (functions described in this chapter)
- Recording (including track bouncing)
- Automatic punching in/out
- Track type setting

All these operations are stored on the SD card as song information. Even when you turn the unit off (put it in standby), the previous operations are stored and can be undone when you turn the unit on again.

When listening to a part that you replaced in your last recording, for example, you might find that the previous take was better. In such a case, you can use the undo function to easily get your previous take back.

NOTE

- The **UNDO/REDO** button lights when a single undo or multiple undo has been performed.
- When you change the track type, the assignment is turned OFF and any recorded track is deleted. If you undo this, the recorded track will be restored and the track type changed back, but the assignment setting will not be restored. (See "Setting the track type" on page 33.)

Undo feature settings

1. When the recorder is stopped, press the **MENU** button to open the **MENU** screen.
2. Use the **JOG/DATA** dial or the **CURSOR (▲/▼/◀/▶)** buttons to select (highlight green) **PREFERENCE**, and then press the **F4 (▶)** button.



The **PREFERENCE** menu screen opens.

3. Use the **CURSOR (▲/▼)** buttons to select (highlight blue) **Undo History**.

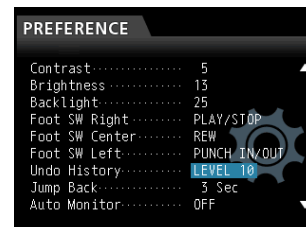

4. Set the undo level.

LEVEL 1 (Default)

The **HISTORY LIST** is not displayed when you press the **UNDO/REDO** button. In other words, this returns the unit to the state before the last operation (single undo). (To cancel an undo, press the **UNDO/REDO** button again.)

LEVEL 10

When you press the **UNDO/REDO** button, the **HISTORY LIST** appears and you can return to the state to 10 operations earlier.

NOTE

Even when you change from **LEVEL 10** to **LEVEL 1**, the history for a maximum of 10 actions remains stored. The position of the cursor in the **HISTORY LIST** shows the current undo position.

Undoing the last operation (single undo)

Press the **UNDO/REDO** button to return to the state before the last operation.

After doing this, the **UNDO/REDO** button lights, showing that redo (see below) is possible.

■ Canceling an undo operation (redo)

Press the **UNDO/REDO** button when it is lit.

The undone operation is redone, restoring the state before the undo, and the **UNDO/REDO** button becomes unlit.

6 - Basic Recording

Undoing older operations (multiple undo)

To use the multiple undo function, first you must set the Undo History on the PREFERENCE menu to LEVEL 10. (See "Undo feature settings" on page 39.)

1. Set Undo History in the PREFERENCE menu to LEVEL 10.

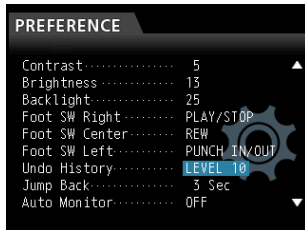

2. When the Home screen is open, press the UNDO/REDO button to display the HISTORY LIST.

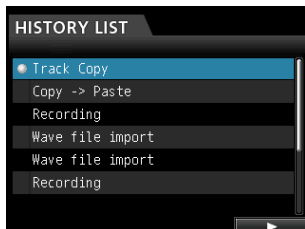

The maximum number of operations in the undo history is 10. In other words, a maximum of 10 operations can be undone.

This operation is called "multiple undo" because it allows you to undo multiple events at once and return to an earlier state.

3. Use the JOG/DATA dial to select (highlight blue) the event that you want to return to (all operations after the selected event will be undone).
4. Press the F4 (▶) button.
The multiple undo is executed and the song is restored to the state just after the selected event was performed.

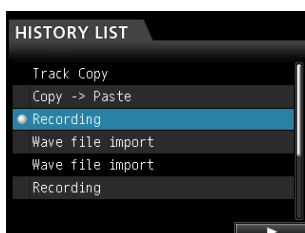

In this state, the UNDO/REDO button lights.

The record of operations undone by a multiple undo is not immediately erased. The unit has simply been returned to a previous state.

On the HISTORY LIST screen, the ● icon appears next to the last event not undone. If the most recent event in the HISTORY LIST is selected, pressing the F4 (▶) button returns to the state before the multiple undo was executed.

CAUTION

- When saving a song, a maximum of 10 operation events can be saved in the history with the song data. If the number of history events exceeds 10, the oldest events in it are erased. These erased events cannot be restored.
- When the UNDO/REDO button is lit after a multiple undo, if you perform a new operation that is added to the history, the history of events after the multiple undo will be erased, and you will not be able to redo any of these undone events.

NOTE

Since the history is stored with the song information, even when the power is turned off (put in standby), the previous operation remains stored, so undo operations will be possible the next time the power is turned on.

7 - Recorder Functions

Punching in and out

Punching in/out is a technique used to replace a part of an already recorded track.

Start playback and when you reach the part that you want to replace, switch to record (punch in), then switch back to playback (or stop) when you finish replacing the part that you want (punch out).

1. Decide what part of the track you plan to re-record.
 - Choose a point to begin where the new recording can sit well with the existing recording.
2. Press the **REC** buttons of the tracks that you want to partially re-record to put them into recording standby (**REC** buttons start flashing).
3. Start playback before the part you want to replace.
4. When the part you want to replace is reached, press the **RECORD (●)** button and start your performance. Recording starts (punch in).
5. When you finish the replacement recording, press the **PLAY (▶)** button. Playback resumes (punch out).

TIP

You can also press the **STOP (■)** button to punch out at the end of the replacement recording.

Using a footswitch to punch in/out

You can connect a TASCAM RC-3F footswitch (sold separately) to the **REMOTE** jack on the front panel and use it to punch in and out.

In step 4 above, step on the footswitch instead of pressing the **RECORD (●)** button, and in step 5, step on the footswitch again instead of pressing the **PLAY (▶)** button.

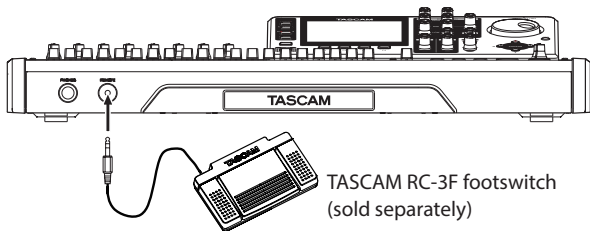

NOTE

Step on the switch (pedal) that you have set to **PUNCH IN/OUT** in the footswitch settings. By default, the center pedal is set to **PUNCH IN/OUT**. (See "Setting the footswitch" below.)

Setting the footswitch

Set the footswitch on the **PREFERENCE** screen.

1. When the recorder is stopped, press the **MENU** button to open the **MENU** screen.

2. Use the **JOG/DATA** dial or the **CURSOR (▲/▼/◀/▶)** buttons to select (highlight green) **PREFERENCE**, and then press the **F4 (▶)** button.



The **PREFERENCE** screen opens.

3. Use the **CURSOR (▲/▼)** buttons to select (highlight blue) **Foot SW Right**.

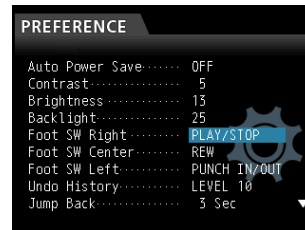

4. Use the **JOG/DATA** dial to select the function that you want to assign to the right pedal of the TASCAM RC-3F footswitch.
 - Options:** PLAY, REC, STOP, FF, REW, PUNCH IN/OUT, PLAY/STOP (right pedal default), CUE LOCATE
5. In the same way, set **Foot SW Center** for the function of the center pedal and **Foot SW Left** for the left pedal.
 - Options:** PLAY, REC, STOP, FF, REW, PUNCH IN/OUT (center pedal default), PLAY/STOP, CUE LOCATE (left pedal default)
6. After making the settings, press the **HOME** button to return to the Home screen.

Footswitch function list

Function	Description
PLAY	Same as unit's PLAY (▶) button
REC	Same as unit's RECORD (●) button
STOP	Same as unit's STOP (■) button
FF	Same as unit's F FWD (▶▶) (TO LAST REC) button
REW	Same as unit's REW (◀◀) (TO ZERO) button
PUNCH IN/OUT	Punches in when pressed during playback, punches out when pressed during recording.
PLAY/STOP	Starts playback when stopped, stops in other states.
CUE LOCATE	Locates last point where playback started.

Bouncing tracks

Like many multitrack recorders, this unit allows you to bounce tracks (ping-pong recording). Track bouncing allows you to combine the signals of multiple tracks and use them to create new mono or stereo recordings. In this way, you can virtually record more than 32 tracks. Note, however, that the original tracks cannot be separated again, so save them if they are important to you.

7 - Recorder Functions

In Bounce mode, the recording source track signals pass through the mixer tracks via the bounce bus, and they are sent to the bounce tracks.

If you make a mistake, you can use the undo function of this unit to undo the incorrect operation. (See “Undoing an operation” on page 39.)

Using the bounce function

1. When in **Multi Track** mode and the recorder is stopped, press the **BOUNCE** button.

The Recorder switches to **Bounce** mode.

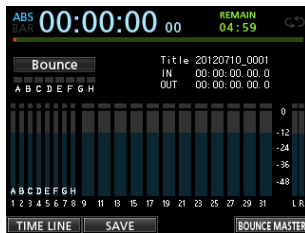

NOTE

In **Bounce** mode, **Bounce** appears in the upper left of the Home screen.

2. Press the **REC** button(s) of the track(s) on which you want to record the bounce. The **REC** button for the bounce target track starts flashing.

When bouncing in stereo, press the **REC** buttons for two mono tracks or one stereo track. The button or buttons start flashing.

When bouncing in mono, press the **REC** button for one mono track (1 to 8). The button starts flashing.

You should also set the fader of the bounce target track to 0 dB.

NOTE

Though the track fader and **STEREO** fader settings of the bounce destination affect the monitoring volume, they do not affect the recording level. If you want the monitoring level to be the same as the recording level, set the bounce target track and **STEREO** faders to 0 dB.

3. Press the **SELECT** button to specify the bounce source.

You can select any tracks except the bounce target tracks and any inputs as bounce sources. To set an input as a bounce source, assign it to a stereo bus and press its **SOURCE** button.

Use the track faders and the **PAN** knobs on the Mixer screen to adjust the signals of tracks to be bounced.

When bouncing in stereo, the lower numbered track becomes the left channel.

When bouncing in mono, set the **PAN** knobs on the Mixer screen of tracks that will be bounced completely to the left.

To adjust the bounce master level when in **Bounce** mode, press the **F4** (**BOUNCE MASTER**) button to show a fader. Use the **JOG/DATA** dial to adjust it.

CAUTION

If a bounce source is selected before selecting a destination, the audio signals of the bounce sources will not be output from the **STEREO OUT** or **MONITOR OUT** jacks until you select the bounce destination.

4. Locate to the point where you want to start the bounce and press the **RECORD** (●) button to start bouncing.

Press the **STOP** (■) button at the position where you want to end the bounce.

Checking the bounce result

Mute the bounce source tracks and play back the song. (See “Muting tracks” on page 37.)

If you are not satisfied with the result because you think the balance between the instruments or the pan settings are not good, for example, undo the operation. (See “Undoing an operation” on page 39.)

If you are satisfied with the result, press the **BOUNCE** button to return to **Multi Track** mode.

Once the track bounce completes, you can make new recordings over (overwrite) the other tracks.

TIP

If it is possible that you might need the original tracks at some time later, copy or back up song data to a computer before bouncing tracks. (See “Copying songs” on page 30 and “Connecting to a computer” on page 64.)

NOTE

To hear the audio recorded to the bounce target track(s), set the monitor destination to **BOUNCE** so that you can monitor the bounce bus signal.

Direct location function

You can specify a time or measure/beat to be located without using marks. On the Home screen, use the **JOG/DATA** dial to specify the location point.

The Home screen counter has two display modes: **ABS** (absolute time) and **BAR** (bar/beat).

The **BAR** display is based on the metronome setting.

In **BAR** mode, you can locate a position in beat units. The current position of the recorder is shown as a time (measure-beat) at the top of the Home screen. The tempo is also displayed.

The **ABS** display is based on the absolute time. In **ABS** mode, you can locate a position in frame units. The current position of the recorder is shown as a time (hours: minutes: seconds: frames) at the top of the Home screen (30 frames per second).

You can specify a time in this time display area and move the transport to that point.

Locating a specified time directly

In **ABS** mode, you can locate a specified time directly using the following procedure. Direct location this way is not possible when recording.

1. Press the **HOME** button to open the Home screen.
2. **ABS** appears to the left of the counter on the Home screen. If **ABS** does not appear, press the **METRONOME** button to open the **METRONOME** screen.

Use the **CURSOR** (▲/▼) buttons to select the **BAR DISP** item, and then use the **JOG/DATA** dial to set it to **OFF**. This will cause **ABS** to appear on the Home screen.

- Turn the **JOG/DATA** dial to change the time (the speed that the time changes corresponds to the speed that the dial is turned).
- After setting the desired time value, press the **PLAY (▶)** button to start playback from that time.

Locating a specified bar/beat directly

In BAR mode, in the same way that you can locate a specified time directly in ABS mode, you can locate a position by specifying a time in bars and beats using the following procedure. Direct location this way is not possible when recording.

- Press the **HOME** button to open the Home screen.
- BAR** appears to the left of the counter of the Home screen. If **BAR** does not appear, press the **METRONOME** button to open the **METRONOME** screen..
Use the **CURSOR (▲/▼)** buttons to select the **BAR DISP** item, and then use the **JOG/DATA** dial to set it to **ON**. This will cause **BAR** to appear on the Home screen.
- The value cycles automatically when they reach the highest or lowest value in a field.
When set to 4/4, if the beat field exceeds 04, for example, the bar value will increase by one, and the beat field will return to 01.
In the same way, when you turn the **JOG/DATA** dial to lower a value and the beat value passes through 01, the bar value will decrease and the total value will change in succession. When set to 4/4, for example, if the value drops below 01 when the cursor is located under the beat field, the bar value will decrease by one, and the beat field will return to 04.
- After setting the desired measure/beat, press the **PLAY (▶)** button to start playback from that beat.

Location marks

This unit allows you to set up to 99 location marks in each song. For example, you could mark the intro, vocal entry points and the starts of verses.

Setting a location mark

When stopped, recording or playing back, press the **MARK SET** button at a point where you want a location mark.

A mark number (**MARK xx**) appears on the Home screen (xx is the mark number).

The displayed mark number is the mark at the current position or the mark that is placed closes before the current position. A flag icon is also shown above the timeline.

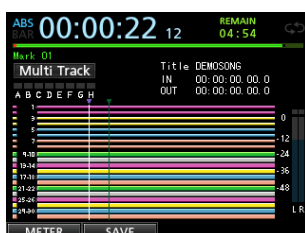

NOTE

The marks are numbered in the order that you enter them. They are not numbered according to their positions in the song.

Therefore, **MARK 05** could appear before **MARK 01** in a song, for example.

Skipping to location marks

Press the **F FWD (▶▶)** or **REW (◀◀)** button to skip to the next or previous mark.

NOTE

Marks are skipped to in time order, not in numerical order.

Deleting a location mark

You can delete marks when the recorder is stopped.

- Press the **F FWD (▶▶)** or **REW (◀◀)** button to move to the mark that you want to delete.
- Press the **MARK SET** button to delete the location mark.

NOTE

This operation cannot be undone. Make sure you want to execute it.

Returning to zero or the last recording position

You can easily jump to the beginning of a song (00:00:00:00 = ZERO point) or to the last recording position (LAST REC point) by using two buttons at once.

To return to the beginning of a song (00:00:00:00 = ZERO point), press and hold the **STOP (■)** button and press the **REW (◀◀) (TO ZERO)** button.

To return to the last recording position (LAST REC point), press and hold the **STOP (■)** button and press the **F FWD (▶▶) (TO LAST REC)** button. This function is useful when you want to record again after finishing recording.

Fast forwarding and rewinding

During playback or when stopped, press the **REW (◀◀)** or **F FWD (▶▶)** button to rewind or fast-forward while the button is pressed. The rewind and fast-forward speed is fixed at 10 times normal speed.

Cueing with the JOG/DATA dial

You can use the **JOG/DATA** dial to jog to a precise playback position. There are two ways to cue by jogging: while viewing a track's waveform and while listening to the audio of tracks.

Jogging while viewing a waveform

- Use the transport buttons or other locate functions to move the playback position near the position where you want to cue playback.
- Press the **JOG PLAY** button to enter jog mode.
If in timeline display mode, press the **F1** key to switch to waveform display.
- Press the **SELECT** button for the track that you want to view.
The waveform of the selected track appears.

7 - Recorder Functions

If a stereo track is selected, the displayed track (odd or even) changes each time the **SELECT** button is pressed, and you can monitor only the displayed track.

4. Use the **CURSOR** (◀/▶) buttons to increase/decrease the horizontal zoom (time) as necessary.

Press the **CURSOR** ◀ button to decrease the horizontal zoom (time), or the **CURSOR** ▶ button to increase it.

You can also use the **CURSOR** (▲/▼) buttons to increase/decrease the vertical zoom (audio level).

Press the **CURSOR** ▲ button to increase the vertical zoom (audio level), or the **CURSOR** ▼ button to decrease it.

Increasing the zoom makes it easier to cue precisely.

5. Use the **JOG/DATA** dial to locate the cue point.
6. After you find the cue point, press the **JOG PLAY** button to return to the Home screen.

Jogging while listening to audio

1. Use the transport buttons or other locate functions to move the playback position near the position where you want to cue playback.

2. Press the **JOG PLAY** button to enter jog mode.

If in waveform display mode, press the **F1** key to switch to timeline display.

3. Use the **CURSOR** (◀/▶) buttons to increase/decrease the horizontal zoom (time) as necessary.

Press the **CURSOR** (◀) button to decrease the horizontal zoom (time), or the **CURSOR** (▶) button to increase it.

Increasing the zoom makes it easier to cue precisely.

The jogging sound, which is the sound of a short increment being repeated, can be heard.

4. While listening to the jog sound, use the **JOG/DATA** dial to locate the cue point.
5. After you find the cue point, press the **JOG PLAY** button to return to the Home screen.

NOTE

The transport buttons can be used even in jog mode. However, when the timeline is displayed, pressing the **PLAY** button switches between normal playback and jog playback, and pressing the **STOP** button activates jog playback.

When in jog mode, you can move in 1/10 frame (1/300 seconds) units. You can also set IN and OUT points with 1/10 frame precision.

Repeat playback

Use the repeat playback function to play the same part again and again.

The repeat playback interval is the audio between the IN and OUT points.

Setting IN/OUT points

In addition to setting the repeat playback interval, the IN and OUT points are also used to set track editing intervals and as the punch-in and punch-out points when automatically punching in and out. Moreover, these points are used as the start and end points of the mixed-down master file when creating a master file.

You can set these points when the unit is recording, playing back or stopped.

NOTE

The IN and OUT points cannot be set or edited in the following modes: repeat playback, auto punch and mastering.

Adding IN/OUT points

Regardless of whether the unit is stopped, playing back or recording, when the recorder is at the desired position, press and hold the **MARK SET** button and press the **IN** or **OUT** button.

The position where you pressed the **IN/OUT** button is set as the IN/OUT point and the time is shown on the Home screen.

Locating IN/OUT points

When stopped or playing back, press the **IN** or **OUT** button.

Using repeat playback

1. Set the IN point and OUT points as the start and end points of the repeat playback interval, and then return to the Home screen.

2. Press the **REPEAT** button.

The  icon appears on the Home screen, and repeat playback starts.

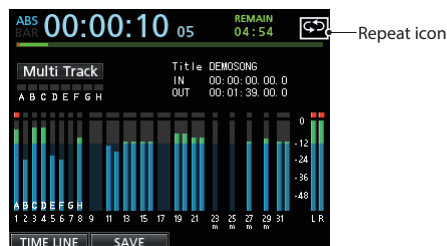

After starting from the IN point, when playback reaches the OUT point, it returns to the IN point and continues.

Playback continues to repeat between the IN and OUT points.

3. To end repeat playback, press the **REPEAT** button, so that the  icon disappears from the Home screen.

Jumpback playback

Press the **JUMPBACK (PREVIEW)** button during playback to move back a set number of seconds and restart playback.

If you want to hear a passage again during playback, press the **JUMPBACK (PREVIEW)** button to go back the set number of seconds and replay that passage.

1. When the recorder is stopped, press the **MENU** button to open the MENU screen.
2. Use the **JOG/DATA** dial or the **CURSOR** (▲/▼/◀/▶) buttons to select (highlight green) **PREFERENCE**, and then press the **F4** (▶) button.



The **PREFERENCE** screen opens.

- Use the **CURSOR** (▲/▼) buttons to select (highlight blue) **Jump Back**, then use the **JOG/DATA** dial to set the jumpback time.

Options: 1 Sec to 10 Sec, 20 Sec, 30 Sec (default: 3 Sec)

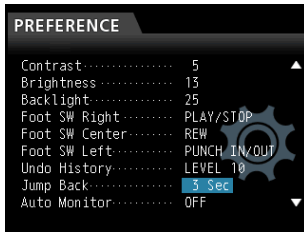

- After making the setting, press the **HOME** button to return to the Home screen.
- Press the **JUMPBACK** button during playback to move back by the time set in step 3.

Previewing cue points

You can preview playback to check whether it is cued correctly. This function can be used to preview audio both before and after the current playback position.

- When the recorder is stopped, press the **MENU** button to open the MENU screen.
- Use the **JOG/DATA** dial or the **CURSOR** (▲/▼/◀/▶) buttons to select (highlight green) **PREFERENCE**, and then press the **F4** (▶) button.



The **PREFERENCE** screen opens.

- Use the **CURSOR** (▲/▼) buttons to select (highlight blue) **Preview Time**, then use the **JOG/DATA** dial to set the preview playback time.

Preview Time: 1 Sec to 10 Sec (default: 4 Sec)

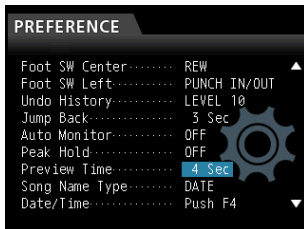

- After making the setting, press the **HOME** button to return to the Home screen.

- Preview playback before or after the cue point.

To preview after the cue point:

While playback is stopped, hold the **PREVIEW** button and press the **OUT** button to play from the current point for the preview time, and then return to the current point and stop.

To preview before the cue point:

While playback is stopped, hold the **PREVIEW** button and press the **IN** button to skip back the preview time and then play to the current time and stop.

Automatic punching in and out

You can use the punch in/out function to automatically record between punch-in and punch-out points set in advance.

When using auto punch in/out recording, playback starts from the pre-roll point before the punch-in point where recording starts. Once the punch-out point is reached, recording ends, but playback continues for the post-roll time and then stops.

In automatic punch in/out recording, monitoring of the recording tracks changes as follows.

- Pre-roll period: Track playback signal + input source signal
 - Punch in–out interval: Input source signal
 - Post-roll period: Track playback signal + input source signal
- Tracks not armed for recording can be monitored the entire time.

When using this auto punch in/out function, the above monitoring changes occur not only during actual recording, but also in the Rehearsal mode.

In Rehearsal mode, you can simulate auto punch in/out recording, so you can rehearse your performance and also check whether the IN and OUT points are set correctly.

You can also use punch in/out in with the repeat function. By using these functions together, you can repeatedly rehearse punch in/out recording, or record multiple takes of the same section, letting the unit work automatically. After recording multiple takes, you can choose the best one.

Setting punch-in/out points

There are two ways to set the punch-in/out points.

LAST REC:

This option sets the starting and ending points of the last recording (or rehearsal) as the punch in and out points.

IN - OUT:

This option sets the IN and OUT points as the punch-in/out points. The first of these points will be used as the punch-in point and the second as the punch-out point.

- When the recorder is stopped, press the **HOME** button to open the Home screen.
- Press the **REC** button for the track(s) on which you want to automatically punch in and out.
- Press the **AUTO PUNCH** button to open the **AUTO PUNCH** screen.

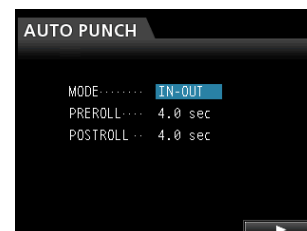

7 - Recorder Functions

4. Use the **CURSOR** (▲/▼) buttons to select (highlight blue) **MODE**, **PREROLL** or **POSTROLL**, and then use the **JOG/DATA** dial to set the value.

MODE: LAST REC or IN-OUT

PREROLL: 1.0 to 9.9 sec

POSTROLL: 1.0 to 9.9 sec

After setting **MODE**, **PREROLL** and **POSTROLL**, press the **F4** (▶) button to return to the Home screen. **Auto Punch** appears at the top of the screen when automatic punching is enabled.

You can also press the **AUTO PUNCH** button again to return to the Home screen without enabling automatic punching.

NOTE

You can press the **AUTO PUNCH** button before putting any tracks into recording standby. Press the **REC** button of any track to put it into recording standby after enabling automatic punching.

Checking punch-in/out points

When punch-in/out points are set, you can confirm the setting by pressing the **PLAY** (▶) button.

The playback starts from the pre-roll point and continues to the post-roll point. When the punch-in point is reached, on tracks armed for recording, already recorded audio will be muted and only input signals will be heard. When the punch-out point is reached, already recorded audio and input signals will both be heard.

If you want to change the punch-in/out points, locate the desired points and set them again.

If there are no problems with the punch-in/out points and pre-roll and post-roll times rehearse recording, as described below.

Rehearsing with automatic punching

You can rehearse before punch in/out recording. During rehearsal, monitoring operates the same way as in actual recording, but no recording occurs.

1. When the **AUTO PUNCH** button is lit and at least one of the tracks is in recording standby, press the **REHEARSE** button. The **REHEARSE** button lights.

2. Press the **RECORD** (●) button.

Automatic punch in/out rehearsal starts.

- Playback starts from the pre-roll point. You can monitor both the track playback and input source signals during the pre-roll.
- When the punch-in point is reached, monitoring changes to only the input source signal, and the **RECORD** (●) button starts flashing (indicating that this is a rehearsal).
- When the punch-out point is reached, monitoring of both the track playback and input source signals resumes, and the **RECORD** (●) button becomes unlit.
- Playback stops at the post-roll point.

Before starting a rehearsal, you can press the **REPEAT** button to repeat rehearsal of the auto-punch interval until you press the **STOP** (■) button. (**AUTO PUNCH**, **REHEARSE** and **REPEAT** buttons all light in this case.)

Recording with automatic punching

After rehearsing, record with auto punch in/out.

1. If necessary, press the **REHEARSE** button so that it becomes unlit.
2. Press the **RECORD** (●) button.
 - Playback starts from the pre-roll point. You can monitor both the track playback and input source signals during the pre-roll.
 - When the punch-in point is reached, monitoring changes to only the input source signal, and the **RECORD** (●) button starts flashing (indicating that this is a rehearsal).
 - When the punch-out point is reached, monitoring of both the track playback and input source signals resumes, and the **RECORD** (●) button becomes unlit.
 - Playback stops at the post-roll point.

Before starting punch in/out recording, you can press the **REPEAT** button so that it lights. Then, you can repeat automatic punch in/out recording up to 8 times (takes). This uses the recorder's virtual track feature.

After recording, you can choose your favorite take from one of the 8 takes recorded on virtual tracks. (See "Checking takes" below.)

NOTE

You can undo auto punch in/out operations.

Checking takes

After recording one or more takes, follow these procedures to check them.

After punch in/out recording completes, the **VIRTUAL TRACK** screen opens, as shown below.

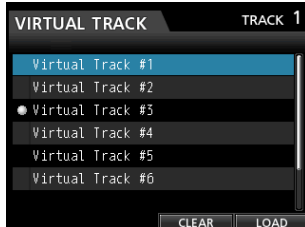

1. Use the **JOG/DATA** dial or the **CURSOR** (▲/▼) buttons to select (highlight blue) a take in the list.
2. Press **F4 (LOAD)** to assign that virtual track to the physical track.
Playback the take to check it.
Repeat steps **1** and **2** to check other takes.
3. If you are satisfied with the result, press the **VIRTUAL TRACK** button to close this screen.
To end Auto Punch mode, press the **AUTO PUNCH** button.
If you are not satisfied with the result, press the **RECORD** (●) button again and record another take.

Virtual tracks

This unit has 8 virtual tracks for each track.

Since there are 8 virtual tracks for each track, you can record multiple takes of lead vocals and improvised solos, for example, and then choose the best takes afterwards.

After recording, assign an unused virtual track to the physical track, and then record another take. By repeating this process, you can use multiple virtual tracks for different takes.

Recording to virtual tracks

Follow these procedures to record a virtual track.

1. Select the track.
2. Press the **VIRTUAL TRACK** button.
3. Select **UNUSED**.
4. Press the **F4 (LOAD)** button to assign the virtual track to be recorded to.
5. Once you have completed the setting, press the **HOME** button to return to the Home Screen.

Assigning virtual tracks

Follow these procedures to assign a virtual track to a physical track.

1. Press the **SELECT** button of a track you want to assign a virtual track to when the Home screen is open, and then press the **VIRTUAL TRACK** button.
(You can also press the **VIRTUAL TRACK** button first, and then select the track.)
The **VIRTUAL TRACK** screen opens.

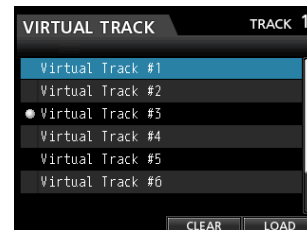

NOTE

- When creating a song, Virtual Track #1 is assigned to each physical track.
 - Recording, playback, and editing is only possible on virtual tracks assigned to physical tracks.
 - You can assign an already recorded virtual track to a physical track and record over it.
2. Use the **JOG/DATA** dial to select the virtual track that you want to assign.
 3. Press the **F4 (LOAD)** button to assign the virtual track to the physical track.
The virtual track assigned to the physical track is marked with an icon on the screen.

NOTE

- To delete a virtual track, press the **F3 (CLEAR)** button in step **3** above.
- A virtual track assigned to a physical track cannot be deleted.
- If you assign an unused virtual track, the physical track becomes empty.

8 - Track Editing

In the past, editing recordings made on tape recorders required advanced techniques, but with this unit editing is easy and accurate.

Moreover, unlike with a tape recorder when an editing error could not be undone, this unit uses non-destructive editing, which means you can edit without altering the original data so the undo function can be used to correct an edit easily. (See "Undoing an operation" on page 39.)

Overview of track editing

This unit has the following track editing functions.

- COPY/PASTE
- COPY/INSERT
- MOVE/PASTE
- MOVE/INSERT
- OPEN (insert silence)
- CUT (remove part)
- SILENCE (erase part)
- CLONE TRACK (duplicate track)
- CLEAN OUT (delete track)

Editing points

The IN, OUT and TO points are used as editing points for the COPY/PASTE, COPY/INSERT, MOVE/PASTE and MOVE/INSERT functions.

The IN and OUT points are used as editing points for the OPEN, CUT, and SILENCE functions.

These are the same IN and OUT points used for repeat playback.

■ IN point

The IN point is the start point for the part of the track to be edited.

Press and hold the **MARK SET** button and press the **IN** button to set the IN point at the current position.

■ OUT point

The OUT point is the end point for the part of the track to be edited.

Press and hold the **MARK SET** button and press the **OUT** button to set the OUT point at the current position.

■ TO point

The TO point is the current playback position.

NOTE

If you press the **JOG PLAY** button to enable jog mode, you can set IN and OUT points with subframe (1/10 frame) precision.

Basic editing procedures

1. When the recorder is stopped, press the **TRACK EDIT** button to open the **TRACK EDIT** menu.

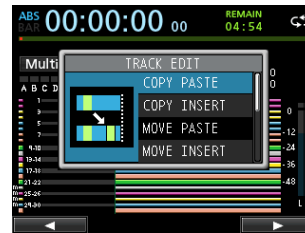

2. Use the **JOG/DATA** dial or the **CURSOR (▲/▼)** buttons to select (highlight blue) the desired track editing function, and then press the **F4 (▶)** button.

The corresponding function window opens.



COPY/PASTE window

3. Select the setting item value.

If there are multiple setting items, use the **CURSOR (▲/▼)** buttons to select one, and then use the **JOG/DATA** dial to set the value.

4. Press the **F2 (YES)** button to execute the function.

NOTE

Press the **F1 (NO)** button to close the **COPY/PASTE** window without executing the function.

Explanation of items

■ SOURCE

This is the track to be edited.

The choices available depend on the editing function.

- 1 to 12: Single track
- 13/14 to 31/32: Stereo track
You can also use track **SELECT** buttons to set this.
- ALL: Every track from 1 to 32



COPY/PASTE window

■ IN/OUT/TO

To change the IN/OUT/TO points, exit the TRACK EDIT screen, and set them again as necessary.

■ TARGET Track

This is the track that is edited. In the case of OPEN, CUT, SILENCE and CLEAN OUT, the source track itself is the target track.

The options depend on what you have set for the SOURCE track.

When the SOURCE track is ALL (all tracks), the TARGET track must also be ALL (all tracks).

■ TIMES

Set the number of times that the copied section will be pasted between 1 and 99.

COPY/PASTE

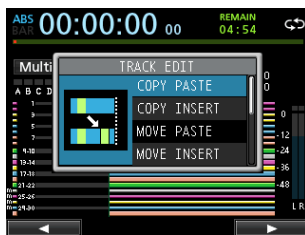
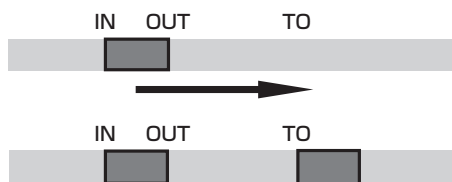

This function copies the audio data from between the IN and OUT points on the source track, and pastes it on the target track starting from the TO point. This operation does not change the source track between the IN and OUT points.

This operation overwrites recorded data on the target track. Therefore, the length of the target track is not changed.

You can make multiple copies in a single operation.

In other words, you can overwrite the target track from the TO point with a designated number of repetitions of the source data.

The following parameters are used in this operation.

- SOURCE Track
- IN/OUT/TO
- TARGET
- TIMES

COPY/INSERT

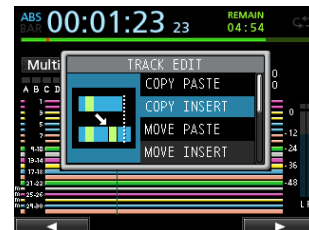
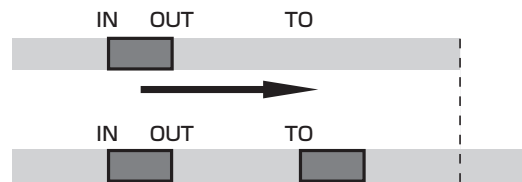

This function copies the audio data from between the IN and OUT points on the source track, and inserts it on the target track starting from the TO point. This operation does not change the source track between the IN and OUT points.

This operation inserts recorded data into the target track. The recorded data on the target track after the TO point is offset by the amount of time used by the inserted audio data. Therefore, the target track becomes longer.

You can make multiple copies in a single operation. In other words, you can insert a designated number of repetitions of the data into the target track from the TO point.

The following parameters are used in this operation.

- SOURCE Track
- IN/OUT/TO
- TARGET
- TIMES

8 - Track Editing

MOVE/PASTE

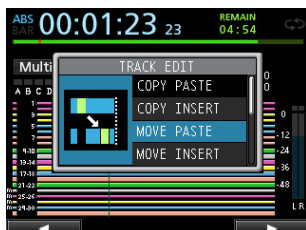
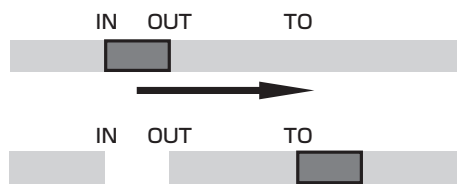

The audio data between the IN and OUT points on the source track is removed and pasted on the target track from the TO point. This operation leaves a silence between the IN and OUT points on the source track.

This operation overwrites recorded data on the target track. Therefore, the length of the target track is not changed.

The following parameters are used in this operation.

- SOURCE Track
- IN/OUT/TO
- TARGET Track

MOVE/INSERT

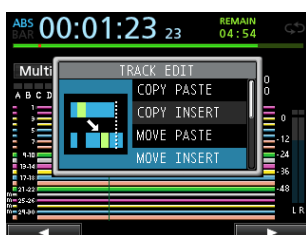
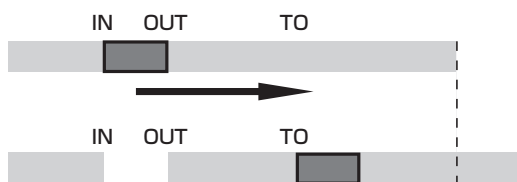

The audio data between the IN and OUT points on the source track is removed and inserted in the target track starting from the TO point. This operation leaves a silence between the IN and OUT points on the source track.

This operation inserts recorded data into the target track starting from the TO point. Therefore, the target track becomes longer.

The following parameters are used in this operation.

- SOURCE Track
- IN/OUT/TO
- TARGET Track

OPEN (Insert Silence)

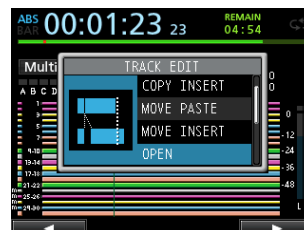
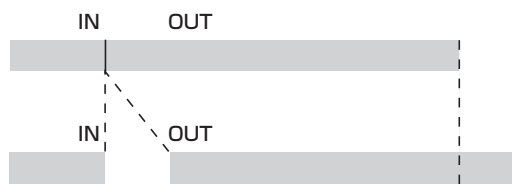

This function inserts silence between the IN and OUT points on the selected track.

This function splits the track at the IN point and shifts the recorded data after the IN point to after the OUT point. Therefore, the track becomes longer.

The following parameters are used in this operation.

- TARGET Track
- IN/OUT

CUT (Remove Part)

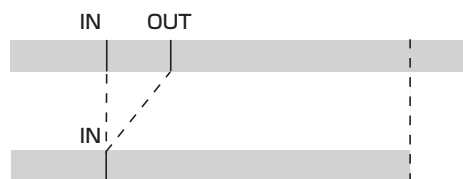

This function cuts (deletes) the audio data between the IN and OUT points on the selected track, and shifts the remaining recording after the OUT point forward to the IN point. Therefore, the track becomes shorter.

The following parameters are used in this operation.

- TARGET Track
- IN/OUT

SILENCE (Erase Part)

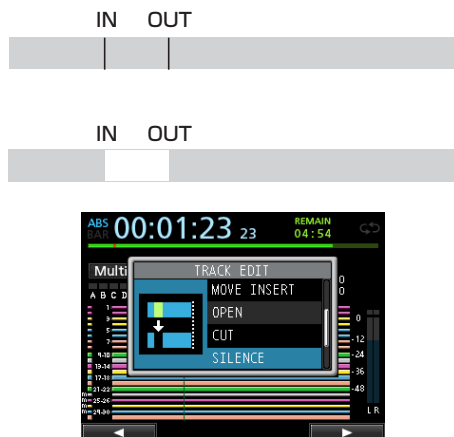

This function cuts (deletes) the audio data between the IN and OUT points on the selected track.

This creates silence between the IN and OUT points, as though there had been no recording.

This operation does not change the length of the track.

The following parameters are used in this operation.

- **TARGET Track**
- **IN/OUT**

TIP

You can use this function to delete short noises, for example.

CLEAN OUT (delete track)



Use this function to completely erase the selected track.

This deletes the entire track, so the IN, OUT and TO points have no effect.

The following parameter is used in this operation.

- **TARGET Track**

CLONE TRACK (duplicate track)

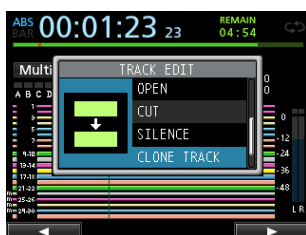

Use this function to duplicate a mono or stereo track to a different track.

This copies the entire track, so the IN, OUT and TO points have no effect.

The following parameters are used in this operation.

- **SOURCE Track**
- **TARGET Track**

NOTE

If you choose the same track for both the SOURCE and the TARGET track, a Same Track notification appears and the operation will not be executed.

9 - Using Internal Effects

This chapter explains the dynamic effects, guitar effects, and send effects that can be applied to individual mic and guitar inputs.

You can select one of four types of dynamic effects (COMPRESSOR, NOISE SUPPRESSOR, DE-ESSER, EXCITER) for use with all inputs (A to H).

The library settings of guitar and send effects can be used for other songs.

Even when parameter settings are not stored in the library, effect assignments and parameters are always stored as part of a song.

Dynamic effects

When you press the **DYNAMICS** button, the inserted effect for the last selected input (INPUT A to H) is displayed.

You can select one of the four types of effects (COMPRESSOR, NOISE SUPPRESSOR, DE-ESSER, EXCITER) and apply it to all inputs (A to H) (simultaneous application has some limitations).

You cannot use multiple types of dynamic effects simultaneously.

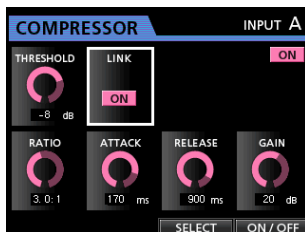

CAUTION

When using a guitar effect together with a dynamic effect, the dynamic effect can be inserted on a maximum of 2 channels.

The selected input (A to H) and on/off state are shown on the screen.

Inserting a dynamic effect

Press the **DYNAMICS** button to open the **DYNAMICS** screen. Press the **SOURCE** button to select the input (A to H) where you want to insert the dynamic effect.

Press the **F3** (SELECT) button to select the effect that you want to insert. Press the **F4** (ON/OFF) button to set the selected effect to ON and insert it.

You can also align the cursor with **INSERT EFFECT** on the Mixer screen and use the **JOG/DATA** dial to turn the effect on/off.

Adjusting dynamic effects

You can edit the parameters of the selected dynamic effect. The parameters differ depending on the effect type.

Use the **CURSOR** (▲/▼/◀/▶) buttons to select the parameter that you want to change, and then use the **JOG/DATA** dial to set the value.

NOTE

There is no preset or library function for dynamic effects.

Guitar effects

This unit has multi-effects for guitar. You can insert and use these effects on tracks.

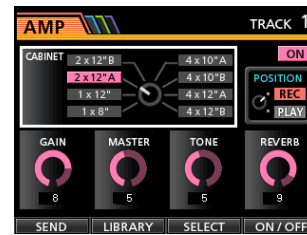

Inserting a guitar effect

Press the **EFFECT** button to open the **GUITAR EFFECT** / **SEND EFFECT** screen (the last displayed effect appears).

If the **SEND EFFECT** screen is open, press the **F1** (GUITAR) button to open the **GUITAR EFFECT** screen.

If there is any effect already inserted on a track, the **SELECT** button lights and the track number appears in the upper right corner of the screen.

If no effect has been inserted, the **SELECT** button is unlit, and **TRACK --** appears in the upper right corner of the screen.

Press the **SELECT** button of a track to insert the effect on it.

You can also align the cursor with **INSERT EFFECT** on the Mixer screen and use the **JOG/DATA** dial to turn the effect on/off.

NOTE

A guitar effect has a mono input and a mono output, but when inserted on a stereo track, it can have a stereo output and some types will have a stereo effect.

CAUTION

Since guitar effects are mono, when they are inserted on stereo tracks, the effect is sent only to the odd-numbered track. (See the illustration below.)

- For example, when inputs G and H are assigned to stereo track 9/10 and you insert a guitar effect, the effected sound will be recorded on track 9 (input G).
- Since some effects work in stereo, we recommend that you set the track type to stereo, and then assign the same input to both odd and even numbers. (For example, assign input H/H to tracks 9/10.)



Adjusting guitar effects

You can edit the parameters of the selected guitar effect. The parameters differ depending on the effect type.

Press the **F3 (SELECT)** button to select the effect that you want to edit.

Use the **CURSOR (▲/▼/◀/▶)** buttons to select the parameter that you want to change, and then use the **JOG/DATA** dial to set the value.

Select whether to apply the effect during recording or during playback with the **POSITION** parameter on the Guitar Effect screen.

Loading guitar effect settings

1. On the Guitar Effect screen, press the **F2 (LIBRARY)** button to open the library list.
2. Use the **JOG/DATA** dial to select the effect setting that you want to load, and then press the **F4 (▶)** button.
3. The setting is loaded and the library list closes, but the Guitar Effect screen stays open.

Press the **F1 (◀)** button to return to the Guitar Effect screen without loading a setting.

NOTE

Factory preset settings are stored in the **PRESET** category, and user settings are stored in the **USER** category.

Saving guitar effects in the library

You can save adjusted effect settings as a user setting in the library.

1. When the Guitar Effect screen is open, press the **F2 (LIBRARY)** button to open the **PRESET/USER** library list. Use the **JOG/DATA** dial to select the **USER** area, and then press the **F3 (SAVE)** button.

NOTE

The library list has a **PRESET** category and a **USER** category. **PRESET** area data cannot be overwritten.

2. Enter a name, if necessary.
Names in the **PRESET** library cannot be changed.

Send effects

The internal send effect can be applied to signals sent to Send Effect 1.

You can use one of the three types of send effects (**REVERB**, **DELAY** and **CHORUS**) available. You cannot use multiple types of effects simultaneously.



Using send effects

You can send input channel or track signals to the send effects. Set channel signal send levels and whether the signal is pre or post fader on the Mixer screen. (See "Sending signals to internal/external effects" on page 36.)

The return signal from this effect is sent to the stereo bus. In Bounce mode, however, it is sent to the bounce bus. (See "Bouncing tracks" on page 41.)

Adjusting send effects

Adjust parameters on the **EFFECT** screen.

Press the **EFFECT** button to open the **EFFECT** screen. If the Guitar Effect is shown, press the **F1 (SEND)** button to switch to the Send Effect screen.

Press the **F3 (SELECT)** button to select the effect type (**REVERB**, **DELAY** or **CHORUS**).

Use the **CURSOR (▲/▼/◀/▶)** buttons to select the parameter that you want to change, and then use the **JOG/DATA** dial to set the value.

Loading send effect settings

1. On the Send Effect screen, press the **F2 (LIBRARY)** button to open the library list.
2. Use the **JOG/DATA** dial to select the effect setting that you want to load, and then press the **F4 (▶)** button.
3. The setting is loaded and the library list closes, but the Send Effect screen stays open.

Press the **F1 (◀)** button to return to the Send Effect screen without loading a setting.

Saving send effects in the library

You can save adjusted effect settings as a user setting in the library.

1. When the Send Effect screen is open, press the **F2 (LIBRARY)** button to open the **PRESET/USER** library list. Use the **JOG/DATA** dial to select the **USER** area, and then press the **F3 (SAVE)** button.

NOTE

The library list has a **PRESET** category and a **USER** category. **PRESET** area data cannot be overwritten.

2. Enter a name if necessary.
Names in the **PRESET** library cannot be changed.

10 - Mixing Down and Mastering Songs

Mixing down tracks

Mixing down tracks is the process of adjusting the volumes and stereo positions of each recorded track and combining them into a well-balanced stereo track.

Including recorded tracks (32 maximum) and inputs (8 maximum), you can mix down up to 40 total tracks.

Levels and balance

Use the track faders to balance the relative levels of the tracks. Then, use the **STEREO** fader to adjust the overall level. Watching the stereo level meters on the display, adjust the level until it is suitable.

If the level is too loud, the sound will become distorted.

NOTE

The track meters on the display show the recorded signal levels of the tracks. Therefore, these meters do not change when the **TRACK** faders are adjusted.

TIP

You do not need to keep the entire song at the same volume. For example, you could gradually increase the volume during a guitar solo.

Fader group

You can group multiple faders to control them simultaneously with a single fader.

Group and ungroup tracks while the **FADER GROUP** button is lit.

■ Grouping tracks

1. Press the **FADER GROUP** button.
2. Adjust the level and balance between tracks you want to control.
3. Press the **SELECT** buttons of tracks to control.

A lit **SELECT** button indicates a track in the group.

The track fader with the smallest number will be the master fader, and faders in the group can be controlled by it. When a fader other than the master fader is moved, the **SELECT** button of the master fader blinks and the movement will have no effect.

This fader group internally retains the relative level differences from the master fader that it had when it was set. The relationship between physical faders is not retained.

NOTE

After tracks have been grouped, they will not be ungrouped when you press the **FADER GROUP** button. (The **FADER GROUP** button will blink.) In this case, if the group master fader is moved, the **SELECT** buttons of tracks in the group will light during operation.

If another fader is moved, the **SELECT** button of the master fader will blink and the movement will have no effect.

■ Ungrouping tracks

1. Press all the **SELECT** buttons of tracks in the group to turn them off.
2. Press the **FADER GROUP** button.

If you press the **FADER GROUP** button before turning off all the buttons (a button is still lit), the **FADER GROUP** button will blink, indicating that tracks are still grouped.

CAUTION

After ungrouping tracks, the positions of the physical faders and the actual levels (values shown onscreen) might not match. In such a case, when you move a physical fader, the actual level will change to match the physical fader value, and thereafter the physical fader will control the level. This might cause a sudden level change and loud noise, so turn the stereo fader down beforehand.

NOTE

After grouping tracks, if the group master fader changes because the lowest numbered track is ungrouped or a lower numbered track is added to the group, the track levels are reset to their physical fader values.

Stereo position (panning)

Use the **PAN** knobs on the Mixer screen of each mono track to set the stereo position of the track signal.

For stereo tracks, instead of panning, adjust the balance (**BAL**) between left and right channels.

Track equalizer

Each track has a 3-band equalizer that can be adjusted on the Mixer screen.

1. Press the **MIXER** button to open the Mixer screen.



2. Adjust the track equalizer.

The equalizer parameters are as follows.

	GAIN	FREQ
HIGH	Setting range: ± 12 dB (Default: 0 dB)	Setting range: 1.7 kHz to 18 kHz (Default: 10 kHz)
MID	Setting range: ± 12 dB (Default: 0 dB)	Setting range: 32 Hz to 18 kHz (Default: 1.0 kHz)
LOW	Setting range: ± 12 dB (Default: 0 dB)	Setting range: 32 Hz to 1.6 kHz (Default: 100 Hz)

Use track **SELECT** buttons to select desired tracks.

Use **HIGH**, **MID** and **LOW GAIN** knobs to adjust the gain of each band.

Use the **HIGH**, **MID** and **LOW FREQ** knobs to adjust the center frequency of each band.

Use the **MID Q** knob to set the resonance (width) of the **MID FREQ** band.

Setting range: 0.25 to 16 (Default: 0.5)

Press the **EQUALIZER ON/OFF** button to turn the equalizer on or off.

Use **INPUT SOURCE (A-H)** buttons to select inputs to set the equalizer. (See "Using the input equalizer" on page 35.)

3. After making the settings, press the **HOME** button to return to the Home screen.

10 - Mixing Down and Mastering Songs

Send effects

This unit has three types of send effects.

Adjust the level of the signal sent to the effect from each track by using their **SEND EFF 1/EFF 2** knobs.

NOTE

Adjust the **RETURN LEVEL** on the Send Effect screen.

1. Press the **EFFECT** button to open the Effect screen.



2. Select and adjust the send effect.

Press the **EFFECT** button to open the Effect screen where the last operation was performed. Press the **F3 (SELECT)** button to select one of the three available types (**REVERB**, **DELAY** or **CHORUS**). You cannot use multiple types of effects simultaneously.

Align the cursor with the parameter that you want to adjust, and then use the **JOG/DATA** dial to adjust it.

The return from the send effect is mixed with the stereo signal.

3. After making the send effect setting, press the **HOME** button to return to the Home screen.
4. Use the **SEND EFF 1** knob to adjust the level of the signal sent to the send effect of each track.

TIP

When using an external effect, connect the output of the external effect (**EFFECT RETURN**) to **INPUT A** to **H**. By assigning the connected input to the stereo bus, you can return the effect sound to the stereo bus. (See "Assigning inputs to a stereo bus" on page 33.)

Creating a master file

When you are satisfied with your mix, this unit can create a stereo master file by recording the mixed down tracks.

Master files created by this unit are saved with their songs.

A master file can be recorded by an external stereo recorder and can also be converted by the unit into a WAV file and stored with the same name as the song in the song's folder on the SD card.

CAUTION

Only one master file ("[song name].wav") can be created in each song. (When mastering, another file besides the "[song name].wav" master file is created, but it is only for use by the unit. Do not erase it.)

Setting the start and end points

Before creating a master file, set the start and end points to be used for the mixed down master file. The range between the song's IN and OUT points will be recorded as the master file.

Usually, you will probably want to set the beginning of the song as the IN point and the end of the song as the OUT point.

Press and hold the **MARK SET** button and press the **IN** button where you want to set the IN (start) point of the master file, and press and hold the **MARK SET** button and press the **OUT** button where you want to set the OUT (end) point.

For more information about how to correct the IN/OUT points, see "Setting IN/OUT points" on page 44.

Creating a master file

After setting the IN and OUT points, you are ready to create the master file.

1. When in **Multi Track** mode, press the **MIXDOWN/MASTERING** button.

The recorder switches to **Mixdown** mode and the Home screen reopens.

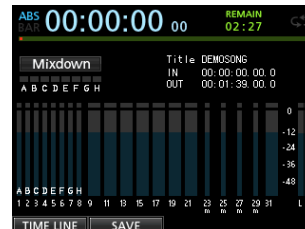

If you play or record, you can hear the signal of the mixed tracks (the signal to be recorded) through headphones or a monitoring system.

NOTE

- In **Mixdown** mode, **Mixdown** appears on the upper left corner of the Home screen.
 - If the interval between the **IN** and **OUT** points is shorter than 4 seconds, when you start to record, **Trk Too Short** appears and the mixdown recording will not be performed.
 - When in **Mixdown** mode, some playback functions do not work. If you try to use one of these functions, **In Mixdown Mode** appears.
2. Press the **RECORD (●)** button.

The mixdown starts and the **RECORD (●)** button lights. Regardless of the recorder's current position, the mixdown starts from the IN point.

If necessary, adjust the track faders or the Mixer screen's **PAN** knobs while mixing down the tracks to stereo. These adjustments will be reflected in the master file.

When the recorder reaches the OUT point, recording automatically stops.
 3. If you want to redo the creation of the stereo master track, press the **RECORD (●)** button.

A new master file will be created, and the previous master file will be overwritten.

NOTE

After recording the master file, you can play back the master file to check it. (See "Checking the master file" in the following section.)

10 - Mixing Down and Mastering Songs

Exiting Mixdown mode

Press the **MIXDOWN/MASTERING** button twice to return to Multi Track mode.

Checking the master file

Follow these procedures to listen to a master file after you have completed recording it.

1. When in Mixdown mode, press the **MIXDOWN/MASTERING** button.

The recorder switches to Mastering mode and the Mastering screen opens.

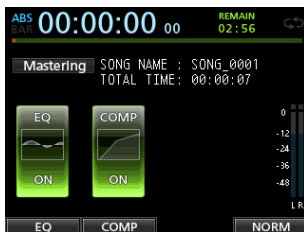

NOTE

- In Mastering mode, Mastering appears in the upper left of the Home screen.
 - When in Multi Track mode, press the **MIXDOWN/MASTERING** button to switch to Mixdown mode, and then press the **MIXDOWN/MASTERING** button again to switch to Mastering mode.
 - You cannot switch to Mastering mode if there is no master file.
2. In this state, press the **PLAY (▶)** button to play back the master file that you have created.

CAUTION

Confirm that both the **EQ** and **COMP** items are set to **OFF**. If either is set to **ON**, the playback sound of the master file will be affected by the equalizer and/or compressor. (See "Using the mastering equalizer" on page 57 and "Using mastering compression" on page 57.)

3. When in Mastering mode, the transport buttons work as follows.
 - Press the **PLAY (▶)** button to play back the master file from the current position until its end.
 - Use the **REW (◀◀)** button and the **F FWD (▶▶)** button to rewind and fast-forward in the same way as in ordinary recorder mode.
 - Press the **STOP (■)** button to stop playback.
 - Track recording is not possible.
 - Repeat playback and location mark functions cannot be used.

Since the master file playback signal is output from the **STEREO OUT** jack, you can record the output to an external stereo recorder.

If you are not satisfied with this master file, you can perform a new mixdown.

NOTE

To listen to a master file recorded in a saved song, load the song, change the recorder to Mastering mode, and then press the **PLAY (▶)** button to start playback.

Ending master file checking

After checking the master file, press the **MIXDOWN/MASTERING** button to return to Multi Track mode.

Using the mastering tools

This unit has specialized tools for enhancing the sound of the master file. Use the equalizer, compressor, and normalize functions to adjust the overall volume and sound quality.

Switch to Mastering mode and use the mastering tools to enhance the master file.

Mastering procedures

Follow the steps below to master the file that has been mixed down.

■ Step 1 - Enter Mastering mode.

When in Mixdown mode, press the **MIXDOWN/MASTERING** button.

The recorder switches to Mastering mode and the Mastering screen opens.

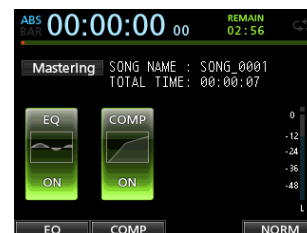

NOTE

- When in Multi Track mode, press the **MIXDOWN/MASTERING** button to switch to Mixdown mode, and then press the **MIXDOWN/MASTERING** button again to switch to Mastering mode.
- You cannot switch to Mastering mode if there is no master file.

■ Step 2 - Use the mastering tools to adjust the sound.

You can use the following mastering tools: **EQUALIZER (F1 (EQ))** button), **COMPRESSOR (F2 (COMP))** button) and **NORMALIZE (F4 (NORM))** button).

You can also switch between a multi-band and single-band type compressor on the **COMP MULTI** screen by pressing the **F2** button.

When using the multi-band compressor, the parameter display on the **COMP MULTI** screen is split into **LOW BAND**, **MID BAND** and **HIGH BAND** areas, allowing separate adjustments for each band.

Make the necessary settings for each tool. (For further details, see "Using the mastering equalizer," "Using mastering compression" and "Using normalize," below.)

10 - Mixing Down and Mastering Songs

When in **Mastering** mode, you can use the **PLAY** (▶), **STOP** (■), **REW** (◀◀) and **F FWD** (▶▶) transport buttons to monitor the playback signal as you adjust settings.

■ Step 3 - Record a new master file using the mastering tools.

After adjusting the mastering tool settings, press the **RECORD** (●) button to start recording.

The recording starts and the **PLAY** (▶) and **RECORD** (●) buttons light.

Recording always starts from 00:00:00:00 regardless of the current position.

Recording in **Mastering** mode overwrites the previous master file.

At the end of the master file, recording finishes automatically and the position returns to 00:00:00:00.

NOTE

If you stop the recording in the middle, a new master file will be created until the time when you stopped the unit.

■ Step 4 - Check your recording.

Turn the equalizer and compressor off before playing back the master file to check the mastering results.

Single undo and redo can be used, so you can compare the sound before and after using the mastering tools.

■ If you are not satisfied with the result

Undo the operation to return the master file to mixdown state, and apply the mastering tools again from step 1.

NOTE

Multiple undo and redo cannot be used when the recorder is in **Mastering** mode.

Use the **MID Q** knob to set the resonance (width) of the **MID FREQ** band.

Setting range: 0.25 to 16 (Default: 0.5)

Press the **EQUALIZER ON/OFF** button to turn the equalizer on or off.

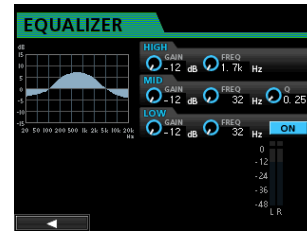

NOTE

The "Q" value is the center frequency of the equalizer divided by the bandwidth. A high Q value reduces the range of the cut or boost applied to the frequencies. Depending on the equalizer setting, the graph at the top of the screen changes.

3. After making the settings, press the **F1** (◀) button to return to the **Mastering** screen.
4. On the **Mastering** screen, the EQ is shown as either **ON** or **OFF**.



Using the mastering equalizer

1. When the **Mastering** screen is open, press the **F1** (EQ) button to open the **EQUALIZER** screen.

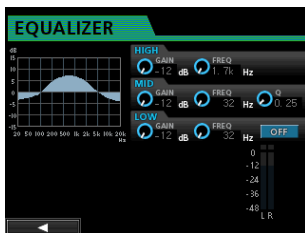

2. Adjust mastering equalization on this screen.

The equalizer parameters are as follows.

	GAIN	FREQ
HIGH	Setting range: ±12 dB (Default: 0 dB)	Setting range: 1.7 kHz to 18 kHz (Default: 10 kHz)
MID	Setting range: ±12 dB (Default: 0 dB)	Setting range: 32 Hz to 18 kHz (Default: 1.0 kHz)
LOW	Setting range: ±12 dB (Default: 0 dB)	Setting range: 32 Hz to 1.6 kHz (Default: 100 Hz)

Use the **HIGH**, **MID** and **LOW GAIN** knobs to adjust the gain of each band.

Use the **HIGH**, **MID** and **LOW FREQ** knobs to adjust the center frequency of each band.

Using mastering compression

You can choose between single band and multi-band compressors.

Multi-band compressors allow independent settings for the low, mid and high frequency ranges, so you can adjust the overall level balance. By using compression, you can also reduce unwanted peaks and increase the overall gain to make the song louder, creating a mastered sound with greater impact.

1. When the **Mastering** screen is open, press the **F2** (COMP) button to open the **COMP MULTI** screen.



10 - Mixing Down and Mastering Songs

- Press the **F3 (LIBRARY)** button to open the library list.

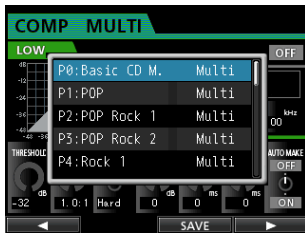

- Use the **JOG/DATA** dial or the **CURSOR (▲/▼)** buttons to select (highlight blue) the desired preset, and then press the **F4 (▶)** button.

After the preset is loaded, the library list closes, but the COMP MULTI screen stays open.

- When using the multi-band compressor, move the cursor to the band display area, use the **JOG/DATA** dial to switch among the bands, and then set the parameter for each band as desired.



Multiband compressor



Single band compressor

At this time, the selected band is shown in the upper left.

- Use the **CURSOR (▲/▼/◀/▶)** buttons to select the parameter to adjust, and then use the **JOG/DATA** dial to set it.

THRESHOLD

The threshold value determines when the compressor becomes active.

RATIO

Sets how much compression is applied after the level exceeds the threshold.

KNEE

Sets the transition curve.

GAIN

Adjusts the output level.

ATTACK

Adjusts how fast the compressor responds after the level exceeds the threshold.

RELEASE

Adjusts how fast the compressor disengages after the level drops below the threshold.

AUTO MAKE

This feature automatically adjusts the volume to prevent it from being reduced by the compressor.

- When using the multi-band compressor, move the cursor to **CROSSOVER** and then use the **JOG/DATA** dial to adjust the frequency range of each band.



- Press the **F4 (ON/OFF)** button to turn the compressor on or off. The ON or OFF state is shown on the **Mastering** screen.

- After setting the parameters, press the **F1 (◀)** button to return to the **Mastering** screen.

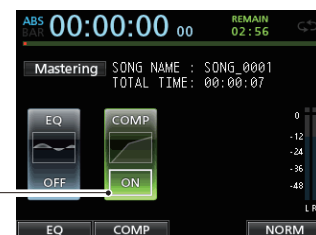

Compressor ON/OFF

Using normalize

Use the normalize function to automatically adjust the volume.

This function detects the highest volume level and raises the overall volume until the highest level reaches the maximum limit.

CAUTION

If you use equalization or compression after normalizing the track, distortion might occur. Use the normalize function after adjusting the sound with equalization and compression.

- When the **Mastering** screen is open, press the **F4 (NORM)** button to open the **NORMALIZE** screen.

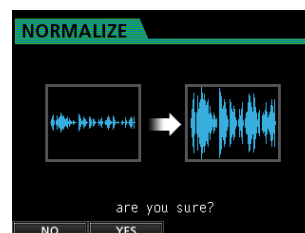

- Press the **F2 (YES)** button to normalize the master track.
- Once normalization completes, the **Mastering** screen reopens.

Exiting Mastering mode

To exit **Mastering** mode and return to **Multi Track** mode, press the **MIXDOWN/MASTERING** button.

11 - Various Other Functions

Metronome

This unit has a built-in metronome that can be used when the recorder is running.

You can set it to work during both playback and recording or only during recording.

1. When the recorder is stopped, press the **METRONOME** button to open the **METRONOME** screen.

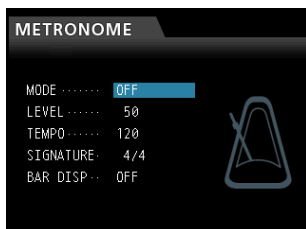

2. Set the following items.

Use the **CURSOR** (**▲**/**▼**) buttons to select the desired item, and then use the **JOG/DATA** dial to set its value.

MODE

You can select from the following modes.

Mode	Description
OFF	Default, metronome off
REC&PLAY	Active during recording and playback
REC	Active only during recording

LEVEL

Set the metronome volume.

The setting range is from 0 to 127. (Default: 60)

TEMPO

Set the speed.

The setting range is from 20 to 250 (BPM). (Default: 120)

SIGNATURE

Set the time signature to 4/4, 3/4, etc.

The setting range is from 1/1 to 12/8. (Default: 4/4)

BAR DISP

Set the **BAR** display to **ON** or **OFF**. (Default: **OFF**)

3. After making the settings, press the **HOME** button to return to the Home screen.

The metronome works according to the **MODE** setting made in step 2 above.

When enabled, the **METRONOME** button flashes in time with the metronome tempo.

The metronome signal is not recorded even if set to work during recording.

NOTE

- When the metronome is working, you can monitor the sound of the metronome through connected external speakers. Note, however, in this case that the metronome sound could also be recorded if you are using a microphone to record in the same room.
- When the metronome is running, you can adjust the **LEVEL** item on the **METRONOME** screen, but other items cannot be changed.
- You can use the metronome as a click track to help keep time when recording rhythm guitar or bass, for example, as the first tracks of a song.
- If you want to use the metronome alone for practice, you can either turn each track's fader all the way down during playback or play a song that does not have any recordings.

Tuner function

You can use the built-in chromatic tuner to tune guitars.

1. Connect a guitar or bass to the **MIC/LINE INPUT H**.
Tuning cannot be performed with instruments connected to **MIC/LINE INPUTS A to G**.
2. Set the **LINE-GUITAR** switch on the rear panel to **GUITAR**. (See "Selecting the input sources" on page 33.)
3. When the recorder is stopped, press the **MENU** button to open the **MENU** screen.
4. Use the **JOG/DATA** dial to select the **TUNER** menu item and then press the **F4** (**▶**) button.
The **TUNER** screen opens.

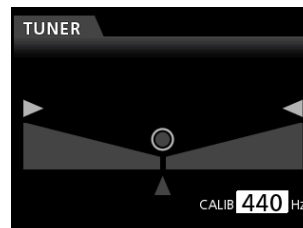

5. Use the **JOG/DATA** dial or the **CURSOR** (**▲**/**▼**) buttons to set the standard frequency of A4.
The setting range is from 435Hz to 445Hz. (Default: 440Hz)
6. Play the instrument and begin tuning.
The pitch name closest to the string appears above the meter.
Tune the instrument so that the target pitch name appears and the center of the tuning meter lights.
A bar appears to the left or right of the center if the sound is lower or higher than the target pitch. The bar becomes longer as the sound shifts away from the target pitch.

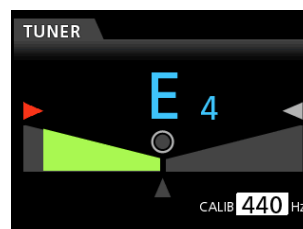

11 - Various Other Functions

When the pitch played matches the note shown, the center , and icons light green.

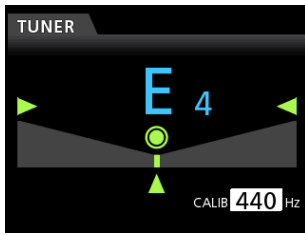

- After tuning the instrument, press the **HOME** button to return to the Home screen.

PREFERENCE menu settings

Use the PREFERENCE menu to change various settings to optimize the unit for your use conditions and requirements, as well as to restore the factory settings.

Follow these steps to open the PREFERENCE menu.

- When the recorder is stopped, press the **MENU** button to open the MENU screen.



- Use the **JOG/DATA** dial or the **CURSOR** (/ / /) buttons to select PREFERENCE, and then press the **F4** () button.

The PREFERENCE screen opens.

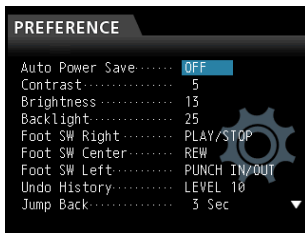

- On the PREFERENCE screen, use the **CURSOR** (/) buttons to select a parameter, and then use the **JOG/DATA** dial to change its setting.

Menu item	Function	Reference
Auto Power Save	Set automatic power saving	Page 60
Contrast	Adjust display contrast	Page 27
Brightness	Adjust display brightness	
Backlight	Adjust display backlight	
Foot SW Right	Set right footswitch pedal assignment	Page 41
Foot SW Center	Set center footswitch pedal assignment	
Foot SW Left	Set left footswitch pedal assignment	
Undo History	Set length of undo history	Page 39
Jump Back	Set jumpback time	Page 44
Auto Monitor	Set automatic monitoring	Page 60
Preview Time	Set preview playback time	Page 45
Peak Hold	Set peak hold time	Page 35
Song Name Type	Set file name format	Page 61
Date/Time	Set date and time	Page 26
Initialize	Restore default settings	Page 61

Setting automatic power saving

Use the Auto Power Save item to set the amount of time until the unit power turns off after the last user operation or function completes.

The options and default value are as follows.

Options: OFF, 3 min, 5 min, 10 min, 30 min (default)

NOTE

The Auto Power Save function is disabled under the following conditions.

- During recording or playback
- When the metronome is in use
- When the record function is ON
- When a signal is output from the **STEREO OUT**

CAUTION

By default, this is set to turn the unit off automatically after 30 minutes. Set this to "OFF" if you do not want the unit to turn off automatically.

Setting automatic monitoring

Input monitoring is possible when recording is enabled and the transport is stopped.

If automatic monitoring is ON, when playback starts, input sounds are muted, and only playback sounds can be monitored.

Use the **AUTO MONITOR** item to set this function.

OFF (default):

Input sounds are not muted even when playback starts.

When recording is enabled, input and playback sounds are mixed.

ON:

When playback starts, input sounds are muted.

When recording is enabled, only playback sounds can be heard.

Setting the song name format

Use the **SONG NAME TYPE** item to set the format used for song names created by this unit to **WORD** (default) or **DATE**.

WORD: The characters set are used for the beginning of the song name.

Example (set to "TASCAM"): "TASCAM0001"

DATE: The date is used for the beginning of the song name.

Example (created on July 10, 2012): "201207100001"

Setting the WORD

When the **SONG NAME TYPE** on the **PREFERENCE** screen is set to **WORD**, press the **F4** (▶) button to open the setting screen. The length of the word is limited to XX single-byte alphanumeric characters. (See "Editing names" on page 28.)

Restoring the initial preference settings

You can restore the **PREFERENCE** screen settings to their initial values (factory defaults). This operation is called initialization.

1. When the recorder is stopped, press the **MENU** button to open the **MENU** screen.
2. Use the **JOG/DATA** dial or the **CURSOR** (▲/▼/◀/▶) buttons to select (highlight green) **PREFERENCE**, and then press the **F4** (▶) button.

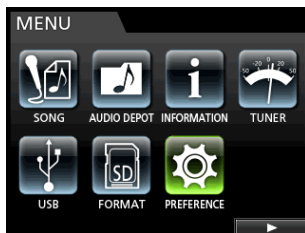

The **PREFERENCE** screen opens.

3. Use the **CURSOR** (▲/▼) buttons to select **Initialize**, and then press the **F4** (▶) button.

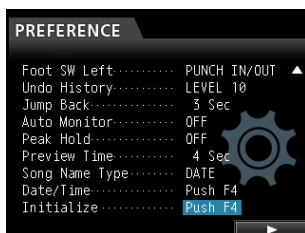

4. When the confirmation message appears, press the **F2** (YES) button to confirm.

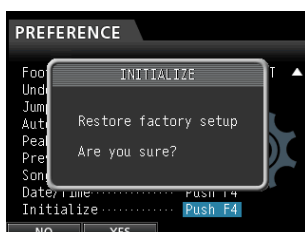

5. Once initialization completes, the messages closes, but the **PREFERENCE** screen remains open.

NOTE

If you want to cancel the initialization, press the **F1** (HOLD) button.

6. After making the settings, press the **HOME** button to return to the Home screen.

Viewing information

You can view information about the current song (currently loaded song), the SD card and the firmware.

1. When the recorder is stopped, press the **MENU** button to open the **MENU** screen.
2. Use the **JOG/DATA** dial or the **CURSOR** (▲/▼/◀/▶) buttons to select (highlight green) **INFORMATION**, and then press the **F4** (▶) button.

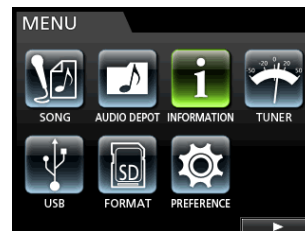

The **INFORMATION** screen opens.

The following information is shown on the **INFORMATION** screen.

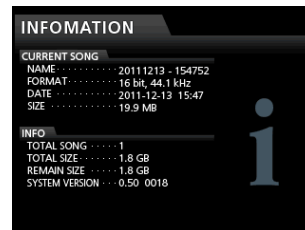

CURRENT SONG

NAME
FORMAT
DATE
SIZE

INFO

TOTAL SONG
TOTAL SIZE
REMAIN SIZE
SYSTEM VERSION

12 - SD Card Management

The recording files are stored on SD cards.

Depending on the capacity of the SD card, the card is formatted using the FAT16 or FAT32 file system.

SD card capacity	File system
512 MB to 2 GB	FAT16
Above 2 GB	FAT32

Moreover, this unit is compatible with SD card write-protection, so you can write-protect your cards to prevent accidental deletion by formatting them. (See "About write-protected SD cards" on page 24.)

When an SD card is inserted, the unit mounts the card and enables it for use. At this time, if the inserted SD card has not been formatted by this unit, a message appears prompting you to format it.

If the inserted SD card has no setup file on it, a message appears prompting you to create a setup file.

When an SD card is ejected, the unit unmounts it and then a No Card message appears.

CAUTION

- Ejection during recording is not supported.
- Formatting cannot be undone.

NOTE

- The FAT (File Allocation Table) format is a file system format that can be read by a computer.
- SD and SDHC cards that are at least 512MB in size can be used. A list of SD cards that have been confirmed for use with this unit can be found on our web site. Please access to a product page of this product from the TEAC Global Site (<http://teac-global.com>) to find the list or contact the TASCAM customer support service.

Quick formatting an SD card

Use the QUICK FORMAT item to quickly format an SD card. Using QUICK FORMAT erases all files on the card and automatically creates new MUSIC, UTILITY and AudioDepot folders, as well as the dp-24.sys file that is necessary to use the card with this unit.

CAUTION

This operation erases all data from the SD card and cannot be undone. Confirm that you will not lose important data before quick formatting a card.

1. When the recorder is stopped, press the **MENU** button to open the MENU screen.
2. Use the **JOG/DATA** dial or the **CURSOR** (▲/▼/◀/▶) buttons to select (highlight green) **FORMAT**, and then press the **F4** (▶) button.

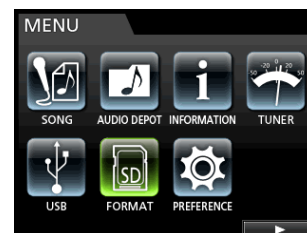

The format screen where you can choose Quick Format or Full Format opens.

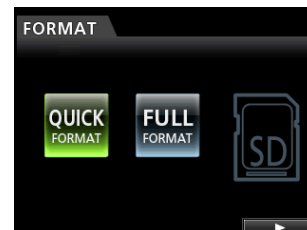

3. Use the **JOG/DATA** dial to select **QUICK FORMAT** and press the **F4** (▶) button. A **QUICK FORMAT** confirmation message appears.

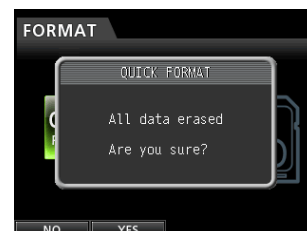

4. Press the **F2** (YES) button to execute the quick format. If you want to cancel the quick format, press the **F1** (NO) button.
5. Once the quick format completes, the message closes, but the **FORMAT** screen remains open.

NOTE

When a card is formatted, one song is automatically created in the MUSIC folder.

Full formatting an SD card

Use the **FULL FORMAT** item to completely format an SD card. Using **FULL FORMAT** erases all files on the card and automatically creates new **MUSIC**, **UTILITY** and **AudioDepot** folders, as well as the **dp-24.sys** file that is necessary to use the card with this unit.

Using Full Format, memory errors are checked during formatting. A full format takes longer than a quick format.

CAUTION

This operation erases all the data from the SD card. This operation cannot be undone. Confirm that you will not lose important data before full formatting a card.

Follow these procedures to fully format an SD card.

1. When the recorder is stopped, press the **MENU** button to open the **MENU** screen.
2. Use the **JOG/DATA** dial or the **CURSOR** (**▲/▼/◀/▶**) buttons to select (highlight green) **FORMAT**, and then press the **F4** (**▶**) button.



The format screen where you can choose Quick Format or Full Format opens.



3. Use the **JOG/DATA** dial to select **FULL FORMAT** and press the **F4** (**▶**) button. A **FULL FORMAT** confirmation message appears.



4. Press the **F2** (**YES**) button to execute the full format. If you want to cancel the full format, press the **F1** (**NO**) button.
5. Once the full format completes, the message closes, but the **FORMAT** screen remains open.

NOTE

*When a card is formatted, one song is automatically created in the **MUSIC** folder.*

13 - Exchanging Data with a Computer

By connecting this unit to a computer using the USB cable, you can backup song data from an SD card in the unit to a computer and restore backed-up song data from a computer to the card. In addition, you can export track files and stereo master files from songs to the computer, as well as import audio files from the computer to the unit.

Backed-up data can be restored to a different DP-32SD unit than the one that created it. In other words, files can be freely exchanged between DP-32SD units, making it easy to add additional recordings or mix existing recordings in different location.

CAUTION

If you want to remove an SD card from this unit and back up its data on a computer using a card reader, always turn off the unit's power before removing the card.

NOTE

In this chapter, "computer" refers to a Windows or Mac personal computer connected to this unit. (See "Operating system requirements" in the following section.)

The following types of data can be transferred from this unit to a computer.

Entire songs

You can transfer the data for an entire song from the unit's MUSIC folder to a computer. This operation is called "backing up". In addition, data backed up on a computer can be transferred to the MUSIC folder, and then restored as a song file. This operation is called "restoring".

WAV format tracks

Export specified track files as WAV files to the AudioDepot folder of the SD card. In addition, you can import specified track files by storing WAV files from a computer in the AudioDepot folder beforehand.

In other words, data transfer between the computer and track files is carried out through the AudioDepot folder.

Master file

A master file created on this unit can be transferred to a computer as a stereo WAV file (from the "Song name" folder inside the MUSIC folder).

Only export of the master file is possible.

Operating system requirements

You can connect this unit to computers with the following operating systems.

Windows

- Windows 8 (including 8.1)
- Windows 7
- Windows Vista
- Windows XP

Mac OS X

- OS X Yosemite (10.10)
- Mac OS X Mavericks (10.9)
- Mac OS X Mountain Lion (10.8)
- Mac OS X Lion (10.7)
- Mac OS X Snow Leopard (10.6)

When this unit is connected to a computer, the computer recognizes it as a removable disk. There is no need for a special driver.

NOTE

Data transfer between this unit and a computer occurs at USB 2.0 speed (maximum). Data can still be transferred if the computer connection is USB 1.1, but it will be slower. In addition, to assure USB 2.0 speed, use a cable that meets USB 2.0 standards.

Connecting to a computer

When connected to a computer via USB, this unit's record, playback and other recorder functions cannot be used.

To connect with a computer, use a mini-B-type USB 2.0 cable to connect the USB port on the rear panel of the unit with a USB port on the computer.

It does not matter whether you turn the unit's power ON before or after the USB connection is made.

When this unit is ON, enable the USB connection with the USB item of the MENU screen.

The currently loaded song is saved before the USB connection becomes effective. When connected, the following screen appears on the display.

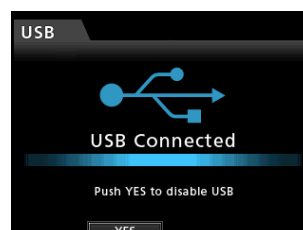

After making a USB connection, you must turn the power on and enable the USB connection in the USB item of the MENU screen.

This unit appears as an external drive named DP-32SD on the computer's display.

Clicking on the DP-32SD drive will display the MUSIC, UTILITY, and AudioDepot folders.

CAUTION

- Be sure to use the included TEAC PS-P1220E AC adaptor to supply power to this unit. Power cannot be supplied to this unit via USB.
- Do not disconnect the AC adaptor or otherwise cut the power to the unit during data transfer. Doing so will cause all the data to be lost beyond recovery.
- Do not change the names of folders inside the DP-32SD.

NOTE

The UTILITY folder is used, for example, to update the system software used by the unit. In addition, do not delete or change the names of individual files in the Song subfolder inside the MUSIC

13 - Exchanging Data with a Computer

folder. You can, however, delete an entire Song folder if you no longer need that song.

Disconnecting

Follow these procedures to disconnect the USB connection correctly.

CAUTION

When transferring data, do not disconnect the unit or remove the USB cable. Doing so could cause data on the computer or this unit to be damaged.

NOTE

When disconnecting from a computer, the procedure on the computer might be called "eject," "unmount" or "remove."

Disconnecting from Windows computers

When using Windows 8 (including 8.1), Windows 7, Windows Vista or Windows XP, follow the procedures below to disconnect.

A PC card icon and arrow appear in the taskbar (usually at the bottom right of the screen).



1. Left click on this icon to open a pop-up bar. Click on this pop-up bar to disconnect this unit from the computer.
2. After a message appears on the computer screen saying that the unit can be disconnected, press the applicable function key to disconnect it from the computer. After that, unplug the USB cable.

The Home screen opens on the display.

CAUTION

If a message appears on the computer screen saying that this unit cannot be disconnected safely, do not disconnect the USB cable.

Close all the computer programs and windows that are accessing files on this unit, and then try the operation again.

Disconnecting from Mac computers

1. Drag the DP-32SD icon that represents this unit to the Trash, or use Command + E to eject the DP-32SD.

TIP

Depending on the OS version and settings you might also be able to eject the DP-32SD icon by clicking on an eject icon next to it in a Finder window or by using a control key.

2. After the DP-32SD icon disappears from the display, press the function key to disconnect this unit and the computer. After that, unplug the USB cable.

The Home screen opens on the display.

Track import and export

You can import and export individual tracks between a computer and this unit using the AudioDepot folder.

Files must be WAV files (with the ".WAV" extension) to be imported/exported as tracks.

You can import both mono and stereo files, and export mono files.

If you want to import an audio file of a different format into this unit, you must convert it to a WAV file first.

Importing tracks

1. Connect the unit to a computer. (See "Connecting to a computer" on page 64.)
2. Use the computer to copy WAV files to the AudioDepot folder on the SD card in this unit.

NOTE

The files to be copied must have single-byte alphanumeric character names. If you try to copy a file with double-byte characters, it cannot be imported because the file name will not appear on the display in step 6 below.

3. Disconnect the unit properly from the computer, and then unplug the USB cable. (See "Disconnecting" on page 65.)
4. Press the **MENU** button to open the MENU screen.
5. Use the **JOG/DATA** dial or the **CURSOR** (▲/▼/◀/▶) buttons to select (highlight green) **AUDIO DEPOT**, and then press the **F4** (▶) button.



WAV files that can be imported appear.

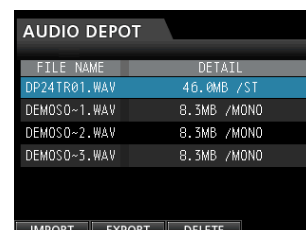

6. Use the **JOG/DATA** dial or the **CURSOR** (▲/▼) buttons to select the WAV file that you want to import, and then press the **F1** (IMPORT) button.

Empty tracks that can be imported appear.

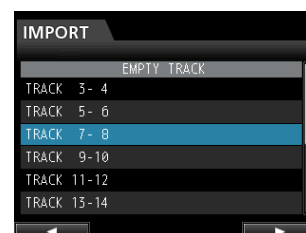

NOTE

- If you are trying to import a WAV file with attributes that do not match the current song, an error pop-up message appears. For example, this occurs if the current song is 44.1 kHz and you try to import a 48 kHz WAV file. If there is no file that can be imported, **FILE NOT FOUND** appears.

13 - Exchanging Data with a Computer

- When the file name is short, spaces appear after the file name, but those spaces are not included in the actual file name.
7. Use the **JOG/DATA** dial or the **CURSOR** (**▲/▼**) buttons to select the track to be imported, and then press the **F4** (**▶**) button.

A confirmation message appears.



NOTE

If the WAV file to be imported is stereo, you must select a track pair.

8. Press the **F2** (**YES**) button to start importing the file.

NOTE

- If there is not enough space or the file format is wrong, an error message appears.
 - The beginning of the file is set at the start of the song (00:00:00:00). In the same way as with other recording tracks, you can edit a track with an imported file. (See "Overview of track editing" on page 48.)
 - To import a stereo WAV file, an empty stereo track is necessary.
9. Once importing completes, a pop-up window appears and then the **Audio Depot** screen reopens.
 10. Press the **HOME** button to return to the Home screen.

Exporting tracks

1. When the recorder is stopped, press the **MENU** button to open the **MENU** screen.
2. Use the **JOG/DATA** dial or the **CURSOR** (**▲/▼/◀/▶**) buttons to select (highlight green) **AUDIO DEPOT**, and then press the **F4** (**▶**) button.
3. Press the **F2** (**EXPORT**) button.

The **EXPORT** screen opens showing a list of tracks that contain audio data.

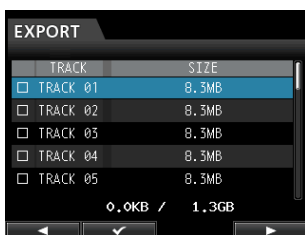

NOTE

Song tracks that do not have audio data are not displayed in the file list.

4. Use the **JOG/DATA** dial to select (highlight blue) the track that you want to export, and then press the **F2** (**✓**) button.

A check mark **✓** appears in the box next to the selected track.

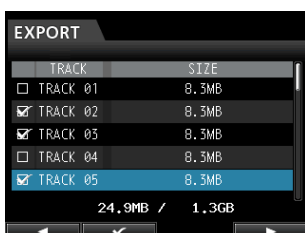

By checking multiple boxes (**✓**), you can export more than one track at once.

NOTE

To remove a check mark **✓** from a box, press the **F2** (**✓**) button again while the track is selected (highlighted blue).

5. After you finish putting checks (**✓**) next to the tracks you want to export, press the **F4** (**▶**) button.

A confirmation message appears.

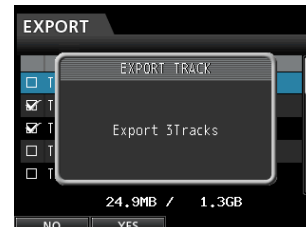

6. Press the **F2** (**YES**) button to export the selected track to the **AudioDepot** folder.

NOTE

When a track file with the same name already exists in the **AudioDepot** folder, a number is added to the file name end, so the existing track is not overwritten.

7. After a pop-up message appears, the **Audio Depot** screen reopens.
8. Press the **HOME** button to return to the Home screen.
9. Connect the unit to a computer. (See "Connecting to a computer" on page 64.)
10. Operate the computer to copy track files from the **AudioDepot** folder of the SD card to the computer.
11. After exporting track files to the computer, disconnect the unit from the computer using the proper procedures, and then unplug the USB cable. (See "Disconnecting" on page 65.)

Deleting files from the AudioDepot folder

1. When the file list is displayed, use the **JOG/DATA** dial or the **CURSOR** (**▲/▼**) buttons to select the files that you want to delete.
2. Press the **F3** (**DELETE**) button to open a confirmation message.



3. Press the **F2** (**YES**) button to confirm deletion.

If you want to delete multiple files, repeat the procedure above.

14 – Troubleshooting

If you are having trouble with the operation of this unit, please try the following before seeking repair.

If these measures do not solve the problem, please contact the store where you purchased this unit or TASCAM customer support service. In addition, see the "Messages" chapter starting on page 68 for the meaning of messages that may appear on the display. Consult this table if a message appears when an operation cannot be completed by the unit.

The SD card is not recognized.

- Confirm that the SD card is completely inserted.

Why can't I hear any sound when I play back?

- Are the track faders of the tracks set to a proper level?
- Is the **STEREO** fader set to a proper level?
- Have you connected the **PHONES** or **MONITOR OUT** jacks to your headphones or monitoring system properly?
Is your monitoring system set up correctly?
- Is the **MONITOR LEVEL** knob set to a proper level? (**PHONES** jack only)

The sound I am trying to record sounds distorted.

- Are the **INPUT A** to **H TRIM** knobs on the top of the unit set too high?
Is the input source too loud?
- Is the monitoring system distorted because the monitoring level is too high?

Why can't I record?

- You must have at least one track in recording standby (**REC** indicator flashing) before you can start recording by pressing the **RECORD (●)**.
- Are input sources assigned to tracks? (See "Assigning inputs" on page 33.)

Noise occurs if I connect a passive guitar or bass directly.

- Connecting another device to the unit's **STEREO OUT** jacks might reduce the noise.
- This might be caused by interference from another device. If there is a power amplifier or other device that uses a large transformer, a fluorescent light or something similar nearby, you might be able to reduce the noise by changing the distance and orientation of this unit in relation to such equipment.

The unit turns off.

- This product is compliant with the European ErP standby power regulations. In order to comply with these regulations, the automatic power saving function is set to 30 minutes when the unit is shipped from the factory. So, by default, the unit will turn off automatically after 30 minutes elapse without any operation. Change the automatic power saving function setting if you want to disable it. (See "Setting automatic power saving" on page 60.)

15 – Messages

General messages

The following list shows messages that could appear during the use of this unit.

These messages alert you to conditions that might arise while you are using the unit. Consult the table below if you see something you do not understand or if you want to know how to solve a problem.

Message	Description and remedy
Can not Import	This pop-up appears when the sample frequency or bit rate of the selected file in the AUDIO DEPOT IMPORT menu differs from the current song.
Cannot Clear Current	The current track cannot be deleted. A virtual track assigned to a physical track cannot be deleted.
Card Error	The card could not be recognized properly. Replace the card.
Card Full	The card has no remaining capacity. Erase unnecessary files or move them to your computer to make open space.
Empty Export Track	You tried to export a track that does not contain any recording data. This pop-up appears if you try to export a song track that does not contain a recording. (See “Exporting tracks” on page 66.) Export a song track that has a recording.
Export File Too Big	The track to be exported exceeds the available capacity on the SD card. You have tried to export a track to the AudioDepot folder, but the size is too large for the remaining space on the SD card. Delete unnecessary songs or files from the AudioDepot folder to create more space on the SD card, then try to export the track again.
File Not Found	The file to be imported could not be found. You tried to import a WAV file from the AudioDepot folder, but there are no WAV files in it. (See “Importing tracks” on page 65.) Connect the unit to a computer and transfer files that you want to import from the computer to the AudioDepot folder of the unit.
Format Error Format CARD	The formatting of the card is abnormal or corrupted. This message also appears if you used a computer connected via USB to format the card in FAT format and if an unformatted card is inserted in the unit. Always use the DP-32SD to format cards to be used with it. Replace the card or format it using the FORMAT menu. FAT formatting erases all data currently on the card.
I/O Too Short	The interval between IN and OUT points is too short. You tried to use repeat mode, but the time between the IN and OUT points is too short.
Import Failed Export Failed	Importing or exporting failed.
Import File Too Large	The size of file to be imported is too large. You tried to import a WAV file from the AudioDepot folder that is too large for the remaining space on the SD card. Free up some space in the AudioDepot folder by deleting unnecessary songs, and try again.
In Bounce Mode	Bounce mode is active. You tried to perform an action that is not possible while in Bounce mode.
In Master Mode	Mastering mode is active. You tried to perform an action that is not possible while in Mastering mode.
In Punch Mode	Auto punch mode is active. You tried to perform an action that is not possible while in auto punch mode.
In Repeat Mode	Repeat playback mode is active. You tried to perform an action that is not possible while in repeat playback mode.
Invalid Card	The inserted SD card is in a format the cannot be used by this unit. Insert another SD card after turning off the unit, or format the card using FORMAT on the MENU screen.
Invalid Card Change Card	Something might be wrong with the card. Replace the card.
Mark Full	It is not possible to add more location marks. You tried to store more than 99 location marks in a song. (See “Location marks” on page 43.) Delete some location marks and try again.
Master File Not Found	A master file could not be found. This message appears if you try to enter Mastering mode, but you have not made any mixdown recording yet. First make a mixdown recording.
Master Track Too Large	The master file is too large. You tried to create a master file that is larger than the remaining open space on the SD card. To make more space, format the SD card (see “Quick formatting an SD card” on page 62 and “Full formatting an SD card” on page 63), delete unnecessary files or connect the unit to a computer to transfer (and then delete) files.

Message	Description and remedy
MBR Error Init CARD	The formatting of the card is abnormal or corrupted. Replace the card or format the card using the FORMAT menu. Formatting erases all data currently on the card.
No Card	No SD card is in the unit. Load a recordable SD card.
No Armed Track	There is no track in recording standby (armed). You tried to enter auto punch mode or pressed the RECORD button when no tracks were in recording standby. (See “Automatic punching in and out” on page 45.) Put a track into recording standby before pressing RECORD or activating auto punch.
No Undo History	There is no undo history. There are no actions to be undone. (See “Undoing an operation” on page 39.)
Not Stopped	The recorder transport is not stopped. When the recorder is not stopped, this message appears if you press a button, such as UNDO/REDO , that works only when the recorder is stopped.
Now Recording	The unit is recording. This message appears when you try to operate a menu while the unit is recording. Some other operations are also not allowed during recording.
OUT point must be set after the IN point.	You cannot set the OUT point before the IN point. Set the OUT point after the IN point.
Protected Card	The inserted SD card is write-protected. To record or edit, turn off the unit and unlock the write-protection on the SD card.
Recorded Track Not Found	When trying to use the export function, no recordings were found on the current song's tracks. No tracks have been recorded in the current song, or virtual tracks with recordings have not been assigned to physical tracks. Select a recorded song, assign the track you want to export to a physical track, and then export it. (See “Virtual tracks” on page 47.)
Revert to discard changes.	Edits and changes made since the song was loaded will be cleared, and the song will be reset to status it had when loaded. Proceed only when you are sure you wish to discard all changes.
Same Track	The same track has been specified. This message appears when using the clone track function if the source track is also set as the destination track.
Song Protected	The song is protected. You are trying to change (record, edit, etc.) a protected song. (See “Protecting songs” on page 31.) Unprotect the song.
Stereo Track Full	All the stereo tracks already have recordings. This message appears if you try to import a stereo file when all the stereo tracks in the song already have recordings, even if some mono tracks are still open.
Track Full	All the tracks already have recordings. This message appears if you try to import a file when all tracks in the song already have recordings. (See “Importing tracks” on page 65.)
Trk Edit Fail	Track editing failed. Save the song, turn the unit off and on again, and then try the track edit one more time.
Trk Too Short	The track is too short. You are trying to record in mixdown mode, but the time between the IN and OUT points is too short. The IN and OUT points must be at least 4 seconds apart. (See “Setting IN/OUT points” on page 44.)
Turn off the Guitar Effect or use two or less Dynamic Effects.	While using a guitar effect, the use of dynamic effects is limited to one or two channels. To use dynamic effects on three or more channels, turn the guitar effect OFF.
Work Memory Full	The working memory is full. Even if the SD card has enough remaining space, this error could occur if you perform many editing operations. You may be able to continue to work after executing the DELETE UNUSED item in the SONG menu to increase the amount of available working memory. (See “Undoing an operation” on page 39.)
Virtual Track has different Track Type	Since a virtual track has been recorded, the track type cannot be changed. If you want to change it, clear the recorded virtual track.

15 – Messages

Message	Description and remedy
Audio Rst Fail	<p>If any of these errors occur, turn the unit's power off and restart it. If the error message continues to appear frequently, please contact the store where you purchased this unit or a TASCAM customer support service.</p>
Device Error	
File Error	
Not Continued	
Remote Cmd	
Remote Rx	
Sys Rom Err	
System Err 50	
System Error 1	
System Error 2	
System Error 3	
System Error 4	
System Error 5	
System Error 6	
System Error 7	
System Error 8	
System Error 9	
Writing Failed	

Ratings

Recording media

- SD card (512 MB to 2 GB)
- SDHC card (4 GB to 32 GB)

File system

- SD card (512 MB to 2 GB): FAT16
 - SDHC card (4 GB to 32 GB): FAT32
-

Input/output ratings

Analog audio input/output ratings

INPUT A to H jack

- **XLR type (Balanced)**

Connector: XLR-3-31 (1: GND, 2: HOT, 3: COLD)

Input impedance: 2.4 k Ω

Rated input level: -14 dBu

Maximum input level: +2 dBu

- **Standard jack type (Balanced)**

Connector: 6.3 mm (1/4") TRS standard jack

Input impedance:

Above 22 k Ω

1 M Ω (INPUT H only, when **LINE-GUITAR** switch is set to **GUITAR**)

Rated input level: +4 dBu

Maximum input level: +20 dBu

STEREO OUT jack

Connector: RCA pin jack

Rated output level: -10 dBV

Maximum output level: +6 dBV

Output impedance: 200 Ω

EFFECT SENDS jack

Connector: 6.3 mm (1/4") TS standard jack

Rated output level: -10 dBV

Maximum output level: +6 dBV

Output impedance: 200 Ω

MONITOR OUT jack

Connector: 6.3 mm (1/4") TRS standard jack

Rated output level: -2 dBu

Maximum output level: +14 dBu

Output impedance: 200 Ω

PHONES jack

Connector: 6.3 mm stereo jack

Maximum output level: 70 mW+70 mW or more
(THD+N 0.1% or less, 32 Ω load)

Control input/output ratings

USB port

Connector: USB 4-pin mini-B type

Format: Mass Storage Class USB 2.0 HIGH SPEED

REMOTE jack

Connector: 2.5 mm TRS jack

Audio performance

Frequency response

INPUT (MIC/LINE) → STEREO OUT/EFFECT SENDS/MONITOR
OUT: 20 Hz to 20 kHz, +1 dB/-1 dB

Distortion

INPUT (MIC/LINE) → STEREO OUT/EFFECT SENDS/MONITOR
OUT: 0.01% or less

S/N ratio

INPUT (MIC/LINE) → STEREO OUT/EFFECT SENDS/MONITOR
OUT: 90 dB or more

Operating requirements

See the TEAC Global Site (<http://teac-global.com/>) for updated information about OS compatibility.

Windows

Pentium 300 MHz or faster

128 MB or more memory

USB port (USB 2.0 recommended)

Mac

Power PC, iMac, G3, G4 266 MHz or faster

64 MB or more memory

USB port (USB 2.0 recommended)

Recommended USB host controller

Intel chipset

Supported OS

Windows:

Windows 8 (including 8.1)

Windows 7

Windows Vista

Windows XP

Mac:

Mac OS X Mavericks (10.9)

Mac OS X Mountain Lion (10.8)

Mac OS X Lion (10.7)

Mac OS X Snow Leopard (10.6)

16 – Specifications

General

Power supply

AC adaptor (TEAC PS-P1220E)

Power consumption

12 W (Phantom power ON)

Dimensions

514 x 100.4 x 336.9 mm (Width x Height x Depth, excluding projections)

Weight

6.2 kg/13.67 lb

Operating temperature range

5 to 35°C/41 to 95°F

Dimensional drawings

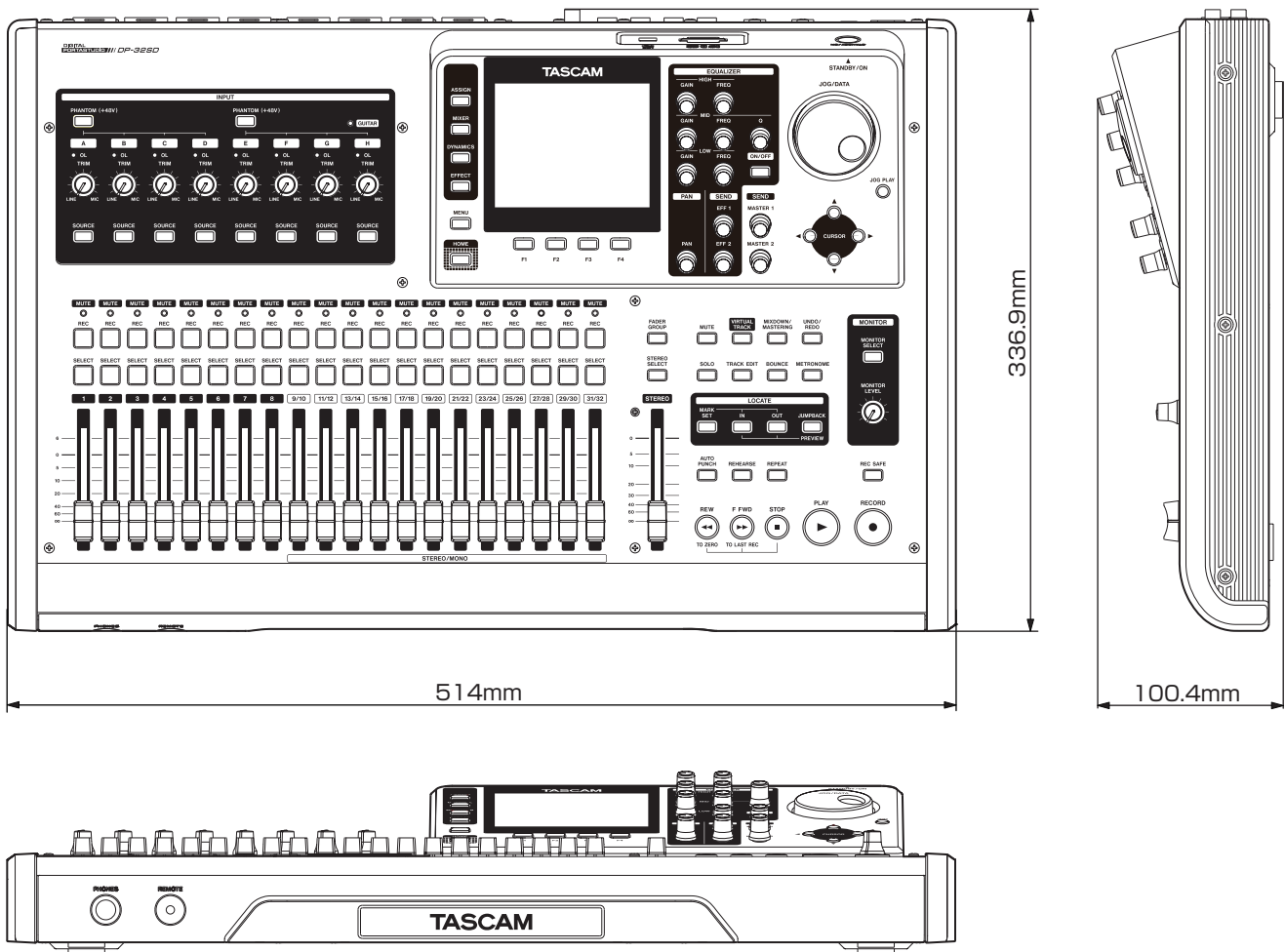

* Illustrations in this manual may differ from the actual product.

* In order to improve the product, specifications and appearance could be changed without prior notice.

Block diagram

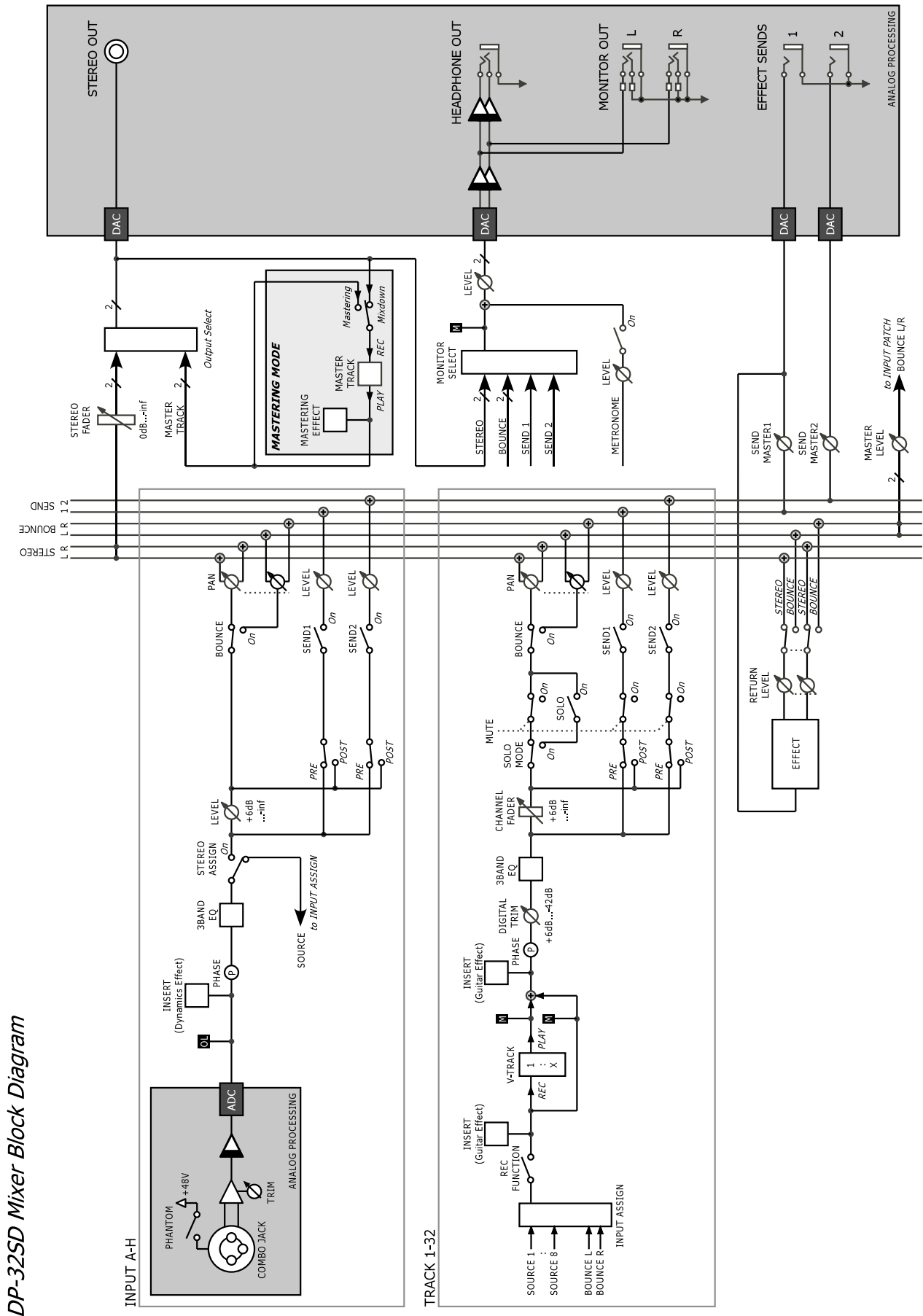

DP-32SD Mixer Block Diagram

16 – Specifications

Level diagram

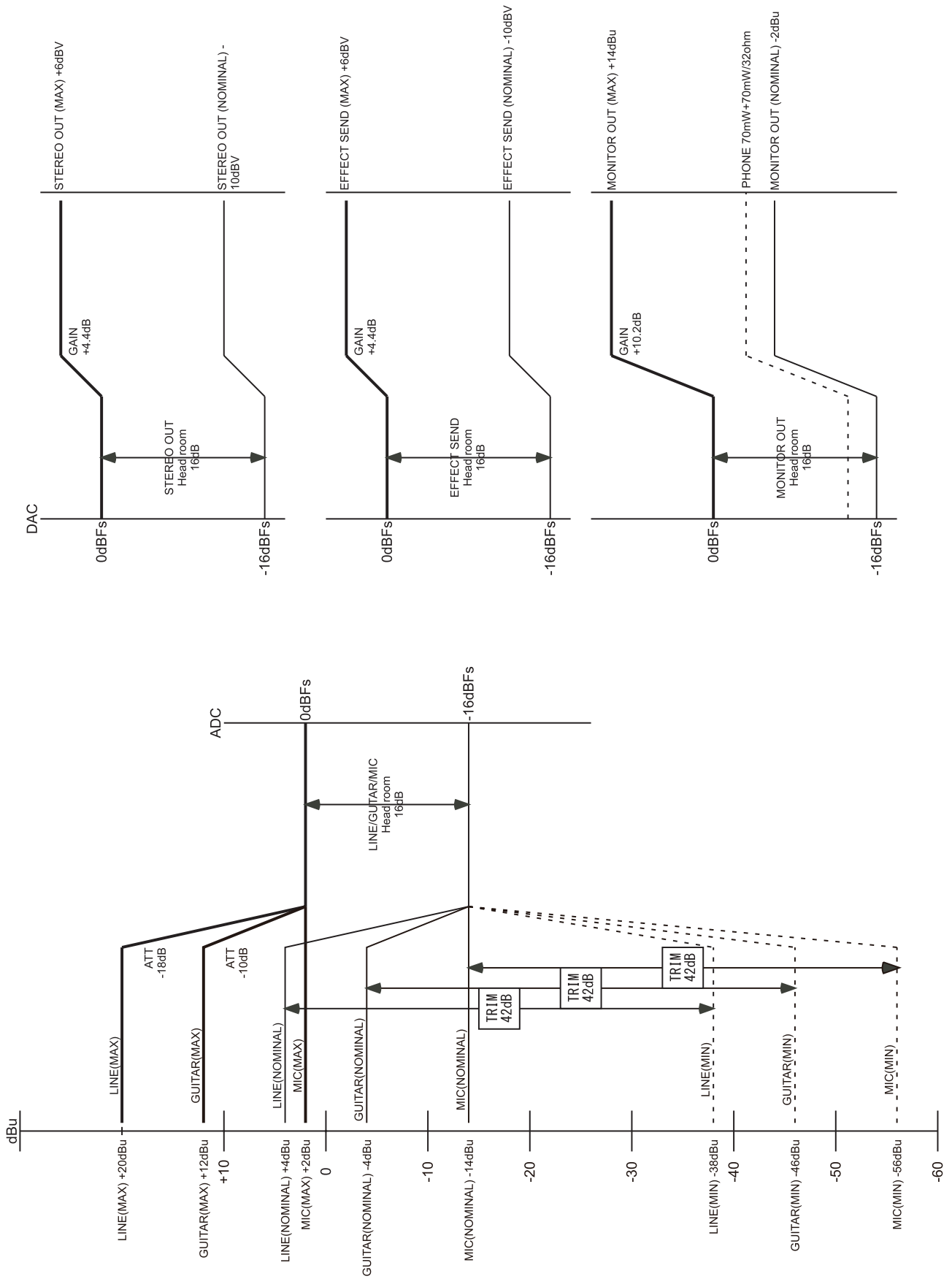

WARRANTY

< In the United States >

This warranty gives you specific legal rights and you may also have other rights which vary from state to state. This warranty is only valid within the country the unit was originally purchased.

WHAT IS AND IS NOT COVERED

Except as specified below, this warranty covers all defects in materials and workmanship in this product. The following are not covered by the warranty:

1. **Damage to or deterioration of the external cabinet.**
2. **Damages resulting from accident, misuse, abuse or neglect.**
3. **Damage resulting from failure to perform basic daily maintenance and/or calibration or otherwise resulting from failure to follow instructions contained in your owner's manual.**
4. **Damage occurring during shipment of the product. (Claims must be presented to the carrier)**
5. **Damage resulting from repair or attempted repair by anyone other than TEAC or an authorized TASCAM service station.**
6. **Damage resulting from causes other than product defects, including lack of technical skill, competence, or experience of the user.**
7. **Damage to any unit which has been altered or on which the serial number has been defaced, modified or is missing.**

WHO IS COVERED UNDER THE WARRANTY

This warranty may be enforced only by the original purchaser.

LENGTH OF WARRANTY

All parts except heads and disk drives are warranted for one (1) year from the date of original purchase. Heads and disk drives are warranted to ninety (90) days from date of original purchase. Labor is warranted for ninety (90) days from date of original purchase.

WHAT WE WILL PAY FOR

We will pay all labor and material expenses for items covered by the warranty. Payment of shipping charges is discussed in the next section of this warranty.

HOW YOU CAN GET WARRANTY SERVICE

Your unit must be serviced by an authorized TASCAM service station in the United States. (This warranty is not enforceable outside the U.S.) If you are unable to locate an authorized TASCAM service station in your area, please contact us. We either will refer you to an authorized service station or instruct you to return the unit to the factory. Whenever warranty service is required, you must present a copy of the original dated sales receipt from an Authorized TASCAM Dealer.

You must pay any shipping charges if it is necessary to ship the product to service. However, if the necessary repairs are covered by the warranty, we will pay return surface shipping charges to any destination within the United States.

LIMITATION OF IMPLIED WARRANTIES

Any implied warranties, INCLUDING WARRANTIES OF MERCHANTABILITY AND FITNESS FOR A PARTICULAR PURPOSE, are limited in duration to the length of this warranty.

EXCLUSION OF DAMAGES

TEAC's liability for any defective product is limited to repair or replacement of the product, at TEAC's option. TEAC shall not be liable for:

1. **Damages based upon inconvenience, loss of use of the product, loss of time interrupted operation or commercial loss; or**
2. **Any other damages, whether incidental, consequential or otherwise.**

Some states do not allow limitations on how long an implied warranty lasts and/or do not allow the exclusion or limitation of incidental or consequential damages, so the above limitations and exclusions may not apply to you.

To locate an Authorized Service Center in Your Area

CALL 1-800-447-8322

< Europe >

This product is subject to the legal warranty regulations of the country of purchase. In case of a defect or a problem, please contact the dealer where you bought the product.

Ce produit est sujet aux réglementations concernant la garantie légale dans le pays d'achat. En cas de défaut ou de problème, veuillez contacter le revendeur chez qui vous avez acheté le produit.

Dieses Gerät unterliegt den gesetzlichen Gewährleistungsbestimmungen des Landes, in dem es erworben wurde. Bitte wenden Sie sich im Gewährleistungsfall an den Händler, bei dem sie das Gerät erworben haben.

Questo apparecchio è conforme alle norme sulla garanzia vigenti nel rispettivo Paese in cui esso è stato acquistato. Si prega di rivolgersi al proprio commerciante, presso il quale è stato acquistato l'apparecchio, nel caso in cui si voglia richiedere una prestazione in garanzia.

Las condiciones de garantía de este aparato están sujetas a las disposiciones legales sobre garantía del país en el que ha sido adquirido. En caso de garantía, debe dirigirse al establecimiento donde adquirió el aparato.

< In other countries/areas >

This warranty gives you specific legal rights, and you may also have other rights that vary by country, state or province.

If you have a warranty claim or request, please contact the dealer where you bought the product.

该保证书赋予了顾客特定的合法权利，并且因国家、州或省等地域的不同，顾客可能拥有其他权利。如需申请或要求保修，请与购买本产品的销售店进行联系。

If you require repair services for your TASCAM equipment, please contact the dealer where the product was purchased from or the TASCAM Distributor in your country. A list of TASCAM Distributors can be found on our website at: <http://teac-global.com/>

TASCAM

TEAC CORPORATION

Phone: +81-42-356-9143

1-47 Ochiai, Tama-shi, Tokyo 206-8530 Japan

<https://tascam.jp/jp/>

TEAC AMERICA, INC.

Phone: +1-323-726-0303

10410 Pioneer Blvd. Suite #1 and #4, Santa Fe Springs, California 90670, U.S.A.

<https://tascam.com/us/>

TEAC UK Ltd.

Phone: +44-1923-797205

Meridien House, 69-71 Clarendon Road, Watford, Herts, WD17 1DS, United Kingdom

<http://tascam.eu/en/>

TEAC EUROPE GmbH

Phone: +49-611-71580

Bahnstrasse 12, 65205 Wiesbaden-Erbenheim, Germany

<http://tascam.eu/en/>

TEAC SALES & TRADING(SHENZHEN) CO., LTD

Phone: +86-755-88311561~2

Room 817, Block A, Hailun Complex, 6021 Shennan Blvd., Futian District, Shenzhen 518040, China

<http://tascam.cn/>

1218.MA-2776A

Printed in China

WARRANTY

Model/Modèle/Modell
Modello/Modelo/型号

DP-32SD

Owner's name/Nom du possesseur/Name des Eigentümers
Nombre del propietario/Nombre del propietario/顾客姓名

Serial No./No de Série/Numéro de série/序列号
Numero di serie/Número de serie/序列号

Address/Adresse/Adresse
Indirizzo/Dirección/顾客地址

Date of purchase/Date de l'achat/Datum des Kaufs
Date dell'acquisto/Fecha de compra/购买日期

Dealer's name/Nom du détaillant/Name des Handlers
Nombre del comerciante/Nombre del establecimiento/销售店名

TASCAM
<http://teac-global.com/>

Dealer's address/Adresse du détaillant/Adresse des Handlers
Indirizzo del commerciante/Dirección del establecimiento/销售店地址

Sample