

---

# GelDoc Go Imaging System with Image Lab Touch Software

## User Guide

Version 3.0



**BIO-RAD**



# **GeIDoc Go Imaging System with Image Lab Touch Software**

## **User Guide**

**Version 3.0**

BuildTime: Mon 01/27/2020 12:34:38.01 by Job: "IL\_bMain\_W\_UserDocs\_VerDeploy", BN: 283 from  
"//depot/projects/Imaging/Main/...@232045" BuildType: BT\_DEV



## Legal Notices

No part of this publication may be reproduced or transmitted in any form or by any means, electronic or mechanical, including photocopy, recording, or any information storage or retrieval system, without permission in writing from Bio-Rad Laboratories, Inc..

Bio-Rad reserves the right to modify its products and services at any time. This guide is subject to change without notice. Although prepared to ensure accuracy, Bio-Rad assumes no liability for errors or omissions, or for any damage resulting from the application or use of this information.

The GelDoc Go imaging system uses the Linux operating system, which contains software licensed under the following licenses as well as others:

- Gnu Public License v 1.0, 2.0, 3.0
- Lesser Gnu Public License v 2.0, 2.1, 3.0
- Apache License v 2.0
- BSD License

Image Lab Touch software is based in part on the work of the CImg project (<http://cimg.eu/>). To see the license for details, paste the following link into a web browser:

[http://cecill.info/licences/Licence\\_CeCILL-C\\_V1-en.txt](http://cecill.info/licences/Licence_CeCILL-C_V1-en.txt)

The software provided as part of the GelDoc Go Imaging System includes free open source and public-source software. Certain OPEN LICENSES require that the source materials be made available to recipients or other requestors under the terms of the same OPEN LICENSE. The corresponding open source software can be downloaded at:

<http://bio-rad.com/GelDocGo-opensource>

### To view the OPEN LICENSES

1. Open the Online Help system on your GelDoc Go instrument.
2. Tap Help Topics at the bottom of the screen, and then tap Legal Notices.
3. Insert a USB drive into the port on your instrument.
4. Tap the Download Software Licenses button located in the bottom-right corner of the screen.

The license information is downloaded to a Software Licenses folder created on the USB drive.

SYBR is a trademark of Thermo Fisher Scientific Inc. Bio-Rad Laboratories, Inc. is licensed by Thermo Fisher Scientific Inc to sell reagents containing SYBR Green I for use in real-time PCR, for research purposes only.

BIO-RAD, MINI-PROTEAN, and TRANS-BLOT are trademarks of Bio-Rad Laboratories, Inc. in certain jurisdictions.

All trademarks used herein are the property of their respective owner.

Copyright © 2019 by Bio-Rad Laboratories, Inc. All rights reserved.

## Technical Support Department

The Technical Support department in the U.S. is open Monday through Friday, 5:00 AM to 5:00 PM, Pacific time.

**Phone:** 1-800-424-6723, option 2

**Email:** [Support@bio-rad.com](mailto:Support@bio-rad.com) (U.S./Canada Only)

For technical assistance outside the U.S. and Canada, contact your local technical support office or click the Contact us link at [www.bio-rad.com](http://www.bio-rad.com).



# Table of Contents

|   |    |
|---|----|
| <b>Chapter 1 Safety and Regulatory Compliance</b> ..... | 9  |
| Important Safety Information .....                      | 9  |
| Warranty .....  | 10 |
| General Precautions .....                               | 10 |
| Regulatory Notices .....                                | 11 |
| Safety Alerts .....                                     | 11 |
| Types of Safety Hazards .....                           | 11 |
| Levels of Potential Risk .....                          | 12 |
| Instrument Safety Warnings .....                        | 13 |
| Notice .....  | 14 |
| Power Safety .....                                      | 14 |
| Fuses .....   | 14 |
| <b>Chapter 2 Introduction</b> .....                     | 15 |
| Product Features .....                                  | 15 |
| Front and Side Panel Components .....                   | 16 |
| Rear Panel Components .....                             | 17 |
| Image Lab Touch Software .....                          | 18 |
| Optional Accessories .....                              | 19 |
| Printer .....   | 19 |
| Sample Trays .....                                      | 19 |
| Technical Specifications .....                          | 20 |
| Environmental Requirements .....                        | 21 |
| <b>Chapter 3 Starting Image Lab Touch</b> .....         | 23 |
| About the Welcome Screen .....                          | 23 |
| What's in the Suitcase? .....                           | 24 |
| Interacting with the Touch Screen .....                 | 24 |
| Entering Text on the Touch Screen .....                 | 25 |
| Using the On-Screen Keyboard .....                      | 25 |

|  |           |
|--|-----------|
| Using the On-Screen Keypad .....                     | 26        |
| Choosing Imaging Settings .....                      | 27        |
| Locking the System .....                             | 28        |
| Unlocking the System .....                           | 29        |
| Getting Help .....                                   | 30        |
| <b>Chapter 4 Logging In to Image Lab Touch .....</b> | <b>31</b> |
| Creating the First User Account .....                | 31        |
| Creating a Password .....                            | 32        |
| Changing a Password .....                            | 33        |
| Removing a Password .....                            | 34        |
| Creating the First Administrator Account .....       | 34        |
| Becoming an Administrator after Initial Login .....  | 35        |
| Setting Administrator Options .....                  | 36        |
| <b>Chapter 5 Understanding the Views .....</b>       | <b>39</b> |
| Main Toolbar Settings .....                          | 39        |
| Camera View .....                                    | 40        |
| Preview .....  | 41        |
| Image View .....                                     | 42        |
| The Image View Toolbar .....                         | 43        |
| The Gallery .....                                    | 44        |
| Color Cues .....                                     | 45        |
| <b>Chapter 6 Choosing a Sample Tray .....</b>        | <b>49</b> |
| Applications Listed by Tray Type .....               | 50        |
| UV/Stain-Free Tray .....                             | 50        |
| Blue Tray .....                                      | 51        |
| White Tray .....                                     | 51        |
| <b>Chapter 7 Acquiring Images .....</b>              | <b>55</b> |
| Multichannel Images .....                            | 55        |
| Placing the Sample in the Imager .....               | 56        |
| Acquiring an Image — General Steps .....             | 56        |
| Setting Image Type and Size .....                    | 57        |
| Choosing Image Type .....                            | 57        |
| Choosing Image Size .....                            | 57        |



|   |           |
|---|-----------|
| Choosing the Application .....  | 59        |
| (Multichannel) Selecting a Channel Color .....                        | 60        |
| Previewing an Image .....   | 61        |
| Exposure Settings .....   | 63        |
| Setting Exposure for Most Gels and Blots .....                        | 63        |
| Setting Exposure for Stain-Free Gels .....                            | 64        |
| Automatic Exposure Settings .....                                     | 65        |
| Setting the Exposure Automatically .....                              | 66        |
| Specifying the Region of Interest for Auto-Exposure .....             | 66        |
| Setting the Exposure Manually .....                                   | 68        |
| Acquiring the Image .....   | 68        |
| (Stain-Free Gel) Gel Activation .....                                 | 70        |
| (Stain-Free Gel) Acquiring an Image after Canceling Acquisition ..... | 70        |
| (Multichannel) Retaking an Image .....                                | 70        |
| <b>Chapter 8 Excising Bands from Samples .....</b>                    | <b>73</b> |
| Excising Bands on a UV/Stain-Free Tray .....                          | 73        |
| Excising Bands on a White or Blue Tray .....                          | 76        |
| <b>Chapter 9 Viewing Images .....</b>                                 | <b>77</b> |
| Accessing the Gallery .....   | 77        |
| Searching for Images in the Gallery .....                             | 78        |
| Selecting and Opening Images in the Gallery .....                     | 79        |
| Sorting Images in the Gallery by Date .....                           | 80        |
| Checking Intensity Values .....                                       | 81        |
| Viewing Multichannel Images in Image View .....                       | 83        |
| Viewing a Composite or Merged Image in Grayscale .....                | 85        |
| Comparing Images .....  | 86        |
| Copying Image Settings .....  | 88        |
| Viewing Image Information .....                                       | 90        |
| <b>Chapter 10 Merging Images .....</b>                                | <b>91</b> |
| Naming Merged Images .....  | 93        |
| <b>Chapter 11 Managing Images .....</b>                               | <b>95</b> |
| Adding Notes to an Image File .....                                   | 95        |
| Changing the File Naming Format .....                                 | 96        |

|  |            |
|--|------------|
| Renaming Images .....  | 98         |
| Printing Images .....  | 99         |
| Deleting Images .....  | 99         |
| <b>Chapter 12 Exporting Images .....</b>                                 | <b>101</b> |
| Exporting Images .....   | 102        |
| Preparing to Export Images .....   | 105        |
| Creating a Shared Folder on a Windows Computer .....                     | 105        |
| Creating a Shared Folder on a Mac Computer .....                         | 108        |
| Determining the UNC of a Previously Shared Folder .....                  | 110        |
| Determining the UNC Path to a Network Folder on a Windows Computer ..... | 110        |
| Determining the UNC Path to a Network Folder on a Mac Computer .....     | 111        |
| Export Formats .....   | 113        |
| Choosing Export Formats .....  | 113        |
| Exporting to a USB Flash Drive or External Hard Drive .....              | 115        |
| Exporting to a Shared Folder for the First Time .....                    | 116        |
| Exporting to a Shared Folder on a Network or Computer .....              | 117        |
| Entering Log-in Credentials .....  | 117        |
| Exporting to a Recent Location .....                                     | 119        |
| Removing Network Locations .....   | 121        |
| Disconnecting from a Shared Folder .....                                 | 121        |
| <b>Chapter 13 System Settings .....</b>                                  | <b>123</b> |
| Setting the System Date, Time, and Time Zone .....                       | 123        |
| Setting the Sound Volume .....   | 126        |
| Setting the System Language .....  | 126        |
| Configuring the Network Connection .....                                 | 127        |
| <b>Appendix A Maintaining the Imaging System .....</b>                   | <b>129</b> |
| Reinstalling Image Lab Touch Software .....                              | 129        |
| Ensuring the Instrument is Level .....                                   | 129        |
| Cleaning the Instrument .....  | 131        |
| Maintaining Transilluminator Bulbs .....                                 | 132        |
| Replacing UV Transilluminator Bulbs .....                                | 132        |
| Replacing the Fuses .....  | 134        |

|  |     |
|--|-----|
| <b>Appendix B Important Imaging Concepts</b> .....           | 137 |
| Specifying the Region of Interest for Optimal Exposure ..... | 137 |
| Adjusting How Images Are Displayed .....                     | 137 |
| Adjusting Image Brightness and Contrast .....                | 138 |
| Restoring Default Settings .....                             | 139 |
| <b>Appendix C Ordering Information</b> .....                 | 141 |

## Table of Contents

## Chapter 1 Safety and Regulatory Compliance

**Note:** This equipment has been tested and found to comply with the limits for a Class A digital device pursuant to Part 15 of the FCC Rules. These limits are designed to provide reasonable protection against harmful interference when the equipment is operated in a commercial environment. This equipment generates, uses, and can radiate radiofrequency energy. If not installed and used in accordance with the instruction manual, it may cause harmful interference to radio communications. Operation of this equipment is intended for laboratory use only and if used in a residential area, is likely to cause harmful interference in which case users will be required to correct the interference at their own expense.

### Important Safety Information

Please read these instructions before operating the GelDoc Go imaging system. These instruments are suitable for research use only. Therefore, they must be used only by specialized personnel who know the health risks associated with the reagents that are normally used with these instruments.



**WARNING:** Because the imaging of some applications involves UV illumination, the GelDoc Go Imaging System is labeled as Group 3 (High Risk) by the International Electrotechnical Commission standard IEC/EN 62471. The instrument should be used only by trained personnel who know the health risks associated with the UV radiation normally associated with these instruments. Users should be trained on the appropriate personal protective equipment for working with UV light to minimize UV exposure.

To perform band excision using the UV/Stain-Free tray, the transilluminator drawer is pulled out with the UV source enabled. This exposes the user to UV radiation, which can cause permanent damage to the eyes and skin. In its lowered position, the instrument's optional acrylic shield provides some UV protection. However, in its raised position, it does not provide complete protection to the user, and it does not protect others who are standing in the area around the imager.

To protect users and bystanders, these procedures must be followed:

- Protect all skin surfaces (including the neck, ears, and hands). Before performing band excision, the user and anyone near the imager must put on personal protective equipment including UV protective safety glasses, a face shield, lab coat, and gloves. A typical and reasonable expectation of use is three operations per user a day for three minutes each.
- Bystanders without protective gear must stand at least 1.5 meters (five feet) away from the imager and limit their exposure to no more than one hour per day.

**Note:** There is no exposure to UV radiation with the blue or white trays. No protective gear is necessary when excising bands with these trays.

## Warranty

The GelDoc Go imaging system is warranted against defects in materials and workmanship for one year. If any defect occurs in the instrument during this warranty period, Bio-Rad Laboratories, Inc. will repair or replace the defective parts at its discretion without charge. The following defects, however, are specifically excluded:

- Defects caused by improper operation
- Repair or modification done by anyone other than Bio-Rad Laboratories, Inc. or the company's authorized agent
- Use of spare parts supplied by anyone other than Bio-Rad Laboratories, Inc.
- Damage caused by accident or misuse
- Damage caused by disaster
- Corrosion caused by improper solvents or samples

## General Precautions

- Read the user guide carefully.
- Use the instrument only for the intended purpose of gel and blot image acquisition in research laboratories.
- Connect the instrument to a grounded power source and to a circuit breaker.
- Do not pour liquids on or inside the instrument.
- Clean the sample tray after use.

## Regulatory Notices

The GelDoc Go imaging system is designed and certified to meet EN 61010, the internationally accepted electrical safety standard, EMC regulations, and TUV requirements. Certified products are safe to use when operated in accordance with this user guide. Do not modify or alter these instruments in any way. Modification or alteration of these instruments will

- Void the manufacturer's warranty
- Void the regulatory certifications
- Create a potential safety hazard





Bio-Rad Laboratories, Inc. is not responsible for any injury or damage caused by use of these instruments for purposes other than those for which they are intended or by modifications of the instruments not performed by Bio-Rad Laboratories, Inc., or an authorized agent.

## Safety Alerts

Alert icons appear in cautionary and warning paragraphs in this guide to call attention to safety hazards.

### Types of Safety Hazards

Most alert icons depict the relevant type of safety hazard.

| Alert Icon  | Explanation  |
|---|--|
|  | General — Indicates a potential hazard requiring special attention. This icon appears when the hazard or condition is of a general nature.                       |
|  | Electrical Hazard — Indicates a potential hazard requiring special attention when you are working with electricity or electrical equipment.                      |
|  | Extreme heat and flammable materials<br>Indicates a potential hazard requiring special attention when you are working with extreme heat and flammable materials. |

| Alert Icon  | Explanation  |
|---|--|
|  | Radiation hazard<br>Indicates a potential hazard requiring special attention when you are working with UV radiation. |

## Levels of Potential Risk

Each alert icon appears in a paragraph type in this guide that indicates the level of potential risk posed by the hazard or action described.

### Cautions

A caution (example shown below) alerts you to take or avoid a specific action that could result in loss of data or damage to the instrument. A caution can also indicate that minor or moderate injury might occur if the precaution against a potential hazard is not taken.



**Caution:** With the exception of cleaning or replacing light bulbs, refer all servicing to qualified Bio-Rad personnel or their agents.

### Warnings

A warning (example shown below) precedes an action that, if not followed correctly, could cause serious injury or death to the operator, serious or total loss of data, or serious damage to the instrument.





**WARNING! Radiation Hazard** — Keep the UV shield open for as little time as possible.



## Instrument Safety Warnings

Before you operate the instrument, carefully read the explanation for each safety icon.

| Safety Icon  | Explanation  |
|--|--|
|   | <b>Caution:</b> With the exception of cleaning or replacing light bulbs, refer all servicing to qualified Bio-Rad personnel or their agents. If you experience technical difficulties with the instrument, contact Bio-Rad to schedule service. The instrument should not be modified or altered in any way. Alteration voids the manufacturer's warranty and might create a potential safety hazard for the user. |
|   | <b>WARNING!</b> If any interlock is defeated, there is a possibility of UV-B radiation hazard due to UV-B light exposure. Exercise caution when servicing the instrument.  |
|  | <b>WARNING!</b> This instrument must be connected to an appropriate AC voltage outlet that is properly grounded.   |

The following warning label is also affixed to all GelDoc Go instruments:

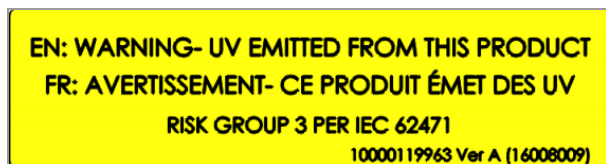

In the IEC/EN 62471 standard developed by the International Electrotechnical Commission, Group 3 is classified as High Risk, where even momentary exposure to ultraviolet light (Actinic UV (200nm -- 400 nm) is hazardous. Specifically, when viewing around the UV shield at a distance of 20cm, the measured Actinic UV emission is approximately 4 W/m<sup>2</sup>, with a permissible exposure time of about 7 seconds.

Ensure anyone using the instrument wears approved personal protective equipment (PPE).

## Notice

Bio-Rad's imaging systems are intended for laboratory use only. These devices are meant for use by specialized personnel who know the health risks associated with reagents used in electrophoresis. The UV light source is computer controlled, and proper interlocks are implemented to avoid users' accidental exposure to UV radiation. Bio-Rad Laboratories, Inc. is not responsible for any injury or damage caused by use of these instruments for purposes other than those for which they are intended, or for instrument modifications not performed by Bio-Rad Laboratories, Inc. or an authorized agent.

## Power Safety

The imaging systems use a universal power supply that automatically chooses the correct voltage for your country or region.

The operating voltage requirement for the GelDoc Go imaging system is 100–240 VAC; 50–60 Hz.

## Fuses

The imaging systems have two user-serviceable fuses, F1 and F2, which are located on the rear panel and are a part of the power entry module. See [Replacing the Fuses on page 134](#) for more information.

## Chapter 2 Introduction

The GelDoc Go imaging system facilitates high sensitivity and high quality image acquisition for selected gels and blots applications. The system uses Bio-Rad's Image Lab Touch software to control image capture and optimization. You interact with the instrument via an integrated touch screen and a simple user interface. Using Image Lab Touch software, you can acquire and view images, fine tune their appearance, and print them. You can also export images to a computer and analyze them with Image Lab desktop software.

**Note:** Image Lab Touch software does not support image analysis. Use Image Lab desktop software version 6.1 or greater on a separate computer to analyze images acquired with the imaging systems.

Bio-Rad imaging systems are compact gel/blot imaging instruments. These instruments automate the process of selecting acquisition parameters and acquire high-quality and high-sensitivity gel and multichannel western blot images with the tap of an on-screen button.

Using the GelDoc Go imaging system, you can acquire data from 1 or 2 channels in a multichannel image, including fluorescent applications.

## Product Features

The GelDoc Go imager has a built-in UV transilluminator and white LEDs for epi (reflective) illumination. The imager works with gels and blots stained with a wide range of dyes and fluorophores.

Additional features include

- Support for colorimetric western blotting applications and DNA/protein gel visualization
- Dynamic flat fielding specific to each application
- Smart, tray-based imaging that identifies the correct applications and presents appropriate filter and illumination sources for each

## Front and Side Panel Components

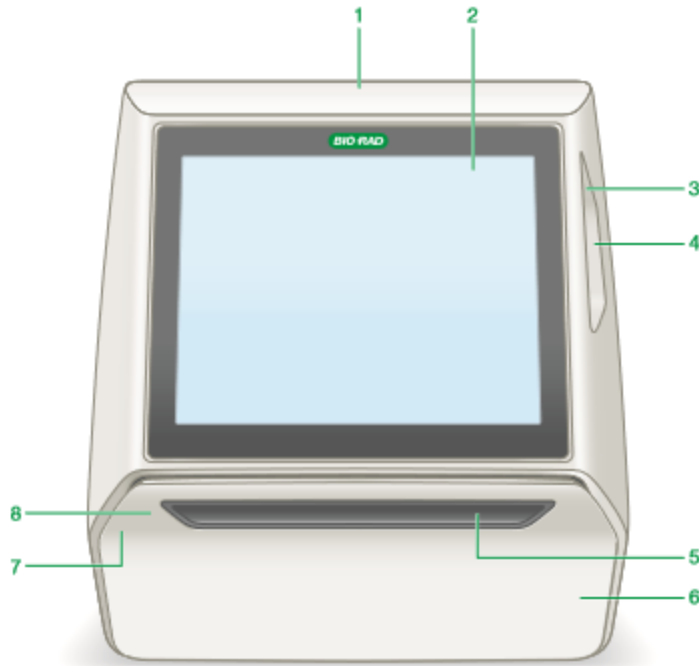

### LEGEND

|   |                      |   |   |
|---|----------------------|---|---|
| 1 | Drip pad             | 5 | Transilluminator drawer handle          |
| 2 | Touch screen         | 6 | Transilluminator drawer (open position) |
| 3 | USB 3.0 A port       | 7 | Imaging stage                           |
| 4 | System on/off button | 8 | Sample tray                             |

## Rear Panel Components

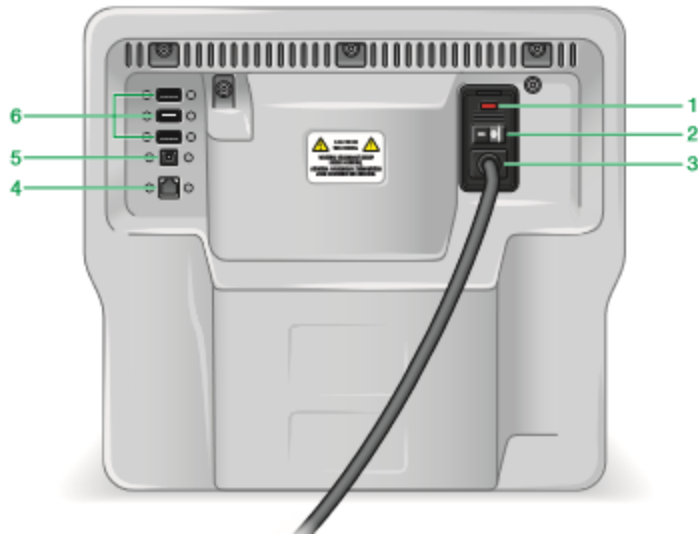

### LEGEND

1 Fuses

2 On/off switch

3 AC power receptacle

4 Ethernet port

5 USB B port

6 USB 2.0 A ports

## USB Ports

The instrument has three types of USB ports:

- Use the USB 2.0 A ports on the back of the instrument to connect any of the following accessories to the imaging system:
  - Printer
  - Mouse
  - Keyboard
- Use the USB 3.0 A port on the side of the instrument to connect a USB drive to quickly copy large data files
- The USB B port on the back of the instrument is for Bio-Rad Service personnel only. Do not use this port.

## Ethernet Port

Use this port to connect the instrument to a network drive.

**Note:** The GelDoc Go imaging system cannot be controlled by an external computer.

## Image Lab Touch Software

The imager ships with Image Lab Touch software installed.

## Optional Accessories

See [Appendix C, Ordering Information](#), for a list of optional accessories and replacement parts.

### Printer

An optional USB printer, the Mitsubishi P95 thermal printer, is available from Bio-Rad for use with the imaging system.

### Sample Trays

| Tray                      | Description   |
|---------------------------|---|
| UV/Stain-Free Sample Tray | The UV/Stain-Free tray is shipped with the imaging system. The UV tray is made of UV transmissive glass that blocks other wavelengths of light from the transilluminator fluorescent bulbs, reducing the background light in the emission spectrum of samples imaged using trans-UV excitation. The UV/Stain-Free tray can be used with all blotting applications |
| White Sample Tray         | The optional white tray is for use with transillumination of colorimetric gels, such as coomassie or silver stained samples.  |
| Blue Sample Tray          | The optional blue tray is a UV-to-blue-light conversion screen that makes appropriately stained DNA samples visible while protecting them from UV damage.   |

See [Chapter 6, Choosing a Sample Tray](#), for more information.

## Technical Specifications

| <b>Supported Applications</b>  |   |
|--------------------------------|---|
| Fluorescence                   | Yes   |
| Chemiluminescence              | No  |
| Colorimetry                    | Yes   |
| Gel documentation              | Yes   |
| <b>Hardware Specifications</b> |   |
| Touch screen functionality     | <ul style="list-style-type: none"> <li>■ Multitouch capable</li> <li>■ Display resolution 1024 x 768 pixels</li> <li>■ 9.7" (24.64 cm) display</li> </ul>                   |
| Onboard computer system        | <ul style="list-style-type: none"> <li>■ 2 GB RAM</li> <li>■ 32 GB disk space</li> <li>■ 4 USB ports</li> </ul>   |
| Sample thickness               | Maximum supported thickness: 5 mm   |
| Maximum image area             | <ul style="list-style-type: none"> <li>■ Length: 14 cm</li> <li>■ Width: 21 cm</li> </ul>   |
| Excitation source              | <ul style="list-style-type: none"> <li>■ Trans-UVB (standard)</li> <li>■ Epi-white (standard)</li> <li>■ Trans-white (optional)</li> <li>■ Trans-blue (optional)</li> </ul> |
| Detector                       | 6.3 MP CMOS   |
| Pixel size                     | 2.4 $\mu\text{m}$ x 2.4 $\mu\text{m}$   |
| Emission filter                | 535–645 nm (standard)   |
| Dynamic range                  | >3.5 orders of magnitude  |
| Pixel density (gray levels)    | 65,535  |



|                                |   |
|--------------------------------|---|
| Instrument size                | <ul style="list-style-type: none"> <li>■ Depth: 44.8 cm (18")</li> <li>■ Width: 36.0 cm (14.2")</li> <li>■ Height: 35.3 cm (14")</li> </ul> |
| Instrument weight              | ~16 kg (~35 lbs)  |
| <b>Operating Ranges</b>        |   |
| Operating voltage              | 100–240 VAC, 50–60 Hz   |
| Operating temperature          | 10–28°C   |
| Operating humidity             | 20–80% relative humidity (noncondensing)  |
| <b>Automation Capabilities</b> |   |
| Workflow automated selection   | Application driven, tray-based imaging and autoselection of excitation source   |
| Image flat fielding            | Dynamic; precalibrated and optimized per application  |
| Autoexposure                   | 2 user-defined modes (rapid or optimal)   |

## Environmental Requirements

The imaging systems require a space 38 x 37 x 46 cm (W x H x D) and a clearance of at least 8 cm from the back for instrument ventilation and for connecting or disconnecting the AC power cord. Place the imager on a sturdy and level laboratory bench or table away from excessive heat and moisture. The imager's operating temperature range is 10–28°C. The imager contains a universal power supply that supports a voltage range of 100–240 VAC.



**WARNING!** Transilluminators are powerful sources of UV radiation, which can cause serious damage to unprotected eyes and skin. The accessory UV shield provides UV protection. However, this shield does not guarantee complete protection nor does it provide protection to others in the area around the imager. Before performing band excision, the user and anyone near the imager must put on protective gear including eyeglasses (laboratory glasses provide adequate protection), a face shield, lab coat, and gloves.



## Chapter 3 Starting Image Lab Touch

**Note:** Before starting the imaging system, verify the rocker switch on the power entry module is in the On position.

Press the On button on the imaging system. The imaging system turns on and Image Lab Touch software starts automatically.

The Welcome screen appears.

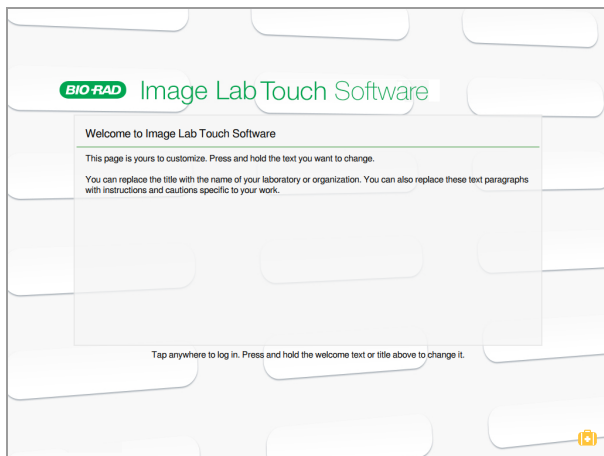

### About the Welcome Screen

On the Image Lab Touch Software Welcome screen, you can customize the text for your organization. For example, you can enter the name of your business or laboratory in the upper box and add a warning message or other helpful information in the second box. You can enter one line of text in the upper box, and you can fill the lower box with text. The box does not scroll.

#### To edit Welcome screen text

1. Press and hold on the text you want to change. The on-screen keyboard appears.
2. Enter your text.
3. Tap the keyboard key on the lower right to save your changes and close the keyboard. For information on the keyboard, see [Using the On-Screen Keyboard on page 25](#).

## What's in the Suitcase?



Tapping the Suitcase in the lower right corner of the Welcome screen displays the Service Logout command, which enables service personnel to log out of Image Lab Touch and access service tools.

## Interacting with the Touch Screen

In Image Lab Touch, you access imaging settings by tapping the setting type on the touch screen.

- Tap an imaging settings tile to open dialog boxes in which you can specify imaging settings.
- Tap an icon to execute a command or to open a menu or a view.
- Tap a box to display an on-screen keyboard or numeric keypad in which you can enter data.

| Action     | Definition  |
|------------|---|
| Tap        | Briefly touch the screen surface.   |
| Double-tap | Tap twice quickly.  |
| Pan        | Touch and then move your finger left or right.  |
| Swipe      | Slide a finger up, down, or across a box or screen to scroll contents.                                      |
| Stretch    | Place a thumb and one or two fingers together on the screen, and then move them apart to zoom in.           |
| Pinch      | Place a thumb and one or two fingers slightly apart on the screen, and then move them together to zoom out. |

Alternatively, you can use a USB mouse to click tiles and icons or to click in boxes, and you can enter the data with a USB keyboard.

**Important:** Plug in the USB mouse before you turn on the system to enable the mouse pointer to appear.

**Tip:** When you use a USB mouse, read the instruction *tap* in this guide as *click*.

## Entering Text on the Touch Screen

You can enter or edit text in text boxes using the on-screen keyboard or keypad. You can also enter text using a USB keyboard.

### To access the on-screen keyboard or keypad

- ▶ Tap in a text box.  
The appropriate on-screen input device appears.

## Using the On-Screen Keyboard

Text boxes appear on the screen in which you can enter or edit text.

- ▶ Tap in a box to display the on-screen keyboard.  
Use the on-screen keyboard or attach a USB keyboard to the imager to enter data.

You can switch between an English language and Simplified Chinese keyboard. Tap the Globe key on the bottom left of the keyboard to change keyboards and enter English alphabetic characters, numbers and symbols, or Simplified Chinese characters.

**Tip:** You can change the system language to display all on-screen text in either English language or Simplified Chinese language.

- ▶ Tap keys to enter data.

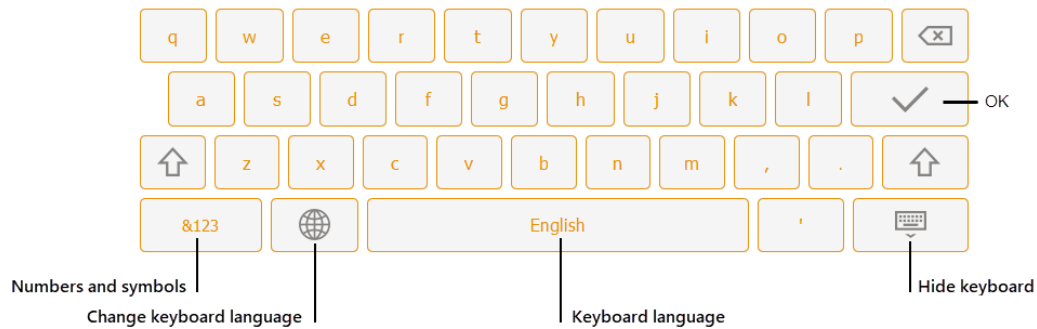

## Using the On-Screen Keypad

Text boxes appear on the screen in which you can enter or edit numerals or text. You can enter numerals using the on-screen numeric keypad.

### To display the numeric keypad

- ▶ Tap in a box.

The keypad appears on the screen.

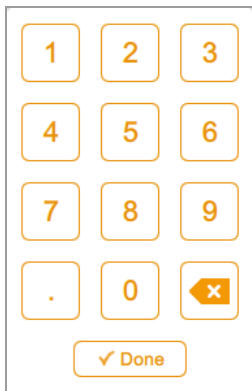

### To use the keypad

- Tap the text box to display the range of valid values below the box.
- If a number you tap does not appear on the screen, verify that the number is within the range of valid values. Invalid numbers are not accepted. If you enter an invalid number and tap Done, the box turns red.
- Some properties are set by entering data in multiple text boxes. After you enter data in a box, tap the next box. All edits in each box are saved automatically.
- Tap Done or tap anywhere else on the screen to close the keypad.

## Choosing Imaging Settings

Image Lab Touch displays an imaging settings tile for each channel image you want to acquire. For example, when you tap Single, Camera view displays a single imaging settings tile in the left pane:

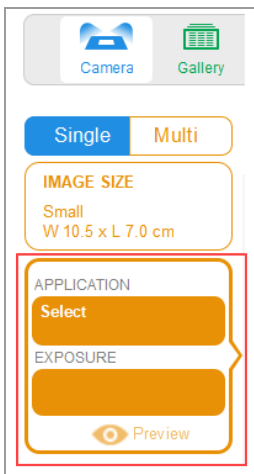

1. Tap Single or Multi to acquire a single-channel or multichannel image.



2. Tap Image Size to display image size settings and then select the image size you want.

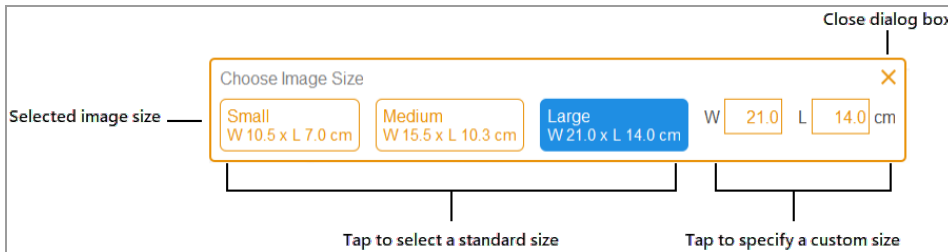

The dimensions of the image size you select appear when you tap Image Size. Similarly, the application and exposure settings you select appear under Application and Exposure. For example, when you tap Application in the tile, application categories and application types compatible with the selected application category appear:

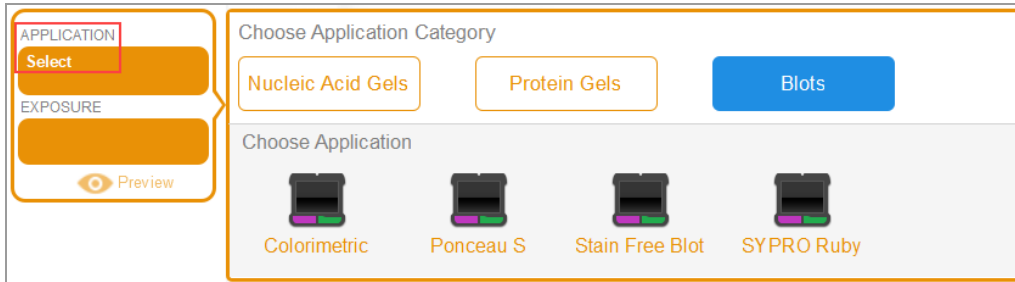

## Locking the System

If your imaging system has an administrator and if you log in with a password, you can lock the system. This prevents other users from interrupting an acquisition or changing settings.

While the system is locked, only you (the current user) or an administrator can log you off the locked system. If an administrator chooses to log you off while an action is in progress, the action and the lock are canceled.

### To lock the system during an acquisition

1. Tap Camera to start an acquisition.
2. In the progress bar that appears, tap the Lock icon in the lower right corner.

The system locks and the acquisition continues.

### To lock the system at any time

- ▶ On the main toolbar, tap User Settings and then tap Lock Display.

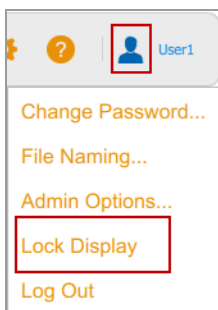



The touch screen appears dimmed. The name of the current user and buttons for unlocking or logging off the system appear in the upper right area.

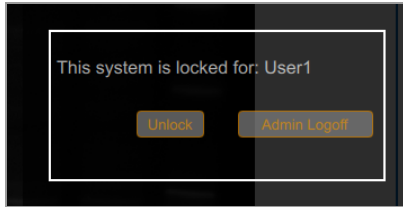

## Unlocking the System

The user who locked the system (that is, the current user) can unlock it. An administrator can also unlock the system by logging off the user who created the lock. When the user is logged off, the lock is canceled, and the system is again available.

### To unlock the system (current user only)

1. On the locked screen, tap Unlock.
2. Enter your password in the box that appears.

The lock is canceled and you can continue to work with the system.

### To log off the current user (administrators only)

1. On the locked screen, tap Admin Logoff.

The system prompts you to identify yourself as an administrator:

2. Enter your user name and password and tap OK.

If an action is in progress, a message notifies you that data might be lost if you log off the current user.

3. Tap Yes to log off the current user or No to cancel.

## Getting Help

Online help is available in each main view and in selected dialog boxes.

### To access help

- Tap the question mark icon in the main toolbar to open the help topic for the current screen.
- Scroll to display longer topics and to access links to related topics.
- Tap Help Topics at the bottom of any help topic to view a list of all main help topics.

### To close Help

- ▶ Tap the X in the upper right corner of the topic.

## Chapter 4 Logging In to Image Lab Touch

The first person to start Image Lab Touch on the instrument must create an account. The person can create a personal user account or an administrator account. The software prompts you to indicate whether to be an administrator when you create the first account.

After the first person creates the first account, subsequent users can log into a general user account or create a personal user account. After the first Administrator account is created, only the administrator can assign the administrator account to other users.

**Important:** Until an administrator is designated, all user accounts have administrative privileges.

This chapter explains how to create the first accounts in Image Lab Touch software.

### Creating the First User Account

The first time you run Image Lab Touch software, you must enter a user name to log in. The first person to log into Image Lab Touch is also be prompted to indicate if the account will be an administrator account

#### To create the first user account

1. Tap anywhere in the Welcome screen.

The login dialog box appears.



The image shows a login dialog box with a text input field containing the placeholder text "Enter user name". To the right of the input field is a plus sign icon and the word "Create" below it.

2. Tap inside the text box.
3. Using the on-screen keyboard that appears, tap in a user name and then tap Create.

**Note:** For information on the Image Lab Touch keyboard, see Using the On-Screen Keyboard on page 1.

The system prompts you to choose whether you want to be an administrator and displays information that helps you decide.

4. Tap No.

Image Lab Touch opens to the default view.

## Creating a Password

After an administrator has been appointed, the administrator can require users to log in with a password and set other options to ensure the security of the system. Administrators always log in with a password. Passwords must be 6–32 characters long and contain at least one of the following:

- Uppercase letter
- Lowercase letter
- Number
- Special character

### To create a password

1. Tap User Settings in the main toolbar.

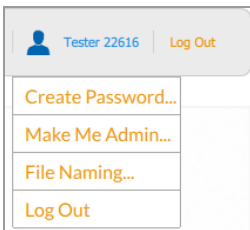

2. Tap Create Password. The Create password dialog box appears.

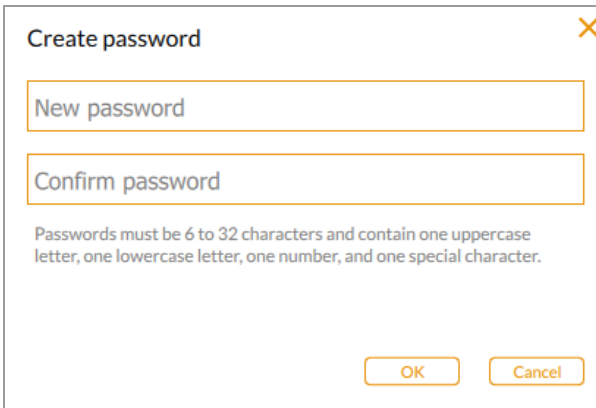

3. Tap New password. The on-screen keyboard appears.
4. Type a password.
5. In the Confirm password box, enter the password again.
6. Tap OK.

## Changing a Password

### To change a password

1. Tap User Settings in the main toolbar.

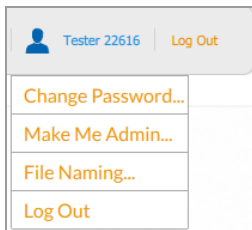

2. Tap Change Password.

The Change password dialog box appears.

A screenshot of a "Change password" dialog box. The dialog has a title bar with "Change password" and a close button (X). It contains three text input fields: "Current password", "New password", and "Confirm password". Below the fields, there is a password requirement note: "Passwords must be 6 to 32 characters and contain one uppercase letter, one lowercase letter, one number, and one special character." At the bottom, there are two buttons: "OK" and "Cancel".

3. Tap Current password. The on-screen keyboard appears.
4. Type your current password.
5. Enter a new password in the New password box.
6. Enter the new password again in the Confirm password box.
7. Tap OK.

## Removing a Password

If no administrator has been assigned, or if the administrator does not require users to log in with a password, you can remove your password.

### To remove a password

1. Tap User Settings in the main toolbar.
2. Tap Change Password in the dropdown menu.
3. In the Change Password dialog box, enter your current password.
4. Leave the New Password and Confirm Password fields blank and tap OK.

## Creating the First Administrator Account

This section explains how to create the first administrator account during initial login. See also [Becoming an Administrator after Initial Login on page 35](#).

The first user to log into Image Lab Touch can choose whether or not to be an administrator. If not, the user can continue with a standard account.

Image Lab Touch provides a Make Me Admin in the user drop-down menu and the first user to select that option becomes the administrator, setting up the administrative password and selecting administrator options. Once an administrator is designated, all users must create passwords to log in.

Until an administrator is appointed

- Any user can become an administrator at any time
- All users can perform administrative tasks
- Users are not required to have passwords

After an administrator has been appointed, only the administrator can create other administrators, and other users' privileges revert to those of a standard user.

**Tip:** Store your administrative password somewhere safe. For security purposes, administrative password recovery requires the instrument to be serviced.

### To create the first administrator account during initial login

1. Tap anywhere in the Welcome screen.
2. Using the on-screen keyboard that appears, tap in a user name and then tap Create. The system prompts you to choose whether you want to be an administrator and displays information that helps you decide.
3. To become an administrator, tap Yes and type a password in the box that appears. The Administrator Options dialog box appears, in which you can choose options for managing Image Lab Touch software user accounts. For information, see [Setting Administrator Options on page 36](#)
4. Choose the options you want and tap Close. The Imager opens to the default view.

## Becoming an Administrator after Initial Login

### To become an administrator after initial login

**Note:** This feature is available only if no other user has chosen to be administrator. If an administrator is already appointed, only that user can give that role to other users.

1. In any view, tap Make Me Admin in the User menu.

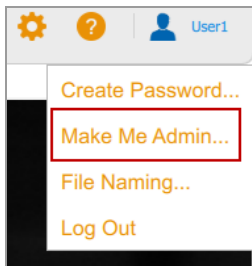

The Administrator Options dialog box appears, in which you can choose options for managing Image Lab Touch software user accounts. For information, see [Setting Administrator Options on page 36](#)

2. Choose the options you want and tap Close.

## Setting Administrator Options

Having an administrator adds security and file access control features to the imaging system. When you log in as an administrator, you can set the following administrator options.

**Table 1. For All User Accounts**

| This Option                      | When Selected  |
|----------------------------------|--|
| Require Password                 | Requires all users to log in with a password. If the user has no password, they must create one.   |
| Require Approval for New Users   | Requires administrator to approve all new user accounts.   |
| Restrict Deletion of Images      | Prevents all users who are not administrators from deleting images.  |
| Restrict Network Export Location | Restricts users to a top-level network location to which they may export files.  |
| Require Secure File Export       | When selected, the Require Password, Require Approval for New users, and Restrict Deletion of Images check boxes are also automatically selected, to ensure secure file exports supporting regulatory standards. |
| Restrict Export to USB           | When selected, only administrators can export files to a USB flash drive.  |

**Table 2. For Individual User Accounts**

| This Option          | When Selected   |
|----------------------|---|
| Admin                | Makes this user an administrator.   |
| Disabled             | Disables this user's account. Only administrators can access disabled accounts. |
| Must Change Password | Requires this user to reset password.   |
| Reset Password       | Allows the administrator to enter a new password for a user.                    |



### To set administrator options

1. Tap User Settings and then tap Admin Options.

The Administrator Options dialog box appears.

|       | Admin                               | Disabled                 | Must Change Password     | Reset Password |
|-------|-------------------------------------|--------------------------|--------------------------|----------------|
| User1 | <input checked="" type="checkbox"/> | <input type="checkbox"/> | <input type="checkbox"/> | Reset          |
| User2 | <input type="checkbox"/>            | <input type="checkbox"/> | <input type="checkbox"/> | Reset          |
| User3 | <input type="checkbox"/>            | <input type="checkbox"/> | <input type="checkbox"/> | Reset          |
| User4 | <input type="checkbox"/>            | <input type="checkbox"/> | <input type="checkbox"/> | Reset          |

2. Select the checkbox for each option you want to enforce.

Note the following:

- If you select Require Secure File Export, Image Lab Touch automatically selects the Require Password, Require Approval for New Users, and Restrict Deletion of Images checkboxes.
- If you select Restrict Network Export Location, the Select Network Folder dialog box opens:
  - Enter the file path and tap Connect.
  - Enter your Administrator user name and password.
  - Tap OK.

3. Clear the checkbox for each option you want to allow.



## Chapter 5 Understanding the Views

Image Lab Touch software guides you through the processes of acquiring and managing images in four views:

- Camera View
- Preview
- Image View
- Gallery



Color Cues in these views signal different states in the system. For information, see [Color Cues on page 45](#)

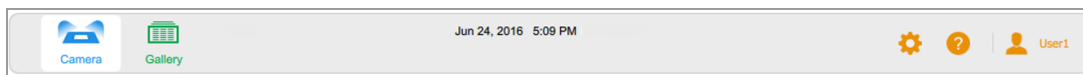

### Main Toolbar Settings

The main toolbar appears at the top of every Image Lab Touch view.



Tapping a toolbar object opens a view or a menu.

| Object  | Explanation  |
|---|--|
|  | <b>Camera view</b> — displays a view of the sample in the sample tray.   |
|  | <b>Gallery</b> — displays thumbnails of all images you acquired. You can view, browse, delete, print, or export images. Double-tapping a thumbnail displays the image full size in Image View. |
|  | <b>Retake</b> — visible when you acquire a multichannel image, enables you to retake one or more channel images immediately after acquisition.   |
| [Date and time]   | <b>Date and Time</b> — displays the current date and time. Your Image Lab Touch administrator can change this setting in the System Settings menu.   |

| Object  | Explanation  |
|---|--|
|  | <p><b>System Settings</b> — menu enabling system options and white tray recalibration dialog box.</p> <p><b>Note:</b> When the instrument identifies the white tray for the first time, a Calibration dialog automatically appears.</p> <p>Once an administrator has been set, only the administrator can access the Date and Time, Time Zone, and Language options.</p> |
|  | <p><b>Help</b> — displays procedures and concepts for the view on screen.</p>  |
|  | <p><b>User Settings</b> — menu that accesses commands to change your password, set a file naming format for acquired images, view Admin settings, lock the display, or log out. Name of current user appears to its right.</p>   |

## Camera View

When you log in to the imaging system, Camera view displays the imaging stage as the default view. The orange exclamation point indicates that you must take an action before you can acquire an image. Tap the exclamation point to find out more.

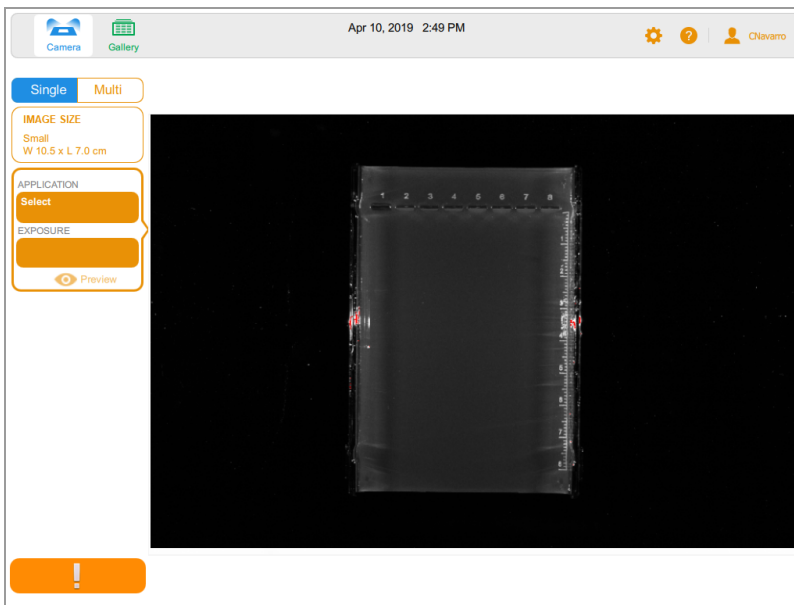

When you place a sample in the imager, Camera view displays the sample as it appears in the current tray. From the left pane, you can choose imaging settings, such as image size, application, and exposure, for each channel you want to acquire.

After you choose these settings, the orange exclamation point button changes to the green camera button and you can acquire the image.

The acquired image appears full size in Image View and also as a thumbnail in the Gallery.

- **Main toolbar** — accesses Camera view, the Gallery, help topics, system settings, and user settings. For more information, see [Main Toolbar Settings on page 39](#).
- **Imaging area** — displays the sample in the imager.
- **Image Settings Tiles** — tapping Application or Exposure in a tile displays options for that setting.
- **Preview** — tapping Preview in the tile displays an image of the sample, which you can use to direct the software to optimize for a specific area.
- **Camera button** — tapping this button at the bottom left of the screen acquires an image of the sample.

For more information, see [Acquiring an Image — General Steps on page 56](#).

## Preview

Preview quickly displays an image of the sample in the imager so you can determine whether sufficient sample is visible and identify the region for which you want to set an automatic exposure.

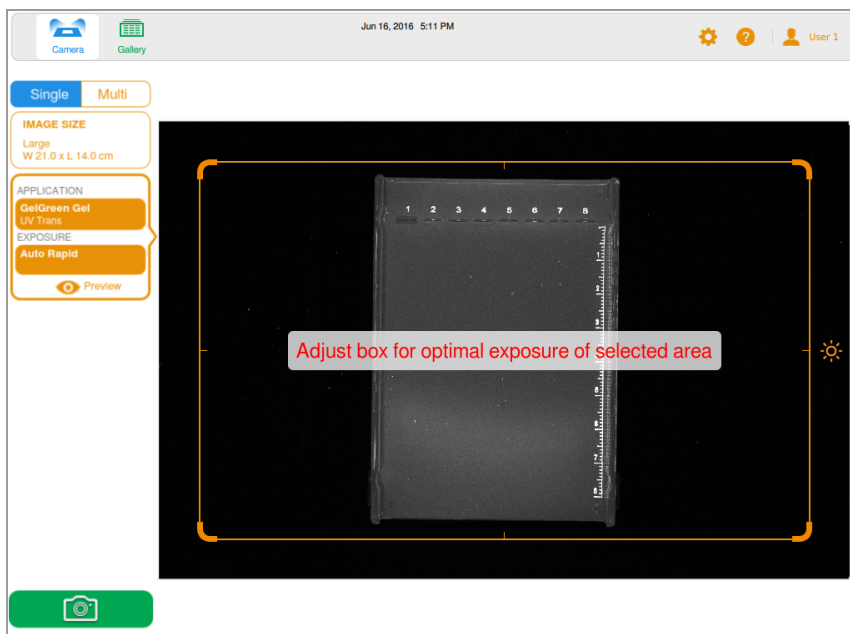

For more information, see [Previewing an Image on page 61](#).

## Image View

When you acquire an image, it is automatically saved to the Gallery and opened in Image View. The image automatically opens in full-size view.

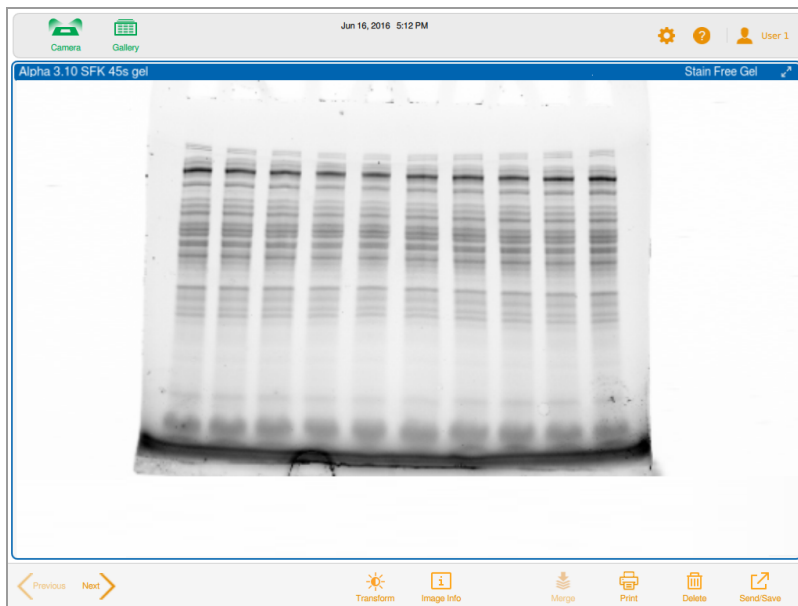









## The Image View Toolbar

The Image View toolbar appears at the bottom of Image View. Its settings enable you to fine tune and manage images.

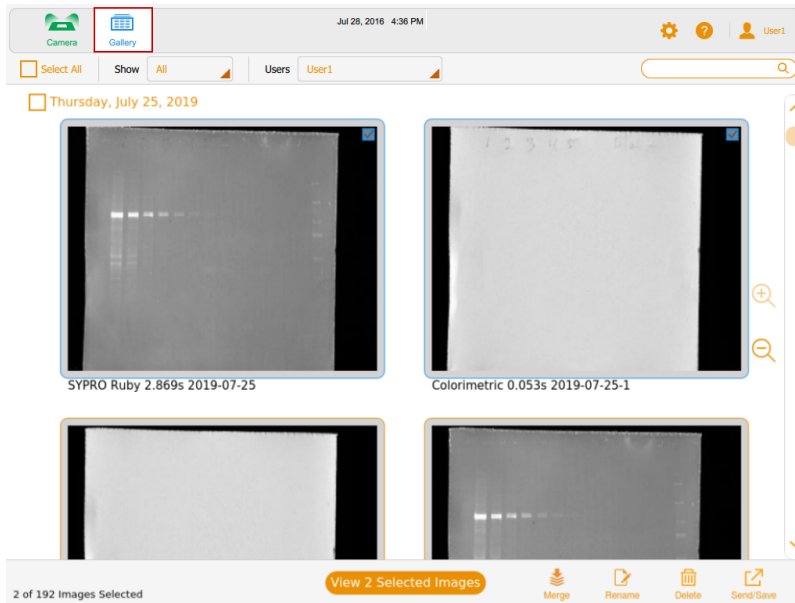

**Table 3. Image View Icons**

| Icon  | Description   |
|---|---|
|    | Visible when a single image is displayed. Tap to scroll through Previous and Next images selected for display in the Gallery.   |
|    | <b>Copy Zoom</b> — visible when multiple images are displayed. Selecting a zoomed image and then tapping this icon copies the zoom setting of the selected image to the other displayed images. |
|    | <b>Transform</b> — enables you to optimize image appearance by adjusting brightness and contrast.   |
|  | <b>Image Info</b> — lists acquisition details for the active image and the name of the user who acquired it. You can rename an image or add notes about it.                                     |
|  | <b>Merge</b> — combines up to three images into a multichannel image.   |
|  | <b>Print</b> — prints the displayed image to the local printer.   |
|  | <b>Delete</b> — deletes the displayed image.  |
|  | <b>Send/Save</b> — saves the displayed image to a USB drive or network drive.   |

## The Gallery

The Gallery displays thumbnail images of all acquired images, ordered by date acquired. The most recent acquisition date appears first, which also serves as the file name. You can change this name in the Image Info box.



Tap a thumbnail image in the Gallery to open it full size in Image View, delete selected images, and save selected images to a USB flash drive, an external hard drive, a stand-alone computer, or a network drive. Tap zoom icons to make thumbnails bigger or smaller.



To compare images, you can select up to four images in the Gallery to display in Image View.

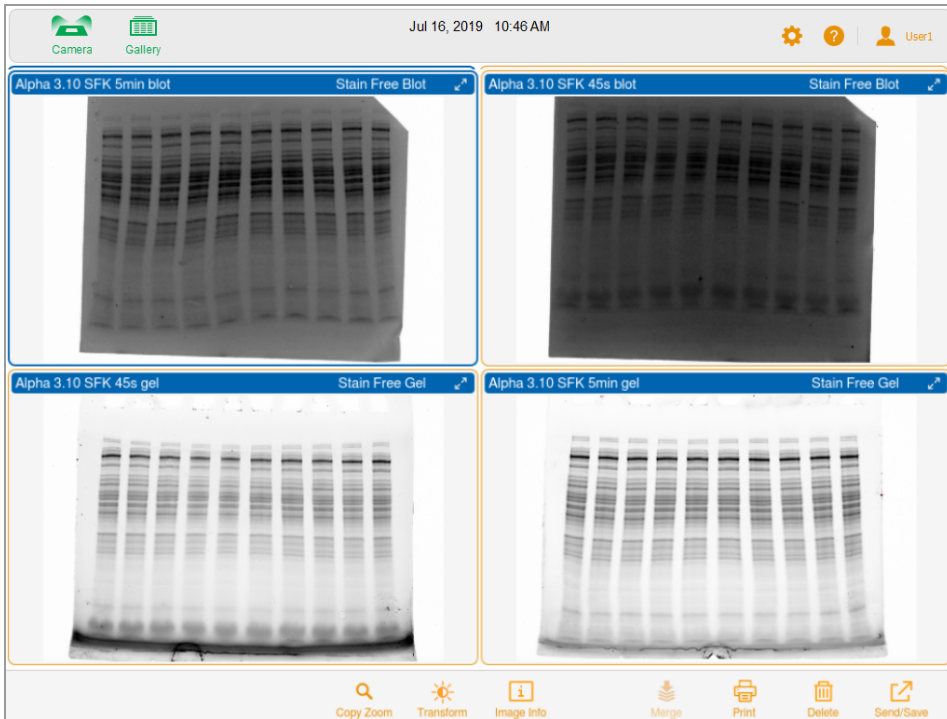

For more information, see [Comparing Images on page 86](#).

## Color Cues

Image Lab Touch color cues signal you to the various states of the system.

**Note:** In this section, the definition of each color cue is followed by an example screen, in which a red outline highlights the use of the color cue.

**Blue** indicates a selected object. In this image, Camera view and single image are selected.

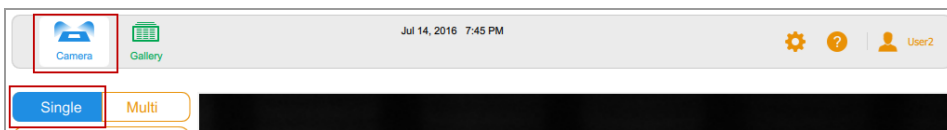

In the Gallery and in Image View, selected images are outlined in blue.

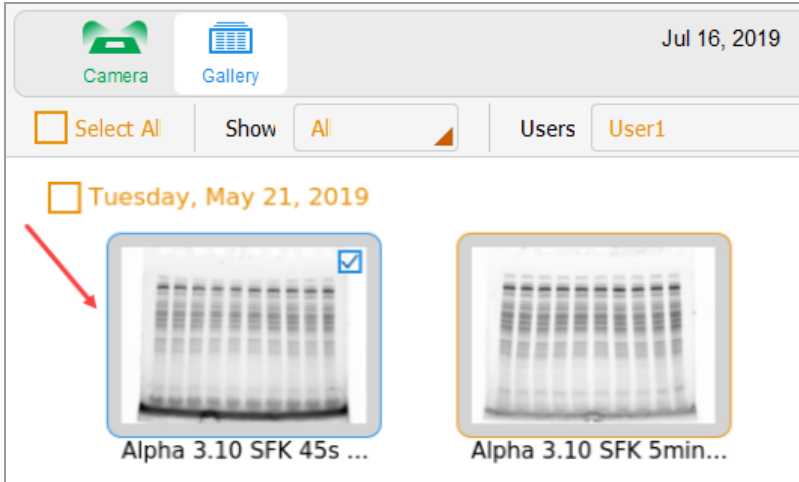

**Green** and **Orange** indicate active objects. In the following graphic, the green color cue indicates that you can select Gallery. The orange color cue indicates that you can create a multichannel image.

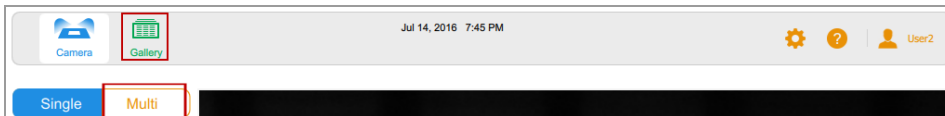

The image capture button on the bottom left corner appears in one of three colors:

- Green
- Orange
- Red

**Green** indicates that the camera is ready; you can capture an image of the sample.



**Orange** indicates that an action is required before you can continue. In the next image, the orange exclamation point appears in place of Camera to indicate that an error message requires action.



- ▶ Tap the orange exclamation point to display a message that explains what to do.

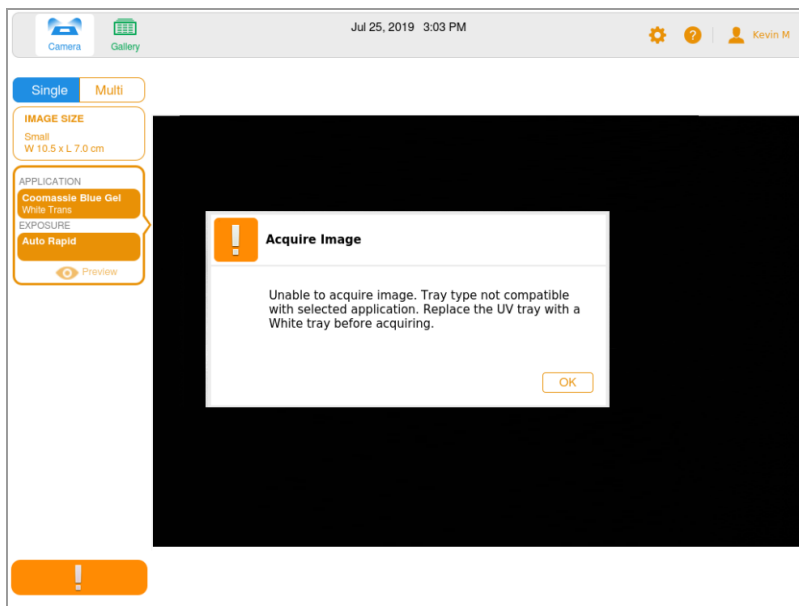

**Red** indicates a critical error.



- ▶ Tap the red exclamation point to display the message. You must log out of Image Lab Touch and restart the imager to correct the error.







## Chapter 6 Choosing a Sample Tray

Before you acquire an image, you must select a sample tray designed for the application.

The imaging system supports the following trays:

| Icon  | Sample Tray Name   |
|---|--------------------|
|  | UV/Stain-Free tray |
|  | White Tray         |
|  | Blue Tray          |

The imager detects the type of sample tray on the imaging stage. If the tray in the transilluminator drawer does not support the application, an error message appears and the imager does not acquire the image.

**Tip:** When two tray types can be used, both are shown. An asterisk identifies the recommended tray.

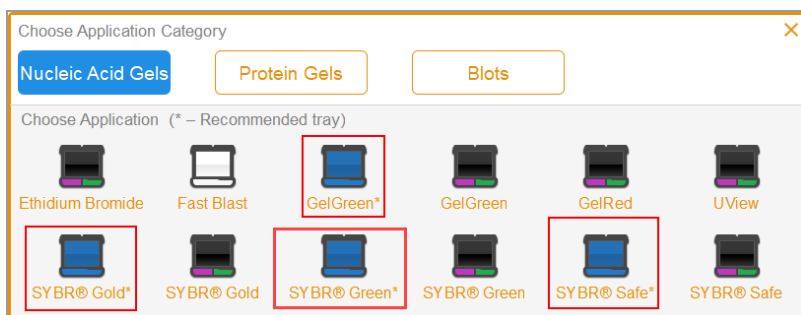

### To position a sample on the sample tray

1. Place the sample face up and center it on the appropriate sample tray.
2. Pull out the transilluminator drawer.
3. Place the sample tray on the imaging stage.

**Tip:** Center the sample carefully so it fills the image area. If you enlarge the image by zooming in, check to ensure that the sample is still centered.

4. Close the transilluminator drawer.

## Applications Listed by Tray Type

The GelDoc Go Imaging System ships with the UV/Stain-Free Tray. Two optional trays are available for purchase. Applications you can use with each tray are listed in the following tables.

- UV/Stain-Free Tray
- Blue Tray
- White Tray

### UV/Stain-Free Tray

| Applications for the UV/Stain-Free Tray |                          |
|---|--------------------------|
| ■ Colorimetric Blot                     | ■ Coomassie Fluor Orange |
| ■ Ethidium Bromide                      | ■ GelGreen               |
| ■ GelRed                                | ■ Oriole                 |
| ■ Ponceau S                             | ■ Stain-Free blot        |
| ■ Stain-Free gel                        | ■ SYBR® Gold             |
| ■ SYBR® Green                           | ■ SYBR® Safe             |
| ■ SYPRO Ruby                            | ■ SYPRO Ruby Blot        |
| ■ UView                                 |                          |

## Blue Tray

### Applications for the Optional Blue Tray

- |               |              |
|---------------|--------------|
| ■ GelGreen    | ■ SYBR® Gold |
| ■ SYBR® Green | ■ SYBR® Safe |

## White Tray

**Important:** The white tray must be calibrated before it is used for the first time.

### Applications for the Optional White Tray

- |                  |              |
|------------------|--------------|
| ■ Coomassie Blue | ■ Fast Blast |
| ■ Silver Stain   |              |

## Calibrating the White Tray

The optional white tray requires calibration before it can be used for the first time.

**Note:** If you subsequently obtain another white tray, Bio-Rad recommends that you calibrate the new tray.

When the imaging system detects that a white tray has been inserted for the first time, a message indicates that the tray is not calibrated and lists steps to calibrate it.

### To calibrate the white tray

1. Complete the steps listed in the message box.

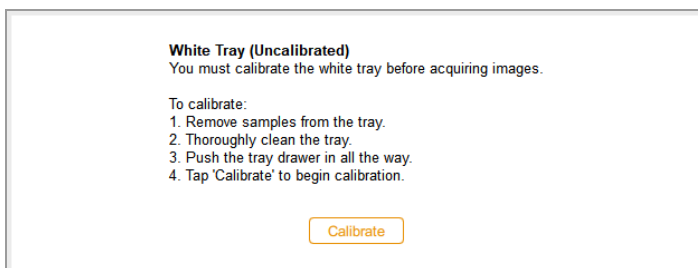

2. Tap Calibrate.

The system starts calibrating the white tray. A progress bar monitors the process.

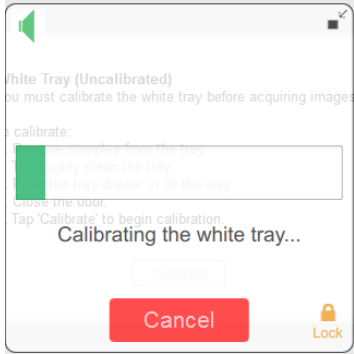

A message notifies you when calibration is complete.

3. Tap OK to close the message.

### Calibrating a Replacement White Tray

When you replace the white tray, Bio-Rad recommends that you calibrate the new tray.

#### To calibrate a replacement white tray

1. Tap User Settings, and then tap Calibrate White Tray.

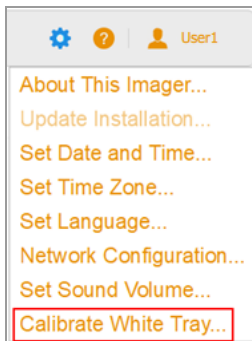



A message displays the steps to calibrate the tray.

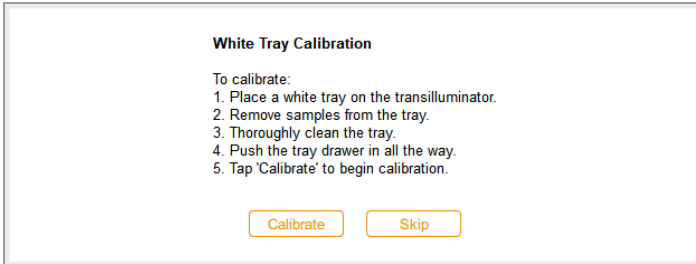

2. Complete the steps listed in the message box.

3. Tap Calibrate.

The system starts calibrating the white tray. A progress bar monitors the process.

A message notifies you when calibration is complete.

4. Tap OK to close the message.



## Chapter 7 Acquiring Images

Instructions for acquiring an image apply to both single channel and multichannel images unless they are preceded by (Single Channel) or (Multichannel).

The steps for acquiring single channel and multichannel images are similar. Acquiring a multichannel image requires repeating some steps for an additional channel, and a few procedures are specific to single or multichannel images.

Before you can acquire an image, you must place a sample on the sample tray and then place the tray on the imaging stage. You can specify acquisition settings before you place the sample on the sample tray or after you place the tray in the transilluminator drawer. The imager retains your settings until you change them.

### Multichannel Images

**Note:** Only applications for blots are available for multichannel images.

You can configure 1–2 channels on the GelDoc Go imaging system for multichannel acquisition. The image size you choose applies to all channels in the acquisition.

When you choose an application for a channel, a plus sign surrounded by a dotted outline tile appears below the selected channel. Tapping inside the outline box changes it into an imaging settings tile for the next channel.

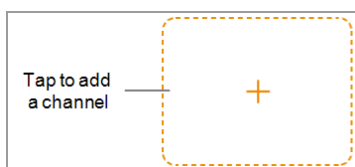

## Placing the Sample in the Imager

You must use the tray that supports the application you select. The imaging system detects the type of sample tray on the imaging stage. If the tray in the transilluminator drawer does not support the selected application, an error message appears and you will not be able to acquire the image.

### To place the sample in the imager

1. Place the sample face up on the sample tray.

**Tip:** If you plan to zoom in or out on the image, center the sample on the tray as accurately as possible.

2. Pull out the transilluminator drawer.
3. Place the sample tray on the imaging stage.
4. Close the transilluminator drawer.

## Acquiring an Image — General Steps

These general steps outline the workflow for acquiring an image.

**Note:** You can configure 1–2 channels on the GelDoc Go Imaging System for multichannel acquisition. The image size you choose applies to all channels in the acquisition.

### To acquire an image

1. In Camera view, do one of the following:
  - (Single Channel) Tap Single to configure a single-channel image.

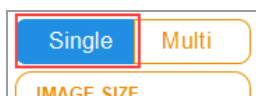

- (Multichannel) Tap Multi to configure a multichannel image.

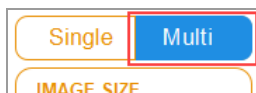

2. Specify the image size so that the sample fills as much of the screen as possible.
3. (Multichannel) Select a channel color or keep the default color. (You can change the channel color at any time.)

4. Choose the application.
5. Preview the image (optional).
6. Keep the default automatic exposure option or change the exposure options.

**Note:** When you set an automatic exposure time and specify a region of interest, the optimal auto-exposure time applies to that region only.

7. (Multichannel) Repeat steps 3–6 for the remaining channels.
8. Acquire the image.

## Setting Image Type and Size

Image type and size settings appear at the top of the left pane in Camera view. In multichannel acquisitions, the image type and size you choose apply to all channels.

### Choosing Image Type

#### To choose an image type

- ▶ Tap Single or Multi to acquire a single-channel or multichannel image.



### Choosing Image Size

You can choose a preset image size or specify a custom size. The preset sizes correspond to these Bio-Rad gels:

- **Small** — Mini-PROTEAN
- **Medium** — Criterion
- **Large** — Pulsed Field Agarose

### To choose a preset image size

- ▶ Tap Image Size to select a size in the dialog box that appears.



The dimensions of the selected image size appear under Image Size.

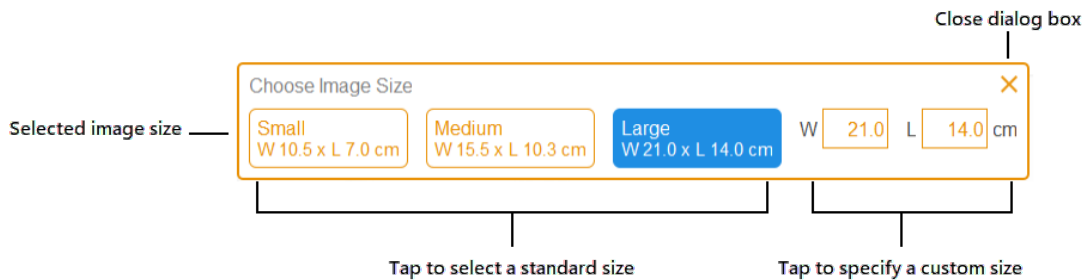

### To specify a custom image size for a gel or blot image

1. In Camera view, tap Image Size.
2. Tap the W (width) or L (length) box. When you enter one dimension, the software automatically calculates the other according to the imager's 3:2 aspect ratio.
3. Using the keypad, enter the width or length of the image (in cm).

Valid width values are 9.0–21.0 cm. Valid length values are 6.0–14.0 cm.

### To change the image size manually

- ▶ Place a thumb and one or two fingers slightly apart on the screen and move them together (pinch to zoom) without lifting them from screen until the image is the size you want.

## Choosing the Application

You can choose from a list of predefined applications for common sample types.

Image Lab Touch software supports three application categories: nucleic acid gels, protein gels, and blots. Multichannel images can be acquired only for blots.

**Important:** You must use the tray that supports the application you select. The imager detects the type of sample tray on the imaging stage. If the tray in the transilluminator drawer does not support the selected application, an error message appears when you try to acquire the image.

When you choose an application, the software selects the illumination source. Detailed settings appear in the imaging settings tile under the name of the selected application. The default automatic exposure setting also appears. You can change the default exposure setting.

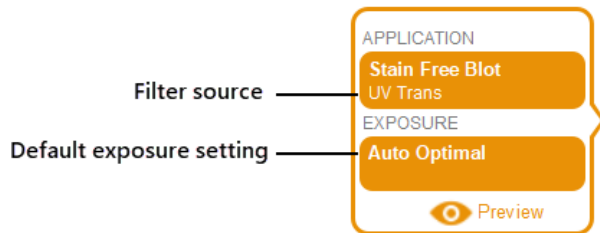

### To choose an application

1. In Camera view, tap Application in an imaging settings tile.

The Application box appears.

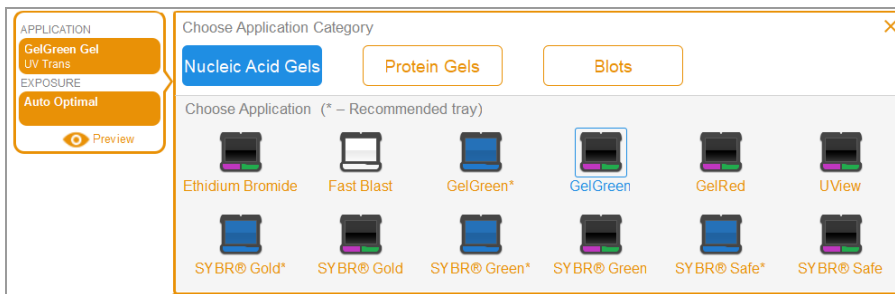

2. Under Choose Application Category, tap an application category.

The Choose Application list displays only applications compatible with the category you selected.

For example, when you tap Blots, only applications for blots appear.

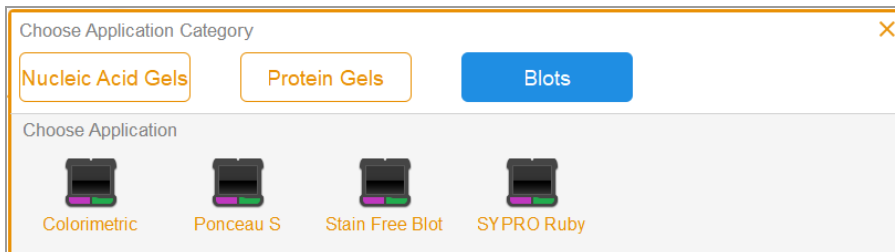

3. Tap an application.

(Multichannel) When you configure the first channel, the system eliminates applications that are redundant or incompatible with the application you selected, and so on for the second channel you configure.

4. (Multichannel) Repeat steps 1–3 for the second channel you want to add.

## (Multichannel) Selecting a Channel Color

Assigning channels different colors makes it easier to identify the channels in a composite image. You can use any channel color with any application when you specify channel settings.

**Note:** There is no relationship between the emission wavelength of the sample and the channel color.

Acquisition options for a channel display a default channel color. You can keep the default color or change it. You can change a channel color at any time. If you change the channel color to one already assigned to another channel, the channels swap colors.

### To select a channel color

1. Tap to view the color list.

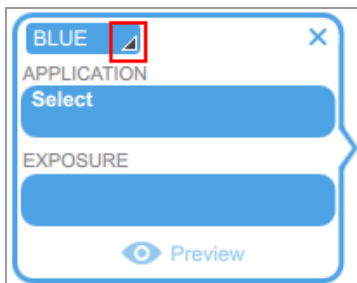



2. Tap a color to select it.

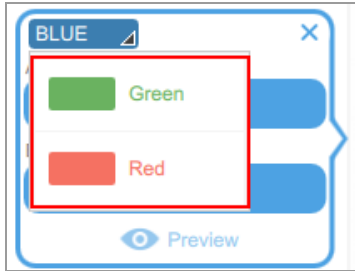

## Previewing an Image

When you put a sample in the imager and close the drawer, Preview appears at the bottom of the imaging settings tile.

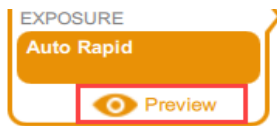

When you tap Preview for an auto exposure, the system displays an image of the sample using the appropriate light source for the application.

View the image to identify a region of interest by resizing or moving the rectangle. If sufficient sample is visible, you can then select either Auto Optimal or Auto Rapid exposure for the image you want to acquire.

**Important:** Keep the imager drawer closed while viewing the preview image.

### To preview an image

1. Specify an application.
2. Tap Preview to view an image of the sample.

**Note:** If you are capturing multiple images, you can preview only one at a time.

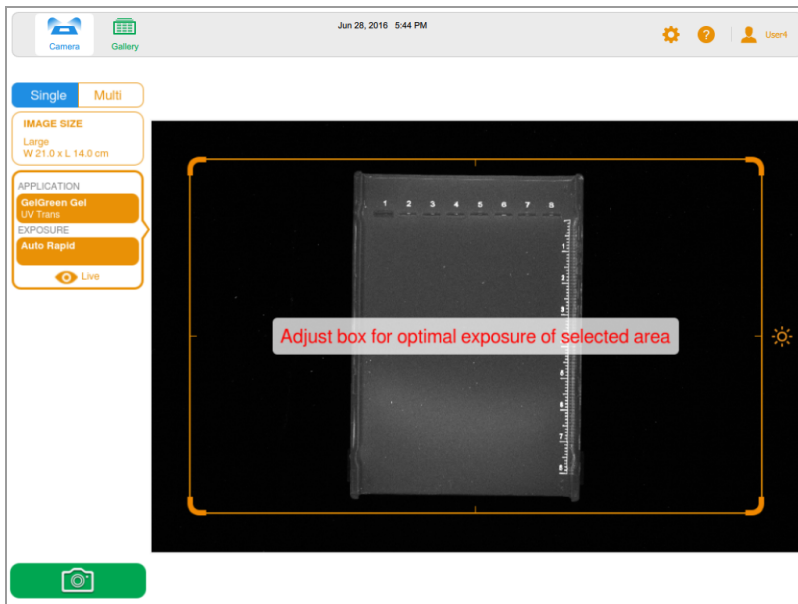

3. Inspect the preview image to verify that important sample features are visible in the sample.
4. Use the grip on each corner to adjust the preview window and specify a region of interest (for example a lane or band).



For information, see [Specifying the Region of Interest for Auto-Exposure on page 66](#).

5. Tap Camera to start the Auto Exposure for the defined region of interest.

**To clear the preview image, do any of the following:**

- Open the drawer.
- Select an application that uses a different tray.
- Switch between single and multichannel modes.
- Log out.
- Delete a channel and then add it again.

## Exposure Settings

Steps for specifying exposure settings are specific to the type of application you select, and how you choose to expose it: automatically (Optimal or Rapid) or manually. Refer to the subsection about the type of application you want to image.

- Most gels and blots
- Stain-Free gels

### Setting Exposure for Most Gels and Blots

#### To choose an automatic exposure setting for a gel or blot

1. In Camera view, tap Exposure.
2. Tap Auto, and then tap Optimal or Rapid Auto-exposure. For information, see [Automatic Exposure Settings on page 65](#).
3. (Optional) Tap Preview, and then specify the region of interest in the preview image.
4. Tap Camera to acquire the image.

#### To manually set an exposure time for a gel or blot

1. In Camera view, tap Exposure.
2. Tap Set Manual Exposure Time.
3. Enter the time in the text box using the numeric keypad.
4. Tap Camera to acquire the image.

## Setting Exposure for Stain-Free Gels

Before you set the exposure time for a Stain-Free gel, you can choose a gel activation time.

### To set the gel activation time

1. Tap Exposure.
2. Under Select Gel Activation, choose a gel activation time:
  - **No Activation** — to retake an image for a previously activated gel.
  - **45 sec** — if you plan to transfer the gel to a blot for immuno-detection.
  - **5 min** — when you want to detect proteins that are low in concentration and you plan to quantitate the maximum number of bands. This duration provides an optimal signal-to-noise ratio because gel activation is close to completion at the end of five minutes.

### To choose automatic exposure settings

1. Tap Auto.
2. Choose Optimal or Rapid Auto-exposure. For information, see [Automatic Exposure Settings on page 65](#).
3. Tap Camera to acquire the image.

### To set a manual exposure time

1. Tap Manual.
2. Tap the sec (seconds) box to display the keypad.
3. Enter the exposure time in seconds.
4. Tap Done.
5. Tap Camera to acquire the image.

## Automatic Exposure Settings

You can choose how Image Lab Touch calculates an automatic exposure. Two automatic exposure settings, Optimal and Rapid, are available:

- When you choose Optimal, the dynamic range of the image is maximized to show faint bands. When you specify a region of interest, the dynamic range is optimized for the specified area only.
- When you choose Rapid, the software calculates a reasonable exposure time more quickly than Optimal by allowing a wider window of intensity to capture a reasonable image, but with a greater chance of overexposed or underexposed images.

**Tip:** Using Rapid Auto-exposure can help you estimate manual exposure time. Choose Rapid Auto-exposure and acquire the image. When the acquired image appears, tap Image Info in the lower toolbar to view the exposure time. Using this exposure time as a baseline, manually set the exposure time to obtain the image quality you want.

|                                |                               |   |
|--------------------------------|-------------------------------|---|
| Name                           | User1 2019-05-15 11h08m29s    | X |
| Notes                          |                               |   |
| <b>Acquisition Information</b> |                               |   |
| Imager                         | GelDoc Go                     |   |
| Exposure Time (sec)            | 0.758 (Optimal Auto-exposure) |   |
| Serial Number                  | KNOWNGD21                     |   |
| Software Version               | 0.9.0.360                     |   |
| Application                    | Colorimetric                  |   |
| Excitation Source              | White Epi Illumination        |   |
| Emission Filter                | No Filter                     |   |
| Flat Field                     | Applied (White Epi)           |   |
| <b>Image Information</b>       |                               |   |
| Acquisition Date               | 5/15/2019 11:08:29 AM         |   |
| User Name                      | User1                         |   |
| Image Area (mm)                | X: 210.0 Y: 140.0             |   |
| Pixel Size (µm)                | X: 68.4 Y: 68.4               |   |
| Data Range (int)               | 0 - 65535                     |   |

## Setting the Exposure Automatically

Image Lab Touch software estimates the best exposure time for obtaining good-quality images with the optimal dynamic range.

**Important:** Maximum automatic exposure is set to 30 seconds. If you need a longer exposure, use the manual exposure settings.

### To choose an automatic exposure setting

1. In Camera view, tap Exposure.
2. Tap one of the following:
  - Optimal Auto-exposure
  - Rapid Auto-exposure
3. (Optional) Tap Preview to obtain a preview image and then specify the region of interest.
4. Tap Camera to acquire the image.

## Specifying the Region of Interest for Auto-Exposure

When you preview an image, you can specify a region of interest such as a band. Image Lab Touch sets the automatic exposure so that the brightest pixels in the region of interest are exposed to near saturation, and the rest of the image is exposed to show as much dynamic range as possible.

**Note:** You cannot specify a region of interest for a Stain-Free gel.

**Tip:** Consider excluding the brightest bands from the region of interest as they might make it difficult to properly expose fainter features of your sample.

Consider specifying the region of interest when you want to do the following:

- To evaluate relative signal intensities, all features that you want to compare must be unsaturated. To prevent saturation of features, specify a region that encompasses the features to be compared.
- To push the limits of sensitivity, specify a region of faint or no apparent signal. The software optimizes the exposure to reveal features in the specified region, but this might cause saturation of more intense features on the blot.

**Important:** Keep the drawer closed during preview. Opening the drawer clears the preview image.

### To specify the region of interest in a preview image

1. Tap Preview in the imaging tile and wait for the light source to warm up.



A low-resolution image of the blot appears with a selection rectangle you can adjust to surround an area of interest.

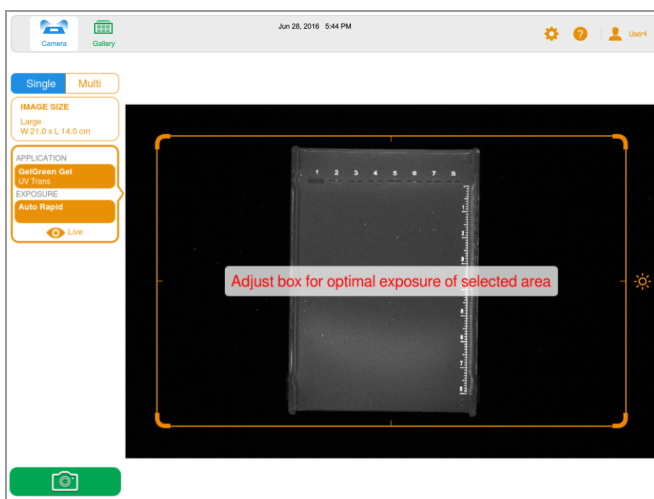

2. To resize the rectangle, drag a corner.
3. To move the rectangle, drag an edge.

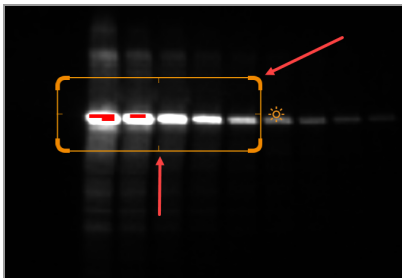

4. To acquire the image, tap Camera.  
In Camera view, Preview now reads Live.

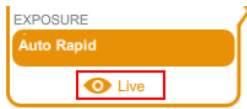

5. Tap Live to return to a view of the sample on the imaging stage.
6. Tap the camera icon to acquire the image.

## Setting the Exposure Manually

For a manual exposure time, Image Lab Touch software enables you to enter time manually in seconds.

### To choose a manual exposure setting

1. In Camera view, tap Exposure.
2. Tap Manual.
3. Tap the sec (seconds) box to display the keypad.
4. Enter the exposure time in seconds.

The maximum time allowed is 99 seconds.

**Tip:** You can use the exposure time from a Rapid Auto-exposure image as a baseline for estimating exposure time.

5. Tap Camera to acquire the image.

## Acquiring the Image

After you specify the image settings, you can acquire the image. Make sure the transilluminator drawer is pushed in all the way and closed.

**Note:** If an exclamation point appears on the screen in place of the Camera, a problem is preventing image acquisition. The color of the exclamation point indicates the severity of the problem. An orange exclamation point indicates that an action must be taken before the image can be acquired. A red exclamation point indicates that the camera is disconnected. Log out of Image Lab Touch and restart the imager to correct the error.



### To view the error message

- ▶ Tap the button in the bottom left corner of the screen.



A screen message explains how to correct the error.

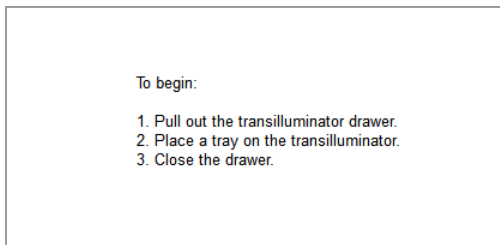

### To acquire a gel or blot image

- ▶ Tap Camera.

Acquisition starts. A progress bar monitors the acquisition.

When the image is acquired, it appears in Image View. You can adjust the appearance of the image. You can also print, rename, and delete the image in this view.



(Multichannel) If you cancel the process during multichannel acquisition, the software stops acquiring images and stores the images that have been acquired in the Gallery.

## (Stain-Free Gel) Gel Activation

When you select a gel activation time for a Stain-Free gel and tap Camera, gel activation starts before acquisition. You can monitor the progress of gel activation and stop it when the gel is properly activated.

### To stop gel activation and skip to acquisition

1. Monitor gel activation carefully.
2. When the gel is properly activated, tap Skip in the progress box.

The software skips the remaining time for gel activation and acquires the image.

## (Stain-Free Gel) Acquiring an Image after Canceling Acquisition

**Important:** Do not open the drawer or move the sample.

When you activate a Stain-Free gel and then cancel image acquisition in progress, you can use the same gel, keep or change exposure settings, and acquire the image again.

### To acquire an image after canceling acquisition

1. Tap Exposure.
2. Select No Activation.
3. Set exposure options.
4. Tap Camera to reacquire the image.

## (Multichannel) Retaking an Image

You can retake one or more images in a multichannel image right after acquisition. You can also delete one or more channels to generate a different multichannel image. The new multichannel image results from the combination of the remaining channel images.

**Important:** Do not leave the current view, open the drawer, or log out. Any of these actions makes retaking an image unavailable.

You can change the exposure settings and retake the channel image to achieve different results. You can also change automatic or manual exposure options.

When you retake an image, Image Lab Touch does the following:

- Replaces the channel image you specify with a new image acquired using modified exposure settings. The other channel images are retained.
- Generates a new composite image by combining the channel image you retake with the channel images you keep. (A *composite image* combines the data from the channel images into one image.)
- Stores the original multichannel image and the new multichannel image in the Gallery. (A *multichannel image* consists of a composite image plus the channel images generated during one acquisition.)

### To retake a channel image

1. Tap Retake in the main toolbar.

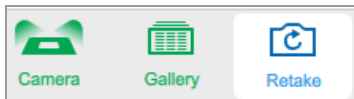

2. Change the exposure settings in one or more channels.

The previous and current settings appear under Exposure in the imaging settings tile.

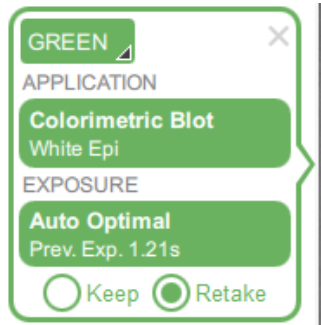

3. (Optional) Select an area of interest.
4. (Optional) To revert back to the previous settings, tap Keep in the imaging settings tile.
5. To retake the image, tap Camera.



## Chapter 8 Excising Bands from Samples

You can excise bands of interest from agarose or acrylamide gels for applications such as mass spectrometry or DNA cloning.

The procedure for excising bands varies depending on the sample tray in use.

### Excising Bands on a UV/Stain-Free Tray



**WARNING!** Transilluminators are powerful sources of UV radiation, which can cause serious damage to unprotected eyes and skin. The accessory UV shield provides some UV protection; however, this shield does not protect others standing in the area around the imager. Specifically, when viewing around the UV shield at a distance of 20cm, the measured Actinic UV emission is approximately 4 W/m<sup>2</sup>, with a permissible exposure time of about 7 seconds. Before performing band excision, the user and other lab personnel in proximity to the imager must put on protective gear including UV protective safety glasses, a face shield, lab coat, and gloves to ensure that no skin is exposed. A typical and reasonable expectation of use is three operations a day per user for three minutes each. Bystanders without protective gear must stand at least 1.5 meters (five feet) away from the imager and limit their exposure to no longer than one hour per day.

**Important:** Before excising bands, you must install the UV shield.

#### To install the UV shield

1. Pull out the transilluminator drawer.
2. Place a UV tray on the transilluminator drawer surface.

3. Place the shield over the tray:

- a. Ensure the flap at the front of the UVshield is at a 90° angle.



- b. Insert the flap into the slot at the front of the drawer.

If the flap is inserted properly, the shield fits easily over the tray.

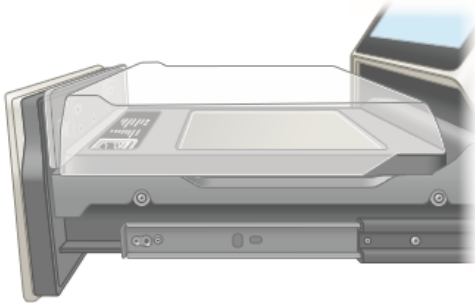

**Important:** Before you begin excising bands, you must put on the required protective gear and ensure that the UV shield is installed.

The UV lights turn off after 15 minutes of continuous use. To turn the UV lights back on, tap Turn Transilluminator On.

**To excise bands on a Blot/UV/Stain-Free tray**

1. To avoid damaging the surface of the sample tray, place a sheet of clear glass or plastic on the tray before you add the gel sample.
2. Place a gel sample in the center of the tray.
3. In Camera view, tap Turn Transilluminator On.

Turn Transilluminator On changes from green to blue and the UV lights turn on, illuminating the gel.

**Note:** The UV lights turn on only when both the sample tray and the UV shield are in place. If the lights do not turn on, verify that the UV shield is installed correctly.

4. Raise the UV shield no more than is necessary to work with the sample.



**Caution:** Keep the UV shield open for as little time as possible.

5. Reach around the sides of the shield to excise the bands.



**Caution:** Sharp cutting tools can easily damage the surface of the tray. Use a *chopping* motion rather than a *sawing* motion.

6. When you finish excising bands, tap Turn Transilluminator Off to turn off the UV lamps.
7. Remove the UV shield, remove the sample tray, and slide in the transilluminator drawer.

## Excising Bands on a White or Blue Tray

Working with white and blue trays does not require using the UV shield. However, you must wear XcitaBlue goggles to see bands on a blue tray.



**Caution:** Sharp cutting tools can easily damage the surface of the trays.

To avoid this, place a sheet of clear glass or plastic on the tray before you add the gel sample. Use a *chopping* motion rather than a *sawing* motion.

### To excise bands on a white or blue tray

1. Open the transilluminator drawer and place a tray on the transilluminator.
2. Place a gel sample in the center of the tray.
3. In Camera view, tap Turn Transilluminator On.

The transilluminator turns on, illuminating the gel.

**Note:** The lights turn on only when the sample tray is in place.

4. Excise the bands.
5. When you have finished excising the bands, tap Turn Transilluminator Off.
6. Slide in and close the transilluminator drawer.



## Chapter 9 Viewing Images

The Gallery displays thumbnails of all images you acquire, in order by the date of acquisition, most recent acquisition date shown first.

**Note:** Administrators can view all users' images at once or view an individual user's images.

### Accessing the Gallery

#### To access the Gallery

- ▶ Tap Gallery in the main toolbar.

A Gallery similar to the following appears.

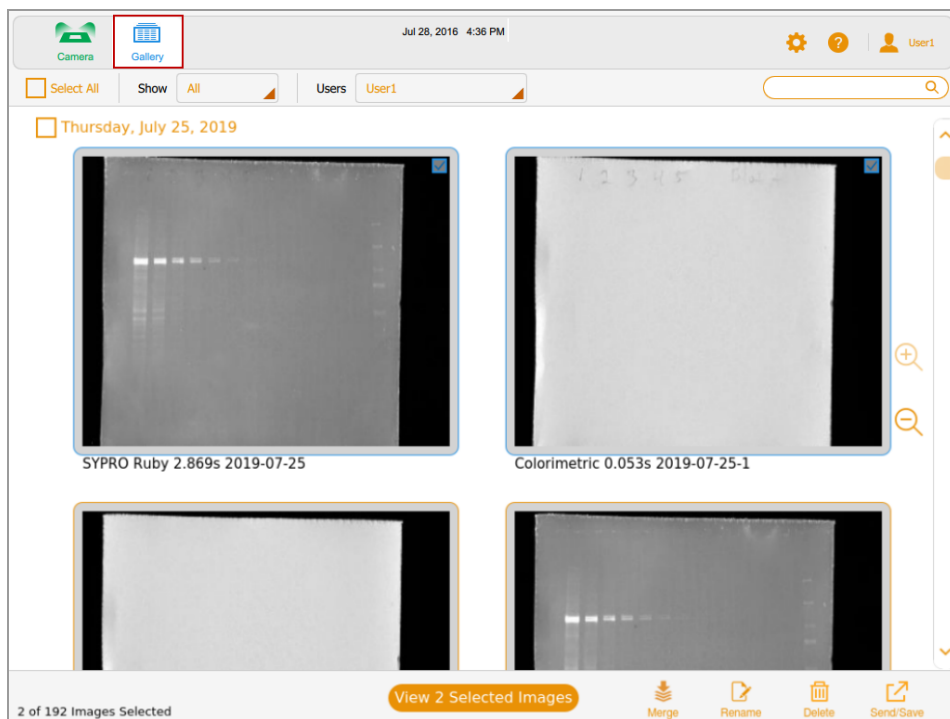

You can change the size of the thumbnails in the Gallery by tapping the plus and minus zoom icons on the right side of the Gallery screen.

The image name appears below each thumbnail image. By default, each name consists of the user name and the date and time of acquisition, for example: User1 2016-07-16 15hr7min33sec.scn.

You can change the file name in the Image Information box. You can also change the image name format.

See [Changing the File Naming Format on page 96](#).

## Searching for Images in the Gallery

You can search for images of interest in the Gallery. Search text is not case sensitive. You can enter any part of the date or name. You can also search by application name or type.

### To search for an image

1. Tap the search box to display the keyboard.

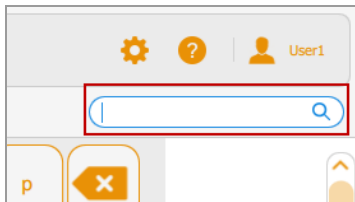

2. Enter search text. As you enter search text, images that match the search text appear in the Gallery.
3. Tap Done.

### To return to a thumbnail view of all your images

- ▶ Clear the search box.

## Selecting and Opening Images in the Gallery

### To select an image

- ▶ Tap a thumbnail.

The selected image thumbnail appears outlined in blue and a check box appears in the upper right corner.

### To open the selected image

- ▶ Double-tap the selected image to open it full size in Image View.

### To open 1–4 images

- ▶ Select 1–4 images and tap View x Selected Images in the bottom toolbar (where x is the number of images selected).

The selected images appear outlined in blue, and with checkboxes selected.

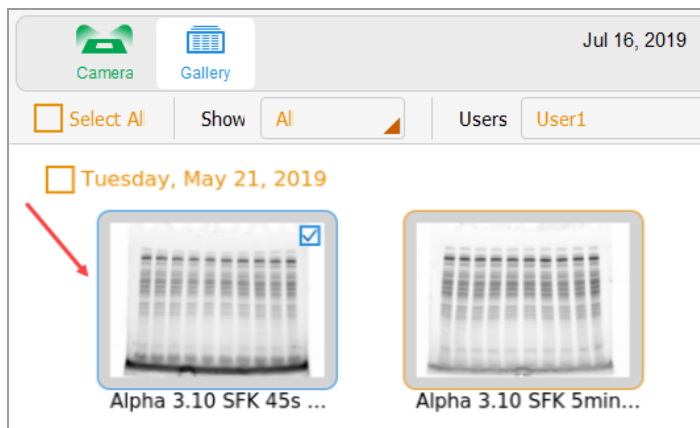

### To select all images you acquired on a single date

- ▶ Tap a date checkbox.

All images you acquired on the selected date appear outlined in blue, and with check boxes selected.

### To select all of your images

- ▶ Tap Select All.

All images are selected and appear outlined in blue.

## Sorting Images in the Gallery by Date

By default, the Gallery shows all images you acquired, starting with the last image acquired on the date you specify. When you acquire another image, the Gallery displays that image and all other images in the Gallery. You can filter the display by date to focus on images of immediate interest.

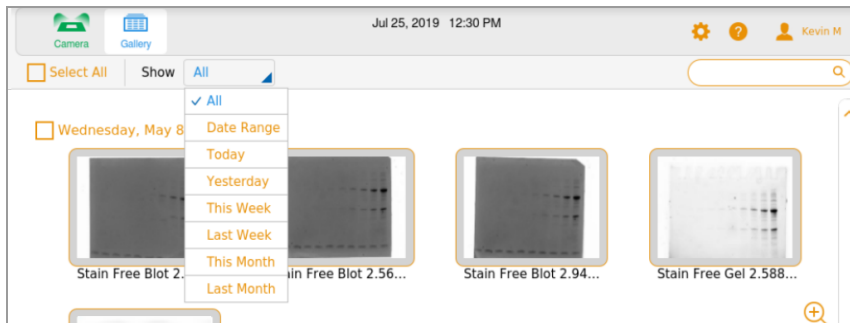

### To filter images by date

1. Tap Show All in the image selection toolbar to open the dropdown list.
2. In the Date dropdown list that appears, tap one of the following.
  - **Date Range** — displays images acquired within a range of dates you specify. Tap the calendar boxes to specify dates in any order.
  - **Today** — displays images you acquired today starting at 12:00:00 AM and ending at 11:59:59 PM
  - **Yesterday** — displays images you acquired yesterday starting at 12:00:00 AM and ending at 11:59:59 PM.
  - **This Week** — displays images you acquired this week starting at, for example, 12:00:00 AM Sunday and ending at 11:59:59 PM the following Saturday.
  - **Last Week** — displays images you acquired starting at 12:00:00 AM Sunday last week and ending at 11:59:59 PM the following Saturday.
  - **This Month** — displays images you acquired this month starting at 12:00:00 AM of the first calendar day of the month and ending at 11:59:59 PM of the last calendar day of the month. For example, the month of January starts at 12:00:00 AM January 1 and ends at 11:59:59 PM January 31.
  - **Last Month** — displays images you acquired starting at 12:00:00 AM of the first calendar day of last month and ending at 11:59:59 PM of the last calendar day of last month.

## Checking Intensity Values

In Image View, you can display the average intensity value and the percentage of saturation for any spot in an image. A 3 x 3-pixel region of the image is averaged, except at the edge or corner, where a 3 x 2 or 2 x 2-pixel region is averaged.

When viewing a multichannel image, you can check intensity values in any of the channel views or in the composite view.

**Note:** Hiding a channel in a composite image also hides the intensity values for that channel.

You can use the saturation percentage to estimate how much to increase exposure time to maximize the dynamic range of the image. For example, if the spot is 50% saturated, doubling the exposure time results in about 100% saturation. Viewing intensity values is also useful when comparing images.

### To view intensity values in an image

1. In Image View, display an image.
2. Tap any spot in the image.

Intensity values for the selected spot appear.



Crosshairs mark the pixel area being evaluated. Intensity values fade out after a few moments.

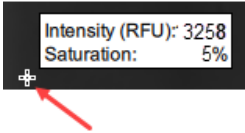

**To view intensity values in a composite image**

1. In Image View, display a multichannel image.
2. Tap any spot in the composite image.

Color-coded intensity values appear for each channel in the composite image.

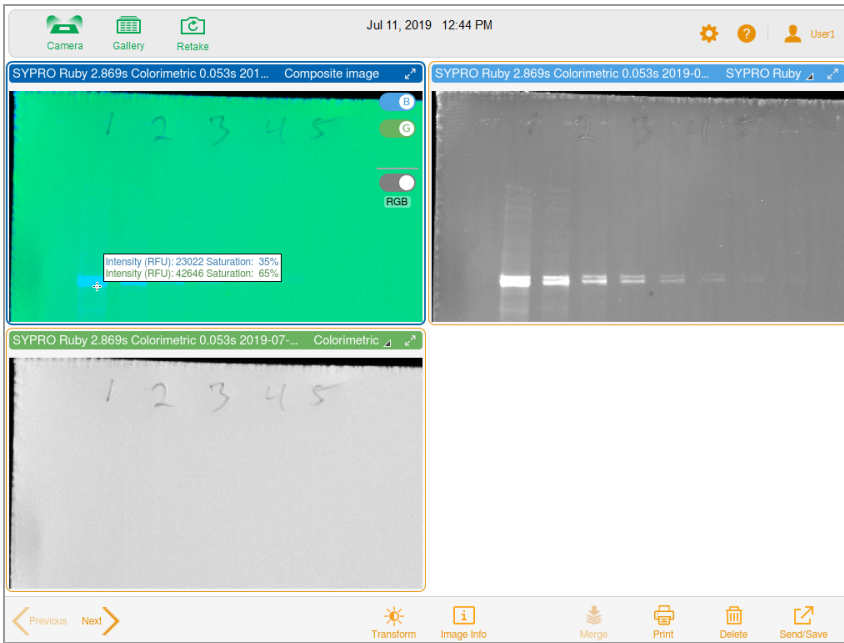

Crosshairs mark the pixel area being evaluated. Intensity values fade out after a few moments.



## Viewing Multichannel Images in Image View

After a multichannel image is acquired, the composite image and its individual channel images appear in Image View. A blue border surrounds the selected image.

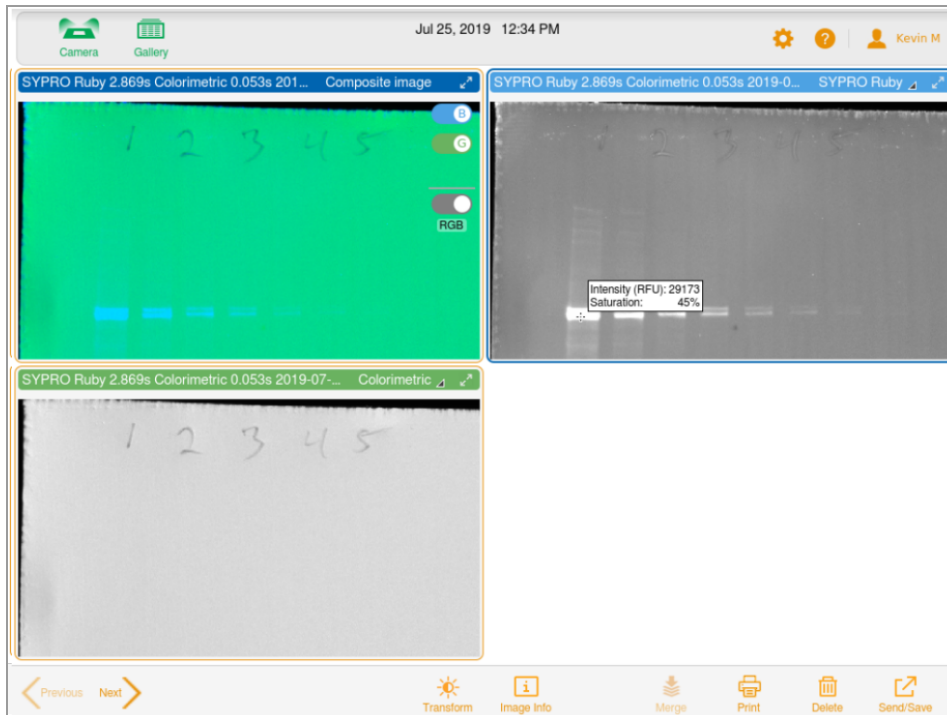

Images you open in the Gallery also appear in Image View. You can select and open up to four images at a time in the Gallery, all of which appear together in Image View.

### To view more than one multichannel image at a time

1. In the Gallery, select multichannel images you want to view.
2. In the lower toolbar, tap View x Selected Images, where x is the number of images you selected.

The multichannel images you selected appear in Image View.

**To view a single image in a multichannel image**

- ▶ Tap the Previous and Next arrows at the lower right corner of each image.

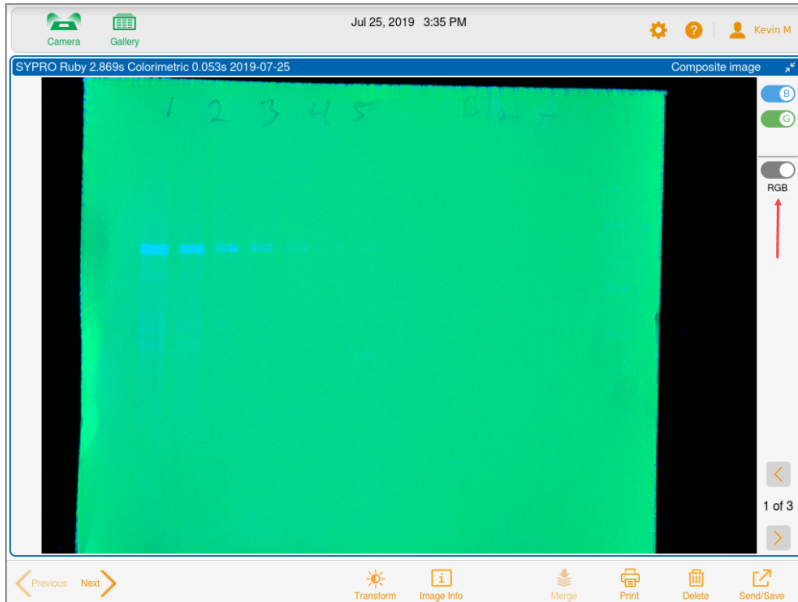

**To view an image full size**

- ▶ Tap the expand arrows in the upper right corner of the image.

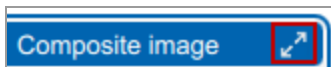



## Viewing a Composite or Merged Image in Grayscale

In Image View, you can view, export, or print the composite or merged image in grayscale. In the Gallery, the thumbnail of the image also appears in grayscale. Channel colors of individual images are unaffected by the grayscale setting.

By default, a composite or merged image appears in Image View in RGB, the combined color settings of its channels.



### To view the image in grayscale

- ▶ Tap the RGB toggle below the channel colors.

The toggle name changes to Gray and the image appears in grayscale.

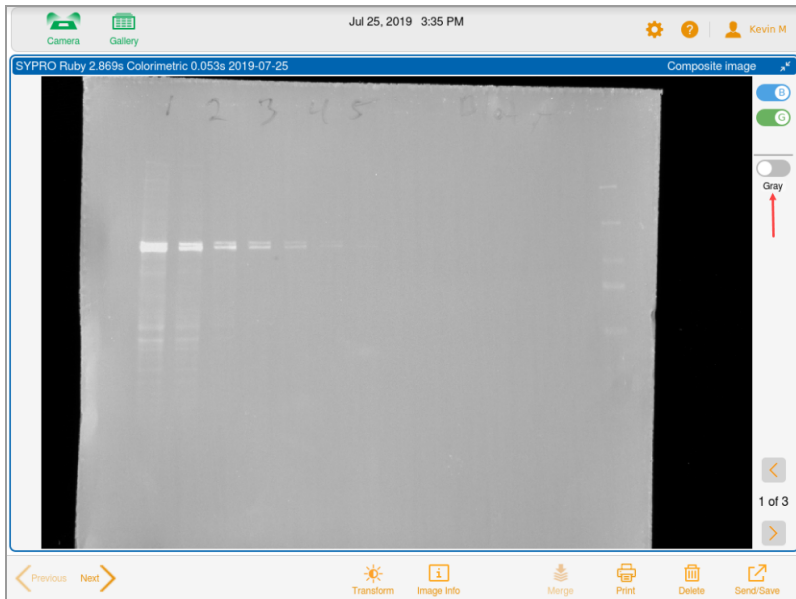

## Comparing Images

In the Gallery you can open and compare up to four images of a gel or blot at a time. The selected images appear in Image View.

### To open multiple images

1. Select 1–4 images in the Gallery.

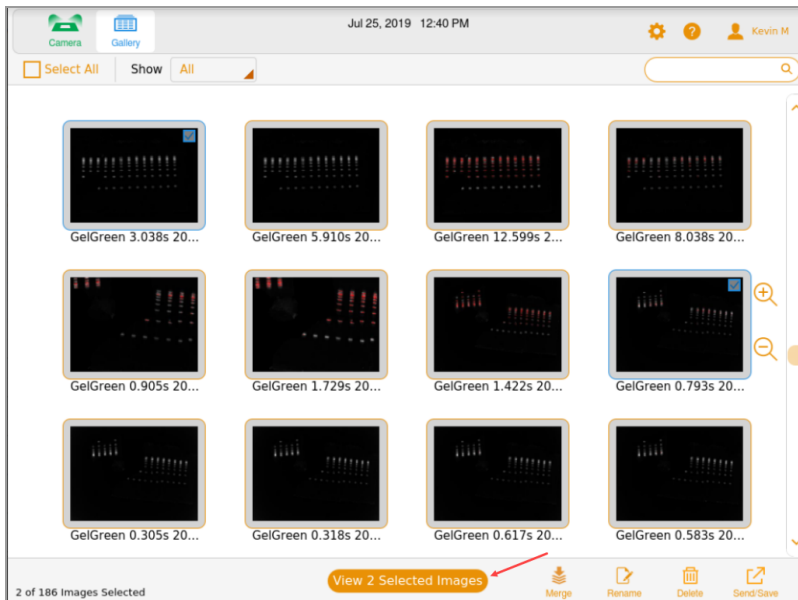

2. In the bottom toolbar, tap View x Selected Images (where x is the number of images selected).

The images you select in the Gallery open in Image View. By default, the top left image is selected.

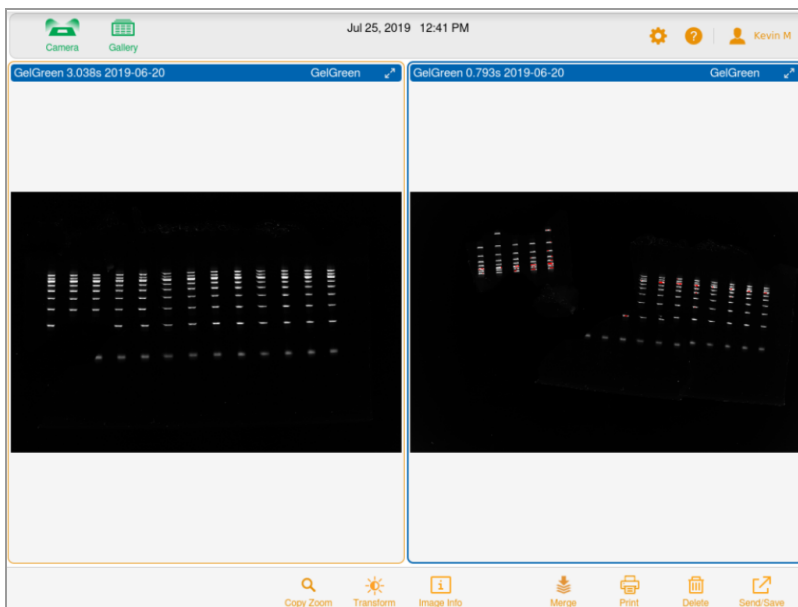

## Copying Image Settings

It is easier to compare images that have the same transform and zoom settings. You can copy these settings from one image to the others you selected.

### To copy zoom settings from one image to the others

1. Select the image with the zoom settings you want to copy.



2. In the bottom toolbar, tap Copy Zoom.

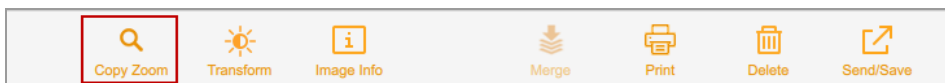

The pan and zoom settings of the selected image are copied to the other images.

### To copy transform settings from one image to the others

1. Select the image with the transform settings you want to copy.
2. In the bottom toolbar, tap Transform.



The transform settings for the selected image appear.

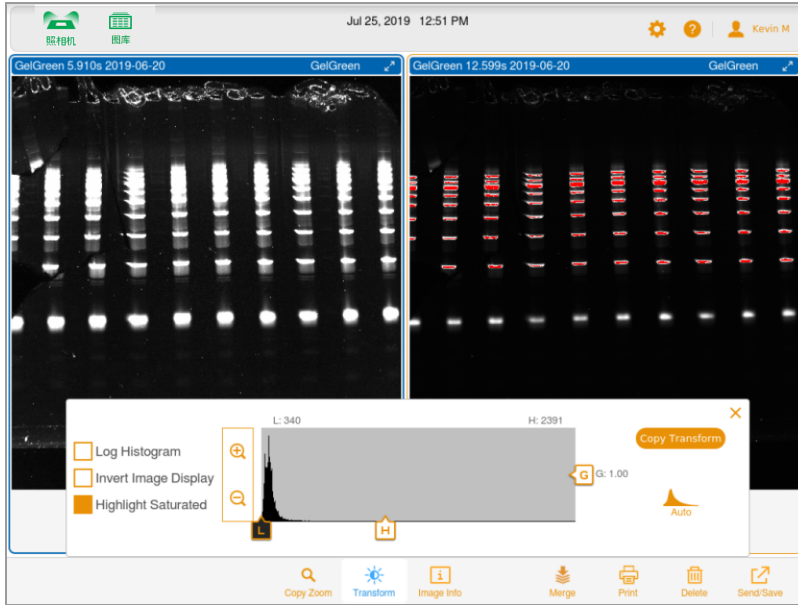

3. Tap Copy Transform in the transform settings box to copy the transform settings to the other images. The Copy Transform only applies to the images that are visible on the screen. Channels that are not visible are not affected.

## Viewing Image Information

The Image Information box provides information such as the image name, the acquisition's exposure duration and date, and the application type.

### To view information about the image

- ▶ In Image View, tap Image Info in the bottom toolbar.

The Image Information box appears, with the image information for the selected channel displayed. To see information for another channel image, tap that channel image and then tap the Image Info button.

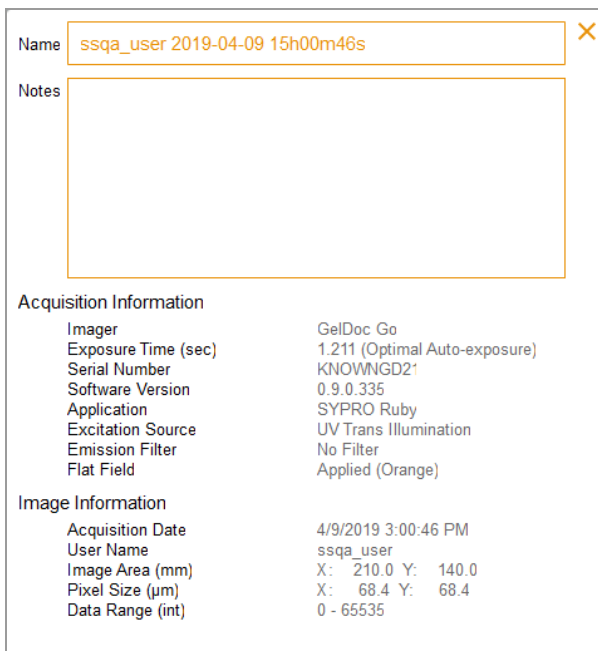

The screenshot shows a modal window titled "Image Information" with a close button (X) in the top right corner. The window is divided into several sections:

- Name:** ssqa\_user 2019-04-09 15h00m46s
- Notes:** A large empty text area.
- Acquisition Information:**

|                     |                               |
|---------------------|-------------------------------|
| Imager              | GelDoc Go                     |
| Exposure Time (sec) | 1.211 (Optimal Auto-exposure) |
| Serial Number       | KNOWNGD21                     |
| Software Version    | 0.9.0.335                     |
| Application         | SYPRO Ruby                    |
| Excitation Source   | UV Trans Illumination         |
| Emission Filter     | No Filter                     |
| Flat Field          | Applied (Orange)              |
- Image Information:**

|                  |                     |
|------------------|---------------------|
| Acquisition Date | 4/9/2019 3:00:46 PM |
| User Name        | ssqa_user           |
| Image Area (mm)  | X: 210.0 Y: 140.0   |
| Pixel Size (µm)  | X: 68.4 Y: 68.4     |
| Data Range (int) | 0 - 65535           |

## Chapter 10 Merging Images

You can merge images to create multichannel images from up to three single images already acquired. Original image data are not affected and can be used for quantitation as well as for determining the molecular weight or size of proteins. You can view merged images in grayscale. File names for merged images use the format specified in User > File Naming Preferences on the main toolbar.

**Note:** You cannot merge multichannel images.

### To merge images

1. In the Gallery, select up to three images.



2. On the lower toolbar, tap Merge.

The merged image appears in Image View.

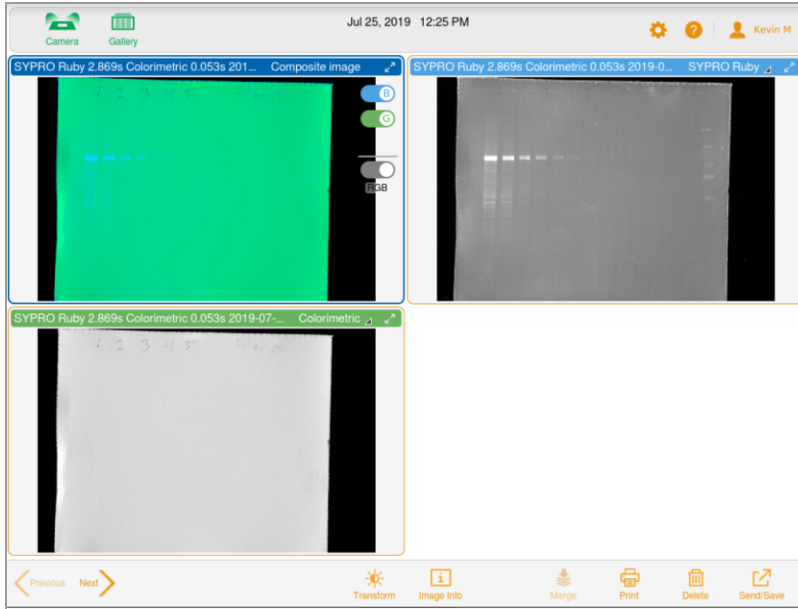

**To view merged image information**

- ▶ On the Gallery lower toolbar, tap Image Info. In the Image Information box, detailed information about each image merged appears in Notes.

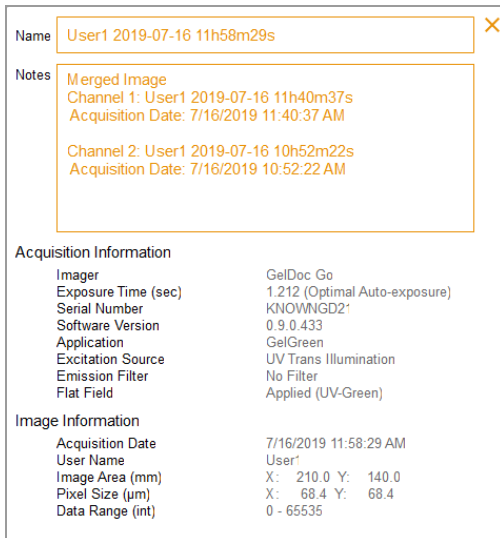



## Naming Merged Images

The system names the merged image by combining the application and exposure time for each image, and then appending the date the merged image was created.

If the name is already in use in the Gallery, the system generates another name by adding a hyphen and an incremental number (starting at 1) to the end of the combined name. The system continues to increase the added number incrementally (-2, -3, -4 and so on) until the name is unique.

### To view the names of the source images

- With the merged image open in Image View, tap Image Info in the bottom toolbar.

In the Image Info box, the Notes section displays the names of the images that were merged.

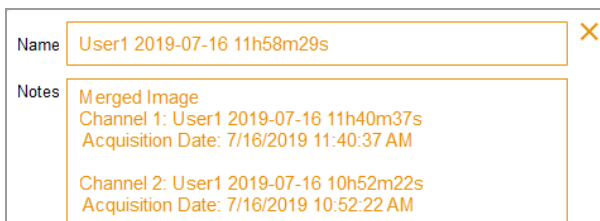



# Chapter 11 Managing Images

## Adding Notes to an Image File

### To add information to an image file

1. In Image View, tap Image Info in the bottom toolbar.

The Image Information box appears.

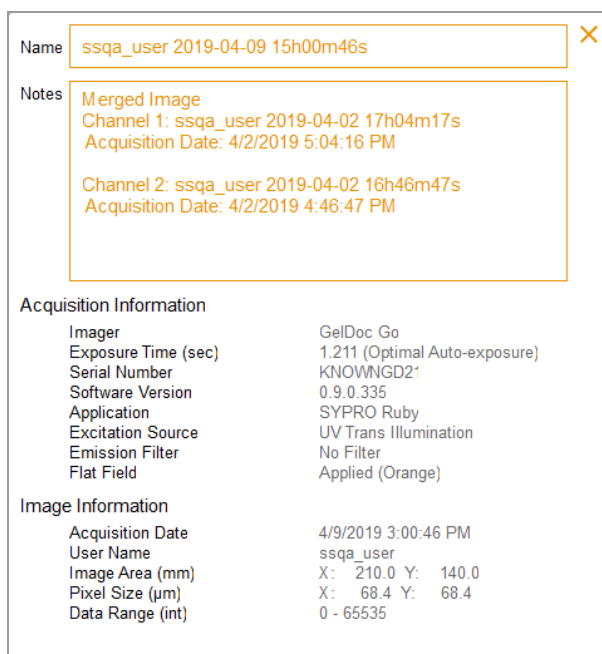

The screenshot shows a modal window titled 'Image Information' with a close button (X) in the top right corner. It is divided into four sections:

- Name:** ssqa\_user 2019-04-09 15h00m46s
- Notes:** Merged Image  
Channel 1: ssqa\_user 2019-04-02 17h04m17s  
Acquisition Date: 4/2/2019 5:04:16 PM  
Channel 2: ssqa\_user 2019-04-02 16h46m47s  
Acquisition Date: 4/2/2019 4:46:47 PM
- Acquisition Information:**

|                     |                               |
|---------------------|-------------------------------|
| Imager              | GelDoc Go                     |
| Exposure Time (sec) | 1.211 (Optimal Auto-exposure) |
| Serial Number       | KNOWNGD21                     |
| Software Version    | 0.9.0.335                     |
| Application         | SYPRO Ruby                    |
| Excitation Source   | UV Trans Illumination         |
| Emission Filter     | No Filter                     |
| Flat Field          | Applied (Orange)              |
- Image Information:**

|                  |                     |
|------------------|---------------------|
| Acquisition Date | 4/9/2019 3:00:46 PM |
| User Name        | ssqa_user           |
| Image Area (mm)  | X: 210.0 Y: 140.0   |
| Pixel Size (µm)  | X: 68.4 Y: 68.4     |
| Data Range (int) | 0 - 65535           |

2. Tap in the Notes box.
3. Enter your notes using the on-screen keyboard.
4. Tap the keyboard key on the lower row of the keyboard to close the keyboard.

The notes you type are automatically saved.

For more information, see [Viewing Image Information on page 90](#).

## Changing the File Naming Format

By default, the file name consists of the elements user name, date, and time. In the File Naming Preference dialog box, you can change the file naming format at any time.

- You can remove an element and replace it with another element.
- You can include the Text element, which holds up to 32 alphanumeric characters.
- You can reorder the elements.

To change the file naming format, you select up to four of the seven elements in the File Name Elements List and arrange them in the order you prefer.

**Tip:** The File Name Elements list includes a combination element, App/Exposure, which is useful when you want to include more than four kinds of information in the format.

### To change the file name format

1. Tap User Settings, and then tap File Naming.

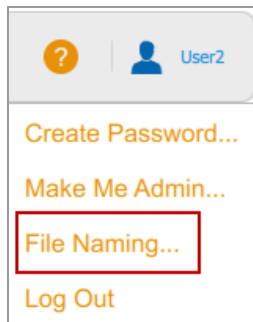

The File Naming Preference dialog box appears. Default elements are User Name, Date, and Time.

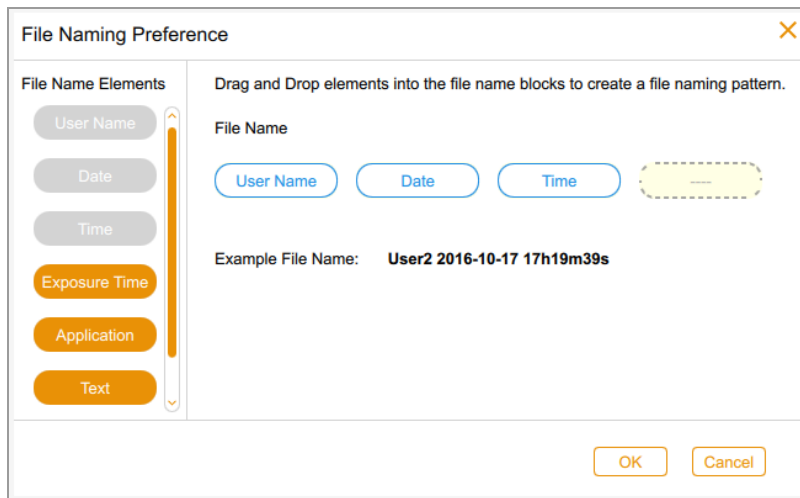

2. Do one or both of the following:
  - To remove an element from the file name pattern, drag an element from the format onto the File Name Elements list.
  - To add an element to the file name pattern, drag an element from the File Name Elements list onto an empty position.

An example of the file name in progress appears as you select each element.

3. Repeat Step 2 as applicable.
4. Tap OK to save the format.

The software names all images you acquire using the new file naming pattern.

## Renaming Images

When you acquire an image, the system assigns it a default name. You can change this name in Image View or in the Gallery. In the Gallery, you can also save a series of images with the same name plus an incremental number. Doing so makes it easy to find related images.

An image name can consist of up to 190 alphanumeric characters. Spaces are permitted except at the beginning and end.

**Note:** The following characters cannot be used: \ / : \* ? " < > |

### To rename an image in the Gallery

1. Select an image.
2. Tap Rename in the bottom toolbar.
3. In the Rename dialog box, enter a name for the image.
4. Tap OK.

### To rename multiple images in the Gallery

1. Select more than one image.
2. Tap Rename.
3. In the Rename dialog box, enter a name for the first image.
4. Tap OK.

The system labels the remaining images with the same name as the first image plus a consecutive number. For example: GelDocBlot\_1, GelDocBlot\_2, and so on.

### To rename an image in Image View

1. In Image View, tap Image Info.
2. In the Image Information box, tap in the Name box to select the image name.
3. Type a new name.
4. Tap OK to save the image name.

## Printing Images

You can print one image at a time on the Mitsubishi P95 printer only. The printer produces a black and white image in landscape orientation. The printout includes the user name, acquisition date and time, and the application used. You can zoom the image and print the portion of the image within the view, or you can print the entire image. For more information about the printer, see its operation manual.

### To print an image

1. Ensure that the printer is connected to the imager and is turned on.
2. In Image view, display the image you want to print.
3. Tap Print.
  - Tap Current View to print the portion of the image within the view.
  - Tap Entire Image to print the complete image.

## Deleting Images

In Image View, you can delete any open image. In the Gallery, you can delete multiple images at the same time.

### To delete images in the Gallery

1. Do one of the following to select images to delete:
  - Tap one or more thumbnails.
  - Tap the checkbox for one or more days to select all thumbnails for those days.
  - Tap Select All to select all thumbnails in the Gallery.
2. Tap Delete and then tap OK.

### To delete an image in Image View

1. Do one of the following:
  - If one image is open in Image View, tap Delete.
  - If more than one image appears in Image View, select the image you want to delete.
2. Tap Delete and then tap OK.





## Chapter 12 Exporting Images

After acquiring images using Image Lab Touch software, you can import your images into Image Lab. To do so, first export the acquired images to a USB flash drive or a shared folder. Then copy the exported images to a computer running Image Lab software.

You can export images from the imaging system to one of the following:

- Flash drive or external hard drive
- Shared folder on a network drive or stand-alone computer

Image Lab Touch software exports the images to a folder at the top level of the destination location. The folder is named *GeIDoc Images* plus a time stamp, for example, *GeIDoc Images 2019-04-01\_15.11.29*. A folder with a time stamp is created each time you export images.

### For More Information

For more information about image analysis, see the Image Lab Software User Guide.

## Exporting Images

Before you can export images to a network or to a stand-alone computer, a shared folder must be present on the destination computer or network, and you must know the UNC path to the shared folder.

You can export images from the Gallery or from Image View.

### To export images

1. Do one of the following:
  - Select one or more images in the Gallery to export.

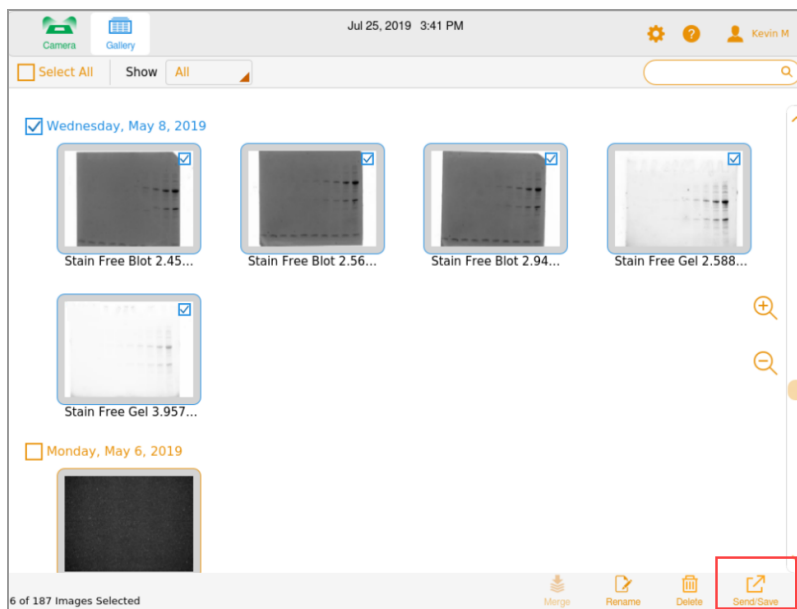

- Display up to four images in Image View and select an image to export.



2. Tap Send/Save on the bottom toolbar.

Network and export format settings appear in the right side of the screen.

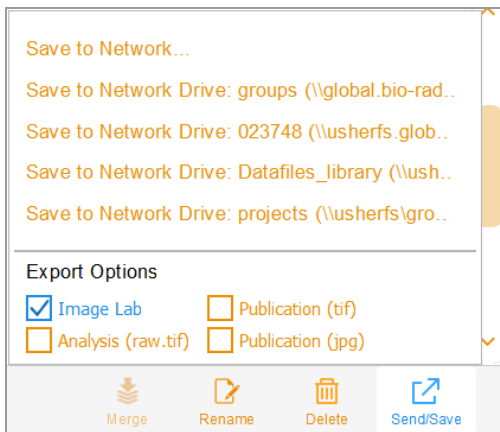

3. Under Export Options, choose the file formats in which you want to export the images.
4. In the Network list, tap a target network drive.

## Chapter 12 Exporting Images

A progress box monitors the export.

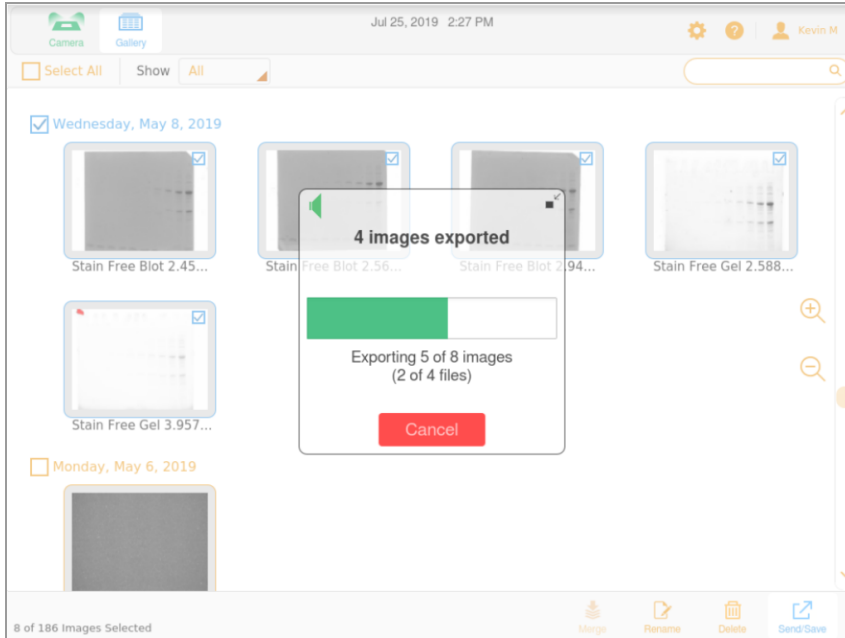

5. When the export finishes, tap OK.

## Preparing to Export Images

Before you can export images to a stand-alone computer, a shared folder must be present on the computer, and you must provide the UNC path to that folder.

The UNC (universal naming convention) is a standard for identifying servers and computers on a shared network. It is the full network path name of a folder, including the network server name. This path is the same as a Windows folder path except that it uses double backslashes (\\) to precede the name of the computer.

**Note:** The procedures for determining the UNC path and creating a shared folder on it are based on recent versions of Windows and Mac operating systems. If your computer is running on a different operating system version, you might notice differences in the user interface.

### Creating a Shared Folder on a Windows Computer

This section explains how to create a shared folder on a Windows computer and how to determine its UNC.

**Note:** In order to export images to a Windows computer, ensure that the imaging system is connected to the stand-alone computer or to the network port by Ethernet cable.

#### To create a shared folder on a Windows computer

1. Log in as the Windows Administrator for the computer.
2. Create a destination folder.
3. Right-click the folder and select Properties in the menu that appears.
4. Click the Sharing tab in the Properties dialog box.

5. Under Network File and Folder Sharing, click Share.

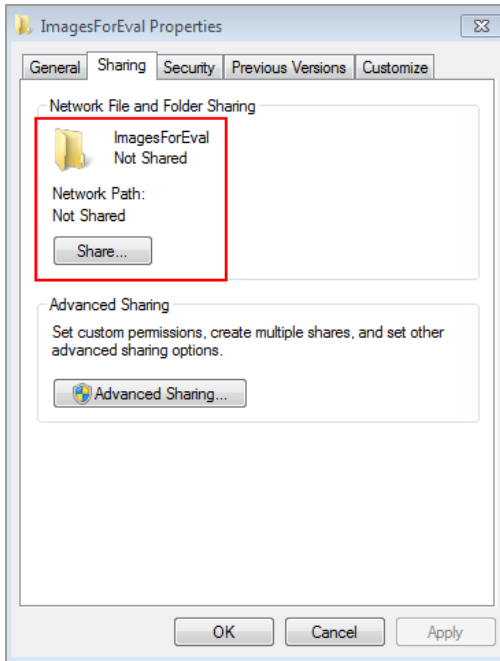

6. Choose users with whom you want to share the destination folder.
7. Click Share and then click Done.
8. (Optional) Set Read/Write permissions for each user.
9. Click Close.

**To determine the UNC path to the shared folder**

- ▶ On the Sharing tab, in the Network Files and Folder Sharing section the UNC path appears under Network Path.

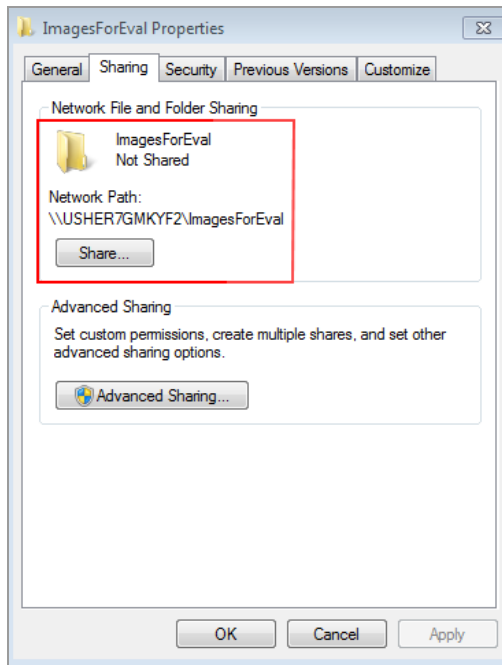

Write down this path. You will enter this address when you export an image.

## Creating a Shared Folder on a Mac Computer

This section explains how to create a shared folder on a Mac computer and how to determine its UNC.

**Tip:** The UNC for a Mac computer includes its Apple Filing Protocol (AFP) or Server Message Block (SMB).

**Note:** In order to export images to a Mac computer, ensure that the imaging system is connected to the stand-alone computer or to the network port by Ethernet cable.

### To create a shared folder on a Mac computer

1. Log in as the Administrator.
2. Create a destination folder.
3. Click the folder and choose Get Info in the menu that appears.

The <folder name> Info dialog box appears.

4. Select Shared Folder.

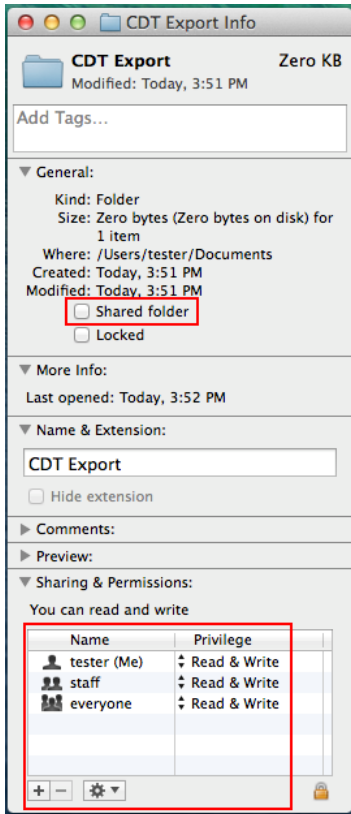



5. On the Apple menu, open System Preferences and select File Sharing in the Sharing dialog box.
6. In the Sharing & Permissions box, verify that the users with whom you want to share the folder have permission to read and write to this folder.

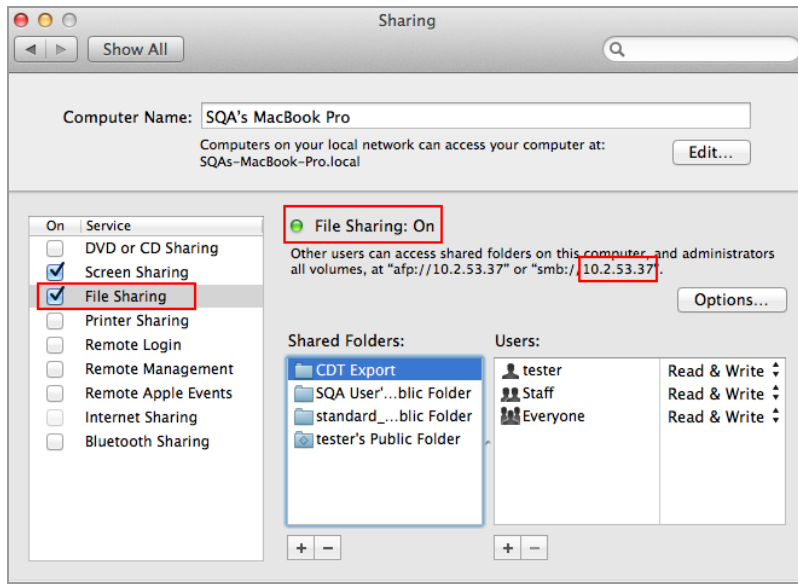

7. In the Service pane, select File Sharing.
8. Under File Sharing: On, locate the SMB address and write it down.  
You will enter the SMB address when you export an image.
9. Click Options.
10. In the dialog box that appears, select Share files and folders using SMB.

You can select both SMB and AFP. By default, OS X Mavericks and later systems automatically enable SMB and AFP for compatibility with Windows computers, Macs using Mavericks and Yosemite, and Macs using older versions of OS X.

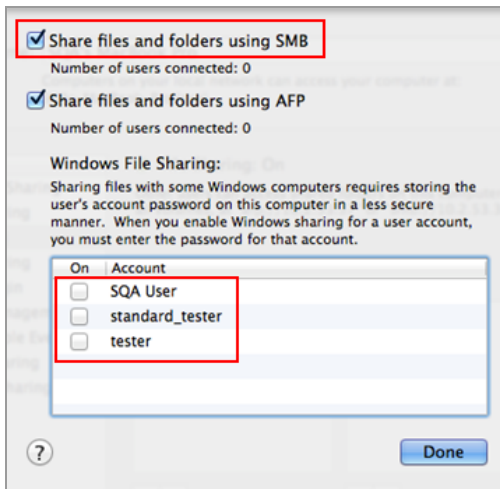

11. Click Done.

## Determining the UNC of a Previously Shared Folder

In order to export images to a computer, you must provide the UNC path to the folder. This section explains how to determine the UNC of a folder that has already been shared on Windows or Mac computer.

## Determining the UNC Path to a Network Folder on a Windows Computer

If the folder is located on a mapped network drive, you will need to determine the path to that drive as well. Mapped network drives appear in Windows Explorer as simulated drives. This is indicated by a drive letter, for example (H:). This section also explains how to determine the path to a mapped network drive on a Windows computer.

### To determine the UNC path to network folder on a Windows computer

1. Log in as the Windows Administrator for the computer.
2. In the Navigation pane, click the Network icon and navigate to and select the destination folder.

The address bar displays the network path to the destination folder, beginning with the word Network.

3. Click the address bar. Then UNC path appears in the address bar, for example:

\\ImagesForEval

4. Write down this path. You will enter this address when you export an image.

### To determine the path to a mapped drive

1. Log in as the Windows Administrator for the computer.
2. In the Navigation pane, click the network folder that contains the destination folder.

The address bar displays the mapped network path to the destination folder, beginning with the word Computer, for example:

```
Computer > ILTuser (\usherfs\users) (H:) > ImagesForEval
```

3. To construct the UNC path, follow this rule:

```
\\<shared_folder_name>\mapped_foldername\destination folder
```

In this example

- \usherfs\users — is the shared folder location
- ILTuser — is the mapped folder name
- ImagesForEval — is the destination folder

For example:

```
\\usherfs\users\ILTuser\ImagesForEval
```

## Determining the UNC Path to a Network Folder on a Mac Computer

**Tip:** The UNC for a Mac computer includes its Apple Filing Protocol (AFP) or Server Message Block (SMB).

**Note:** In order to export images to a Mac computer, ensure that the imaging system is connected to the computer or to the network port by Ethernet cable.

### To determine the UNC path to a network folder on a Mac computer

1. Log in as the Administrator.
2. On the Apple menu, open System Preferences and select File Sharing in the Sharing dialog box.

## Chapter 12 Exporting Images

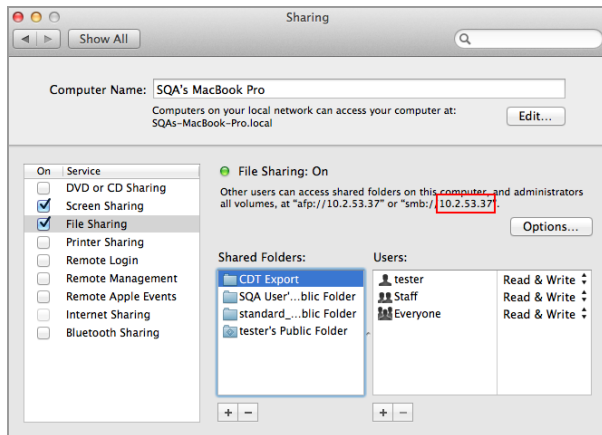

3. Note the AFP or SMB path that appears below File Sharing: On. In this image, the SMB is 10.2.53.37.

This is the computer's IP address, which is used to determine the computer name in the UNC path.

4. To construct the UNC path, follow this rule:

`\\SMB #\Users\\`

In this example

- 10.2.53.57 — is the SMB
- Tester — might be the user name
- CDT Export — is the folder name

For example:

`\\10.2.53.57\Users\Tester\CDT Export`

## Export Formats

You can export images to display them in a presentation, submit them for publication, analyze them in more detail, or copy them to a computer running Image Lab software. Using Image Lab software you can analyze the images or set additional publication options. For more information, see the Image Lab Software User Guide.

In Image View, you can export one image at a time. The software exports the current view of the image when a publication format is selected. In this view, zooming and panning are considered.

In Gallery View, you can export multiple images at the same time. The software exports the full size of the images in all selected formats.

### Choosing Export Formats

Table 4 on page 114 lists the file formats into which you can export images.

To help you identify exported images the software appends application name in parentheses to the end of the file name. This is especially helpful for multichannel images.

#### Example

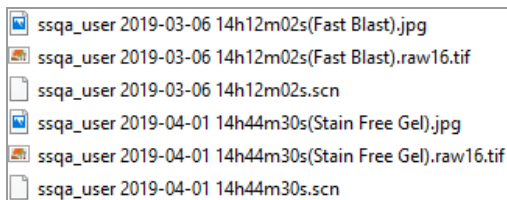

## Export File Formats

**Table 4. Export file formats**

| Export Option | File Extension | Description   |
|---------------|----------------|---|
| Image Lab     | .scn or mscn   | <p>By default, Image Lab is selected. Image Lab Touch exports a single-channel image in .scn format or a multichannel image in .mscn format.</p> <p><b>Note:</b> If you are exporting an mscn format file from Image View, only the displayed image is exported.</p> <p>To work with images in Image Lab software, use these formats.</p>   |
| Publication   | .tif or .jpg   | <p>Image Lab Touch exports the current view of an image in .tif or .jpg format at 300 DPI, which is suitable for publication. You can also insert an image in .tif or .jpg format into presentation software such as Keynote or PowerPoint.</p> <p><b>Tip:</b> Additional publication options are available in Image Lab software. For example, in Image Lab you can export an image at up to 1200 DPI. To set these publication options for the image, export the image in the .scn or .mscn format, open the file in Image Lab, set the options, and export the image in .tif or .jpg.</p> <p><b>Note:</b> In a multichannel acquisition, the composite image is exported as shown in the Image View and/or Gallery View using the composite view options (channel selection and gray/RGB color selection).</p> |
| Analysis      | .raw.tif       | <p>Image Lab Touch exports 16-bit .tif format (raw16.tif), which retains original pixel intensity data from the image acquisition. This raw image data enhances quantitative analysis. You can also use this format to import the image into image editing software that supports the 16-bit .tif format.</p> <p><b>Note:</b> You cannot export a composite image from a multichannel acquisition in .raw16.tif format.</p>   |

## Exporting to a USB Flash Drive or External Hard Drive

The flash drive or external hard drive must meet the following requirements:

- Supports USB 2.0 or above
- Is formatted with FAT32 or NTFS format
- Has no encryption software or other software add-ons on the drive

**Note:** USB drives formatted as FAT32 export files much more quickly than USB drives formatted as NTFS. If your USB export takes too long, reformat the USB drive as FAT32.

### To export images in the Gallery to a USB flash drive or external hard drive

1. Insert a USB flash drive in or connect an external hard drive to the imager USB port.
2. From the Gallery, select the images you want to export.
3. Tap Send/Save on the bottom toolbar.
4. Select export options.
5. Tap Save to USB Drive.

A progress box monitors the image export.

6. When the export finishes, tap OK.

### To export an image in Image View to a USB flash drive or external hard drive

**Note:** You can export only one image at a time in Image View.

1. Double-tap an image to display it in Image View.
2. Insert a USB flash drive in or connect an external hard drive to the imaging system USB port.
3. Tap Send/Save on the bottom toolbar.
4. Select export options.
5. Tap Save to USB Drive.

A progress box monitors the image export.

6. When the export finishes, tap OK.

## Exporting to a Shared Folder for the First Time

**Note:** The following characters are not supported in paths to shared folders: \* ? " < > | ;

When you enter a path that includes an unsupported character, an error message appears. Folder names that include unsupported characters cannot be selected in browse results. You can rename the shared folder to exclude the unsupported character or choose another folder that does not include one of these characters in its name.

Before exporting images to a shared folder on a network drive or a stand-alone computer for the first time, obtain the following information:

- The UNC path to the shared folder on the network drive or stand-alone computer
- Log-in credentials to the shared folder

### To export images to a shared folder

1. Verify that the imager is connected via an Ethernet cable to a network outlet or to a stand-alone computer.
2. Do one of the following:
  - Select the images you want to export in the Gallery.
  - Go to Image View by acquiring an image or by opening an image in the Gallery.
3. In the bottom toolbar, tap Send/Save.
4. Select Export Options.



5. Tap Save to Network.  
The Save to Network dialog box appears.
6. Type the pathname to the shared folder on the network drive or stand-alone computer.  
Enter the network drive server name or IP address.

Server name pathname format: `\\ServerName\Share1\Path\To\Folder`



Example: `\\BioServer1\Share1\Images\Experiment1`

IP address pathname format: `\\PAddress\Share1\Path\To\Folder`

Example: `\\10.1.52.162\Share1\Images\Experiment1`

7. Tap Save.
8. If a log-in dialog box appears, enter the log-in credentials to the shared folder. For a network drive, enter the network domain name, your user name on the domain, and your password in this form:

*domain\_name\username\password*

Example: **Global.xyz.com\jdoe**

9. Tap OK.

A progress bar monitors the image export. When the export finishes, tap OK.

## Exporting to a Shared Folder on a Network or Computer

**Note:** The following characters are not supported in paths to shared folders: \* ? " < > | ;

When you enter a path that includes an unsupported character, an error message appears. Folder names that include unsupported characters cannot be selected in browse results. You can rename the shared folder to exclude the unsupported character or choose another folder that does not include one of these characters in its name.

### Entering Log-in Credentials

When you export an image to a shared folder on a network drive or a stand-alone computer, you must enter log-in credentials. After you connect to a shared folder, the connection remains active until you log out.

Before you export images to a shared folder, obtain the following information:

- The UNC path to the shared folder on the network drive or stand-alone computer.
- Log-in credentials to the shared folder

If you do not have write permission to the shared folder, see your system administrator for write permission.

### To export images to a shared folder

1. Verify that the imager is connected via an Ethernet cable to a network outlet or to a stand-alone computer.
2. Do one of the following:
  - In the Gallery, select one or more images to export.
  - In Image View, display an image to export.
3. Tap Send/Save in the bottom toolbar.
4. Select export options.
5. Tap Save to Network and then tap Browse.

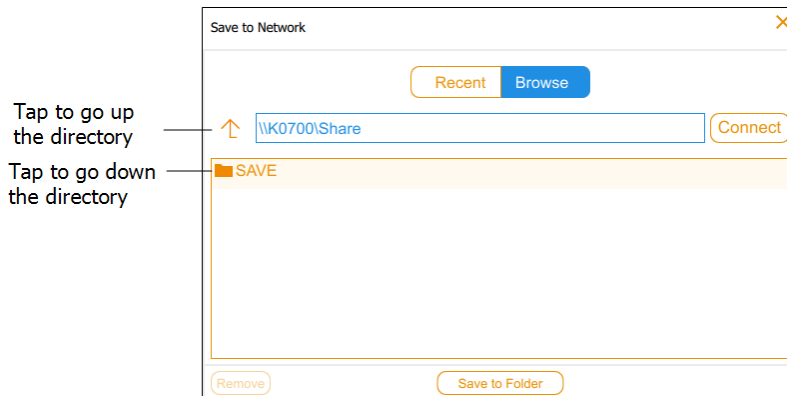

Do one of the following:

- Enter the UNC path name to the shared folder on the network drive or stand-alone computer.

**Tip:** This is the path name you noted when you set up the shared folder. See either [Determining the UNC Path to a Network Folder on a Windows Computer on page 110](#) or [Determining the UNC Path to a Network Folder on a Mac Computer on page 111](#).

- Tap the path name you want under Save in the Save to Network dialog box.

6. Tap Connect.

If you are not connected to the network drive or computer, the system prompts you for log-in credentials.

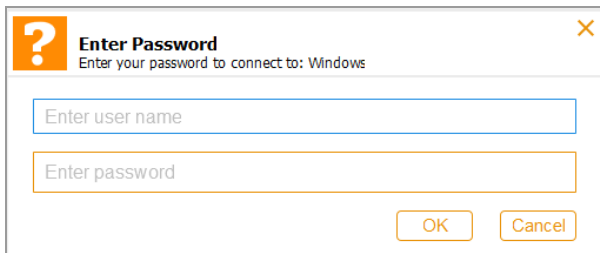

7. Enter the log-in credentials to the shared folder and then tap OK.

For a network drive, type the network domain name, your user name on the domain, and your domain password in this form:

*domain\_name\username*

*user password*

8. Tap Save to Folder. A progress box monitors the image export.
9. When the export finishes, tap OK.

## Exporting to a Recent Location

When you export images to a shared folder on a network drive or stand-alone computer, the software saves the location you enter. The next time you export an image, the Save to Network dialog box displays the ten most recent locations you entered, most recent location first.

### To export images to a recent location

1. Verify that the imager is connected via an Ethernet cable to a network outlet or to a stand-alone computer.
2. In the Gallery or in Image View, select the images you want to export.
3. Tap Send/Save in the bottom toolbar.
4. Select export options.
5. Tap Save to Network.

The Save to Network dialog box appears.

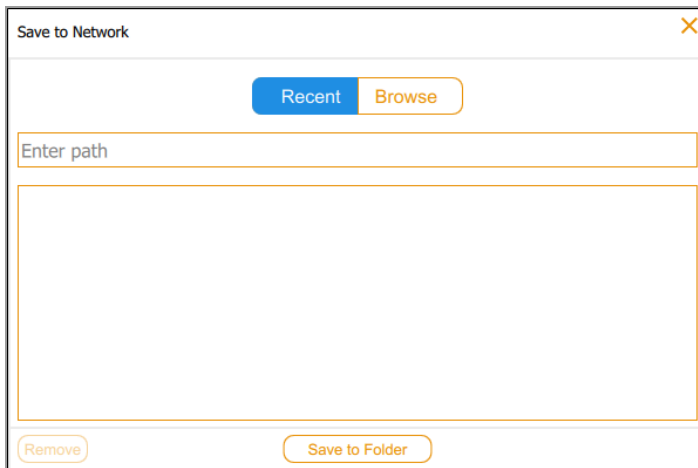

6. Tap a shared folder in the recent locations list and then tap Save to Folder.

A log-in dialog box appears if the connection to the network drive or stand-alone computer is not active.

7. Enter the log-in credentials to the shared folder.

To enter the log-in credentials for a network drive, type the network domain name, your user name on the domain, and your domain password. Type the domain and user name in this form:

*domain\_name\username*

for example; **Global.xyz.com\jsmith**

8. Tap OK.

A progress box monitors the image export.

9. When the export finishes, tap OK.

## Removing Network Locations

### To remove network locations from the list

- ▶ Tap a location and then tap Remove.

### Disconnecting from a Shared Folder

The imaging system remains connected to a shared network folder until you log out or turn off the imaging system or until the network disconnects you.



## Chapter 13 System Settings

The System Settings menu displays options that can be changed for your site. Users can view information about the imager and change the system sound level when they log in.

Administrators can also set the following options for your site:

- Date and time
- Time zone
- Language from English (the default) to Simplified Chinese
- Network connection

This chapter explains how to set these options.

### Setting the System Date, Time, and Time Zone

Before you begin to work with the imaging system, verify that the date and time settings are correct for your locale.

**Note:** The date and time appear in the default names assigned to acquired images.

If your instrument is connected to a network you can enable the automatic date and time setting, which synchronizes your system with the date and time information from an NTP server for your geographic location.

You can also set a particular date and time by selecting a specific time zone.

If your instrument is not connected to a network, you can manually set the date and time.

#### **To automatically set the date and time**

1. Tap Settings in the main toolbar, and then tap Set Date and Time.

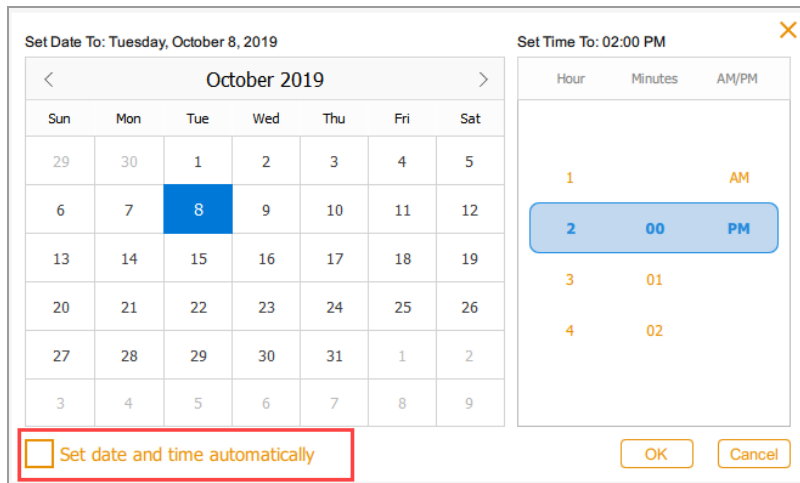

2. Select the Set date and time automatically check box, and then tap OK.

Image Lab Touch sets the date and time based on NTP..

**Important:** When the checkbox is selected, you cannot manually change the date and time.



**To set the system time zone**

1. Tap Settings in the main toolbar, and then tap Set Time Zone.

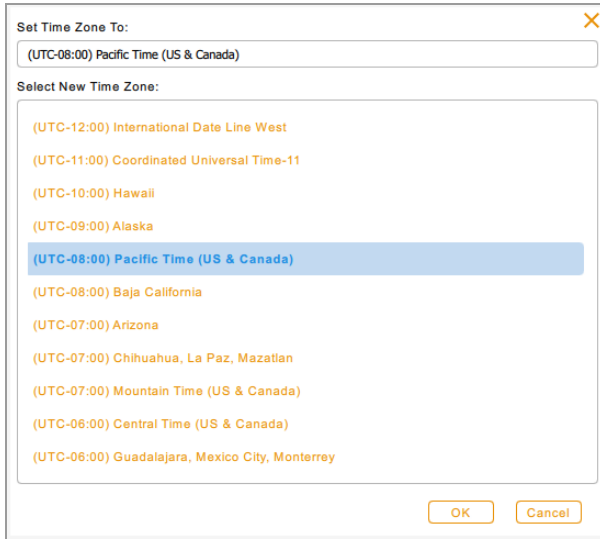

2. From the Select New Time Zone list, scroll to find the time zone for your locale.
3. Tap the time zone to select it and then tap OK.

**To manually set the current date and time**

1. Tap Settings in the main toolbar, tap Set Date and Time in the list that appears.
2. Ensure the Set date and time automatically check box is cleared.
3. In the Calendar box, tap the angle brackets to display the current month.

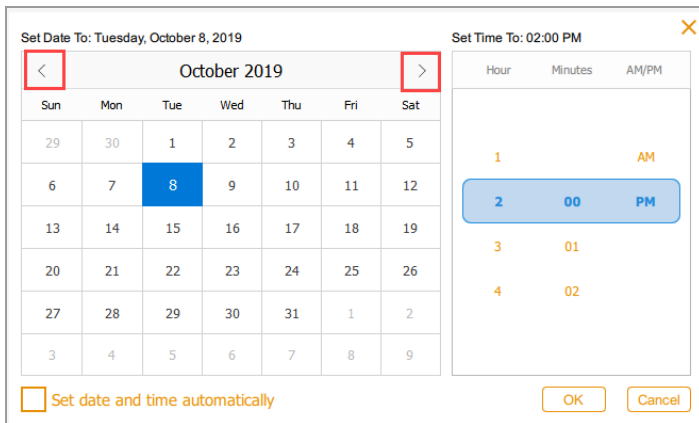

4. Tap the day of the month.
5. Scroll through the Hour and the Minutes lists until the current time appears in the blue band.
6. Scroll to position AM or PM in the blue band under AM/PM.
7. Tap OK.

The selected date and time appear at the top of the all Image Lab Touch screens.

## Setting the Sound Volume

You can change the system sound volume or turn off the sound.

### To set the sound volume

1. Tap Settings in the main toolbar.
2. Tap Set Sound Volume in the list that appears.
3. Tap a volume level.
4. Tap X to close the list.

## Setting the System Language

**Note:** Only those with the administrator role can change the system language.

You can change the system language from English language to Simplified Chinese. Image Lab Touch software will display all on-screen text in the selected language. It will also display the on-board keyboard in the selected language.

**Tip:** You can choose to display the on-screen keyboard in either English language or Simplified Chinese without changing the system language. See [Using the On-Screen Keyboard on page 25](#) for more information.

### To set the system language

1. Tap Settings in the main toolbar.
2. Tap Set Language in the list that appears.
3. Tap the appropriate language.
4. Tap X to close the list.

## Configuring the Network Connection

**Note:** Only those with the administrator role can configure the network connection.

The GelDoc Go instrument can connect to your network using a static or dynamic IPv4 connection.

Using a dynamic connection, the GelDoc Go's IP address can change each time it restarts. In this case, the instrument automatically establishes a new connection to the network each time it restarts. A static IP address never changes, thus the instrument always reconnects to the same network address each time it restarts.

**Tip:** If you choose to set a static connection, you might need the assistance of your system administrator for specific network settings.

**Important:** The GelDoc Go instrument must restart to apply the changes.

### To set the network connection

1. Log into the GelDoc Go instrument as an administrator.
2. Tap Settings in the main toolbar.
3. Tap About This Instrument in the list that appears. The imager's information screen appears.

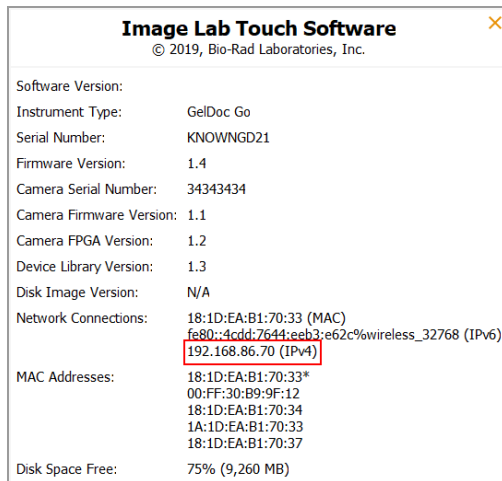

4. Write down the IPv4 address located in the Network Connections section. You will need this number to set a static connection.
5. Tap X to close the system information screen.
6. Tap Settings in the main toolbar.

- From the menu that appears, tap Network Configuration. The IPv4 Properties dialog box appears.

Internet Protocol Version 4 (TCP/IPv4) Properties

You can get IP settings assigned automatically if your network supports this capability. Otherwise, you need to ask your network administrator for the appropriate IP settings.

Obtain an IP address automatically

Obtain a Link-Local Only IP address automatically

Use the following IP address:

IP address: [ ] . [ ] . [ ] . [ ]

Subnet mask: [ ] . [ ] . [ ] . [ ]

Default gateway: [ ] . [ ] . [ ] . [ ]

Obtain DNS server address automatically

Use the following DNS server addresses:

Preferred DNS server: [ ] . [ ] . [ ] . [ ]

Alternate DNS server: [ ] . [ ] . [ ] . [ ]

OK Cancel

- If your network supports a dynamic connection, tap the following options:
  - Obtain an IP address automatically
  - Obtain a Link-Local Only IP address automatically
  - Obtain DNS server address automatically
- To set a static connection, tap Use the following IP address and Use the following DNS server addresses options and then provide the IP address, subnet mask, default gateway, and DNS server details for your site.

**Tip:** See your system administrator for the appropriate settings.

  - IP address — the IPv4 number that you noted in [Step 4 on page 127](#)
  - Subnet mask — the numeric filter used to define the subnet to which the IP address belongs
  - Default gateway — (required if you plan to access computers that are on another subnet from the GelDoc Go instrument) this is the IP address of the node that allows communication between the subnets
  - DNS server — the IP address of the node that translates a server name to its IP address
- Tap OK to save the changes.
- Tap X to close the dialog box.

# Appendix A Maintaining the Imaging System

## Reinstalling Image Lab Touch Software

You can reinstall the version of Image Lab Touch currently in use or a previously installed version.

### To reinstall Image Lab Touch

1. Obtain the USB flash drive on which the installation software is stored.
2. Verify that the installation software is in the root directory of the flash drive.
3. Ensure that no image acquisitions or exports are in progress.
4. Insert the USB flash drive into the USB port on the imager's side panel.
5. Tap Settings on the main toolbar.

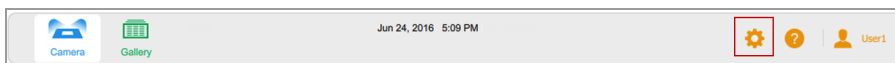

Image Lab Touch detects the installation software in the root directory of the USB flash drive. Update Installation appears in the Settings list.

6. Tap Update Installation and tap OK.

The installation process begins.

**Important:** Do not interrupt the installation process. When it is complete, the imager restarts automatically.

## Ensuring the Instrument is Level

The GeIDoc Go instrument should be level to prevent samples from sliding on the sample tray and ensure the best imaging. Place the instrument on the surface where you will be using it, and complete the steps below.

To level the instrument

1. Open the drawer and place a sample tray on the surface.
2. Retrieve the bubble level included with your instrument accessories.

3. Place the bubble level on the tray, in the middle, as shown in the following graphic.

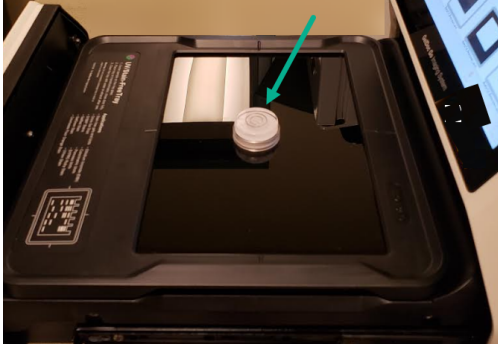

4. Close the drawer.
5. If necessary, power on the instrument.
6. Tap the camera icon.

The image appears on the screen.

If the bubble is not in the middle of the inner circle seen on the level, you must raise or lower the instrument's feet to level it.

7. Lift the instrument and rotate the feet as applicable to move the bubble to the center.
  - To raise the instrument, rotate the feet outward.
  - To lower the instrument, rotate the feet inward.
  - To move the bubble, rotate each foot inward or outward until the bubble appears in the middle of the inner circle on the screen.

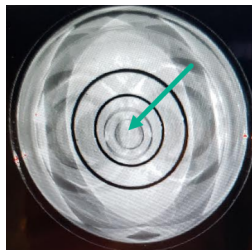

Each time you adjust the feet you need to acquire a new image to view the new position of the bubble.

8. Open the drawer slightly and then close it again to acquire a new image.

You do not need to tap the camera icon again.

9. When the bubble is centered in the middle of the level, you can remove the level from the tray and close the drawer.

**Important:** If you move the instrument to a new location, you must repeat this process to level it again.

## Cleaning the Instrument

During normal operation, residue can build up on internal and external areas of your GelDoc Go instrument. On sample trays, residual contamination can affect image data and dust particles can glow under UV illumination.

Use the instructions below to clean the following areas:

- Sample trays
- Transilluminator glass
- Touch screen
- Black rubber top mat
- Plastic exterior

### To clean the instrument surfaces and accessories

- ▶ Wipe down each surface using a standard laboratory detergent or mild solvent (such as 70% EtOH, MeOH, or IPA).

**Important:** Note the following:

- For glass areas, use a nonabrasive lint-free towelette.
- Do not clean sample trays in a dishwasher.
- For Coomassie stain, clean until no remaining stain is visible on the towelette.
- You can safely submerge the rubber mat in water

## Maintaining Transilluminator Bulbs

The imager uses custom UV bulbs that are only available from Bio-Rad. See [Appendix C, Ordering Information](#) for the catalog number.

**Note:** Standard-length bulbs do not fit in the imager.

Depending on the amount of use, the UV bulbs can last for many years. When a bulb fails, an error message specifies which bulb has failed.

## Replacing UV Transilluminator Bulbs

One or more transilluminator bulbs can fail at any time. Bio-Rad recommends that you replace all four bulbs, including those that still work. Replacing all bulbs at once ensures consistent light over the imaging stage.

To replace the transilluminator bulbs, use a 2.5 mm hex wrench.

**Important:** Transilluminator bulbs contain heavy metals, including mercury. Do not throw used bulbs in the trash. Dispose of them in accordance with local recycling and disposal guidelines.

### To prepare to replace the bulbs

1. Turn off the power to the imager.
2. Disconnect the AC power cord from the imager.
3. Pull out the imager drawer.

### To remove the transilluminator cover

1. Loosen the four screws — two on each side of the transilluminator cover.

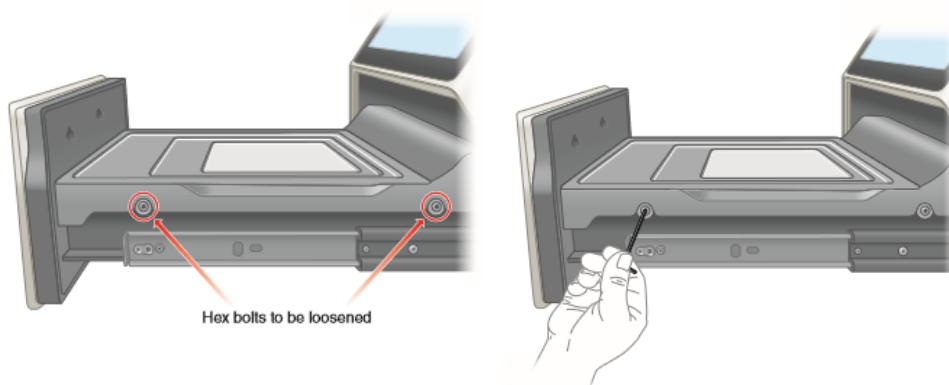



**Tip:** Leave the loosened screws in the threaded holes to avoid misplacing them.

2. Lift the the transilluminator cover and remove it.
3. Avoid scratching or damaging the UV filter glass.

**To replace the transilluminator lamps**

**Important:** Use caution when touching the lamps. They can be hot.

1. Rotate a lamp until it loosens and the pins are vertical and aligned with the socket.

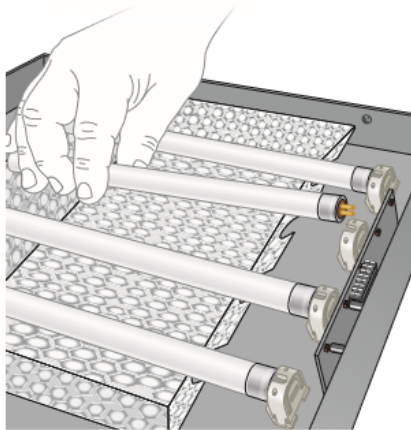

2. Remove the lamp.
3. Set the new lamp in place and rotate it until the pins are seated and horizontal.

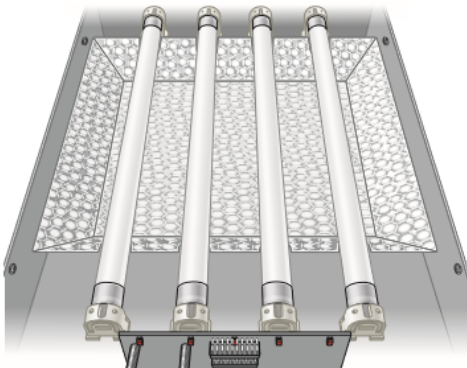

4. Repeat steps 1–3 for each lamp you want to replace.

### To replace the transilluminator cover

1. Set the transilluminator cover on the drawer.
2. Secure the cover to the drawer with the screws.

## Replacing the Fuses

Replace the fuses with one of the following acceptable replacement fuses:

| Name     | Number    | Voltage                 | Description |
|----------|-----------|-------------------------|-------------|
| Schurter | 0034.3123 | 250 V, 5 x 20 mm,<br>4A | Slow blow   |

### To replace the GelDoc Go fuses

1. Unplug the power cord from the back of the instrument.
2. Using a small flathead screwdriver, insert the tip to loosen the black fuse box cover.



3. Pull out the red fuse box.



4. Pull out the fuse box and gently pop out the fuse.



5. Insert a new fuse, and then press the fuse box back into its slot.

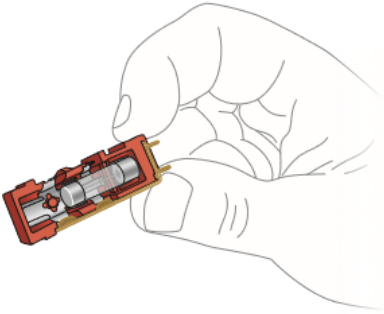

6. Press the fuse box into place.

## Appendix B Important Imaging Concepts

This appendix provides additional information on important concepts for working with the imaging systems.

### Specifying the Region of Interest for Optimal Exposure

Preview displays a low-resolution image of the sample. When you select an automatic exposure setting, you can use the preview image to specify the region of interest by surrounding bands or other features with a selection rectangle.

Image Lab Touch acquires the entire image and sets the automatic exposure so that the brightest pixels in the region of interest are exposed to near saturation and the rest of the image is exposed to show as much dynamic range as possible. Specifying a region of interest is especially valuable when you are setting automatic exposure for chemiluminescent or fluorescent samples.

Try specifying the region of interest for the following purposes:

- To evaluate relative signal intensities, all features that you want to compare must be unsaturated. To prevent saturation of features, specify a region of the blot encompassing the area of interest.
- To push the limits of sensitivity, specify a region of faint or no apparent signal. The software optimizes the exposure to reveal features in the specified region, but might cause saturation of more intense features on the blot.

### Adjusting How Images Are Displayed

Image Lab Touch software optimizes images based on the range of intensity levels in the image and the known behavior of the applications. Use this optimized image as a starting point. Use the histogram scale and the grayscale curve settings in the Transform dialog box to adjust the image brightness and contrast as necessary.

**Important:** The transform settings change only the *appearance* of the image, not the underlying data.

## Adjusting Image Brightness and Contrast

Transform adjusts image brightness and contrast, optimizing the image display to highlight features of interest. The minimum to maximum range varies depending on the light and dark values present in the image. Adjustments to brightness and contrast do not change the data. They change only the way the data are displayed.

The frequency distribution histogram shows the total data range in the image and the amount of data at each point in the range.

Use the Low and High sliders to narrow the displayed grayscale range.

- The High indicator determines the intensity value shown at the maximum value of the grayscale in the gel image.
- The Low indicator determines the intensity value shown at the minimum value of the grayscale in the gel image.
- The Gamma slider changes the grayscale curve. A value of 1 is linear. A value of  $<1$  redistributes more of the grayscale to the first half of the intensity values. A value of  $>1$  redistributes more of the grayscale to the second half of the intensity values.

A logarithmic histogram can reveal the presence of intensity values that are otherwise obscured. In images with a large background area, the intensity value of most pixels is that of the background. Often, there are too few pixels at the intensity values of the data peaks of interest to make these peaks readily visible in a linear histogram.

A linear histogram can be useful when intensity values are more evenly distributed. Used in combination with the logarithmic histogram, the linear histogram shows more clearly the relative quantity of pixels at each intensity value.

### To change the histogram scale

1. Open an image in Image View and tap Transform.
2. Tap the Log Histogram box to choose the logarithmic scale.

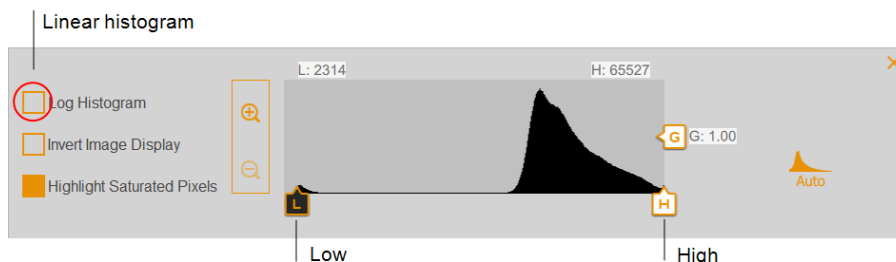

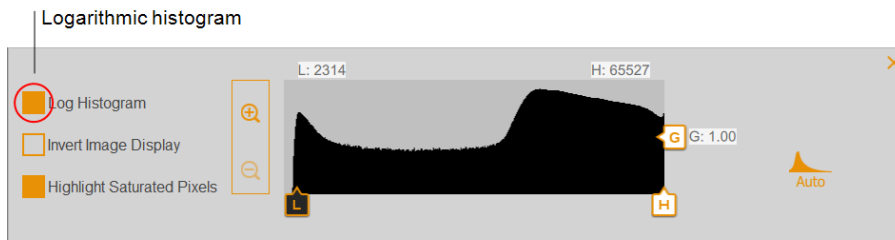

### To change the light intensity range displayed in the image

- ▶ Tap and drag the Low or High slider.
  - Drag the Low slider to the right to obscure the background and low-intensity bands and to make high-intensity bands more visible.
  - Drag the High slider to the left to make the background, nonspecific binding, and low-intensity bands more visible. Intense bands might look overexposed.

### To adjust the grayscale curve

- ▶ Tap and drag the Gamma slider or touch anywhere in the slider bar.

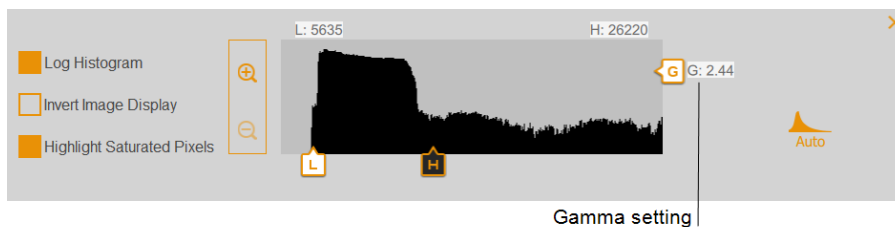

### Other Display Options

- **Zoom in and out** — displays greater detail about the intensity range.
- **Highlight saturated pixels** — are displayed in red areas with saturated signal intensity (higher than a measurable range).
- **Invert image display** — inverts dark and light areas. Clear the box to return to original display.

### Restoring Default Settings

After changing the brightness and contrast settings for an image, you can restore the default settings.

#### To restore default settings

- ▶ Tap Auto.

Appendix B Important Imaging Concepts

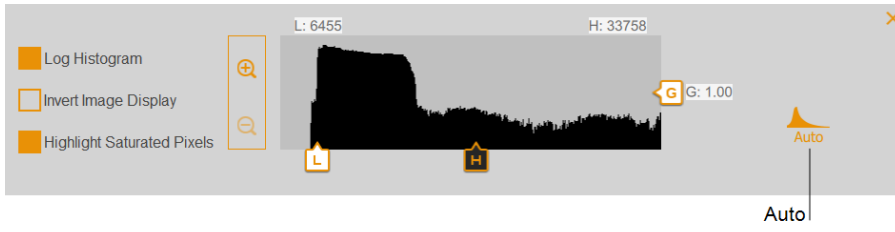



## Appendix C Ordering Information

| Catalog #                             | Description  |
|---------------------------------------|--|
| <b>Imaging Systems</b>                |  |
| 12009077                              | GelDoc Go Imaging System with Image Lab Touch Software           |
| <b>Analysis Software</b>              |  |
| 1709690                               | Image Lab Software   |
| 12012931                              | Image Lab Software on a USB drive                                |
| 1709691                               | Image Lab Software, Security Edition, 1 license                  |
| 17006130                              | Image Lab Software, Security Edition, 1 license on a USB drive   |
| 1709692                               | Image Lab Software, Security Edition, 5 licenses                 |
| 17006171                              | Image Lab Software, Security Edition, 5 licenses on a USB drive  |
| 1709693                               | Image Lab Software, Security Edition, 10 licenses                |
| 17006172                              | Image Lab Software, Security Edition, 10 licenses on a USB drive |
| <b>GelDoc Go Imaging System Trays</b> |  |
| 12012165                              | White Tray   |
| 12012160                              | Blue Tray  |
| 12012189                              | UV/Stain-Free Tray   |
| <b>Optional Accessories</b>           |  |
| 12012164                              | UV Safety Shield for GelDoc Go Imaging System                    |
| 1708377                               | Holder for Sample Trays and UV Shield                            |
| 1708185                               | XcitaBlue Viewing Goggles  |
| 12012190                              | GelDoc Go Gel Alignment Kit                                      |
| 1708089                               | Mitsubishi Printer, 100/240V, USB                                |

Appendix C Ordering Information

| <b>Catalog #</b>              | <b>Description</b>   |
|-------------------------------|--|
| 1703760                       | Gel Cutter Ruler   |
| 12012147                      | GelDoc Go Imaging System IQ/OQ Kit   |
| <b>Replacement Parts</b>      |  |
| 16005724                      | UVB Lamp Replacement, 302 nm   |
| 20002706                      | Fuse, 4 A, 250 VAC   |
| 1707581                       | Mitsubishi Thermal Printer Paper, 4 rolls  |
| <b>Nucleic Acid Standards</b> |  |
| 1708351                       | EZ Load 20 Base Pair Molecular Ruler   |
| 1708352                       | EZ Load 100 Base Pair Molecular Ruler, 500 µl, 100 applications  |
| 1708353                       | EZ Load 100 Base Pair PCR Molecular Ruler, 500 µl, 100 applications  |
| <b>Protein Standards</b>      |  |
| 1610373                       | Precision Plus Protein All Blue Standards, 500 µl, 50 applications   |
| 1610363                       | Precision Plus Protein Unstained Standards, 1 ml, 100 applications   |
| 1610374                       | Precision Plus Dual Color Standards, 500 µl, 50 applications   |
| 1610376                       | Precision Plus Protein WesternC Blotting Standards, 250 µl, 50 applications  |
| <b>Buffers</b>                |  |
| 1610732                       | 10x Tris/Glycine/SDS, 1L   |
| 1610743                       | 50x, TAE (Tris Acetic Acid/EDTA) Buffer, 1L  |
| 1610747                       | 4x Laemmli Sample Buffer, 10 ml  |
| <b>Electrophoresis Cells</b>  |  |
| 1656001                       | Criterion Cell, includes electrophoresis buffer tank, lid with power cables, 3 sample loading guides   |
| 1658004                       | Mini-PROTEAN Tetra Cell for Mini Precast Gels, 4-gel vertical electrophoresis system, includes electrode assembly, companion running module, tank, lid with power cables, mini cell buffer dam |





**Bio-Rad  
Laboratories, Inc.**

*Life Science Group*

**Web site** [bio-rad.com](http://bio-rad.com) **USA** 1 800 424 6723 **Australia** 61 2 9914 2800 **Austria** 43 01 877 89019 **Belgium** 32 03 710 53 00  
**Brazil** 55 11 3065 7550 **Canada** 1 905 364 3435 **China** 86 21 6169 8500 **Czech Republic** 36 01 459 6192 **Denmark** 45 04 452 10 00  
**Finland** 35 08 980 422 00 **France** 33 01 479 593 00 **Germany** 49 089 3188 4393 **Hong Kong** 852 2789 3300 **Hungary** 36 01 459 6190  
**India** 91 124 4029300 **Israel** 972 03 963 6050 **Italy** 39 02 49486600 **Japan** 81 3 6361 7000 **Korea** 82 2 3473 4460 **Mexico** 52 555 488 7670  
**The Netherlands** 31 0 318 540 666 **New Zealand** 64 9 415 2280 **Norway** 47 0 233 841 30 **Poland** 36 01 459 6191 **Portugal** 351 21 4727717  
**Russia** 7 495 721 14 04 **Singapore** 65 6415 3188 **South Africa** 36 01 459 6193 **Spain** 34 091 49 06 580 **Sweden** 46 08 555 127 00  
**Switzerland** 41 0617 17 9555 **Taiwan** 886 2 2578 7189 **Thailand** 66 2 651 8311 **United Arab Emirates** 971 4 8187300  
**United Kingdom** 44 01923 47 1301

