MK-145 TILE SAW

OWNER'S MANUAL, PARTS LIST & OPERATING INSTRUCTIONS



Revision 102	07.2018
Manual Part# 158286	

Caution: Read all safety and operating instructions before using this equipment. This owner's manual **MUST** accompany the equipment at all times.

INTRODUCTION

We at MK Diamond want to congratulate you on selecting the MK-145 Tile Saw. We are certain that you will be pleased with your purchase. MK Diamond takes pride in producing the finest products in the industry.

Operated correctly, your MK-145 should provide you with years of quality service. In order to help you, we have included this manual. This owners manual contains information necessary to operate and maintain your MK-145 safely and correctly. Please take a few minutes to familiarize yourself with the MK-145 by reading and reviewing this manual.

If you should have questions concerning your MK-145, please feel free to call our friendly customer service department at: 1-800-421-5830

Regards,

MK Diamond

NOTE THIS INFORMATION FOR FUTURE USE:

MODEL NUMBER:	
SERIAL NUMBER:	
PURCHASE PLACE:	
PURCHASE DATE:	

NOTE: For your (1) one year warranty to be effective, complete the warranty card (including the Serial Number) and mail it in as soon as possible.

TABLE OF CONTENTS

	Page
SAFETY:	
Safety Messages	4
Damage Prevention Message	4
General Safety Precautions	4-6
California Proposition 65 Message	7
Hazard Symbols	7
Electrical Requirements and Grounding Instructions	8-11
Lock Out	11
Safety Label Locations	12
Tile Saw Specific Warnings	12
Product Specifications	13
UNPACKING AND ASSEMBLY	
Unpacking	14
Contents	14
Transport	15
Assembly	15-17
SETUP, ADJUSTMENT AND OPERATION	
Setup	18-19
Adjustment and Operation	20-23
Cleanup	24
MAINTENANCE AND TROUBLESHOOTING	
Maintenance	25
Troubleshooting	26-27
EXPLODED VIEW AND PARTS LIST	
Exploded View	28
Parts List	29
THEORY	
Theory of Diamond Blades	30
ACCESSORIES ORDERING AND RETURN INSTRUCTIONS	
Accessories	31
ORDERING and RETURN INSTRUCTIONS	
Ordering Information	32
Return Material Policy	32
Packaging Instructions	32
Authorized Service Centers	33

Read and follow all safety, operating and maintenance instructions. Failure to read and follow these instructions could result in injury or death to you or others. Failure to read and follow these instructions could also result in damage and/or reduced equipment life.

SAFETY MESSAGES

A safety message alerts you to potential hazards that could hurt you or others. Each safety message is preceded by a safety alert symbol () and one of three words: **DANGER**, **WARNING**, or **CAUTION**.



DANGER

You **WILL** be **KILLED** or **SERIOUSLY INJURED** if you do not follow directions.



WARNING

You **CAN** be **KILLED** or **HARMED** if you do not follow directions.



CAUTION

You **CAN** be **INJURED** if you do not follow directions. It may also be used to alert against unsafe practices.

DAMAGE PREVENTION AND INFORMATION MESSAGES:

A Damage Prevention Message is to inform the user of important information and/or instructions that could lead to equipment or other property damage if not followed. Information Messages convey information that pertains to the equipment being used. Each message will be preceded by the word **NOTE**, as in the example below.

NOTE: Equipment and/or property damage may result if these instructions are not followed.

GENERAL SAFETY PRECAUTIONS AND HAZARD SYMBOLS

In order to prevent injury, the following safety precautions and symbols should be followed at all times!

SAFETY PRECAUTIONS



ALWAYS read this Owner's Manual before operating the machine.



ALWAYS keep the Blade Guard in place.



REMOVE ADJUSTING KEYS AND WRENCHES

Form a habit of checking to see that keys and adjusting wrenches are removed from the power tool before it is turned on.



KEEP WORK AREA CLEAN

Cluttered work areas and benches invite accidents.



DO NOT USE IN DANGEROUS PLACES



DO NOT use power tools in damp or wet locations nor expose them to rain. Always keep the work area well lighted.

**KEEP CHILDREN AWAY**

All visitors and children should be kept a safe distance from work area.

**MAKE THE WORKSHOP KID PROOF**

Make the workshops kid proof by using padlocks, master switches or by removing starter keys.

**DO NOT FORCE THE TOOL**

A power tool will do a job better and safer operating at the rate for which it was designed.

**USE THE RIGHT TOOL**

DO NOT force a tool or an attachment, to do a job that it was not designed to do.

**USE THE PROPER EXTENSION CORD**

If using an extension cord make sure it is in good condition first. When using an extension cord, be sure to use one heavy enough to carry the current your product will draw. An undersized cord will cause a drop in line voltage that will result in a loss of power and overheating. TABLE 1, Page 9 shows the correct AWG size to use depending on cord length and nameplate ampere rating. If in doubt, use the next heavier gage. The smaller the gage number, the heavier the cord.

**USE PROPER APPAREL**

DO NOT wear loose clothing, gloves, neckties, rings, bracelets, or other jewelry that may be caught in moving parts. Non-slip footwear is recommended. Wear protective hair covering to contain long hair.



ALWAYS wear approved eye protection.



ALWAYS wear approved respiratory protection.

**SECURE WORK**

Clamps or a vise should be used to hold work whenever practical. Keeping your hands free to operate a power tool is safer.

**DO NOT OVERREACH**

Keep proper footing and balance at all times by not overreaching.

**MAINTAIN TOOLS WITH CARE**

Keep tools clean for the best and safest performance. Always follow maintenance instructions for lubricating, and when changing accessories.

**DISCONNECT TOOLS**

Power tools should always be disconnected before servicing or when changing accessories, such as blades, bits, cutters, and the like.



ALWAYS place the power **ON/OFF** switch in the **OFF** position when the saw is not in use



USE RECOMMENDED ACCESSORIES

Consult the owner's manual for recommended accessories. Using improper accessories may increase the risk of personal or by-stander injury.



NEVER STAND ON THE TOOL

Serious injury could occur if a power tool is tipped, or if a cutting tool is unintentionally contacted.



CHECK FOR DAMAGED PARTS

Before using a power tool, check for damaged part. A guard or any other part that is damaged should be carefully checked to determine if would operate properly and perform its intended function. Always check moving parts for proper alignment or binding. Check for broken parts and mountings and all other conditions that may affect the operation of the power tool. A guard, or any damaged part, should be properly repaired or replaced.



DIRECTION OF FEED

ALWAYS feed work into a blade or cutter against the direction of rotation. A blade or cutter should always be installed such that rotation is in the direction of the arrow imprinted on the side of the blade or cutter.



NEVER LEAVE A TOOL UNATTENDED

TURN POWER OFF - Do not leave a tool until it comes to a complete stop. Always turn a power tool **OFF** when leaving the work area, or when a cut is finished.

CALIFORNIA PROPOSITION 65 MESSAGE

Some dust created by power sanding, sawing, grinding, drilling, and other construction activities contain chemicals known (to the State of California) to cause cancer, birth defects or other reproductive harm. Some examples of these chemicals are:

- Lead, from lead-based paints
- Crystalline silica, from bricks and cement and other masonry products
- Arsenic and chromium, from chemically treated lumber

For further information, consult the following sources:

<http://www.osha.gov/dsg/topics/silicacrystalline/index.html>

<http://www.cdc.gov/niosh/docs/96-112/>

<http://oehha.ca.gov/prop65/law/P65law72003.html>

<http://www.dir.ca.gov/Title8/sub4.html>

<http://www.P65warnings.ca.gov>

Your risk from these exposures varies depending on how often you do this type of work. To reduce your exposure to these chemicals, work in a well-ventilated area, and work with approved safety equipment, such as dust masks that are specially designed to filter out microscopic particles. Where use of a dust extraction device is possible, it should be used. To achieve a high level of dust collection, use an industrial HEPA vacuum cleaner. Observe OSHA 29 CFR part 1926.57 and 1926.103.

HAZARD SYMBOLS



ELECTRICAL SHOCK

NEVER touch electrical wires or components while the engine is running. They can be sources of electrical shock which could cause severe injury or burns.



ROTATING PARTS

Keep hands, feet, hair, and clothing away from all moving parts to prevent injury. Never operate the motor with covers, shrouds, or guards removed.



OVER SPEED

NEVER tamper with the governor components or settings to increase the maximum speed. Severe personal injury and damage to the engine or equipment can result if operated at speeds above maximum.



DO NOT EXPOSE TO RAIN

DO NOT expose to rain or use in damp locations.



WARNING

Sawing and drilling generates dust. Excessive airborne particles may cause irritation to eyes, skin and respiratory tract. To avoid breathing impairment, always employ dust controls and protection suitable to the material being sawed or drilled; See OSHA (29 CFR Part 1910.1200).

ELECTRICAL REQUIREMENTS AND GROUNDING INSTRUCTIONS

In order to prevent electrical shock and injury, the following electrical safety precautions and symbols should be followed at all times!



WARNING

In case of a malfunction or breakdown, grounding provides a path of least resistance for electrical current to reduce the risk of electric shock. This tool is equipped with an electric cord which has an equipment-grounding conductor and a grounding plug. The plug must be plugged into a matching outlet that is properly installed and grounded in accordance with all local codes and ordinances.

- **DO NOT** modify the plug provided - if it will not fit the outlet, have the proper outlet installed by a qualified electrician.
- Improper connections of the equipment-grounding conductor can result in a risk of electric shock. The equipment-grounding conductor is the insulated conductor that has an outer surface that is green, with or without yellow stripes. If repair or replacement of the electric cord or plug is necessary, **DO NOT** connect the equipment-grounding conductor to a live terminal.
- Check with a qualified electrician or service personnel if the grounding instructions are not completely understood, or if in doubt as to whether the tool is properly grounded.
- Use only 3-wire extension cords that have 3-prong grounding plugs and 3-pole receptacles that accept the tool's plug.
- Repair or replace a damaged or worn cord immediately.

This tool is intended for use on a circuit that has an outlet that looks like the one shown in Sketch A. The tool has a grounding plug that looks like the plug illustrated in Sketch A. A temporary adapter, which looks like the adapter illustrated in sketches B and C, may be used to connect this plug to a 2-pole receptacle as shown in Sketch B, if a properly grounded outlet is not available. The temporary adapter should be used only until a properly grounded outlet can be installed by a qualified electrician. The green-colored rigid ear, plug, and the like, extending from the adapter, must be connected to a permanent ground, such as a properly grounded outlet box.

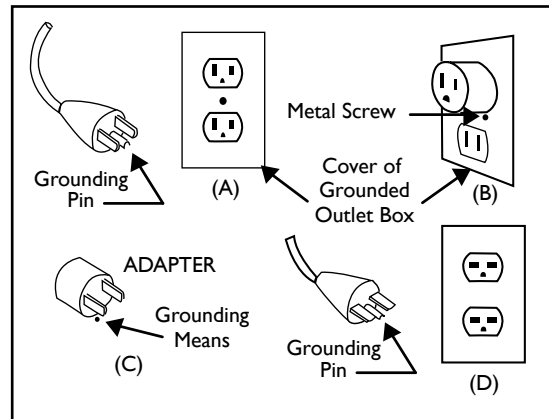

Circuit and Adapter Information

NOTE: Use of a temporary adapter is not permitted in Canada.

ELECTRIC MOTOR SAFETY

For maintenance care and operation of the electric motor, refer to your electric motor instruction booklet furnished with the electric motor. Protect the electric motor from dust as much as possible and keep ventilating openings clean. Before plugging in the machine, make sure that the outlet voltage is within the voltage marked on the machines's data plate.



CAUTION



DO NOT spray water on the electric motor. **DO NOT** touch the plug with wet hands. To reduce the risk of electrocution, keep all connections dry and off the ground.



DO NOT operate electric motor in an explosive environment.



DO NOT EXPOSE TO RAIN

DO NOT expose to rain or use in damp locations.



WARNING



If operating the equipment in damp locations is unavoidable, **ALWAYS** use a Ground Fault Circuit Interrupter, **ALWAYS** wear rubber gloves and footwear in damp conditions.



DO NOT abuse the cord. Never use the cord to carry the equipment or to pull the plug from the outlet. Keep the cord away from heat, sharp edges, and moving parts. Replace damaged cords immediately. Damaged cords increase the risk of electric shock.



WARNING

To reduce the risk of electrocution, keep all connections dry and off the ground. A Ground Fault Circuit Interrupter (GFCI) should be provided on the circuit(s) or outlet(s) to be used for this machine. Receptacles are available having built-in GFCI protections and may be used for this measure of safety. When using an extension cord, GFCI should be installed closest to the power source, followed by the extension cord and lastly, the machine.



WARNING

The water pump requires a GFCI. To reduce risk of electrical shock when operating the machine with the pump plugged into the 3-pole receptacle on the motor, connect the machine to a GFCI outlet. See the pump manual and informational tags enclosed separately for all pump information.

**WARNING**

To avoid the possibility of the appliance or plug receptacle getting wet, position the machine to one side of a wall mounted receptacle. This will prevent water from dripping into the receptacle or plug. A "drip loop," shown in the picture below, should be arranged by the user to properly position the power cord relative to the power source. Use the drip loop as a way to prevent GFCI and plug from getting wet.

The "drip loop" is that part of the cord below the level of the receptacle (or the connector, if an extension cord is used). This method of positioning the cord prevents the travel of water along the power cord and coming in contact with the receptacle.

If the plug or receptacle gets wet, **DO NOT** unplug the cord. Disconnect the fuse or circuit breaker that supplies power to the tool. Then unplug and examine for presence of water in the receptacle.

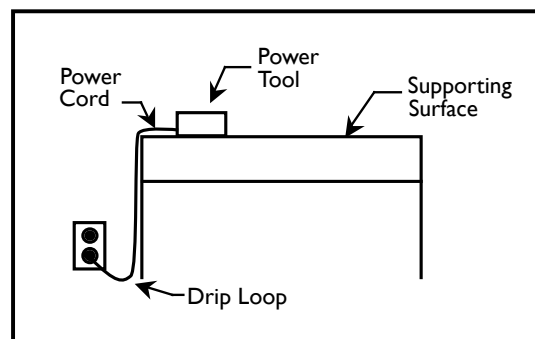

Drip Loop Information

**WARNING**

Use only extension cords that are intended for outdoor use. These extension cords are identified by a marking "Acceptable for use with outdoor appliances; store indoors while not in use." Use only extension cords having an electrical rating not less than the rating of the product. **DO NOT** use damaged extension cords. Examine extension cords before using and replace if damaged. **DO NOT** abuse extension cords and **DO NOT** yank on any cord to disconnect. Keep cords away from heat and sharp edges. Always disconnect the extension cord from the receptacle before disconnecting the product from the extension cord.

ALWAYS make certain that the power source required for the electric motor is correct and always use the correct NEMA configuration plug. Motors can burn out when the line voltage falls 10% below the voltage rating of the motor. Failure to use proper voltage will cause the motor to overheat. Make certain that the correct size grounded (3-wires) extension cord is used.

**WARNING**

Use of undersized extension cords result in low voltage to the motor that can result in motor burnout and premature failure. MK Diamond warns that equipment returned to us showing signs of being run in a low voltage condition, through the use of undersized extension cords, will be repaired or replaced totally at the customer's expense. There will be no warranty claim.

To choose the proper extension cord,

- Locate the length of extension cord needed in the table below.
- Once the proper length is found, move down the column to obtain the correct AWG size required for that length of extension cord.

MOTOR SPECS			EXTENSION CORD LENGTH			
Motor	Voltage	Amps	25'	50'	100'	200'
156428-R	120V 1 Ph	7.4	16 ga	14 ga	10 ga	8 ga

SAFETY LABEL LOCATIONS

Safety labels contain important safety information. Please read the information contained on each safety label. These labels are considered a permanent part of your saw. If a label comes off or becomes hard to read, contact MK Diamond or your dealer for a replacement.

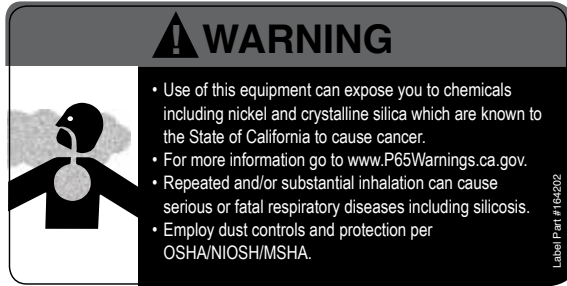

Part # 164202
A

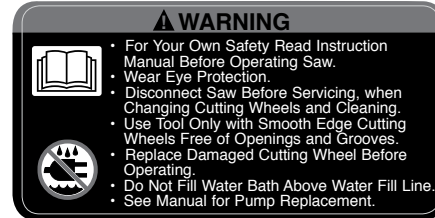

Part # 155806
B



A
Part# 155806



B
Part# 164202



C
Water Basin

Decal/Label	Location	Description
A	Switch Side	Warning - Silica
B	Back	Prop 65
C	Water Basin	Warning water level

TILE SAW SPECIFIC WARNINGS

Wear eye protection.

Use splash guard for every operation for which it can be used.

Disconnect saw before servicing, when changing cutting blades, and cleaning. Replace damaged cutting blade before operating.

PRODUCT SPECIFICATION

The MK-145 is a versatile tabletop tile saw. Operated and used according to this manual, the MK-145 will provide years of dependable service.

General Description

The MK-145 tile saw is engineered as a self-contained wet saw consisting of a powerful 120V motor in a hard plastic case. The saw is capable of cutting a tile up to (1) inch (25mm) thick. The water basin located below the tabletop can be filled with ordinary tap water, and is easily cleaned following use.

Motor Specifications

Motor specifications for the MK-145 are listed in Table.

Voltage	120V
Overall Amperage	Switch Side
Frequency	50/60Hz
RPM	6000
Weight	11lbs/ 5kgs
Part #	158252

Blade Capacity

The MK-145 uses a 4-1/2 inch diameter continuous rim MK Diamond blade with a 1/16-inch cutting width. The MK 145 can miter cut at a 45-degree miter angle or a 22.5-degree angle for octagonal shapes.

Tile Types

The MK-145 can cut a variety of tile types including Porcelain, Terracotta, Marble, Quarry and Slate, or almost any other non-ferrous material.

NOTE The MK-145 is not designed to cut plastic or ferrous (metals) material.

UNPACKING

Your MK-145 has been shipped from the factory thoroughly inspected. Only minimal assembly is required.

If not done, remove the MK-145 from the box and place on a flat surface. Remove the Water Basin Cover (See Step 1 of the Blade Guard Installation Procedure; page 15.), and remove the accessories package from the Water Basin.



CAUTION Use proper lifting techniques when lifting the MK-145.

CONTENTS

In your container, you will find one (1) MK-145 Saw, one (1) 4-1/2 inch diamond blade, one (1) metal inner flange, one (1) plastic outer flange, one (1) 45° cutting guide, one (1) adjustable cutting guide, two (2) adjustable cutting guide knobs, one (1) adjustable blade guard, one (1) blade guard retaining screw, one (1) MK-145 table stop, one (1) blade wrench, one (1) owner's manual, and one (1) warranty card.



MK-145 Saw



Diamond Blade



Metal Inner Flange



Plastic Outer Flange



45° Cutting Guide

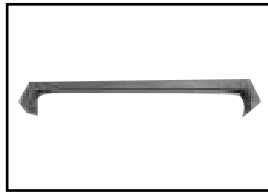

Adjustable Cutting Guide

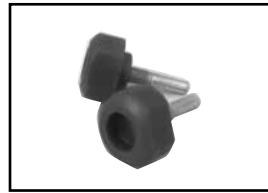

Adjustable Cutting Guide Knobs



Blade Guard



Retaining Nut



MK-145 Table Stop



Blade Wrench



Owner's Manual



Warranty Card

TRANSPORT

The MK-145 weighs approximately eleven (11) pounds, making transport easy.



CAUTION Never transport the MK-145 with water in the Cooling Basin.

The MK-145 is designed with recessed edges in the molded plastic case for ease of transport. To transport the MK-145, simply grasp it by the two recessed edges, lift and move it to the desired location.

BLADE GUARD INSTALLATION

Follow the assembly instructions to prepare your MK-145 for operation.

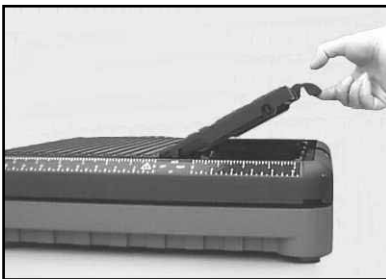

(A)

Lift Water Basin Cover and pull out the Water Basing Cover.

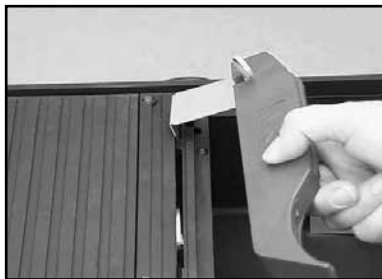

(B)

Insert Blade Guard into the small Slot of Cutting Table.

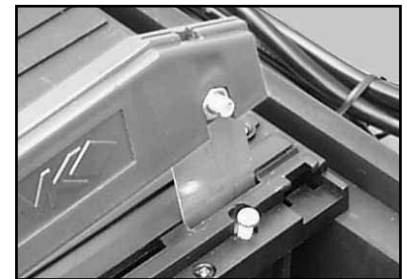

(C)

Rotate Blade Guard upright and insert Blade Guard Retaining Screw.

DIAMOND BLADE INSTALLATION



(A)

Locate the flat sides of the Gear Shaft.

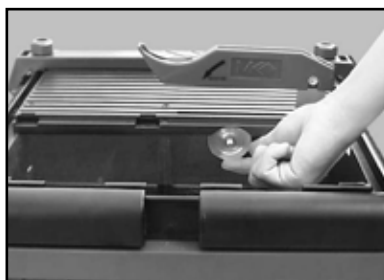

(B)

Install the Metal Inner Flange onto the Gear Shaft and rotate until it is seated on the flat sides of the Gear Shaft.

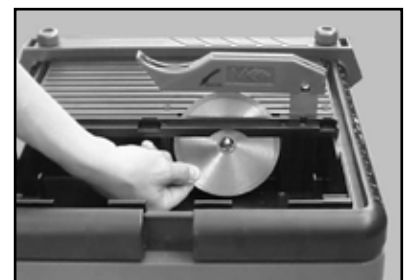

(C)

Orient the Blade with the Directional Arrow facing out and install the Blade through the Table Blade Slot from below.

NOTE: DO NOT cross-thread the retaining nut during installation.



(D)

Verify the Blade is seated on the Gear Shaft and the Directional Arrow matches the Directional Arrow on the Blade Guard.

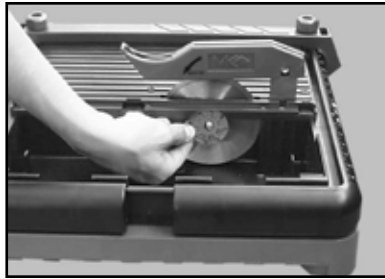

(E)

Install the Plastic Outer Flange onto the Gear Shaft.

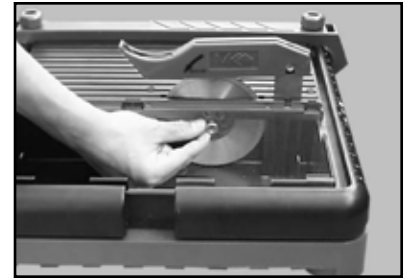

(F)

Install the Retaining Nut onto the Gear Shaft – **DO NOT CROSS-THREAD THE NUT.**

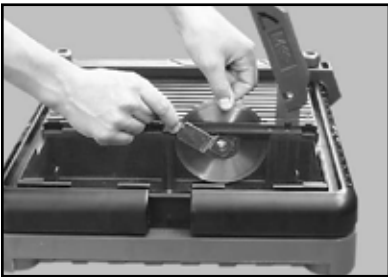

(G)

Hold the Diamond Blade still and rotate the Blade Wrench clockwise to tighten - **DO NOT OVER TIGHTEN.**

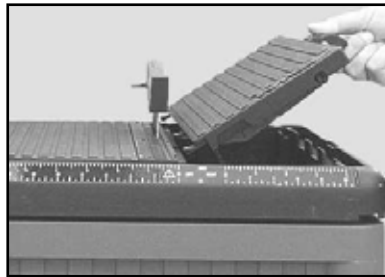

(H)

Insert the three (3) Cover Retaining Tabs into the three (3) Cover Alignment Slots and seat the Water Basin Cover on the MK-145.

ADJUSTABLE CUTTING GUIDE INSTALLATION

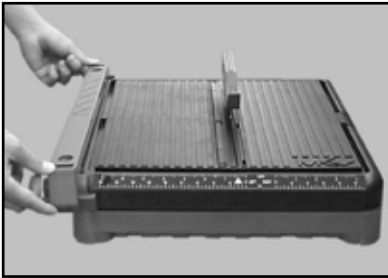

(A)

Fit the Retaining Tabs of the Adjustable Cutting Guide to the grooves on the side and slide the Adjustable Cutting Guide onto the MK-145.

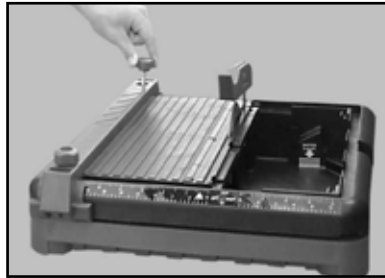

(B)

Install the two Retaining Knobs into either side of the Adjustable Cutting Guide.

TABLE STOP INSTALLATION

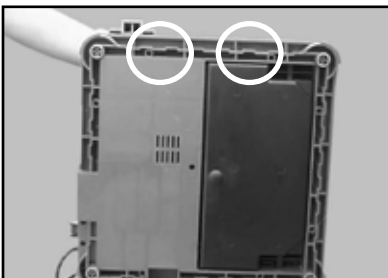

(A)

Rotate the MK-145 onto the back end and locate the Table Stop Retaining Slots.



(B)

Install the Table Stop into the MK-145 Retaining Slots.

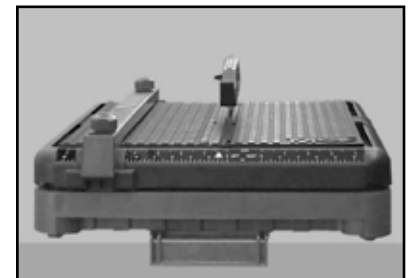

(C)

Place the MK-145 onto the workbench and position the Table Stop against the side of the work bench.

SETUP

- Before powering or starting, check for damage, that could prevent this equipment from proper operation or performing its intended function. Check for binding and improper alignment of moving parts. Check for damaged, broken, or missing parts.
- Verify the On/Off switch is in the OFF position.
- Before connecting the MK-145 to a power supply, be sure the voltage, cycle and phase of the job site power source meet the requirements of the table.
- If using an extension power cord, ensure sure the length and wire gauge correspond to the requirements listed in table on Page 11. An extension power cord that is too small in wire gauge (diameter), or too long in length, will cause the motor to overheat and could cause premature failure.
- Use an approved Ground Fault Circuit Interrupter (GFCI).
- Do not cover the motor vents as this could lead to motor overheating.
- Do not overfill the Cooling Basin.

Voltage	120V
Frequency	50/60Hz
Phase	1

NOTE: In order to avoid breaker tripping, a 15-amp circuit breaker should be used.

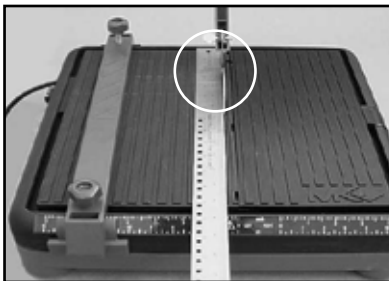

(A)

Place MK-145 on a flat, level surface. Verify the Diamond Blade is aligned with the Blade Guard support angle using straight edge.

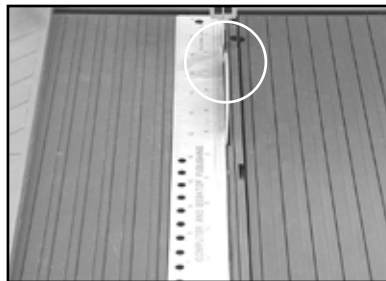

(B)

Loosen the Blade Guard support screw and align the Blade Guard to the Diamond Blade. Retighten the Blade Guard Support Screw.



(C)

Lift Water Basin Cover. Pull out on Water Basin Cover to remove.

**WARNING**

DO NOT FORCE TOOL, it will do the job better and safer at the rate for which it was designed.

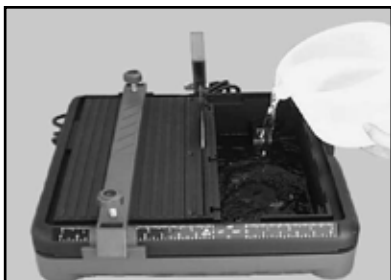

(D)

Fill the Water Basin up to the mark indicated on the Water Level Label.

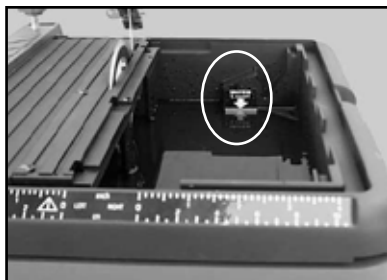

(E)

Verify the Water Basin water level, is below the upper limit Indicator Arrow.

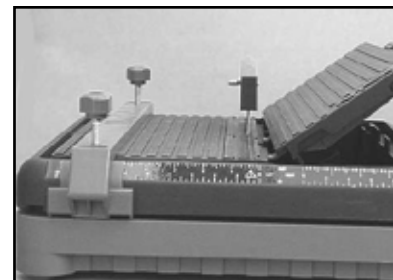

(F)

Insert the three (3) Cover Retaining Tabs into the three (3) Cover Alignment Slots. Seat the Water Basin Cover.

**WARNING**

If an extension cord is used, first verify it meets the requirements of table on page 11. Plug the MK-145 Saw into the extension cord, plug the extension cord into a GFCI and finally, plug the GFCI into the power source in that order.



(G)

Verify the ON/OFF Switch is in the OFF position.



(H)

Plug the MK-145 into a GFCI.



(I)

Plug the GFCI into the power source.

CUTTING STRAIGHT EDGES

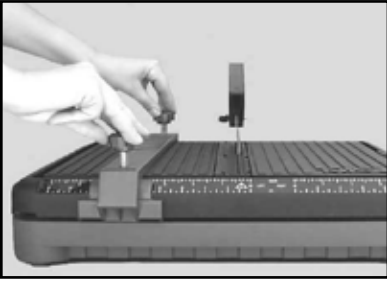

(A)

Loosen the two (2) Retaining Knobs and align the measuring arrow of the Adjustable Cutting Guide to the cut length indicated on the Cutting Table ruler then retighten the Retaining Knobs.

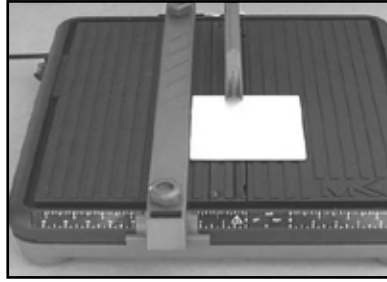

(B)

Position the tile against the Adjustable Cutting Guide.

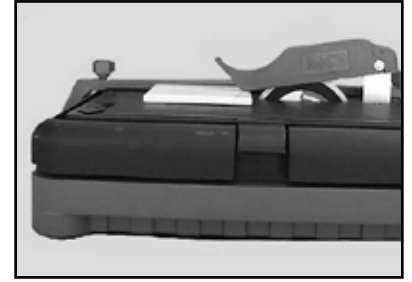

(C)

Set Blade Guard above the top of the tile.



(D)

Turn ON the MK-145 and verify Cooling Water Flow around Blade Guard.

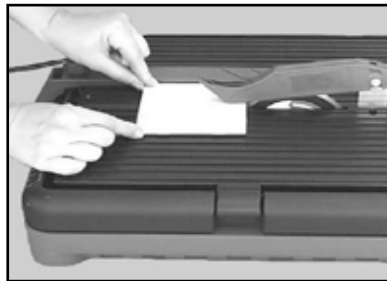

(E)

Feed the tile into the diamond blade with a steady even pressure (forcing the tile will cause the blade to slow which could cause motor overheating).



(F)

Turn saw OFF when cutting is complete.

**CAUTION**

DO NOT FORCE TOOL, it will do the job better and safer at the rate for which it was designed.

DIAGONAL CUTTING

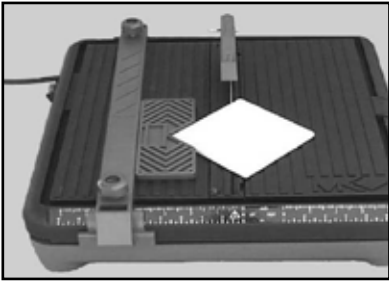

(A)

Place the diagonal cutting guide against the Adjustable Cutting Guide and fit the tile into the retaining slot of the diagonal cutting guide.

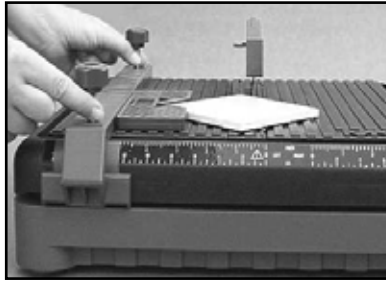

(B)

Loosen the two (2) Retaining Knobs, align the Adjustable Cutting Guide to the desired cut position and retighten the Retaining Knobs.



(C)

Set Blade Guard above the top of the tile.



(D)

Turn on the MK-145 and verify cooling water flow around Blade Guard.



(E)

Feed the tile into the Diamond Blade with a steady even pressure (forcing the tile will cause the blade to slow which could cause motor overheating).



(F)

Turn saw OFF when cutting is complete.

**CAUTION**

DO NOT FORCE TOOL, it will do the job better and safer at the rate for which it was designed.

CUTTING 22.5° AND 45° DEGREE ANGLES**CAUTION**

Placing the Adjustable Cutting Guide against the edge of the tile will provide added support during the cut, and, will reduce the chance of being injured by sharp edges and chips.

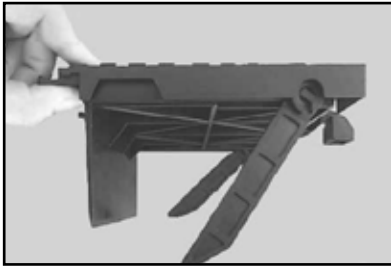

(A)

Pull out the two (2) Cover Stays located on the bottom of the Water Basin Cover.

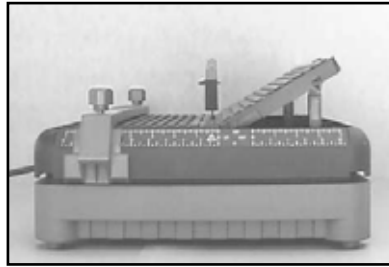

(B)

22.5 Degree Cutting

Place the Cover Stays into the two (2) 22.5-degree Angle Slots (lower slots) located inside the Water Basin then go to Step D.

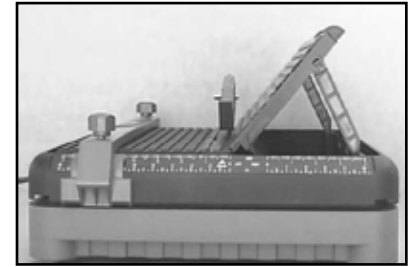

(C)

45 Degree Cutting

Place the Cover Stays into the two (2) 45-degree Angle Slots (upper slots) located inside the Water Basin then go to Step D.

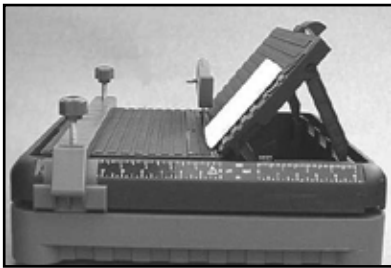

(D)

Place the tile onto the raised Cutting Table with the glazed side down. Verify the tile is resting against the tile support groove of the Cutting Table.

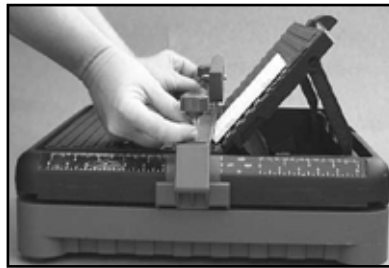

(E)

Loosen the two (2) Retaining Knobs. Position the Adjustable Cutting Guide against the edge of the tile then retighten the Retaining Knobs.

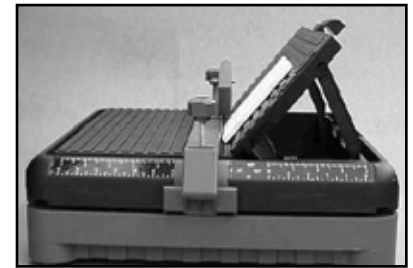

(F)

Set Blade Guard above the top of the tile.



(G)

Turn ON the MK-145. Verify cooling water flow around Blade Guard.

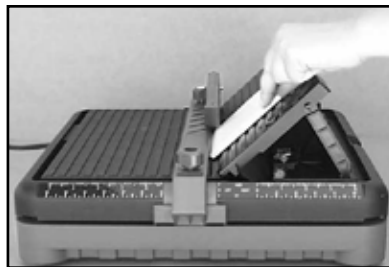

(H)

Feed the tile into the Diamond Blade with a steady even pressure (forcing the tile will cause the blade to slow which could cause motor overheating).



(I)

Turn saw OFF when cutting is complete.

CLEANUP

**WARNING**

NEVER empty the Cooling Basin with the ON/OFF switch in the ON position, or when power is applied.

NOTE:

DO NOT use solvents or acids when cleaning the MK-145.



(A)

Verify the ON/OFF switch is in the OFF position.



(B)

Unplug the MK-145 from the power source and unplug the MK-145 from the GCFI.



(C)

Lift Water Basin Cover and pull out on Water Basing Cover to remove.



(D)

Empty the contents of the Water Basin.

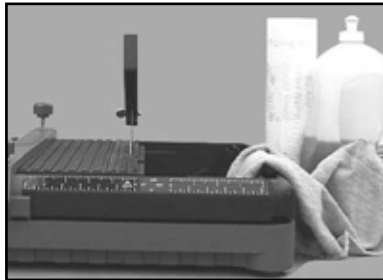

(E)

Clean the MK-145 with clean, fresh water then rinse and dry with a clean cloth or paper towels.

NOTE:

Conform to Federal, State and Local laws, codes and ordinances relative to environmental protection if unsure of disposal requirements.

BLADE DRESSING

Like most cutting instruments, a diamond blade performs best when it is dressed. Over time and use, diamonds on the outer edge will become smoothed or “glazed” over. This will reduce grinding efficiency and may cause the blade to “wander” or bend giving the illusion of an alignment problem. When this occurs, the blade will need to be dressed. The diamond blade can be dressed using the MK Dressing Stick (part number 152792) and by following the steps below.



(A)
Setup the MK-145
for operation.

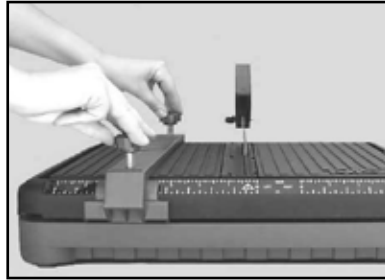

(B)
Loosen the two (2) Retaining
Knobs and position the Ad-
justable Cutting Guide to cut a
length of 1/16-inch then re-
tighten the Retaining Knobs.

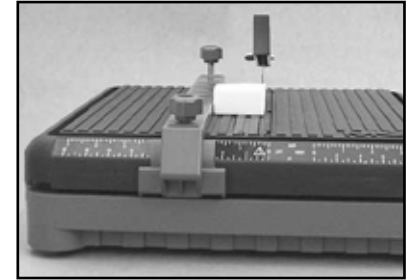

(C)
Place the Dressing Stick on
the Cutting Table against
the Adjustable Cutting
Guide.

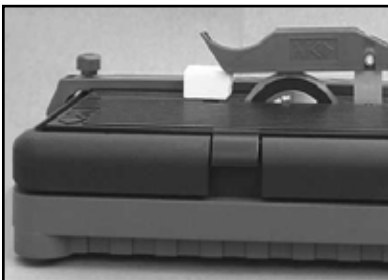

(D)
Set Blade Guard above the
top of the Dressing Stick.



(E)
Turn on the MK-145 and
verify Cooling Water Flow
around Blade Guard.

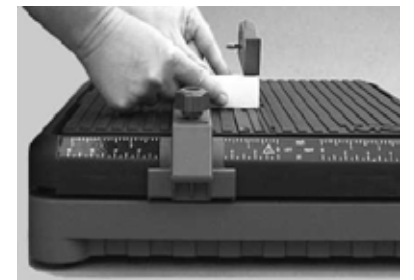

(F)
Feed the Dressing Stick into
the Diamond Blade with
steady even pressure.



(G)
Turn saw off when cutting
is complete.

DIAMOND BLADE CHANGE-OUT

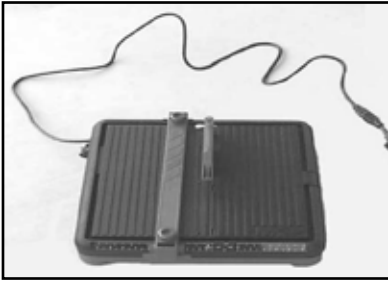

(A)

Unplug the MK-145 from the power source and unplug the MK-145 from the GCFI.

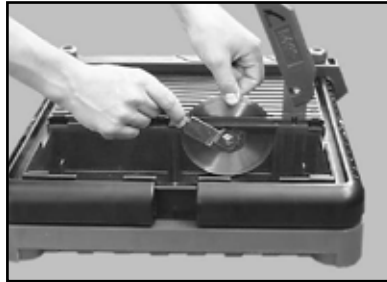

(B)

Hold the Diamond Blade still, rotate the Blade Wrench counter-clockwise to loosen and remove the Retaining Nut and Outer Flange.

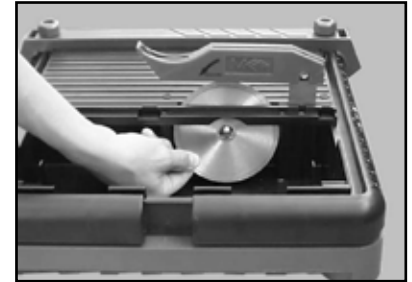

(C)

Remove the Blade out from between the Table Blade Slot from below.

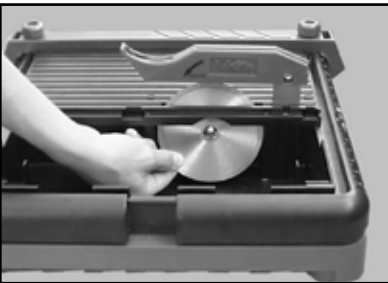

(D)

Orient the Blade to the Gear Shaft with the Directional Arrow facing out and install the Blade through the Table Blade Slot from below.

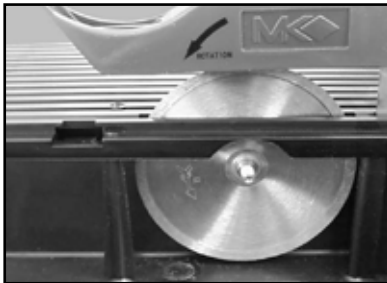

(E)

Verify the Blade is seated on the Gear Shaft and verify Blade Directional Arrow matches the Directional Arrow on the Blade Guard.



(F)

Install the Plastic Outer Flange onto the Gear Shaft and install the Retaining Nut onto the Gear Shaft.

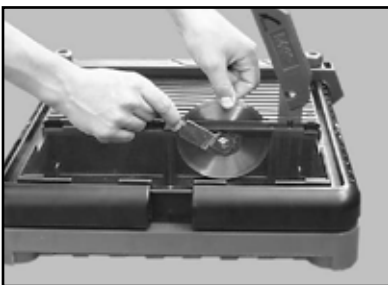

(G)

Hold the Diamond Blade still and rotate the Blade Wrench clockwise to tighten – DO NOT OVER TIGHTEN.

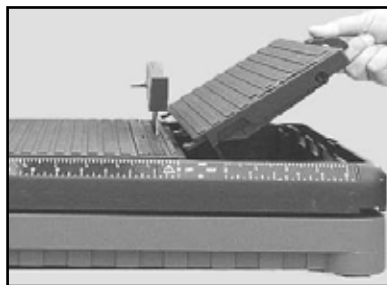

(H)

Insert the three (3) Cover Retaining Tabs into the three (3) Cover Alignment Slots and seat the Water Basin Cover.

NOTE: DO NOT cross-thread the Retaining Nut during installation.

**WARNING**

Turn the ON/OFF switch to the OFF position and unplug the saw from the power source before performing any troubleshooting procedure.

MOTOR STOPS TURNING

(A)

If not fully connected, re-connect plugs and turn on the saw. If fully connected, go to step B.



(B)

If the GFCI is tripped reset it and turn on the saw. If the GFCI is not tripped, go to step C.



(C)

If the circuit breaker is not 15 amps, move the saw to a 15-amp circuit breaker and turn on saw. If the circuit breaker is 15 amps, go to step D.



(D)

If tripped, reset the breaker once and turn on the saw. If the saw trips again, proceed to step F. If the circuit breaker is not tripped, go to step E.

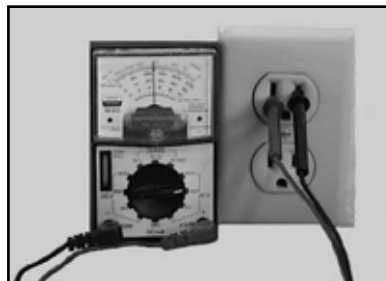

(E)

If power source is not at 120V move the saw to another circuit and turn on the saw.

BLADE WILL NOT CUT PROPERLY



(A)

If blade is smooth, sharpen per Blade Sharpening Section of this manual. If blade is not glazed, go to step B.



(B)

Verify blade rotates in counter-clockwise direction as indicated by arrow on the diamond blade. If not rotating correctly, reposition the blade to correct position. If rotating correctly, go to step C.

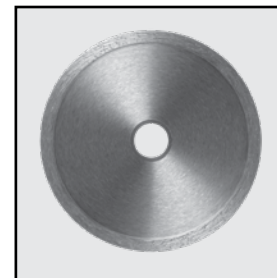

(C)

If the blade core is bent, replace blade per the Diamond Blade Change-out procedure of this manual. If the blade core is not bent, go to step D.



(D)

Check Blade is correct for material being cut.

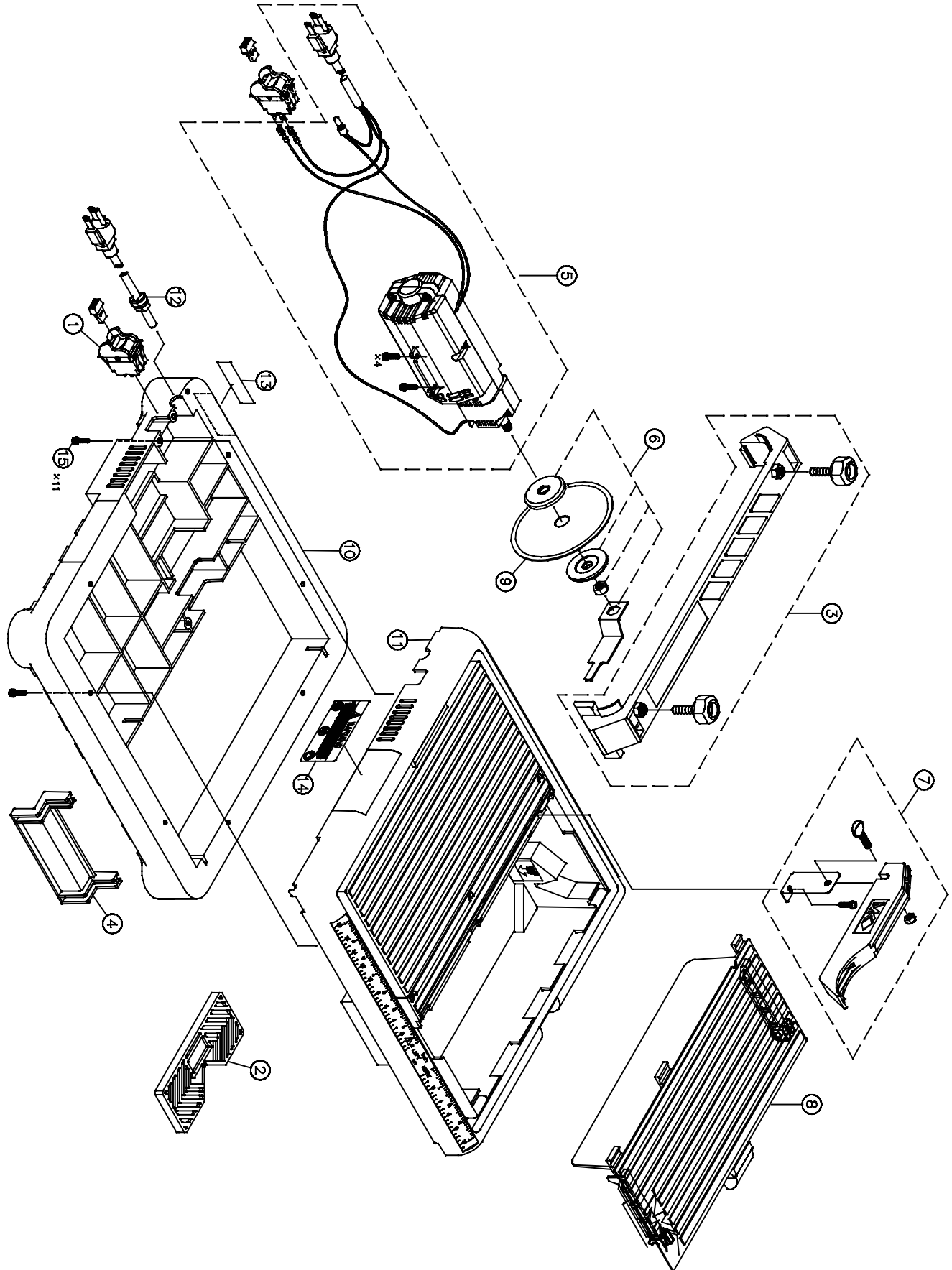

ITEM	DESCRIPTION	PART #
1	SWITCH	158303
2	DIAGONAL CUTTING GUIDE	158304
3	ADJUSTABLE CUTTING GUIDE	158305
4	TABLE STOP	158306
5	MOTOR ASSEMBLY	158307
6	FLANGE ASSEMBLY	158308
7	BLADE GUARD ASSEMBLY	158309
8	CUTTING TABLE COVER ASSEMBLY	158310
9	DIAMOND BLADE	158311
10	MK-145 MOLDED BASE	158312
11	MK-145 MOLDED TOP	158313
12	POWER CORD	158314
13	WARNING LABEL	158315
14	NAMEPLATE LABEL	158316
15	MOUNTING SCREWS (TOP TO BASE)	158317

THEORY OF DIAMOND BLADES

Diamond blades do not really cut; they grind the material through friction. Diamond crystals, often visible at the leading edge and sides of the rim/segment, remove material by scratching out particles of hard, dense materials, or by knocking out larger particles of loosely bonded abrasive material. This process eventually cracks or fractures the diamond particle, breaking it down into smaller pieces. As a result, a diamond blade for cutting soft, abrasive material must have a hard metal matrix composition to resist this erosion long enough for the exposed diamonds to be properly utilized. Conversely, a blade for cutting a hard, non-abrasive material must have a soft bond to ensure that it will erode and expose the diamonds embedded in the matrix. These simple principles are the foundation of “controlled bond erosion”



Types of Cutting

There are two basic types of cutting-Dry or Wet. The choice of which type of blade to use depends on:

- The requirements of the job
- The machine/tool utilizing the Diamond Blade
- The preference of the operator

In the case of DRY cutting, the overwhelming popularity and quantity of hand-held saws and the flexible nature of MK Diamond blades to professionally handle most ceramic, masonry, stone and concrete materials, make the DRY cutting blade a very attractive tool. When using a DRY blade, the user must be aware of distinct operating practices to ensure optimum performance. DRY cutting blades require sufficient airflow about the blade to prevent overheating of the steel core. This is best accomplished by shallow, intermittent cuts of the material with periods of “free-spinning” (for several seconds) between each cut, to maximize the cooling process.

For WET cutting applications, MK has the exact blade to compliment both the material to be cut and the wet cutting machine to be used. During cutting operations, liberal amounts of water act as a coolant to support the cutting effectiveness and longevity of the WET blade. Additionally, using water adds to the overall safety of cutting operations by keeping the dust signature down.

KNOW ALL YOU CAN ABOUT THE MATERIAL YOU WISH TO CUT

ITEM	PART #	DESCRIPTION	
1	158309	Blade Guard Assembly	
2.	158304	Diagonal Cutting Guide	
3.	158305	Adjustable Cutting Guide	
4.	158311	Diamond Blade	
5	152610	Ground Fault circuit Interrupter (Not Included)	

ORDERING INFORMATION

You may order MK Diamond products through your local MK Diamond distributor or, you may order direct from MK Diamond.

When ordering direct from MK Diamond, please have the following information ready before calling:

- The Model Number of the saw
- The Serial Number of the saw
- Where the saw was purchased and when
- The Part Number for the part(s) being ordered
- The Part Description for the part(s) being ordered

NOTE: Standard orders are \$50.00 or more when ordering direct from MK Diamond. A \$6.00 charge will be added to orders having a net billing value under \$50.00. A nominal handling fee of \$5.00 may apply to some orders.

All parts may be ordered by calling toll free to – 800 421-5830 or 310 539-5221 and asking for Customer Service. For technical questions, call – 800 474-5594.

RETURN MATERIALS POLICY

To expedite the service relative to the return of a product purchased through MK Diamond, please observe the following:

NOTE: When returning all items, they must have been purchased within the previous twelve (12) months.

- Have the Model Number of the saw
- Have the Serial Number of the saw
- Have the location of where the saw was purchased
- Have the date when the saw was purchased
- Contact Customer Service for approval to return the item(s)
- Obtain a Returned Goods Number (RGA) authorizing the return
- Follow the packaging instructions in the following section
- Ensure the RGA number is on the outside of the returned package
- Ensure your item(s) are prepaid to the destination

For returned items, call toll free to – 800 421-5830 or 310 539-5221 and ask for Customer Service.

PACKAGING INSTRUCTIONS

- Remove the Cutting Head and Support Angle Assembly
- Dry the saw before shipping
- When packing, include the following: Saw, Diamond Blade, Blade Guard and Support Angle Assembly and Adjustable Cutting Guide (Other Accessories are not required)
- Package the unit in its original container or one of comparable size (do not ship the unit partially exposed)
- Ensure all parts are secured in the packaging to prevent moving

AUTHORIZED SERVICE CENTERS

For quicker repair time, you may contact MK Diamond Customer Service, toll free, at 800 421-5830 or 310 539-5221 for the Authorized Service Center closest to you or visit our web site at www.mkdiamond.com. For technical questions, call – 800 474-5594.

CONTACT

Please contact MK Diamond Products, Inc. Customer Service Department with any questions you might have regarding distributors, parts or service.

Telephone: **(800) 421-5830**

Fax: **(310) 539-5158**

E-mail: **Customer_Service@MKDiamond.com**

Customer Service Hours: **Monday through Friday, 6AM-4PM PST**

MK Diamond Products, Inc.

1315 Storm Parkway

Torrance, CA 90501

MK DIAMOND PRODUCTS, INC. LIMITED WARRANTY

MK DIAMOND PRODUCTS, INC. will guarantee every machine they build, to be free from defects in material and workmanship for (1) one year from date of purchase. The obligation of MK DIAMOND PRODUCTS, INC. under this warranty is limited to the repair or replacement of any parts which, under normal use, prove to be defective in material or workmanship. The parts involved or the unit in question should be returned to MK DIAMOND PRODUCTS, INC. or to a point designated by us, transportation prepaid.

This warranty does not obligate us to bear the cost of labor or transportation charges in connection with replacement or repair of defective parts. Likewise, it shall NOT apply to any unit which has been subjected to misuse, neglect or accident. This warranty does NOT apply to any machine which has been repaired or altered outside our factory.

This warranty does NOT obligate MK DIAMOND PRODUCTS, INC., with respect to items not of our manufacture, such as engines, motors, hydraulics, etc., which are subject to their own guarantees and warranties.

We shall in no event be liable for consequential damages or contingent liabilities arising out of failure of any equipment or parts to operate properly.

© COPYRIGHT 2018, MK DIAMOND PRODUCTS, INC. ALL RIGHTS RESERVED.

The MK Diamond logo is a registered trademark of MK Diamond Products, Inc. and may not be used, reproduced, or altered without written permission. All other trademarks are the property of their respective owners and used with permission.

MK Diamond may have patents, patent applications, trade marks, copyrights of other intellectual property right covering this product in this document.

This manual MUST accompany the equipment at all times. This manual is considered a permanent part of the equipment and should remain with the unit if resold.

The information and specifications included in this publication were in effect at the time of approval for printing.

MK-145 TILE SAW
OWNER'S MANUAL & OPERATING INSTRUCTIONS



MK Diamond Products, Inc.

MK Diamond Products, Inc.
1315 Storm Parkway
Torrance, CA 90501

Toll-Free: (800) 421-5830
Phone: (310) 539-5221
Fax: (310) 539-5158
www.mkdiamond.com