

SILENT *Piano*TM
SH

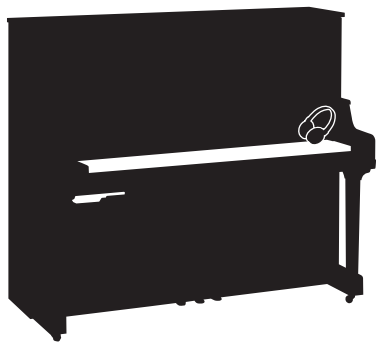

Owner's manual
Manuel de l'utilisateur
Bedienungsanleitung
Manual del propietario
Uso e manutenzione
使用说明书
Manual do Proprietário

IMPORTANT NOTICE FOR THE UNITED KINGDOM

Applies to power adaptor Connecting the Plug and Cord

IMPORTANT:

THE WIRES IN THE MAINS LEAD ARE COLOURED IN ACCORDANCE WITH THE FOLLOWING CODE:

BLUE: NEUTRAL

BROWN: LIVE

As the colours of the wires in the mains lead of this apparatus may not correspond with the coloured markings identifying the terminals in your plug, proceed as follows:

The wire which is coloured BLUE must be connected to the terminal which is marked with the letter N or coloured BLACK.

The wire which is coloured BROWN must be connected to the terminal which is marked with the letter L or coloured RED.

Make sure that neither core is connected to the earth terminal of the three pin plug.

FCC INFORMATION (U.S.A)

1. IMPORTANT NOTICE: DO NOT MODIFY THIS UNIT!

This product, when installed as indicated in the instructions contained in this manual, meets FCC requirements. Modifications not expressly approved by Yamaha may void your authority, granted by the FCC, to use the product.

2. IMPORTANT:

When connecting this product to accessories and/or another product use only high quality shielded cables. Cable/s supplied with this product MUST be used. Follow all installation instructions. Failure to follow instructions could void your FCC authorization to use to use this product in the USA.

3. NOTE:

This product has been tested and found to comply with the requirements listed in FCC Regulations, Part 15 for Class "B" digital devices. Compliance with these requirements provides a reasonable level of assurance that your use of this product in a residential environment will not result in harmful interference with other electronic devices. This equipment generates/uses radio frequencies and, if not installed and used according to the instructions found in the users manual, may cause interference harmful to the operation of other electronic devices. Compliance with FCC regulations does not guarantee that interference will not occur in all installations. If this product is found to be the source of interference, which can be determined by turning the unit "OFF" and "ON", please try to eliminate the problem by using one of the following measures:

Relocate either this product or the device that is being affected by the interference.

Utilize power outlets that are on different branch (circuit breaker or fuse) circuits or install AC line filter/s.

In the case of radio or TV interference, relocate/reorient the antenna. If the antenna lead-in is 300 ohm ribbon lead, change the lead-in to co-axial type cable.

If these corrective measures do not produce satisfactory results, please contact the local retailer authorized to distribute this type of product. If you can not locate the appropriate retailer, please contact Yamaha Corporation of America, Electronic Service Division, 6600 Orangethorpe Ave, Buena Park, CA 90620

The above statements apply ONLY to those products distributed by Yamaha Corporation of America and its subsidiaries.

Information for Users on Collection and Disposal of Old Equipment



This symbol on the products, packaging, and/or accompanying documents means that used electrical and electronic products should not be mixed with general household waste.

For proper treatment, recovery and recycling of old products, please take them to applicable collection points, in accordance with your national legislation and the Directives 2002/96/EC.

By disposing of these products correctly, you will help to save valuable resources and prevent any potential negative effects on human health and the environment which could otherwise arise from inappropriate waste handling.

For more information about collection and recycling of old products, please contact your local municipality, your waste disposal service or the point of sale where you purchased the items.

[For business users in the European Union]

If you wish to discard electrical and electronic equipment, please contact your dealer or supplier for further information.

[Information on Disposal in other Countries outside the European Union]

This symbol is only valid in the European Union. If you wish to discard these items, please contact your local authorities or dealer and ask for the correct method of disposal.

Information concernant la Collecte et le Traitement des déchets d'équipements électriques et électroniques



Le symbole sur les produits, l'emballage et/ou les documents joints signifie que les produits électriques ou électroniques usagés ne doivent pas être mélangés avec les déchets domestiques habituels.

Pour un traitement, une récupération et un recyclage appropriés des déchets d'équipements électriques et électroniques, veuillez les déposer aux points de collecte prévus à cet effet, conformément à la réglementation nationale et aux Directives 2002/96/EC.

En vous débarrassant correctement des déchets d'équipements électriques et électroniques, vous contribuerez à la sauvegarde de précieuses ressources et à la prévention de potentiels effets négatifs sur la santé humaine qui pourraient advenir lors d'un traitement inapproprié des déchets.

Pour plus d'informations à propos de la collecte et du recyclage des déchets d'équipements électriques et électroniques, veuillez contacter votre municipalité, votre service de traitement des déchets ou le point de vente où vous avez acheté les produits.

[Pour les professionnels dans l'Union Européenne]

Si vous souhaitez vous débarrasser des déchets d'équipements électriques et électroniques veuillez contacter votre vendeur ou fournisseur pour plus d'informations.

[Information sur le traitement dans d'autres pays en dehors de l'Union Européenne]

Ce symbole est seulement valable dans l'Union Européenne. Si vous souhaitez vous débarrasser de déchets d'équipements électriques et électroniques, veuillez contacter les autorités locales ou votre fournisseur et demander la méthode de traitement appropriée.

Verbraucherinformation zur Sammlung und Entsorgung alter Elektrogeräte



Befindet sich dieses Symbol auf den Produkten, der Verpackung und/oder beiliegenden Unterlagen, so sollten benutzte elektrische Geräte nicht mit dem normalen Haushaltsabfall entsorgt werden.

In Übereinstimmung mit Ihren nationalen Bestimmungen und den Richtlinien 2002/96/EC, bringen Sie alte Geräte bitte zur fachgerechten Entsorgung, Wiederaufbereitung und Wiederverwendung zu den entsprechenden Sammelstellen.

Durch die fachgerechte Entsorgung der Elektrogeräte helfen Sie, wertvolle Ressourcen zu schützen und verhindern mögliche negative Auswirkungen auf die menschliche Gesundheit und die Umwelt, die andernfalls durch unsachgerechte Müllentsorgung auftreten könnten.

Für weitere Informationen zum Sammeln und Wiederaufbereiten alter Elektrogeräte, kontaktieren Sie bitte Ihre örtliche Stadt oder Gemeindeverwaltung, Ihren Abfallentsorgungsdienst oder die Verkaufsstelle der Artikel.

[Information für geschäftliche Anwender in der Europäischen Union]

Wenn Sie Elektrogeräte ausrangieren möchten, kontaktieren Sie bitte Ihren Händler oder Zulieferer für weitere Informationen.

[Entsorgungsinformation für Länder außerhalb der Europäischen Union]

Dieses Symbol gilt nur innerhalb der Europäischen Union. Wenn Sie solche Artikel ausrangieren möchten, kontaktieren Sie bitte Ihre örtlichen Behörden oder Ihren Händler und fragen Sie nach der sachgerechten Entsorgungsmethode.

Información para Usuarios sobre Recolección y Disposición de Equipamiento Viejo



Este símbolo en los productos, embalaje, y/o documentación que se acompañe significa que los productos electrónicos y eléctricos usados no deben ser mezclados con desechos hogareños corrientes.

Para el tratamiento, recuperación y reciclado apropiado de los productos viejos, por favor llévelos a puntos de recolección aplicables, de acuerdo a su legislación nacional y las directivas 2002/96/EC.

Al disponer de estos productos correctamente, ayudará a ahorrar recursos valiosos y a prevenir cualquier potencial efecto negativo sobre la salud humana y el medio ambiente, el cual podría surgir de un inapropiado manejo de los desechos.

Para mayor información sobre recolección y reciclado de productos viejos, por favor contacte a su municipio local, su servicio de gestión de residuos o el punto de venta en el cual usted adquirió los artículos.

[Para usuarios de negocios en la Unión Europea]

Si usted desea deshacerse de equipamiento eléctrico y electrónico, por favor contacte a su vendedor o proveedor para mayor información.

[Información sobre la Disposición en otros países fuera de la Unión Europea]

Este símbolo sólo es válidos en la Unión Europea. Si desea deshacerse de estos artículos, por favor contacte a sus autoridades locales y pregunte por el método correcto de disposición.

Informazioni per gli utenti sulla raccolta e lo smaltimento di vecchia attrezzatura



Questo simbolo sui prodotti, sull'imballaggio, e/o sui documenti che li accompagnano significa che i prodotti elettriche e elettroniche non dovrebbero essere mischiati con i rifiuti domestici generici.

Per il trattamento, recupero e riciclaggio appropriati di vecchi prodotti, li porti, prego, ai punti di raccolta appropriati, in accordo con la Sua legislazione nazionale e le direttive 2002/96/CE.

Smaltendo correttamente questi prodotti, Lei aiuterà a salvare risorse preziose e a prevenire alcuni potenziali effetti negativi sulla salute umana e l'ambiente, che altrimenti potrebbero sorgere dal trattamento improprio dei rifiuti.

Per ulteriori informazioni sulla raccolta e il riciclaggio di vecchi prodotti, prego contatti la Sua amministrazione comunale locale, il Suo servizio di smaltimento dei rifiuti o il punto vendita dove Lei ha acquistato gli articoli.

[Per utenti imprenditori dell'Unione europea]

Se Lei desidera disfarsi di attrezzatura elettrica ed elettronica, prego contatti il Suo rivenditore o fornitore per ulteriori informazioni.

[Informazioni sullo smaltimento negli altri Paesi al di fuori dell'Unione europea]

Questo simbolo è validi solamente nell'Unione europea. Se Lei desidera disfarsi di questi articoli, prego contatti le Sue autorità locali o il rivenditore e richieda la corretta modalità di smaltimento.

Для инструментов с заземленным кабелем питания

ПРЕДУПРЕЖДЕНИЕ

Электропитание/кабель питания

- Подключайте только к электросети с соответствующим напряжением и защитным заземлением. Неправильное заземление может вызвать поражение электрическим током.

Беречь от воды

- Не держите инструмент там, где он может попасть под дождь, рядом с водой, а также в сырых и влажных помещениях. Не ставьте на него емкости с жидкостью, которая может пролиться и попасть в отверстия.

Беречь от огня

- Не ставьте на инструмент зажженные свечи и другие подобные предметы. Горящий предмет может упасть и вызвать пожар.

ВНИМАНИЕ!

Место установки

- При установке инструмента убедитесь в том, что используемая электрическая розетка легкодоступна. При возникновении какого-либо сбоя или неисправности немедленно отключите питание инструмента и отсоедините кабель питания от электросети. Даже если питание устройства отключено, инструмент продолжает в минимальном количестве потреблять электроэнергию. Если инструмент не используется в течение длительного времени, отсоедините кабель питания от электросети.

Для инструментов с незаземленным кабелем питания

ПРЕДУПРЕЖДЕНИЕ

Беречь от воды

- Не держите инструмент там, где он может попасть под дождь, рядом с водой, а также в сырых и влажных помещениях. Не ставьте на него емкости с жидкостью, которая может пролиться и попасть в отверстия.

Беречь от огня

- Не ставьте на инструмент зажженные свечи и другие подобные предметы. Горящий предмет может упасть и вызвать пожар.

ВНИМАНИЕ!

Место установки

- При установке инструмента убедитесь в том, что используемая электрическая розетка легкодоступна. При возникновении какого-либо сбоя или неисправности немедленно отключите питание инструмента и отсоедините кабель питания от электросети. Даже если питание устройства отключено, инструмент продолжает в минимальном количестве потреблять электроэнергию. Если устройство не используется в течение длительного времени, отсоедините кабель питания от электросети.

Для инструментов с блоком питания

ПРЕДУПРЕЖДЕНИЕ

Беречь от воды

- Не держите инструмент там, где он может попасть под дождь, рядом с водой, а также в сырых и влажных помещениях. Не ставьте на него емкости с жидкостью, которая может пролиться и попасть в отверстия.

Беречь от огня

- Не ставьте на инструмент зажженные свечи и другие подобные предметы. Горящий предмет может упасть и вызвать пожар.

ВНИМАНИЕ!

Место установки

- При установке инструмента убедитесь в том, что используемая электрическая розетка легкодоступна. При возникновении какого-либо сбоя или неисправности немедленно отключите питание инструмента и отсоедините кабель питания от электросети. Даже если кнопка питания находится в положении STANDBY, устройство продолжает в минимальном количестве потреблять электроэнергию. Если устройство не используется в течение длительного времени, отсоедините кабель питания от электросети.

部件名称	有毒有害物质或元素					
	铅 (Pb)	汞 (Hg)	镉 (Cd)	六价铬 (Cr (VI))	多溴联苯 (PBB)	多溴二苯醚 (PBDE)
外壳、框架	×	○	○	○	○	○
印刷线路板	×	○	○	○	○	○

○：表示该有毒有害物质在该部件所有均质材料中的含量均在SJ/T 11363-2006标准规定的限量要求以下。

×：表示该有毒有害物质至少在该部件的某一均质材料中的含量超出SJ/T 11363-2006标准规定的限量要求。

(此产品符合EU的RoHS指令。)

(この製品はEUのRoHS指令に適合しています。)

(This product conforms to the RoHS regulations in the EU.)

(Dieses Produkt entspricht der RoHS-Richtlinie der EU.)

(Ce produit est conforme aux réglementations RoHS de l'EU.)

(Este producto cumple con los requisitos de la directive RoHS en la UE.)



此标识适用于在中华人民共和国销售的电子信息产品。

标识中间的数字为环保使用期限的年数。

이 기기는 가정용(B급) 전자파적 합기기로서
주로 가정에서 사용하는 것을 목적
으로 하며, 모든 지역에서 사용할 수 있습니다.



SILENT *Piano*TM
SH

Owner's manual

SPECIAL MESSAGE SECTION

This product utilizes an external power supply (adaptor). DO NOT connect this product to any power supply or adaptor other than one described in the manual, on the name plate, or specifically recommended by Yamaha.



WARNING:

Do not place this product in a position where anyone could walk on, trip over, or roll anything over power cords or other connecting cords. The use of an extension cord is not recommended! If you must use an extension cord, the minimum wire size for a 25' cord (or less) is 18 AWG.



NOTE:

The smaller the AWG number, the larger the current handling capacity. For longer extension cords, consult a local electrician.

This product should be used only with the components supplied or; a cart, rack, or stand that is recommended by Yamaha. If a cart, etc., is used, please observe all safety markings and instructions that accompany the accessory product.



SPECIFICATIONS SUBJECT TO CHANGE:

The information contained in this manual is believed to be correct at the time of printing. However, Yamaha reserves the right to change or modify any of the specifications without notice or obligation to update existing units.

Do not attempt to service this product beyond that described in the user-maintenance instructions. All other servicing should be referred to qualified service personnel.

This product, either alone or in combination with an amplifier and headphones or speaker/s, may be capable of producing sound levels that could cause permanent hearing loss. DO NOT operate for a long period of time at a high volume level or at a level that is uncomfortable. If you experience any hearing loss or ringing in the ears, you should consult an audiologist.



IMPORTANT:

The louder the sound, the shorter the time period before damage occurs.

Some Yamaha products may have benches and/or accessory mounting fixtures that are either supplied as a part of the product or as optional accessories. Some of these items are designed to be dealer assembled or installed. Please make sure that benches are stable and any optional fixtures (where applicable) are well secured BEFORE using. Benches supplied by Yamaha are designed for seating only. No other uses are recommended.



NOTICE:

Service charges incurred due to lack of knowledge relating to how a function or effect works (when the unit is operating as designed) are not covered by the manufacturer's warranty, and are therefore the owners responsibility. Please study this manual carefully and consult your dealer before requesting service.



ENVIRONMENTAL ISSUES:

Yamaha strives to produce products that are both user safe and environmentally friendly. We sincerely believe that our products and the production methods used to produce them, meet these goals. In keeping with both the letter and the spirit of the law, we want you to be aware of the following:



Disposal Notice:

Should this product become damaged beyond repair, or for some reason its useful life is considered to be at an end, please observe all local, state, and federal regulations that relate to the disposal of products that contain lead, batteries, plastics, etc. If your dealer is unable to assist you, please contact Yamaha directly.

PLEASE KEEP THIS MANUAL

Introduction

Features

Yamaha's Innovative Silencing System

- The hammer shank stopper stops the movement of the hammer just before striking the string, and the optical sensor will catch keystroke information precisely. The internal tone generator receives the keystroke information and reproduces enrich sound of the piano.
- The noncontact optical sensor faithfully detects subtle movement of the keys without affecting the touch of the keys. You can enjoy the natural expression of the music.

Realistic Piano Voice

- The piano voice is faithfully sampled from the Yamaha CFX concert grand piano. You can enjoy the clear and beautiful tone of the piano.
- The piano voice is sampled with the binaural sampling* method. Even if you listen through headphones, you can enjoy the immersive sound, as if it sounds from the piano. In addition, you can enjoy the natural sound for a long time without straining the ear.
- The unit is equipped with various effects that reproduce the specific resonance of an acoustic piano (Damper Resonance, String Resonance, and Sustain Sample). You can also add subtle sound produced when the keys are released (Key-off Sample). By combining these, you can enjoy the realistic and rich piano sound even when used with the Silent Piano™ function.

* Binaural sampling: method that uses two microphones set at the ear position of a performer and records the sound from a piano as it is.

Useful Features for Lesson

- You can record your performance on the internal memory or commercially available USB storage device. Since you can record your performance as an audio data (WAV) as well as a MIDI data (USB Audio Recorder), it is now easy to create your own CDs or upload your performance to the net.
- The metronome is built in this unit. You can practice playing or record your performance more accurately with the metronome.
- Since the unit has two headphone jacks, you can practice sharing your performance with others, or enjoy a duet. The supplied headphones have an open type structure which reproduces the high-quality and clear sound.
- 50 masterpieces of piano are preset on the unit. The unit also comes with a corresponding music book "50 greats for the Piano."
- In addition to a piano voice, the unit has various voices of instruments, such as harpsichord or pipe organ.

Accessories

Check that the following items are supplied with your piano.

- AC adaptor (PA-150A/PA-150B/MU24-Y120200-A1 [upright piano], PJP-PS04/MU24-Y120200-A1 [grand piano] or an equivalent recommended by Yamaha) × 1
- Power cable × 1 *
- Headphones × 1
- Headphones hanger × 1
- Attachment screws for headphones hanger × 2
- Owner's manual × 1
- Music book "50 greats for the Piano" × 1

* Supplied only if the PJP-PS04 AC adaptor is supplied with your piano.

Installation

- ⚠ Avoid placing this instrument in direct sunlight, in close proximity to heating equipment or other high temperature areas, or in locations with a high degree of humidity.
- ⚠ Avoid placing this instrument in dusty or dirty areas.
- ⊘ Do not expose this instrument to spray or fumes.
- ⚠ Use only the specified AC adaptor. Use of other AC adaptors may result in damage, overheating, or fire.

Trademarks and Copyrights

- The contents of this owner's manual and the copyrights thereof are under exclusive ownership by Yamaha Corporation.
- Yamaha, Silent Piano, Silent, CFX, and Disklavier are trademarks of Yamaha Corporation.
- The company names and product names in this owner's manual are trademarks or registered trademarks of their respective companies.

Table of Contents

Chapter 1	Getting Started6	Chapter 6	Connecting to Other Devices33
	Part Names and Functions6		Connecting to Audio Devices.....33
	Connecting the AC Adaptor9		Connecting to MIDI Devices.....35
	Attaching the Headphones Hanger10		Connecting the USB Storage Device.....36
	Turning the Power On10		Connecting Powered Speakers [for Grand Piano].....37
	Turning the Power Off.....10		
Chapter 2	Playing the Piano11	Chapter 7	Using Various Functions38
	Using the Silent Piano™ Function11		Setting the Various Convenient Functions (Function Setup)38
	Selecting Voices12		Details on Each Function Setup Item40
	Applying the Reverb Effect14		Restoring the Default Settings.....45
	Using the Metronome15		Changing the Language Support for the Song File Name45
Chapter 3	Playing Back Songs16		Deactivating the Auto Power-off Function46
	Songs You Can Play on This Unit16	Chapter 8	Appendix47
	Playing Back the Demonstration Song.....17		Messages.....47
	Playing Back the Preset Song.....18		Troubleshooting.....48
	Playing Back the Song Recorded on the Internal Memory19		Preset Voice List.....49
	Playing Back the Song Saved on the USB Storage Device.....20		Song List.....50
	Operations during Playback.....22		Playback Sequence of Song Files on the USB Storage Device51
	Changing the Playback Tempo.....23		Specifications.....52
Chapter 4	Recording Your Performance24		Index53
	Recording Your Performance on the Internal Memory24		
	Recording Your Performance on the USB Storage Device.....26		XG Voice List D2
	Recording with the Metronome.....28		XG Drum Kit List..... D5
Chapter 5	Handling Song Files29		MIDI Data Format..... D7
	Copying a Song File to the USB Storage Device.....29		MIDI IMPLEMENTATION CHART D18
	Deleting a Song File31		

Getting Started

Part Names and Functions

■ Piano

Upright piano

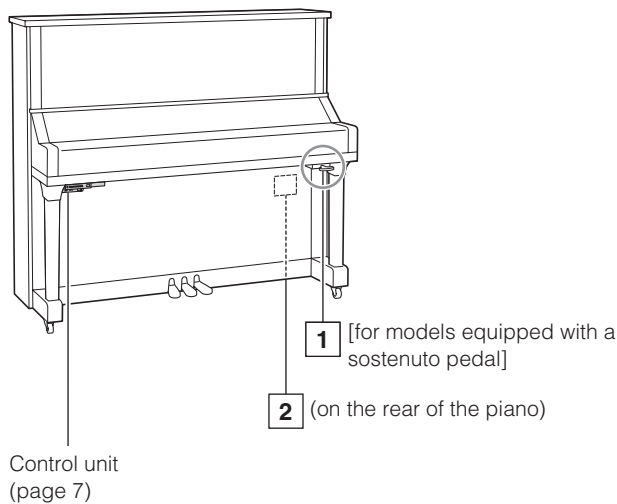

Grand piano

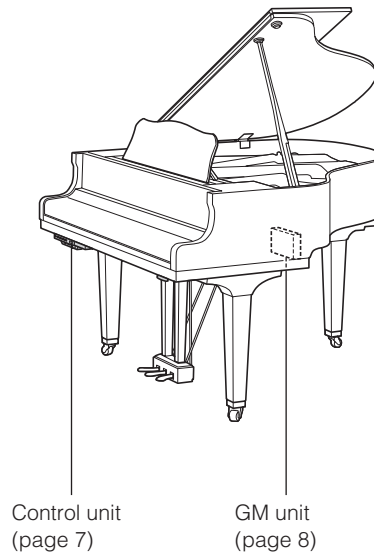

- 1 Silencing lever**
Activates the Silent Piano™ function (page 11).

- 2 DC12V jack**
Connect the supplied AC adaptor (page 9).

■ Pedals

Upright piano

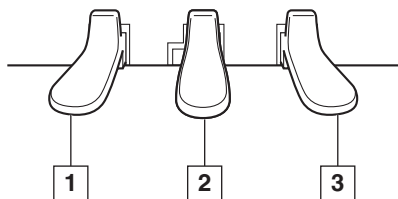

- 1 Soft pedal / shift pedal**
Reduces the volume and slightly changes the timbre notes played after the pedal is pressed.
When you select the Electric Piano voice, this pedal switches between on and off of the chorus effect.
When you select the Vibraphone voice, this pedal switches between on and off of the vibrato.
When you select the Jazz Organ voice, this pedal switches the rotary speaker speed (fast and slow).

Grand piano

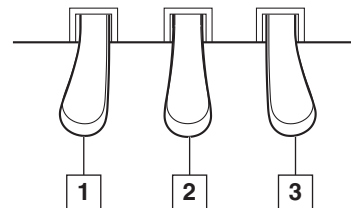

- 2 Silencing pedal**
[For models not equipped with a sostenuto pedal]
Activates the Silent Piano™ function (page 11).
- Sostenuto pedal**
[For models equipped with a sostenuto pedal]
Sustains the notes that are being played at that time even after you release the keys. Subsequently played notes are not affected.
- 3 Damper pedal**
Sustains notes even after you release the keys. While performing with the Piano voice, this recreates a sympathetic resonance occurs in the strings and soundboard on an acoustic piano (Damper Resonance effect). You can set the depth of this resonance in the Function Setup (page 38).

Part Names and Functions

■ Control unit (front panel)

Upright piano

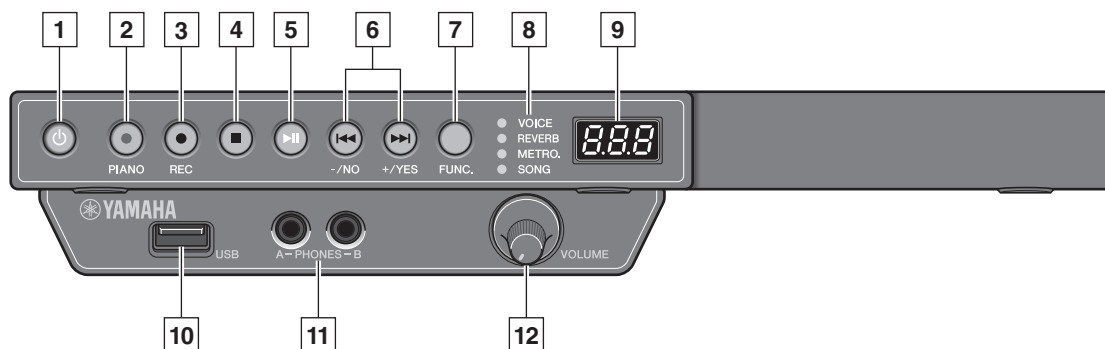

Grand piano

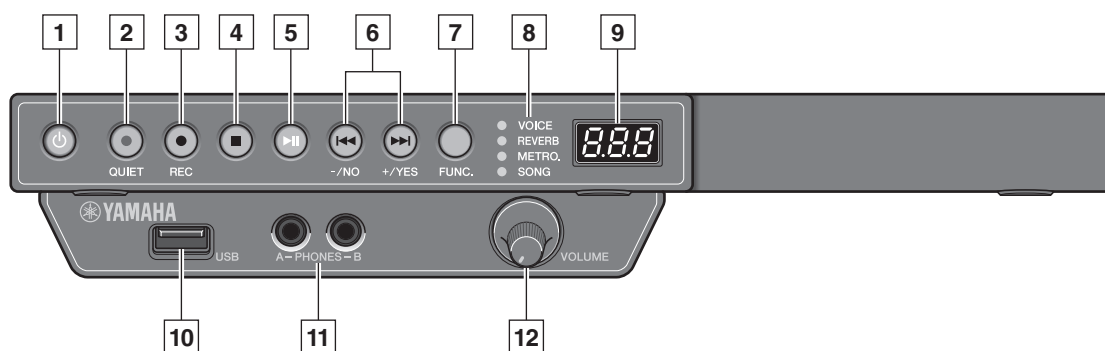
**1 POWER**  **button**

Turns the digital piano on and off.

2 PIANO button

[For upright pianos]

Switches the voice of the digital piano to the Piano voice.

QUIET button

[For grand pianos]

Activates the Silent Piano™ function (page 11).

3 REC button

Places the instrument in record standby mode.

4 STOP button

Stops playback.

5 PLAY/PAUSE button

Starts and pauses playback.

6 +/YES and -/NO buttons

Select songs, voices, and parameters, or set values of various settings.

7 FUNC. button

Switches the function. The function will be switched as follows each time you press this button.

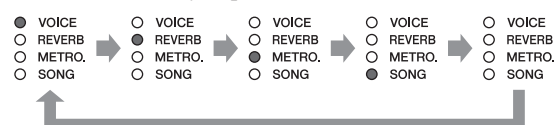
**8 Function indicators**

Show the selected function.

9 Display

Shows the voice number, song number, or values of various settings.

10 USB port

Connect the USB storage device (page 36).

11 PHONES jacks (stereo mini jack)

You can connect two stereo headphones, allowing you to share your playing with another person.

12 VOLUME knob

Adjusts the volume for headphones, the OUTPUT jacks (only for grand piano), and the AUX OUT jack (page 11).

Part Names and Functions

■ Control unit (bottom panel)

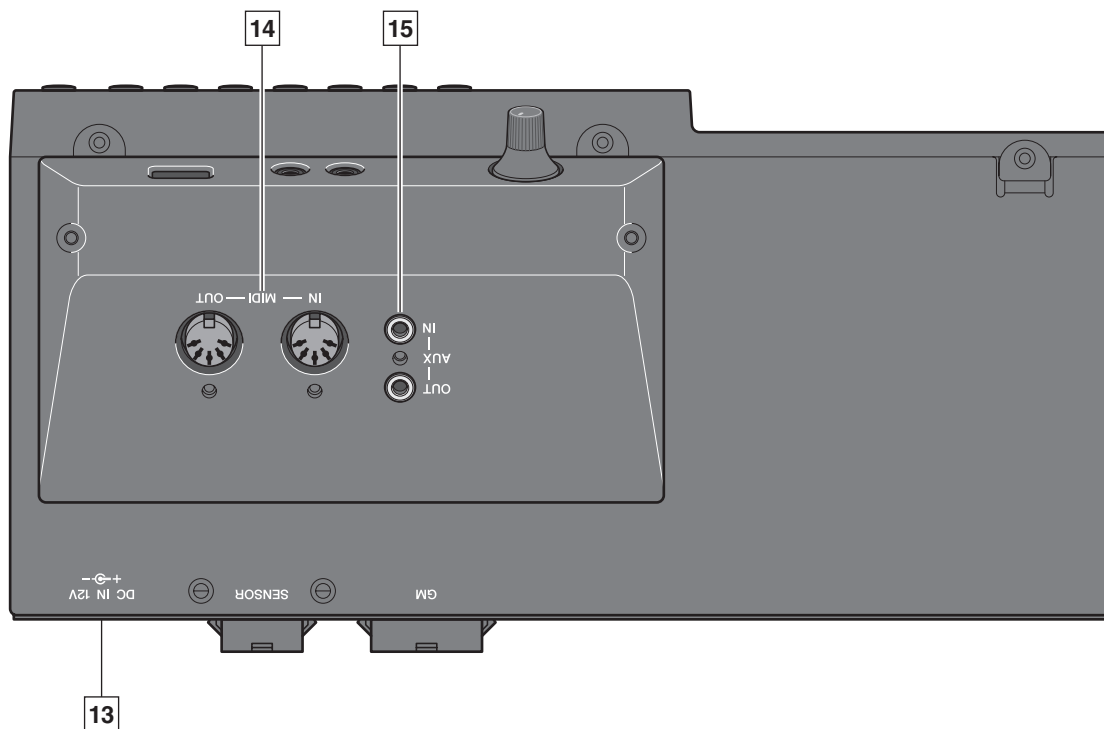
**13 DC IN 12V jack**

Connect the supplied AC adaptor (page 9).

14 MIDI IN/MIDI OUT jacks

Connect to the input or output jacks of external MIDI devices.

15 AUX IN/AUX OUT jacks (stereo mini jack)

Connect to the input or output jacks of external audio devices.

■ GM unit [for grand piano]

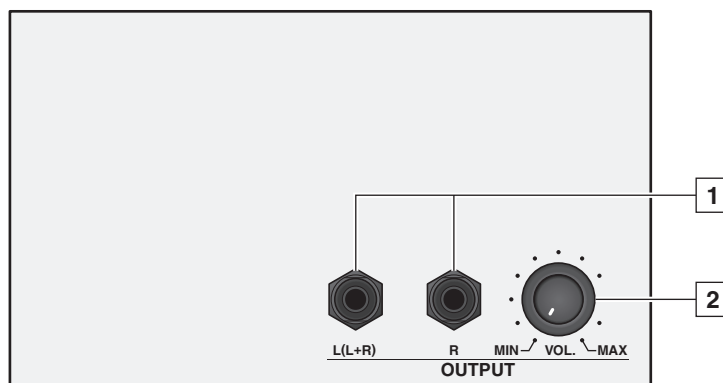
**1 OUTPUT L (L+R)/R jacks (TRS phone jack)**

Connect the optional powered speakers (page 37).

2 OUTPUT VOL. knob

Adjusts the volume for the OUTPUT L (L+R)/R jacks.

Connecting the AC Adaptor

■ Upright piano

Note

For some models, the PA-150B, PJP-PS04, or MU24-Y120200-A1 AC adaptor is supplied.

- 1** Connect the AC adaptor to the DC12V jack at the rear of the piano.
- 2** Loop the cord through the hook on the piano, as shown.
- 3** Connect the AC adaptor to the AC wall outlet.

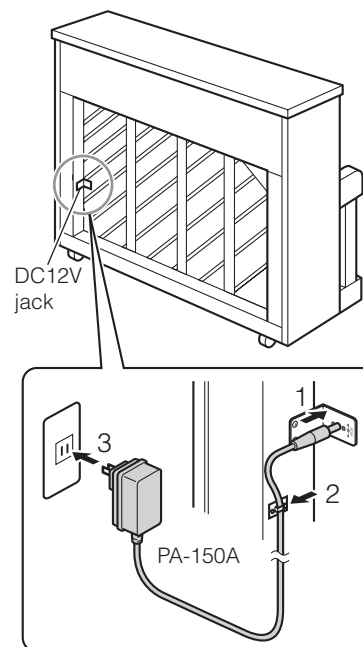

■ Grand piano

Note

For some models, the MU24-Y120200-A1 AC adaptor is supplied.

- 1** Connect the AC adaptor to the DC IN 12V jack at the rear of the control unit.
- 2** Connect the power cable to the AC adaptor.
- 3** Connect the power cable extended from the AC adaptor to the AC wall outlet.

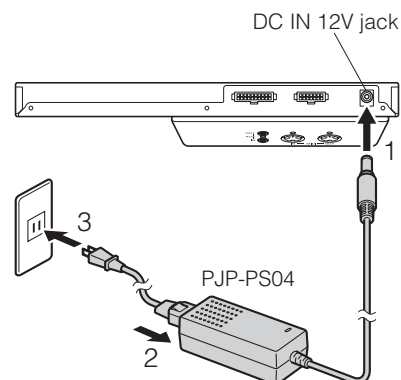

⚠ Warning

Use the Yamaha PA-150A/PA-150B/PJP-PS04/MU24-Y120200-A1 AC adaptor, or an equivalent recommended by Yamaha. Use of other AC adaptors may result in damage, overheating, or fire.

⚠ Caution

- Do not stretch the cord or bend its ends.
- Do not attempt to use the cord if it is stretched or if the ends of the cord have been bent. Attempting to do so may cause interruptions to the power supply.
- Always turn off the main unit power before disconnecting the AC adaptor.
- When you wish to move the piano, unplug the AC adaptor from the AC outlet and disconnect it from the DC12V or DC IN 12V jack before proceeding.
- Unplug the AC adaptor from the AC outlet if you do not intend to use the instrument for an extended period of time.

■ Notice for the AC adaptor (PA-150B)

Depending on your particular locale, the AC adaptor having a separable plug should be used. In this case, make sure to follow the explanations below for your safety.

If the plug is accidentally removed from the AC adaptor

Without touching the metallic section, slide the plug into place as shown below then push it in completely until you hear the click sound.

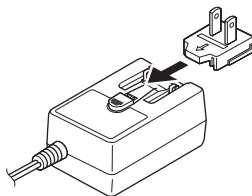

Slide the plug as indicated.

The shape of the plug differs depending on locale.

⚠ Warning

- Make sure to keep the plug attached to the AC adaptor. Using the plug alone can cause electric shock or fire.
- Never touch the metallic section when attaching the plug. To avoid electric shock, short circuit or damage, also be careful that there is no dust between the AC adaptor and plug.

Attaching the Headphones Hanger

Attach the hanger to the underside of the control unit with the two screws supplied.

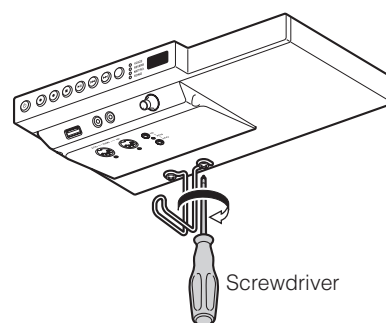

Turning the Power On

1 Press the POWER button.

The POWER lamp lights up.

The display shows the voice number "1" (Piano).



Note

- The sound is not output properly if you hold down the keyboard while turning the power on. Remove your hand from the keyboard when turning the power on.
- [For grand pianos] The Silent Piano™ function will be automatically activated and the QUIET lamp lights up when you turn the power on.

Turning the Power Off

After use, turn the power off.

1 Press the POWER button.

The POWER lamp turns off.



Playing the Piano

Using the Silent Piano™ Function

- 1** [For upright pianos not equipped with a sostenuto pedal]
Press the center pedal and slide it to the left.

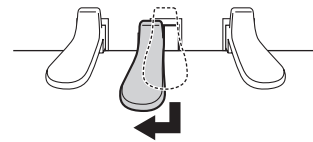

- [For upright pianos equipped with a sostenuto pedal]
Pull the silencing lever towards you until you hear a click and feel the mechanism catch.

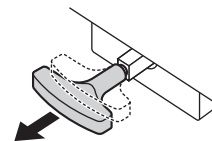

- [For grand pianos]
Press the QUIET button.

The QUIET lamp lights up and the Silent Piano™ function is activated.

Note

[For grand pianos] The Silent Piano™ function will be activated and the QUIET lamp lights up immediately after turning the power on. In that case, this operation is unnecessary.



- 2** **Plug the headphones into the PHONES jack.**

You can use two sets of headphones simultaneously.

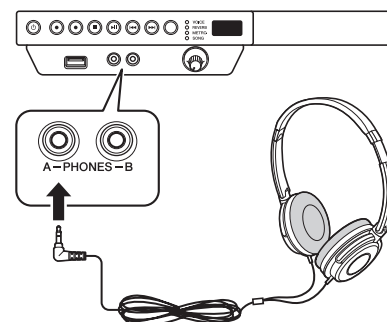

- 3** **Adjust the volume with the VOLUME knob.**

To set the appropriate volume, adjust it while playing the keyboard and listening to the sound.

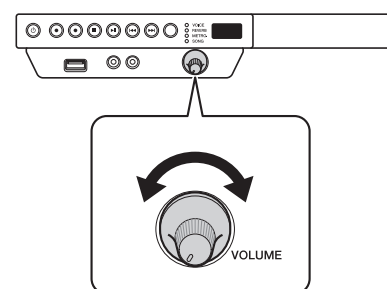

⚠ Caution

- To prevent damage to your hearing, refrain from raising the volume to excessive levels, and do not use the headphones for extended periods of time.
- Do not pull the headphone cord or apply excessive force on the plug. This can damage the headphone and lead to sound output malfunction.

Note

- The keying sound of the keyboard remains even though the Silent Piano™ function is activated.
- Adjusting the volume with the VOLUME knob affects the output level of headphones, the OUTPUT jacks (only for grand piano), and the AUX OUT jack.

Selecting Voices

When using the Silent Piano™ function, you can use the internal voices of this unit to perform with voices other than that of a piano.

1 Press the FUNC. button repeatedly to switch the function to VOICE.



The number of the currently selected voice appears on the display.

2 Press the +/YES or -/NO button to select the desired voice.

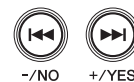

	Voice	Explanation
	Off	The unit does not use any voices.
	Piano	A piano sound sampled from the Yamaha CFX concert grand piano.
	Electric Piano 1	An electronic piano sound produced by an FM synthesizer.
	Electric Piano 2	The sound of an electric piano using hammer-struck metallic “tines.”
	Electric Piano 3	The sound of an electric piano widely used in rock and popular music.
	Harpichord 1	The sound of the instrument frequently used in baroque music.
	Harpichord 2	A harpsichord with an added upper octave.
	Vibraphone	Vibraphone played with relatively soft mallets
	Celesta	The sound of a celesta (a percussion instrument in which hammers strike metallic bars to produce sound).
	Pipe Organ 1	The voice featuring the combination of pipes (8'+4'+2') of a principal (brass instrument) organ.
	Pipe Organ 2	The voice featuring a full coupler of a pipe organ.
	Pipe Organ 3	A pipe organ sound that combines flute-type (woodwind type) stops of different pitches (8'+4').
	Pipe Organ 4	A pipe organ sound that combines flute-type (woodwind type) stops of different pitches (8'+4'+1-1/3').
	Jazz Organ	The sound of a “tonewheel” type electric organ.
	Strings	Stereo-sampled, large-scale strings ensemble with realistic reverb.
	Choir	A big, spacious choir voice.
	Synth Pad	A warm, mellow, and spacious synth sound.
	Piano + Strings	Combination of the Piano and Strings (with a slower attack) voices (dual voice).
	Piano + Synth Pad	Combination of the Piano and Synth Pad voices (dual voice).
	Piano + Electric Piano 1	Combination of the Piano and Electric Piano 1 voices (dual voice).

Note

You can recall the default voice setting (Piano) by pressing the +/YES and -/NO buttons simultaneously.

Note

- The voice setting reverts to its default setting when you turn the unit off.
- The selected voice applies only to the sound of your performance. It does not apply to the song playback.
- See “Preset Voice List” on page 49 for details on voices.

Selecting Voices

■ Using voice variations

The unit provides “voice variations” (alternate versions with effect) for your enjoyment when playing other voices than Piano.

1 Press the soft/shift pedal to alter the sound of the voice.

When you select the Electric Piano voice:

The pedal switches between on and off of the chorus effect.

When you select the Vibraphone voice:

The pedal switches between on and off of the vibrato.

When you select the Jazz Organ voice:

The pedal switches the rotary speaker speed (fast and slow).

Upright piano

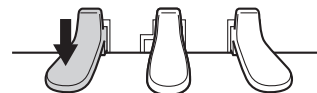

Grand piano



■ Changing the voice to that of a piano [for upright piano]

You can change the voice to that of a piano with the touch of a button.

1 Press the PIANO button.

The PIANO lamp lights up and the voice is changed to that of a piano.



Applying the Reverb Effect

A piano sounds differently depending on the size of the room, or the material of the building in which it is played. The reverberation is the major reason for this difference. Using the reverb functions and simulating the reverberation in a concert hall, gives you the feeling of the being at a live performance.

- 1 Press the FUNC. button repeatedly to switch the function to REVERB.**

The current depth setting appears on the display.

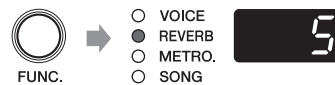

- 2 Hold the FUNC. button for a second to switch to the reverb type selection display.**

The currently selected reverb type blinks on the display.

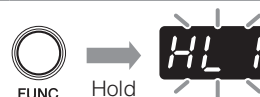

- 3 Press the +/YES or -/NO button to select the desired reverb type.**

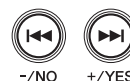

Reverb Type	Reverb Type	Explanation
	Room	Reverberation similar to that heard in a normal room.
	Hall 1	Reverberation similar to that heard in a small concert hall.
	Hall 2	Reverberation similar to that heard in a large concert hall.
	Stage	Reverberation similar to that heard on a stage.

Note

You can recall the default reverb type by pressing the +/YES and -/NO buttons simultaneously.

- 4 Press the FUNC. button to return to the reverb depth setting display.**



- 5 Press the +/YES or -/NO button to adjust the reverb depth.**

You can adjust the reverb depth in the range of 0 to 20. The reverb is off when you set the depth to 0.



Note

You can recall the default reverb depth by pressing the +/YES and -/NO buttons simultaneously.

Note

- The reverb setting (type and depth) does not revert to its default setting when you turn the unit off.
- The default reverb setting is different for each voice.

Using the Metronome

The unit features the built-in metronome that helps you to play at the accurate tempo.

- 1 Press the FUNC. button repeatedly to switch the function to METRO.**

The current tempo setting appears on the display.

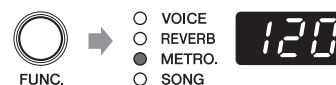

- 2 Press the PLAY/PAUSE button to start the metronome.**



- 3 Press the +/YES or -/NO button to change the tempo.**

You can change the tempo in the range of 5 to 500 (bpm).

Note

You can recall the default tempo setting (120) by pressing the +/YES and -/NO buttons simultaneously.

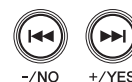

- 4 Hold the FUNC. button for a second to switch to the beat setting display.**

The current beat setting blinks on the display.

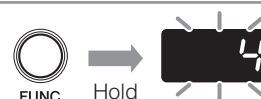

- 5 Press the +/YES or -/NO button to change the beat.**

You can change the beat in the range of 2 to 15, or 0.

The first beat is accented with the bell sound and the rest with clicks.

When the beat is set to 0, clicks sound on all beat.

Note

You can recall the default beat setting (0) by pressing the +/YES and -/NO buttons simultaneously.



- 6 Press the FUNC. button to return to the tempo setting display.**



- 7 Press STOP button to stop the metronome.**



Note

- The metronome setting (tempo and beat) reverts to its default setting when you turn the unit off.
- The tempo appears on the tempo setting display indicates the number of beats in a minute, and one beat represents a quarter. When you play a song written in different measure unit from quarter note, change the setting (e.g. when playing a song in 3/2, set beat to 6/4).
- You can also use metronome when recording your performance (page 28).
- You can adjust the volume of the metronome in the Function Setup (page 38).

Playing Back Songs

Songs You Can Play on This Unit

The unit can play the preset songs, songs you recorded, or commercially available songs. In this manual, they are collectively called “songs.” You can simply listen to these songs, but also practice playing along with the song playback.







■ Playable song data format

Song Format	MIDI song In a MIDI song, the information of your keyboard performance (such as keystroke and velocity) is recorded. This is not a recording of the actual sound. Based on the performance information, the tone generator outputs the sound.	Audio song An audio song is a recording of the actual sound performed.
File Format	SMF0 Standard MIDI File format 0 for playback and recording. MIDI songs recorded with this unit are saved in this format. SMF1 Standard MIDI File format 1 for playback only. ESEQ Format developed by Yamaha, for playback only.	WAV Audio file format commonly used in computers. The unit can play back 44.1kHz/16bit stereo WAV file. Audio songs recorded with this unit are saved in this format.
Extension	.MID / .EVT / .ESQ / .PLS / .KAR / .FIL	.WAV

Note

- Keys do not move during the song playback.
- Use headphones or commercially available powered speakers to listen to the song.
- You can also play back the music software for Disklavier purchased from the “Yamaha MusicSoft” website. For further information, refer to the following website:
Yamaha MusicSoft: <http://www.yamahamusicsoft.com/>

■ Playable song type (song category)

Song Category		Explanation
	Demonstration songs	The demonstration songs on the unit.
	Preset songs	The songs preset on the unit. These correspond to the score in the music book “50 greats for the Piano.”
	User songs on the internal memory	The MIDI songs you recorded and saved on the unit.
	USB MIDI (user songs)	The MIDI songs you recorded and saved on the USB storage device.
	USB MIDI (external songs)	The MIDI songs created with other instrument on the USB storage device.
	USB AUDIO (user songs)	The audio songs you recorded and saved on the USB storage device.
	USB AUDIO (external songs)	The audio songs created with other instrument on the USB storage device.

Note

Songs you recorded with this unit are called “user songs.” Songs created with other instrument are called “external songs.”

Playing Back the Demonstration Song

You can play back any of the demonstration songs stored in this unit.

- 1 Press the FUNC. button repeatedly to switch the function to SONG.**

The song number of the currently selected category appears on the display.

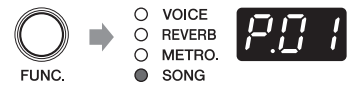

- 2 Hold the FUNC. button for a second to switch to the song category selection display.**

The currently selected song category blinks on the display.

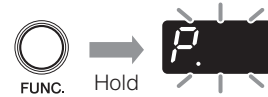

- 3 Press the +/YES or -/NO button to select "d." (demonstration songs).**



- 4 Press the FUNC. button to return to the song selection display.**



- 5 Press the +/YES or -/NO button to select the desired song number.**

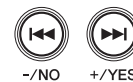

Song Number	Explanation
d.01 – d.03	Plays back only the selected song. When the playback advanced to the end of the selected song, playback stops.
Random playback	Plays back all demonstration songs continuously in random order.
All playback	Plays back all demonstration songs continuously in sequence.

Note

- You can recall the first song within the selected category by pressing the +/YES and -/NO buttons simultaneously.
- See "Demonstration songs" on page 50 for details on demonstration songs.

- 6 Press the PLAY/PAUSE button.**

Playback begins.

The PLAY/PAUSE lamp lights up and the time counter (measures) on the display advances.



See also "Operations during Playback" on page 22.

Playing Back the Preset Song

Besides the demonstration songs, 50 piano songs are preset in this unit. These correspond to the score in the music book “50 greats for the Piano.” This will help you to practice playing along with the song playback.

- 1 Press the FUNC. button repeatedly to switch the function to SONG.**

The song number of the currently selected category appears on the display.



- 2 Hold the FUNC. button for a second to switch to the song category selection display.**

The currently selected song category blinks on the display.



- 3 Press the +/YES or -/NO button to select “P.” (preset songs).**



- 4 Press the FUNC. button to return to the song selection display.**



- 5 Press the +/YES or -/NO button to select the desired song number.**



Song Number	Explanation
P.01 – P.50	Plays back only the selected song. When the playback advanced to the end of the selected song, playback stops.
Random playback	Plays back all preset songs continuously in random order.
All playback	Plays back all preset songs continuously in sequence.

Note

- You can recall the first song within the selected category by pressing the +/YES and -/NO buttons simultaneously.
- See “Preset songs” on page 50 for details on preset songs.

- 6 Press the PLAY/PAUSE button.**

Playback begins.

The PLAY/PAUSE lamp lights up and the time counter (measures) on the display advances.



See also “Operations during Playback” on page 22.

Playing Back the Song Recorded on the Internal Memory

Your performance that has been recorded as a MIDI song and saved on the internal memory can also be played back.

Note

To record your performance, see "Recording Your Performance on the Internal Memory" on page 24.

1 Press the FUNC. button repeatedly to switch the function to SONG.

The song number of the currently selected category appears on the display.

2 Hold the FUNC. button for a second to switch to the song category selection display.

The currently selected song category blinks on the display.

3 Press the +/YES or -/NO button to select "U." (user song on the internal memory).

4 Press the FUNC. button to return to the song selection display.

5 Press the +/YES or -/NO button to select the desired song number.

Song Number	Explanation
U.01 – U.10	Plays back only the selected song. When the playback advanced to the end of the selected song, playback stops.
Random playback	Plays back all user songs on the internal memory continuously in random order.
All playback	Plays back all user songs on the internal memory continuously in sequence.

Note

- You can recall the first song within the selected category by pressing the +/YES and -/NO buttons simultaneously.
- If you select an empty song (which contains no data), the song number and the blank indication (- - -) appears alternately on the display.
- If the internal memory contains no songs, "random playback" and "all playback" do not appear on the display.

6 Press the PLAY/PAUSE button.

Playback begins.
The PLAY/PAUSE lamp lights up and the time counter (measures) on the display advances.

See also "Operations during Playback" on page 22.

Playing Back the Song Saved on the USB Storage Device

Connecting commercially available USB storage device to the unit allows you to play back songs stored on that device.

1 Connect the USB storage device to the USB port at the front of the control unit.

For details, see “Connecting the USB Storage Device” on page 36.

2 Press the FUNC. button repeatedly to switch the function to SONG.

The song number of the currently selected category appears on the display.



3 Hold the FUNC. button for a second to switch to the song category selection display.

The currently selected song category blinks on the display.



4 Press the +/-YES or -/NO button to select desired category.



Song Category		Explanation
	USB MIDI (user songs)	The MIDI songs you recorded and saved on the USB storage device.
	USB MIDI (external songs)	The MIDI songs created with other instrument on the USB storage device.
	USB AUDIO (user songs)	The audio songs you recorded and saved on the USB storage device.
	USB AUDIO (external songs)	The audio songs created with other instrument on the USB storage device.

Note

If the USB storage device contains no external songs, song category for external songs (F. or C.) does not appear on the display.

5 Press the FUNC. button to return to the song selection display.



Playing Back the Song Saved on the USB Storage Device

6 Press the +/YES or -/NO button to select the desired song number.

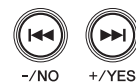

Song Number	Explanation
S.00 – S.99	Plays back only the selected song. When the playback advanced to the end of the selected song, playback stops.
F.00 – F.99	
100 – 399	
A.00 – A.99	
C.00 – C.99	
100 – 399	
Random playback	Plays back all songs in the selected category continuously in random order. (The example shows the USB MIDI user song category.)
All playback	Plays back all preset songs in the selected category continuously in sequence. (The example shows the USB MIDI user song category.)

Note

- You can recall the first song within the selected category by pressing the +/YES and -/NO buttons simultaneously.
- If you select the user songs that contains no data, the song number and the blank indication (- - -) appears alternately on the display.
- If the selected song category contains no songs, “random playback” and “all playback” do not appear on the display.

7 Press the PLAY/PAUSE button.

Playback begins.

The PLAY/PAUSE lamp lights up and the time counter (measures or time) on the display advances.



See also “Operations during Playback” on page 22.

Operations during Playback

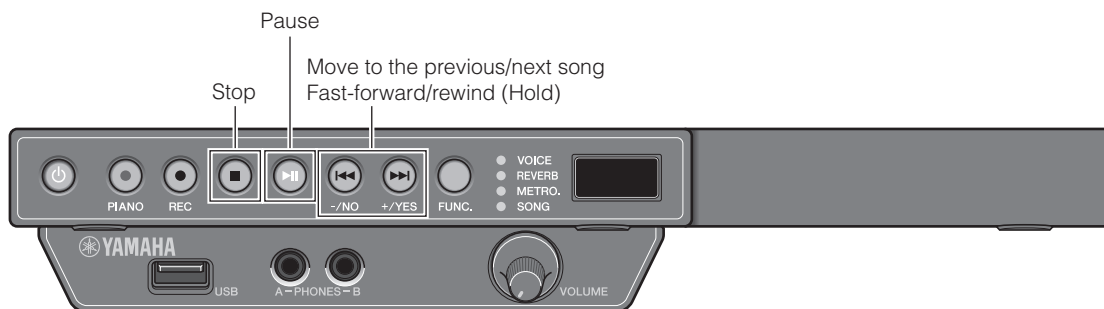

■ Pausing playback

You can pause playback and restart it from where the song was paused.

Press the PLAY/PAUSE button during playback. While playback is paused, the PLAY/PAUSE lamp blinks.

Press the PLAY/PAUSE button to restart playback again.

■ Stopping playback

You can stop playback and start it from the beginning of the song.

Press the STOP button during playback.

Press the PLAY/PAUSE button to start playback again.

■ Moving to the other song

To move to the previous song

Press the -/NO button at the beginning of the song, during playback or pause.

To move to the next song

Press the +/YES button during playback or pause.

To move to the beginning of the song

Press the -/NO button during playback or pause.

■ Fast-forward or rewind

Hold the +/YES or -/NO button during playback or pause.

Changing the Playback Tempo

You can speed up or slow down the playback tempo. Slowing down the playback tempo can be useful when practicing a difficult piano part.

- 1 During playback or pause, hold the FUNC. button for a second to switch to the tempo setting display.**

The current tempo setting blinks on the display.

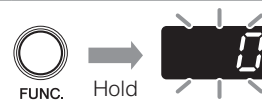

- 2 Press the +/-NO or +/-YES button to adjust the tempo.**

You can adjust the playback tempo in the range of -50 to +50 (%). Set 0 to revert to the original tempo.

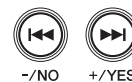

Note

- You can adjust the tempo relatively for the original one. For example, if you set 10% for the song of which tempo is 100 bpm, the song will be played back at 110 bpm (10% faster than the original).
- You can recall the original tempo by pressing the +/-YES and +/-NO buttons simultaneously.

- 3 Press the FUNC. button to return to the song playback display.**



Note

- The tempo reverts to its original tempo when you select another song.
- You cannot change the playback tempo of audio songs.

Recording Your Performance

Recording Your Performance on the Internal Memory

You can record your performance on the internal memory of the unit. Recorded performances are saved as a MIDI song (SMF0).

Note

- You can record up to 10 songs on the internal memory.
- You can record up to approximately 500 KB, which equates to a standard song of approximately 30 minutes in length, per one recording.
- The recorded performances are preserved even if you turn the unit off.
- You can also use metronome when recording your performance (page 28).

1 Press the FUNC. button repeatedly to switch the function to SONG.

The song number of the currently selected category appears on the display.

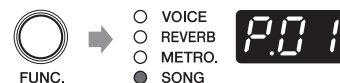

2 Hold the FUNC. button for a second to switch to the song category selection display.

The currently selected song category blinks on the display.

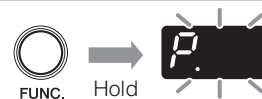

3 Press the +/-YES or -/NO button to select "U." (user song on the internal memory).



4 Press the FUNC. button to return to the song selection display.



5 Press the REC button.

The REC lamp blinks and the unit turns into the recording standby mode.

The smallest number of empty song (which contains no data) in the selected song category is automatically selected.



Note

- If there is no empty song, the last song on the internal memory is selected. The display shows the song number and "FUL" alternately.
- If the capacity of the memory is running out, "EnP" appears on the display. You can start recording, but the capacity may become full during recording. We recommend you to delete unnecessary files first (page 31), to ensure sufficient capacity.

Recording Your Performance on the Internal Memory

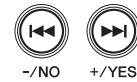
6 Press the +/YES and –/NO buttons to select the destination song number.**Note**

- If you select an empty song (which contains no data), the song number and the blank indication (- -) appears alternately on the display.
- Note that the new recording will erase the existing data if you select a song which contains data.
- To cancel recording, press the STOP or REC button.

7 Press the PLAY/PAUSE button.

Recording starts.

The REC and PLAY/PAUSE lamps light up and the time counter (measures) on the display advances.

8 Begin playing.**Note**

If the song being recorded exceeds the size limit (approximately 500 KB) during recording, "FUL" appears on the display and recording stops automatically. Press either the STOP, +/YES or –/NO button to save the data.

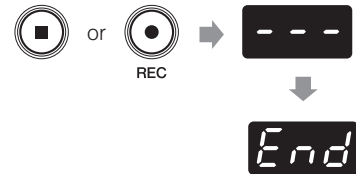
9 Stop playing, and press the STOP or REC button.

Recording stops.

When recording is stopped, dashes appear on the display indicating that recorded data is being saved.

If the data is successfully saved, "End" will appear on the display.

Then the song number will appear.

⚠ Caution

Do not turn the unit off while dashes appear on the display as this may corrupt the data or damage the internal memory.

Note

- If the capacity of the memory has run out during recording, "FUL" appears on the display and the data is not saved. Delete unnecessary files (page 31) and try again.
- If you stop recording without playing, the selected song will be deleted.

Recording Your Performance on the USB Storage Device

You can record your performance directly on the USB storage device. Recorded performances are saved as a MIDI song (SMF0) or an audio song (USB Audio Recorder, 44.1kHz/16bit stereo WAV).

Note

- You can record as much as the capacity of the USB storage device allows.
- You can record up to approximately 500 KB per one MIDI song recording and up to 80 minutes per one audio song recording.
- You can also use metronome when recording your performance (page 28).

1 **Connect the USB storage device to the USB port at the front of the control unit.**

For details, see “Connecting the USB Storage Device” on page 36.

2 **Press the FUNC. button repeatedly to switch the function to SONG.**

The song number of the currently selected category appears on the display.

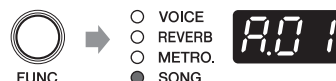

3 **Hold the FUNC. button for a second to switch to the song category selection display.**

The currently selected song category blinks on the display.

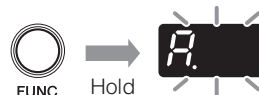

4 **Press the +/-YES or -/NO button to select desired category.**

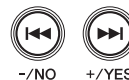

Song Category		Explanation
	USB MIDI (user songs)	Select this to record your performance as a MIDI song
	USB AUDIO (user songs)	Select this to record your performance as an audio song

5 **Press the FUNC. button to return to the song selection display.**



6 **Press the REC button.**

The REC lamp blinks and the unit turns into the recording standby mode.

The smallest number of empty song (which contains no data) in the selected song category is automatically selected.



Note

- If there is no empty song, “FUL” appears on the display.
- If the capacity of the USB storage device is running out, “EnP” appears on the display. You can start recording, but the capacity may become full during recording. We recommend you to delete unnecessary files first (page 31), to ensure sufficient capacity.

Recording Your Performance on the USB Storage Device

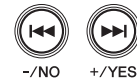
7 Press the +/YES or -/NO button to select the destination song number.**Note**

- If you select an empty song (which contains no data), the song number and the blank indication (- -) appears alternately on the display.
- Note that the new recording will erase the existing data if you select a song which contains data.
- To cancel recording, press the STOP or REC button.

8 Press the PLAY/PAUSE button.

Recording starts.

The REC and PLAY/PAUSE lamps light up and the time counter (measures or time) on the display advances.

9 Begin playing.**Note**

- [For MIDI song recording] If the song being recorded exceeds the size limit (approximately 500 KB) during recording, "FUL" appears on the display and recording stops automatically. Press either the STOP, +/YES or -/NO button to save the data.
- [For audio song recording] If the song being recorded exceeds the size limit (80 minutes) or the capacity of the USB storage device has run out during recording, "FUL" appears on the display and recording stops automatically. Press either the STOP, +/YES or -/NO button to save the data.
- [For audio song recording] The sound input from the AUX IN jack is also recorded.

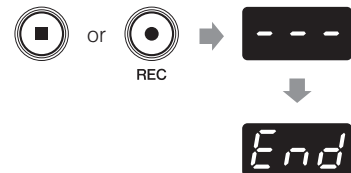
10 Stop playing, and press the STOP or REC button.

Recording stops.

When recording is stopped, dashes appear on the display indicating that recorded data is being saved.

If the data is successfully saved, "End" will appear on the display.

Then the song number will appear.

⚠ Caution

Do not turn the unit off while dashes appear on the display as this may corrupt the data or damage the USB storage device.

Note

- [For MIDI song recording] If the capacity of the USB storage device has run out during recording, "FUL" appears on the display and the data is not saved. Delete unnecessary files (page 31) and try again.
- [For MIDI song recording] If you stop recording without playing, the selected song will be deleted.
- [For audio song recording] If you stop recording without playing, a song with no sound will be saved.

Recording with the Metronome

You can use the metronome to record performance.

- 1 Press the FUNC. button repeatedly to switch the function to METRO.**

The current tempo setting appears on the display.

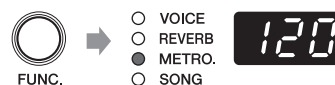

- 2 Press the PLAY/PAUSE button to start the metronome.**



- 3 Press the +/YES or -/NO button to change the tempo.**

You can change the tempo in the range of 5 to 500 (bpm).

Note

You can recall the default tempo setting (120) by pressing the +/YES and -/NO buttons simultaneously.

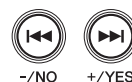

- 4 Hold the FUNC. button for a second to switch to the beat setting display.**

The current beat setting blinks on the display.

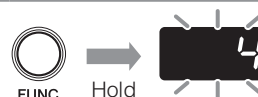

- 5 Press the +/YES or -/NO button to change the beat.**

You can change the beat in the range of 2 to 15, or 0.

The first beat is accented with the bell sound and the rest with clicks.

When the beat is set to 0, clicks sound on all beat.

Note

You can recall the default beat setting (0) by pressing the +/YES and -/NO buttons simultaneously.

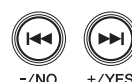

- 6 Press the FUNC. button to return to the tempo setting display.**



- 7 Start recording.**

See “Recording Your Performance on the Internal Memory” on page 24 or “Recording Your Performance on the USB Storage Device” on page 26.

Note

- The metronome also stops when recording stops.
- The metronome sound is not recorded.

Handling Song Files

Copying a Song File to the USB Storage Device

You can copy the user song on the internal memory to the USB storage device. You can use this function to make a backup on the USB storage device to protect your valuable music data.

Note

You can copy only the user song on the internal memory to the USB storage device.

- 1 Connect the USB storage device to the USB port at the front of the control unit.**

For details, see “Connecting the USB Storage Device” on page 36.

- 2 Press the FUNC. button repeatedly to switch the function to SONG.**

The song number of the currently selected category appears on the display.

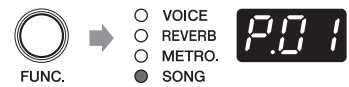

- 3 Hold the FUNC. button for a second to switch to the song category selection display.**

The currently selected song category blinks on the display.

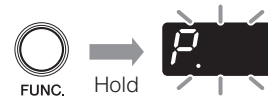

- 4 Press the +/YES or -/NO button to select “U.” (user song on the internal memory).**



- 5 Press the FUNC. button to return to the song selection display.**



- 6 Press the +/YES or -/NO button to select the desired song number.**

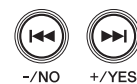

Continued on next page ➡

Copying a Song File to the USB Storage Device

7 Hold the REC button for 3 seconds.

“SAV” appears on the display.

Then the smallest number of empty song in the USB MIDI user song category and the blank indication (- - -) appears alternately on the display.

Note

- If there is no empty song in the USB MIDI user song category, “FUL” appears on the display and the song cannot be copied. Delete unnecessary files (page 31) and try again.
- You cannot copy demonstration songs or preset songs. If you try to copy such songs, “E01” or “Pro” appears on the display.

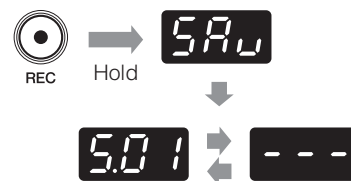

8 Press the +/YES or -/NO buttons to select the destination song number.

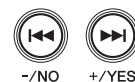

9 Press the FUNC. button.

“n-y” and “SAV” appears alternately on the display.



10 Press the +/YES button.

Copying starts.

Dashes appear on the display indicating that the selected song is being copied.

If the song is successfully copied, “End” will appear on the display.

⚠ Caution

Do not turn the unit off or disconnect the USB storage device while dashes appear on the display as this may corrupt the data or damage the internal memory and/or the USB storage device.

Note

To cancel copying, press the -/NO or STOP button.



Deleting a Song File

You can delete the user song on the internal memory or the USB storage device.

Note

You can delete only the user song on the internal memory or the USB storage device.

- To delete the song file stored on the USB storage device, connect the USB storage device to the USB port at the front of the control unit.**

For details, see “Connecting the USB Storage Device” on page 36.

- Press the FUNC. button repeatedly to switch the function to SONG.**

The song number of the currently selected category appears on the display.

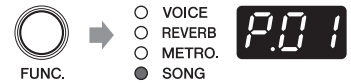

- Hold the FUNC. button for a second to switch to the song category selection display.**

The currently selected song category blinks on the display.

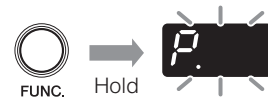

- Press the +/-NO or +/-YES button to select desired category.**

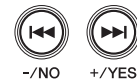

Song Category	Explanation
User song on the internal memory	Select this to delete the user song on the internal memory
USB MIDI (user songs)	Select this to delete the MIDI songs on the USB storage device
USB AUDIO (user songs)	Select this to delete the audio songs on the USB storage device

- Press the FUNC. button to return to the song selection display.**



- Press the +/-YES or +/-NO button to select the desired song number.**

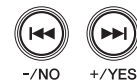

Continued on next page ➡

Deleting a Song File

7 Hold the REC and STOP buttons simultaneously for 3 seconds.

“n-y” and “dEL” appears alternately on the display.

Note

You cannot delete songs other than user songs. If you try to delete such songs, “E01” or “Pro” appears on the display.



↓ Hold

**8 Press the +/YES button.**

Deletion starts.

Dashes appear on the display indicating that the selected song is being deleted.

If the song is successfully deleted, “End” will appear on the display.

⚠ Caution

Do not turn the unit off or disconnect the USB storage device while dashes appear on the display as this may corrupt the data or damage the internal memory and/or the USB storage device.

Note

To cancel deleting, press the -/NO or STOP button.



Connecting to Other Devices

Connecting to Audio Devices

⚠ Caution

Be sure to turn the unit and audio devices off before attempting to connect them.

Note

The AUX IN or AUX OUT jack on this unit is a stereo mini jack. If your connection cable is not compatible, you will need to use an adaptor. Please use a nonresistant cable and adaptor.

■ Connecting to the AUX OUT jack

When connected to a compo system or IC recorder:

You can record performances played using the Silent Piano™ function.

When connected to powered speakers or a stereo system:

You can listen to performances played using the Silent Piano™ function. The signal output from this jack is the same sound as that heard when listening through headphones.

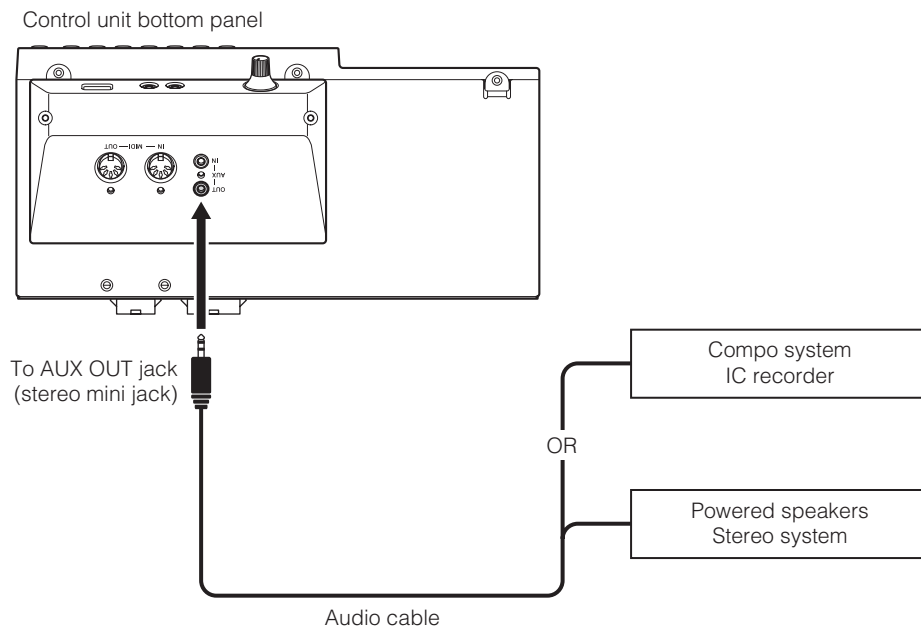

Note

Adjusting the volume with the VOLUME knob affects the output level of the AUX OUT jack.

Connecting to Audio Devices

■ Connecting to the AUX IN jack

When connected to other sound modules or playback devices (such as CD players):

You can use the Silent Piano™ function together with the sound received from the connected devices.

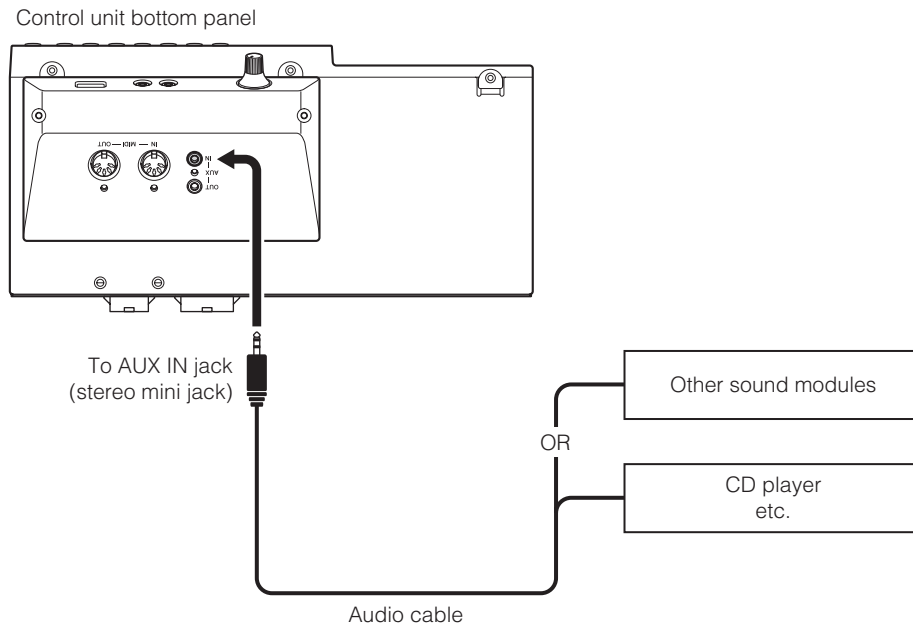
**⚠ Caution**

Do not route the output from the AUX OUT jack to the AUX IN jack. Doing so will cause feedback of the audio signal which may damage the unit and/or the connected device.

Note

- During the playback of audio songs, you cannot hear the sound input through the AUX IN jack.
- You can transpose (page 42) or fine tune (page 42) the pitch of the sound input through the AUX IN jack.

Connecting to MIDI Devices

⚠ Caution

Be sure to turn the unit and MIDI devices off before attempting to connect them.

■ Connecting to the MIDI OUT jack

When connected to other MIDI device:

You can reproduce the Silent Piano™ performances using sound modules such as synthesizers and other MIDI devices.

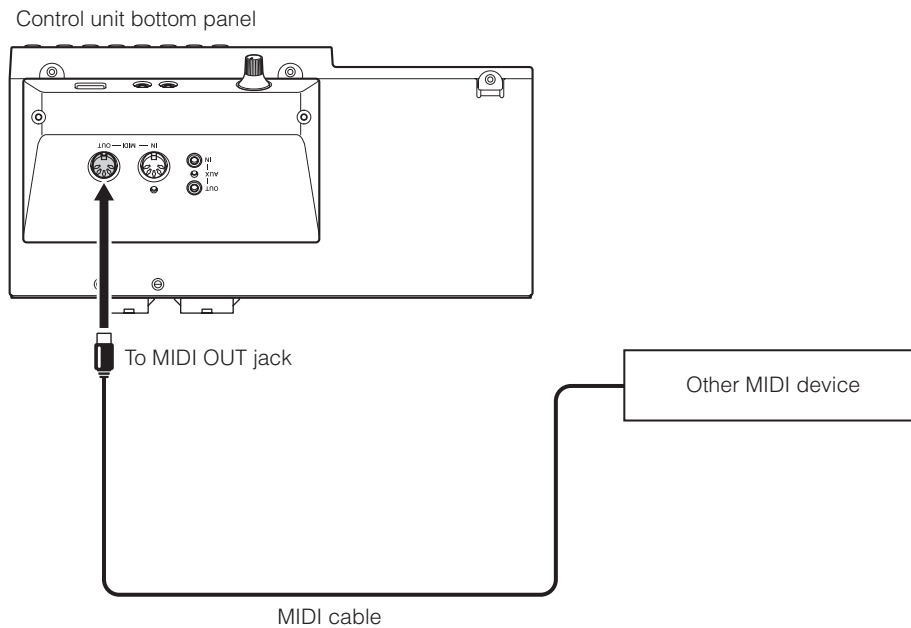

■ Connecting to the MIDI IN jack

When connected to a sequencer:

You can use the sound module of this unit to reproduce performance data received from connected devices.

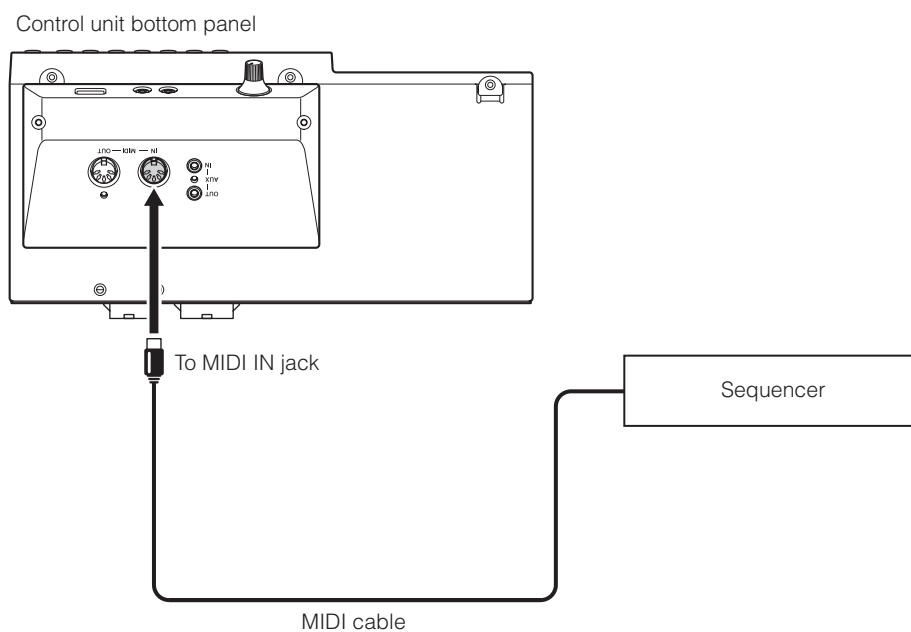

Connecting the USB Storage Device

Connecting commercially available USB storage device to the unit allows you save your performance, and playback songs stored on the device. Connect the USB storage device into the USB port at the front of the control unit.

⚠ Caution

- Do not remove the USB storage device or turn the unit on or off during data transfer as breakage may result.
- Do not insert and remove the USB storage device too frequently as breakage may result.
- Be careful not to bump the USB storage device with your legs when it is connected to the unit.
- Do not insert any objects other than the USB storage device into the USB port as it may become unusable.

Note

- Check that the USB storage device is free of memory and software protection before attempting to use it, as these kinds of protection will prohibit access to the memory.
- The unit is USB 1.1 compliant. You can also connect USB 2.0 devices, however data will be transferred at USB 1.1 speeds.
- You can use only one USB storage device with the unit.

■ Compatible devices

USB flash memory

You can use commercially available USB flash memories. The USB flash memory should be formatted in FAT16 or FAT32 file system.

Note

Yamaha does not assure the operation of the commercially available USB flash memories.

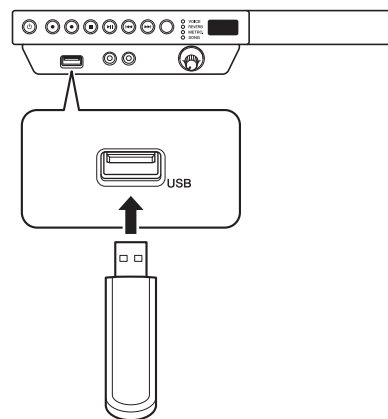

Connecting Powered Speakers [for Grand Piano]

The OUTPUT L (L+R)/R jacks let you connect the optional powered speakers. You can also use the OUTPUT VOL. knob to fine-adjust the volume of these jacks.

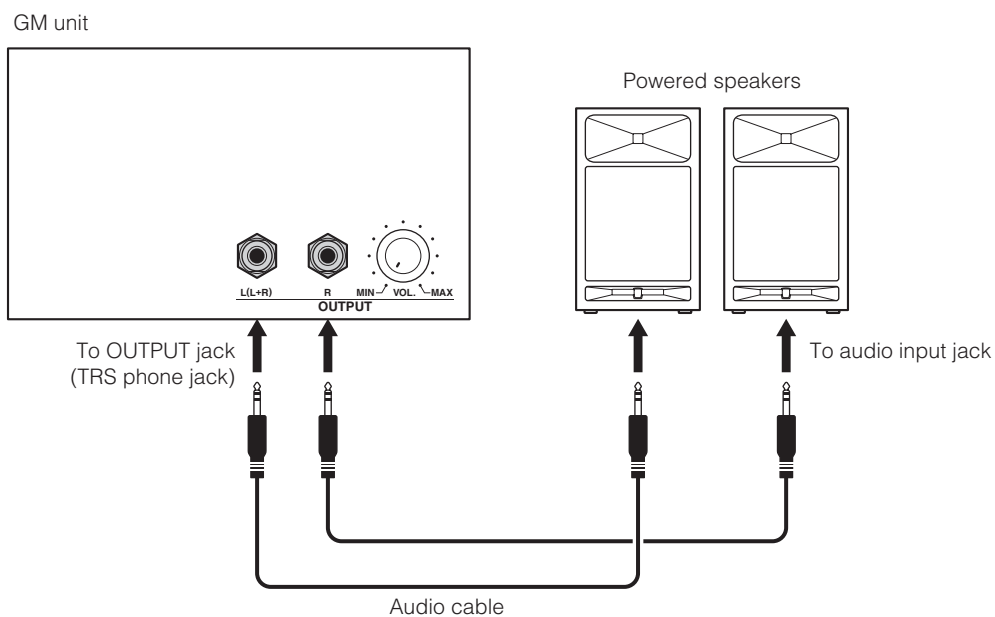

Note

- Adjusting the volume with the VOLUME knob also affects the output level of the OUTPUT L (L+R)/R jacks.
- If you want to output monaural sound with one speaker, connect it to the OUTPUT L (L+R) jack.

Using Various Functions

Setting the Various Convenient Functions (Function Setup)

To get the most out of your piano, set some of the various convenient functions, such as fine tuning of the pitch, adjusting the metronome volume, etc.

■ Function Setup items

Function Setup Item		Item Number	Page
Brilliance		F1	40
Touch	Touch Sensitivity	F2.1	40
	FIXED Velocity	F2.2	40
Keyboard	Keyboard Transpose	F3.1	40
	Keyboard Tuning	F3.2	40
Scale	Scale	F4.1	41
	Base Note	F4.2	41
Metronome Volume		F5	41
Song	Single Repeat	F6.1	41
	Song Balance	F6.2	42
	Song Transpose	F6.3	42
	Audio Tuning	F6.4	42
Acoustic Processing	Damper Resonance Depth	F7.1	42
	String Resonance Depth	F7.2	42
	Sustain Sample Depth	F7.3	43
	Key-off Sample Volume	F7.4	43
MIDI	MIDI Transmit Channel	F8.1	43
	Piano Playback Channel	F8.2	43
	Local Control	F8.3	44
	Program Change	F8.4	44
	Control Change	F8.5	44
Auto Power-off		F9	44

Setting the Various Convenient Functions (Function Setup)

■ Basic operations

- 1 Press the FUNC. button repeatedly to turn off all function indicators.**

The unit enters the Function Setup mode and the Function Setup item number appears on the display.

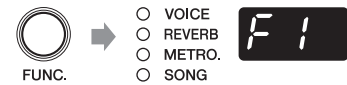

- 2 Press the +/YES or -/NO button to select the desired item.**



- 3 Hold the FUNC. button for a second to switch to the parameter setup display.**

The current parameter for the selected item blinks on the display.

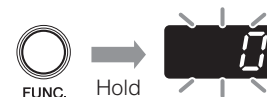

- 4 Press the +/YES or -/NO button to change the parameter.**

Note

You can recall the default parameter by pressing the +/YES and -/NO buttons simultaneously.



- 5 Press the FUNC. button to return to the item selection display.**



- 6 Press the FUNC. button again to exit the Function Setup mode.**

Details on Each Function Setup Item

■ Brilliance



You can adjust the timbre brilliance of the sound from mellow to bright.

Setting range	-2 (mellow)	The unit produces soft and mellow tone.
	-1 (mellow/normal)	The setting between mellow and normal.
	0 (normal)	The unit produces standard tone.
	1 (normal/bright)	The setting between normal and bright.
	2 (bright)	The unit produces bright tone.
Default setting		0 (normal)

Note

This setting does not revert to its default setting when you turn the unit off.

■ Touch Sensitivity



You can select the keyboard touch sensitivity. Select one to match different playing styles and preference.

Setting range	-2 (soft)	The unit produces maximum loudness with a light keystroke.
	-1 (soft/medium)	The setting between soft and medium.
	0 (medium)	The unit responds to a fairly standard keystroke.
	1 (medium/hard)	The setting between medium and hard.
	2 (hard)	The unit requires a quite hard keystroke to produce maximum loudness.
	Off (FIXED)	The unit produces all notes at the same volume regardless of the strength of keystroke.
Default setting		0 (medium)

Note

- You can set the velocity in "F2.2 FIXED Velocity" when Off (FIXED) is selected.
- This setting does not revert to its default setting when you turn the unit off.

■ FIXED Velocity



You can change the velocity when you select Off (FIXED) in the Touch Sensitivity setting.

Setting range	1 to 127
Default setting	64

Note

- This item does not appear when the parameter other than Off (FIXED) is selected in "F2.1 Touch Sensitivity."
- This setting does not revert to its default setting when you turn the unit off.

■ Keyboard Transpose



You can transpose the pitch of keyboard playing. Transposition can be set in semitone increments. For example, if you set the transposition amount to 5, playing C3 key produces pitch F3.

Setting range	-12 to 12
Default setting	0

■ Keyboard Tuning



You can fine tune the pitch of the keyboard in 0.2 Hz increments. This is useful when you play the piano along with other instruments.

Setting range	414.8 to 466.8 (Hz)
Default setting	440.0 (Hz)

Note

- The value appears as a two-digit number and one decimal place (e.g. "40.2" for 440.2 Hz).
- This setting does not revert to its default setting when you turn the unit off.

Details on Each Function Setup Item

■ Scale

F4.1

Certain genres of music are composed based on scales other than equal temperament, which is the common piano tuning scale. You can enjoy various scales with this setting.

Setting range	1 (equal temperament)	One octave is divided into twelve equal intervals. Currently the most popular piano tuning scale.
	2 (pure temperament major)	Based on natural overtones, three major chords using these scales produce a beautiful, pure sound.
	3 (pure temperament minor)	
	4 (Pythagorean temperament)	This scale, designed by Pythagoras, a Greek philosopher, is based on the interval of a perfect 5th. The 3rd produces swells, but the 4th and 5th are beautiful and suitable for some leads.
	5 (meantone temperament)	This scale is an improvement of the Pythagorean in that the swell of the 3rd has been eliminated. The scale became popular during the late 16th century through the late 18th century.
	6 (Werckmeister temperament)	These scales combine meantone temperament and Pythagorean temperament in different ways. With these scales, modulation changes the impression and feel of the songs. They were often used in the era of Bach and Beethoven. They are often used today to reproduce the music of that era on harpsichords.
	7 (Kirnberger temperament)	
Default setting		1 (equal temperament)

Note

This setting does not revert to its default setting when you turn the unit off.

■ Base Note

F4.2

You need to specify the root when you select a scale other than equal temperament in the Scale setting.

Setting range	C, C#, D, E ♭, E, F, F#, G, A ♭, A, B ♭, B
Default setting	C

Note

- This item does not appear when 1 (equal temperament) is selected in "F4.1 Scale."
- Upper bar indicates the sharp note, and lower bar indicates the flat note.

E[♯] (C#)E_♭ (E ♭)

- This setting does not revert to its default setting when you turn the unit off.

■ Metronome Volume

F5

You can adjust the volume of the metronome.

Setting range	1 to 20
Default setting	15

■ Single Repeat

F6.1

You can play back the currently selected song repeatedly.

Setting range	On, Off
Default setting	Off

Note

This setting is deactivated during random playback or all playback.

Details on Each Function Setup Item

■ Song Balance

F6.2

You can adjust the volume balance between keyboard playing and song playback (MIDI and audio). Increase the value to reduce the volume of keyboard playing. Decrease the value to reduce the volume of song playback.

Setting range	-64 to 64
Default setting	0

Note

- The original volume balance is set for some PianoSoft songs. During the playback of such songs, priority is given to their original volume balance.
- The piano sound of PianoSoft songs (including the demonstration and preset songs on the unit) is recognized as keyboard playing. Therefore, increasing this value reduces the volume of the piano sound.
- This setting does not revert to its default setting when you turn the unit off.

■ Song Transpose

F6.3

You can transpose the pitch of song playback (MIDI and audio) or sound input through the AUX IN jack. Transposition can be set in semitone increments. For example, if you set the transposition amount to 5, playing C3 key produces pitch F3.

Setting range	-12 to 12
Default setting	0

■ Audio Tuning

F6.4

You can fine tune the pitch of audio song playback or sound input through the AUX IN jack in 1 cent increments.

Setting range	-50 to 50 (cent)
Default setting	0 (cent)

Note

100 cents is equal to one semitone.

■ Damper Resonance Depth

F7.1

You can set the depth of the Damper Resonance effect, which is applied when you press the damper pedal. This setting is effective for the Piano voice.

Setting range	0 to 10
Default setting	5

Note

This setting does not revert to its default setting when you turn the unit off.

■ String Resonance Depth

F7.2

You can set the depth of the String Resonance effect. This setting is effective for the Piano voice.

Setting range	0 to 10
Default setting	5

Note

This setting does not revert to its default setting when you turn the unit off.

String Resonance

When the hammer of an acoustic piano strikes the string, other strings will resonate, creating an expressive tone. The effect that reproduces this resonance is called "String Resonance effect."

This effect reproduces the natural resonance on the strings of the keys that are already held down when you play the keyboard.

Details on Each Function Setup Item

■ Sustain Sample Depth

F7.3

You can set the depth of the Sustain Sample effect, which is applied when you press the damper pedal. This setting is effective for the Piano voice.

Setting range	0 to 10
Default setting	5

Note

This setting does not revert to its default setting when you turn the unit off.

Sustain Sample

The sample of the unique change in tone of resonance on the strings and soundboard of an acoustic piano when you press the damper pedal.

■ Key-off Sample Volume

F7.4

You can set the volume of the Key-off Sample. This setting is effective for the Piano voice.

Setting range	0 to 10
Default setting	5

Note

This setting does not revert to its default setting when you turn the unit off.

Key-off Sample

The sample of the subtle noises produced when you release your finger from the keyboard.

■ MIDI Transmit Channel

F8.1

You can assign the channel on which the unit transmits the MIDI data of keyboard playing.

Setting range	1 to 16	The unit transmits the MIDI data of keyboard playing on assigned channel.
	Off	The unit does not transmit the MIDI data.
Default setting		1

Note

- When you use the dual voices, the first voice data is transmitted on the specified channel. The second voice data is transmitted on the next channel to the specified one.
- This setting does not revert to its default setting when you turn the unit off.

■ Piano Playback Channel

F8.2

You can assign the desired channel that is played back as a piano part when the unit receives the MIDI data.

Setting range	Off	The unit plays back the MIDI data from the external MIDI device as a song part.
	1	The unit plays back the 1 channel of the MIDI data from the external MIDI device as a piano part.
	1-2	The unit plays back the 1 and 2 channels of the MIDI data from external MIDI device as piano parts
Default setting		Off

Note

This setting does not revert to its default setting when you turn the unit off.

Details on Each Function Setup Item

■ Local Control

F8.3

You can select whether the keyboard playing data is transmitted to the internal tone generator of the unit.

Setting range	On	The keyboard playing data is transmitted to the internal tone generator. The note you played on the keyboard is reproduced with the internal tone generator of the unit.
	Off	The keyboard playing data is not transmitted to the internal tone generator. The note you played on the keyboard is reproduced on the external MIDI device.
Default setting		On

■ Program Change

F8.4

You can select whether the unit transmits or receives program change numbers.

Setting range	On	The unit transmits or receives program change numbers.
	Off	The unit does not transmit or receive program change numbers.
Default setting		On

Note

- For details on program change numbers, see “MIDI Data Format” on page D7.
- This setting does not revert to its default setting when you turn the unit off.

■ Control Change

F8.5

You can select whether the unit transmits or receives control change messages.

Setting range	On	The unit transmits or receives control change messages.
	Off	The unit does not transmit or receive control change messages.
Default setting		On

Note

- For details on control change messages, see “MIDI Data Format” on page D7.
- This setting does not revert to its default setting when you turn the unit off.

■ Auto Power-off

F9

You can turn the power off automatically if you do not operate the unit for 30 minutes with the auto power-off function. You can activate or deactivate the auto power-off function.

Setting range	On	The auto power-off function is activated. The unit is automatically turned off if you do not operate it for 30 minutes.
	Off	The auto power-off function is deactivated. Use the POWER  button to turn the unit off.
Default setting		On

Note

This setting does not revert to its default setting when you turn the unit off.

Restoring the Default Settings

You can erase the backup of all settings made and restore the factory default settings.

- 1 While holding the **STOP** button, press the **POWER** button to turn the unit on.

“CLr” appears on the display and all settings are reset to factory default.

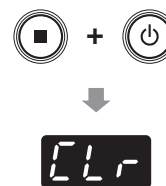

⚠ Caution

DO NOT turn the unit off while “CLr” appears on the display as may corrupt the data or damage the internal memory.

Note

The user songs on the internal memory will be retained.

Changing the Language Support for the Song File Name

Depending on this setting, folders or files the unit can recognize vary.

Setting	Explanation
International	Folders or files named in alphabet and umlaut can be recognized.
Japanese	Folders or files named in alphabet and Japanese can be recognized.

- 1 To change this setting to **International**, while holding the **FUNC.** and **-/NO** buttons simultaneously, press the **POWER** button to turn the unit on.

“Int” appears on the display and the setting is changed to International.

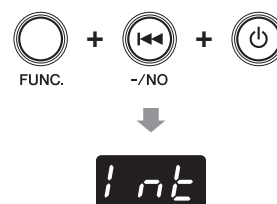

- To change this setting to **Japanese**, while holding the **FUNC.** and **+ /YES** buttons simultaneously, press the **POWER** button to turn the unit on.

“JA” appears on the display and the setting is changed to Japanese.

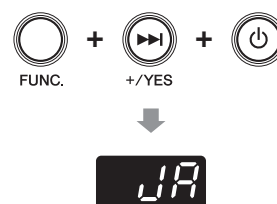

Note

This setting does not revert to its default setting when you turn the unit off.

Deactivating the Auto Power-off Function

- 1 While holding the **FUNC.** button, press the **POWER** button to turn the unit on.















“PoF” appears on the display and the auto power-off function is deactivated.



Note

If you deactivate the auto power-off function with this step, “F9 Auto Power-off” in Function Setup (page 44) is automatically set to off.

Messages

Message	Situation	Remedy
	The unit is being initialized to the factory default settings.	DO NOT turn the unit off when “CLR” appears in the display.
	The song file is not compatible with the unit, or the song file may be damaged.	You cannot select this song file.
	The USB storage device is protected.	Unprotect the USB storage device.
	The capacity of the USB storage device becomes full.	Delete unnecessary files on the USB storage device (page 31), or use another USB storage device with sufficient capacity.
	The number of files and folders exceeds the system limit.	Delete unnecessary files on the USB storage device (page 31).
	Audio song playback or recording has failed.	If you are using a USB storage device to which data has already been stored or deleted a number of times, first make sure that the device does not contain important data, then format it and connect to the unit again.
	A malfunction has occurred in the unit.	Contact your nearest Yamaha dealer or authorized distributor.
	The capacity of the internal memory on the unit or the USB storage device is running out.	Delete unnecessary files to ensure sufficient capacity before starting recording (page 31).
	The internal memory is being cleaned up. All settings made and user song files on the internal memory are being cleared, because the power has been turned off before the operations were completed.	DO NOT turn the unit off when “FCL” appears in the display.
	The capacity of the internal memory on the unit or the USB storage device is insufficient, and the operation cannot be completed.	Delete unnecessary files to ensure sufficient capacity before starting recording (page 31).
	You tried to overwrite or delete a protected song.	You cannot overwrite or delete a protected song.
	You tried to overwrite a read-only file.	Cancel the read-only setting for the file.
	The USB storage device connected to the unit is unformatted.	Format the USB storage device using a computer.
	The overcurrent is induced in the USB storage devices.	Disconnect the device from the USB port, and then turn the unit on again.
	The unit cannot communicate with the USB storage device connected.	Disconnect the USB storage device and connection it again. If the message still appears even when the USB storage device is connected properly, the device may be damaged.
	This USB storage device connected to the unit is not supported on the unit.	Try another USB storage device.
	The number of the USB storage devices connected exceeds the system limit.	You can use only one USB storage device with the unit.

Troubleshooting

If you have problems with the unit, here are a few troubleshooting tips. If you cannot solve the problem easily yourself, consult your Yamaha piano dealer. **DO NOT** attempt to repair the piano or the AC adaptor yourself.

Symptom	Cause	Remedy
The unit does not turn on.	The AC adaptor may not be plugged in correctly.	Insert the AC adaptor firmly into the DC12V or DC IN 12V jack and AC outlet (page 9).
The unit turns on but no sound is heard.	The VOLUME knob may be turned to the far left position.	Adjust the setting to an optimal level (page 11).
	The voice is set to Off.	Select the voice (page 12).
The pedal has no effect.	The pedal sensor may not be connected correctly.	Connect the cable firmly to the SENSOR jacks on the rear of the control unit.
The acoustic piano emits sound when I am using the Silent Piano™ function to play.	Playing with extreme force may result in sound being emitted from the acoustic piano.	Moderate the strength of your playing.
The balance or volume varies when listening through commercially available headphones.	Headphone properties differ depending on their type, so different headphones may have different balance or volume characteristics.	Use the same type of headphones for optimum performance.
I can hear a rattling sound from the piano body when playing with the Silent Piano™ function.	This is not a fault. This is the sound of the acoustic piano's keystroke.	
When I play a rapid series of notes with the Silent Piano™ function, a loud sound is emitted that is not part of the performance.	This is not a fault. The structure of the Silent Piano™ causes this to occur in some cases.	
Sound is not output properly or evenly.	Since the keyboard was held down when turning on the unit, the unit detects the keyboard position incorrectly.	Turn off the unit. Remove your hand from the keyboard, then turn it back on.
No reverb effect is applied to the sound.	The reverb depth may be set to 0.	Increase the reverb depth to apply an appropriate amount of reverb (page 14).
The sound lingers excessively.	The reverb depth or the Damper Resonance effect depth may be set to an excessive level.	Set these parameters to an appropriate level (pages 14 and 42).
Noise is heard from the headphones or speakers.	The noise may be due to interference caused by the use of a mobile phone in close proximity to the unit.	Turn the mobile phone off, or use it away from the unit.
	The headphones or speakers may not be connected correctly.	Connect the headphones or speakers to the corresponding jacks firmly (page 11 or 37).
The pitch of the unit is different to that of other instruments.	The pitch is different depending on the instrument.	You can adjust the pitch of this unit to match that of other instruments (page 38).

Preset Voice List

No.	Voice	Explanation
1	Piano	This sound was sampled from the Yamaha CFX concert grand piano. It uses different samples depending on the strength of your playing and produces smoother tonal changes. Even the tonal changes produced by the damper pedal and the subtle sounds of releasing a key are reproduced. The sympathetic vibration (String Resonance) that occurs among the strings of an acoustic piano has also been simulated. Suitable not only for classical compositions but also for piano pieces of any style.
2	Electric Piano 1	An electronic piano sound produced by an FM synthesizer. The tone will change as you vary your playing touch. Ideal for popular music. Pressing the soft pedal/shift pedal switches between on and off of the chorus effect.
3	Electric Piano 2	The sound of an electric piano using hammer-struck metallic “tines.” Soft tone when played lightly, and an aggressive tone when played hard. Pressing the soft pedal/shift pedal switches between on and off of the chorus effect.
4	Electric Piano 3	A different type of electric piano sound. Widely used in rock and popular music. Pressing the soft pedal/shift pedal switches between on and off of the chorus effect.
5	Harpsichord 1	The sound of the instrument frequently used in baroque music. Variations in playing touch will not affect the volume, and a characteristic sound will be heard when you release the key.
6	Harpsichord 2	A harpsichord with an added upper octave. Produces a more brilliant sound.
7	Vibraphone	Vibraphone played with relatively soft mallets. The tone becomes more metallic the harder you play. Pressing the soft pedal/shift pedal switches between on and off of the vibrato.
8	Celesta	The sound of a celesta (a percussion instrument in which hammers strike metallic bars to produce sound). This instrument is well-known for its appearance in “Dance of the Sugarplum Fairies” from Tchaikovsky’s “Nutcracker Suite.”
9	Pipe Organ 1	This voice features the combination of pipes (8'+4'+2') of a principal (brass instrument) organ. It is suitable for Baroque church music.
10	Pipe Organ 2	This voice features a full coupler of a pipe organ, famous for the sound used in Toccata and Fugue by Bach.
11	Pipe Organ 3	A pipe organ sound that combines flute-type (woodwind type) stops of different pitches (8'+4'). This is a gentle sound that is ideal for accompanying hymns.
12	Pipe Organ 4	A pipe organ sound that combines flute-type (woodwind type) stops of different pitches (8'+4'+1-1/3'). This is brighter than Pipe Organ 3, and is suitable for solos.
13	Jazz Organ	The sound of a “tonewheel” type electric organ. Often heard in jazz and rock idioms. Pressing the soft pedal/shift pedal switches the rotary speaker speed (fast and slow).
14	Strings	Stereo-sampled, large-scale strings ensemble with realistic reverb.
15	Choir	A big, spacious choir voice. Perfect for creating rich harmonies in slow pieces.
16	Synth Pad	A warm, mellow, and spacious synth sound. Ideal for sustained parts in the background of an ensemble.
17	Piano + Strings	Combination of the Piano and Strings (with a slower attack) voices (dual voice).
18	Piano + Synth Pad	Combination of the Piano and Synth Pad voices (dual voice).
19	Piano + Electric Piano 1	Combination of the Piano and Electric Piano 1 voices (dual voice).

Song List

■ Demonstration songs

No.	Title <Composer>
d.01	Polonaise op.53 "Héroïque" <F. F. Chopin>
d.02	Piano Sonata No.18 K.576 1st mov. <W. A. Mozart>
d.03	"Little Overture" from The Nutcracker op.71a <P. I. Tchaikovsky>

■ Preset songs

No.	Title <Composer>	No.	Title <Composer>
P.01	Invention No.1 <J. S. Bach>	P.26	Etude op.10-12 "Revolutionary" <F. F. Chopin>
P.02	Invention No.8 <J. S. Bach>	P.27	Valse op.64-1 "Petit chien" <F. F. Chopin>
P.03	Gavotte <J. S. Bach>	P.28	Valse op.64-2 <F. F. Chopin>
P.04	Prelude (Wohltemperierte Klavier I No.1) <J. S. Bach>	P.29	Valse op.69-1 "L'adieu" <F. F. Chopin>
P.05	Menuett G dur BWV. Anh.114 <J. S. Bach>	P.30	Nocturne op.9-2 <F. F. Chopin>
P.06	Le Coucou <L.-C. Daquin>	P.31	Träumerei <R. Schumann>
P.07	Piano Sonate No.15 K.545 1st mov. <W. A. Mozart>	P.32	Fröhlicher Landmann <R. Schumann>
P.08	Turkish March <W. A. Mozart>	P.33	La Prière d'une Vierge <T. Badarzewska>
P.09	Menuett G dur <W. A. Mozart>	P.34	Dolly's Dreaming and Awakening <T. Oesten>
P.10	Little Serenade <J. Haydn>	P.35	Arabesque <J. F. Burgmuller>
P.11	Perpetuum mobile <C. M. v. Weber>	P.36	Pastorale <J. F. Burgmuller>
P.12	Ecossaise <L. v. Beethoven>	P.37	La chevaleresque <J. F. Burgmuller>
P.13	Für Elise <L. v. Beethoven>	P.38	Liebesträume Nr.3 <F. Liszt>
P.14	Marcia alla Turca <L. v. Beethoven>	P.39	Blumenlied <G. Lange>
P.15	Piano Sonate op.13 "Pathétique" 2nd mov. <L. v. Beethoven>	P.40	Barcarolle <P. I. Tchaikovsky>
P.16	Piano Sonate op.27-2 "Mondschein" 1st mov. <L. v. Beethoven>	P.41	Melody in F <A. Rubinstein>
P.17	Piano Sonate op.49-2 1st mov. <L. v. Beethoven>	P.42	Humoresque <A. Dvorak>
P.18	Impromptu op.90-2 <F. P. Schubert>	P.43	Tango (España) <I. Albeniz>
P.19	Moments Musicaux op.94-3 <F. P. Schubert>	P.44	The Entertainer <S. Joplin>
P.20	Frühlingslied op.62-6 <J. L. F. Mendelssohn>	P.45	Maple Leaf Rag <S. Joplin>
P.21	Jägerlied op.19b-3 <J. L. F. Mendelssohn>	P.46	La Fille aux Cheveux de Lin <C. A. Debussy>
P.22	Fantaisie-Impromptu <F. F. Chopin>	P.47	Arabesque 1 <C. A. Debussy>
P.23	Prelude op.28-15 "Raindrop" <F. F. Chopin>	P.48	Clair de lune <C. A. Debussy>
P.24	Etude op.10-5 "Black keys" <F. F. Chopin>	P.49	Rêverie <C. A. Debussy>
P.25	Etude op.10-3 "Chanson de l'adieu" <F. F. Chopin>	P.50	Cakewalk <C. A. Debussy>

Playback Sequence of Song Files on the USB Storage Device

The illustration below shows the playback sequence of song files stored on the USB storage device.

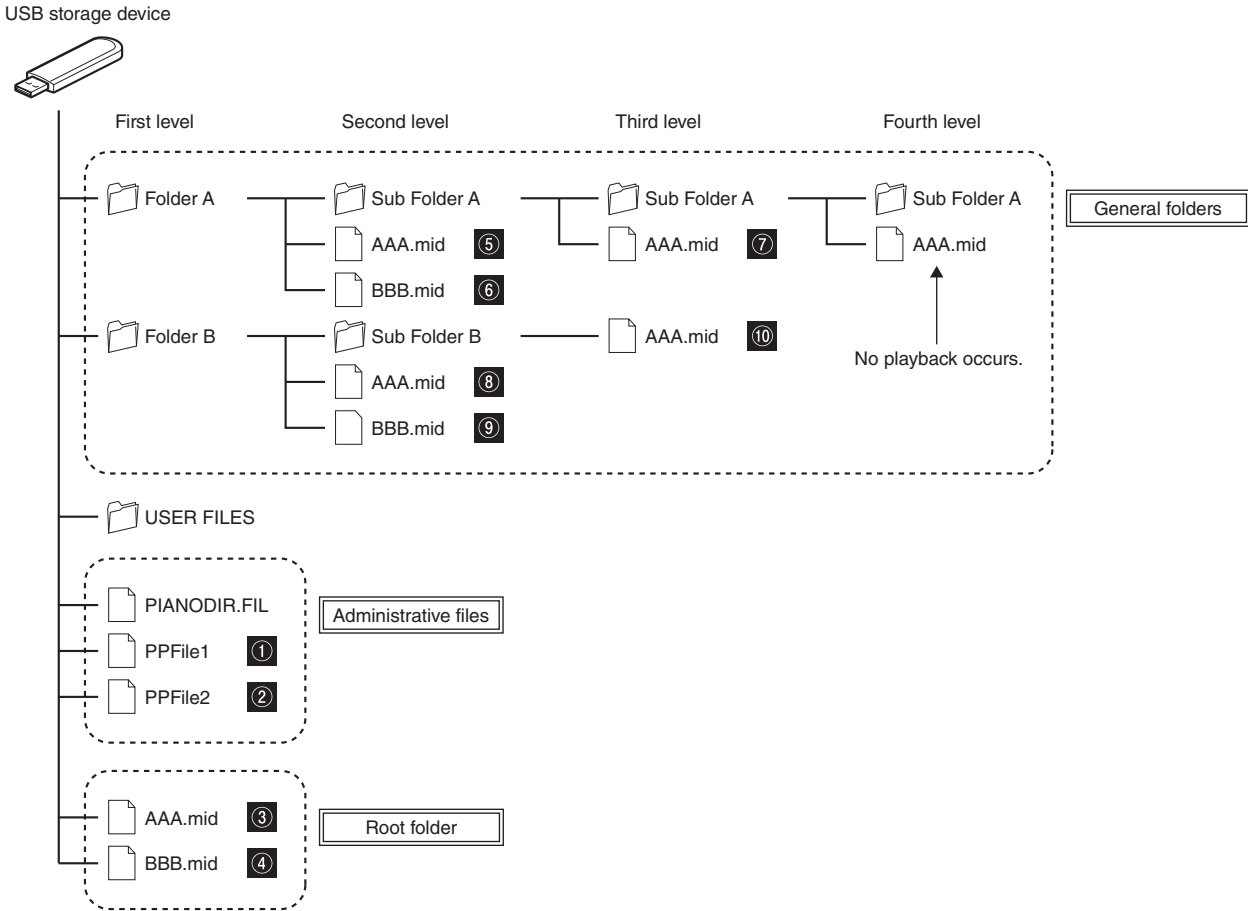

■ Playback sequence of user songs

User songs are named as follows, and saved in the USER FILES folder. The “**” section indicates the song number. Playback occurs in order of the number in the “**” section.

- USERSONG**.MID (MIDI song)
- USERAUDIO**.WAV (audio song)

■ Playback sequence of external songs

Priority	Folder/File	
1	Administrative files	Playback occurs in the order specified in the administrative file.
2	Root folder	Playback occurs in an alphabetical order.
3	General folders	Playback occurs in an alphabetical order.

Note
The unit cannot recognize song files saved in a folder lower than the third level. If you manage song files on the USB storage device with the computer, make sure to save them to the first, second or third level folder.

Specifications

			Upright Piano	Grand Piano	
Pedals			Damper pedal, Silencing pedal/ Sostenuto pedal* ¹ , Soft pedal	Damper pedal, Sostenuto pedal, Shift pedal	
Sensor System	Key Sensor		Noncontact continuous detection optical sensor		
	Hammer Sensor		—	Noncontact 2-point optical fiber sensor	
	Pedal Sensors	Damper Pedal	Continuous detection sensor		
		Sostenuto Pedal	ON/OFF detection sensor* ¹	ON/OFF detection sensor	
Soft/Shift Pedal		ON/OFF detection sensor			
Silencing System	Mechanism		Hammer shank stopper operated by silencing pedal/silencing lever* ¹	Hammer shank stopper operated by motor drive	
	Action		—	Quick Escape mechanism	
Internal Tone	Digital Tone	Type	AWM Stereo Sampling		
		Sound Engine (Piano)	CFX Binaural Sampling		
		Piano Effects	Damper Resonance, String Resonance, Sustain Sample, Key-off Sample		
		Polyphony (max.)	256		
	Number of Voices		19 (16 voices + 3 dual voices)		
	Voice Selection		Piano, Electric Piano 1, Electric Piano 2, Electric Piano 3, Harpsichord 1, Harpsichord 2, Vibraphone, Celesta, Pipe Organ 1, Pipe Organ 2, Pipe Organ 3, Pipe Organ 4, Jazz Organ, Strings, Choir, Synth Pad, Piano + Strings (dual), Piano + Synth Pad (dual), Piano + Electric Piano 1 (dual)		
Voice Selection (Playback)		480 XG voices + 12 Drum / SFX kits			
Wave Memory			256MB		
Functions			Voice Variations		
			Reverb Type Switch (Room, Hall 1, Hall 2, Stage)		
			Reverb Depth Adjustment		
			Metronome		
			MIDI Recording/Playback		
			Audio (WAV) Recording/Playback		
			Brilliance Adjustment (5 steps)		
			Keyboard Tuning (414.8 Hz to 466.8 Hz)		
			Damper Resonance Depth Adjustment		
			String Resonance Depth Adjustment		
			Sustain Sample Depth Adjustment		
			Key-off Sample Volume Adjustment		
			Auto Power-off		
Preset Songs			53 (50 greats for the Piano + 3 piano demonstrations)		
Connectors	Headphones		PHONES (stereo mini jack) × 2		
	Audio		AUX IN/AUX OUT (stereo mini jack)		
	Speakers		—	OUTPUT L/R (TRS phone jack, impedance balanced)	
	MIDI		MIDI IN/MIDI OUT		
	USB		USB TO DEVICE		
	Power		DC12V	DC IN 12V	
Power Consumption			11W (DC 12V)	17W (DC 12V)	
Weight			4 kg	10 kg	
Accessories			AC adapter (PA-150A/PA-150B/MU24-Y120200-A1 [upright piano], PJP-PS04/MU24-Y120200-A1 [grand piano] or an equivalent recommended by Yamaha), Power cable* ² , Headphones, Headphones hanger, Attachment screws for headphones hanger, Owner's manual, Music book "50 greats for the Piano"		

* 1 For models equipped with a sostenuto pedal.

* 2 Supplied only if the PJP-PS04 AC adaptor is supplied with your piano.

Index

- A**
- AC adaptor4, 9
 - Accessory4
 - Administrative file51
 - All playback 17, 18, 19, 21
 - Audio device 33, 34
 - Audio song 16, 51
 - Auto power-off 44, 46
- B**
- Base note41
 - Beat setting (metronome)..... 15, 28
 - Binaural sampling3
 - Brilliance40
- C**
- Control change44
 - Control unit7, 8
 - Copying29
- D**
- Damper pedal6
 - Damper Resonance6, 42
 - Deleting31
 - Demo song 16, 17, 50
 - Dual voice 12, 49
- E**
- ESEQ16
 - External song 16, 51
- F**
- Fast-forward22
 - FIXED velocity40
 - Function Setup38, 40
- G**
- General folder51
 - GM unit8, 37
- H**
- Headphones4, 11
 - Headphones hanger4, 10
- I**
- Internal memory 16, 19, 24
- K**
- Key-off Sample43
- L**
- Language support45
 - Local control44
- M**
- Message47
 - Metronome 15, 28
 - Metronome volume41
 - MIDI data formatD7
 - MIDI device35
 - MIDI IMPLEMENTATION CHARTD18
 - MIDI song 16, 51
 - MIDI transmit channel43
- P**
- Pause22
 - Piano playback channel43
 - Playback16
 - Playback sequence51
 - Playback tempo23
 - Power10
 - Powered speakers33, 37
 - Preset song 16, 18, 50
 - Program change44
- R**
- Random playback 17, 18, 19, 21
 - Recording24
 - Restoring of the factory default setting45
 - Reverb14
 - Reverb depth14
 - Reverb type14
 - Rewind22
 - Root folder51
- S**
- Scale41
 - Shift pedal6
 - Silencing lever6, 11
 - Silent Piano™ function11
 - Single repeat41
 - SMF0 16, 24, 26
 - SMF116
 - Soft pedal6
 - Song 16, 50
 - Song balance42
 - Song category16
 - Sostenuto pedal6
 - Stop22
 - String Resonance42
 - Sustain Sample43
- T**
- Tempo setting (metronome) 15, 28
 - Touch sensitivity40
 - Transpose40, 42
 - Tuning of the pitch40, 42
- U**
- USB AUDIO16
 - USB Audio Recorder26
 - USB MIDI16
 - USB storage device 20, 26, 29, 36, 51
 - USER FILES folder51
 - User song 16, 51
- V**
- Voice 12, 49, D7
 - Voice variations13
 - Volume11
- W**
- WAV 16, 26
- X**
- XG drum kitD5
 - XG voiceD2



SILENT *Piano*TM
SH

Data list

XG Voice List

Voice Group	Voice Name	MSB	LSB	PRG	Element	
Piano	GrandPiano	0	0	1	2*	
	GrndPianoKSP	0	1	1	1	
	MellowGrPno	0	18	1	2	
	PianoStrings	0	40	1	2	
	Dream	0	41	1	2	
	BrightPiano	0	0	2	2	
	BritePnoKSP	0	1	2	1	
	ElecGrandPno	0	0	3	2	
	ElecGrPnoKSP	0	1	3	2	
	DetunedCP80	0	32	3	2	
	LayeredCP1	0	40	3	2	
	LayeredCP2	0	41	3	2	
	Honkytonk	0	0	4	2	
	HonkytonkKSP	0	1	4	2	
	El.Piano1	0	0	5	2	
	El.Piano1KSP	0	1	5	1	
	MellowEP1	0	18	5	2	
	ChorusEP1	0	32	5	2	
	HardEl.Piano	0	40	5	2	
	VXfadeEl.P1	0	45	5	2	
	60sEl.Piano1	0	64	5	1	
	El.Piano2	0	0	6	2	
	El.Piano2KSP	0	1	6	1	
	ChorusEP2	0	32	6	2	
	DXEPHard	0	33	6	2	
	DXLegend	0	34	6	2	
	DXPhaseEP	0	40	6	2	
	DX+AnalogEP	0	41	6	2	
	DXKotoEP	0	42	6	2	
	VXfadeEl.P2	0	45	6	2	
	Harpsichord	0	0	7	1	
	Harpsi.KSP	0	1	7	1	
	Harpsichord2	0	25	7	2	
	Harpsichord3	0	35	7	2	
	Clavi.	0	0	8	1	
	Clavi.KSP	0	1	8	1	
	Clavi.Wah	0	27	8	2	
	PulseClavi.	0	64	8	1	
	PierceClavi.	0	65	8	2	
	Chromatic Percussion	Celesta	0	0	9	1
		Glockenspiel	0	0	10	1
		MusicBox	0	0	11	2
		Orgel	0	64	11	2
		Vibraphone	0	0	12	1
VibesKSP		0	1	12	1	
HardVibes		0	45	12	2	
Marimba		0	0	13	1	
MarimbaKSP		0	1	13	1	
SineMarimba		0	64	13	2	
Balimba		0	97	13	2	
LogDrums		0	98	13	2	
Xylophone		0	0	14	1	
TubularBells		0	0	15	1	
ChurchBells		0	96	15	2	
Carillon		0	97	15	2	
Dulcimer		0	0	16	1	
Dulcimer2		0	35	16	2	
Cimbalom		0	96	16	2	
Santur		0	97	16	2	
Organ	DrawbarOrgan	0	0	17	1	
	DetDrawOrgan	0	32	17	2	
	60sDrawOrg1	0	33	17	2	
	60sDrawOrg2	0	34	17	2	
	70sDrawOrg1	0	35	17	2	
	DrawbarOrg2	0	36	17	2	
	60sDrawOrg3	0	37	17	2	
	EvenBarOrg	0	38	17	2	
	16+2*2_3Org	0	40	17	2	
	OrganBass	0	64	17	1	
	70sDrawOrg2	0	65	17	2	
	CheezyOrgan	0	66	17	2	
	DrawbarOrg3	0	67	17	2	
	Perc.Organ	0	0	18	1	
	70sPercOrg1	0	24	18	2	
	DetPercOrgan	0	32	18	2	
	LightOrgan	0	33	18	2	

Voice Group	Voice Name	MSB	LSB	PRG	Element	
Organ	Perc.Organ2	0	37	18	2	
	RockOrgan	0	0	19	1	
	RotaryOrgan	0	64	19	2	
	SlowRotary	0	65	19	2	
	FastRotary	0	66	19	2	
	ChurchOrgan	0	0	20	2	
	ChurchOrgan3	0	32	20	2	
	ChurchOrgan2	0	35	20	2	
	NotreDame	0	40	20	2	
	OrganFlute	0	64	20	2	
	Trem.OrganFl	0	65	20	2	
	ReedOrgan	0	0	21	1	
	PuffOrgan	0	40	21	2	
	Accordion	0	0	22	1	
	AccordIt	0	32	22	2	
	Harmonica	0	0	23	1	
	Harmonica2	0	32	23	2	
	TangoAccord	0	0	24	1	
	TangoAccord2	0	64	24	2	
	Guitar	NylonGuitar	0	0	25	1
		NylonGuitar2	0	16	25	1
		NylonGuitar3	0	25	25	2
		VelGtrHarmo	0	43	25	1
Ukulele		0	96	25	1	
SteelGuitar		0	0	26	1	
SteelGuitar2		0	16	26	1	
12StrGuitar		0	35	26	2	
Nylon&Steel		0	40	26	2	
Steel&Body		0	41	26	2	
Mandolin		0	96	26	2	
JazzGuitar		0	0	27	1	
MellowGuitar		0	18	27	1	
JazzAmp		0	32	27	2	
CleanGuitar		0	0	28	1	
ChorusGuitar		0	32	28	2	
MutedGuitar		0	0	29	1	
FunkGuitar1		0	40	29	2	
MuteSteelGtr		0	41	29	2	
FunkGuitar2		0	43	29	1	
JazzMan		0	45	29	2	
Overdriven		0	0	30	1	
GuitarPinch		0	43	30	1	
Distortion		0	0	31	1	
FeedbackGtr		0	40	31	2	
FeedbackGtr2		0	41	31	2	
GtrHarmonics		0	0	32	1	
GtrFeedback		0	65	32	1	
GtrHarmonic2		0	66	32	1	
Bass		AcousticBass	0	0	33	1
		JazzRhythm	0	40	33	2
		VXUprghtBass	0	45	33	2
		FingerBass	0	0	34	1
	FingerDark	0	18	34	2	
	FlangeBass	0	27	34	2	
	Bass&DistEG	0	40	34	2	
	FingerSlap	0	43	34	1	
	FingerBass2	0	45	34	2	
	Mod.Bass	0	65	34	2	
	PickBass	0	0	35	1	
	MutePickBass	0	28	35	1	
	FretlessBass	0	0	36	1	
	Fretless2	0	32	36	2	
	Fretless3	0	33	36	2	
	Fretless4	0	34	36	2	
	Syn.Fretless	0	96	36	2	
	SmthFretless	0	97	36	2	
	SlapBass1	0	0	37	1	
	ResonantSlap	0	27	37	1	
	PunchThumb	0	32	37	2	
	SlapBass2	0	0	38	1	
	Velo.Sw.Slap	0	43	38	1	
	SynthBass1	0	0	39	1	
	SynBass1Dark	0	18	39	1	
	FastResoBass	0	20	39	1	
	AcidBass	0	24	39	1	
ClaviBass	0	35	39	2		

* The number of elements becomes 4 when the damper pedal is pressed.

Voice Group	Voice Name	MSB	LSB	PRG	Element
Bass	TechnoBass	0	40	39	2
	Orbiter	0	64	39	2
	SquareBass	0	65	39	1
	RubberBass	0	66	39	2
	Hammer	0	96	39	2
	SynthBass2	0	0	40	2
	MellowSyBass	0	6	40	1
	SequenceBass	0	12	40	2
	ClickSynBass	0	18	40	2
	SynBass2Dark	0	19	40	1
	SmoothSyBass	0	32	40	2
	ModulrSyBass	0	40	40	2
	DXBass	0	41	40	2
	XWireBass	0	64	40	2
Strings	Violin	0	0	41	1
	SlwAtkViolin	0	8	41	1
	Viola	0	0	42	1
	Cello	0	0	43	1
	Contrabass	0	0	44	1
	Trem.Strings	0	0	45	1
	SlwAtTremStr	0	8	45	1
	SuspenseStr	0	40	45	2
	PizzicatoStr	0	0	46	1
	Orch.Harp	0	0	47	1
	YangChin	0	40	47	2
Timpani	0	0	48	1	
Ensemble	Strings1	0	0	49	1
	StereoStrngs	0	3	49	2
	SlwAtkStrngs	0	8	49	1
	ArcoStrings	0	24	49	2
	60'sStrings	0	35	49	2
	Orchestra	0	40	49	2
	Orchestra2	0	41	49	2
	TremOrchestra	0	42	49	2
	Velo.Strings	0	45	49	2
	Strings2	0	0	50	1
	S.SlowStrngs	0	3	50	2
	LegatoStrngs	0	8	50	2
	WarmStrings	0	40	50	2
	Kingdom	0	41	50	2
	70'sStrings	0	64	50	1
	Strings3	0	65	50	1
	SynStrings1	0	0	51	2
	ResoStrings	0	27	51	2
	SynStrings4	0	64	51	2
	SynStrings5	0	65	51	2
	SynStrings2	0	0	52	2
	ChoirAahs	0	0	53	1
	StereoChoir	0	3	53	2
	ChoirAahs2	0	16	53	2
	MellowChoir	0	32	53	2
	ChoirStrings	0	40	53	2
	VoiceOohs	0	0	54	1
	SynthVoice	0	0	55	1
	SynthVoice2	0	40	55	2
	Choral	0	41	55	2
	AnalogVoice	0	64	55	1
	OrchestraHit	0	0	56	2
	OrchestrHit2	0	35	56	2
Impact	0	64	56	2	
Brass	Trumpet	0	0	57	1
	Trumpet2	0	16	57	1
	BriteTrumpet	0	17	57	2
	WarmTrumpet	0	32	57	2
	Trombone	0	0	58	1
	Trombone2	0	18	58	2
	Tuba	0	0	59	1
	Tuba2	0	16	59	1
	MutedTrumpet	0	0	60	1
	FrenchHorn	0	0	61	1
	Fr.HornSolo	0	6	61	1
	FrenchHorn2	0	32	61	2
	HornOrchestr	0	37	61	2
	BrassSection	0	0	62	1
	Tp&TbSection	0	35	62	2
	BrassSect2	0	40	62	2
	HighBrass	0	41	62	2
	MellowBrass	0	42	62	2
	SynthBrass1	0	0	63	2
	QuackBrass	0	12	63	2
	ResoSynBrass	0	20	63	2
	PolyBrass	0	24	63	2

Voice Group	Voice Name	MSB	LSB	PRG	Element	
Brass	SynthBrass3	0	27	63	2	
	JumpBrass	0	32	63	2	
	AnaVelBrass1	0	45	63	2	
	AnalogBrass1	0	64	63	2	
	SynthBrass2	0	0	64	1	
	SoftBrass	0	18	64	2	
	SynthBrass4	0	40	64	2	
	ChoirBrass	0	41	64	2	
	AnaVelBrass2	0	45	64	2	
	AnalogBrass2	0	64	64	2	
	Reed	SopranoSax	0	0	65	1
		AltoSax	0	0	66	1
		SaxSection	0	40	66	2
		HyperAltoSax	0	43	66	1
		TenorSax	0	0	67	1
		BreathyTenor	0	40	67	2
		SoftTenorSax	0	41	67	2
		TenorSax2	0	64	67	1
BaritoneSax		0	0	68	1	
Oboe		0	0	69	1	
EnglishHorn		0	0	70	1	
Bassoon		0	0	71	1	
Pipe	Clarinet	0	0	72	1	
	Piccolo	0	0	73	1	
	Flute	0	0	74	1	
	Recorder	0	0	75	1	
	PanFlute	0	0	76	1	
	BlownBottle	0	0	77	2	
	Shakuhachi	0	0	78	1	
	Whistle	0	0	79	1	
	Ocarina	0	0	80	1	
	Synth. Lead	SquareLead	0	0	81	2
SquareLead2		0	6	81	1	
LMSquare		0	8	81	2	
Hollow		0	18	81	1	
Shroud		0	19	81	2	
Mellow		0	64	81	2	
SoloSine		0	65	81	2	
SineLead		0	66	81	1	
SawtoothLead		0	0	82	2	
SawtoothLd2		0	6	82	1	
ThickSaw		0	8	82	2	
DynamicSaw		0	18	82	1	
DigitalSaw		0	19	82	2	
BigLead		0	20	82	2	
HeavySynth		0	24	82	2	
WaspySynth		0	25	82	2	
PulseSaw		0	40	82	2	
Dr.Lead		0	41	82	2	
VelocityLead		0	45	82	2	
Seq.Analog		0	96	82	2	
CalliopeLead		0	0	83	2	
PureLead		0	65	83	2	
ChiffLead		0	0	84	2	
Rubby		0	64	84	2	
CharangLead		0	0	85	2	
DistortedLd		0	64	85	2	
WireLead		0	65	85	2	
VoiceLead		0	0	86	2	
SynthAahs		0	24	86	2	
VoxLead		0	64	86	2	
FifthsLead		0	0	87	2	
BigFive		0	35	87	2	
Bass&Lead		0	0	88	2	
Big&Low	0	16	88	2		
Fat&Perky	0	64	88	2		
SoftWhirl	0	65	88	2		
Synth. Pad	NewAgePad	0	0	89	2	
	Fantasy	0	64	89	2	
	WarmPad	0	0	90	2	
	ThickPad	0	16	90	2	
	SoftPad	0	17	90	2	
	SinePad	0	18	90	2	
	HornPad	0	64	90	2	
	RotaryStrngs	0	65	90	2	
	PolySynthPad	0	0	91	2	
	PolyPad80	0	64	91	2	
	ClickPad	0	65	91	2	
	AnalogPad	0	66	91	2	
	SquarePad	0	67	91	2	
	ChoirPad	0	0	92	2	
	Heaven	0	64	92	2	

Voice Group	Voice Name	MSB	LSB	PRG	Element	
Synth. Pad	Itopia	0	66	92	2	
	CCPad	0	67	92	2	
	BowedPad	0	0	93	2	
	Glacier	0	64	93	2	
	GlassPad	0	65	93	2	
	MetallicPad	0	0	94	2	
	TinePad	0	64	94	2	
	PanPad	0	65	94	2	
	HaloPad	0	0	95	2	
	SweepPad	0	0	96	2	
	Shwimmer	0	20	96	2	
	Converge	0	27	96	2	
	PolarPad	0	64	96	2	
	Celestial	0	66	96	2	
	Synth. Effects	Rain	0	0	97	2
		ClaviPad	0	45	97	2
		HarmoRain	0	64	97	2
		AfricanWind	0	65	97	2
Carib		0	66	97	2	
SoundTrack		0	0	98	2	
Prologue		0	27	98	2	
Ancestral		0	64	98	2	
Crystal		0	0	99	2	
SynthDr.Comp		0	12	99	2	
Popcorn		0	14	99	2	
TinyBells		0	18	99	2	
RoundGlocken		0	35	99	2	
GlockenChime		0	40	99	2	
ClearBells		0	41	99	2	
ChorusBells		0	42	99	2	
SynthMallet		0	64	99	1	
SoftCrystal		0	65	99	2	
LoudGlocken		0	66	99	2	
ChristmasBel		0	67	99	2	
VibeBells		0	68	99	2	
DigitalBells		0	69	99	2	
AirBells		0	70	99	2	
BellHarp		0	71	99	2	
Gamelimba		0	72	99	2	
Atmosphere		0	0	100	2	
WarmAtmos.		0	18	100	2	
HollowRelease		0	19	100	2	
NylonElPiano		0	40	100	2	
NylonHarp		0	64	100	2	
HarpVox		0	65	100	2	
Atmos.Pad		0	66	100	2	
Planet		0	67	100	2	
Brightness		0	0	101	2	
FantasyBells		0	64	101	2	
Smokey		0	96	101	2	
Goblins		0	0	102	2	
GoblinsSynth		0	64	102	2	
Creeper		0	65	102	2	
RingPad		0	66	102	2	
Ritual		0	67	102	2	
ToHeaven		0	68	102	2	
Night		0	70	102	2	
Glisten		0	71	102	2	
BellChoir		0	96	102	2	
Echoes		0	0	103	2	
Echoes2		0	8	103	2	
EchoPan		0	14	103	2	
EchoBells		0	64	103	2	
BigPan		0	65	103	2	
SynthPiano		0	66	103	2	
Creation		0	67	103	2	
StarDust	0	68	103	2		
Reso&Panning	0	69	103	2		
Sci-Fi	0	0	104	2		
Starz	0	64	104	2		
Ethnic	Sitar	0	0	105	1	
	DetunedSitar	0	32	105	2	
	Sitar2	0	35	105	2	
	Tambra	0	96	105	2	
	Tamboura	0	97	105	2	
	Banjo	0	0	106	1	
	MutedBanjo	0	28	106	1	
	Rabab	0	96	106	2	
	Gopichant	0	97	106	2	
	Oud	0	98	106	2	
	Shamisen	0	0	107	1	
	Koto	0	0	108	1	

Voice Group	Voice Name	MSB	LSB	PRG	Element	
Ethnic	Taisho-kin	0	96	108	2	
	Kanoon	0	97	108	2	
	Kalimba	0	0	109	1	
	Bagpipe	0	0	110	2	
	Fiddle	0	0	111	1	
	Shanai	0	0	112	1	
	Shanai2	0	64	112	1	
	Pungi	0	96	112	1	
	Hichiriki	0	97	112	2	
	Percussive	TinkleBell	0	0	113	2
		Bonang	0	96	113	2
		Altair	0	97	113	2
GamelanGongs		0	98	113	2	
StereoGamlan		0	99	113	2	
RamaCymbal		0	100	113	2	
AsianBells		0	101	113	2	
Agogo		0	0	114	2	
SteelDrums		0	0	115	1	
GlassPerc.		0	97	115	2	
ThaiBells		0	98	115	2	
Woodblock		0	0	116	1	
Castanets		0	96	116	1	
TaikoDrum		0	0	117	1	
GranCassa		0	96	117	1	
MelodicTom		0	0	118	2	
MelodicTom2		0	64	118	1	
RealTom		0	65	118	2	
RockTom		0	66	118	2	
SynthDrum		0	0	119	1	
AnalogTom	0	64	119	1		
ElectroPerc.	0	65	119	2		
Rev.Cymbal	0	0	120	1		
Sound Effects	GtrFretNoise	0	0	121	1	
	BreathNoise	0	0	122	1	
	Seashore	0	0	123	2	
	BirdTweet	0	0	124	2	
	TelephonRing	0	0	125	1	
	Helicopter	0	0	126	1	
	Applause	0	0	127	1	
	Gunshot	0	0	128	1	
	SFX	CuttingNoise	64	0	1	1
		CuttingNoiz2	64	0	2	2
StringSlap		64	0	4	1	
Fl.KeyClick		64	0	17	1	
Shower		64	0	33	1	
Thunder		64	0	34	1	
Wind		64	0	35	1	
Stream		64	0	36	2	
Bubble		64	0	37	2	
Feed		64	0	38	2	
Dog		64	0	49	1	
Horse		64	0	50	1	
BirdTweet2		64	0	51	1	
Ghost		64	0	55	2	
Maou		64	0	56	2	
PhoneCall		64	0	65	1	
DoorSqueak		64	0	66	1	
DoorSlam		64	0	67	1	
ScratchCut		64	0	68	1	
ScratchSplit		64	0	69	2	
WindChime		64	0	70	1	
TelphonRing2		64	0	71	1	
CarEngineIgn		64	0	81	1	
CarTiresSql		64	0	82	1	
CarPassing		64	0	83	1	
CarCrash		64	0	84	1	
Siren		64	0	85	2	
Train		64	0	86	1	
JetPlane		64	0	87	2	
Starship		64	0	88	2	
Burst		64	0	89	2	
RollrCoaster		64	0	90	2	
Submarine	64	0	91	1		
Laugh	64	0	97	1		
Scream	64	0	98	1		
Punch	64	0	99	1		
Heartbeat	64	0	100	1		
FootSteps	64	0	101	1		
MachineGun	64	0	113	1		
LaserGun	64	0	114	2		
Explosion	64	0	115	2		
Firework	64	0	116	2		

XG Drum Kit List

█ : Same as Standard Kit 1

█ : No Sound

MIDI		Key Off	Alternate Group	Program Change							
Note #	Note			0-127	1-127	127	127	127	127		
13	C#-1		3	Surdo Mute							
14	D-1		3	Surdo Open							
15	D#-1			Hi Q							
16	E-1			Whip Slap							
17	F-1		4	Scratch H							
18	F#-1		4	Scratch L							
19	G-1			Finger Snap							
20	G#-1			Click Noise							
21	A-1			Metronome Click							
22	A#-1			Metronome Bell							
23	B-1			Seq Click L							
24	C0			Seq Click H							
25	C#0			Brush Tap							
26	D0	○		Brush Swirl							
27	D#0			Brush Slap							
28	E0	○		Brush Tap Swirl					Reverse Cymbal	Reverse Cymbal	
29	F0	○		Snare Roll							
30	F#0			Castanet					Hi Q 2	Hi Q 2	
31	G0			Snare Soft	Snare Soft 2			Snare Noisy	Snare Snappy Electro	Snare Noisy 4	
32	G#0			Sticks							
33	A0			Kick Soft					Kick 3	Kick 3	
34	A#0			Open Rim Shot	Open Rim Shot H Short						
35	B0			Kick Tight				Kick 2	Kick Gate	Kick Analog Short	
36	C1			Kick	Kick Shot			Kick Gate	Kick Gate Heavy	Kick Analog	
37	C#1			Side Stick	Side Stick Light					Side Stick Analog	
38	D1			Snare	Snare Short	Snare Snappy	Snare Rock	Snare Noisy 2		Snare Analog	
39	D#1			Hand Clap							
40	E1			Snare Tight	Snare Tight H	Snare Tight Snappy	Snare Rock Tight	Snare Noisy 2		Snare Analog 2	
41	F1			Floor Tom L		Tom Room 1	Tom Room 1	Tom Electro 1		Tom Analog 1	
42	F#1		1	Hi-Hat Closed						Hi-Hat Closed Analog	
43	G1			Floor Tom H		Tom Room 2	Tom Room 2	Tom Electro 2		Tom Analog 2	
44	G#1		1	Hi-Hat Pedal						Hi-Hat Closed Analog 2	
45	A1			Low Tom		Tom Room 3	Tom Room 3	Tom Electro 3		Tom Analog 3	
46	A#1		1	Hi-Hat Open						Hi-Hat Open Analog	
47	B1			Mid Tom L		Tom Room 4	Tom Room 4	Tom Electro 4		Tom Analog 4	
48	C2			Mid Tom H		Tom Room 5	Tom Room 5	Tom Electro 5		Tom Analog 5	
49	C#2			Crash Cymbal 1						Crash Analog	
50	D2			High Tom		Tom Room 6	Tom Room 6	Tom Electro 6		Tom Analog 6	
51	D#2			Ride Cymbal 1							
52	E2			Chinese Cymbal							
53	F2			Ride Cymbal Cup							
54	F#2			Tambourine							
55	G2			Splash Cymbal							
56	G#2			Cowbell						Cowbell Analog	
57	A2			Crash Cymbal 2							
58	A#2			Vibraslap							
59	B2			Ride Cymbal 2							
60	C3			Bongo H							
61	C#3			Bongo L							
62	D3			Conga H Mute						Conga Analog H	
63	D#3			Conga H Open						Conga Analog M	
64	E3			Conga L						Conga Analog L	
65	F3			Timbale H							
66	F#3			Timbale L							
67	G3			Agogo H							
68	G#3			Agogo L							
69	A3			Cabasa							
70	A#3			Maracas						Maracas 2	
71	B3	○		Samba Whistle H							
72	C4	○		Samba Whistle L							
73	C#4			Guiro Short							
74	D4	○		Guiro Long							
75	D#4			Claves						Claves 2	
76	E4			Wood Block H							
77	F4			Wood Block L							
78	F#4			Cuica Mute				Scratch H 2		Scratch H 2	
79	G4			Cuica Open				Scratch L 2		Scratch L 2	
80	G#4		2	Triangle Mute							
81	A4		2	Triangle Open							
82	A#4			Shaker							
83	B4			Jingle Bells							
84	C5			Bell Tree							
85	C#5										
86	D5										
87	D#5										
88	E5										
89	F5										
90	F#5										
91	G5										

* Key Off: Keys marked with a circle stop sounding the instant they are released.

* Alternate Group: Playing any instrument within a numbered group will immediately stop the sound of any other instrument in the same group of the same number.

XG Drum Kit List

█ : Same as Standard Kit 1

█ : No Sound

MIDI				127	127	127	127	126	126
Note #	Note	Key Off	Alternate Group	Dance Kit	Jazz Kit	Brush Kit	Symphony Kit	SFX Kit1	SFX Kit2
13	C#-1		3						
14	D-1		3						
15	D#-1								
16	E-1								
17	F-1		4						
18	F#-1		4						
19	G-1								
20	G#-1								
21	A-1								
22	A#-1								
23	B-1								
24	C0								
25	C#0								
26	D0	○							
27	D#0								
28	E0	○		Reverse Cymbal					
29	F0	○							
30	F#0			Hi Q 2					
31	G0			Snare Techno	Snare Jazz H	Brush Slap 2			
32	G#0								
33	A0			Kick Techno Q			Kick Soft 2		
34	A#0			Rim Gate		Open Rim Shot Light			
35	B0			Kick Techno L			Gran Cassa		
36	C1			Kick Techno	Kick Jazz	Kick Jazz	Gran Cassa Mute	Cutting Noise	Phone Call
37	C#1			Side Stick Analog	Side Stick Light	Side Stick Light		Cutting Noise 2	Door Squeak
38	D1			Snare Clap	Snare Jazz L	Brush Slap 3	Band Snare		Door Slam
39	D#1							String Slap	Scratch Cut
40	E1			Snare Dry	Snare Jazz M	Brush Tap 2	Band Snare 2		Scratch H 3
41	F1			Tom Analog 1		Tom Brush 1			Wind Chime
42	F#1		1	Hi-Hat Closed 3					Telephone Ring 2
43	G1			Tom Analog 2		Tom Brush 2			
44	G#1		1	Hi-Hat Closed Analog 3					
45	A1			Tom Analog 3		Tom Brush 3			
46	A#1		1	Hi-Hat Open 3					
47	B1			Tom Analog 4		Tom Brush 4			
48	C2			Tom Analog 5		Tom Brush 5			
49	C#2			Crash Analog			Hand Cymbal		
50	D2			Tom Analog 6		Tom Brush 6			
51	D#2						Hand Cymbal Short		
52	E2							Flute Key Click	Car Engine Ignition
53	F2								Car Tires Squeal
54	F#2								Car Passing
55	G2								Car Crash
56	G#2			Cowbell Analog					Siren
57	A2						Hand Cymbal 2		Train
58	A#2								Jet Plane
59	B2						Hand Cymbal 2 Short		Starship
60	C3								Burst
61	C#3								Roller Coaster
62	D3			Conga Analog H					Submarine
63	D#3			Conga Analog M					
64	E3			Conga Analog L					
65	F3								
66	F#3								
67	G3								
68	G#3							Shower	Laugh
69	A3							Thunder	Scream
70	A#3			Maracas 2				Wind	Punch
71	B3	○						Stream	Heart Beat
72	C4	○						Bubble	Foot Steps
73	C#4							Feed	
74	D4	○							
75	D#4			Claves 2					
76	E4								
77	F4								
78	F#4			Scratch H 2					
79	G4			Scratch L 2					
80	G#4		2						
81	A4		2						
82	A#4								
83	B4								
84	C5							Dog	Machine Gun
85	C#5							Horse	Laser Gun
86	D5							Bird Tweet 2	Explosion
87	D#5								Firework
88	E5								
89	F5								
90	F#5							Ghost	
91	G5							Maou	

* Key Off: Keys marked with a circle stop sounding the instant they are released.

* Alternate Group: Playing any instrument within a numbered group will immediately stop the sound of any other instrument in the same group of the same number.

MIDI Data Format

Preset Voice List

Voice Name	Bank		Program Change (0 – 127)
	MSB	LSB	
Piano	108	0	0
Electric Piano 1	108	0	5
Electric Piano 2	108	0	4
Electric Piano 3	108	1	4
Harpsichord 1	108	0	6
Harpsichord 2	108	1	6
Vibraphone	108	0	11
Celesta	108	0	8
Pipe Organ 1	108	1	19
Pipe Organ 2	108	0	19
Pipe Organ 3	108	2	19
Pipe Organ 4	108	3	19
Jazz Organ	108	0	16
Strings	108	0	48
Choir	108	0	52
Synth Pad	108	0	89

* Dual voices (Piano + Strings, Piano + Synth Pad, Piano + Electric Piano 1) cannot be recalled from the external MIDI devices.

MIDI Channel Message (1)

MIDI Events	Status byte		1st Data byte		2nd Data byte		[MIDI (Silent)]					[Internal Sequencer]				
	Status	Data (HEX)	Parameter	Data (HEX)	Parameter	MIDI Reception		MIDI Transmission			Song Playback			MIDI Recording		
						Song Part	Piano Playback Channel	Panel Operation	Song Playback	MIDI Input	PLAY	PLAY (Piano Part)	REW	Piano	Others	
Key Off [GM1] [GM2]	8nH (n: Channel Number)	kk	Key Number (0-127)	vv	Velocity (0-127)	○	○	○ (Keyboard)	×	×	○	○	×	○	○	
Key On [GM1] [GM2]	9nH (n: Channel Number)	kk	Key Number (0-127)	vv	Key On: vv=1-127 Key Off: vv=0	○	○	○ (Keyboard)	×	×	○	○	×	○	○	
Control Change	BnH	0 (00H)	Bank Select MSB [GM2]	0 (00H) 64 (40H) 118 (76H) 119 (77H) 120 (78H) 121 (79H) 126 (7EH) 127 (7FH)	Normal SFX Voice GS Rhythm GS Normal GM2 Rhythm GM2 Normal SFX Kit Drum Kit	○	○	○ (Voice)	×	×	○	○	○	○	○	
		1 (01H)	Modulation [GM1] [GM2]	0-127 (00H..7FH)	Data	○	×	×	×	×	○	×	○	×	×	
		5 (05H)	Portamento Time [GM2]	0-127 (00H..7FH)	Data	○	×	×	×	×	○	×	○	×	×	
		6 (06H)	Data Entry MSB [GM2]	0-127 (00H..7FH)	Data	○	×	×	×	×	○	×	○	×	×	
		7 (07H)	Main Volume [GM1] [GM2]	0-127 (00H..7FH)	Data	○	○	○ (Voice Setting)	×	×	○	○	○	○	○	
		10 (0AH)	Panpot [GM1] [GM2]	0-127 (00H..7FH)	L64...C...R63	○	×	×	×	×	○	×	○	×	×	
		11 (0BH)	Expression [GM1] [GM2]	0-127 (00H..7FH)	Data	○	×	×	×	×	○	×	○	×	×	
		32 (20H)	Bank Select LSB [GM2]	0-127 (00H..7FH)	Data	○	○	○ (Voice)	×	×	○	○	○	○	○	
		38 (26H)	Data Entry LSB [GM2]	0-127 (00H..7FH)	Data	○	×	×	×	×	○	×	○	×	×	
		64 (40H)	Damper [GM1] [GM2]	0-127 (00H..7FH)	Data	○	○	○ (Pedal)	×	×	○	○	○	○	○	
		65 (41H)	Portamento [GM2]	0-127 (00H..7FH)	OFF: 0-63 ON: 64-127	○	×	×	×	×	○	×	○	×	×	
		66 (42H)	Sostenuto [GM2]	0-127 (00H..7FH)	OFF: 0-63 ON: 64-127	○	○	○ (Pedal)	×	×	○	○	○	○	○	
		67 (43H)	Soft Pedal [GM2]	0-127 (00H..7FH)	OFF: 0-63 ON: 64-127	○	○	○ (Pedal)	×	×	○	○	○	○	○	
		71 (47H)	Harmonic Content [GM2]	0-127 (00H..7FH)	-64...0...+63	○	×	×	×	×	○	×	○	×	×	
		72 (48H)	Release Time [GM2]	0-127 (00H..7FH)	-64...0...+63	○	×	×	×	×	○	×	○	×	×	
		73 (49H)	Attack Time [GM2]	0-127 (00H..7FH)	-64...0...+63	○	×	×	×	×	○	×	○	×	×	
		74 (4AH)	Brightness [GM2]	0-127 (00H..7FH)	-64...0...+63	○	×	×	×	×	○	×	○	×	×	
		75 (4BH)	Decay Time [GM2]	0-127 (00H..7FH)	-64...0...+63	○	×	×	×	×	○	×	○	×	×	
		76 (4CH)	Vibrate Rate [GM2]	0-127 (00H..7FH)	-64...0...+63	○	×	×	×	×	○	×	○	×	×	
		77 (4DH)	Vibrate Depth [GM2]	0-127 (00H..7FH)	-64...0...+63	○	×	×	×	×	○	×	○	×	×	
		78 (4EH)	Vibrate Delay [GM2]	0-127 (00H..7FH)	-64...0...+63	○	×	×	×	×	○	×	○	×	×	
		84 (54H)	Portamento Control	0-127 (00H..7FH)	Key no. (0-127)	○	×	×	×	×	○	×	×	×	×	
		91 (5BH)	Effect1 Depth (Reverb Send Level) [GM2]	0-127 (00H..7FH)	Data	○	×	○ (Voice Setting)	×	×	○	×	○	×	○	
		93 (5DH)	Effect3 Depth (Chorus Send Level) [GM2]	0-127 (00H..7FH)	Data	○	×	○ (Voice Setting)	×	×	○	×	○	×	○	
		94 (5EH)	Effect4 Depth (Variation Send Level)	0-127 (00H..7FH)	Data	○	×	×	×	×	○	×	○	×	×	
		96 (60H)	RPN Increment	— —	The data byte is ignored	○	×	×	×	×	○	×	×	×	×	
		97 (61H)	RPN Decrement	— —	The data byte is ignored	○	×	×	×	×	○	×	×	×	×	
		98 (62H)	NRPN LSB	0-127 (00H..7FH)	Data	○	×	×	×	×	○	×	○	×	×	
		99 (63H)	NRPN MSB	0-127 (00H..7FH)	Data	○	×	×	×	×	○	×	○	×	×	
		100 (64H)	RPN LSB [GM2]	0-127 (00H..7FH)	Data	○	×	×	×	×	○	×	○	×	×	
		101 (65H)	RPN MSB [GM2]	0-127 (00H..7FH)	Data	○	×	×	×	×	○	×	○	×	×	
Mode Message	BnH (n: Channel Number)	120 (78H)	All Sound Off [GM2]	0 (00H)	Data	○	○	×	×	×	○	○	×	×	×	
		121 (79H)	Reset All Controllers [GM1] [GM2]	0 (00H)	Data	○	○	×	×	×	○	○	×	×	×	
		122 (7AH)	Local Control	0 (00h) 127 (7FH)	OFF ON	○	○	×	×	×	×	×	×	×	×	
		123 (7BH)	All Note Off [GM1] [GM2]	0 (00H)	Data	○	○	×	×	×	○	○	×	×	×	
		124 (7CH)	Omni Off [GM2]	0 (00H)	Data	○	×	×	×	×	○	×	×	×	×	
		125 (7DH)	Omni On [GM2]	0 (00H)	Data	○	×	×	×	×	○	×	×	×	×	
		126 (7EH)	Mono [GM2]	0-16 (00H..10H)	Data	○	×	×	×	×	○	×	×	×	×	
		127 (7FH)	Poly [GM2]	0 (00H)	Data	○	×	×	×	×	○	×	×	×	×	
Program Change [GM1] [GM2]	CnH (n: Channel Number)	pp (00H..7FH)	Voice Number (0-127)	— —	—	○	○	○ (Voice)	×	×	○	○	○	○	○	
Channel After Touch [GM1] [GM2]	DnH (n: Channel Number)	vv (00H..7FH)	Data	— —	—	○	×	×	×	×	○	×	×	×	×	
Polyphonic After Touch	AnH (n: Channel Number)	kk (00H..7FH)	Key Number (0-127)	vv (00H..7FH)	Data	○	○	○ (Keyboard)	×	×	○	×	○	○		
Pitch Bend Change [GM1] [GM2]	EnH (n: Channel Number)	cc (00H..7FH)	LSB	dd (00H..7FH)	MSB	○	×	×	×	×	○	×	○	×	×	
Realtime Message	FBH MIDI Clock	—	—	—	—	×	×	×	×	×	—	—	—	×	×	
	FAH Start	—	—	—	—	×	×	×	×	×	—	—	—	×	×	
	FBH Continue	—	—	—	—	×	×	×	×	×	—	—	—	×	×	
	FCH Stop	—	—	—	—	×	×	×	×	×	—	—	—	×	×	
	FEH Active Sens [GM2]	—	—	—	—	○	×	×	×	×	—	—	—	×	×	
	FFH System Reset	—	—	—	—	×	×	×	×	×	—	—	—	×	×	

* For upright pianos (excluding some models), the sostenuto pedal information (Control Change 66) is not transmitted.

MIDI Channel Message (2)

Parameters Controlled by NRPN (Non-Registered Parameter Numbers)

NRPN		Data Entry		Parameter	Data Range	[MIDI (Silent)]					[Internal Sequencer]				
MSB	LSB	MSB	LSB			MIDI Reception	MIDI Transmission		Song Playback			MIDI Recording			
						Song Part	Piano Playback Channel	Panel Operation	Song Playback	MIDI Input	PLAY	PLAY (Piano Part)	REW	Piano	Others
01H	08H	mmH	---	Vibrato Rate	mm: 00H-40H-7FH (-64...0...+63)	○	×	×	×	×	○	×	○	×	×
01H	09H	mmH	---	Vibrato Depth	mm: 00H-40H-7FH (-64...0...+63)	○	×	×	×	×	○	×	○	×	×
01H	0AH	mmH	---	Vibrato Delay	mm: 00H-40H-7FH (-64...0...+63)	○	×	×	×	×	○	×	○	×	×
01H	20H	mmH	---	Low Pass Filter Cutoff Frequency	mm: 00H-40H-7FH (-64...0...+63)	○	×	×	×	×	○	×	○	×	×
01H	21H	mmH	---	Low Pass Filter Resonance	mm: 00H-40H-7FH (-64...0...+63)	○	×	×	×	×	○	×	○	×	×
01H	30H	mmH	---	EQ BASS	mm: 00H-40H-7FH (-64...0...+63)	×	×	×	×	×	×	×	×	×	×
01H	31H	mmH	---	EQ TREBLE	mm: 00H-40H-7FH (-64...0...+63)	×	×	×	×	×	×	×	×	×	×
01H	34H	mmH	---	EQ BASS Frequency	mm: 04H-28H (32...2.0k [Hz])	×	×	×	×	×	×	×	×	×	×
01H	35H	mmH	---	EQ TREBLE Frequency	mm: 1CH-3AH (500...16.0k [Hz])	×	×	×	×	×	×	×	×	×	×
01H	63H	mmH	---	EG Attack Time	mm: 00H-40H-7FH (-64...0...+63)	○	×	×	×	×	○	×	○	×	×
01H	64H	mmH	---	EG Decay Time	mm: 00H-40H-7FH (-64...0...+63)	○	×	×	×	×	○	×	○	×	×
01H	66H	mmH	---	EG Release	mm: 00H-40H-7FH (-64...0...+63)	○	×	×	×	×	○	×	○	×	×
14H	rrH	mmH	---	Drum Low Pass Filter Cutoff Frequency	rr: drum instrument note number mm: 00H-40H-7FH (-64...0...+63)	○	×	×	×	×	○	×	×	×	×
15H	rrH	mmH	---	Drum Low Pass Filter Resonance	rr: drum instrument note number mm: 00H-40H-7FH (-64...0...+63)	○	×	×	×	×	○	×	×	×	×
16H	rrH	mmH	---	Drum EG Attack Rate	rr: drum instrument note number mm: 00H-40H-7FH (-64...0...+63)	○	×	×	×	×	○	×	×	×	×
17H	rrH	mmH	---	Drum EG Decay Rate	rr: drum instrument note number mm: 00H-40H-7FH (-64...0...+63)	○	×	×	×	×	○	×	×	×	×
18H	rrH	mmH	---	Drum Pitch Coarse	rr: drum instrument note number mm: 00H-40H-7FH (-64...0...+63)	○	×	×	×	×	○	×	×	×	×
19H	rrH	mmH	---	Drum Pitch Fine	rr: drum instrument note number mm: 00H-40H-7FH (-64...0...+63)	○	×	×	×	×	○	×	×	×	×
1AH	rrH	mmH	---	Drum Level	rr: drum instrument note number mm: 00H-7FH (0...127)	○	×	×	×	×	○	×	×	×	×
1CH	rrH	mmH	---	Drum Pan	rr: drum instrument note number mm: 00H, 01H-40H-7FH (RND, L63...C...R63)	○	×	×	×	×	○	×	×	×	×
1DH	rrH	mmH	---	Drum Reverb Send Level	rr: drum instrument note number mm: 00H-7FH (0...127)	○	×	×	×	×	○	×	×	×	×
1EH	rrH	mmH	---	Drum Chorus Send Level	rr: drum instrument note number mm: 00H-7FH (0...127)	○	×	×	×	×	○	×	×	×	×
1FH	rrH	mmH	---	Drum Variation Send Level	rr: drum instrument note number mm: 00H-7FH (0...127) (Variation Connection = SYSTEM) mm: 00H, 01H-7FH (OFF, ON) (Variation Connection = INSERTION)	○	×	×	×	×	○	×	×	×	×
24H	rrH	mmH	---	Drum HPF Cutoff Frequency	rr: drum instrument note number mm: 00H-40H-7FH (-64...0...+63)	×	×	×	×	×	×	×	×	×	×
30H	rrH	mmH	---	Drum EQ Bass Gain	rr: drum instrument note number mm: 00H-7FH (0...127)	×	×	×	×	×	×	×	×	×	×
31H	rrH	mmH	---	Drum EQ Treble Gain	rr: drum instrument note number mm: 00H-7FH (0...127)	×	×	×	×	×	×	×	×	×	×
34H	rrH	mmH	---	Drum EQ Bass Frequency	rr: drum instrument note number mm: 04H-28H (32...2.0k [Hz])	×	×	×	×	×	×	×	×	×	×
35H	rrH	mmH	---	Drum EQ Treble Frequency	rr: drum instrument note number mm: 1CH-3AH (500...16.0k [Hz])	×	×	×	×	×	×	×	×	×	×
40H	rrH	mmH	---	Drum VELOCITY PITCH SENS.	rr: drum instrument note number mm: 00H-0FH (0...15)	×	×	×	×	×	×	×	×	×	×
41H	rrH	mmH	---	Drum VELOCITY LPF CUTOFF SENS.	rr: drum instrument note number mm: 00H-0FH (0...15)	×	×	×	×	×	×	×	×	×	×

* NRPN MSB: 14H-1FH (for drums) message is accepted as long as the channel is set with a drum voice.
* Data Entry LSB will be ignored.

Parameters Controlled by RPN (Registered Parameter Numbers)

RPN		Data Entry		Parameter	Data Range	[MIDI (Silent)]					[Internal Sequencer]				
MSB	LSB	MSB	LSB			MIDI Reception	MIDI Transmission		Song Playback			MIDI Recording			
						Song Part	Piano Playback Channel	Panel Operation	Song Playback	MIDI Input	PLAY	PLAY (Piano Part)	REW	Piano	Others
00H	00H	mmH	---	Pitch Bend Sensitivity [GM1] [GM2]	mm: 00H-18H (0...+24 [semitones])	○	×	×	×	×	○	×	×	×	×
00H	01H	mmH	llH	Fine Tune [GM1] [GM2]	mm ll: 00H 00H -100 [cent] ... mm ll: 40H 00H 0 [cent] ... mm ll: 7FH 7FH 100 [cent]	○	×	×	×	×	○	×	○	×	×
00H	02H	mmH	---	Coarse Tune [GM1] [GM2]	mm: 28H-40H-58H (-24...0...+24 [semitones])	○	×	×	×	×	○	×	○	×	×
00H	05H	mmH	llH	Modulation Sensitivity [GM2]	mm: Specified in semitone increments ll: Specified in 100/128 cent increments	○	×	×	×	×	○	×	×	×	×
7FH	7FH	---	---	Null [GM2]	---	○	×	×	×	×	○	×	×	×	×

MIDI Parameter Change Table

■ MIDI Parameter Change Table (XG SYSTEM)

Address (H)	Size (H)	Data (H)	Parameter	Description	XG Default (H)	[MIDI (Silent)]					[Internal Sequencer]				
						MIDI Reception		MIDI Transmission			Song Playback			MIDI Recording	
						Song Part	Piano Playback Channel	Panel Operation	Song Playback	MIDI Input	PLAY	PLAY (Piano Part)	REW	Piano	Others
00	00	00	4	00-0F 00-0F 00-0F	MASTER TUNE	-102.4...0...+102.3 [cent] 1st bit3-0→bit15-12 2nd bit3-0→bit11-8 3rd bit3-0→bit7-4 4th bit3-0→bit3-0									
		04	1	00-7F	MASTER VOLUME	0...127									
		05	1	00-7F	MASTER ATTENUATOR	0...127									
		06	1	28-58	TRANSPOSE	-24...0...+24 [semitones]									
		7D	1	N	DRUM SETUP RESET	N: Drum setup number									
		7E	1	00	XG SYSTEM ON	00=XG system ON									
		7F	1	00	ALL PARAMETER RESET	00=ON									
TOTAL SIZE						07									

■ MIDI Parameter Change Table (SYSTEM INFORMATION)

Address (H)	Size (H)	Data (H)	Parameter	Description	[MIDI (Silent)]					[Internal Sequencer]					
					MIDI Reception		MIDI Transmission			Song Playback			MIDI Recording		
					Song Part	Piano Playback Channel	Panel Operation	Song Playback	MIDI Input	PLAY	PLAY (Piano Part)	REW	Piano	Others	
01	00	00	E	20-7F	Model Name 1	32...127 (ASCII CHARACTER)									
										
		0D	1	20-7F	Model Name 14	32...127 (ASCII CHARACTER)									
		0E	1		NOT USED										
		0F	1		NOT USED										
TOTAL SIZE						10									

* Transmitted in response to dump request. Not received.

■ MIDI Parameter Change Table (EFFECT1)

Address (H)	Size (H)	Data (H)	Parameter	Description	XG Default (H)	[MIDI (Silent)]					[Internal Sequencer]				
						MIDI Reception		MIDI Transmission			Song Playback			MIDI Recording	
						Song Part	Piano Playback Channel	Panel Operation	Song Playback	MIDI Input	PLAY	PLAY (Piano Part)	REW	Piano	Others
02	01	00	2	00-7F 00-7F	REVERB TYPE MSB REVERB TYPE LSB	Refer to Effect Parameter List									
		02	1	00-7F	REVERB PARAMETER 1	Refer to Effect Parameter List									
		03	1	00-7F	REVERB PARAMETER 2	Refer to Effect Parameter List									
		04	1	00-7F	REVERB PARAMETER 3	Refer to Effect Parameter List									
		05	1	00-7F	REVERB PARAMETER 4	Refer to Effect Parameter List									
		06	1	00-7F	REVERB PARAMETER 5	Refer to Effect Parameter List									
		07	1	00-7F	REVERB PARAMETER 6	Refer to Effect Parameter List									
		08	1	00-7F	REVERB PARAMETER 7	Refer to Effect Parameter List									
		09	1	00-7F	REVERB PARAMETER 8	Refer to Effect Parameter List									
		0A	1	00-7F	REVERB PARAMETER 9	Refer to Effect Parameter List									
		0B	1	00-7F	REVERB PARAMETER 10	Refer to Effect Parameter List									
		0C	1	00-7F	REVERB RETURN	→odB...0dB...+6dB (0...64...127)									
		0D	1	01-7F	REVERB PAN	L63...C...R63									
TOTAL SIZE						0E									
02	01	10	1	00-7F	REVERB PARAMETER 11	Refer to Effect Parameter List									
		11	1	00-7F	REVERB PARAMETER 12	Refer to Effect Parameter List									
		12	1	00-7F	REVERB PARAMETER 13	Refer to Effect Parameter List									
		13	1	00-7F	REVERB PARAMETER 14	Refer to Effect Parameter List									
		14	1	00-7F	REVERB PARAMETER 15	Refer to Effect Parameter List									
		15	1	00-7F	REVERB PARAMETER 16	Refer to Effect Parameter List									
TOTAL SIZE						06									

MIDI Parameter Change Table

Address (H)	Size (H)	Data (H)	Parameter	Description	XG Default (H)
02 01 20	2	00-7F	CHORUS TYPE MSB CHORUS TYPE LSB	Refer to Effect Parameter List	41(=CHORUS1) 00
	22	1 00-7F	CHORUS PARAMETER 1	Refer to Effect Parameter List	Depends on Chorus Type
	23	1 00-7F	CHORUS PARAMETER 2	Refer to Effect Parameter List	Depends on Chorus Type
	24	1 00-7F	CHORUS PARAMETER 3	Refer to Effect Parameter List	Depends on Chorus Type
	25	1 00-7F	CHORUS PARAMETER 4	Refer to Effect Parameter List	Depends on Chorus Type
	26	1 00-7F	CHORUS PARAMETER 5	Refer to Effect Parameter List	Depends on Chorus Type
	27	1 00-7F	CHORUS PARAMETER 6	Refer to Effect Parameter List	Depends on Chorus Type
	28	1 00-7F	CHORUS PARAMETER 7	Refer to Effect Parameter List	Depends on Chorus Type
	29	1 00-7F	CHORUS PARAMETER 8	Refer to Effect Parameter List	Depends on Chorus Type
	2A	1 00-7F	CHORUS PARAMETER 9	Refer to Effect Parameter List	Depends on Chorus Type
	2B	1 00-7F	CHORUS PARAMETER 10	Refer to Effect Parameter List	Depends on Chorus Type
	2C	1 00-7F	CHORUS RETURN	--dB...0dB...+6dB (0...64...127)	40
	2D	1 01-7F	CHORUS PAN	L63...C...R63	40
	2E	1 00-7F	SEND CHORUS TO REVERB	--dB...0dB...+6dB (0...64...127)	00

TOTAL SIZE 0F

	02 01 30	1 00-7F	CHORUS PARAMETER 11	Refer to Effect Parameter List	Depends on Chorus Type
		31 1 00-7F	CHORUS PARAMETER 12	Refer to Effect Parameter List	Depends on Chorus Type
		32 1 00-7F	CHORUS PARAMETER 13	Refer to Effect Parameter List	Depends on Chorus Type
		33 1 00-7F	CHORUS PARAMETER 14	Refer to Effect Parameter List	Depends on Chorus Type
		34 1 00-7F	CHORUS PARAMETER 15	Refer to Effect Parameter List	Depends on Chorus Type
		35 1 00-7F	CHORUS PARAMETER 16	Refer to Effect Parameter List	Depends on Chorus Type

TOTAL SIZE 06

Address (H)	Size (H)	Data (H)	Parameter	Description	XG Default (H)
02 01 40	2	00-7F	VARIATION TYPE MSB VARIATION TYPE LSB	Refer to Effect Parameter List	05(=DELAY L, C, R) 00
	42	2 00-7F	VARIATION PARAMETER 1 MSB VARIATION PARAMETER 1 LSB	Refer to Effect Parameter List	Depends on Variation Type
	44	2 00-7F	VARIATION PARAMETER 2 MSB VARIATION PARAMETER 2 LSB	Refer to Effect Parameter List	Depends on Variation Type
	46	2 00-7F	VARIATION PARAMETER 3 MSB VARIATION PARAMETER 3 LSB	Refer to Effect Parameter List	Depends on Variation Type
	48	2 00-7F	VARIATION PARAMETER 4 MSB VARIATION PARAMETER 4 LSB	Refer to Effect Parameter List	Depends on Variation Type
	4A	2 00-7F	VARIATION PARAMETER 5 MSB VARIATION PARAMETER 5 LSB	Refer to Effect Parameter List	Depends on Variation Type
	4C	2 00-7F	VARIATION PARAMETER 6 MSB VARIATION PARAMETER 6 LSB	Refer to Effect Parameter List	Depends on Variation Type
	4E	2 00-7F	VARIATION PARAMETER 7 MSB VARIATION PARAMETER 7 LSB	Refer to Effect Parameter List	Depends on Variation Type
	50	2 00-7F	VARIATION PARAMETER 8 MSB VARIATION PARAMETER 8 LSB	Refer to Effect Parameter List	Depends on Variation Type
	52	2 00-7F	VARIATION PARAMETER 9 MSB VARIATION PARAMETER 9 LSB	Refer to Effect Parameter List	Depends on Variation Type
	54	2 00-7F	VARIATION PARAMETER 10 MSB VARIATION PARAMETER 10 LSB	Refer to Effect Parameter List	Depends on Variation Type
	56	1 00-7F	VARIATION RETURN	--dB...0dB...+6dB (0...64...127)	40
	57	1 01-7F	VARIATION PAN	L63...C...R63	40
	58	1 00-7F	SEND VARIATION TO REVERB	--dB...0dB...+6dB (0...64...127)	00
	59	1 00-7F	SEND VARIATION TO CHORUS	--dB...0dB...+6dB (0...64...127)	00
	5A	1 00-01	VARIATION CONNECTION	INSERTION, SYSTEM	00
	5B	1 00-7F	VARIATION PART NUMBER	Reception: Part1...16 (0...15) Transmission: Part1...16 (0...15) AD (64) OFF (127)	7F
	5C	1 00-7F	MW VARIATION CONTROL DEPTH	-64...0...+63	40
	5D	1 00-7F	BEND VARIATION CONTROL DEPTH	-64...0...+63	40
	5E	1 00-7F	CAT VARIATION CONTROL DEPTH	-64...0...+63	40
	5F	1 00-7F	AC1 VARIATION CONTROL DEPTH	-64...0...+63	40
	60	1 00-7F	AC2 VARIATION CONTROL DEPTH	-64...0...+63	40

TOTAL SIZE 21

	02 01 70	1 00-7F	VARIATION PARAMETER 11	Refer to Effect Parameter List	Depends on Variation Type
		71 1 00-7F	VARIATION PARAMETER 12	Refer to Effect Parameter List	Depends on Variation Type
		72 1 00-7F	VARIATION PARAMETER 13	Refer to Effect Parameter List	Depends on Variation Type
		73 1 00-7F	VARIATION PARAMETER 14	Refer to Effect Parameter List	Depends on Variation Type
		74 1 00-7F	VARIATION PARAMETER 15	Refer to Effect Parameter List	Depends on Variation Type
		75 1 00-7F	VARIATION PARAMETER 16	Refer to Effect Parameter List	Depends on Variation Type

TOTAL SIZE 06

[MIDI (Silent)]

MIDI Reception		MIDI Transmission		
Song Part	Piano Playback Channel	Panel Operation	Song Playback	MIDI Input
○	×	○ (Voice Setting)	×	×
○	×	○ (Voice Setting)	×	×
○	×	×	×	×
○	×	○ (Voice Setting)	×	×
○	×	×	×	×
○	×	×	×	×
○	×	×	×	×
○	×	×	×	×
○	×	×	×	×
○	×	×	×	×

[Internal Sequencer]

Song Playback			MIDI Recording	
PLAY	PLAY (Piano Part)	REW	Piano	Others
○	×	○	×	○
○	×	○	×	○
○	×	○	×	×
○	×	○	×	○
○	×	○	×	×
○	×	○	×	×
○	×	○	×	×
○	×	○	×	×
○	×	○	×	×
○	×	○	×	×

○	×	×	×	×
○	×	×	×	×
○	×	×	×	×
○	×	×	×	×
○	×	×	×	×
○	×	○	×	×
○	×	×	×	×
○	×	○ (Voice Setting)	×	×

○	×	○	×	×
○	×	○	×	×
○	×	○	×	×
○	×	○	×	×
○	×	○	×	×
○	×	○	×	×
○	×	○	×	×
○	×	○	×	×
○	×	○	×	×
○	×	○	×	○

[MIDI (Silent)]

MIDI Reception		MIDI Transmission		
Song Part	Piano Playback Channel	Panel Operation	Song Playback	MIDI Input
○	×	×	×	×
○	×	×	×	×
○	×	×	×	×
○	×	×	×	×
○	×	×	×	×
○	×	×	×	×
○	×	×	×	×
○	×	×	×	×
○	×	×	×	×
○	×	×	×	×
○	×	×	×	×
○	×	×	×	×
○	×	×	×	×
○	×	×	×	×
○	×	×	×	×
○	×	×	×	×

[Internal Sequencer]

Song Playback			MIDI Recording	
PLAY	PLAY (Piano Part)	REW	Piano	Others
○	×	○	×	×
○	×	○	×	×
○	×	○	×	×
○	×	○	×	×
○	×	○	×	×
○	×	○	×	×
○	×	○	×	×
○	×	○	×	×
○	×	○	×	×
○	×	○	×	×
○	×	○	×	×
○	×	○	×	×
○	×	○	×	×
○	×	○	×	×

MIDI Parameter Change Table

MIDI Parameter Change Table (MULTI EQ)

Table with columns: Address (H), Size (H), Data (H), Parameter, Description. Lists parameters for EQ TYPE, EQ GAIN, EQ FREQUENCY, EQ Q, EQ SHAPE, EQ GAIN2, EQ FREQUENCY2, EQ Q2, NOT USED, EQ GAIN3, EQ FREQUENCY3, EQ Q3, EQ GAIN4, EQ FREQUENCY4, EQ Q4, EQ GAIN5, EQ FREQUENCY5, EQ Q5, EQ SHAPE5.

* The MULTI EQ parameter cannot be reset to its factory setting with XG SYSTEM on.

Table with columns: MIDI Reception (Song Part, Piano Playback Channel, Panel Operation, Song Playback, MIDI Input), MIDI Transmission, Song Playback (PLAY, PLAY (Piano Part), REW), MIDI Recording (Piano, Others). Shows parameter support across modes.

MIDI Parameter Change Table (EFFECT2)

Table with columns: Address (H), Size (H), Data (H), Parameter, Description. Lists parameters for INSERTION EFFECT TYPE MSB/LSB, INSERTION EFFECT PARAMETER 1-16, MW INSERTION CONTROL DEPTH, BEND INSERTION CONTROL DEPTH, CAT INSERTION CONTROL DEPTH, AC1/AC2 INSERTION CONTROL DEPTH.

Table with columns: Address (H), Size (H), Data (H), Parameter, Description. Lists parameters for INSERTION EFFECT PARAMETER 11-16.

Table with columns: Address (H), Size (H), Data (H), Parameter, Description. Lists parameters for INSERTION EFFECT PARAMETER 1 MSB/LSB through 10 MSB/LSB.

* The EFFECT2 parameter cannot be reset to its factory setting with XG SYSTEM on.

The second byte of the address is considered as an insertion effect number. n: insertion effect number

The insertion effect number range is from 0 to 1. Values outside the range are handled as unknown and ignored. For effect types that do not require MSB, the parameters for address 02-0B will be received and the parameters for address 30-42 will not be received. For effect types that require MSB, the parameters for address 30-42 will be received and the parameters for address 02-0B will not be received. When bulk dumps that include effect type data are transmitted, the parameters for address 02-0B will always be transmitted. However, for effect types that require MSB, the parameters for address 02-0B will not be received when the bulk dump is received.

Table with columns: MIDI Reception (Song Part, Piano Playback Channel, Panel Operation, Song Playback, MIDI Input), MIDI Transmission, Song Playback (PLAY, PLAY (Piano Part), REW), MIDI Recording (Piano, Others). Shows parameter support across modes.

Table with columns: MIDI Reception (Song Part, Piano Playback Channel, Panel Operation, Song Playback, MIDI Input), MIDI Transmission, Song Playback (PLAY, PLAY (Piano Part), REW), MIDI Recording (Piano, Others). Shows parameter support across modes.

Table with columns: MIDI Reception (Song Part, Piano Playback Channel, Panel Operation, Song Playback, MIDI Input), MIDI Transmission, Song Playback (PLAY, PLAY (Piano Part), REW), MIDI Recording (Piano, Others). Shows parameter support across modes.

MIDI Parameter Change Table

MIDI Parameter Change Table (MULTI PART)

Table with 6 columns: Address (H), Size (H), Data (H), Parameter, Description, XG Default (H). Rows include parameters like BANK SELECT MSB, PROGRAM NUMBER, MONO/POLY MODE, etc.

[MIDI (Silent)]

Table with 5 columns: Song Part, Piano Playback Channel, Panel Operation, Song Playback, MIDI Input. Rows correspond to parameters from the main table, indicating MIDI reception/transmission status.

[Internal Sequencer]

Table with 5 columns: PLAY, PLAY (Piano Part), REW, Piano, Others. Rows correspond to parameters from the main table, indicating internal sequencer recording status.

TOTAL SIZE 29

Continuation of MIDI Parameter Change Table (MULTI PART) with parameters 30-52, including Rev PITCH BEND, SCALE TUNING C, etc.

Continuation of MIDI (Silent) table for parameters 30-52.

Continuation of Internal Sequencer table for parameters 30-52.

Data list

MIDI Parameter Change Table

Address (H)	Size (H)	Data (H)	Parameter	Description	XG Default (H)	[MIDI (Silent)]					[Internal Sequencer]						
						MIDI Reception		MIDI Transmission			Song Playback			MIDI Recording			
						Song Part	Piano Playback Channel	Panel Operation	Song Playback	MIDI Input	PLAY	PLAY (Piano Part)	REW	Piano	Others		
	53	1	28-58	PAT PITCH CONTROL	-24...0...+24 [semitones]	40	○	×	×	×	×	○	×	×	×	×	
	54	1	00-7F	PAT LOW PASS FILTER CONTROL	-9600...0...+9450 [cent]	40	○	×	×	×	×	○	×	×	×	×	
	55	1	00-7F	PAT AMPLITUDE CONTROL	-100...0...+100 [%]	40	○	×	×	×	×	○	×	×	×	×	
	56	1	00-7F	PAT LFO PMOD DEPTH	0...127	00	○	×	×	×	×	○	×	×	×	×	
	57	1	00-7F	PAT LFO FMOD DEPTH	0...127	00	○	×	×	×	×	○	×	×	×	×	
	58	1	00-7F	PAT LFO AMOD DEPTH	0...127	00	○	×	×	×	×	○	×	×	×	×	
	59	1	00-5F	AC1 CONTROLLER NUMBER	0...95	10	○	×	×	×	×	○	×	○	×	×	
	5A	1	28-58	AC1 PITCH CONTROL	-24...0...+24 [semitones]	40	○	×	×	×	×	○	×	×	×	×	
	5B	1	00-7F	AC1 LOW PASS FILTER CONTROL	-9600...0...+9450 [cent]	40	○	×	×	×	×	○	×	×	×	×	
	5C	1	00-7F	AC1 AMPLITUDE CONTROL	-100...0...+100 [%]	40	○	×	×	×	×	○	×	×	×	×	
	5D	1	00-7F	AC1 LFO PMOD DEPTH	0...127	00	○	×	×	×	×	○	×	×	×	×	
	5E	1	00-7F	AC1 LFO FMOD DEPTH	0...127	00	○	×	×	×	×	○	×	×	×	×	
	5F	1	00-7F	AC1 LFO AMOD DEPTH	0...127	00	○	×	×	×	×	○	×	×	×	×	
	60	1	00-5F	AC2 CONTROLLER NUMBER	0...95	11	○	×	×	×	×	○	×	×	×	×	
	61	1	28-58	AC2 PITCH CONTROL	-24...0...+24 [semitones]	40	○	×	×	×	×	○	×	×	×	×	
	62	1	00-7F	AC2 LOW PASS FILTER CONTROL	-9600...0...+9450 [cent]	40	○	×	×	×	×	○	×	×	×	×	
	63	1	00-7F	AC2 AMPLITUDE CONTROL	-100...0...+100 [%]	40	○	×	×	×	×	○	×	×	×	×	
	64	1	00-7F	AC2 LFO PMOD DEPTH	0...127	00	○	×	×	×	×	○	×	×	×	×	
	65	1	00-7F	AC2 LFO FMOD DEPTH	0...127	00	○	×	×	×	×	○	×	×	×	×	
	66	1	00-7F	AC2 LFO AMOD DEPTH	0...127	00	○	×	×	×	×	○	×	×	×	×	
	67	1	00-01	PORTAMENTO SWITCH	OFF, ON	00	○	×	×	×	×	○	×	○	×	×	
	68	1	00-7F	PORTAMENTO TIME	0...127	00	○	×	×	×	×	○	×	○	×	×	
	69	1	00-7F	PITCH EG INITIAL LEVEL	-64...0...+63	40	○	×	×	×	×	○	×	×	×	×	
	6A	1	00-7F	PITCH EG ATTACK TIME	-64...0...+63	40	○	×	×	×	×	○	×	×	×	×	
	6B	1	00-7F	PITCH EG RELEASE LEVEL	-64...0...+63	40	○	×	×	×	×	○	×	×	×	×	
	6C	1	00-7F	PITCH EG RELEASE TIME	-64...0...+63	40	○	×	×	×	×	○	×	×	×	×	
	6D	1	01-7F	VELOCITY LIMIT LOW	1...127	01	○	×	×	×	×	○	×	×	×	×	
	6E	1	01-7F	VELOCITY LIMIT HIGH	1...127	7F	○	×	×	×	×	○	×	×	×	×	
TOTAL SIZE						3F											
	70	1		NOT USED		—	—	—	—	—	—	—	—	—	—	—	
	71	1		NOT USED		—	—	—	—	—	—	—	—	—	—	—	
	72	1	00-7F	EQ BASS GAIN	-12dB...+12dB	40	×	×	×	×	×	×	×	×	×	×	
	73	1	00-7F	EQ TREBLE GAIN	-12dB...+12dB	40	×	×	×	×	×	×	×	×	×	×	
TOTAL SIZE						04											
	74	1		NOT USED		—	—	—	—	—	—	—	—	—	—	—	
	75	1		NOT USED		—	—	—	—	—	—	—	—	—	—	—	
	76	1	04-28	EQ BASS FREQUENCY	32...2.0k [Hz]	0C	×	×	×	×	×	×	×	×	×	×	
	77	1	1C-3A	EQ TREBLE FREQUENCY	500...16.0k [Hz]	36	×	×	×	×	×	×	×	×	×	×	
	78	1		NOT USED		—	—	—	—	—	—	—	—	—	—	—	
	79	1		NOT USED		—	—	—	—	—	—	—	—	—	—	—	
	7A	1		NOT USED		—	—	—	—	—	—	—	—	—	—	—	
	7B	1		NOT USED		—	—	—	—	—	—	—	—	—	—	—	
	7C	1		NOT USED		—	—	—	—	—	—	—	—	—	—	—	
	7D	1		NOT USED		—	—	—	—	—	—	—	—	—	—	—	
	7E	1		NOT USED		—	—	—	—	—	—	—	—	—	—	—	
	7F	1		NOT USED		—	—	—	—	—	—	—	—	—	—	—	
TOTAL SIZE						0C											
0A	nn	40	1	00-7F	MW OFFSET LEVEL CONTROL	-100 - 100 [%]	40	○	×	×	×	×	○	×	○	×	×
		41	1	00-7F	BEND OFFSET LEVEL CONTROL	-100 - 100 [%]	40	○	×	×	×	×	○	×	○	×	×
		42	1	00-7F	CAT OFFSET LEVEL CONTROL	-100 - 100 [%]	40	○	×	×	×	×	○	×	○	×	×
		43	1	00-7F	PAT OFFSET LEVEL CONTROL	-100 - 100 [%]	40	○	×	×	×	×	○	×	○	×	×
		44	1	00-7F	AC1 OFFSET LEVEL CONTROL	-100 - 100 [%]	40	○	×	×	×	×	○	×	○	×	×
		45	1	00-7F	AC2 OFFSET LEVEL CONTROL	-100 - 100 [%]	40	○	×	×	×	×	○	×	○	×	×
TOTAL SIZE						06											

nn: part number

If there is a Drum voice assigned to the part, the following parameters are ineffective.

- BANK SELECT LSB
- PORTAMENTO
- MONO/POLY
- SCALE TUNING
- POLY AFTER TOUCH
- PITCH EG

MIDI Parameter Change Table

■ MIDI Parameter Change Table (DRUM SETUP)

Address (H)	Size (H)	Data (H)	Parameter	Description	XG Default (H)	[MIDI (Silent)]					[Internal Sequencer]				
						MIDI Reception		MIDI Transmission			Song Playback			MIDI Recording	
						Song Part	Piano Playback Channel	Panel Operation	Song Playback	MIDI Input	PLAY	PLAY (Piano Part)	REW	Piano	Others
3n	rr	00	1	00-7F	PITCH COARSE	-64...0...+63	40								
		01	1	00-7F	PITCH FINE	-64...0...+63 [cent]	40								
		02	1	00-7F	LEVEL	0...127	Depends on the note								
		03	1	00-7F	ALTERNATE GROUP	OFF, L...127	Depends on the note								
		04	1	00-7F	PAN	RND, L63...C...R63	Depends on the note								
		05	1	00-7F	REVERB SEND	0...127	Depends on the note								
		06	1	00-7F	CHORUS SEND	0...127	Depends on the note								
		07	1	00-7F	VARIATION SEND	0...127	7F								
		08	1	00-01	KEY ASSIGN	SINGLE, MULTI	00								
		09	1	00-01	Rcv NOTE OFF	OFF, ON	Depends on the note								
		0A	1	00-01	Rcv NOTE ON	OFF, ON	01								
		0B	1	00-7F	LOW PASS FILTER CUTOFF FREQUENCY	-64...0...+63	40								
		0C	1	00-7F	LOW PASS FILTER RESONANCE	-64...0...+63	40								
		0D	1	00-7F	EG ATTACK RATE	-64...0...+63	40								
		0E	1	00-7F	EG DECAY1 RATE	-64...0...+63	40								
		0F	1	00-7F	EG DECAY2 RATE	-64...0...+63	40								
TOTAL SIZE						10									
		20	1	00-7F	EQ BASS GAIN	-12...+12 [dB]	40	x	x	x	x	x	x	x	x
		21	1	00-7F	EQ TREBLE GAIN	-12...+12 [dB]	40	x	x	x	x	x	x	x	x
		22	1		NOT USED	---	---	---	---	---	---	---	---	---	---
		23	1		NOT USED	---	---	---	---	---	---	---	---	---	---
		24	1	04-28	EQ BASS FREQUENCY	32...2.0k [Hz]	0C	x	x	x	x	x	x	x	x
		25	1	1C-3A	EQ TREBLE FREQUENCY	500...16.0k [Hz]	36	x	x	x	x	x	x	x	x
		26	1		NOT USED	---	---	---	---	---	---	---	---	---	---
		27	1		NOT USED	---	---	---	---	---	---	---	---	---	---
		28	1		NOT USED	---	---	---	---	---	---	---	---	---	---
		29	1		NOT USED	---	---	---	---	---	---	---	---	---	---
		2A	1		NOT USED	---	---	---	---	---	---	---	---	---	---
		2B	1		NOT USED	---	---	---	---	---	---	---	---	---	---
		2C	1		NOT USED	---	---	---	---	---	---	---	---	---	---
		2D	1		NOT USED	---	---	---	---	---	---	---	---	---	---
TOTAL SIZE						0E									

n: drum setup number (0-1)
 rr: note number (0D-5B)

- In the following cases, the unit will initialize all drum setups.
- XG SYSTEM ON received
 - GM SYSTEM ON received
 - GM LEVEL 2 SYSTEM ON received
 - GS RESET received
 - DRUM SETUP RESET received (only when in XG mode)

When a part to which a drum setup is assigned receives a program change, the assigned drum setup will be initialized.
 If the same drum setup is assigned to two or more parts, changes in drum setup parameters (including program changes) will apply to all parts to which it is assigned.

System Exclusive Messages (1)

- * Not received when Receive System Exclusive Message is set to off.
- * Not transmitted when Transmit System Exclusive Message is set to off.

System Exclusive Messages (Universal Non Realtime Messages)

MIDI Event	Data Format	[MIDI (Silent)]					[Internal Sequencer]			MIDI Recording Recorded from panel
		MIDI Reception		MIDI Transmission			Song Playback			
		Song Part	Piano Playback Channel	Panel Operation	Song Playback	MIDI Input	PLAY	PLAY (Piano Part)	REW	
GM1 System On [GM1] [GM2]	F0 7E XN 09 01 F7 11110000 F0 = Exclusive status 01111110 7E = Universal Non-Real Time 0xxxxxxx XN = When N is received N=0-F, whichever is received. X=ignored 00001001 09 = Sub-ID #1=General MIDI Message 00000001 01 = Sub-ID #2=General MIDI On 11110111 F7 = End of Exclusive	○	×	×	×	×	○	×	×	×

System Exclusive Messages (2)

System Exclusive Messages (XG)

MIDI Event	Data Format	[MIDI (Silent)]				[Internal Sequencer]				
		MIDI Reception		MIDI Transmission		Song Playback			MIDI Recording	
		Song Part	Piano Playback Channel	Panel Operation	Song Playback	PLAY	PLAY (Piano Part)	REW	Piano	Others
XG Parameter Change	F0 43 1n 4C hh mm ll dd ... F7 11110000 F0 = Exclusive status 01000011 43 = YAMAHA ID 0001nnnn 1n = Device Number n=always 0 (when transmit), n=0-F (when receive) 01001100 4C = Model ID 0hhhhhhh hh = Address High 0mmmmmmm mm = Address Mid 0lllllll ll = Address Low 0ddddd dd = Data ... 11110111 F7 = End of Exclusive	○ Refer to Parameter Change Table	○ Refer to Parameter Change Table	○ Refer to Parameter Change Table	×	○	○	○	○	○
XG Bulk Dump	F0 43 0n 4C aa bb hh mm ll dd ... dd cc F7 11110000 F0 = Exclusive status 01000011 43 = YAMAHA ID 0000nnnn 0n = Device Number n=always 0 (when transmit), n=0-F (when receive) 01001100 4C = Model ID 0aaaaaaa aa = Byte Count MSB 0bbbbbbb bb = Byte Count LSB 0hhhhhhh hh = Address High 0mmmmmmm mm = Address Mid 0lllllll ll = Address Low 0ddddd dd = Data : 0ddddd dd = Data 0cececcc cc = Checksum 11110111 F7 = End of Exclusive	○ Refer to Parameter Change Table	○ Refer to Parameter Change Table	○ Refer to Parameter Change Table	×	○	○	○	○	○
XG Parameter Request	F0 43 3n 4C hh ll F7 11110000 F0 = Exclusive status 01000011 43 = YAMAHA ID 0011nnnn 3n = Device Number n=always 0 (when transmit), n=0-F (when receive) 01001100 4C = Model ID 0hhhhhhh hh = Address High 0mmmmmmm mm = Address Mid 0lllllll ll = Address Low 11110111 F7 = End of Exclusive	○ Refer to Parameter Change Table	○ Refer to Parameter Change Table	×	×	×	○	○	○	×
XG Dump Request	F0 43 2n 4C hh mm ll F7 11110000 F0 = Exclusive status 01000011 43 = YAMAHA ID 0010nnnn 2n = Device Number n=always 0 (when transmit), n=0-F (when receive) 01001100 4C = Model ID 0hhhhhhh hh = Address High 0mmmmmmm mm = Address Mid 0lllllll ll = Address Low 11110111 F7 = End of Exclusive	○ Refer to Parameter Change Table	○ Refer to Parameter Change Table	×	×	×	○	○	○	×

System Exclusive Messages (2)

■ System Exclusive Messages (Others)

MIDI Event	Data Format	[MIDI (Silent)]				[Internal Sequencer]				
		MIDI Reception		MIDI Transmission		Song Playback			MIDI Recording	
		Song Part	Piano Playback Channel	Panel Operation	Song Playback	PLAY	PLAY (Piano Part)	REW	Piano	Others
MIDI Master Tuning	F0 43 1n 27 30 00 00 mm ll cc F7 11110000 F0 = Exclusive status 01000011 43 = YAMAHA ID 0001nnnn 1n n= always 0(when transmit), n=0-F(when receive) 00100111 27 = Model ID of TG100 00110000 30 = Address High 00000000 00 = Address Mid 00000000 00 = Address Low 0000mmmm 0m = Master Tune MSB 0000llll 0l = Master Tune LSB 0ccccc cc = don't care 11110111 F7 = End of Exclusive	x	x	x	x	x	x	x	x	x

■ System Exclusive Messages (Preset Voice)

MIDI Event	Data Format	[MIDI (Silent)]				[Internal Sequencer]				
		MIDI Reception		MIDI Transmission		Song Playback			MIDI Recording	
		Song Part	Piano Playback Channel	Panel Operation	Song Playback	PLAY	PLAY (Piano Part)	REW	Piano	Others
String Resonance Depth	F0 43 73 01 50 11 0n 02 dd F7 11110000 F0 = Exclusive status 01000011 43 = YAMAHA ID 01110011 73 = Clavinova ID 00000001 01 = Model ID (Clavinova common ID) 01010000 50 = SubID 00010001 11 = SubID 0000nnnn 0n = Channel (00-0F) 00000010 02 = SubID (String Resonance Depth) 0ddddd dd = Depth (00-48) 11110111 F7 = End of Exclusive	○	x	○ (Function)	x	○	x	○	x	x
Sustain Sample Depth	F0 43 73 01 50 11 0n 03 dd F7 11110000 F0 = Exclusive status 01000011 43 = YAMAHA ID 01110011 73 = Clavinova ID 00000001 01 = Model ID (Clavinova common ID) 01010000 50 = SubID 00010001 11 = SubID 0000nnnn 0n = Channel (00-0F) 00000011 03 = SubID (Sustain Sample Depth) 0ddddd dd = Depth (00-48) 11110111 F7 = End of Exclusive	○	x	○ (Function)	x	○	x	○	x	x
Key Off Sampling Depth	F0 43 73 01 50 11 0n 04 dd F7 11110000 F0 = Exclusive status 01000011 43 = YAMAHA ID 01110011 73 = Clavinova ID 00000001 01 = Model ID (Clavinova common ID) 01010000 50 = SubID 00010001 11 = SubID 0000nnnn 0n = Channel (00-0F) 00000100 04 = SubID (Key Off Sampling Depth) 0ddddd dd = Depth (00-50) 11110111 F7 = End of Exclusive	○	x	○ (Function)	x	○	x	○	x	x
Soft Pedal Depth	F0 43 73 01 50 11 0n 05 dd F7 11110000 F0 = Exclusive status 01000011 43 = YAMAHA ID 01110011 73 = Clavinova ID 00000001 01 = Model ID (Clavinova common ID) 01010000 50 = SubID 00010001 11 = SubID 0000nnnn 0n = Channel (00-0F) 00000101 05 = SubID (Soft Pedal Depth) 0ddddd dd = Depth (00-7F) 11110111 F7 = End of Exclusive	○	x	x	x	○	x	○	x	x

* For each depth value, the rest value is 40H = voice parameter.

MIDI IMPLEMENTATION CHART

YAMAHA
Model: Silent Piano SH

Date: 07-June-2012
Version: 1.00

Function...		Transmitted	Recognized	Remarks
Basic Channel	Default	1, 2	1-16	
	Changed	1-16	×	
Mode	Default	3	3	
	Messages	×	×	
	Altered	*****	×	
Note Number		0-127	0-127	
	: True voice	*****	0-127	
Velocity	Note ON	○ 9nH, v=1-127	○ 9nH, v=1-127	
	Note OFF	×	○ 9nH, v=0 or 8nH	
After Touch	Key's	○	○	
	Ch's	×	×	
Pitch Bend		×	○ 0-24 semi	*1
Control Change	0, 32	○	○	Bank Select
	1	×	○	Modulation
	7	○	○	Main Volume
	10	×	○	Panpot
	11	×	○	Expression
	6, 38	×	○	Data Entry
	64, 66, 67	○ *2	○	Pedal
	71-74	×	○	
	84	×	○	Portamento Control
	91	○	○	Effect1 Depth
	93	○	○	Effect3 Depth
	96-97	×	○	RPN Inc, Dec
	100-101	×	○	RPN LSB, MSB
Prog Change		○ 0-127	○ 0-127	
	: True #	*****		
System Exclusive		○	○	
Common	: Song Pos.	×	×	
	: Song Sel.	×	×	
	: Tune	×	×	
System Real Time	: Clock	×	×	
	: Commands	×	×	
Aux Messages	: All Sound Off	×	○ (120, 126, 127)	
	: Reset All Cntrls	×	○ (121)	
	: Local ON/OFF	×	○ (122)	
	: All Notes OFF	×	○ (123-125)	
	: Active Sense	○	○	
	: Reset	×	×	
Notes	*1 For some Harpsichord voices, the pitch may not be changed according to the pitch bend setting range. *2 For upright pianos (excluding some models), the sostenuto pedal information (66) is not transmitted.			

Mode 1 : OMNI ON, POLY Mode 2 : OMNI ON, MONO ○ : Yes
 Mode 3 : OMNI OFF, POLY Mode 4 : OMNI OFF, MONO × : No



YAMAHA CORPORATION

10-1, Naka-ku, Hamamatsu, 430-8650 JAPAN
Manual Development Group

© 2013 Yamaha Corporation

YF091E0

Published 03/2017 MWNB-E0 (N) Printed in Japan