

# POWERCHAIR OWNER'S MANUAL

**FRONTIER V6**  
**FRONTIER V4**  
**EXTREME X8**



**ENGLISH**



Join Magic Mobility  
on social media:



## Contents

Important warranty information	6
Warranty terms	6
Commencement of warranty period	6
Repair and replacement	6
Voiding of warranties	6
Extension of warranties	6
Lifetime Limited Warranty	6
One year warranty	6
Warranty exclusions	6
Replacement/repair parts warranty exclusions	7
Spare parts warranty	7
Additional notes	7
Australian consumers only	7
1 Power wheelchair owner's manual	8
1.1 Intended use	8
2 Safety and damage warnings	10
3 Safety	10
3.1 Transfers	11
3.2 Motor vehicle transport	11
3.3 Weight limitations	11
3.4 Stairs and escalators	12
3.5 Transportation products for your wheelchair	12
3.6 Public streets and roadways	12
3.7 Stationary obstacles: (steps, kerbs, etc)	12
3.8 Climbing or descending an incline	15
3.9 Maximum recommended incline	15
3.10 Removable parts	16
3.11 Cornering information	16
3.12 Electromagnetic fields (further information is in Appendix B – Electromagnetic interference (EMI))	16
3.13 Positioning belts	17

3.14	Weather precautions	17
3.15	Reaching and bending	17
3.16	Prescription drugs/physical limitations	17
3.17	Alcohol/smoking	17
3.18	Trapping hazards	18
4	Specifications	19
4.1	The Frontier V6	19
4.2	The Extreme X8	19
4.3	The Frontier V4 front wheel drive	20
4.4	The Frontier V4 rear wheel drive	20
4.5	Standards testing	21
4.6	Dimensions, mass and turning parameters	21
5	Operating instructions	22
5.1	Performance adjustments	22
5.2	Positioning	22
5.3	Freewheel mode – pushing the powerchair	22
5.4	Electrical safety protection	23
5.5	Seat tilt option - if fitted	24
5.6	Power elevating seat option - if fitted	24
5.7	Transfer tilt - if fitted (Frontier only)	25
5.8	Slope sensor (inclinometer) - if fitted	25
5.8.1	Backrest angle inhibits	25
5.8.2	Seat raise inhibits	26
5.8.3	Troubleshooting	26
5.8.4	Steering lock option - if fitted (Extreme X8 only)	26
6	Joystick controls	27
6.1	Joystick	27
6.2	Joystick power	27
6.3	Rain and water	27
6.4	Joystick lead	27
6.5	Controller program	27
6.6	Precautions for use	28
6.7	LED joystick module	28

6.7.1	Control panel	29
6.7.2	LED control system indication	29
6.7.3	LED joystick troubleshooting	30
6.8	LED joystick module	32
6.8.1	Control panel	32
6.8.2	LED control system indication	33
6.8.3	Basic programming and set-up	35
6.9	CJSM2-BT joystick module	37
6.9.1	Control panel	37
6.9.2	LCD screen control system indication	38
6.9.3	Basic programming and set-up	41
6.9.4	Pairing the CJSM-BT	42
6.9.5	Discovery mode	43
6.9.6	CJSM-BT infrared (IR)	43
6.10	Diagnostics	46
6.11	Common troubleshooting	47
6.12	Locking the control system	48
6.13	Care	48
7	Bluetooth (if installed)	49
7.1	Pairing	49
8	Batteries and charging	50
8.1	Batteries	50
8.2	Batteries	50
8.3	Battery run-in	50
8.4	Charging procedure	51
8.5	Battery gauge	52
8.6	Public transportation	53
8.7	Battery disposal and recycling	53
9	Care and maintenance	53
9.1	General guidelines	53
9.2	Batteries	54
9.3	Tyres and castors	54
9.3.1	Frontier tyre inflation	54
9.3.2	Extreme X8 tyre inflation	55

9.3.3	Tyre puncture repair	56
9.3.4	Tyre wear	56
9.4	Upholstery	56
9.5	Cleaning	56
9.6	Corrosion protection	56
9.6.1	Paint scratches and chips	57
9.6.2	Beach, salt water and coastal areas	57
9.6.3	Snow and ice, salted roads and footpaths	57
9.6.4	Post usage cleaning	57
9.6.5	Preventative Maintenance	57
9.7	Storage	58
9.8	Transportation	58
9.9	Daily checks	58
9.10	Weekly checks	58
9.11	Annual Checks	59
9.12	Disposal	59
10	Servicing	60
10.1	Electromagnetic interference (EMI) from radio wave sources	60
11	Technical specifications	61
12	Non-OEM parts	70
12.1	Non-OEM parts, assembly by a third party and customisation	70
Appendix A	ISO 7176-19	71
	WARNINGS	76
	<b>Appendix B - Electromagnetic interference (EMI)</b>	77
	Electromagnetic Interference (EMI) from radio wave sources	77
	Powered wheelchair electromagnetic interference (EMI)	77
	WARNINGS	78
	Important information	78
	Contact Magic Mobility if you require further information	78

## Important warranty information

### Warranty terms

#### COMMENCEMENT OF WARRANTY PERIOD

The warranty period begins on the date that the product is first received by the customer, or thirty (30) days from the shipping date from Magic Mobility, whichever comes first.

#### REPAIR AND REPLACEMENT

Customers should contact the agent from whom the product was purchased. Magic Mobility will, at our discretion, repair/replace items that are considered faulty at time of manufacture.

The availability of replacement units is subject to the discretion of the agent, not the manufacturer. For more information regarding replacement units, contact your Magic Mobility agent.

#### VOIDING OF WARRANTIES

Installation of components by an unauthorised agent will void the warranty. If non-Magic Mobility parts are used or installed, it may void the warranty and effect the wheelchair's performance.

Servicing to controllers or other electronic equipment must be carried out by an authorised agent. Any attempt to open or dismantle these items will void the warranty.

Batteries: gradual deterioration in battery performance due to being left in a discharged state or left in poor conditions (extreme temperatures, unclean or damp environments) is not covered under warranty.

Your wheelchair is not covered under warranty if it is submerged in water, or is exposed to corrosive liquids. Please note that salt water is considered highly corrosive and proper cleaning care and maintenance as described in this manual should be followed.

#### EXTENSION OF WARRANTIES

Warranty must not be altered, waived or extended. An extension to the warranty period is authorized by Magic Mobility on Magic Mobility documentation.

#### LIFETIME LIMITED WARRANTY

Frame, bogie and trailing arms, forks.

### One year warranty

The Magic Mobility wheelchair is under full warranty for the first twelve (12) months from the commencement date. This warranty does not detract from but is in addition to your legal rights.

### Warranty exclusions

Damage or corrosion due to misuse, accidents or alterations

General wear and tear (tyres, batteries, upholstery, scratches, damage etc)

Accidents, including collision, fire, theft and riot.

Alterations including modification and tampering.

Repairs performed or replacement parts installed by any person other than an Authorised Dealer.

A replacement part or accessory not conforming to Magic's specification.

## **Replacement/repair parts warranty exclusions**

Parts replaced under the warranty period are solely covered for the original warranty period of the wheelchair.

## **Spare parts warranty**

Spare parts under the warranty period (current models): There is no extended warranty for parts.

Spare parts outside the warranty period (current models): A replacement may be offered, but has a limited 60 day warranty.

Spare parts (legacy models): A replacement may be offered, but has a limited 30 day warranty.

## **Additional notes**

Magic Mobility will take reasonable steps to ensure that spare parts are available for 5 years after a model has been upgraded

- Electrical parts – a replacement may be offered, but Magic Mobility but has a limited 30 day warranty
- Mechanical parts – a replacement may be offered for a mechanical part. The warranty on this item is limited to 12 months

Upon acceptance of goods at delivery the purchaser accepts the “Terms & Conditions of Sale”

## **Australian consumers only**

*Magic Mobility goods come with guarantees that cannot be excluded under the Australian Consumer Law. You are entitled to a replacement or refund for a major failure and for compensation for any foreseeable loss or damage. You are also entitled to have the good repaired if the goods fail to be of acceptable quality and the failure does not amount to major failure*

# 1 Power wheelchair owner's manual

Thank you for choosing a Magic Mobility product. We are proud of the quality construction of every chair we build. This owner's manual explains the operation of your new chair. Please read it carefully as it contains important safety, care and maintenance information.

Magic Mobility's power wheelchair series may be custom made to measure and may vary in detail from chair to chair however this owner's manual should cover all basic features and options. If your wheelchair has been customised especially for you, you can request additional instructions.

Magic Mobility endeavours to supply a wide variety of features and options to meet the needs of the user. However, final selection and specifications of the type of wheelchair to be used by any individual rests solely with the user and his/her healthcare professional capable of making such a selection. Magic Mobility can only stand by our performance specifications when genuine Magic Mobility components have been used. When third party parts or assembly has taken place, we strongly advise you seek additional instructions for use.

All of the information and specifications in this document are current at the time of printing. However due to our policy of continual product improvements we reserve the right to make changes at any time without notice. This may lead to slight variations between the illustrations and explanations in this manual and the model you have purchased.

## 1.1 Intended use

The intended use of a Magic Mobility power wheelchair is to provide mobility to persons limited to a sitting position that have the capability of operating a powered wheelchair both indoors and outdoors. Power chairs with and without seat lift function can accept occupants with a maximum weight of 155 kgs /340lbs and 182kgs/400lbs respectively.

Magic Mobility is not liable for damage to property or personal injury arising out of unsafe use of a power chair. Magic Mobility is also not liable for any property damage or personal injury arising out of the failure of any person and/or user to following the instructions and recommendations set forth in this manual.

If you experience any problems with your power chair that you are unable to solve, or if you do not feel capable of safely following any of the instructions and/or recommendations as contained in this manual, please contact your Magic Mobility dealer. You will find the model designation and serial number of the wheelchair on the base of the frame as shown below; and on your owner's manual:





Figure 1 - Frontier V6 serial number location





Figure 2 - Extreme X8 serial number location



Figure 3 - Frontier V4 serial number location

## 2 Safety and damage warnings

Throughout this manual, you will find the following safety and damage warnings.

	<p>WARNING! This is a warning which, if ignored, may cause injury to yourself and other people</p>
	<p>STOP! This is an instruction that, if not followed, may result in damage to your power chair. It means 'do not do this' or 'do not let this happen'.</p>

## 3 Safety

Throughout this manual, you will find the following safety and damage warnings.

Please read and follow all instructions in this owner's manual before attempting to operate your power chair for the first time. If there is anything in this manual you do not understand, or if you require additional assistance for setup, contact your Magic Mobility Dealer before operating the wheelchair.

Buying a Magic Mobility wheelchair opens up a whole new World and we are keen for you to explore new possibilities. However, we strongly recommend that when learning your driving capabilities, the capabilities of your wheelchairs and learning where potential hazards may be; you always have someone with you as an All-terrain buddy. They can help check out the terrain and also help you if you need it. We always recommend carrying a mobile phone or GPS alert so that you can reach help if you need it.

There are certain situations, including some medical conditions, where the power chair user will need to practice operating the power chair in the presence of a trained attendant. A trained attendant can be defined as a family member or care professional specially trained in assisting a power chair user in various daily living activities.

The contents of this manual are based on the expectation that a qualified healthcare professional has properly fitted the power chair to the user and the prescribing healthcare professional has trained the user in the operation of the wheelchair, the dangers that can be encountered, and has ensured that the user is capable of this.

Using your Magic Mobility product safely also depends upon your own good judgement and/or common sense, as well as that of your provider, caregiver, and/or health professional. Magic Mobility is not responsible for injuries and/or damage resulting from any person's failure to follow the warnings, cautions and instructions in this owner's manual.

	<p>WARNING! If you are going to be stationary in your power chair for an extended period of time, turn off the power. This will conserve battery power and remove the chance of unexpected chair movement through inadvertent joystick contact or from electromagnetic sources</p>
---	--

### 3.1 Transfers

It is recommended that you have a trained attendant present while you learn to transfer. To reduce the chance of injury:

- Be sure the power is turned off
- Be sure the power chair is not in freewheel mode (See section Error! Reference source not found.)
- Ensure footrests are swung away or removed
- For side transfers ensure armrests and legrests are swung away or removed, position yourself as far back as possible in the power chair seat to prevent the power chair from tipping forward.

	WARNING! Avoid putting all your weight on either armrests or footrests. This may cause the power chair to tip and cause injury
---	--



### 3.2 Motor vehicle transport

Wheelchair positioning belts are not designed with the intent of providing proper restraint during motor vehicle transportation. An ISO 7176-19 compliant system is available from Magic Mobility.

All Magic Mobility electric wheelchairs have been tested to and conform to the requirements of ISO 7176-19. The Frontier V6 Mid Wheel Drive and Extreme X8 also comply with the requirements of ANRI/RESNA WC/19; further details of this are available on request.

For detailed information see **Error! Reference source not found.**

NOTE: ISO = International Organisation for Standardisation

	WARNING! Whenever feasible, wheelchair users should transfer to the vehicle seat and use vehicle manufacturer installed restraint system.
	WARNING! The primary goal of ISO 7176-19 is to reduce the potential for injury to wheelchair seated occupants in the event of a vehicle impact. Modifications or additions to the wheelchair (changes to the frame, aftermarket cushions, harnesses) may reduce its safety in a vehicle accident. If unsure of their effect, please consult a suitably qualified professional for advice.

### 3.3 Weight limitations



Your power chair is rated for a maximum weight capacity of 182 kg/400 lbs (see table). Do not carry passengers or heavy weights on any part of the wheelchair.

Seating arrangements	Maximum user weight
No seat elevator fitted	182 kg/400 lbs
Seat elevator or tilt fitted	155 kg/340 lbs

	<p>STOP! Exceeding the weight capacity voids your warranty and may result in damage to your power chair.</p>
---	--

### 3.4 Stairs and escalators

This power chair is not specifically designed to negotiate stairs but is able to do so only in cases with low step heights and long step landings.

	<p>WARNING! Take great care using your power chair to negotiate stairs. Never use your power chair to negotiate escalators. Always use an elevator or lift where possible. You may cause injury to yourself and to others.</p>
	<p>STOP! Trying to negotiate stairs or escalators may result in damage to your power chair.</p>

### 3.5 Transportation products for your wheelchair

If it is necessary to use a transportation product such as a vehicle hoist or lift, Magic Mobility recommends that the manufacturer’s instructions and specifications are closely reviewed before using that product.



### 3.6 Public streets and roadways

	<p>WARNING! You should not operate your power chair on public streets and roadways. This is in accordance with local traffic laws, which vary by country. Please check your local traffic laws. Be aware that it may be difficult for traffic to see you when you are seated on your power chair. Obey all local pedestrian traffic rules. Wait until your path is clear of traffic, and then proceed with extreme caution</p>
---	--

### 3.7 Stationary obstacles: (steps, kerbs, etc)

Proceed with extreme caution when driving near raised surfaces, unprotected ledges, and/or drop-offs (kerbs, porches, stairs, escalators, lifts etc). Always approach an obstacle so both front wheels touch that obstacle together. Never attempt to climb a kerb or obstacle at an angle.

Given the off-road capabilities of the power chair, it may be capable of climbing and descending an obstacle of up to 4"/100mm in height, however this can vary greatly depending on the setup of the wheelchair, weight distribution and the user’s ability.

	<p>WARNING! It is recommended that an attendant assists when attempting new obstacles and whilst familiarising yourself with your new wheelchair. Never try to travel backwards down any step, kerb, or other obstacle. This may cause the power chair to tip and cause personal injury.</p>
	<p>STOP! Do not attempt to climb obstacles when the seat is reclined or elevated.</p>

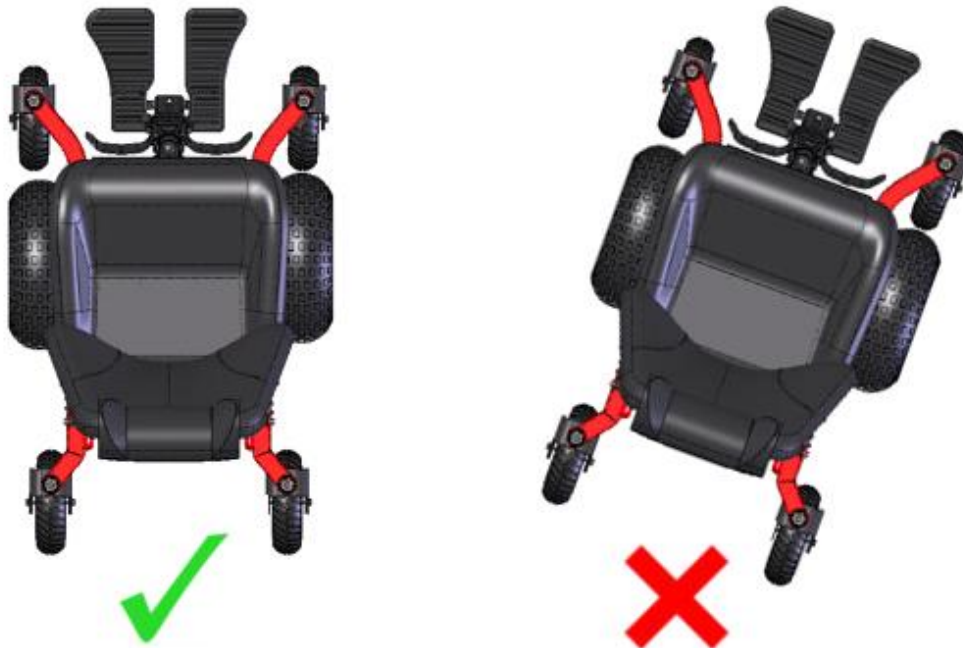

Figure 4 - Frontier V6 correct and incorrect approaches to obstacles

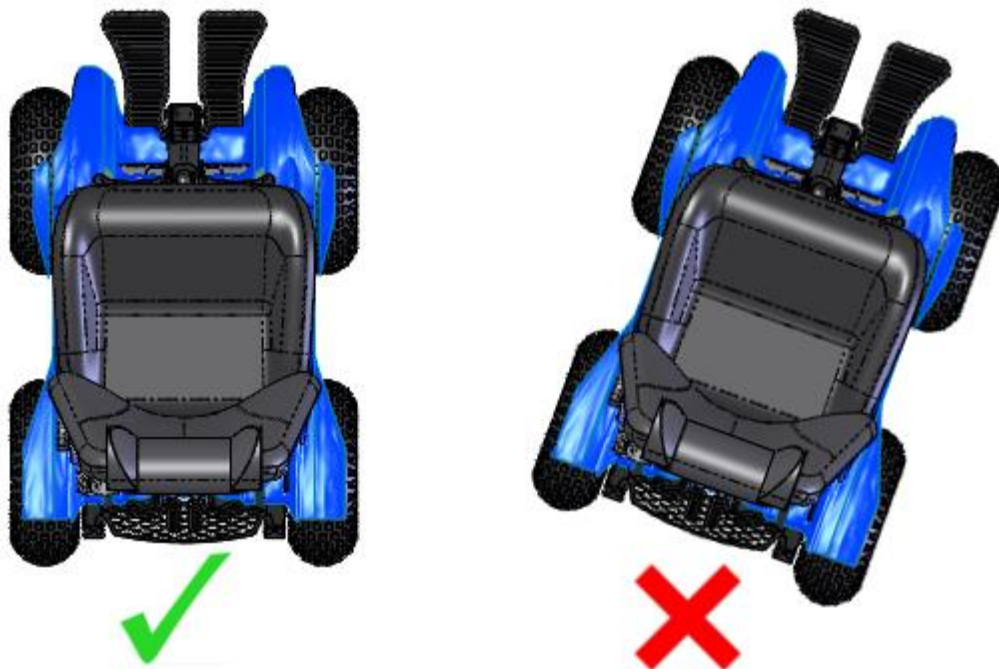

Figure 5 - Extreme X8 correct and incorrect approaches to obstacles

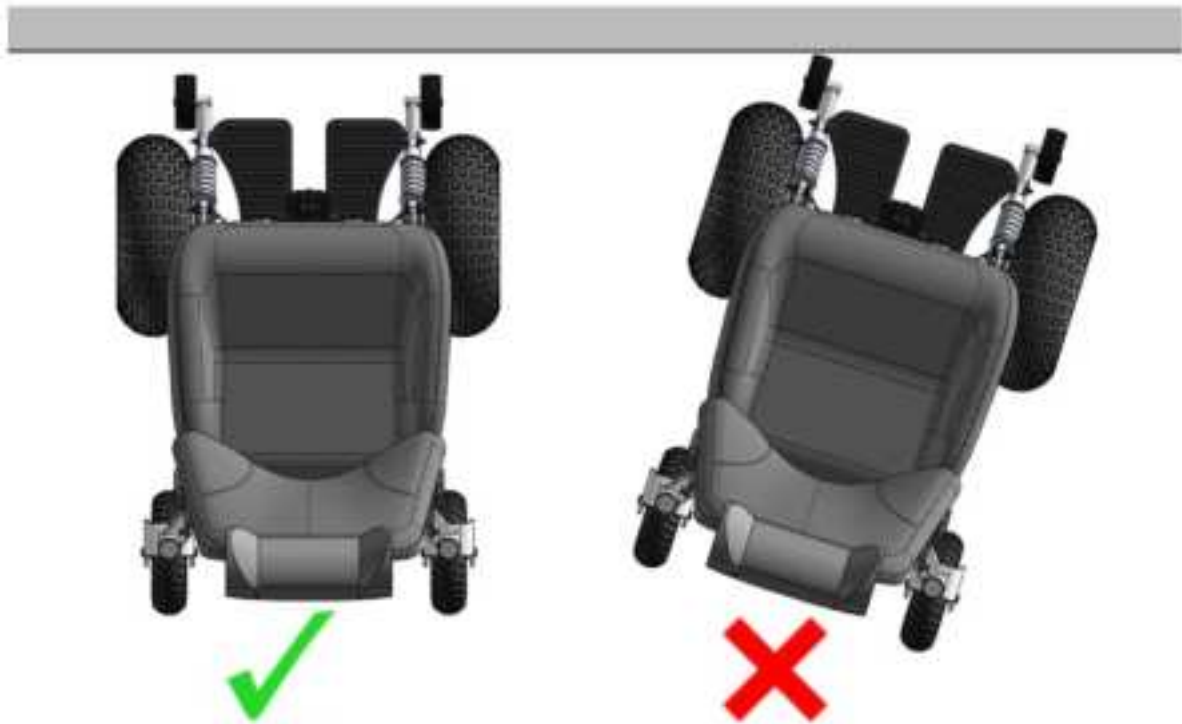

Figure 6- Frontier V4 FWD correct and incorrect approaches to obstacles

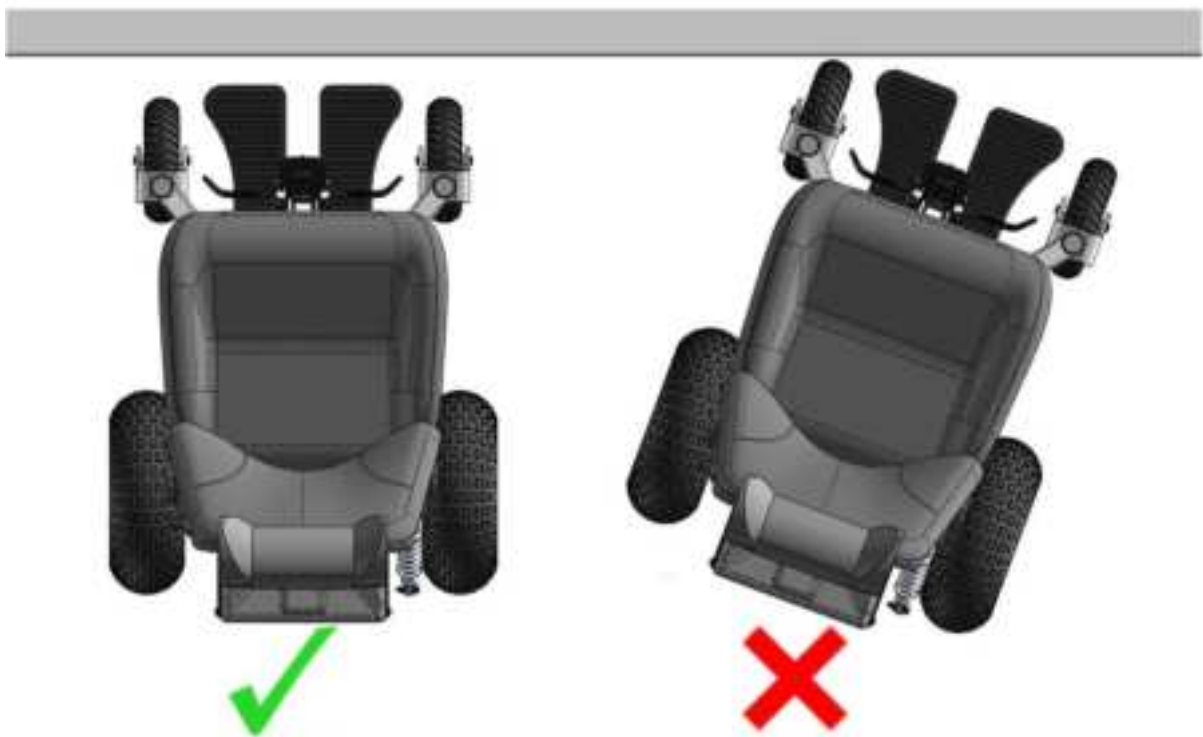

Figure 7 - Frontier V4 RWD correct and incorrect approaches to obstacles

### 3.8 Climbing or descending an incline

When climbing an incline, try to keep your power chair moving; however, do not use excessive speed. If you must stop, start up again slowly and then accelerate cautiously. If at any time you feel uncomfortable, reduce your acceleration rate.

When driving down an incline, set your power chair to the slowest speed setting and drive in the forward direction only. If your power chair starts to move down the incline faster than you anticipated or desired, allow it to come to a complete stop by releasing the joystick. Once the chair has stopped push the joystick forward slightly to ensure a safely controlled descent.

The following advice is recommended for your safety:

- Do not drive at an angle up or down the face of the incline. Drive your power chair straight up or down the incline. This greatly reduces the possibility of tipping the chair over.
- Avoid potentially hazardous inclines e.g. areas covered with snow, ice, mud, cut grass, or wet leaves.
- As with all off-road driving adventures, you should always be sure that the terrain ahead of you is clear of unexpected hazards. We advise that you have someone with you who can check ahead for any hazards.
- When exploring alone, proceed with extreme caution and we advise you always carry your mobile phone or GPS alert so that you can reach help.
- Avoid sudden stops and starts
- When on any sort of an incline or decline, never place the power chair in freewheel mode while seated on it or standing next to it.
- Never attempt to travel backwards down an incline.
- Be aware that stopping distances increase when travelling down an incline.



WARNING! Always exercise extreme caution on inclines and follow the advice above to reduce the risk of personal injury

### 3.9 Maximum recommended incline

Most public access ramps have a maximum gradient 1 in 14 (AS1428.1). Therefore, Magic Mobility recommends that the maximum slope of an incline you attempt to safely ascend or descend on your power chair does not exceed a 1 in 14 gradient.

Extreme care must be taken when ascending any incline over a 1 in 14 gradient to ensure the wheelchair is not driven in an unstable position.



WARNING! Any attempt to climb or descend a slope steeper than 1 in 14 gradient may put your power chair in an unstable position and cause it to tip, resulting in personal injury.

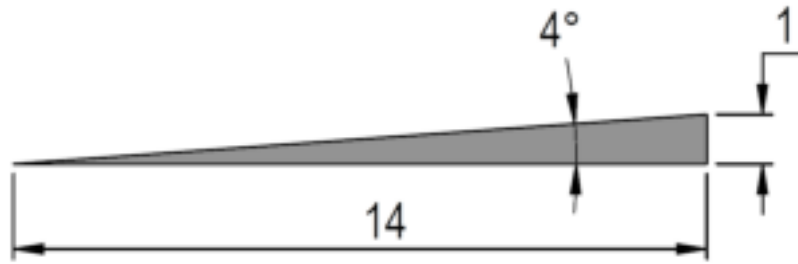

Figure 8 - 1 in 14 gradient

### 3.10 Removable parts

	<p><b>STOP!</b> Do not attempt to lift or move a power chair by any of its removable parts (armrests, legrest, backrest). This may result in personal injury and/or damage to the chair.</p>
--	--

### 3.11 Cornering information

Most public access ramps have a maximum gradient 1 in 14 (AS1428.1). Therefore, Magic Mobility

Excessively high cornering speeds can create the possibility of tipping. If you feel that you may tip over in a corner, immediately reduce your speed and steering angle (i.e. lessen the sharpness of the turn)

The following advice is recommended for your safety:

- Reduce cornering speed
- Reduce steering angle
- Beware of uneven, rough and slippery terrain
- Avoid turning on inclined surfaces
- Be aware of changing surfaces - such as passing from a paved area to a gravel area at high speed while turning
- Avoid abrupt directional changes.

	<p><b>WARNING!</b> When cornering, lower your speed and follow the advice above to reduce the risk of personal injury</p>
--	---

### 3.12 Electromagnetic fields (further information is in Appendix B - Electromagnetic interference (EMI))

Your power chair's performance may be influenced by electromagnetic fields caused by mobile telephones or other radiating devices, such as hand-held radios, radio and television stations, wireless computer links, microwave sources, and pagers.

Your power chair may also be a source of electromagnetic and radio frequency interference. Be aware that your power chair may affect the performance of alarm systems and other radiating devices.

	<p><b>WARNING!</b> Turn off your power chair when using products, which emit electromagnetic fields. This will eliminate the possibility of unintended movement caused by electromagnetic sources. Failure to take this precaution may result in personal injury</p>
--	--



### 3.13 Positioning belts

It is the obligation of the purchasers, therapists and other healthcare professionals to determine if a positioning belt is required to ensure the safe operation of this equipment by the user.



WARNING! Ensure your positioning belt is fastened securely and correctly. Serious personal injury may result if you fall from the power chair.

### 3.14 Weather precautions

Your power chair's surface temperature may increase when exposed to heat sources – eg. Sunlight.



WARNING! Do not operate your power chair in icy or slippery conditions (i.e. footpaths and roads). Such use may adversely affect the performance and safety of your power chair, resulting in an accident and personal injury. Salted surfaces will cause accelerated corrosion of your wheelchair.

### 3.15 Reaching and bending



WARNING! Avoid bending, leaning, or reaching for objects while seated in the wheelchair. If you have to pick them up from the floor we suggest you use a specially designed "Pick up stick". Movements such as these may cause your power chair to tip, possibly resulting in personal injury.

### 3.16 Prescription drugs/physical limitations

Consult your physician if you are taking prescribed or over-the-counter medication or if you have certain physical limitations.



WARNING! Do not operate your power chair in icy or slippery conditions (i.e. footpaths and roads). Such use may adversely affect the performance and safety of your power chair, resulting in an accident and personal injury. Salted surfaces will cause accelerated corrosion of your wheelchair.

### 3.17 Alcohol/smoking



WARNING! Do not operate your power chair while you are under the influence of alcohol, as this may impair your ability to operate your power chair in a safe manner, resulting in personal injury to yourself and others.



WARNING! It is strongly recommended that you do not smoke cigarettes while seated in your wheelchair. The power chair has passed the necessary flammability requirements, but it is strongly advised to keep ashtrays at a safe distance from seat cushions, to ensure cigarettes are completely extinguished before disposal, and we strongly advise against leaving lit cigarettes unattended.

### 3.18 Trapping hazards

Your power chair has numerous areas which may be trapping/pinching hazards. Always exercise caution when using your power functions and avoid putting body parts or objects into the mechanisms during operation. Serious personal injury will occur.

## 4 Specifications

### 4.1 The Frontier V6

A Frontier V6 power chair is depicted below. This will help you identify some of the features referred to throughout this manual.



### 4.2 The Extreme X8

An Extreme X8 power chair is depicted. This will help you identify some of the features referred to throughout this manual.



### 4.3 The Frontier V4 front wheel drive

A Frontier V4 Front Wheel Drive (FWD) power chair is depicted. This will help you identify some of the features referred to throughout this manual.



### 4.4 The Frontier V4 rear wheel drive

A Frontier V4 Rear Wheel Drive (RWD) power chair is depicted. This will help you identify some of the features referred to throughout this manual.



#### 4.5 Standards testing

The Frontier V6 and Extreme X8 have been tested to International Standards and meet all requirements of a class B medical device. Information regarding the performance attributes and controlled testing results of the power chair may be obtained from the power chair manufacturer. If you would like access to this information, please contact your Magic Mobility Dealer.

#### 4.6 Dimensions, mass and turning parameters

The following table details the dimensions of the wheelchairs used for standards testing. Your chair is likely to differ depending on options chosen.

Parameter	Extreme X8	Frontier V6	Frontier V4 RWD	Frontier V4 FWD
Height range of push handles	980	945	940	940
Ground Clearance	50	55	50	50
Mass	168kg	168kg	169kg	170kg
Length - Rearward	360/410	625	280	715
Length - Overall	1250/1580	1240	1200	1180
Length - Stowage	1040	950	970	1005
Width - Overall	710	710	710	710
Width - Stowage	710	710	710	710
Width - Wheelbase	560	525	575	575
Height - Stowage	1110	1055	1050	1040
Rotational - 180°	1460	1345	1295	1100
Rotational - 360°	2180	1370	1860	1240
Rotational - Offset	0	0	0	0
Diagonal	1270	1265	1240	1100

## 5 Operating instructions

The speed and direction of the power chair is controlled with by the joystick

- Turn on your power chair
- Use the joystick to control the speed and direction of travel

At times, particularly during high acceleration on inclines, not all of the castor wheels will contact the ground. This is a normal part of the chairs operation; if at any time you feel uncomfortable, reduce your acceleration rate or speed.

### 5.1 Performance adjustments

Performance adjustments to your power chair should only be made by professionals of the healthcare field, or by persons fully conversant with both this process and the driver's capabilities.

	<p>WARNING! Changing the performance settings could adversely affect your power chair. You may cause injury to yourself and to others.</p>
	<p>STOP! Incorrect settings could cause damage to the chair and to surrounding property.</p>

### 5.2 Positioning

If your power chair was configured at your Magic Mobility Dealer, please consult your health care professional before changing the seat position or making any other adjustment. Some adjustments may degrade your power chair's performance and safety by changing its centre of gravity.

### 5.3 Freewheel mode - pushing the powerchair

Located on each side of the chair, in front of each drive wheel is a motor release lever (see below). To disengage the built-in or "running" brakes simply push the down levers on each side.

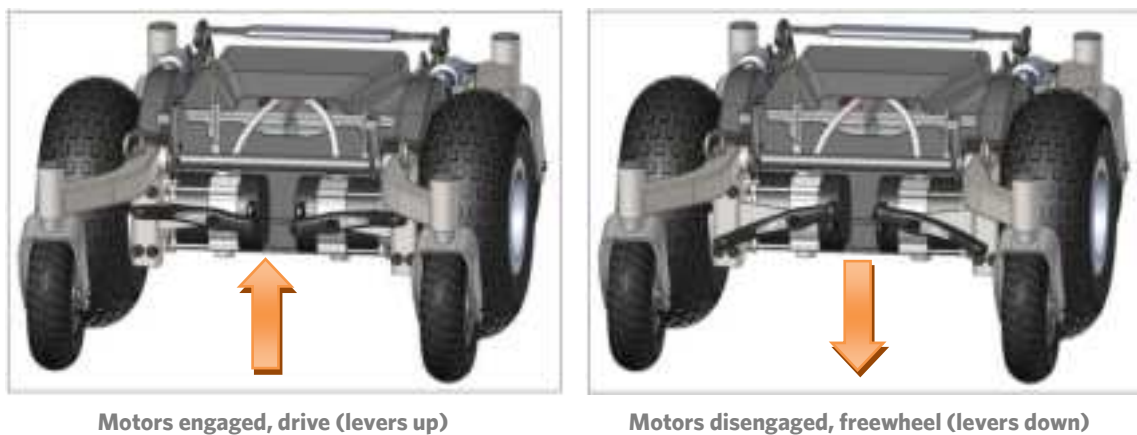
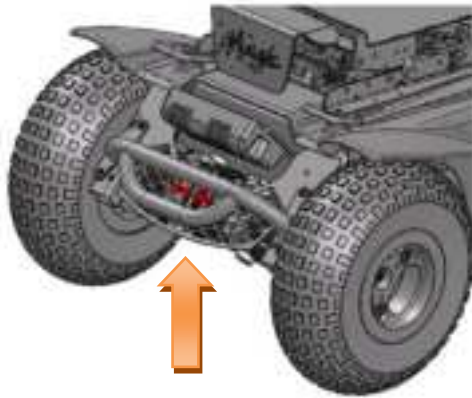
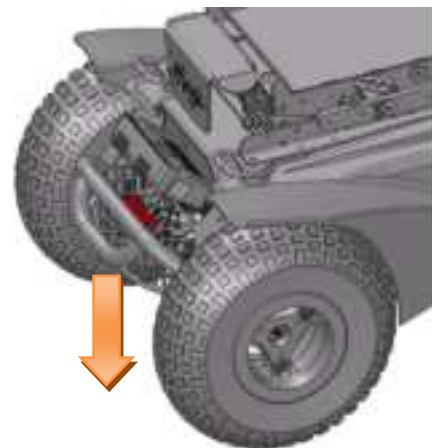

Figure 9 - Frontier V6 drive and freewheel mode



**Motors engaged, drive (levers up)**



**Motors disengaged, freewheel (levers down)**

**Figure 10 - Extreme X8 drive and freewheel mode**

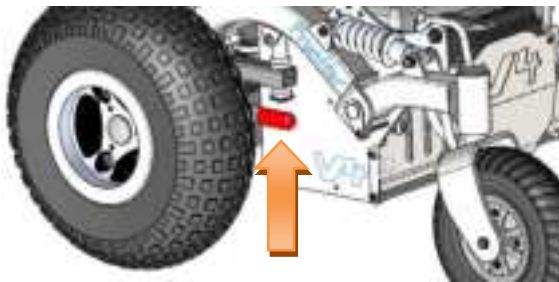

**Motors engaged, drive (levers up)**

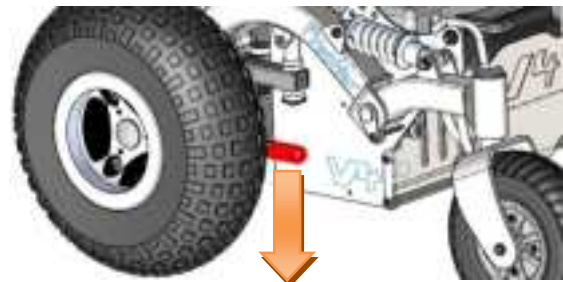

**Motors disengaged, freewheel (levers down)**

**Figure 11 - Frontier V4 FWD and Frontier V4 RWD drive and freewheel mode**

The wheelchair controls will not function and a message will appear on the screen “brake error” when the chair is in free-wheel mode. This feature has been intentionally incorporated to protect the user from unsafe situations. These levers are intended for use by the attendant.

Push the levers back up again firmly after manually positioning the chair. Turn the power off and on again to remove the error message.

	<p>WARNING! Do not use your chair in freewheel mode or attempt to place your chair into freewheel mode without an attendant present. You may cause injury to yourself and to others. Do not place your power chair in freewheel mode while on an incline. The chair could roll uncontrollably on its own, leading to injury to yourself and others.</p> <p>WARNING! THERE IS NO BRAKING ON THIS WHEELCHAIR WHEN IT IS IN FREEWHEEL MODE.</p>
--	--



### 5.4 Electrical safety protection

Your wheelchair has a fuse fitted into the battery circuit to protect the motors and electronics from an accidental current overload. In the case of a blown fuse, the chair will not drive and you will need to contact your Magic Mobility dealer for repair/replacement.

### 5.5 Seat tilt option - if fitted

To operate the seat tilt:

- Bring your power chair to a complete stop on a flat level surface.
- Always fasten the positioning belt when operating the seat tilt option.
- Push the 'Mode' button on the joystick. Select seat tilt by moving the joystick left or right. Once the seat tilt option is highlighted, moving the joystick forward or backwards will operate the function.
- Once the seat reaches its highest tilt angle, the tilt action stops; release the joystick at this point.
- Before driving, return the seat to its upright position. When returning to the upright position, always be sure that the mechanism has reached its lowest limit or normal seated position.

	<p>WARNING! Never tilt the seat from its upright position on an inclined surface or on bumpy or uneven surfaces. Never raise the seat tilt while your power chair is in freewheel mode. Failure to heed this warning can result in the power chair tipping over and causing personal injury.</p>
	<p>CRITICAL! Do not put your fingers, toes or any objects into the tilt mechanism while it is operating. Serious personal injury will occur.</p>

### 5.6 Power elevating seat option - if fitted

The power elevating seat will allow more freedom and independence by extending your level of reach. The seat height can be adjusted to match a surface to which you are transferring.



The scissor action of the seat elevator may be a dangerous hazard. Under no circumstances should you put your hands, fingers, toes or any part of your body in the seat elevator mechanism while it is operating. Ensure that no one in the vicinity of the wheelchair has any part of their body in the seat elevator mechanism while it is working.

To operate the power elevating seat:

- Bring your power chair to a complete stop on a flat level surface.
- Always fasten the positioning belt when operating the power elevating seat.
- Push the 'Accessory Mode Selection' button on the joystick. Select power elevating seat by moving the joystick left or right. Once the power elevating seat option is highlighted, moving the joystick forward or backwards will operate the function.
- Once the seat reaches its highest elevation, the action stops; release the joystick at this point.
- Before driving, always be sure that the mechanism has returned the seat to its lowest position.

The power seat elevator is fitted with a system that reduces the speed of the power wheelchair when the seat has been elevated approximately 2"/50mm.



	<p>WARNING! Fasten the positioning belt when using the seat elevator</p> <p>WARNING! Never elevate the seat from its lowest position on an inclined surface</p> <p>WARNING! Never raise the seat when crossing bumpy or uneven surfaces</p> <p>WARNING! Do not put the power wheelchair into freewheel mode with the seat elevated</p> <p>WARNING! Maintain recommended tyre pressures for good stability</p>
	<p>STOP! Do not put your fingers, toes or any other body part or object into the scissor mechanism while it is operating. Serious personal injury will occur.</p>

**5.7 Transfer tilt - if fitted (Frontier only)**

The transfer tilt option allows the seat front to be lowered by up to 2.75"/70mm to improve the ease of transferring in and out of the power wheelchair. All of the wheelchair driving functionality is turned off while the chair is tilted forwards to prevent damage to the legrests and footplates which could occur with the seat in this position.

To operate the transfer tilt:

- Bring your power chair to a complete stop on a flat level surface
- Select "tilt" on the P&G controller. Once the tilt option is highlighted moving the joystick forward or backwards will operate the function.
- Once the seat reaches its lowest position, the action stops; release the joystick at this point.
- The wheelchair is being inhibited from driving, this red symbol will be flashing. 
- Always be sure that the mechanism has returned the seat back to horizontal or the wheelchair will not drive.

**5.8 Slope sensor (inclinometer) - if fitted**

The slope sensor option enables the chair to be aware of its backrest angle relative to the horizon. This includes the accumulation of *backrest recline*, *seating tilt* and *ground incline* put together. The slope sensor uses this information to minimise the chance of the chair becoming unstable through body weight being too far back.

5.8.1 BACKREST ANGLE INHIBITS

The inhibit/s depending upon the backrest angle are as follows:

	<p><b>Backrest angle</b></p>	<p><b>Resulting inhibit</b></p>
	<p>0° - 30°</p>	<p>None</p>
	<p>31° - 50°</p>	<p>Lift</p>
	<p>&gt; 51°</p>	<p>Lift Up Tilt Back Recline Back Drive</p>

## 5.8.2 SEAT RAISE INHIBITS

The inhibit/s depending upon the backrest angle are as follows:

A further inhibit may be activated depending upon the height of seat lift. When lifted above a certain height, your LCD Joystick Module will display an orange turtle or your LED Joystick Module's speed indicator lights will flash. This indicates that due to the seat elevation, the chair will experience the following inhibits:

- Speed
- Tilt back
- Recline back

## 5.8.3 TROUBLESHOOTING

If your chair has a slope sensor and a function does not seem to be operating

- Drive the lift function downwards until it stops in the home position;
- Drive the tilt function forwards until it stops in the home position;
- Drive the recline function forwards until it stops in the home position;
- If your chair is still inhibited, refer to the Common Troubleshooting section and follow instructions for your particular Joystick Module

## 5.8.4 STEERING LOCK OPTION – IF FITTED (EXTREME X8 ONLY)

The purpose of the steering lock is to provide greater straight-line directional stability. This is particularly useful when reversing the wheelchair down-ramps out of a vehicle. This is achieved by locking the steering tie-rod and is engaged by the chair operator via the joystick.

- Bring your power chair to a complete stop on a flat level surface.
- Push the 'mode' button on the joystick. Select the steering lock option by moving the joystick left or right. Once the Steering lock option is highlighted (as shown to the right), moving the joystick forward or backwards will operate the function.
- Once the steering lock is engaged; release the joystick at this point.
- Before driving normally, ensure that you have disengaged the steering lock with the joystick.



**WARNING!** When the steering lock is engaged, only drive the wheelchair forwards and backwards. Attempting to drive the wheelchair normally with the steering lock engaged could cause serious damage.

## 6 Joystick controls

The joystick controls may be customised and may be one of a number of different models depending upon users requirements. This manual contains information on the standard joystick control.

### 6.1 Joystick

This controls the speed and direction of the wheelchair. Push the joystick in the direction you wish to go. The further you push it, the faster the speed. Releasing the joystick stops the wheelchair and automatically applies the brakes.

### 6.2 Joystick power

If the power chair begins to move in an unexpected manner, immediately release the joystick and turn the wheelchair off. Unless the joystick is damaged, this should stop your power chair.

If the joystick is not in the neutral (centre) position when you turn on the power, you may cause a fault in the system. Releasing the joystick and turning the power off and on again will reset the system.



**WARNING!** Always turn the power off when you are stationary to prevent unexpected movement.

### 6.3 Rain and water

The joystick hand control unit IS NOT WATERPROOF. The joystick module is splash proof but may be permanently damaged if water transgresses the rubber seals (this damage is not covered under warranty).

We recommend carrying a plastic bag large enough to cover the joystick module and the user's hand, in case of rain.

### 6.4 Joystick lead

If for any reason, the joystick lead is disconnected take care when reconnecting, do not force the plug into the socket. The lead is polarised and should only be fitted one way.



**STOP!** Forcing the plug into the socket the wrong way can permanently damage the electronics system. Also, do not place the lead so that it can be pinched in the seat frame or the power base frame.

### 6.5 Controller program

The controller program affects speed, acceleration, deceleration, and braking. The drive mode settings are pre-set at the factory. If your Magic Mobility Dealer changes these settings, please make note of these changes.



**WARNING!** Do not attempt to reprogram your chair. Only the power chair manufacturer, an authorised representative of the manufacturer, or a trained service technician should program the controller.

## 6.6 Precautions for use

The R-net cannot take into account circumstances which put the wheelchair or the controller outside of their specified operating conditions, and so it is important that the user follows the precautions below:

### Do not drive the wheelchair:

- Beyond restrictions indicated in the wheelchair user manual, for example maximum inclines, kerb height etc.
- In places or on surfaces where a loss of wheel grip could be hazardous, for example on wet grassy slopes.
- If the controller or other crucial components are known to require repair.

For contact information please visit [www.pgdt.com](http://www.pgdt.com)

Magic Mobility accepts no liability for losses of any kind arising from unexpected stopping of the wheelchair or improper programming of the control system, improper use of the wheelchair, improper use of the control system or if any of the criteria detailed in this document are not met.

## 6.7 LED joystick module

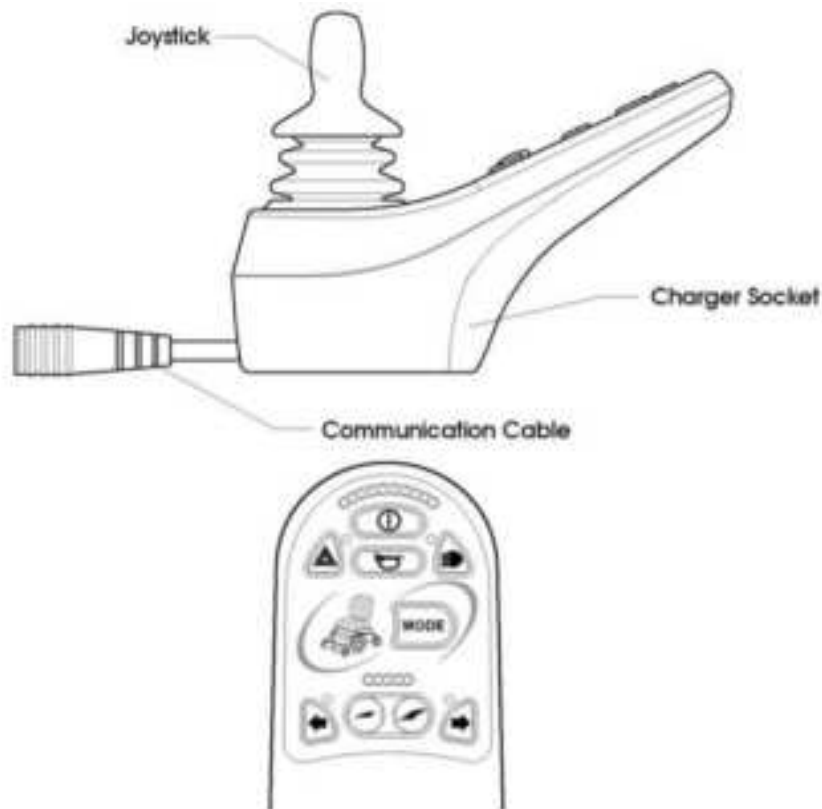

Figure 12 - LED joystick module

6.7.1 CONTROL PANEL

	On/Off Button: This button turns the R-net on and off. Do not use this button to stop the wheelchair, except in an emergency.
	Horn Button: This button operates the wheelchair's horn.
	The Mode button allows the user to navigate through the available operating Modes for the control system.
	The maximum speed / profile indicator is a gauge which shows the maximum speed setting for the wheelchair or the selected drive profile
	Speed Decrease Button - decreases the maximum speed setting.
	Speed Increase Button - increases the maximum speed setting.
	This button activates and de-activates the wheelchairs Lights. When activated the LED will illuminate.
	This button activates and de-activates the wheelchairs Hazard lights. When activated the LED will flash.
	This button activates and de-activates the wheelchairs Left Indicators lights. When activated the LED will flash.
	This button activates and de-activates the wheelchairs Right Indicators lights. When activated the LED will flash.
	Actuator Indicator: This LED set displays which Actuator channel is currently being controlled when the Control System is in Actuator Mode

6.7.2 LED CONTROL SYSTEM INDICATION

The status of the control system can be understood by observing the LED Battery Gauge and LED Speed/Profile Indicator. The control system is on when any of the Battery Gauge LEDs are on.

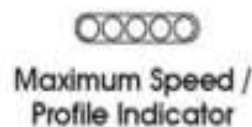

**Basic speed indicator signals**





Steady	All is well. The number of LEDs illuminated shows the maximum speed setting OR the profile selected (e.g. 4 LEDs indicates speed/profile 4)
Rippling up and down	This indicates the control system is locked, refer to Locking the Control System (below) for details of how to unlock the control system.
Flashing	Inhibit: This indicates the speed of the wheelchair is being limited for safety reasons. The exact reason will depend on the type of wheelchair, however, the most common cause is that the seat is in the elevated position.
Rippling outwards	The Control System has detected that a new module has been added and is reconfiguring.
Speeds 2 and 4 flash 	When the control system requires a reboot; for example, after a module re-configuration, the second and fourth speed indicator LEDs will flash.









**Battery gauge signals**

Steady	All is well. The charge available in the battery is displayed.
Slowly flashing	The control system is functioning correctly, but you should charge the battery as soon as possible.
Stepping up	The wheelchair batteries are being charged.
Rapid flashing	System trip: The control system safety circuits have been triggered and are preventing the wheelchair from moving. The R-net has detected a problem somewhere in the wheelchair's electrical system. See below.

6.7.3 LED JOYSTICK TROUBLESHOOTING

Also see 6.10 diagnostics and troubleshooting.

	The battery needs charging or there is a bad connection to the battery. Check the connections to the battery. If the connections are good, try charging the battery
	The left hand motor* has a bad connection. Check the connections to the left hand motor
	The left hand motor* has a short circuit to a battery connection. Contact your service agent
	The right hand motor* has a bad connection. Check the connections to the right hand motor

	<p>The right hand motor* has a short circuit to a battery connection. Contact your service agent</p>
	<p>The wheelchair is being prevented from driving by an external signal. The exact cause will depend on the type of wheelchair you have</p>
	<p>A joystick fault is indicated. Make sure that the joystick is in the centre position before switching on the control system</p>
	<p>A possible control system fault is indicated. Make sure that all connections are secure</p>
	<p>The parking brakes have a bad connection. Check the parking brake and motor connections. Make sure the control system connections are secure</p>
	<p>An excessive voltage has been applied to the control system. This is usually caused by a poor battery connection. Check the battery connections</p>
	<p>A communication fault is indicated. Make sure that the joystick cable is securely connected and not damaged</p>
	<p>An Actuator trip is indicated. If more than one actuator is fitted, check which actuator is not working correctly. Check the actuator wiring</p>

If the problem persists after you have made the checks described below contact your service agent.

*\*If Motor Swap has been enabled, then left and right hand references will need transposing.*

## 6.8 LED joystick module

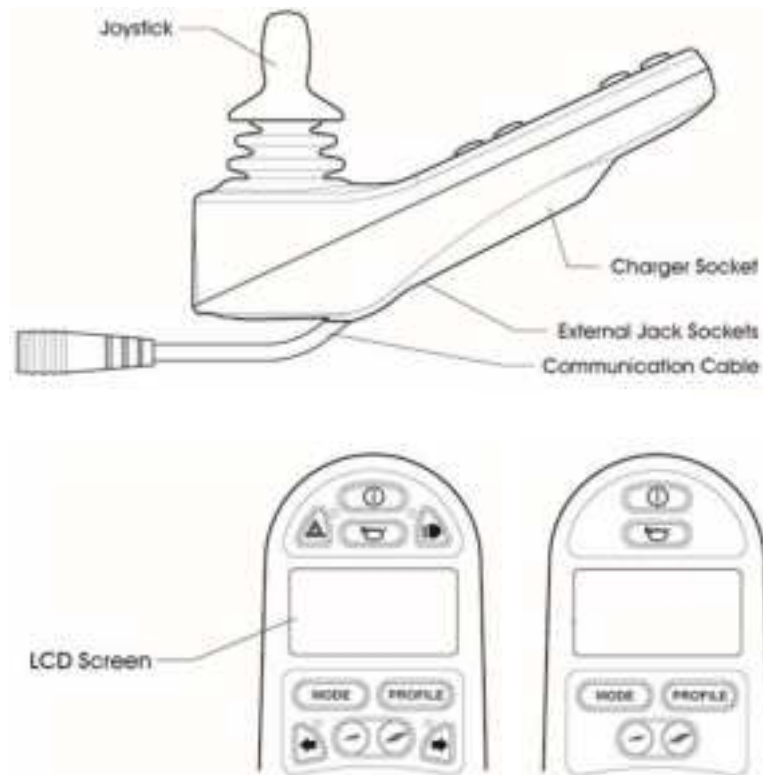



Figure 13 - LCD joystick module (with and without light buttons)

### 6.8.1 CONTROL PANEL

	On/Off Button: This button turns the R-net on and off. Do not use this button to stop the wheelchair, except in an emergency.
	Horn Button: This button operates the wheelchair's horn.
	The Mode button allows the user to navigate through the available operating Modes for the control system.
	The Profile button allows the user to navigate through the available operating Profiles for the control system.
	Speed Decrease Button - decreases the maximum speed setting. Speed Increase Button - increases the maximum speed setting.
	This button activates and de-activates the wheelchairs Lights. When activated the LED will illuminate.
	This button activates and de-activates the wheelchairs Hazard lights. When activated the LED will flash.





	This button activates and de-activates the wheelchairs Left Indicators lights. When activated the LED will flash.
	This button activates and de-activates the wheelchairs Right Indicators lights. When activated the LED will flash.

### 6.8.2 LED CONTROL SYSTEM INDICATION

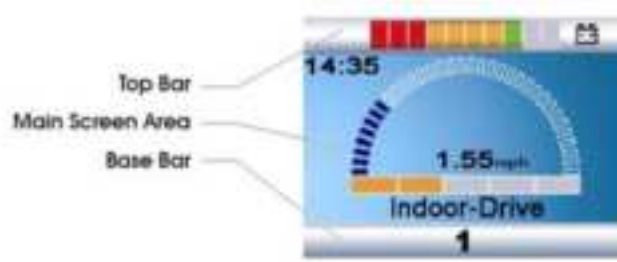

The colour LCD screen is split into 3 areas of information.





#### Top bar

	Battery Indicator: Displays the charge available in the battery and indicates the battery's status. See 'Batteries & Charging' for further information
	Focus symbol: When multiple controllers are installed, the one currently in control of your power chair will display this symbol

#### Base bar

	Current Profile: The currently selected Profile is shown in numeric form.
	Motor Temperature: This symbol means your control system has reduced power to the motors to protect them against heat damage.
	Control System Temperature: This symbol means your control system has reduced its own power to protect itself against heat damage.

#### Main screen area

<b>Drive Screen</b>	
	Profile Name: This displays the name of the currently selected profile.
	Clock: This displays the current time digitally. The clock is user adjustable. Refer to Settings Menu section (below) for details.
	Speed Display: This gives a proportional display of the wheelchairs speed.

	Maximum Speed Indicator: Displays the current maximum speed setting.
<b>1.55mph</b>	Digital Speed Display: Displays your power chair's actual speed.
	Inhibit: If the speed of the wheelchair is being limited (for example, by a raised seat), this orange symbol will be displayed.  If the wheelchair is being inhibited from driving (for example, by using transfer tilt), this red symbol will be flashing.

<b>Mode screen</b>	
	Actuator Mode: Displays the sections of the chair currently selected for movement.
	Bluetooth Mode: When Bluetooth Mode is entered the following screen will be displayed.
	Message Window: The R-net displays warning icons and informational messages, in a dedicated message window.
	Restart: When the control system requires a reboot this symbol will flash.
	Timer: This symbol is displayed when the control system is changing between different states.
	Sleep: This symbol will be displayed for a short time before the R-net enters into a sleep state.
	Cross and Tick: Displayed during configuration procedures: Process completed correctly (Tick). Process not completed correctly (Cross)
	E-stop (emergency stop): If you have an External Profile Switch and activate it while driving your chair or an actuator, the action will stop and this symbol will be displayed.
	Joystick Displaced: If you operate the Joystick before or just after you switch the control system on, the screen will flash the joystick displaced screen. If you don't return the joystick to the central position within 5 seconds, your chair will not move. Turn the control system off and on again to reset.

	<p>Control System Locked: The Control System can be locked either by using a sequence of deflections with a Joystick or with a physical Key.</p> <p>Refer to 6.9.5 Locking the Control System for a detailed description of the Locking and Unlocking procedures.</p>
--	---

<p><b>Diagnostic screen</b></p>	
	<p>Diagnostic Screen: When the control safety circuits have operated to prevent the wheelchair from moving, a diagnostic screen is displayed</p>

6.8.3 BASIC PROGRAMMING AND SET-UP

The colour LCD screen is split into 3 areas of information.

<p>Basic programming can be achieved by pushing and holding the decrease/increase speed buttons at the same time.</p> <p>This will take you to the settings menu.</p>		
---	--	--

**Set time**

Deflect the joystick right once to enter clock adjustment. Use further joystick deflections to set the time.

**Display time**

The options are 12hr, 24hr or Off. Left and right joystick deflections are used to change between the options.

**Distance**



<b>Total distance</b>	This displays the total distance driven using your current power module.
<b>Trip distance</b>	This displays the total distance driven since the last reset.
<b>Display distance</b>	Sets whether total distance or trip distance appears as the odometer display.
<b>Clear trip distance</b>	A right joystick deflection will clear (reset) the trip distance value.
<b>Exit</b>	A right joystick deflection will return to the settings menu.

**Backlight**

This sets the intensity of the LCD backlight. The adjustable range is 0% to 100% in steps of 10%. Adjustments are made with left and right joystick deflections.

**Background**

This sets the colour of the screen background. Left and right joystick deflections are used to change between the options. Choose 'Blue' or 'White' for a background of the specified colour with all Profiles. Choose 'Auto' for a background which is blue for slower indoor profiles and white for faster outdoor profiles.

**Exit**

Exits the Settings Menu back to normal operation.

## 6.9 CJSM2-BT joystick module

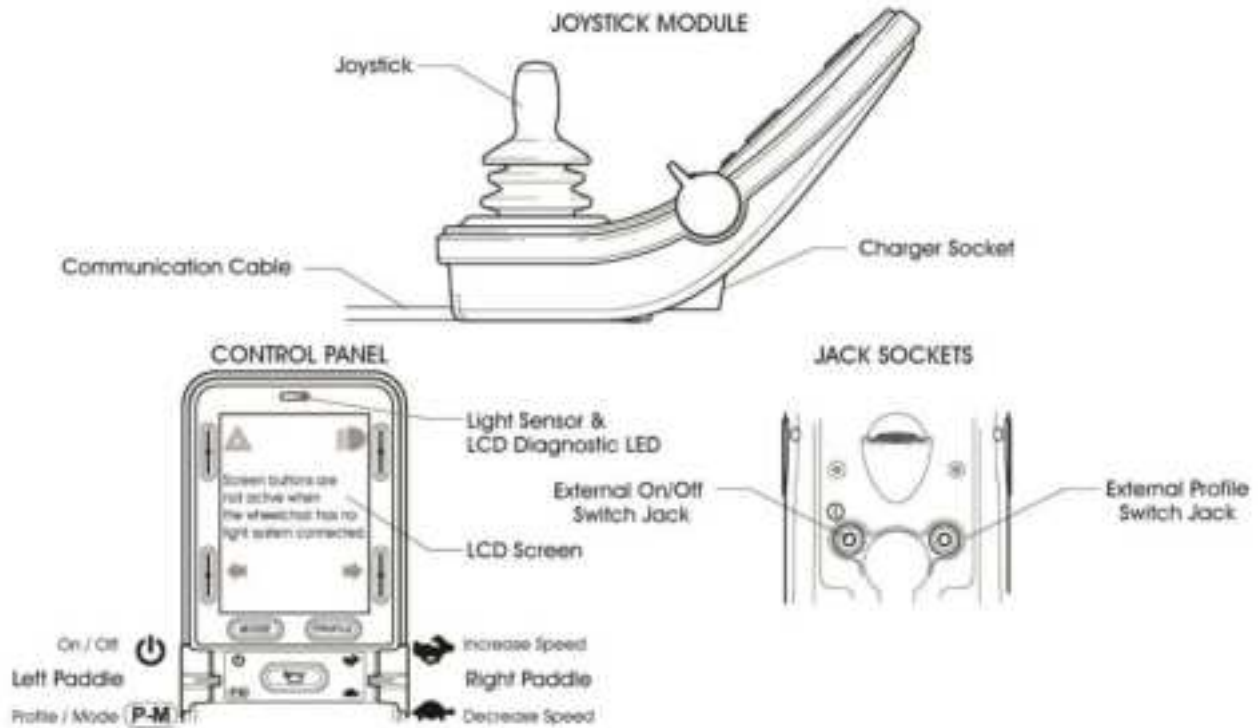

Figure 14 - CJSM2 joystick module

### 6.9.1 CONTROL PANEL

#### Paddle switches

	On/Off Paddle Switch: operated via forward deflections of the left paddle.
	Profile/Mode Paddle Switch: selects available drive Profiles and operating Modes via reverse deflections of the left paddle.
	Speed Paddle: allows adjustment of the control system's speed setting.

#### Buttons

	Horn button: operates the wheelchair's horn
	Mode button: allows the user to navigate through the available Modes for the control system
	Profile button: allows the user to navigate through the available Profiles for the control system

**Screen buttons**

These buttons operate the lighting functions: Hazards, Lights, Left Indicator and Right Indicator. The function of each button is illustrated by an icon displayed on the LCD screen next to the button.



Pressing the relative button activates and deactivates its function. Once the function is activated, the icon on the LCD will illuminate or flash depending on the function.

If no lighting system is fitted, these buttons will be inactive

The top left button, when held for a short time will open the settings menu

**Light sensor**

The Joystick Module contains an ambient light sensor which automatically adjust screen brightness.

Refer to Basic Programming and Set-up for options

**LCD diagnostic LED**

This LED indicates the control system is switched on in the event of an LCD screen failure. Turn the control system on and off, if the problem persists contact your Magic Mobility Dealer

6.9.2 LCD SCREEN CONTROL SYSTEM INDICATION



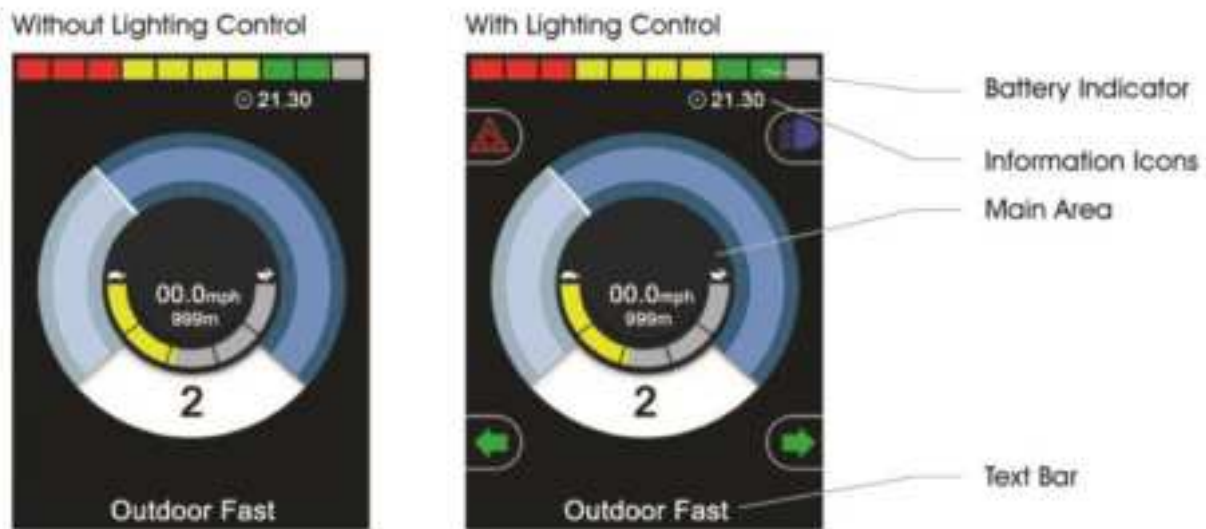

The status of the control system is indicated by the LCD screen, which is split into 4 areas of information:



**Battery indicator**

	<p>Battery indicator: displays the charge available in the battery and indicates the battery's status</p> <p>Steady: All is well</p> <p>Flashing slowly: Charge the batteries as soon as possible</p> <p>Stepping up: the batteries are being charged</p>
---	---





**Information bar**

	<p>Focus symbol: When multiple controllers are installed, the one currently in control of your power chair will display this symbol</p>
	<p>Bluetooth: This symbol appears when a Bluetooth Module is connected to the system. The symbol is blue when paired with a Bluetooth device, and white when not paired</p>
	<p>Motor temperature: This symbol means your control system has reduced power to the motors to protect them against heat damage.</p>
	<p>Control system Temperature: This symbol means your control system has reduced its own power to protect itself against heat damage.</p>
	<p>Clock: This displays the current time digitally. The clock is user adjustable</p>

**Text bar**

	<p>This displays text describing the operating condition of the control system (e.g. profile name, mode name or axis name)</p>
---	--

**Main screen area**

<p><b>Drive Screen</b></p>	
	<p>Current profile: the currently selected Profile</p>
	<p>Speed indicator: gives a graphical display of the wheelchairs speed</p>
	<p>Maximum speed Indicator: displays the current maximum speed setting</p>

	Digital speed display: displays your power chair's actual speed
	Odometer: displays the total distance the wheelchair has travelled or the trip distance since the last reset
	Inhibit: If the speed of the wheelchair is being limited, this orange symbol will be displayed. If the wheelchair is being inhibited from driving, this red symbol will be flashing
	Latched drive: symbol displayed if the control system is in latched drive

**Seating mode screen**

	Displays the sections of the chair currently selected for movement and a direction arrow Move the joystick left or right to select the desired axis Move the joystick forwards or backwards to move the seat
--	--





**Bluetooth mode screen**

Bluetooth Mode: when Bluetooth Mode is entered, one of the following screens will be displayed	
--	--

**General information symbols**

	Limp: this message is displayed if a user switch has become disconnected and the control system is programmed to still allow drive, at a reduced rate
	Restart: When the control system requires a reboot this symbol will flash
	Timer: this symbol is displayed when the control system is changing between different states
	Sleep: This symbol will be displayed for a short time before the R-net enters into a sleep state
	Tick: Process completed correctly



	Cross: Process not completed correctly
	E-stop (emergency stop): If an external profile switch is activated during drive or actuator operation, this symbol will be displayed
	Joystick displaced: If the Joystick is operated before or just after the control system is switched on, the screen will flash the joystick displaced screen. Return the joystick to the central position within 5 seconds or the chair will not move. Turn the control system off and on again to reset
	Control system locked: This symbol is displayed if the control system is locked
	Diagnostic screen: When the control safety circuits have operated to prevent the wheelchair from moving a diagnostic screen is displayed

### 6.9.3 BASIC PROGRAMMING AND SET-UP

<p>Press and hold the top left hand screen button (hazard key) for 1 second</p> <p>The settings menu will be displayed</p>		
--	---	---

#### Time

<b>Set time</b>	Deflect the joystick right to enter clock adjustment. Use further joystick deflections to set the time
<b>Display time</b>	Deflect the joystick right to enter clock adjustment. Use further joystick deflections to choose between 12hr, 24hr or Off

#### Distance

<b>Total distance</b>	This displays the total distance driven using your current power module
<b>Trip distance</b>	This displays the total distance driven since the last reset.
<b>Display distance</b>	Sets whether total distance or trip distance appears as the odometer display.
<b>Clear trip distance</b>	A right joystick deflection will clear (reset) the trip distance value.
<b>Exit</b>	A right joystick deflection will return to the settings menu.

**Backlight**

<b>Backlight</b>	This sets the intensity of the LCD backlight. The adjustable range is 0% to 100% in steps of 10%. Adjustments are made with left and right joystick deflections
<b>Auto backlight</b>	The joystick has an ambient light sensor. If set to On, the display adjusts the screen brightness based on the light sensor reading.

**Program menu**

Diagnostics allows the user to read diagnostic information from the control system



**Exit**

Exits the settings menu back to normal operation

6.9.4 PAIRING THE CJSM-BT

	<p>Enter the CJSM2 setting menu, and select Bluetooth. Pre-programmed device names should appear.</p> <p>Magic has pre-programmed the following:</p> <ul style="list-style-type: none"> <li>● iPad</li> <li>● iPhone</li> <li>● PC</li> <li>● Android Device</li> </ul> <p>(Press and hold the top left hand screen button (hazard key) for 1 second to enter the settings menu)</p>
	<p>To start the pairing process, turn the device on by deflecting the joystick to the right.</p> <p>After turning a device on, power cycle the controller</p> <p>Select the item you want to pair to by scrolling down, a right deflection selects the device</p>

### 6.9.5 DISCOVERY MODE

Deflect the joystick forward for 10 seconds until it beeps, then deflect the Joystick backwards until it beeps. There should now be a flashing Bluetooth icon on the CJSM2 display. This means the CJSM2 is discoverable.

Select the device (e.g. Tom's iPad) to be connected and search for Bluetooth devices, this will start the connection to R-net. Once connection is successful, "Tom's iPad" will appear in the connected devices window and navigation of the iPad will be possible using the R-net CJSM2-BT.

To connect to an additional device (e.g. Tom's PC), select the device and repeat the above process. Up to four devices can be connected.

#### Selecting different connected devices

Once the devices are paired they will remain connected to R-net. On entering "My Devices" mode, the last device connected will always be the option highlighted in the menu. To select a different device scroll to the desired device and deflect the joystick either right or left. After a couple of seconds, a static Bluetooth icon will appear on the CJSM2 screen and navigation of the new device can commence.

#### Disabling connected devices

To disable a connected device and remove it from the menu displayed in "My Devices", Select Bluetooth in the setting menu, the devices can be disabled through a right deflection of the joystick. Note re-pairing is not required if the device is subsequently turned on.

### 6.9.6 CJSM-BT INFRARED (IR)

The CJSM2-BT includes an IR transmitter and receiver that allows commonly used IR devices to be replicated. (Note: Not all IR devices are compatible with the CJSM2-BT)

These devices include:

TV	AV System	Curtain Openers
DVD	Soundbar	Media Manager
VCR	Blu Ray	Aux
Set Top Box	Projector	Door Openers
CD	Receiver/Preamp	Air Conditioners
Home theatre System	Switcher	Lighting

For an enquiry about a specific device, please be ready with the device brand, device type and model

E.g. Panasonic → Home Theatre System → SA-BT Blu Ray System.

#### IR Mode

R Mode is accessed via mode selection. IR mode will only be available if IR codes have been stored in the CJSM2-BT

On entering IR mode you will be presented with a list of available IR appliances and their associated IR commands.

Using the TV as an example; commands such as: On/off, channel up, channel down, volume up and volume down may be displayed. When the CJSM2-BT is transmitting the selected command, it is highlighted with a red background.



Figure 15 - Infrared transmission screen

**IR set up**

IR Setup is accessed through the settings ,enu. On entering the IR setup menu, the default appliances will appear. By selecting an appliance, its commands will be shown.

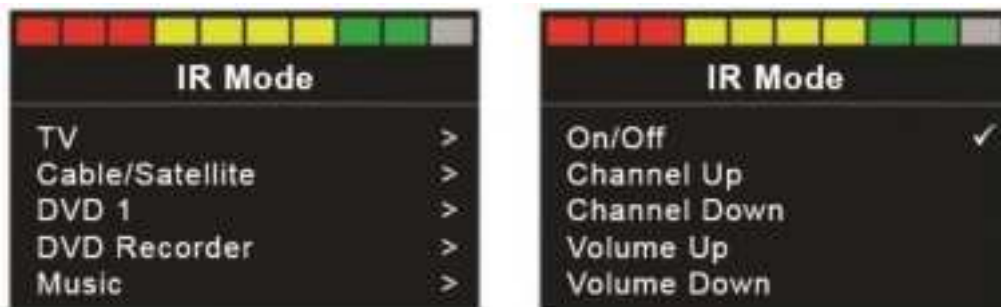

Figure 16 - Infrared set up screens

If a command is ticked (✓), this means it has a stored IR Code. If there is no tick, then there is no stored IR code for that command.

**Learning an IR code**

To teach the CJSM-BT an IR Code, enter IR setup and select an appliance

- Select the command to be learnt (e.g. TV > Channel Up)
- Select learn code, by using the right button while the command is highlighted



Figure 17 - Learn infrared code screens

- Point the TV remote control at the CJSM2-BT's Receiver LED and press the 'channel up' button on your TV remote twice. A 'beep' will be heard after each press; after the first press, the '2x' on the LCD screen will change to '1x' to ask you to confirm the code by pressing the 'channel up' button once more

- A check denotes a successful learn operation; A cross denotes an unsuccessful learn operation (try again)



- Once the code is learnt, select 'exit' to return to the TV commands menu.
- there is now a tick beside the newly learnt command, as it now has a stored IR code

Note: The first time an IR code has been learnt, turn the CJSMBT off and on to ensure correct operation

### Learning an IR code sequence

An IR Code 'sequence' allows one CJSMBT command to do many IR commands at once. E.g. simultaneously turning on a DVD player and a TV

To create a sequence:

- Select the command to use as the sequence initiator. In this example, TV > On/Off.
- Select learn code, by using the right button while the command is highlighted.
- Point the TV remote control at the CJSMBT's receiver LED and press the TV remote's On/Off button twice.
- After each successful learn operation a check momentarily appears on the screen, select learn code again.
- Point the DVD remote control at the CJSMBT's Receiver LED and press the On/Off button twice.
- After each successful learn operation a check momentarily appears on the screen, select learn code again to add to the sequence or select exit if finished.

Now the On/Off command will have a tick and 3 dots beside it, showing a learnt sequence.



Figure 18 - IR learnt sequence screen

Use the same process to learn multi-digit channels. You can choose to store specific channels rather than digits in your 'Channel Selection' menu.

### Enabling and Disabling IR Codes

IR codes can be enabled or disabled in the IR set up menu.

- To disable an IR Code, select the - key on the front panel of the CJSMBT. Disabled IR codes appear with an X against the highlighted command.
- To enable an IR code, select the + key on the front panel of the CJSMBT. An enabled code appears with a tick against the highlighted command.



Figure 19 - Disabled and enabled IR codes

### Deleting IR codes

To delete an IR code for a command, highlight the specific command in the appliance menu and press the right button. Then select the delete code option (Figure 20)

To delete all IR codes for an appliance, select delete all fodes and turn the CJSM2-BT off and on to ensure correct operation



Figure 20 - Deleting individual IR codes (left) and sets of IR codes for an appliance (right)

## 6.10 Diagnostics

Repairs to any joystick should only be conducted by authorised service agents. An incorrect or badly effected repair could result in an unsafe set-up of a wheelchair. Magic Mobility accepts no liability for losses of any kind arising from an incorrect or badly effected repair.

### Trip code displayed

When the control system safety circuits have operated and the system has prevented the wheelchair from moving, either a diagnostics screen will be displayed or an LED will Flash.

Penny and Giles have a comprehensive website that helps you to look up trip codes. If you have access to a PC, it may help you to find and rectify simple issues by yourself.

<http://support.pgdt.com/Online-Diagnostics/Trip-Codes/R-net-Trip-Code-Database.aspx>

Contact your Magic Mobility Dealer and give them the information from the Diagnostic screen. This will help them to identify how to fix the problem.

Additionally, the following items should be checked if possible

- Switch off the CJSM2
- Make sure that all connectors are mated securely and no wires have been pinched
- Check the motor brakes are engaged

- Switch on the CJS2 again and try to drive the wheelchair. If the safety circuits operate again, switch off and do not try to use the wheelchair.

### No trip code displayed

If the wheelchair will not drive or drives slowly and you do not have a trip code on your screen, then the cause is likely to be related to drive inhibits that are in place for safety

Inhibit switches include; seat lift, transfer tilt, backrest recline and slope sensor

If any of these switches are activated, driving performance is affected. Return the seat to its full upright position, ensure the transfer tilt is not activated, lower the seat elevator and check for improvement

The backrest recline inhibit is located on the back of the chair on the part with Magic logo. Check for any items that could interfere with the switch such as a coat or bag

## 6.11 Common troubleshooting

Repairs to any joystick should only be conducted by authorised service agents. An incorrect or badly effected

**Centre joystick** - The most common cause of this trip is if the joystick is deflected away from centre before and during the time it is switched on.

- Ensure that the joystick is centred and turn the CJS2 on and off

**Low battery** - This occurs when the CJS2 detects that the battery voltage has fallen below 16V

- Charge the batteries

**High battery voltage** - This occurs when the CJS2 detects that the battery voltage has risen above 35V

- Check the condition of the batteries and the connections to the CJS2.

**Brake error** - This occurs when the CJS2 detects a problem in the motor brakes or the connections to them

- Check the motor brakes are not dis-engaged (see the 'Free Wheel' section of your Power Wheelchair Owner's Manual)

**Motor error** - This occurs when the CJS2 detects that a motor has become disconnected

- Check the motors, cables and connections to the CJS2

**Inhibit active** - This occurs when any of the inhibit inputs are active and in a latched state.

- Cycle the power. This will drop out of latched mode and might clear the trip.
- Check all wiring and switches connected to the inhibits

**Gone to sleep** - This occurs when the CJS2 has been left inactive for a time greater than set in sleep timer

**Charging** - This occurs when the CJS2 detects that a charger is connected to either inhibit 1 or inhibit 3. The battery charging screen will be displayed during charger connection.

- Disconnect the charger from the wheelchair

**Bad cable** - This occurs when the CJS2 detects a fault in the wiring between any of the modules

- Check all cables and connections for continuity and any possible pinch points
- If there is any visible damage to cables, contact your service agent to replace.

## 6.12 Locking the control system

The Control System can be locked by either using a button sequence on the keypad or with a physical Key. This will be set up at the factory.

### Keypad locking

- While the control system is switched on, depress and hold the On/Off button
- After 1 second the control system will beep. Now release the On/Off button
- Deflect the joystick forwards until the control system beeps.
- Deflect the joystick in reverse until the control system beeps.
- Release the joystick, there will be a long beep.
- The wheelchair is now locked.
- The following screen will be displayed, the next time the control system is switched on.



### To unlock the wheelchair

- If the control system has switched off, press the On/Off button.
- Deflect the joystick forwards until the control system beeps.
- Deflect the joystick in reverse until the control system beeps.
- Release the joystick, there will be a long beep.
- The wheelchair is now unlocked.

### Key locking

- With the control system switched on, insert and remove a PGDT supplied key into the charger socket on the joystick module. A short beep will be heard.
- The wheelchair is now locked.
- The following screen will be displayed, the next time the control system is switched on.



### To unlock the wheelchair

- If the control system has switched off, press the On/Off button.
- Insert and remove a PGDT supplied key into the charger socket on the joystick module. A short beep will be heard.
- The wheelchair is now unlocked.

## 6.13 Care

- Avoid knocking your control system, especially the joystick.
- When transporting your wheelchair ensure the control system is well protected.



- To prolong the life of the control system, keep exposure to extreme conditions to a minimum. Always clean your control system if it becomes contaminated with food or drink.
- Use a damp cloth and washing up liquid mixed with water. Do not use abrasive or spirit based cleaning agents.

Also see Section 8.

## 7 Bluetooth (if installed)

The LCD joystick does NOT include a Bluetooth transmitter/receiver. You will only be able to access Bluetooth mode if you have an R-net Bluetooth module installed.

The R-net Bluetooth modules allow a wheelchair user to control a Bluetooth enabled device either through a Joystick or via a SID connected to the R-net Omni. Typical applications include PC mouse control or operation of a smart device.

Up to two mouse modules and one iDevice module may be connected enabling simultaneous control of three Bluetooth devices, one being an iOS device.



**R-net Bluetooth Module**

### 7.1 Pairing

Bluetooth mode is accessed via Mode selection. While in Bluetooth mode, the screen shown on the right will appear.

(To make a Bluetooth module operate with a PC you will need an aftermarket Bluetooth receiver dongle connected and with the drivers installed).

The Bluetooth Module must be put into Discovery Mode in order to discover new devices for pairing.



**Bluetooth Mode Screen**

Use the following procedure:

- Operate your Input Device in the forward direction and hold until it beeps. This will take approximately 10 seconds, then release.
- Operate your Input Device in the reverse direction and hold until it beeps. This will take approximately 10 seconds, then release.

The Bluetooth Module is now in discovery mode and ready to be paired with a Bluetooth device.

Once a Bluetooth module has successfully been paired with a Bluetooth device, the module remembers the device's ID. This means the wheelchair user can drive outside the operating range, turn off the control system or the Bluetooth device, and upon returning within range of the switched on device, the Bluetooth connection will be automatically reinstated.

Once the Bluetooth device has been paired, further instructions will normally appear on your device. More help, if required, can be found in PG Drives Technology's manual SK79614. This manual is available through your Magic Mobility Dealer on request.

### Android devices

A list of R-Net compatible devices can be found at [www.pgdt.com/smartdevices](http://www.pgdt.com/smartdevices) and the R-Net for Android App is available from the play store; search for "PGDT", "R-net" or "R-net for Android"

**iDevices**

The R-net iDevice Module allows pairing with an iPad or an iPhone. Once paired, the iDevice Module uses the accessibility options switch control or voice control to allow R-net input device commands (joystick nudges) to control or access any of the applications of the iDevice.



## 8 Batteries and charging

### 8.1 Batteries

Your power chair uses a pair of high quality long lasting gel cell batteries that are sealed and maintenance free. Your power chair has a 24V system which is supplied by two 12V batteries. There is no need to check the electrolyte fluid level they contain. Despite their similarity to automotive batteries, they are not the same. Automotive batteries are not designed to handle a long, deep discharge, and are also unsafe for use in power chairs.

Always have your batteries installed by a trained wheelchair technician.

Do not mix and match battery manufacturers or technology, or use batteries that do not have similar date codes. Never mix Gel batteries with AGM batteries.

	<p>WARNING! Battery posts, terminals, and related accessories contain lead and lead compounds, wash your hands after touching.</p> <p>WARNING! Corrosive chemicals are contained in the batteries. Use only AGM or gel-cell batteries to reduce the risk of leakage or explosive conditions.</p> <p>WARNING! When fitting alternate batteries, ensure their terminal posts cannot touch any part of the wheelchair frame.</p>
	<p>STOP! Automotive batteries and chargers are unsafe for use in power wheelchairs</p>

### 8.2 Batteries

Charge daily

We recommend using only a high quality intelligent battery charger that is compatible with your power chair's batteries. Only use the supplied off-board charger unless otherwise approved by Magic Mobility. Do not use an automotive-type battery charge.

The charger is voltage limited and will shut off automatically when left on overnight.

The charger will not operate after the batteries have been discharged to an extremely low voltage. If this happens, call your Magic Mobility dealer for assistance.

### 8.3 Battery run-in

Proper care of the battery during the 'run in' (initial care) period is particularly important for battery life.

**Procedure**

- Ensure the battery is fully charged before the first use,

- Use the chair normally during the day, avoid excessive loads during the first 5 cycles,
- Charge the chair fully overnight, checking that the charger indicates that the battery is fully charged (enters float mode),
- Repeat steps 2 and 3 for the first 20 times (cycles) to complete the 'Run in' procedure.

**Notes**

The new battery will take longer to achieve the full charge, but the time required will improve. Initially you may find that you have to limit the amount of use during the day for the full charge to be achieved.

The battery capacity is reduced when new, this is normal and will improve during the run-in process.

**8.4 Charging procedure**



Battery charging is via a socket within the joystick module. When a charger is plugged in, the joystick unit recognises the unit is plugged in and chair driving is inhibited.

The following procedure is valid for the recommended charger brand - consult your separate charger instructions if supplied with an alternative charger.

- 1 Ensure the wheelchair is turned off.
- 2 Always make sure that the charger is turned off before plugging it into the wheelchair.
- 3 Plug the charger into the charging socket on the joystick module.
- 4 Please consult the instruction manual supplied with your charger for detailed instructions.

The following advice is recommended to help care for your batteries:

- Avoid ultra-deep discharges (deep discharges reduce cycle life).
- Don't leave batteries at a low state of charge for an extended period of time (e.g. after a day's use fully recharge the batteries overnight).
- After discharging the batteries to a low state of charge, recharge them fully (this may take more than 8 hours).

	WARNING! Always protect the batteries from freezing and never charge a frozen battery. Doing so can result in personal injury and damage to the battery
	STOP! Do not put the charger on the seat of the wheelchair when charging as the charger can become quite warm. Always put the charger on the floor near the chair when in use.

To get the maximum range from your batteries:



- Fully charge the batteries prior to the trip.
- Ensure that the tyre pressures are correct for the weight and the terrain.
- Avoid stop-go driving; try to maintain a constant speed.
- Try to avoid inclines.
- Limit baggage weight carried.

Do not operate the control system if the battery is nearly discharged. Failure to comply with this condition may leave the user stranded in an unsafe position, such as in the middle of a road. Magic Mobility accepts no liability for losses of any kind arising from failure to comply with this condition.

### 8.5 Battery gauge

Battery charging is via a socket within the joystick module. When a charger is plugged in, the joystick unit recognises

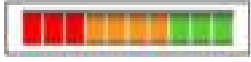
LCD screen battery gauge:

	The batteries are charged if the battery gauge shows red, yellow and green.
	You should charge the batteries as soon as you can if the battery gauge shows just red and yellow
	You should charge the batteries immediately if the battery gauge shows just red, either steady or flashing slowly.

LED Battery Gauge:



(LEDs 1 - 10)	The batteries are charged if the battery gauge shows red, yellow and green.
(LEDs 1 - 7)	You should charge the batteries as soon as you can if the battery gauge shows just red and yellow.
(LEDs 1 - 3)	You should charge the batteries immediately if the battery gauge shows just red, either steady or flashing slowly.

Your battery gauge may also flash in different patterns to indicate your battery's status

- LEDs on, Steady: This indicates that all is well and displays your level of remaining charge.
- LEDs Flashing Slowly: The control system is functioning correctly but needs charging.
- LEDs Light up sequentially, Stepping Up: The wheelchair batteries are being charged. You will not be able to drive the wheelchair until the charger is disconnected and you have switched the control system off and on again.

#### How your battery gauge works

The battery gauge lets you know how much charge is left in your batteries. The best way for you to use the gauge is to learn how it behaves as you drive the wheelchair. Like the fuel gauge in a car, it is not completely accurate, but it will help you avoid running out of "fuel".

When you switch on the control system, the battery gauge shows an estimate of the remaining battery charge. The battery gauge gives you a more accurate reading about a minute after you start driving the wheelchair.

The amount of charge in your batteries depends on the way you use your wheelchair, the temperature of the batteries and their age. These factors will affect the distance you can travel in your wheelchair. All wheelchair batteries will gradually lose their capacity as they age.

If your battery gauge reading seems to fall more quickly than usual, your batteries may be worn out. When you replace worn out batteries, fit the type recommended by Magic Mobility. If you use another type, the battery gauge may be inaccurate.

### 8.6 Public transportation

The Gel Cell batteries are Federal Aviation Administration (FAA) approved, allowing safe transportation on aircraft, buses and trains. However, Magic Mobility recommends that any specific requirements of the carrier are checked in advance. When flying with your wheelchair, please call the airline for any specific information they need. Magic Mobility has a “flying with your wheelchair” fact sheet on the website that covers most questions.

### 8.7 Battery disposal and recycling

If you encounter a damaged or cracked battery, contact your Magic Mobility Dealer for instructions on disposal. Your Magic Mobility Dealer will also have all the necessary information on the recycling of batteries as well as all other wheelchair parts, which is our recommended course of action.

## 9 Care and maintenance

Like any motorised vehicle, your power chair requires routine maintenance checks. You can perform some of these checks, but it is recommended that every 12 months the chair is inspected by a factory authorised service facility. Repairs or replacements should only be carried out with manufacturer-approved components to assure proper performance (see 10 Servicing). With appropriate care, your power chair should give you many years of operation.

	<p>STOP! Do not use parts, accessories, or adapters other than those authorised by Magic Mobility. This may void your warranty and cause damage to your power chair.</p>
---	--

### 9.1 General guidelines

Avoid exposing your power chair to any type of moisture where possible (rain, snow, mist, salt water, or wash). Such exposure can damage your power chair – see section 9.6 - Corrosion Protection. Should your power wheelchair come into contact with water, dry as thoroughly as possible with a towel and then allow it to sit in a warm room for 10-12 hours to dry. Check the joystick operation and brakes before using your power wheelchair. If there are any doubts or inconsistencies with your wheelchair, please contact your Magic Mobility dealer

	<p>STOP!</p> <p>DO NOT leave the power wheelchair in rain or a storm of any kind.</p> <p>DO NOT use the power wheelchair in a shower or leave it in a damp bathroom whilst taking a shower.</p> <p>DO NOT leave power wheelchair in a damp area or outdoors for any length of time.</p> <p>Direct exposure to rain or damp will cause electrical and mechanical malfunctions and may cause the chair to prematurely rust.</p>
---	---

- Avoid knocking or bumping the controller, especially the joystick.
- Keep the controller clean
- Avoid exposure to extreme temperatures
- Do not place the controller cable so it may be pinched in any of the seat or power base frames
- Do not charge in extreme temperatures

Some parts of the power wheelchair are susceptible to extremes of temperature. It is possible for the batteries to freeze. The temperature at which the batteries freeze depends on a number of factors including their chemical composition, the level of charge and their usage. At elevated temperatures; the power wheelchair may operate at a reduced speed. This a safety feature built into the controller to protect the motors and other electrical components.



## 9.2 Batteries

The batteries used in your power chair are sealed, no maintenance gel cells and require only correct charging procedures – see Battery Charging 8.2. Typically these batteries should last from 1 to 2 years depending upon type of usage.

## 9.3 Tyres and castors

Lower tyre pressures provide more traction in mud, sand and snow. For use on firmer surfaces, tyre pressures may be increased up to a maximum of 8 psi/ 55 kPa depending upon the weight of the user, their preferences and driving capability. The chart below may be of some assistance when increasing tyre pressures. It is not recommended that tyre pressures greater than 8psi /55 kPa are used.

Tyre pressures should be checked weekly. All pneumatic tyres are fitted with automotive type valves and can be inflated using most typical automotive hand and foot type pumps. Never use service station air outlets.

	STOP! Under inflated tyres may be dangerous and can leave the tyres prone to punctures. Failure to use the correct inflation pressure can result in reduced performance or cause an unsafe situation to occur
	STOP! Over inflated tyres may cause the tyre to explode and cause bodily harm. The recommended tyre pressure is also listed on the sidewall of the tyre

### 9.3.1 FRONTIER TYRE INFLATION

	Tyre description	Magic Mobility recommended optimum operating pressure	Maximum tyre pressure according to tyre capacity
All-terrain	Black, low pressure, knobby	<b>3.6 psi</b> (25 kPa) MAX 8psi (55kPa)	24 psi 165 kPa
Hybrid	14 x 3 pneumatic	<b>36 psi</b> (248 kPa)	50 psi 343 kPa
Compact 73 and 40	12 ½ x 2 ¼ pneumatic	<b>36 psi</b> (248 kPa)	40 psi 275 kPa

	Tyre description	Magic Mobility recommended optimum operating pressure	Maximum tyre pressure according to tyre capacity
Castors (compact)	200x50 or 175x50 pneumatic	<b>36 psi</b> (248 kPa)	36 psi 248 kPa
Castors (AT and Hybrid)	2.50-4 pneumatic	<b>36 psi</b> (248 kPa)	36 psi 248 kPa

9.3.2 EXTREME X8 TYRE INFLATION

Tyre	Tyre description	Magic Mobility recommended optimum operating pressure	Maximum tyre pressure according to tyre capacity
All-terrain	Black, low pressure, knobby	<b>3.6 psi</b> (25 kPa) MAX 8psi (55kPa)	24 psi 165 kPa

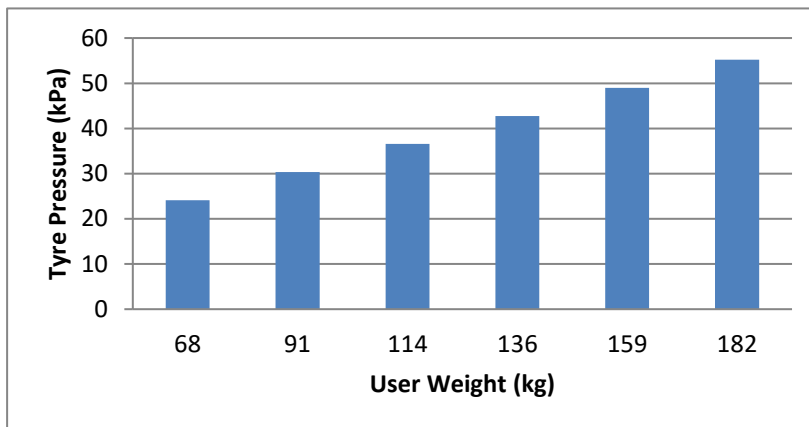

Advisory Tyre Pressures for user weight (Metric)

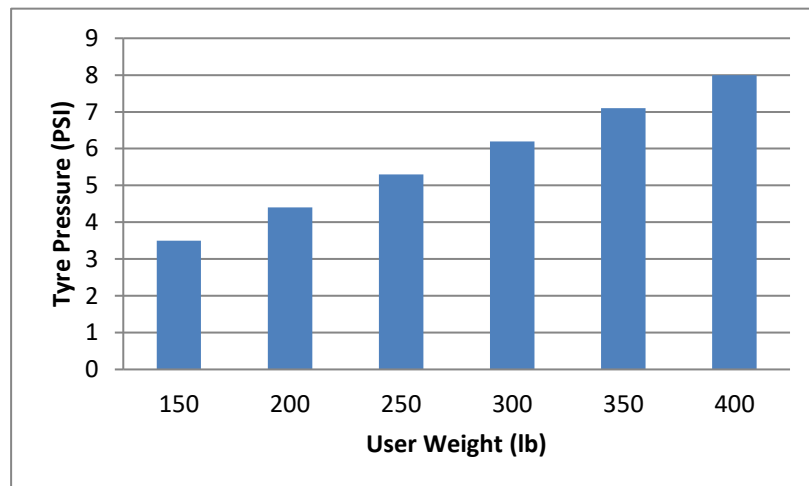

Advisory Tyre Pressures for user weight (Imperial)

### 9.3.3 TYRE PUNCTURE REPAIR

Unfortunately, punctures can and do happen. There are several precautions you can take to minimise the likelihood:

- Fit solid wheels – they do lead to a harder ride, but will never go flat.
- Have tyre slime installed into the tubes.
- Keep your tyres correctly inflated and replace them when they are badly worn or cracked.

Puncture repairs can be done by your Magic Mobility Dealer, most bicycle, ATV or car tyre outlets.

#### **Extreme X8 and Frontier All Terrain Knobby Tyres**

If you have the Magic Mobility knobby wheel Puncture Resistant Kit (tyre liner + slime), you are less likely to experience a puncture. If you do not yet have this kit, you can contact your Magic Mobility Dealer to have the kit fitted to your current wheels. When the time comes, the kit can be switched into your new tyres.

### 9.3.4 TYRE WEAR

Tyre wear varies greatly depending on usage (from months to years), but no matter what sort of time your tyres last this is mostly governed by your typical daily requirements. To achieve the most from your tyres it is important to have them correctly inflated. Always use manufacturer recommended parts. Replace tyres when the tread pattern wears to less than 2mm/0.1" in depth as tyres will start to lose safe traction and can be more prone to puncture.

## 9.4 Upholstery

The power chair upholstery may be cleaned using mild soap and water. Avoid getting water into any electric components. Never use any chemicals to clean a vinyl seat, as they may cause the seat to become slippery, or dry out and crack. A general purpose upholstery cleaner may be used on velour.

Upholstery life may be affected by skin oils and human sweat particularly that caused by particular medications. It is recommended that should cracking or significant wearing of the upholstery occur, it should be replaced.

## 9.5 Cleaning

Your power chair has a powder coated metal frame that allows it to be easily wiped clean with a damp cloth. Never hose off or pressure clean your power chair or place it in direct contact with water.

## 9.6 Corrosion protection

The V6 power chair has been manufactured using a range of processes that have been developed to resist corrosion. Although all effort has been made to ensure the long-term durability of the product we cannot guarantee that the wheelchair will remain corrosion-free for the duration of its usable life. Prevention, protection and maintenance are essential to reducing the risk of corrosion on the wheelchair.

The most common causes of corrosion to the power chair are:

- Chipping or scratching of paint or undercoat caused by impact with rocks or other hard objects.
- The accumulation of grit salt, dirt and moisture on the chassis components.
- Exposure to highly corrosive environments such as the beach and coastal areas, rivers and creeks.



### 9.6.1 PAINT SCRATCHES AND CHIPS

If your power chair chassis or any other steel components are scratched or chipped leaving the bare metal exposed it is recommended to undertake the following steps to repair the paintwork:

- Lightly sand the exposed area to flatten it and remove any loose edges of paint and any chipping that has occurred. Ensure any surface corrosion has been removed in this process.
- Apply a cleaning solvent to the area to remove any dust, impurities and oils.
- Apply primer over the area to be touched up.
- After allowing adequate drying time, apply the touch-up paint ensuring that it covers all exposed areas. When dry, the area should now be protected from further corrosion.

If it is not practical to perform the above steps, products that neutralise rust and prevent it from spreading can be used such as the many commercially available 'rust converter' products.

### 9.6.2 BEACH, SALT WATER AND COASTAL AREAS

Salt water and the surrounding environment is highly corrosive.

Exposure to coastal areas will also increase the likelihood of corrosion occurring on the power chair even if it is not used on the beach. Coastal air generally has a far higher salt content than inland areas. The highest coastal corrosion rates are generally within approximately 500 metres (1640 ft) of the shoreline. If you live in a coastal area or regular use the wheelchair near the beach please see section Error! Reference source not found. below for maintenance advice.

### 9.6.3 SNOW AND ICE, SALTED ROADS AND FOOTPATHS

Avoid using the wheelchair on salted surfaces where possible as the salt can have a detrimental effect on many of the components used in the wheelchair. If the wheelchair has been driven on wet, icy or salted surfaces please see section 9.6.4 below for maintenance advice.

### 9.6.4 POST USAGE CLEANING

When the power chair has been used in coastal, wet or salty environments, we recommend that extra cleaning care is taken to reduce the risk of rusting. When returning from your drive all parts should be wiped down with warm water on a cloth. Under no circumstances should the wheelchair be hosed down. The wheelchair should then be left in a warm and dry environment. It may also help to blow as much of the sand and/or salt off as possible.

### 9.6.5 PREVENTATIVE MAINTENANCE

Prior to using your wheelchair in wet or corrosive environments it is suggested that you protect your wheelchair by thoroughly coating all metal surfaces with a water dispersant. Common products include oiled-based spray applicants (e.g. WD40) or lanolin-based dispersants (e.g. Lanotec). This coating should provide a barrier between the water and the painted steel surfaces of your power chair.

A lubricant (such as a WD40) can be sprayed on the lift and tilt mechanism, if fitted, as protection.

The underside of the wheelchair (battery box and chassis components) can be sprayed by using a ramp another standards-approved lifting device to enable access to these areas.



**CRITICAL! Your wheelchair has electric motors and must NEVER be driven through water, into rivers, creeks and the sea.**

## 9.7 Storage

Store your Magic Mobility power chair in a warm dry environment. If you do not use your power chair regularly, it is recommended that the batteries be charged at least once per week. Always store your batteries fully charged

If you are storing your power chair for an extended period of time, please contact your Magic Mobility Dealer who can give you advice on disconnecting the batteries and blocking up the power chair to avoid flat-spotting the tyres

Exposing the wheelchair to excessive temperatures will affect the battery life. Avoid storing the wheelchair in extreme warm and cold environments.

	<p>WARNING! Battery posts, terminals, and related accessories contain lead and lead compounds, wash your hands after touching.</p> <p>WARNING! Dropping a tool or touching a watch or bracelet across the terminals can result in electric shock, sparks, smoke, fire or explosion. Use extreme caution around exposed battery terminals</p> <p>WARNING! Corrosive chemicals are contained in the batteries. Use only AGM or gel-cell batteries to reduce the risk of leakage or explosive conditions. Always wear safety glasses and a face shield. Ventilate well.</p>
---	--

## 9.8 Transportation

Always be sure your power chair and its components are properly secured when it is being transported. Please contact your Magic Mobility Dealer for advice regarding transporting your particular chair.

## 9.9 Daily checks

**Joystick:** With the control system switched off, check that the joystick is not bent or damaged and that it returns to centre when you release it. Ensure the joystick boot is not torn or cracked where water can enter and that all electrical connections are secure.

	<p>STOP! Do not use the joystick if the boot is torn or cracked. If the joystick boot becomes torn or cracked, ensure it is replaced IMMEDIATELY.</p>
---	---

## 9.10 Weekly checks

**Electrical brakes:** This test should be carried out on a level floor with at least one metre clear space around the wheelchair.

- Switch on the control system.
- Check that after 1 second the battery gauge remains on or flashes slowly.
- Push the joystick slowly forwards until you hear the electrical brakes operate. The chair may start to move.
- Immediately release the joystick, you must be able to hear each electrical brake operate within a few seconds.
- Repeat the test three times, pushing the joystick backwards, left and right respectively.

**Operation:** If your wheelchair is fitted with lights, turn indicators or seat adjustment actuator, checks the operation of these.

**Connectors:** Check all connectors are secure, properly mated and free from damage.

**Cables:** Check condition of all cables for damage.

**Joystick:** Gaiter: Check the thin rubber gaiter around the base of the joystick for damage or splitting. Check visually only, do not handle the gaiter.

**Mounting:** Make sure the controller is securely fixed to your wheelchair. Do not over tighten any screws

**Tyre pressure and wear:** Check the tyre pressure is to the specification as detailed in section Error! Reference source not found. Error! Reference source not found.. Check the tyres for wear.

	<p>STOP! If any of the above checks reveal a problem, please see your Magic Mobility Dealer for repair.</p>
---	---

### 9.11 Annual Checks

It is highly recommended to service your power chair annually. Take your power chair to your Magic Mobility Dealer to ensure it is functioning correctly.

### 9.12 Disposal

The symbols below mean that in accordance with local laws and regulations your product should be disposed of separately from household waste. When this product reaches the end of its life, take it to the local collection point designated by local authorities. The separate collection and recycling of your product at the time of disposal will help conserve natural resources and ensure that it is recycled in a manner that protects the environment.

Ensure you are the legal owner of the product prior to arranging for the product disposal in accordance with the above recommendations and national requirements.

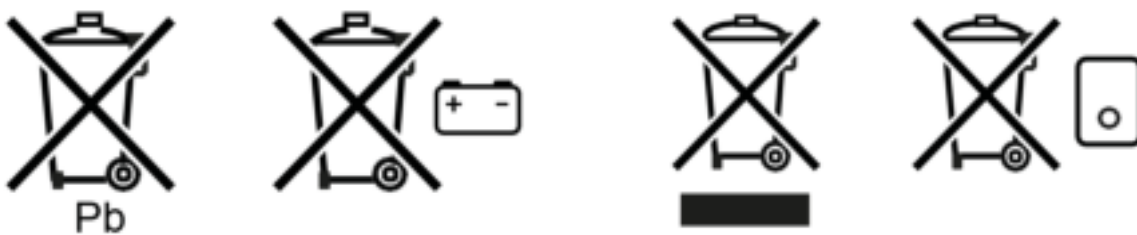

There may be special local regulations in force with regard to disposal or recycling, these must be taken into account when disposing of your wheelchair. (This can include the cleaning or decontamination of the wheelchair prior to disposal).

The following list may be helpful:

**Steel:** frame, front and rear arms, forks, legrest, armrest, under-seat positioning

**Aluminium:** wheels

**Aluminium and copper:** Motors

**Lead:** Batteries



**Plastic:** castor wheels, handles, tube stoppers, footplate.

**Packaging:** plastic wrapping, cardboard.

**E-waste:** charger, power module, seating module, controller.

Disposal or recycling should be done through a licensed agent or authorised place of disposal. Alternatively, your wheelchair may be returned to your dealer for disposal.

## 10 Servicing



Please contact your Magic Mobility Dealer to arrange your annual service. Your local representative can also discuss the availability of loan (rental) units during repairs and servicing. It should be noted that many of our power chairs are highly customised and a loan (rental) chair may not be appropriate.

If you notice symptoms such as motor noise, frayed harnesses, damaged connectors, uneven tyre wear, unusual motion or broken parts or anything else that may be a cause for concern between services, please also contact your Magic Mobility Dealer immediately. If required, Head Office can help you find your nearest Dealer (see Error! Reference source not found. Error! Reference source not found.).

Set-Up of the Electronic Control Unit is to be performed ONLY by individuals authorised by Magic Mobility. The final tuning adjustments of the controller may affect other activities of the wheelchair.

	<p>STOP! If non-certified individuals perform any work on these units, the warranty is void and damage to the equipment could occur.</p>
---	--

Do not modify, or have your power chair modified in any way not authorised by Magic Mobility. Unauthorised changes constitute remanufacturing of the wheelchair. The person or group who make the changes will have full liability of the wheelchair under the Therapeutic Goods Act (TGA).

	<p>WARNING! Unauthorised modifications void your warranty and may result in personal injury.</p>
	<p>STOP! Unauthorised modifications void your warranty, constitute remanufacturing and may render your chair unsafe.</p>

### 10.1 Electromagnetic interference (EMI) from radio wave sources

Powered Wheelchairs may be susceptible to electromagnetic interference (EMI), which is interfering electromagnetic energy (EM) emitted from a variety of sources. For further information see Error! Reference source not found..

## 11 Technical specifications



This product complies with the regulations and guidelines for medical aids and carries a CE symbol.

The product meets the requirements and standards below. These are checked by independent institutions

Standard	Definition / description			Test dummy weight
93/42 EEC	EU guideline			N/A
EN 12182: 2012 Class B	Assistive products for persons with disability - General requirements and test methods			No seat elevator 182 kg
	Extreme X8	Frontier V6	Frontier V4	With seat elevator 155 kg
EN 12184: 2014 Class B	Electrically powered wheelchairs, scooters and their chargers - Requirements and test methods			No seat elevator 182 kg
	Extreme X8	Frontier V6	Frontier V4	With seat elevator 155 kg
ISO 7176-8: 2014	Requirements and test methods for impact, static and fatigue strengths			No seat elevator 182 kg With seat elevator 155 kg
ISO 7176-9: 2009	Climate tests for electric wheelchairs			N/A
ISO 7176-14: 2008	Requirements and test methods for control systems for electric wheelchairs			N/A
ISO 7176-16: 2012	Requirements for resistance to ignition of upholstered parts			N/A
ISO 7176-19: 2008	Wheelchairs - Part 19: Wheeled mobility devices for use as seats in motor vehicles:			N/A
	Extreme X8	Frontier V6	Frontier V4	

Model	Extreme X8	Frontier V6	Frontier V4
	Maximum user weight		
No seat elevator	155 kg		
With seat elevator	182 kg		

Description	
Maximum battery dimensions (l x w x h)	260x172x210 mm
Battery capacity	70 Ah (C20)
Maximum permissible charging voltage	24V
Maximum charging current	12 A (rms)
Charging connector type	Controller, manual
Insulation	Class 2 double insulated

Magic Mobility is not able to provide technical specifications for non-Magic Mobility parts, nor can we guarantee performance according to the table above.

Don't see what you need - please get in touch

Description	Minimum	Maximum
Total length (including legrests)		
Extreme X8      Central footplate	1040 mm (stowage)	1250 mm
Frontier V6      Central footplate	1240 mm (stowage)	950 mm
Frontier V4 RWD      Central footplate	970 mm (stowage)	1200 mm
Frontier V4 FWD      Central footplate	1005 mm (stowage)	1180 mm
Total width		
Extreme X8	710 mm	
Frontier V6      Hybrid / All Terrain	710 mm	710 mm
Frontier V4      Hybrid / All Terrain	710 mm	710 mm
Total weight: Basic configuration, no batteries		
Extreme X8	95 kgs	135 kgs
Frontier V6	85 kgs	125 kgs
Frontier V4	80 kgs	120 kgs
Total weight influencers: batteries (set of 2)	46 kgs	
Transport weight of the heaviest part	23 kgs	

Description	Minimum	Maximum
Dynamic stability: Maximum safe slope  Extreme X8  Frontier V6  Frontier V4	6°  6°  6°	
Min. braking distance at maximum speed  Extreme X8  Frontier V6  Frontier V4 RWD  Frontier V4 FWD	1500 mm  1670 mm  1630 mm  1500 mm	1700 mm  1760 mm  1870 mm  1870 mm
Static stability  Extreme X8 Downwards / Upwards / Sideways  Frontier V6 Downwards / Upwards / Sideways  Frontier V4 Downwards / Upwards / Sideways	10° / 10° / 10°  10° / 10° / 10°  10° / 10° / 10°	
Estimated Range - NB: The following aspects have a negative influence on the range of action: Obstacles, rugged terrain, driving on slopes, exposure to temperatures below freezing point and frequent use of powered seat options  Extreme X8  Frontier V6  Frontier V4	20 km  34 km  34 km	
Climbing capability for obstacles  Extreme X8  Frontier V6  Frontier V4	120mm  110 mm  50 mm	

Description	Minimum	Maximum
Max speed forward		
Extreme X8	10 kph	
Frontier V6	10 kph	
Frontier V4	10 kph	
Turning radius		
Extreme X8	1140 mm	
Frontier V6	1085 mm	
Frontier V4	545 mm	
Turning space / reversing width		
Extreme X8	1100 mm	
Frontier V6	1050 mm	
Frontier V4	1055 mm	
Ground clearance		
Extreme X8	50 mm	
Frontier V6	55 mm	
Frontier V4	50 mm	

Technical specifications: Rehab seating system		Minimum	Maximum
Seat angle	Fixed seat	4°	
	Powered tilt	0°	50°
	Powered tilt with seat elevator	0°	45°
Seat depth		305 mm	510 mm
Seat width		305 mm	610 mm



Technical specifications: Rehab seating system		Minimum	Maximum
Seat to floor height (fixed seat)	Extreme X8	470mm	
	Frontier V6	435 mm	
	Frontier V4	435 mm	
Seat to floor height (powered seat tilt)	Extreme X8	470 mm	
	Frontier V6	435 mm	
	Frontier V4	435 mm	
Seat to floor height (powered seat tilt & seat elevator)	Extreme X8	470 mm	770 mm
	Frontier V6	435 mm	735 mm
	Frontier V4	435 mm	735 mm
Backrest angle	Fixed	0°	15°
	Powered recline	0°	160°
	Powered anti-shear recline	0°	155°
Backrest height (seat pan to top of back cushion)		560 mm	700 mm
Single post removable armrest			
Armrest pad height (seat pan to top armpad)		220 mm	390 mm
Armrest width (on seat pan)		35 mm	75 mm
Armrest pad width (on armrest profile)		75 mm	
Armrest depth (on seat pan)		305 mm	560 mm
Armrest pad depth (on armrest profile)		255 mm	380 mm
Armrest pad angle (horizontal)		-12°	12°

Technical specifications: Rehab seating system		Minimum	Maximum
Flexi Armrest (reclining flip back)			
Armrest pad height (seat pan to top armpad)		220 mm	390 mm
Armrest pad width (on armrest profile)		75 mm	
Armrest pad depth (on armrest profile)		255 mm	
Armrest pad angle (vertical)		-14°	26°
Armrest pad angle (horizontal)		-12°	12°
Centre mount legrest	Lower leg length (from seat pan)	300 mm	380 mm
	Knee angle	107° / 97° / 97° / 112°	
	Ankle angle	75°	100°
Power centre mount legrest	Lower leg length (from seat pan)	300 mm	380 mm
	Knee angle X8/V6/V4 FWD/V4 RWD	110° / 95° / 95° / 95°	180°
	Max length compensation	260 mm	
	Ankle angle	75°	95°
Swingaway legrests	Lower leg length (from seat pan)	300 mm	380 mm
	Knee angle	100°	
	Ankle angle	80°	115°
Swingaway legrests, manual elevating / power elevating	Lower leg length (from seat pan)	300 mm	380 mm
	Knee angle	100°	180°
	Ankle angle	80°	115°

Technical specifications: Rehab seating system		Minimum	Maximum
Multi-position headrest			
Headrest height adjustment range		200 mm	
Headrest depth adjustment range		100 mm	
Headrest angle (vertical)		45°	45°
Headrest width		220 or 330 mm	
Lateral Supports			
Lateral support width adjustment range		70 mm	
Lateral support height adjustment range		25 mm	
Lateral support depth adjustment range		125 or 175 or 235 mm	
Height Adjustable Push Handles (if fitted)			
Push rail height adjustment range		250mm	
Seat Angle	Fixed seat	4°	
	Powered tilt	0°	50°
	Powered tilt with seat elevator	0°	45°
Seat depth		410 mm	510 mm
Seat width		410 mm	610 mm
Seat to floor height (fixed seat)	Extreme X8	600 front / 545 mm rear	
	Frontier V6	565 front / 510 mm rear	
	Frontier V4	565 front / 510 mm rear	
Seat to floor height (powered seat tilt)	Extreme X8	600 front / 545 mm rear	
	Frontier V6	565 front / 510 mm rear	
	Frontier V4	565 front / 510 mm rear	

Technical specifications: Rehab seating system		Minimum	Maximum
Seat to floor height (powered seat tilt & seat elevator)	Extreme X8	600 front /545 mm rear	900 front / 845mm rear
	Frontier V6	600 front /545 mm rear	900 front / 845mm rear
	Frontier V4	600 front /545 mm rear	900 front / 845mm rear
Backrest angle	Manual recline	0°	170°
	Powered recline	0°	150°
Backrest height (seat pan to top of back cushion)		600 mm	750 mm
Single post removable armrest			
Armrest pad height (seat pan to top armpad)		240 mm	390 mm
Armrest width (on seat pan)		57 mm	97 mm
Armrest pad width (on armrest profile)		100 mm	
Armrest depth (on seat pan)		430 mm	560 mm
Armrest pad depth (on armrest profile)		405 mm	460 mm
Armrest pad angle (horizontal)		-12°	12°
Flexi Armrest (reclining flip back)			
Armrest pad height (seat pan to top armpad)		220 mm	390 mm
Armrest pad width (on armrest profile)		100 mm	
Armrest pad depth (on armrest profile)		405 mm	460 mm
Armrest pad angle (vertical)		-14°	26°
Armrest pad angle (horizontal)		-12°	12°
Centre mount legrest	Lower leg length (from seat pan)	300 mm	380 mm
	Knee angle	107° / 97° / 97° / 112°	
	Ankle angle	75°	100°

Technical specifications: Rehab seating system		Minimum	Maximum
Power centre mount legrest	Lower leg length (from seat pan)	300 mm	380 mm
	Knee angle X8/V6/V4 FWD/V4 RWD	110° / 95° / 95° / 95°	180°
	Max length compensation	260 mm	
	Ankle angle	75°	95°
Swingaway legrests	Lower leg length (from seat pan)	300 mm	380 mm
	Knee angle	100°	
	Ankle angle	80°	115°
Swingaway legrests manual elevating / power elevating	Lower leg length (from seat pan)	300 mm	380 mm
	Knee angle	100°	180°
	Ankle angle	80°	115°
MPS headrest (standard)			
Headrest height adjustment range		67 mm	
Headrest depth adjustment range		0 mm	
Headrest angle (vertical)		40°	40°
Headrest width		310 mm	
Lateral Supports		Built in seat	
Lateral support width adjustment range		N/A	
Lateral support height adjustment range		N/A	
Lateral support depth adjustment range		N/A	
Height Adjustable Push Handles (if fitted)			
Push rail height adjustment range		250 mm	

## 12 Non-OEM parts

### 12.1 Non-OEM parts, assembly by a third party and customisation

If non-Magic Mobility parts are fitted to the wheelchair, Magic Mobility is not responsible for their compatibility, performance or instructions for use. Please refer to the relevant manufacturer's manuals for appropriate use. Magic Mobility wheelchairs comply with International Standards in a standard wheelchair configuration, all variants and non-Magic Mobility components are not tested. In addition, if non-Magic Mobility parts are fitted, it could void the warranty as Magic Mobility cannot guarantee their compatibility. In the instance where non-Magic parts are fitted, then they are fitted at your own risk/risk of the final person who assembles the wheelchair. In the instance where parts are assembled by a third party agent, they take the responsibility of being the manufacturer.

## Appendix A – ISO 7176-19

The wheelchair is not provided with a wheelchair anchored belt restraint as standard. It must be requested at the time of ordering the wheelchair or it can be retrofitted later on by a Magic Mobility dealer.

All Magic Mobility electric wheelchairs have been tested to and conform to the requirements of ISO 7176-19. The Frontier V6 Mid Wheel Drive and Extreme X8 also comply with the requirements of ANRI/RESNA WC/19; further details of this are available on request.

The Magic Mobility wheelchairs were tested with either 4 point strap restraints or the Magic Mobility 16mm (5/8") retractable docking pin. The tie downs have a rectangular aperture 25x50mm. Any hook or loop of the restraining strap must fit through this hole

It is recommended that people who use wheelchairs should transfer to the vehicle seat and use the vehicle-installed occupant restraint system when this is feasible.

When seat positioning options are fitted the following should be followed whenever feasible

- Seat elevator:** Fully DOWN i.e. the seat at its lowest
- Seat tilt:** Fully DOWN i.e. the seat parallel to the ground
- Legrest:** Fully DOWN i.e. feet close to the floor, knees bent at 90°
- Backrest:** Upright i.e. at or close to 90° to the seat

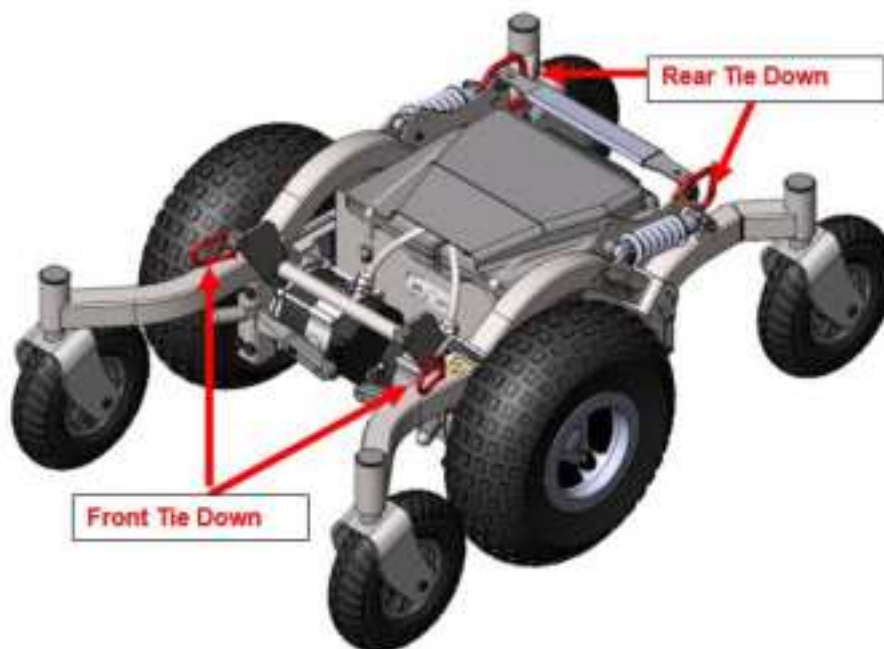

Figure 21 - V6 tie down locations

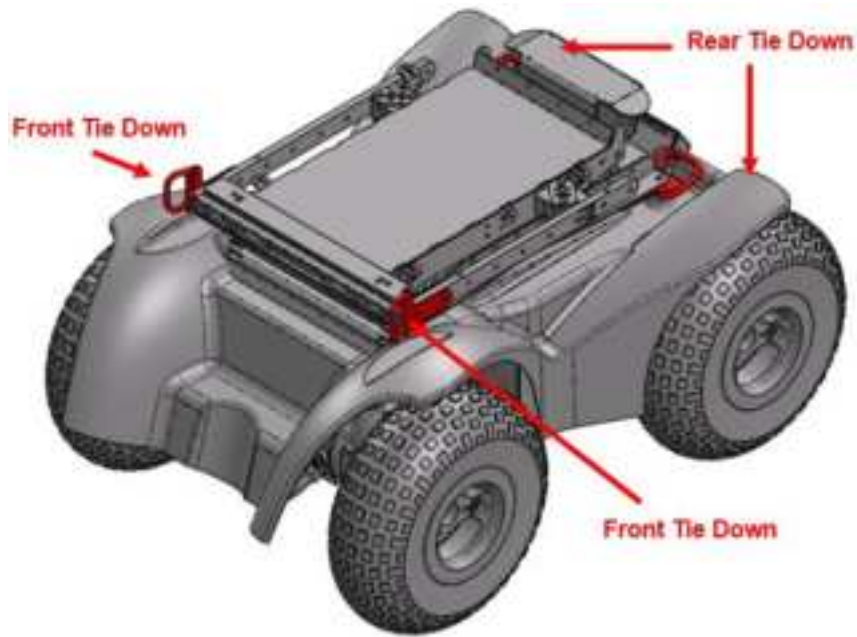

Figure 22 - X8 tie down locations

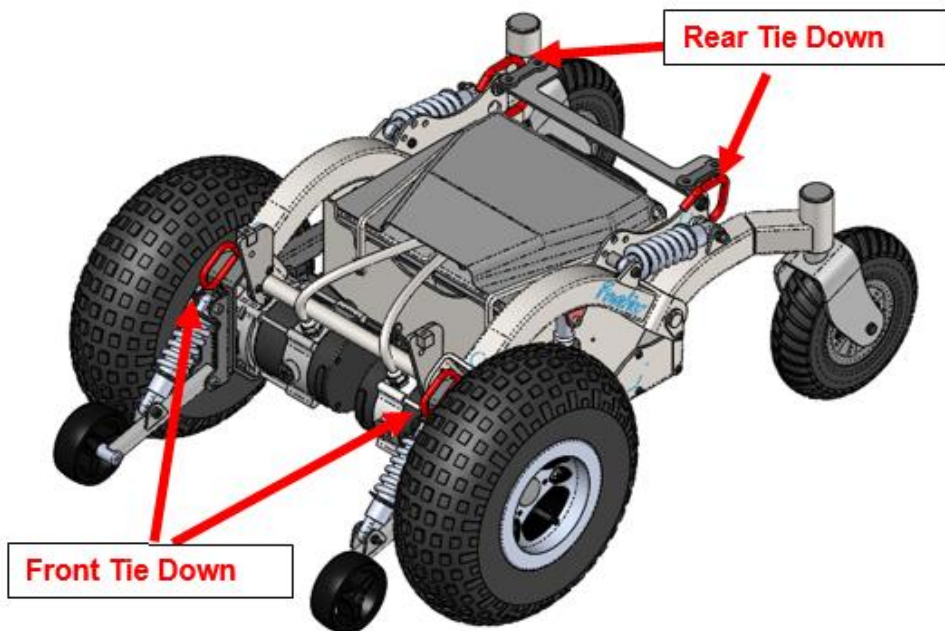

Figure 23 - V4 FWD tie down locations



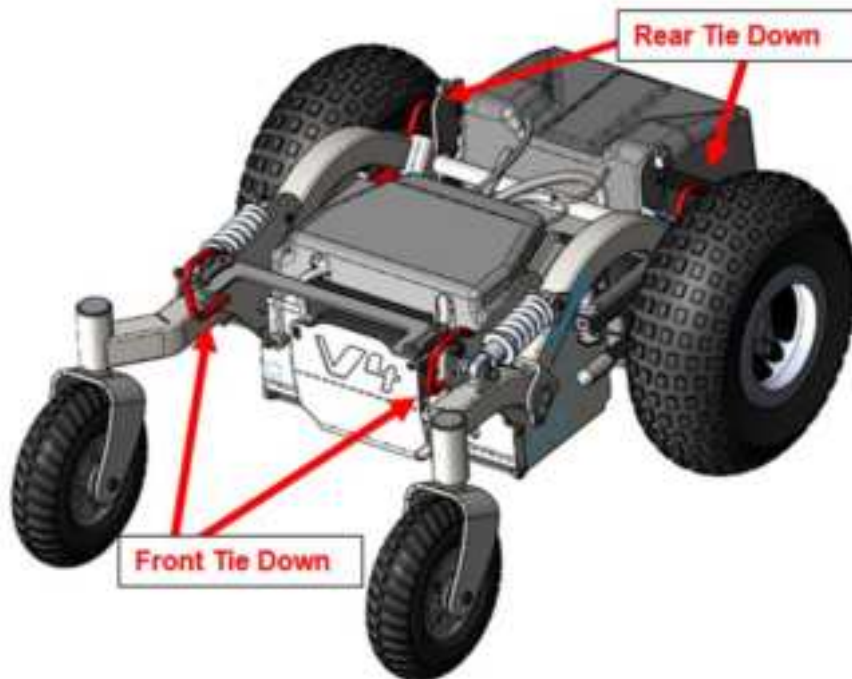
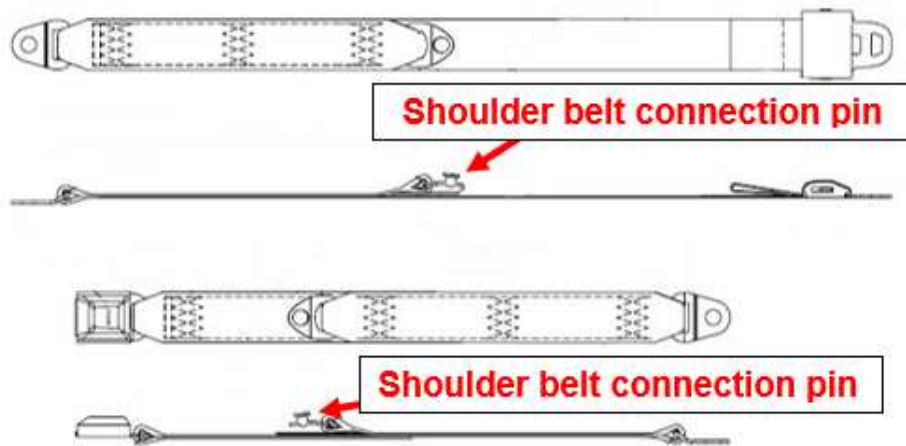

Figure 24 - V4 RWD tie down locations

<p>All securement points are identified with a hook symbol</p>	
--	--

The wheelchair provides for anchoring a pelvic belt restraint that conforms to the requirements of ISO 7176-19. The seatbelt is anchored over a 14mm spigot by an M8 (minimum grade 8.8) bolt. The pelvic belt restraint can be used in conjunction with a vehicle anchored shoulder belt with a standard lower anchorage connector as a crashworthy three point belt restraint in motor vehicles.

Magic Mobility supply either a 600mm or 700mm compatible crashworthy wheelchair anchored pelvic belt restraint when ISO 7176-19 tie downs are requested. This belt is designed to accommodate use on either side of the vehicle. The belt is equipped with standard interconnect hardware to enable attachment of suitably equipped vehicle anchored shoulder belts. The free end of the vehicle anchored shoulder belt is installed over the shoulder belt connection pin.



**Figure 25 - The wheelchair anchored pelvic belt**

The pelvic belt should be worn low across the front of the pelvis, so that the angle of the pelvic belt restraint is between 30° to 75° relative to the horizontal as shown in Figure 26.

A steeper (greater) angle within the preferred zone is desirable.

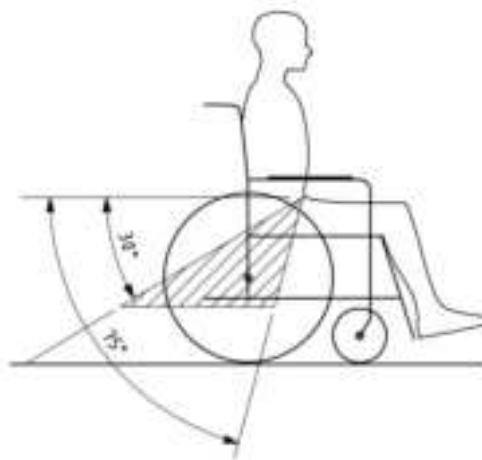

**Figure 26 - Preferred angles of pelvic belt restraints**

The belt restraint buckle of three point belt restraints must be placed in contact with the occupant's body and away from wheelchair components.

Upper torso belt restraints should fit directly over, and in contact with, the middle of the shoulder.

The junction of the shoulder belt and pelvic belt of three point belts should be located near the hip opposite to the shoulder over which the diagonal belt crosses and not near the midline of the occupant.

Belt restraints should not be held away from the body by the wheelchair components or parts, such as the wheelchair armrests or wheels.

Belt restraints should be adjusted as tightly as possible, consistent with user comfort. Belt restraints should not be worn or twisted in a manner that reduces the area of contact of the belt webbing with the occupant.



Figure 27 - Improper belt restraint fit

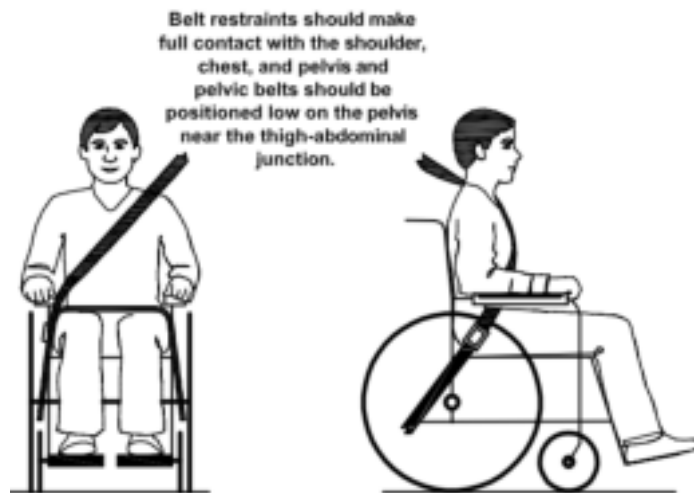

Figure 28 - Proper belt restraint fit

The mass of a Magic Mobility electric wheelchair can range between 120 and 190Kgs depending upon options fitted. A variety of options have been tested, please contact Magic Mobility for details

This wheelchair was tested with a 76Kg/152lbs ATD. Occupants with a higher weight are at increased risk during an accident.



## WARNINGS



The wheelchair complies with the requirements of ISO 7176-19:2008 and, as such has been designed and tested for use only as a forward facing seat in motor vehicles

The wheelchair has been dynamically tested in a forward facing orientation with the ATD restrained by both pelvic and shoulder belts (e.g. a shoulder belt as part of a three point belt restraint)

Both pelvic and shoulder belt restraints should be used to reduce the possibility of head and chest impacts with vehicle components

In order to reduce the potential of injury to vehicle occupants, wheelchair mounted trays not specifically designed for crash safety should

- 1) Be removed and secured separately in the vehicle, or
- 2) Be secured to the wheelchair but positioned away from the occupant with energy absorbing padding placed between the tray and the occupant

When possible, other auxiliary wheelchair equipment should either be secured to the wheelchair or removed from the wheelchair and secured in the vehicle during travel, so that it does not break free and cause injury to vehicle occupants in the event of a collision

The wheelchair should be inspected by a manufacturer's representative before reuse following involvement in any type of vehicle collision

Alterations or substitutions should not be made to the wheelchair securement points or to structural and frame part or components without consulting Magic Mobility

Spill proof batteries such as gelled electrolyte should be installed on powered wheelchairs when used in a motor vehicle

Care should be taken when applying the occupant restraint to position the seat buckle so that the release button will not be contacted by wheelchair components during a crash

## Appendix B – Electromagnetic interference (EMI)

### Electromagnetic Interference (EMI) from radio wave sources

Powered Wheelchairs may be susceptible to electromagnetic interference (EMI), which is interfering electromagnetic energy (EM) emitted from sources such as radio stations, TV stations, amateur radio (HAM) transmitters, two-way radios and cellular phones. The interference (from radio wave sources) can cause the powered wheelchair to release its brakes, move by itself, or move in unintended directions. It can also permanently damage the powered wheelchair's control system. The intensity of the interfering EM energy can be measured in volts per meter (V/m). Each powered wheelchair can resist EMI up to a certain intensity. This is called its "immunity level" The higher the immunity level, the greater the protection. At this time, current technology is capable of achieving at least a 20 V/m immunity level, which would provide useful protection from the more common sources of radiated EMI. This powered wheelchair model as shipped, with no further modification, has an unknown immunity. There are a number of sources of relatively intense electromagnetic fields in the everyday environment. Some of these sources are obvious and easy to avoid. Others are not apparent and exposure is unavoidable. However, we believe that by following the warnings listed below, your risk to EMI will be minimised.

The sources of radiated EMI can be broadly classified into three types:

- 1) Hand held portable transceivers (transmitters-receivers) with the antenna mounted directly on the transmitting unit. Examples include: citizens band (CB) radios, "walkie talkie," security, fire and police transceivers, cellular telephones, and other personal communication devices. \*\*NOTE: Some cellular telephones and similar devices transmit signals while they are ON, even when not being used;
- 2) Medium-range mobile transceivers, such as those used in police cars, fire trucks, ambulance, and taxis. These usually have the antenna mounted on the outside of the vehicle; and
- 3) Long range transmitters and transceivers, such as commercial broadcast transmitters (radio and TV broadcast antenna towers) and amateur (HAM) radios.

NOTE: Other types of hand-held devices, such as cordless phones, laptop computers, AM/FM radios, TV sets, CD players, and small appliances such as electric shavers and hair dryers, so far as we know are not likely to cause EMI problems to your powered wheelchair.

### Powered wheelchair electromagnetic interference (EMI)

Because EM energy rapidly becomes more intense as one moves closer to the transmitting antenna (source), the EM fields from hand-held radio wave sources (transceivers) are of special concern. It is possible to unintentionally bring high levels of EM energy very close to the powered wheelchair's control system while using these devices. This can affect powered wheelchair movement and braking. Therefore, the warnings listed below are recommended to prevent possible interference with the control system of the powered wheelchair.



## WARNINGS



Electromagnetic interference (EMI) from sources such as radio and TV stations, amateur radio (HAM) transmitters, two way radios and cellular phones can affect powered wheelchairs.

Following the warnings listed below should reduce the chance of unintended brake release or powered wheelchair movement which could result in serious injury.

Do not operate hand held transceivers (transmitter-receivers), such as citizens band (CB) radios, or turn ON personal communication devices, such as cellular phones, while the powered wheelchair is turned ON.

Be aware of nearby transmitters, such as radio or TV stations, and try to avoid coming close to them.

If unintended movement or brake release occurs, turn the powered wheelchair OFF as soon as it is safe to do so.

Be aware that adding accessories or components, or modifying the powered wheelchair, may make it more susceptible to EMI (Note: There is no easy way to evaluate their effect on the overall immunity of the powered wheelchair)

Report all incidents of unintended movement or brake release to the powered wheelchair manufacturer, and note whether there is a source of EMI nearby.

### Important information

- 1) 20 volts per meter (V/m) is a generally achievable and useful immunity level against EMI (as of May 1994) (the higher the level the greater the protection)
- 2) This product has an unknown immunity.

### United States of America (ONLY)

Caution: Federal law restricts this device to sale by or on the order of a practitioner licensed by the law of the State in which he/she practices.

---

### Contact Magic Mobility if you require further information

2/112 Browns Road, Noble Park Vic 3174  
 Tel +61 3 8791 5600 Email [sales@magicmobility.com.au](mailto:sales@magicmobility.com.au)  
<http://www.magicmobility.com.au>

© Copyright Magic Mobility 2014

Sunrise Medical S.r.l.  
Via Riva, 20 - Montale  
29122 Piacenza  
Italia  
Tel +39 0523 573111  
Fax +39 0523 570060  
www.SunriseMedical.it

Sunrise Medical AG  
Erlenauweg 17  
CH-3110 Münsingen  
Schweiz/Suisse/Svizzera  
Fon +41 (0)31 958 3938  
Fax +41 (0)31 958 3848  
www.SunriseMedical.ch

Sunrise Medical AS  
Delitoppen 3  
1540 Vestby  
Norge  
Telefon +47 66 96 38 00  
Faks +47 66 96 38 80  
post@sunrisemedical.no  
www.SunriseMedical.no

Sunrise Medical AB  
Box 9232  
400 95 Göteborg  
Sweden  
Tel: +46 (0)31 748 37 00  
Fax: +46 (0)31 748 37 37  
www.SunriseMedical.se

MEDICCO s.r.o.  
H - Park, Heršpická 1013/11d,  
625 00 Brno  
Czech Republic  
Tel +42 (0)547 250 955  
Fax +42 (0)547 250 956  
www.medicco.cz  
info@medicco.cz  
Bezplatná linka 800 900 809

Sunrise Medical ApS  
Park Allé 289 G  
DK-2605 Brøndby  
Tlf 70 22 43 49  
info@sunrisemedical.dk  
www.sunrisemedical.dk

Sunrise Medical Pty. Ltd  
6 Healey Circuit, Huntingwood  
NSW 2148,  
Australia  
Phone +61 (0)2 9678 6600  
Orders Fax +61 (0)2 9678 6655  
Admin Fax +61 (0)2 9831 2244  
www.sunrisemedical.com.au

Sunrise Medical  
North American Headquarters  
2842 Business Park Avenue  
Fresno, CA, 93727, USA  
(800) 333-4000  
(800) 300-7502  
www.SunriseMedical.com

Sunrise Medical GmbH  
Kahlbachring 2-4  
69254 Malsch/Heidelberg  
Deutschland  
Tel +49 (0) 7253/980-0  
Fax +49 (0) 7253/980-222  
www.SunriseMedical.de

EC REP

Sunrise Medical  
Thorns Road  
Brierley Hill  
West Midlands  
DY5 2LD  
England  
Phone: +44 (0)845 605 66 88  
Fax: +44 (0)845 605 66 89  
www.SunriseMedical.co.uk

Sunrise Medical S.L.  
Polígono Bakiola, 41  
48498 Arrankudiaga - Vizcaya  
España  
Tel +34 (0) 902142434  
Fax +34 (0) 946481575  
www.SunriseMedical.es

Sunrise Medical Poland  
Sp. z o.o.  
ul. Elektronowa 6,  
94-103 Łódź  
Polska  
Telefon + 48 42 275 83 38  
Fax + 48 42 209 35 23  
pl@sunrisemedical.de  
www.Sunrise-Medical.pl

Sunrise Medical B.V.  
Groningenhaven 18-20  
3433 PE NIEUWEGEIN  
The Netherlands  
T: +31 (0)30 - 60 82 100  
F: +31 (0)30 - 60 55 880  
info@sunrisemedical.nl  
www.SunriseMedical.nl

Sunrise Medical HCM B.V.  
Vossenbeemd 104  
5705 CL Helmond  
The Netherlands  
+31 (0)492 593 888  
customerservice@sunrisemedical.nl  
www.SunriseMedical.nl  
www.SunriseMedical.eu (International)

Sunrise Medical S.A.S  
ZAC de la Vrillonnerie  
17 Rue Mickaël Faraday  
37170 Chambray-Lès-Tours  
Tel + 33 (0) 247554400  
Fax +30 (0) 247554403  
www.sunrisemedical.fr

Magic Mobility  
2/112 Browns Road  
Noble Park, Vic 3174  
Australia  
Tel +61 (0)3 8791 5600  
www.magicmobility.com.au

