

Sep.2014 / Vol.147

M i t s u b i s h i E l e c t r i c

ADVANCE

Expanding in Space Utilization

• **Editorial-Chief**

Kiyoshi Sakai

• **Editorial Advisors**

*Toshio Masujima
Mitsutaka Matsukura
Makoto Egashira
Koji Miyahara
Chikao Nishida
Masami Fujii
Yoshiki Hama
Tetsuyuki Yanase
Yutaka Kobayashi
Tatsuya Ichihashi
Shinji Yamana
Takafumi Kawai
Masato Oshita
Toshihiro Kurita*

• **Vol. 147 Feature Articles Editor**

Kojiro Yoshida

• **Editorial Inquiries**

Kiyoshi Sakai
Corporate Total Productivity Management
& Environmental Programs
Fax: +81-3-3218-2465

• **Product Inquiries**

Yutaka Kobayashi
Planning & Administration Dept.
Electronic Systems Group
Fax: +81-3-3218-2864

Mitsubishi Electric Advance is published on line quarterly (in March, June, September, and December) by Mitsubishi Electric Corporation. Copyright © 2014 by Mitsubishi Electric Corporation; all rights reserved. Printed in Japan.

The company names and product names described herein are the trademarks or registered trademarks of the respective companies.

CONTENTS

Technical Reports

Establishment of Regional Navigation Satellite System Utilizing Quasi-Zenith Satellite System1
by *Masayuki Saito, Junichi Takiguchi and Takeshi Okamoto*

Digital Channelizer for High Throughput Satellite Communications7
by *Futaba Ejima, Minoru Akita and Akinori Fujimura*

Application and Evaluation of Observation Data by Advanced Microwave Scanning Radiometer 2 – Achievement of World’s Top-Class Microwave Radiometer AMSR Series –11
by *Tatsuhiko Noguchi and Takaaki Ishikawa*

History and Achievements of “BMS 100.00%” – Mission Success Activities of MELCO Satellites16
by *Toshimasa Sasaki, Yasuhiro Yamamori and Yasushi Mori*

Precis

Our daily life is supported by various services that utilize space, such as satellite broadcasting, automotive navigation, and weather forecasting. The dreams that humankind have had regarding the world of space are now much closer to us and are being actively used in reality. Against this backdrop, Mitsubishi Electric plans to contribute to the establishment of a safe and secure society by working on satellite systems as pertaining to many fields, such as communications, positioning, and observation, along with working on related ground systems, such as ground control systems for satellite tracking and large telescopes.

Establishment of Regional Navigation Satellite System Utilizing Quasi-Zenith Satellite System

Authors: *Masayuki Saito**, *Junichi Takiguchi** and *Takeshi Okamoto**

1. Introduction

The Global Navigation Satellite System (GNSS) is a constellation of satellites, transmitting (broadcasting) signals that superimpose navigation messages including satellite position and others for use by a receiver to determine its own location. The GNSS consists of a space segment, a control segment, and a user segment. The space segment is a group of navigation satellites whose position and time are accurately controlled. The control segment includes several ground stations and controls those satellites. The user segment is an application system including users' receivers.

While the U.S. Global Positioning System (GPS) is the GNSS best known to the public, the Russian Global Navigation Satellite System (GLONASS) is currently in operation, while the Japanese Quasi-Zenith Satellite System (QZSS; nicknamed "MICHIBIKI"), European Galileo, Chinese BeiDou, and Indian IRNSS (Indian Regional Navigational Satellite System) are under development. GNSS systems are now widely used in daily life for car navigation, and are also beginning to be used for supporting ship and aircraft navigation, topographic surveys, and ground monitoring.

This paper describes the QZSS that serves as a regional navigation satellite system consisting of four satellites, and presents test results conducted by using vehicles in an urban area, which demonstrates the most characteristic effects of the QZSS.

2. Challenges for GNSS and Solutions

The positioning principle of GNSS comprises: receiving positioning signals broadcasted by the positioning satellites, accurately measuring the distances between the satellites and the receiver, and determining the location by using the principle of triangulation. To achieve a highly accurate positioning system using carrier phase of the positioning signal, normally at least five positioning satellites are required, because the following unknown quantities need to be obtained, namely: the coordinates (x, y, z) of the measurement point, the error of the receiver clock, and an integer multiple of the wavelength contained in the

observed positioning signal called ambiguity. In the GPS, four satellites on each of six orbital planes, giving a total of 24 positioning satellites and reserve satellites, are orbiting the earth. However, during certain time periods in Japan, the number of visible satellites decreases and the geometric arrangement of the satellites called Position Dilution of Precision (PDOP) deteriorates. The positioning accuracy is affected by the PDOP and it is currently not possible to achieve highly accurate and stable positioning at all hours.

In addition, the positioning availability is severely deteriorated in metropolitan areas, where there are many high-rise buildings, elevated roads, trees, pedestrian bridges, and other structures that obstruct the views of positioning satellites. Furthermore, due to fluctuations in the radio wave characteristics in the ionosphere and troposphere, there is a delay in the radio wave propagation from a positioning satellite to the receiver. This in turn causes an error in the measured distance between the positioning satellite and the receiver, and thus reduces the positioning accuracy. Therefore, it is difficult to build a position control system for automobiles, trains and other mobile objects by using only the existing GPS satellites.

QZSS solves this problem by performing two roles: serving as an additional GPS satellite that is always near the zenith, and broadcasting augmentation signal to provide high positioning accuracy for users throughout Japan and in nearby sea areas. The former and the latter roles are respectively called the availability enhancement service and the performance enhancement service. In Japanese metropolitan areas, some usable GPS satellites are likely to be obstructed by high-rise buildings. But if a positioning satellite is at a high elevation angle where it is not obstructed and is always available, a high-accuracy positioning service can be attained anywhere at any time. The QZSS thus provides both the availability enhancement service and the performance enhancement service.

3. Quasi-Zenith Satellite System

3.1 Outline of QZSS

Figure 1 shows the configuration of QZSS as the GNSS. The QZSS consists of a ground system corresponding to the control segment and a satellite system corresponding to the space segment. The satellite system is a constellation of the first Quasi-Zenith Satellite (QZS1) launched in September 2010, and a further two Quasi-Zenith Orbit (QZO) satellite's and a Geostationary Orbit (GEO) satellite both to be newly developed.

Each of the additional two QZSs follows an elliptical orbit that has an eccentricity of 0.075, an argument of perigee of 270°, an orbital inclination angle of 47° or smaller, and an average radius of 42,164 km, and keeps a right ascension of ascending node of +/-135° shifted from that of QZS1. When this orbit is viewed from Japan, it draws an asymmetric figure-of-eight trajectory that comes back to the same position in about one day. A configuration with a

plurality of such satellites always maintains a high elevation angle viewed from Japan. Figure 2 shows the trajectory of QZS projected onto the earth's surface. Figure 3 shows the elevation angles of a constellation of four satellites viewed from Tokyo: QZS1, an additional two QZO satellites and a GEO satellite both to be launched in the future. In Tokyo, at any time in 24 hours, at least one of them gives an elevation angle of greater than 70°. GEO satellite is to be positioned anywhere from 90° to 180° east longitude. If it is positioned near 135° east, it can always be viewed at a position with an elevation angle close to 48°.

At the monitoring station in the ground system, positioning signals from the quasi-zenith satellites and GPS satellites are monitored at all times and the observation data from those satellites are transmitted to the master control station. At the master control station,

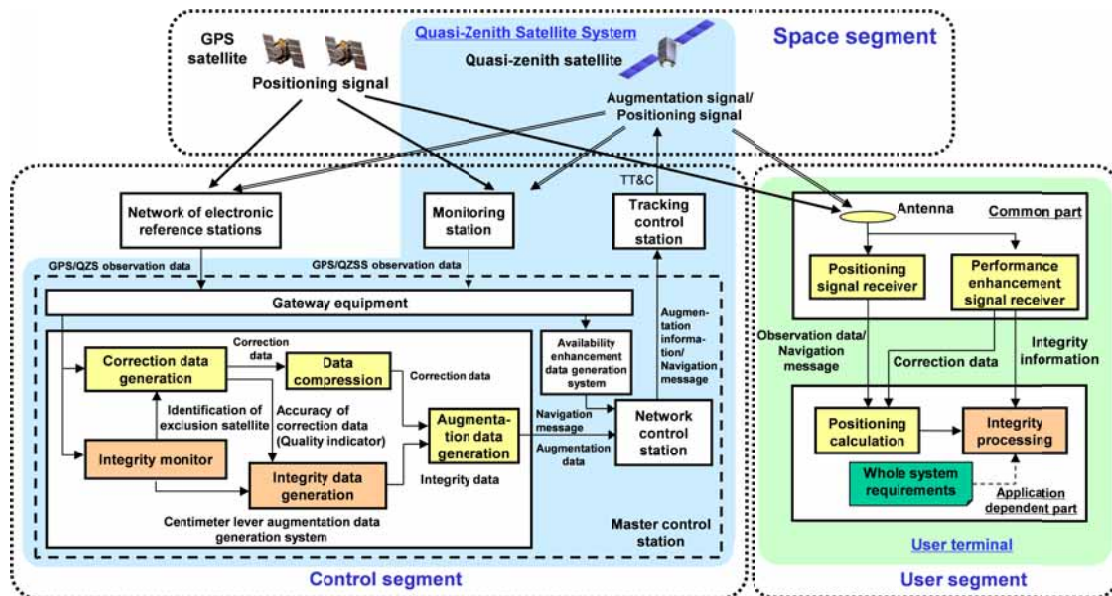

Fig. 1 Configuration of positioning system using QZS

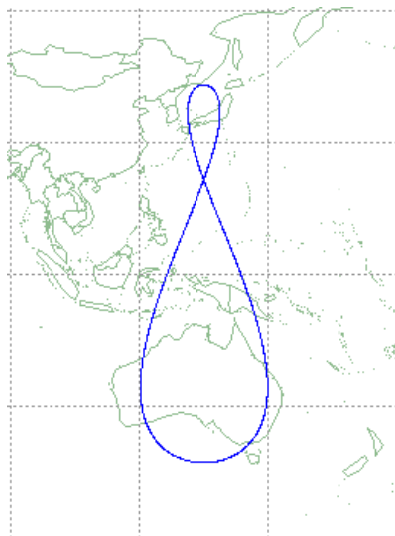

Fig. 2 Trajectory of quasi-zenith satellite projected onto the earth's surface (from IS-QZSS⁽¹⁾)

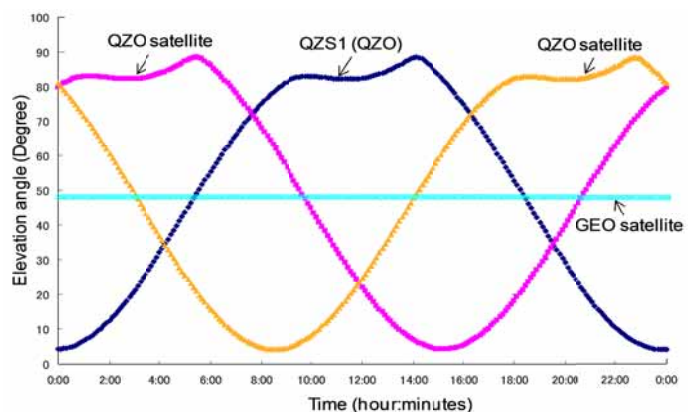

Fig. 3 Elevation angles of quasi-zenith satellites viewed from Tokyo

the availability enhancement data generation system determines the orbit of each satellite, performs time management, and generates navigation messages.

Meanwhile, with respect to Centimeter Level Augmentation Service (CLAS), the Centimeter Level Augmentation Data covering the territorial land and sea of Japan is generated by using about 300 Electronic Reference Stations (ERSs) among the 1,200 or so ERSs throughout Japan. In the Centimeter Level Augmentation Data Generation System, the positioning signals transmitted by QZS, GPS satellite, and so on, and acquired at the Monitoring Stations and the network of ERSs are received. The received observation data are processed to generate correction data, which are then compressed to 2kbps. The observation data also input to the Integrity Monitor to monitor any anomaly and to generate integrity data as a quality indicator of correction data, and the Centimeter Level Augmentation Data (correction data, integrity data, and other information) are generated for broadcasting.

Centimeter Level Augmentation Data along with the navigation message are uplinked from the master control station to the QZS satellite via the tracking control station. The Centimeter Level Augmentation Data are broadcast from QZS to all over Japan using an L6b signal. The navigation message is superimposed on the various availability enhancement signals and broadcast from QZS. A user terminal receives the augmentation data from QZS along with the positioning signals from the QZS, GPS satellite, and so on, and performs positioning calculations to determine its own position. At the same time, the reliability of the obtained position data can be checked in real time by using the integrity information in the augmentation data.

The QZSS operation is scheduled to commence in April 2018.

3.2 Availability enhancement and performance enhancement signals

The QZSS provides a GPS availability enhancement service, which is intended to expand the area and time in urban and mountainous areas where the positioning is available, by utilizing the QZS in combination with the U.S. GPS satellites to improve PDOP.

To ensure compatibility and interoperability with the modernized GPS, the positioning signals broadcast from QZS to enhance the GPS availability are designed based on the modernized GPS signals. The L1C/A, L1C, L2C and L5 signals are used as the positioning signals, and the deviation of the signal specifications from those of the modernized GPS signals has been minimized.

As the performance enhancement service, submeter level augmentation data are assigned to the L1Sa signal, and Centimeter Level Augmentation Data are assigned to the L6b signal, which corresponds to the LEX signal, the MICHIBIKI's original experimental signal. The L6b signal has a transmission capacity of 2 kbps (the net transmission capacity of the augmentation data is 1,695 bps), and is transmitted at a rate of 1 message per second. Each message consists of a header that contains PRN number, Message Type ID, Alert Flag, etc.; data part that contains the augmentation data; and 256-bit Reed-Solomon code.

Table 1 shows the availability/performance enhancement signal specifications of QZS.

3.3 Performance enhancement function

3.3.1 Centimeter Level Augmentation Data

Table 1 Availability/Performance enhancement signal specifications of QZS

Carrier wave	Signal name	Channel	PRN code and modulation method		Signal description
L1 1575.42 MHz	L1-C/A signal	—	Same code sequence as L1-C/A signal, BPSK(1)		Positioning signal same as L1-C/A of GPS satellite, 50 bps/50 sps
	L1C signal	L1CD	Same code sequence as L1C signal, BOC/MBOC		Positioning signal same as L1C of GPS satellite, 50 bps/100 sps
		L1CP			Data-less
	L1S signal	L1Sa	Same code sequence as L1-C/A signal, BPSK(1)		Submeter level augmentation data, 250 bps/500 sps
L1Sb		TBD		Providing a platform for the demonstration of positioning technology (GEO satellite)	
L2 1227.60 MHz	L2C signal	—	Same code sequence as L2C signal, BPSK(1)	L2C(CM) code	Positioning signal same as L2C of GPS satellite, 25 bps/50 sps
				L2C(CL) code	Data-less
L5 1176.45 MHz	L5 signal	I channel	Same code sequence as L5 signal, BPSK(10)		Positioning signal same as L5 of GPS satellite, 50 bps/100 sps
		Q channel	Kasami sequence, BPSK(10)		Data-less
	L5Sa and L5Sb signals	I channel	TBD		Providing a platform for the demonstration of positioning technology (QZO satellite)
		Q channel	TBD		Providing a platform for the demonstration of positioning technology (GEO satellite)
L6 1278.75 GHz	L6b signal	Q channel	Kasami sequence, BPSK(5)		Centimeter level augmentation data, 2,000 bps/250 sps

PRN: Pseudo Random Noise, BPSK: Binary Phase Shift Keying, BOC: Binary Offset Carrier, MBOC: Multiplexed BOC, SBAS: Satellite-Based Augmentation System, GEO: GEostationary Orbit, QZO: Quasi-Zenith Orbit

MICHIBIKI has adopted the State Space Reproduction (SSR) method⁽²⁾ for the CLAS to broadcast Centimeter Level Augmentation Data to all over Japan using LEX signal, which corresponds to the L6b signal in the QZSS. The Centimeter Level Augmentation Data Generation System receives and processes the GPS observation data acquired by the network of the ERPs, to estimate various errors using the wide-area dynamic error model called State Space Modeling (SSM) and generate correction data as an SSR data for a satellite clock error, a satellite orbit error, an ionospheric delay, a tropospheric delay, and a signal bias. By considering the physical characteristics of each error, the SSR is compressed to 2 kbps to be accommodated in the LEX signal, which is then broadcast to the whole of Japan as Centimeter Level Augmentation Data (coded SSR message). Users decode this Centimeter Level Augmentation Data for use in the positioning calculation.

This system has been confirmed in the demonstration experiment for the application using stationary and mobile positioning user terminal to satisfy the target performances of the measurement accuracy of 3 cm (rms) in a horizontal direction and 6 cm (rms) in a height direction, and 60 seconds in TIFF (Time to First Fix) including the augmentation data receiving time under good satellite visibility conditions⁽³⁾.

3.3.2 Network configuration

The Centimeter Level Augmentation Data is divided into two categories: correction data for clock and orbit errors and signal bias of the satellite, and the correction data for the position-dependent ionospheric and tropospheric delays. The position-dependent correction data are provided for the grid points arranged over the entire service area at an interval of about 60 km. Figure 4 shows an example of the network configuration with 12 network zones covering the entire

anticipated service area, i.e., the main islands of Japan and the surrounding ocean area.

4. Verification of Availability & Performance Synergistic Effect

4.1 Evaluation system (user segment)

We have conducted experiments to verify the positioning accuracy and positioning availability. The measurements were performed in Marunouchi, a busy area in Tokyo with high-rise buildings, using a high-accuracy GPS Mobile Mapping System (MMS) equipped with a LEX signal receiver that can receive the Centimeter Level Augmentation Data from the QZS satellite. The configuration of the MMS evaluation system is illustrated in Fig. 5. The MMS is mounted on an instrumented vehicle consisting of: an antenna on

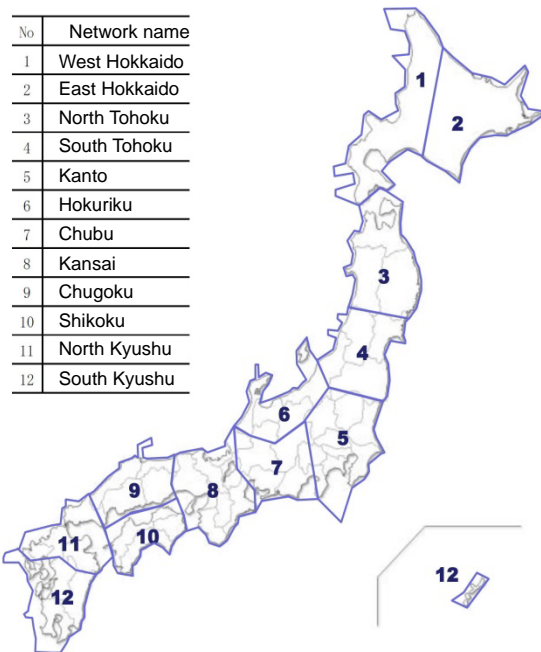

Fig. 4 Network configuration example for centimeter-class augmentation data

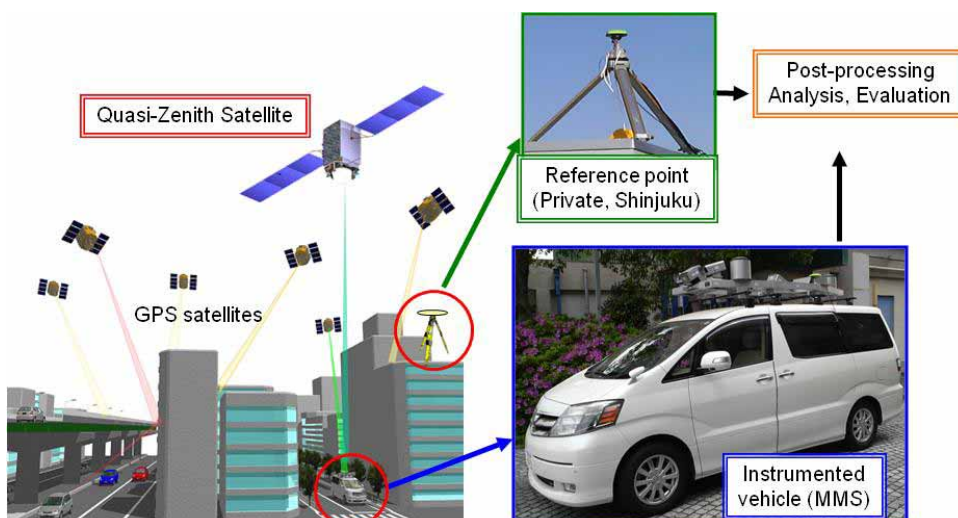

Fig. 5 Evaluation system

the roof to receive signals from QZS and GPS satellites, an Internal Navigation System (INS) that improves the positioning accuracy and continues performing positioning calculations while those signals are not available, a video camera and laser scanner to acquire image information, and an in-vehicle control system that processes and records the acquired data. In the experiments, while the MMS vehicle is running in the Marunouchi area, positioning signals and Centimeter Level Augmentation Data from QZS1 and GPS satellites are received and recorded. The INS data are also recorded. By using the positioning signals and Centimeter Level Augmentation Data received from the QZS, GPS satellite, and so on, and the INS data, the post-processing was performed for: (1) positioning calculation using only GPS satellites, (2) positioning calculation using QZS + GPS satellites, and (3) hybrid calculation of INS and the result of QZS + GPS positioning calculation. To determine the true value, a private reference point was fixed in Shinjuku about 5 km away from the measurement area of Marunouchi, and the true value was obtained by the post-processing of the hybrid calculation using the INS and the Flächen Korrektur Parameter (FKP) method, which is an officially accepted topographic survey method for mobile objects. The measurements were performed on June 21, 2012 at a positioning frequency of 5 Hz.

4.2 Improvement of positioning availability by quasi-zenith satellite

The results of the positioning calculation while

driving in Marunouchi are summarized in Fig. 6 and Table 2. In Fig. 6, the calculated results are plotted on the maps for the positioning with GPS satellites only, positioning with QZS + GPS satellites, and hybrid calculation of the INS and QZS + GPS result. In these maps, black lines indicate the true value. Table 2 shows the positioning availability (FIX rate) of each positioning. Compared to the positioning result with GPS satellites only, the addition of one QZS improved the positioning availability by about 1.7 times from 28.6% to 47.3%. Furthermore, the hybrid calculation with INS achieved 100% availability (3.5 times that of GPS satellites only). Figure 7 shows the skyplots of QZS and GPS satellites at various positioning points. When QZS and GPS satellites are used in combination, positioning is available with a total of five or more satellites, whereas in the case of GPS satellites only, five or more GPS satellites are needed to obtain a positioning solution, resulting in lower availability data.

4.3 Synergistic effect of availability enhancement and performance enhancement

Table 2 shows the accuracy of positioning with GPS satellites only and QZS + GPS satellites. It is clear that the addition of QZS improves the positioning accuracy. Figure 8 shows the time course of the accuracy of the INS hybrid positioning (with and without QZS availability enhancement) in comparison with the true value, which was calculated by using the hybrid positioning of the FKP method and INS. In addition to the GPS signals, by using both the availability and



Fig. 6 Positioning results

Table 2 Effects of QZS

No	Processing type	Availability		Accuracy rms (cm)		
		FIX rate	Improvement factor	Horizontal	Height	3D
1	Positioning with GPS only	28.6%	–	133	104	169
2	Positioning with QZS + GPS	47.3%	1.7 times	35	27	45
3	Hybrid positioning with QZS + GPS + INS	100%	3.5 times	–	–	–

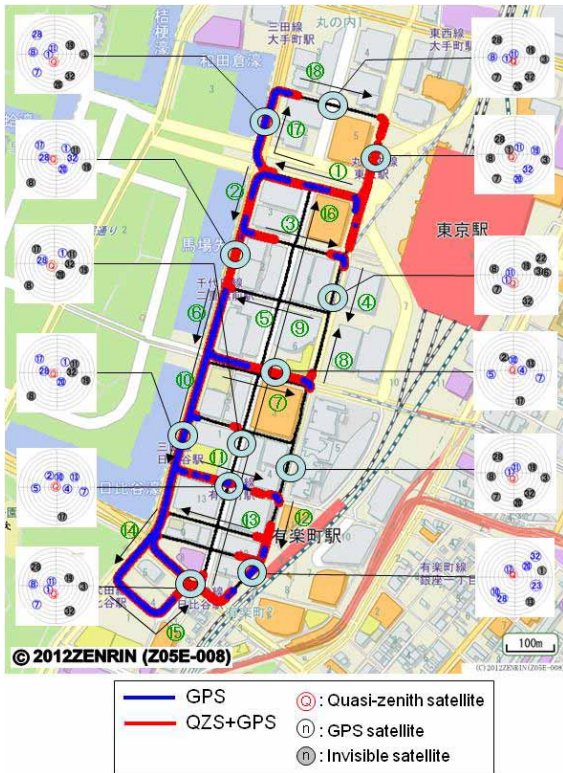

Fig. 7 Arrangement of satellites used for positioning at various locations en route

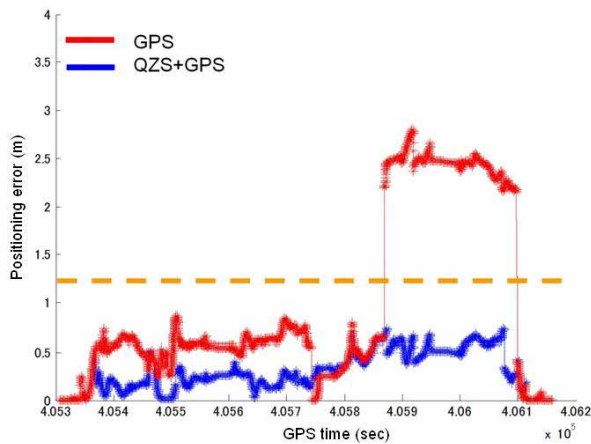

Fig. 8 Accuracy improvement by reduced multipath effects

performance enhancement signals of the QZS satellite, the positioning accuracy is certainly improved. This is attributed to an increased FIX rate, which in turn increases the observation update frequency of the navigation filter in the hybrid positioning mode. In addition, up to 2.5 m level positioning errors due to multipath effects in the GPS signals are also reduced. This is a synergistic effect of the availability and performance enhancement by the QZS, that is, signals from QZS are less affected by multipath effects because of its high elevation angle, and thus the multipath effects of GPS signals are mitigated in the positioning calculation.

We have confirmed an expanded area where the positioning accuracy is 1.75 m (half of the lane width) or less, which has been achieved by the synergistic effect of the availability and performance enhancement. These results indicate that, in an automatic driving system, the loads on the on-vehicle sensors such as cameras and laser equipment can be reduced, and thus the QZS is expected to be effective for automatic driving systems and other applications.

5. Conclusion

We have evaluated the availability enhancement and performance enhancement functions of the QZS. The availability is significantly improved by the combination of QZS and GPS satellites. We have confirmed that the performance is equivalent to that of conventional topographic surveys. The experimental results also indicate the possibility of automatic vehicle driving by utilizing the synergistic effect of the availability and performance enhancement.

A wide variety of services are expected in the future, including topographic surveys, information-oriented construction, IT-based agriculture, and high-accuracy lane navigation.

References

- (1) Japan Aerospace Exploration Agency: User Interface Specification for Quasi-Zenith Satellite System (IS-QZSS) Ver. 1.5 (2013)
- (2) Wuebbena, G., et al.: PPP-RTK: precise point positioning using state-space representation in RTK networks, the 18th International Technical Meeting, ION GNSS_05 (2005)
- (3) Saito, M., et al.: Centimeter-class Augmentation System Utilizing Quasi-Zenith Satellite System Performance Verification, ION GNSS Conference (2011)

Digital Channelizer for High Throughput Satellite Communications

Authors: Futaba Ejima*, Minoru Akita* and Akinori Fujimura*

1. Introduction

We have developed a new channelizer aboard a multi-beam satellite for a next-generation high-speed satellite communication system. The channelizer achieves flexible routing and a high spectral efficiency by changing the frequency and beam allocation in a flexible manner by means of digital signal processing, and thus is an indispensable key component for flexible communication satellites of the future.

We have adopted half-band filter (HBF) method for the demultiplexer and multiplexer of the channelizer to reduce circuit space and power consumption. We have newly developed a channel separate-type routing switch and a circuit control method for reducing vacant channel power and improving the reliability.

We fabricated an engineering model (EM) with eight ports (two for redundancy), where each port has a bandwidth of 40 MHz and the sub-channel has a bandwidth of 2.5 MHz.

This paper outlines the digital channelizer, and describes the functions and performance of its constituent elements: demultiplexer, multiplexer and routing switch, as well as the development results of the EM.

2. Digital Channelizer

2.1 Outline of channelizer

(1) Functions and performance of channelizer

The channelizer is a digital route switching device aboard a communication satellite, consisting of a demultiplexer, a routing switch and a multiplexer as shown in Fig. 1. Uplink signals provided from each port are A/D converted and decomposed into sub-channels by the demultiplexer. The decomposed sub-channel signals

are then route-switched at the routing switch and mapped to arbitrary beams and frequencies. At the multiplexer, the signals rearranged by the routing switch are multiplexed, D/A converted and sent to the output ports. The overall telemetry and command control of the channelizer is performed through a 1553B interface.

The channelizer is also equipped with power monitoring, gain control, and unnecessary wave notching functions for each sub-channel.

Figure 2 shows the external appearance of the EM of the channelizer, which was fabricated in March 2013 and Table 1 shows the key performance characteristics of the channelizer.

For the effective use of frequency spectrum, the bandwidth of each guard band that overlaps between two sub-channels was set to 0.25 MHz. In addition, the adjacent sub-channel selectivity was designed to exceed 50 dB so that weak signals from a small mobile terminal are not affected by high-power signals from a large ground station.

(2) Developed technologies

i) Fabrication using a Field Programmable Gate Array (FPGA) for space use

For the demultiplexer and multiplexer of this channelizer, the HBF was chosen to reduce the circuit size and power consumption, and the digital signal processing unit was fabricated using several units of RTAX4000, FPGA for space use.

ii) High-speed inter-board transmission

Serial transmission at 2 Gbps has been achieved by the combination of a high-speed serializer and deserializer for the inter-board signal interface, a backplane using circuit boards and connectors approved for space

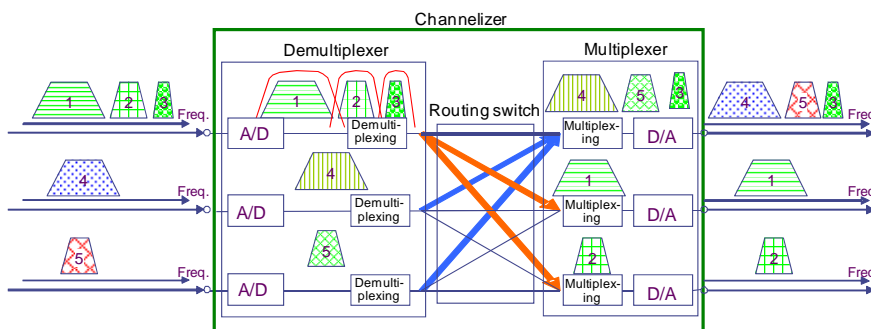

Fig. 1 Functional block diagram of channelizer



Fig. 2 External appearance of channelizer EM

use, and a backplane wiring method considering the impedance matching.

iii) High-heat dissipation technology

Since the channelizer is a power-hungry component (over 200 W), its design includes various high-efficiency heat dissipation technologies to avoid the maximum allowable temperature of the parts being exceeded. These technologies are: high-accuracy thermal analysis, high-heat conductivity sheet, high-heat dissipation frame, and high-heat dissipation circuit board.

Table 1 Key performance characteristics of the channelizer

Parameters	Performance
Size	45cm × 30cm × 25cm
Power consumption	300 W
Mass	40 kg
Input port	8 ports × 40 MHz (Operation: 6 ports)
Output port	8 ports × 40 MHz (Operation: 6 ports)
Sub-channel bandwidth	2.5 MHz
Guard band	0.25 MHz
Adjacent channel suppression	Higher than 50 dB
Redundancy	Input/output ports: 8 (2 for Redundancy) Switch and control units: 2 (1 for redundancy)

2.2 Demultiplexer and multiplexer

The demultiplexer and multiplexer consist of frequency converters (FCs) and half band filter (HBF) ^{(1) (2) (3)}. Figure 3 shows a functional block diagram of the proposed demultiplexer, which is configured in a tree structure. The signal input into each branch of the tree is divided into two halves in the frequency domain, and at the final stage, adjacent interfering channel components are removed by the sub-channel filter (SCF). In this manner, the input signal is divided into multiple sub-channels. The multiplexer also consists of FCs and HBFs configured in a tree structure and multiplexes multiple sub-channel signals into one

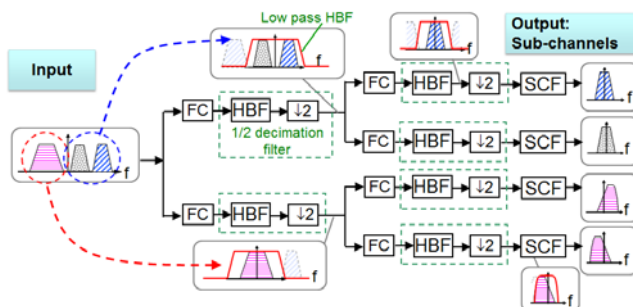

Fig. 3 Functional block diagram of demultiplexer

signal.

In the actual design, based on the fact that the operation speed in each branch and the number of branches are inversely proportional, time-division processing is applied to the arithmetic processor, enabling the circuit size to be reduced to about one tenth of that without such processing⁽⁴⁾.

The HBF for this tree configuration has been designed to have filter characteristics with a roll-off rate of 20%, enabling the whole channelizer circuit to be designed to operate at a clock speed of 50 MHz, only 1.25 times the input bandwidth (40 MHz), thus minimizing power consumption.

Figure 4 shows the number of multipliers and the memory capacity as functions of the number of sub-channels. For a system with 256 or fewer sub-channels, the proposed scheme has the advantage that fewer multipliers are required and thus the circuit size is smaller than those of the competitors' polyphase discrete fourier transform (PDFT) scheme^{(5) (6)}.

Based on these results, the EM of the channelizer has adopted the proposed tree structure using HBFs.

Figure 5 illustrates the frequency characteristics of the SCF, showing good agreement between the measured and the design characteristics. It has been confirmed that the EM exhibits an adjacent sub-channel band suppression of 50 dB or more.

2.3 Routing switch

After the digital input signal is demultiplexed into sub-channels, the routing switch redirects each sub-channel to its specified channel. This time, we have developed a channel-separate-type routing switch along with its control method, which is optimized for switching operation on a satellite.

When a routing switch is installed in a satellite, heat generation and power consumption generally increase in proportion to the number of channels. The new switch not only reduces the heat generation and power consumption, but also delivers the high reliability that is essential to prevent the risk of all services being suspended in the event of a failure in the routing switch

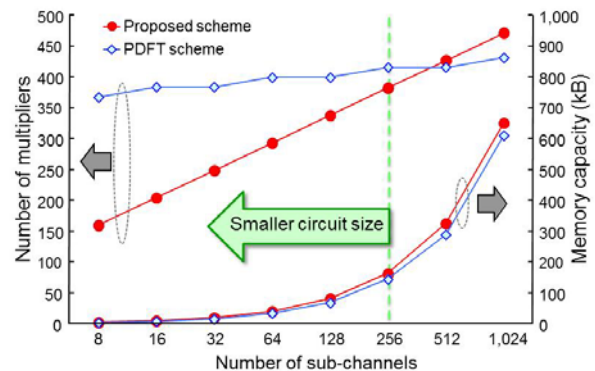

Fig. 4 Number of multipliers and memory capacity vs. the number of sub-channels

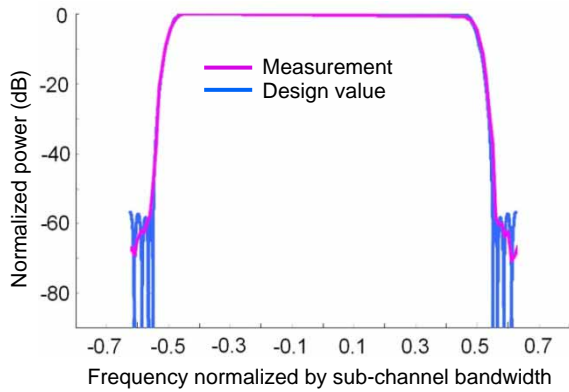

Fig. 5 Frequency characteristics of sub-channel filter

where lines are concentrated.

Figure 6 shows the configuration of the channel-separate-type routing switch, where the switching in each port is separated from other channels, and the operation of inter-port channel switching is segmented into blocks so that the power control can be performed block by block. In addition, Channel Permutation (CP), i.e., re-arrangement of signals within each channel, is performed at the pre- and post-stages of the channel separate-type routing switch.

At the pre-stage channel permutation (Pre-CP), channels in each input port are permuted so that each channel goes to a specific power control unit block. As a result of this permutation, the switching table is updated so that the output port and output channel are matched to each correct output position, and the channel permutations for the output ports are properly performed (Post-CP). In addition, the Pre-CPs and switching operation can be set up for multicast and broadcast operation.

With this configuration, there is no restriction on the channel arrangement in each port, and thus power

consumption can be efficiently managed by collecting vacant channels into certain blocks and cutting the power supply to those blocks.

The reliability has also been improved so that even if a part of the routing switch fails, operation can be continued by assigning the defective channel to a block to which the power supply is being cut. In addition, when the satellite goes into light load mode, minimum communication lines can be kept in operation at a reduced power level by collecting the minimum required channels into a certain block and cutting the power to other blocks.

Yet another control mode further improves the reliability. When some block has continued switching operation for a certain time, the operation can be transferred to another block, and thus the electrical and thermal stresses imposed for a long time on the semiconductor devices in each block are dispersed without stopping the service. With this control mode, the service life of the devices can be extended and the reliability can be further improved.

3. Development Results of the EM of the Channelizer

The EM of the channelizer was fabricated and tested for vibration strength, impact resistance, thermal vacuum performance, and electro-magnetic compatibility (EMC). The tests were conducted under the environmental conditions required for a standard DS2000 satellite, and satisfactory results were obtained.

As a typical communication characteristic, Fig. 7 shows a constellation of the output signal from the channelizer EM when transmitting a carrier wave modulated by the quadrature phase shift keying (QPSK).

Since this QPSK signal has an occupied bandwidth of 8 MHz, the channelizer demultiplexed the signal into four sub-channels, and after switching, multiplexed it

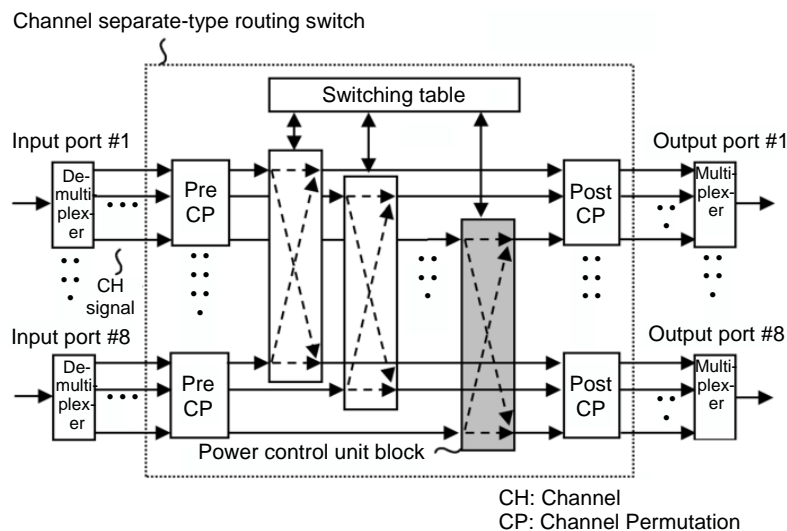

Fig. 6 Configuration of channel-separate-type routing switch

into one channel again. As shown in Fig. 7, the QPSK signal is restored satisfactorily. The restoration results of other QPSK signals with different bandwidths were also satisfactory, with error vector magnitudes (EVM: the difference from the ideal signal points) of 1 to 4%.

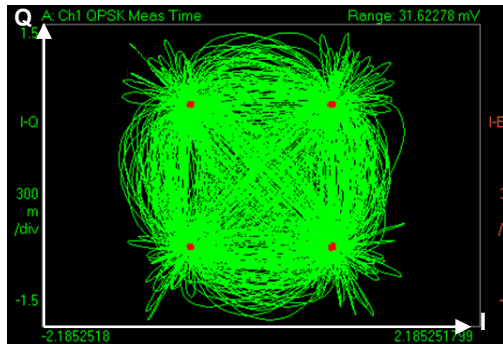

Fig. 7 Constellation of channelizer output signal

4. Conclusion

The digital channelizer is a key component for next-generation high-speed satellites. We have completed the development of the EM of the channelizer aboard a satellite. By installing a channelizer in a satellite, the frequencies and beams can be assigned in a flexible manner, which not only improves the efficiency of normal satellite communication services, but also makes it possible to deal with a drastic change in the communication demand in case of failure. It is also expected to improve the flexibility of satellite communications in response to various needs of society.

References

- (1) Fujimura, A., et al.: A Study of Digital Demultiplexer/Multiplexer for Flexible Regenerative Payloads, Proceedings of the 2011 IEICE General Conference, B-3-3 (2011) (in Japanese)
- (2) Fujimura, A., et al.: A Study of Digital Demultiplexer/Multiplexer for Flexible Regenerative Transponders, Proceedings of the 2011 IEICE Society Conference, B-3-10 (2011) (in Japanese)
- (3) Fujimura, A., et al.: A Study of Digital Demultiplexer/Multiplexer for Digital Satellite Transponders, Proceedings of the 2012 IEICE Society Conference, B-3-4 (2012) (in Japanese)
- (4) Fujimura, A., et al.: A Novel DEMUX/MUX Method for Flexible Digital Channelizers using Half Band Filters, 31st AIAA ICSSC (2013)
- (5) Yamashita, F., et al.: Fundamental Characteristics of Onboard Bandwidth-Variable FFT Filter Bank, IEICE Transactions B, J85B, No. 12, 2290-2299 (2002) (in Japanese)
- (6) Di Cecca, F., et al.: Payload Aspects of Mobile Satellite Systems with On-Ground Beamforming and Interference Cancellation, ICWITS, 2012 IEEE International Conference (2012)

Application and Evaluation of Observation Data by Advanced Microwave Scanning Radiometer 2 – Achievement of World’s Top-Class Microwave Radiometer AMSR Series –

Authors: *Tatsuhiro Noguchi** and *Takaaki Ishikawa**

1. Introduction

Mitsubishi Electric has been developing microwave radiometers since it first developed the Microwave Scanning Radiometer (MSR) aboard the Marine Observation Satellite (MOS-1) launched in 1987, which was followed by successors with extended missions: the Advanced Microwave Scanning Radiometer (AMSR) aboard the Advanced Earth Observation Satellite 2 (ADEOS-II) and the Advanced Microwave Scanning Radiometer for EOS (AMSR-E) aboard NASA's Aqua satellite. Currently, the Advanced Microwave Scanning Radiometer 2 (AMSR2) is operating in orbit aboard Global Changing Observation Mission 1st - Water (GCOM-W1) launched in May 2012 (Fig. 1). Observation data from AMSR2 are provided to and used in many countries around the world.



Fig. 1 Global Changing Observation Mission 1st - Water (GCOM-W1) (Source: JAXA)

This paper describes the significance and role of the AMSR series developed by Mitsubishi Electric, how their observation data have been used, their future prospects, and other topics.

2. Data Utilization, Achievement and Evaluation of AMSR2

A microwave scanning radiometer is a passive radio wave sensor that observes phenomena related to the global circulation of water such as water vapor content, precipitation, and sea surface temperature. AMSRs are utilized around the world for monitoring and modeling this circulation. Table 1 shows the observation frequencies and observation targets of AMSR2.

AMSR2 was launched aboard GCOM-W1 on May 18, 2012⁽¹⁾ and initial operations were smoothly conducted, acquiring the first observation image on July 4, 2012⁽²⁾ and moving into regular operations on August 10, 2012⁽³⁾. After AMSR2 completed the initial calibration operation for about eight months, it started providing brightness temperature products on January 25, 2013⁽⁴⁾, followed by precipitation, sea surface temperature and other physical products starting on May 17, 2013. On June 13, 2013, the Earth Observation Research Center (EORC) started providing the real-time service of monitoring tropical cyclones⁽⁵⁾ and other applications (Fig. 2). The Japan Meteorological Agency (JMA) as a user also started to use the products of

Table 1 Observation frequencies and targets of AMSR2

Frequency Observation target	7 GHz band	10 GHz band	18 GHz band	23 GHz band	36 GHz band	89 GHz band
Integrated water vapor			○	●	○	
Integrated cloud liquid water			○	○	●	
Precipitation		○	●	○	○	●
Sea surface wind speed	○	○		○	●	
Sea surface temperature	●	○		○	○	
Sea ice concentration	○		○	○	●	●
Snow depth		○	○	○	●	○
Soil moisture	●	●	○	○	○	○

●: Most important frequency

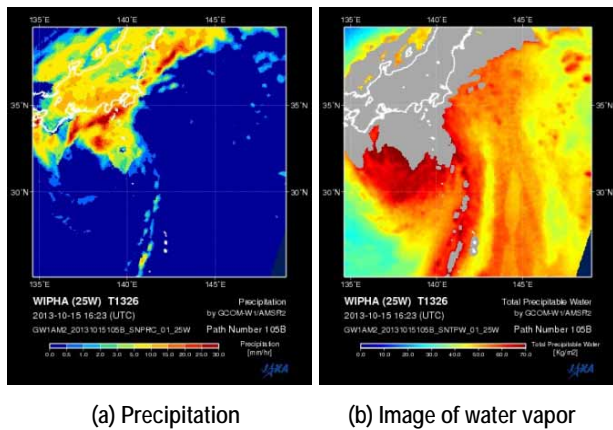

Fig. 2 Real-time monitoring of Typhoon No. 26 by AMSR2 data (Source: JAXA)

AMSR2, namely: the sea surface temperature product for their sea surface temperature analysis system from May 27, 2013 (Fig. 3), and various AMSR2 products for their numerical weather prediction system from September 12, 2013 (Fig. 4)⁽⁶⁾, thus improving the accuracy of predictions and forecasts. As an example, when a typhoon forms near Japan and grows larger, the accuracy of the projected typhoon path and size has been improved. Meanwhile, AMSRs are also serving as global environmental monitors. Figure 5 shows the distribution of sea ice in the Arctic area identified by AMSR-E and AMSR2 (on September 24, 2007 and

August 24, 2012). The analysis of these sea ice observation data revealed that the area of Arctic sea-ice in 2012 was the smallest on record⁽⁷⁾.

In the Japan Fisheries Information Service Center, General Incorporated Association (JAFIC), the use of the sea-surface temperature data of AMSR-E has delivered good results in predicting fishing grounds and reducing the fuel consumption of fishing boats. As a result, the observation data of AMSR2 have also been continuously incorporated into the infrastructure of the fishery management system. For the development of this infrastructure, JAFIC won the Prime Minister's Award of the 2013 Space Development and Utilization Award sponsored by the Cabinet Office⁽⁸⁾, which is expected to encourage wider applications for fishery resource management, fuel reduction, and fishery modernization in many other countries.

In addition, the GCOM-W1 which is equipped with AMSR2 won the "2013 Nikkei Global Environmental Technology Award," which is awarded for excellent achievements toward global environmental conservation. The prize was given to JAXA⁽⁹⁾ for the uniqueness of the technology and contribution to social life.

3. Re-activation of AMSR-E and Reciprocity Calibration

The AMSR series is a sensor that rotates at 40 rpm (one revolution every 1.5 seconds) and acquires

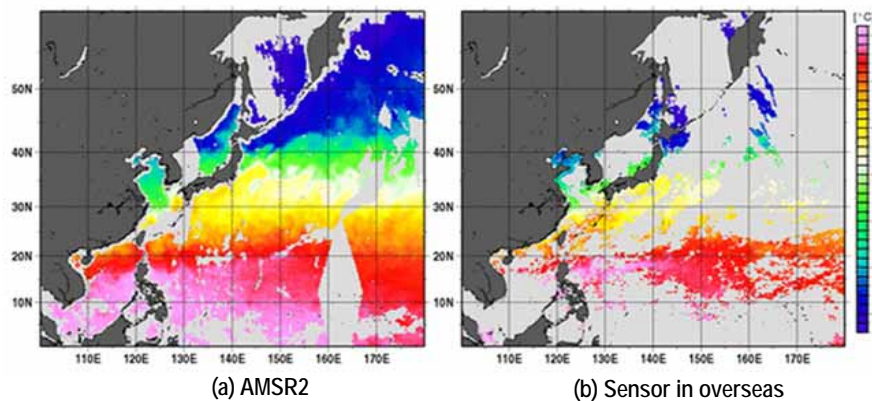

Fig. 3 Comparison of distribution of sea surface temperatures (Source: JAXA/JMA)

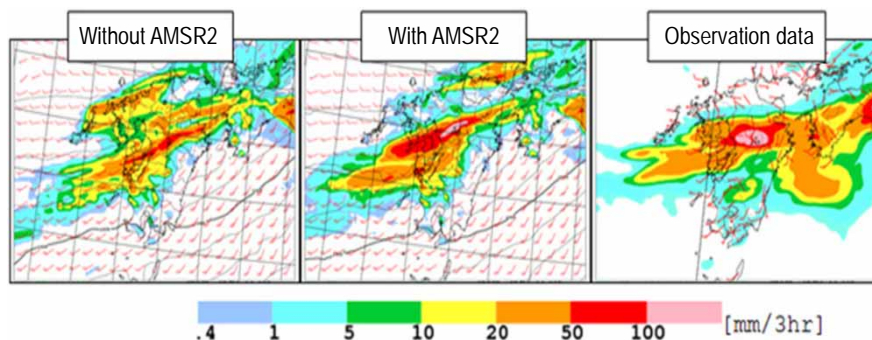

Fig. 4 Projection of precipitation distribution (Difference between with and without AMSR2 data) (Source: JAXA/JMA)

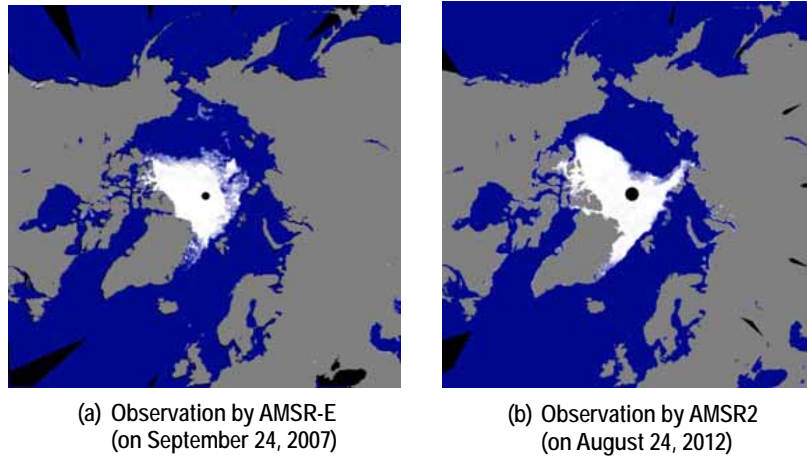

Fig. 5 Distribution of sea ice in the Arctic (Source: JAXA)

land/sea surface data covering a wide area of over 1,600 km. Since AMSR-E was launched in May 2002, it has been transmitting valuable observation data for about nine and a half years until it stopped its rotation and observation in October 2011⁽¹⁰⁾. The data from AMSR-E had been used by many users around the world including the U.S., China and Japan. While the observation and data transmission service was taken over by AMSR2 which was launched in May 2012, a project to re-activate the operation of AMSR-E was conducted mainly for cross calibration of the AMSR2's observation data, and also in response to a strong request from NASA which has been running the AMSR-E mission. The Aqua satellite carried not only AMSR-E but also many other sensors, and their observations were ongoing. Therefore, a meticulous plan was drawn up to prevent any fluctuation in the rotation of AMSR-E from adversely affecting the attitude of the satellite, and in February 2012, observation without rotation was successfully resumed. In September 2012, an attempt was made to achieve a rotation speed of 4 rpm (normal rotation: 40 rpm), but the target speed was not reached. Based on this result, the final re-activation plan was formulated for resuming the observation at a low rotation speed of 2 rpm. In December 2012, the command operations were conducted and AMSR-E successfully resumed observation at 2 rpm. For over one and half years since then until now in July 2014, observations have been continuing without any significant change. This achievement was highly appreciated by NASA, and the recovery of AMSR-E received an award from the NASA Headquarters in September 2013 (Fig. 6). The award was addressed to individuals: two from Mitsubishi Electric, and one each from JAXA and Mitsubishi Space Software. As a meteorological observation sensor, the AMSR system is now incorporated into the U.S. infrastructure, being positioned at the same level as LANDSAT, and resulting in rising expectations for the AMSR series.



Fig. 6 Award from NASA for the recovery of AMSR-E

4. Utilization of Observation Data in Overseas

The AMSR-E system aboard the NASA's Aqua satellite, which was launched in May 2002, continued to operate for about nine and a half years, much longer than the mission life of three years (design life: five years), and its data has been used by many countries around the world as shown in Table 2 (listed in order of the amount of data used in July 2013). In order for AMSR2 to fulfill the mission of its predecessor AMSR-E, GCOM-W1 has joined the constellation of earth observatory satellites named A-Train⁽¹¹⁾, which is led by NASA (USA) and consists of the U.S. Aqua, Aura and CloudSat satellites and the joint U.S.-French CALIPSO satellite. Multiple satellites in A-Train fly over the same point within an interval of several minutes, enabling the same object to be observed using different sensors for microwave, infrared and optical images, and studies are in progress on, for example, the integral use of the U.S.'s different sensors (Moderate Resolution Imaging Spectroradiometer (MODIS), Atmospheric Infrared Sounder (AIRS), etc.).

Efforts to improve the observation accuracy are also in progress by increasing the observation frequency for the same location by means of the cross calibration between AMSR2, TMI⁽¹²⁾, SSMIS⁽¹³⁾ and other sensors of the same type.

Table 2 Utilization of AMSR-E data (Top 10)

Ranking	Country	Data size (GB)	File counts	User
1	USA	36,872	1,760,329	555
2	China	25,506	1,074,053	786
3	Canada	10,232	1,741,630	58
4	Germany	5,448	255,951	47
5	Japan	2,231	79,871	48
6	Argentina	1,105	26,668	14
7	France	1,066	23,208	24
8	Norway	821	19,294	14
9	Korea	721	18,680	22
10	Denmark	715	16,793	7

Remarks: Status of utilization in 2013 (Compilation by the National Space Science and Technology Center (NSSTC)): Utilized in more than 50 countries, Total number of utilizing institutions: 2,519.

The observation data of AMSR2 are also utilized by the National Oceanic and Atmospheric Administration (NOAA) to predict the path and size of hurricanes⁽¹⁴⁾ with good results. It is now expected that the data will be used for estimating areas to be evacuated and economic damages due to a meteorological disaster. The U.S.'s Joint Typhoon Warning Center (JTWC)⁽¹⁵⁾ also uses the observation data for monitoring and forecasting typhoons and hurricanes. According to the compilation by NOAA and National Snow and Ice Data Center (NSIDC) on the data transmission destinations (Table 2), the number of Chinese institutions (number of users) that used the AMSR-E's soil moisture data recently surpassed that of the USA, which clearly indicates the increasing international value of AMSR2 which has taken over the observation work of AMSR-E.

5. Future Prospects

Figure 7 shows the Japanese and U.S. future plans for microwave scanning radiometers. Because of the situation in the U.S. with the set-back of the development of the microwave imager/sounder (MIS), and because the Defense Weather Satellite System (DWSS) of the U.S. Air Force (USAF) was cancelled, the AMSR series is now the world's standard microwave scanning radiometer.

Based on the achievements and advantages of the AMSR series, Mitsubishi Electric will not only fully utilize the heritage of AMSRs but also develop a high-frequency receiver system, downsize the equipment, increase the density of integration, and create other new technologies. In addition, to win the next AMSR project as well as to expand the sales for the infrastructure market, Mitsubishi Electric is investigating applications of the observation data.

6. Conclusion

Japanese AMSRs aboard satellites have evolved from the stage of nurturing domestic technology to the stage of practical applications that contribute to society within the framework of international cooperation.

We need to continue developing a lineup of AMSR series pursuing higher functionality and performance in response to various users' needs. We will strive to meet those needs and contribute to society, where observations from space will help to create a safer society and improve the quality of life.

References

- (1) JAXA press release: Launch Result of the Global Changing Observation Mission 1st - Water "SHI-

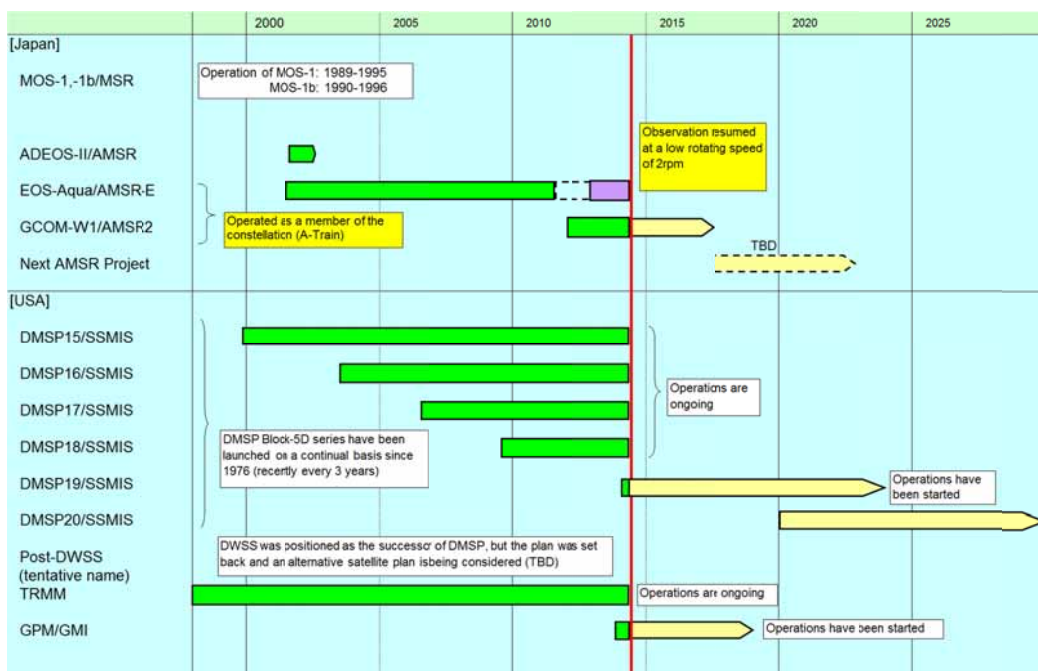

Fig. 7 Japanese and U.S. future plans for microwave scanning radiometers

- ZUKU" (GCOM-W1) and the Korean Multi-purpose Satellite 3 (KOMPSAT-3) by H-IIA Launch Vehicle No. 21
http://www.jaxa.jp/press/2012/05/20120518_h2af21_e.html
- (2) JAXA press release: SHIZUKU Observation Data Acquired by AMSR2
http://www.jaxa.jp/press/2012/07/20120704_shizuku_e.html
- (3) JAXA press release: Global Change Observation Mission 1st – Water "SHIZUKU" (GCOM-W1) Regular Observation Operations
http://www.jaxa.jp/press/2012/08/20120810_shizuku_e.html
- (4) JAXA press release: SHIZUKU (GCOM-W1) to Provide Brightness Temperature Products
http://www.jaxa.jp/press/2013/01/20130125_shizuku_e.html
- (5) JAXA/EORC Tropical Cyclones Real-Time Monitoring
http://sharaku.eorc.jaxa.jp/TYPHOON_RT/index_j.html
- (6) JAXA press release: Application of Data Acquired by SHIZUKU at Japan Meteorological Agency
http://www.jaxa.jp/press/2013/09/20130912_shizuku_e.html
- (7) JAXA press release: Arctic Sea Ice Observation Data Analysis Results–Ice extent has shrunk to smallest in recorded history–
http://www.jaxa.jp/press/2012/08/20120825_arctic_sea_e.html
- (8) Cabinet Office, Space Strategy Planning Office press release: 2013 Space Development and Utilization Award Winners
<http://www8.cao.go.jp/space/prize/kettei.pdf>
- (9) Nikkei Global Environmental Technology Award: 2013 (23rd) Nikkei Global Environmental Technology Award Winners
<http://www.nikkei-events.jp/chikyu-kankyo/>
- (10) JAXA press release: Observation Halted by Advanced Microwave Scanning Radiometer-EOS (AMSR-E)
http://www.jaxa.jp/press/2011/10/20111004_amsr-e_e.html
- (11) NASA Missions: Introducing the A-Train
http://www.nasa.gov/mission_pages/a-train/a-train.html
- (12) NASA Facts: TRMM Microwave Imagers
http://trmm.gsfc.nasa.gov/overview_dir/tmi.html
- (13) NSIDC Instrument Description: Special Sensor Microwave Imager/Sounder (SSMIS)
http://nsidc.org/data/docs/daac/ssmis_instrument
- (14) NOAA: Hurricane HENRIETTE
<http://www.nhc.noaa.gov/archive/2013/ep08/ep082013.discus.019.shtml>
- (15) NASA Missions: NASA Marks the Joint Typhoon Warning Center's 50th Anniversary
http://www.nasa.gov/mission_pages/hurricanes/features/typhoon_prt.htm

History and Achievements of “BMS 100.00%” – Mission Success Activities of MELCO Satellites

Authors: *Toshimasa Sasaki**, *Yasuhiro Yamamori** and *Yasushi Mori**

1. Introduction

Mitsubishi Electric has established the Brand of Mission Success (BMS) promotion center to focus on raising the ability to verify product quality. The BMS Promotion Center, consisting of third-party experts, has been conducting various reviews and defect prevention activities^{(1) (2)}. The results of their activities greatly contributed to the successful launch and placing into orbit of 27 satellites from September 2002 to August 2013.

MELCO has won many projects in the fields of communication satellites and meteorological satellites including: Himawari-7[☆], Super Bird-C2[☆], Michibiki[☆], ST-2[☆], Turksat-4A/4B[○], Himawari-8 and -9[○], and three quasi-zenith satellites[○]. These domestic and overseas satellites are manufactured based on the DS2000 bus, which is the standard platform for geostationary satellites developed independently by MELCO. Through these projects, MELCO has accumulated experience and achievements in a wide range of businesses including rocket procurement, launch site campaign management, and initial orbital operations (☆: Already placed in orbit, ○: Design, manufacturing, or testing stage).

2. BMS 100.00% Activities

2.1 Approach to developing high-quality satellites

Mitsubishi Electric always strives to meet 100% the customer’s required specifications. However, at Mitsubishi Electric Kamakura Works, in order to earn the customer’s absolute trust, we have set our goal two ranks higher than 100%: a quality level of 100.00%. As the main means for improving the ability to verify product quality, we are continuing the “BMS 100.00%” activities to ensure the success of satellite missions.

In these campaigns, third-party members carry out independent checks and verifications, as well as various reviews and defect prevention activities. The BMS Promotion Center oversees all the activities of the departments related to the space business. If any quality-related problem occurs, they begin tracing and investigations for the recommendations. Their activities are reported once a week to the general manager of Kamakura Works. The main activities of BMS 100.00% are shown in Fig. 1^{(1) (2)}.

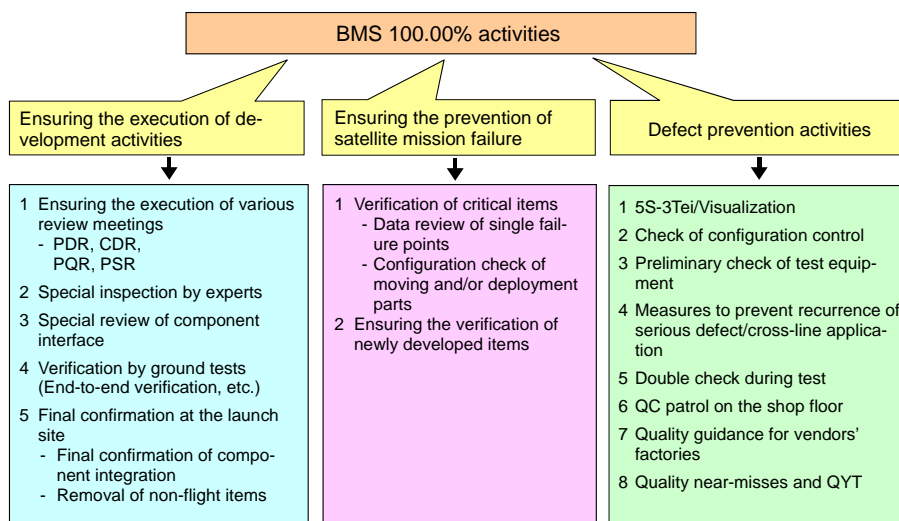

PDR: Preliminary Design Review, CDR: Critical Design Review, PQR: Post Qualification test Review, PSR: Pre Shipment Review, QC: Quality Control, QYT: Quality Yochi Training

Fig. 1 Main activities of BMS 100.00%

2.2 Examples of activities for commercial satellites

This section describes some examples of the activities that help maintain the high quality of commercial satellites based on the DS2000 bus.

2.2.1 Actual product review

A special review meeting is continually conducted on a sampling basis according to the level of complexity of the product and past experience, where the performance of the actual product is reviewed by experts, electrical engineers and mechanical engineers at each layer of the board, component, subsystem and system levels. When the meeting is held, regarding the assembly conditions of cables and thermal control materials and/or the clearance and moving conditions of mechanisms, the designer's intentions and remarks by the experts are discussed by the relevant designers and shop-floor technicians, aiming to utilize the meeting to create the best product without fail, and to recognize and share the tacit knowledge of the experts such as their experience and know-how by converting it to explicit knowledge.

2.2.2 Mission operation readiness review

In addition to the above-described actual product review for the satellite hardware, "readiness review meetings" are conducted to strengthen the verification, where the state of preparation for mission operation is verified with the participation of the third-party experts. While the preparations for mission operation are steered by the Orbit Raising and Operation Control Board (OROCCB), multiple readiness review meetings are conducted as shown in Fig. 2, where the experts review the state of preparation and confirm that the customer's intentions are properly reflected.

2.3 Further enhancement of BMS 100.00% activities

No matter how high the reliability of a satellite system, if any trouble or accident occurs during the launch site campaign or transportation of the satellite or GSE (Ground Support Equipment) to the site, the satellite mission would fail or the project might be set back. In addition, although the world's commercial satellite market has been standardized, a certain number of satellite missions still fail because of critical design or manufacturing failures. Such failures involve quality or reliability related issues that must be addressed from the design stage.

While the "BMS 100.00%" activities have been conducted on a continual basis as shown in Fig. 1, MELCO has implemented two additional approaches as described below.

2.3.1 Efforts for system safety management in the approach to satellite development

In a satellite development project, a system safety

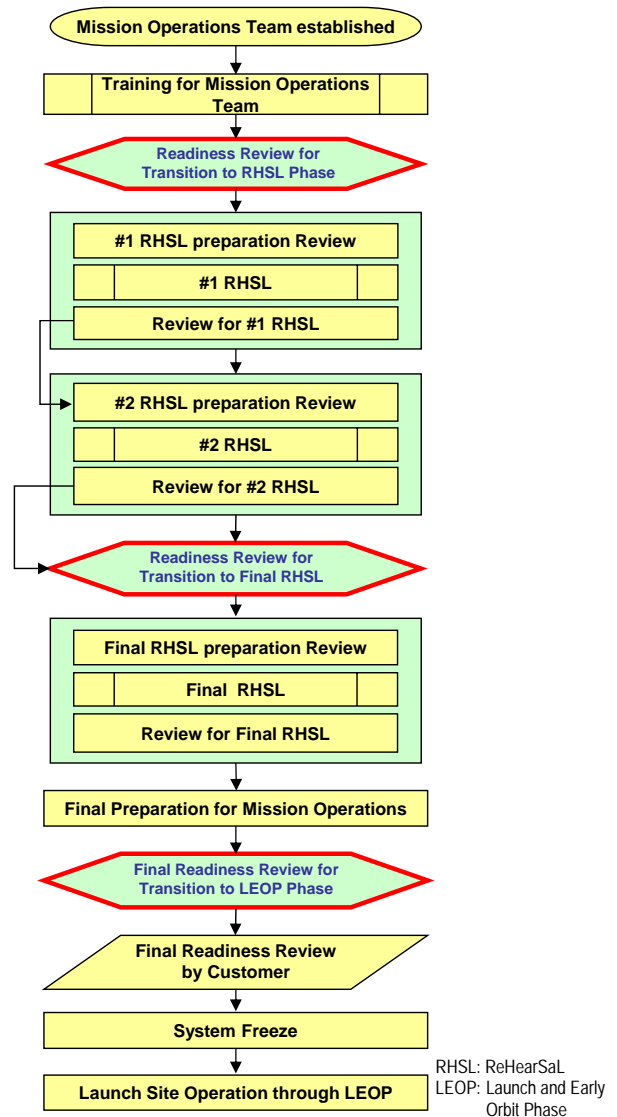

Fig. 2 Strengthening of verification by OROCCB-steered readiness review meetings

management program is implemented from an early stage of the project to ensure the safety of the satellite itself and relevant works. The term "system safety" does not mean the safety of the system. Rather, it is used as a proper noun to define a systematic approach to safety management defined in ISO 14620-1 Space Systems - Safety Requirements Part 1.

In the commercial satellites that are based on the DS2000 bus, safety is also implemented with priority on an inherent safety design, which follows the policy of the system safety (Fig. 3).

It is widely known that the two concepts – reliability that secures product operation and safety that prevents accidental/contingent operation – do not necessarily coexist.

If the reliability of operation deteriorates because of giving priority to safety or, conversely, safety is compromised because of ensuring reliability, the product design or system development is not sophisticated. To deal with



Fig. 3 Safety design order of precedence

these issues, it is important to consider the danger inherent in the components of the satellite bus, and relevant GSEs and tasks, as well as to confirm from an early stage of the project that the key factors for ensuring safety are implemented in the new project as well. It is also necessary to objectively assess, in the presence of third-party members, the influence of any change or modification of the product or tasks.

In June 2003, MELCO established the System Safety Management Group to administer the system safety management activities and promote standardization. This group was positioned as a third-party expert and continued its activities for 10 years. During this period, they provided training for each project, design, quality control, and quality assurance personnel; conducted visualization of common hazards, standardization of control methods, and accumulation of the results using risk assessment, Fault Tree Analysis (FTA) and other techniques; and shared a common understanding with relevant personnel and improved the management level⁽³⁾. In April 2013, the activities of system safety management were strengthened and integrated into the quality assurance section of space business, where the System Safety, Reliability & Quality Management Section was established to continue the activities of the system safety management, as well as to strive for both safety and reliability in closer contact with both product development and manufacturing.

2.3.2 Efforts for quality and reliability in the approach to satellite development

In October 2008, MELCO established the Reliability Engineering Center⁽²⁾ to strengthen the structure for further raising quality and reliability. This Center addresses the design issues of the satellite system that arise due to the unique environment of space such as space debris, radiation, and electrostatic charge/discharge. This section describes recent examples of their activities.

(1) Space debris mitigation measures

Space debris poses an increasing threat to satellites. Therefore, even an unmanned satellite needs

protective measures against space debris. MELCO has been actively participating in the ISO TC 20/SC 14/WG 7 Orbital Debris Working Group, the Spacecraft Design Standard Working Group of the Japan Aerospace Exploration Agency (JAXA) and other activities, thus collecting relevant information including the trends of other countries and space agencies, expressing opinions as a satellite manufacturer and creating specification drafts. As for the trends of the Japanese and overseas standards and specifications obtained through these activities, we also strive to feed them back to the satellite system design.

Space debris mitigation measures that should be considered in the satellite design include: 1) prevention of debris generation (prevention of the orbital debris environment from worsening), 2) protection against debris (prevention of collision damage that would lead to component failure), and 3) ground safety (prevention of injury to people caused by remnants surviving atmospheric reentry). With regard to measure 2) in particular, special care must be taken in selecting the analysis program and data to be used, because a difference in the collision frequency due to a different debris environment model significantly affects the satellite design.

Currently available simulation models used for forecasting the satellite debris environment include: MASTER2005 and MASTER2009 (European Space Agency (ESA)), and ORDEM2000 (National Aeronautics and Space Administration (NASA)). It is essential to correctly understand the differences between these simulation models and their features. Figure 4 shows an example of the space debris environment around the geostationary orbit satellites⁽⁴⁾.

It is also necessary to prepare for a drastic change in the orbital environment caused by a crash in orbit such as the Chinese satellite destruction experiment in 2007, and the accidental collision of U.S. and Russian

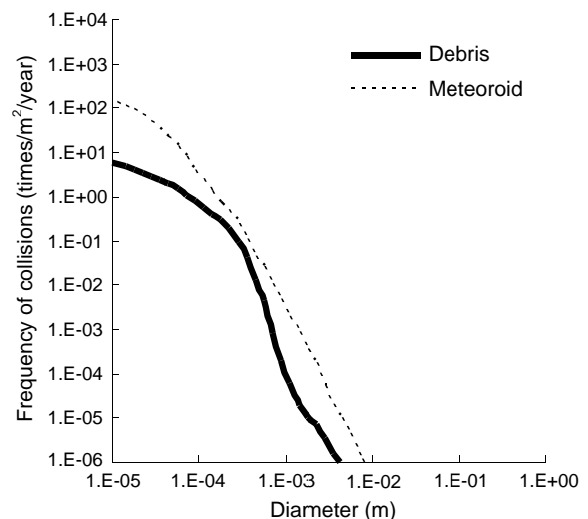

Fig. 4 Space debris environment around geostationary orbit satellites

satellites in 2009. In order to deal with such issues, it is increasingly important to discuss and form a network with relevant external institutions and experts.

(2) Evaluation of electrostatic charge/discharge

In order to understand how the materials and parts used in a satellite system are charged by charged particles in space, we have been working with an external research institute. We evaluate the degree of electrostatic charge and occurrence of discharge when various materials are irradiated by an electron beam and gather data about their electrostatic charge/discharge characteristics for analysis. For example, we tested samples of the latest coaxial cable, glass cloth tape, white paint, and metal mount. All of these materials and parts are either directly exposed to the space environment, or are barely shielded and are expected to be charged to a high electrostatic potential. The experimental results enabled us to determine the leakage characteristics and discharge threshold under the installed condition, and thus predict the electrostatic potential and number of electrical discharges during a mission. In this way, by analyzing the electrostatic charges using gathered data, it is possible to perform design reviews, to take corrective actions, and to implement preventive measures at an early stage (Fig. 5).

3. Future Prospects of BMS 100.00% Activities

The BMS 100.00% activities for MELCO's satellites have been continuing for more than 10 years since September 2002, and are now entering a new stage. The BMS Promotion Center, as an administrative unit, has been taking the initiative to promote the process of the "Plan, Do, Check, Act (PDCA)" cycle, which conveys the experiences and issues learned through the BMS 100.00% to future work for improvement. This approach has encouraged in-house communication, leading to improvements in working procedures and

standards. However, to improve the space business, it is important to devise a way to share the huge amount of information accumulated through BMS 100.00% more effectively and actively, and to convey it to the next generation of staff as useful knowledge.

To this end, the following issues should be addressed:

(1) Promotion of knowledge utilization

To improve the working efficiency and preventive quality control, revise the guidebook for the project staff so that they actively use the knowledge gained through the BMS 100.00% activities in detail in the upstream processes.

(2) Feedback to education and training

In the education curriculum for personnel, utilize the knowledge gained through the BMS 100.00% activities as a reference, and prepare new contents and revise existing materials.

(3) Feedback to standardization activities

Encourage new measures for in-house standardization activities and configuration management based on the knowledge gained through the BMS 100.00% activities.

4. Conclusion

When writing this paper, we reviewed the course of "BMS 100.00%" – Mission Success Activities of MELCO Satellites, and realized that the consecutive successes of satellite launching and orbit placement were the result of each person involved in various tasks to implement safety, quality and reliability and boldly challenge each issue. To ensure the continued success of BMS 100.00% activities in future, it is essential for each person to maintain a challenging attitude, and to convey his/her experiences to the next generation. The mission success activities for the MELCO's space business will be steadily raised to ensure the Quality Brand of Mission Success for satellites.

References

- (1) Inagawa, Y.: Reliability & Quality Improvement Activity for Satellite Development, Mitsubishi Denki Giho, Vol. 79, No. 8, 559-562 (2005) (in Japanese)
- (2) Inagawa, Y.: Quality Improvement Program for Space Satellites, Mitsubishi Denki Giho, Vol. 83, No. 3, 231-234 (2009) (in Japanese)
- (3) Mori, Y., et al.: Considerations on the Framework for Preventive Safety Management with Qualitative Risk Matrix (Risk Communication for an Improvement of Risk Assessment), Transactions of the Japan Society of Mechanical Engineers, Series C, Vol. 76, No. 772, 3760-3767 (2010) (in Japanese)
- (4) Kanai, N.: Unmanned Spacecraft Design to Limit Orbital Debris, The Journal of Reliability Engineering Association of Japan, Vol. 34, No. 31, 178-185 (2012) (in Japanese)

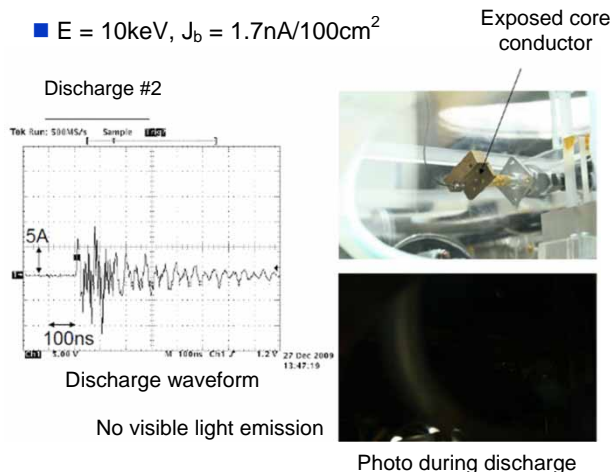

Fig. 5 Electrostatic charge/discharge test

