

MP

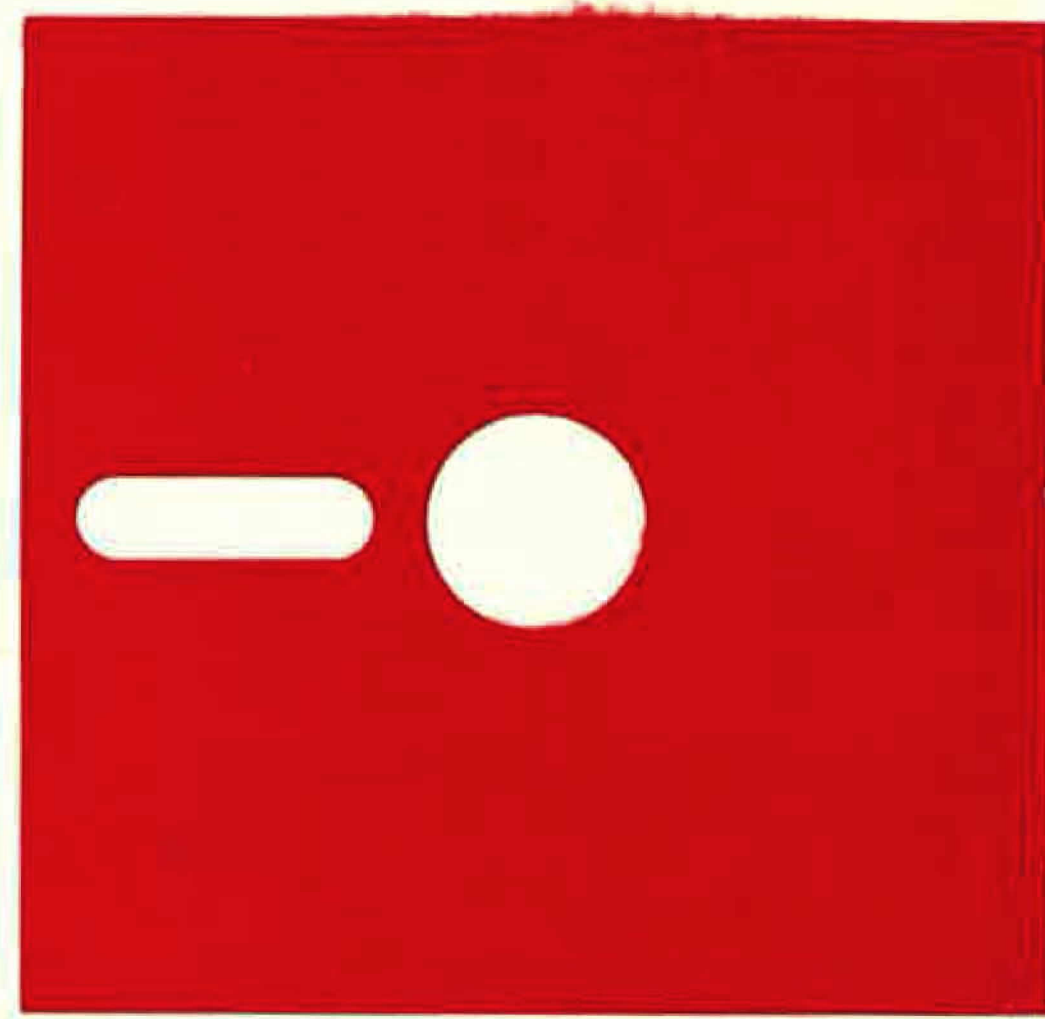

FLEXIBLE DISK DRIVE

91/92

PRODUCT MANUAL

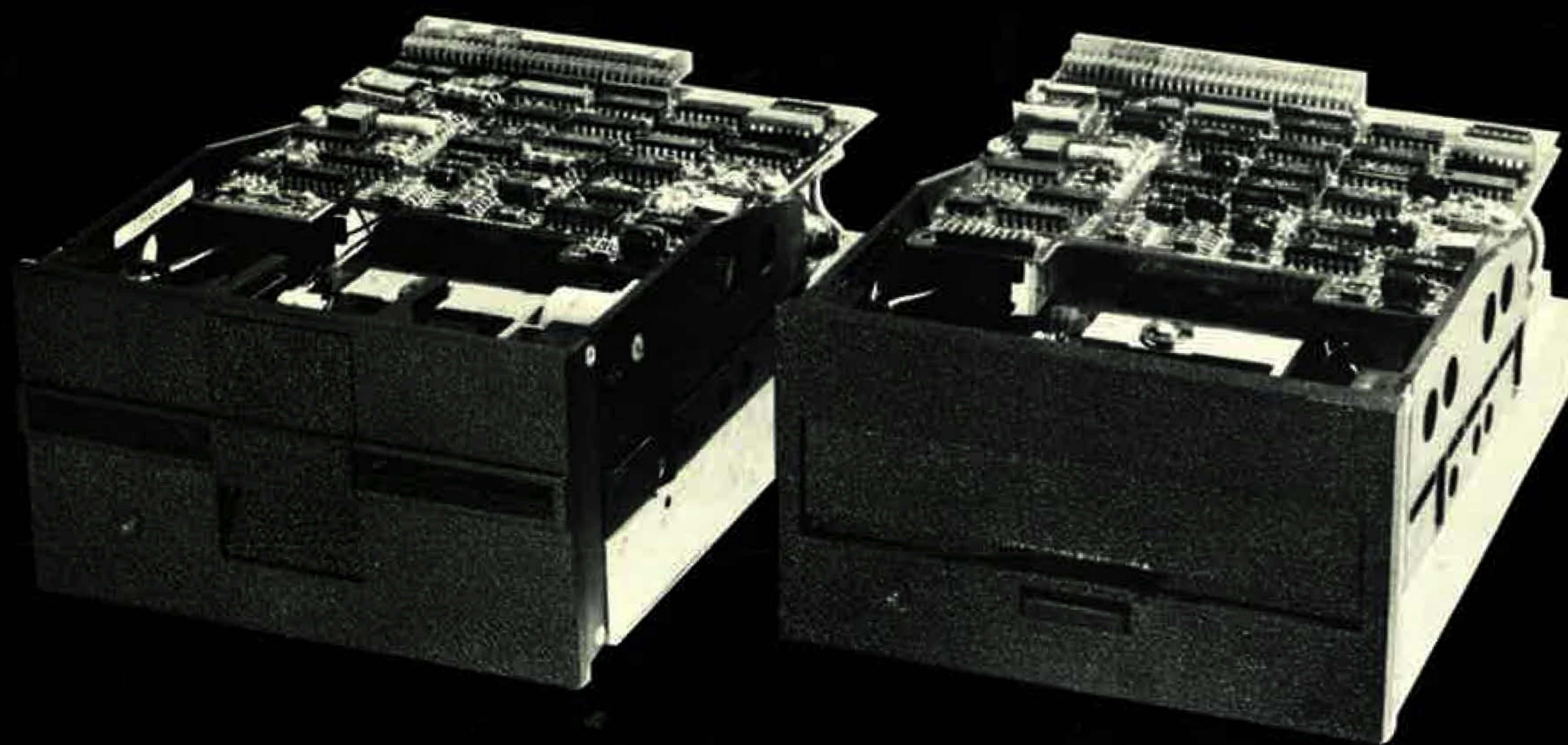



PROPRIETARY NOTICE

Information contained in this manual is copyrighted, and may not be duplicated in full or in part by any person without prior written approval from Micro Peripherals, Inc. (MPI)

The purpose of this manual is to provide the user of MPI's Model 91/92 and 91S/92S Flexible Disk Drives with adequately detailed documentation necessary for efficient installation, operation, maintenance, and ordering of spare parts for the equipment supplied.

Every effort has been made to keep the information contained in this manual current and accurate as of the date of publication or revision. However, no guarantee is given or implied that the manual is error free, or that it is accurate with regard to any particular specification.

Published June 1981



9754 Deering Avenue
Chatsworth, California 91311
(213) 709-4202
TWX: 910-494-1213

TABLE OF CONTENTS

SECTION 1	GENERAL DESCRIPTION	Page
1.1	INTRODUCTION	1-1
1.2	PURPOSE OF EQUIPMENT	1-3
1.3	PHYSICAL DESCRIPTION	1-3
1.4	FUNCTIONAL DESCRIPTION	1-3
1.5	SPECIFICATIONS	1-4
1.5.1	Capacity Specifications	1-4
1.5.2	Functional Specifications	1-4
1.5.3	Physical Specifications	1-5
1.5.4	Reliability Specifications	1-5
SECTION 2 INSTALLATION AND CHECKOUT		
2.1	INTRODUCTION	2-1
2.2	UNPACKING	2-1
2.3	INSTALLATION	2-2
2.4	HARDWARE	2-2
2.5	DUST COVER	2-2
2.6	COOLING	2-4
2.7	INPUT/OUTPUT CABLE	2-4
2.8	DC POWER	2-4
2.9	OPERATION	2-4
2.9.1	Flexible Diskette Loading	2-4
2.9.2	Flexible Diskette Removal	2-5
2.9.3	Diskette Handling Recommendations	2-5
2.10	INITIAL CHECKOUT	2-6

TABLE OF CONTENTS (Continued)

SECTION 3	THEORY OF OPERATION	Page
3.1	INTRODUCTION	3-1
3.2	INTERFACING REQUIREMENTS	3-2
3.2.1	Input Lines	3-2
3.2.1.1	Line Termination	3-2
3.2.1.2	Programmable Shunt	3-2
3.2.1.3	Drive Select 1 to 4	3-3
3.2.1.4	Motor On	3-3
3.2.1.5	Direction Select	3-3
3.2.1.6	Step	3-3
3.2.1.7	Write Gate	3-3
3.2.1.8	Write Data	3-3
3.2.1.9	Side Select	3-6
3.2.1.10	In Use (optional feature)	3-6
3.2.2	Output Lines	3-6
3.2.2.1	Track 00	3-6
3.2.2.2	Index/Sector	3-6
3.2.2.3	Write Protect	3-7
3.2.2.4	Read Data	3-7
3.2.3	Connector J2	3-7
3.2.4	Connector J1	3-7
3.3	HOW TO USE THE DRAWINGS	3-9
3.4	GENERAL DESCRIPTION	3-9
3.4.1	Head Positioning Control	3-10
3.4.2	Track 00 Sensor	3-11

TABLE OF CONTENTS (Continued)

SECTION 3 (Continued)	Page
3.4.3 Spindle Drive Control	3-12
3.4.4 Index Sensor	3-12
3.4.5 Head Load Mechanism	3-12
3.4.6 Side Selection	3-12
3.4.7 Data Recording and Retrieving	3-12
3.5 DETAILED DESCRIPTIONS	3-15
3.5.1 Power up/Power down Logic	3-15
3.5.2 Stepper Motor Control Logic	3-15
3.5.3 Track 00 Logic	3-16
3.5.4 Drive Motor Control Logic	3-16
3.5.5 Index Logic	3-19
3.5.6 Head Load Logic	3-19
3.5.7 Side Select Logic	3-19
3.5.8 Write Protect Logic	3-20
3.5.9 Write/Erase Logic	3-20
3.5.10 Read Logic	3-23
3.6 DATA ENCODING AND RECOVERY	3-23
3.6.1 FM Encoding	3-23
3.6.2 MFM Encoding	3-24
3.6.3 M ² FM	3-24
3.6.4 Data Recovery	3-25
3.6.4.1 Bit Shift	3-25
3.6.4.2 Write Precompensation	3-25
3.6.4.3 Data Separation	3-25
3.6.5 Track Format	3-26

TABLE OF CONTENTS (Continued)

SECTION 4	MAINTENANCE	Page
4.1	INTRODUCTION	4-1
4.2	GENERAL INFORMATION	4-1
4.3	PREVENTIVE MAINTENANCE	4-2
4.3.1	Read/Write Head(s) and Load Pad Inspection	4-2
4.4	RECOMMENDED TOOLS AND TEST EQUIPMENT	4-3
4.4.1	Removal/Replacement	4-3
4.4.2	Adjustment and Measurement	4-3
4.5	REMOVAL/REPLACEMENT PROCEDURES	4-3
4.5.1	Printed Circuit Board Assembly (PCBA)	4-10
4.5.2	Shield Assembly	4-10
4.5.3	Right-Hand Guide/Write Protect Assembly	4-10
4.5.4	Left-Hand Guide Assembly	4-11
4.5.5	Front Panel Bezel and Activity LED	4-11
4.5.6	Cone Assembly	4-13
4.5.7	Carrier Assembly	4-13
4.5.7.1	Index LED	4-14
4.5.7.2	Carrier/Index LED Installation	4-14
4.5.8	Index/Load Boss	4-14
4.5.9	Solenoid	4-15
4.5.10	Drive Motor	4-16
4.5.11	Track 00 Sensor	4-17
4.5.12	Door Button Assembly	4-17
4.5.13	Stepper Band	4-19
4.5.14	Stepper Motor	4-20
4.5.15	Head/Carriage Assembly	4-20

TABLE OF CONTENTS (Continued)

SECTION 4 (Continued)	Page
4.5.16 Ejector Assembly	4-21
4.5.17 Spindle Bearings	4-22
4.5.18 Head Load Pad Assembly	4-23
4.5.19 Harness Assembly	4-23
4.6 ADJUSTMENT PROCEDURES	4-26
4.6.1 Radial-Track Alignment	4-26
4.6.2 Index-To-Data Alignment	4-26
4.6.3 Track 00 Sensor Alignment	4-29
4.6.4 Speed Control Adjustment	4-29
4.6.5 Track 00 End Stop Adjustment	4-29
4.6.6 Drive Belt Adjustment	4-30
4.6.6.1 Mylar (Yellow) Drive Belt Adjustment	4-30
4.6.6.2 Neoprene (Black) Drive Belt Adjustment	4-30
4.6.7 Ejector Latch and Ejector Latch Release Adjustments	4-30
4.6.7.1 Ejector Latch Adjustment	4-32
4.6.7.2 Ejector Latch Release Adjustment	4-32
4.7 MEASUREMENT PROCEDURES	4-32
4.7.1 Compliance Measurement	4-32
4.7.2 Erase Measurement	4-33
4.7.3 High Frequency Playback Measurement	4-33
SECTION 5 TROUBLESHOOTING	
5.1 INTRODUCTION	5-1
5.2 PRELIMINARY TROUBLESHOOTING STEPS	5-2
5.3 DRIVE WON'T STEP OR STEPS ERRATICALLY.	5-2

TABLE OF CONTENTS (Continued)

SECTION 5 (Continued)	Page
5.4 HEAD/CARRIAGE OSCILLATES AT TRACK 00	5-3
5.5 DRIVE MOTOR WON'T ROTATE	5 3
5.6 HEAD WILL NOT LOAD	5-3
5.7 BAD INDEX OUTPUT	5-3
5.8 BAD WRITE PROTECT OUTPUT	5-4
5.9 ACTIVITY INDICATOR DOES NOT LIGHT	5-4
5.10 READ ERRORS - ALL TRACKS	5-4
5.11 READ ERRORS - RANDOM TRACKS	5-4
5.12 READ ERRORS - INSIDE TRACKS	5-5
5.13 CANNOT READ PREWRITTEN DATA: CAN READ SELFWRITTEN DATA	5-5
5.14 CANNOT WRITE DATA	5-5
5.15 ERASE BAD	5-5
5.16 DRIVE SPEED UNSTABLE	5-5
SECTION 6 OPTIONS	
6.1 INTRODUCTION	6-1
6.2 DOOR CLOSED SWITCH	6-1
6.3 DOOR LOCK MECHANISM	6-1
6.4 READY OPTION	6-2
APPENDIX A Spare Parts List	A-1
APPENDIX B Drawings and Schematics	B-1
APPENDIX C Signal Name Definitions	C-1

LIST OF ILLUSTRATIONS

FIGURE		Page
1-1	Model 91/92 and 91S/92S Disk Drives	1-2
2-1	Outline and Mounting Dimensions	2-3
2-2	Diskette Orientation	2-6
3-1	Track Access Timing	3-4
3-2	Read Initiate Timing	3-4
3-3	Read Signal Timing	3-4
3-4	Write Initiate Timing	3-5
3-5	Write Data Timing	3-5
3-6	General Control and Data Timing Requirements (head load solenoid is activated with drive select)	3-5
3-7	Index/Sector Timing (Soft Sector)	3-6
3-8	Index/Sector Timing (Hard Sector)	3-6
3-9	DC Power Connector, J2	3-7
3-10	J1 Connector Dimensions	3-7
3-11	Interface Signals	3-8
3-12	Shunt Configuration	3-8
3-13	Write Protect Feature	3-9
3-14	Functional Block Diagram	3-11
3-15	Basic Recording Technique	3-14
3-16	Wave Forms in Read Sequence	3-14
3-17	Stepper Motor Control Timing	3-17
3-18	Motor Control Timing	3-18
3-19	Write Timing	3-21
3-20	Read Timing	3-22
3-21	FM Encoding	3-24

LIST OF ILLUSTRATIONS (Continued)

FIGURE		Page
3-22	MFM Encoding	3-24
3-23	M ² FM Encoding	3-25
3-24	Typical Track Format	3-27
4-1	Top View Of Drive	4-5
4-2	Bottom View Of Drive	4-7
4-3	Model 91S, Exploded View	4-9
4-4	Activity Indicator Assembly	4-12
4-5	Door Button Assembly	4-18
4-6	Stepper Band	4-18
4-7	Ejector Assembly	4-22
4-8	Radial Track Alignment Patterns	4-27
4-9	Index-to-Data Alignment Pattern	4-28
4-10	Ejector Block and Latch - top view	4-31
4-11	Ejector Assembly	4-31
6-1	Door Closed Switch	6-2
B-1	Logic PCBA Component Layout	B-2
B-2	Logic PCBA Schematic	B-3
B-2A	Logic PCBA Schematic	B-4
B-3	Ready PCBA Component Layout	B-5
B-4	Ready PCBA Schematic	B-6

LIST OF TABLES

TABLE		Page
2-1	Recommended Connectors - P1	2-2
3-1	Section Index	3-1
3-2	Write/Read and Side Selection Conditions	3-19
3-3	Comparison of Encoding Techniques.	3-27
4-1	Section Index	4-1
4-2	Removal/Replacement Procedures	4-4
4-3	Removal/Replacement Adjustment Check List	4-8
4-4	Harness Assembly Wire List	4-25
4-5	Adjustment Procedures	4-26
5-1	Trouble Symptoms	5-1

SECTION 1

GENERAL DESCRIPTION

1.1 INTRODUCTION

This product manual contains specifications and information relating to the Micro Peripherals Inc. Model 91/92 and 91S/92S Flexible Disk Drives. This document consists of the following sections:

SECTION	I	-	General Description
SECTION	II	-	Installation - Checkout
SECTION	III	-	Theory of Operation
SECTION	IV	-	Maintenance
SECTION	V	-	Troubleshooting
SECTION	VI	-	Options
APPENDIX	A	-	Spare Parts List
APPENDIX	B	-	Drawings and Schematics
APPENDIX	C	-	Signal Name Definition

This section provides a physical and functional description, and specifications for the Models 91/92 and 91S/92S Flexible Disk Drives. In addition to the standard features described, the following additional features are included in all models:

- A. "Write Protect" can be used as "Disk Installed" indication.
- B. Termination of input signals can be either 150 ohms or split 220/330 ohms.

NOTE

A high level of commonality exists between the 91/92 and 91S/92S drives. Therefore the following descriptions will generally apply to all models. Unique features of each model will be identified and individually described, as appropriate. For ease of explanation, flexible disk drives discussed in this product manual will be referred to as Model 91/92 unless differentiation is necessary.

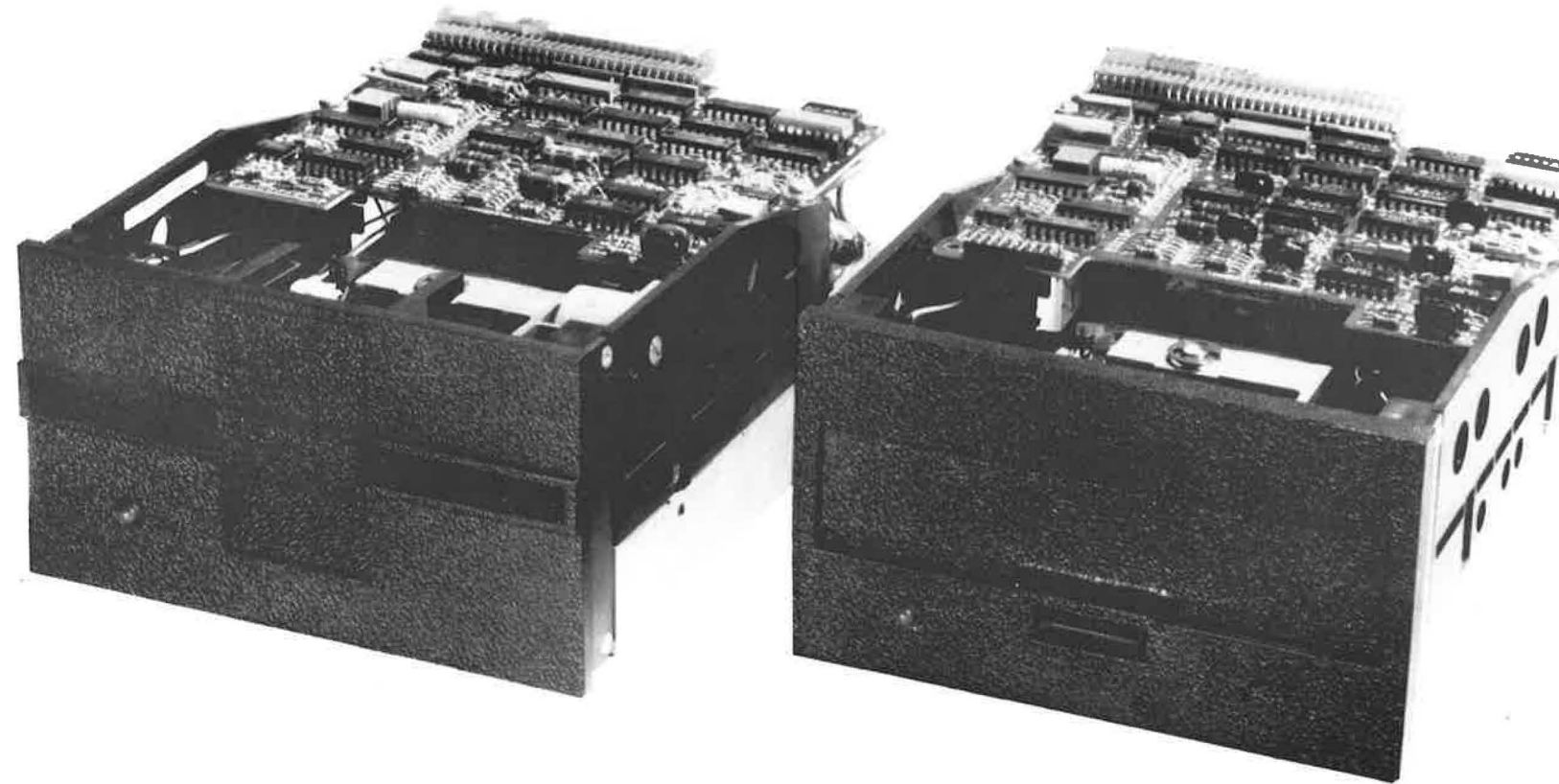

MODEL 91S/92S

MODEL 91/92

Figure 1-1: 91/92 and 91S/92S Disk Drives

1.2 PURPOSE OF EQUIPMENT

The Model 91/92 Disk Drive is a compact disk memory device designed for random-access data storage, data entry, and data output applications. Typical applications are intelligent terminal controllers, microcomputers, word processing systems, data communications systems, error logging, micro-program logging, and point-of-sale terminals. The Model 91/92 is designed to meet and perform to ANSI specification, utilizing standard 5 1/4 inch diskettes.

1.3 PHYSICAL DESCRIPTION

The Model 91/92 can be mounted vertically or horizontally. However, when mounted horizontally, it is recommended that the 91/92 be positioned so that the PCBA is on the top side. The mechanical components consist of an aluminum chassis, on which is mounted a spindle (belt-driven by a DC motor); a stepper motor/band combination for positioning the magnetic head assembly; and a cone/clutch assembly for centering and holding the recording media under operation. Access for diskette loading is at the front of the drive.

The recording-head assembly is of a glass bonded ferrite/ceramic structure, with lifetime expectancy in excess of 20,000 hours. The electronic circuitry is mounted on a PCBA located on top of the drive. Power and interface signals plug directly into this board. The following basic circuits are included:

- A. Stepper motor control logic
- B. Read circuit
- C. Write erase circuit
- D. Spindle Drive Motor speed control
- E. Index; Track 00 and Write Protect sensing
- F. Head load drive

1.4 FUNCTIONAL DESCRIPTION

The Model 91/92 is self-contained and requires no operator intervention during operation. The drive consists of a media-rotating system, a head-load and positioning system, and a write/erase and read system. When the front door is opened, access for inserting the diskette is provided. When inserting the diskette, all positions except "in/out" are controlled internally by physical guides. Correct "in/out" is assured by inserting the diskette until a "click" is heard. On the Model 91S/92S all positions except "out" are controlled by physical guides. A correct "in" is assured by inserting the diskette until contacting a guide stop.

Closing the front door activates the cone/clutch system which serves two purposes in the following order:

- A. Correct centering of the media
- B. Clamping the media to the spindle hub

The spindle hub rotates at a constant speed of 300 RPM by means of a DC motor/tachometer and a reference in a closed-loop system. When in operation, it is important that the head-to-media relationship be controlled. This is accomplished by the head-load system in the following way: The media is pressed against the Index/Load Boss which is referenced to the head and the spindle hub; and in Model 91/91S a felt pad is loaded against the media on the opposite side of the head with a force of approximately 18 gr.

The recording head is positioned over the correct track by means of a four-phase stepper motor/band direct-drive mechanism, and its associated electronics. A one-step movement causes a one-track movement. With band positioning, very high step rates can be accomplished with the 91/92 system.

When a Write Protected diskette is inserted, the write protect sensor normally disables the write/erase circuits in the drive. When writing, a 0.00525 inch (nominal) data track is recorded, followed by a tunnel erase which trims the track down to 0.005 inch (nominal). Data recovery electronics include a low-frequency amplifier, a differentiator, a cross-over detector, a digital filter, and a final pulse generator.

1.5 SPECIFICATIONS

The mechanical and electrical specifications for the Model 91/92 Flexible Disk Drives are given in the following paragraphs.

1.5.1 Capacity Specifications (K BYTES)

	MODEL	<u>91</u>	<u>92</u>
Single Density (unformatted)			
Per Disk		250	500
Per Track		3.13	3.13
Double Density (unformatted)			
Per Disk		500	1000
Per Track		6.25	6.25

1.5.2 Functional Specifications

Tracks	80	160
Track Density (TPI)	96	96
Recording Density (BPI)		
Single Density	2788	2961
Double Density	5576	5922

1.5.2 Functional Specifications (cont'd)

Rotational Speed (RPM)	300 \pm 1 1/2%
Average Latency	100ms
Transfer Rate	
Single Density	125K bits/sec
Double Density	250K bits/sec
Encoding Method	FM, MFM, M ² FM
Access Time	
Track to Track	5ms
Average	150ms
Head Settling Time	25ms
Head Load Time	35ms
Power-Up-Delay	0.5sec
Interfacing	Industry/ANSI compatible

1.5.3 Physical Specifications

Environmental	
Operating Temperature	40°F to 115°F (4.4°C to 46.1°C)
Non-Operating Temperature	-40°F to 160°F (-40°C to 71°C)
Operating Humidity	20% to 80% (non-condensing)
Non-Operating Humidity	5% to 95% (non-condensing)
Operating Altitude	-500 to 10,000 FT (-152.4 to 3,048m)
Non-Operating Altitude	-1000 to 50,000 FT (-304.8 to 15,240m)
Vibration & Shock (operating)	0.5g, 6 to 600Hz
Electrical	
DC Power	+12V \pm 5%, 0.7 Amp (1.4 Amp surge) 0.2v ripple +5V \pm 5%, 0.4 Amp, 0.1v ripple
Power Dissipation	11W operation; 4W standby
Mechanical	
Height	3.25 in. (82.6mm)
Width	5.75 in. (146.1mm)
Length	7.75 in. (196.9mm)
Weight	3.1 lbs. (1.41kg)
Media Requirements	
Diskette	Industry Compatible, 5 1/4in.
Sectoring	Soft; 10,16
Type	Single or Double Sided Single or Double Density

1.5.4 Reliability Specifications

MTBF	9,200 hours (@ 25% duty cycle)
MTTR	0.5 hours
Design Life	5 years
Media Life	3x10 ⁶ passes/track
Data Integrity	
Soft Errors	1 per 10 ⁹ bits read
Hard Errors	1 per 10 ¹² bits read
Seek Errors	1 per 10 ⁶ seeks

UL and CSA Approved

SECTION 2

INSTALLATION AND CHECKOUT

2.1 INTRODUCTION

This section provides the information and procedures necessary to place the Model 91/92 Flexible Disk Drives into operation.

2.2 UNPACKING

CAUTION

During unpacking, care must be exercised to ensure that all tools are non-magnetic and do not inflict damage to the unit.

As the unit is unpacked, inspect it for possible shipping damage. All claims for this type of damage should be filed promptly with the transporter involved. If a claim is filed for damages, save the original packing material. Most packing material may be reuseable if reasonable care is used in unpacking. Unpack the drive as follows:

- A. Remove external packing material carefully.
- B. Remove the drive from the container.
- C. Remove internal packing materials, following instructions provided on the package.
- D. Ensure that front access door opens and closes, and that the head-load arm raises when door is opened.
- E. Ensure that bezel is secured.
- F. Ensure that drive hub manually rotates freely.
- G. Ensure that stepper motor/head carriage assembly is not binding at any point, by manually moving carriage back and forth.

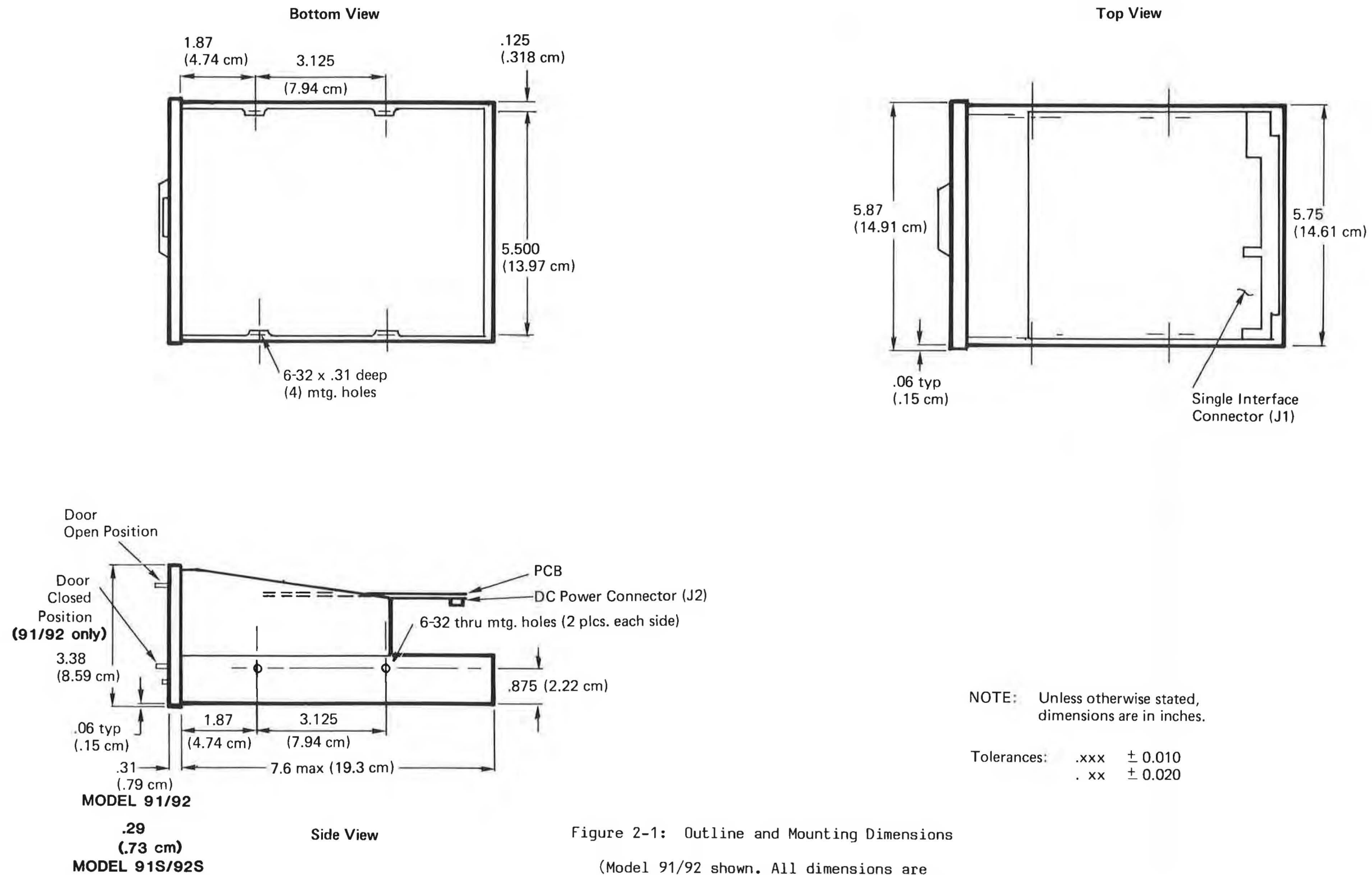

Figure 2-1: Outline and Mounting Dimensions

(Model 91/92 shown. All dimensions are applicable to 91S/92S except as noted.)

2.6 COOLING

Heat dissipation from a single disk drive is normally less than 15 watts (40 Btu/Hr). When the drive is mounted so that the components have access to free flow of air, normal convection cooling allows operation over the specified temperature range. When the drive is mounted in a confined environment, air flow may have to be provided to maintain specified air temperatures in the vicinity of the motors, PCBA, and the diskette.

2.7 INPUT/OUTPUT CABLE

Refer to Table 2-1 for cable connector part number and attachment. The maximum cable length from connector to connector is 10 feet. All inputs and outputs are paired, one line for function, one for ground. Figure 3-11 provides information relative to the connector pin/signal assignments for I/O cable.

2.8 DC POWER

DC power to the drive is via connector P2/J2, which is located on the noncomponent side of the PCBA near the spindle motor. The drive uses +12V DC and +5V DC. Paragraph 1.5.3 outlines the voltage and current requirements. The connector is an AMP Mate-N-Lock Part No. 1-480424-0.

2.9 OPERATION

The Model 91/92 Flexible Disk Drive is under direct control of the interface and power sources. No special start-up procedures are necessary. Secure both power and I/O connectors prior to disk loading.

2.9.1 Flexible Diskette Loading

- A. Apply DC power to drive.
- B. 91/92 - Open drive door by pushing door latch button.
91S/92S - Open drive door by lifting the bottom edge of door with one finger while applying pressure to the door just over the center with the other finger.

- C. Remove diskette from its storage envelope and insert in the drive. The index hole must be on the left side of the jacket and the label on the right towards the door. (See Figure 2-2.)

91/92 - Push the diskette forward until a "click" is heard.

91S/92S - Push the diskette forward until contacting guide stops.

- D. 91/92 - Close door by pushing door down until latch secures the door.

91S/92S - Close door by pushing door down until fully seated flush with bezel face.

2.9.2 Flexible Diskette Removal

- A. Open the drive door and remove the diskette.

NOTE

When the drive door is opened on the Model 91/92 only, the flexible diskette will automatically be ejected to a position where it can be easily removed.

- B. Always store the diskette in its storage envelope in order to maintain the highest data integrity.

- C. Close drive door.

2.9.3 Diskette Handling Recommendations

Since the recorded diskette contains vital information, reasonable care should be exercised in its handling. Longer diskette life and troublefree operation will result if the following recommendations are followed:

- A. Do not use a writing device which deposits flakes (i.e., lead or grease pencils) when writing on a diskette jacket label.
- B. Do not fasten paper clips to diskette jacket edges.
- C. Do not touch diskette surface exposed by jacket slot.
- D. Do not clean diskette in any manner.
- E. Keep diskette away from magnetic fields and from ferro-magnetic materials that may be magnetized.
- F. Return diskette to envelope when removed from drive.

2.3 INSTALLATION

Due to its small size and light weight, the Model 91/92 can be installed or mounted in any convenient location or position. However, the drive must be installed in a location that will prevent the I/O cable from exceeding 10 feet in length. Refer to Figure 2-1 for dimensions and mounting provisions.

2.4 HARDWARE

The flexible disk drive is a precision device in which certain critical internal alignments must be maintained. Therefore, in keeping with rigid disk requirements, it is important that the mounting hardware does not introduce significant stress on the drive.

NOTE

Any mounting scheme in which the drive is part of the structural integrity of the enclosure is not permitted.

Since the disk drive cannot be subjected to significant stress when it is slide mounted, this type of mounting generally satisfies the foregoing requirement. Mounting schemes should allow for adjustable brackets or incorporate resilient members to accommodate tolerances. Mounting schemes involving more than two hard mounting points should be avoided.

2.5 DUST COVER

Since the flexible disk drive is not provided with a dust cover, the design of an enclosure should incorporate a means to prevent direct ingress of loose items, e.g., dust, paper punch waste, etc.

Table 2-1

RECOMMENDED CONNECTORS - P1

TYPE OF CABLE	MANUFACTURER	CONNECTOR P/N	CONTACT P/N
Twisted Pair, 26	AMP	583717-5	1-583616-1
Flat Cable	3M "Scotchflex"	3463-0001	N.A.

3.2 INTERFACING REQUIREMENTS

Communication is established via two connectors. Connector J1 establishes a communication link for all input/output signals. These signals are TTL compatible. Connector J2 provides DC power to the device.

3.2.1 Input Lines

The input control lines have the following electrical specifications:

- A. True, Logical Zero = 0V to 0.4V (at $I_{in} = 48$ ma max).
- B. False, Logical One = +2.5V to +5.25V (at $I_{out} = 250$ ua max).

3.2.1.1 Line Termination

The signal interface used by Model 91/92 is of the "bus" or "daisy-chain" type. Only one 91/92 unit is logically connected to the interface at any given time. All input signals are terminated directly by a 150 ohm or a 220/330 ohm resistor network. In a daisy-chain configuration, only the last device in the daisy chain should have the terminating network; while in a star configuration, every device should be terminated.

3.2.1.2 Programmable Shunt

The main function of this device is to assign the proper address to the drive in a multi-drive configuration. In addition, it also determines when the headload solenoid should be activated by using either position 1-14 (with Select) or 7-8 (with Motor On). If position 5-10 is left shorted, the drive is essentially always selected, but the activity light will not come on, and the solenoid will not be activated until the drive position is selected. The programmable shunt is AMP P/N 435704-16 (MPI P/N 1-79600-001). For convenience, the programmable shunt could be replaced by a dip switch, AMP P/N 4-35626-4. (If dip switch is used, maximum height is exceeded by .150 inch.) The seven lines channeled through the shunt are:

	Designator	Pins
A. Head Load w/Select	T1	1-14
B. Drive Select 1	T2	2-13
C. Drive Select 2	T3	3-12
D. Drive Select 3	T4	4-11
E. MUX	T5	5-10
F. Drive Select 4	T6	6-9
G. Head Load w/Motor On	T7	7-8

3.2.1.3 Drive Select 1 To 4

The Select lines provide a means of selecting and deselecting one of the four disk drives attached to the controller. When the signal logic level is true (low), the disk drive electronics are activated, the head is loaded, and the drive is conditioned to respond to step or read/write commands. When the logic level is false (high), the input control lines and output status lines are disabled. A select line must remain stable in the true (low) state until the execution of a step or read/write command is completed. After the desired device is selected, allow a 35 msec delay before initiating a read if loading head with select (see Figure 3-2).

3.2.1.4 Motor On

This input is provided to extend the life of the DC spindle motor. The motor should be turned off if no activity is required of the Model 91/92 after 10 revolutions of the diskette. A minimum of 0.5 seconds is required before performing a read or write after the MOTOR ON line is activated (see Figures 3-2 and 3-4).

3.2.1.5 Direction Select

The direction of motion of the Read/Write head is defined by the state of this input line. A true (low) level defines direction as "IN" (towards center of the disk); a false (high) level defines the direction as "OUT" (see Figure 3-1).

3.2.1.6 Step

Together with the direction line, a single pulse on this input will move the Read/Write head one track in or out, dependent on the state of the direction line. The motion of the head is initiated on the trailing edge of step pulse. A minimum of 0.2 us pulse width at a maximum frequency of 200 Hz should be maintained to assure step integrity (see Figure 3-1).

3.2.1.7 Write Gate

When true, this input line permits writing of data. When inactive, it permits transmitting data to the controller. Allow a minimum of 1 msec after dropping Write Gate before expecting valid Read Data (see Figures 3-4 and 3-6).

3.2.1.8 Write Data

This input, in conjunction with the Write Gate input, provides data to be written on the diskette. The frequency of the write oscillator should be held within 0.1% with a pulse width of a minimum of 0.2 usec and maximum of 3.5 usec. The frequency is dependent upon the encoding scheme used and the density option exercised (see Figures 3-4 and 3-5). It is recommended that the

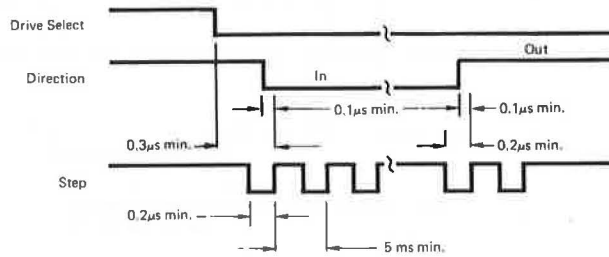

Figure 3-1: Track Access Timing

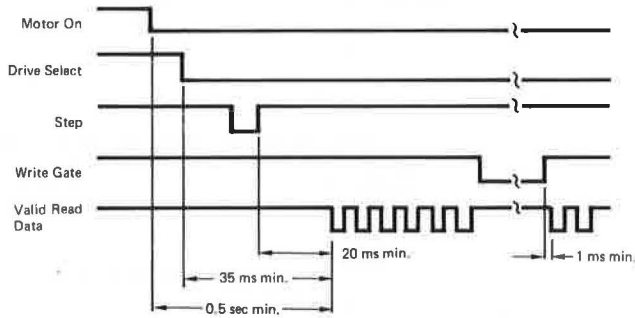

Figure 3-2: Read Initiate Timing

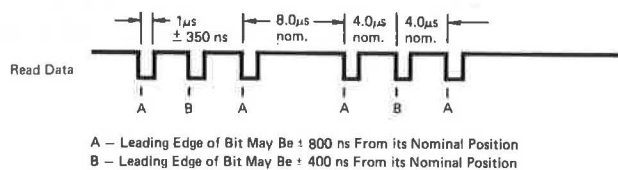

Figure 3-3: Read Signal Timing

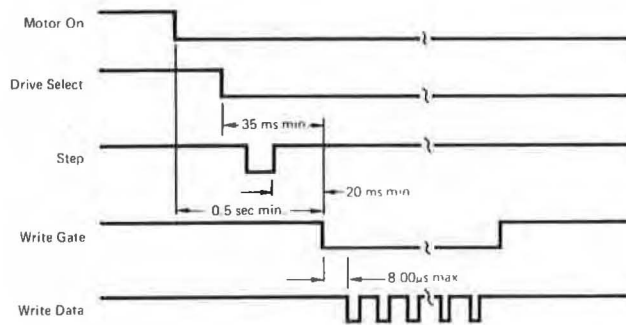

Figure 3-4: Write Initiate Timing

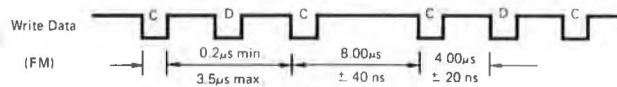

Figure 3-5: Write Data Timing

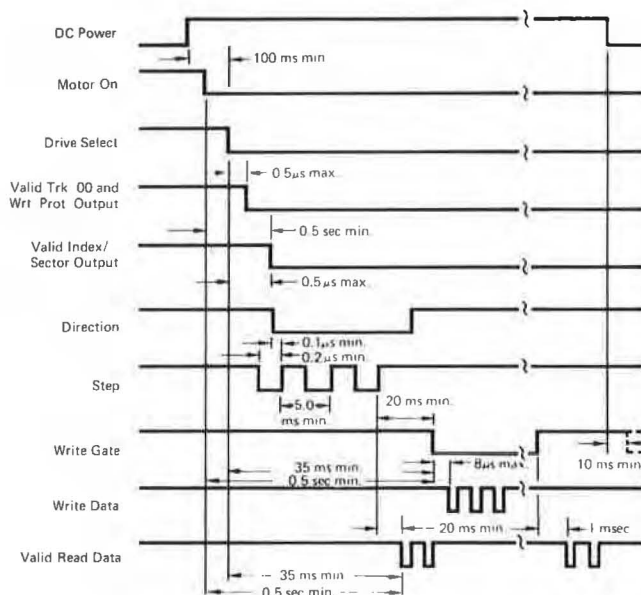

Figure 3-6: General Control and Data Timing Requirements (Head Load Solenoid is Activated with Drive Select)

first leading edge of Write Data occurs no sooner than 4 usec and no later than 8 usec after leading edge of Write Gate. The same recommendation exists for the last Write Data and trailing edge of Write Gate.

3.2.1.9 Side Select

This input is used to select either the upper or lower head. A 35 usec delay should be allowed for the read amp to recover after a head select event occurs. Only then will valid data be present. (For Model 91, this line should always be high.)

3.2.1.10 In Use (Optional Feature)

This line is connected to a driver which could be used for an indicator light, or a solenoid for latching the front door.

3.2.2 Output Lines

The control output signals are driven with an open-collector output stage capable of sinking a maximum of 48 ma at logical zero as true state with maximum voltage of 0.4V measured at the driver. When the line driver is in a logical one or false state, the collector cutoff current is a maximum of 250 ua.

3.2.2.1 Track 00

This output, when true, indicates that the Read/Write head(s) are located over Track 00.

3.2.2.2 Index/Sector

Once every revolution, a pulse is transmitted to the controller indicating the beginning of a track, but only if a single hole diskette is used. If multi-hole media is used in conjunction with the index, sector pulses (10, 16) will also be transmitted to the host system. Leading edge of sector to leading edge of index is 6.25 msec \pm 0.10 msec for 16-sector media (see Figures 3-7 and 3-8).

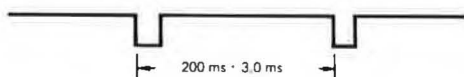

Figure 3-7: Index Sector Timing
(soft sector)

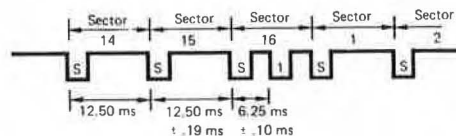

Figure 3-8: Index Sector Timing
(hard sector)

3.2.2.3 Write Protect

This interface signal is provided by the drive to give the user an indication that a write protected or read-only diskette has been installed (see Figure 3-13). This output is false when the diskette is not write protected. This line may easily be used as a Disk Installed Indicator, if only write protected disks are used.

3.2.2.4 Read Data

This output represents digitized data as detected by the drive electronics. Information transmitted will be in the encoding scheme used. Pulse width of both clock and data bits will be 1 usec ± 350 nsec. In FM encoding, maximum bit shift for a clock is ± 800 nsec while that for data is ± 400 nsec from their nominal bit positions (see Figure 3-3). The leading edge of each Read Data pulse represents the true position of the flux transition on the recording media.

3.2.3 Connector J2

The DC power connector is located on the non-component side of the printed circuit board. The recommended mating connector is AMP P/N 1-480424-0 using AMP pins P/N 60619-1.

3.2.4 Connector J1

Connection to J1 is through a 34-pin PCBA edge connector. Even numbered pins are located on the component side while odd numbered pins are located on the solder side. A key slot is provided between pins 4 and 6. The recommended connector is 3M Scotchflex P/N 3463-001, or AMP P/N 583717-5 using AMP contacts P/N 1-583616-1.

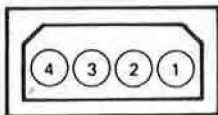

- Pin 1 +12V DC
- Pin 2 12V Return
- Pin 3 5V Return
- Pin 4 +5V DC

Figure 3-9: DC Power Connector, J2

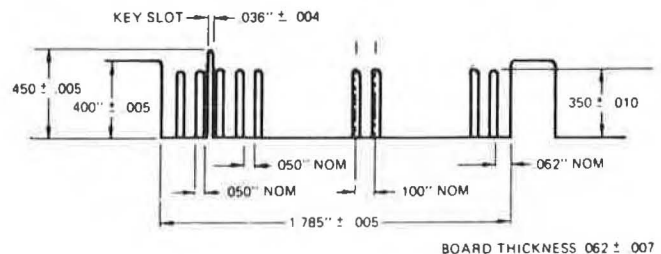
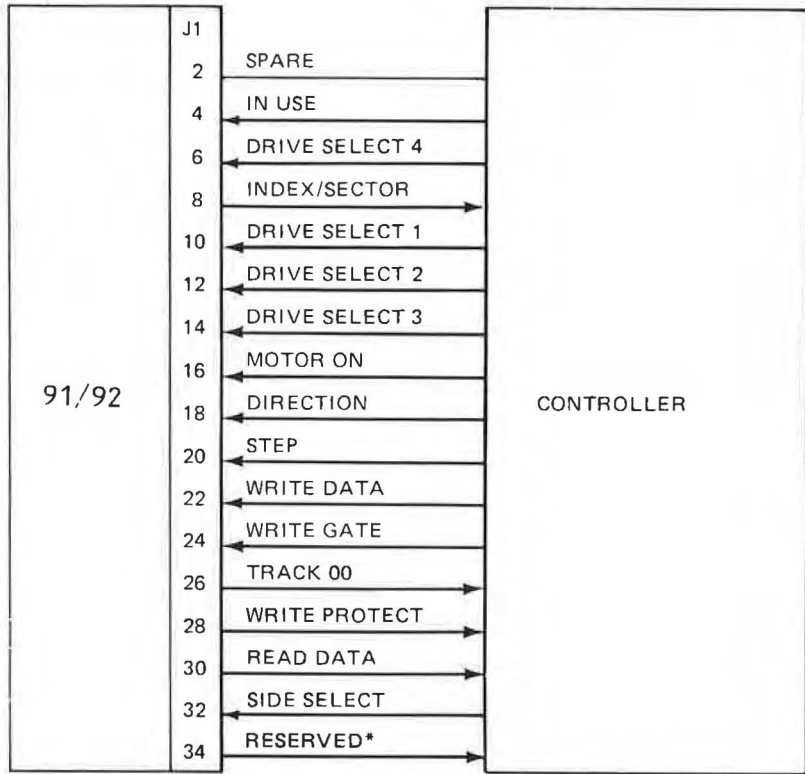

Figure 3-10: J1 Connector Dimensions



ODD PINS RETURN (DC GROUND)

* RESERVED FOR OPTIONS



Figure 3-11: Interface Signals - 91/92

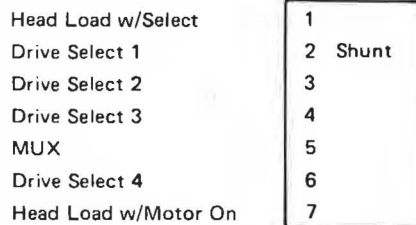

Figure 3-12: Shunt Configuration

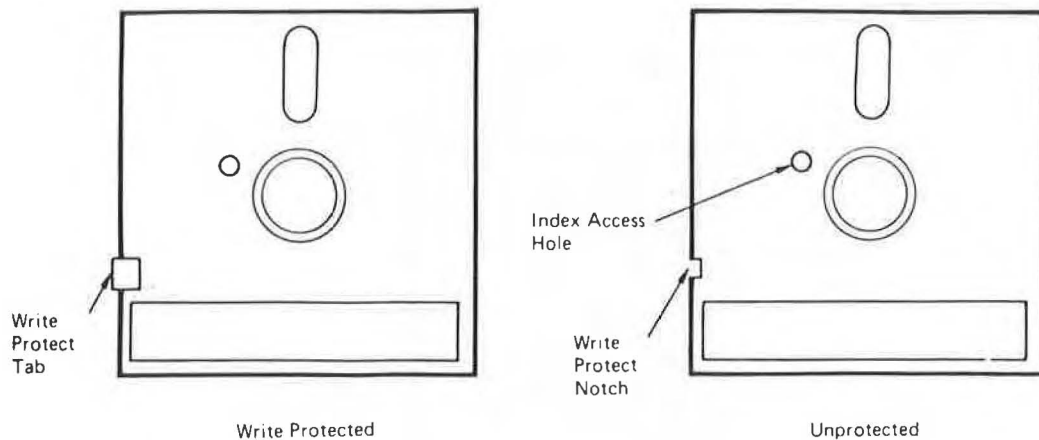

Figure 3-13: Write Protect Feature

3.3 HOW TO USE THE DRAWINGS

Drawing 4-04002-001, two sheets, illustrates the electronics of the disk drive. The electronics of the drive is completely contained on one printed circuit board assembly (PCBA) located on the top of the drive. Components are installed on the PCBA using the grid system. Columns on the board are number annotated; rows on the board are letter annotated. On the drawing sheets IC's have a number/letter designator inside the component symbol. This number/letter designator physically locates the component on the PCBA.

In general, input signals are shown entering the drawing sheets from the left, and output signals are shown leaving the drawing sheets to the right. Preceding or following some signal lines is a three digit alphanumeric designator enclosed in parenthesis. These designators locate the source or destination of the signal.

The first number of the designator references a sheet of the drawing. The letter in the designator references a letter row on the designated sheet of the drawing. The final number of the designator references a number column of the drawing. Note that the drawings are prepared on a letter/number grid.

The sense of logic signals within the disk drive is: zero volts is the true, or active, state and plus 3.4 volts is the false, or inactive, state. Note that the voltage levels are actually: 0V DC to +0.4V DC and + 2.4V DC to +5V DC. A slash (/) following a signal term on the drawing indicates that this signal is active in the high state.

To reduce "clutter" on the drawing sheets, the component part numbers are listed on the first page in Appendix B.

3.4 GENERAL DESCRIPTION

The basic functions of the flexible disk drive are to record and read digital data on a diskette, and to receive and generate the control signals

necessary for completion of the read/write functions. All of the electronics of the disk drive are contained on a single printed circuit board assembly (PCBA).

NOTE

There is no difference between the PCBA for Model 91 (single head) and the PCBA for Model 92 (dual head).

Figure 3-14 is a functional block diagram of the following mechanical and electrical components of the disk drive:

- A. Head positioning control
- B. Track 00 sensor
- C. Spindle drive control
- D. Index sensor
- E. Head load mechanism
- F. Side selection
- G. Data recording and retrieving
 - 1. Write protect sensor
 - 2. Write/erase control
 - 3. Data recording
 - 4. Data reading

3.4.1 Head Positioning Control

The head positioning circuit is comprised of a four-phase stepper motor/ pulley/band combination for converting rotational to linear motion. The pulley/ band is attached to the head carriage. Signals from the stepper motor control logic drive the stepper motor which, through the pulley/band, move the head carriage assembly. The stepper motor control logic responds to signals from the user supplied interface.

The four-phase stepper motor operates in a "one-phase on" mode. One step of the motor equals a one-track linear motion of the head(s). This one-to-one ratio results in high positioning accuracy and high step rates. When positioned at Track 00 the correct phase on is 4. To move the head(s) toward the center of the diskette, with the DIRECTION line high, the correct phase sequence is as follows:

TRACK	PHASE ON
00	4
01	1
02	2
03	3
04	4

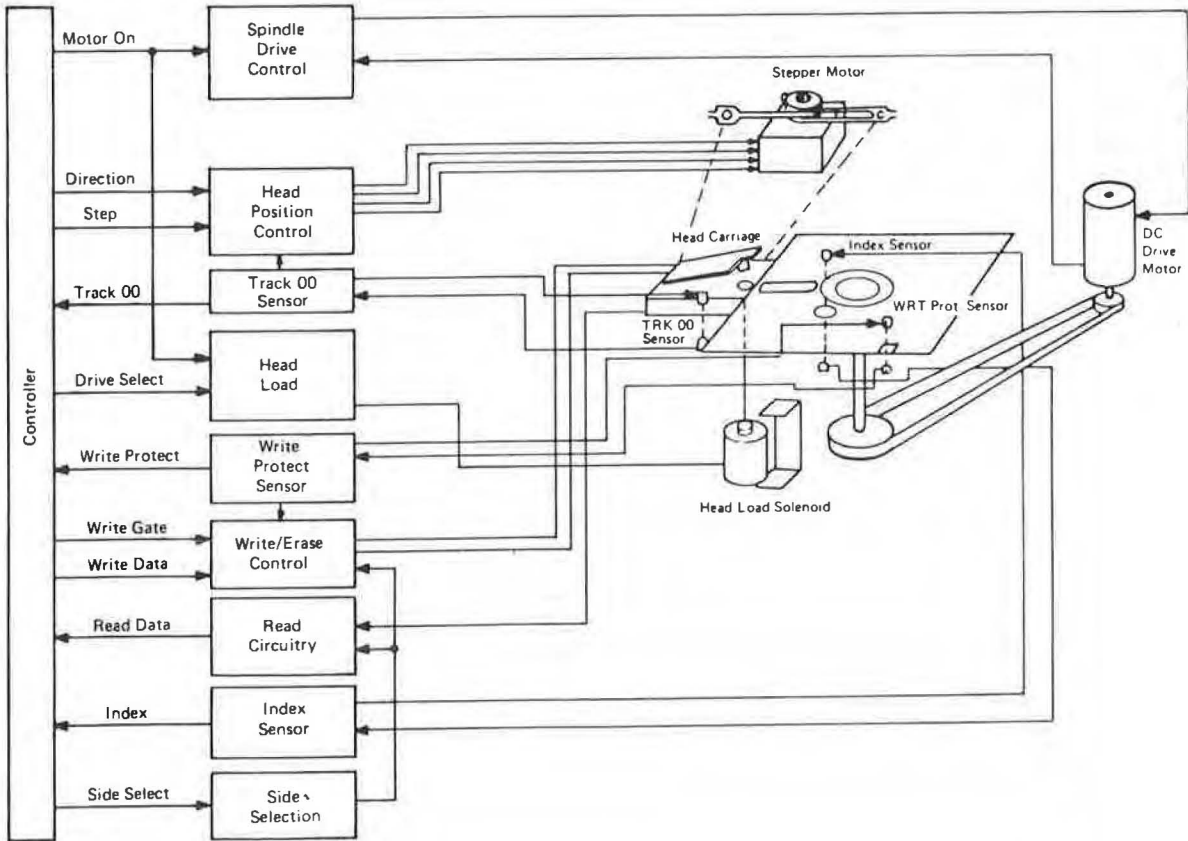

Figure 3-14: Functional Block Diagram

3.4.2 Track 00 Sensor

The track 00 sensor comprises a light source (LED) and a photo-transistor positioned on either side of a shutter mounted on the head carriage assembly. The output of this photo detector connects to a conditioning circuit that converts the output of the photo-transistor to digital TTL levels. When the head positioning logic positions the head over track 00, the output of the conditioning circuit is a low-true logic level on the TRACK 00 interface line. This signal also inhibits the stepper motor circuitry from responding to any "step out" command.

3.4.3 Spindle Drive Control

The spindle is rotated, via a belt, by a DC motor/AC tachometer combination. The electronics for speed control takes timing information from the tachometer (A), compares it with a reference time (B), and generates a driving voltage for the spindle motor proportional to the difference between (A) and (B). When the MOTOR ON interface line is true the control circuit allows the motor to come up to speed. The control circuit also includes a section that disables the motor drive in case of no tachometer output for approximately 150 milliseconds (possible indication of a binding spindle or motor). The diskette is held on the spindle hub by a clamping mechanism which actuates in conjunction with the front door.

3.4.4 Index Sensor

The LED and phototransistor in the index sensor photo detector are mounted on opposite sides of the index hole in the diskette. The index hole acts as the shutter. When the light beam from the LED passes through the diskette hole and strikes the phototransistor, the output of the phototransistor, through a conditioning circuit, generates a low true logic level on the INDEX interface line. The position of the phototransistor is adjustable.

3.4.5 Head Load Mechanism

The head load mechanism consists of a head load solenoid and a head load solenoid driver. The interface logic may be connected to energize the solenoid via either DRIVE SELECT or MOTOR ON interface signals (see paragraph 3.2.1.4). Activating the solenoid causes the diskette to be pressed against a fixed platen and a spring loaded load arm with a felt pad (Model 91) or upper head (Model 92) opposite the head to press the diskette against the head. This load arm is lifted when the front access door is opened regardless of the state of the solenoid.

3.4.6 Side Selection

The Model 92 disk drive has two read/write heads; one on each side of the diskette. Therefore, prior to the read or write process the desired "side" (head) of the diskette must be selected. Interface signal SIDE SELECT controls a decoder that enables the read/write amplifiers for either head zero (bottom head) or head one (top head) to be connected into the read/write circuits to the interface.

3.4.7 Data Recording and Retrieving

The drive uses tunnel-erase head(s). The erase gap follows the write/read gap in the head assembly. The erase gap erases the edges of the written track to provide a guard band between tracks to allow for positioning tolerances among drives. The recording and retrieving electronics consist of:

- A. Write current source

- B. Steering Circuit
- C. Erase driver
- D. Read amplifier
- E. Differentiator
- F. Cross-over detector
- G. Pulse generator

3.4.7.1 Data Recording

To record digital data, current is passed through the winding on the write/read head core which sets up a flux field across the write/read gap. This orients the iron oxide particles on the diskette surface underneath the gap to the same polarity. The direction of the flux field is a function of the polarity of the write current. Data is written by reversing the current through the head. Each flux reversal represents a data bit. The head(s) in the drive uses a center-tapped write/read winding, where the current reversal is accomplished by steering the current through one or the other of the two halves of the winding. Figure 3-15 shows the basic recording technique. The following conditions must be accomplished by the user before the recording can begin:

- A. Spindle speed must be stabilized. This condition will exist 0.5 seconds after the MOTOR ON command is issued.
- B. Head/media must be stabilized subsequent to the HEAD LOAD command. This requires 35 milliseconds.
- C. Head must be settled subsequent to the STEP command. This requires 30 milliseconds (5 milliseconds for motion and 25 milliseconds for settling).

The preceding conditions may be overlapped. It is recommended that the first WRITE DATA command be within 4 to 8 microseconds after WRITE GATE goes true, and the last WRITE DATA command be within 4 to 8 microseconds before WRITE GATE goes false. The erase circuit enables the erase current 430 microseconds after WRITE GATE goes true and disables the erase current 850 microseconds after WRITE GATE goes false. These time relationships are optimized for proper erasure on both inner and outer tracks.

3.4.7.2 Data Retrieving

The retrieving (read) electronics comprises the following elements:

- A. Read amplifier

- B. Linear filter
- C. Differentiator
- D. Cross-over detector
- E. Digital filter
- F. Pulse shaper

Before reading can begin, several conditions must be established by the user system. First, the same conditions applicable to data recording must be met. Additionally, if the previous operation was writing, 1 millisecond must be allowed after termination of WRITE GATE to allow for erase and circuit-settling time. Figure 3-16 shows wave forms in the read sequence. The head generates a wave form with peaks corresponding to the flux transitions. This wave form is amplified, fed through a low-pass filter, and then differentiated to make the peaks occur at zero cross-over. The read signal is next fed to a cross-over detector, which generates a pulse for each zero cross-over. These pulses are fed through a digital filter which removes false pulses. Finally, the pulse shaper generates a one microsecond pulse corresponding to each flux transition. This composite read data is sent to the user interface via the READ DATA line.

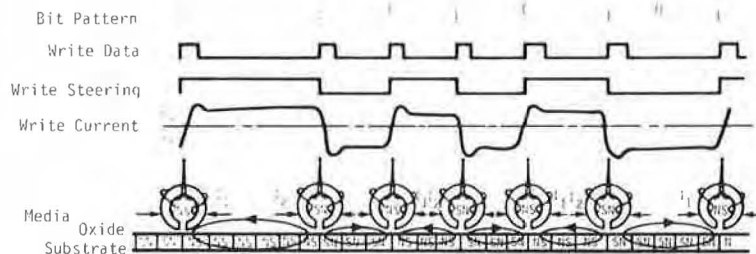

Figure 3-15: Basic Recording Technique

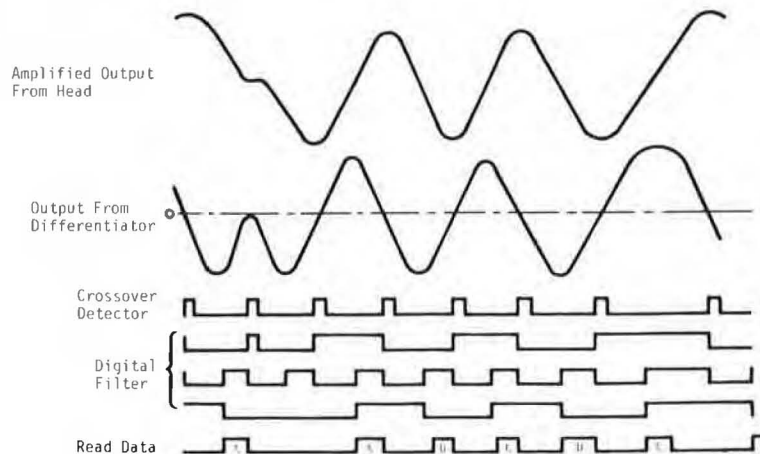

Figure 3-16: Wave Forms in Read Sequence

3 5 DETAILED DESCRIPTIONS

The following paragraphs give details of the operation of the disk drive electronics. The descriptions are referenced to sheets 2 and 3 of drawing 4-04002-001. Timing diagrams are interspersed with the text. "Zone" reference numbers and letters in the text locate the circuits on the sheets of drawing 4-04002-001. Voltage levels in timing diagrams are TTL unless otherwise noted. Drawing 4-04002-001 is located in Appendix B.

3.5.1 Power up/Power down Logic (See Sheet 2, Zone B5, B6)

The power up/power down logic ensures that no extraneous writing or erasing is performed while applying or removing power to/from the disk drive. The logic comprises CR1 and CR2 connected between Vcc and multiplexer 5A. This guarantees that 5A will be the first IC to power down and the last IC to power up. Thus, for approximately 10 to 30 milliseconds after the rest of the logic has powered up, the outputs for 5A are floating, preventing any writing or erasing. When 5A finally powers up, and its outputs begin to respond to input signals, the inputs have already stabilized to the levels needed to prevent any extraneous writing or erasing.

3.5.2 Stepper Motor Control Logic (See Sheet 3, Zone C)

The stepper motor control logic consists of two-stage counter 3C and associated logic to decode the outputs of the counter to the correct phases of the stepper motor to cause steps in the desired direction. Each step consists of rotating the stepper motor shaft 1.8 degrees. This rotational motion is converted to linear motion by the band/pulley assembly. The diameter of the pulley is such that a rotation of 1.8 degrees translates into a linear motion of 0.010415 inches, which is the track-to-track spacing required (96 tracks per inch equals 0.010415 inches per track).

The stepper motor is a four-phase, 200 pole, 1.8 degree per pole (step) stepper motor. It is operated so that one phase is always energized. Refer to Timing Diagram Figure 3-17.

A minimum 0.2 microsecond low STEP interface pulse at J1-20 clocks counter 3C. The outputs of 3C at pins 13 and 14 generate phases 01, 02, 03, and 04. Pins 7 and 10 of 3C are low true active enable lines. These inputs are controlled by gate 4C-12, which disables the counter if any of its inputs are low true.

Input 4C-1 (W), from 6C-4 (sheet 2) is the same polarity as WRITE GATE. This input disables stepping while writing. Input 4C-2 is the SELECT/ signal, which is the opposite polarity of DRV SEL (when shunt 1G-5 to 1G-10 is disconnected). Thus, no stepping is allowed when the drive is deselected. Input 4C-13 is connected to gate 4C-8, the inputs to which are TRACK 00/ and DIRECTION. Thus, no stepping is permitted in the out direction when the head/ carriage assembly is located at track 00. This is the electronic track 00 stop.

3.5.3 Track 00 Logic (See Sheet 3, Zone B)

The track logic consists of the track 00 sensor (a LED and a phototransistor), a comparator (4F) and additional logic to generate the TRACK 00 interface output signal. Refer to Timing Diagram, Figure 3-17.

When the head/carriage assembly is located at track 00, the light from the LED is allowed to strike the track 00 phototransistor. This turns on the transistor and establishes a low logic level at J4-12 and comparator 4F-10. This causes the comparator output at 4F-13 to go to a high logic level. The output of 4F-13 is gated with 3C-13 and 3C-14 at gate 4C-6 to generate a low level at 4C-6 when the head/carriage assembly is at track 00 and phase 4 is energized. This is necessary because the track 00 phototransistor may be partially or fully on when the head/carriage is positioned at tracks 01 or 02. However, at these times phase 4 is not energized.

The output of 4C-6 is inverted by 3D-4 and disables stepping in the out direction as described in paragraph 3.5.2. The TRACK 00 signal is also gated with SELECT/ to give the low active TRACK 00 output signal at interface connector J1-26.

3.5.4 Drive Motor Control Logic (See Sheet 3, Zone A)

The drive motor control logic comprises tachometer signal digitizer 4F, enable one-shot 6E, reference one-shot 6E-13, time compare gate 6C, integrator network CR3, C16, R31, low-frequency amplifier 4F, and power output transistor Q3. Figure 3-18 is a Timing Diagram of the Drive Motor Logic. When input signal MOTOR ON becomes high at input pin 10 of 6E, this one-shot triggers which, via 6C-13, causes the anode of CR3 to go high. This charges C16 through CR3 from R33. The resultant positive voltage at input pin 7 of 4F is amplified and coupled through Q3 as the starting voltage for the drive motor at output pin 31 of J4.

One-shot 6E is also enabled by signal MOTOR ON so that, after the start trigger generated by MOTOR ON switching high, successive triggers from the TACH DIG signal cause 6E-12 (termed STALLED/) to remain low. If the MOTOR ON signal at J1-16 goes high, 6E becomes disabled which removes the charging source from C16 and causes the drive motor to stop. Also, if the motor stalls TACH DIG will stop triggering 6E-9, the one-shot will time out, and STALLED/ will go high.

The output of the tachometer attached to the drive motor is digitized by 4F. The resultant digital signal, termed TACH DIG, is the trigger source for reference one-shot 6E-1. The TACH DIG signal is also one input to comparator gate 6C. 6C compares the TACH DIG signal with the output of one-shot 6E-13. If the drive motor rotates too slowly, TACH DIG becomes low for a longer period than the output of the reference one-shot. This generates a positive pulse at the output of 6C-10 which makes the charge on C16 more positive. The increased charge is amplified by 4F and causes an increase in motor speed. If the drive motor is operating too fast,

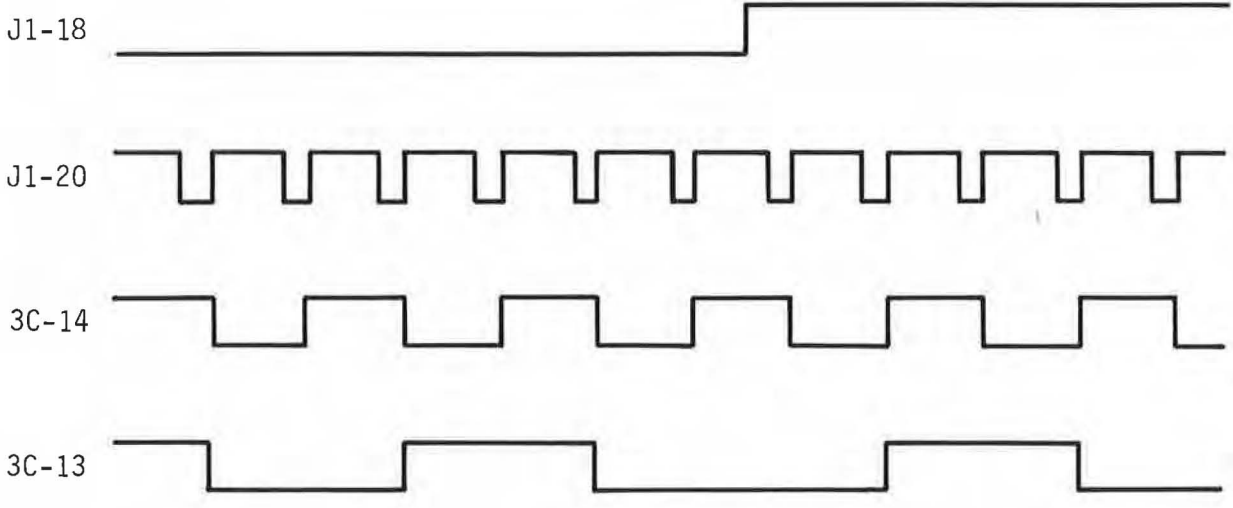

VOLTAGE OF PHASE SIGNALS (LOW = +.3V, HIGH = +12V)

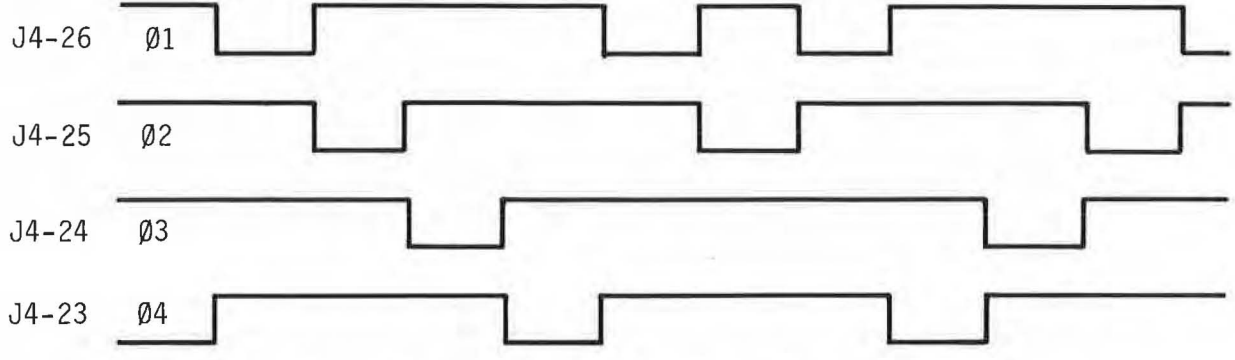

TRACK NO. 00 | 01 | 02 | 03 | 04 | 05 | 06 | 05 | 04 | 03 | 02 |

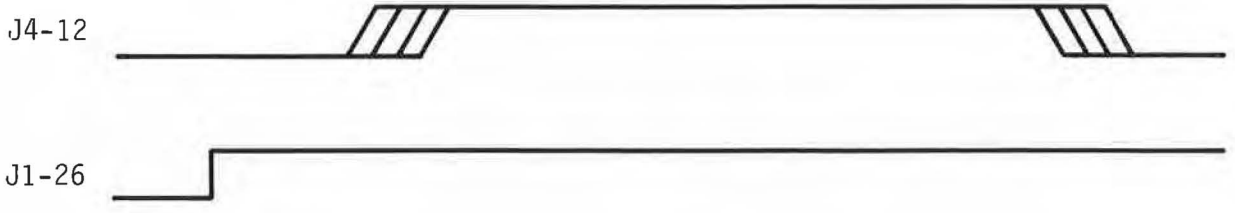

Figure 3-17: Stepper Motor Control Timing

the output of 6C-10 will switch low, back-biasing CR-3, causing C16 to start discharging through R31. This makes the input at 4F-7 more negative, reducing the amplitude at the output of 4F, which slows down the drive motor. Finally TACH DIG will become low for a longer time than the reference signal, causing positive pulses charging C16 once again and stabilizing the motor speed.

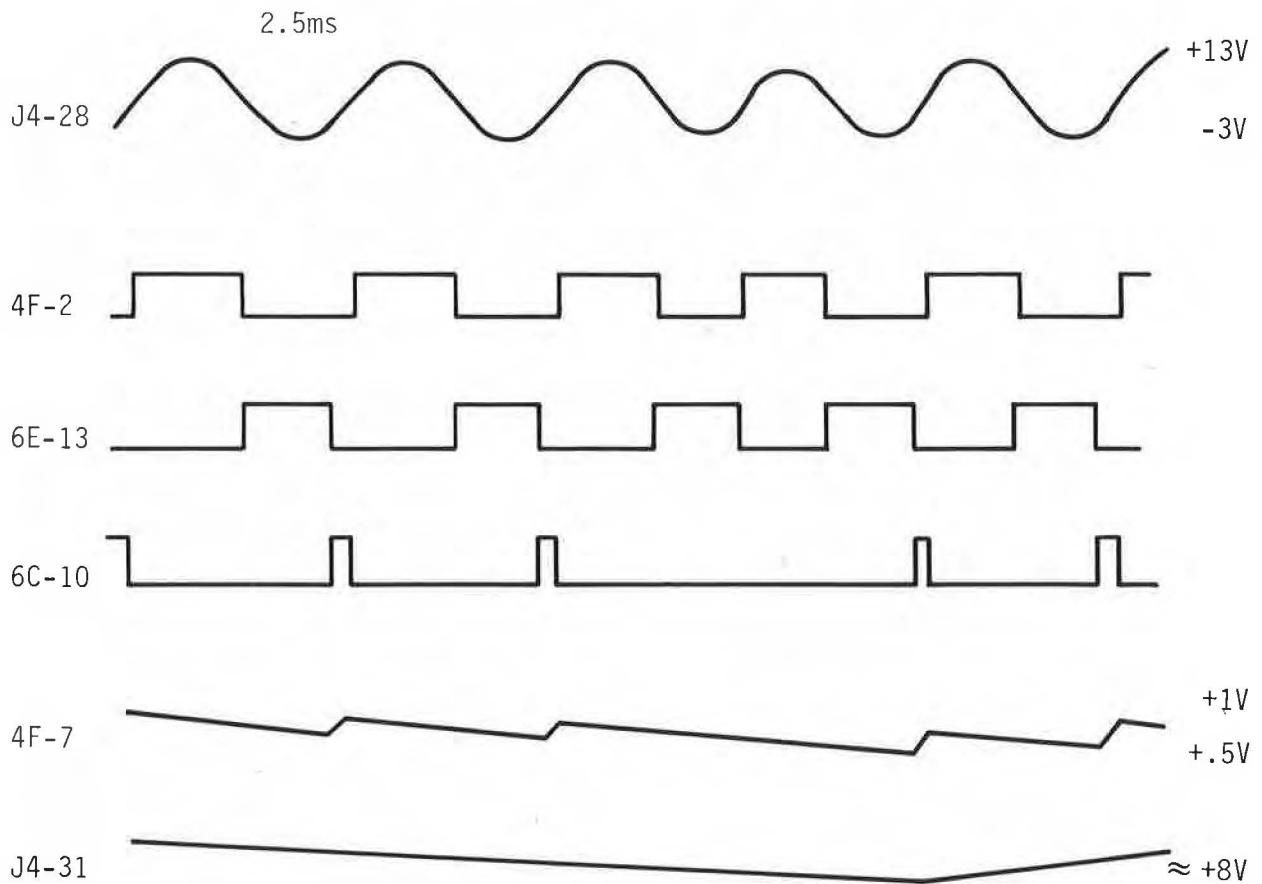

Figure 3-18: Motor Control Timing

3.5.5 Index Logic (See Sheet 3, Zone B)

The index logic consists of an LED and a phototransistor, a comparator (4F) and an output driver (2G-6). The LED and phototransistor supply signals to comparator 4F-14. This circuit is identical to the TRACK 00 detector circuit.

When an index, or sector, hole in the diskette passes under the index LED, the light impinges on the phototransistor, which causes 4F-14 to go to a high logic level. This output signal is gated with SELECT/ to generate the low-active INDEX output signal at connector J1-8.

3.5.6 Head Load Logic (See Sheet 3, Zone D)

The head load logic consists of part of programmable shunt 1G and high current driver 5G. When shunt point 1G-7 is connected to 1G-8 the head is loaded by the low-active MOTOR ON signal.

When the shunt points 1G-1 and 1G-14 are connected, the head is loaded by the low-active DRV SEL signals.

3.5.7 Side Select Logic (See Sheet 2, Zone B5, B6)

The side select logic comprises data selector 5A and associated circuits. To select side 0, a high level is placed on J1-32 (SIDE SELECT). Side 0 is the bottom head in Model 92 drives and the only head in Model 91 drives. In Model 91 (single head drive) systems, SIDE SELECT can be left disconnected, (note the termination resistor on this input). A high level on SIDE SELECT becomes a low level on pins 3 and 14 of decoder 5A. 5A is a dual decoder. Decoder section 1 controls writing or reading on either head 0 or head 1. Decoder section 2 controls the erase winding on each head.

A low level on SIDE SELECT becomes a high level on pins 3 and 14 of decoder 5A; and selects head 1, the top head in Model 92 systems. Output pins 4 and 5 control head 0; output pins 6 and 7 control head 1. The active level at these outputs is low. In addition to selecting a head, or selecting between heads, either a read or write operation must be selected at the WRITE GATE input pin. The level at WRITE GATE is inverted to control 5A input pin 2. Table 3-2 relates the levels at SIDE SELECT, WRITE GATE, pins 4, 5, 6, and 7 of 5A to the read or write condition of heads 0 and 1.

Table 3-2: Write/Read and Side Selection Conditions

WRITE GATE	SIDE SELECT	5A PINS				SIDE SELECTED	READ/ WRITE
		4	5	6	7		
High	High	Low	High	High	High	0	Read
Low	High	High	Low	High	High	0	Write
High	Low	High	High	Low	High	1	Read
Low	Low	High	High	High	Low	1	Write

When the output pins of decoder 5A become low levels, emitter current paths are supplied to read/write transistor pairs, thus enabling the appropriate function.

Note that SIDE SELECT, in conjunction with control inputs at pins 13 and 15 of decoder 5A, enables HEAD 1 or HEAD 0 ERASE circuits during write/erase operations.

3.5.8 Write Protect Logic (See Sheet 2, Zone A)

The write protect logic comprises the WRITE PROTECT sensor (an LED and a phototransistor), analog-to-TTL translator 3G-2 and 3G-4, a "write-disable" gate (3E-3), and output driver 3E-11.

When a write-protected diskette is inserted into the drive, the light from the LED is blocked from turning on the phototransistor. This causes 3G-1 to be high, 3G-2 to be low, and 3G-4 to be high. 3G-4 is gated with SELECT/ by gate 3E-11 to generate the low-active WRITE PROTECT signal at J1-28. The low output at 3G-2 makes 3E-3 high. 3E-3 is wire ANDed with gate 6C-1. If either 6C-1 output or 3E-3 output is high, writing is disabled at the enable input of decoder 5A and the erase coils are disabled by disabling one-shots 5B-5 and 5B-13. If 3E-3 output is high, either SELECT/ is low or a write-protected diskette is installed. If 6C-1 is high the controlling device is issuing a read command.

When an unprotected diskette is inserted into the drive, the light from the LED turns on the phototransistor and 3G-1 becomes low. This disables gate 3E-11 from generating WRITE PROTECT and, if SELECT/ is high enables the erase one-shots and decoder 5A in the WRITE mode.

3.5.9 Write/Erase Logic (See Sheet 2, Zones B,C,D, 4-7)

The write/erase logic comprises write flip-flop 2E, a write current source (resistors R23, R24), two pairs of differentially operated write current drivers (1A), erase one-shots 5B and erase driver gates 6A.

Before writing can be done the drive must be selected and an unprotected diskette must be installed. Figure 3-19 is a Timing Diagram of the write/erase logic.

A low level on the WRITE GATE initiates writing on the selected head. This enables the write current drivers in 1A (zones D7, C7) and write flip-flop 2E. Write flip-flop 2E-11 is clocked by W DATA. The state of the Q and \bar{Q} outputs of 2E cause the flow of current through the R/W head of the selected head to reverse with each clock. This current reversal generates a flux reversal on the diskette, writing a data bit.

When WRITE GATE goes low, erase one-shot 5B-13 triggers and enables the erase selection of decoder 5A. The appropriate erase head is selected by SIDE SELECT via pin 14 of 5A. The duration of the

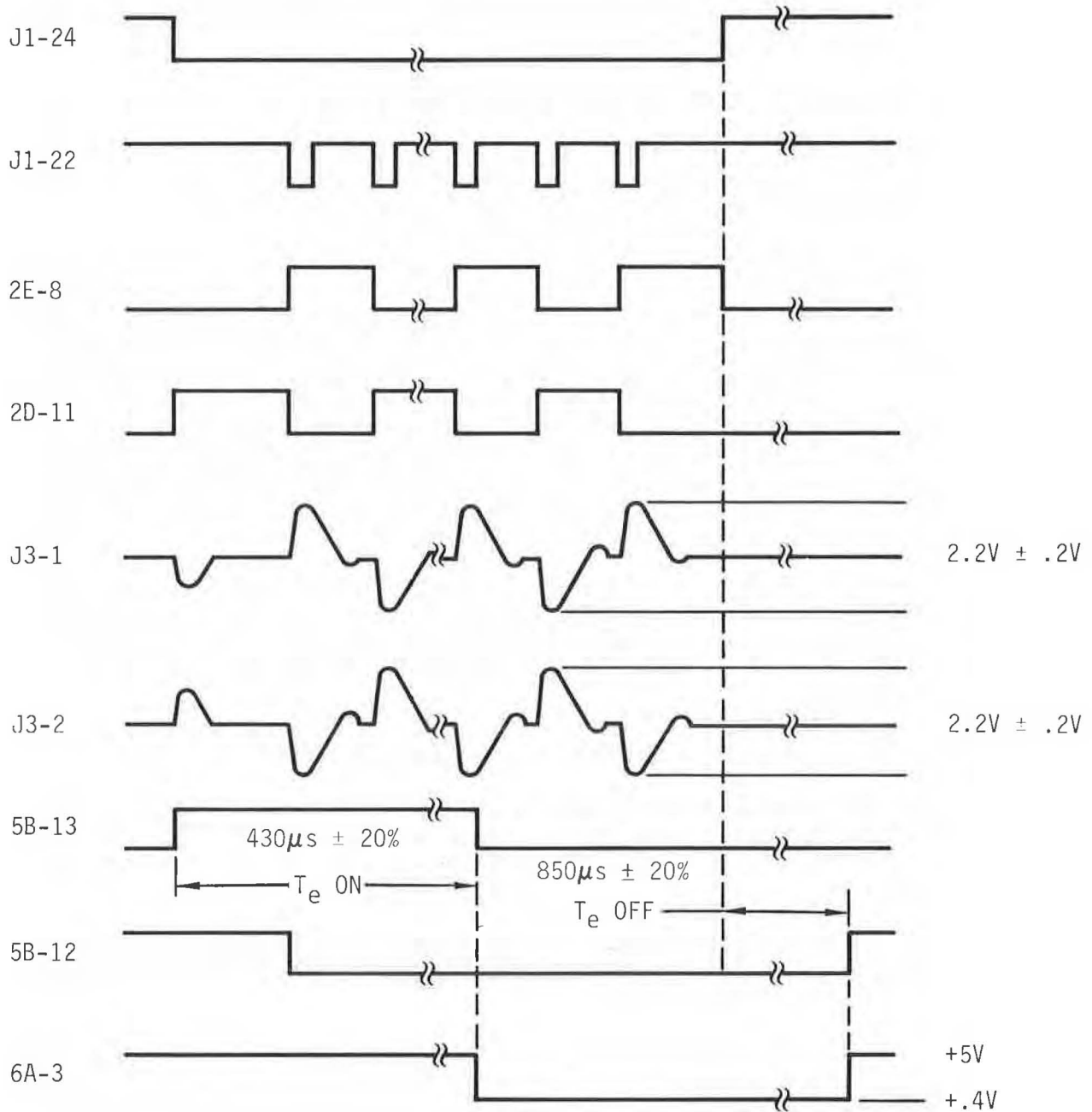

Figure 3-19: Write Timing

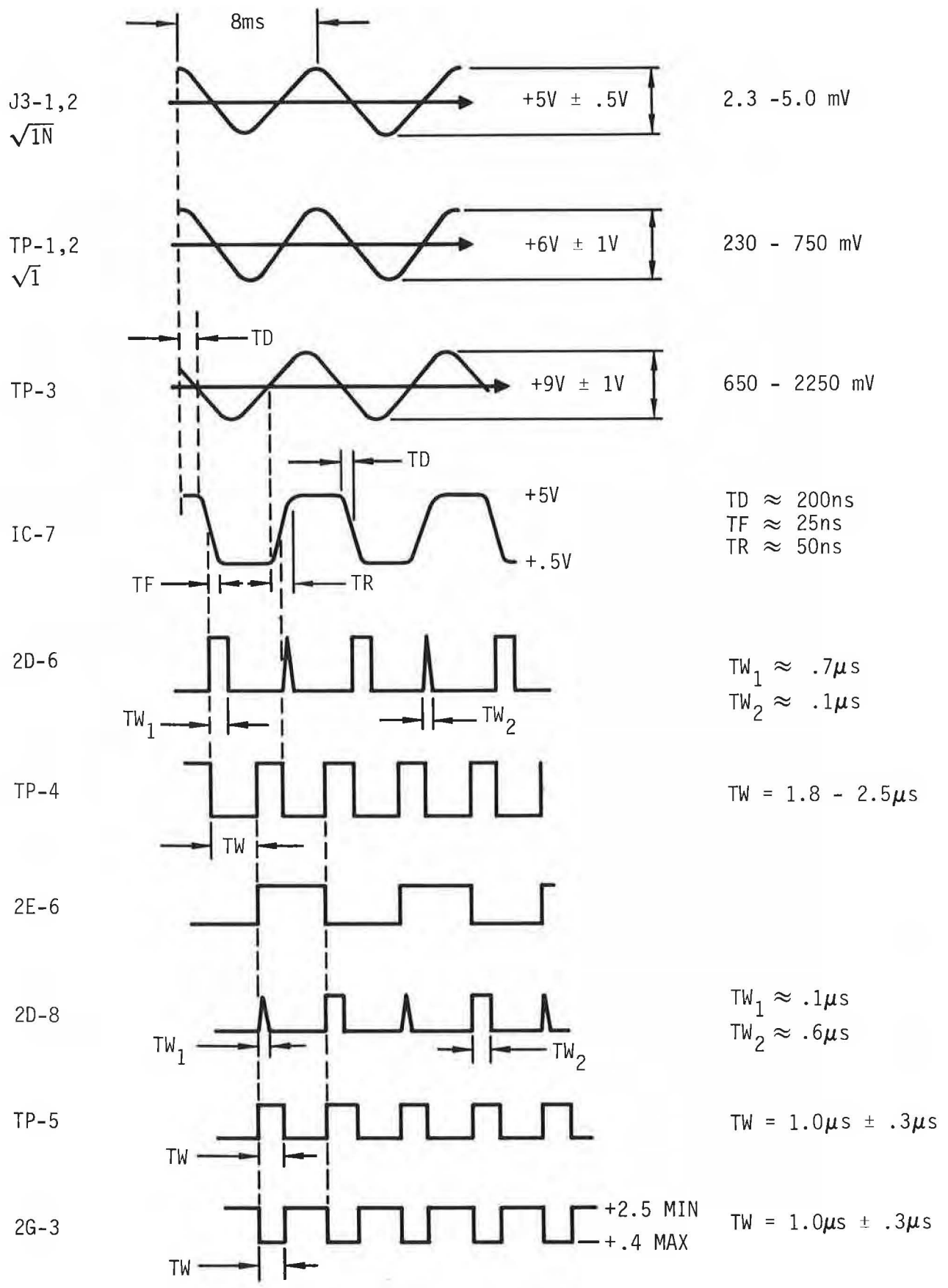

Figure 3-20: Read Timing

erase signal is a function of the second erase one-shot (5B-5) which energizes the tunnel-erase coil of the read/write/erase head(s).

3.5.10 Read Logic (See Sheet 2, Zone D)

The read logic comprises preamplifier 2A, emitter followers Q1 and Q2, low-pass filter components L1, L2, L3, L4, C6, differentiator 2B, crossover detector IC, digital filter 1E and 2E, and pulse shaper 1E. Figure 3-20 illustrates the read logic timing.

A read/write head senses flux changes on the diskette and generates a sine wave with the peaks occurring at the time of the flux changes. The output of the head is approximately 1.2 to 2.7 millivolts peak-to-peak, depending upon the flux changes per inch (FCI) on the diskette track as detected by the read/write head. The read signal is amplified by 2A. The gain of 2A is between 100 and 150. Therefore, the differential signal at the cathodes of CR4 and CR5 is between 120 and 400 millivolts peak-to-peak. The amplified signal is coupled through emitter followers Q1 and Q2 and the LC filter to differentiator 2B.

Pins 7 and 8 of the differentiator have a zero crossing that corresponds to each peak of the read signal. These outputs are AC coupled through C10 and C11 to crossover detector IC, which generates a high-to-low or low-to-high digital transition for each zero crossing detected from differentiator 2B.

The output of IC-7 is connected to the frequency doubler circuit R30, C14, and 2D, the output of which clocks digital filter one-shot 1E. 1E and 2E block out false crossover detections. The output of 2E-6 is frequency doubled by R40, C25, and 2D, which clocks one-shot pulse shaper 1E-10. The output of 1E-5 is the composite clock and read data signal, which is gated with signal SELECT to form the low active READ DATA output signal.

3.6 DATA ENCODING AND RECOVERY

This section provides applications information relevant to the recording and recovery of data with the Model 91/92 Flexible Disk Drives. The three most common methods for encoding data are described in the following paragraphs. Table 3-3 shows a comparison of these encoding techniques.

3.6.1 FM Encoding

FM (frequency modulation) encoding has the following rules:

- A. A data bit, if it is a "1", occurs at the center of the bit cell.

B. A clock bit occurs at the start of the bit cell.

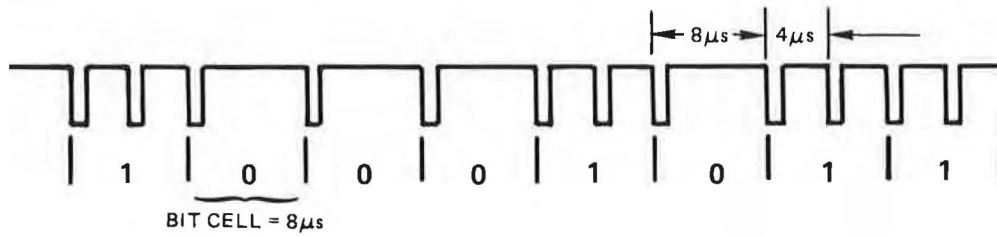

Figure 3-21: FM Encoding

3.6.2 MFM Encoding

MFM (modified FM) encoding has the following rules:

- A. A data bit, if it is a "1", occurs at the center of the bit cell.
- B. A clock bit occurs at the start of the bit cell, but only if no data bit occurred in the previous bit cell and no data bit will occur in the current bit cell.

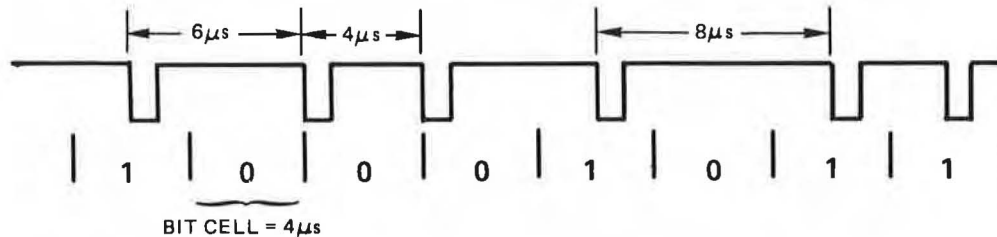

Figure 3-22: MFM Encoding

3.6.3 M²FM Encoding

M²FM (modified MFM) encoding has the following rules:

- A. A data bit, if it is a "1", occurs at the center of the bit cell.
- B. A clock bit occurs at the start of the bit cell, but only if neither a data bit nor a clock bit occurred in the previous bit cell and no data bit will occur in the current bit cell.

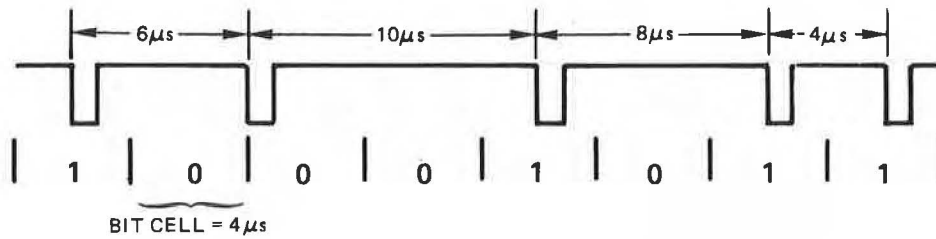

Figure 3-23: M²FM Encoding

3.6.4 Data Recovery

Data recovery refers to the retrieving of data from the flexible diskette. The following paragraphs describe the problems associated with data recovery and methods to ensure data reliability.

3.6.4.1 Bit Shift

Bit shift refers to the displacement of a bit, as detected by the drive, from its nominal position. The causes of bit shift are manifold -- R/W head resolution, media resolution, diskette speed variation, signal-to-noise ratio of read head output. Any data separation technique used must have a read window of at least 1.5 µs to handle this bit shift.

3.6.4.2 Write Precompensation

Certain data patterns cause more bit shift than other patterns. This bit shift is predictable and can thus be partially compensated for. For example, if it is known that a bit will be shifted by 500 ns when it is read back, then the bit can be deliberately written 200 ns early. This would give a bit shift of about 350 ns when it is read back. This method of reducing bit shift is called write precompensation.

Bit shift is greater on the inner tracks of the diskette than on the outer tracks, making write precompensation necessary only on the inner tracks. Write precomp of 250 to 300 ns should be used on tracks 36 through 79. If due to controller limitations, write precomp must be used on all tracks, then 125 to 150 ns should be used. Table 3-3 shows which encoding methods require the use of write precompensation.

3.6.4.3 Data Separation

Data separation refers to the separating of the composite data coming from the drive into separate clock and separate data bits.

For FM recording, a one-shot data separator is quite sufficient. For double density recording, a phase-lock-loop (PLL) data separator should be used. There is another method of data separation, the digital counter method. This method is a very poor approximation of a PLL. It has a theoretical read window of only 1.0 us which, as per paragraph 3.6.4.1, is not sufficient to handle bit shift.

In MFM recording, data bits and clock bits are subject to the same amount of bit shift. A PLL separator with a 50% data window and a 50% clock window should be used.

In M²FM recording, data bits are subject to more bit shift than clock bits. A PLL separator with a 60% data window and a 40% clock window should be used.

3.6.5 Track Format

When determining the track format to be used, the following timing restraints should be considered (see Figure 3-24).

- A. Postamble: The postamble period must be at least 3 ms to allow for spindle speed variation of $\pm 1\frac{1}{2}\%$.
- B. Data Gap: The data gap period must be at least 1 ms to allow for tunnel erase turn off time.

Encoding Technique	FM	MFM	M ² FM
Bit Cell Time	8 μ s	4 μ s	4 μ s
Possible pulse spacing	4 μ s	4 μ s	4 μ s
	8 μ s	6 μ s	6 μ s
		8 μ s	8 μ s
			10 μ s
Frequency components of read signal	125 KHz	125 KHz	125 KHz
	62.5 KHz	93.75 KHz	93.75 KHz
		62.5 KHz	62.5 KHz
			50 KHz
Encoder complexity	Simple	Moderate	Moderate
Write precompensation needed	No	Yes	Yes
Data separator recommended	One-shot	PL0(50-50 window)	PL0(60-40 window)
Data separator complexity	Simple	Moderate	Moderate

Table 3-3: Comparison of Encoding Techniques

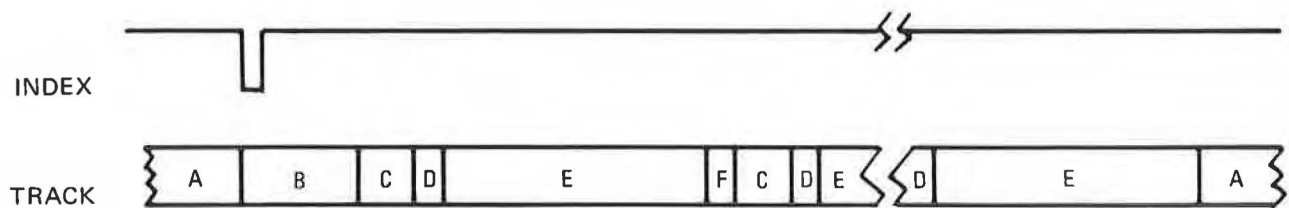

A – Postamble D – ID Gap
 B – Preamble E – Data Record
 C – ID Record F – Data Gap

Figure 3-24: Typical Track Format

SECTION 4

MAINTENANCE

4.1 INTRODUCTION

This section contains preventive maintenance procedures, component removal/replacement procedures, adjustment and measurement procedures. The material is referenced to drawings located throughout the text, a spare parts list located in Appendix A, and drawings and schematics located in Appendix B. Adjustment procedures will be required if parts are changed due to malfunction and measurements should be made periodically to ensure data quality or if malfunctions are suspected. It is recommended that a master alignment diskette be kept and that each alignment be verified to the master.

TABLE 4-1: SECTION INDEX

Topic	Paragraph
Preventive Maintenance	4.3
Recommended Tools and Test Equipment	4.4
Removal/Replacement Procedures	4.5
Adjustment Procedures	4.6
Measurement Procedures	4.7

4.2 GENERAL INFORMATION

The following statements are applicable to all facets of drive maintenance:

- A. Do not remove any components or the printed circuit board or connect or disconnect any plugs while power is applied to the drive.
- B. Component-location instructions, such as right guide, left guide, etc., are referenced as viewed from the rear of the drive.

- C. Female connectors that carry signals internal to the drive slip over pins of the male connectors. Most of the connectors are keyed so that they cannot be plugged into the wrong receptacle. However, they can be inserted upside down. For positioning accuracy one side of the female connectors is slotted with so-called "windows" over the pins. Installation instructions are given to install the connectors with the window side facing a certain direction, i.e., toward the chassis, away from the chassis, etc.
- D. Do not use magnetic tools within the drive.
- E. Instructions are given to "remove screws or replace screws"; it is understood that flat washers, lock washers, and shims (where required) are also to be removed and, more importantly, replaced. It is important to always replace the exact quantity of washers and shims that were removed and in the same order.

4.3 PREVENTIVE MAINTENANCE

The only recommended preventive maintenance to ensure optimum performance of the disk drive is periodic cleaning of the read/write head(s) and inspection of the head load pad.

4.3.1 Read/Write Head(s) and Load Pad Inspection

Inspect the load pad (or top head) for excessive oxide, using a dental mirror.

CAUTION

Do not move the upper head arm any further than is allowed by the door in its open position.

Refer to Figure 4.1. To clean the head(s) use a lint-free cloth or a cotton swab moistened with either methyl alcohol or 91% Isopropyl alcohol. Wipe the head(s) carefully to remove all accumulated oxide and dirt. Dry the head(s) using a lint-free cloth. If cleaning the head(s) does not improve operation, refer to the troubleshooting section. If head(s) are damaged or worn, refer to the head/carriage replacement procedure (paragraph 4.5.15). If head load pad is dirty or worn, refer to head load pad replacement procedure (paragraph 4.5.18).

4.4 RECOMMENDED TOOLS AND TEST EQUIPMENT

The following list of tools and test equipment are recommended for the removal/replacement procedures and the adjustment and measurement procedures in this section.

4.4.1 Removal/Replacement

- A. Wire cutters
- B. Needlenose pliers with serrated jaws
- C. Phillips head screwdriver, No. 0 and No. 1
- D. Phillips head torque screwdriver, No. 0 set to 20 inch-ounces
- E. Phillips head torque screwdriver, No. 1 set to 30 inch-ounces
- F. Hex screwdriver, 0.050 inch
- G. Dental mirror
- H. Nut driver, 0.25 inch
- I. Bent nose tweezers
- J. Slot head screwdriver

4.4.2 Adjustment and Measurement

- A. Oscilloscope, dual trace, with channel "add" and external sync capability.
- B. Read/write (scratch) diskette
- C. CE alignment diskette (MPI part number 1-42003-001 double/1-42002-001 single)
- D. Phillips head screwdrivers, No. 0 and No. 1
- E. Phillips head torque screwdriver, No. 0 set to 2.0 inch-ounces

4.5 REMOVAL/REPLACEMENT PROCEDURES

The following material gives sequential instructions for removing and replacing major components of the disk drive. Table 4-2 lists the removal/replacement procedures contained in this section. Figures 4-1 and 4-2 are top and bottom views of the disk drive that illustrate the components for which replacement instructions are given. The appropriate paragraph should be referenced when performing any of these procedures. An exploded view of the

Model 91S is illustrated in figure 4-3 and should be used only as a reference to familiarize yourself with the arrangement of the assemblage. Table 4-3 references assemblies that may need to be adjusted when major components are removed/replaced.

TABLE 4-2: REMOVAL/REPLACEMENT PROCEDURES

Procedure	Paragraph
Printed Circuit Board Assembly (PCBA)	4.5.1
Shield Assembly	4.5.2
Right-Hand Guide/Write Protect Assembly	4.5.3
Left-Hand Guide Assembly	4.5.4
Front Panel Bezel and Activity LED	4.5.5
Cone Assembly	4.5.6
Carrier Assembly	4.5.7
Index/Load Boss Assembly	4.5.8
Solenoid	4.5.9
Drive Motor	4.5.10
Track 00 Sensor	4.5.11
Door Button Assembly (91/92 only)	4.5.12
Stepper Band	4.5.13
Stepper Motor	4.5.14
Head/Carriage Assembly	4.5.15
Ejector Assembly (91/92 only)	4.5.16
Spindle, Bearings and Pulley	4.5.17
Head Load Pad Assembly	4.5.18
Harness Assembly	4.5.19

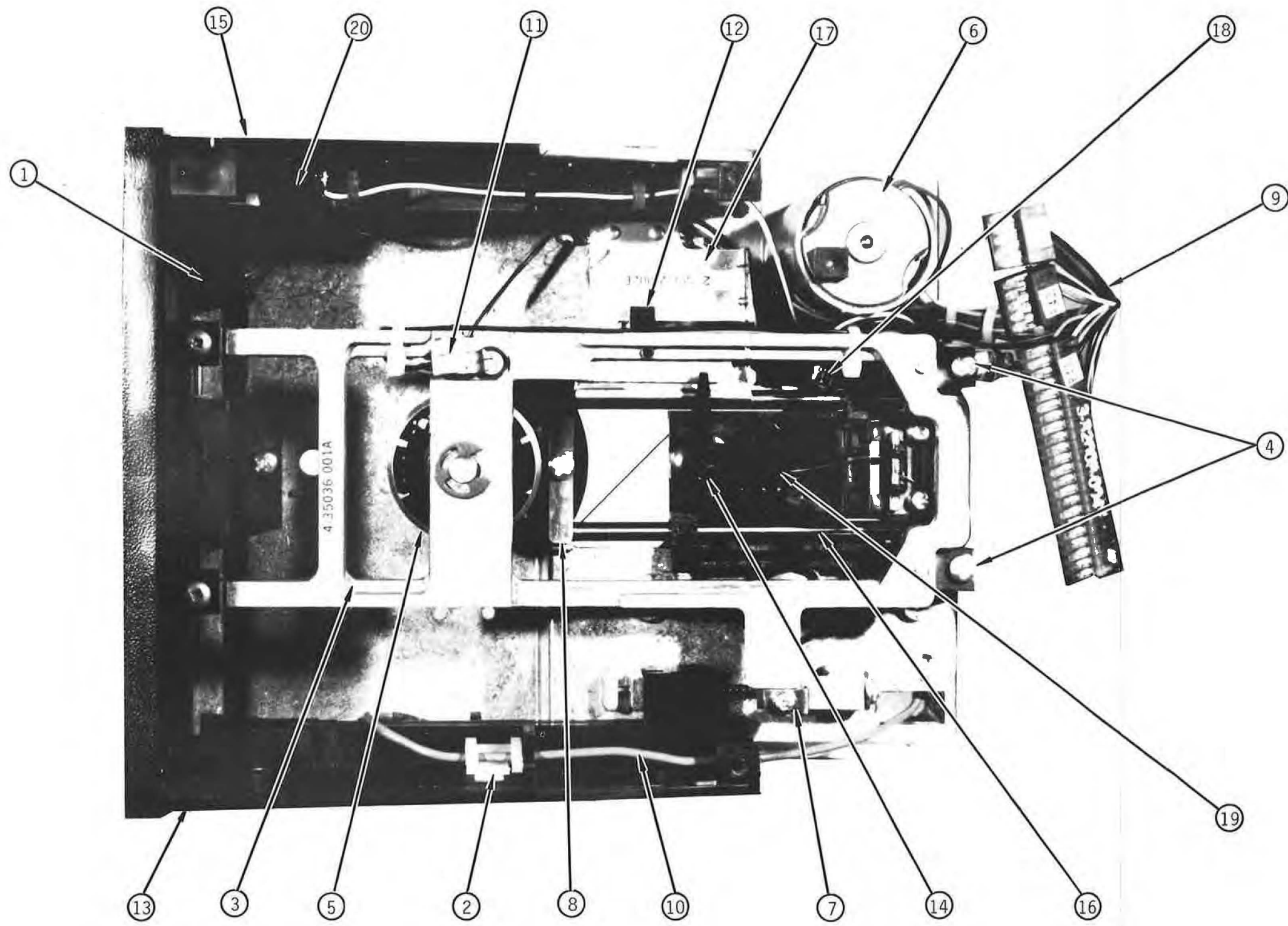

Figure 4-1: Top View of Drive

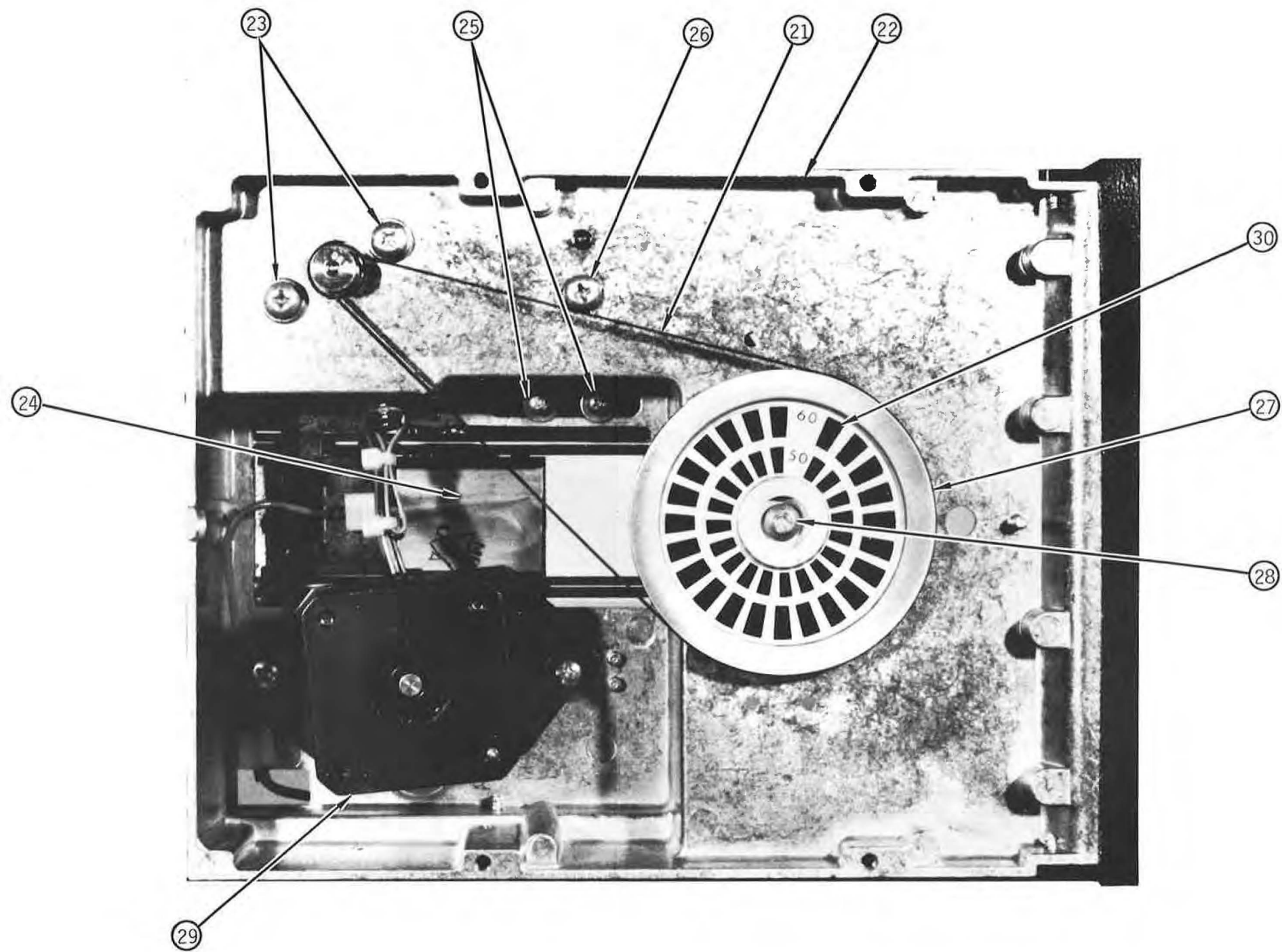

Figure 4-2: Bottom View of Drive

Figure 4-2 Parts List

21. Drive Belt
22. Drive Chassis
23. Drive Motor Mounting Screws
24. Head/Carriage Assembly
25. Index/Load Boss Mounting Screws
26. Solenoid Mounting Screw
27. Spindle Pulley
28. Spindle Pulley Mounting Screw
29. Stepper Motor Assembly
30. Strobe Label

TABLE 4-3: REMOVAL/REPLACEMENT ADJUSTMENT CHECK LIST

ASSEMBLY	CHECK OR ADJUSTMENT	PARAGRAPH
Head/carriage	Radial-track alignment	4.6.1
	Track 00 sensor alignment	4.6.3
	Track 00 set screw adjustment	4.6.5
	Compliance	4.7.1
Stepper motor	Radial-track alignment	4.6.1
Track 00 sensor	Track 00 sensor alignment	4.6.3
Index/load boss	Index-to-data alignment	4.6.2
Carrier	Index-to-data alignment	4.6.2
	Ejector (91/92 only)	4.6.7
Printed Circuit	Drive motor speed	4.6.4
Board (PCB)	Index-to-data alignment	4.6.2
Drive motor	Drive motor speed	4.6.4
	Drive belt	4.6.6
Spindle Pulley	Drive motor speed	4.6.4
	Drive belt	4.6.6
Head Load Pad	Compliance	4.7.1

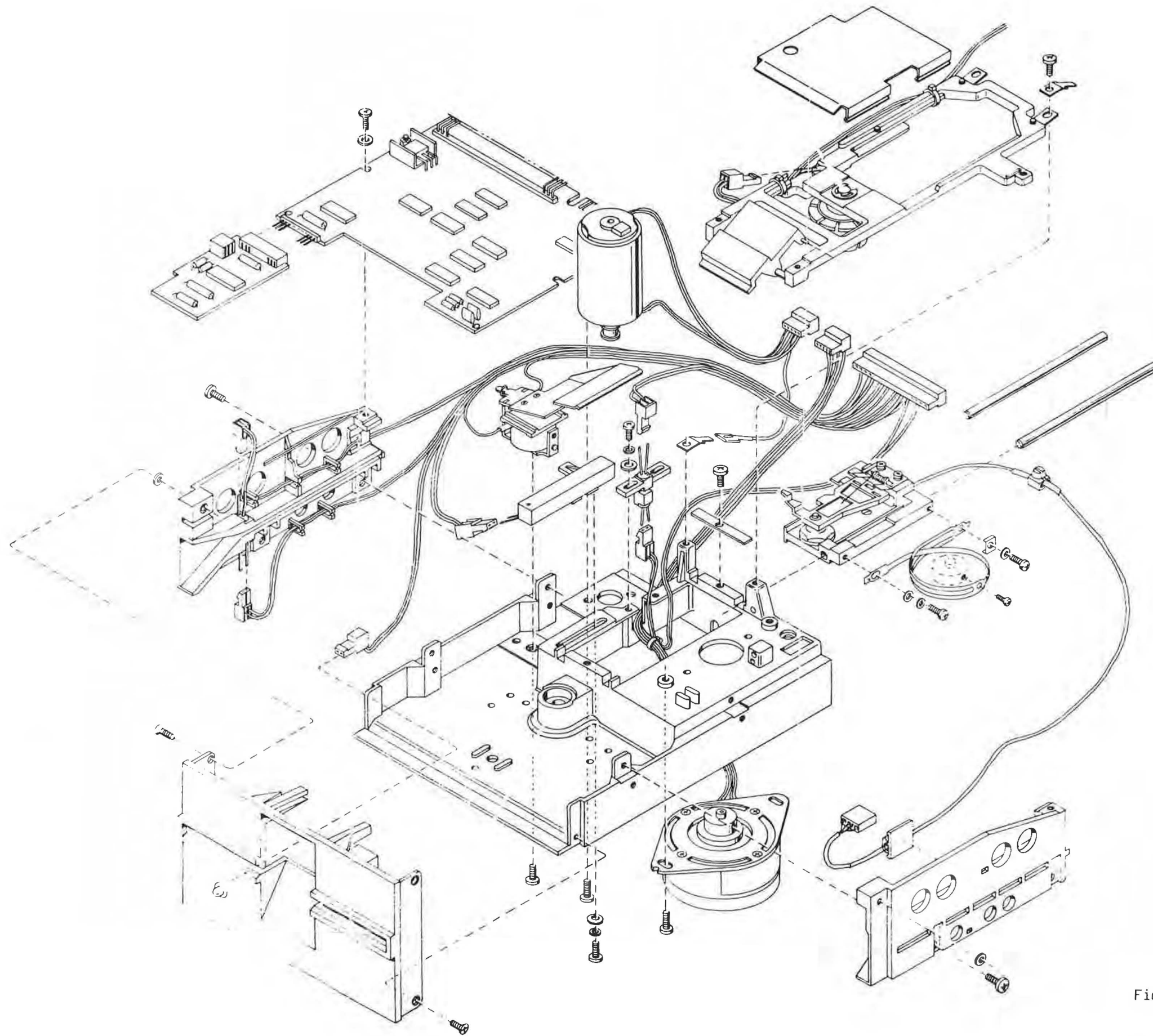

Figure 4-3: Model 91S, Exploded View

4.5.1 Printed Circuit Board Assembly (PCBA)

To remove the printed circuit board (PCBA) proceed as follows:

- A. Remove the I/O connector and DC power connector.
- B. Remove screws (2) at each side of PCBA.
- C. Pull PCBA slightly to the rear of the disk drive.
- D. Remove head connector(s) below and at left front edge of PCBA. Grip the connector(s), not the cables, when removing.
- E. Remove connectors P4-1, P4-2, and P4-3 at right rear of PCBA.
- F. Slide PCBA out the rear of the disk drive.

To replace the PCBA perform the preceding steps A. through F. in the reverse order.

4.5.2 Shield Assembly

To remove the shield assembly, located over the head/carriage assembly, proceed as follows:

- A. The shield snaps over the carrier assembly; grip the left side, press down on the left-center of the shield, and lift the left side up. This will unsnap the shield from the left side of the carrier assembly.
- B. Lift the shield to the right and up from the disk drive.

To replace the shield, perform the preceding steps A. and B. in the reverse order.

CAUTION

Be sure not to pinch the index LED wires under the right side of the carrier and the shield when installing.

4.5.3 Right-Hand Guide/Write Protect Assembly

The write protect sensor is an integral part of the right-hand guide. To remove this assembly proceed as follows:

- A. Remove the PCBA (see paragraph 4.5.1).
- B. Remove screws (2) holding guide to the disk frame at the bottom of the guide.

- C. Remove flat head, countersunk screw at top-front of guide holding guide to bezel.
- D. The guide is now free of the drive assembly.
- E. Unplug the two female connectors from the write protect photo transistor and LED.
- F. Remove the wires from the cable clamp. The guide/write protect assembly is now free of the drive assembly.

To replace the right-hand guide assembly perform the preceding steps A. through F. in the reverse order. Be sure that:

- A. The windows in the female connectors both face away from the guide, when installed.
- B. Wires to the write protect LED are routed through the cable clamp on the guide.

4.5.4 Left-Hand Guide Assembly

To remove the left-hand guide assembly proceed as follows:

- A. Remove the PCBA (see paragraph 4.5.1).
- B. Remove screws (2) holding guide to the drive chassis at the bottom of the guide.
- C. Remove flat head, countersunk screw at top-front of guide holding guide to front panel bezel.
- D. Remove head cable(s) from cable clamps. Guide is now free of drive assembly.

To replace the left-hand guide assembly perform the preceding steps A. through D. in the reverse order.

4.5.5 Front Panel Bezel and Activity LED

To replace the activity indicator it is necessary to remove the bezel. To remove the bezel proceed as follows. Figure 4-4 shows the activity indicator mounting hardware:

- A. Remove four (4) flat head, countersunk screws holding bezel to guides and drive chassis.
- B. Open door to free bezel from door/carrier assembly.
- C. Pull bezel forward slightly and remove female connector from activity LED. Bezel is now free of the drive assembly.

4.5.5.1 Activity LED Removal: To replace the activity LED proceed as follows:

- A. Remove bezel (see paragraph 4.5.5).
- B. Loosen activity indicator ring around activity indicator clip and pry off.
- C. From the front of the bezel, press LED out of the holder. This removes the LED.

4.5.5.2 Activity LED Installation: To install the activity LED proceed as follows:

- A. Perform the steps in paragraph 4.5.5.1.
- B. Press LED into clip in bezel from rear of bezel until it snaps in.
- C. Hold LED clip with fingers and fit ring over rear part of clip. Press ring until it is flush against bezel.
- D. Fit female connector over LED leads with green wire connected to longest LED lead.
- E. Install bezel to drive chassis and guide assemblies (see paragraph 4.5.5).

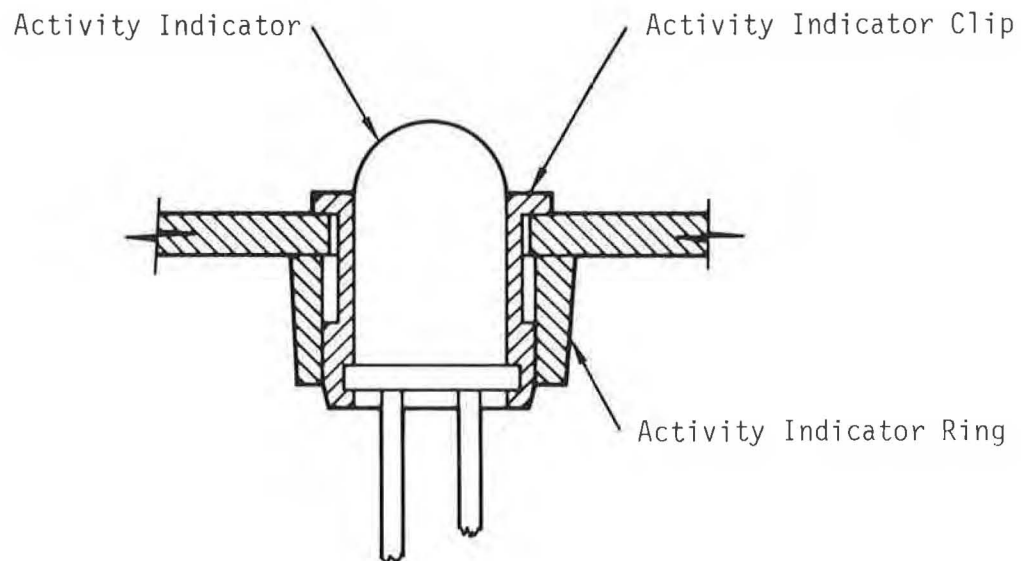

Figure 4-4: Activity Indicator Assembly

4.5.6 Cone Assembly

The cone assembly fits within the drive spindle assembly. To remove this assembly proceed as follows:

- A. Be sure the door is closed.
- B. Remove the snap ring and shims from the top of the carrier assembly.
- C. Open door.
- D. Cone will remain seated in spindle hub and can be lifted out of the drive assembly.

NOTE

Be sure to keep track of the number of shims between snap ring and carrier. The same shims must be replaced during installation.

To replace the cone assembly perform the preceding steps in the reverse order.

NOTE

Be sure that the replacement cone has a shim and then a spring on the shaft of the cone before replacing it in the spindle hub.

4.5.7 Carrier Assembly

The carrier assembly lifts the cone from the spindle and the upper arm from the disk media when the door is opened. To remove this assembly proceed as follows:

- A. Remove the PCBS (see paragraph 4.5.1).
- B. Remove shield assembly (see paragraph 4.5.2).
- C. Remove cone assembly (see paragraph 4.5.6).
- D. Remove screws (2) from rear of carrier holding carrier to drive chassis mounting posts.
- E. Cut tie wraps holding index LED wires to carrier.
- F. Remove index LED female connector.
- G. 91S/92S only: Remove screws (2) attaching bezel to RH & LH guides and loosen screws (2) attaching bezel to chassis.
91/92 only: Remove screws (2) attaching carrier assembly to front door.

Figure 4-1 Parts List

1. Activity Indicator Female Connector
2. Cable Clamp
3. Carrier Assembly
4. Carrier Mounting Screws
5. Cone/Clutch Assembly
6. Drive Motor Assembly
7. Ejector Latch Release (91/92 only)
8. Guide Rod Clamps
9. Harness Assembly
10. Head Cable
11. Index LED Female Connector
12. Index/Load Boss Assembly
13. Left Hand Guide
14. Load Pad Assembly
15. Right Hand Guide/Write Protect Assembly
16. Shield Assembly
17. Solenoid Assembly
18. Track 00 Assembly
19. Upper Arm
20. Write Protect LED Female Connector

- H. Open front door.
- I. 91S/92S only: Swing top of bezel forward allowing door pins to slip free of bezel door slots.
- J. The carrier is now free.

CAUTION

Do not lift the carrier straight up. The upper step of the upper head arm rests on top of the carrier assembly. Lifting carriage straight up may damage the head assembly.

Slide the carrier to the right, to clear the head assembly upper arm, and lift out of the unit.

- 4.5.7.1 Index LED: The index LED is part of the carrier assembly. The carrier assembly must be replaced to replace the index LED.
- 4.5.7.2 Carrier/Index LED Installation: As mentioned, the index LED is an integral part of the carrier assembly. To install this assembly perform the following steps in the order listed:
 - A. Install carrier assembly by performing in reverse the procedures called out in 4.5.7 steps G thru J.
 - B. Install screws (2) in rear of carrier assembly loosely.
 - C. Install cone assembly (see paragraph 4.5.6).
 - D. Close door.
 - E. Center door in front opening of bezel.
 - F. Tighten rear carrier screws.
 - G. Install index LED female connector with connector windows down.
 - H. Tie wrap index connector wires to the carrier assembly at front and rear.
 - I. Perform any adjustments called out in Table 4-3.

4.5.8 Index/Load Boss

To remove the index/load boss assembly proceed as follows:

- A. Remove PCBA (see paragraph 4.5.1).

- B. Remove shield assembly (see paragraph 4.5.2).
- C. Remove index photo transistor female connector at front of boss assembly; pull to right side.
- D. Place drive on its left side.
- E. Remove the screws (2) in the adjustment slot in the recessed area in the base of the drive chassis.
- F. Lift boss assembly up and out of the drive assembly.

To replace the index/load boss assembly proceed as follows:

- A. Place drive on its left side.
- B. Install index/load boss assembly with LED toward front of drive.
- C. Install screws loosely in the adjustment slot in the recessed area in the base of the disk drive chassis.
- D. Install index photo transistor connector with windows toward drive chassis.
- E. Perform any adjustments called out in Table 4-3.

4.5.9 Solenoid

To remove the solenoid, proceed as follows:

- A. Remove the PCBA (see paragraph 4.5.1).
- B. Remove the right-hand guide (see paragraph 4.5.3).
- C. Unsolder two leads from the solenoid. Note that older drives may have the leads attached to the solenoid with spade lugs.
- D. Turn the drive on its side and remove the solenoid mounting screw (1) from bottom of drive chassis.
- E. Solenoid is now free.

CAUTION

Be careful not to lift solenoid load arm straight up so that it bends upper arm assembly past its normal unloaded position.

- F. Tilt solenoid and lift to the side and up out of the drive chassis.

To replace the solenoid perform the preceding steps in the reverse order; be sure that:

- A. The bottom part of the load arm of the solenoid is beneath the index/load boss.
- B. The top part of the load arm is beneath the top step of the upper arm.
- C. Wires are not pinched between the bottom of the solenoid and the disk drive chassis.
- D. Wires do not interfere with solenoid spring.

4.5.10 Drive Motor

To remove the drive motor, proceed as follows:

- A. Remove PCBA (see paragraph 4.5.1).
- B. Place disk drive on its left side.
- C. Remove the drive belt by gripping belt near small pulley (motor end); simultaneously pull belt toward spindle pulley and away from the drive chassis. This will rotate belt off spindle pulley. The belt can now be lifted off the motor pulley.
- D. Remove two drive motor mounting screws from the bottom of the drive chassis.
- E. Drive motor is now free; cut tie wraps holding drive motor wires in harness and pull motor ground spade lug from chassis.

To replace the drive motor proceed as follows:

- A. Perform the preceding steps in the reverse order.
- B. Be sure that the wire harness is not pinched between the motor and the chassis.
- C. Mount motor so that motor wires exit from rear-center of motor to rear of drive chassis. Tie wrap motor wires into wire harness.
- D. After installing belt, refer to Table 4-3 for adjustment references.

NOTE

Do not tighten screws in motor mount until belt is adjusted.

4.5.11 Track 00 Sensor

To remove the track 00 sensor proceed as follows:

- A. Remove the PCBA (see paragraph 4.5.1).
- B. Remove the shield assembly (see paragraph 4.5.2).
- C. Remove the track 00 photo transistor female connector (top of frame) and track 00 LED female connector (recessed area, bottom of frame).
- D. Remove screws (2) at top of chassis holding sensor assembly to the drive chassis.
- E. Sensor is now free and can be slid to the side and up out of the drive chassis.
- F. Refer to Table 4-3 for adjustments necessary.

To replace the track 00 sensor perform the preceding steps in the reverse order. Do not tighten screws until adjustment procedures referenced in Table 4-3 are performed. Note that when replacing the connectors, the connector windows face the chassis.

4.5.12 Door Button Assembly

NOTE

This removal/replacement procedure is associated with the Model 91/92 only. The Model 91S/92S is not equipped with a door button assembly.

To remove the door button assembly proceed as follows (see Figure 4-5):

- A. Remove bezel (see paragraph 4.5.5)
- B. Remove bezel bracket mounting screw.
- C. Remove retention ring from one end of rod.
- D. Slide rod from assembly; be sure to catch spring.

To replace the door button assembly perform the preceding steps in the reverse order.

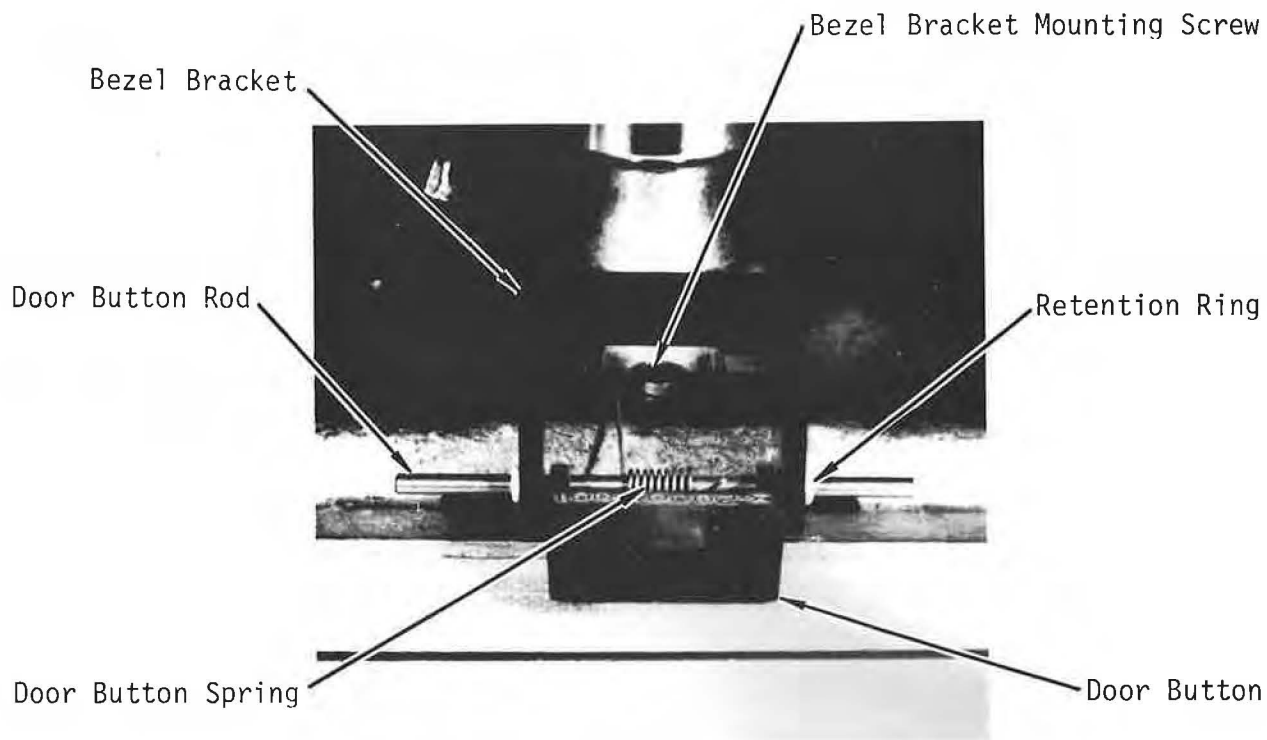

Figure 4-5. Door Button Assembly

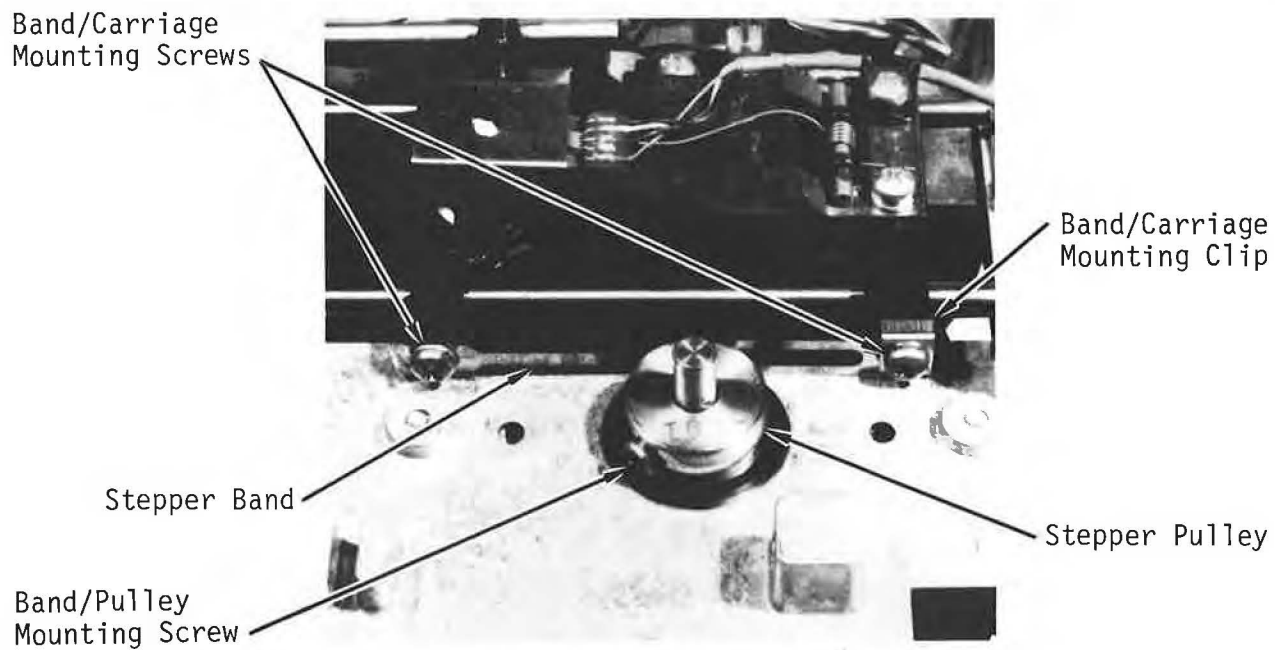

Figure 4-6. Stepper Band

4.5.13 Stepper Band

To remove the stepper band (see Figure 4-6) proceed as follows:

- A. Remove the PCBA (see paragraph 4.5.1).
- B. Open the door.
- C. Remove the left-hand guide (see paragraph 4.5.4).
- D. Place disk drive on right side.
- E. Remove two stepper band mounting screws, washers and band mounting clip from head/carriage assembly. Remove screw mounting band to pulley.
- F. Band can now be lifted off stepper motor pulley.

To replace the band perform the following steps (see Figure 4-6):

- A. Consider the preceding steps in the reverse order.
- B. On the band, slip one head end through the slot in the band.
- C. Wrap the band around the pulley.
- D. Lay band flat against head/carriage assembly; install screw, washers, and band-mounting clip in rear of head/carriage assembly; note large end of band goes to front of drive chassis.

NOTE

The band mounting clip hole is offset. Install the clip so that the hole is closer to the chassis of the disk drive.

- E. Hold band firmly against head/carriage assembly; install screw in front-of-band hole, large end of band.
- F. Pull band tight against head/carriage assembly and tighten screw in front of assembly. Move carriage forward and backward; ensure that there is no band crinkle (metal on metal rubbing).
- G. Screws should be tightened with torque screwdriver to 20 inch-ounces.

4.5.14 Stepper Motor

To remove the stepper motor proceed as follows:

- A. Remove the PCBA (see paragraph 4.5.1).
- B. Loosen front band mounting screw.
- C. Remove screw mounting band to pulley.
- D. Cut tie wraps enclosing stepper motor wires in wire harness.
- E. Remove two screws on bottom of drive chassis adjacent to the stepper motor.
- F. Remove stepper motor from drive chassis.

To replace the stepper motor, perform the preceding steps in the reverse order. Refer to Table 4-3 for required adjustments.

4.5.15 Head/Carriage Assembly

To remove the head/carriage assembly proceed as follows:

- A. Remove the PCBA (see paragraph 4.5.1).
- B. Remove shield assembly (see paragraph 4.5.2).
- C. Remove left hand guide (see paragraph 4.5.4).
- D. Remove stepper band (see paragraph 4.5.13).
- E. Remove head cable clamp from chassis (plastic clamp in left rear of chassis).
- F. Loosen the two copper guide rod clamps from front and rear of head assembly by loosening the screws in each of these clamps.
- G. Remove left-hand guide rod by prying from front and sliding guide rod out the rear of the chassis.
- H. Lift head/carriage assembly off the right hand guide rod and out of drive chassis.
- I. Be careful of banging and bending upper arm leaf spring. See CAUTION statement at paragraph 4.3.1.

To replace the head/carriage assembly, perform the preceding steps in the reverse order and observe the following precautions:

- A. Be sure that the guide rods are firmly seated in the drive chassis.
- B. Route head cables from head/carriage assembly through chassis properly.
- C. Be sure guide rod clamps are securely tightened.
- D. Be sure rear clamp has ground lugs (2) secured underneath screw.
- E. Be sure carriage rides freely on guide rods after installation.
- F. Refer to Table 4-3 for required adjustment procedures.

4.5.16 Ejector Assembly

NOTE

This removal/replacement procedure is associated with the Model 91/92 only. The Model 91S/92S is not equipped with a diskette ejector assembly.

To remove the ejector assembly proceed as follows (refer to Figure 4-7):

- A. Remove the PCBA (see paragraph 4.5.1).
- B. Remove ejector latch release (if necessary) from carrier by removing screw and sliding latch off carrier assembly.
- C. Remove ejector latch from drive chassis by removing screw and sliding latch off drive chassis mounting post.
- D. Slide rod out of mounting blocks and remove spring and plastic block.

To replace the ejector assembly, perform the preceding steps in the reverse order. Refer to Table 4-3 for required adjustment procedures.

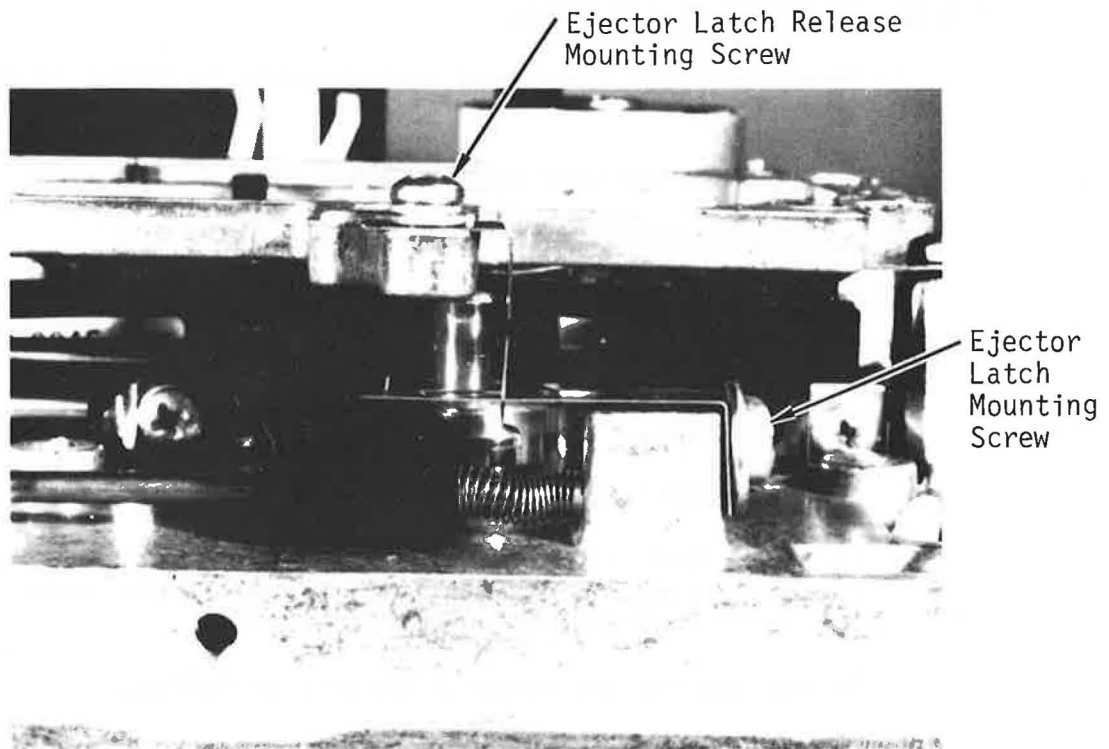

Figure 4-7
Ejector Assembly

4.5.17 Spindle, Bearings and Pulley

The spindle pulley can be removed by:

- A. Remove the Spindle Drive Bolt
- B. Remove the Spindle Pulley Mounting Screw
- C. Pull the Spindle Pulley from the Spindle Hub Shaft

NOTE

There will be a wave washer and some quantity of shims on the pulley shaft. The same quantity of shims and the wave washer must be replaced in the same order.

NOTE

To replace the spindle and bearings, the unit must be returned to the factory.

4.5.18 Head Load Pad Assembly

To replace the head load pad assembly in Model 91 drives, proceed as follows:

- A. Remove PCBA (see paragraph 4.5.1).
- B. Remove shield (see paragraph 4.5.2).
- C. Manually position head/carriage assembly all the way to the rear of the drive (Track 00); be sure to push carriage not the upper arm.
- D. Open door.
- E. Grip upper arm.
- F. With bent nose tweezers, squeeze the plastic pieces of the Head Load Pad which protrude through the upper arm and press until it drops out of the upper arm.

To replace the pad assembly proceed as follows:

- A. Hold pad assembly with bent nose tweezers centered underneath hole in upper arm.
- B. Close door.
- C. Press lightly on upper arm to engage pad assembly; remove tweezers.
- D. Press on upper arm until pad assembly snaps into place.

CAUTION

Do not move the upper head arm any further than is allowed by the door in its open position.

- E. Refer to Table 4-3 for required adjustment procedures.

4.5.19 Harness Assembly

If it becomes necessary to replace the harness assembly proceed as follows:

- A. Remove PCBA (see paragraph 4.5.1), this frees the head connector(s) and PCBA connectors (P4-1, P4-2, and P4-3).

B. Remove connections from:

1. Bezel activity LED
2. Right hand guide write protect sensor (two connections).
3. Index/load boss sensor
4. Index LED
5. Solenoid (two connections).
6. Track 00 sensor (two connections).

C. All harness connections should now be free.

D. Cut plastic tie wraps which tie harness assembly to drive motor and stepper motor wires.

To replace the harness assembly, perform the preceding steps in the reverse order; refer to Table 4-4, Cable Harness Wire List, for connector termination information.

Table 4-4: Harness Assembly Wire List

<u>FROM</u>	<u>TO</u>	<u>WIRE COLOR</u>
P4-1	Not connected	
P4-2	Not connected	
P4-3	Not connected	
P4-4	Activity light +	Green
P4-5	Activity light -	Black
P4-6	Index LED +	Green
P4-7	Index LED -	Black
P4-8	Index transistor +	Red
P4-9	Index transistor -	Black
P4-10	Track 00 LED +	White
P4-11	Track 00 LED -	Black
P4-12	Track 00 transistor +	Red
P4-13	Track 00 transistor -	Black
P4-14	Write protect LED +	White
P4-15	Write protect LED -	Black
P4-16	Write protect transistor +	Red
P4-17	Write protect transistor -	Black
P4-18	Not connected	
P4-19	Not connected	
P4-20	Not connected	
P4-21	Head load solenoid -	Black
P4-22	Head load solenoid +	Green

4.6 ADJUSTMENT PROCEDURES

Table 4-5 lists the adjustment procedures contained in this section. The appropriate paragraph should be referred to when performing any of these procedures. It is recommended that a master alignment diskette be kept and that each alignment be verified to the master.

TABLE 4-5: ADJUSTMENT PROCEDURES

Procedure	Paragraph
Radial Track	4.6.1
Index to Data	4.6.2
Track 00 Sensor	4.6.3
Speed Control	4.6.4
Track 00 End Stop	4.6.5
Drive Belt	4.6.6
Ejector Latch and Release (91/92 only)	4.6.7

4.6.1 Radial-Track Alignment

To perform radial track alignment perform the following steps in the order listed:

- A. Apply power to the disk drive. Apply controls to the drive for recalibration to track 00.
- B. Insert a CE alignment diskette (MPI Part No. 1-42003-001 double/ MPI Part No. 1-42002-001 single) and close the door.
- C. Sync oscilloscope on leading edge of signal on TP 6 (output of 4F-14). Connect oscilloscope probes to TP1 and TP2 (inputs to 2B-1,-14). Set the oscilloscope to 50mV/cm, ac coupled, channel A and B added, with B inverted, 20ms/division. Attach ground probes to TP7.
- D. Load head and apply 32 stepping pulses, with the DIRECTION line low. The carriage should now be located around track 32. The proper phase relationship of stepper motor phases should be: phase 4 = 0V, phase 1, 2 and 3 = +12V.

LEFT 70% of RIGHT

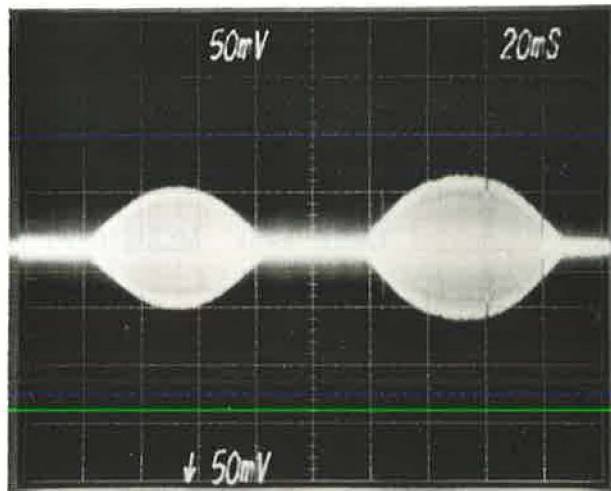

EQUAL AMPLITUDE

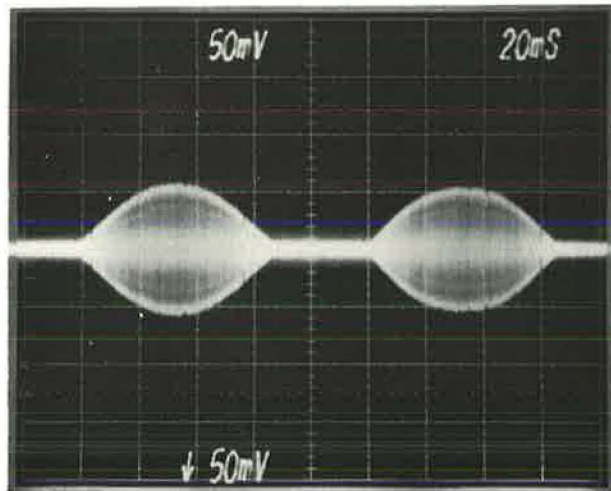

RIGHT 70% of LEFT

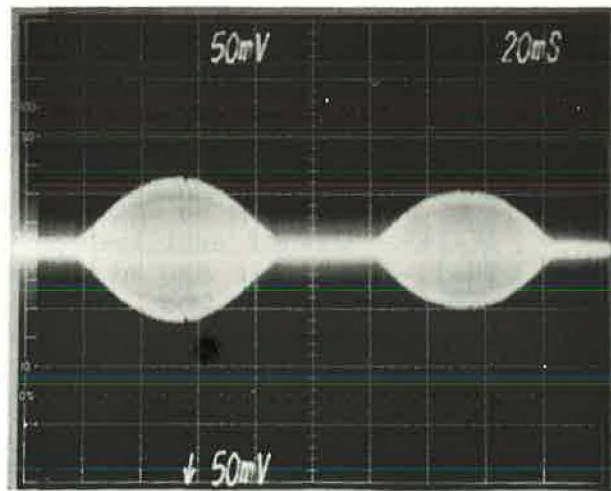

Figure 4-8: Radial Track Alignment Patterns

- E. With power on loosen the stepper motor mounting screws on bottom of drive and rotate the motor so that the "cat's eye" pattern appears on the scope and adjacent lobes are within 70% amplitude (see Figure 4-8). Tighten mounting screws. Command a return to track 00 and then step back to track 32 to verify proper alignment. Command a seek to track 64 and then step back to track 32 to verify proper alignment.

4.6.2 Index-To-Data Alignment

To perform the index-to-data alignment perform the following steps in the order listed:

- A. Verify the radial-track alignment (see paragraph 4.6.1) then move the head to track 01.
- B. Set the oscilloscope to 50 microseconds per division.
- C. The index sensor mounting screws are located at the bottom of the drive in the recessed area. Loosen the two screws and slide the sensor such that the oscilloscope picture shows a data pattern starting 200 \pm 75 microseconds from the start of the trace.
- D. Using a 20 inch-ounce torque screwdriver, tighten the screws carefully so that no variations in the oscilloscope display occur.

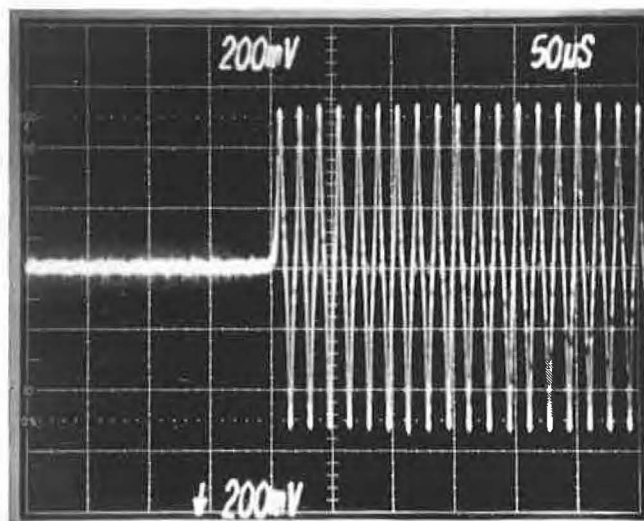

Figure 4-9: Index-to-Data Alignment Pattern

4.6.3 Track 00 Sensor Alignment

To align the track 00 sensor perform the following steps in the order listed.

- A. Verify the radial-track alignment (see paragraph 4.6.1).
- B. Apply power to the disk drive and select drive.
- C. Connect channel A probe to connector J4-12; set oscilloscope trigger to INTERNAL/AUTO.
- D. Loosen the two track 00 sensor mounting screws (top/rear of disk drive, adjacent to solenoid) and adjust the sensor for the conditions in E. and F. following.
- E. When the carriage is positioned over track 00 or 01 the signal at J4-12 should be at 0.5 volts (maximum).
- F. Command a step-in to track 03. Signal at J4-12 should go to +4.0 volts minimum.
- G. Tighten the sensor mounting screws.

4.6.4 Speed Control Adjustment

To adjust the speed control perform the following steps in the order listed:

- A. Apply power to the disk drive and select drive. Apply 0V to MOTOR ON.
- B. Insert a diskette and close the door.
- C. Turn disk drive on its side and observe the strobe effect of spindle pulley. If operating from 60 Hz power observe outer trace; if operating from 50 Hz power observe inner trace. Adjust R38 on PCB for a stable strobe pattern. Note that a small amount of strobe "creep" is permissible.

4.6.5 Track 00 End Stop Adjustment

To adjust the track 00 end stop perform the following steps in the order listed:

- A. Verify the radial track alignment (see paragraph 4.6.1).
- B. Verify the track 00 sensor alignment (see paragraph 4.6.3).
- C. Apply power to the disk drive and select drive.

- D. Command a seek to track 00.
- E. Adjust the setscrew located on the left-hand boss in the rear of the drive to approximately 0.010 inch from the end of the carriage (approximately one-third revolution of the set screw). Command a maximum track seek, then a return to track 00. Assure that the carriage does not hit the end stop.
- F. Alternate Adjustment Method: Using an alignment diskette, restore to TRK 00. Assure that a read signal is present. Turn the TRK 00 set screw clock-wise until the read signal amplitude is minimal. Now turn set screw counter clock-wise while pushing back on head carriage until read signal amplitude reaches approximately one-half of its original value. This assures that the head assembly will not restore past TRK 00.

4.6.6 Drive Belt Adjustment

The new Model drives all have neoprene (black) drive belts. Older Model drives have mylar (yellow) belts. They are adjusted differently as follows:

4.6.6.1 Mylar (Yellow) Drive Belt Adjustment

Loosen drive motor mounting screws (bottom of chassis). Adjust drive motor so that the tension on one leg of the drive belt is 17 \pm 1 grams. A tensiometer may be used to make this measurement. Tighten the drive motor mounting screws after adjusting the belt.

4.6.6.2 Neoprene (Black) Drive Belt Adjustment

Loosen drive motor mounting screws (bottom of chassis). Position the drive motor as close to the spindle assembly as possible. Tighten the drive motor mounting screws. No belt tension measurement is necessary.

4.6.7 Ejector Latch And Ejector Latch Release Adjustments

NOTE

This adjustment procedure is associated with the Model 91/92 only. The Model 91S/92S is not equipped with a diskette ejector system.

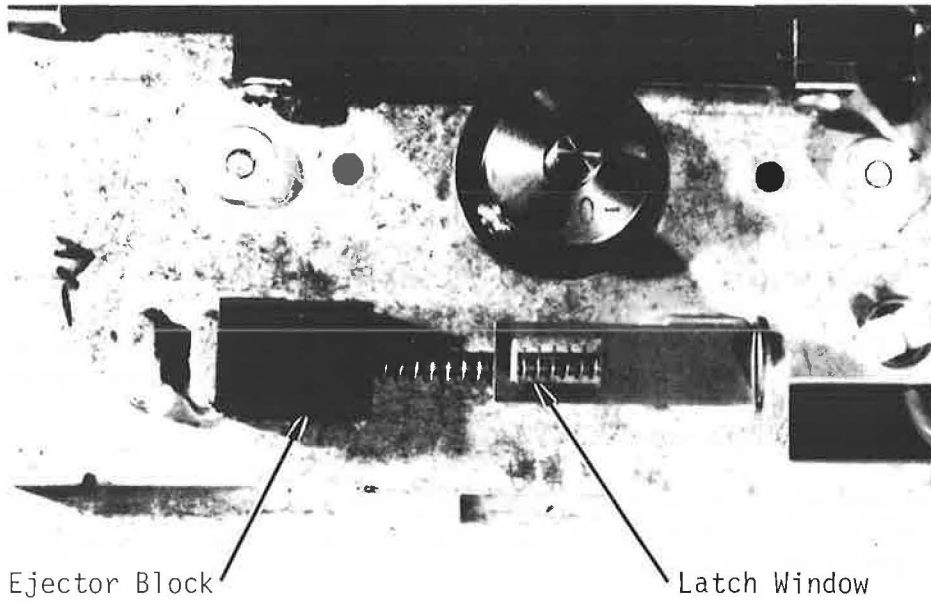

Figure 4-10: Ejector Block and Latch
(top view)

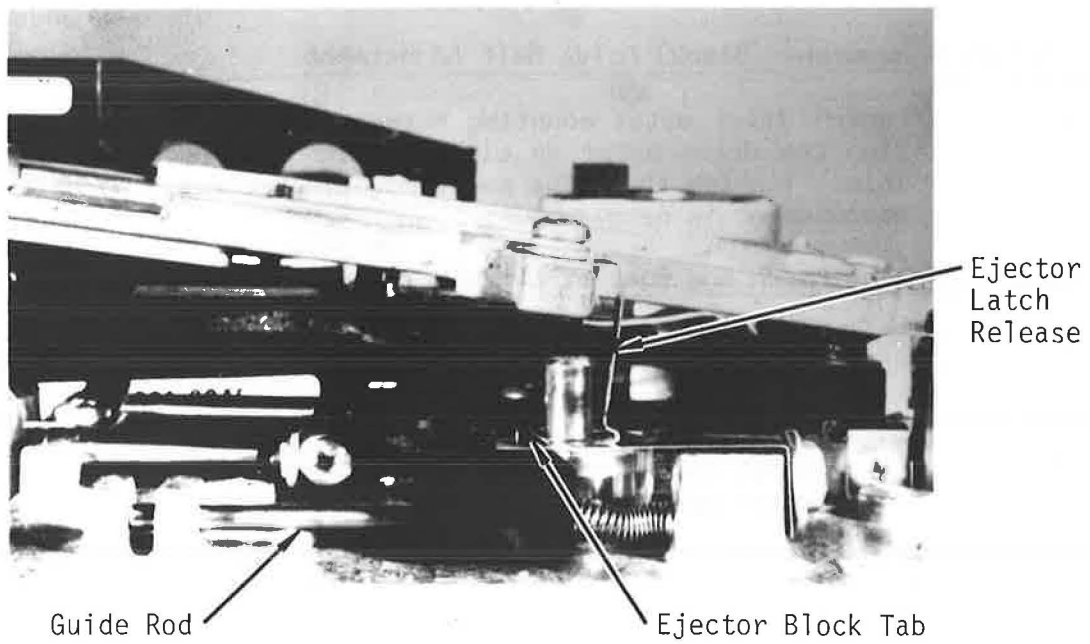

Figure 4-11: Ejector Assembly

After installing some component of the ejector assembly (spring, block, etc.), it may be necessary to adjust either, or both, the ejector latch and ejector latch release. Before attempting to make any adjustments, ensure that the ejector latch and the ejector latch release are not deformed in shape. Any deformed parts should be replaced.

4.6.7.1 Ejector Latch Adjustment

With the carrier assembly in the open position, verify that no gap exists between the ejector latch and the chassis boss. If there is a gap, loosen the ejector latch mounting screw and press the latch firmly against the chassis. Tighten the mounting screw to 11in. lbs.(See Figure 4-11).

4.6.7.2 Ejector Latch Release Adjustment

With the carrier assembly in the closed position, verify that ejector latch release is contacting the rear inside of the ejector latch window (See Figure 4-7). If it is not, loosen the latch release mounting screw and slide the ejector latch release toward the rear of the drive until contact is made, then tighten the mounting screw.

With the carrier assembly in the open position, verify that the tip of the ejector latch release remains in the window of the ejector latch (See Figure 4-11). Slide the ejector block toward the rear of the drive until it becomes latched. Close the carrier assembly and then reopen it. The ejector block should be disengaged. Repeat this procedure four to five times to ensure smooth operation of the mechanism.

4.7 **MEASUREMENT PROCEDURES**

The following list of measurement procedures should be made periodically to ensure data quality or if malfunctions are suspected:

- A. Compliance Measurement
- B. Erase Measurement
- C. High Frequency Playback Measurement

4.7.1 Compliance Measurement

To measure compliance perform the following steps in the order listed:

- A. Apply power to the disk drive and select drive.
- B. Step head(s) to track 79.

- C. Write a 1F pattern (62.5 KHz) on the entire track.
- D. Connect oscilloscope probes to TP1 and TP2 as in radial track alignment procedure (paragraph 4.6.1).
- E. Apply a 15 gram load to the upper arm directly above the load pad. If the amplitude observed on the oscilloscope increases by more than 10% the drive has poor compliance; refer to troubleshooting information Section 5.

4.7.2 Erase Measurement

To measure the effectiveness of the erase, perform the following steps in the order listed.

- A. Apply power to the disk drive and select drive.
- B. Step the head(s) to track 64.
- C. Write a 1F pattern (62.5 Kilohertz) on the entire track.
- D. Connect oscilloscope to TP1 and TP2 as described in radial-track alignment procedure (see paragraph 4.6.1).
- E. Connect a jumper from ground to gate 6A pin 7 (Model 91/92 bottom head) or 6A pin 1 (Model 92 top head).
- F. Step back and forth across track 64 for about 15 seconds.
- G. At the end of the 15-second period, remove jumper installed in Step E above, return head(s) to track 64. The amplitude displayed on the oscilloscope should be reduced by at least 85% in some parts of the trace.
- H. If the amplitude decrease is less than 85%, refer to the troubleshooting information, Section 5.

4.7.3 High Frequency Playback Measurement

To measure the amount of high frequency playback, perform the following steps in the order listed.

- A. Apply power to the disk drive and select drive.
- B. Step the head to track 79.
- C. Write a 2F (250 Kilohertz) pattern on the entire track.
- D. Connect oscilloscope to TP1 and TP2 as described in radial-track alignment procedure (see paragraph 4.6.1).
- E. The peak-to-peak amplitude displayed on oscilloscope should be a minimum of 65mv p-p. If the amplitude is less than 65mv p-p, refer to the troubleshooting information, Section 5.

SECTION 5

TROUBLESHOOTING

5.1 INTRODUCTION

This section contains general troubleshooting information. It is assumed that the user has read and understands the material in section 3, Theory Of Operation.

The first step in troubleshooting should be to verify that the controlling device and interface to the disk drive are functioning properly. Next, isolate the trouble to the electronic, the electromechanical, or the mechanical components of the drive. Table 5-1 is a list of some trouble symptoms referenced to paragraphs which include possible causes, and suggested fixes.

TABLE 5-1: TROUBLE SYMPTOMS

Topic	Paragraph
Preliminary Troubleshooting Steps	5.2
Drive Won't Step or Steps Erratically	5.3
Head/Carriage Oscillates at Track 00 (Restore Error)	5.4
Drive Motor Won't Rotate	5.5
Head Will Not Load	5.6
Bad Index Output	5.7
Bad Write Protect Output	5.8
Activity Indicator Does Not Light	5.9
Read Errors--All Tracks	5.10
Read Errors--Random Tracks	5.11

TABLE 5-1: TROUBLE SYMPTOMS (Continued)

Topic	Paragraph
Read Errors--Inside Tracks	5.12
Cannot Read Prewritten Data: Can Read Self-Written Data	5.13
Cannot Write Data	5.14
Erase Bad	5.15
Drive Speed Unstable	5.16

5.2 PRELIMINARY TROUBLESHOOTING STEPS

The following preliminary steps should be performed first when a suspected malfunction occurs:

- A. Check for proper operation of controlling device and interface to disk drive.
- B. Check for proper supply voltages to the printed circuit board assembly (PCBA); refer to section 3, Interface Requirements.
- C. Check for proper insertion of programmable shunt and terminator.
- D. Check for proper programming of shunt.

5.3 DRIVE WON'T STEP OR STEPS ERRATICALLY

Verify that head cable(s) do not interfere with carriage movement.

- A. With DIRECTION input low, apply stepping pulses and monitor stepper motor control logic for proper signals as shown by timing diagram, Figure 3-17. The stepper motor control logic is illustrated in Zone C of Sheet 3 of drawing 4-04002-001.
- B. In order to step, the following circuit points must be at the levels indicated:
 1. Counter 3C pins 7 and 10 must be low.
 2. Counter 3C pin 9 must be high.
- C. If signals measured are as shown by Figure 3-17, replace the stepper motor (see paragraph 4.5.14).

5.4 HEAD/CARRIAGE OSCILLATES AT TRACK 00 (RESTORE ERROR)

The track 00 logic is illustrated on Sheet 3, Zones B and C.

- A. Position the head/carriage to extreme rear of drive.
- B. Check J4-12 for a low level. If it is not low, replace the track 00 sensor.
- C. Check track 00 logic for correct signals.

5.5 DRIVE MOTOR WON'T ROTATE

The drive motor logic is illustrated on Sheet 3, Zone A.

- A. Signal MOTOR ON must be a low level for drive motor to rotate.
- B. Short together the collector and the emitter of output driver Q3. This should cause the drive motor to rotate at full speed, generating a TACH signal. If drive motor does not rotate, replace it (see paragraph 4.5.10). Check the drive motor logic and compare with timing diagram, figure 3-18.

5.6 HEAD WILL NOT LOAD

The head load logic is illustrated on Sheet 3, Zone D.

- A. Check driver 5G pin 3 for a low level. If output is low, replace head load solenoid.
- B. Double-check shunt 1G for proper programming.

5.7 BAD INDEX OUTPUT

The index logic is illustrated on Sheet 3, Zone B.

- A. Block index LED light path. If J4-8 is a low level, replace index/load boss assembly (see paragraph 4.5.8).
- B. Remove diskette and close door. Check J4-8 for a low level; if J4-8 is low proceed to step E.
- C. Check J4-6 for approximately 1.5 volts; if J4-6 is 0 volt or 5 volts, replace carrier (see paragraph 4.5.7).
- D. If J4-6 is approximately 1.5 volts, replace index/load boss assembly (see paragraph 4.5.8).
- E. Check for correct signal levels throughout index logic.

5.8 BAD WRITE PROTECT OUTPUT

The write protect logic is illustrated on Sheet 2, Zone A and B.

- A. Block write protect LED light path. If J4-16 is a low level, replace right hand guide/write protect assembly (see paragraph 4.5.3).
- B. Unblock write protect LED light path. If J4-16 is a high level, replace right hand guide/write protect assembly.
- C. Check for correct signal levels throughout write protect logic.

5.9 ACTIVITY INDICATOR DOES NOT LIGHT

The activity indicator logic is illustrated on Sheet 3, Zone D.

- A. Check activity indicator logic for correct signal levels.
- B. If signal levels are correct, replace activity indicator.

5.10 READ ERRORS — ALL TRACKS

The read logic is illustrated on Sheet 2, Zone C and D.

- A. Verify that head is loaded by visually checking that head load pad (or upper head on Model 92) contacts diskette. If head is not loaded refer to paragraph 5.6.
- B. Check compliance (see paragraph 4.7.1). If compliance is bad, replace load pad assembly (see paragraph 4.5.18) and/or clean head.
- C. Check read logic for proper signals as compared with timing diagram, Figure 3-20.
- D. On Model 91 drives, J1-32 must be high in order to read.
- E. Check HDO READ (or HD1 READ if checking read of top head on Model 92) for a low level.
- F. With power removed from the PCBA, check CR4, CR5, Q1, and Q2 for proper resistance readings.
- G. Replace PCBA. If still no read signals from drive, replace head/carriage assembly (see paragraph 4.5.15).

5.11 READ ERRORS — RANDOM TRACKS

- A. Replace drive motor (see paragraph 4.5.10).

5.12 READ ERRORS — INSIDE TRACKS

Verify that shield assembly is installed on carrier.

- A. Check compliance (see paragraph 4.7.1). If compliance is bad, replace load pad assembly (see paragraph 4.5.18), and/or clean head.
- B. Check erase capability (see paragraph 4.7.2). If erase is bad, see paragraph 5.16.
- C. Check high frequency output (see paragraph 4.7.3). If output is bad, replace head/carriage assembly (see paragraph 4.5.15).
- D. Replace amplifier integrated circuit chip 2A on PCBA.

5.13 CANNOT READ PREWRITTEN DATA: CAN READ SELF-WRITTEN DATA

- A. Check radial track alignment (see paragraph 4.6.1).
- B. Check index-to-data alignment (see paragraph 4.6.2).

5.14 CANNOT WRITE DATA

- A. Check WRITE PROTECT output (see paragraph 5.8).
- B. Check HDO WRITE (or HD1 WRITE if top head on Model 92) for low level.
- C. Check PCBA write circuits for correct signals per timing diagram, Figure 3-19.

5.15 ERASE BAD

- A. If no decrease in amplitude is observed after the 15-second period outlined in paragraph 4.7.2, replace head/carriage assembly (see paragraph 4.5.15).
- B. If amplitude decrease is less than 85%, replace load pad assembly (see paragraph 4.5.18), and/or clean head.

5.16 DRIVE SPEED UNSTABLE

- A. Check for bad spindle bearings by removing drive belt and slowly rotating spindle pulley manually. If spindle pulley rotates erratically, return drive to the factory to have spindle bearings replaced (see paragraph 4.5.16).
- B. If spindle speed drifts slowly, replace capacitor C19 on the PCBA.

SECTION 6

OPTIONS

6.1 INTRODUCTION

There are several optional features which allow the user to configure the 91/92 Disk Drive to satisfy a specific requirement. The options available for the model 91/92 and discussed within this section are as follows:

- A. Door Closed Switch
- B. Door Lock
- C. Ready

6.2 DOOR CLOSED SWITCH (Figure 6-1)

This optional feature informs the user as to whether the door of the drive is open or in the closed position. This is accomplished by means of a microswitch, mounted on the right hand guide (as viewed from rear of drive), and activated by the carrier assembly which controls the switch actuator. The normally closed terminal of the switch is wired into connector J-5 pin 6 of the drive logic and goes high when the switch is activated. On the drive logic at gate 2G, this high switch output; 'anded' with the Drive Select signal, will output a low on J1-34 to the user when the door is closed.

6.3 DOOR LOCK MECHANISM

The user can lock and unlock the drive door by controlling the interface signal on J1-4, driving it to a logical zero or logical one respectively. The solenoid within the door lock mechanism, when energized, causes the mechanism's actuator to interfere with normal door opening movement. When de-energized, movement is unrestricted: the door is unlocked.

On the model 91/92 Drive, with its button release door, the door lock mechanism disables the button from being depressed when energized. The model 91S/92S Drive employs the mechanism to restrict movement of the door. The Door Lock solenoid is electrically connected to the drive through connector J-4, pins 18 and 19.

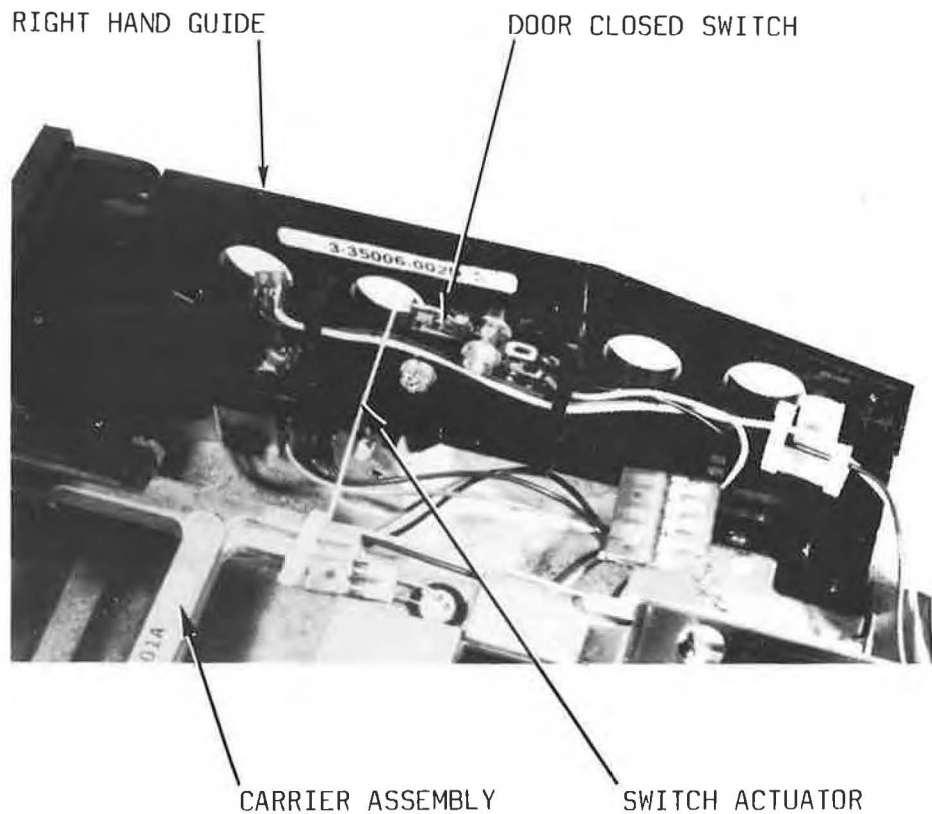

Figure 6-1: Door Closed Switch

6.4 READY

The ready option signals the user that a diskette is installed in the disk drive and is rotating at the speed necessary to read or write data. When the ready option is installed and properly adjusted, the absence of a Ready signal would signify incorrect diskette speed. This could be the result of a broken drive belt, malfunctioning drive motor, or a binding diskette.

In examining the Ready Logic Schematics in appendix B, the trailing edge of the Index signal will fire the adjustable single shot U1. The output, U1-4, will go low and enable the non-adjustable single shot at U1-9. When Index is again sensed, the leading edge will fire the non-adjustable single shot and the Ready signal, on pin U1-5, will be true. When the diskette is rotating properly a continuous stream of Index pulses will be sent to both retriggerable single shots maintaining a constant Ready signal.

Adjustment of single shot U1-4 is made when the diskette is rotating at the correct speed while monitoring the Ready signal. Turn potentiometer R2 counter-clockwise until the Ready signal begins to toggle, then clockwise until the Ready signal remains constantly high.

APPENDIX A
SPARE PARTS LIST

MICRO PERIPHERALS MODEL 91/92 & 91S/92SRECOMMENDED SPARE PARTS LIST

MPI P/N	DESCRIPTION
1. <u>REPLACEABLE PARTS AND SUB ASSEMBLIES</u>	
3-29003-XXX	PCB Assembly
1-79600-006	Shunt
3-35003-001	Spindle Drive Motor Assembly
2-35039-001	Stepper Motor Assembly
4-27053-001	Stepper Band
2-32002-002	Head Load Solenoid Assembly
2-35000-002	Track 00 Assembly
2-35032-001	Shield Assembly
3-35006-002	Rt Hand Guide/Write Protect Assy
4-21013-006	Lt Hand Guide
1-35028-001	Cone/Clutch Assembly
3-22016-001	Spindle Pulley
4-35009-001	Carriage/Head Assembly (Single, 91/91S)
4-35034-001	Carriage/Head Assembly (Double, 92/92S)
3-32003-004	Harness Assembly
1-50500-001	Drive Belt - Neoprene (Black)
2-35001-004	Index/Load Boss Assembly
1-35045-001	Door/Carrier Assembly (SLA)
1-35029-001	Door/Carrier Assembly (MPI)
1-35023-001	Load Pad Assembly (91/91S)
1-35026-001	Indicator L.E.D. Assembly
1-77004-151	Terminator - 150 Pullup
1-77005-001	Terminator - 220 /330
3-35040-001	Bezel Assembly (SLA)
4-21014-001	Bezel (MPI)
1-35048-001	Ejector Mechanism Assembly (MPI)
NOTE: <u>READILY AVAILABLE COMPONENTS AND HARDWARE NOT INCLUDED</u>	

MICRO PERIPHERALS MODEL 91/92 & 91S/92SRECOMMENDED SPARE PARTS LIST

MPI P/N	DESCRIPTION
<u>II. COMPONENTS</u>	
1-76000-010	IC, 74LS10
1-76000-014	IC, 74LS14
1-76000-033	IC, 74LS33
1-76000-074	IC, 74LS74
1-76000-086	IC, 74LS86
1-76000-123	IC, 74LS123
1-76000-139	IC, 74LS139
1-76000-169	IC, 74LS169
1-76001-038	IC, 7438
1-76004-463	IC, 75463
1-76006-311	IC, LM311
1-76006-339	IC, LM339
1-76005-054	IC, CA3054
1-76007-592	IC, NE592
1-76004-478	IC, 75478
1-76008-001	IC, 7391
1-78501-001	Transistor, 2N3904
1-78503-001	Transistor, TIP 110
1-75000-150	Diode, IN4150
1-77000-223	Resistor DIP, 22K
1-77002-151	Resistor SIP, 150
1-77002-472	Resistor SIP, 4.7K
1-79000-103	Pot, 10K
1-79001-503	Pot, 50K
1-78001-151	Inductor, 150uH
1-78001-561	Inductor, 560uH
1-78001-331	Inductor, 330uH
<u>III. SPECIAL TOOLS</u>	
1-42002-001	C.E. Alignment Diskette (96 TPI - Single)
1-42003-001	C.E. Alignment Diskette (96 TPI - Double)
	Model 91/92 Technical Manual

APPENDIX B
DRAWINGS AND SCHEMATICS

I.C. PART LIST

I.C. DESIGNATOR	TYPE	MPI P/N
1A, 2A	CA3054	1-76005-054
1C	LM311	1-76006-311
1E, 5B, 6E	74LS123	1-76000-123
2B	NE592	1-76007-592
2D	74LS86	1-76000-086
2E	74LS74	1-76000-074
2F, 3D, 3G	74LS14	1-76000-014
2G, 3E	7438	1-76001-038
3C	74LS169	1-76000-169
4C	74LS10	1-76000-010
4F	LM339	1-76006-339
5A	74LS139	1-76000-139
5G	75478	1-76004-478
6A	75463	1-76004-463
6C	74LS33	1-76000-033
6Ga, 6Gb	75478	1-76004-478

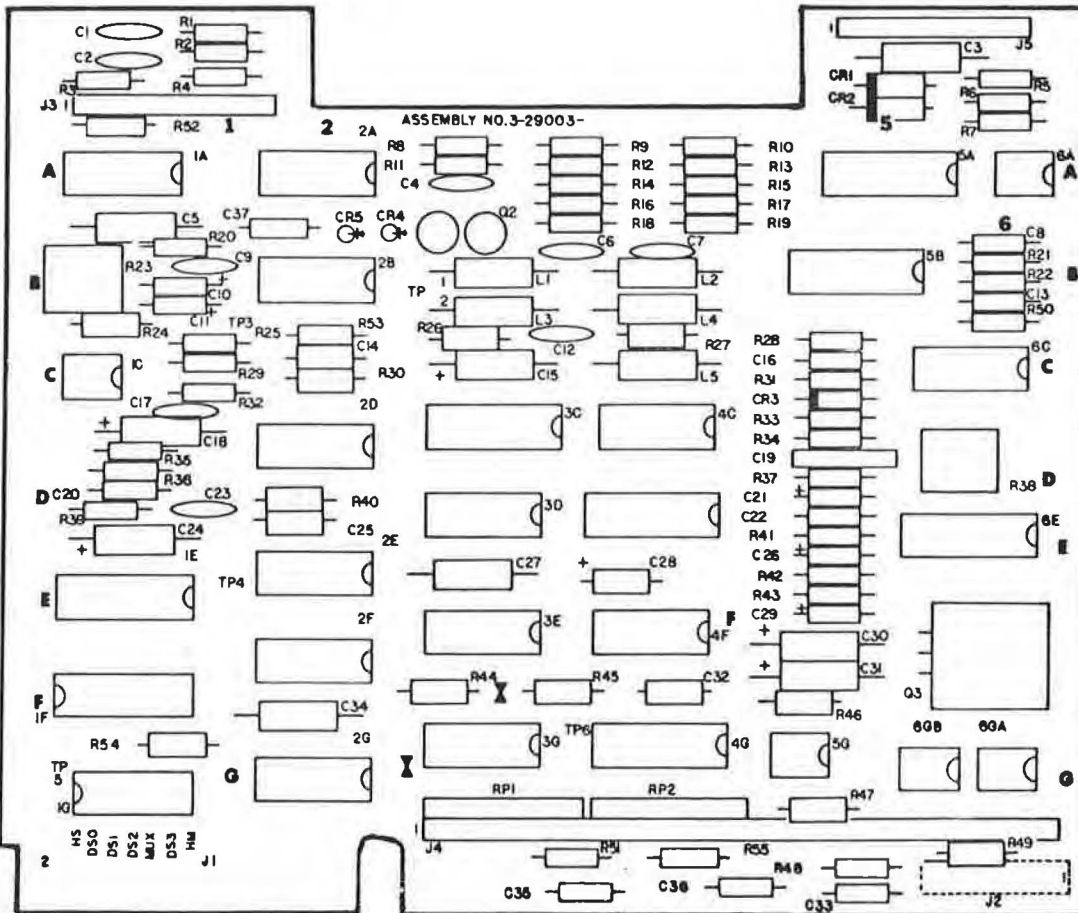

Figure B-1: PCBA Component Layout

<u>REFERENCE NUMBER</u>	<u>PART NUMBER</u>	<u>DESCRIPTION</u>
1	2-28013-003	PCB, Ready Logic
2	1-76000-123	I.C., 74LS123
3	1-77003-103	RESISTOR, 10K, 1/4 W, 5%
4	1-77003-563	RESISTOR, 56K, 1/4 W, 5%
5	1-79001-503	POTENTIOMETER, 50K
6	1-74014-156	CAPACITOR, 15 uf, 16V Electrolytic
7	1-60006-001	CONNECTOR, PCB Mount

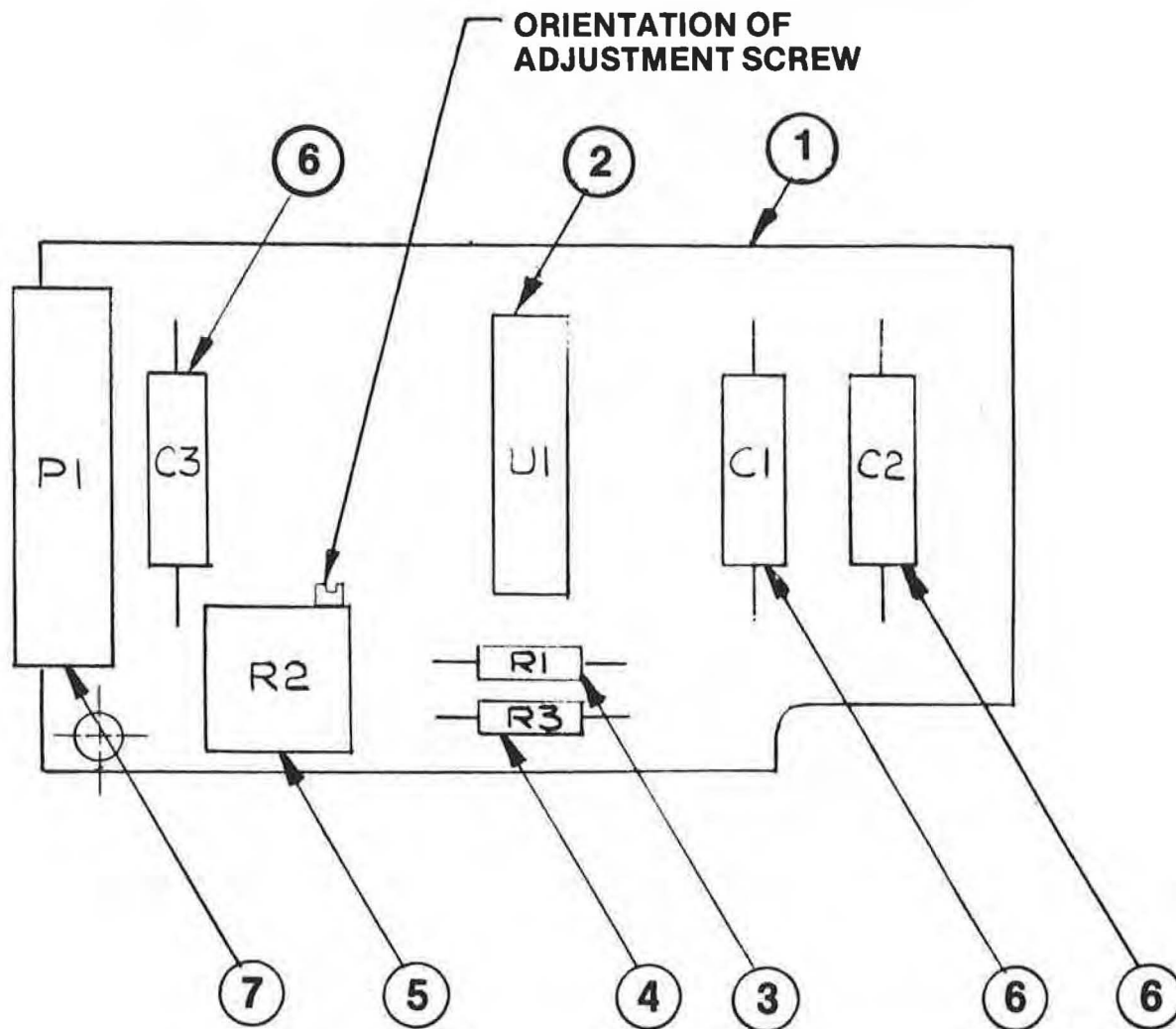
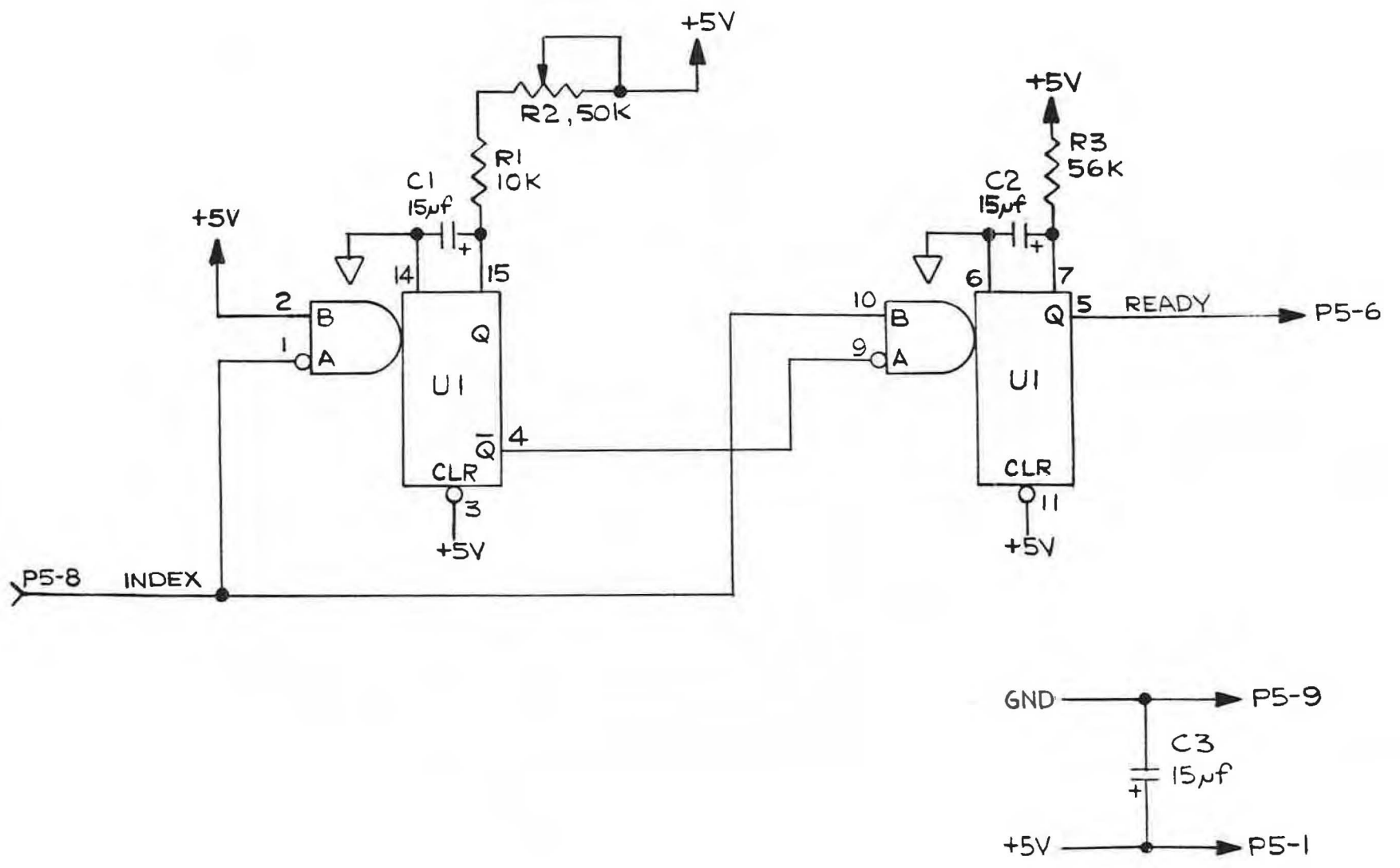

Figure B-3: Ready PCBA Component Layout

Figure B-4: Ready PCBA Schematic
B-6



APPENDIX C
SIGNAL NAME DEFINITIONS

SIGNAL NAME DEFINITIONS

SIGNAL

DRIVE SEL	When low indicates that the drive is in a select mode.
HDO ERASE	When low indicates that erase coil of bottom head is energized.
HDO READ	When low indicates that bottom head of drive is in read mode.
HDO WRITE	When low indicates that bottom head of drive is in write mode.
HD1 ERASE	When low indicates that erase coil of top head is energized.
HD1 READ	When low indicates that top head of drive is in read mode.
HD1 WRITE	When low indicates that top head of drive is in write mode.
HEAD LOAD	When low indicates that the head load solenoid is energized.
MOTOR ON/	When high indicates that the drive motor is enabled.
PHASE 1	When low indicates that 01 of the stepper motor is active.
PHASE 2	When low indicates that 02 of the stepper motor is active.
PHASE 3	When low indicates that 03 of the stepper motor is active.
PHASE 4	When low indicates that 04 of the stepper motor is active.
SELECT/	When high indicates that drive output signals, the stepper logic, and the write logic are enabled.
STALLED/	When high indicates that drive motor is in a stalled condition.
TACH DIG	This signal is the digitized representation of the output of the drive motor tachometer.
TRACK 00/	When high indicates that the read/write head is located at track 00.

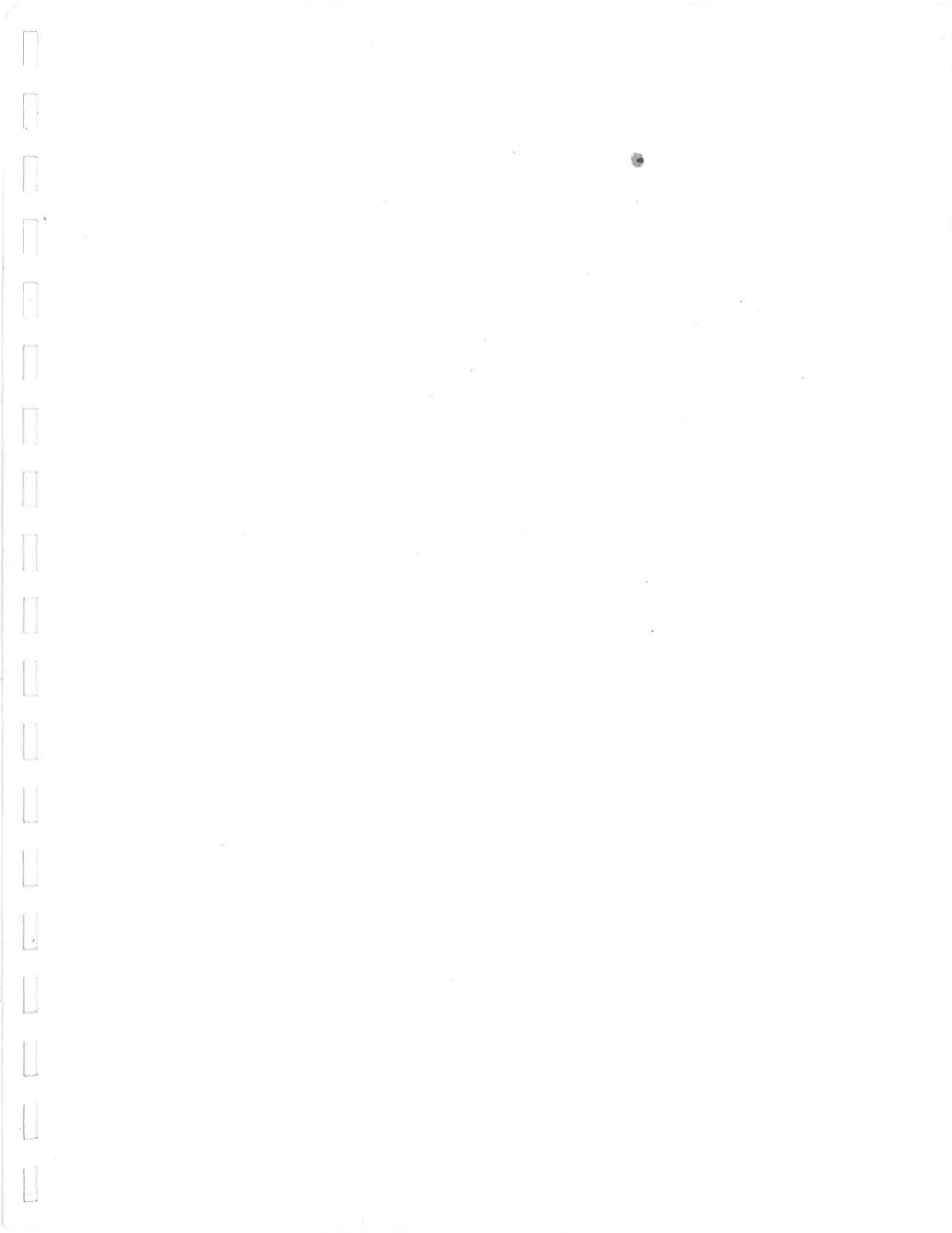

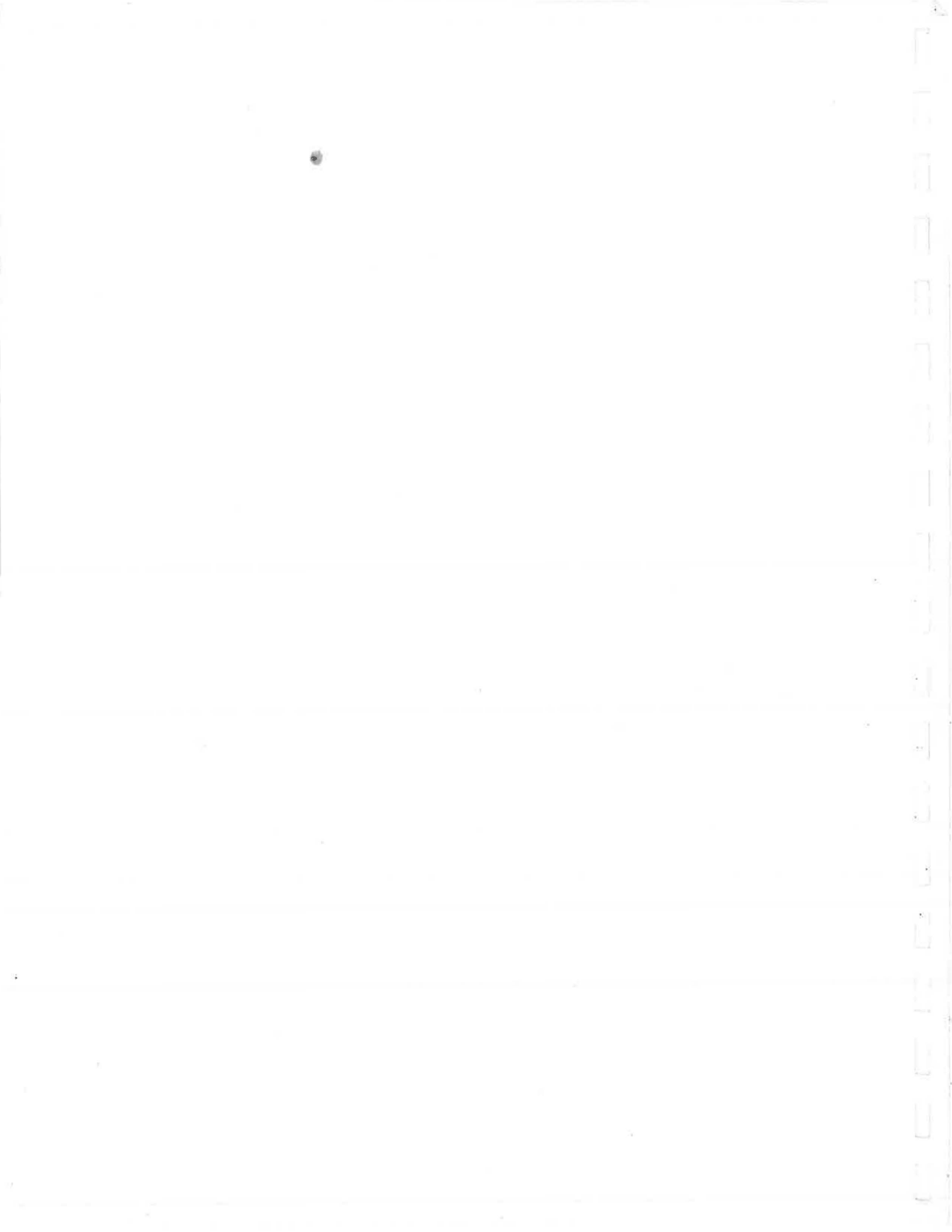

REVISIONS				
ZONE	LTR	DESCRIPTION	DATE	APPROVAL
SEE SHEET 1				

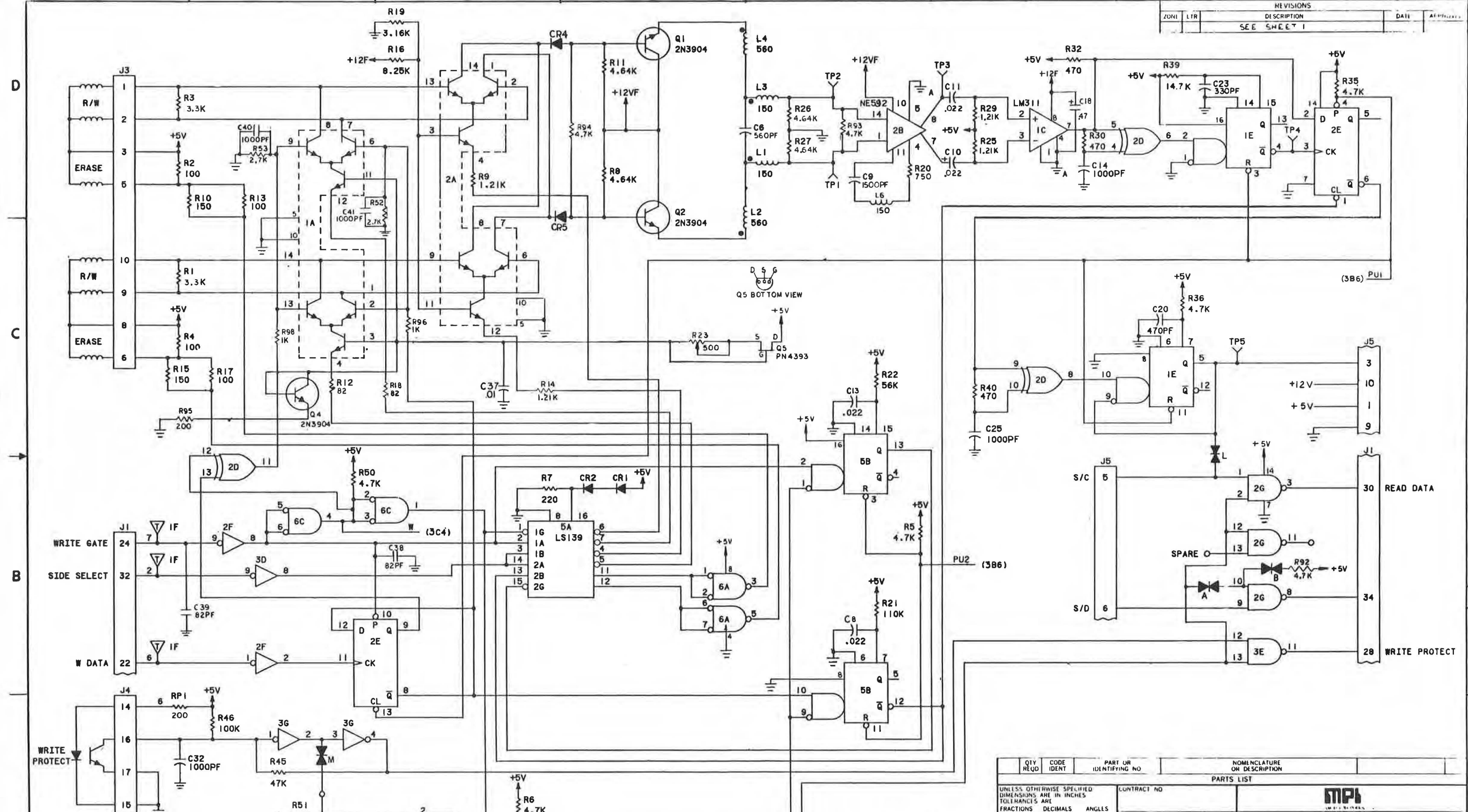

- 3. COILS ARE IN MICROHENRIES
 - 2. CAPACITANCE VALUES ARE IN MICROFARADS
 - 1. RESISTANCE VALUES ARE IN OHMS
 - 4. COMPONENTS WITHOUT VALUES ARE NOT USED.
- NOTES: UNLESS OTHERWISE SPECIFIED

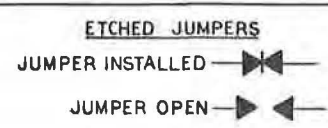

QTY REQD	CODE IDENT	PART OR IDENTIFYING NO	NOMENCLATURE OR DESCRIPTION
PARTS LIST			
UNLESS OTHERWISE SPECIFIED DIMENSIONS ARE IN INCHES TOLERANCES ARE FRACTIONS DECIMALS ANGLES		CONTRACT NO	
MATERIAL		APPROVALS	
FINISH		DATE	
NEXT ASSY		CHECKED	
USED ON		DRAWN	
APPLICATION		SCALE NONE	
DO NOT SCALE DRAWING		SHEET 2 OF 3	

91/92 LOGIC

Page B-3

SIZE	CODE IDENT NO	DRAWING NO	REV
D		4-04002-400	N2

14-04002-400

