

Westfield Sports Cars Limited, Unit One Gibbons Industrial Park, Dudley Road, Kingswinford, West Midlands,
DY6 8XF
+ 44 (0) 1384 400077

XTR2

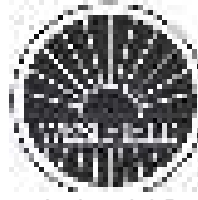

CONSTRUCTION MANUAL



Westfield Sports Cars Limited, Unit One Gibbons Industrial Park, Dudley Road, Kingswinford, West Midlands,
DY6 8XF
+ 44 (0) 1384 400077

Published by WESTFIELD SPORTS CARS LTD.

First Published 2002

Copyright © 2003
Westfield Sports Cars Ltd.

All rights reserved. Apart from any fair dealing for the purposes of private study, research, criticism or review, as permitted under the Copyright, Design and Patents Act 1988, no part of this publication may be reproduced, stored in a retrieval system, or transmitted in any form or by means electronic, electrical, chemical, optical, photocopying, recording or otherwise without prior written permission. All enquiries should be addressed to the publisher.

Section 1

WELCOME

Because you are reading this CONSTRUCTION MANUAL you are either contemplating the purchase of a WESTFIELD Sports Car or have already done so. In either case we would like to thank you for your interest in our product which we firmly believe is the best available. To that end we are prepared to back up our claims with a full warranty on every part bought through us.

WESTFIELD SPORTS CARS were established in 1982. Since then WESTFIELD has produced many thousands of cars. We lay claim to the title of 'Europe's biggest component car manufacturer'. Though an enviable title, WESTFIELD does not intend to rest on its laurels. We are constantly improving our cars, developing many options and additions with which to further the desirability of our product.

At WESTFIELD SPORTS CARS we believe that much of the enjoyment of the car should be in its actual construction, this is why this CONSTRUCTION MANUAL has been produced.

The whole point of building a WESTFIELD is to realise a vehicle that will suit the purpose for which it is intended. With many thousands of satisfied owners, both here and abroad, we believe that at WESTFIELD we have accomplished that objective.

It is in our best interests to deliver to you the means of building a car, simply and quickly, with a minimum of complication and a maximum amount of fun.

We sincerely hope you enjoy that experience.

A handwritten signature in black ink, appearing to read 'Chris Smith', with a stylized flourish at the end.

Chris Smith
Managing Director
WESTFIELD SPORTS CARS

CONTENTS

Page

Section

1	INTRODUCTION	
	Contents	1.2
	Safety	1.3
	Getting Started	1.4
	Tools you will Need	1.5
	Suzuki MegaBusa Donor List	1.6
	Torque Chart	1.7
	Bolt Finder Chart	1.9
2	Brake Pipes	
3	Clutch Line	
4	Chassis Wiring Loom	
5	Pedals & Brackets	
6	Steering	
7	Fuel Tank	
8	Gear Change Lever Bracket	
9	Hand Brake Lever & Cable	
10	Gear Lever & Linkage	
11	Front Suspension	
12	Track Rods & Front Brake Hoses	
13	Rear Differential & Sprocket	
14	Anti-Roll Bar Assembly	
15	Rear Suspension	
16	Fuel System	
17	Dry Sump Tank & Catch Tank	
18	Dry Sump Kit	
19	Engine Fitting & Installation	
20	Reverse Mechanism & Linkage	
21	Bodywork	
22	Exhaust Installation	
23	Interior	

SAFETY

You will Not need to use Welding or Grinding equipment in the Building of a WESTFIELD Sports Car, however, it is VERY IMPORTANT that you take ALL necessary SAFETY Precautions.

1. ALWAYS WEAR:
 - Goggles or Protective Glasses when Drilling.
 - Protective Gloves when Handling Fibreglass.
2. DO NOT Guess at the Torque Settings.
 - Always refer to the Torque Settings Table.
 - If you do not own a Torque Wrench, then hire one from a Good Quality Hire Shop.
3. IT IS ESSENTIAL that the Supports placed Under the Chassis during the Build Process are Suitable and SAFE for use.
 - WESTFIELD SPORTS CARS manufacture Chassis Support Frames that are Designed Specifically for the Purpose and are available from the Factory.
4. DO NOT use Bricks, Building Blocks or Wooden Packing Cases.
 - Bricks and building blocks are NOT suitable as they are liable to topple.
 - Wooden Packing Cases are NOT suitable, as they are liable to Crush as the Weight of the Car increases during the Build Process.
5. DO NOT Connect the Battery +TVE Lead until the Wiring Loom has been Fully Installed and ALL Earth Cables have been Connected.
 - The Battery MUST NOT be connected until ALL TESTS have been completed.
6. DO NOT Fill the Fuel Tank until the car is complete.
 - The Fuel Tank MUST NOT be filled until all of the 'SET-UP' Tests have been completed.
7. PLEASE take Care with Brake Fluid and Brake Fluid Spillage.
8. ALWAYS have a Suitable Fire Extinguisher at Hand.

Have FUN but please, be SAFE!

GETTING STARTED

1. If you HAVE purchased the Optional WESTFIELD Chassis Support Stands then, with the help of an assistant, Lift and Position the Chassis onto these Supports.
 - If you HAVE NOT purchased these stands, then ensure that the chassis is positioned onto suitable supports, which allow the various parts to be fitted.

IMPORTANT

DO NOT ATTEMPT to MODIFY ANY of the items supplied without specific reference to the TECHNICAL HELPLINE at the FACTORY

STORAGE OF BODYWORK

- The Bodywork MUST NOT be Stored in Plastic Sheet, in Damp or Humid Conditions.
- DO NOT Store Bodywork in Direct Sunlight, in Greenhouses or Conservatories.
- WESTFIELD SPORTS CARS WILL NOT accept any WARRANTY CLAIM for Damage to Bodywork where the Damage has been caused by any of the above conditions

TOOLS you will NEED

1. Combination Spanner Set : 5/16" To 3/4" A/F Imperial
2. Combination Spanner Set : 8mm To 19mm A/F Metric
3. Socket Set : Imperial And Metric
4. Torque Wrench : 1/2" Square Drive : Range 0-100 lb ft
5. Drill Set To Include : 5/32", 3/16", 1/4" & 5/16" Drill Bits
6. Metric `Allen' Keys : 1 Set
7. Socket Drive `Allen' Key : 6mm
8. Socket Drive `Allen' Key : 8mm
9. Circlip Pliers : Internal And External
10. Tap : 1/2" UNF
11. Tap : M18 X 1.5mm
 - (Note The M18 X 1.5mm Tap Is Only Required To Clean Out The Residual Powder Coating That May Have Been Left- In The Top Wishbone Threads)
12. Hole Cutter : 1 ¼ " Diameter - Steering Column
13. Hole Cutter : 1 ¾ " Diameter - (45mm) Loom
14. Hole Cutter : 2" Diameter - Gear Stick
15. Pop Rivet Gun
16. Brake Pipe Bending Tool
17. Rivnut Fixing Kit
18. Electric Drill
19. 12" Hacksaw
20. Engineering Hammer
21. Centre Punch
22. Hide Hammer
23. Two 'G' Clamps
24. Bench Vice : Machine Type
25. Flat Blade Screwdrivers : 1 Set
26. Phillips Screwdrivers : 1 Set
27. Round File : 5/16" Diameter
28. File : 12" Long Flat Blade File
29. Tape Measure
30. Metal Cutters

IN ADDITION, for the WESTFIELD `SEI' & XTR2 ONLY:

1. 41mm A/F METRIC Socket
2. Torque Wrench, ½" Square Drive with a Range of 250 lb ft.
(If necessary, HIRE both the Socket and Torque Wrench when required)

SUZUKI MEGABUSA DONOR LIST

PARTS REQUIRED:-

- Engine & Gearbox Complete (With Number.)
- Throttle Linkages & Injection Assembly
- Full Engine Wiring Harness* (Requires Modification – See Note Below)
- E.C.U.

SENSORS:-

- Intake Air Pressure Sensor
- Atmospheric Pressure Sensor
- Intake Air Temperature Sensor
- Starter Motor Assembly
- Starter Motor Relay
- Chain Sprocket Nut & Washer
- Ignition Coils x 4 (These are part of the Spark Plug Caps)
- Regulator / Rectifier Unit
- Fuel Pump Relay
- Dash Complete (For Fault Finding)
- Photo Copy Of Donor Log Book If Available

IMPORTANT NOTES:

- Never purchase engines with any damage to casings or without IDENTITY NUMBERS.
- Establish if the safety recall has been completed on Timing Chain Tension Adjuster (Suzuki Warranty). If this has been done there will be a 'RECALL COMPLETION' LABEL attached under the pillion seat on the left hand side of The 'U' LOCK storage area.

Example:-



*** Note***

The Wiring Loom will require modification before installation.
WESTFIELD SPORTS CARS can carry out this modification for a fee.

TORQUE CHART

Settings in Pounds Feet and Newton Metres:	ft-lbs.	Nm	
Three Way Brake Pipe Unions	5	7	
Rear Brake Caliper Mounting Bolts (Steel)	40	54	*
Steering Rack Mounting Bolts to Chassis	20	27	
Track Rod End Nuts to Steering Arm	28	38	
Wishbone Securing Bolts to Chassis	35	40	
Lower Ball Joint Securing Bolts to Wishbone	22	34	
Lower Ball Joint Nut to Upright Block	28	38	
Top Ball Joint Nut to Upright Block	25	34	
Steering Column Upper Mounting Bolts	20	27	**
Steering Column Shaft Couplings	20	27	**
Steering Column Securing Clamp	28	38	**
Front Brake Caliper Mounting Bolts (Steel)	40	54	*
Shock Absorber to Chassis Mounting Bolts	30	40	
Handbrake Mounting Bolts	22	30	
Seat Belt Mounting Bolts	26	35	
Steering Wheel Nut	35	47	
Wheel Nuts (Rimstock)	65	90	
Differential Unit Bolts to Chassis (SEi)	30	40	
Rear Brake Caliper Mounting Bolts (SEi)	35	47	*
Drive Shaft Hub Nut (SEi)	250	340	
Oil Pressure Switch	9	12	
Neutral Switch	9	12	
Sprocket Retaining Bolt (Modified Cap Head)	104	54	*
6mm Bolts	9	12	
8mm Bolts	18	24	
9mm Bolts	20	27	
10mm Bolts	28	39	
Sump Pan Retaining Bolts (In sequence as instructed)	9	12	

TORQUE CHART Continued...

General Notes:

- i) Use the Bolt Finder Chart to identify the CORRECT bolt sizes
- ii) Use Extra Care when Torque Tightening into Alloy Engine Block & Components.
- * Denotes: APPLY a Thread Locking Adhesive to threads when fitting
- ** Denotes: MAXIMUM Torque Setting

Suspension Bolt Tightening Notes:

- i) It is IMPORTANT to REMEMBER that ALL suspension bolts and Nyloc Nuts will be Torque tightened during the Set-Up stage. WESTFIELD SPORTS CARS STRONGLY RECOMMEND that during the assembly of the suspension that ALL suspension bolts and Nyloc Nuts are `NIPPED` ONLY and NOT Torque tightened.

BOLT FINDER PAGE

METRIC BOLT FINDER (Actual Length)

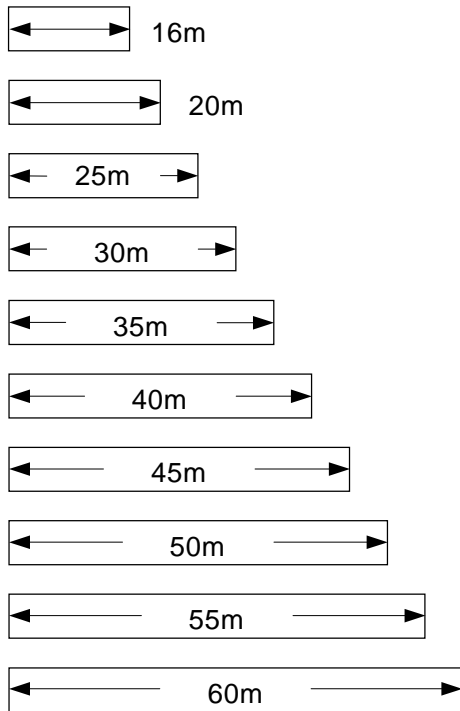

DIAMETER (Actual Size)

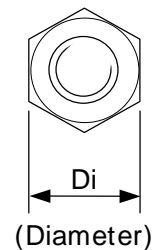
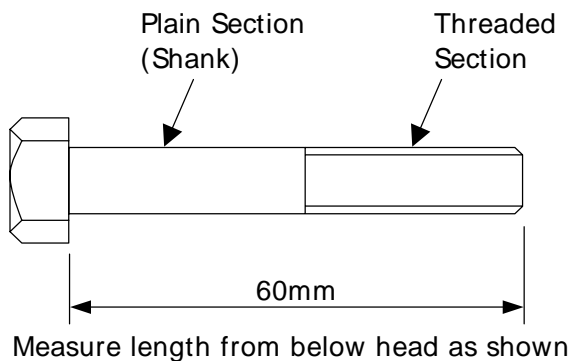
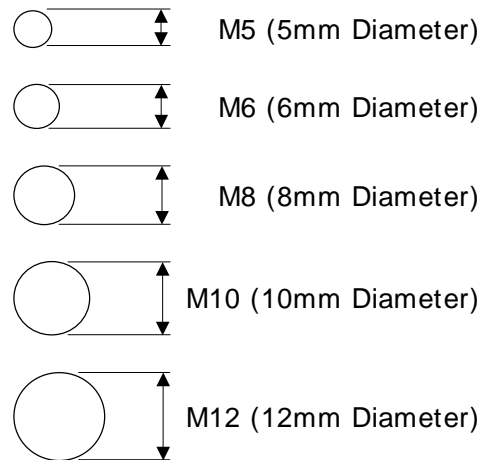

NOTES:

- i) The DIFFERENCE between a BOLT and a SETSCREW is:
- A Bolt is only partially threaded and has a plain upper section whereas a Setscrew is threaded along its whole length.
- ii) The Length of a BOLT or a SETSCREW is measured from the underside of the head, refer to Diagrams above.
- iii) The Diameter of a BOLT is measured across the plain (non-threaded) section.
- iv) The Diameter of a SETSCREW is measured across the top of the threads.

Section 2

SECTION 02 - BRAKE PIPES

- ALWAYS USE NEW BRAKE PIPES.
- TAKE CARE when FORMING the brake pipes to make sure that you achieve a smooth uniform bend using a pipe bending tool if possible.
- Westfield recommends that you PRACTICE bending on a scrap or spare brake pipe before attempting to bend any of the brake pipes supplied.
- DO NOT USE metal clips to support the brake pipes or allow the brake pipes to make contact with other metal parts or foul any nuts, bolts or moving parts.
- To comply with SVA Regulations, all pipes MUST be secured with clips spaced at a Maximum Distance of 300mm apart.

Tools Required:-

- Electric Drill / 3.5 (or 9/64) Dia Drill Bit / Pop Rivet Gun / Pipe Bending Tool / 2 x 10mm Spanners / 11mm Spanner / 13mm Spanner / 17mm Spanner

Parts Required:-

- 1 x Brake Pipe Kit (See Page 5 For List Of Pipes Supplied)
- 2 x Brake Master Cylinders
- "P" Clips + Pop Rivets to Suit
- 3 x Three Way Brake Pipe Connector ("T" Piece)
- 1 x Brake Light Switch and Copper Washer

Step 1: Fit Brake Master Cylinders & Brake Light Switch



Front Brake Cylinder

Rear Brake Cylinder

Brake Light Switch

Rear Brake Line

View From Drivers Side

Step 1: Cont'd,

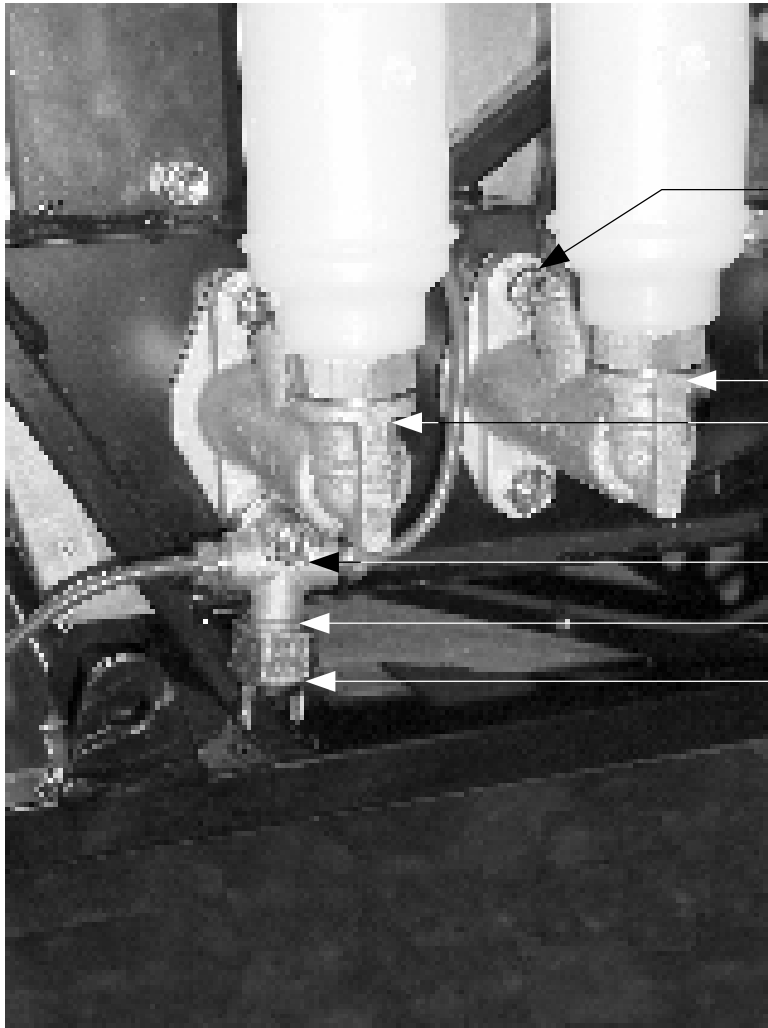

3 x M8 Bolts x 25 Long
(Plus 1x50 Long Bolt For
Switch Mounting).
Insert Bolts From Inside
Pedal Box & Secure With
Nyloc Nuts

Front Brake Cylinder
Rear Brake Cylinder

3 Way Brake Pipe Connector
Drill Out Mounting Hole To
Fit Onto M8 Bolt x 50 Long
Prior To Installation

Copper Washer
Brake Light Switch

View From Front

Step 2: Fit Rear Brake Line

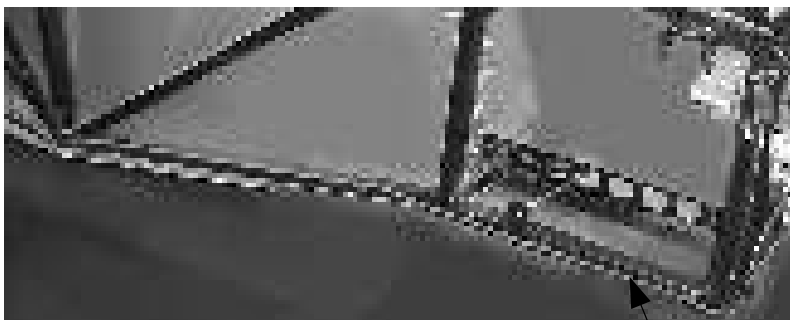

Brake Light Switch

Rear Brake Line

View From Drivers Side
(Front Section Of Chassis)

This Brake Line **MUST** Run Along the Side
Edge of the Chassis Rail (As Shown)
& **NOT** Along the Top of the Chassis Rail.

Step 2: Cont'd,

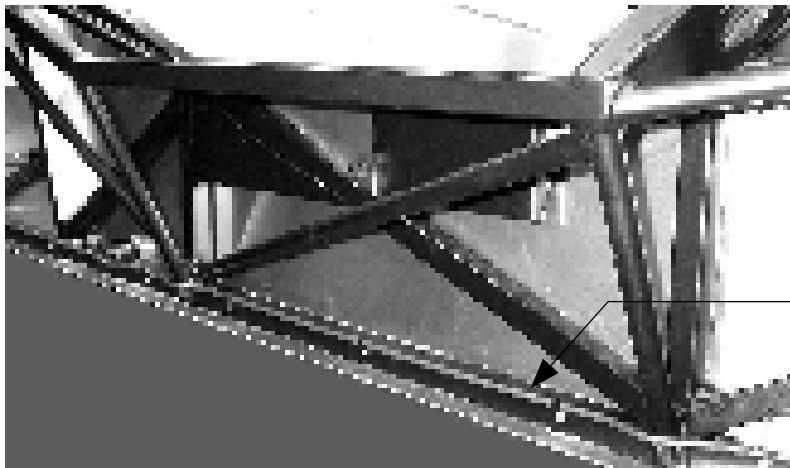

Rear Brake Line

View From Drivers Side
(Mid Section Of Chassis)

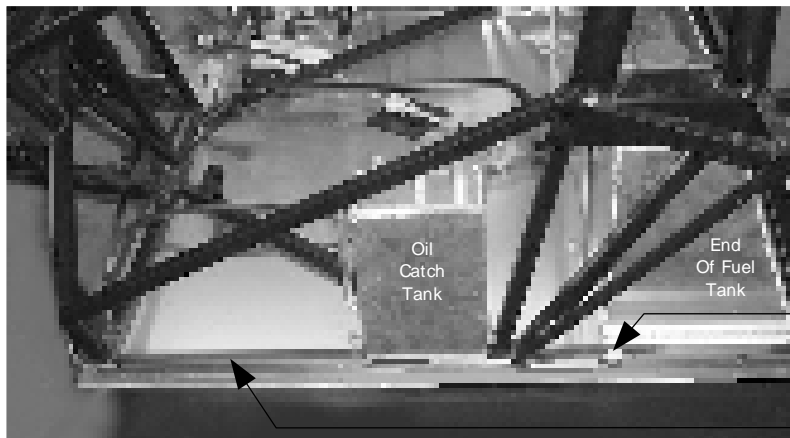

Rear Brake Pipe Coupler

Rear Brake Line

View From Drivers Side
(Engine Bay Area Of Chassis)

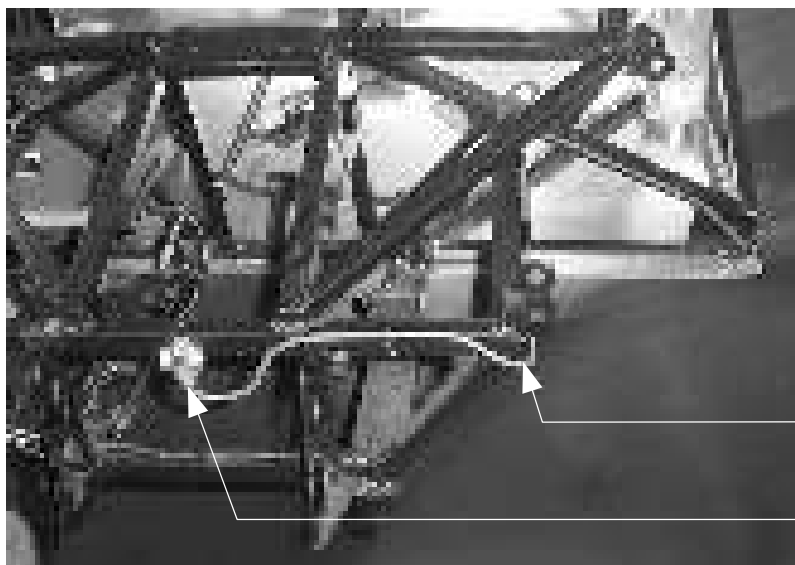

Rear Brake Line

3 Way Brake Pipe Connector

View From Rear Of Car
(Rear Section Of Chassis)

Step 3: Fit Front Brake Line 3 Way Connector



3 Way Brake Pipe Connector

View From Front

Step 4: Fit Front Drivers Side Brake Line

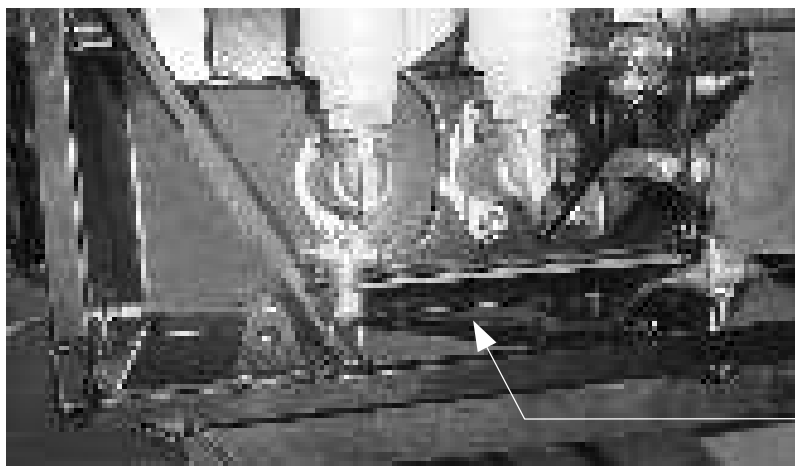

Front Brake Line
(Drivers Side)

View From Front

Step 5: Fit Front Passenger Side Brake Line

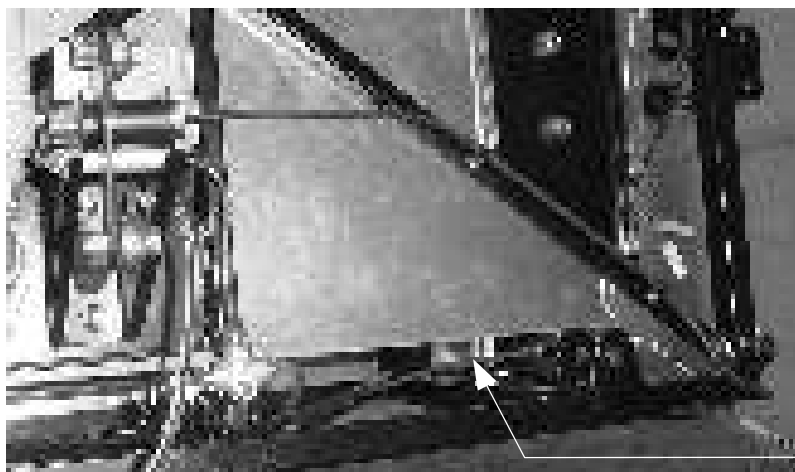

Front Brake Line
(Passenger Side)

View From Front

Brake Pipe List:-

Item	Quantity Supplied	Description (Westfield Code)	Pipe Length (Millimetres)	Location On Car
1	1	Brake Pipe (2312041)	285	Front Brake Cylinder To Front T-Piece
2	1	Clutch Pipe (2312049)	2250	From Clutch Cylinder To Rear Of Car (See Section 3 Of This Manual)
3	1	Brake Pipe (2312022)	1350	Rear Brake Pipe Coupler To Rear T-Piece
4	2	Brake Pipe (2312030)	470	Front T-Piece To Front Brakes
5	1	Brake Pipe (2312052)	320	Rear T-Piece To Rear Brake
6	1	Brake Pipe (2312061)	250	Rear T-Piece To Rear Brake
7	1	Brake Pipe (2312070)	200	Rear Brake Cylinder To Brake Switch
8	1	Brake Pipe (2312083)	2150	Brake Switch To Rear Brake Pipe Coupler

Note:

The Silver Fittings On Items 1 & 7 Are 5/16" UNF Fittings And Screw Into The Brake Cylinders. All Of The Other Fittings Supplied Are Gold And Are M10.

Section 3

SECTION 03 - CLUTCH PIPE

- ALWAYS USE NEW CLUTCH PIPE
- TAKE CARE when FORMING the clutch pipe to make sure that you achieve a smooth uniform bend using a pipe bending tool if possible.
- Westfield recommends that you PRACTICE bending on a scrap or spare pipe before attempting to bend the clutch pipe supplied.
- DO NOT USE metal clips to support the clutch pipe or allow the clutch pipe to make contact with other metal parts or foul any nuts, bolts or moving parts.

Tools Required:-

- Electric Drill / 3.5 (or 9/64) Dia Drill Bit / Pop Rivet Gun / Pipe Bending Tool / 2 x 10mm Spanners / 11mm Spanner / 13mm Spanner

Parts Required:-

- 1 x Clutch Pipe (See Page 5 Of Section 2 For Details Of Pipe Supplied)
- 1 x Clutch Master Cylinder Kit Complete

Step 1: Clutch Master Cylinder Assembly

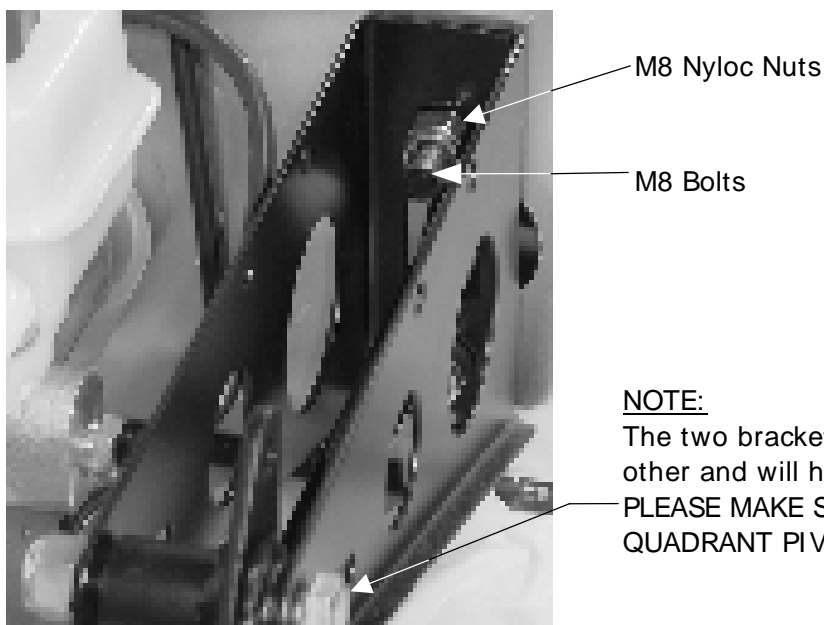
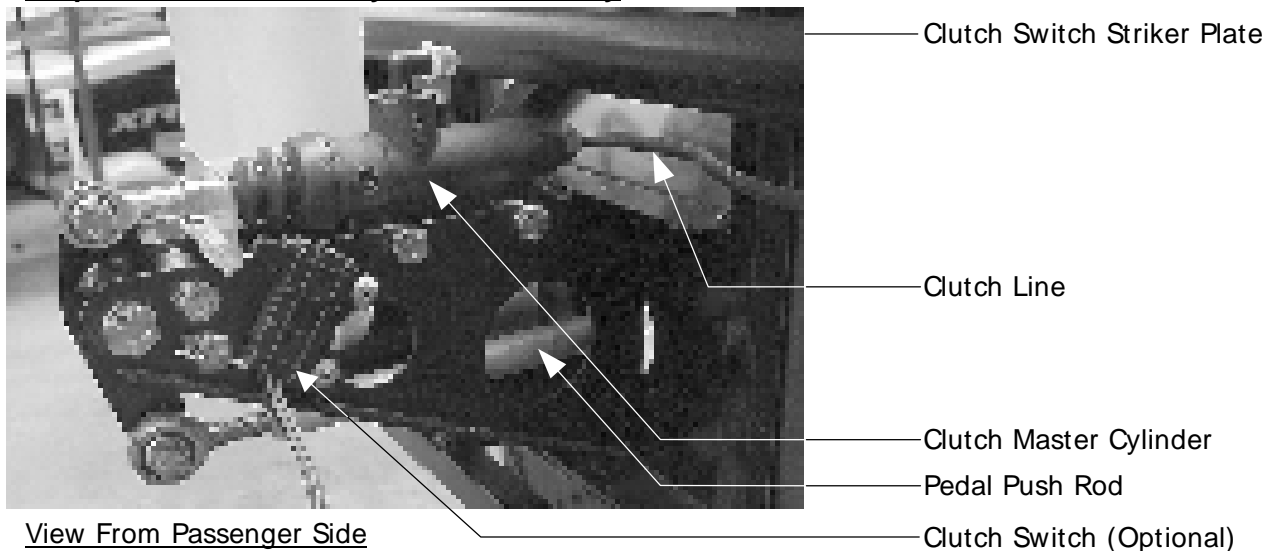

NOTE:

The two brackets are separate from each other and will have to be overlapped.
PLEASE MAKE SURE THAT HOLES FOR QUADRANT PIVOT LINE UP

Fitting The Cylinder Mounting Brackets

Step 1: Cont'd,

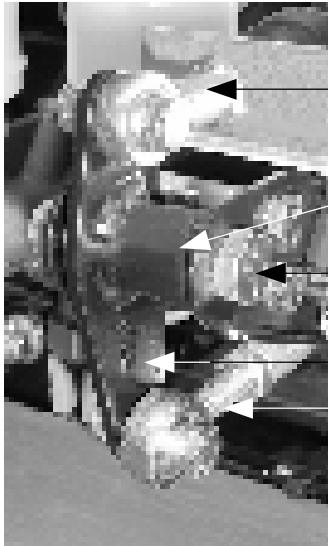

Do NOT Fit Clutch Push Rod At This Stage

Lubricate Bush With Copper Slip BEFORE Installation

M8 x 45mm Bolt and Nyloc Nut.
DO NOT OVERTIGHTEN NUT

Ensure Quadrant Moves Freely

Do NOT Fit Pedal Push Rod At This Stage

Quadrant Installation

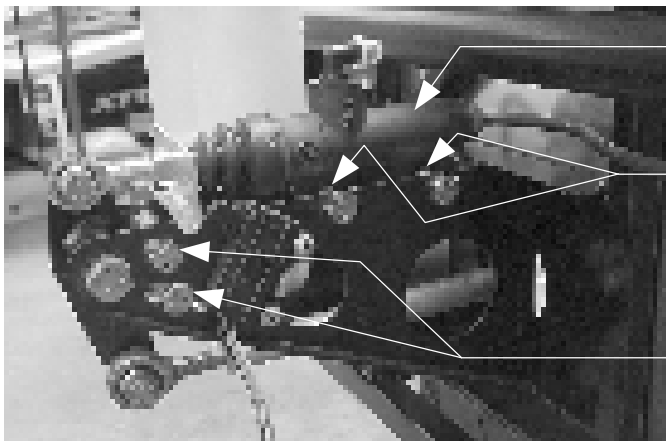

Clutch Cylinder

Fit Spacers Either Side Of Cylinder & Secure With M6 Bolts x 45 Long & Nyloc Nuts

Pedal Stop Tubes – 2 Off Each Fixed With M6 Bolt x 45 Long & Nyloc Nut

Clutch Cylinder Assembly / Installation

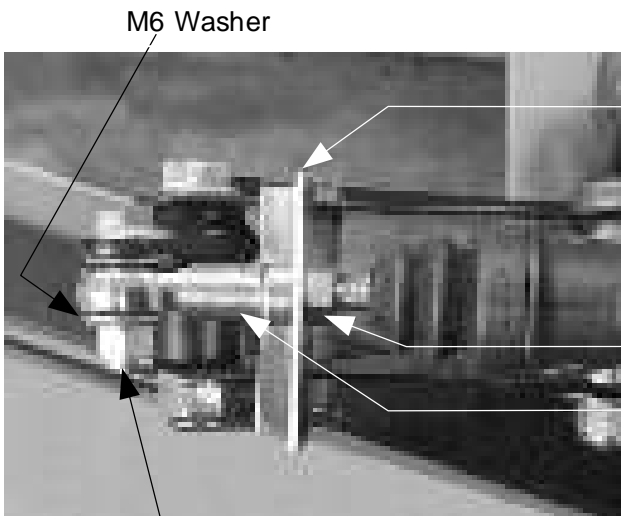

M6 Washer

Clutch Switch Activation Plate

M6 Plain Nut

Rod End

M6 Bolt x 25 Long & Nyloc Nut

Clutch Cylinder Rod End Assembly

Step 1: Cont'd,

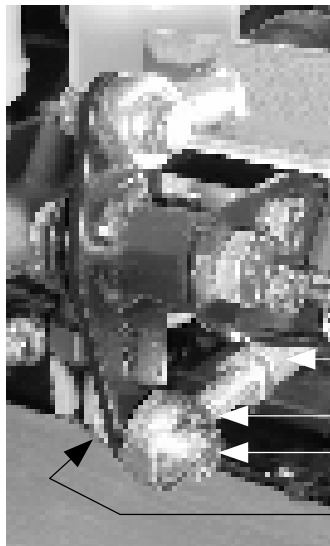

- Pedal Push Rod
- 5/16" Rod End
- M6 Bolt x 30 Long
- M6 Nyloc Nut

Pedal Push Rod End Assembly

Step 2: Fit Clutch Line

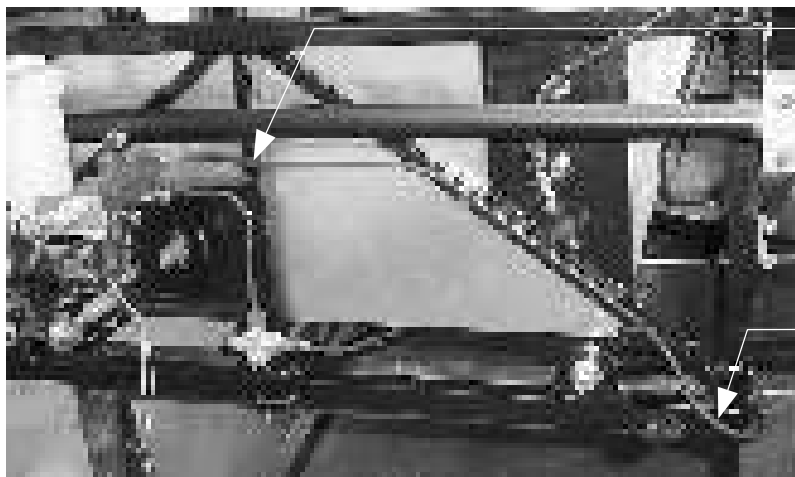

— Clutch Line

— Clutch Line

View From Front Of Car



— Clutch Line

Clutch Line **Must** Be Fitted To The **Edge** Of The Tube as Shown And Not Along The Top Face

View From Passenger Side
(Front Section Of Chassis)

Step 2: Cont'd,



Clutch Line End Connector

Clutch Line

This Clutch Line **MUST** Run Along the Side Edge of the Chassis Rail (As Shown) & **NOT** Along the Top of the Chassis Rail.

View From Passenger Side
(Mid Section Of Chassis)

Step 3: Fit Clutch Reservoir

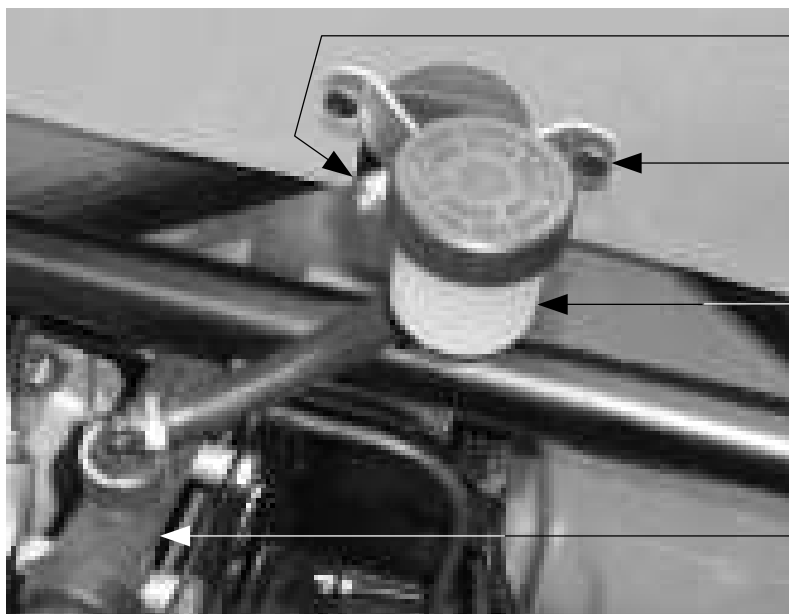

M6 Button Head Screw x 16 Long + Nyloc Nut

Rivet Bracket To Body
Work After Final Body Fitting. (Leave Reservoir Loose For Now)

Clutch Reservoir

Clutch Cylinder

View From Front Of Car

Section 4

SECTION 04 - CHASSIS WIRING LOOM

- IT IS RECOMMENDED THAT YOU ALWAYS USE THE WESTFIELD CHASSIS WIRING LOOM.
- DO NOT USE metal clips to support the wiring loom or allow the wiring loom to make contact with any moving parts or sharp edges.

Tools Required:-

- Electric Drill / 4.1 Dia Drill Bit / Pop Rivet Gun / 1" Masking Tape / Fine Pointed Marker Pen / Side Cutters / 3mm Allen Key / M8 Combination Spanner

Parts Required:-

- Westfield Chassis Loom / Loom Saddles / 4.1mm Dia x 10mm Long Closed Pop Rivets / Cable Ties / 4 x M5 x 25mm Button Head Screws / 4 x M5 Nyloc Nuts / 4 x M5 Plain Washers / 4 x Aluminum Spacers / 1" Foam Tape

Step 1: Fuse Box Mounting Plate

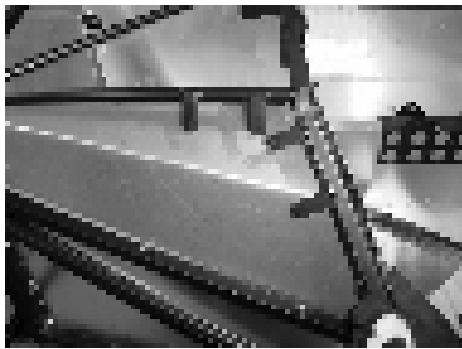

4 Fuse Box Mounting Lugs
(Welded To The Top Frame
Chassis Rails)

View From Passenger Side

Step 2: Loom Mounting Side Panels

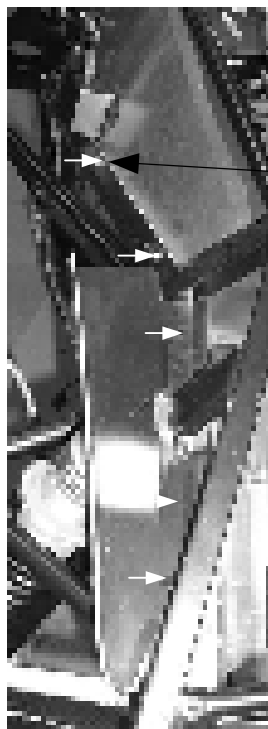

Loom Mounting Side
Panels

- Position Panels As Shown
- Trim Panels to Fit Correctly
- Drill Through Panels Into Chassis Rail (Shown By '→')
- Rivet Through Loom Saddles & Panel Into Chassis To Secure

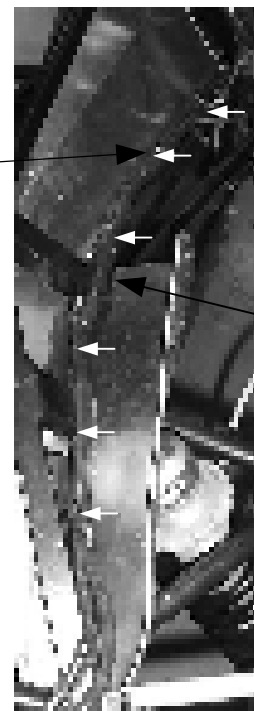

NOTE
Loom
Shown
For Ref.
Only At
This
Stage

Step 3: ECU Mounting Plate

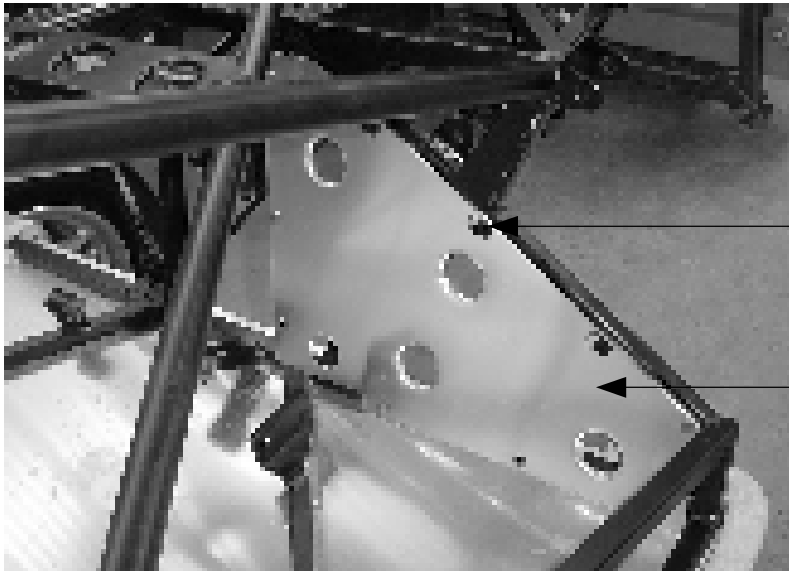

Loom Saddles (3 Places)
(Rivet Through Saddles &
Panel Into Chassis Rail)

ECU Mounting Plate

View From Passenger Side
(Engine Bay Area Of Chassis)

Step 4: Installation Of Main Chassis Loom Saddles

Fit Loom Saddles In Approximate Positions Shown By Arrows

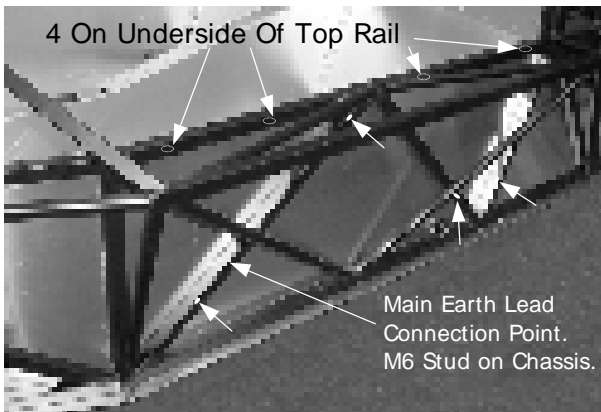

4 On Underside Of Top Rail

Main Earth Lead
Connection Point.
M6 Stud on Chassis.

View From Passenger Side
(Mid Section Of Chassis)

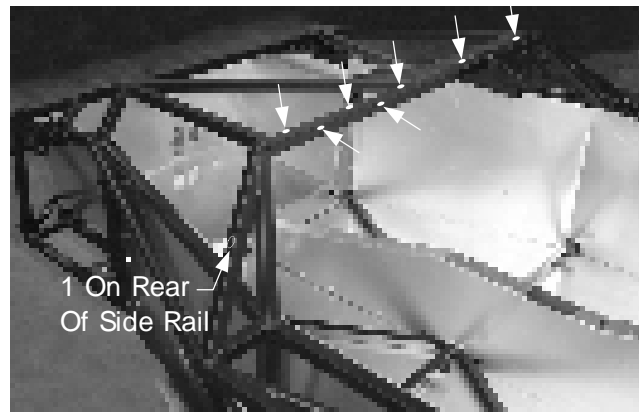

1 On Rear
Of Side Rail

View From Passenger Side
(Front Section & Top Frame Of Chassis)



View From Drivers Side
(Mid Section Of Chassis)



View From Passenger Side
(Engine Bay Area Of Chassis)

Step 5: Main Loom Identifier & Installation

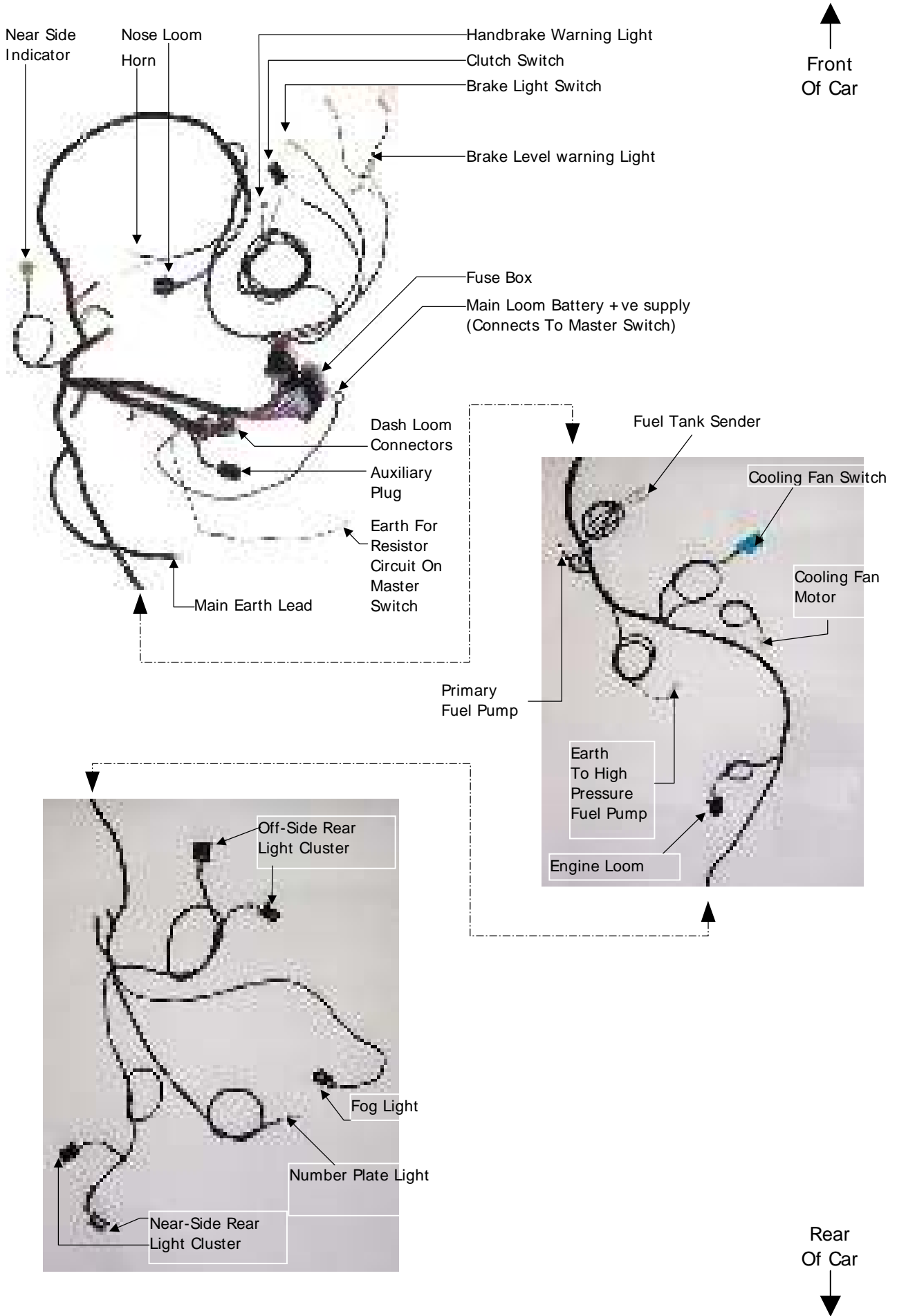

Step 5: Cont'd,

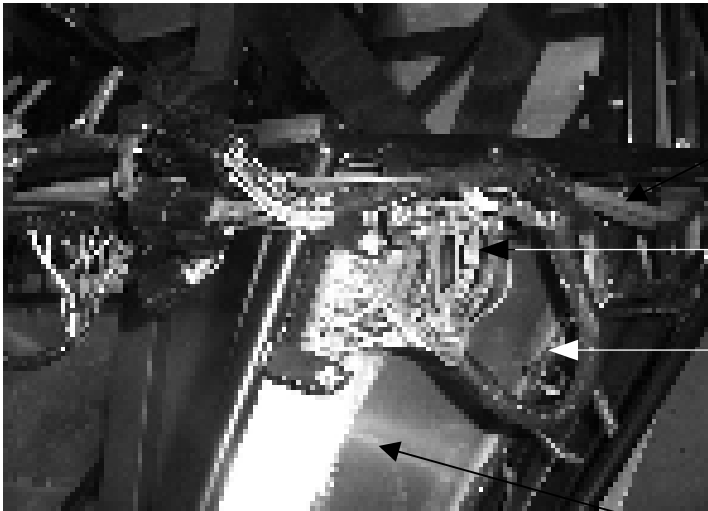

Main Battery Power Cables

Fuse Box On Underside Of Brackets Place Loom Onto The Passenger Side Loom Mounting Panel. Arrange Loom So The Fuse Boxes Line Up With The Fuse Box Mounting Plate

Under Scuttle Panel

View From Front Of Car
(Top Frame Section Of Chassis)

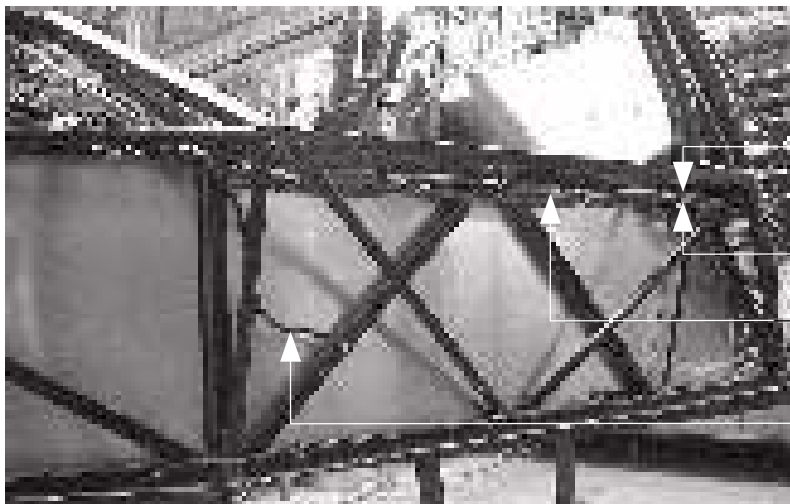

Run The 2 Red Main Battery Cables Supplied Along The Chassis With The Wiring Loom

Wiring Loom

Main Earth Lead

View From Passenger Side
(Mid Section Of Chassis)



Main Positive Battery Lead

Reverse Solenoid

Positive Lead for Reverse Solenoid

View From Passenger Side
(Engine Bay Area Of Chassis)

Step 5: Cont'd,

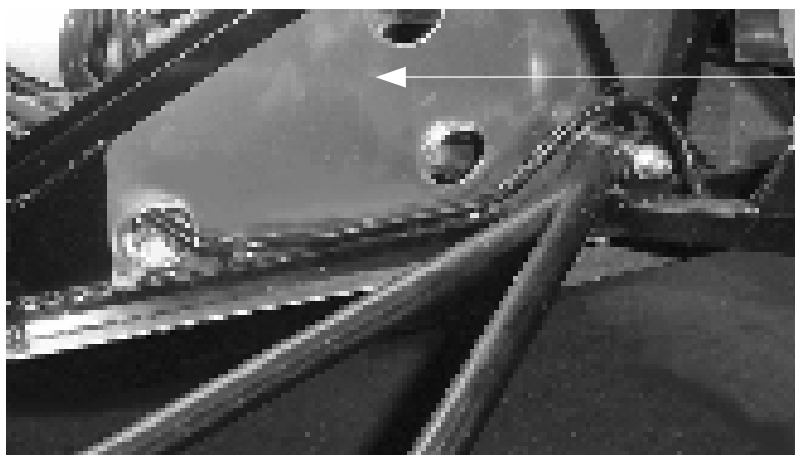

Rear Of ECU
Mounting Plate

View From Rear Of Car
(Rear Section Of Chassis)



Rear Of ECU
Mounting Plate

View From Underside & Drivers Side Of Car
(Rear Section Of Chassis)

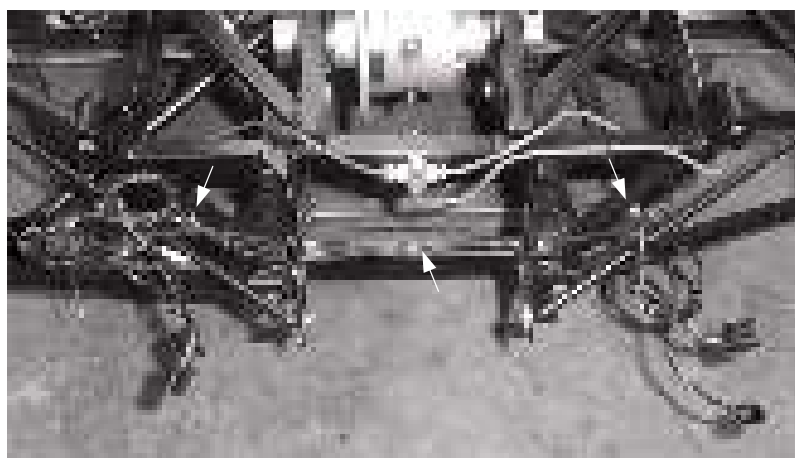

View From Rear Of Car
(Rear Section Of Chassis)

Step 6: Master Switch Installation & Connection

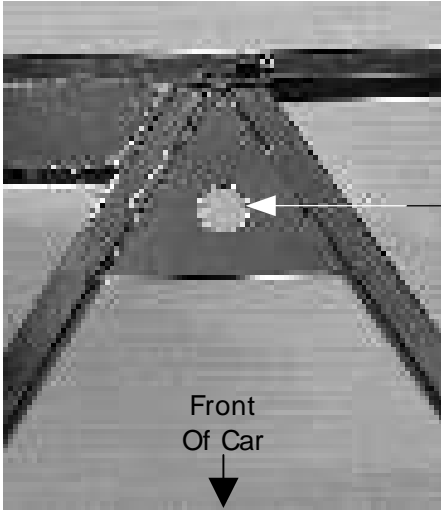

Large Hole Already In Chassis Top Frame
 Drill 2 More Holes For Fixing Screws
 Fix Master Switch In As Shown

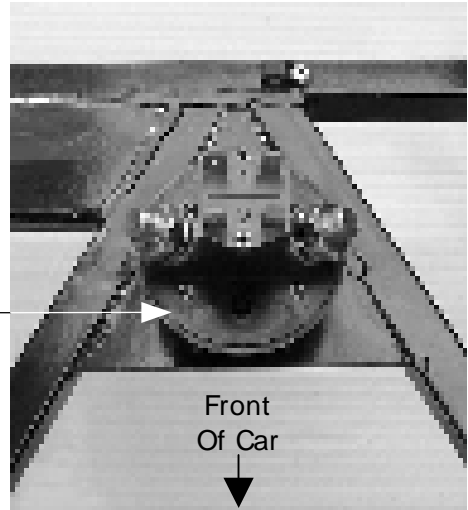

Views From Front Of Car
 (Top Frame Section Of Chassis)

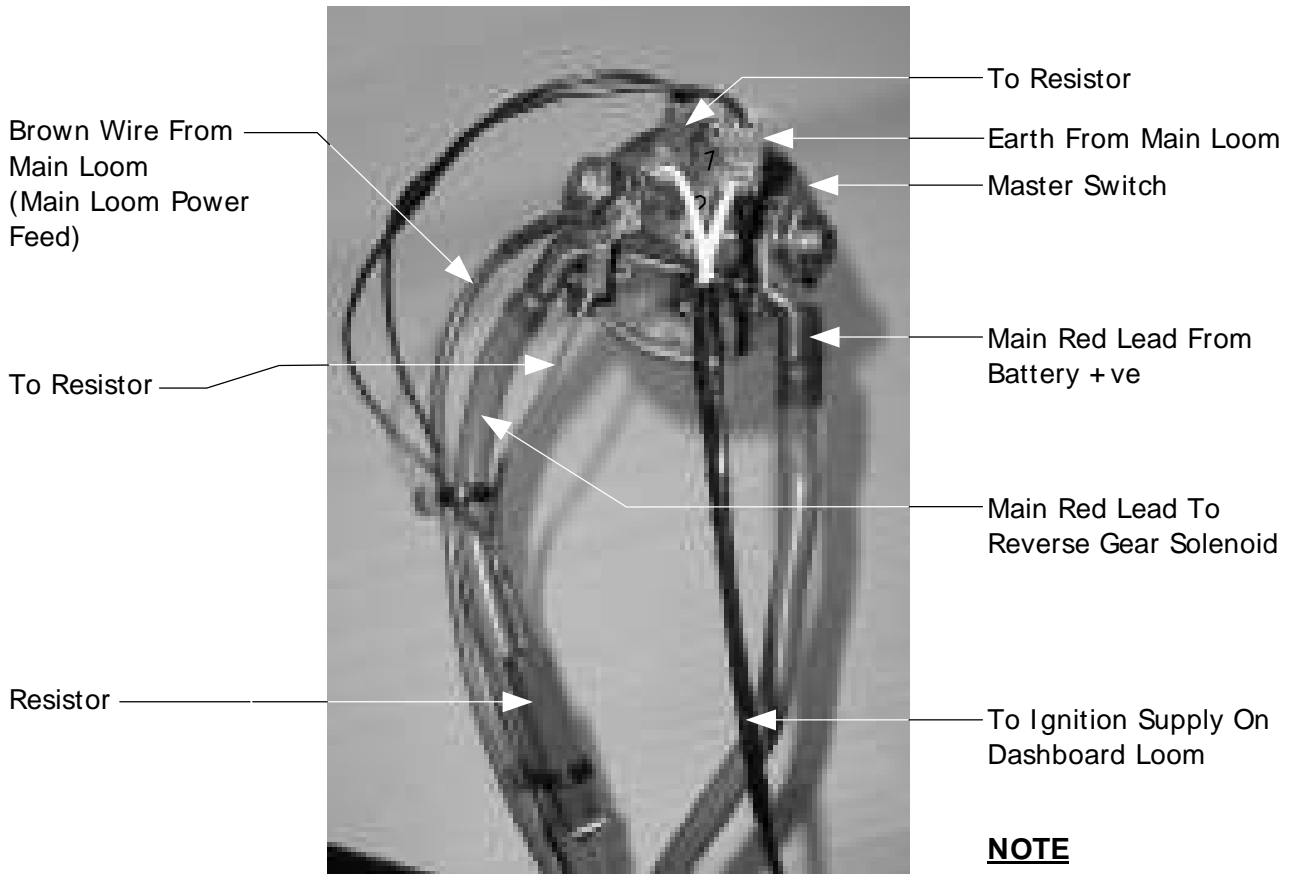

View From Underside Of Switch
 Switch Removed From Chassis For Clarity

NOTE
 THE MASTER SWITCH **MUST BE WIRED AS SHOWN**
 (See Instructions Sheet In Master Switch Pack For Further Details.)

Step 7: Battery Tray & Battery Installation

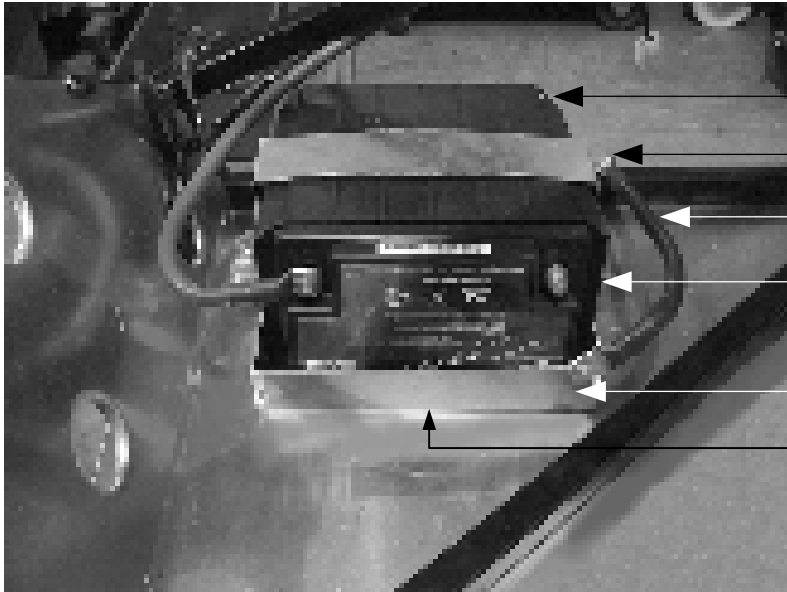

- Battery Strap
- M6 Stud welded on Chassis
- Battery -VE Cable
- Battery
- Battery Tray

Fixing Details

- Drill 4 Holes Through Battery Tray & Floor Panel
- Run A Bead Of Silicone All Around The Bottom Of The Tray
- Fix Tray To Floor Panel Using Rivets

View From Drivers Side
(Engine Bay Area Of Chassis)

Step 8: Fuse Box Installation

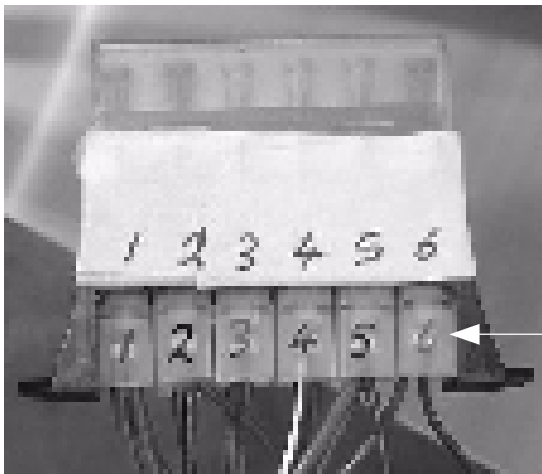

Before fitting the fuse boxes to the chassis the wires / connectors must be removed, as the fuse boxes will not pass through the 1 3/4" hole in the panel. The fuse boxes and the connectors **MUST** be labelled before removing them. Label fuse boxes and connectors either 1 – 24 or A – X to avoid confusion



Place fuse boxes in required location with the fuses facing into the car using M6 x 16 button head screws and nuts.

View From Passenger Side
(Top Frame Section Of Chassis)

Step 9; Main Power Cables In Engine Bay

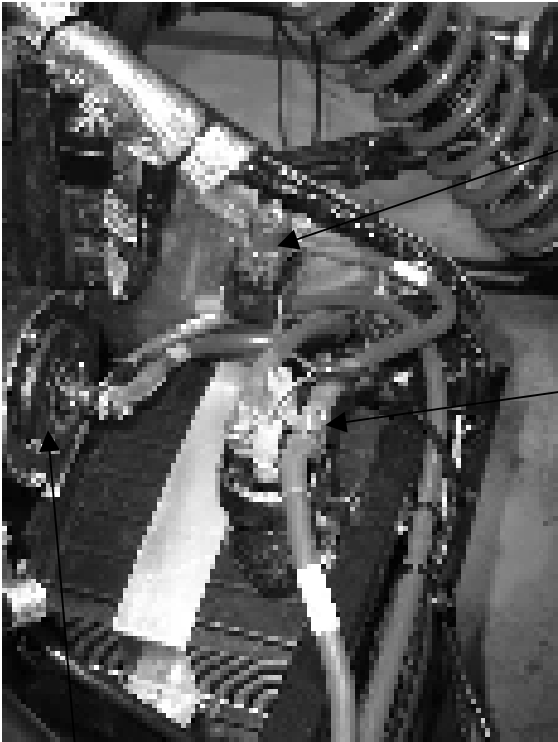

Starter Relay

Reverse Solenoid

Reverse Motor

MAIN WIRING LOOM DETAILS

CONNECTION	LOOM CONNECTOR TYPE	LOOM WIRE COLOURS	NOTES
<u>LOOM FRONT SECTION</u>			
BRAKE LEVEL WARNING LIGHT	4 FEMALE SPADE CONNECTORS	BLACK ; BLACK / WHITE	2 PAIRS TOTAL. 1 PAIR TO EACH CYLINDER TOP. ORIENTATION OF EACH PAIR UNIMPORTANT
BRAKE LIGHT SWITCH	2 FEMALE SPADE CONNECTORS	GREEN ; GREEN / PURPLE	CONNECTION ORIENTATION UNIMPORTANT
CLUTCH SWITCH	CONNECTOR BLOCK	WHITE / RED	PRE-WIRED - CUSTOMER TO FIT SPARE BLOCK SUPPLIED TO CLUTCH SWITCH WIRES – BLUE & BLACK. ORIENTATION UNIMPORTANT
HANDBRAKE WARNING LIGHT	BARE WIRES	BLACK ; BLACK / WHITE	CUSTOMER TO FIT CONNECTION BLOCK SUPPLIED TO HANDBRAKE SWITCH WIRES – GREY & BLACK. ORIENTATION UNIMPORTANT
NOSE LOOM	11 WIRE CONNECTOR BLOCK	VARIOUS	PRE-WIRED
HORN	2 FEMALE SPADE CONNECTORS	BLACK ; BLACK TO ONE CONNECTOR PURPLE / BLACK TO OTHER CONNECTOR	ORIENTATION UNIMPORTANT
NEAR SIDE INDICATOR	CONNECTOR BLOCK	BLACK ; GREEN / RED	PRE-WIRED
FUSE BOX	2 FUSE HOLDER BLOCKS	VARIOUS	PRE-WIRED BUT TO BE LABELLED, REMOVED & REFITTED BY CUSTOMER
AUAIILIARY PLUG	4 WIRE CONNECTOR BLOCK	ORANGE, GREEN, BROWN, BLACK	FOR EXTRA AUXILIARY CIRCUIT, IE; CIGAR LIGHTER ETC
MAIN LOOM POSITVE SUPPLY	RING TERMINAL	BROWN	CONNECTS TO MASTER SWITCH
DASHBOARD LOOM	12 WIRE CONNECTOR BLOCK x 2	VARIOUS	PRE-WIRED
EARTH FOR RESISTOR CIRCUIT ON MASTER SWITCH	1 FEMALE SPADE CONNECTOR	BLACK	SEE MASTER SWITCH INSTALLATION SECTION
MAIN EARTH LEAD	RING TERMINAL	5 BLACK	CONNECTS TO CHASSIS

<p>4.12</p> <p>FUEL TANK SENDER</p> <p>PRIMARY FUEL PUMP</p> <p>EARTH TO HIGH PRESSURE FUEL PUMP</p> <p>COOLING FAN SWITCH</p> <p>COOLING FAN MOTOR</p> <p>ENGINE LOOM</p> <p>REVERSE SOLONOID</p>	<p>2 FEMALE SPADE CONNECTORS</p> <p>1 FEMALE SPADE CONNECTOR</p> <p>1 FEMALE SPADE CONNECTOR</p> <p>CONNECTOR BLOCK (BLUE)</p> <p>CONNECTOR BLOCK (WHITE)</p> <p>CONNECTOR BLOCK</p> <p>2 FEMALE SPADE CONNECTORS</p>	<p><u>LOOM MID SECTION</u></p> <p>BLACK ; GREEN / BLACK</p> <p>GREEN</p> <p>BLACK</p> <p>GREEN ; BLACK</p> <p>2 BLACK</p> <p>ORANGE, GREEN ; WHITE / BLACK ; WHITE / RED</p> <p>ORANGE, BLACK / GREEN ;</p>	<p>ORIENTATION UNIMPORTANT</p> <p>PRE-WIRED TO PUMP MOUNTED ON CHASSIS SIDE</p> <p>PRE-WIRED TO PUMP MOUNTED ON CHASSIS FLOOR</p> <p>PRE-WIRED</p> <p>PRE-WIRED</p> <p>PRE-WIRED</p> <p>TO SPADE TERMINALS ON SOLONOID, ORIENTATION UNIMPORTANT.</p>
<p><u>LOOM REAR SECTION</u></p>			
<p>OFFSIDE REAR LIGHT CLUSTER</p> <p>NEAR SIDE REAR LIGHT CLUSTER</p> <p>FOG LIGHT</p> <p>NUMBER PLATE LIGHT</p>	<p>3 TERMINAL CONNECTOR BLOCK</p> <p>2 TERMINAL CONNECTOR BLOCK</p> <p>3 TERMINAL CONNECTOR BLOCK</p> <p>2 TERMINAL CONNECTOR BLOCK</p> <p>2 PIN CONNECTOR BLOCK</p> <p>BARE WIRES</p>	<p>BLACK – 1 PAIR GREEN / PURPLE RED / ORANGE</p> <p>BLACK ; GREEN / WHITE</p> <p>BLACK – 1 PAIR GREEN / PURPLE – 1 PAIR RED / BLACK</p> <p>BLACK ; GREEN / RED</p> <p>BLACK ; RED / BLUE</p> <p>BLACK ; RED / BLACK</p>	<p>BRAKE & SIDE LIGHT</p> <p>INDICATOR (DRIVER SIDE) BRAKE & SIDE LIGHT</p> <p>INDICATOR (PASSENGER SIDE)</p> <p>CUSTOMER TO FIT BULLET CONNECTORS SUPPLIED</p>

SECTION 04 - DASHBOARD WIRING LOOM

Step 9: Dashboard Loom Identifier & Installation

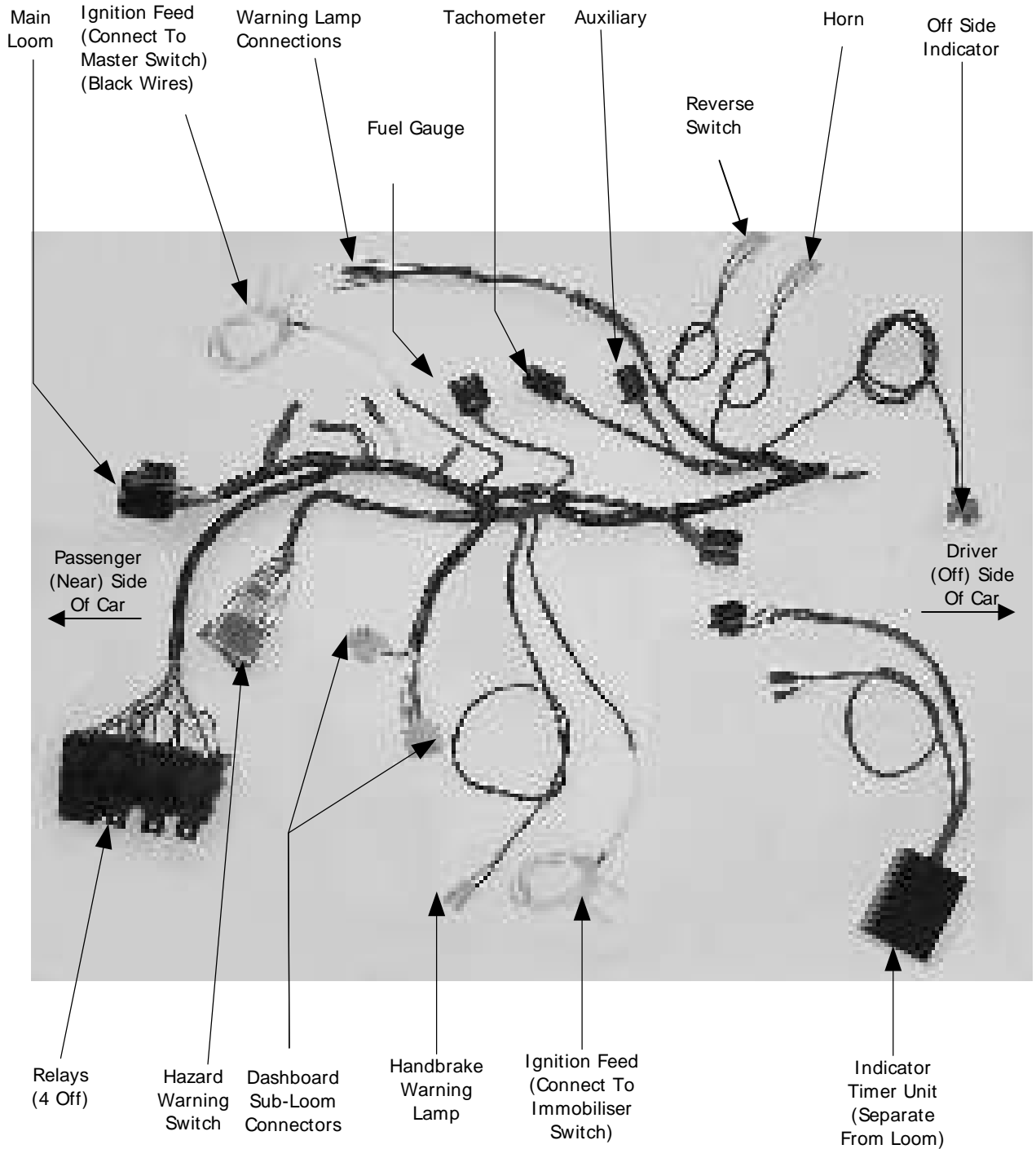

Dashboard Wiring Loom Fitted to Chassis

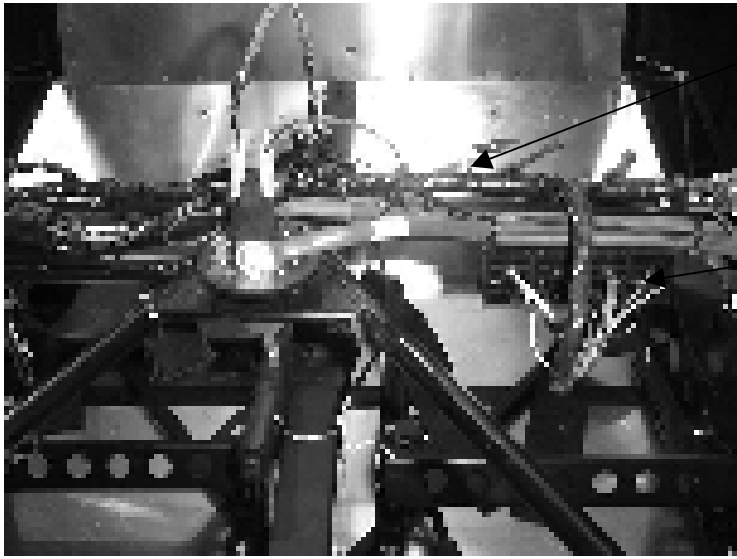

Dashboard Loom
Runs along Top of
Chassis Rail

Relays Mounted
Under Dashboard
Chassis Rail

DASHBOARD WIRING LOOM DETAILS

CONNECTION	LOOM CONNECTOR TYPE	LOOM WIRE COLOURS	NOTES
MAIN LOOM	13 WAY BLACK CONNECTOR BLOCK – MALE	8 WIRES	PRE-WIRED
	13 WAY BLACK CONNECTOR BLOCK – FEMALE	11 WIRES	PRE-WIRED
IGNITION RELAY EARTH FEED	BARE WIRES	2 BLACK	CUSTOMER TO FIT TO MASTER SWITCH
WARNING LAMP CONNECTIONS	BARE WIRES	8 WIRES PAIRED AS FOLLOWS: BLACK ; RED / ORANGE ORANGE ; GREEN BLACK ; GREEN / WHITE BLACK ; GREEN / RED	CAPILLARY CLOCK ILLUMINATION NEUTRAL LAMP OFF SIDE INDICATOR NEAR SIDE INDICATOR
FUEL GAUGE	3 WAY BLACK CONNECTOR BLOCK	GREEN ; BLACK ; GREEN / BLACK	PRE-WIRED
TACHOMETER	3 WAY BLACK CONNECTOR BLOCK	GREEN - 1 PAIR ; BLACK – 1 PAIR ; WHITE / BLACK	PRE-WIRED
AUXILLARY	2 WAY BLACK CONNECTOR BLOCK	BLACK – 1 PAIR ; GREEN – 1 PAIR	PRE-WIRED
REVERSE SWITCH	2 FEMALE SPADE CONNECTORS	ORANGE / ORANGE/BLACK	PRE-WIRED
HORN	2 FEMALE SPADE CONNECTORS	PURPLE ; PURPLE / BLACK	PRE-WIRED
OFF SIDE INDICATOR	CONNECTOR BLOCK	BLACK ; GREEN / WHITE	PRE-WIRED
INDICATOR TIMER UNIT	PRE-WIRED PLUG	VARIOUS	TIMER UNIT IS A SEPARATE ITEM TO THE LOOM
IGNITION FEED	BARE WIRES	2 WHITE	CUSTOMER TO FIT TO IMMOBILISER SWITCH
HANDBRAKE WARNING LAMP	2 FEMALE SPADE CONNECTORS	BLACK ; BLACK/ WHITE	PRE-WIRED
DASH' SUB-LOOM CONNECTORS	7 WAY WHITE CONNECTOR & 5 WAY WHITE CONNECTOR	VARIOUS	PRE-WIRED
HAZARD WARNING SWITCH	PRE-CONNECTED	VARIUS	PRE-WIRED
RELAYS	CONNECTOR RAIL	VARIOUS	3 RELAYS & 1 FLASHER UNIT

SECTION 04 - REMAINING ELECTRICAL COMPONENTS

Step 10: Rectifier Mounting

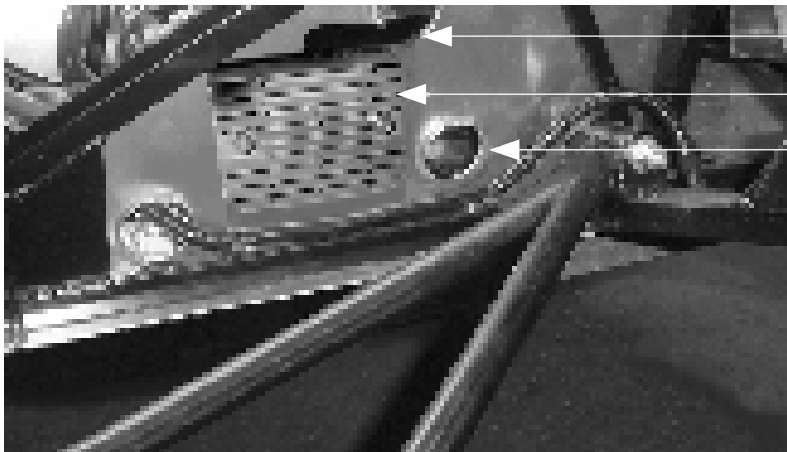

- Rectifier Cable
- Rectifier Unit
- Rear Of ECU Mounting Plate

View From Rear Of Car
(Rear Section Of Chassis)

Step 11: ECU Mounting



- Main Loom
- Engine Loom (See Note Below)
- Starter Motor Relay
- Front Of ECU Mounting Plate
- ECU Unit

View From Passenger Side
(Engine Bay Area Of Chassis)

NOTE

The Engine Loom Supplied MUST Be returned to Westfield Sports Cars For Modification.

Front Light Wiring Loom

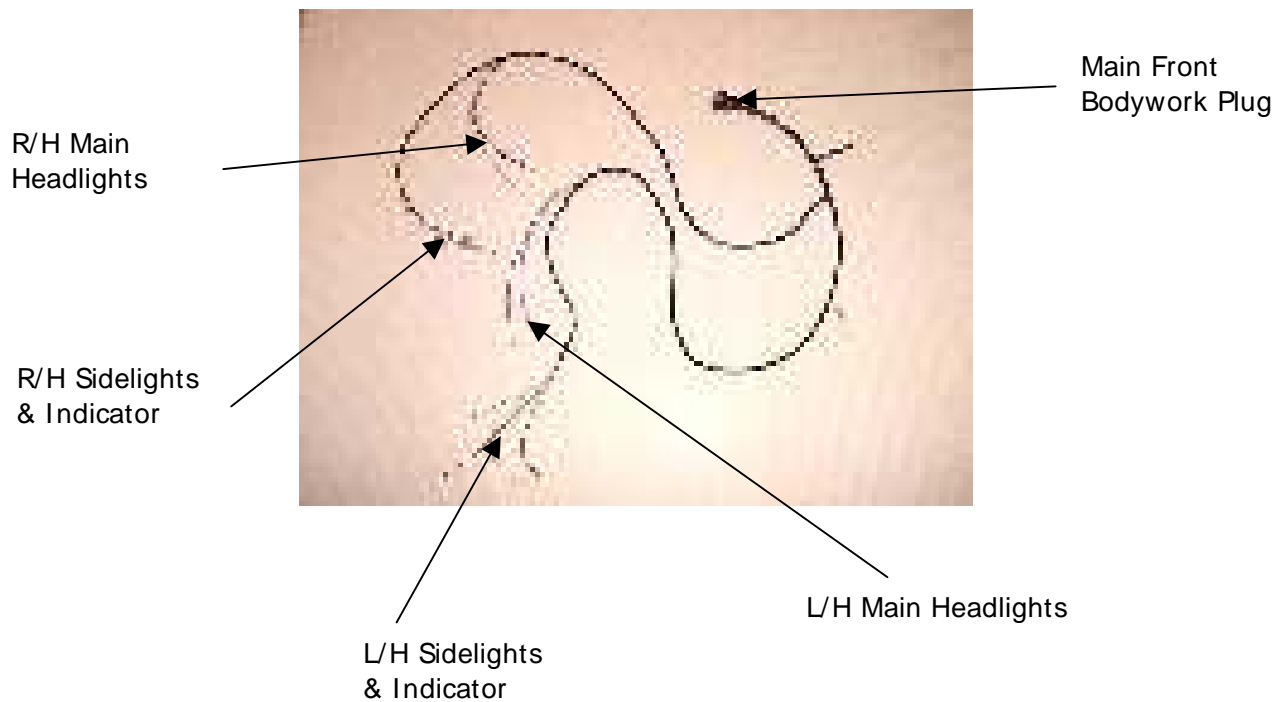

LEFT HAND CLUSTER

Blue/Pink	Dipped Beam (OUTER LIGHT)
Blue/Slate	Main Beam (INNER LIGHT)
Black	Common Earth
Red/Orange	Sidelight
Black	Earth
Green/Red	Indicator
Black	Earth

RIGHT HAND CLUSTER

Blue/Pink	Dipped Beam (OUTER LIGHT)
Blue/Slate	Main Beam (INNER LIGHT)
Black	Common Earth
Red/Black	Sidelight
Black	Earth
Green/White	Indicator
Black	Earth

There are some plastic clips on the inside of the Nose Bodywork section for you to fasten the front loom up away from the wheels etc.

Section 5

SECTION 05 - PEDALS & BRACKETS

Tools Required:-

- 2 x 13mm Combination Spanners / 2x 10mm Combination Spanners / Long Nosed Pliers / Electric Drill / 6.5mm Drill Bit / 5mm Drill Bit

Parts Required:-

- Throttle Pedal / Brake Pedal / Clutch Pedal (all Pedals are fitted with `DU' bearing bushes as standard) / 3 x Pedal Pivot Bush / 5 x Mounting Brackets / 1 x Clevis / 1 x Clevis Pin / 1 x Split Pin / 2 x Extension Rods (Brake Pedal) / 1 x Extension Rod (Clutch Pedal) / 2 x Pedal Rubbers / 1 x Throttle Cable / 1 x Throttle Cable Bracket / 1 x Non-Adjustable Brake Bias Bar / 1 x Adjustable Brake Bias Bar / 1 x Pedal Mounting Stud / 1 x Spacer Zinc Plated 55mm Long / 1 x Spacer Zinc Plated 25mm Long.
- 10 x M6 Button Head Screws x 16mm Long + Washers + Nyloc Nuts
- 2 x M6 Hexagon Head Setscrew x 20mm Long + Plain Lock Nut
- 3 x 5/16" UNF Bolts X 1-1/2" Long + Lock Nuts
- 2 x M5 Button Head Screws x 16mm Long + Washers + Nyloc Nuts

Step 1: Fit Pedal Mounting Brackets

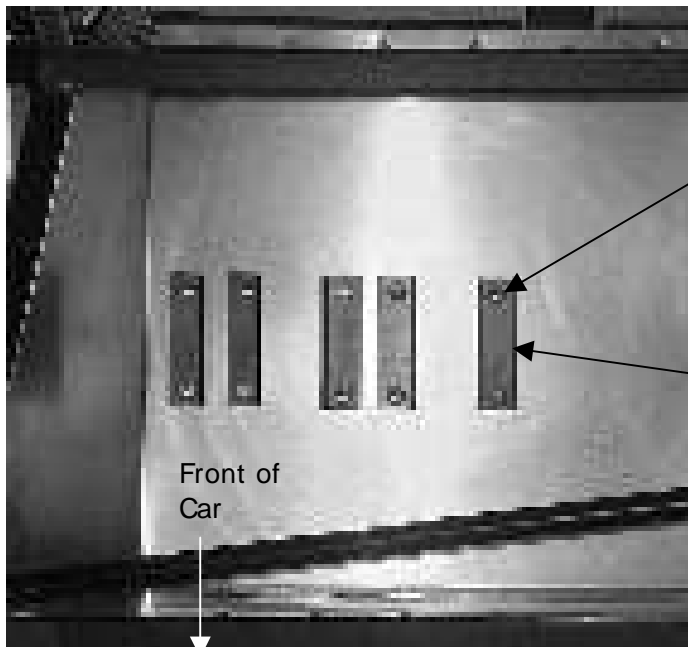

View From Above Pedal Box

M6 Button Head Screws x 16 Long

Pedal Mounting Brackets

NOTE

- i) Decide On The Approximate Position Of The Pedals.
- ii) Underneath The Pedal Box Floor There Is A Mounting Channel With 20 Pre-Drilled Holes. Select The Holes That Best Match The Required Pedal Bracket Position.
- iii) Drill Through The Pedal Box Floor From Underneath Using The Selected Holes As A Guide.
- iv) Secure The Brackets To The Floor Using The Screws Supplied. (The Screws MUST Be Inserted From the Top Of The Assembly.)

Step 2: Fit Pedals



Clutch Pedal

Brake Pedal

NOTE

The Brake Pedal Is Shown With An Adjustable Bias-Bar Fitted. The Non-Adjustable Bias-Bar MUST Be Fitted Initially To Pass The SVA Test.

Accelerator Pedal

M8 x 220mm long

Zinc Plated Stud

M6 Plain Nut

M6 Bolt x 20 Long

Lubricate The Steel Spacer Bushes with `Copper Slip` Before Inserting Into The Assembly.

You MUST Ensure All Pedals Move Freely After Tightening The Nyloc Nuts.

Spacer 55mm Long

Spacer 25mm Long

View From Drivers Seat Area

Step 3: Fit Pedal Push Rods

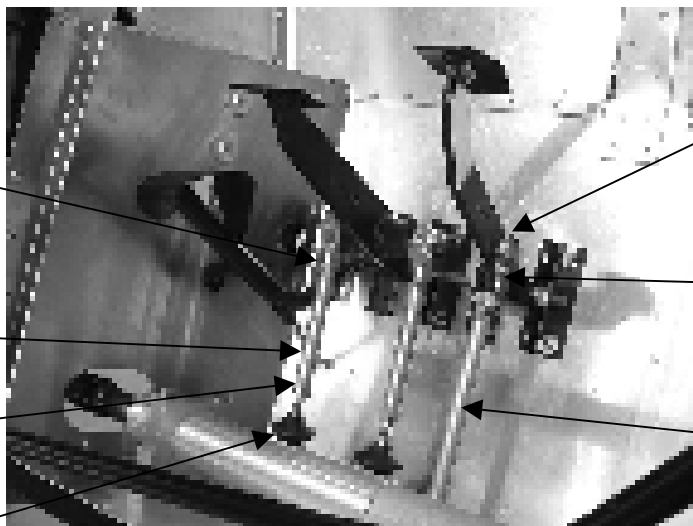

Cut Head Off
2x5/16" UNF
Bolts & Fit 2
Lock Nuts

Brake Pedal
Push Rods

Lock Nut

Rubber
Gaitors

Clevis Pin And
Split Pin

Clevis Fixed
with 5/16" Bolt
and Lock Nut

Clutch Pedal
Push Rod

View From Above

Step 4: Fit Accelerator Cable & Bracket

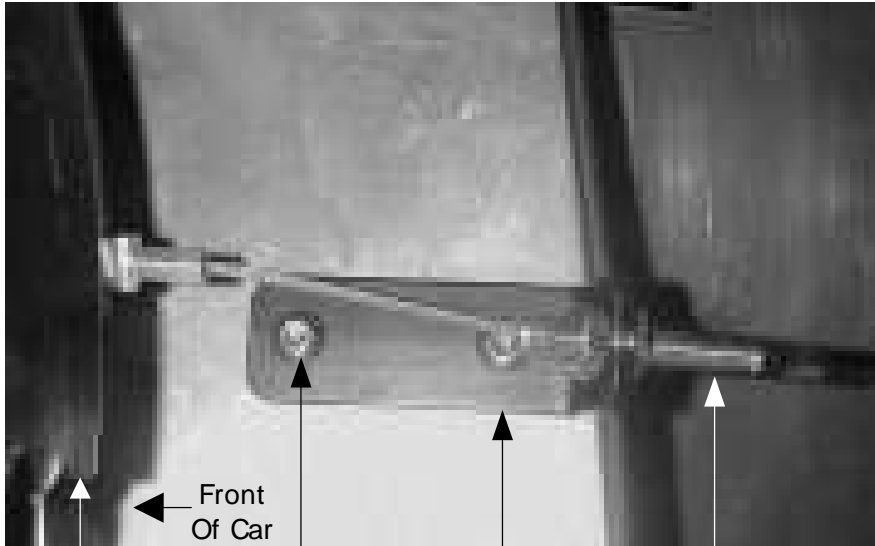

M5 Button
Head Screws

- Accelerator Pedal
 - M5 Button Head Screws
 - Bracket
 - Throttle Cable
- Front Of Car

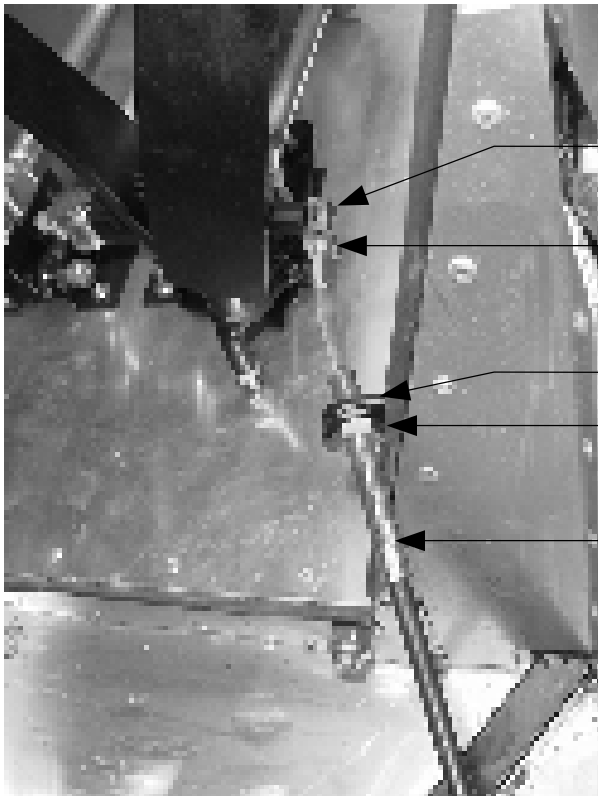

M5 Button Head Screw. Apply 'Loctite' To Thread Before Fitting. Do Not Tighten Down Completely. **Ensure The Cable Clevis Rotates Freely.**

- Cut Off One Leg Of Clevis To Form Angle Bracket As Shown
- Bracket
- Lock Nut Either Side Of Bracket
- Throttle Cable

View From Drivers Seat Area

Section 6

SECTION 06 - STEERING COMPONENT INSTALLATION

Tools Required:-

- Electric Drill / 8mm Dia Drill Bit / 2 x 13mm Spanners / 1 x 6mm Allen Key
- NOTE: Instructions to convert from R/H to L/H see page 6.6

Parts Required:-

- 1 x Steering Rack / 1 Set Rack Clamp Blocks / 1 x Upper steering Column / 1 x Centre Steering Column / 1 x Steering Column Mounting Bracket
- 6 x M8 Bolts x 80mm Long + Washers + Nyloc Nuts
- 2 x M8 Cap Head Bolts x 35mm Long + Nyloc Nuts

Step 1: Install Steering Rack

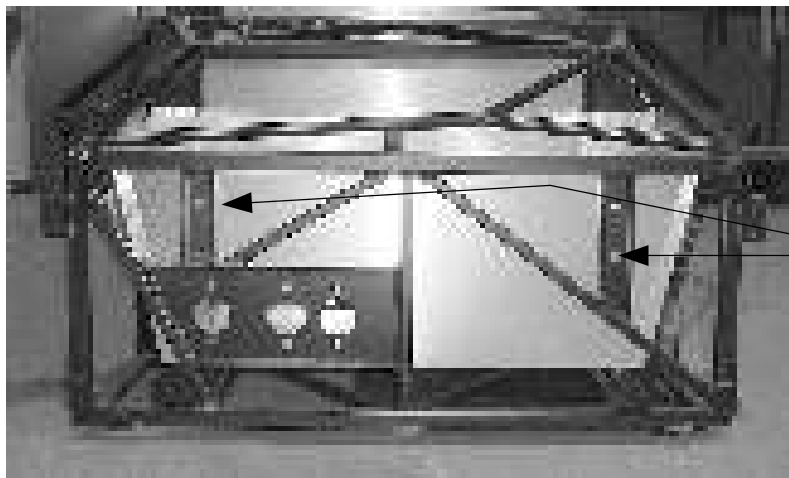

Steering Rack
Mounting Holes

View From Front Of Car
(Bare Chassis Shown For Clarity)

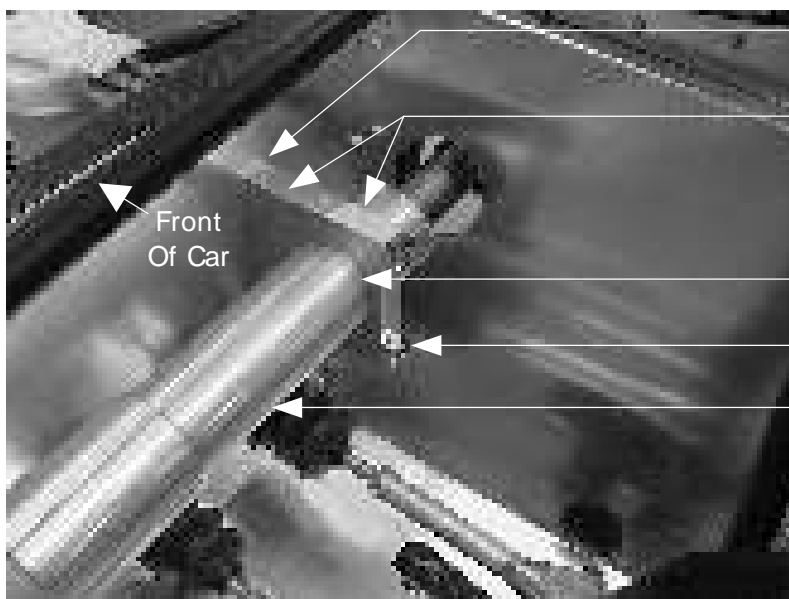

Drill Through The Pedal Box
Front Using The Steering
Rack Mounting Holes In The
Chassis As A Guide

Rack Clamp Blocks

Butt The Rack Shoulder Up
Against The Clamp Block

M8 Bolts x 80mm Long

Steering Rack

Pedal Box

Step 1: Cont'd,

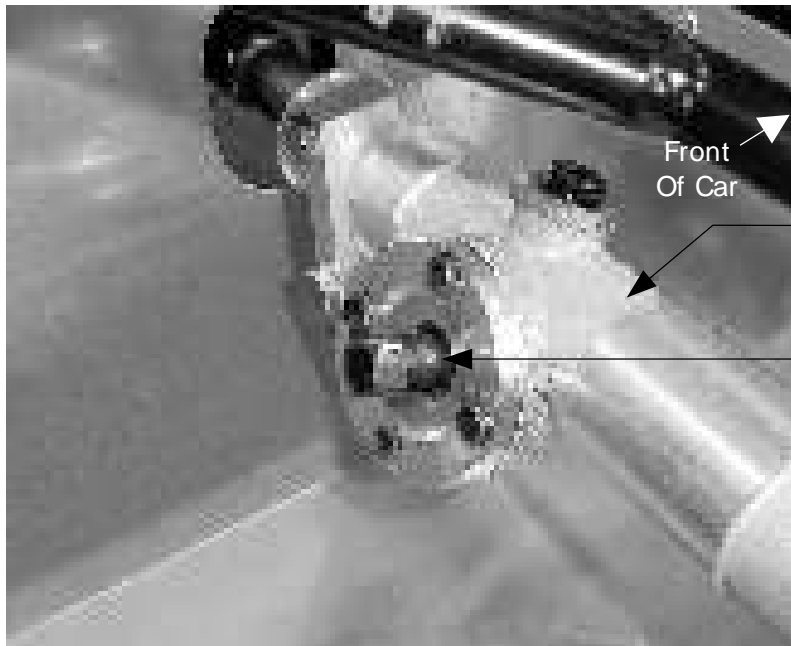

Steering Rack

Install Rack With Pinion Shaft Facing Up Towards The Passenger Seat Approximately As Shown.

NOTE

Do NOT Fully Tighten The Clamp Bolts At This Stage.

Step 2: Install Upper Steering Column & Mounting Bracket

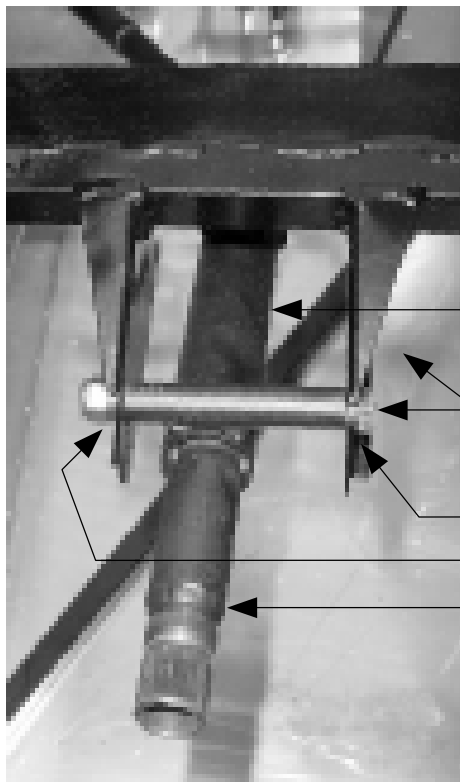

Column Mounting Bracket

M8 Bolts x 80mm Long
(At Front & Rear of Bracket)

Washer

Washer & Nyloc Nut

Upper Steering Column

View From Drivers Seat

Step 3: Install Main Steering Column

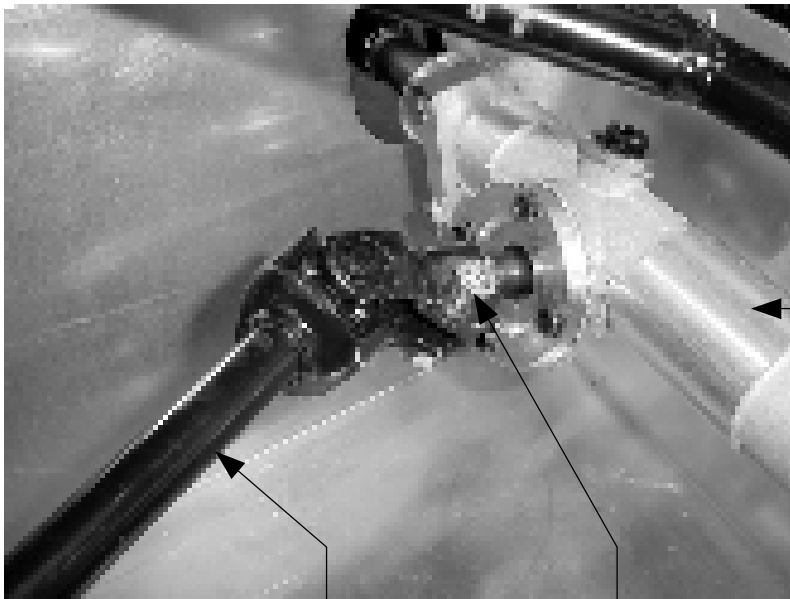

Steering Rack

Lower Connection

Main Steering Column

Pinch Bolt

Upper Steering Column

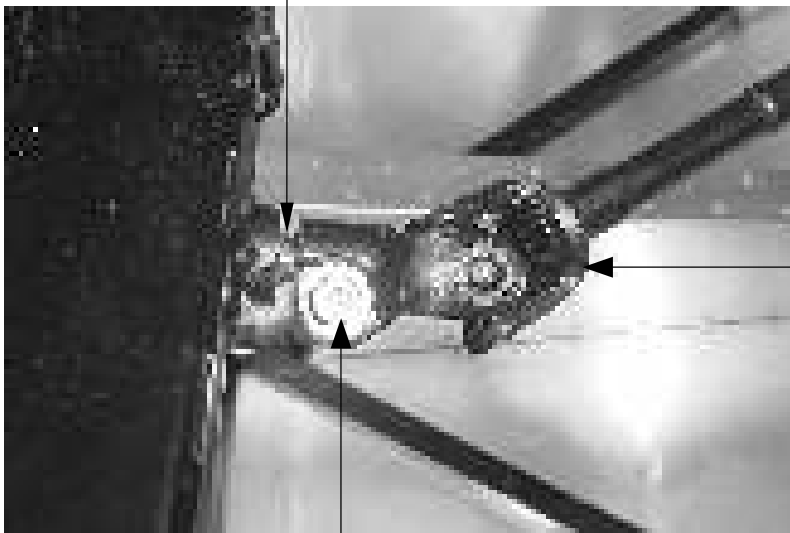

Main Steering Column

Upper Connection

Pinch Bolt

NOTE

Ensure That The Steering Column Rotates Freely BEFORE Tightening Up The Pinch Bolts And The Steering Column Mounting Block Bolts.

Instructions To Convert Steering Rack From R/ H To L/ H

Remove four cap screws from Aluminium Cover Housing.

Remove Locknut and Grubscrew from Aluminium Rack Casting. Carefully remove Spring and Tensioner below Grubscrew.

Remove Split pin from Steering Arm Housing nearest the Pinion. Remove Steering Arm Housing Carefully taking care not to loose any components.

Attach your Steering Centre Column Universal Joint to the Pinion splines and clamp up tight with an M8 nut and bolt. Hold the U/J in soft jaws in a vice and carefully tap Rack Housing to remove Pinion from the Rack. One bearing should come out on the Pinion, leaving the other bearing in position. Remove Universal Joint.

Now slide the Rack out away from the Pinion area of the Housing, and then remove the knurled Housing containing the second bearing, out of the Rack Casing.

Gently tap tin cover plate through the 5/8" diameter hole to push out the second bearing, blanking plate and shim washer.

Finally remove bearing from Pinion.

Re-Assembly

Place the Shim into the knurled housing, followed by a bearing. Replace the knurled housing back into the Rack Casing. Slide the Rack back through the Housing.

Place the Pinion into the knurled housing, splines end first and push through the bearing in the bottom of the knurled housing.

Push the other bearing into the knurled housing locating the end of the Pinion. Place the tin cover plate on top of this bearing. Now replace Aluminium cover and locate with four cap screws. Do not tighten screws at this stage.

Replace Steering Arm Assembly carefully and tighten up to obtain firm fit for joint and replace split pin.

To adjust Pinion engagement, rotate knurled housing to obtain a running fit for the Rack and Pinion. Tighten four cap screws in Aluminium cover.

Replace Rack Tensioner, Grubscrew and Locknut and adjust Grubscrew to obtain running fit. Lock up Locknut.

Section 7

SECTION 07 - FUEL TANK INSTALLATION

Tools Required:-

- Electric Drill / 5.5mm Dia Drill Bit / 2 x 8mm Spanners

Parts Required:-

- 1 x Fuel Tank / 1 Pair Tank Clamp Straps / Adhesive Backed Foam Strip
- 4 x M5 Button Head Screws x 15mm Long + Large Diameter Washers + Nyloc Nuts

Step 1: Install Fuel Tank

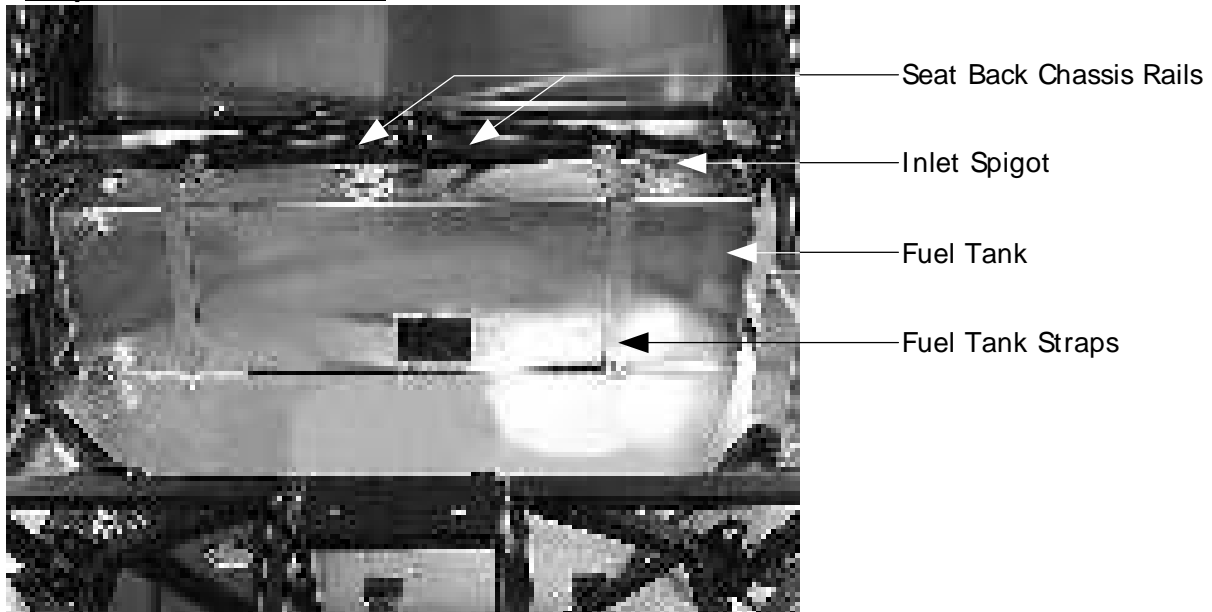

View From Rear Of Car

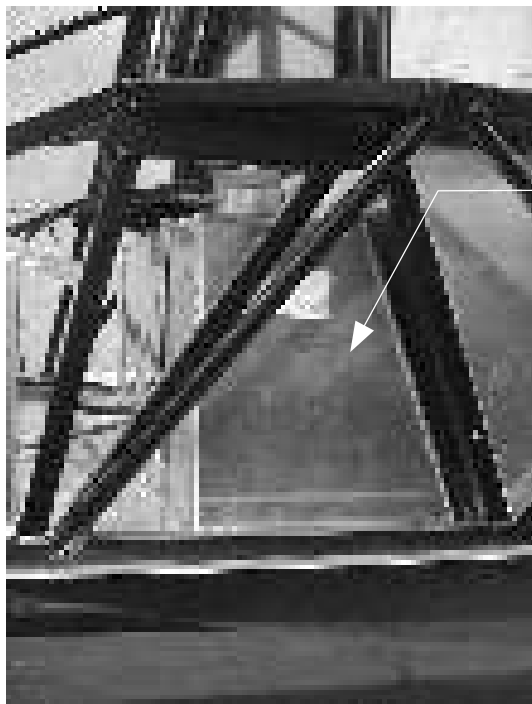

View From Drivers Side

Fuel Tank

NOTE

- Attach Adhesive Backed Foam Strip To The Floor Panel In The Area Under The Fuel Tank.
- Push The Tank Up To The Seat Back Chassis Rails.
- Line The Hole Through The Fuel Tank Up With The Hole In The Seat Back Panel To Ensure The Handbrake Cable And The Gear Change Rod Will Pass Through.
- Line The Back Of The Tank Straps With Adhesive Backed Foam Strip And Position Onto The Tank In The Required Location.
- Mark The Strap Hole Positions In The Seat Back Panel And The Floor Panel For Both Straps, Remove The Straps And Drill Through The Panels Where Marked.
- Re-Fit The Straps And Secure With M5 Button Head Screws, Washers & Nyloc Nuts. Ensure That A Washer Is Fitted Under Each Bolt Head And Under Each Nyloc Nut. (The Screws MUST Be Assembled So That The Nyloc Nuts Are In The Engine Bay Area Of The Car.)

Section 8

SECTION 08 - HANDBRAKE & GEAR LEVER BRACKET

Tools Required:-

- 1 Electric Drill, 3.2mm Drill Bit and Pop Rivet Tool

Parts Required:-

- 1 Westfield Gear lever Bracket, 3.2mm Pop Rivets.

Step 1: Bracket Installation

Place the Gear Lever Bracket onto the Top of the Tunnel as shown so that the Angle matches the Tunnel Top.

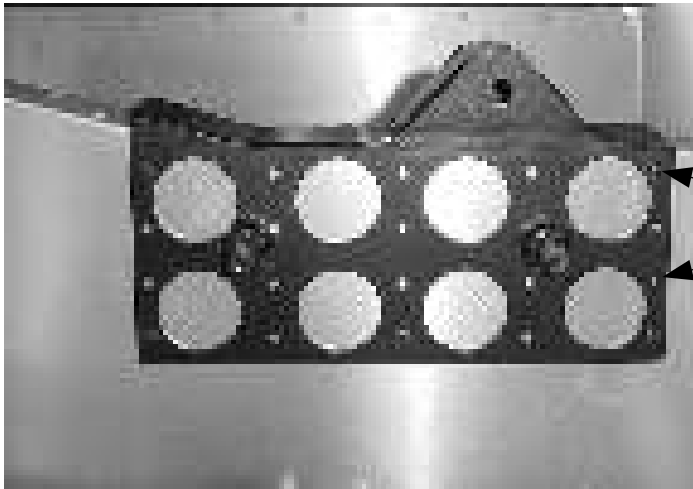

Drill All Of The 3.2mm Holes Through The Lever Plate Side And Then Rivet To The Tunnel.
Repeat For Both Sides Of Bracket

View From Drivers Side Of Car

Section 9

SECTION 09 - HANDBRAKE LEVER & CABLE

Tools Required:-

- Electric Drill / 5.5mm Dia Drill Bit / 25mm Dia. Drill / 1 x 13mm Spanner / 2 x 8mm Spanners / Long Nose Pliers

Parts Required:-

- 1 x Handbrake Lever / 1 x Handbrake Rod / 2 x Spacers / 1 x Handbrake Cable & Compensator
2 x Handbrake Cable Mounting Plates
- 2 x M8 Clevis Pins + Split Pins
- 5 x M8 Washers
- 4 x M5 Button Head Screws x 10mm Long + Nyloc Nuts + Large Diameter Washers

Step 1: Drill Through Seat Back Panel

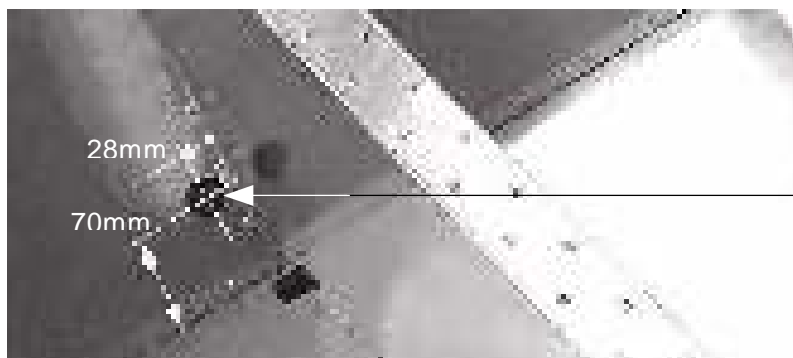

Drill 25mm Diameter Hole
Through Seat Back Panel

NOTE

Be Careful Not To Hit Fuel
Tank At Rear Of Panel.

View Of Drivers Side Seat Back Panel & Tunnel

Step 2: Assemble The Handbrake Lever & Rod

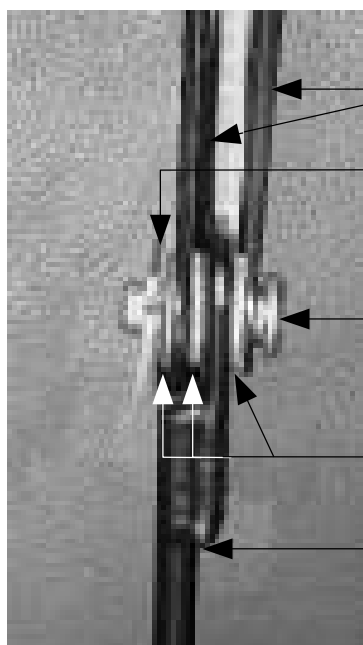

Handbrake Lever Side Plates

Split Pin

Clevis Pin

M8 Washers (3 Off)

Handbrake Rod

View From Underside of Assembly

NOTE

The Arrangement Of The 3 Washers Needs To Be
Decided To Ensure That The Handbrake Switch
Activation Bracket Clears The Centre Tunnel.
See Next Page For Bracket Location & Orientation

Step 3: Install The Handbrake Lever & Rod

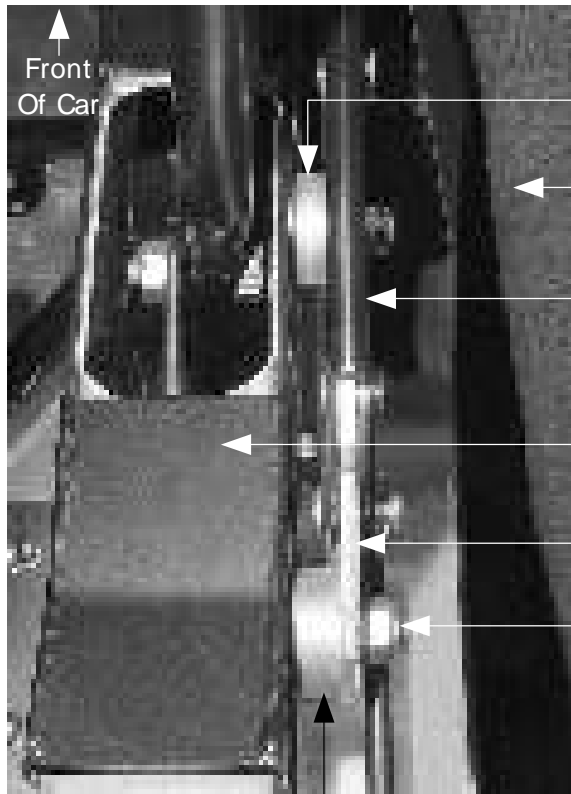

- Spacer
- Drivers Seat Area
- Handbrake Lever
- Centre Tunnel / Mounting Bracket
- Handbrake Lever Mounting Plate
- M8 Nyloc Nuts Fitted To Handbrake Lever Mounting Studs
- Spacer

View From Rear Of Assembly

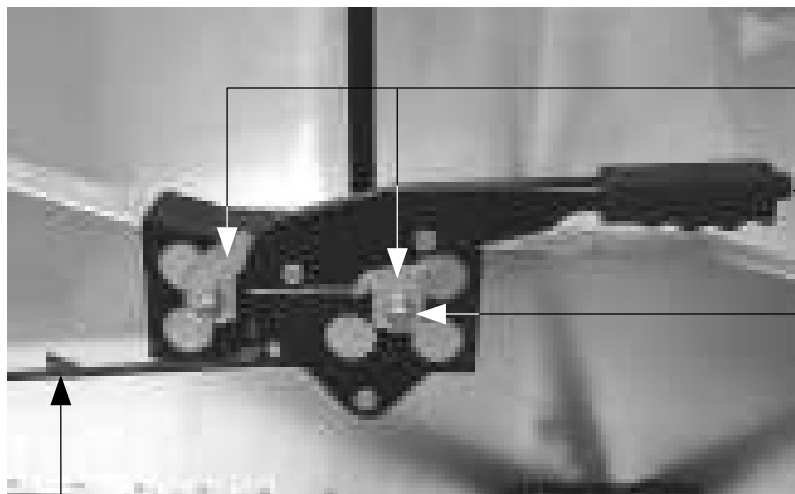

- Handbrake Lever Mounting Plate
- Handbrake Lever
- M8 Stud Mounting Points

NOTE
 Fit Lever & Rod Assembly So That The Rod Goes Through The 25mm Diameter Hole In The Seat Back Panel & The Lever Sits On The M8 Studs

Handbrake Switch Activation Bracket
 NOTE ORIENTATION

View From Drivers Side

Step 4: Layout The Handbrake Cable Compensator & Install Mounting Plates

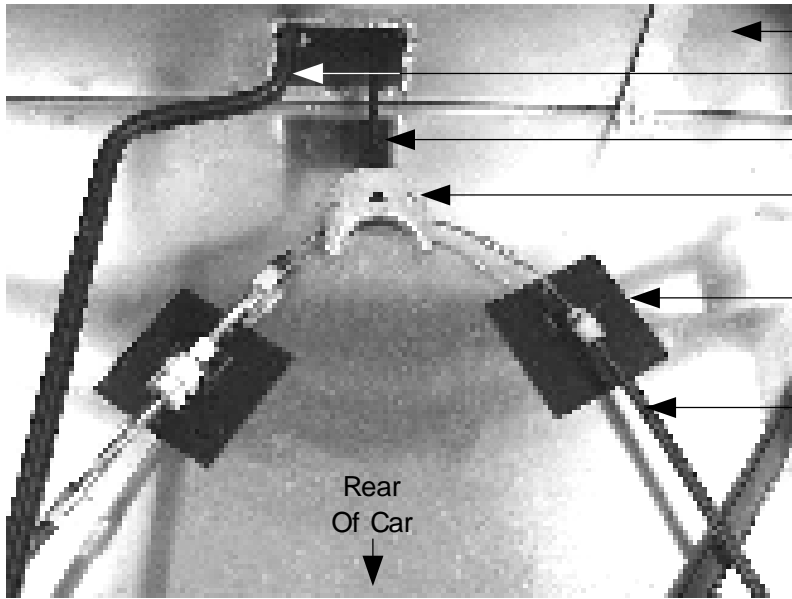

View From Rear Of Car

- Fuel Tank
- Gearchange Rod
- Handbrake Rod
- Handbrake Compensator
- Handbrake Mounting Plates
- Handbrake Cable

NOTE

- i) Once Cable & Brackets Are In The Correct Position, Mark The Mounting Plate Hole Positions Onto The Chassis Floor & Remove Plates & Cable
- ii) Drill Through The Floor & Fit Mounting Plates Using M5 Button Head Screws. Ensure That Large Diameter Washers Are Fitted Underneath The Floor Panel And Secure Each Screw With A Nyloc Nut

Step 4: Install The Handbrake Cable & Compensator

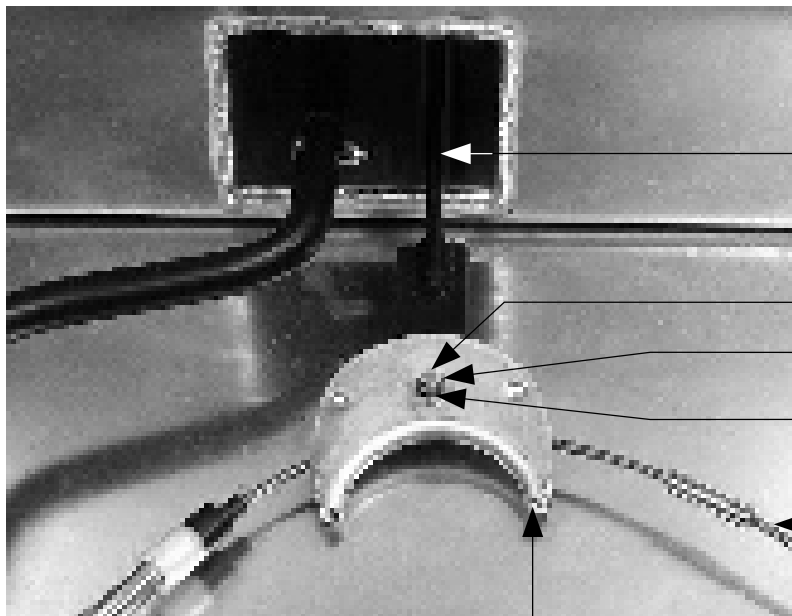

- Handbrake Rod
- Clevis Pin
- Split Pin
- Fit M8 Washers Above & Below Compensator
- Handbrake Cable
- Handbrake Compensator

NOTE

Route The Cables To The Appropriate Rear Corners Of The Car Where They Will Be Connected To The Brake Callipers Later.

Section 10

SECTION 10 - GEAR LEVER AND LINKAGE

Tools Required: -

- 2 x 13mm Spanners / 2 x 10mm Spanners

Parts Required:-

- 1 x Gear Lever / 1 x Linkage Rod (long) 2 x M6 Male Rod Ends 2 x M6 plain nuts
- 1 x M8 x 50 Long Bolt 2 x M8 Flat Washers 1 x M8 Nyloc Nut 1 x M6 x 25 Hex Bolt
- 1 x M6 Nyloc 1 x 42mm Long Inner Bush

Step 1: Assemble Gear Change Rod & Lever

- Assemble the Two M6 Rod Ends (with the Plain Nuts) into the end of the Long Aluminium Gearchange Rod & fix one end to the Centre Position of the Gear Lever with a M6 x 25 Hex Bolt and Nyloc Nut.
- Place the Inner Bush into the Pre-Fitted DU Bushes in the Gear Lever

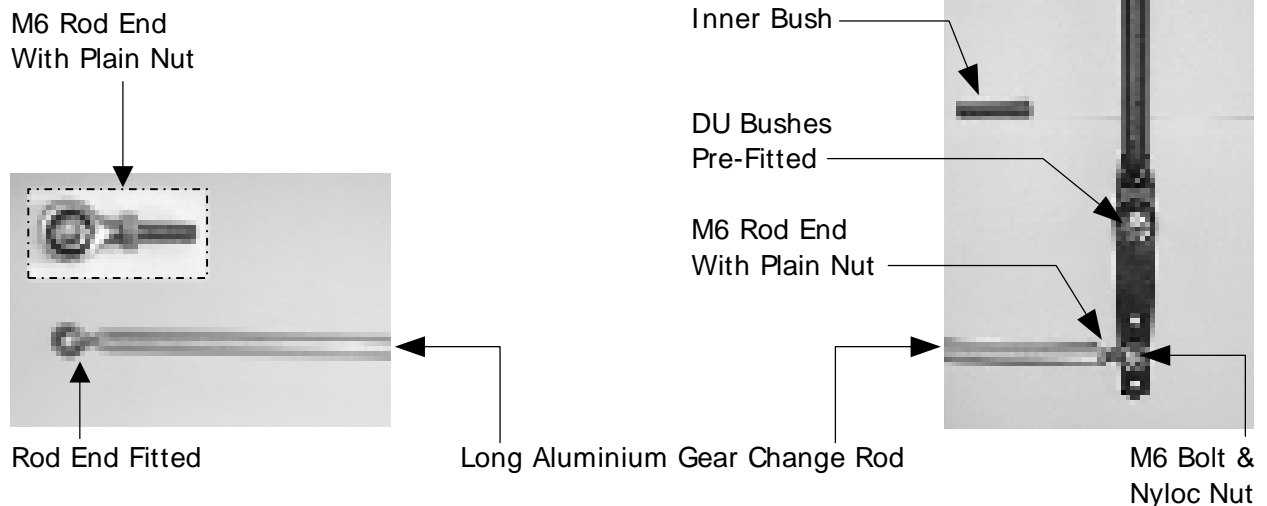

Step 1: Installing The Gear Change Rod & Lever

Carefully Slide the Rod down through the Tunnel towards the Rear of the Car until the Lever is in its Operating Position.



View From Passenger Side

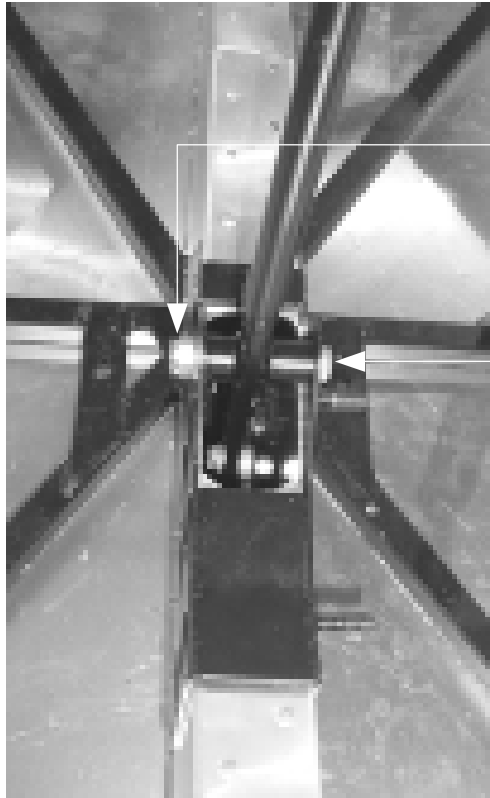

M8 Washer & Nyloc Nut

M8 Bolt x 50 Long
Ensure Bolt Head Is This
Side To Clear Handbrake
Lever

View From Rear Of Car

NOTE: The rest of the Linkage Cannot be fitted until the Engine is Installed.
Adjustment of the Rod Ends will be made after final installation.

Section 11

SECTION 11 - FRONT SUSPENSION / WISHBONES AND UPRIGHTS

Tools Required:-

- 1 x 5/8" AF Spanner / 1 x 11/16" AF Spanner / 2 x 17mm Spanner / 1 x 13mm Spanner / 1 x 27mm Spanner / 1 x 6mm Allen Key

Parts Required:-

- 2 x Lower Front Wishbones / 2 x Top Front Wishbones / 2 x Lower Front Ball Joints
- 2 x Upper Front Ball Joints / 6 x 7/16" UNF x 2½" Long Bolts / 2 x 7/16" UNF x 3¾" Long Bolts
- 8 x 7/16" UNF Nyloc Nuts / 2 x M18 Thin Lock Nut / 2 x M10 x 25 Long Bolts / 2 x M10 Nyloc Nuts
- 4 x 7/16" Large Repair Washers / 12 x 7/16" Plain Washers / 2 x Assembled Front Upright Corners.
NOTE: All Wishbones Will Be Pre-assembled With Nylon Bushes.

Step 1: Lower Front Wishbones

Bolt Lower Front Wishbone into chassis mountings as shown. Repeat both sides of Car.

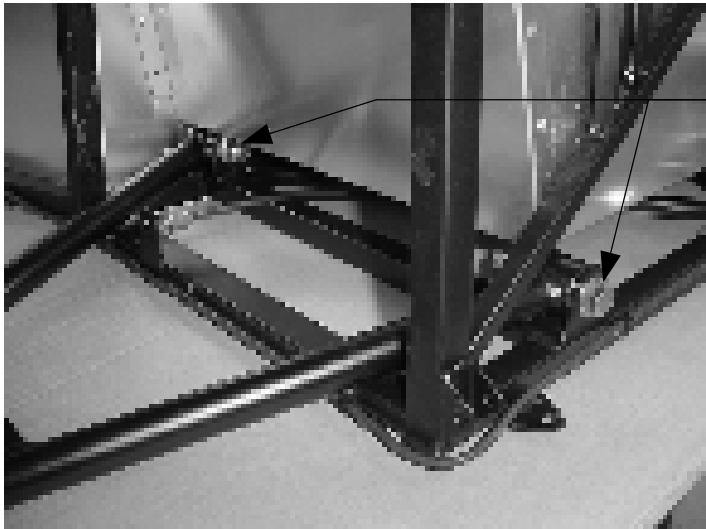

2 Bolts 7/16" UNF x 2½" Long with Washers and Nyloc Nuts

View From Drivers Side

Step 2: Top Front Wishbones

Bolt the Top Front Wishbone into the chassis mountings as shown. Ensure the Wishbone is installed with the Shortest Leg towards the rear of the car.

NOTE: The Position of the Two Repair Washers on this Wishbone. Repeat Both Sides of Car.

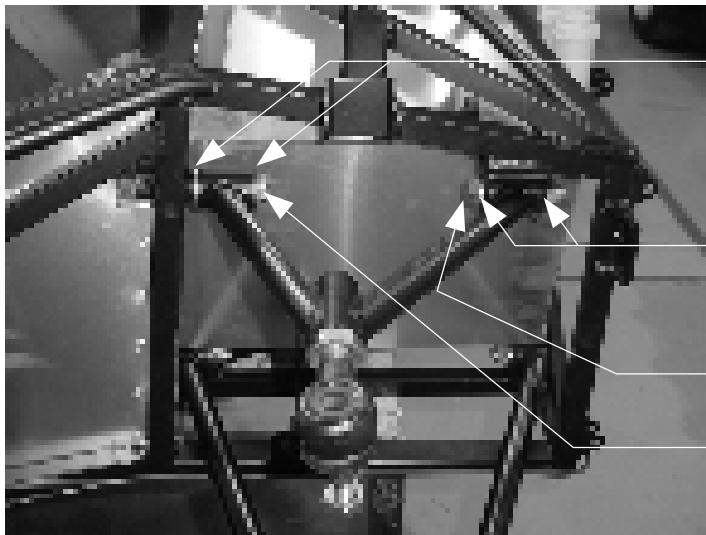

Important:
Fit 7/16" Repair Washers both sides of the Nylon Suspension Bush on this Bolt Only.

7/16" Plain Washer Each Side

7/16" UNF x 2½" Long Bolt

7/16" UNF x 3¾" Long Bolt

View From Drivers Side

Step 3: Lower Ball Joints

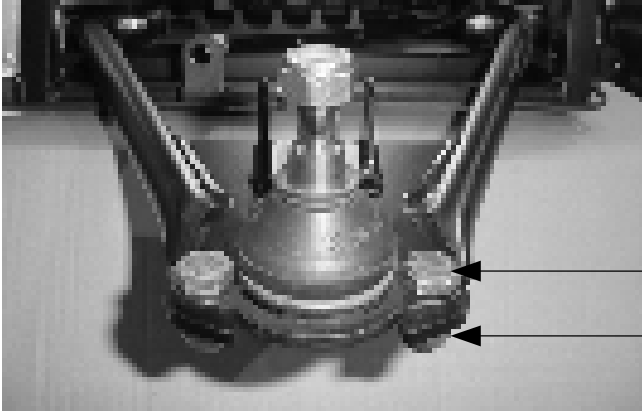

M10 Setscrews x 25 Long

M10 x Nyloc Nuts

View From Drivers Side

Step 4: Upper Ball Joints

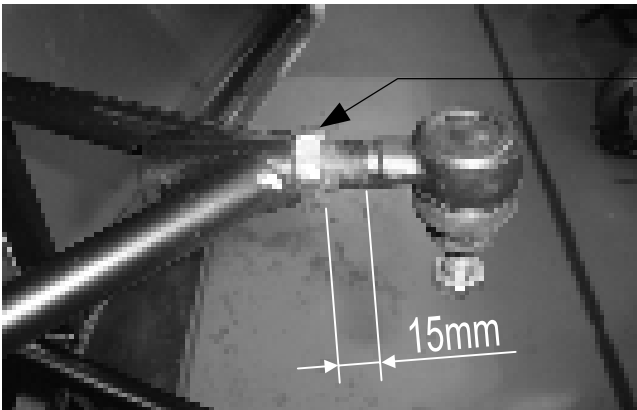

1 x M18 Thin Locknut

Note: For a start point set the ball joint with about 15mm of thread exposed.

View From Drivers Side

Step 5: Ball Joint Mounting Blocks

The Mounting Blocks are supplied Bolted into the Top and Bottom of each Front Upright. Remove the Blocks from the Upright then Fix them to the Tapered Bolt on the Top and Bottom Ball Joints using the special Nuts provided with the Ball Joints.

Note: All the tapers are the same so you can use any block on any joint.

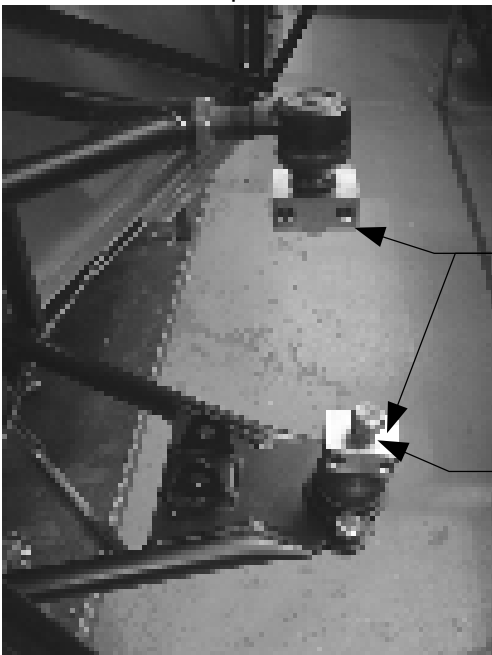

Mounting Blocks

Important:

The Top and Bottom Ball Joint Blocks **Must** be Assembled with the Special Nuts provided on the Ball Joints.

View From Front Of Car (Passenger Side)

Step 6: Fitting Front Upright

Once the Ball Joint Blocks are Bolted up tight you are ready to Install the Front Upright.

Hold the Upright with the Steering Arm towards the Front of the Car and the Brake Caliper towards the Rear.

Place the Upright onto the Lower Block and Assemble using Two Cap Screws.

Lower the Top Block into the Upright and Repeat the Assembly Procedure.

NOTE: Do Not tighten the Top Cap Screws Fully at this Stage as the Set-Up of the Car is Adjusted on this Joint.

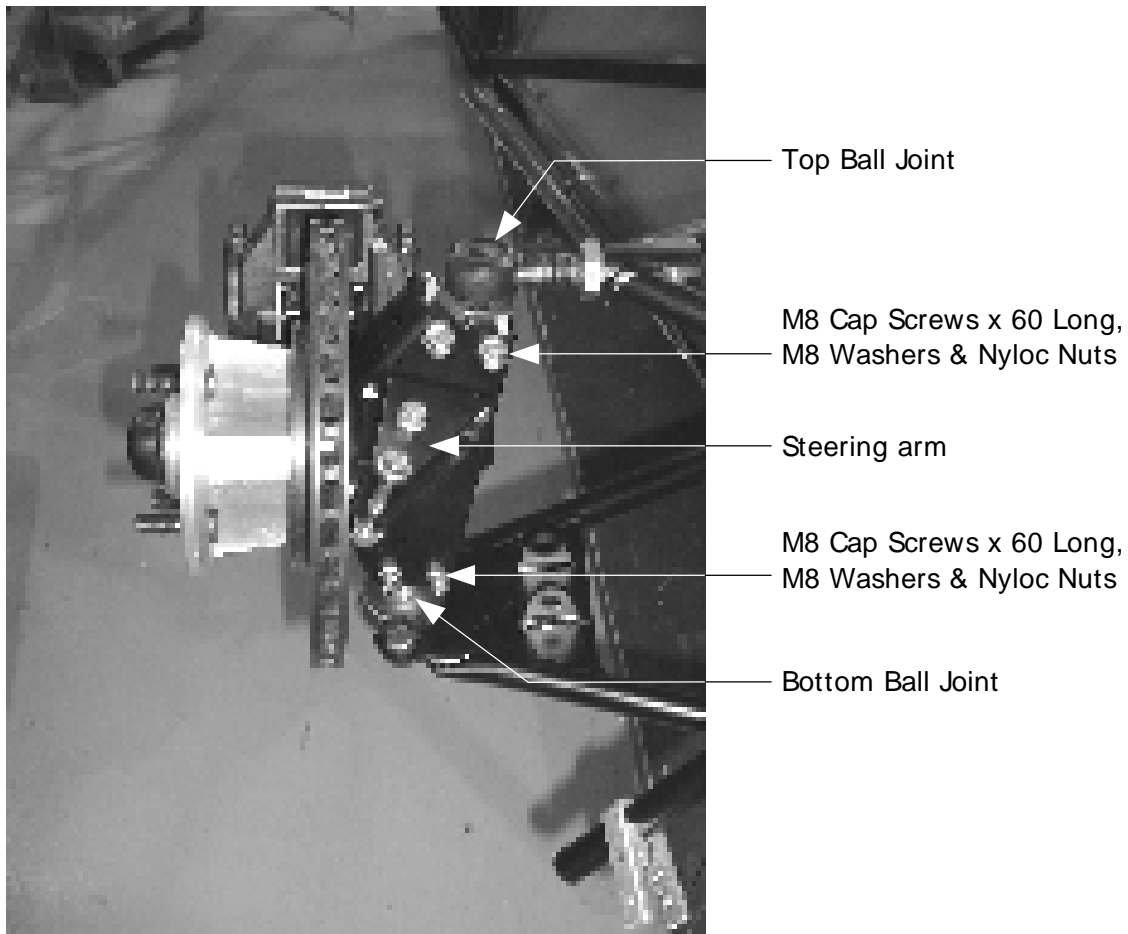

View From Front Of Car (Drivers Side)

Section 12

SECTION 12 - TRACK RODS & FRONT BRAKE HOSES

Tools Required:-

- 1 x 12mm Spanner / 2 x 13mm Spanners / 1 x 14mm Spanner

Parts Required:-

- 2 x Track Rods / 2 x Rod Ends (3/8" UNF x 5/16" Hole) / 2 x 3/8" UNF Lock Nuts
- 2 x M8 Setscrews x 45mm Long / 2 x M8 Nyloc Nuts / 4 x M8 Washers / 4 x 6mm Long Spacers
- 2 x Front Brake Hoses

Step 1: Install Track Rod

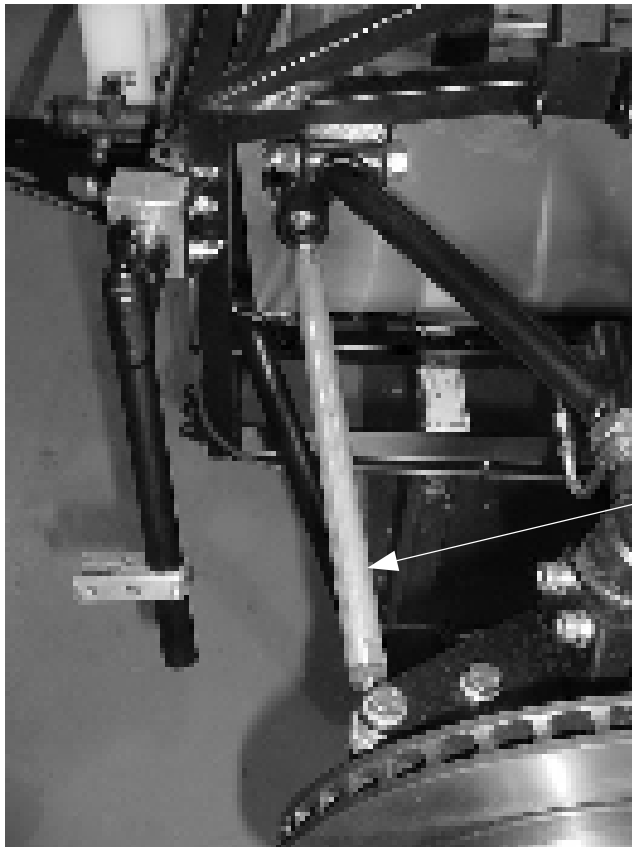

Track Rod

View From Passenger Side Of Car

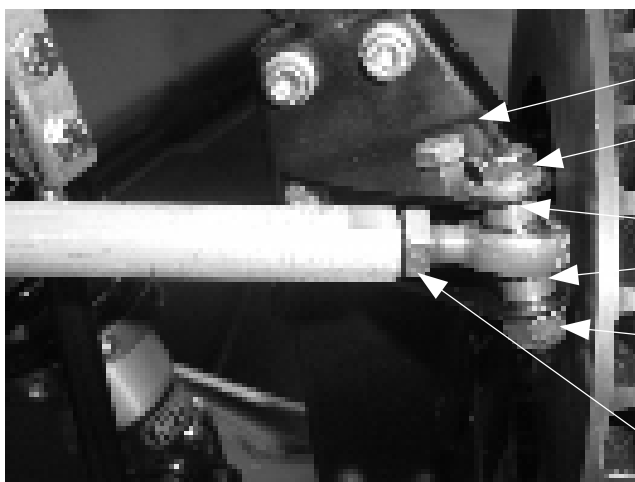

Passenger Side Upright

M8 Setscrew x 45mm Long

2 off Steel spacers x 6mm Long

M8 Nyloc Nut & Washers

3/8" UNF Locknut

View From Front Of Car

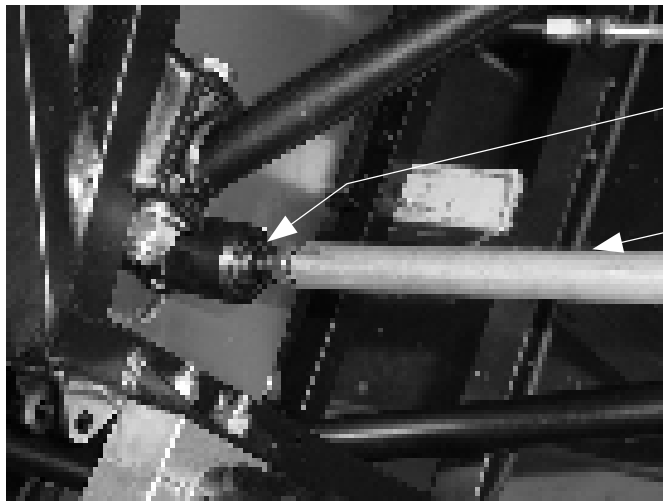

Steering Rack End Stud &
3/8" Lock Nut

Track Rod

View From Front Passenger Side Of Car

Repeat Procedure For Other Side Of Car.

Step 2: Install Front Brake Hoses

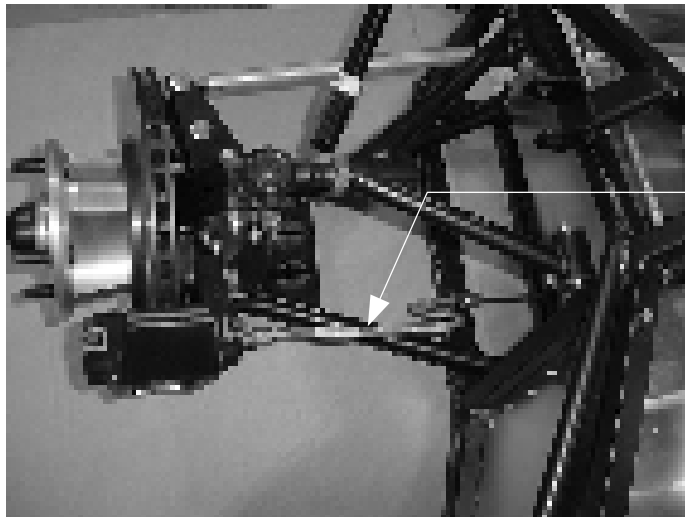

Brake Hose

View From Rear Of Passenger Side Of Car

NOTE

Ensure The Brake Hose Is Finally Adjusted To Clear The Shock Absorber And Spring When The Steering Is Rotated From Lock To Lock.

(Must Clear To Pass SVA)

Section 13

SECTION 13 - REAR DIFFERENTIAL & SPROCKET

Tools Required:-

- 2 x 17mm Spanners / 2 x 5/8" Spanners / 1 x 8mm Allen Key / 1 x 3mm Allen Key

Parts Required:-

- 1 x Differential Unit / 1 x Sprocket / 2 x Differential Unit Adjusters / 2 x Bearing Carriers / Loctite
- 2 x 7/16" UNF x 3 1/4" Long Bolts / 2 x 7/16" UNF Washers & Nyloc Nuts / 2 x M10 x 55mm Long Bolts / 6 x M10 Washers / 10 x M10 x 30mm Long Setscrews / 12 x M10 Nyloc Nuts / 2 x M10 Socket Cap Screw x 100mm Long / 4 x M10 Lock Nuts

Step 1: Assemble Differential Unit

Slide Bearing Carriers Onto Differential As Shown

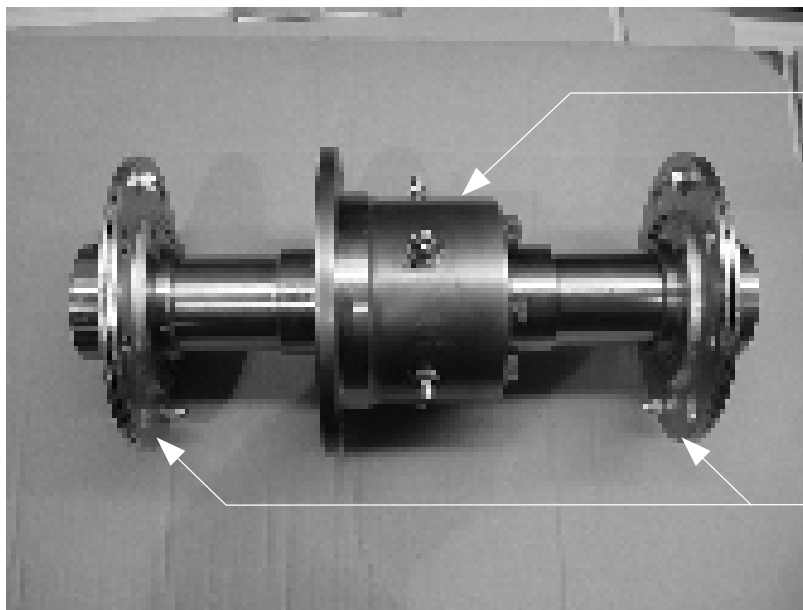

Differential Unit

NOTE

There Are Two Grub Screws In The End Of Each Bearing. DO NOT Tighten At This Stage As The Unit Will Be Adjusted At A Later Date And Fixed In Place Using These Grub Screws.

Bearing Carriers Fitted

Step 2: Install Differential Unit

Fit Differential Into Chassis And Fix Into Place Using The Lower Mounting Points To Begin With

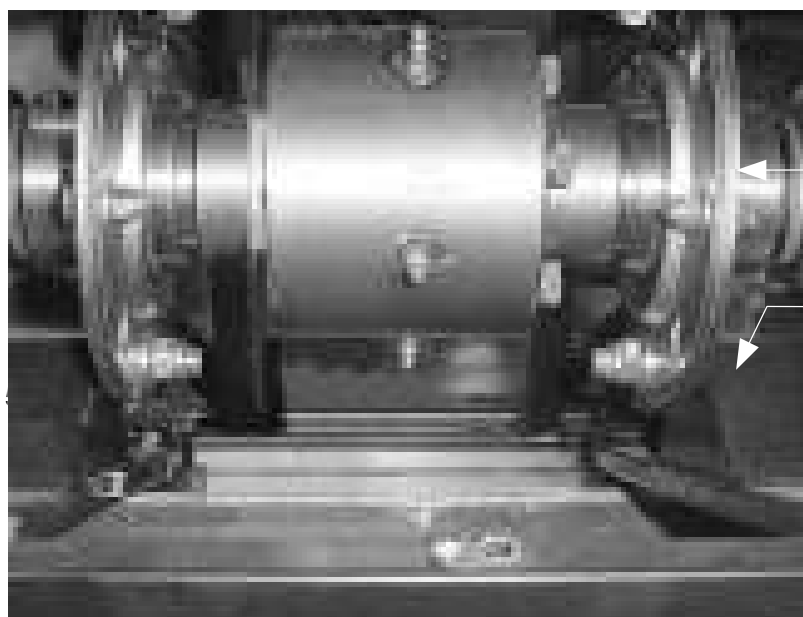

Carrier Bearing

Chassis Bracket

View From Rear Of Car

Step 2: Install Differential Unit & Chain Tensioners

Fit Chain Tensioners To Differential And Chassis

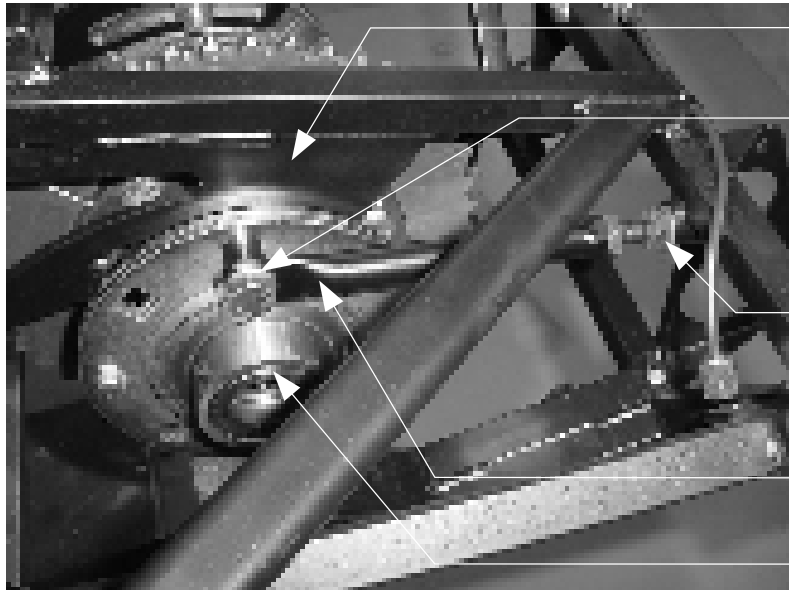

Quadrant Plate

M10 Bolt x 55mm Long
With Washers Under Head
Fit Washer & Nyloc Nut On
Other Side Of Quadrant Plate
To Secure Bolt

M10 Socket Cap Screw x
100mm Long With Washers &
Lock Nuts

Chain Tensioner

Bearing Carrier

View From Passenger Side



Bearing Carrier

M10 Socket Cap Screw x
100mm Long
Differential and Chain
Adjustment Bolt

View From Rear Of Car

Step 3: Install Sprocket

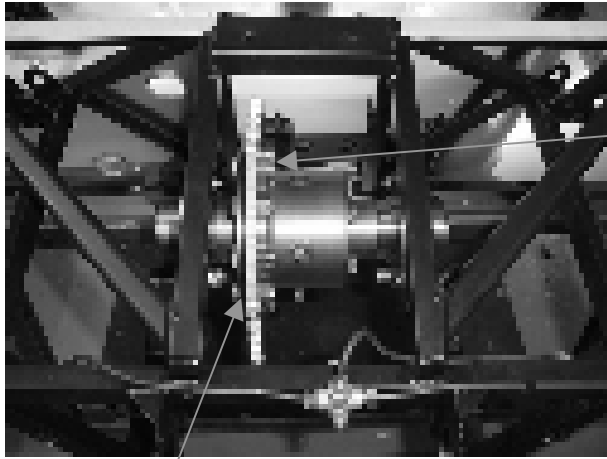

Use M10 x 30 Bolts and Nyloc Nuts Provided.

NOTE: On the Internal Diameter of The Sprocket on One Side Only There Is A Chamfer. This Must Go up To The Flange Face On The Diff.

View From Rear Of Car

Note: When The Engine And Differential With Chain Fitted Are Lined Up Correctly The 4 Grub Screws In The Two Main Differential Bearing Carriers Need To Be Locked Up Tightly.

Section 14

SECTION 14 - ANTI-ROLL BAR ASSEMBLIES

Tools Required: -

- 2 x 10mm Spanners / 2 x 5/8" Spanners

Parts Required:-

- Front Anti Roll Bar / Rear Anti-Roll Bar / 4 x Anti Roll Bar Mounting Blocks / 4 x Upper Clevis Blocks / 2 x Lower Front Clevis Blocks / 2 x Rear Mounting Brackets / 2 x Front Drop Link Rods / 2 x Rear Drop Link Rods / 8 x Rod Ends (5/16" UNF x 3/8" Hole) / 16 x Rod End Bushes
- 4 x M6 Bolts x 55mm Long / 12 x M6 Bolts x 40mm Long / 2 x M6 Bolts x 35mm Long / 30 x M6 Washers / 20 x M6 Nyloc Nuts / 2 X 7/16" UNF Bolt X 2¾" Long / 2 x 7/16" Washers & Nyloc Nuts

Step 1: Fit Front Anti Roll Bar

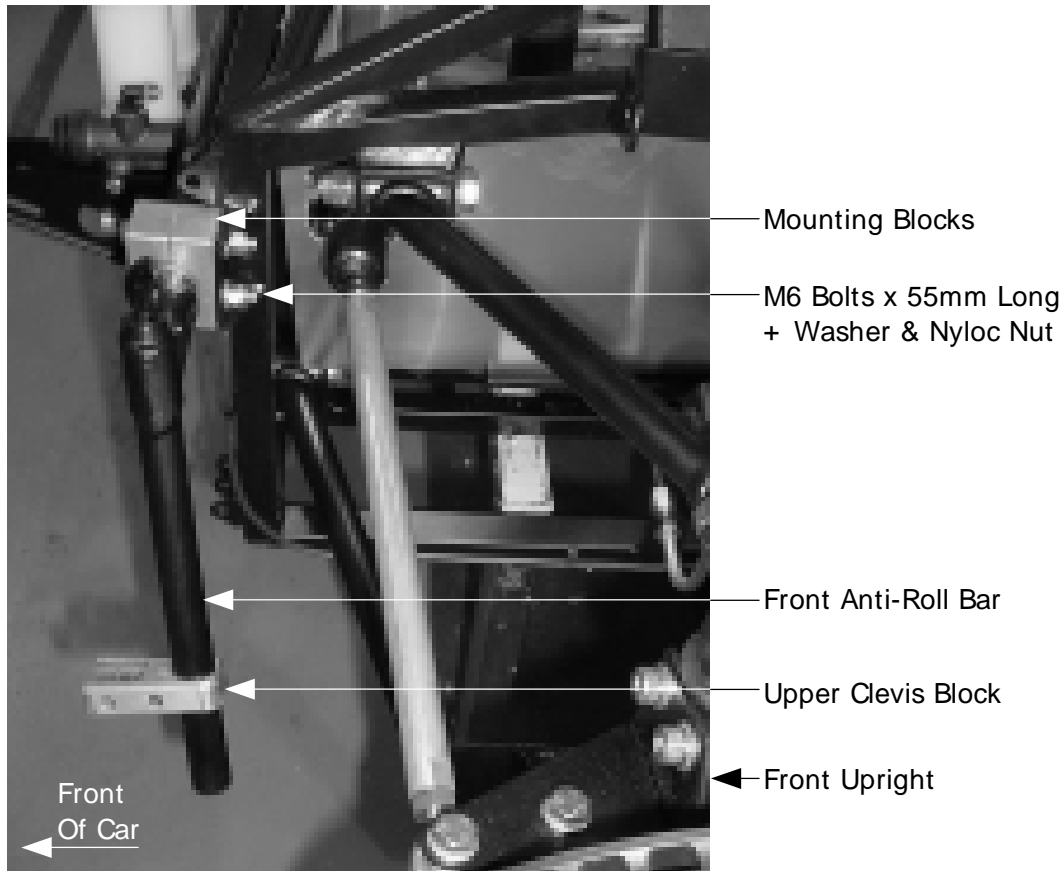

View From Passenger Side

Step 2: Assemble Front Drop Links

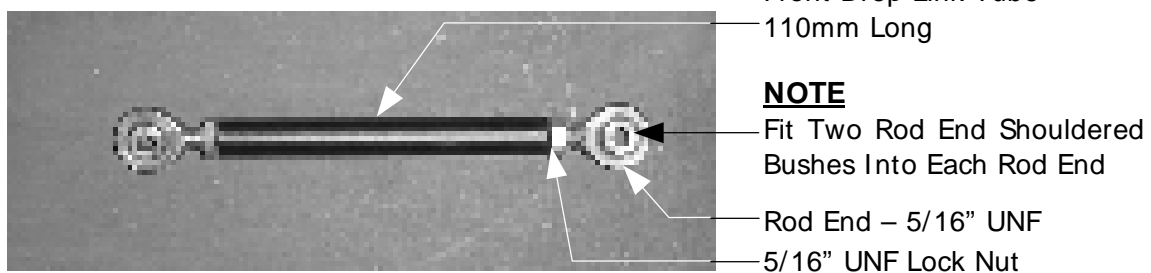

Assemble 1 Pair For Front

Step 3: Assemble Lower Front Clevis Block

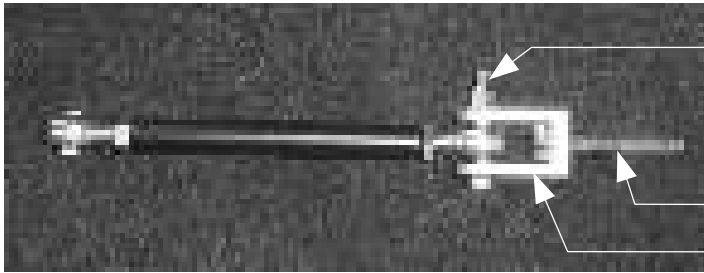

M6 Bolt x 40mm Long
Ensure Bolt Passes Through The
Clevis Block, The Shouldered Rod End
Bushes & The Rod End Before Being
Secured with A Washer and Nyloc Nut

7/16" UNF Bolt X 2 3/4" Long

Lower Front Clevis Block

Assemble 1 Pair For Front

Step 4: Install Front Drop Links

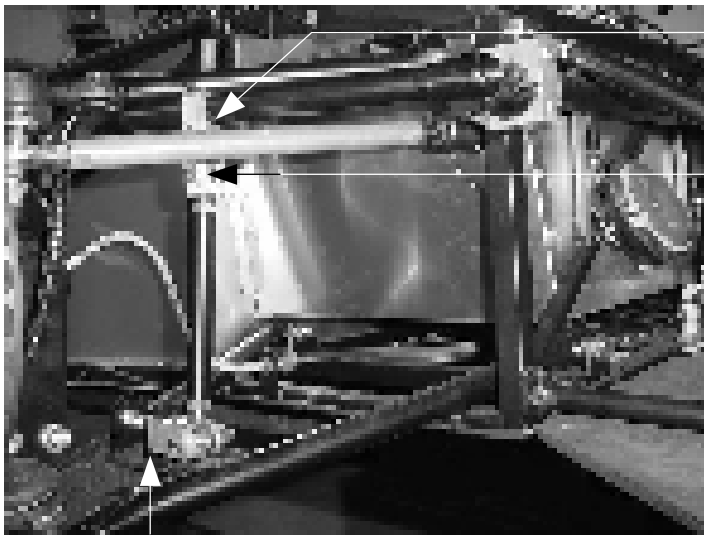

Fit 2 x M6 Bolts x 40mm Long
Through Upper Clevis Block

Ensure That The Lower Bolt Passes
Through The Upper Clevis Block, The
Shouldered Rod End Bushes and The
Rod End Before Being Secured with A
Washer and A Nyloc Nut

NOTE: DO NOT fit the Lower Bolt Into the Lower Suspension Mounting Bracket At This Stage.
(The Picture Above is to show how the Lower Front Clevis Block will fit later.)
DO NOT fully tighten any of the Nuts at this Stage as everything will be finally adjusted
during the Car Set-Up Stage.

Step 5: Assemble Rear Anti Roll Bar Mounting Bracket To Blocks And Bar

Note The Rear Anti-Roll Bar Assembly Can Be Completed On or Off The Car.
However, the Anti Roll Bar Itself Cannot Be Fitted To The Car Until The Rear
Upper Wishbones Have Been Installed As Shown In Section 15 - Step 2.

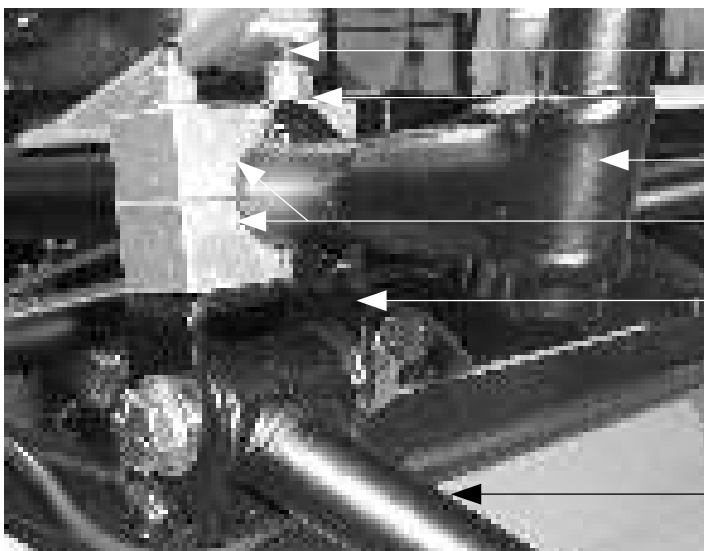

Mounting Bracket Bolts

M6 Washer & Nyloc Nut

Anti-Roll Bar

Clevis Blocks

Mounting Bracket

Rear Upper Wishbone

View Showing Fitting Of Roll Bar After Rear Upper Wishbone Has Been Installed

Step 6: Install Rear Drop Links

Assemble the Rear Drop Links in the same manner as the Front Drop Links. The rear Drop Link tubes are 178mm Long. Note that the Lower Rod End fits into the Mounting Bracket on the Lower Wishbone. (There are no Lower Clevis Blocks at the Rear.)



Fit 2 x M6 Bolts x 40mm Long
Through Upper Clevis Block

Ensure That The Lower Bolt Passes
Through The Upper Clevis Block, The
Shouldered Rod End Bushes and The
Rod End Before Being Secured with A
Washer and A Nyloc Nut

Rear Drop Link

Lower Wishbone Mounting Bracket

NOTE: DO NOT fit the Lower Bolt Into the Lower Wishbone Mounting Bracket At This Stage.
(The Picture Above is to show where the Lower Bolt Will Fit Later.)
DO NOT fully tighten any of the Nuts at this Stage as everything will be finally adjusted during the Car Set-Up Stage.

Section 15

SECTION 15 - REAR SUSPENSION / WISHBONES, UPRIGHTS & DRIVESHAFTS

Tools Required:-

- 1 x 5/8" AF Spanner / 1 x 11/16" AF Spanner / 2 x 17mm Spanner / 1 x 13mm Spanner / 1 x 27mm Spanner / 1 x 6mm Allen Key

Parts Required:-

- 2 x Lower Rear Wishbones / 2 x Top Rear Wishbones / 2 x Assembled Rear Upright Corners
- 2 x Driveshafts / 2 Rear Brake Hoses
- 8 x 7/16" UNF x 23/4" Long Bolts / 2 x 7/16" UNF x 33/4" Long Bolts / 4 x Rod Ends (1/2" UNF x 1/2" Hole) / 14 x 7/16" UNF Nyloc Nuts / 30 x 7/16" Plain Washers / 4 x 7/16" UNF x 3" Long Bolts / 4 x Reducing Sleeves For Rod Ends / 4 x 7/16" Repair Washers

NOTE: All Wishbones Will Be Pre-assembled With Nylon Bushes.

Step 1: Lower Rear Wishbones

Bolt Lower Rear Wishbone into Chassis Mountings as shown. Repeat Both Sides of Car.

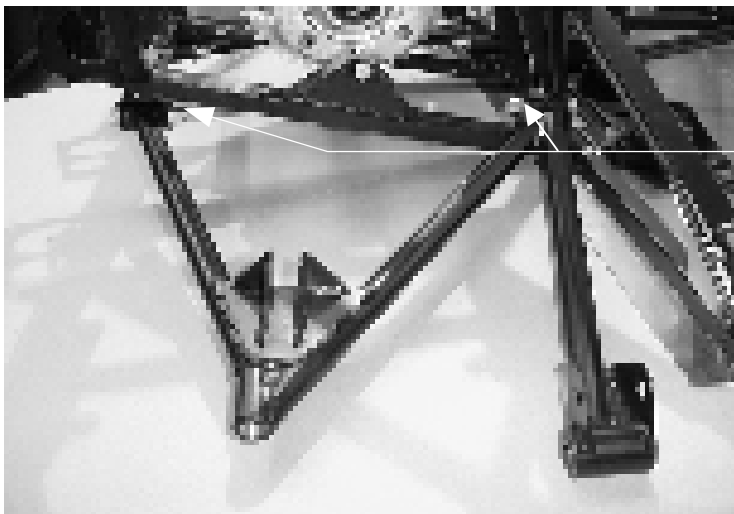

2 Bolts 7/16" UNF x 23/4" Long with Washers Under Head and Nyloc Nuts

View From Drivers Side

Step 2: Top Rear Wishbones

Bolt the Top Rear Wishbone into the chassis mountings as shown.

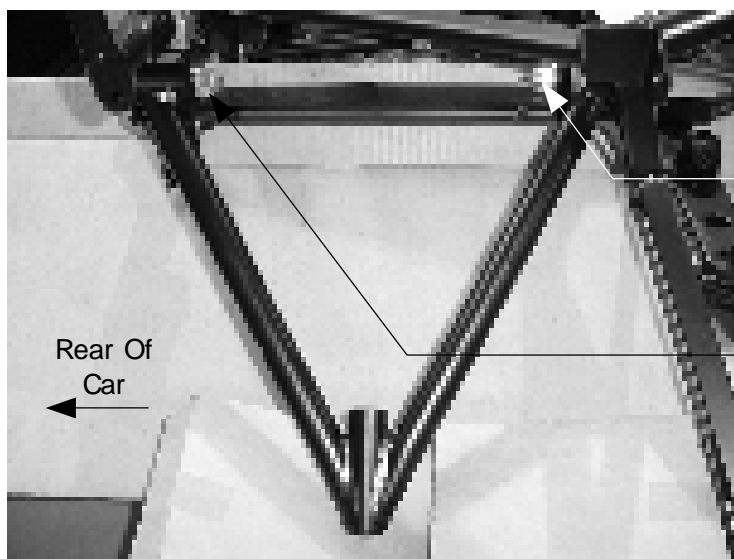

7/16" UNF x 23/4" Long with Washers Under Head and Nyloc Nut

7/16" UNF x 3" Long with Washers Under Head and Nyloc Nut

NOTE

Anti-Roll Bar Mounting Clevis & Block Assembly To Be Fitted Before Bolt. (See Next Photograph)

View From Drivers Side

Step 2: Top Rear Wishbones Cont'd



Anti-Roll Bar Mounting
Clevis & Block Assembly

Anti-Roll Bar

Top Wishbone

View From Rear

Step 3: Fit Rod Ends

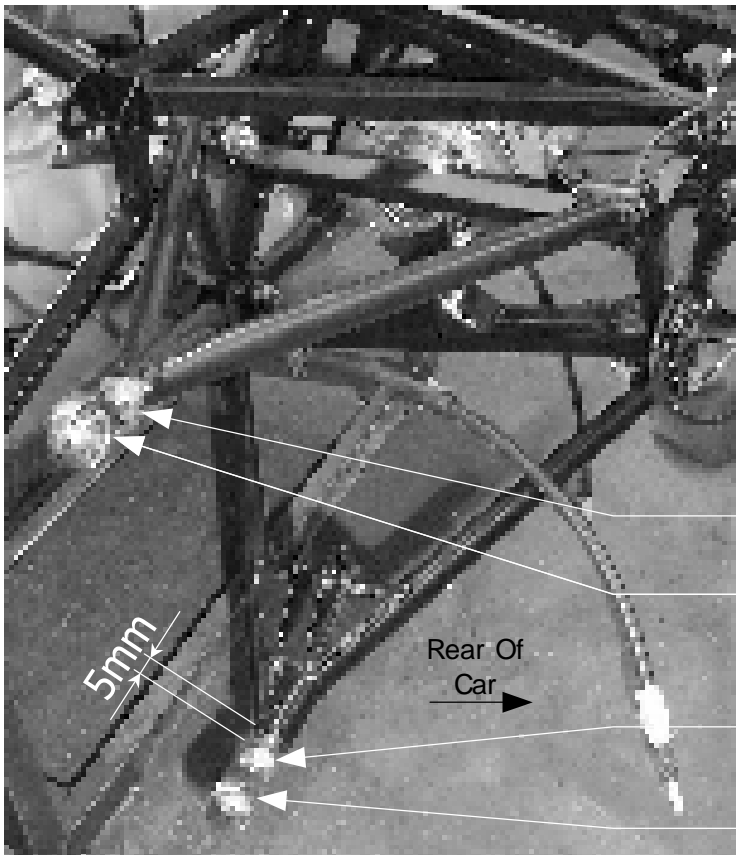

½" UNF Lock Nut
NOTE: For a start point set
the Rod Ends with about
5mm of thread exposed.

Upper Rod End And Sleeve

½" UNF Lock Nut

Lower Rod End And Sleeve

5mm

Rear Of
Car

View From Drivers Side

Step 4: Fit Upright Lower Fixings

Hold the Upright Assembly with the Brake Caliper towards the Rear of the Car.
Each Upright has a letter `L' or `R' on it to identify which side of the car it should go on.
(`R' is for the Drivers Side and `L' is for the Passenger Side)

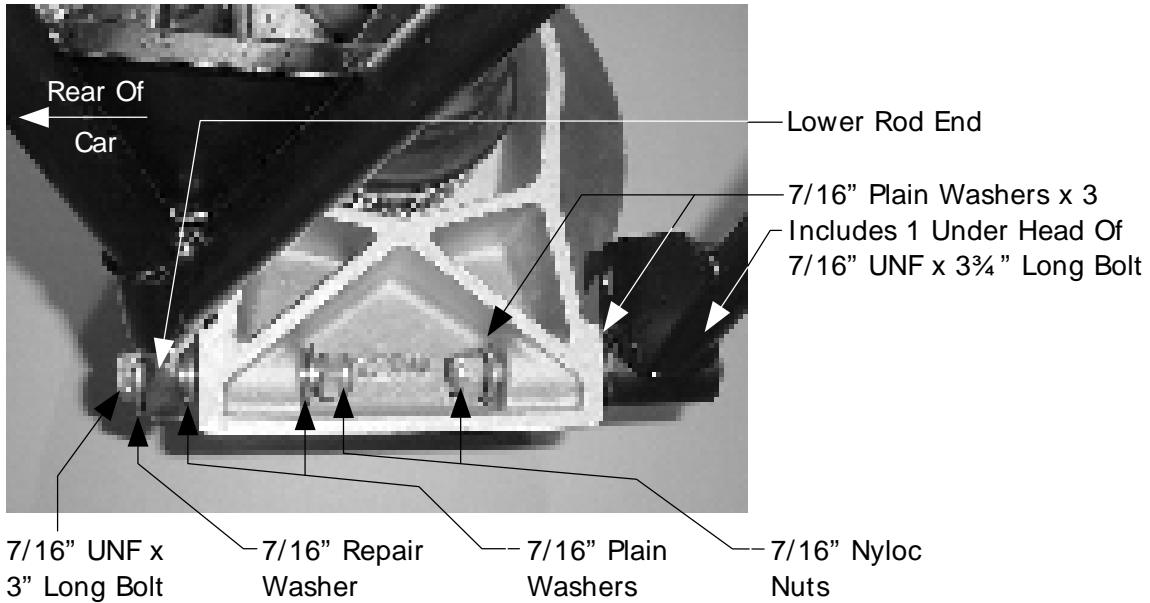

View From Back Of Passenger Side Upright

Step 5: Fit Upright Upper Fixing

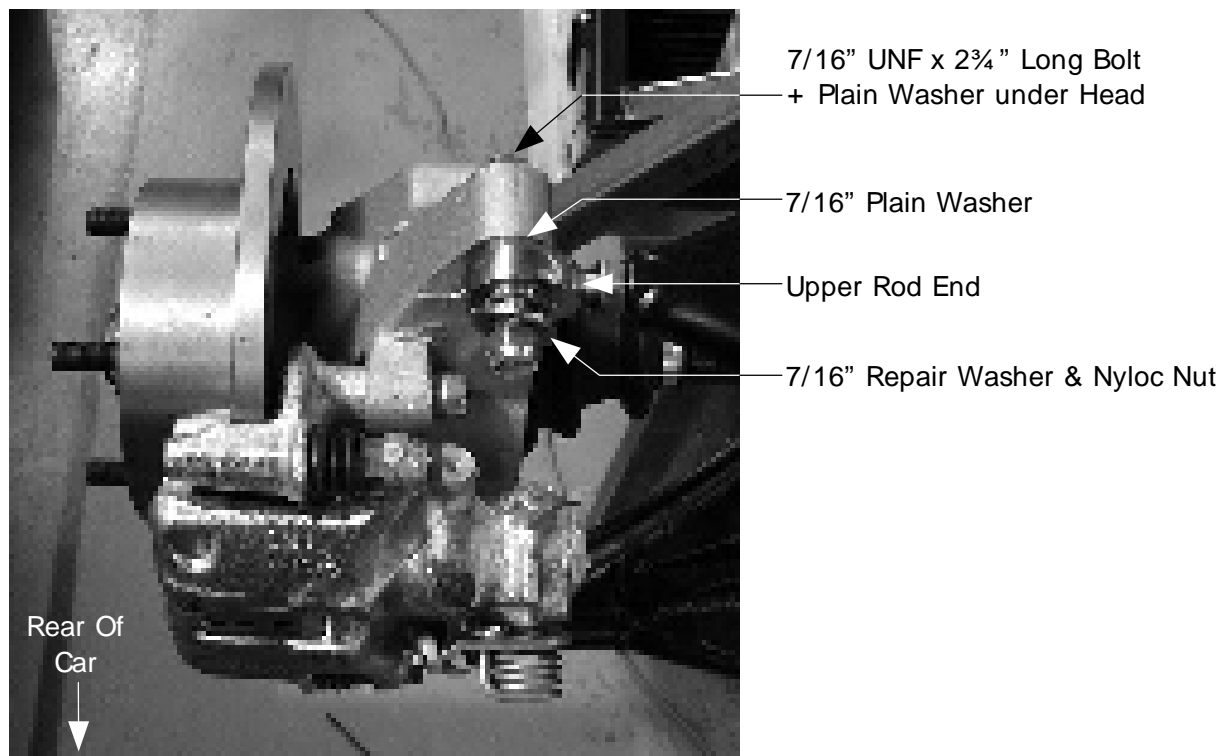

View From Above & From Rear Of Car

NOTE: Do Not Fully Tighten the Top and Bottom Nyloc Nuts that secure the Rod Ends at this Stage as the Set-Up of the Car is Adjusted on these Joints.

Step 6: Fit Rear Brake Hoses



Rear Brake Hose

NOTE

Ensure The Brake Hose Is Finally Adjusted To Clear Any Moving Parts (Must Clear To Pass SVA)

Hose + Copper Washer

Bleed Valve

Rear Brake Caliper

View From Rear Of Car

Step 7: Connect Handbrake Cable

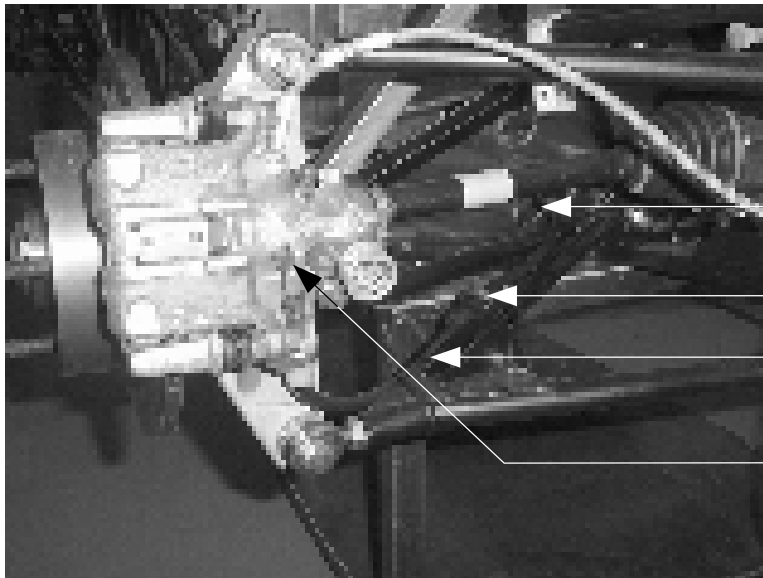

Hole In ECU Mounting Plate

Cable Tie To Wishbone Arm

Handbrake Cable

Connect Cable Ends To Lever On Calipers

View From Rear Of Car

Section 16

SECTION 16 - FUEL SYSTEM

Tools Required:-

- Electric Drill / 3.2mm Drill Bit / Pop Rivet Tool / 6.5mm Drill Bit / 4mm Allen Key / 7mm Socket / Flat Blade Screwdriver / 2 x 12mm Spanner

Parts Required:-

- 1 x Swirl Pot / 1 x 'Facet' Fuel Pump & Mounting Kit / 1 x Main Fuel Pump / 1 x Fuel Filter / 1 x Fuel Pressure Regulator / 1 x Main Fuel Pump Bracket / 1 x Fuel Filter Bracket / 8mm Fuel Hose / 10mm Fuel Hose / 1/2" Fuel Hose / 1 Set Of Jubilee Clips
- 2 x M6 Button Head Screws x 20mm Long / 2 x M6 Bolts x 40mm Long / 4 x M6 Washers / 4 x M6 Nyloc Nuts / 3.2mm Rivets

Step 1: Swirl Pot Installation

Place the Swirl Pot approximately in the position shown below, Mark the Fixing Hole Centres and Drill through the seat back panel with a 6.5mm Drill

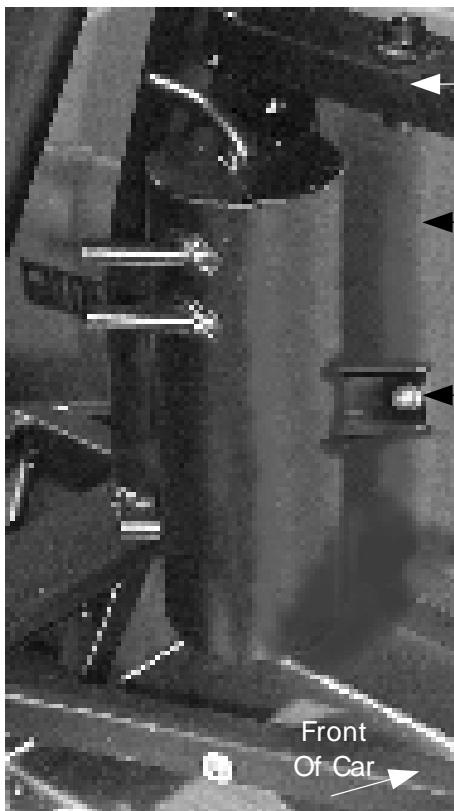

Seat Belt Mounting Rail

Seat Back Panel

M6 Button Head Screws x 20mm Long
With Washer Under Head & Nyloc Nut

Front
Of Car

View From Inside Engine Bay

Step 2: Main Fuel Pump Installation

Position Bracket As Shown, Mark Hole Centres, Drill Through Floor Plate Using 3.2mm Drill Bit & Rivet Bracket To Floor. Secure Pump With Jubilee Clip.

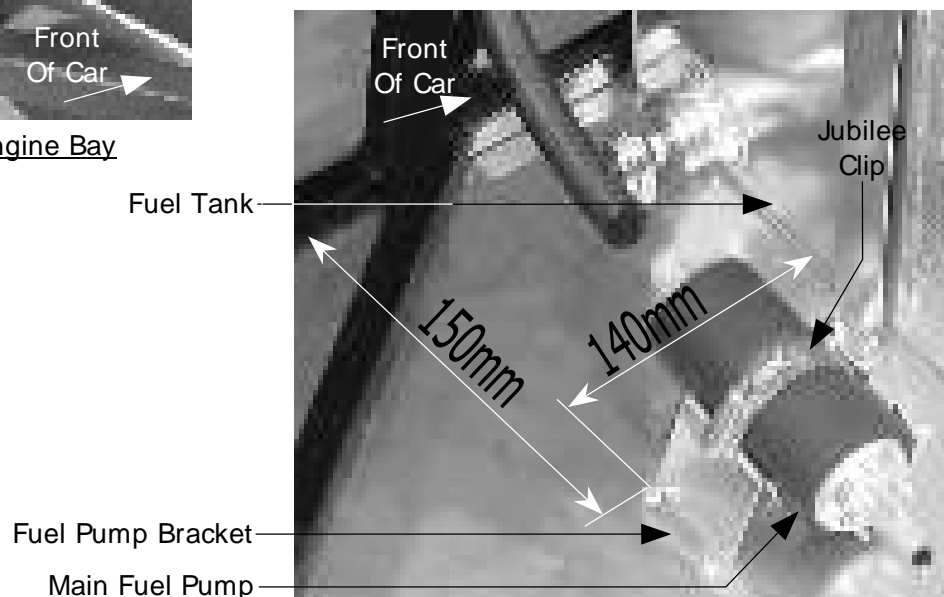

View From Inside Engine Bay

Step 3: Fuel Filter Installation

Position Bracket As Shown, Mark Hole Centres, Drill Through Floor Plate Using 3.2mm Drill Bit & Rivet Bracket To Floor. Secure Filter With Jubilee Clip.

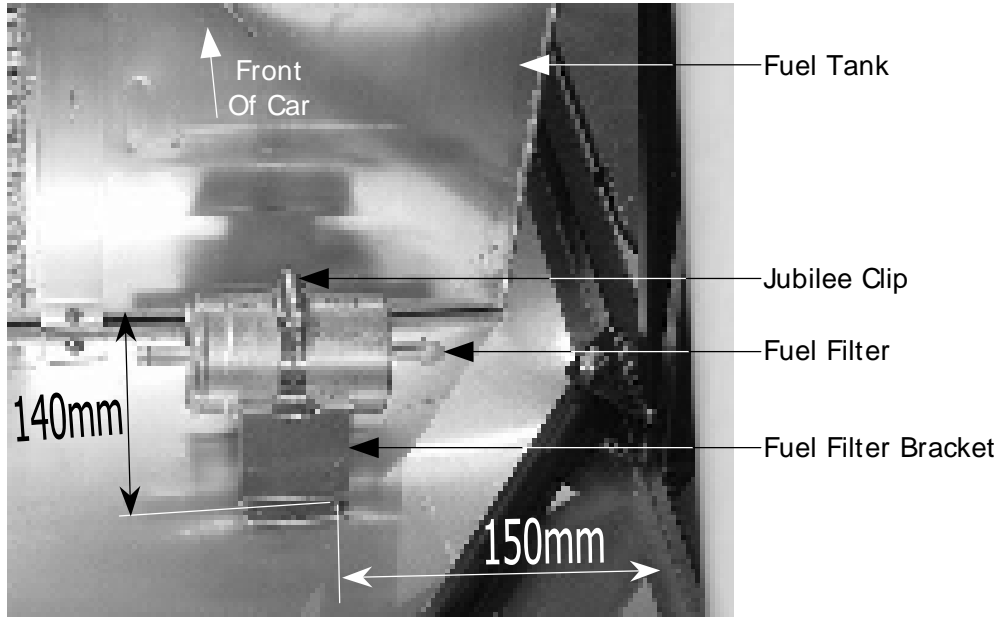

View From Inside Engine Bay

Step 4: Secondary Fuel Pump Installation - 'Facet' Type Pump

Fit Aluminium Bracket To Chassis then Secure the Pump to the Bracket.

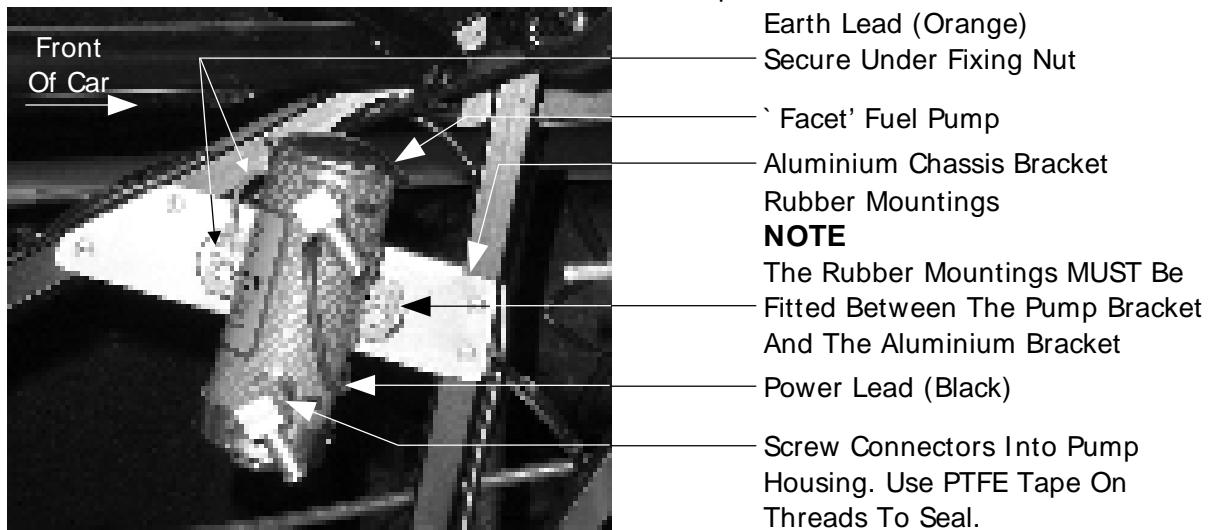

View From Inside Engine Bay



View From Passenger Side Of Car

Step 5: Fuel Regulator Fitting

Fit the Fuel Pressure Regulator to the Top Engine Mounting Frame as shown.

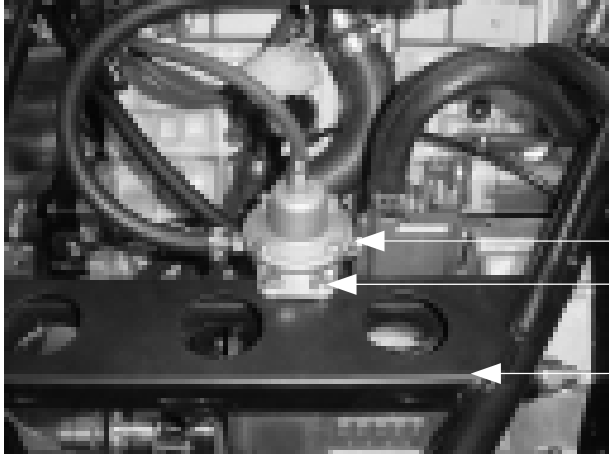

NOTE

The Regulator Should Only Be Fitted After The Frame Has Been Bolted To The Engine and Installed In The Car.

Fuel Pressure Regulator

M6 Bolts x 40mm Long with Nyloc Nuts

Top Engine Frame

View From Rear Of Car

Step 6: Fitting Fuel Pipes

Fit the Pipe from the Main Fuel Pump to the Fuel Filter and secure each end using Jubilee Clips.

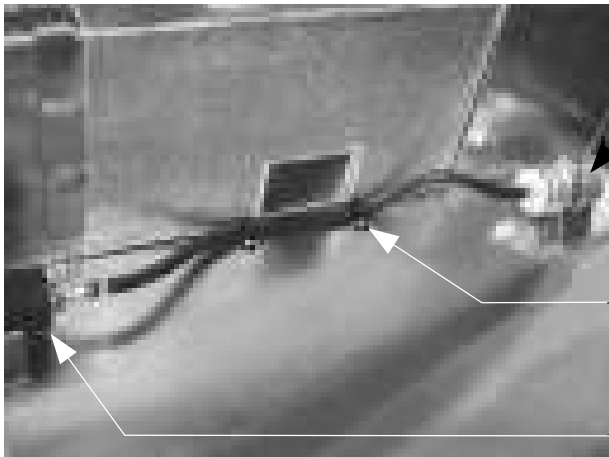

Fuel Filter

8mm (5/16") Fuel Pipe – Fit 2 x `P' Clips In Positions Shown And Rivet To Floor Plate

NOTE

Ensure Pipe Is Tight Up Against The Fuel Tank & Floor To Clear The Handbrake Rod Fitted In Section 9. (Omitted Here For Clarity)

Fuel Filter

Fit the Pipe from the Fuel Tank to the `Facet' Fuel Pump. Again, Secure with Jubilee Clips.

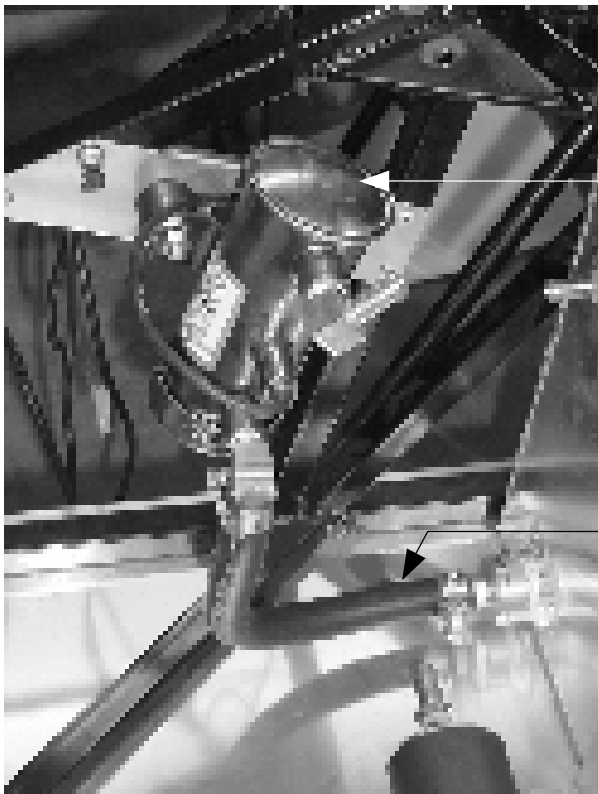

`Fuel' Pump

10mm (3/8") Fuel Pipe

Remaining Fuel Pipe Connection Details

Fit remaining pipes using a Jubilee Clip at each end. See sketch below for further details.

PIPE SIZE	FROM	TO	Pipe No. On sketch
Before Engine Fitting:			
1/2"	Swirl Pot	Main Fuel Pump	1
8mm (5/16")	Swirl Pot	'Facet' Fuel Pump	2
8mm (5/16")	Swirl Pot	Fuel Tank Return	3
After Engine Fitting:			
8mm (5/16")	Swirl Pot	Fuel Pressure Regulator	4
8mm (5/16")	Fuel Pressure Regulator	Engine Injector Rail	5
8mm (5/16")	Fuel Filter	Engine Injector Rail	6

NOTE – Return This Pipe To Westfields For Modification.

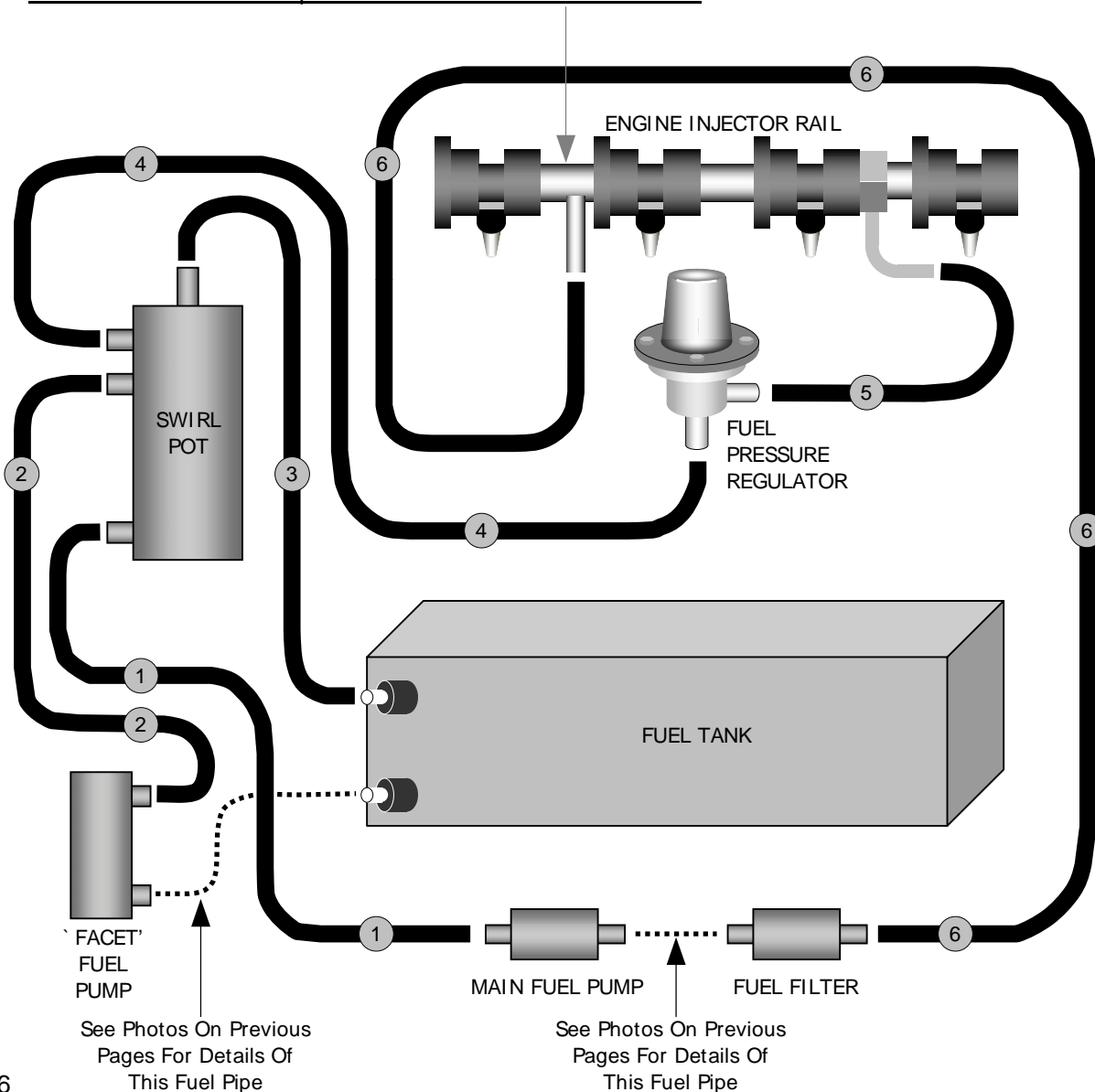

Section 17

SECTION 17 - DRY SUMP TANK & OIL CATCH TANK

Tools Required:-

- 1 Electric Drill / 9mm Drill Bit / Rivsert Tool / 2 x 10mm Spanner

Parts Required:-

- 1 x Dry Sump Tank / 1 x Oil Catch Tank / 2 x 20mm Long Spacers / 2 x M6 Bolts x 35 Long
4 x M6 Setscrews x 20mm Long / 6 x M6 Nyloc Nuts / 10 x M6 Washers / 2 x M6 Rivserts
- 1 x Dry Sump Tank Bracket

Step 1: Catch Tank & Dry Sump Tank Installation

Place the Catch Tank onto the Floor Panel as shown and mark the position of the two fixing holes onto the Panel.

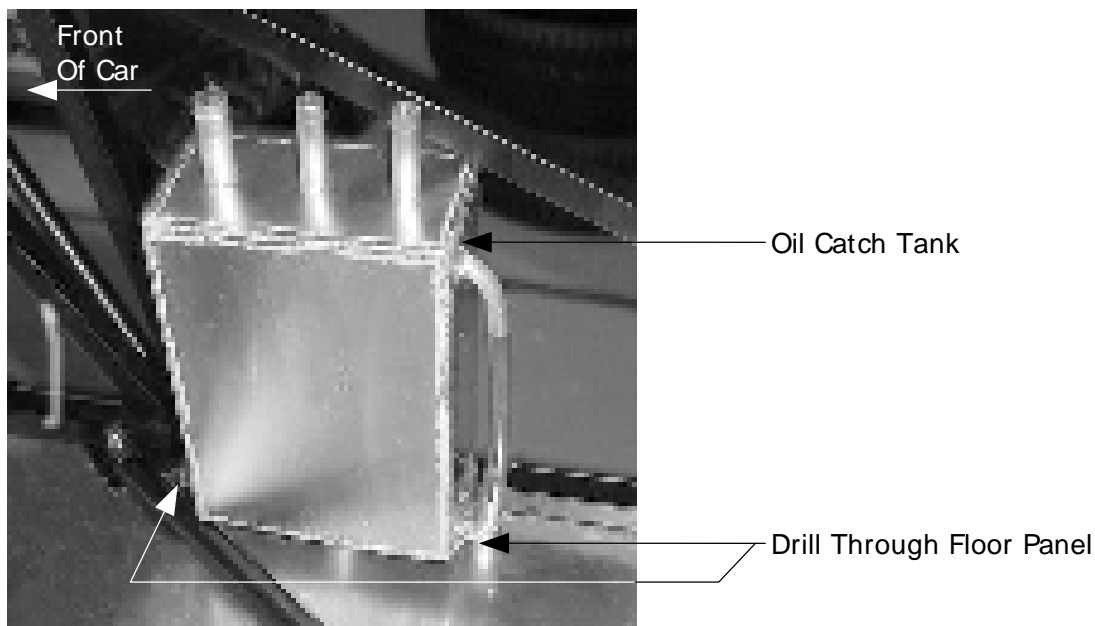

View From Inside Engine Bay

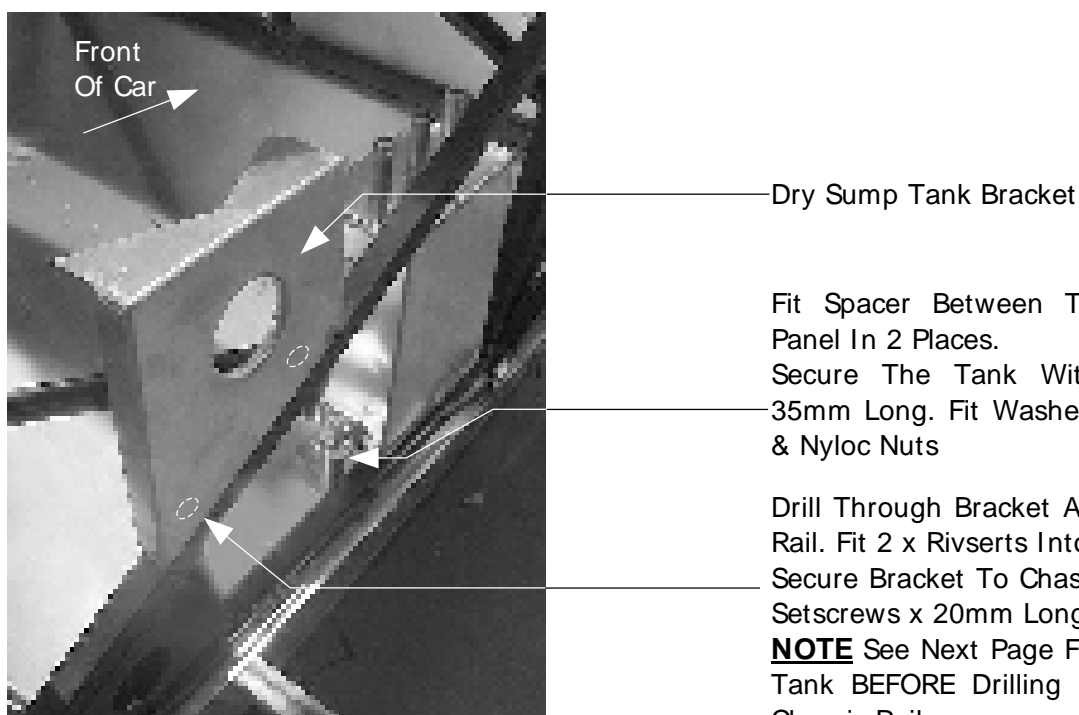

Fit Spacer Between Tank And Floor Panel In 2 Places.

Secure The Tank With M6 Bolts x 35mm Long. Fit Washers Under Heads & Nyloc Nuts

Drill Through Bracket And Into Chassis Rail. Fit 2 x Rivserts Into Chassis Rail.

Secure Bracket To Chassis With 2 x M6 Setscrews x 20mm Long & Washers

NOTE See Next Page For Locating The Tank BEFORE Drilling Fixing Holes In Chassis Rail.



Dry Sump Tank

Drill Through Brackets And
Secure Tank With 2 x M6
Bolts x 20mm Long +
Washers & Nyloc Nuts

To Locate The Tank

On The Bottom Of The Tank There
Is A Drain Plug With A Protection
Tube Around It.

The Tank Must Be Positioned So
The Drain Point Tube Protrudes
Through The Floor Panel Until The
Bottom Of The Tank Sits On The
Floor. Drill a 40 Dia Hole In The
Floor Panel To Clear The Tube.

View From Rear Of Car

Section 18

SECTION 18 - DRY SUMP KIT FITTING

Parts Required:-

- 1 x Engine / 1 x Dry Sump Kit / 1 Set Of Dry Sump Installation Instructions

THE PHOTOS SHOWN IN THIS SECTION ARE TO BE READ IN CONJUNCTION WITH THE INSTALLATION INSTRUCTION PACK PROVIDED WITH THE DRY SUMP KIT

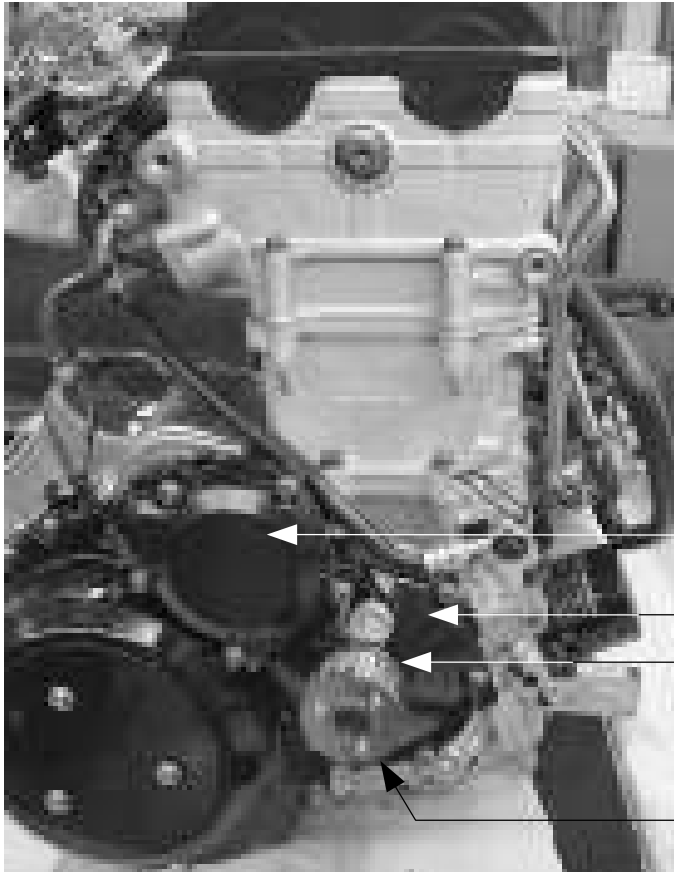

Starter Motor Drive Cover

Starter Clutch Cover

Starter Clutch Cover Plug Location Replaced With Item 8 (Seal Housing) & Item 7 (Seal)

Item 5 (Drive Pulley) Assembled And Secured With M10 Socket Cap Screw

BEFORE Fitting The Pump Bracket To The Engine.

1. Fit The Mounting Straps Into The Bracket Holes
2. Remove One Crank Case Bolt (As Shown Below)



NOTE - Remove This Crank Case Bolt

Pump Mounting Strap (Item 39)

Pump Bracket (Item 14)

Pump Mounting Strap (Item 39)

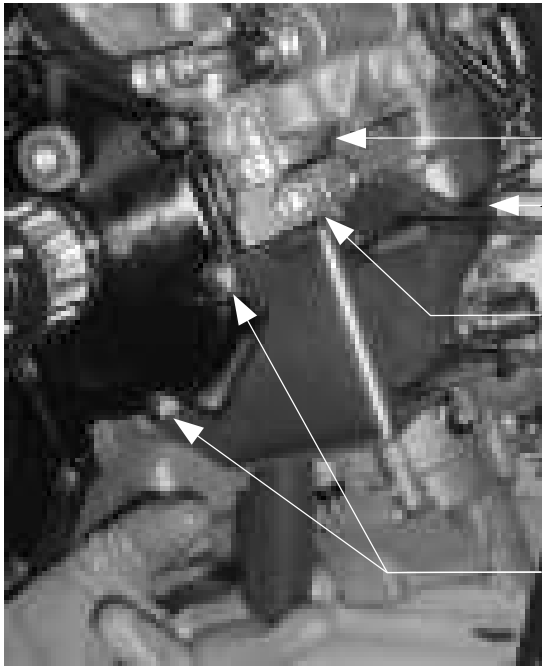

Lever Bar

Re-Fit Crank Case Bolt To Secure Tail End Of Bracket

Use Cap Head Bolt (Item 13) To Secure Top Of Bracket.

Position Lever Bar As Shown To Hold The Nut At The Rear Of The Bracket. This Will Assist With The Tightening Of The Bolt.

Use 2 Bolts From Starter Clutch Cover For Securing The Front End Of The Bracket

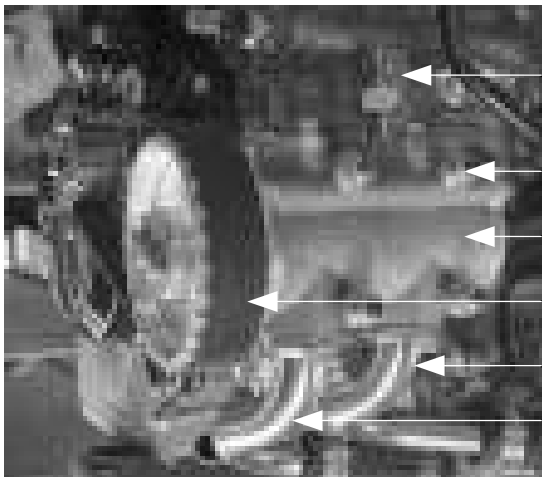

Oil Return Union (Item 19)

M6 Washers & Nyloc Nuts

Dry Sump Pump (Item 24)

Pump Drive Belt (Item 1)

Scavenge Pipe (Item 31)

Scavenge Pipe (Item 56)

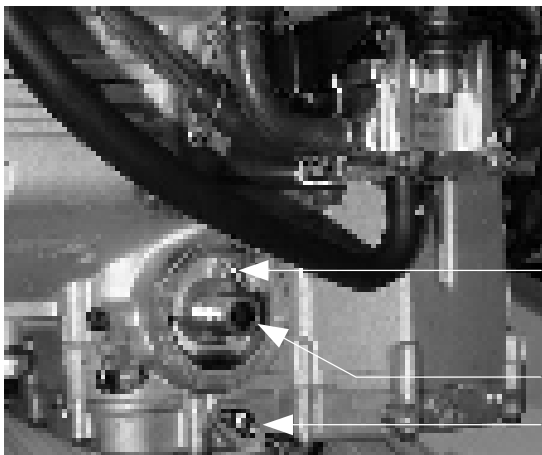

Oil Flow Restrictor Screw
Remove Using 8mm Allen Key

Oil Filter Connection Point

Oil Gallery – Blank Off Using Item 16 & 17

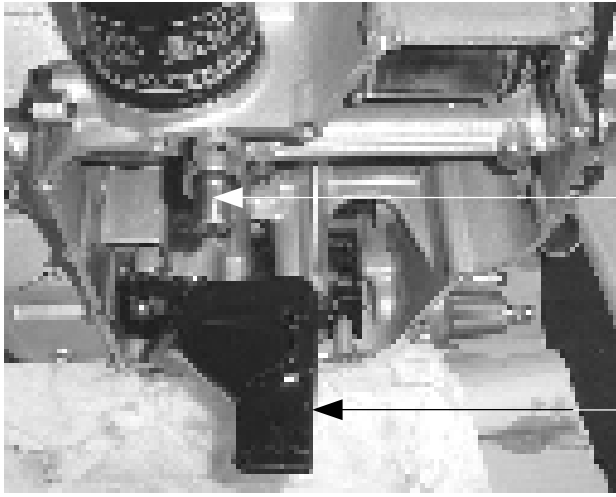

Oil Pressure Relief Valve
DO NOT Remove

Oil Pick-Up Pipe
REMOVE & DISCARD

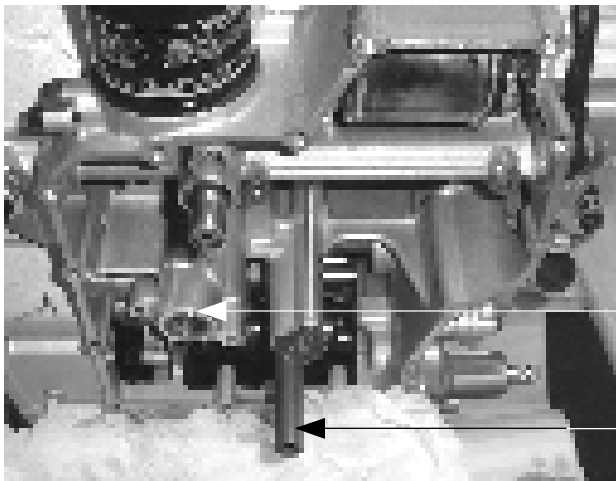

O'-Ring MUST BE Re-Fitted

Oil Return Pipe
Remove & Shorten To Suit Drawing

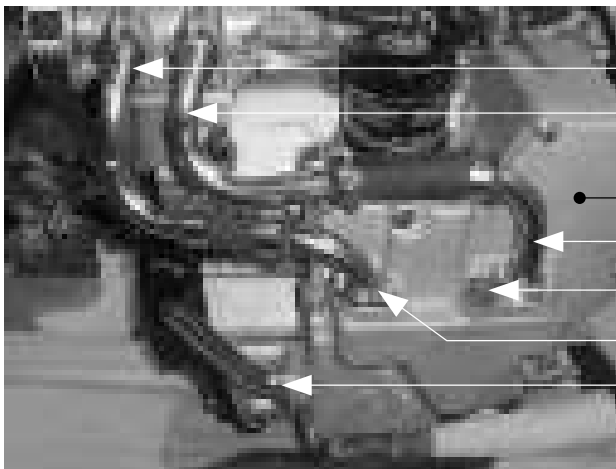

Scavenge Pipe (Item 56)

Scavenge Pipe (Item 31)

Dry Sump Pan

Scavenge Pipe (Item 55)

Sump Plug (Tighten)

Scavenge Pipe (Item 57)

Oil Feed Pipe (Item 53)



Overflow Hose

Section 19

SECTION 19 - ENGINE PREPARATION & INSTALLATION

Tools Required:-

- 1 x Spanner

Parts Required:-

- 1 x Engine Fitted With Dry Sump System / Drive Sprocket / Reverse Gear Drive Flange / Clutch Slave Cylinder + Mounting Brackets / Oil Pressure Adapter / Gear Linkage Support Plate, Bracket, Levers & Rod / Top Engine Frame / Loom Saddles / MAP Sensor / Air Filter Plate / Rubber Trumpets / Air Temperature Sensor / Plastic Elbow / Air Filter / Exhaust Manifold

Note ; It is easier to fit the Exhaust Manifold at this stage before the engine is fitted into the Chassis. For instruction see Section 22.

Step 1: Fit Clutch Slave Cylinder



Secure Bracket To Engine With 2 - M6 Setscrews x 20mm Long & Spring Washers

Upper Bracket

Clutch Slave Cylinder



Secure Bracket To Clutch Cylinder With 2 - M8 Setscrews x 20mm Long & Spring Washers

Clutch Slave Cylinder

Lower Bracket

Secure Bracket To Engine With 1 - M6 Setscrews x 35mm Long & Spring Washer

Step 2: Fit Sprocket & Reverse Gear Drive Flange

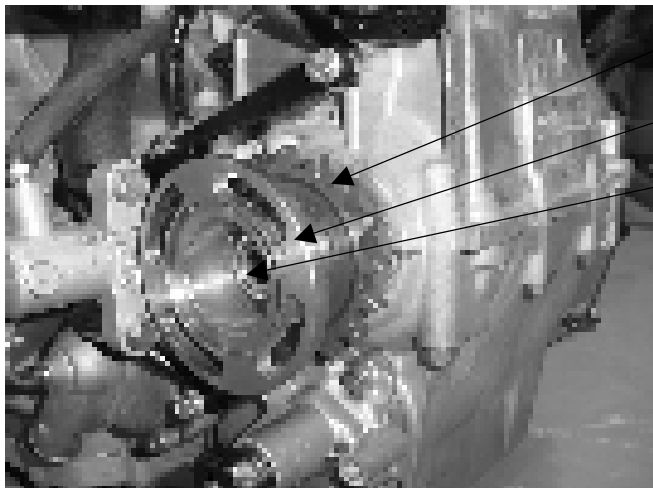

- Sprocket
- Reverse Gear Drive Flange
- Modified Nut
- Machine Face Of Nut Until It Is Flush With The Face Of The Existing Counterbore. i.e. To This Point. If this Creates a Problem Return Your Nut To WSC To Be Modified

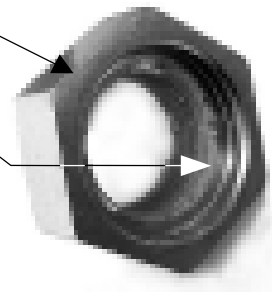

Step 3: Exhaust Manifold Studs

Remove the Existing Bike Manifold and Cap Head Screws from the Engine if they have not been removed already.
 Carefully clean the mounting surface on the Engine and fit the 8 Exhaust Manifold Mounting Studs supplied by Westfield

Step 4: Oil Pressure Adaptor



- Dry Sump Pump Drive Pulley
- Oil Pressure Adaptor Connection Point

Step 5: Gear Linkage Plates & Mechanism



- Gear Change Support Bracket
- M8 Repair Washer
- Gear Change Pivot Lever - Long End To Left Hand Side Of The Car
- M8 x 55mm Long Bolt+ Washer Under Head
- Main Support Plate
- Dry Sump Pan M6 Fixing Bolts x 3

View From Under Front Nearside Corner Of Engine (As Installed In Car)

Step 5: Gear Linkage Plates & Mechanism

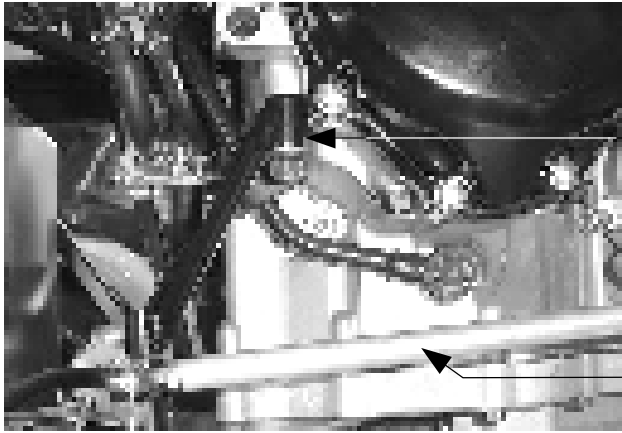

Gear Change Support Bracket Top Fixings
M8 x 45mm Long + Washer Under Head

Rear Gear Change Rod Fitted With Rod
Ends + Lock Nuts At Each End

View From Nearside Of Engine (As Installed In Car)

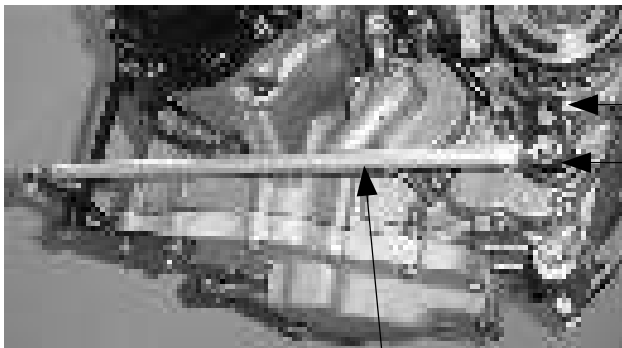

M6 Bolt x 20mm Long + Spring Washer

Gear Change Lever – NOTE; To Get The
Best Gear Lever Ratio It Is Advisable To
Reduce The Length Of This Lever From
65mm to 35mm Hole Position.

Rear Gear Change Rod ½" dia Aluminium

Step 6: Fit Loom Saddles To Engine Frame

Fit Loom Saddles To Engine Frame As shown Before Fitting Engine Into Frame.

2 Loom Saddles
On Under Side
Of Support
Tube

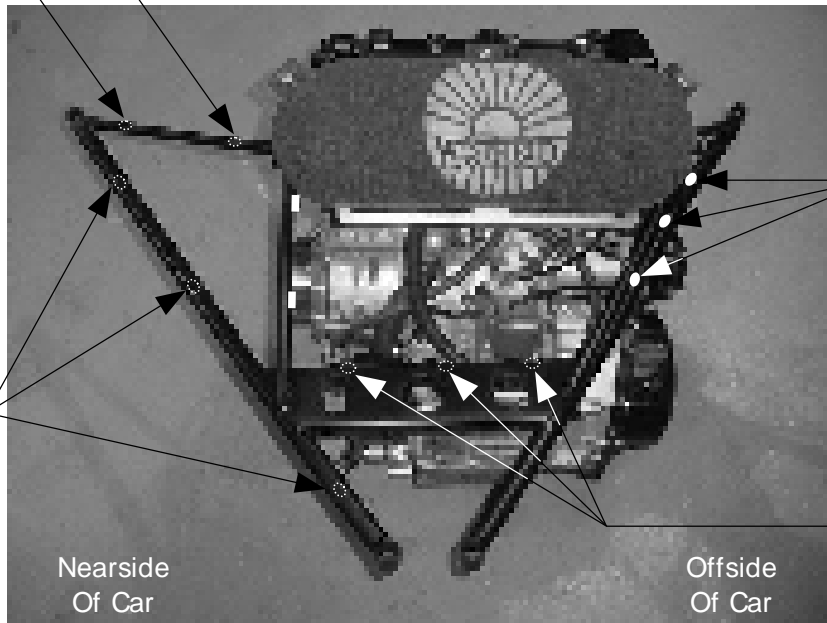

3 Loom Saddles
On Top Of Main
Side Tube

3 Loom Saddles
On Under Side
Of Main Side
Tube

3 Loom Saddles
On Back Face
Of Brace Plates

Nearside
Of Car

Offside
Of Car

Step 7: Fit Frame To Engine

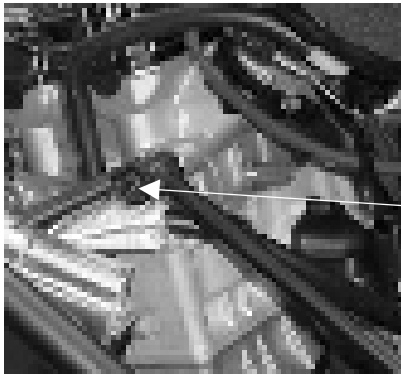

Nearside Mounting Point

M10 x 1mm X
50mm Long
Special Bolts
(Self Coloured) Fit
through
Metalastic Bushes

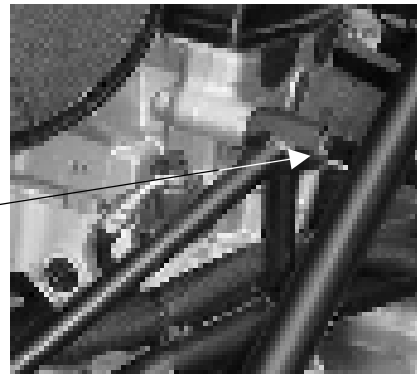

Offside Mounting Point

Step 8: Fit Sensors



View From Rear Nearside Corner Of Engine
(Note: Piping Would Not Have Normally Been Fitted At This Stage.)

Throttle Position Sensor
(Already Located)

Fuel Rail Return (Modified
by Westfield Upon
Request)

Manifold Pressure Sensor
(MAP)
Locate On End Of Fuel Rail
As Shown

Atmospheric Air Pressure
Sensor
Locate On Top Of Cross
Brace Plates As Shown

Step 9: Fit Air Filter Plate



Rubber Trumpets

NOTE

4 Trumpets Are Supplied
With The Engine - 2 Long &
2 Short. Keep The 2 Short
Ones & Discard The 2 Long
Ones. 2 Additional Short
Ones Are Supplied By
Westfield.

Air Temperature Sensor
NOTE Keep This Off The
Original Motor Bike Air Box.

Air Filter Mounting Plate

90° Elbow (See Step 10)

Step 10: Fit & Pipe Up Elbow

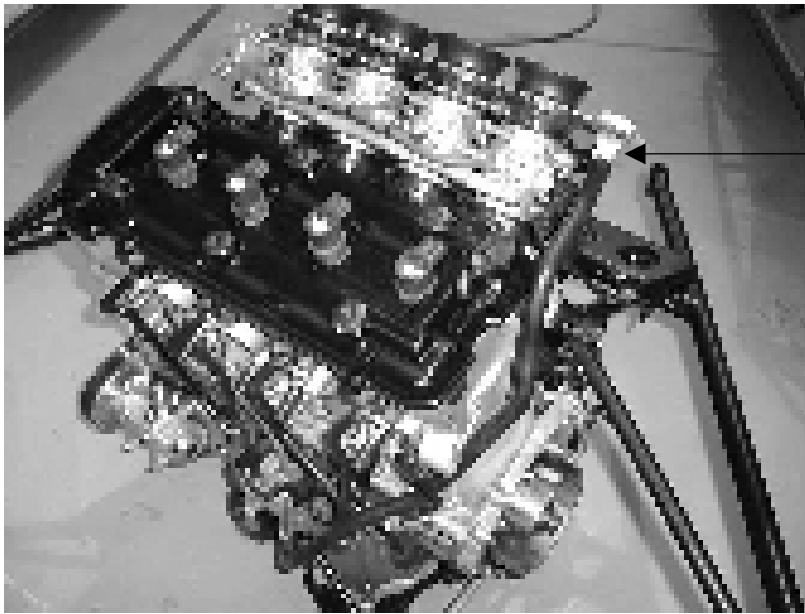

Elbow Supplied By Westfield
Connected to Engine Pulse
Air Tube

Step 11: Fit Engine to Earth Strap

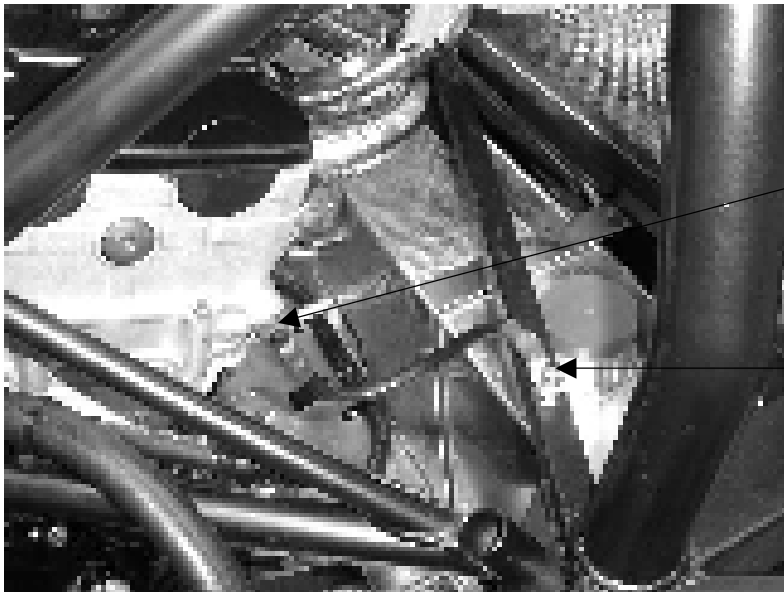

Engine end Fitted with M10
x 1 Bolt

Chassis end Fitted To M6
Bolt Provided on Chassis
With M6 Nyloc And Washer

Section 20

SECTION 20 - REVERSE GEAR ASSEMBLY

Tools Required:-

- 4mm Allen Key / 3mm Allen Key / 2 x mm Spanner / 1 x mm Spanner / 1 x mm Spanner

Parts Required:-

- 1 x Reverse Gear Lever, Inner Bush & Knob / 1 x Reverse Gear Cable & Rose Joints / 1 x Reverse Gear Motor Assembly
- 3 x M8 Bolts x 25mm Long + 3 x Washers + 3 x Nyloc Nut
- All Fixings For Mounting This Assembly Should Be Supplied with The Assembly

Step 1: Install The Reverse Gear Lever & Cable

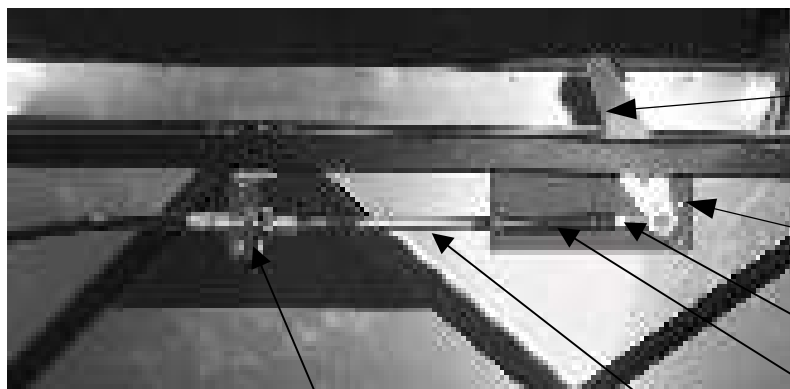

Reverse Gear Lever
Note: Knob To Be Fitted After Bodywork

Lever Mounting Bracket (Welded To Chassis)

Rose Joint

Return Spring (Lever)

View From Drivers Side

Cable Mounting Bracket (Welded to Chassis)

Reverse Gear Cable

Reverse Gear Cable
M5 Countersunk Head Screw x 25mm Long

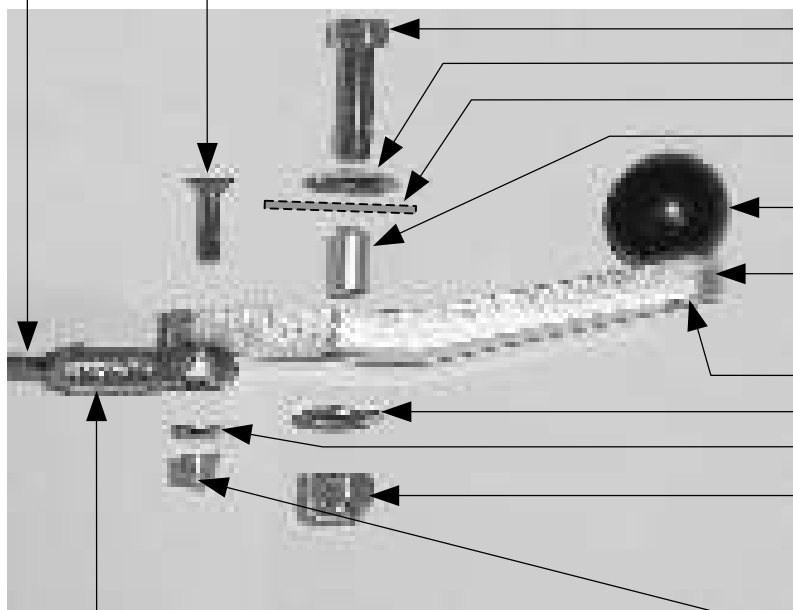

Pivot Bolt – M8 x 25mm Long

M8 Washer

Bracket Is In This Location

Lever Inner Bush

Gear Knob

Gear Lever

M6 Countersunk Head Screw x 16mm Long

M8 Washer

M5 Washer

M8 Nyloc Nut

Rose Joint

Gear Lever / Cable Exploded Assembly

M5 Nyloc Nut

Step 2: Engine End Of Cable

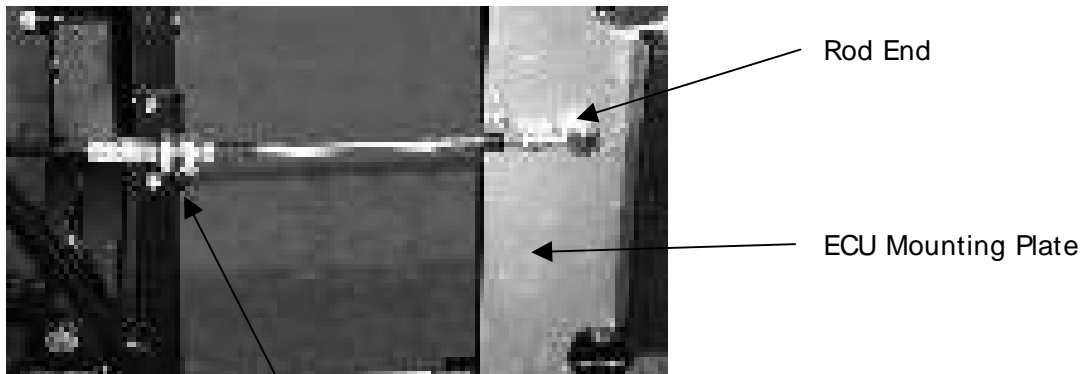

Bulkhead Mounting (Welded To Chassis)

Step 3: Mounting Reverse Assembly

This Step of the Assembly needs quite a lot of care taken to make sure the mechanism is aligned with the engine correctly. Before you start it is advisable that you remove the Motor from the mechanism to make it easier to handle.



Place the mounting plate next to the engine drive flange with the plate to the left of the angle bracket on the top engine frame and behind, (to the right) of the angle bracket on the bottom engine frame. Now operate the small actuating lever (which operates the drive dog) and jam the dog away from the mounting plate as far as possible with a screwdriver. Then line up the drive dog and engine flange so that the outside diameters are together and clamp in position with a pair of grips.

NOTE: With The Drive Flanges Still In The Clamped Position



Top Mounting Point, When Positioned Correctly Drill Two Holes Through Angle To Take M8 x 25mm Bolts.

If Required Place Washers As Spacers Between Mounting Plates To Keep The Plates And Flanges Parallel

Bottom Mounting Point, When Positioned Correctly Drill One Hole Through Angle To Take M8 x 25mm Bolts.

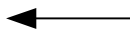

FRONT OF CAR

Step 3: Fit Cable At Engine End And Check Operation



Assemble Rod End To Lever With M6 x 35 Bolt Supplied. To check Operation Operate the lever in the cockpit backward and forwards, The drive dog should freely engage into the slots in the flange and then return right back to the large mounting plate face.

Step 4 : Refit Electric Motor

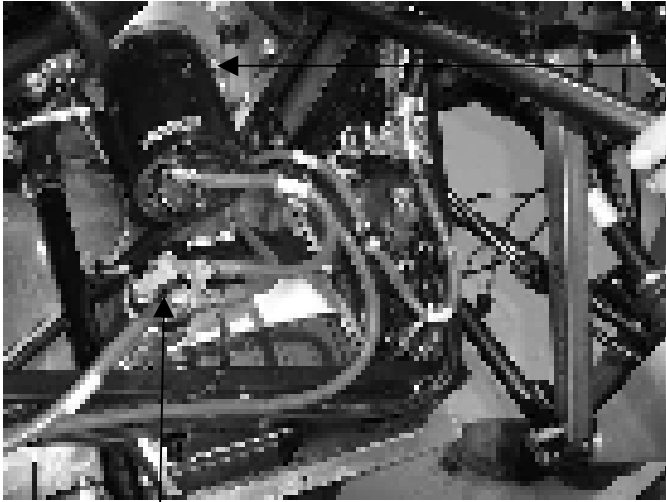

Replace Motor Using 2 off
M8X 25 Set screws and
Washers Provided.

Solenoid For Reverse Mechanism

SEE WIRING DIAGRAM ON NEXT PAGE

Installation For Left Hand Drive

The Cockpit Lever end of the cable is mounted in the same way as shown in Step 1 of this section of the manual except the handle and knob should face in towards the driver.

The Engine End Of The Cable

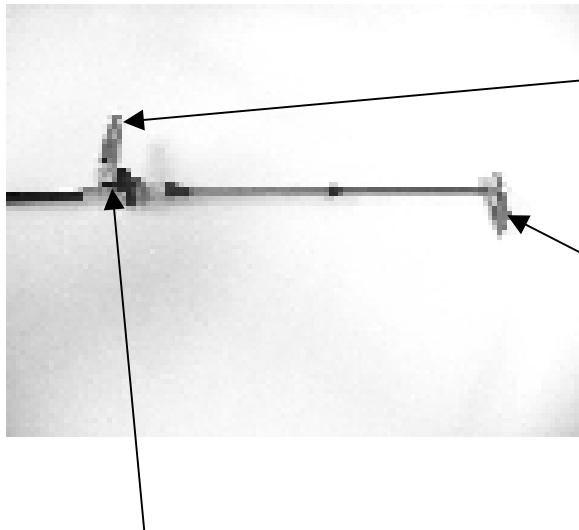

Small operating lever on reverse mechanism.

Cable abutment (Is Already welded to chassis) Inner fixed with two large washers and M5 Nyloc.

New Bracket Fixed to cable outer fixing nuts and loosely mounted to the lever arm with M5 dome head screw and Nyloc.

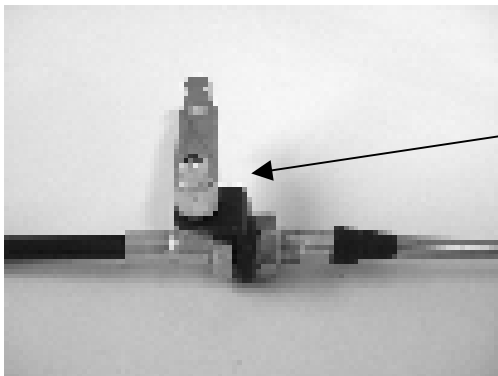

Close up of lever set up.

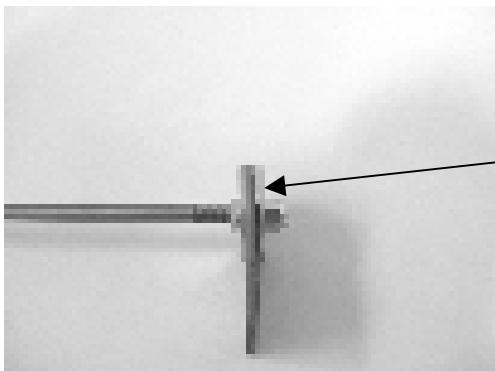

Chassis mounting With Two M5 Repair washers. One either side and a M5 Nyloc

WIRING DIAGRAM – XTR2 REVERSE MECHANISM

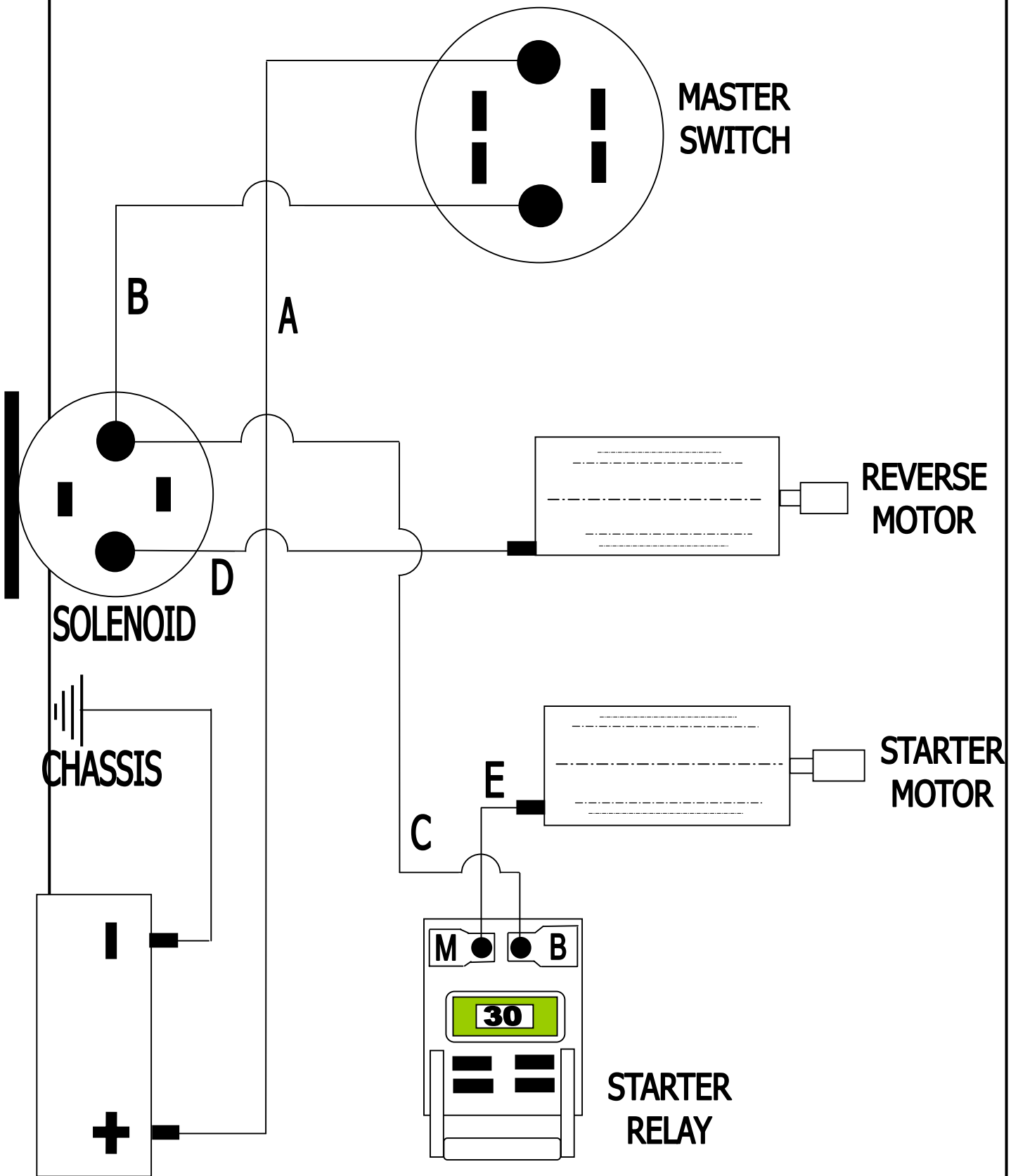

CABLE	LENGTH	TERMINALS
A	100"	M6 - M10
B	84"	M8 - M10
C	16"	M6 - M8
D	11"	M6 - M8
E	50"	M6 - M6

Section 21

SECTION 21 – BODYWORK TRIMMING AND FITTING

Parts Required: -

- Full Set of Bodywork / Water Radiator / Oil Cooler / Cooling Fan / Oil Cooler Brackets / Splitter Frame and Board / Brake Ducting / Light Fittings Front And Rear / Rear Bodywork Stays / Nose Fitting Catches And Pins / Windscreen / Side Repeaters

Step 1: Bodywork Trimming

Most of the trimming of your bodywork should have been done for you before you receive it. It is most important that you pre-fit the bodywork to the chassis before you have it painted.

Check all these areas shown below before the pre-fit.

1.a. Seat Belt Slots

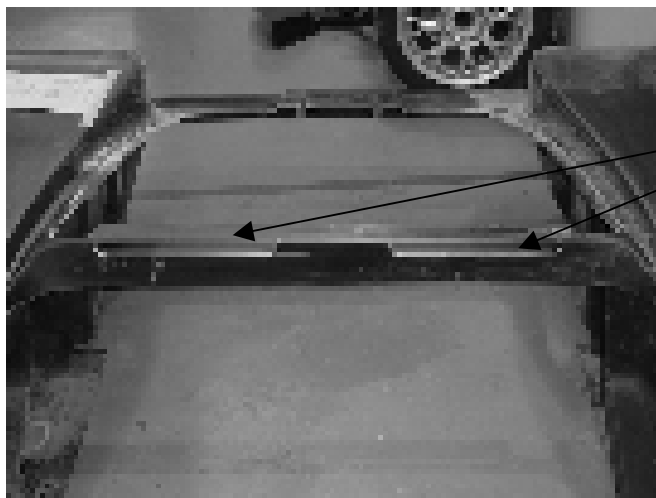

Seat Belt

1.b. Light Holes Front and Rear

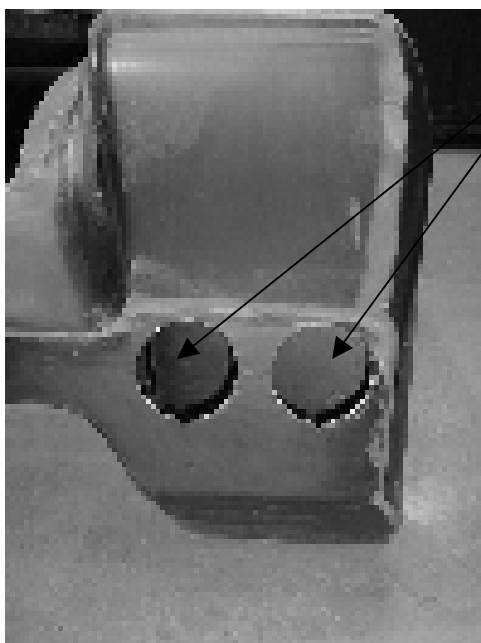

Holes to suit rear light units

Mounting holes for dip and main beam headlamp brackets

Holes to suit front light unit's indicator and side

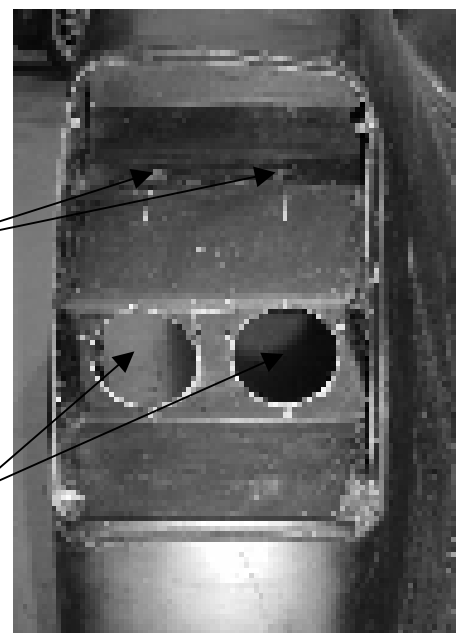

1.c. Fog light holes

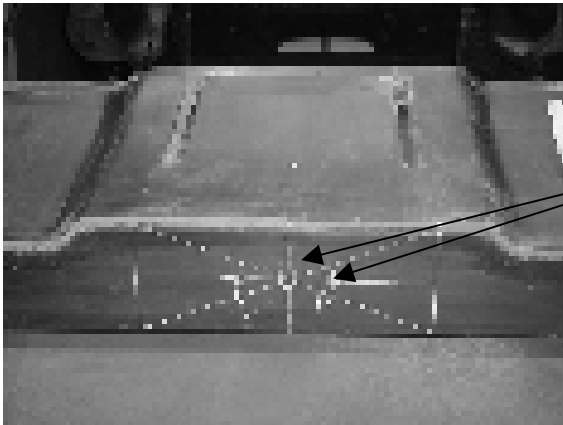

Centre Hole For Cable Two
Smaller holes for M5 Retaining
Studs.

1.d. Fuel Filler Hole

The main hole will already be in place on your bodywork but you need to drill the six fixing holes as shown.



Insert filler cap into pre-cut hole and drill the six 5mm holes through.

1.e. Inner Rear Arches

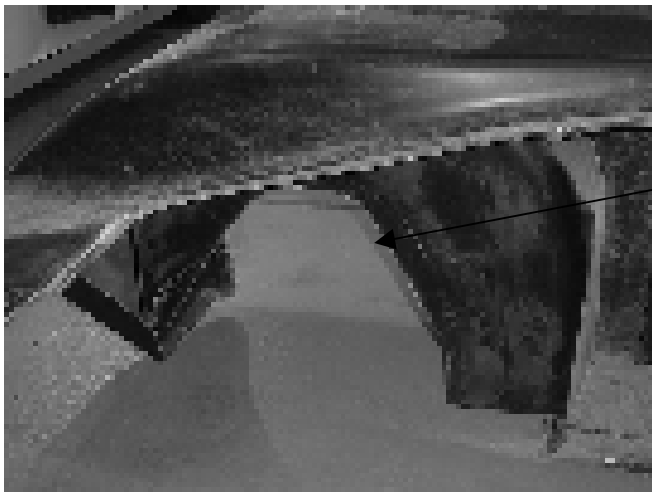

These Rear arches will be Pre-trimmed but just check your clearance when you have the bodywork on the rolling chassis doing the Pre-fit

1.f. Windscreen Mounting Holes

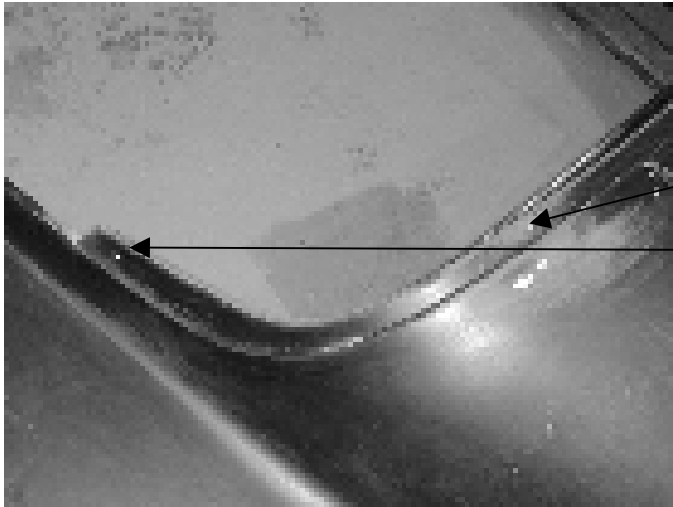

Carefully position the windscreen onto the pre-formed recess, and drill through the five holes in the screen with a 4mm drill. Then remove the screen and drill through the underside surface only with a 9mm drill. This is to allow the M4 nut to clamp up on the correct face of the bodywork.

1.g. Oil Cooler Mounting



Oil cooler in position mounted from two brackets supplied and bolted through the flanges front and rear of the right hand side air intake. Mounted using M6 nuts and bolts.

View from Inside Bodywork Looking At Right Hand Side of Car

1.h. Radiator and Cooling Fan

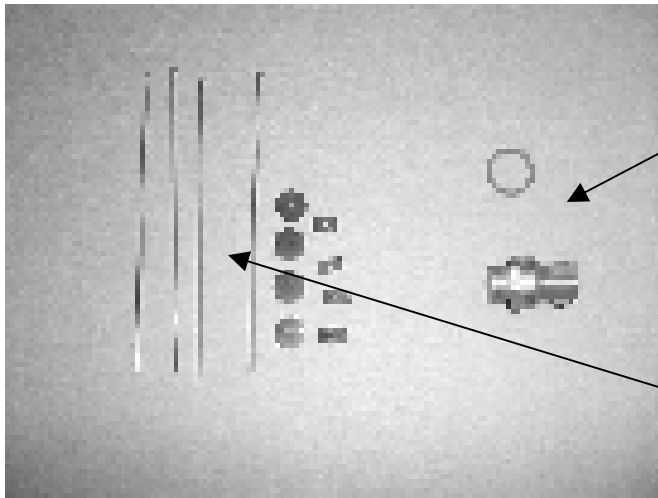

Thermostat Switch and Washer

Fan Mounting Kit

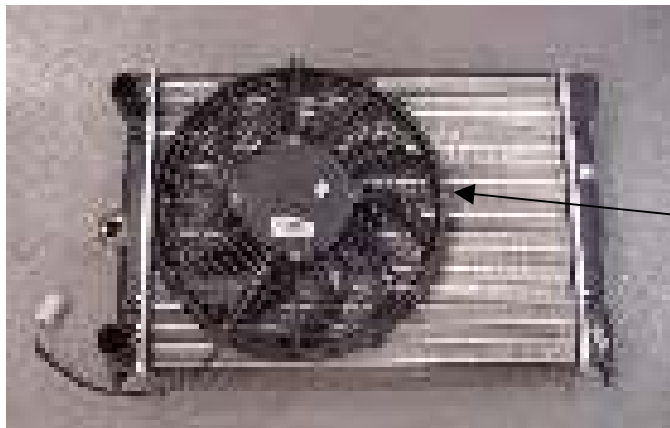

Cooling fan needs to be positioned close to the thermostat switch socket and retained by the fan mounting kit. Care is needed when pushing the fan mounting pins through the radiator, so as not to pierce the tubes.



The four plastic bosses on the outside of the radiator need to be tapped M6 to the bottom of the blind hole (Make Sure You Do Not Go To Deep And Break Into The Main Radiator)

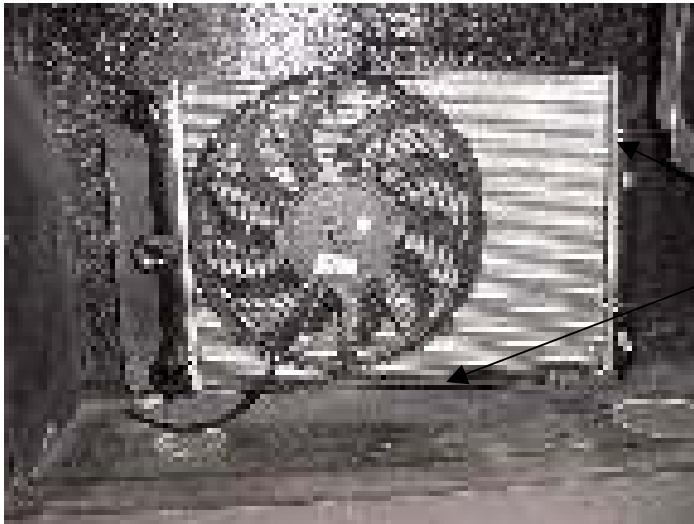

The radiator sits level with the bottom of the intake with the inlet and outlet towards the back of the car, and is bolted through the return flanges at either end using the M6 tapped holes.

View From Inside Engine Bay Towards The Left Side Air Intake

1.i. Front Loom Connector Holes



Front Loom Connector hole and fixing screw holes.

Clearance around clutch master cylinder reservoir bracket.

1.j. Dashboard And Surround



Place the already trimmed dashboard into position in the interior panel. Check in the areas shown that there is clearance behind the dashboard for the clocks and switches to pass through. Mark them with a marker pen.



Remove the marked areas

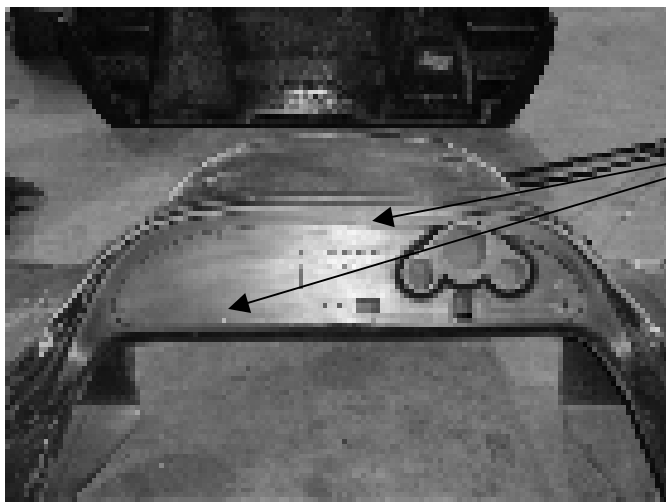

Drill through the dashboard mounting holes then remove dashboard and fit rivnuts into the interior panel in each position.

1.k. Pedal Box Cover

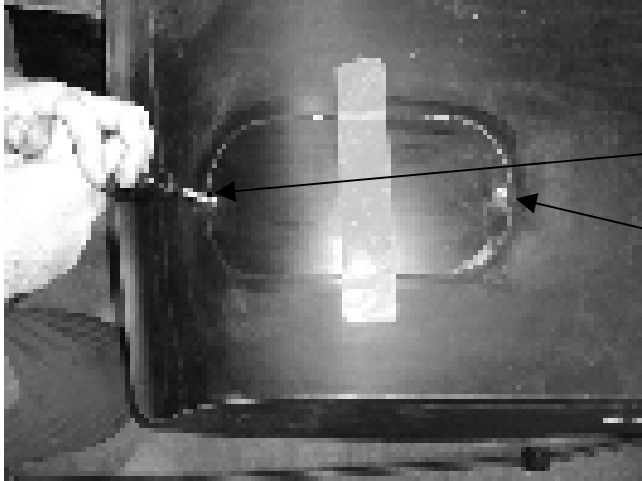

Place the cover into the recess on the main body section and drill two 5mm pilot holes through both surfaces. Then remove the cover and drill and rivnut the underneath flange.

1.l. Reverse Lever and Button Holes

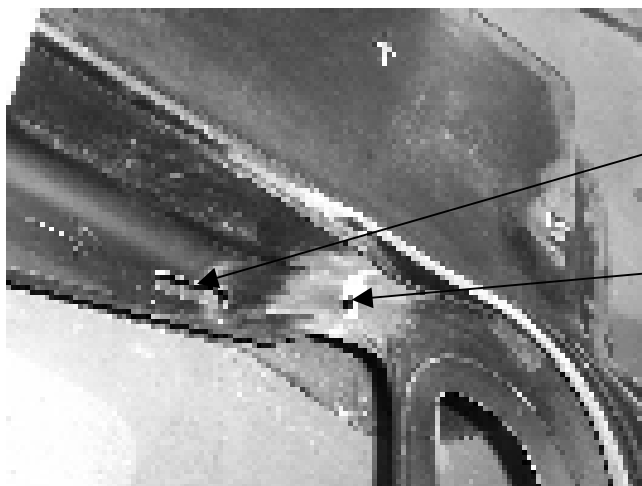

Measure as accurately as possible the position of your reverse lever in the cockpit and then open up a slot for it to operate in. Then position a 12mm hole correctly so that you can push the button whilst you are operating the lever forwards.

NOTE: This Picture is of a Left Hand Drive Car

1.m Engine Cover

The engine cover will already have a pre-trimmed hole which will go over the engine and air filter. Place the cover onto the main body section and check you have enough clearance around this area and also round the two rear roll over bar stays. All that is left then is to line up the air intake scoop with this profile and drill about eight 5mm holes around the flange and engine cover to bolt the two parts together.

1.n. Side Repeaters

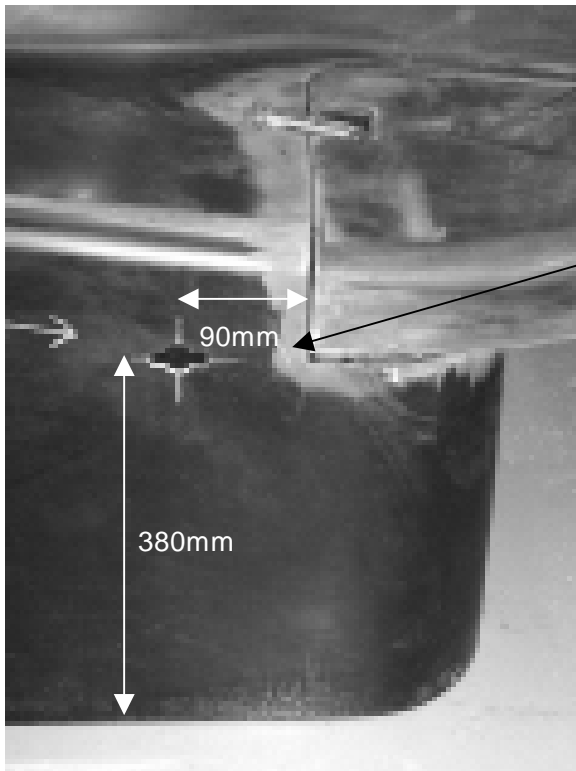

Drill a pilot hole in each side of the bodywork at 380mm from the bottom of the body and 90mm from the nose location step. Then file out the shape shown until it locates the side repeater correctly.

1.o. Mirror Mounting Holes

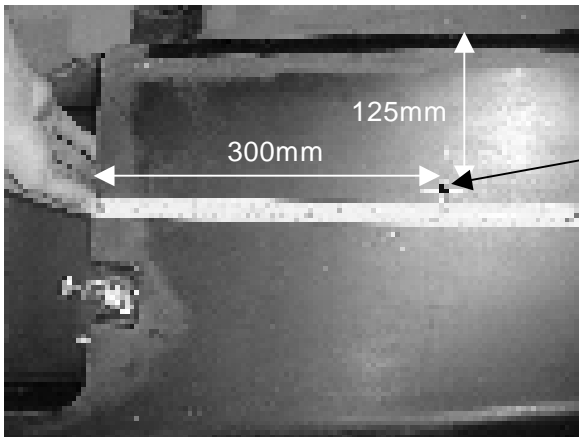

Drill one 8mm hole each side where shown for the mirror pedestal to fix.

Step2: Fit Splitter Frame

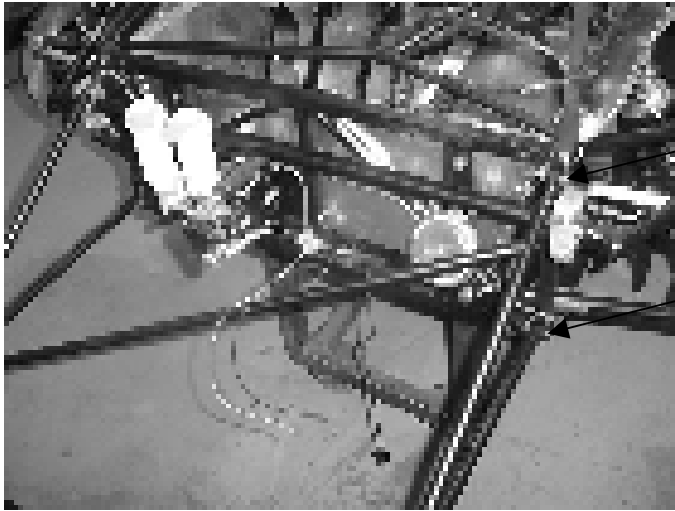

Mount the splitter frame from the four “U” brackets welded to the chassis. The two top fixings on the frame are adjustable so that when fitting the nose and splitter board the correct fit can be obtained.

YOU ARE NOW READY TO PRE-FIT THE MAIN BODY SECTION AND THE NOSE

Step 3: Main Body Pre-Fitting

Placing the bodywork onto the chassis will require at least two people. Before lifting the body make sure you have covered the roll bar with some protective material so as not to damage the coating. Lift the body over the chassis and lean it to one side and feed it over the outrigger down the cockpit side and then do the same on the other side. The bottom edge of the side sections needs to be placed onto the 25mm section of aluminium floor that protrudes outside the lower chassis rails. Then push the body section backwards as far as it will go so that the seatback section is up against the seatbelt mounting rail. Drill two holes through the panel just below the seatback rail and retain using two M6 countersunk screws with special seat washers from the bodywork side.

M6 countersunk screws with special seat washers hold the bodywork back to the chassis

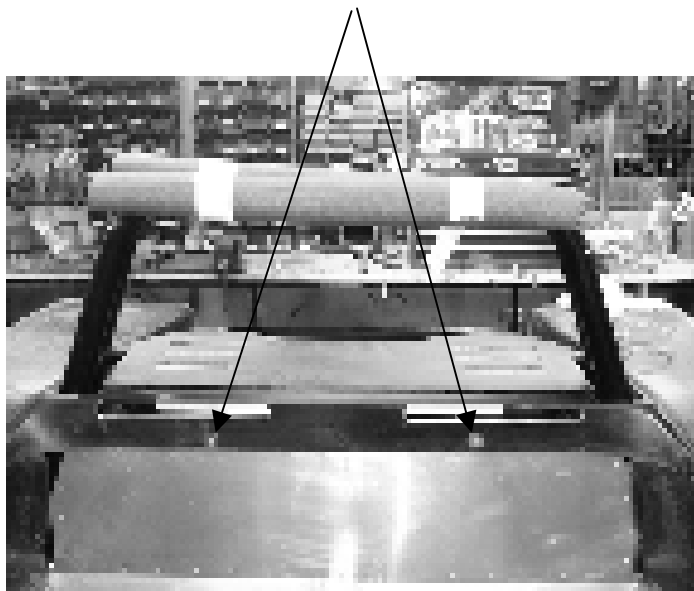

Now re-check that all of the pre-trimmed areas mentioned above, to be sure you have the correct fit now that the bodywork is in position.

When you are happy with all these points then you can drill the fixings underneath the car. These holes are drilled through the 25mm overhanging section of the Aluminium floor pan about 12mm in from the outside edge of the sheet. This will go through the Fibreglass ready for the bolts. Use M8 x 20 bolts with large repair washers and Nyloc nuts. We recommend a minimum of four fixings per side and we have placed large access holes in the underside of the bodywork for this job.

3.a Rear Body Support Stays

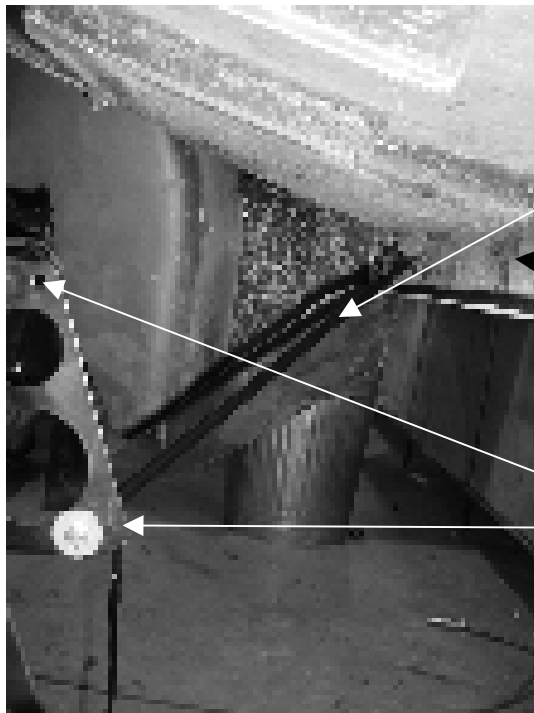

Rear bodywork support stay

Rear face of bodywork

Rear wing and Stay mounting holes

Two rear body support stays need to be fitted from the outside face of each rear wing mounting bracket on the chassis up to the bodywork. If you are going to fit a rear wing it is advisable to place the wing posts through the slots in the bodywork now to enable you to line up the bodywork to the posts. Using an M6 bolt and nut, secure the top wing post mounting to the chassis and then using just a bolt and the body stay (end without a washer welded) secure the bottom mounting. Do the same on the other side. Now raise the bodywork slightly so that the top surface is level with the central cross rail as shown. Finally drill the two holes through the rear face of the bodywork. It is best to pilot through the M6 bush on the stay with a 5mm drill to get the correct position. If you are not fitting a rear wing then just lift the rear section until the top of the two sidepod sections are approximately parallel to the ground then drill the two rear holes.

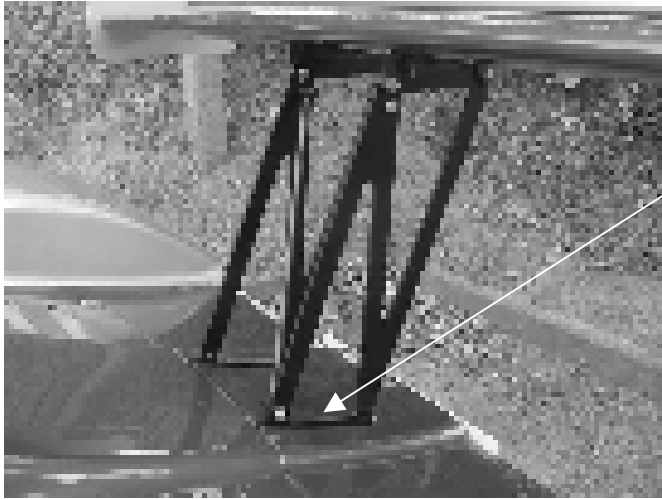

Bodywork to be level with this cross member on the wing mounting plates.

Step 3 b. Splitter Board Mounting

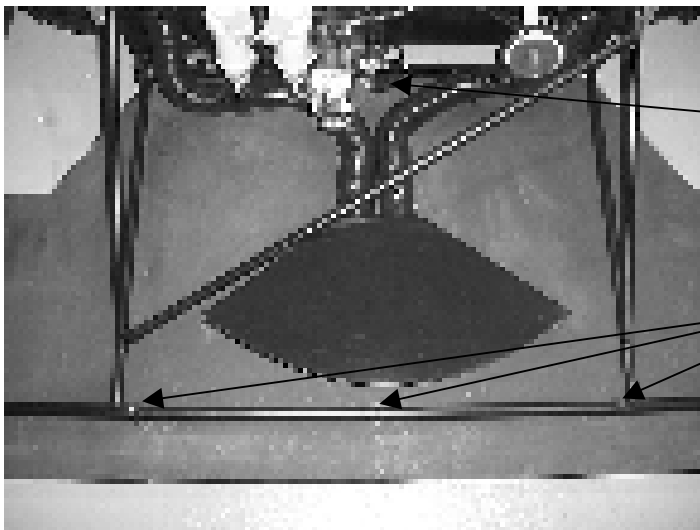

The splitter board is mounted on top of the three tags welded to the bottom rail of the chassis and then through the five tapped bushes along the front rail of the frame. Use five M6 countersunk screws for the front rail and M6 button heads and Nyloc for the three rear fixings.

The Brake Ducting intake would be best fixed in position when you have finally pre-fitted the nose so that you know it is in the correct position. It needs to be a snug fit to the inside of the nose and then bolted through the splitter board with M5 button head screws and Nylocs.

Step 3 c; Nose Fitting

The nose should now sit onto the splitter board and slide back onto the locating blocks on the main body section. The five slots in the lower front return should locate around the M6 bosses in the front cross member of the splitter frame to both hold the nose sideways and down onto the splitter board. If the two body sections do not meet correctly the angle of the splitter frame can be altered using the adjusters on the frame to achieve the best fit.

Then the over centre catches can be fitted in the recess on the two sections. You are also supplied two location pins and gromets which can be fitted as shown.

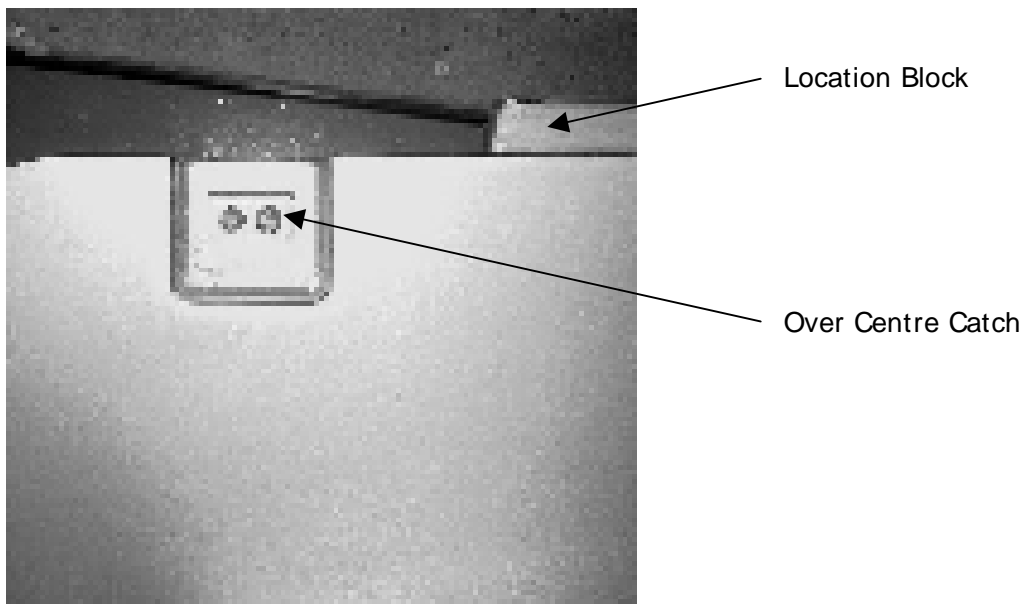
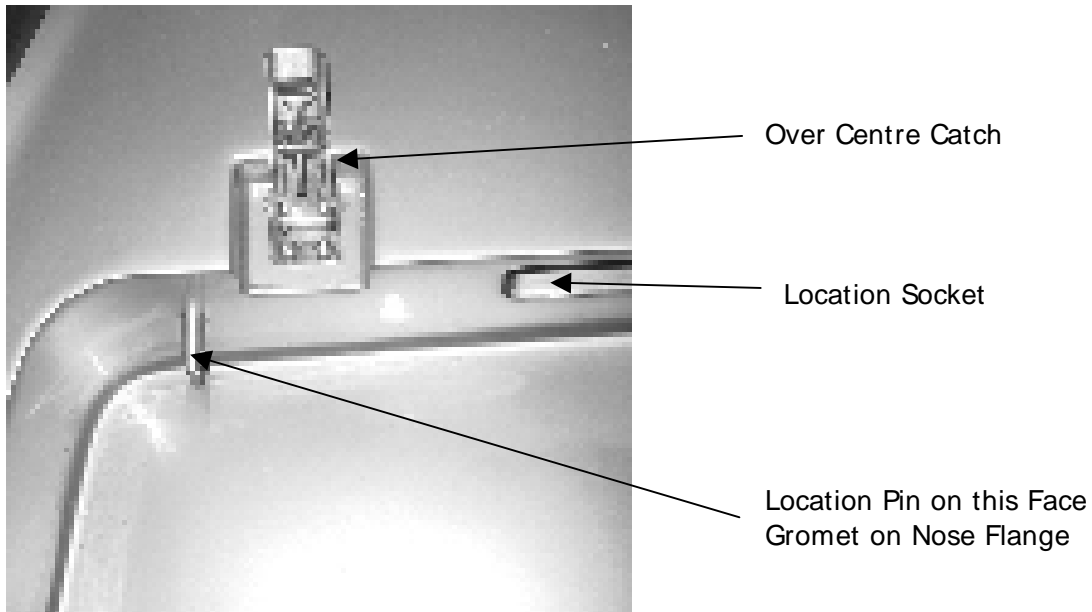

Step 3 d. Headlight Covers

Place the Headlight covers in position and drill three holes down each side with a 5mm drill through both the lens and the fibreglass. Then remove the lens and open up the holes in the bodywork and fit rinuts.

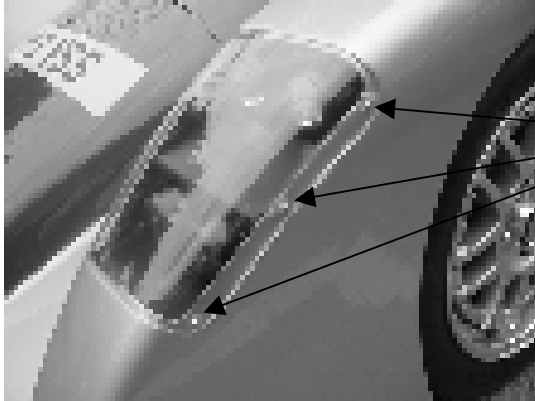

6 x 5mm Stainless Dome headed screws fitted, 3 down each side of the lens. (Picture after car is Painted)

Section 22

SECTION 22 - EXHAUST INSTALATION

Parts Required:-

- Complete Exhaust System (Comprising- Manifold, Long silencer, Short silencer, Intermediate Pipe, Three band clamps, two silencer-clamping straps and a retaining strap.)
- 8 x exhaust studs and 8 x M8 Binx nuts (supplied in kit)

Step 1 Fitting Manifold

As previously mentioned the exhaust manifold is easier to fit before the engine is fitted into the chassis. So when the top engine frame is fitted then you can fit the manifold. First fit the 8 x M8 studs supplied with your kit into the cylinder head. Tighten these studs using two M8 nuts locked together onto each stud. Check before fitting the manifold that you have an Exhaust gasket in each port, if you have not or wish to change them for new ones you can purchase these from Westfield. Then locate all the clamping rings onto the studs and bolt up with the M8 Binx nuts supplied.

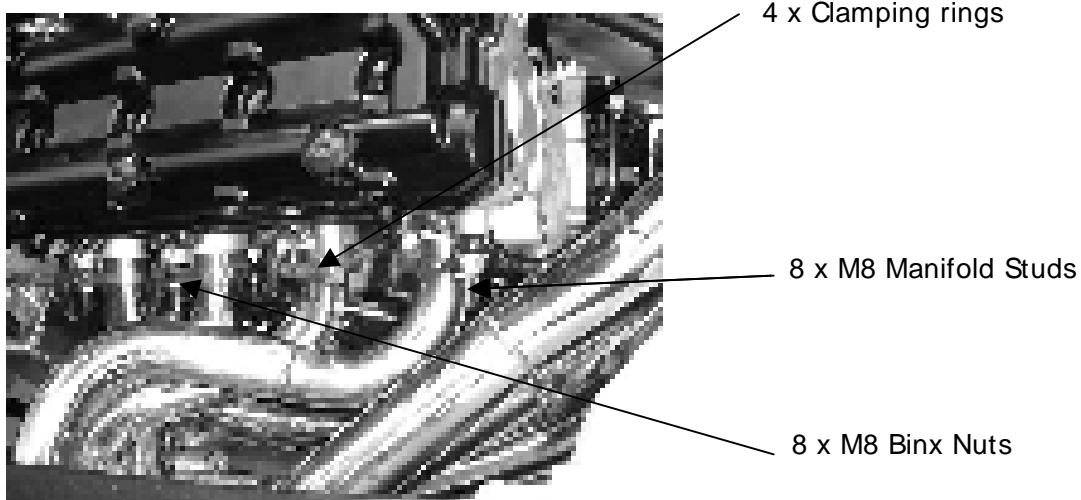

Note; The Remainder of this Section can only be completed when the Bodywork is Finally fitted.

Step 2: Main Cat Silencer and Pipe

If you are fitting a Rear Wing you need to fit the two Wing posts and cross stays before you can fit this section of the exhaust because it goes through the middle of the posts. If you are putting your XTR2 through an SVA test then you cannot submit it with the wing or post fitted, so just fit the exhaust as now described.

The round end of the silencer has the Catalytic converter fitted and should go onto the manifold with a band clamp as shown, with the oval end (widest section parallel to the ground) running over the Differential area. Here will fit the mounting bracket with a long flat mounting strap that can be riveted or rivnuted to the chassis. This would be best done when the whole system is in position.

Main Catalyst Silencer

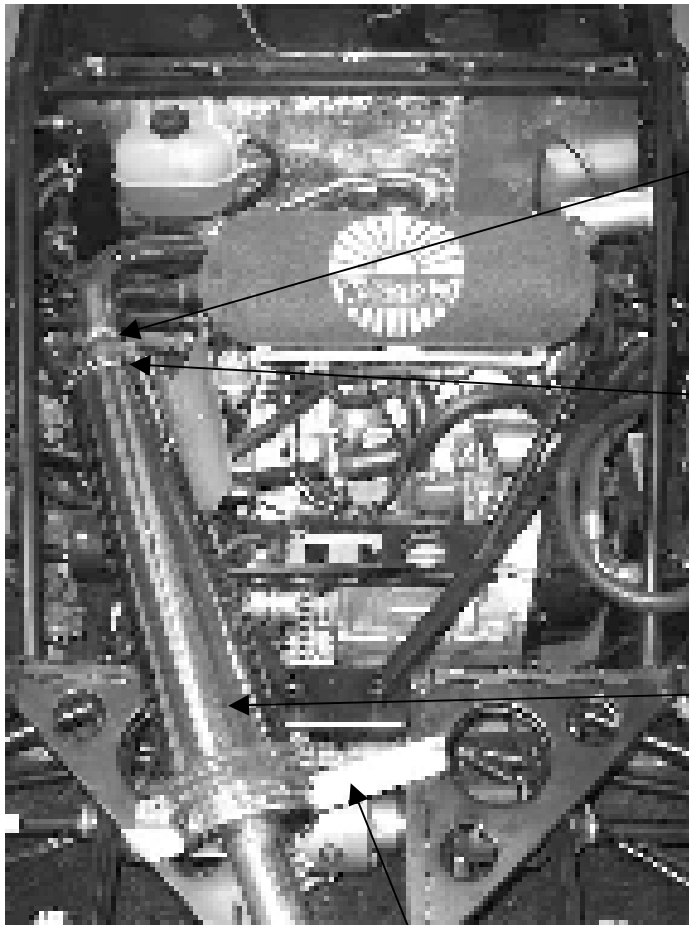

Band Clamp

Round End of Silencer
with Catalyst Fitted

Oval End

Rear Mounting Bracket for Long Silencer will fit level
to outside of chassis tubes (Later Chassis do not
have the flat plates with swaged holes)

Step 3 : Rear Pipe and Small Silencer

The later exhaust systems have a loose section of pipe that goes between the two silencers to make fitting slightly easier. This is the section that goes through the rear Wing Post if you have fitted one.

View Looking Towards The Back of the Car Inside the Engine Bay



Small Rear Silencer Box and Link Pipe going through the Wing Mounting Post.

Silencer Mounting Strap bolted to the top of the Anti Roll Bar Blocks

SECTION 23 – INTERIOR AND DASHBOARD

Parts Required:-

- Dashboard, Speedo/Tacho, Water Temp Gauge, Oil Press/Temp Gauge, All Switches, Fuel Level Indicator, Ignition Switch, LED Warning Lights

Step 1: Assemble Dashboard

First mount the three clocks in positions with the Speedo/Tacho in the centre, water temperature on the left and oil pressure/temperature on the right.

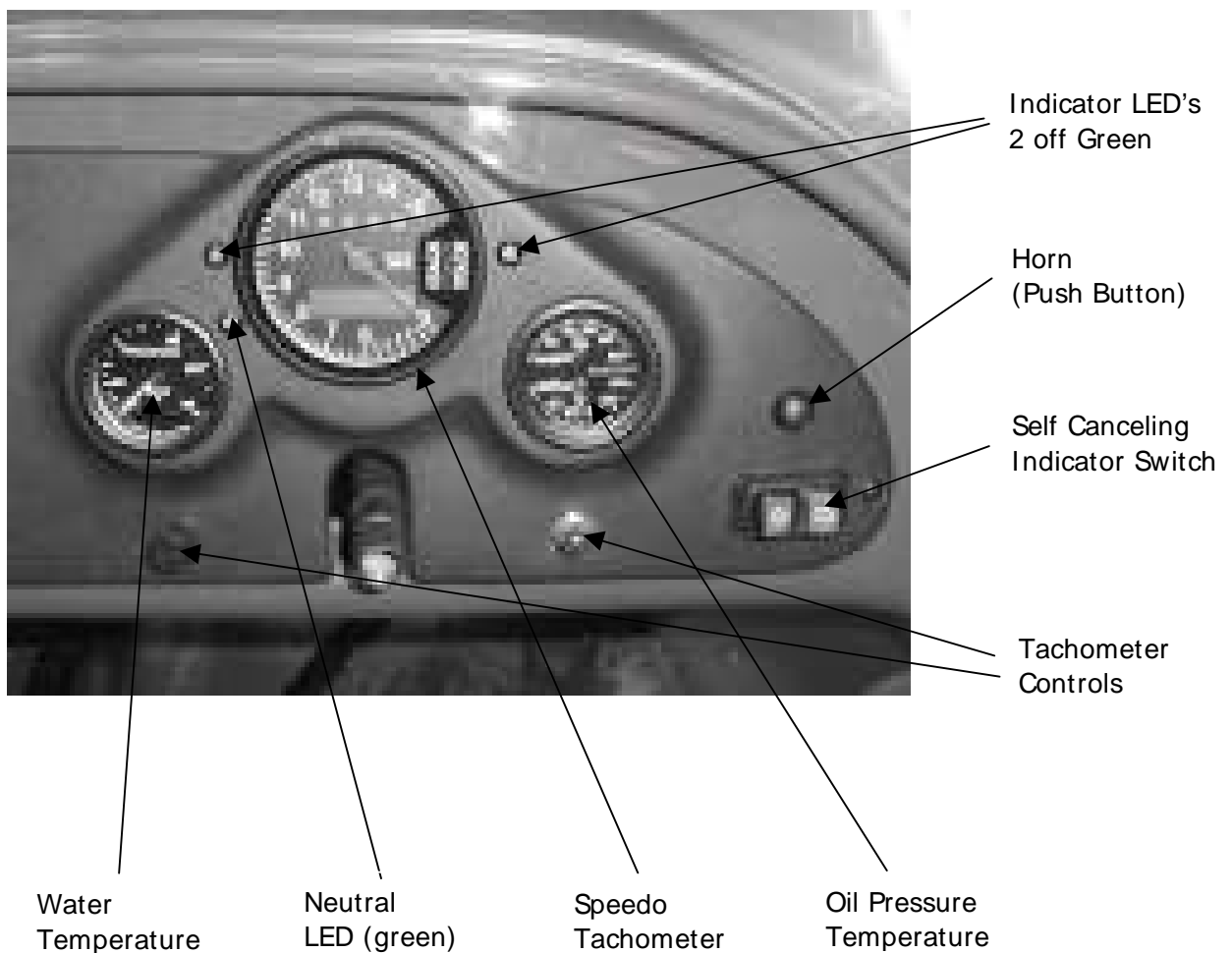

Switch Layout

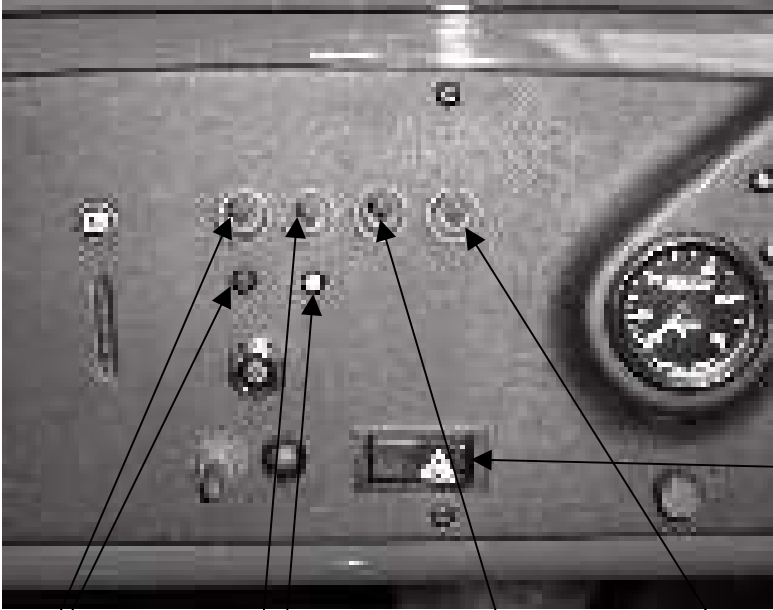

Hazard
Warning
Light Switch

Fog Light
Switch &
LED (Red)

Main Beam
Headlight &
LED (Blue)

Dip Beam
Headlight

Side Lights

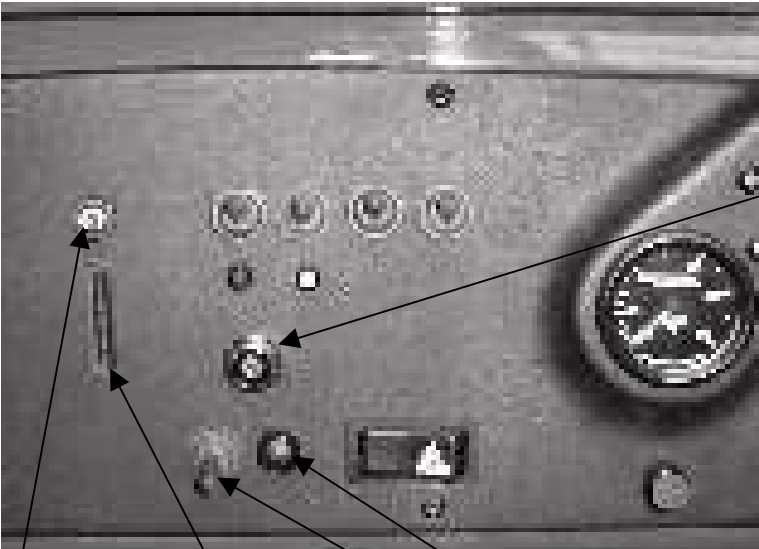

Secondary Ignition
Switch/Immobiliser

Handbrake
Warning Light

Fuel Level
Indicator

Ignition Switch &
Starter Button

Step 2 ; Seat Frame Mountings

Assemble the two seat mounting frames using the 18 M6 x 20 button head screws and then bolt to the adjustable seat runners using the M8 x 20 cap screws and nuts. Then locate in the front two mounting holes in the chassis and mark the position of the two rear holes. Then just remove frame from the chassis and drill the 4 holes 8mm. Replace the seat frames and bolt in position.

NOTE: It is advisable to fit the seat frames to the chassis before final fitting of the bodywork. Also do not fit the seats to the frames until the bodywork is in position.

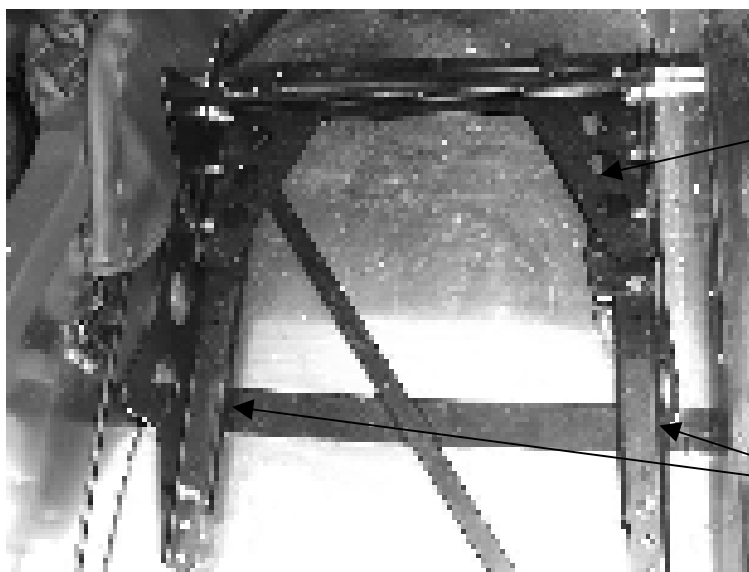

Assembled Seat Frame
in Chassis. On
Adjustable Runners

This Chassis Strap is
the one you need to
Drill the Rear Mounting
Holes Through.

Step 3: Tunnel Protection and Gaiter Set

NOTE: These items must be fitted prior to an SVA test.

Two vinyl covered tunnel protectors are provided and need to be fixed to the top of the tunnel in front and behind the gear lever. They can be fixed on with either Velcro, pop rivets or rivnuts and button head screws. The two gaiters provided one for the gear lever and one for the handbrake must be retained with Velcro or rivets.

There are also two under scuttle pads (vinyl covered) that fit under the dashboard area which are required for SVA. The near side one needs to be removable so that you can access the fuses if necessary.

Tunnel Covers And Gaiters

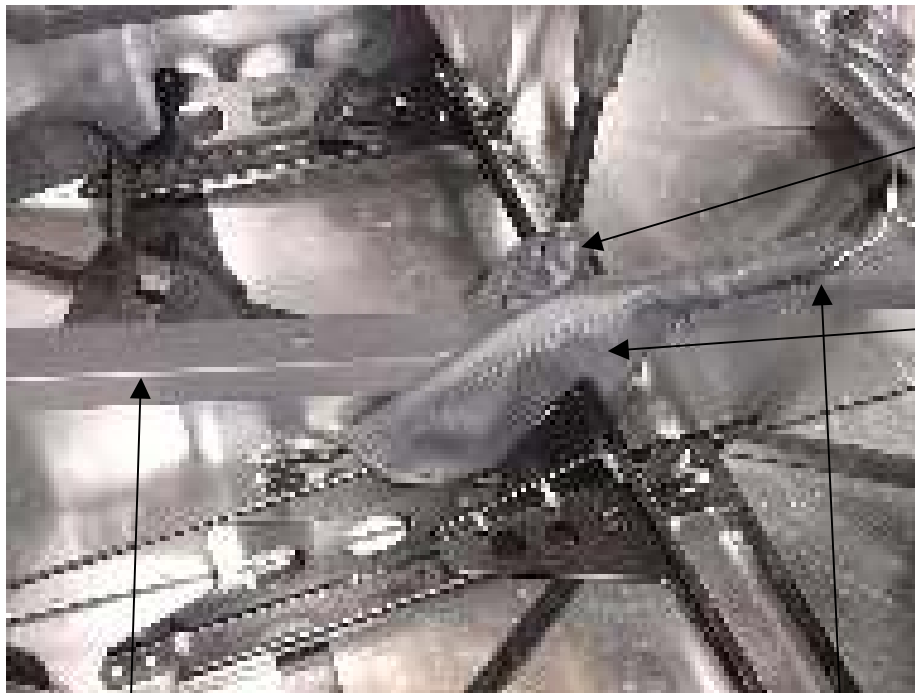

Gear Lever
Gaiter

Handbrake
Lever Gaiter

Rear Tunnel
Cover

Front Tunnel
Cover

Under Scuttle Panels

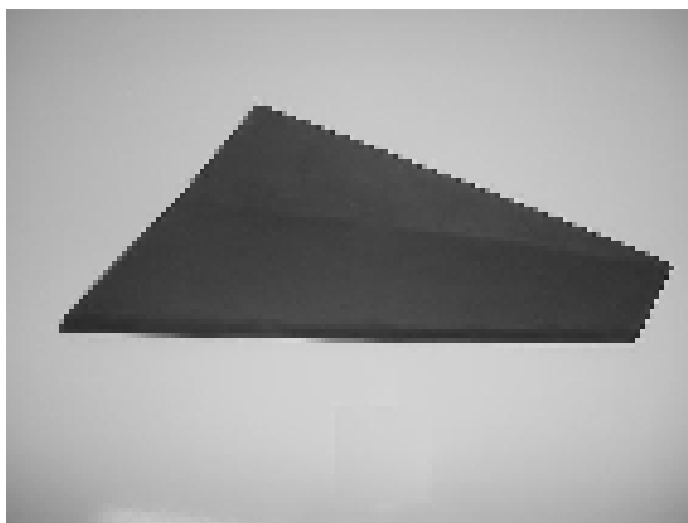

These panels will fit under the scuttle behind the dashboard and cover the triangular section of the chassis from the inside where the fuse boxes are located and the same on the opposite of the car. The near side panel needs to be removable for access to the fuses from inside the car.

Step 4 ; Seat Belt Mountings

The seat belts are to be fixed as shown below

Outer Lower Seatbelt Mounting



The two outer lower seatbelt straps are fixed using two special 7/16 UNF thin headed bolts and a 7/16 washer.

Centre Tunnel Mounting

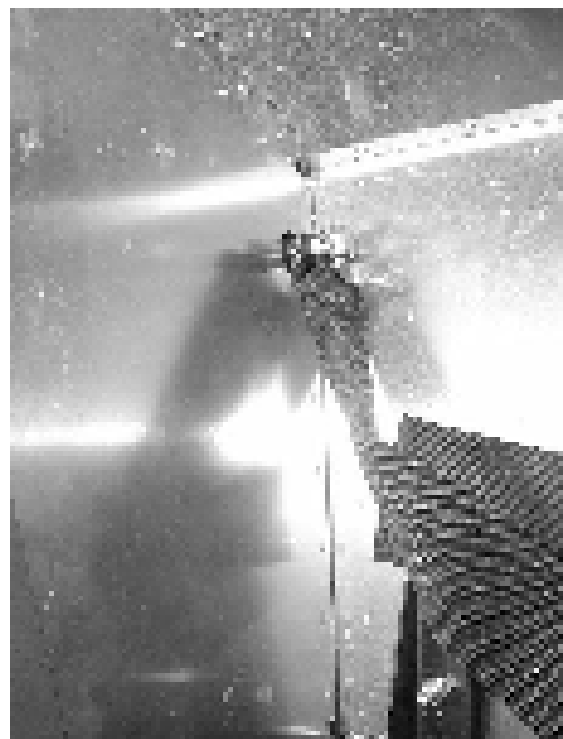
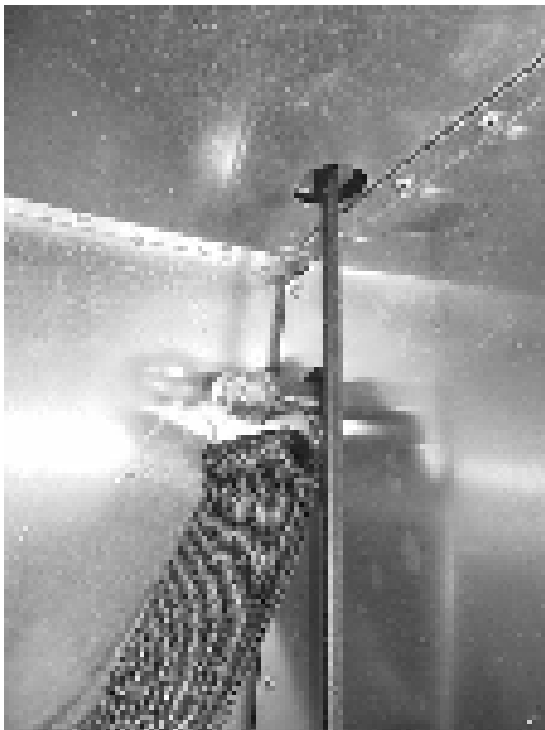

This centre tunnel mounting is one 7/16 unf x 4 inch long bolt straight through, with nyloc and washers. The top belt mountings are 4 x 7/16 unf bolts with special thin nyloc nuts and plain washers.

Tachometer
Controls