



www.lincolnelectriceurope.com

**TOTAL SOLUTIONS FOR
AUTOMATIC WELDING & CUTTING**



"Automation" is an excellent opportunity for companies looking for continuous Improvement and performances.

For Lincoln Electric the automation of welding and cutting processes is not new, but rather a source of innovation that we want to share with our customers.

We invest heavily in the development of intelligent welding and cutting technology solutions to combine the quality and performance you want.

Automation in general brings important changes in the way you organize your workshops. It is for this reason that the pooling of our expertise in the search for the most suitable solution is essential in order to increase your productivity, the reliability, the safety of your staff, all in the greatest respect. of the environment.

This catalog is a concentrate of technology, and you will find I am sure a response to your manufacturing needs, but the easiest for you is still to contact us, so that together we realize your "factory of the future".

I wish you a good visit.

Eric Sellier

Automation EMEAR Vice-President

The ever changing economic conditions of the welding & cutting markets, served by our loyal customers, make it necessary for them to be continually looking to improve and innovate their welding & cutting activities.

As a solution provider, Lincoln Electric's extensive automation range offers productivity solutions across all industrial segments allowing companies to adapt to the ever changing needs of the market environments.

The range is supported by our dedicated technical sales network, and engineering specialists, who can visit your premises to discuss and propose engineering solutions that range from simple plug and play equipment to full turn-key packages offering tangible cost and quality improvements in your process.

Please don't hesitate to contact your local Lincoln Electric office, or representative, to request a site visit or if you require any additional information on the products shown within the catalogue.

Craig Glasgow

Commercial Director - Automation International



SUMMARY

TOTAL AUTOMATIC WELDING AND CUTTING SOLUTIONS

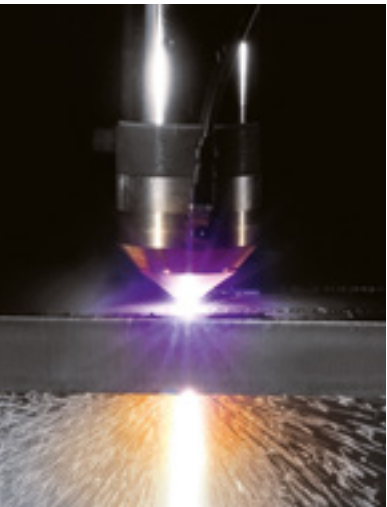

INDUSTRY SEGMENTS 3

CUTTING SYSTEMS 12

CUTTING PROCESSES PRESENTATION 13

FLEXCUT & NERTAJET HPI RANGE 15

- FLEXCUT 125 16
- FLEXCUT 200 17
- NERTAJET HPI2 18
- NERTAJET HPI 19

OXYCUTTING RANGE 21

CUTTING MACHINE RANGE 22

- LINC-CUT S 23

- OPTITOME 2 24
- ALPHATOME 2 25
- EUROTOME 2 26
- OXYTOME 2 & PLASMATOME 2 27
- OXYTOME & PLASMATOME TWIN 28
- CYBERTOME 29

HPC DIGITAL PROCESS 3 30

CUTTING SOFTWARE 32

EXTRACTION TABLES 34

FUME EXTRACTION 36

OPTIONS 37

- NERTAJET bevel HPI 37
- Tube cutting & 4th axis 38
- Numerical drilling unit 39
- Complement for machine 40
- Equipment for oxyfuel process 41

PYTHON X STRUCTURAL 42

WELDING SYSTEMS 44

WELDING PROCESSES PRESENTATION 45

TIG / PLASMA WELDING 46

- TIG/PLASMA installation 47
- Machine range 49
- Welding in line pipe 51
- TOPTIG 52
- Microplasma 53

SUBMERGED ARC WELDING 54

- SAW installation 55
- Power sources 56
- SAW heads & applications 57
- SAW equipment 58

- SAW tractors 59
- SAW column & boom 60
- SAW internal boom 61
- BEAM-MATIC installation 62
- Lamp post solutions 63
- Multiple wires equipment 64
- Strip cladding equipment 65

MIG / MAG WELDING 67

- MIG/MAG welding carriages 69
- ORBITAL welding 70
- FLEX-FAX robotic welding cells 72
- MIG/MAG machine range 75

POSITIONING 76

- LINC-MATIC column & booms 76
- SEAM-MATIC seamer benches 77
- ROTAMATIC ST single roller beds 78
- ROTAMATIC LP single roller beds 79
- ROTAMATIC TR fit up roller beds 80
- ROTAMATIC LP-2R self aligning roller beds 81
- POSIMATIC positioners 82
- HEADMATIC headstock 83
- TURNMATIC turntable 84

SERVICES 85

TOTAL AUTOMATIC WELDING AND CUTTING SOLUTIONS

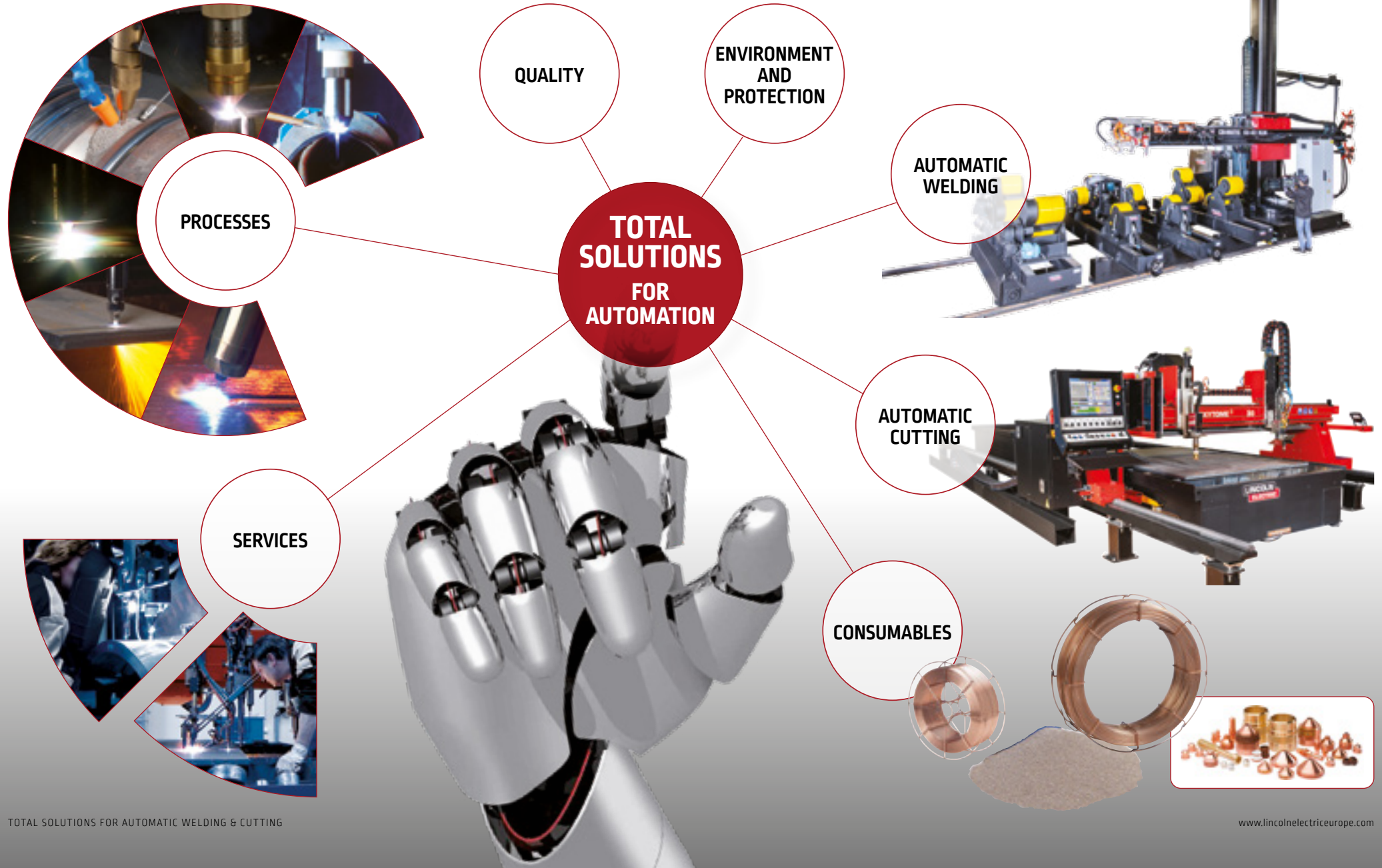

Lincoln Electric offers a large choice of cutting and welding solutions for many segments and diverse industries.

Automation is the solution to:



IMPROVE **QUALITY**

INCREASE **THROUGHPUT**

IMPROVE **WORKER SAFETY**



REDUCE **COSTS**

ADDRESS **SHORTAGE OF LABOUR**



Chemical or food processing, pressure vessels, tanks, general industries



Plasma & Oxyfuel cutting system
with bevelling unit



Clamping bench



Handling

Column & boom

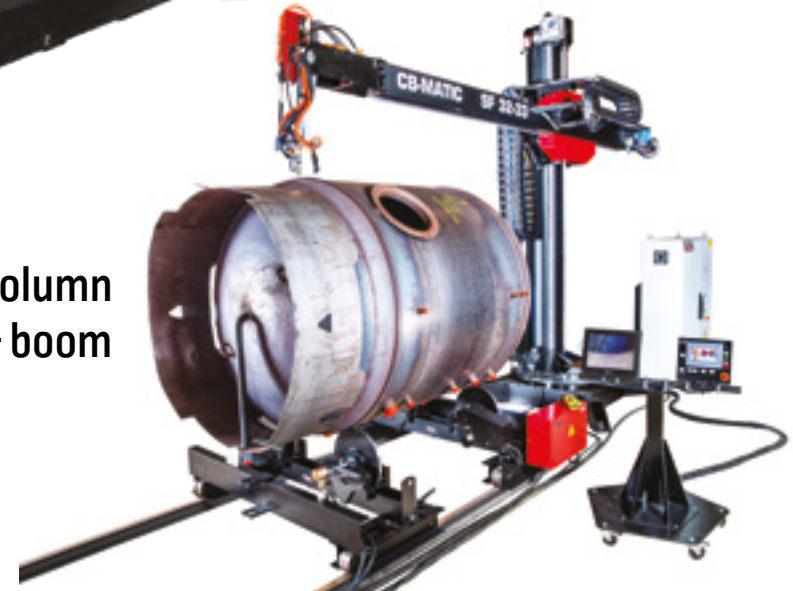

Transportation, automotive, heavy fabrication



Cutting system Plasma High Precision



Beam welder

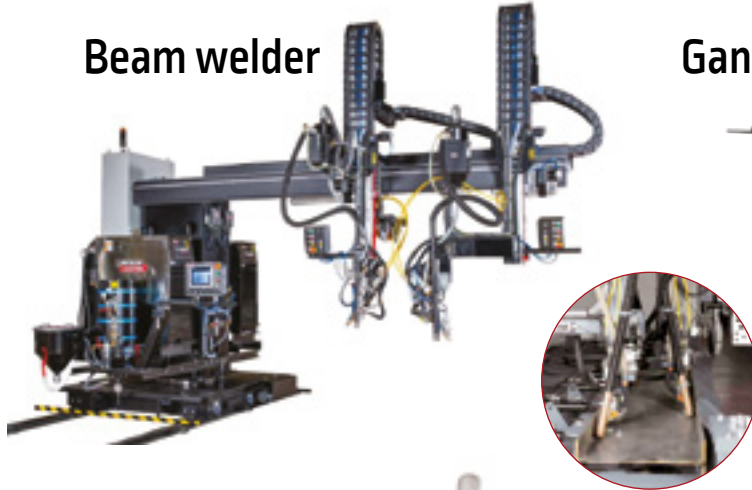

Gantry



Column & boom

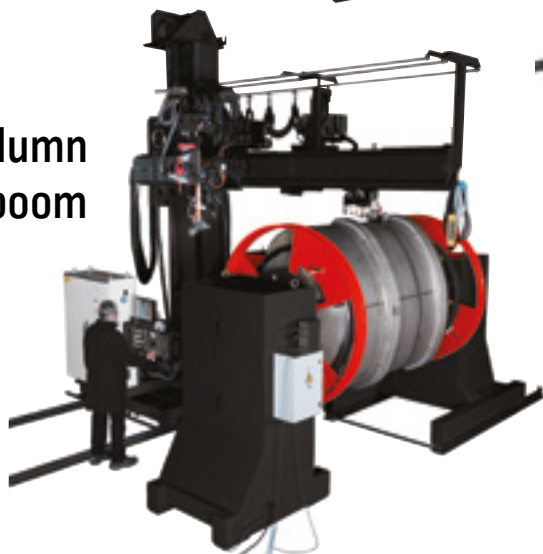

Lathe



SAW tractor

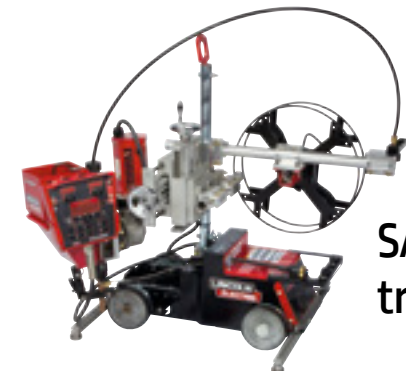

Pipe production, pipeline



SAW gantry



Multi-arcs

TIG + plasma + TIG

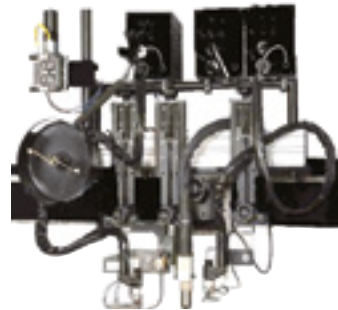

Up to 5 SAW

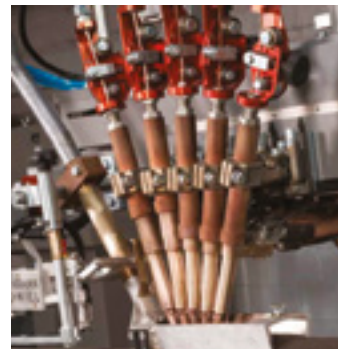

Internal boom



Process piping, offshore, pipe mill



Plasma cutting system
with tube cutting



Side beam



Orbital welding



Column & boom

Structural



Cutting system High Precision
with drilling unit



SAW tractor



Python X Structural

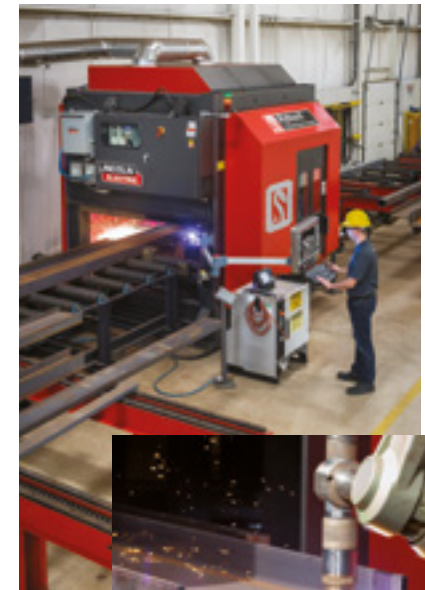

**Beam welder &
Clamping bench**



Power generation, energy



Plasma & oxyfuel cutting system

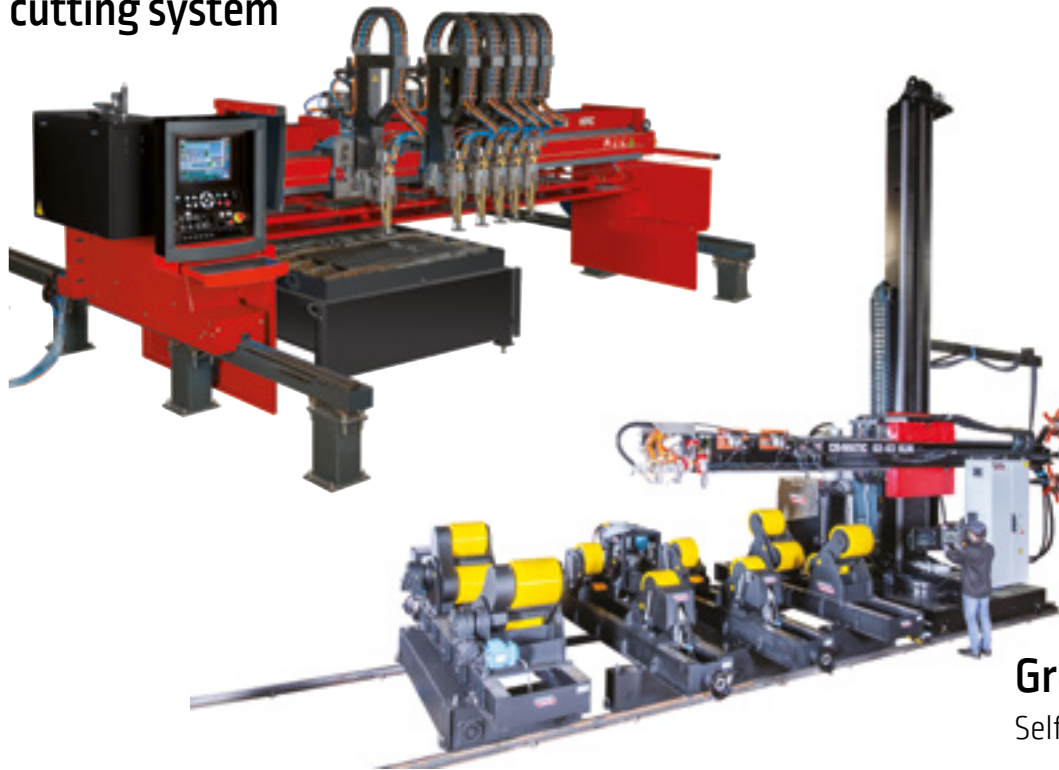

Orbital welding



Column & boom



Growing line

Self aligning roller beds

Shipbuilding



Plasma & Oxyfuel cutting system

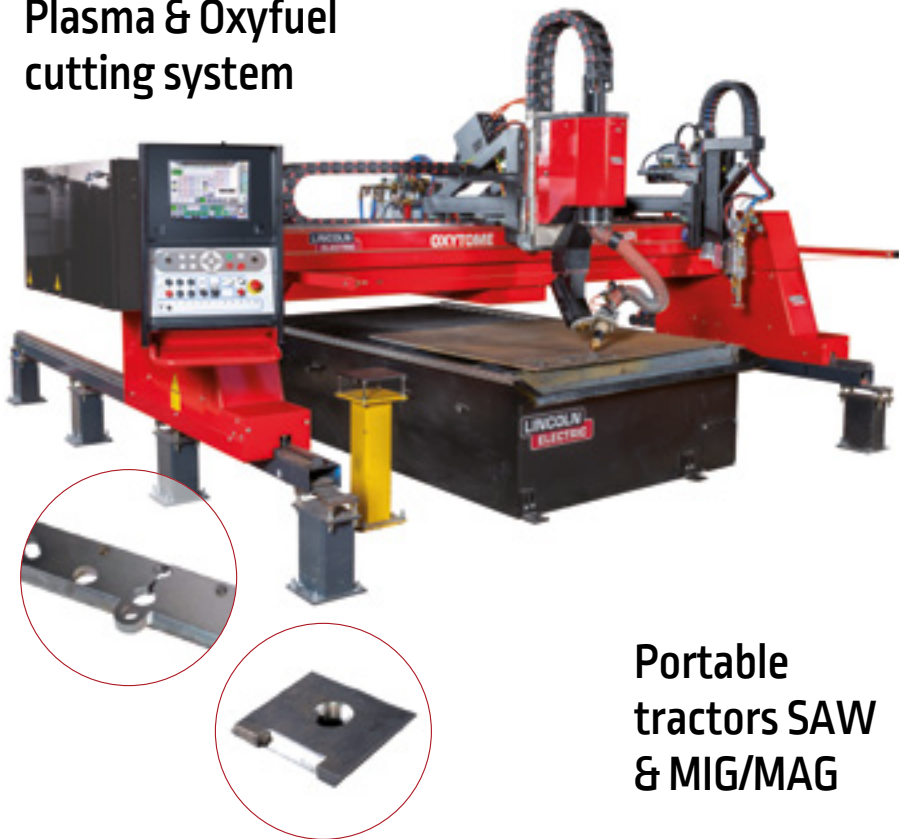

Beam welder



Portable tractors SAW & MIG/MAG



Distribution, sub-contractor, locksmiths



Compact cutting machines



Robotic cell



Handling



CUTTING SYSTEMS



A solution for every application

Plasma cutting

The plasma cutting process, as used in the cutting of electrically conductive metals, utilizes this electrically conductive gas to transfer energy from an electrical power source through a plasma cutting torch to the material being cut.

The basic plasma arc cutting system consists of a power supply, an arc starting circuit and a torch. These system components provide the electrical energy, ionization capability and process control that is necessary to produce high quality, highly productive cuts on a variety of different materials (carbon steel, stainless steel, aluminum, copper.) and thicknesses (from 0.5 to 150 mm).

Plates, round tubes, H or U beam, Channels, HSS tubes, angles... Plasma, oxycutting, bevels, straight cuts, High quality Holes, high quality plasma marking, tube cutting with bevel...

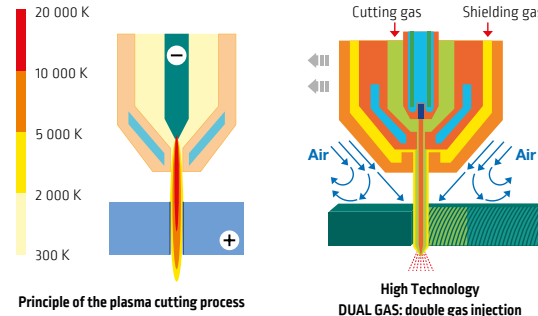

Flame cutting

The oxyfuel process is the most widely applied industrial thermal cutting process. It can cut thicknesses from 3 mm to more than 1000 mm. The equipment is low cost and can be used manually or mechanised. There are several fuel gas and nozzle design options that can significantly enhance performance in terms of cut quality and cutting speed.

A mixture of oxygen and the fuel gas is used to preheat the metal to its "ignition" temperature which, for steel, is around 1150 °C (bright red heat) but well below its melting point. A jet of pure oxygen is then directed into the preheated area instigating a vigorous exothermic chemical reaction between the oxygen and the metal to form iron oxide or slag. The oxygen jet blows away the slag enabling the jet to pierce through the material and continue to cut through the material.

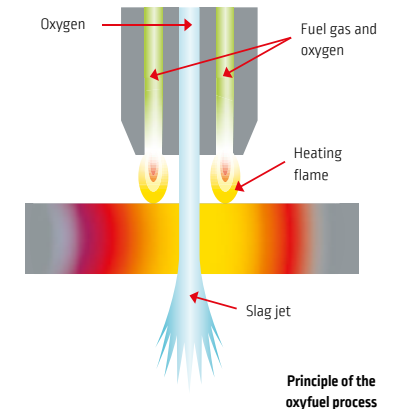

Thickness range multi material

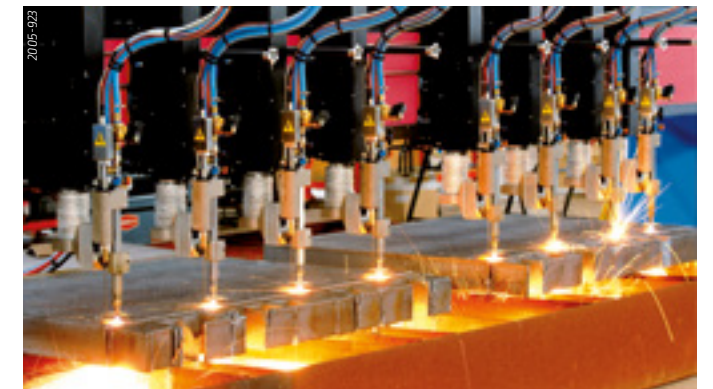
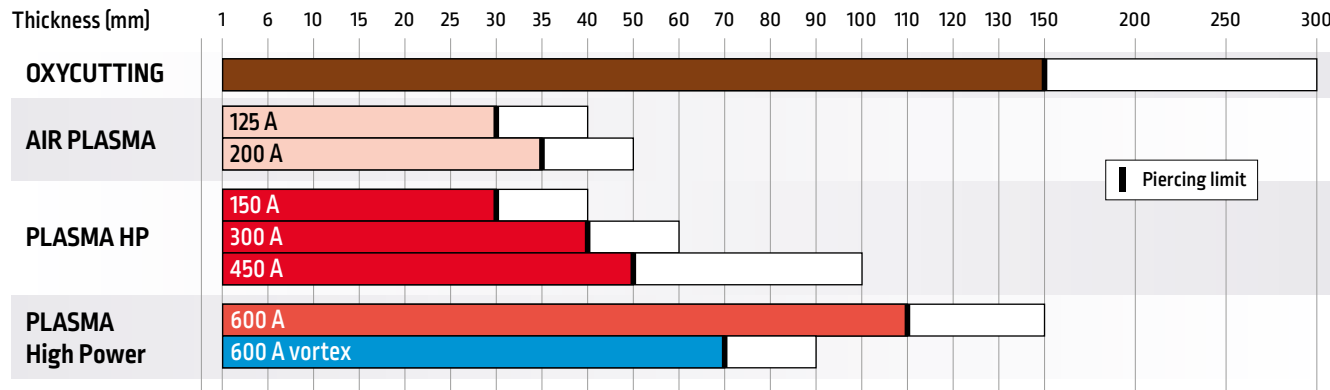

TOTAL SOLUTION PROVIDER

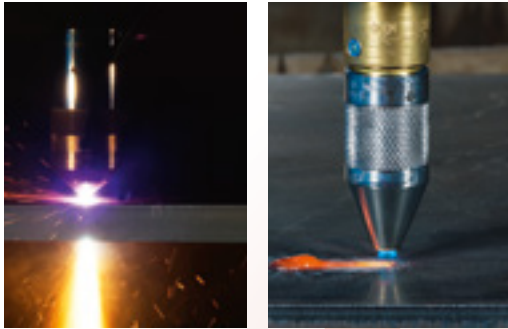

Advance cutting process and improved data base parameters

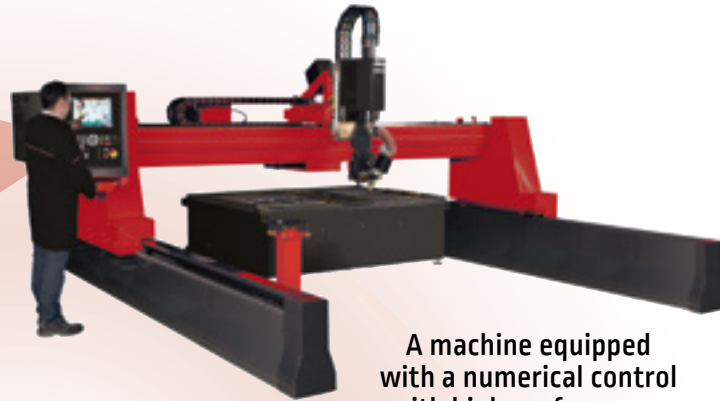

A machine equipped with a numerical control with high performance

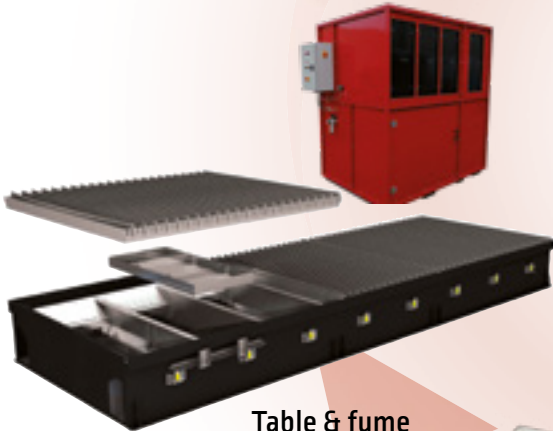
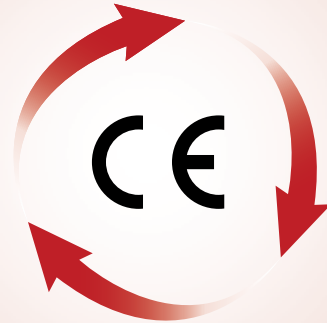

Table & fume extraction



Efficient software and post processor



Technician with cutting expertise

ISO 9013: Main cutting quality criteria

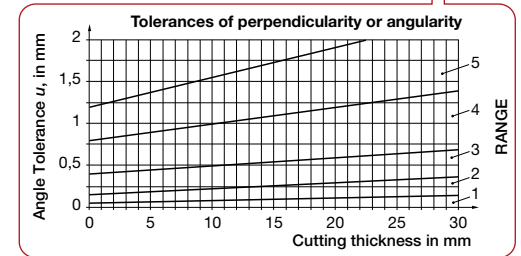
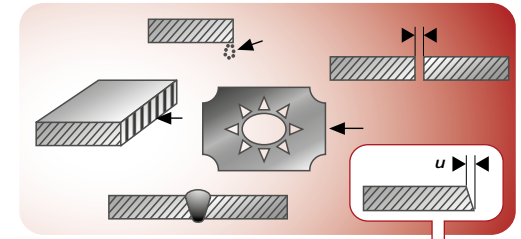

Various features can be evaluated to understand the cutting quality. EN standard ISO 9013 retains mainly three:

- Geometric accuracy,
- Roughness surface,
- Angle / concentricity.

This last criteria determines, based on the thickness, the perpendicularity tolerance in five classifications (ranges 1 to 5).

HPI Plasma cutting complies with EN 1090 infrastructure manufacturing standard.



It sets the requirements for the execution of steel structures to ensure appropriate levels of mechanical resistance, stability, service ability and durability.

Thermal cutting and particularly plasma cutting HPI is identified as a process that can be used in the realization of steel structure: cuts & bolt holes.

FLEXCUT® 125 Industrial air plasma



125A

FLEXCUT® 200 Plasma dual gas



200A

NERTAJET HPI2 High precision



150A

300A

NERTAJET HPI Heavy power



450A

600A

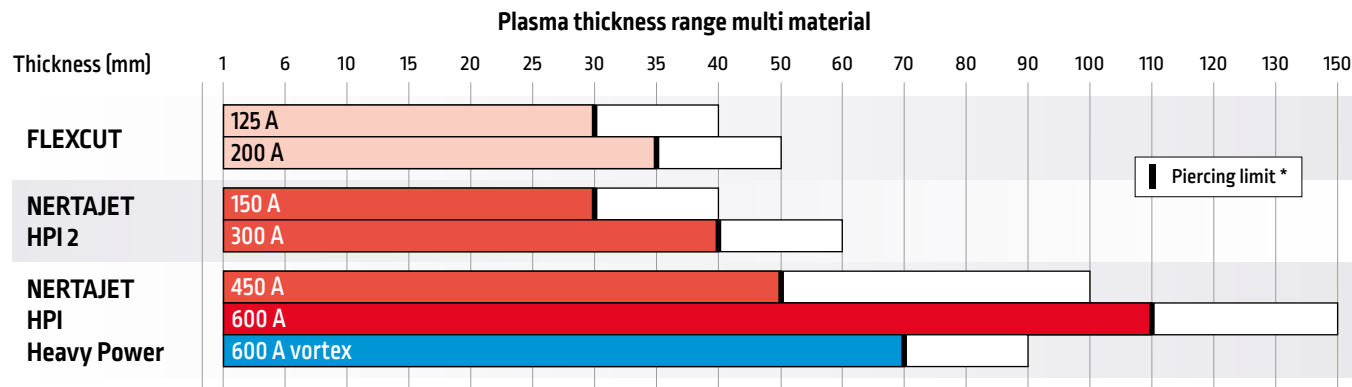

* maximum piercing can be different depending the material

FLEXCUT® 125

125A Powerful, 100% Air Plasma

Make the cut in the big game

Low Operating Costs

Keeping costs under control is important to any efficient plasma cutting operation. The FlexCut® 125 ensures up to six times longer consumable life and maintains faster cut speeds - both of which deliver higher productivity over less time. The completed cut is virtually dross-free, which means less secondary processing.

Best Cutting and Marking Performance

The FlexCut® 125 is designed to deliver on all fronts as the only machine in its class that allows you to plasma mark. Whether you are piercing up to 25mm* mild steel material in a mechanized cutting application, or cutting expanded metal, you can count on less edge bevel and superior edge quality compared to competing cutting systems.

Easy to Set, Easy to Use

The sooner your plasma cutting operation can get started, the more productive it will be. The FlexCut® 125 plasma cutter requires very little time or effort to get down to the business of cutting. Controls are simple, which makes setup easy, and you can get a consistent and reliable arc without needing to rely on high-frequency start systems. The simple user interface provides a means to configure output pressure based on torch length.

* Increase your plate piercing capability up to 30mm on carbon steel by using this system on machines equipped with our advance cycle manage by HPC3



Range of thickness for FLEXCUT® 125 plasma cutting

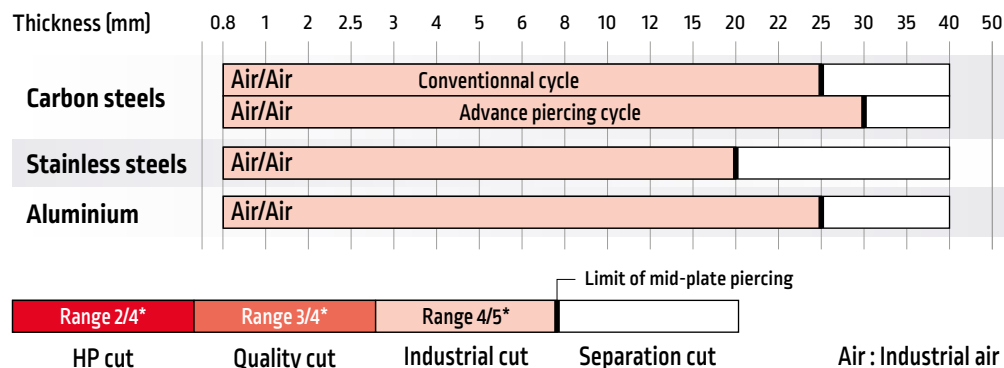

* following ISO9013, standards for classification of thermal cuts

FLEXCUT® 125 - SPECIFICATIONS

Input Power Voltage/Phase/Hz	380/400/415V - 3ph - 50/60Hz
Rated Output: Current / Voltage / Duty Cycle	125A / 175V / 100%
Input Current	40A
Output Range	20-125A
Air Pressure Required	6.2 to 8.3 bars
Air Flow Rate	260l/min at 6.2 bars
Net Weight	53.5 kg

FLEXCUT® 200

Mechanized Dual Gas Plasma Cutting System

Premium Cut Performance:

- 200A, 100% Duty Cycle maximizes production efficiency.
- Operates using air for daily use and intensive production.
- Possibility to cut with O2 or N2 time to time for higher quality.

Easy of Use:

- Full color graphic display with one-knob selection process.
- Reliable arc starting with CleanStrike® Technologie.
- Removable torch head for easy assembly of consumables.

Low Operating Costs:

- Liquid-cooled plasma torch for more consistent cuts and longer-lasting consumable life.
- Less dross reduces need for secondary operations.
- Inverter technology reduces energy demand.



Range of thickness for FLEXCUT® 200 plasma cutting

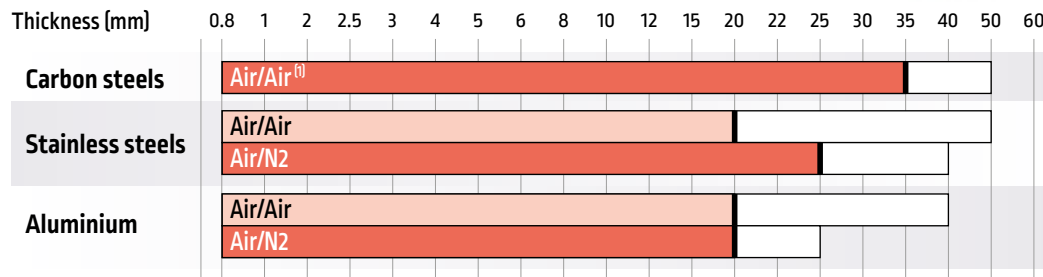

Limit of mid-plate piercing

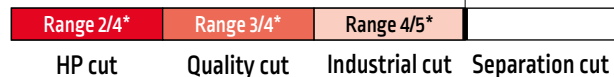

O2 : Oxygen
N2 : Nitrogen
Air : Industrial air

⁽¹⁾ with dual gas injection, the Air/Air process implemented by the FLEXCUT®200 makes it possible to obtain cutting quality on carbon steel beyond market standards. It is also possible to cut with O2 time to time for higher quality parts

FLEXCUT® 200 - SPECIFICATIONS

Input Power Voltage/Phase/Hertz	380/400/415V - 3ph - 50/60Hz
Rated Output: Current / Voltage / Duty Cycle	200A / 190V / 100%
Input Current	71A
Output Range	20-200A
Gas Pressure Required	6.2 to 9 bars
Net Weight	86.2 kg

NERTAJET HPI2 150A or 300A

High Precision Plasma Cutting System

Quality cutting beyond the high precision market standard



Quality:

This cutting tool is used to obtain the following:

- Dimensional and geometrical accuracy of the pieces cut on a wide range of materials.
- Quality of the surface of the cut faces (roughness far below than that of a laser).
- A cut angle (range 2 to 4 in accordance with ISO 9013).
- Holes with a remarkable straightness on carbon steel with **HOLE MASTER**.
- Cuts with no adhering slag.
- Quality maintained thanks to the optimized life time and wear compensation function **CDHC** of plasma components.
- Compatible with EN1090 requirements.

Operating costs:

With NERTAJET HPI2 systems, everything contributes to obtain an economical cutting price:

- Extended life time of wear parts.
- Low O2 gas consumption unlike others plasma HD systems or laser.
- High cutting speed associated with advanced **CYCLE BOOST** and **INSTANT MARKING** functions.

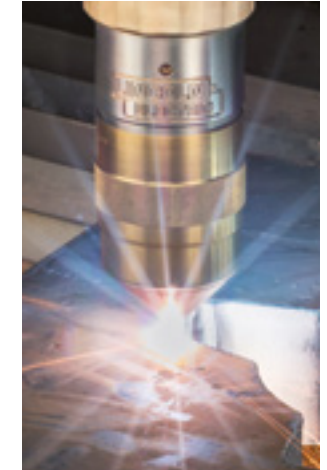

Range of thickness for NERTAJET HPI2 plasma cutting system

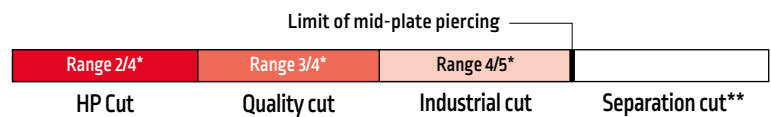
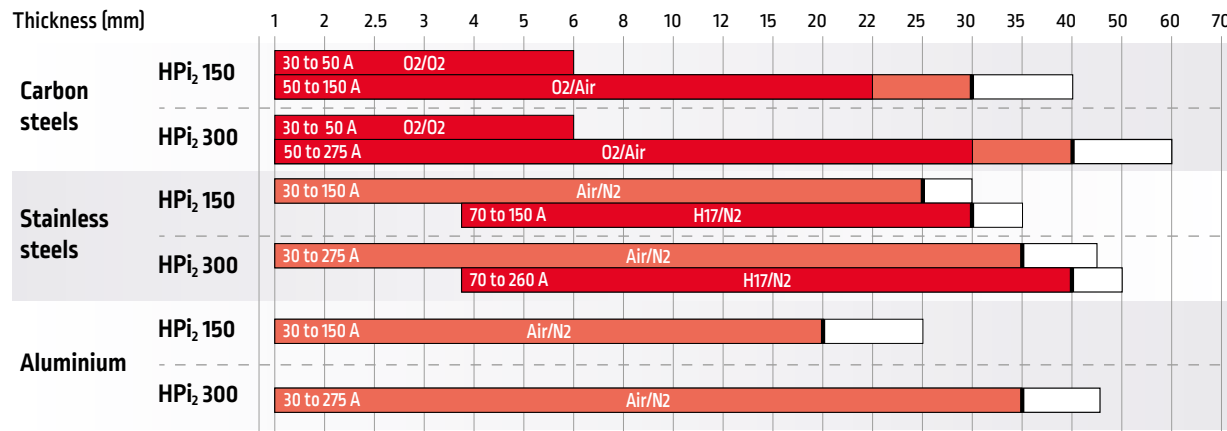

O₂ : Oxygen Air : Industrial air
 N₂ : Nitrogen H17 : Nitrogen/Argon/Hydrogen

*following ISO9013, standards for classification of thermal cuts
 **informative values not present in the HPC database

NERTAJET HPI2 - SPECIFICATIONS

	HPI ₂ 150	HPI ₂ 300
Input Power Voltage/Phase/Hz	230/400/440V - 3ph - 50/60Hz	
Rated Output: Current / Voltage / @ 100%	150A / 230V	300A / 230V
Input Current	101/64/55A	207/124/109A
Output Range	30-150A	30-300A
Gas Pressure Required	9 bars	

NERTAJET HPI 450A

High Precision Plasma Cutting System



Installation designed for heavy thickness mild steel cutting and plasma bevelling.

This cutting tool is used to obtain the following:

- Dimensional and geometrical accuracy of the pieces cut on a wide range of materials.
- Quality of the surface of the cut faces (roughness far below than that of a laser).
- A cut angle (range 2 to 4 in accordance with ISO 9013).
- Holes with a remarkable straightness on carbon steel with **HOLE MASTER**.
- Cuts with no adhering slag.
- Quality maintained thanks to the optimized life time and wear compensation function **CDHC** of plasma components.
- Compatible with EN1090 requirements.
- Available in version HPI 150 or HPI 300.

Operating costs:

With NERTAJET HPI systems, everything contributes to obtain an economical cutting price:

- Extended life time of wear parts.
- High cutting speed associated with advanced **CYCLE BOOST** and **INSTANT MARKING** functions.



Range of thickness for NERTAJET HPI 450 plasma cutting system

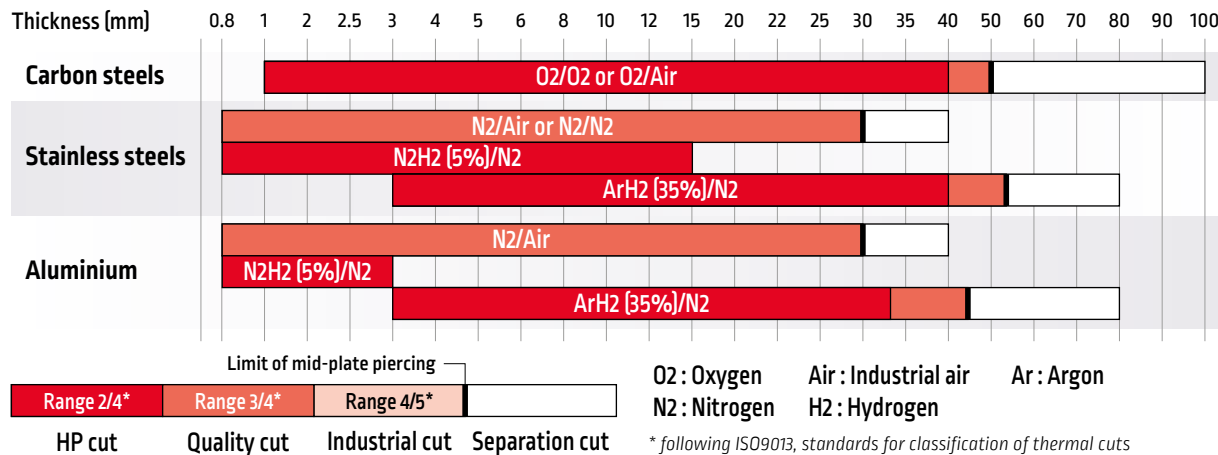

NERTAJET HPI 450 - SPECIFICATIONS

Input Power Voltage/Phase/Hertz	230/400/440V - 3ph - 50/60Hz
Rated Output: Current / Voltage / @ 100%	400A / 230V
Input Current	308/189/164A
Output Range	30-400A
Gas Pressure Required	9 bars

NERTAJET HPI 600A

High Power Cutting Plasma

Installation designed for heavy thickness stainless steel & aluminum from 1 to 150mm.

This installation is designed to cut in plasma up to 150mm. Everything has been designed on this system to work in the roughest conditions while guaranteeing optimum cut quality and ease of use, thanks in particular to its integrated data base and its removable torch nose with simplified assembly of consumables.

Composed in particular of:

- New plasma removable torch head **CPM PRO INOX**:
 - Design to cut up to 150mm,
 - Dual injection process dry gas or with water vortex,
 - No setting, just mount your consumables and cut,
- New advanced function **POWER HIGH Thick** for plate piercing up to 110mm in full automatic.
- Data base and cycle management fully automatic thanks to **HPC**.

This system can be associated with different equipment such as:

- System of fume extraction **PUSH-PULL**.
- Visual protection for operators.

Available in version HPI300.



Range of thickness for NERTAJET HPI 600 plasma cutting system

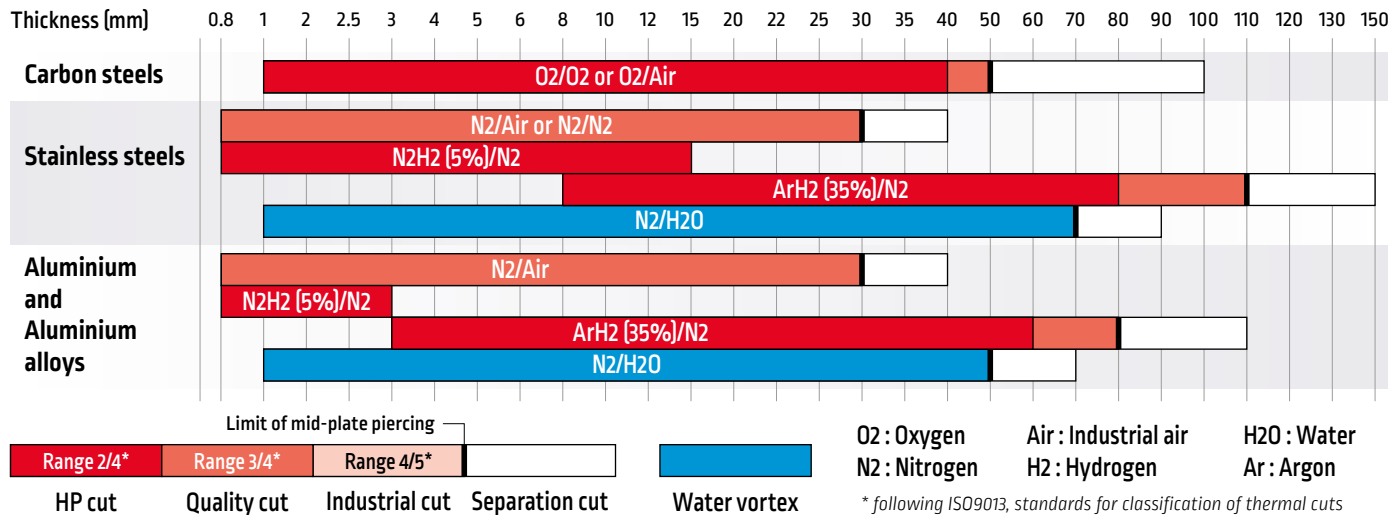

NERTAJET HPI 600 - SPECIFICATIONS

Input Power Voltage/Phase/Hertz	230/400/440V - 3ph - 50/60Hz
Rated Output: Current / Voltage / @ 100%	600A / 230V
Input Current	415/247/217A
Output Range	30-600A
Gas Pressure Required	9 bars

OXYCUTTING RANGE

A large range of oxyfuel cutting torches with performance and flexibility

For oxycutting of non or low alloyed steels from 3 to 300 mm, Lincoln Electric offers a full range of oxyfuel cutting torches: OXYCUT G1, OXYCUT MACH, MACH HP or MACH HPI to install on semi automatic machines [gantry machines] or fully automatic machines [gantry machines type OXYTOME HPC].

MACH HP & MACH HPI

Tool free nozzle change



Thickness
6 to 300 mm

High speed
cutting nozzles

System **OxyCOOL**

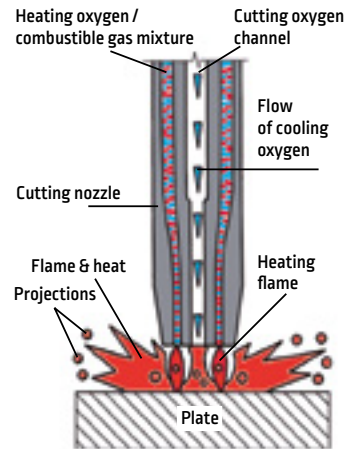

Type of cut

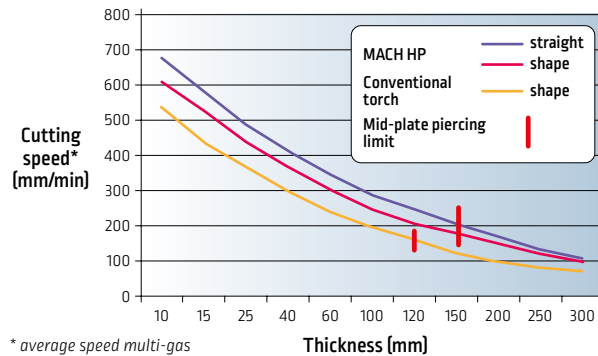

* average speed multi-gas



OXYCUT MACH HP

- Cutting capacity 6 to 300 mm.
- Productivity.
- Cutting quality.
- Fitting of consumables without tools: easy & quick.
- Lifetime.
- Piercing up to 150 mm.



OXYCUT MACH HPI

- Internal ignition.
- Cutting capacity 6 to 300 mm.
- Productivity.
- Cutting quality.
- Fitting of consumables without tools: easy & quick.
- Lifetime.
- Piercing up to 150 mm.



Systems of gas regulation fully controlled by HPC 2 with full automatic cycle:

	OXY Essential	OXY HPI2
Number of torches	4 (1 module of 4)	8 (up to 2 modules of 4)
Gas regulation	Automatic gas	
Maximum thickness: Cutting / Piercing	200 / 150 mm	300 / 150 mm
Tool holders	150 mm stroke	Yes
	250 mm stroke	-
	Cable chain	Yes
	Speed	2 m/min
Oxy torches	MACH HP	✓
	MACH HPI	✓
Fixed electric ignitor*	Option	-
OXY SAFE PIERCING - Including choc sensor (Probe detection) [igniter* and retractable probe]	Option	Standard
Beveling tool with tilting nozzle**		✓
Strip cutting tool**		✓
VXK cutting tool	1	2

* integrated ignitor with MACH HPI

** use without capacitive probe & automatic ignition

CUTTING MACHINES RANGE

A wide range from the simple mechanised carriage to fully automatised large capacity machines, from torch for straight cut to the 3D plasma cutting tool.

The complete offer of Lincoln Electric can answer to all your cutting needs with oxycutting and/or plasma process.

The various tools and options will enable you to produce parts with shapes, with or without bevel for occasional use or intensive production, on small or large format sheet metal.

Portable carriage

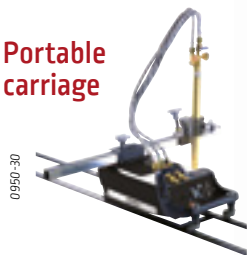

0950-30

MAIN OPTIONS



• Tube cutting



• Beveling



• Drilling



EURO TOME 2

2016-318



LINC-CUT® S

OXY/PLASMATOME 2



2011-545

2014-685



OPTITOME 2



CYBERTOME

2011-014

ALPHATOME 2



Main characteristics, equipment and options

MACHINES	Transversal stroke											Useful longitudinal stroke	PLASMA (maximal number)			OXY (maximal number)		Main technological options			Table			
	1 m	1.5 m	2 m	2.5 m	3 m	3.5 m	4 m	4.5 m	5 m	5.5 m	6 m		6.5 m	...12 m	Air	High Precision	High Power	Manual	Auto	Tube	NERTAJET BEVEL HPI	Drilling unit 2.5	Dry	Water
LINC-CUT® S														2 to 3	1	-	-	-	-	-	-	-	X	X
OPTITOME 2														1 to 6	1	1	-	1	-	X	-	-	X	-
ALPHATOME 2														3 to 24	-	2	-	-	-	X	-	-	X	X
EUROTOME 2														3 to 15	2	1	-	-	4	X	-	-	X	X
OXY/PLASMATOME 2														3 to ...		2		-	8	X	-	-	X	X
OXY/PLASMATOME TWIN														3 to 24		2		-	6	X	X	X	X	X
CYBERTOME														3 to ...		2		-	8	X	X	X	X	X

LINC-CUT® S

Compact plasma cutting table

Boost your responsiveness and free your creativity

The concept of the LINC-CUT® S range is to offer an affordable plasma cutting machine to reinforce your creativity, your reactivity and to cover your production needs. The main features are :

- Fast and simple set up concept.
- Easy to use.
- An intuitive 20" touch screen HMI with an integrated 36-part shape library will get you cutting immediately.
- The 4 numerical axis are equipped with ball bearing railways to provide fluid movement and increase cut quality.
- The machine is supplied with a software package to be installed on your PC to import formats .dxf, .dwg, to draw pieces, to nest and generate machine programs.
- A laser spot simplifies the alignment of sheets.
- Through the FLEXCUT® 125 CE technology with compressed air, the machine produces a high level of quality for the cutting with cost efficiency:
 - High life time,
 - Reduce post process operations,
 - Less dross and better edge quality.

	LINC-CUT® S 1020w	LINC-CUT® S 1530w	LINC-CUT® S 1530d
Plate format	1000 x 2000 mm	1500 x 3000 mm	1500 x 3000 mm
Machine size l x L x h	2400 x 3200 x 1600 mm	2400 x 4200 x 1600 mm	2550 x 4500 x 1400 mm
Table technology	Water	Water	Down draft table (5 sections of 600mm)
Max plate load	355 kg	710 kg	1500 kg
Max scraps capacity	160 kg	320 kg	1440 kg
Power source	FLEXCUT® 125		
Max thickness	Plate piercing: 25mm (edge 40mm)		
Carbon steel and stainless steel	✓	✓	✓
Aluminium	✗	✗	✓
Filtration technology	Water	Water	DIGIFILTER
Exposition to plasma cutting gases	Yes Depends of the size of the workshop, the renewal of the air and the material to cut		No

LINC-CUT® S 1020w or 1530w

Water table concept

Machine frame consist in a strong table with water mixed with liquid, makes it possible to capture the dust released during cutting.

The benefit of this system is to be simple to install and fast to run in production. it requires special attention on the implementation in order not to exceed the limit values of the gas generated: workshop volume, ventilation and materials to be cut.



LINC-CUT® S 1530d

Down draft table version



The table has compartments at every 600 mm that helps extend the effectiveness of extraction.

Each compartment has air diffuser boxes:

- To protect the sides of the table from heating
- To protect the air extraction opening hatches
- To collect the cutting slag or pieces

Associated with a DIGIFILTER 4CD, the assembly allows production without limitations.

OPTITOME 2

Monobloc plasma cutting machine: robust, versatile and efficient

This machine is designed for use with NERTAJET HPI2 plasma installations to achieve very high cutting quality. Its single-piece construction is highly sturdy, allowing simple and quick assembly. This machine can handle heavy-duty production work, up to 300A.

NERTAJET HPI2: the new generation of high-precision plasma installations developed by Lincoln Electric, with advanced functions:

- CYCLE BOOST and INSTANT MARKING: for shorter production times,
- MASTER HOLE and CDHC: for improved cutting quality,
- TOUCH & GO, SOFT PIERCING and TWIN DETECT: for greater simplicity in use.

Main technical characteristics:

- Travel speed 15 m/min (according to EC machines regulation),
- Brushless motorisation guaranteeing accuracy and fluidity of movement,
- Beam height to place rectangular pipes up to 200mm high,
- Absolute encoders.



The table has compartments at every 600 mm that helps extend the effectiveness of extraction.

Each compartment has air diffuser boxes:

- To protect the sides of the table from heating,
- To protect the air extraction opening hatches,
- To collect the cutting slag or pieces.

Version	1530	2010	2040	2060
Cutting width (mm)	1500	2000	2000	2000
Cutting length (mm)	3000	1000	4000	6000
Total width (mm) *	2504	3050	3050	3050
Total length (mm) *	4375	2550	5325	7380
Total height (mm) *	2000	2000	2000	2000

* excluding safety zone and equipments (plasma power source, filter, etc...)

Plasma process	
Number	1
Type	FLEXCUT® 125 FLEXCUT® 200 NERTAJET HPI2 150 or 300
Main options	
1 oxy essential Marker Wen, tube cutting, positioning laser	

ALPHATOME 2

High precision plasma cutting machine: high quality, robustness and productivity

High quality plasma cutting requires more and more precision. The ALPHATOME 2 allows cutting and marking by plasma process on non-alloy or low-alloy carbon steel, stainless steel and light alloy plates with a thickness from 0.5 to 50 mm.

Its linear guideline systems fully protected, double beam concept with central cutting tool, fluidity of movement and dynamism make a machine specially designed for HP plasma cutting at intensive use.



Main technical characteristics:

- High speed up to 25 m/min,
- Numerical control by HPC digital process: management and control fully automated of plasma processes,
- Brushless motorisation ensuring accuracy and fluidity of movement,
- Rails with roller bearing,
- Motor gearboxes with play adjustment,
- Absolute encoders.

Number of cutting tool	Up to 2				
Type plasma	NERTAJET HPI2 150 NERTAJET HPI2 300 NERTAJET HPI 450				
Main options	<ul style="list-style-type: none"> • Visio Process & remote control. • Cut of tube. • Micro percussion marker. • 4th axis. • R = additional rail L = 2 or 3 m Useful travel maxi = 24 m. 				
	Format of the beam width				
	20	25	30	35	40
Cutting width (mm)	2000	2500	3000	3500	4000
Cutting length (mm)	3000+R	3000+R	3000+R	3000+R	3000+R
Total width (mm) *	3410	3910	4410	4910	5410
Total length (mm) *	6200+R	6200+R	6200+R	6200+R	6200+R
Total height (mm) *	2165	2165	2165	2165	2165

* excluding safety zone and equipments (plasma power source, filter, etc ...)

EUROTOME 2

Thermal cutting machine: easy to use, versatile and cost-effective

EUROTOME 2: a rugged mechanical machine design which brings together all the necessary qualities for the implementation of oxycutting, plasma and marking processes.

Equipped with the HPC numerical control with an high quality touchscreen, the EUROTOME 2 fits to all fabrication needs from the lowest thickness (0.5 mm) to the most important with all processes (oxyflame cutting and/or plasma).

Its concept is versatility, **EUROTOME 2 can be equipped with various tools:** 1 to 4 oxyfuel torches managed by OXY Essential, a plasma installation (FLEXCUT® 125 CE or FLEXCUT® 200 or NERTAJET HPI2), a marking tool and a VXK bevelling tool.

The various sizes of beam width (sizes 15, 20, 25, 30 & 35) and length of railway (original rail effective travel 3 m can be extended with 3 m or 1.5 m modules).



Main technical characteristics:

- Travel speed 15 m/min with double motorisation,
- Brushless motorisation with absolute encoders ensuring accuracy and fluidity of movement,
- Separate table on the machine frame,
- Managed by HPC digital process.

"A la carte" version	15	20	25	30	35
Cutting width (mm)	1500	2000	2500	3000	3500
Cutting length (mm)	3050+R				
Total width (mm) *	3300	3800	4300	4800	5300
Total length (mm) *	3600	4100	4600	5100	5600
R = additional rail by modules of 3 m or 1.5 m					

* excluding safety zone and equipments (plasma power source, filter, etc...)

	Plasma process	OXY process
Number	2	up to 4
Type	FLEXCUT® 125 FLEXCUT® 200 NERTAJET HPI2 150 or 300	OXY Essential with: MACH HP MACH HPI
Main options		
Pneumatic marker, straight bevelling block VXK, tube cutting, automatic igniter, capacitive sensor, cabinet cooling by vortex, positioning laser.		

Compatible with standard EN ISO 17916: 2016

OXYTOME 2 & PLASMATOME 2

Thermal cutting machine completely automated, robust, versatile and efficient

The OXYTOME 2 / PLASMATOME 2 HPI range integrates all the features required to implement the plasma and/or oxycutting process. These machines are suitable for all trades using plasma and oxycutting. Their concept is versatility and a wide choice:

Plasma installations:

- From NERTAJET HPI 150 to 600 A in single torch or bi-torch.
- FLEXCUT® 125 CE and FLEXCUT® 200 in single or bi-torch.

Oxy installations:

- Full automatic management of oxyfuel process thanks to OXY Essential or OXY HPI2 systems depending thickness capacity needs.

Applications:

- Cut from 0.5 to 300 mm thickness low alloy steels or non-alloy steels,
- 150 mm thickness stainless steel,
- 130 mm thickness light alloys.

Uses:

- Dry plasma cutting to immersed plasma cutting, cut of tubes.



Main technical characteristics:

- Travel speed 25 m/min,
- Double motorisation with absolute encoders,
- HPC digital process: management and control fully automated for plasma and oxycutting process,
- **OXYTOME 2 HPI** can receive up to 6 tools (6 OXY or 4 OXY and 2 plasma),
- **PLASMATOME 2 HPI** can receive up to 2 plasma installations.

"A la carte" version	15	20	25	30	35	40	45	50	55
Cutting width (mm)	2065	2565	3065	3565	4065	4565	5065	5425	5925
Cutting length (mm)	3350+R								
Total width (mm) *	3500	4000	4500	5000	5500	6000	6500	6920	7420
Total length (mm) *	4996+R								

R = additional rail by modules
of 3 m or 1.5 m / useful travel 30 m maxi.

* excluding safety zone and equipments (plasma power source, filter, etc...)

	Plasma process	OXY process
Number	up to 2	up to 8
	6 tools maxi	
Type	FLEXCUT® 125 FLEXCUT® 200 NERTAJET HPI2 150 NERTAJET HPI2 300 NERTAJET HPI 450 NERTAJET HPI 600	OXY Essential or OXY HPI2 with: MACH HP MACH HPI

Main options

NERTAJET BEVEL HPI, cut of tube, micro percussion marker, laser positioning, 4th axis, automatic indexing, straight bevelling block VXX, camera, aerial cable chains, drilling unit.

OXYTOME & PLASMATOME TWIN

Robust high-precision machines in medium and large format for thermal cutting with fully automated control.

The OXYTOME / PLASMATOME TWIN range is proposed in medium and large format. It fits all trades for the lowest thicknesses (0.5 mm) to the largest accessible for plasma and / or oxycutting.

Its linear guideline systems fully protected, double beam concept, fluidity of movement and dynamism make a machine specially designed for plasma or OXY HPI2 cutting at intensive use.

It is perfectly adapted to implement bevelling applications with plasma HPI all automated.

Combined with one or more torches, it provides versatility cutting applications and cuts of high quality: the HPI Lincoln Electric quality.

Full automatic management of oxyfuel process thanks to OXY HPI2 system.



Main technical characteristics:

- Travel speed 25 m/min,
- Double motorisation in base version,
- Brushless motorisation with absolute encoders ensuring accuracy and fluidity of movement,
- HPC digital process: management and control fully automated for plasma and oxycutting process,
- **OXYTOME TWIN** can receive up to 4 tools,
- **PLASMATOME TWIN** can receive up to 2 plasma installations,
- Double beam transverse with roller bearing,
- Rails with roller bearing fully protected on longitudinal axis,
- Motor gearboxes with play adjustment.

"A la carte" version	30	35	40	45	50
Cutting width (mm)	3425	3925	4425	4925	5425
Cutting length (mm)	4535+R				
Total width (mm) *	4920	5420	5920	6420	6920
Total length (mm) *	6200+R				

R = additional rail by modules of 2 m or 3 m / useful travel 24 m maxi.

* excluding safety zone and equipments (plasma power source, filter, etc...)

	Plasma process	OXY process
Number	up to 2	up to 6
	4 tools maxi	
Type	NERTAJET HPI2 150 NERTAJET HPI2 300 NERTAJET HPI 450 NERTAJET HPI 600	OXY HPI2 with: MACH HP

Main options

NERTAJET BEVEL HPI, cut of tube, micro percussion marker, laser positioning, 4th axis, automatic indexing, straight bevelling block VXX, camera, aerial cable chains, drilling unit.

CYBERTOME

Machine for large and extra large widths metal sheets with on-board operator for intensive use in the harshest environments. Robust, versatile and efficient.

The CYBERTOME range combines all the qualities necessary for the implementation of the plasma process and/or oxycutting high capacity. These machines, available in large and extra large formats, are adapted to all applications ranging from thin material (0.5mm) to the largest accessible for plasma and / or oxycutting. In semi automatic version or fully automated they implement versatile applications:

Plasma installations:

- From NERTAJET HPI 150 to 600 A in single torch or bi-torch.

Oxy installations:

- Full automatic management of oxyfuel process thanks to OXY HPI system.

Applications:

- Cut from 0.5 to 300 mm thickness low alloy steels or non-alloy steels,
- 150 mm thickness stainless steel and 130 mm thickness light alloys.

Uses:

- Dry plasma cutting to immersed plasma cutting with or without automatised bevelling.



Main technical characteristics:

- Travel speed 15 m/min or 30 m/min,
- Double motorisation in base version,
- Brushless motorisation ensuring accuracy and fluidity of movement,
- managed by HPC digital process.

"A la carte" version	40	50	60	70	80	90	...120
Cutting width (mm)	4000	5000	6000	7000	8000	9000	12000
Cutting length (mm)	3000+R						
Total width (mm) *	6500	7500	8500	9500	10500	11500	14500
Total length (mm) *	6000+R						
Total height (mm) *	2640						

Other dimensions on request

R = additional rail by modules of 6 m - 3 m or 1.5 m

* excluding safety zone and equipments (plasma power source, filter, etc...)

The CYBERTOME may receive:

- HPC digital process allowing management and control fully automated for plasma and oxycutting process,
- Automatic indexing of tools,
- Different marking tools for traceability,
- Automatic plasma bevelling unit,
- Oxycutting VXK bevelling unit,
- Cut of tube,
- Thermal protection (heat shields and cooling machine) for cutting very thick.

	Plasma process	OXY process
Number	up to 2	up to 8
	12 tools maxi	
Type	NERTAJET HPI2 150 NERTAJET HPI2 300 NERTAJET HPI 450 NERTAJET HPI 600	OXY HPI2 with: MACH HP

Main options

NERTAJET BEVEL HPI, cut of tube, micro percussion marker, laser positioning, 4th axis, automatic indexing, straight bevelling block VXK, camera, aerial cable chains, drilling unit.

HPC DIGITAL PROCESS 3



Intuitive, automatic, educational

The most intuitive and efficient numerical control on the market.

It fully manages the cutting machine, from the trajectory to the processes.

The ergonomics of the HMI and its large 21" 16/9 touch screen make it a user-friendly and easy-to-use tool. All has been design to be intuitive but also educational with different diagrams integrated explaining simply how to use.

In particular, it includes all the important functions suited to the thermal cutting business such as: Cutting recovery menu, parametric shapes, sheet metal alignment, test menus, automatic adjustment of parameters...

The features of HPC3:

- 60 Parametric Forms,
- Parts directory programmed on external software, ISO code editor,
- Scale, rotation, symmetry,
- Choice origin program,
- Management of sheet metal works,
- Sheet metal alignment assistance tool,
- SMART DATA BASE for "intelligent" plasma and flame cutting processes,
- Controls of processes,
- Dynamic visualization of the part and tracking of the trajectory in real time,
- Program recovery menu: forward/backward on trajectory, offset for restart of the off trajectory cut, zoom,
- Complete setup for machine configuration: Tools, Options, Languages,
- Options: Tube cutting, 2nd digitized transverse axis, NERTAJET BEVEL HPI, digital drilling, automatic indexing, visio-process, laser positioning or measurement [can be offered with version 1 or 2 of HPC]
- 17 languages available.

Hardware & Communication:

- Robust industrial computer,
- SSD hard drive with large capacity,
- Real-time trajectory management system,
- EtherCAT bus management,
- 21" 16/9 industrial touch screen,
- USB, NETWORK & TELESERVICE.

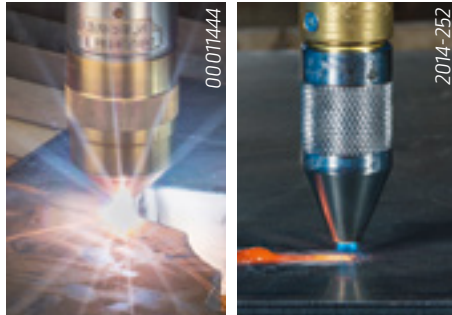

How works the automatic adjustment of processes on HPC DIGITAL PROCESS?

- **Phase 1:**
After selecting the program, the operator chooses the material to be cut.
- **Phase 2:**
HPC provides one or more solutions adapted to the application.
- **Phase 3:**
After accepting the proposal, the setting of each parameter is done automatically.
- **Phase 4:**
When the tool (plasma torch or oxyfuel torch) is equipped with consumables recommended, the machine is ready to cut.



You can chose to use the data base of HPC or to create your own data base.

JOB function gives you the possibility of attaching this process management to a program loaded and selected in the numerical controller. This combination can be stored by the JOB function and then used by any operator.

HPC DIGITAL PROCESS 3

Advanced or Essential control panel:

The Advanced swivel console is equipped with a joystick, ergonomic manual controls and a maintenance mode to simplify the use of the machine. It can be found in particular on the OXYTOME 2 and PLASMATOME 2 range. Also available as a fixed console version with ALPHATOME 2.

The Essential swivel Desk is fully touch-sensitive and is equipped with a maintenance mode that simplifies the use of the machine. It is found in particular on the EUROTOME 2 range. Also available in fixed console with OPTITOME 2.



Software MAGICNEST JUNIOR for HPC

Modular design with programming installed on digital HPC command to:

- Import all types of program (dxf, dwg, dstv...),
- create customized drawing,
- Use a database of standard forms complementary than the HPC propose in standard,
- Customize its own standard forms (optional),
- create a machine program,
- Apply technology for chamfering (optional).



Production monitoring on HPC

Module dedicated for production monitoring. The HPC saves all the actions done during production. These files can be edited with Excel or can be automatically analyzed by CAD/CAM software.

These files data can be saved on a USB key or directly on a customer directory if the CNC is connected on their network.

Data available:

- Number of cutting, - time of cutting,
- Material and process chosen,
- CNC default,
- Failed cut part...

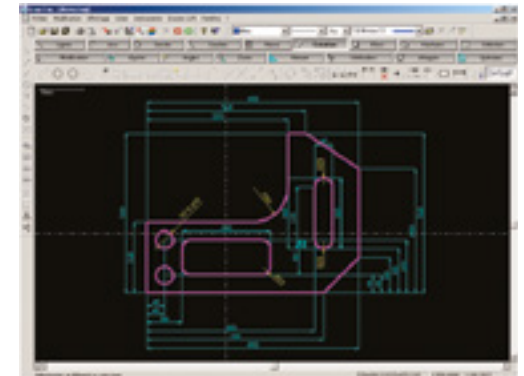
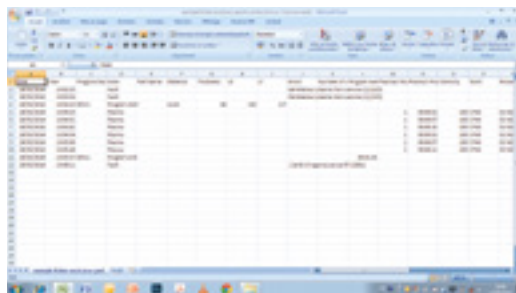



CUTTING SOFTWARE



A well adapted software help increases the automation and the return on investment of machines fitted with the CNC. Lincoln Electric can supply software specially designed for thermal cutting CAD, pressure vessel shapes developed flat, interleaving, plate stock control, communication, translation of external files and files produced by other CAD systems (DXF, DWG, DSTV...).

Software for small and medium industries

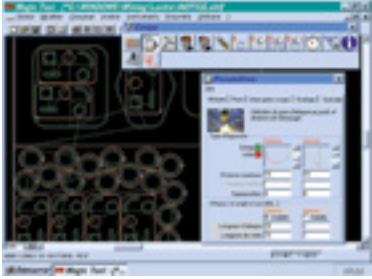
Range of software designed for quick learning and adapted to the needs of small and medium-sized structures

LINC CUT CAD CAM Software suite dedicated for LINC-CUT S range	MAGICNEST 01 Software suite for all CNC with manual nesting	MAGICNEST 10 Software suite for all CNC with automatic nesting
		
Drawing module	Drawing module	Drawing module
Importation of dxf / dwg / dstv...	Importation of dxf / dwg / dstv...	Importation of dxf / dwg / dstv...
Lettering tool	Lettering tool	Lettering tool
Vectorization tool	Vectorization tool	Vectorization tool
Nesting module: manual, matrix or automatic	Manual or matrix nesting module & tools path	Automatic nesting & tools path module using best strategy for maximizing material savings
ISO codes programs generator for machine range LINC-CUT S (VMD CNC interface)	Codes programs generator for different CNC machine: HPC, BURNY, VMD...	Codes programs generator for different CNC machine: HPC, BURNY, VMD...
-	Bridges, micro junction, common cutting, scrap recovery...	Multi-torches, bridges, micro junction, pre-piercing, common cutting, scrap recovery...
-	Quotation tool	Quotation tool
-	Plate storage management	Plate storage management
-	Remaining scrap plate management	Remaining scrap plate management

CUTTING SOFTWARE

Software for medium and heavy industries and high range applications

Range of software designed for medium and heavy industries with powerful functionalities and different modules to manage advance applications like beveling, numerical drilling, tube cutting...

MAGICNEST EXPERT PLUS

This is the best and complete version for machine with option bevel, indexing or piercing. Drawing and nesting functions are similar to MAGICNEST 10. With bevel option, MAGICNEST EXPERT PLUS control open-ended bevelling units that use plasma technology. It may be used for all types of bevel - V, Y, X and K - in multiple pass processes. Possibility to include duct module and special marking [SIC marking or inkjet] in option.

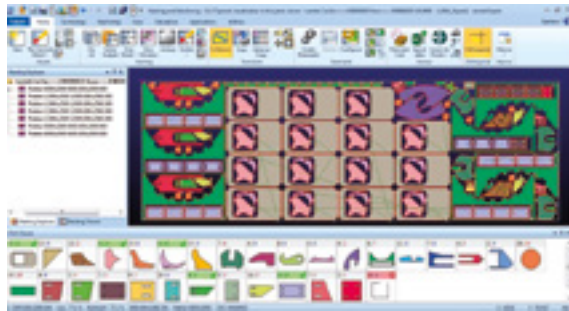

DUCT OPTION MODULE

Duct is a powerful module of MAGICNEST Expert Plus for calculating DUCT figures. Duct is designed in such a way that the user only has to follow the simple steps prompted by the system.

User simply has to select the figure to be developed, enter the required dimensions, and the figure will automatically be developed.

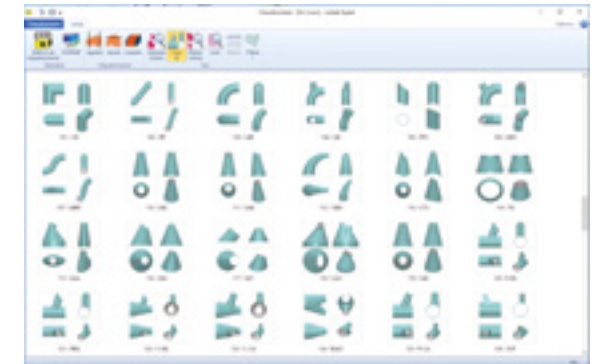

FLEX 3D

Flex3d Tubes is a member of the MAGICNEST Expert Plus family of products for the design and cutting of tubes.

Easy, flexible design Flex3D Tubes gives a real vision of the result on the screen.

It displays the exact tube and simulates in 3D.

Flex3D Tubes allows 3D design in an intuitive and simple way:

It gives the result that the user will obtain when cutting the profile on the machine.

It is a stand alone software available in 2 versions:

- Flex 3D tube: for only one reference part and one job
- Flex 3D tube +: auto nesting and warehouse management, for "mother bars" and remnants

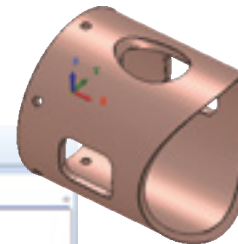

EXTRACTION TABLES

Extraction tables for dry cutting

The extraction tables with air extraction offers unrivalled efficiency in terms of fume extraction thanks to its unique system of transverse extraction ducts.

Robustly designed in one-piece or modular form, the table is divided over its length into multiple sections, extraction taking place across the full width of the table on the module in operation only.

Mechanical or pneumatic flaps actuated by the displacement of the machine provide suction under the sheet at the place of cutting only.

This principle of operation guarantees optimum extraction, irrespective of the size of the sheet being cut, while maintaining a modest extraction air-flow rate.

Technical characteristics:

- Transverse duct extraction system,
- Division into 0.75 meter sections over the length of the table,
- Removable slag boxes,
- Removable workpiece supporting frame with flat iron (section 100 x 6 mm) and wire mesh grid (50 x 50 x 5 mm),
- Maximum capacity: sheet up to 300 mm thick.



Variable water level tables

Variable water level tables are specifically intended for immersed plasma cutting.

This procedure limits pollution by solid or gaseous matter and gives protection against audible and visual stress.

It improves accuracy of cutting while limiting distortions caused by heating of the workpiece.

Technical characteristics:

- Modular construction in lengths of 1.5, 1.75 and 2 m,
- Width: on request,
- Pivoting workpiece support frame.



EXTRACTION TABLES

Extraction tables for dry cutting

Table with slag automatic outfeed

The table has an automatic cleaning system for evacuating slag, small scraps and parts.

The evacuation is done in containers which makes it possible to reduce the maintenance and the cleaning time of the table. The table has compartments and the machine selects the suction zone according to its position and thus makes it possible to obtain efficient fume and dust extraction.



Palletisable table

The palletisation system allows loading and unloading of sheets to cut out of the cutting area.

The preparation of sheets to cut is performed in masked time without risks for the operator.



FUME EXTRACTION

When choosing a filtration unit several parameters must be taken into consideration:

- The quality of the filter elements, the structure of the filter media and the filtration performance
- The performance of the cleaning system of the filter elements
- To be able to control the flow-rate of the extracted air
- To be able to control the filter cleaning based on their level of contamination

The Digifilter is compact, all the elements are integrated.

Dust is collected on the PTFE membrane polyester filter cartridges.

The cleaning of the filter cartridges is done by compressed air, creating an instantaneous and brutal overpressure inside the cartridge allowing the unclogging of the fine dust

The cartridges are therefore maintained in a good cleanliness, ensuring airflow always optimized.

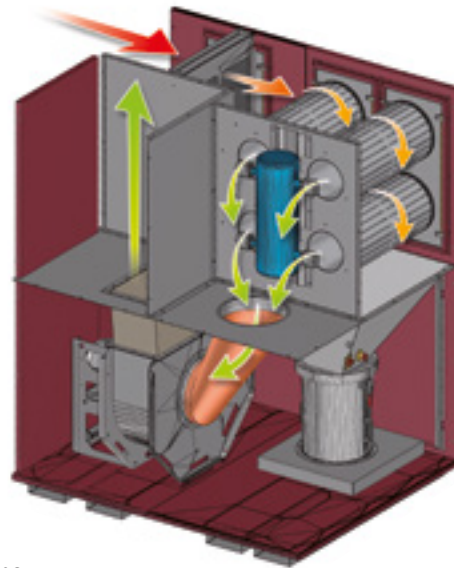

ROTARY LOCK with BIG BAG

This option allows the recovery of dust in Big-Bag.

The choice of recovery mode will be dictated by the daily volume collected and your ISO 14001 approach.

In Big Bag, once collected, the dust is no longer handled and the Big Bag is a validated container for transporting dust to pollutant treatment centers.



PUSH-PULL SOLUTION

This innovative system makes it possible to capture the fumes given off during cuts on the water table. Even if the majority of dust is captured by the table water, the gases and in particular the NOx, escape from the tables and must be extracted to not exceed the exposure limits.

This system therefore allows the smoke to be moved, captured and extracted from the building.

It is composed of:

- 1 A blowing ramp
- 2 A suction ramp
- 3 Ducting
- 4 Rectangular collection duct with shuttle according to machine movement
- 5 Fan motor

Benefits:

- Our PUSH PULL system captures these gases while completely freeing the plasma cutting head
- Unlike conventional sensors surrounding the torch, our system is not vulnerable to splashes, flames and humidity given off during cutting.
- The collecting area is much larger than a traditional hood.

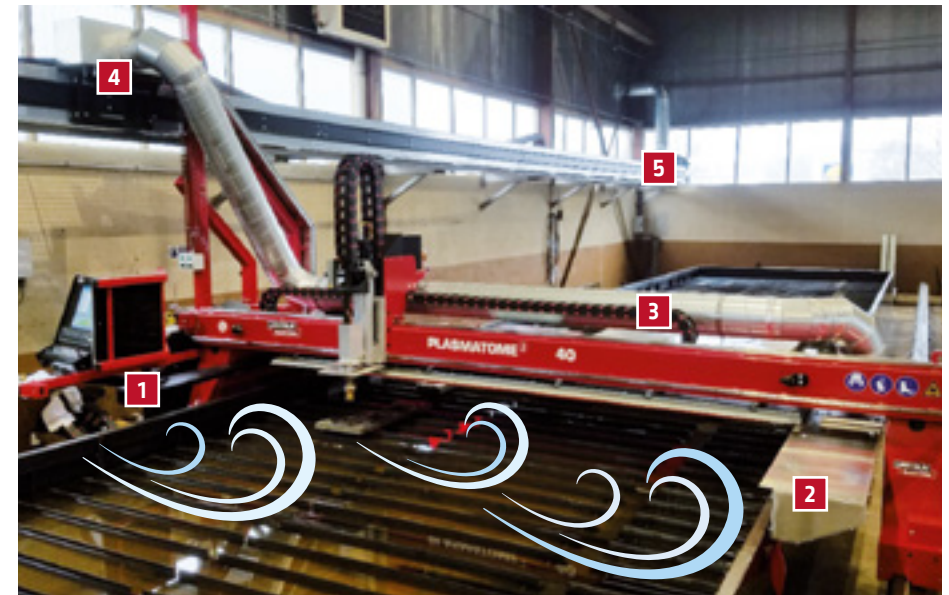

NERTAJET BEVEL HPI

NERTAJET BEVEL HPI is an efficient tool for all cuts that require particular preparation for welding, or any other applications requiring bevels. It thus makes it possible to make V, Y, X and K bevels in a large range of thicknesses and materials.

Precise and robust

- “Machined robot wrist” technology offering:
 - High positioning accuracy: 3 axes are used to ensure the inclination and orientation of the torch.
- High robustness with low sensitivity to shocks:
 - High mechanical conception robustness base on rotation axis,
 - The bottom of the arm is quite far from the plate and tilting parts,
 - Multi-directional choc sensor with large clearance.
- Fully controlled by digital control HPC BEVEL EtherCAT.
- EtherCAT motorization with absolute encoders.
- Compatible with NERTAJET HPI 300 & 450.

AC System integrated intelligent database

- Integrated in the numerical control, AC System automatically corrects the paths to compensate the angular and dimensional deviations generated by the plasma cutting process.
- Allows even when the requested chamfer is not known, to obtain a proposal of parameters defined by extrapolation of the existing data,
- The intuitive & user-friendly IHM gives quick and easy access to the database to refine or create new operating points.

Function CDHC (Cutting Digital Height Control)

- Allows control of torch height during cutting phases. It is particularly important for the respect of the dimensions of the parts and the quality of realization of the chamfers.
- Automatically adjusts the torch position to always be at optimal height to generate the best cutting quality.
- Automatically compensates the wear of plasma consumables especially the electrode. Without this compensation, the dimensions of the chamfered parts would derive of several millimeters.

Advanced features NERTAJET HPI

- Cycle Boost and Instant Marking: to increase productivity.
- Hole Master HPI to increase cutting quality.
- Twin Detect for cutting on dished end.

Function TSB (Trajectory Strategy for Bevel)

- Optimized cutting strategy for an excellent dimensional result.
- Optimized learning cycle for accurate acquisition of sheet position.
- Specific torch orientation cycle for multi-pass chamfers for optimum dimensional results.

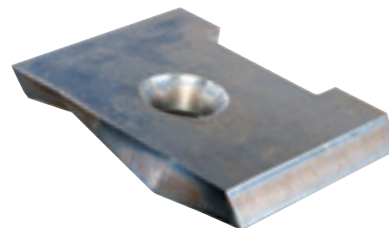
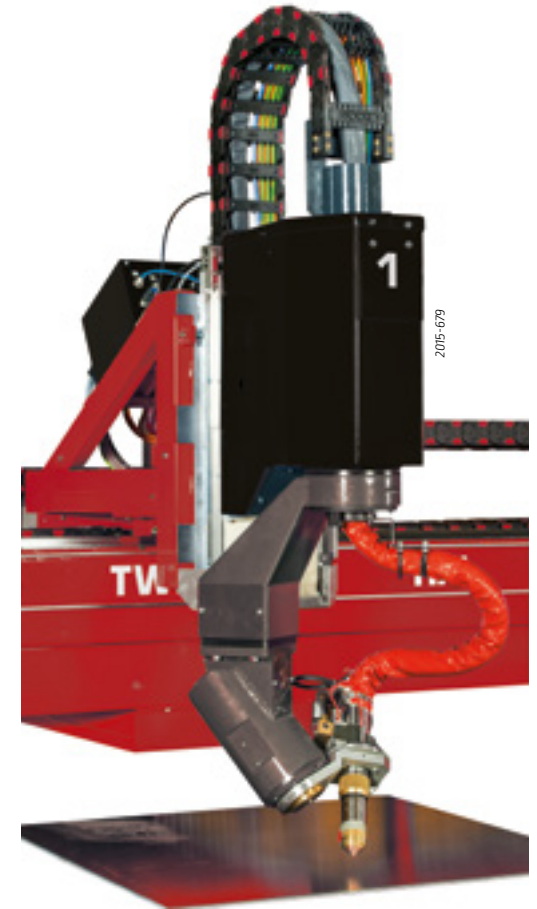

	PLASMATOME / OXYTOME TWIN	CYBERTOME
NERTAJET BEVEL HPI 300 or 450	✓	✓

Type of bevel	V, Y, X and K Dimensional and angular accuracy according to ISO 9013
Rotation axis	+/- 455° 30 rpm/min
Tilt torch	+/- 52° 40 tr/min Allows cutting angles of up to 50°
Z axis slide	250 mm 5 m/min
Options	Tube cutting, cuts on dished end, Z axis slide of 800 mm, mechanical sensor for evolutive chamfering on standard plates

TUBE CUTTING

This option has been developed to meet many cutting applications on round tube from small to large diameter. Thanks to its software interfaces, the machine is able to cut different types of geometry on tube: stitching, cod mouth, separation cut, straight or evolutive bevel etc...

The option is composed of a cabinet control interconnected to the HPC DIGITAL PROCESS, of a motorised headstock with fume extraction duct and an adjustable positioning system according to the diameters of tubes. The positioning of the tube offers many advantages including that the cut piece remains in position after cutting thus avoiding potential risk to safety or damage.

Main technical characteristics:

- With standard motorised headstock:
 - Diameter 400 mm*,
 - Length up to 6 m,
 - Weight maxi of tube: 550 kg,
 - Speed maxi: 30 rpm.
- Central fumes extraction,
- Tube positioning by cross rotators or tube rotators,
- Others dimensions on request,
- NERTAJET BEVEL HPI in option.

* Other diameter on demand



2ND NUMERISED TRANSVERSAL AXIS

Automatic adjustment of the distance between cutting tools done with two CNC axes.

This option can be managed automatically with the nesting software. Inside a same program, different distances can be adjusted between the two torches depending the parts sizes to cut.

This option is mainly used with plasma system but can also be adapted with oxy-fuel process. This option is fully managed by a very nice control interface.



NUMERICAL DRILLING UNIT

Drilling unit can be fitted on cutting machine to combine drilling, thermal cutting and marking in one operation:

- Sheet metal press system,
- Tool length measure system,
- Automatic tool exchanger.

Fully interfaced with the HPC DIGITAL PROCESS System, the management of the drilling unit is simple and user friendly.

Fully automatic management of the drilling unit. Simple and user friendly database of parameters for drilling unit.

This database (spindle speed, rotated speed, ...) can be updated by the operator depending on the tool used.

Minimum and maximum sheet metal thickness depends on the application and cutting machine.

Material could be drilled: carbon, stainless steel and aluminium.

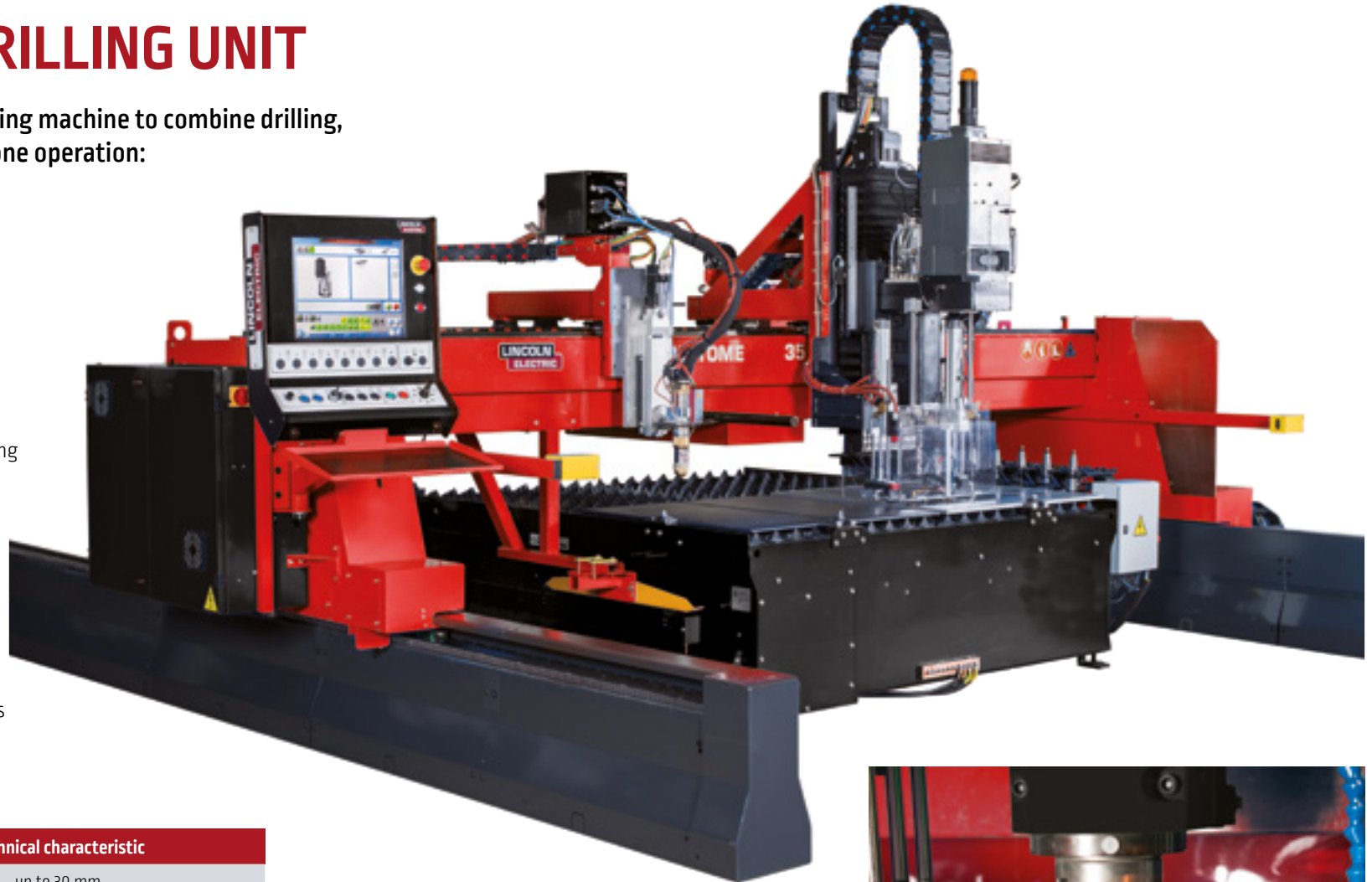

	Technical characteristic
Drill diameters	up to 30 mm
Tapping diameters	up to M18
Tool type	ISO 40
Lubrication	internal/external
Max. spindle motor power	up to 12 kW
Automatic tool exchanger	up to 20 tools
Machine compatible	OXYTOME / PLASMATOME TWIN / CYBERTOME

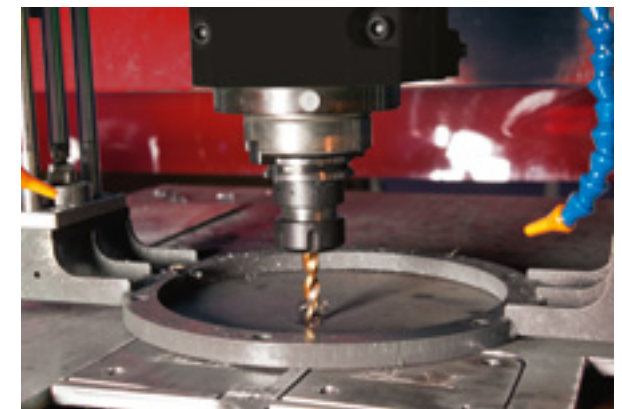

COMPLEMENT FOR MACHINE

Visioproces

A camera is used to display the torch position on a control screen.

The monitored area is about 250 mm in diameter and promotes correct positioning before and during cutting.

The device also monitors the arc.

The operator can control cutting operations and position the torch no matter where the control console is located.

The camera is protected by an anti-dazzle device to protect it from the effects of the plasma arc. The operator can choose between a monochrome or colour display.



Operator visual protection

Curtain easy to adjust to protect the operator against the plasma electric arc.

Gas driven single point automatic lubricators

The units are supplied ready-to-use connected to ball bearing transversal carriages and filled with lubricants. Tool-free activation and time-setting allow easy and accurate adjustment of lubrication flow.

Flexible dispense rate from 1 to 12 months.

Stoppable or adjustable if required.

It's simplified the maintenance of the machine and increase life time of the ball bearing carriages.

Electrical cabinet

It can be equipped with air cooling system, heating system, voltage inverter to meet all requirements of environment.

Pneumatic or Wen marker

The 2 systems are mechanical engravers by percussion of the sheet metal using compressed air.

Combined with the movements of the machine, it is possible to create different types of texts, bending or welding ark etc...

The pneumatic version is recommended for marking on thick sheets from 15mm, ideally combined with flame cutting. The Wen system is suitable for thin thicknesses from 3 or 4 mm. It allows to obtain a precision engraving particularly for text.

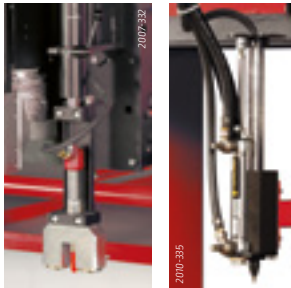

Micro-percussion marking

It allows a fast and accurate marking.

This system can carry out several lines marking with small characters (less than 10 mm).

To perform the marking, the micro marker box is automatically positioned above the sheet metal. Then it drives a pen following its 2 axes dedicated to draw characters and mark the sheet with the desired power (marking depth).

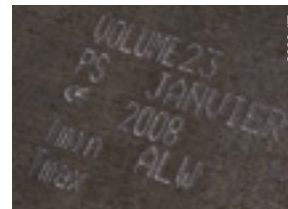

Cutting table lighting

Lighting of the cutting table with 2 leds projectors place on each side of the machine.

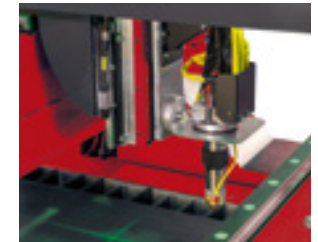

Positioning laser with greencross

Controlled by the interface of the HPC, this tool helps the operator to position the machine to start cutting program or make the alignment of the sheet metal.



EQUIPMENT FOR OXYFUEL PROCESS

Bevel tool for oxyfuel torch

This tool easy to install and use gives the possibility to realize different kind of simple bevel following a straight line: standard V bevel or tapered bevel (bevel over 45° cut on plate edge)

Tapered bevel (bevel over than 45°)

This tool is well adapted to realize tapered bevel on plate edge with or without the assistance of a mechanical sensor to follow the distortion of the plate.



Bevelling block V X K

For bevels parallel to the axes using mechanical sensors. It allow to work on thicknesses up to 70 mm.

The system is equipped with 3 short oxyfuel torches and give the possibility to realize V, Y, X and K bevels.

Each side oxyfuel torches can be adjust following an angle from 10 to 45°.

The two robust rollers of the mechanical sensor are cooling by compressed air. In option, the VXK can be fit on electrical tool holder with a quick mechanical exchanger. It gives the possibility to work with a standard straight cutting torch or with a VXK bevelling block.

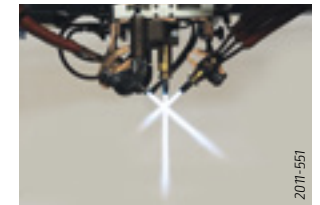
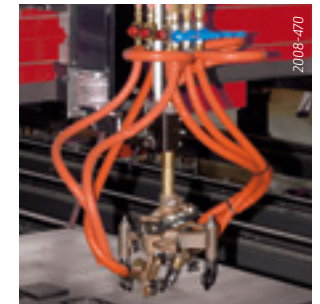

Strip cutting systems

Tools to realize strip cutting. Two systems are available: One system to fit directly on the oxy-fuel torch.

The system use two set of nozzles.

The distance between each other is adjusted by opening more or less the tool. Distance between the 2 nozzles: from 40 to 400 mm.



Set capacitive sensor/automatic ignition for OXY torch with OXY SAFE PIERCING

Proposed in the basic version on OXYTOME 2, OXYTOME RS HPI, OXYTOME TWIN HPI and in option on EUROTOME 2, this unique system on the market, allows to retract during phases of piercing both the sensor and the igniter. OXY SAFE PIERCING authorizes mid plate piercing up to 150 mm thickness in automatic cycle without any disassembly of the probe or the igniter.

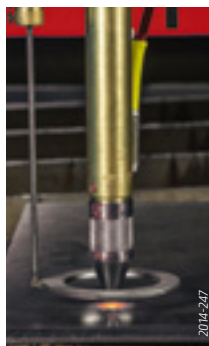

PYROTOME SE, the carriage on rails

The PYROTOME SE is a portable multiprocess carriage for straight or V bevel cuts.

Its electronic speed regulation (10 to 125 cm/min) and robustness make it the indispensable tool for intensive use.

The PYROTOME SE basic version is equipped for oxycutting (plasma cutting on request).

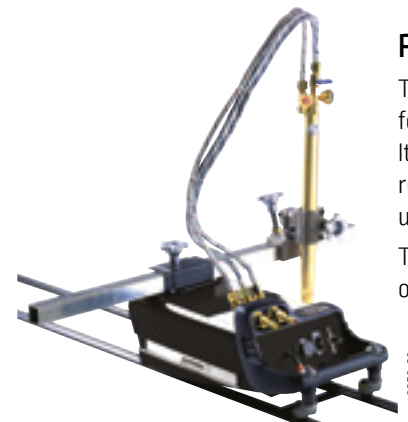

PythonX[®] STRUCTURAL

All in one solution for infrastructure segment

PythonX[®] STRUCTURAL is the leading all-in-one robotic plasma system in the world trusted by more end-users with over 440+ systems installed worldwide.



This CE certified system takes in your drawing files and automatically processes beams, channels, angles, square and rectangular tubes, as well as plate, all on one machine. In addition, the machine produces bolt holes that are EN1090 compliant.

Additional cutting capabilities include copes, slots, cutouts, cut to length, miter cuts, weld preps, and scribe part/layout marks, all done in one place, eliminating countless hours of material handling in between operations.

Because everything is done on one machine, saving you valuable shop space, you'll be able to streamline your operations. PythonX[®] STRUCTURAL allows you to automate structural steel fabrication operations in your plant, saving you time and money.

Simple to use

- 1 Load the raw part for processing
- 2 Open a part file on the HMI
- 3 Press start

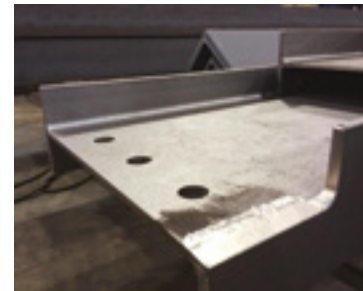

Streamlining a path to more efficient production.

Efficiency is the key advantage when it comes to fabricating structural steel. Only a single operator and no programming are required to operate the **PythonX® STRUCTURAL**.

PythonX® STRUCTURAL delivers the advantage of completely finished pieces at the **LOWEST COST PER TON** versus your competitor's old technology.



How long would it take to fabricate this beam in your shop ?



- 13 bolt holes.
- 3 slots.
- 3 copes.
- Web trim.
- 9 letter piece marks.
- Miter cut/trim.
- Flange notch.
- 2 flush flange cuts.
- 4 layout marks.

Only 4 minutes 26 seconds with PythonX® STRUCTURAL

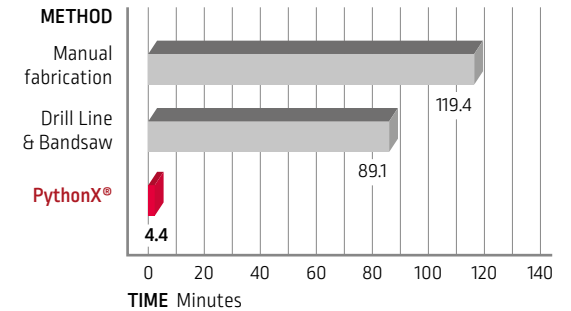

EN1090 compliant bolt holes

PythonX® STRUCTURAL produces unmatched bolt hole quality eliminating the need for operator intervention and consistently outperforms competitive systems. Engineers around the globe can design with confidence knowing that plasma cut holes cut by PythonX® STRUCTURAL can be used in a broad range of load applications* such as:

- Static
- Cyclic
- Seismic

** For complete details, refer to The PythonX® Guide to Plasma Cutting in Codes and Standards available from your local Sales Representative*



WELDING SYSTEMS



WELDING PROCESSES

TIG Technology

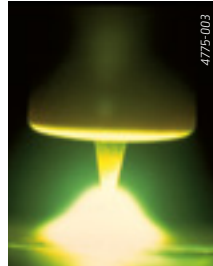
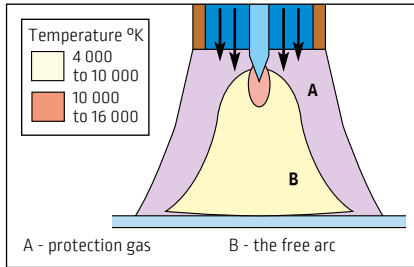

Metals are fused together by heating them with an electric arc. The electric arc is established between a non-consumable (does not melt) tungsten electrode and the workpiece. A filler metal may be used depending on the joint design. The molten metal is shielded from the atmosphere by a stream of inert gas supplied through the torch. The resulting deposited weld metal has the same integrity as the base material. This welding process is used for welding of carbon steel, stainless steel, aluminium, titanium, copper...

The benefits are:

- Good weld bead appearance,
- Aluminium weldability,
- Adapted for fine thickness,
- Welding in all positions.

TOPTIG Technology

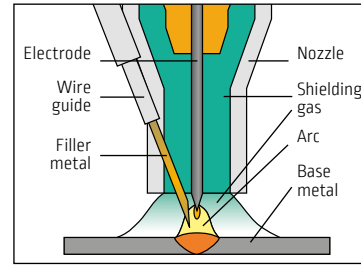

Based on principle of TIG process, an additional filler metal is fed through the nozzle directly into the arc with an angle of 20° to the electrode. This concept guarantees a high deposition rate and an efficient metal transfer. This welding process is used for welding of carbon steel, stainless steel, titanium, inonel, electro-galvanized coated steel (brazing)...

The benefits are:

- TIG high quality welding and guaranteed spatter free,
- Good global productivity,
- Excellent appearance of the weld bead,
- Torch accessibility and welding in all positions.

MIG/MAG Technology

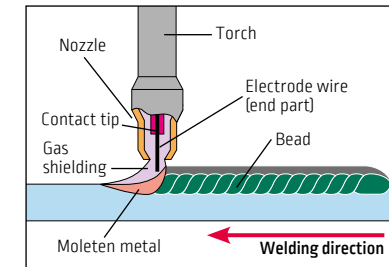

An electric arc forms between a consumable wire electrode and the workpiece (metal) which heats the workpiece metal causing them to fuse. The arc and weld pool are shielded by an inert or active gas. Metal is transferred in the form of drops through the arc towards the workpiece. This welding process is used for welding of carbon steel, stainless steel, aluminium, copper...

The benefits are:

- Easy implementation,
- High welding speed,
- Welding in all positions,
- Low welding investment cost.

SAW Technology

Similar to MIG/MAG welding, SAW involves the formation of an arc between a continuously fed wire electrode. Covering flux is used to generate protective gas and slag protecting the weld metal. The flux can also help donate alloying elements. It is dedicated mainly for flat and fillet welding. This process is generally used for the welding of materials as carbon steel and stainless steel.

The benefits are:

- High deposition rates,
- High penetration,
- Large execution speeds obtained by the use of high currents on one or more electrode-wires,
- Excellent compact joints with good mechanical properties,
- High duty cycle,
- Operator comfort: low fumes and invisible arc.

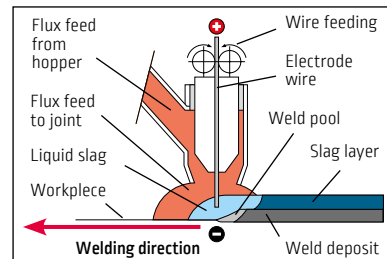

PLASMA Technology

The contribution of energy necessary for welding is ensured by an electric arc in an atmosphere of plasmagene neutral gas. This arc established between an infusible electrode and the parts to be assembled is forced through a nozzle which constricts it mechanically and pneumatically. This welding process is used for welding of carbon steel, stainless steel, duplex, titanium, Inonel, nickel and alloys...

The benefits are:

- Reduction in the preparation times for assemblies by eliminating bevelling for thicknesses up to 10 mm,
- Joint quality: Complete and regular penetration guaranteed, 100% X- ray quality,
- Reduction of the heat affected zone thanks to the arc concentration,
- Respect of the base material chemical composition,
- Low distortion,
- Reduction or elimination of finishing operations,
- Excellent visual aspect.

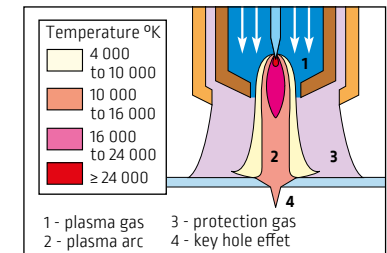

TIG & PLASMA INSTALLATION

Applications

Multi-purpose welding installation to enable the following processes to be used in automatic applications:

- DC TIG with smooth or pulsed current,
- AC TIG with variable polarity,
- DC plasma with smooth or pulsed current.

This installation meets the highest quality standards for welding and productivity for industries as diverse as boiler-making using stainless steels, aeronautics using precious metals, chemical engineering, energy production, transformation and transport as well as prefabrication of gas and petrol pipelines etc.



TIG / PLASMA process and performance

The Plasma process is the ideal extension of TIG for thicknesses greater than 3 mm.

It ensures the same level of quality, higher performances and 100% penetration thanks to Key-Hole technology. The diagram shows the different welding performances according to the materials and thicknesses.

Maximum thickness which can be welded in a single pass is reduced for:

- vertical down and cornice (2G) welding positions,
- small diameter and very thick tubes.

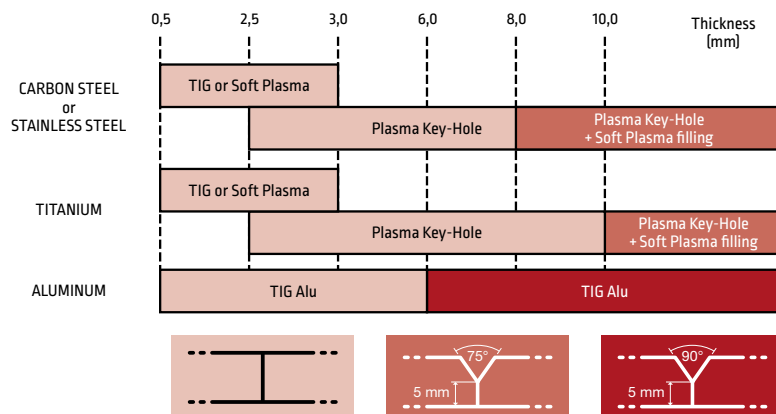

Improvement productivity with PLASMA +TIG Process

The Plasma + TIG process is specially designed for assembling panels for the prefabrication of vessels longer than 4 meters and carrying out circular welds for diameters greater than 2 meters.

This process of using 2 torches in tandem gives a productivity gain of 30-50 % over a single-torch plasma installation.

The "plasma" arc penetrates the butt-jointed panels. The "TIG" arc equipped with filler metal, electromagnetic arc oscillation and a gas trailing shield produces a perfect surface finish which can often be left without any further treatment.

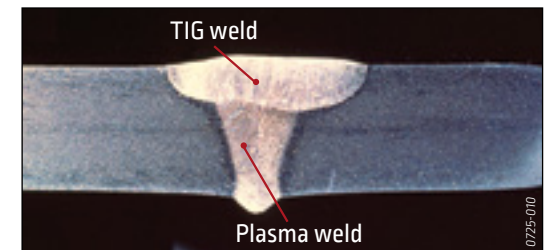
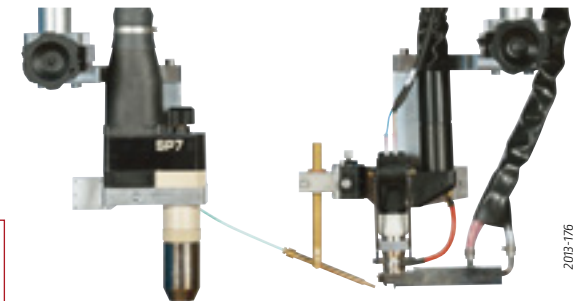
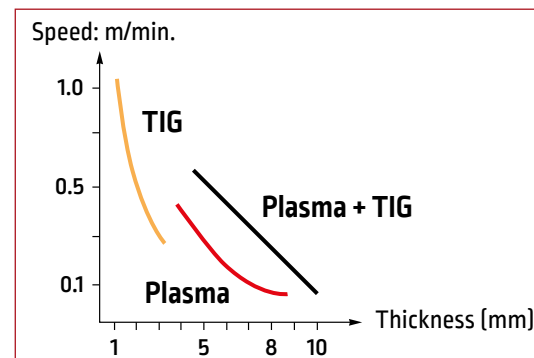

TIG & PLASMA INSTALLATION

Multipurpose installation able to perform Plasma or TIG, DC or pulsed, TIG AC variable polarity.

Management of all welding functions such as:

- Current
- Wire
- Welding speed
- Voltage (AVC)
- Gases

WIRE FEED

It is often necessary to feed the melting bath with metal during the operation in order to prevent the seam from showing hollows, to supply soft steels with deoxidizing elements, for successive seams.

	Characteristics
Carbon & stainless steel, Titanium wires	Ø 0.8 / 1.0 / 1.2 mm
Aluminium wires	Ø 1.2 / 1.6 mm
Max wire speed	6 m/min



HOT WIRE

Productivity improvement by increasing the deposition rate

Hot filler wire enables 2.5 to 3 kg of metal to be deposited per hour for filling bevels using multiple passes or for quality hard-surfacing.

Hot wire is performed by additional power source to the wire feeding system delivering 10 to 200 A.

AVC SYSTEM

A constant distance between the torch and the workpiece is a key of quality to ensure a constant penetration and bead width. The Arc Voltage Control (AVC) keeps this constant distance by automatic regulation of the arc voltage: function fully integrated into the Lincoln Electric system composed of an electrical vertical slide travel 200 mm.



System with large color screen 15", miniaturised camera and additional lighting

VIDEO CAMERA

The TIG/plasma video system VISIOARC VA2 can be easily integrated.

It uses a greatly enlarged image which enables the precise position of the welding torch. The operator can then work at remote distance of the welding head; working easier and improving the quality of the welding operations.

WIRE PLACEMENT

2 micro-slides allow a precise impact of the wire into the molten pool. Manual or electrical option.

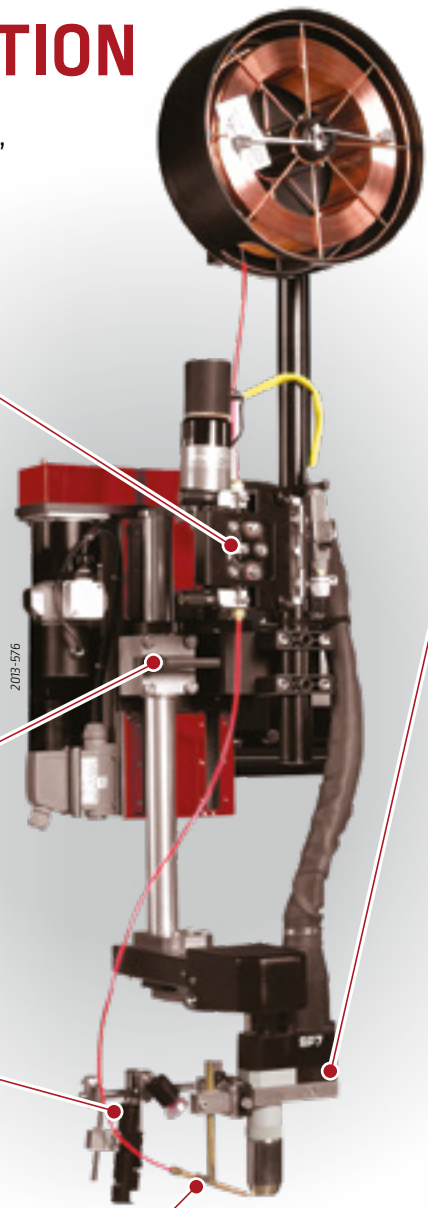

GAS MANAGEMENT

All gases are controlled by the welding installation with flowmeter excepted the plasma gas which is driven by a digital valve in order to fine tune the keyhole process.

COOLING UNIT

The FRIJET 300W is a compact cooling unit used to cool down torches in heavy situation.



	Cooler unit
Primary supply	230 V / 1 ph / 50-60 Hz
Nominal water flow rate	0.26 m³/h
Nominal water pressure	5.5 bars

POWER SOURCE

The NERTAMATIC 450+ is a robust power source polyvalent for TIG and PLASMA applications. An optional AC module can be integrated to control the current by variable polarity for aluminium welding.



	NERTAMATIC 450+
Primary power supply	230 V - 400 V - 415 V - 440 V - 50/60 Hz
Duty cycle	450 A @ 100%
Processes	Plasma/TIG

TORCHES

Water cooled torches high performance to ensure quality and stability of the process and its equipments. Torches equipped with quick connection system for easy change and maintenance.

SP7:

- This torch is the reference in the market, for soft and key hole plasma welding.
- 450 A at 100%.
- Standard electrode simple to replace and self-aligning.
- Cold massive nozzle ensuring long life time.



Options:

- Gas trailing shield to protect welds in sensitive metals.

MEC4:

- For TIG welding
- 500 A at 100%.
- Standard electrode easy to replace.
- Twin HF ignition for better arc striking.

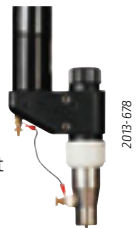

Options:

- Gas trailing shield to protect welds in sensitive metals
- Magnetic arc oscillation.

OCILLARC PLUS For TIG process

Arc deviation

This technique is used to electrically deflect the TIG arc forward in the welding axis, increasing the speed by 30 to 50% for thicknesses of less than 2 mm.



Arc oscillation

Arc oscillation is used to deposit metal over areas up to 15 mm wide to fill bevels or reconstitute surface coating.



CONTROL PANEL

Two different systems to manage the Plasma/TIG process are available.

According the typology of machine, the number of parameters to control, the monitoring and the traceability requirements.

	PILOT ADVANCE	
		
Typology of machine	<ul style="list-style-type: none"> □ Stand alone process for retrofit or integrators □ Simple machine with 1 analog axis 	<ul style="list-style-type: none"> □ Machine management including process with unlimited digital axis
HMI type	<ul style="list-style-type: none"> □ LCD display + quick access buttons □ 99 programs 	<ul style="list-style-type: none"> □ 19" user friendly touch screen □ Unlimited programs
User management	<ul style="list-style-type: none"> □ General lock 	<ul style="list-style-type: none"> □ User profiles management
Traceability & reports	<ul style="list-style-type: none"> □ Program edition 	<ul style="list-style-type: none"> □ Program edition & WPS □ Production monitoring □ Welding ticket □ Process control

PILOT ADVANCE WELDING ACTIVITY UNDER CONTROL



Clear display of welding cycle and related parameters



Graphic display of the machine and welding head



A suite of welding traceability and supervision embedded or off-line with Pilot Cockpit software



Quick access and display of welding functions



EXPLORE YOUR WELDING DATA

EDITION



Export Programs into Excel format



Export WPS into Excel format

TRACEABILITY



Quick summary report after each bead

SUPERVISION



Track all events of your daily job



Alarms extract for maintenance analysis

PLASMA / TIG MACHINES



The Plasma/TIG applications are multiple and varied, here some examples of machines which answer to the main customer needs.

Assembly of vessels by conventional technique

Column and boom with rotators for circumferential welding.

To assemble 2 vessels, it's possible to put them on rotators and the plasma column and boom carries out the circumferential welding.

Safety and operator comfort are guaranteed thanks to the control of the welding operation from the ground.

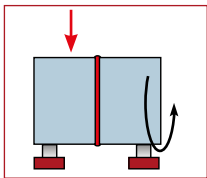

Assembly of flat sheet metal and closure of vessel sections

Seamer bench for longitudinal welding.

The vessel is welded by plasma/TIG or plasma + TIG process inside the INTER seamer bench. The operator can see the joint and adjust the position of the torch thanks to a video camera device.

In/Out feed tables for material handling to help with production.

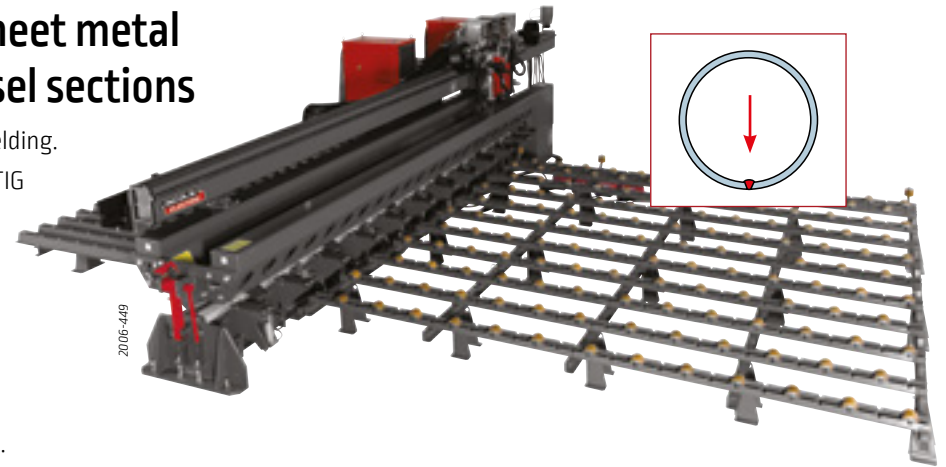

Assembly of vessel in vertical position

This technique is used mainly for large diameter vessels or products whose rigidity is low (ratio diameter, thickness, dimension).

The vertical assembly facilitates the handling of workpieces and reduce tooling needed.

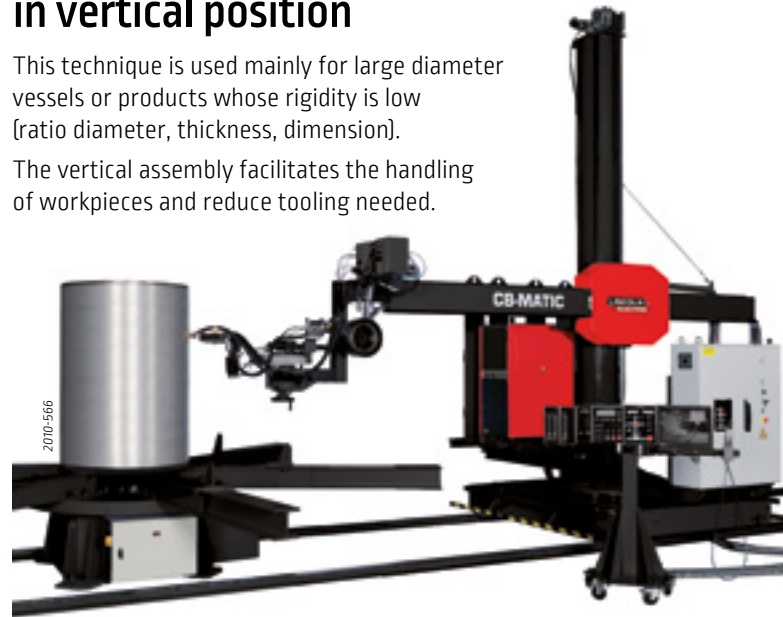

Column and boom with turntable for longitudinal and circumferential welding:

- Longitudinal in vertical down position,
- Circumferential in cornice position.

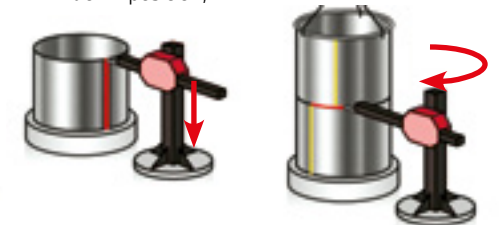

PLASMA / TIG MACHINES

Elliptical tank

The plasma torch movement is controlled by the column and boom. The Headstock HLM+F allows the rotation of the tank and ensures a high flexibility for the mounting and the holding of the piece.



Pipe prefabrication assembly

Mechanisation machine with plasma process and HPW control to weld pipes with elbows and flanges.

The work piece is positioned on the X-rotators and the motorised headstock carries out the rotation.



Pipe production fully automated process

Complete welding system with:

- Column and boom equipped with plasma + TIG process for external longitudinal and circular welding.
- Fixed internal boom equipped with TIG head for internal remelting.
- Pipe holding device with rotators on carriages to turn and move the pipe.



WELDING IN LINE PIPE INSTALLATION

Applications

Lincoln Electric proposes solutions for in line pipe welding to be integrated into pipe mills:

- Monocathode installation with MEC4 TIG torch for tube thickness 0.5 to 3 mm,
- Monocathode installation with SP7 plasma torch for tube thickness 2.5 to 8 mm,
- Tricathode installation with E16 torch for tube thickness 0.5 to 1.5 mm,
- Tricathode installation with E25 torch for tube thickness 1 to 3.5 mm,
- Tricathode installation with combination of TIG + PLASMA + TIG torches for tube thickness 2.5 to 8 mm.



*Piping: Chemical, Petrochemical, Nuclear power industry, Boilers and heat exchanger, Off shore, Cryogenic, Shipbuilding, Military and Aeronautic...
Structure: Industrial building, Commercial center...
Ornamental: Door, Windows, General railing, Furniture, Decoration...*

Typical performances

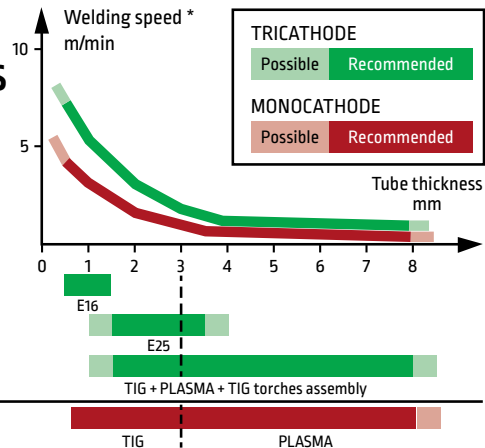

* Welding speeds are indicative and depend on the material, the quality required, and the quality of the pipe mill.

TRICATHODE process

TRICATHODE welding consists of a sequence of three dual-flow TIG processes using a special welding torch. The first arc is fitted with an electromagnetic arc deviation device.

Compared to other welding process used for this type of fabrication, Lincoln Electric's TRICATHODE process is of particular interest in terms of performance flexibility, investment/performance ratio and operating costs.

The basic system consists mainly of:

- 3 x power sources NERTAMATIC 450 Plus,
- 450 A each at 100%, smooth or pulsed current welding,
- Control panel with current control, digital voltage and current displays for each arc, adjustment and displays of gas flow setting, adjustment of electromagnetic arc on first electrode,
- Torches interface including HF source,
- Welding head mounting assembly.



Tricathode Dualgas flux process:

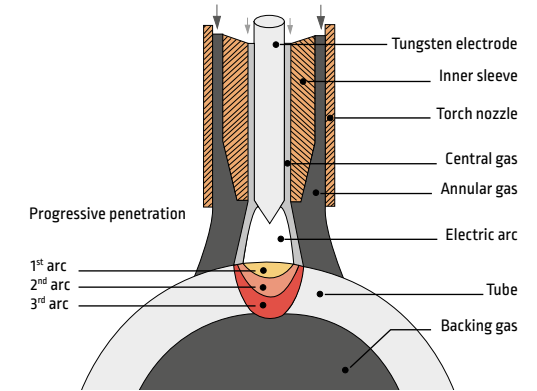

E16 torch

- Implements the dual flow tricathode process.
- 200 Amp per electrode (total 600 Amp).
- Independant adjustment of each electrode to the shoe (one piece design).
- Electrode tungsten Ø 2.4 mm and 3.2 mm.
- Typical application (wall thickness): .5 to 1.5 mm.



E25 torch

- Implements the dual flow tricathode process.
- 400 Amp per electrode (total 1200 Amp).
- Independant adjustment of each electrode to the shoe (one piece design).
- Electrode tungsten Ø 3.2 and Ø 4 mm.
- Typical application (wall thickness): 1 to 3.5 mm.

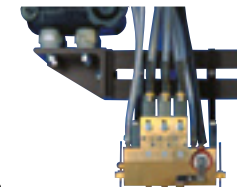

TIG + PLASMA + TIG welding head

- Two MEC4 TIG torches.
- One SP7 plasma torch.
- Independant adjustment on each torch.
- Typical application (wall thickness): 2.5 to 8 mm.



TOPTIG

Applications

TOPTIG process is a major innovation in the world of automatic welding. Developed in the Lincoln Electric research center, **TOPTIG** is a new process from arc welding classical solutions. This new process can be used effectively on carbon or stainless steel plates up to 3 mm or on galvanized sheets with weld brazing.

The activities sectors are:

- Automotive subcontracting,
- Metal furniture,
- Fine boiler making,
- Aeronautics subcontracting.

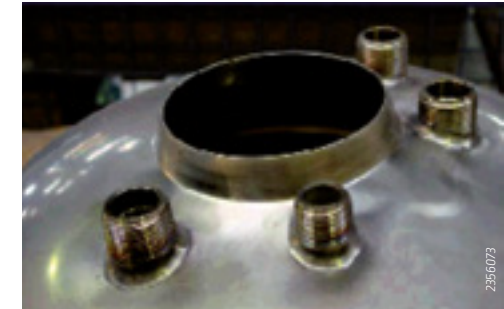

TOPTIG innovative process principle

In TIG automatic welding mode, the filler wire is fed into the weld pool in front of the torch. In the TOPTIG process, the filler wire is fed through the welding nozzle in the area where the temperature is the highest. The wire therefore melts into small droplets exactly as in the MIG process. The use of a pulsed current synchronized with wire gives better control over the welding operation.

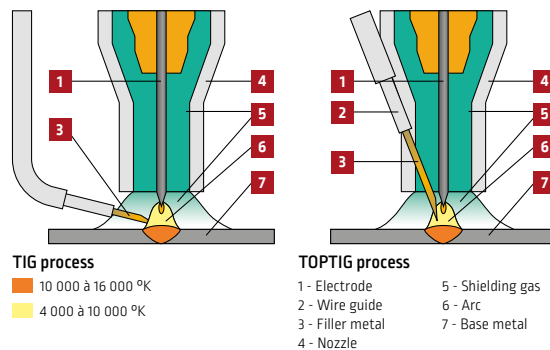

Torch accessibility

Compared with a traditional automatic TIG torch, the compactness of the wire lead-in incorporated into the nozzle gives accessibility at an angle comparable with that obtained using a MIG/MAG torch.

This increases the scope for robotization and extends the range of workpieces which can be welded automatically.

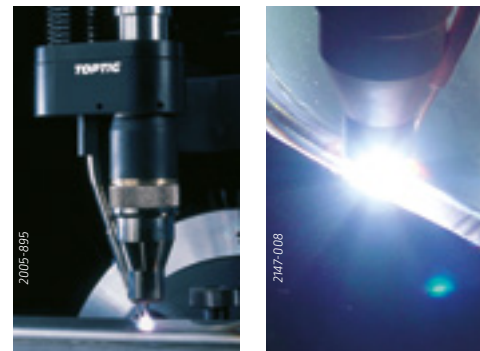

Installation

Lincoln Electric offers two types of **TOPTIG** installation with flat or pulsed current. It can drive a constant or pulsed wire feed which is synchronized with the welding current.

TOPTIG 220DC

TOPTIG 220 DC supplies 220 A at 100% duty cycle. The RC-JOB permits a complete welding cycle to be programmed. Program selection and chaining is carried out by analog signals.



TOPTIG NERTAMATIC 450 PLUS

The console permits a complete welding cycle to be programmed. Program selection is carried out by binary code, and program chaining by pulse. Torch capacity is upgraded to 350 A at 100% using a water cooled nozzle.

MICROPLASMA

Manual and automatic welding applications

For the manual or automatic assembly of thin precious metals in the thickness range: 0.05 - 1.0 mm (stainless steels, Inconel, titanium, silver and gold alloys). For the electric and electronics components industries, small containers, metal filters and tool repairs as well as sectors of the horology, goldsmith and medical industries.

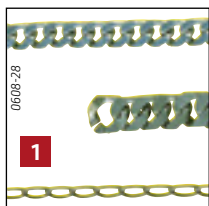

1 - Jewellery



2 - Fine sheet metal work



3 - Small containers



4 - Filters

Installation

PLASMAFIX 51 Characteristics:

- User friendly front panel,
- Multilingual display,
- Programmable welding cycles,
- 100 programs memory,
- Configuration adapted to the user's needs,
- Program print out,
- Also for TIG welding,
- Equipped of RS 232 for coupling a P.C or printer,
- Cooling by a liquid,
- Tungsten electrodes: Ø 1.0 or 1.6 mm, 75 or 150 mm long.

Installation with cooling unit on trolley



Torches

Two types of torch for use in manual or automatic mode:



SP45 automatic



SP45 manual

Torch maintenance box with set of wear parts

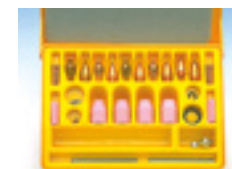

Options

- **Welding lathes**
Precision circumferential machine for microplasma and TIG welding.
- **Trolley**
Able to receive the PLASMAFIX 51 power source, the cooling unit and two gas bottles.
- **Double welding command pedal**
(replaces the torch trigger).
- **Trigger and current adjustment pedal.**

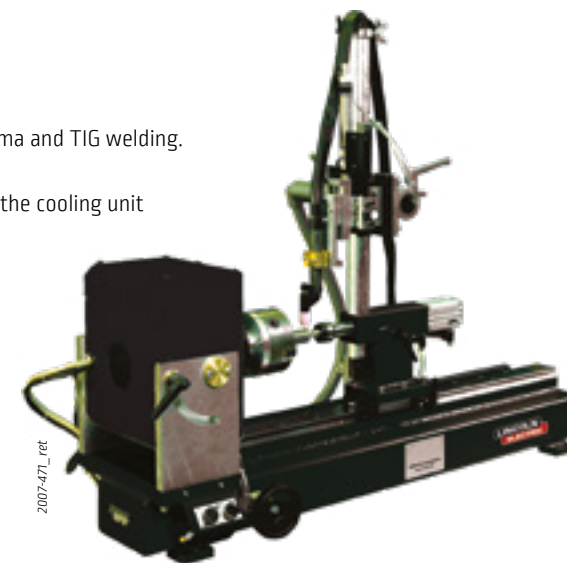

SAW SUBMERGED ARC WELDING

Applications

Process for welding and hard surfacing of low alloyed carbon steel, stainless steel and refractory steel. It combines productivity, quality and operator comfort.

It is used in thicknesses from 3 to 300 mm and provides a high welding speed and high deposition rates. With one or more wires, it is found in many industries: infrastructure, shipbuilding, offshore pipe mill, heavy duty pressure vessels, energy...

Performances

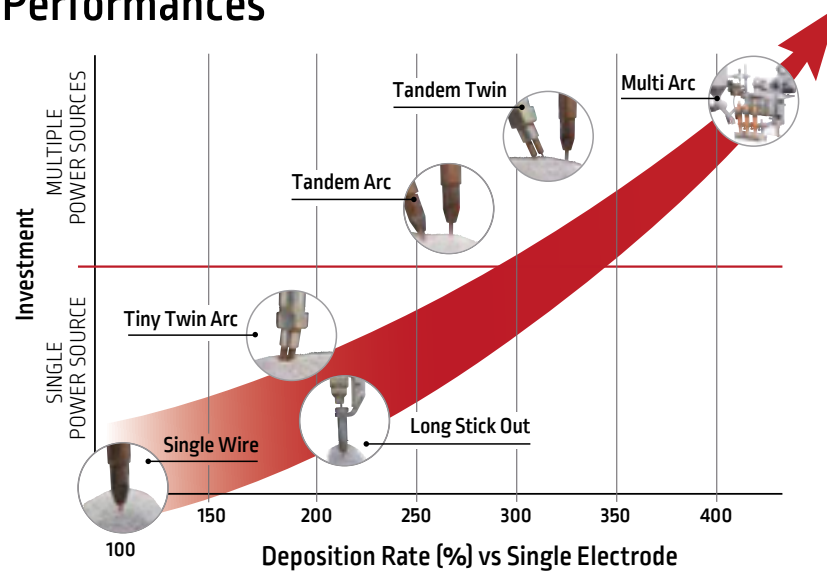

LSO: Long Stick Out

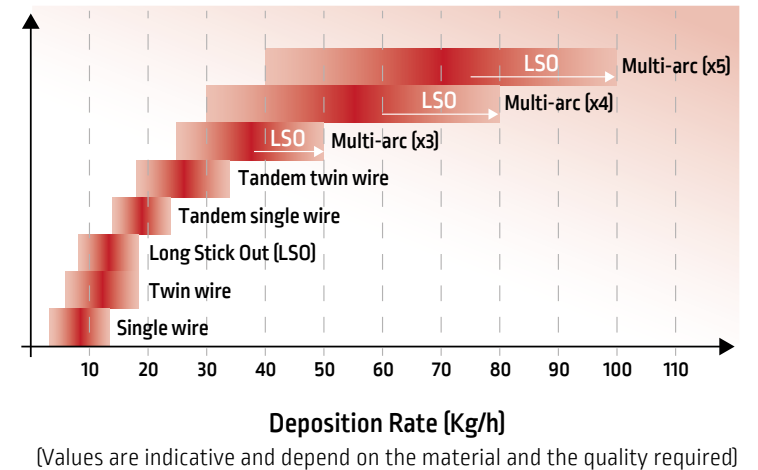

AC wave form

Complete management of the AC wave form with the control of the frequency, balance and offset for a maximum flexibility of production.

Control the penetration and geometry of the weld bead.

Eliminate the effect of magnetic arc blow.

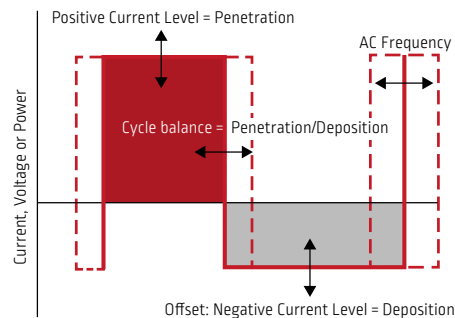
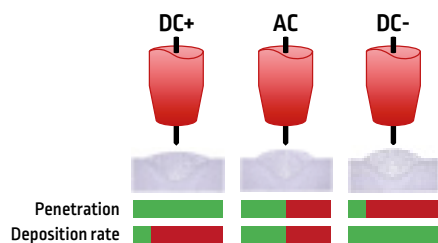

With AC wave form, increase deposition rate up to 50%.

LSO: Long Stick Out

In submerged arc welding, Stick Out, is the distance between the contact tip and the work piece. This distance can be increased using dedicated extensions to obtain what is known as Long Stick Out (LSO).

The wire electrical resistance increases with its length. Thanks to the "Joules" effect, the electrode is pre-heated and melts faster than it would, at the same amperage, with standard Stick Out.

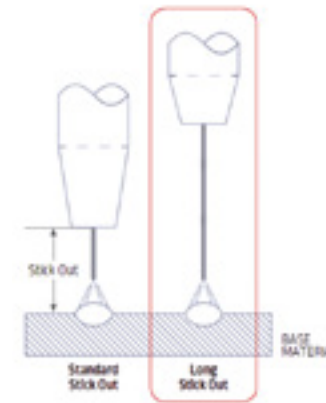

LSO combined to AC wave form, increase deposition rate up to 100%.

SAW INSTALLATION

A large range of welding heads

Tubular version for multipurpose applications:

- Flat welding,
- Longitudinal or circular fillet,
- Single,
- Tandem,
- Long Stick Out,
- Narrow gap.

Dedicated heads for internal diameters.

Remote control RC-MATIC

For immediate action throw push buttons. Connected at the welding head through a cable of 5 m. The operator can get the useful basic function of SAW head management. Fixation of the remote control is secured by a magnet.



Laser spot

To show the wire point of impact relative to the joint on the workpiece. The spot projects an illuminated point in front of the electrode wire for guiding. One spot is used for horizontal alignment and the association of two spots make it possible to monitor the horizontal and vertical position.

Seam tracking

TRACKMATIC device guarantees the good positioning of the torch in the joints to be welded without operator intervention.

A sensing probe finger or an inductive or laser sensor allows joint tracking (height or alignment) and commands the necessary corrections required to the torch trajectory thanks to motorised slides travel 100 - 200 or 500mm. Whilst increasing productivity, it ensures a constant weld quality, a reduction in repair operation and easier use for the operator.

Flux recovery equipment

A compact unit to significantly reduce manual refilling and improve productivity.

- Hopper 10 liters,
- Powered by compressed air,
- Pressure 4 to 6 bars,
- Venturi device with tank,
- Filter cartridge for recovery and dust filtration.

Centralised recovery

Centralised flux recovery system through pushed flux device and electrical turbine.

Ideal system for heavy duty applications.

- Filtration of flux dust,
- Reduced flux consumption,
- Minimum flux handling,
- Optional device to keep temperature of flux up to 120 or 200 °C.

Video Camera

Combined with a laser spot, the video camera unit allows to view the welding area and can remotely control the positioning of the torch in the joint. This is an essential tool for welding in difficult access area like inside a tank of small diameter. The equipment is supplied with a spot light to illuminate over viewed area, and a color LCD industrial screen high definition 15".

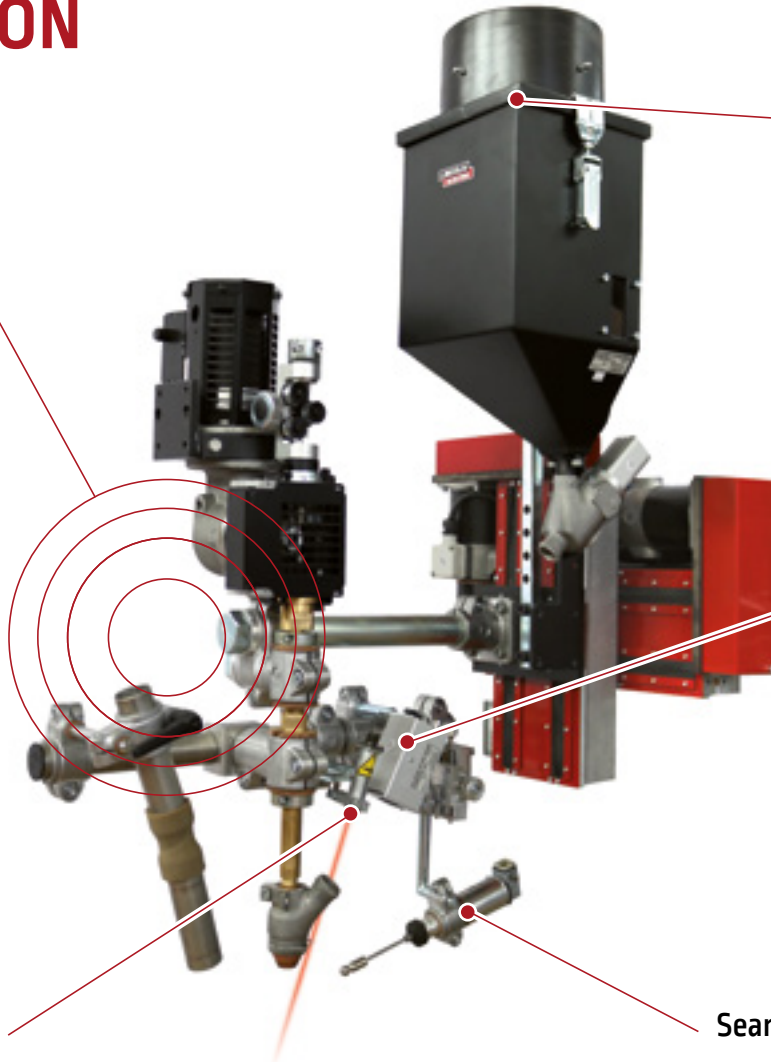

SAW INVERTER POWER SOURCES

FLEXTEC® 650X



POWER WAVE® AC/DC 1000 SD

Lincoln Electric offers inverter technology for DC and AC SAW (Power Wave® AC/DC 1000 SD) or only DC (Flextec® 650X):

- Efficient power consumption reducing operating costs,
- High duty cycle at 100%,
- Easy to integrate from conventional interface to digital unit.
- Multi-purpose installation:
 - CV: Constant Voltage,
 - CC: Constant Current. (only 1000SD)

	FLEXTEC® 650X	POWER WAVE® AC/DC 1000 SD
Power supply (3x 50-60Hz)	380-460-575 V	380-400-460-500-575 V
Effective power at 100%	46 kVA	55 kVA
Current range	40-815 A	100-1 000 A
Duty cycle at 100%	650 A / 44 V	1 000 A / 44 V
Weight	75 Kg	363 Kg
Dimensions L x l x H	745 x 410 x 554 mm	1 248 x 501 x 1 184 mm
Protection index	IP 23	IP 23

MAXSA® 10 Mobile Console

The MAXSA® 10 associated to the Power Wave® AC/DC 1000 SD or FLEXTEC® 650X allows to manage the main welding parameters for a total control of the Submerged Arc process.



PILOT PRO Digital management

Both power sources can be associated to PLC controller PILOT PRO with Arlink® XT protocol for a complete management of the machine movements and the Submerged Arc process inside.



SAW DC MULTI-PROCESS INSTALLATIONS

IDEALARC® DC 1000



IDEALARC® DC 1500



If an application requires pure welding power combined with multi-process power, then the IDEALARC® range with smooth DC output is your best investment. Designed for Semi-automatic and automatic welding, the precise control of the IDEALARC® provides superior MIG, flux-cored, submerged-arc welding and excellent air carbon arc gouging with up to 16.0 mm diameter carbons.

	IDEALARC® DC 1000	IDEALARC® DC 1500
Power supply (3x 50-60Hz)	380-440 V	
Effective power at 100%	74 kVA	121 kVA
Duty cycle at 100%	1 000 A / 44 V	1 500 A / 44 V
Weight	372 Kg	644 Kg
Dimensions L x l x H	991 x 567 x 781 mm	965 x 566 x 1 453 mm

NA-5



NA-3S



Improve productivity with the NA-3S or NA-5 automatic wire feeders. These systems have been specially designed to deposit more weld metal at faster travel speeds which eliminates bottlenecks and cuts costs. NA-3S regulates in CC mode NA-5 regulates in CV mode.

SAW HEADS & CUSTOM APPLICATIONS

Lincoln electric offers a large range of welding heads from standard to special models for a perfect adaptation to the customer application.

Single Arc



- For single or tandem standard or Long Stick Out from 1,6 to 5,0 mm
- Twin wire 2 x 1,6 to 2,4 mm
- Internal diameter 1500 mm

Tandem Arc



Compact tubular head



- Single or tandem wire,
- Internal diameter 750 mm.

Internal head



- Single or tandem wire,
- Internal diameter 500 mm.

Long Stick Out head

Mainly used to increase deposition rate, then the travel speed will increase as well with benefit of better productivity, number of passes reduced, and cost reduction.

It can be used in single wire, or tandem wire with a choice of 1 or 2 LSO torches, in all these industrial applications:

- Power Generation,
- Nuclear,
- Pressure Tanks,
- Windmill,
- Petrochemical,
- Infrastructure.



Narrow gap head

Narrow Gap process used for welding thick plates. Mainly for the following industrial applications:

- Power Generation,
- Nuclear,
- Pressure Tanks,
- Windmill,
- Petrochemical.



Process

It is a Submerged Arc process with single or tandem narrow gap torch, designed to weld thick plate (generally over 50 mm) using practically parallel sides and narrow gap preparation.

Narrow gap process allows to increase productivity and to result in lower cost welding by decreasing the volume of metal needed and the welding time compared to conventional preparation with bevel.

The process is adapted for both longitudinal and circumferential welding.



SAW EQUIPMENT

Flux management

Equipment to improve productivity and ensure operator safety.

Flux recovery

A compact unit to significantly reduce manual refilling of the flux feed hopper 10 liters. Powered by compressed air. Pressure 4 to 6 bar. Venturi device completed with tank and filter cartridge for recovery and dust filtration.

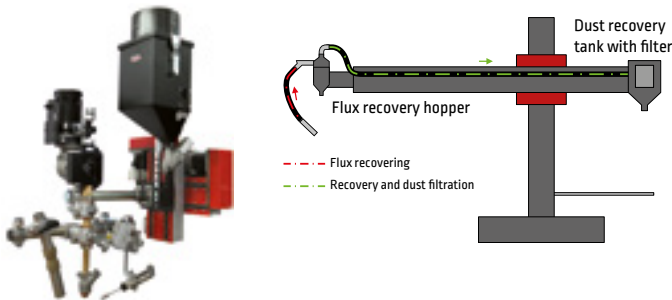

Pushed flux

Pushed flux supply system providing a greater welding autonomy due to the flux tank capacity of 70L.

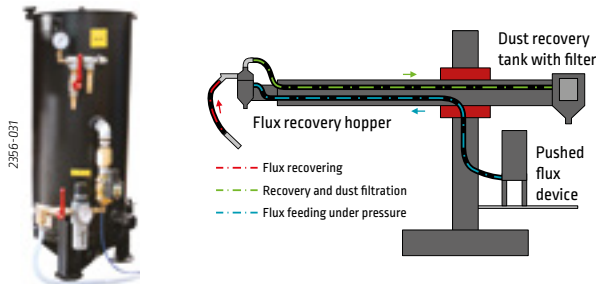

Centralised recovery

Centralised flux recovery system through pushed flux device and electrical turbine with filtration of flux dust. Ideal system for heavy duty application with reduced flux consumption and minimum flux handling. The system can be equipped with a device to keep the temperature of the flux up to 120 or 200 °C.

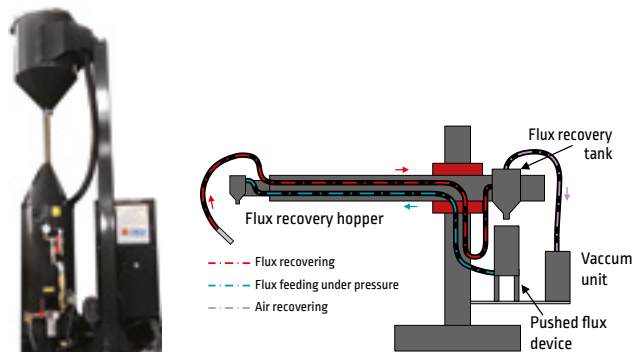

Wire management

Lincoln electric proposes optimized packaging solutions for submerged arc welding. All wires are free from any organic component limiting the diffusible hydrogen contribution to the weld metal.



Drum accessories:

Turn table

designed to dispense all sizes and grades of wire. 4-axis adjustable arm with ceramic inlet guide prevents wire shaving. Quick disconnect allows for easy conduit connections.



The pneumatic Feed Assist

provides an economical method to assist your wire feeder in moving wire through the conduit in applications where long conduit runs are necessary.



SAW TRACTORS

SAW tractors to perform regular weld for many applications:

- Bridge and barge decking
- Shipbuilding
- Offshore
- Large tank fabrication

- Heavy manufacturing
- Beam fabrication

LT-7 tractor

The **LT-7 Tractor** is a self-propelled mechanized wire feeder, designed for submerged arc process with track system capabilities. It is self-guiding and easy to operate.

For welds butts, horizontal fillet and lap joints to the left or right side of the tractor frame.

- Straight weld,
- Curved weld,
- Wire size 2,4 to 4,8 mm,
- Travel speed 0,12 to 1,8 m/min.

Recommended power sources:

- **IDEALARC® DC 1000,**
- **IDEALARC® DC 1500,**
- **FLEXTEC® 650X.**



LT-7 Tractor
Single or twin wire

CRUISER® tractors single or twin wire

For single or twin wire, the self-propelled modular **Cruiser®** and **Tandem Cruiser®** travel carriages can deliver deposition rates up to 13 kg per arc per hour for butt and fillet joints on lengthy plate welding applications.

- Advance control pendant,
- Wire size 1,6 to 5,6 mm,
- Digital meters,
- Travel speed 0,25 to 2,5 m/min.

Recommended power sources:

- **POWER WAVE® AC/DC 1000 SD**

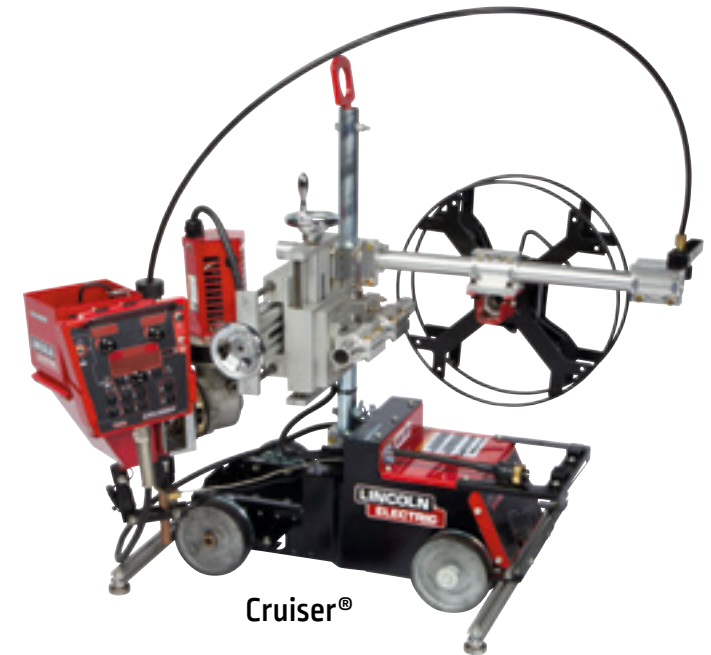

Cruiser®

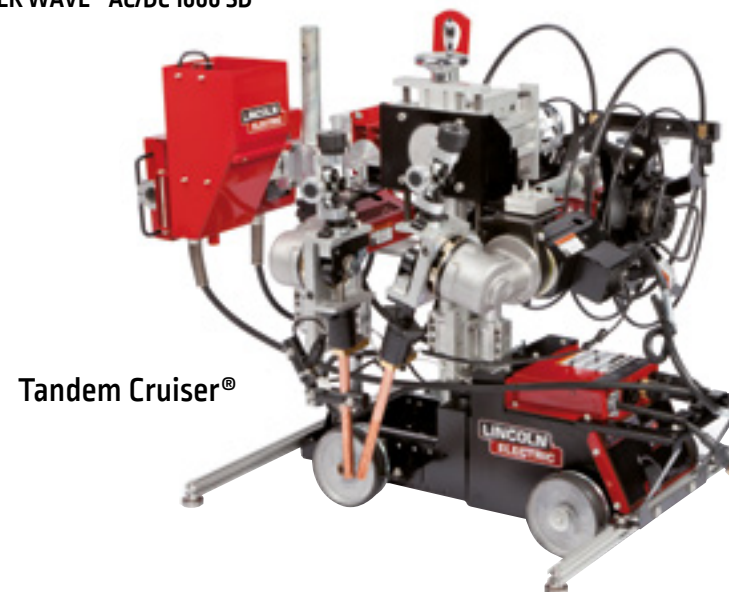

Tandem Cruiser®

SAW COLUMN & BOOM

C&B allows an easy and robust positioning of the submerged arc welding process. Ideal for many industrial segments such as:

- Pressure vessel manufacturers
- Heavy fabrication in mild steel or stainless steel
- Chemical processing
- Power generation, energy
- Infrastructure

Available in various sizes and load capacity, in fixed or mobile version, with a large choice of options C&B is the best versatile equipment of workshops.

C&B associated with various positioning systems allow the movement or rotation of the parts to maximize the use of the equipment in a large range of applications.

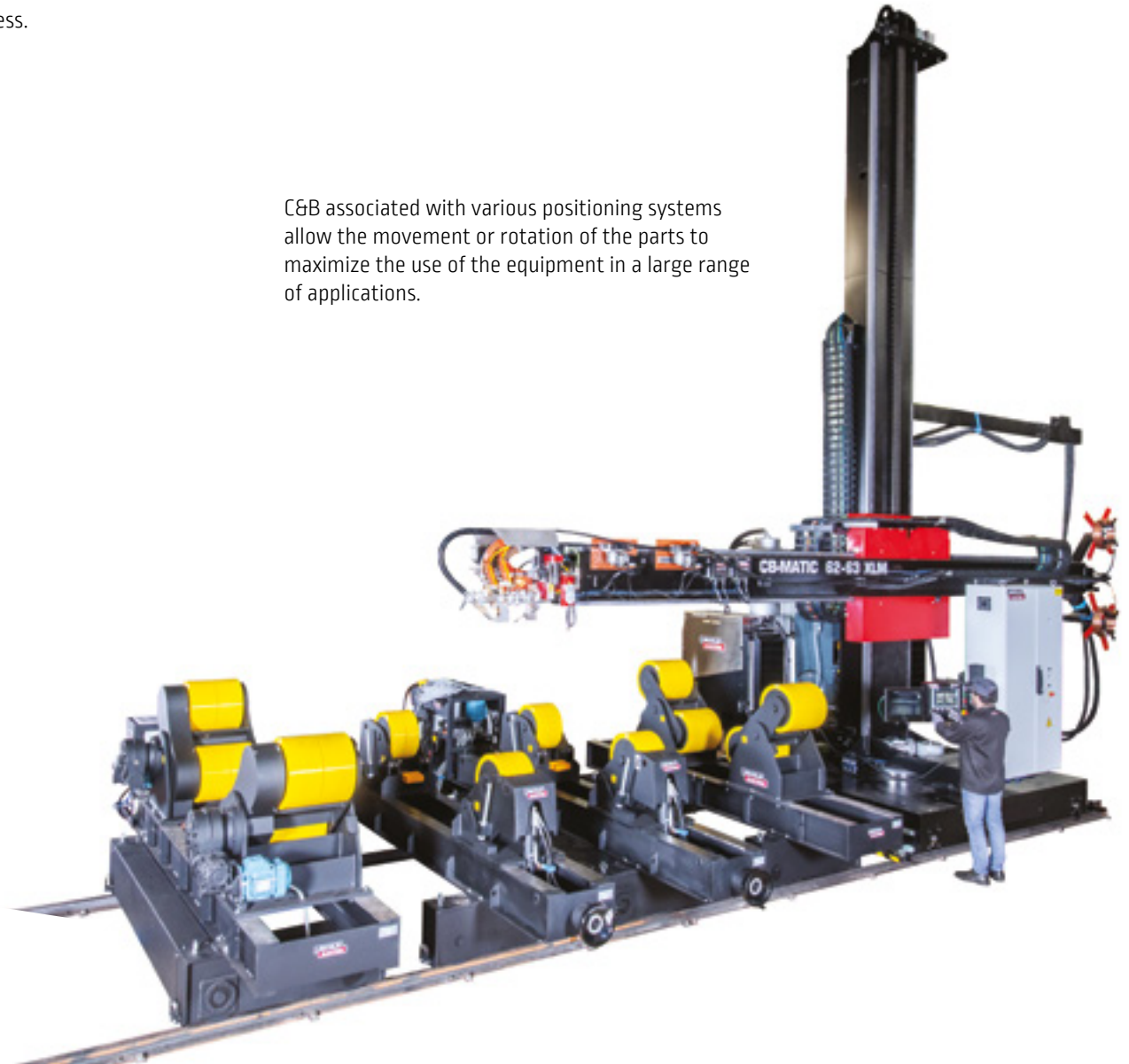

SAW INTERNAL BOOM



The main processes are:

- Pipe manufacturing by internal longitudinal welding,
- Assembling of 2 pipes by circular welding.

Once the internal weld is done, the outside weld is performed by another equipment. The structure and configuration of the internal boom depends of the length of the pipes. Pipes from 4 m to 12 m long.



2013-486LE



2012-562LE

2012-327LE

BEAM-MATIC

The automation of long workpieces welding (beams, wagons, box section constructions) requires sophisticated machines which move on rails.

The **BEAM-MATIC** system is used to weld beams of constant or varying cross-section in widths between 220 and 2 000 mm *.

* *Other dimensions on request.*

2 types of **BEAM-MATIC** are available:

- Cantilever: CT,
- On base column and boom: LM.

The **BEAM-MATIC** allows to weld in MIG-MAG or SAW (single or twin wire) process.

In standard, the machine is equipped with a flux recovery device and a pushed flux supply.

Possibility to use wire spools or wire drums on the 2 **BEAM-MATIC**.

The torch level is fix on the **BEAM-MATIC CT** and it's possible to lift the torch level on the **BEAM-MATIC LM**.

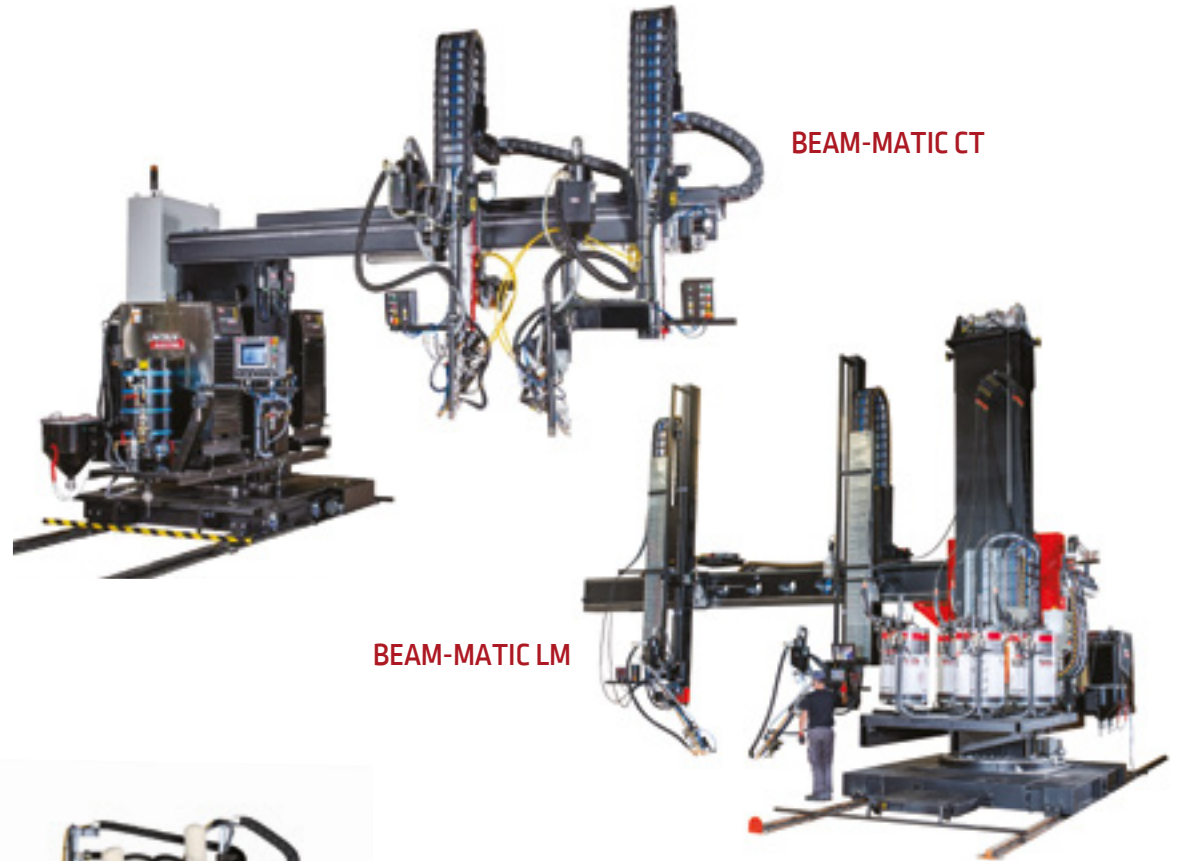
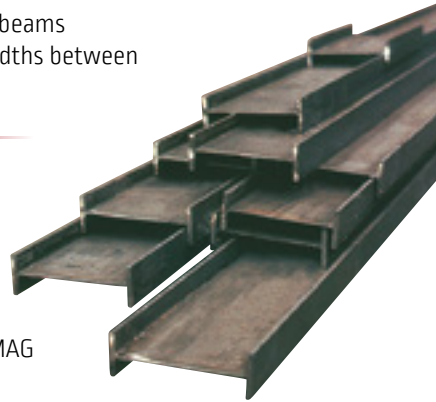

Clamping bench:

The clamping bench allows the positioning of the web and the flanges before the welding, with an additional clamping bench it's possible to save time and increase productivity.



Standard / Dimensions for clamping bench

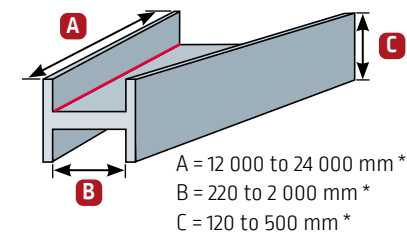

Web thickness: 4 to 20 mm
 Flange thickness: 10 to 30 mm

* *Other dimensions on request.*

LAMP-POST SOLUTIONS

High productivity performance machine equipped with SAW or Plasma welding process. No tacking of parts is required.

A dedicated software manages the lamp post production including automatic positioning of the pole edges before welding according to the various shapes and conicity of each product.

A burner ramp or an inductive system under the lamp-post reduces the welding distortions.

Several options are available on request.

- A:** 3 to 17 m
- B:** 60 mm mini - 600 mm maxi
- C:** 3 to 6 mm
- Round conical, polygonal
(32, 16 and 8 sides)
- Conicity maxi: 50%

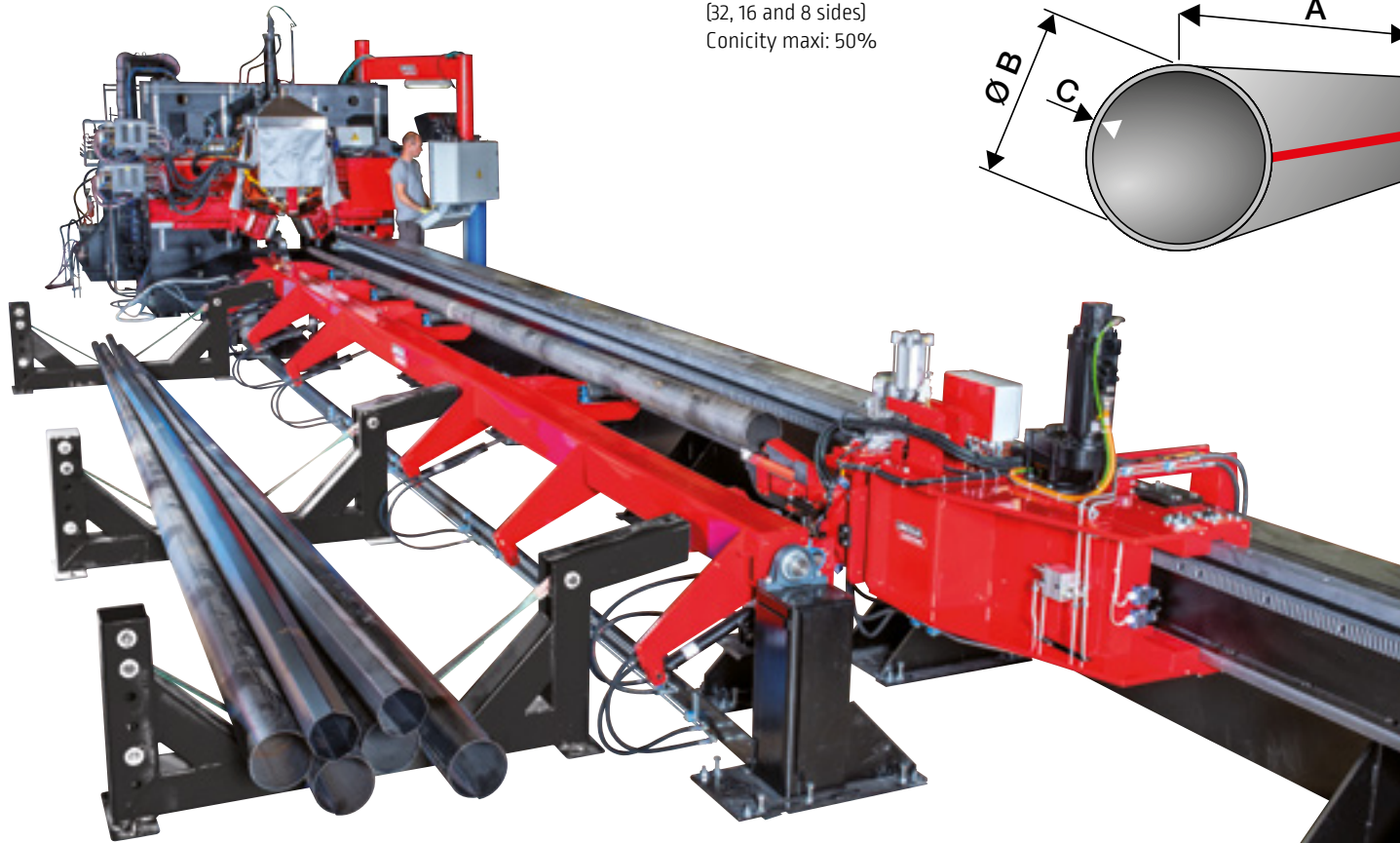
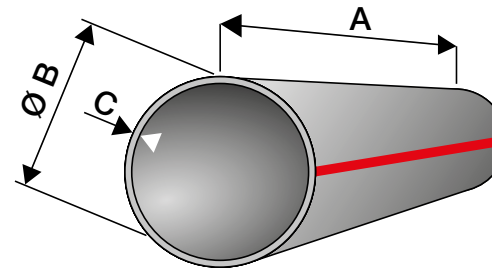
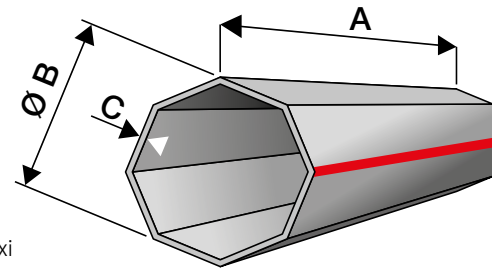

WELDING PROCESSES

- SAW single wire diameter from 1.6 to 5.0 mm
- Plasma welding 3 or 4 heads

MACHINE CYCLE

- PILOT controller
- Overview and control in real time of the machine, parameters recording, remote connection

PERFORMANCES / OUTSTANDING POINTS

- Joint tracking with camera and operator joystick
- Only 1 operator
- Machine availability: 95%
- Fix machine / Movable piece
- Speed range: 1 m/min to 3 m/min according to process and thickness

SAW MULTIPLE WIRES

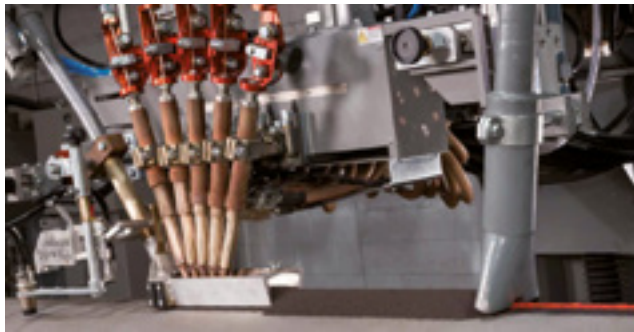

3arc welding head

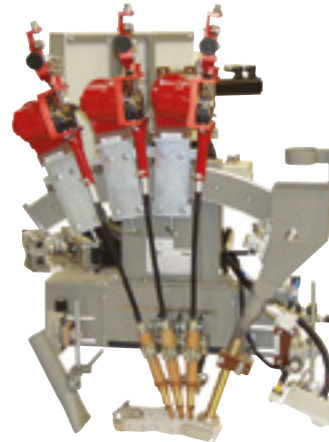

Helical or circumferential welding



Longitudinal welding

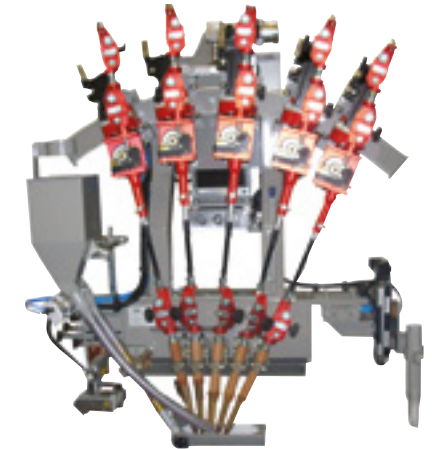

PERFORMANCES

SAW MULTI-ARCS SYSTEM

The **Lincoln Electric** Automation proposes to integrate multiple wires head from Uhrhan & Schwill GmbH company world-renowned specialist for Pipe Mills segment.

E5 system

The E5 system manages all the parameters of the multi-arcs welding and it can be associated to another controller for a complete management of the machine:

- Single arc, Tandem arc or triple arc,
- Long Stick Out process,
- Touchscreen based remote control,
- Management of programs and memorization,
- Manual control of wire and flux feeding,
- Display of all real-time measurement values like voltage, ampere, wire feed speed, torque.



Z5 system

The Z5 system manages the complete machine components and all the parameters of the multi-arcs welding:

- From single arc to multiple arc (x6),
- Long stick out process,
- Large touchscreen,
- Full control of wire and flux feeding system,
- Display and recording of all real-time measurement values like voltage, ampere, wire feed speed, torque, movement speed...
- Seam tracking by laser scanner.

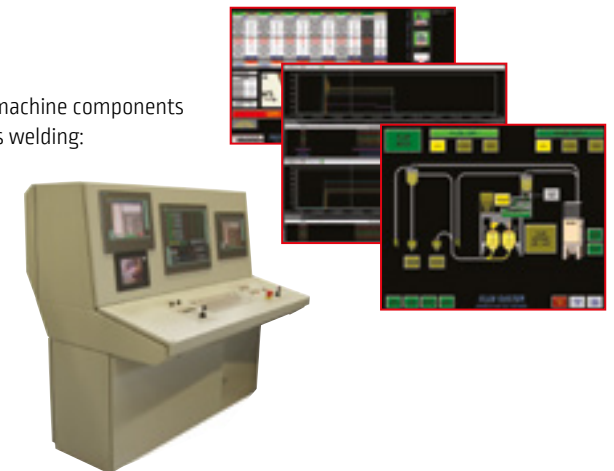

STRIP CLADDING PROCESSES

Cladding is a fundamental process in the pressure vessel industry and is applied across whole spectrum of applications, from Nuclear, Oil and Gas industries to Chemical Processing equipment and steelmaking. Cladding is required on the process side of high pressure critical process plant equipment to provide corrosion resistance against highly severe corrosive service fluid or to increase wear resistance of a component being subjected to heavy wear and tear applications e.g. continuous casting rollers in steel mills.



Submerged arc strip cladding

- The arc causes more penetration into the base material, resulting in dilution levels of ~20%.
- Deposition rate: 12-14 kg/h for 60 x 0,5 mm strip.
- Current range restricted to limit dilution.

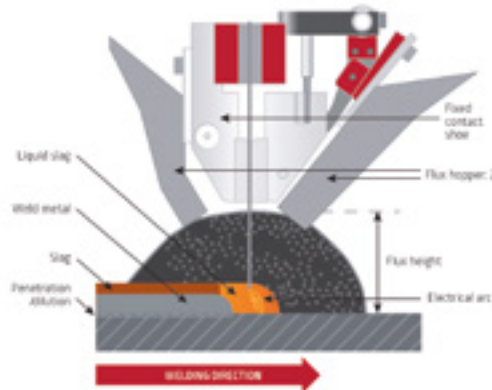

Electro slag strip cladding

Conventional

- Arc-less process, use conductive flux and works on Joule's resistance heating principle.
- The strip current passes through the molten slag. The resulting resistance heating effect melts the strip and deposits the molten weld pool onto the base material.
- Low dilution level (9 to 12%). Process has significant advantages over SAW.

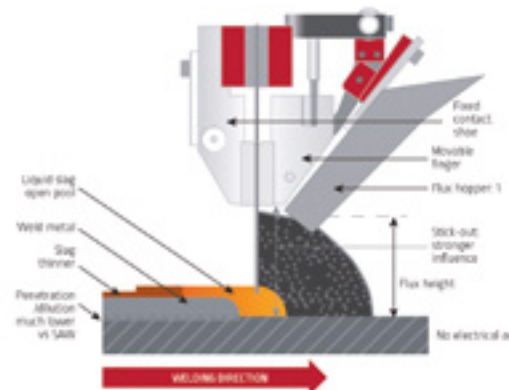

Hybrid Technique*

- Hot metal cored wires added to the molten pool as 3rd constituent.
- Always in single layer, coupled with high welding speed.
- Lowest dilution level coupled with the highest deposition and faster surface coverage rates.

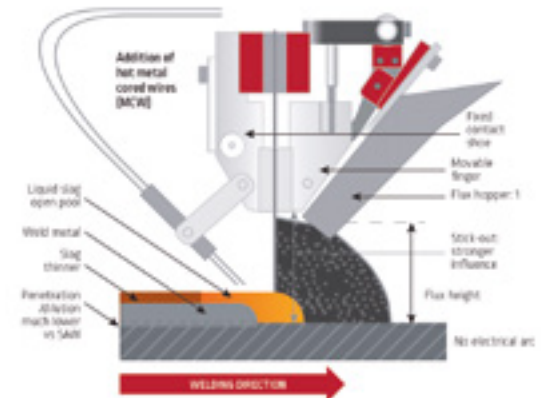

STRIP CLADDING PROCESSES



Comparison:

- Submerged arc (SAW).
- Electro slag conventional (ESW 2D).
- Electro slag hybrid* (ESW 3D).



	Submerged Arc	Electro slag	
		Conventional	Hybrid*
Consumables	Strip + SAW Flux	Strip + ESW Flux	Strip + Metal Cored Wire + ESW Flux
Deposition rate [Kg/h] 60 x 0.5 mm strip	12-14	22-30	28-42
Welding speed (cm/min)	10-14	Normal speed: 15-18 High speed: 24-35	1
Minimum number of layer in Ni-625 to achieve <5% Fe chemistry	2	2	1
Flux type for high speed cladding in single layer	NA	Alloyed	Neutral

* Patent Pending

Welding heads

- In-house designed heads for strip widths 15 to 120 mm.
- Water cooled and robust modular design.
- Power cables can be added as required.
- Easily oriented for desired welding direction.

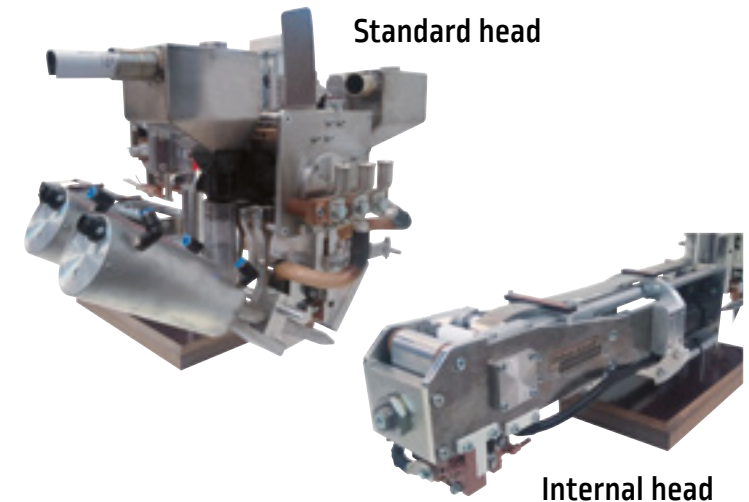

E5 controller

- Management of the welding process with the E5 system and its mobile console.



MIG/MAG INSTALLATION

Wire feeder

AutoDrive® 4R220.
Powerful and robust wire feeders with 4-roll drive system.

Video camera

The video system including protection against spatters and fumes, can be easily integrated. It uses a greatly enlarged image to be viewed thus making the operator's work easier and improving the quality of the welding operation.

Torches

Water cooled torches dedicated for automatic welding MIG/MAG installations.

- Excellent cooling up to the nozzle holder,
- Good gas protection with the long shape of the nozzle.

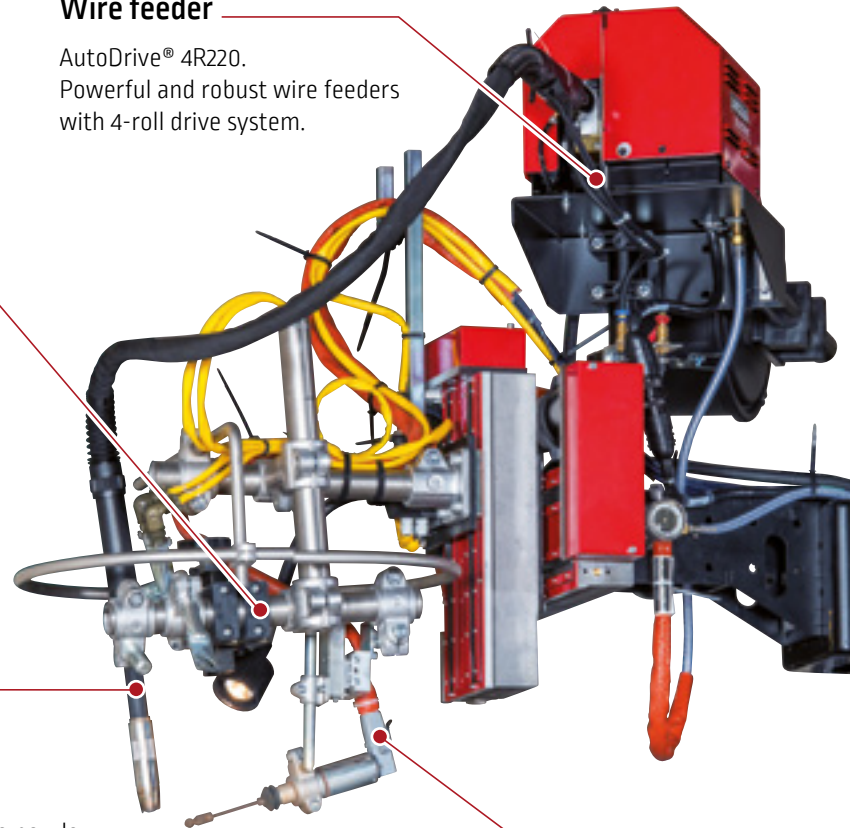

PILOT PRO Digital management



The PLC controller PILOT PRO with Arclink® XT protocol for a complete management of the machine movements and the MIG/MAG process inside.



Seam tracking

TRACKMATIC device guarantees the good positioning of the torch in the joint to be welded without operator intervention.

It ensures a constant weld quality, an increase of productivity.

Characteristics	TM 501W 	TR 600 	TM 700 
Duty cycle	500 A at 100%	400 A at 100%	700 A at 100%
Wire diameter (mm)	1 to 2.4	0.8 to 1.6	1.2 to 3.2
Harness length (m)	1 to 2.5	1 to 4	Without - direct connection
Version	Straight or curved 22 or 45°	Straight or curved 22 or 45°	Straight
Option	-	500 A at 100% with cooled nozzle	Additional gas protection for light metal alloy

MIG/MAG WELDING EQUIPEMENT

Multi-processes power sources

The multi-process Power Wave® R450 and S700 are packed with Lincoln Electric performance technology for welding on thicker materials.

It provides an extremely fast arc response for optimized performance on almost any application and efficiently converts input power to reduce operational costs.



	POWER WAVE® R450	POWER WAVE® S700
Duty cycle at 100% (at 40°C)	450 A / 36,5 V	700 A / 44 V
Primary power supply	230/400/460 V 3ph 50/60Hz	380-415/440-460 V 3ph 50/60Hz
Max primary consumption	54/30/27 A	55/46 A
Current range	5 to 550 A	20 to 900 A
Weight	68 kg	175 kg
Dimensions (W x L x H)	355 x 630 x 571 mm	485 x 932 x 765 mm



AutoDrive® 4R220

- Powerful and dependable robotic wire feeders
- Patented MAXTRAC® 4-roll drive system
- Best in class torque for high-speed applications
- Precise speed control

Add-on modules for Power Wave® R450

STT® Module

- Ideal for productivity and quality improvements with STT® welding and Rapid X®

Advanced Module

- Further expands welding capabilities adding AC polarity, also included STT® welding and Rapid X®



MIG/MAG CARRIAGES

Carriages for MIG/MAG welding



2012-196

WELDYPOCKET



2008-509

WELDYCAR



2012-195

WELDYSTIFFENER



WELDY-RAIL

Autonomous carriage with rechargeable battery. MIG/MAG welding with manual equipment.

Flat position welding, small footprint. Basic application, easy implementation.

All positions welding (permanent magnet).

Exists in 2 models:

- WELDYCAR,
- WELDYCAR PRO with programming (continuous welding or not).

Welding with 2 manual welding torches. Programmable carriage.

Exists in 2 models:

- for height: 60-160 mm,
- for height: 120-320 mm.

All positions welding of carbon steels, stainless steels and aluminium.

Exists in 2 models:

- WELDY-RAIL manual,
- WELDY-RAIL with linear oscillating.

2 rail models:

- Magnetic rail,
- Pneumatic rail.

Applications

This carriage is used to facilitate the implementation of a regular welding. Boiler making in carbon steel.

Angle, butt, overhead and vertical welding with guidance by crabbing arm.

Welding of stiffeners in ship yards.



Angle, butt, overhead and vertical welding. The carriage is travelling on a magnetic or pneumatic rail according to the piece to be welded.

Main features

Carriage speed	15 - 120 cm/min	5 - 140 cm/min	15 - 180 cm/min	5 - 80 cm/min
Dimensions (L x l x h)	140 x 240 x 220 mm	250 x 300 x 260 mm	500 x 500 x 600 mm	220 x 270 x 230 mm
Weight (netto)	5 kg	11 kg	16 kg	7 kg
Options	Arc protection	Pendular oscillating unit. Linear oscillating unit. Magnetic crabbing rails, aluminium wheels... many other options on request.	-	Linear oscillating unit for WELDY-RAIL manual.

Thanks to a modular design, the carriages can be used in different configurations.



2000-438



ORBITAL AUTOMATED WELDING SYSTEMS

GMAW / FCAW / GTAW

The GMAW / FCAW / GTAW welding systems are digital welding solutions for MIG, Flux Cored, Innershield and TIG.

All aspects of the weld are controlled by the system and saved into different programs and passes.

While welding, the operator has the ability to make on-the-move corrections.

These corrections can be set to a specific range by the welding engineer or supervisor.

▣ Full control

The APEX®3 series ergonomic hand-held pendant with con-based interface and full-color screen simplifies the control and monitoring of weld activity.

▣ Easy to use

The weld head is a quick release. It allows for tool-less installation and removal from track ring.

▣ Quick torch set-up

Tool-less adjustment of the welding torch angles.



00009804



00007925

ORBITAL AUTOMATED WELDING SYSTEMS

GMAW / FCAW / GTAW

APEX® 3 series

- Large friendly screen pendant
- Adapted for use in low light and sunlight
- Ergonomic buttons
- Welding programs management including welding process, motion, mechanical oscillation, stick-out regulation, sectors and passes
- User management
- Optional operator pendant



HELIX M85 weld head

- Compact design
- Quick release system
- Tool free torch set-up
- 8,5" (215 mm) radial clearance without torch
- 14,6" (370 mm) radial clearance with standard MIG torch
- 2" (50 mm) oscillation stroke
- Patented gear drive motor
- Precise motion



- Automatic stickout regulation
- Embedded inclinometer

HELIX M45 weld head

- Compact design
- Quick release system
- Tool free torch set-up
- 4,5" (114 mm) radial clearance
- 5" (127 mm) oscillation stroke



- Torch tilt +/- 45°
- Embedded inclinometer

POWERWAVE® S500

- High-performance, reliable welding source
- Inverter technology
- 450A at 100% duty cycle
- Large choice of GMAW and FCAW process
- Optional STT® module



Tracks

OD track rings come in sizes **from 8" (203 mm) to 96" (2 438 mm)** as standards sizes.

All standard track rings are hinged and open using quick-release latches, significantly reducing the setup time.



Flat Track 48" (1 219 mm) can be bolted together to create length tracks as required.



TIG PACKAGE

APEX® 30S

- Stackable cabinet with Power Wave®
- Included gas solenoid and flow sensor



MIG PACKAGE

APEX® 30M

- Combined control and wire feed
- MAXTRAC 4 roll drive system
- Best in class torque for reliable wire delivery

- Tool-less drive roll, wire guide and pressure arm adjustment
- Precise wire feed



FLEX-FAB ROBOTIC WELDING CELLS

High productivity solution

- Performing robot with several features and options
- Advanced welding equipment with a large choice of MIG/MAG processes
- Fume extraction and filtration for a better environment
- Optimized wire feeding system with high quality consumables
- Fixture on demand, depending on the application
- Assistance, service and maintenance of your equipment
- Software solutions to manage data and traceability



Robotic welding cells offering the latest technology, ready to use, including:

- **HIGH PERFORMANCE ARC ROBOT** 6-axis high performance and suitable for arc welding.
- **HOLLOW WRIST** for a better accessibility and reability.
- **TORCH SERVICE CENTER** for calibration and maintenance
- **SMART TAC** for piece detection and relocalisation
- **DOUBLE WORK STATION** to boost productivity
- **WELDING PACKAGE** Power Wave® R450
- **FENCNG PROTECTION** and vertical light curtain

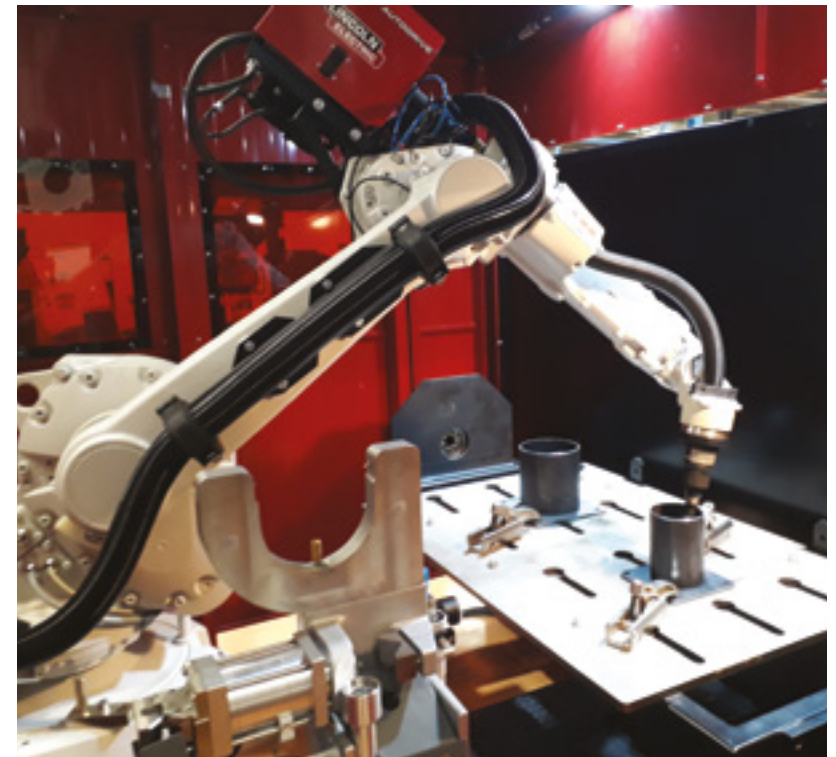

AN OPTIMAL RANGE FOR SMALL TO MEDIUM PARTS

With our Flex-Fab robotic welding cells, we have engineered newer, more advanced and more affordable robotic systems to support manufacturers of all sizes - from the small shop owner to medium part supplier.

An automated robotic welding cell can help you speed up production, reduce labour costs, improve weld integrity and consistency, and reduce downtime.

FLEX-FAB - FT-DS

Benefits:

- Ideal for welding small to medium-sized parts that do not require rotation or repositioning
- Minimal installation
- Improves productivity, quality and safety

Examples of Manufactured Parts:

- Enclosures and boxes, such as electrical panels
- Food service equipment
- Miscellaneous: small brackets, handrails, education institutions

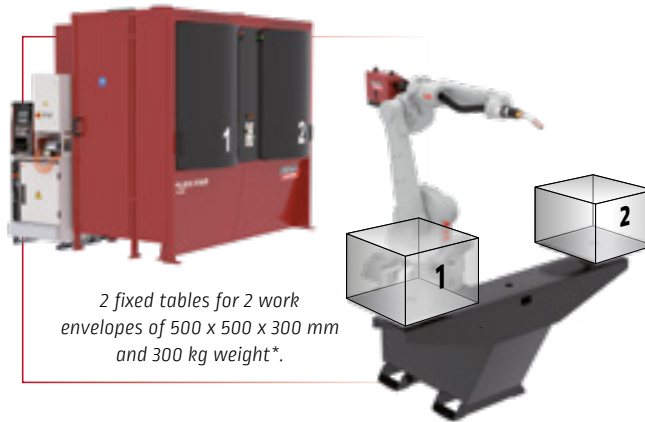

FLEX-FAB - XFT

Benefits:

- Single load and unload area with two independent work zones
- Turntable system provides 180-degree rotating work area for increased throughput efficiency
- Ideal for small- to medium-sized parts not requiring reorientation
- Promotes optimum use of floor space
- Servo-driven positioner has no mechanical components and is nearly maintenance-free

Examples of Manufactured Parts:

- Construction equipment, such as subassemblies, cylinders
- Heat exchangers
- AC ventilation
- Foodservice equipment
- Miscellaneous: brackets, satellite dish brackets, rebar brackets, couplers, stair treads

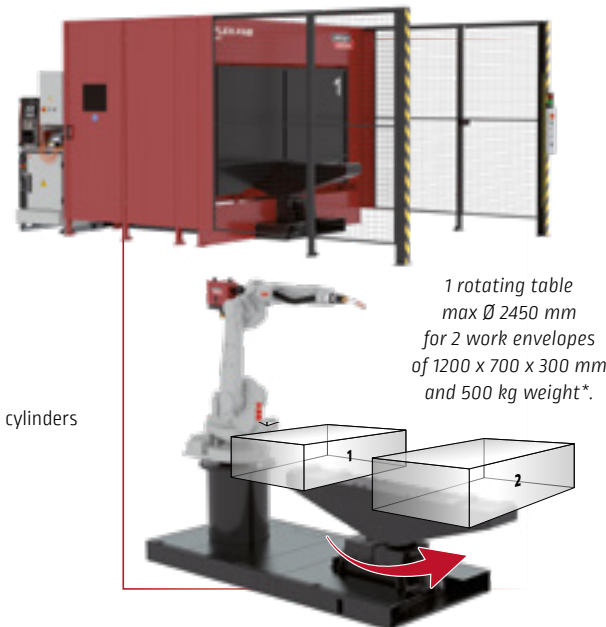

FLEX-FAB - XHS300 FLEX-FAB - XHS600

Benefits:

- Enhance part production by improving productivity, quality and safety
- Dual zone with a rear-mounted robot on an H-Frame positioner
- 180-degree rotation for single load/unload access point
- Smaller arm and system footprint produces higher throughput rates
- Optimized to maximize the work envelope of the robot

Examples of Manufactured Parts:

- Agricultural Equipment
- Recreational Vehicles: cart frame, hitches and components
- Miscellaneous: office furniture, door window frames, water heaters



1 rotating table with
2 headstocks for 2 work envelopes.

XHS300

Ø 1000 - L= 1600 mm - 300 Kg*

XHS600

Ø 1200 - L= 2000 mm - 600 Kg*

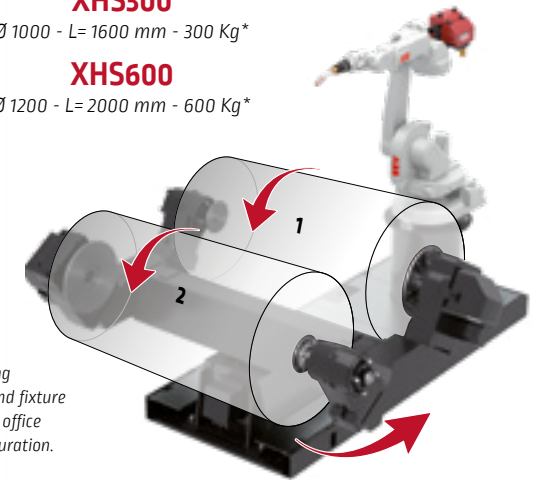

* Theoretical envelop depending
on the part to be welded and fixture
size. A study by our design office
will define the exact configuration.

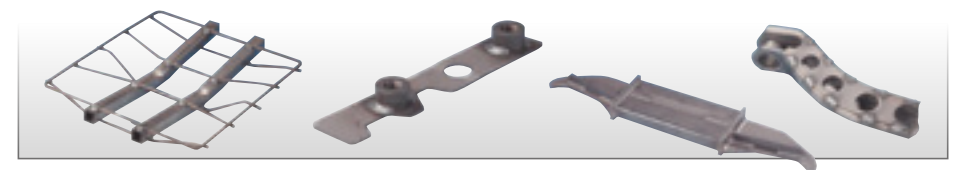

CUSTOMIZED SOLUTIONS

Robolution™, a Lincoln Electric Company, is a full service automation integrator providing engineering, machining, and integrated robotic systems with core competencies in advanced welding system design, high-quality weld fixtures, robotic integration, process automation, and ongoing service and support.

Robolution™ is the specialist for customized solutions and high range of fixture systems.

From beginning to end, design - tooling - machining, Robolution™ completes each step in house.

That means total control over:

- ▣ Quality
- ▣ Lead time
- ▣ Cost
- ▣ Customer service

So that every step meets the customer's expectations.

The team of professionals operates out of the headquarter in Weiterstadt, Germany but delivers on a global level as part of the Lincoln Electric Automation Group.

Robolution™ is a leader in the:

- ▣ Development
- ▣ Construction
- ▣ Installation
- ▣ Sales of robot systems and related components.

The product range includes robot systems incorporating high tech components and extends from standard items of equipment to fully automated, interlinked production lines. Robolution™ is a partner you can trust.

The individual products and installations help ensure the economic success of the customers. Long-lasting and technically faultless products and systems, as well as comprehensive service, are the fundamental elements which guarantee this.

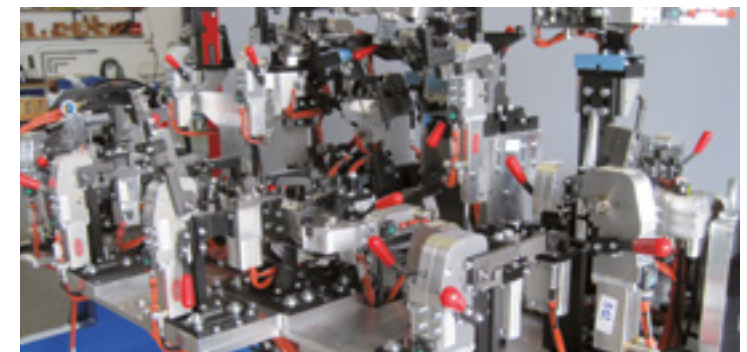

MIG/MAG MACHINES

The **MIG/MAG** applications are used in various domains from the simple carriage for shipyard industry to large gantry for train manufacturing. The choice of the machine depends mainly on the size of the piece to weld. **Lincoln Electric** propose solutions according your need.

Beam welder
with two torches
to weld beams or
frames for structures
or automotive
industries

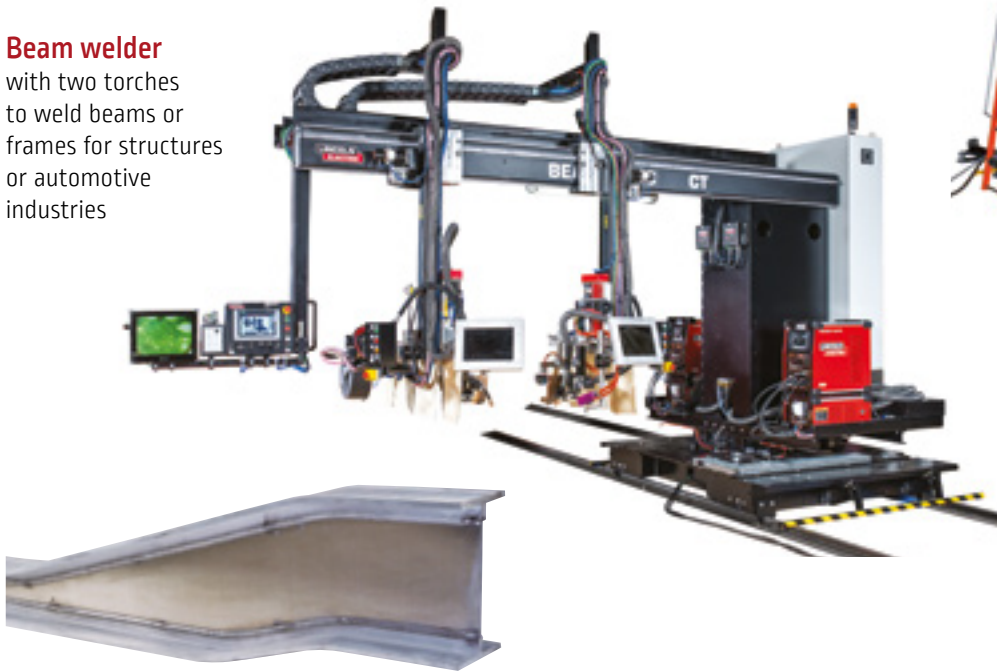

MIG MAG welding aluminium Gantry with two torches to answer applications requiring a high level of productivity with large pieces such as the manufacture of railway wagons.



Column & boom
To weld any kind of vessels
or tank for many industries.



LINC-MATIC-CB-Series: column and booms

Lincoln Electric column and booms are the professional answer to your needs. Ideal for pressure vessels manufacturer of stainless steel, mild steel and light alloy, they maximize your benefit from automatic MIG/MAG, submerged arc, TIG, plasma and plasma+TIG welding processes.

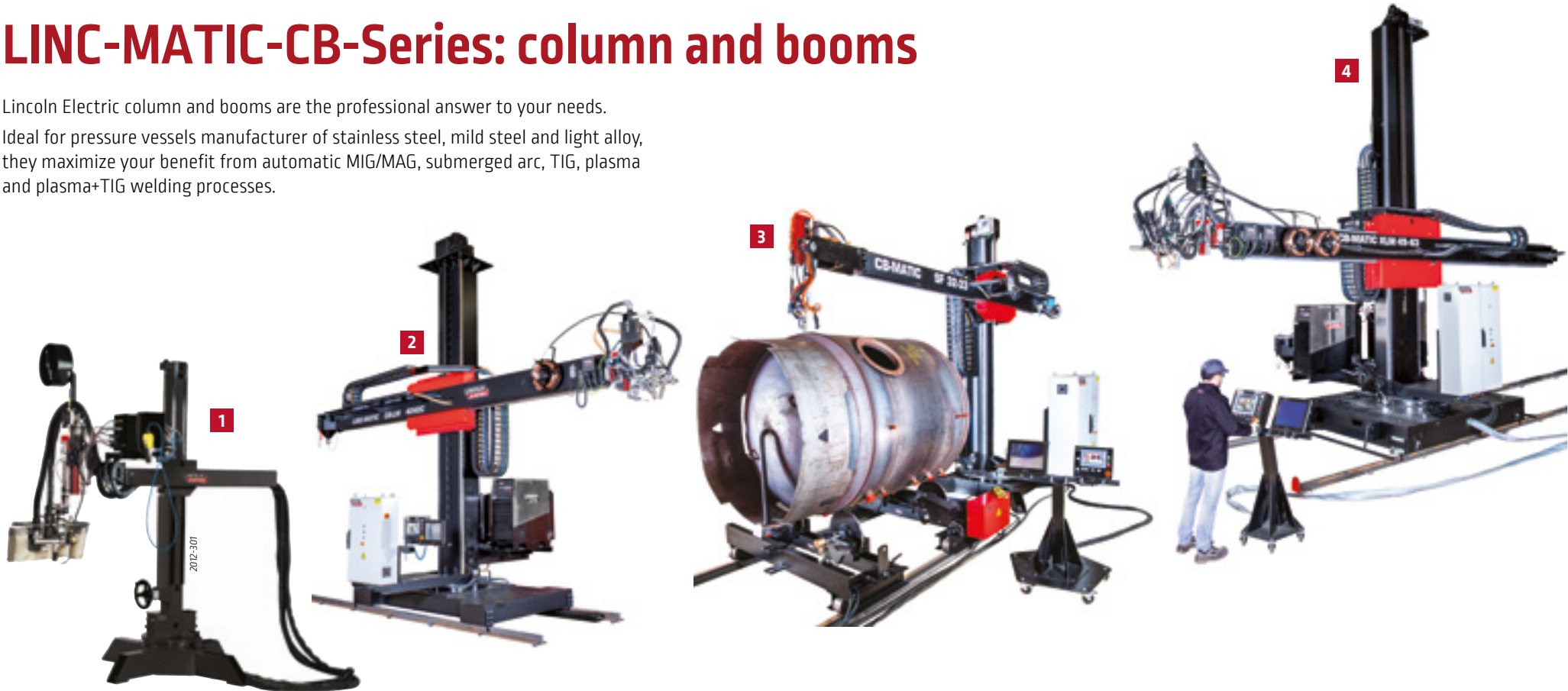

Column and boom choice

According to the welding process and the size of the vessels to work on, it is possible to choose Basic, Classic or Evolutive series and XS, S, L or XL column and boom.

This C&B can be fixed on the ground (F) or mobile on rails (M) and associate with roller beds, positioners, turntables and headstocks.

	B-Series "BASIC"		C-Series "CLASSIC"	E-Series "EVOLUTIVE"		
	1 XS	L*	2 L	3 S	L	4 XL
Size (Column x Boom in mm)	1,5 x 1	3 x 3 to 6 x 6	3 x 3 to 6 x 6	2 x 2 to 4 x 4	2 x 2 to 5 x 5	4 x 4 to 7 x 7
Customization	X	X	X	✓	✓	✓
Motorized axis	X	✓	✓	✓	✓	✓
PILOT controller	X	X	✓	✓	✓	✓
Processes	X	Single SAW	Single or Tandem SAW	Single Plasma / TIG / MIG / SAW	Single or Tandem or Bicephal Plasma / TIG / MIG / SAW	Single or Tandem or Bicephal Plasma / TIG / MIG / SAW

Other dimensions on request.

* Export version (non CE)

SEAM-MATIC: welding seamer benches

Lincoln Electric offers a range of seamers specifically designed for horizontal welding, supporting cylindrical (round or square section) or plan workpieces with a wide range of dimensions.

- ▣ FIN: external welding, small thickness
- ▣ EX: external welding
- ▣ IT: internal welding
- ▣ EXIT: external and internal welding
- ▣ Customized

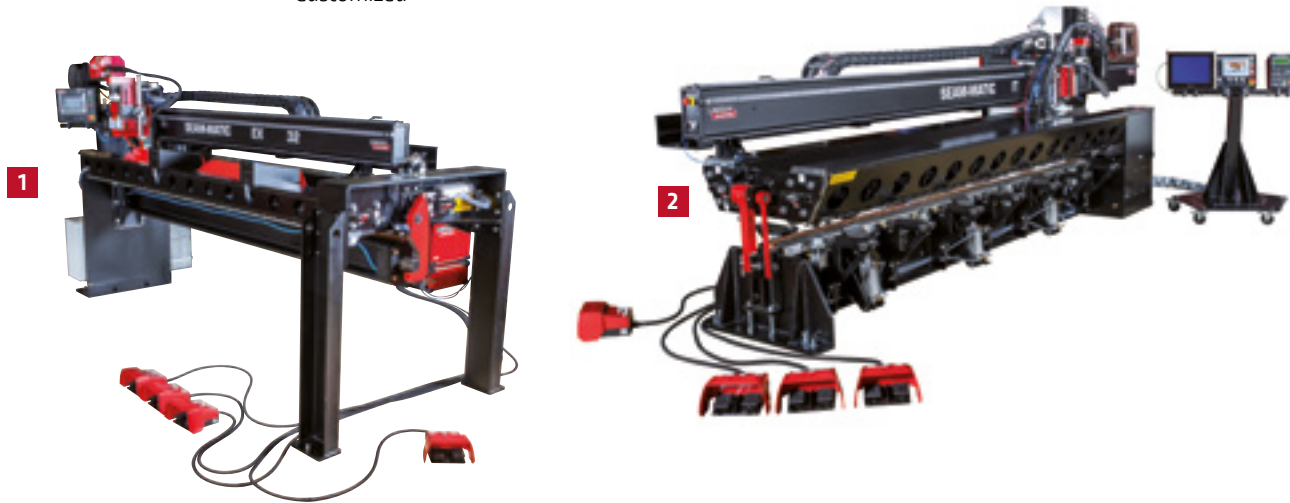

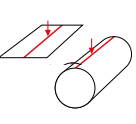
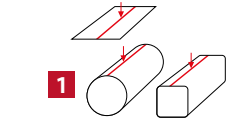
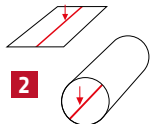
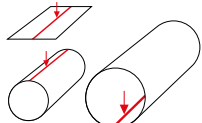
																	
		FIN	EX [xx from 10 to 20]					IT					EXIT				
		10V07	12Vxx	17Vxx	22Vxx	32Vxx	42Vxx	22	32	42	52	62	72	32	42	52	62
Clamping Length* (mm)		1 050	1 250	1 750	2 250	3 250	4 250	2 250	3 250	4 250	5 250	6 250	7 250	3 250	4 250	5 250	6 250
External welding (mm)	∅ mini	80	210	220	270	320	460	-	-	-	-	-	-	380	480	580	600
	∅ maxi	700	xx00	xx00	xx00	xx00	xx00	-	-	-	-	-	-	1 500	1 500	1 550	1 600
Internal welding (mm)	∅ mini	-	-	-	-	-	-	1 450	1 500	1 500	1 550	1 600	1 650	1 500	1 500	1 550	1 600
Thickness (mm)	without tacking	0.6 to 3	0.8 to 5	0.8 to 5	1 to 5	1 to 5	1 to 5	1 to 5	1 to 5	1 to 5	1 to 5	1 to 5	1 to 5	1 to 5	1 to 5	1 to 5	1 to 5
	with tacking	0.6 to 3	0.8 to 8	0.8 to 8	1 to 8	1 to 8	1 to 8	1 to 10	1 to 10	1 to 10	1 to 10	1 to 10	1 to 10	1 to 10	1 to 10	1 to 10	1 to 10

* Maxi weldable length depends of head's configuration (number of torches and their options). To be confirmed on request.

Other capacity on request.

Customized solutions

According the customer's needs, we could adapt the sizes and the process to reach the best productivity and quality.



External seamer, operator platform.

2011-401



Plan seamer with Infeed and outfeed table.

2012-654



Seamer with lifting for variable diameter vessels.

2016-408

ROTAMATIC ST: single roller beds

Medium-duty roller beds: 2 to 30 tons

- Single powered *[one drive roller]* for small unbalance work piece
- Double powered *[two drive rollers]* for work pieces having significant unbalance
- Roller-to-roller center distance adjusting by screw *[except for ST 2: by step]*
- Remote pendant 5m, kit auto and digital display on all versions

Possible options:

- Kit $\pm 1\%$ speed regulation
- Kit encoder 5 000 pts
- Lorry and railway
- Anti-drift



Technical specifications:

Designation		Load capacity (1 drive + 1 idler) kg	Load capacity per section kg	Shell diameter mm	Peripheral speed cm/min	Wheel dimension OD x width mm	Wheel material
ST 2	MT	2 000	1 000	30 to 2 500	12 to 120	Ø 150 x 50	Polyurethane
	M						
	W						Polyamide
	F						
ST 6	M	6 000	3 000	300 to 3 500	12 to 120	Ø 250 x 75	Polyurethane
	W						
	F						
ST 15	M	15 000	7 500	300 to 4 000	12 to 120	Ø 250 x 110	Polyurethane
	W						
	F						
ST 30	W	30 000	15 000	350 to 4 500	12 to 120	Ø 350 x 150	Polyurethane
	F						

Keys: M = Single motorisation / W = Double motorisation / F = Idler roller / MT = Single motorisation with tube system

ROTAMATIC ST options



Special roller beds

Small 6 tons roller beds
Ø 100 to 600 mm

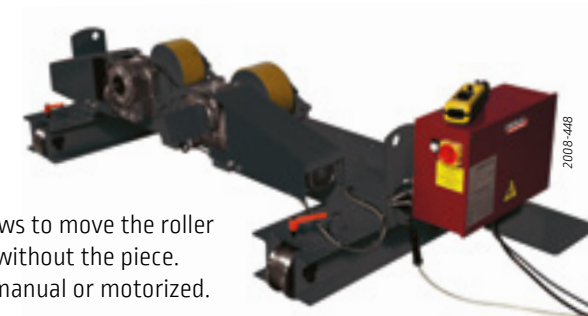

Lorry

The lorry allows to move the roller beds with or without the piece. They can be manual or motorized.

Anti-drift device

The end stop device allows the piece to turn without drifting.

An automatic solution can be proposed with a PLC which controls the idler roller positions.

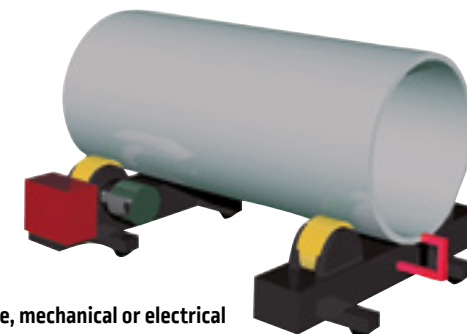

Anti-drift device, mechanical or electrical

ROTAMATIC LP: single roller beds

Heavy-duty roller beds: 42 to 200 tons

- Each rotator is composed of a mechanical structure and rotation roller motorized with roller adjustment by step or screw. In the motorized version, the rotator is equipped with an electrical cabinet
- Double powered [two drive rollers] for work pieces having significant unbalance
- Remote pendant with 10m cable, kit auto and digital display on all versions

Possible options:

- Kit $\pm 1\%$ speed regulation
- Kit encoder 5 000 pts
- Lorry and railway
- Anti-drift



Technical specifications:

Designation	Load capacity (1 drive + 1 idler) kg	Load capacity per section kg	Shell diameter mm	Peripheral speed cm/min	Wheel dimension OD x width mm	Wheel material
LP42	42 000	21 000	700 to 5 000	10 to 100 or 9 to 180	Ø 400 x 200	Steel
					Ø 400 x 250	Polyurethane
LP55	55 000	27 500	700 to 5 000	10 to 100 or 9 to 180	Ø 400 x 250	Steel
					Ø 400 x 300	Polyurethane
LP70	70 000	35 000	900 to 6 000	10 to 100 or 8 to 160	Ø 460 x 250	Steel
					Ø 460 x 300	Polyurethane
LP100	100 000	50 000	900 to 6 000	10 to 100 or 8 to 160	Ø 450 x 250	Steel
					Ø 450 x 300	Polyurethane
LP160	160 000	80 000	1 200 to 6 000	10 to 100 or 9 to 160	Ø 450 x 300	Steel
LP200	200 000	100 000	1 200 to 6 000	10 to 100 or 10 to 160	Ø 500 x 300	Steel



Higher capacity roller beds on request.

ROTAMATIC TR: fit-up roller beds

Fit-up roller beds: 30 to 200 tons

- Idler roller bed section in combination with motorized conventional LP roller bed
- In standard, the up and down movement is made by a manual hydraulic pump

Possible options:

- Automatic hydraulic central pump, recommended for 2 sections configuration
- Lorry and railway



2956-063_ret

Version with automatic hydraulic central for 2 rotators set



Technical specifications:

Designation	Load capacity (2 fit-up) kg	Lifting capacity per section kg	Shell diameter mm	Wheel dimension OD x width mm	Wheel material	Wheels adjustment
TR30	30 000	15 000	700 to 4 500	Ø 300 x 160	Polyurethane	Screw
TR42	42 000	21 000	700 to 5 000	Ø 350 x 250	Polyurethane	Screw
TR55	55 000	27 500	700 to 5 000	Ø 350 x 250	Polyurethane	Screw
TR70	70 000	35 000	900 to 6 000	Ø 400 x 300	Polyurethane	Screw
TR100	100 000	50 000	900 to 6 000	Ø 400 x 250	Steel	Step
TR160	160 000	80 000	1 200 to 6 000	Ø 450 x 250	Steel	Step
TR200	200 000	100 000	1 200 to 6 000	Ø 450 x 300	Steel	Step

Higher capacity roller beds on request.

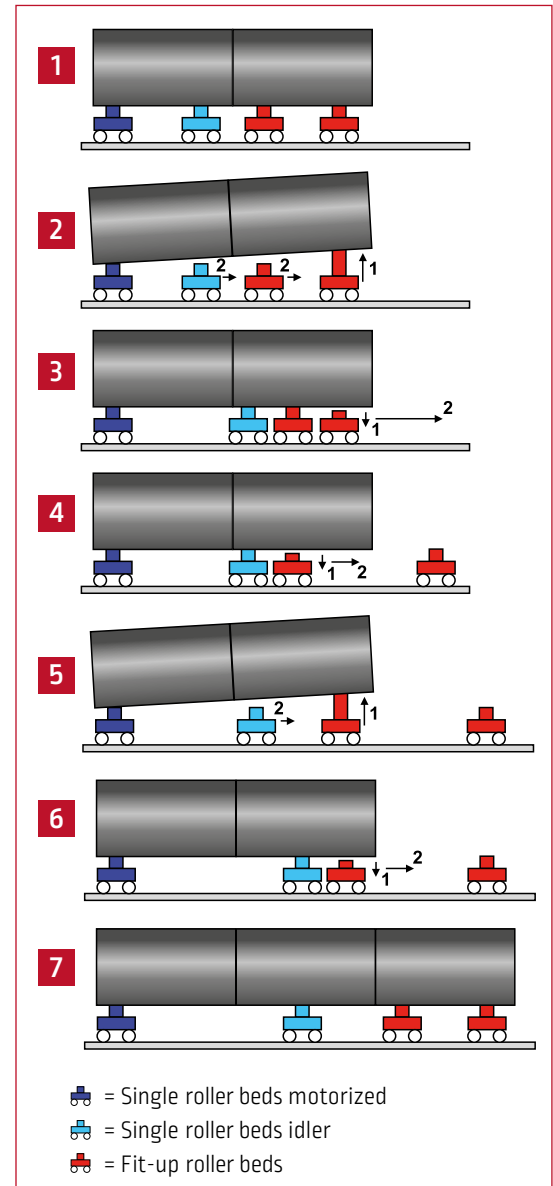

ROTAMATIC LP-2R: self aligning roller beds

12 to 250 tons

- Each roller bed is composed of a mechanical structure and rotation roller motorized or not.
- The motorized version is equipped with remote pendant with 10m cable, kit auto and digital display on all versions
- All 4 wheels are motorized for excellent grip

Possible options:

- Kit \pm 1% speed regulation
- Lorry and railway
- Kit encoder 5 000 pts
- Anti-drift

Technical specifications:

Designation	Load capacity (1 drive + 1 idler) kg	Load capacity per section kg	Mini Shell diameter for 1/2 load mm	Shell diameter for maximum load mm	Peripheral speed cm/min	Wheel dimension OD x width mm	Wheel material
LP12-2R	12 000	6 000	500	1 500 to 4 000	10 to 100 or 10 to 200	Ø 300 x 220	Rubber
LP20-2R	20 000	10 000	500	1 500 to 4 000	10 to 100 or 10 to 200	Ø 350 x 300	Rubber
LP30-2R	30 000	15 000	500	1 500 to 4 500	10 to 100 or 8 to 160	Ø 400 x 300	Rubber
LP42-2R	42 000	21 000	500	1 500 to 5 000	10 to 100 or 9 to 180	Ø 400 x 400	Rubber
LP55-2R	55 000	27 500	800	1 800 to 5 000	10 to 100 or 9 to 180	Ø 500 x 230	Rubber
LP70-2R	70 000	35 000	800	1 800 to 6 000	10 to 100 or 9 to 180	Ø 500 x 400	Rubber
LP100-2R	100 000	50 000	600	1 500 to 6 000	10 to 100 or 8 to 160	Ø 420 x 300	Polyurethane
LP160-2R	160 000	80 000	1 000	1 500 to 6 000	10 to 100 or 8 to 160	Ø 460 x 300	Polyurethane
LP200-2R	200 000	100 000	1 000	1 500 to 7000	10 to 100 or 75 to 150	Ø 500 x 300	Steel
						Ø 500 x 300	Polyurethane
LP250-2R	250 000	125 000	1 000	1 500 to 7000	10 to 100 or 75 to 150	Ø 500 x 300	Steel
						Ø 550 x 400	Polyurethane

Higher capacity roller beds on request.

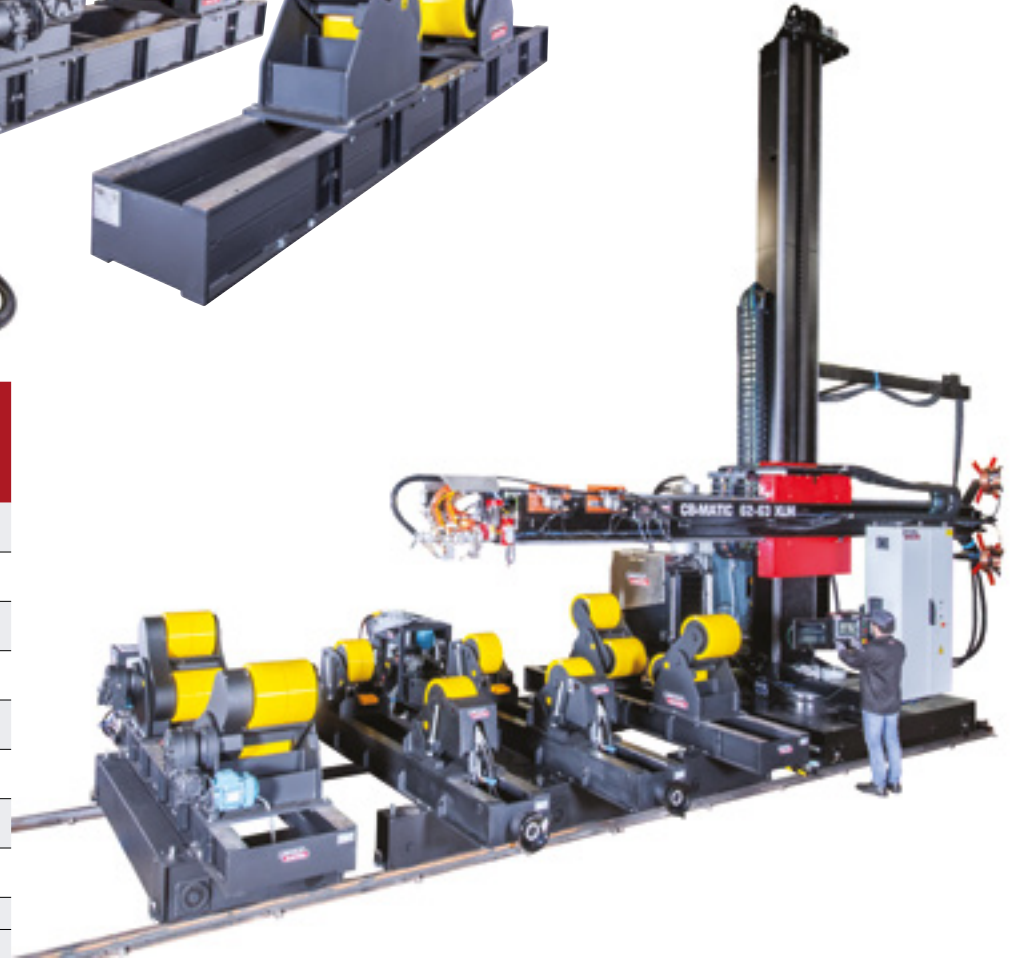

POSIMATIC: positioners



P 1E - P 2E

Light range 2 axis
50 to 200 kg

PS 03 to PS 30

Medium range 2 axis
300 to 3 000 kg



TP 4 to TP 30

Heavy range 2 axis
4 000 to 30 000 kg



TPE 1.5 to TPE 10

Heavy range 3 axis
1 500 to 10 000 kg



APSi 750 to 35000

Heavy range 3 axis programmed
750 to 35 000 kg

	Load all positions Kg [P]	Rotation speed Tr/min	Tilt Torque m.Kg [C1]	Rotation torque m.Kg [C2]	Axis-plate distance m [D]	Turntable height mm
P 1E	50	0.2 to 5	4.5	2	0.075	385
P 2E	200	0.25 to 5	40	4	0.070	500
PS 03	300	0.2 to 3	100	35	0.080	660
PS 08	800	0.16 to 2.4	280	120	0.148	848
PS 15	1 500	0.14 to 1.8	550	225	0.151	1 051
PS 30	3 000	0.1 to 1.5	1 300	450	0.222	1 222

	Load all positions Kg [P]	Rotation speed Tr/min	Tilt Torque m.Kg [C1]	Rotation torque m.Kg [C2]	Axis-plate distance m [D]	Turntable height mm
TP 4	4 000	0.045 to 0.45	1 100	500	0.160	1 130
TP 6	6 000	0.03 to 0.3	2 500	720	0.175	1 165
TP 8	8 000	0.025 to 0.25	3 600	850	0.175	1 050
TP 10	10 000	0.022 to 0.22	6 750	1 450	0.200	1 150
TP 15	15 000	0.02 to 0.2	10 300	2 100	0.240	1 315
TP 20	20 000	0.018 to 0.18	14 200	2 900	0.270	1 370
TP 30	30 000	0.015 to 0.15	22 500	4 400	0.300	1 425
TPE 1.5	1 500	0.06 to 0.6	375	160	0.120	970 to 1 700
TPE 2.5	2 500	0.06 to 0.6	600	200	0.140	1 080 to 1 850
TPE 4	4 000	0.045 to 0.45	1 100	500	0.160	1 060 to 2 010
TPE 6	6 000	0.035 to 0.35	2 500	720	0.175	1 125 to 2 125
TPE 8	8 000	0.025 to 0.25	3 600	850	0.175	1 125 to 2 125
TPE 10	10 000	0.022 to 0.22	6 750	1 450	0.200	1 150 to 2 350
APSi 750	750	0.09 to 2	150	60	0.127	730 to 1 450
APSi 1500	1 500	0.07 to 1.3	300	100	0.128	780 to 1 550
APSi 3500	3 500	0.08 to 1.6	750	280	0.171	980 to 1 750
APSi 7000	7 000	0.05 to 1	1 400	900	0.184	1 000 to 1 850
APSi 10000	10 000	0.04 to 0.75	4 000	1 300	0.196	1 090 to 2 030
APSi 15000	15 000	0.04 to 0.75	7 000	1 800	0.232	1 300 to 2 330
APSi 25000	25 000	0.02 to 0.4	17 500	4 000	0.319	1 600 to 2 860
APSi 35000	35 000	0.02 to 0.4	28 000	5 500	0.318	2 000 to 3 500

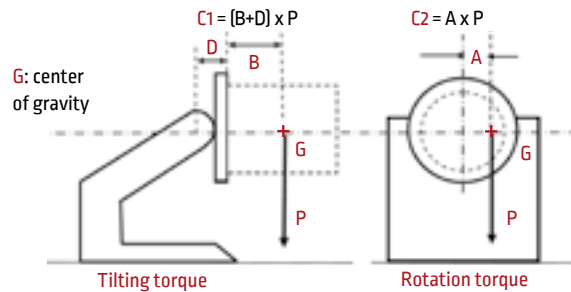

Higher capacity or different rotation speed range on request.

HEADMATIC: headstock

HEADMATIC 2 axis HMM range

Heavy range from 2 T to 30 T

Headstock and tailstock synchronized on rotation and height to handle large workpiece.

Options:

- Programmed position
- Foot pedal
- Movable headstock
- Railway guiding
- Earth contact

	Capacity (Kg)	Rotation speed (Tr/min)	Rotation torque (N.m)	Lifting speed (mm/min)	Axis height (mm)
HMM 2	2 000	0.25 to 1	3 000	560	350 to 1800
HMM 4	4 000	0.25 to 1	3 500	560	350 to 1900
HMM 5	5 000	0.25 to 0.9	4 000	560	400 to 1950
HMM 6	6 000	0.2 to 0.75	5 500	560	450 to 1950
HMM 10	10 000	0.3 to 1.1	7 500	650	500 to 1950
HMM 12	12 000	0.3 to 1.1	10 000	650	550 to 1950
HMM 15	15 000	0.3 to 1.3	15 000	650	550 to 2000
HMM 20	20 000	0.2 to 0.9	22 000	560	550 to 1850
HMM 25	25 000	0.2 to 0.9	25 000	470	700 to 1850
HMM 30	30 000	0.2 to 0.75	35 000	290	750 to 2000



HEADMATIC 3 axis SPS range

Heavy range from 750 Kg to 10 T

Dedicated for most complex product geometry, and set up in a wide variety of positions. Remote control for all functions.

Options:

- Programmed position
- Foot pedal
- Wireless remote control



	Capacity (Kg)	Rotation speed (Tr/min)	Tilting torque (N.m)	Rotation torque (N.m)
SPS 750	750	0.09 to 2	1 500	600
SPS 1500	1 500	0.07 to 1.3	3 000	1 000
SPS 3500	3 500	0.08 to 1.6	6 000	2 800
SPS 5000	5 000	0.05 to 1	10 000	6 000
SPS 10000	10 000	0.04 to 0.75	40 000	18 000

Higher capacity or different rotation speed range on request.

Customized solutions

According to the customer's needs, we could adapt the sizes and the process to reach the best productivity and quality.

Pipe support with SUPER TOP headstock 1 axis combined with X roller beds



HEADMATIC 2 axis for machine integration

- Precised motion
- High torque capacity
- Can be used without tailstock



TURNMATIC: turntable

Turntable 5 to 30 tons

Circular welding can be done by the movement of the turntable without moving the torch.

In the standard range, a turntable can make the rotation of shells up to 30 tons and up to 4 500 mm diameter. Kit $\pm 1\%$ speed regulation.

Possible options:

- Backing gas device
- Tooling & arms



2007-311



2008-362

Designation	Load capacity kg	Mini shell diameter mm	Maxi shell diameter mm	Rotation speed tr /min
TURNMATIC 5 T	5 000	1 200	4 500	0.004 to 0.204
TURNMATIC 10 T	10 000	1 000	4 500	0.004 to 0.204
TURNMATIC 20 T	20 000	1 000	4 500	0.004 to 0.204
TURNMATIC 30 T	30 000	1 000	4 500	0.004 to 0.204

Other sizes, capacities or rotation speed range on request.

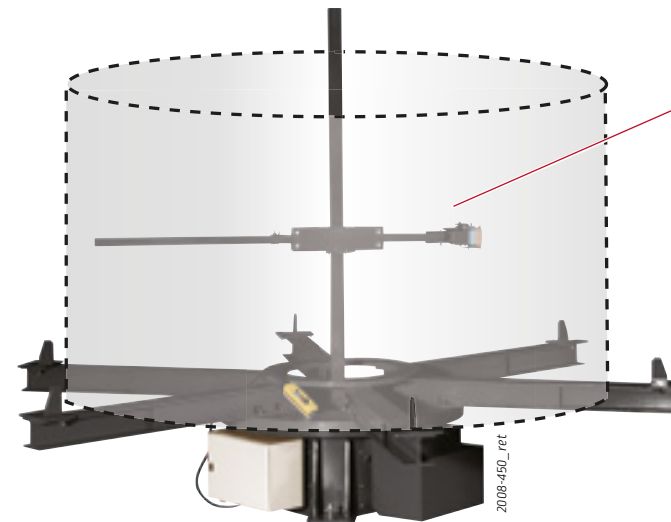

2008-490_ret

Backing gas device

The backing gas device mounted on turntable, complete the turn-key solution of plasma or TIG welding column and boom.

A man hole in the turntable allows the operator to adjust the backing gas device inside the shell.

**LINCOLN
ELECTRIC**

**LINCOLN
ELECTRIC** **PILOT
PRO**

SERVICES



SERVICES

Lincoln Electric services: a complete offer for your production tools.

Far beyond the simple recommendation of processes or equipment, Lincoln Electric work with you in the service field by offering advice and expertise, demonstrations, feasibility studies, installation and commissioning of facilities, training and assistance to the start of production, maintenance, after-sales service and even upgrade of of your equipment.



Solution Centers for Automation

In our Solution Centers it's possible to see and test our cutting and welding systems of the latest generation, which are used for demonstrations and the supply of technical assistance.



Advices and Expertises

On the basis of a personalised diagnosis, our technical specialists will analyse your needs, identify potential improvements, build solutions along with you, define action plans and give you the support you need.

In your premises or in our Solution Centers for Automation.

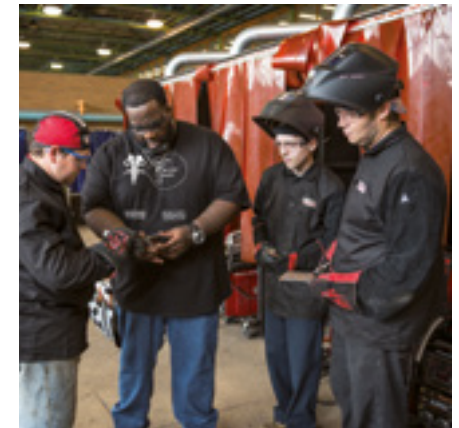

Call Centers

A large team of technicians can answer to every question and keep your manufacturing tools to their best performance levels.



Remote Service

Lincoln Electric offers innovative services with securely connected machines in order to increase performance of your tool:

- On line intervention allowing reduction of machines' down time.
- On line assistance and training for optimisation of your productivity.

Machine installation and training

Dedicated teams are worldwide available to install your machines and train your manufacturing staff.

Our know-how is well known and our expertise based on experience is here to propose a large range of high quality training with customised solutions.



Upgrading your processes and machines

The retrofitting and upgrading services offer enhancement of life duration of your machines while giving new functionalities and new performances and applications.



Production support

You have just invested in a new welding or cutting equipment and would like support while you start up the manufacturing process. Lincoln Electric can offer technical assistance aimed at helping you produce parts independently as soon as possible, by providing step-by-step tracking for the first pieces you turn out.



Maintenance

Lincoln Electric maintenance contracts provide the guarantee of a high performance level for your equipment.

The optimisation of the availability rate and of the life duration of your machines is key regarding your production costs.

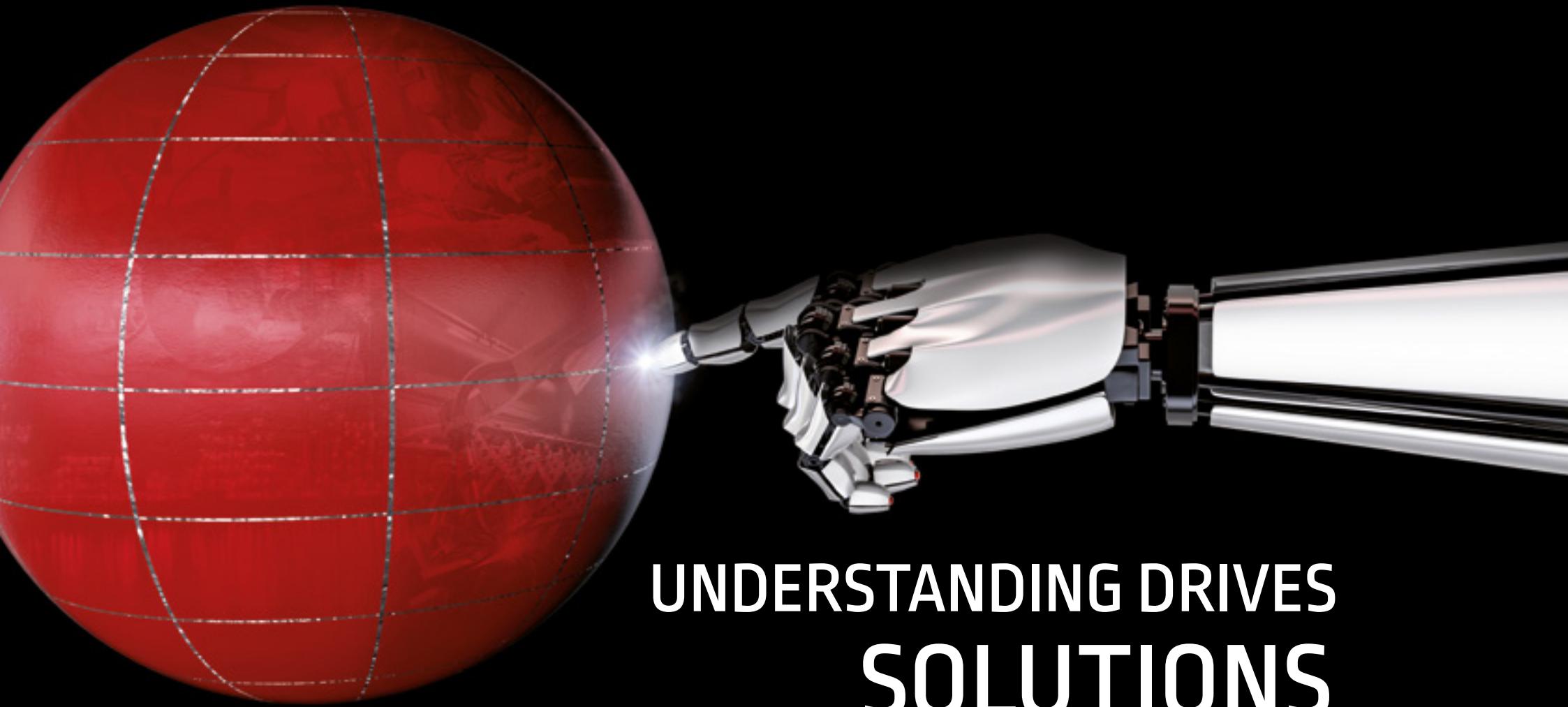

UNDERSTANDING DRIVES SOLUTIONS

www.lincolnelectriceurope.com

Stay Connected



www.youtube.com/channel/UCjmontoTpXR12liNT_7Z1bA



www.facebook.com/LincolnElectricEurope



www.linkedin.com/company/lincoln-electric-europe



www.instagram.com/lincolnelectriceurope

CUSTOMER ASSISTANCE POLICY

The business of Lincoln Electric is manufacturing and selling high quality welding equipment, consumables, and cutting equipment. Our challenge is to meet the needs of our customers and to exceed their expectations. On occasion, purchasers may ask Lincoln Electric for information or advice about their use of our products. Our employees respond to inquiries to the best of their ability based on information provided to them by the customers and the knowledge they may have concerning the application. Our employees, however, are not in a position to verify the information provided or to evaluate the engineering requirements for the particular weldment. Accordingly, Lincoln Electric does not warrant or guarantee or assume any liability with respect to such information or advice. Moreover, the provision of such information or advice does not create, expand, or alter any warranty on our products. Any express or implied warranty that might arise from the information or advice, including any implied warranty of merchantability or any warranty of fitness for any customers' particular purpose is specifically disclaimed.

Lincoln Electric is a responsive manufacturer, but the selection and use of specific products sold by Lincoln Electric is solely within the control of, and remains the sole responsibility of the customer. Many variables beyond the control of Lincoln Electric affect the results obtained in applying these types of fabrication methods and service requirements.

Subject to Change – This information is accurate to the best of our knowledge at the time of printing. Please refer to www.lincolnelectriceurope.com for any updated information.



www.lincolnelectriceurope.com

