



WINEGARD

Assembly & Installation Manual MT-SM40
Window/Side Vehicle Mount



Manual disponible
en español en www.winegard/support

www.winegard.com/trucking

For help, email help@winegard.com

or call 1-800-788-4417











2452428

2452428
Rev1 5-19

Parts

Recommended tools, not provided:
T20 Torx/Star screwdriver, Phillips screwdriver 5/16" drive,
Adjustable wrench

- | | | | |
|----------------------------|---|-----------------------------|---|
| 10-32 x 1/4" Screw (3) |  | Rubber Bumper (2) |  |
| 10-32 x 1/2" Screw (1) |  | Rubber Foot (4)* |  |
| Rubber Washer (1) |  | *Included with antenna unit | |
| 1/4-20 x .75 Hex Screw (2) |  | Mounting Screw (10) |  |
| 10-32" Nylock Nut (2) |  | 3" x 3" Film Plastic (2) | (not shown) |
| Metal Washer (2) |  | | |

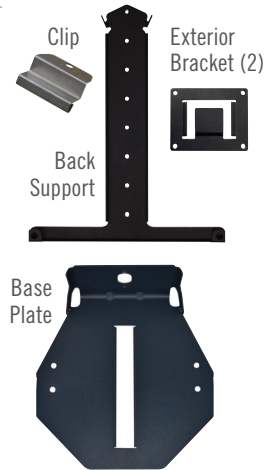

Specifications

- For use with Winegard PL-7000, PL7000R, PL-8000, PL8000R, PL-8035, PL8035R, GM-9000, GM-9035, PA-1000, PA1000R, PA-2000, PA-2035, PA2000R, PA2035R, GM-6000, GM-6035.
- For stationary use only
- Height (once assembled): 13.35", Width: 10.25"
- Extends 5.75" from vehicle
- Adjustable vertical mounting settings every 1.5"
- Window clip swivels 90° to easily level antenna
- Mount weight: 2 lbs



Only hang the window mount assembly on the window when the vehicle is parked and the antenna is in use; store the window mount assembly when not in use.

Model MT-SM40 window mount should only be deployed when the vehicle is stationary. Do not use while the vehicle is moving. Remove prior to traveling.



Assembling the Window Mount

To use with antenna models: PL-7000, PL7000R, PL-8000, PL8000R, PL-8035, PL8035R, GM-9000, GM-9035.



Failure to install in accordance with product manufacturer's installation and assembly instructions could result in property damage, personal injury, and/or death.

1. Align the hole in the clip with the press nut at the top of the back support. The hole in the clip should fit around the raised lip of the press nut. Insert a 10-32 x 1/4" screw through the aligned holes in the clip and back support, and tighten.
2. Push the two rubber bumpers through the two holes in the bottom of the back support. Make sure the rubber bumpers are fully installed before proceeding, as these will prevent the mount from scratching the vehicle.
3. Remove the antenna dome screws with T20 Torx/Star screwdriver or bit. **DO NOT USE A DRILL.** Use caution on edge of reflector and gearing. The reflector can be sharp. See **WARNING** below:



After removing the dome, do not touch the electronics board. Static discharge could damage electronics and cause antenna to become inoperable.

To discharge any built up static electricity after removing the dome, touch the coax connection on the base of the antenna.

DO NOT TOUCH the electronics board or any components. See Step 3 image.

4. Align the holes on the base plate of the mount with the holes in antenna base and screw them together with the two hex screws up from the bottom and fastened inside the dome base with the two metal washers and Nylock nuts. See Step 4 images.
5. Carefully replace the dome on the antenna, and secure with the dome screws. Align the back of the base plate with the back support and connect the two together with the remaining two 10-32 x 1/4" screws. See completed image on opposite page.

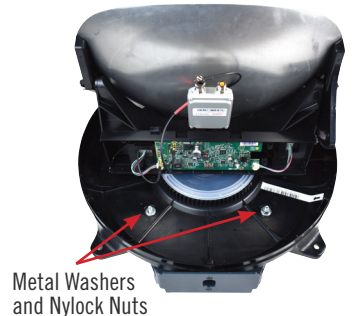
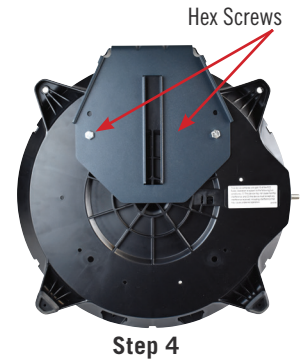
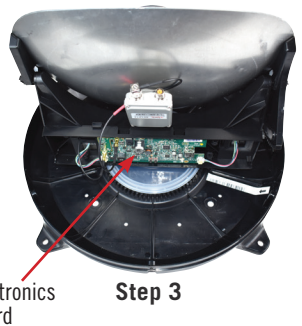

Assembling the Window Mount

To use with antenna models: PA-1000, PA1000R, PA-2000, PA-2035, PA2000R, PA2035R, GM-6000, GM-6035.

! Failure to install in accordance with product manufacturer's installation and assembly instructions could result in property damage, personal injury, and/or death.

1. Align the hole in the clip with the press nut at the top of the back support. The hole in the clip should fit around the raised lip of the press nut. Insert a 10-32 x 1/4" screw through the aligned holes in the clip and back support, and tighten.
2. Push the two rubber bumpers through the two holes in the bottom of the back support. Make sure the rubber bumpers are fully installed before proceeding, as these will prevent the mount from scratching the vehicle.
3. Determine the preferred height of the window mount base against the back support. Align the bottom hole in the window mount base with the preferred hole in the back support. Insert a 10-32 x 1/2" screw through the aligned holes in the back support and base plate. Tighten.
4. Remove the two rubber feet and two foot screws that will sit on the mount base from the bottom of the antenna. Set aside until step 7.
5. Remove the dome screw facing the back support with a 5/16" drive.
6. Align the hole in the dome with the hole in the window mount base and back support. Install the dome screw, with the rubber washer between the dome and back support. Tighten.
7. To complete the installation, position the flat side of the two rubber feet against the holes on the bottom of the window mount base, and install the two screws through the aligned holes in the rubber feet, window mount base, and antenna base. Tighten to 40 in* lbs.

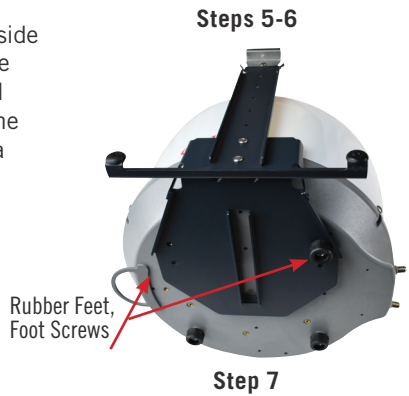
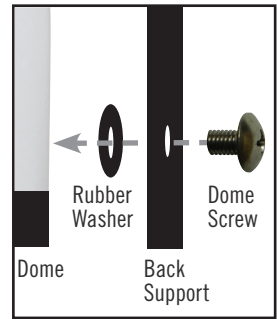
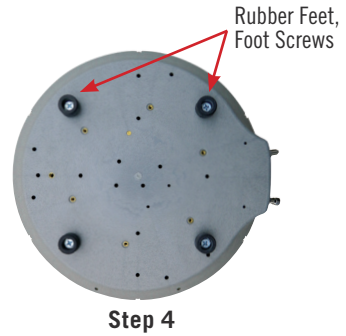
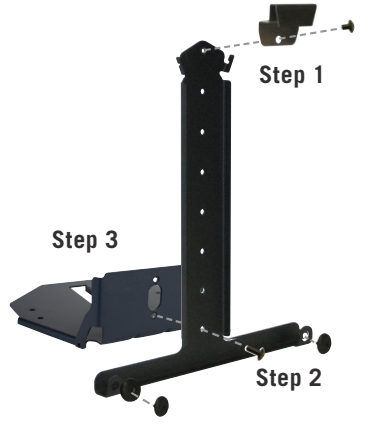

Connect Coax to Antenna

Connect the provided coax cable from the antenna coax port to the “Sat In” port on the back of the receiver. Tighten coax connection until finger-tight, and then tighten a quarter turn more with a wrench. **Do not overtighten.**

A 25 foot coaxial cable is included and recommended for use with the antenna. If using an alternate cable, all cabling should be RG6 with a maximum length of 50 feet from Playmaker to receiver.

Selecting Antenna Location

Choose a location with a clear, unobstructed view of the southern sky. Avoid obstructions such as trees, hills, vehicles, or buildings — these can block the signal from the satellite.

Do not place the antenna in a path of people or vehicles' otherwise, the antenna may be knocked off of the signal if run into, or cables may be disconnected from the unit.

The antenna may take longer to lock onto signal if the antenna is not level.

Use Winegard's Signal Finder App

with augmented reality to determine optimal location.

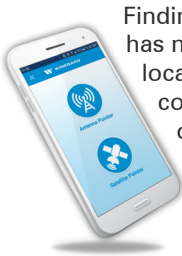

Finding your favorite TV programming has never been easier! Using your current location, the app can help determine the correct antenna positioning to avoid obstructions with the augmented reality (AR) view.



FREE AT



AR view (Augmented Reality)
Point your phone at the southern sky.
See signal obstructions such as trees and buildings.



Installation of Exterior Brackets

After the antenna has been secured to the mount, the assembly can be hung on the edge of a window or on the provided exterior brackets. The exterior brackets will enable the assembly to be hung on the exterior of the vehicle. Complete the following steps to install the exterior brackets on the vehicle.

1. Choose a location on the exterior of the vehicle for the exterior brackets. **Consider possible obstructions to the satellite line-of-sight and where cables will be run.**
2. Clean the areas where the exterior brackets will be installed on the vehicle.
3. Position an exterior bracket over one of the chosen locations for installation, making sure that the top of the exterior bracket is oriented upwards (see image to right for reference). Keep in mind that the antenna assembly should be level front-to-back and side-to-side for best operation.
4. Trace around the edge of the bracket, and mark pilot holes through the bracket.
5. Drill the pilot holes.
6. Apply sealant in the traced area.
7. Mount the exterior bracket with four of the provided mounting screws.
8. Apply sealant over the screws.
9. If using the second exterior bracket repeat steps 3–8.

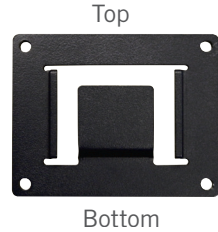

Hanging on Window or Exterior Brackets



Only hang the window mount assembly on an exterior bracket when the vehicle is parked and the antenna is in use; store the window mount assembly when not in use. Model MT-SM40 window mount should only be deployed when the vehicle is stationary. Do not use while the vehicle is moving. Remove prior to traveling.

Once ready to use the antenna, hang the window mount assembly on the window or exterior bracket.

If hanging the assembly on the vehicle window, apply the plastic film where the mount will be hung on the window, and then slide the clip over the plastic film. The window may need to remain slightly open when the window mount is on the window.

If hanging the assembly on the exterior bracket, make sure the sealant is dry, and slide the clip into the exterior bracket. When placing the antenna on the optional exterior bracket, ensure that the window mount is properly secured to the optional exterior bracket; failure to secure properly may result in injury.



Before Traveling

1. Turn off all power.
2. Disconnect all cables (power and/or coax) from the Winegard product.
3. Carefully remove the antenna/extender and window mount from the window or exterior bracket.
4. Store inside the vehicle while traveling.

Warnings



Do not walk under the window mount assembly when deployed.

The window mount should be carefully hung when attaching to the window, or the window may be damaged.

Care should be taken when using the window mount in inclement weather.

When placing the antenna on the optional exterior bracket, ensure that the window mount is properly secured to the optional exterior bracket; failure to secure properly may result in injury.

Model MT-SM40 window mount is intended for stationary use only and must be removed prior to traveling. Do not deploy the window mount while the vehicle is in motion.

**WINEGARD MOBILE PRODUCTS LIMITED WARRANTY
(2 YEARS PARTS; 1 YEAR LABOR)**

Winegard Company warrants this product against defects in materials or workmanship for a period of two (2) years from the date of original purchase. During year one (1) of such warranty, Winegard Company will also pay authorized labor costs to an authorized Winegard dealer to repair or replace defective products. No warranty claim will be honored unless at the time the claim is made, Customer presents proof of purchase to an authorized Winegard dealer (to locate the nearest authorized Winegard dealer, contact Winegard Company, 3000 Kirkwood Street, Burlington, Iowa 52601, Telephone 800-288-8094 or visit www.winegard.com). Customer must provide proof of purchase with a dated sales receipt for the Winegard product to verify the product is under warranty. If the date of purchase cannot be verified, the warranty period shall be considered to begin thirty (30) days after the date of manufacture.

If a defect in material or workmanship is discovered, Customer may take the product to an authorized Winegard dealer for service. Customer must provide proof of purchase to verify the product is under warranty. If the product is brought to an authorized Winegard dealer for service prior to expiration of year one (1) of the warranty period and a defect in material or workmanship is verified by Winegard Technical Services, Winegard Company will cover the Winegard dealer's labor charges for warranty service. The Winegard dealer must contact Winegard Technical Services in advance for pre-approval of the service. Approval of the service is at the sole discretion of Winegard Company.

Alternatively, Customer may ship the product prepaid to Winegard Technical Services (located at 2736 Mt. Pleasant Street, Burlington, Iowa 52601, Telephone 800-788-4417). Customer must return the product along with a brief description of the problem and provide Winegard Technical Services with Customer's name, address, and phone number. Customer must also provide proof of purchase to verify the product is under warranty. If the product is returned before the expiration of the warranty period, Winegard Company will (at its option) either repair or replace the product.

This Limited Warranty does not apply if the product has been damaged, deteriorates, malfunctions or fails from: improper installation, misuse, abuse, neglect, accident, tampering, modification of the product as originally manufactured by Winegard in any manner whatsoever, removing or defacing any serial number, usage not in accordance with product instructions or acts of nature such as damage caused by wind, lightning, ice or corrosive environments such as salt spray and acid rain. This Limited Warranty also does not apply if the product becomes unable to perform its intended function in any way as a result of the television signal provider making any changes in technology or service.

RETURN AUTHORIZATION POLICY

A Return Material Authorization (RMA) is required prior to returning any product to Winegard Company or Winegard Warranty Services under this warranty policy. Please call our Technical Services Department at 800-788-4417 or send an email to warranty@winegard.com to obtain the RMA number. Please furnish the date of purchase when requesting an RMA number. Enclose the product in a prepaid package and write the RMA number in large, clear letters on the outside of the package. To avoid confusion or misunderstanding, a shipment(s) without an RMA number(s) or an unauthorized return(s) will be refused and returned to Customer freight collect.

WINEGARD COMPANY DOES NOT ASSUME ANY LIABILITIES FOR ANY OTHER WARRANTIES, EXPRESS OR IMPLIED, MADE BY ANY OTHER PERSON.

ALL OTHER WARRANTIES WHETHER EXPRESS, IMPLIED OR STATUTORY INCLUDING WARRANTIES OF FITNESS FOR A PARTICULAR PURPOSE AND MERCHANTABILITY ARE LIMITED TO THE TWO YEAR PERIOD OF THIS WARRANTY.

In states that do not allow limitations on implied warranties, or the exclusion of limitation of incidental or consequential damages, the above limitations or exclusions do not apply.

Some states do not allow limitations on how long an implied warranty lasts, or the exclusion of limitation of incidental or consequential damages, so the above limitations or exclusions may not apply to you.

This warranty gives Customer specific legal rights. Customer may also have other rights that may vary from state to state.

WS-MOBWARREV3 Rev. 10/14

www.winegard.com

For help, email help@winegard.com or call 1-800-788-4417

Disclaimer: Although every effort has been made to ensure that the information in this manual is correct and complete, no company shall be held liable for any errors or omissions in this manual. Information provided in this manual was accurate at time of distribution. If the antenna and/or mount do(es) not function as expected, please contact Winegard by emailing help@winegard.com or calling 1-800-788-4417.

Apple and the Apple logo are trademarks of Apple Inc., registered in the U.S. and other countries. App Store is a service mark of Apple Inc., registered in the U.S. and other countries. Google Play and the Google Play logo are trademarks of Google LLC. Winegard® is a registered trademark of Winegard Company.

Winegard Company • 3000 Kirkwood Street • Burlington, IA 52601
1-800-288-8094 • Fax 319-754-0787 • www.winegard.com
Printed in U.S.A. ©2019 Winegard Company Rev1 5-19 2452428