

Canon

EOS-1D C



- Read this manual together with the EOS-1D X Instruction Manual and EOS-1D X Wired LAN Instruction Manual.
- The “Software Start Guide” is included at the end of this manual.



**INSTRUCTION
MANUAL**

Introduction

Based on the top-of-the-line EOS-1D X, the EOS-1D C is a digital SLR camera with enhanced movie shooting functions.

Its advanced movie shooting functions include a full-frame (approx. 36 x 24 mm) CMOS sensor with approx. 18.1 effective megapixels to create beautiful and impressive background blur effects, high ISO speeds for low-light shooting, 4K (4096 x 2160 pixels) movie recording, Full HD 60p/50p, Super 35mm Crop, Canon Log gamma, and uncompressed movie output via HDMI.

Other diverse features include a wide range of shooting functions optimized for professional shooting, a compact and lightweight body for highly mobile movie making, high reliability even in harsh environments, a highly expandable camera system, and adaptability to diverse workflows.

Refer to This Manual while Using the Camera to Further Familiarize Yourself with the Camera

With a digital camera, you can immediately view the image you have captured. While reading this manual, take a few test shots and see how they come out. You can then better understand the camera.

To avoid botched pictures and accidents, first read the “Safety Warnings” (p.88, 89) and “Handling Precautions” (p.8, 9).

Testing the Camera Before Use and Liability

After shooting, play images back and check whether they have been properly recorded. If the camera or memory card is faulty and the images cannot be recorded or downloaded to a computer, Canon cannot be held liable for any loss or inconvenience caused.

Copyrights

Copyright laws in your country may prohibit the use of your recorded images of people and certain subjects for anything but private enjoyment. Also be aware that certain public performances, exhibitions, etc., may prohibit photography even for private enjoyment.

CF Card

In this manual, “card” refers to a CF card. **The CF card** (for recording images) **is not included**. Please purchase it separately.

Instruction Manuals

The EOS-1D C comes with three manuals: 1. EOS-1D C Instruction Manual (this booklet), 2. EOS-1D X Instruction Manual, and 3. EOS-1D X Wired LAN Instruction Manual.

For movie shooting, refer to 1. For basic operations, still photo shooting, playback functions, wired LAN functions, and other information not in 1, see manuals 2 and 3 as they are basically common with those of the EOS-1D X.

● Camera and Wired LAN Instruction Manuals

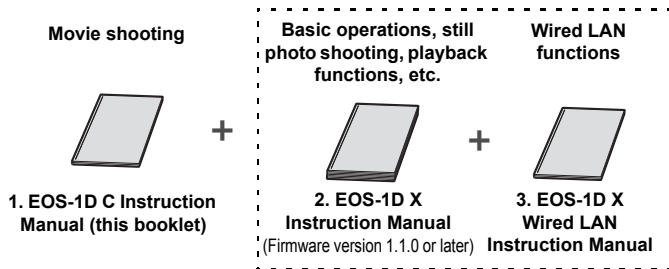

● Software Instruction Manual



Software Instruction Manual (CD-ROM)

The Software Instruction Manuals are included on the CD-ROM as PDF files.

See pages 93 to 96 for an overview of the software programs, installation procedure on a personal computer, and how to view the Software Instruction Manual CD-ROM.

The software that comes with the EOS-1D C differs from that of the EOS-1D X. See "Software Start Guide" on pages 93 to 96.

Item Check List

Before starting, check that all the following items have been included with your camera. If anything is missing, contact your dealer.



Camera

(with body cap and battery compartment cap)



Eyecup Eg



**Battery Pack
LP-E4N**

(with protective cover)

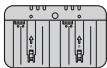

**Battery Charger
LC-E4N**

(with protective covers)



Wide Strap L7



**Interface Cable
IFC-200U**



**Stereo AV Cable
AVC-DC400ST**



**Cable Protector
and Clamp**



**EOS DIGITAL Solution Disk
(Software)**



**Software Instruction
Manual**



(1)



(2)



(3)

- (1) **EOS-1D C Instruction Manual** (this booklet)
- (2) **EOS-1D X Instruction Manual**
- (3) **EOS-1D X Wired LAN Instruction Manual**

* Attach Eyecup Eg to the viewfinder eyepiece.









* Be careful not to lose any of the above items.

Wired LAN







To set up a wired LAN using the Ethernet RJ-45 terminal, refer to the separate "Wired LAN Instruction Manual".

Conventions Used in this Manual

Icons in this Manual

-  : Indicates the Main Dial.
-  : Indicates the Quick Control Dial.
-  : Indicates the Multi-controller.
-  : Indicates the Setting button.
-  4,  6,  10,  16 : Indicates that the corresponding function remains active for 4 sec., 6 sec., 10 sec., or 16 sec. respectively after you let go of the button.

* In this manual, the icons and markings indicating the camera's buttons, dials, and settings correspond to the icons and markings on the camera and on the LCD monitor.

-  : Indicates a function that can be changed by pressing the <MENU> button and changing the setting.
- (p.**)
-  p.**) : Reference page number for more information in this manual.
-  : Warning to prevent shooting problems.
-  : Supplemental information.
-  : Tips or advice for better shooting.
-  : Problem-solving advice.

Basic Assumptions

- It is assumed that an EF lens is used with the camera.
- All operations explained in this manual assume that the power switch is already set to <ON>.
- It is assumed that all the menu settings and Custom Functions are set to their defaults.
- The illustrations in this manual show the camera attached with the EF50mm f/1.4 USM lens as an example.

 For cautions regarding the use of EF Cinema (CN-E) lenses, see pages 17 and 29.

Contents

Introduction 2

Instruction Manuals	3
Item Check List.....	4
Conventions Used in this Manual	5
Handling Precautions	8
Nomenclature	10
Using the Cable Protector and Clamp	14

1 Shooting and Playing Movies 15

▶▶▶ Preparing to Shoot Movies	16
▶▶▶ Shooting Movies.....	18
Autoexposure Shooting	18
Shutter-priority AE	19
Aperture-priority AE	20
Manual Exposure Shooting.....	23
Shooting Still Photos.....	31
Shooting Function Settings	33
Setting the Movie-recording Size	34
Setting the Sound Recording	39
Silent Control.....	42
Setting the Canon Log Gamma.....	43
Setting the Time Code.....	47
MENU Menu Function Settings.....	51
▶▶▶ Playing Movies	57
INFO.: Shooting Information Display.....	60

2	Reference	61
	Differences with the EOS-1D X Instruction Manual	62
	System Map	66
	Menu Settings	68
	Troubleshooting Guide.....	70
	Specifications	76
	Safety Warnings.....	88
3	Software Start Guide	93
	Software Start Guide.....	94
	Index	97

Handling Precautions

Camera Care

- This camera is a precision instrument. Do not drop it or subject it to physical shock.
- The camera is not waterproof and cannot be used underwater. If you accidentally drop the camera into water, promptly consult your nearest Canon Service Center. Wipe off any water droplets with a dry cloth. If the camera has been exposed to salty air, wipe it with a well-wrung wet cloth.
- Never leave the camera near anything having a strong magnetic field such as a magnet or electric motor. Also avoid using or leaving the camera near anything emitting strong radio waves such as a large antenna. Strong magnetic fields can cause camera misoperation or destroy image data.
- Do not leave the camera in excessive heat such as in a car in direct sunlight. High temperatures can cause the camera to malfunction.
- The camera contains precision electronic circuitry. Never attempt to disassemble the camera yourself.
- Do not block the mirror operation with your finger, etc. Doing so may cause a malfunction.
- Use a blower to blow away dust on the lens, viewfinder, reflex mirror, and focusing screen. Do not use cleaners that contain organic solvents to clean the camera body or lens. For stubborn dirt, take the camera to the nearest Canon Service Center.
- Do not touch the camera's electrical contacts with your fingers. This is to prevent the contacts from corroding. Corroded contacts can cause camera misoperation.
- If the camera is suddenly brought in from the cold into a warm room, condensation may form on the camera and internal parts. To prevent condensation, first put the camera in a sealed plastic bag and let it adjust to the warmer temperature before taking it out of the bag.
- If condensation forms on the camera, do not use the camera. This is to avoid damaging the camera. If there is condensation, remove the lens, card and battery from the camera, and wait until the condensation has evaporated before using the camera.
- If the camera will not be used for an extended period, remove the battery and store the camera in a cool, dry, well-ventilated location. Even while the camera is in storage, press the shutter button a few times once in a while to check that the camera is still working.
- Avoid storing the camera where there are corrosive chemicals such as a darkroom or chemical lab.
- If the camera has not been used for an extended period, test all its functions before using it. If you have not used the camera for some time or if there is an important shoot coming up, have the camera checked by your Canon dealer or check the camera yourself and make sure it is working properly.

LCD Panel and LCD Monitor

- Although the LCD monitor is manufactured with very high precision technology with over 99.99% effective pixels, there may be a few dead pixels among the remaining 0.01% or less pixels. Dead pixels displaying only black or red, etc., are not a malfunction. They do not affect the images recorded.
- If the LCD monitor is left on for a prolonged period, screen burn-in may occur where you see remnants of what was displayed. However, this is only temporary and will disappear when the camera is left unused for a few days.
- The LCD monitor display may seem slow in low temperatures, or look black in high temperatures. It will return to normal at room temperature.

Cards

To protect the card and its recorded data, note the following:

- Do not drop, bend, or wet the card. Do not subject it to excessive force, physical shock, or vibration.
- Do not store or use the card near anything having a strong magnetic field such as a TV set, speakers, or magnet. Also avoid places prone to having static electricity.
- Do not leave the card in direct sunlight or near a heat source.
- Store the card in a case.
- Do not store the card in hot, dusty, or humid locations.

Lens

After detaching the lens from the camera, put down the lens with the rear end up and attach the lens caps to avoid scratching the lens surface and electrical contacts.

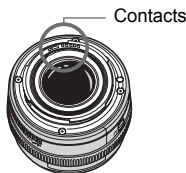

Cautions During Prolonged Use

If you use continuous shooting, Live View shooting, or movie shooting for a prolonged period, the camera may become hot. Although this is not a malfunction, holding the hot camera for a long period can cause slight skin burns.

Nomenclature

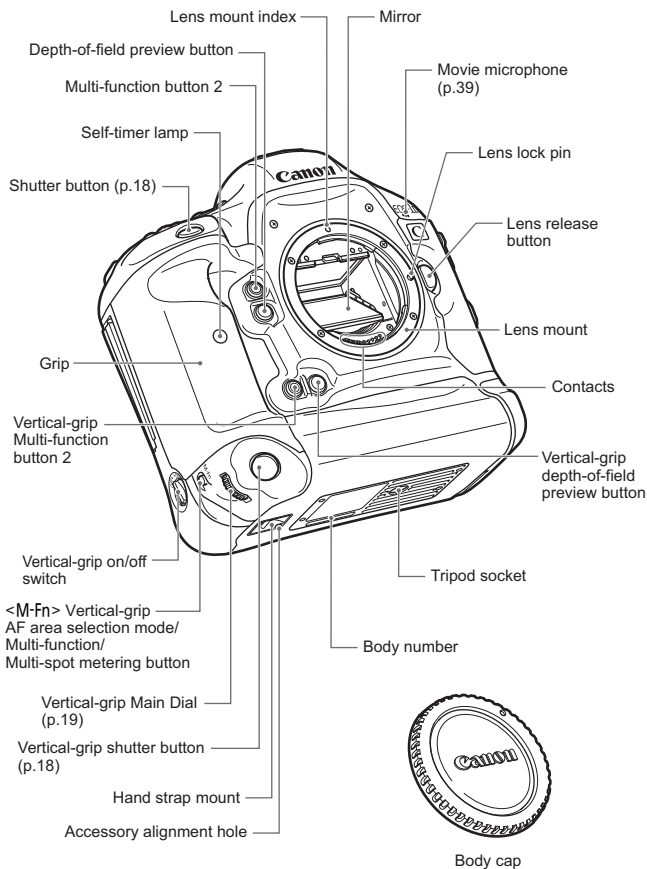

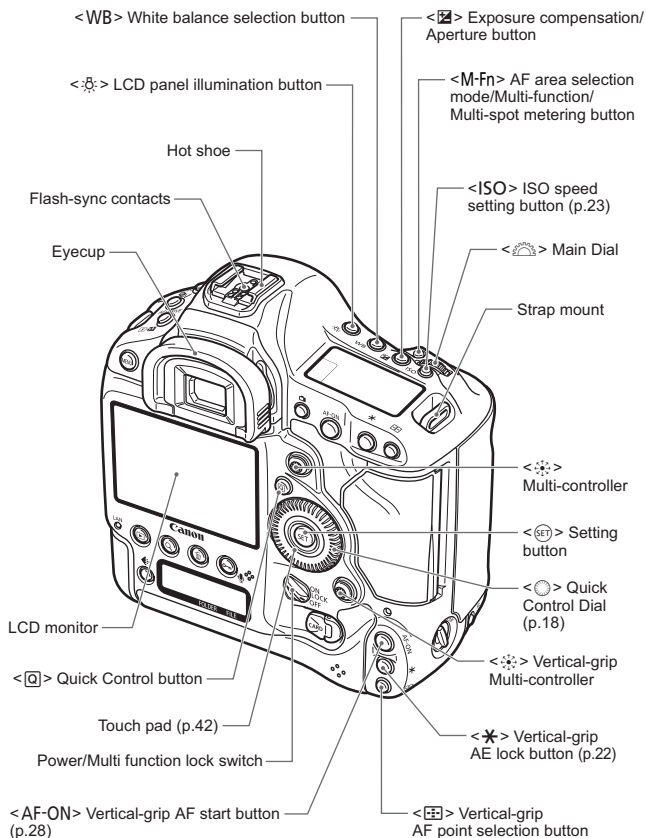

* Parts without reference page numbers are explained in the EOS-1D X Instruction Manual.

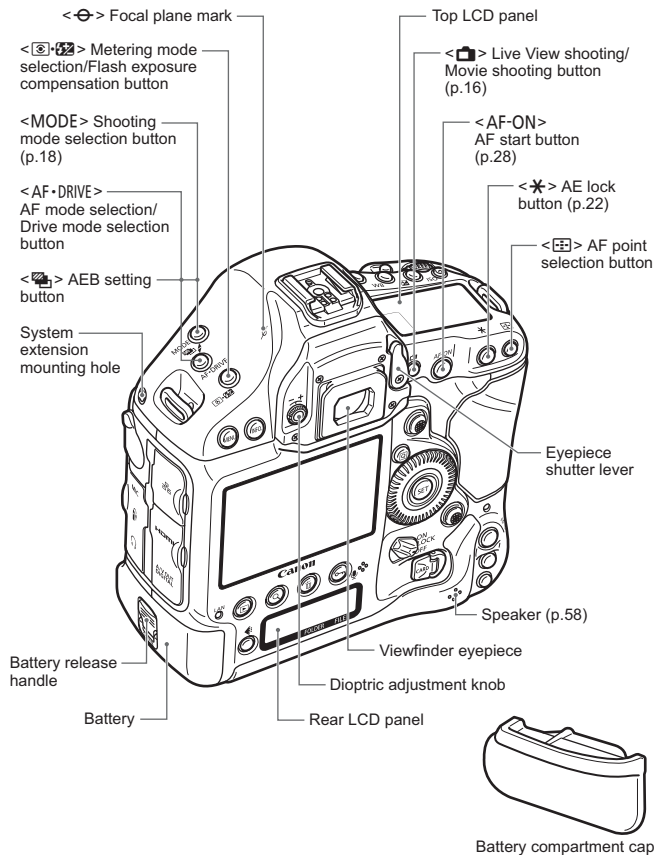

* For the nomenclature of the top LCD panel, rear LCD panel, Battery Pack LP-E4N, and Battery Charger LC-E4N, see pages 24 to 28.

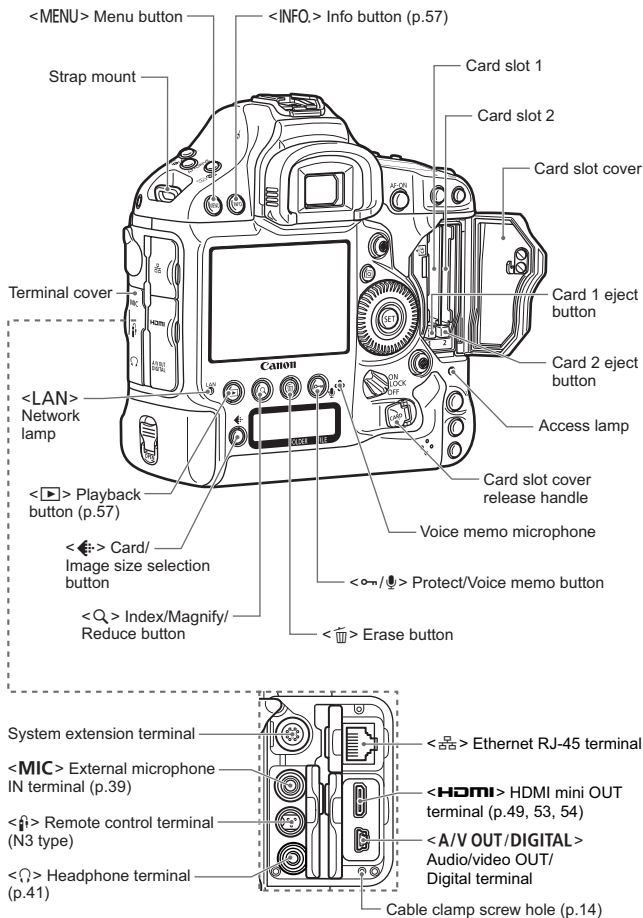

Using the Cable Protector and Clamp

With a Canon HDMI cable (sold separately):

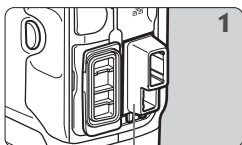

Cable protector

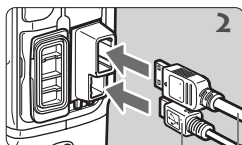

Interface cable
HDMI cable (sold separately)

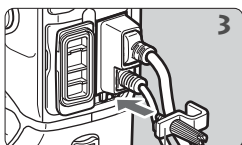

Cable clamp

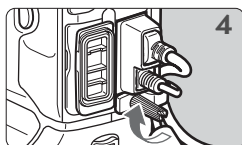

With a third party HDMI cable (commercially available):

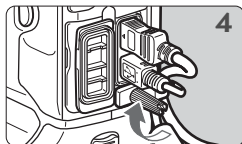
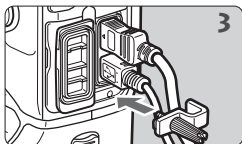
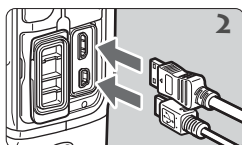
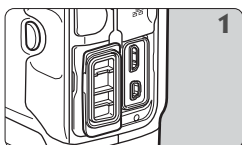

 If the plug of a third-party HDMI cable can fit into the Cable protector, using the Cable protector is recommended.

1

Shooting and Playing Movies

The live image displayed on the camera's LCD monitor can be recorded as a movie to the card. The movie recording format will be MOV.

- This chapter assumes that an EF lens is used with the camera.
- If you use an EF Cinema (CN-E) lens, see the cautions on pages 17 and 29, and start movie shooting.

📷 Preparing to Shoot Movies

Set the camera so it can record the live image displayed on the LCD monitor as a movie. To shoot still photos, see page 31.



1 Check the [Movies] setting.

- Select the [4] tab and check that [**LV** / set.] is set to [**Movies**].
- If it is set to [**Disable**] or [**Stills**], select [**Movies**], then press **<SET>**.
- “LV” stands for Live View.

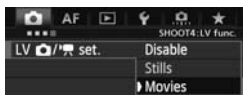

2 Set [Movie rec. size].

- For details on [**Movie rec. size**], see page 34.

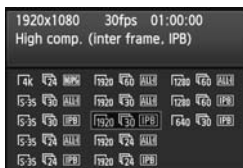

3 Display the image.

- Press the **<📷>** button.
- ▶ The image will appear on the LCD monitor.
- In the **<M>** shooting mode, turn the **<☀️>** or **<🕒>** dial to adjust the brightness.
- A semi-transparent or black mask will appear on the top/bottom or left/right. The image area surrounded by the masking will be recorded as the movie.



- Notes on Movie Shooting are on page 27.
- For information related to card operation confirmation, refer to Canon Web site, etc.

EF Cinema (CN-E) Lenses

With EF Cinema single focal length lenses, you can shoot at all movie-recording quality settings. If you use an EF Cinema zoom lens, you can shoot movies only with $\overline{15}35$ Super 35mm Crop. (Since the image circle is small, the image periphery will be dark if you shoot a movie in $\overline{4k}$ $\overline{19}20$ $\overline{12}80$ $\overline{6}40$ quality or still photo.)

Cards that Can Record Movies

Use a large-capacity card with a fast writing/reading speed (required card performance) as shown in the table. First, shoot a few test movies to see if movies can be recorded accurately with a movie-recording size you set (p.34).

Image Size	Frame Rate	Movie Recording/ Compression Method	Required Card Performance
$\overline{4k}$	$\overline{24}$	\overline{MJPEG} Motion JPEG	UDMA7 100 MB/sec. or faster
$\overline{15}35$	$\overline{30}/\overline{25}/\overline{24}$	\overline{IPB} MPEG-4 AVC/H.264	20 MB/sec. or faster
$\overline{19}20$	$\overline{30}/\overline{25}/\overline{24}$		10 MB/sec. or faster
$\overline{12}80$	$\overline{60}/\overline{50}$		
$\overline{6}40$	$\overline{30}/\overline{25}$		
$\overline{15}35$	$\overline{30}/\overline{25}/\overline{24}$	$\overline{ALL-I}$ MPEG-4 AVC/H.264	30 MB/sec. or faster
$\overline{19}20$	$\overline{60}/\overline{50}$		60 MB/sec. or faster
	$\overline{30}/\overline{25}/\overline{24}$		30 MB/sec. or faster
$\overline{12}80$	$\overline{60}/\overline{50}$		

-  If you use a slow-writing card when shooting movies, the movie may not be recorded properly. Also, if you play back a movie on a card with a slow reading speed, the movie may not play back properly.
- If you want to shoot still photos while shooting a movie, you will need an even faster card.
- To check the card's writing/reading speed, refer to the card manufacturer's Web site.
- To optimize the card's performance, format the card before shooting movies. For card-formatting cautions, see $\overline{1DX}$ page 55.

Shooting Movies

Autoexposure Shooting

When the shooting mode is set to **<P>** or **<BULB>**, autoexposure control will take effect to suit the scene's current brightness. Autoexposure control will be the same for **<P>** and **<BULB>**.



1 Set the shooting mode to **<P/ BULB>**.

- Press the **<MODE>** button and turn the or dial to select **<P>** or **<BULB>**.



2 Focus the subject.

- Before shooting a movie, focus with AF or manual focus ([iDX](#) p.213 to 220).
- When you press the shutter button halfway, the camera will focus with the current AF mode.

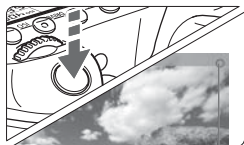

Recording movie

3 Shoot the movie.

- Press the shutter button completely (or press the **<M-Fn>** button) to start shooting a movie.
- ▶ While the movie is being shot, the "●" mark will be displayed on the upper right of the screen.
- Press the shutter button completely (or press the **<M-Fn>** button) again to stop shooting the movie.

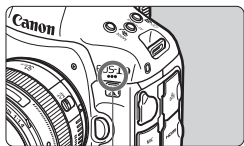

Movie microphone

If Canon Log gamma is set, AF is not possible. If Γ_{4k} , $\Gamma_{5.35}$, or $\Gamma_{1920} : \Gamma_{60} / \Gamma_{50}$ is set, AF is not possible in the **AfQuick** mode.

Shutter-priority AE

When the shooting mode is <Tv>, you can manually set the shutter speed for movie shooting. The ISO speed and aperture will be set automatically to suit the brightness and obtain a standard exposure.



1 Set the shooting mode to <Tv>.

- Press the <MODE> button and turn the <☀> or <⚙> dial to select <Tv>.



Shutter speed

2 Set the desired shutter speed.

- While looking at the LCD monitor, turn the <☀> dial. The settable shutter speeds depend on the frame rate <☹>.
 - ☹₃₀ ☹₂₅ ☹₂₄ : 1/4000 sec. - 1/30 sec.
 - ☹₆₀ ☹₅₀ : 1/4000 sec. - 1/60 sec.



3 Focus and shoot the movie.

- The procedure is the same as steps 2 and 3 for “Autoexposure Shooting” (p.18).



- Changing the shutter speed during movie shooting is not recommended since the changes in the exposure will be recorded.
- When shooting a movie of a moving subject, a shutter speed of 1/30 sec. to 1/125 sec. is recommended. The faster the shutter speed, the less smooth the subject's movement will look.
- If you change the shutter speed while shooting under fluorescent or LED lighting, image flicker may be recorded.

Aperture-priority AE

When the shooting mode is <Av>, you can manually set the aperture for movie shooting. The ISO speed and shutter speed will be set automatically to suit the brightness and obtain a standard exposure.



1 Set the shooting mode to <Av>.

- Press the <MODE> button and turn the <☀> or <⌚> dial to select <Av>.



Aperture

2 Set the desired aperture.

- While looking at the LCD monitor, turn the <☀> dial.



3 Focus and shoot the movie.

- The procedure is the same as steps 2 and 3 for “Autoexposure Shooting” (p.18).

⚠ Changing the aperture during movie shooting is not recommended since changes in the exposure, due to the drive of the lens aperture, will be recorded.

ISO speed in the P, Tv, Av, and BULB modes

- The ISO speed will be set automatically within ISO 100 - 25600.
- Under [**2: ISO speed settings**], if [**ISO speed range**]'s [**Maximum**] setting (**1DX** p.130) is set to [**51200/H**] in the **P**, **Tv**, and **BULB** modes, the automatic ISO speed setting range's maximum will be expanded to H (equivalent to ISO 51200). Note that even if you set [**Maximum**] to [**51200**], the maximum will remain at ISO 25600 and will not be expanded.
- If [**2: Highlight tone priority**] is set to [**Enable**] (**1DX** p.154), the ISO speed will be ISO 200 - 25600.
- Under [**2: ISO speed settings**], [**Auto ISO range**] and [**Min. shutter spd.**] cannot be set (**1DX** p.131, 132) for movie shooting. Also, [**ISO speed range**] cannot be set in the **Tv** mode.

! If [**ISO speed range**]'s [**Minimum**] is set to [**L (50)**] and you switch from still photo shooting to movie shooting, the automatic ISO speed setting range's minimum for movie shooting will be ISO 100. It cannot be expanded to ISO 50.

Notes for Autoexposure, Shutter-priority AE, and Aperture-priority AE

- You can lock the exposure (AE lock) by pressing the <✳> button (IDX p.181). After applying AE lock during movie shooting, you can cancel it by pressing the <☒> button. (AE lock setting is retained until you press <☒>.)
- If you set the power switch to <ON> and turn the <☉> dial, you can set the exposure compensation.
- Pressing the shutter button halfway displays the ISO speed and shutter speed on the screen's bottom. This is the exposure setting for taking a still photo (p.26). The exposure setting for movie shooting is not displayed. Note that the exposure setting for movie shooting may differ from that for still photo shooting.

Using an EX-series Speedlite (Sold Separately) Equipped with an LED Light

This camera is compatible with the function turning on the LED light automatically in low-light conditions during movie shooting in **P**, **Tv**, **Av** or **BULB** mode. **For details, refer to the Speedlite's instruction manual.**

Manual Exposure Shooting

You can manually set the shutter speed, aperture, and ISO speed for movie shooting.



1 Set the shooting mode to <M>.

- Press the <MODE> button and turn the <MODE> dial to select <M>.



2 Set the ISO speed.

- Press the <ISO> button.
- ▶ The ISO speed setting screen will appear on the LCD monitor.
- Turn the <MODE> dial to set the ISO speed.
- For details on the ISO speed, see the next page.



Shutter speed

3 Set the shutter speed and aperture.

- Press the shutter button halfway and check the exposure level indicator.
- To set the shutter speed, turn the <MODE> dial. The settable shutter speeds depend on the frame rate <FR>.
- 30 25 24 : 1/4000 sec. - 1/30 sec.
- 60 50 : 1/4000 sec. - 1/60 sec.
- To set the aperture, turn the <MODE> dial.
- If you cannot set the shutter speed or aperture, set the power switch to <ON>, then turn the <MODE> dial.

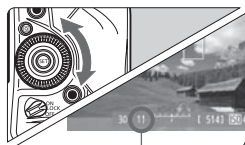

Aperture

4 Focus and shoot the movie.

- The procedure is the same as steps 2 and 3 for “Autoexposure Shooting” (p.18).

ISO speed during manual-exposure shooting

- ISO 400 is set by default.
- You can set the ISO speed manually within ISO 100 - 25600 in 1/3-stop increments. Under [**2: ISO speed settings**], if [**ISO speed range**]'s [**Maximum**] is set to [**51200/H**], the manual ISO speed setting range's maximum will be expanded to H (equivalent to ISO 51200). Note that even if you set [**Maximum**] to [**51200**], the maximum will remain at ISO 25600 and not be expanded. Setting [**Maximum**] to [**H1 (102400)**] or [**H2 (204800)**] will enable the setting range to be expanded up to ISO 102400/204800.
- With [**Auto**] (**A**), the ISO speed will be set automatically within ISO 100 - 25600.
- If [**2: Highlight tone priority**] is set to [**Enable**] (**IDX** p.154), you can set the ISO speed within ISO 200 - 25600 (depending on the [**ISO speed range**] setting).
- Under [**2: ISO speed settings**], [**Auto ISO range**] and [**Min. shutter spd.**] cannot be set (**IDX** p.131, 132) for movie shooting.



- Since shooting a movie at ISO 32000/40000/51200 may result in substantial noise, these speeds are designated as expanded ISO speeds (displayed as [H]).
- If [ISO speed range]'s [Minimum] is set to [L (50)] and you switch from still photo shooting to movie shooting, the manual ISO speed setting range's minimum for movie shooting will be ISO 100. It cannot be expanded to ISO 50.
- Changing the shutter speed or aperture, or zooming the lens during movie shooting, is not recommended since the changes in the exposure, or noise at high ISO speeds, may be recorded.
- When shooting a movie of a moving subject, a shutter speed of 1/30 sec. to 1/125 sec. is recommended. The faster the shutter speed, the less smooth the subject's movement will look.
- If you change the shutter speed while shooting under fluorescent or LED lighting, image flicker may be recorded.



- If ISO Auto is set, you can press the <★> button to lock the ISO speed.
- When you press the <★> button and then recompose the picture, you can see the exposure level difference on the exposure level indicator (iDx) p.25, 26) compared to when you first pressed the <★> button.
- By pressing the <INFO.> button, you can display the histogram.

Information Display

- Each time you press the <INFO.> button, the information display will change.

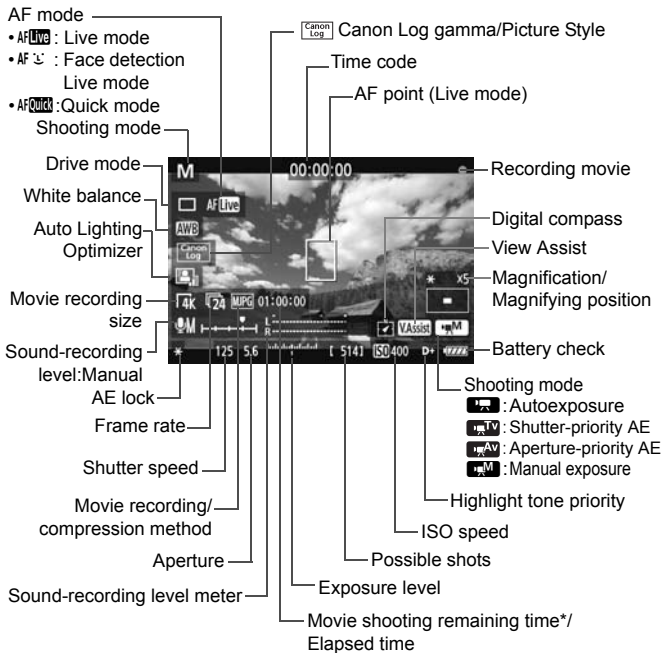

* Applies to a single movie clip.

- You can display the electronic level by pressing the <INFO.> button (p.62).
- If the AF mode is set to [Live mode] or if the camera is connected to a TV set with an HDMI cable (p.273), the electronic level is not displayed.
- If there is no card in the camera, the movie shooting remaining time will be displayed in red.
- When movie shooting starts, the movie shooting remaining time will change to the elapsed time.

Notes on Movie Shooting



- The camera cannot autofocus continuously like a camcorder.
- If you use AF during movie shooting, the focus may become greatly blurred momentarily and the exposure may change.
- If you use a USM lens and perform AF while shooting a movie in low light, horizontal noise stripes may be recorded. With certain lenses having an electronic focusing ring, horizontal noise stripes may be recorded even when you focus manually (MF).
- Zooming the lens during movie shooting is not recommended. Zooming the lens can cause changes in the exposure regardless of whether the lens' maximum aperture changes or not. Exposure changes may be recorded as a result.
- During movie shooting, do not point the lens toward the sun. The sun's heat can damage the camera's internal components.
- Under [**1**: Record func+card/folder sel.], even if [Record func.] is set to [Rec. to multiple] (p.118), the movie cannot be recorded to both Card 1 <[1]> and Card 2 <[2]>. If [Rec. separately] or [Rec. to multiple] is set, the movie will be recorded to the card which is set for [Playback].
- If <[AWB]> is set and the ISO speed or aperture changes during movie shooting, the white balance may also change.
- If you shoot a movie under fluorescent or LED lighting, the movie may flicker.
- When you shoot at high ISO speeds, color tone may be changed depending on the movie-recording size settings.
- When you press the <[Q]> button, the "x5" or "x10" figure displayed on the screen's bottom right indicates the magnification based on 35mm full-frame sensor size.
- **Cautions for movie shooting are on pages 55 and 56.**
- **If necessary, also see "Live View Shooting Cautions" on pages 221 and 222 in the EOS-1D X Instruction Manual.**

Notes on Movie Shooting



- Movie-related settings are under the [CAMERA 4] and [CAMERA 5] tabs (p.51).
- A movie file is recorded each time you shoot a movie. If the file size exceeds 4 GB for a single movie shoot (single clip), a new file will be created.
- The movie image's field of view is approx. 100% (with movie recording size set to [FHD]).
- You can also focus the image by pressing the <AF-ON> button.
- To focus during movie shooting, press the <AF-ON> button. You cannot focus by pressing the shutter button.
- Sizes of AF points and a magnification frame displayed in information display (p.26) depend on the movie-recording size setting (p.34).
- Monaural sound is recorded by the camera's built-in microphone (p.18).
- By connecting a stereo microphone (commercially available) equipped with a 3.5 mm mini plug to the camera's external microphone IN terminal (p.13), stereo sound recording is possible.
- By connecting stereo headphones (commercially available) equipped with a 3.5 mm mini plug to the camera's headphone terminal (p.13), you can listen to the sound during movie shooting.
- The focus preset function is possible for movie shooting when using a (super) telephoto lens equipped with the focus preset mode marketed since the second half of 2011.
- With a fully-charged Battery Pack LP-E4N, the total movie shooting time (with 4K shooting) will be as follows: approx. 1 hr. 25 min. at room temperature (23°C/73°F), and approx. 1 hr. 15 min. at low temperature (0°C/32°F).



Cautions for Using EF Cinema (CN-E) Lenses

- EF Cinema lenses with PL mount are not supported.
- EF Cinema lenses require the aperture to be adjusted manually. Therefore, they are not suitable for autoexposure shooting (p.18) and shutter-priority AE shooting (p.19) for which the aperture is set automatically to suit the brightness.
- If the EF Cinema lens is not fitted with a function for sending information to the camera, the aperture will be indicated as "00." Also, the lens name and other information will not be recorded in the Exif information.
- If the EF Cinema lens can send information to the camera, the aperture will be displayed as the f/number (not as the TNo.).
- The color tone of movies shot with EF lenses and EF Cinema lenses is different. Compared to EF lenses, EF Cinema lenses tend to make movies look slightly more yellow.
- When you shoot a still photo using an EF Cinema lens, lens aberration correction (peripheral illumination correction and chromatic aberration correction) is not applied.
- Additional cautions regarding the use of EF Cinema lenses may be announced on the Canon Web site, etc.

Final Image Simulation

The final image simulation is a function that allows you to see the effects of the Picture Style, white balance, etc., on the image. During movie shooting, the image displayed will automatically reflect the effects of the settings listed below.

Final image simulation for movies

- Picture Style
 - * All settings such as sharpness, contrast, color saturation, and color tone will be reflected.
- Canon Log gamma (without View Assist)
 - * Sharpness, saturation, and hue will be reflected.
- White balance
- White balance correction
- Exposure
- Depth of field
- Auto Lighting Optimizer
- Peripheral illumination correction
- Chromatic aberration correction
- Highlight tone priority

 Even when Canon Log gamma (p. 43) is set, function settings other than the Picture Style will be reflected in the final image simulation.

Shooting Still Photos

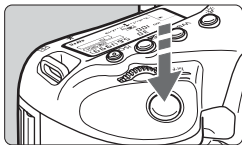

Set [**5: Movie shoot. btn**] to [**M-Fn**] (p.52) and press the shutter button completely. You can then shoot still photos while shooting the movie.

Note that you cannot shoot still photos if



4k, 15:35, 1920:160/150, or Canon Log gamma is set.

Taking still photos during movie shooting

- If you take a still photo during movie shooting, the movie will record a still moment lasting approx. 1 sec.
- The movie and still photo will be recorded as separate files on the card.
- The captured still photo will be recorded to the card, and the movie shooting will resume automatically when the image is displayed.
- If [**Record func.**] (**IDX** p.118) is set to [**Standard**] or [**Auto switch card**], the movies and still photos will be recorded to the same card. If [**Rec. separately**] or [**Rec. to multiple**] is set, the movies will be recorded to the card set for [**Playback**]. The still photos will be recorded at the image-recording quality set for the respective card.
- Functions particular to still photo shooting are shown below. Other functions will be the same as for movie shooting.

Function	Settings
Image-Recording Quality	As set in [2: Img type/size] and [2: JPEG quality].
ISO Speed*	<ul style="list-style-type: none"> • <P/Tv/Av/BULB>: ISO 100 - 25600 • <M>: See "ISO speed during manual-exposure shooting" on page 24.
Exposure Setting	<ul style="list-style-type: none"> • <P/BULB>: Automatically set shutter speed and aperture. • <Tv>: Manually set shutter speed and automatically set aperture. • <Av>: Manually set aperture and automatically set shutter speed. • <M>: Manually set shutter speed and aperture.





* If highlight tone priority is set, the ISO speed range will start from ISO 200.

- If [ 5: **Movie shoot. btn**] is set to [/MFn], still photo shooting is not possible.
- Since the image circle of EF Cinema zoom lenses does not support the image size of 35mm full-frame size image sensor, still photo shooting is not possible. (The image periphery will look dark.)
- AEB cannot be used.
- Even if an external Speedlite is used, it will not fire.
- Continuous still photo shooting is possible during movie shooting. However, the captured images will not be displayed on the monitor. Depending on the still photo's image-recording quality, number of shots during continuous shooting, card performance, etc., the movie shooting may stop automatically.



- If you plan to shoot still photos continuously during movie shooting, it is recommended that you use a card with a higher performance than those specified by “Required Card Performance” on page 17. Setting a smaller image size for still photos and shooting fewer continuous still photos are also recommended.
- You can shoot still photos in all drive modes.
- The self-timer can be used before you start shooting a movie. If used during movie shooting, the self-timer will switch to single shooting.

Shooting Function Settings

MODE / AF / DRIVE / / ISO / / WB Settings

If you press the <MODE>, <AF•DRIVE>, <>, <ISO>, <>, or <WB> button while the image is displayed on the LCD monitor, the setting screen will appear on the LCD monitor and you can turn the <> or <> dial to set the respective function.

When **AFQuick** is set, you can press the <> button to select the AF area selection mode and AF point. The procedure is the same as with viewfinder shooting. During manual-exposure shooting (p.23), you can press the <ISO> button to set the ISO speed.

Note that the <> metering mode and <> flash exposure compensation cannot be set.



Quick Control

If you press the <> button while the image is displayed on the LCD monitor, you can set the following: AF mode, drive mode, white balance, Picture Style, Auto Lighting Optimizer, movie-recording size, and sound-recording level (with [**Sound recording: Manual**] set).

1 Press the <> button.

- ▶ The settable functions will be displayed.

2 Select a function and set it.

- Use <> to select a function.
- ▶ The setting of the selected function is displayed at the bottom.
- Turn the <> or <> dial to set it.

 If [**Canon Log**] is set to [**On**], Picture Style and Auto Lighting Optimizer cannot be set.

 During movie shooting, you can set the following: shutter speed, aperture, ISO speed, exposure compensation, and sound-recording level. (Settable functions may differ depending on the shooting mode and [**Sound recording**] setting.)

MENU Setting the Movie-recording Size



The menu option [**4: Movie rec. size**] enables you to set the movie's image size, frame rate per second, and movie recording/compression method. The frame rate switches automatically depending on the [**3: Video system**] setting.

● Image size

- 4k [4096x2160]** : The image at the center of the image sensor is recorded in 4K resolution. The effective angle of view is approx. 1.3 times the lens focal length.
- 5-35 [1920x1080]** : The image at the center of the image sensor is recorded with the size equivalent to Super 35mm film in Full HD resolution (Super 35mm Crop). The aspect ratio will be 16:9. The effective angle of view is approx. 1.6 times the lens focal length.
- 1920 [1920x1080]** : Full High-Definition (Full HD) recording quality. The aspect ratio will be 16:9.
- 1280 [1280x720]** : High-Definition (HD) recording quality. The aspect ratio will be 16:9.
- 640 [640x480]** : Standard-definition (SD) recording quality. The aspect ratio will be 4:3.

- If you use an EF Cinema (CN-E) zoom lens, set the movie-recording size to **5-35**. If you shoot with a setting other than **5-35**, the image periphery will look dark.
- If **4k** is set, chromatic aberration correction (INDEX p.156) cannot be set (not applied).
- If you shoot a low-contrast subject with [**Live mode**] or [**Live mode**] when **4k** or **5-35** is set, focus may not be achieved with AF. Manual focusing is recommended.

Image Area

When $\overline{4k}$, $\overline{S:35}$, $\overline{1920}$, or $\overline{1280}$ is set, the respective image sensor area below is used to record the movie.

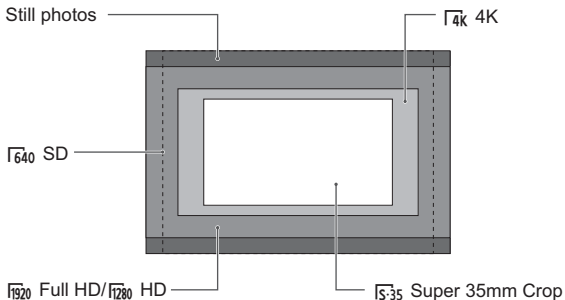

When $\overline{S:35}$ or $\overline{1920}$ is set, the movie will be recorded in 1920x1080 resolution. When $\overline{1280}$ is set, the movie will be recorded in 1280x720 resolution. When $\overline{640}$ is set, the movie will be recorded in 640x480 resolution.

● **Frame rate** (fps: frames per second)

$\overline{60}/\overline{30}$: For areas where the TV format is NTSC (North America, Japan, Korea, Mexico, etc.).

$\overline{50}/\overline{25}$: For areas where the TV format is PAL (Europe, Russia, China, Australia, etc.).

$\overline{24}$: Mainly for motion pictures.

● **Movie recording method and compression method**

MJPG MJPG : When shooting in $\overline{4k}$, Motion JPEG is used to compress the movie recorded. Each frame is compressed separately and recorded without compression between frames. The compression rate is therefore low. Since the image size is large, the file size will also be large.

IPB IPB : Efficiently compresses multiple frames at a time for recording. Since the file size will be smaller than with ALL-I, you can shoot longer.

ALL-I ALL-I (I-only) : Compresses one frame at a time for recording. Although the file size will be bigger than with IPB, the movie will be more suited for editing.

- Still photo shooting (p.31) is not possible if $\overline{4k}$, $\overline{5-35}$, or $\overline{1920}:\overline{60}/\overline{50}$ is set.
- While $\overline{5-35}$, $\overline{1920}:\overline{60}/\overline{50}$, $\overline{1920}:\overline{30}/\overline{25}$ movie-recording sizes all record at Full HD resolution, the recorded image may look slightly different between each setting.

- The $\overline{60}/\overline{50}$ and $\overline{30}/\overline{25}$ frame rate will switch automatically in accordance with the [**3: Video system**] setting.
- The color sampling will be recorded as follows: $\overline{4k}$: YCbCr 4:2:2 (8 bit), $\overline{5-35}$ $\overline{1920}$ $\overline{1280}$ $\overline{640}$: YCbCr 4:2:0 (8 bit). The color matrix will be recorded as follows: $\overline{4k}$ $\overline{640}$: Rec. ITU-R BT.601, $\overline{5-35}$ $\overline{1920}$ $\overline{1280}$: Rec. ITU-R BT.709.

Total Movie Recording Time and File Size Per Minute

Movie-Recording Size			File Size (approx.)	Total Recording Time (approx.)		
				4 GB Card	32 GB Card	128 GB Card
4K	24	MPEG	3.76 GB/min.	55 sec.	8 min.	32 min.
S-35	30 25 24	IPB	385 MB/min.	9 min. 30 sec.	1 hr. 19 min.	5 hr. 16 min.
		ALL-I	685 MB/min.	5 min.	44 min.	2 hr. 57 min.
1920	30 25 24	60 50 ALL-I	1.36 GB/min.	2 min. 30 sec.	22 min.	1 hr. 29 min.
		IPB	235 MB/min.	16 min.	2 hr. 9 min.	8 hr. 37 min.
		ALL-I	685 MB/min.	5 min.	44 min.	2 hr. 57 min.
1280	60 50	IPB	205 MB/min.	18 min.	2 hr. 28 min.	9 hr. 52 min.
		ALL-I	610 MB/min.	6 min.	49 min.	3 hr. 19 min.
640	30 25	IPB	78 MB/min.	48 min.	6 hr. 28 min.	25 hr. 55 min.

- **About movies exceeding 4 GB**

Even if you shoot a movie exceeding 4 GB for a single movie shoot (single clip), you can keep shooting without interruption.

During movie shooting, approx. 30 sec. before the movie reaches the 4 GB file size, the elapsed shooting time or time code displayed in the movie-shooting screen will start blinking. If you keep shooting until the movie file size exceeds 4 GB, a new movie file will be created automatically and the elapsed shooting time or time code will stop blinking.

When you play the movie with the camera, you have to play the movie files individually. Movie files cannot play back consecutively automatically. After the movie playback ends, select the next movie to be played.

- **Movie shooting time limit**

The maximum shooting time of one movie clip is 12 hours. The movie shooting will stop automatically if the card becomes full or if the maximum shooting time elapses. If the card is not full, you can press the shutter button completely (or press the <M-Fn> button) to shoot a movie again. (It will be recorded as a new file.)

- An increase of the camera's internal temperature may cause movie shooting to stop before the maximum recording time shown on the preceding page (p.55).
- Even if [**Record func.**] is set to [**Auto switch card**], the card cannot be switched automatically during movie shooting.
- If you delete part of the multiple movie files created from one successive shooting whose file size exceeds 4 GB for a single movie shoot (single clip), playing them back consecutively or saving them as a single movie file with EOS MOVIE Utility (p.95) is not possible.

 EOS MOVIE Utility can automatically combine individual 4 GB movie files and save them as a single movie file.

About Full HD 1080

Full HD 1080 indicates compatibility with High-Definition featuring 1080 vertical pixels (scanning lines).



MENU Setting the Sound Recording

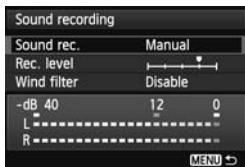

You can shoot movies while recording sound with the built-in monaural microphone or with a commercially-available stereo microphone. You can also freely adjust the sound-recording level.

Set the sound recording with [**4**: **Sound recording**].

Sound Recording/Sound-Recording Level

- [Auto]** : The sound-recording level is adjusted automatically. Auto level control will operate automatically in response to the sound level.
- [Manual]** : You can adjust the sound recording level to one of 64 levels. Select [**Rec. level**] and look at the level meter while turning the <⊙> dial to adjust the sound-recording level. While looking at the peak hold indicator (approx. 3 sec.), adjust so that the level meter sometimes lights up the “12” (-12 dB) mark on the right for the loudest sounds. If it exceeds “0”, the sound will be distorted.
- [Disable]** : Sound will not be recorded.



Wind Filter

When set to [**Enable**], it reduces wind noise when there is wind outdoors. This feature takes effect only with the built-in microphone. Note that [**Enable**] will also reduce low bass sounds, so set this function to [**Disable**] when there is no wind. It will record a more natural sound than with [**Enable**].

● **Using the microphone**

The built-in microphone records monaural sound. Stereo sound recording is possible by connecting an external stereo microphone (commercially-available) equipped with a miniature stereo plug (3.5 mm) to the camera's external microphone IN terminal (p.13). When an external microphone is connected, sound recording will switch automatically to the external microphone.

- The sound volume balance between L (left) and R (right) cannot be adjusted.
- The camera's built-in microphone will also pick up camera operation noise. Using a commercially-available external microphone can prevent (or reduce) these noises from being recorded.
- Do not connect anything other than an external microphone to the camera's external microphone IN terminal.

- Both L and R record audio at a 48 kHz/16-bit sampling rate.
- If [**5: Silent Control**] is set to [**Enable** ] (p.42), you can adjust the sound-recording level with the < > touch pad to reduce the operation noise during movie shooting.

- **Using headphones**

By connecting stereo headphones (commercially available) equipped with a 3.5 mm mini plug to the camera's headphone terminal (p.13), you can listen to the sound during movie shooting. If you are using an external stereo microphone, you can listen to the sound in stereo.

To adjust the headphone's sound volume, press the <Q> button, then hold down the <M> button and tilt the <D> up or down. The sound volume level is not displayed on the screen. Adjust while listening to the headphones.

You can also use headphones during movie playback.





The audio output to the headphones will not have noise reduction applied. It will therefore be different from the sound recorded with the movie.

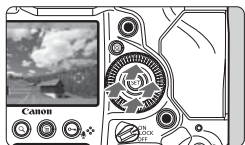

MENU Silent Control

This function is convenient when you want to change the ISO speed, sound-recording level, etc., silently while shooting a movie.









When [**5: Silent Control**] is set to [**Enable** , you can use the touch pad < > on the inner ring of the Quick Control Dial.

You can operate the camera silently just by touching the top, bottom, left, or right of < >.

During movie shooting, you can press < > to display the Quick Control screen and change the settings below with < >.

Settable Functions	Shooting Mode			
	P/B	Tv	Av	M
1. Shutter speed	–	○	–	○
2. Aperture	–	–	○	○
3. ISO speed	–	–	–	○
4. Exposure compensation	○	○	○	–
5. Sound-recording level	○	○	○	○

- If [**5: Silent Control**] is set to [**Enable** , you cannot adjust the sound-recording level with the < > Quick Control dial during movie shooting.
- Even if you change the aperture silently with < >, the movie will still record the lens aperture-driving sound.
- If there is water or dirt on < >, the touch operation may not work. In such a case, use a clean cloth to clean < >. If it still does not work, wait a while and try again.

Before shooting a movie, you can use < > to adjust the sound-recording level in the Quick Control and [**Rec. level**] screens.

Setting the Canon Log Gamma

Canon Log gamma is gamma correction for post-production. It is geared to maximize the image sensor's characteristics and attain a wide dynamic range. It minimizes loss of shadow and highlight details, and tonal information from the shadows to highlights can be incorporated in the movie.

A movie shot with Canon Log gamma can be applied with a lookup table (LUT) during post-production. Download the LUT data from the Canon Web site.

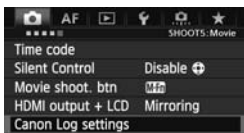

1 Select [Canon Log settings].

- Under the [CAMERA] tab, select [Canon Log settings], then press <SET>.

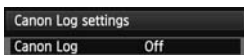

2 Select [Canon Log].

- Press <SET>.

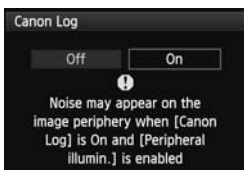



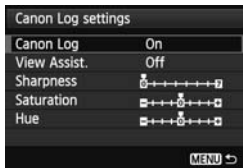

3 Select [On].

- Turn the <Q> dial to select [On], then press <SET>.
- ▶ Canon Log gamma will be set.

- ⚠ If [Canon Log] is [On] for movie shooting, the following restrictions will apply:
- The shooting mode will be set automatically to <M> (Manual exposure). (Shooting is not possible in the **P/BULB**, **Tv**, and **Av** modes.)
 - AF is not possible. Focus manually.
 - ISO Auto will not work. Set the ISO speed manually. (ISO speed is set to ISO 400 when ISO Auto is set.)



4 Adjust the Canon Log gamma.

- Adjust as necessary.
- Turn the <  > dial to select a parameter ([**Sharpness**], [**Saturation**], [**Hue**]), then press <  >.
- Turn the <  > dial to set the parameter, then press <  >.

Sharpness	0: Outline sharpening: Weak	7: Outline sharpening: Strong	
Saturation	-4: Low	+4: High	
Hue*	Red	-4: Magenta-biased	+4: Yellow-biased
	Green	-4: Yellow-biased	+4: Cyan-biased
	Blue	-4: Cyan-biased	+4: Magenta-biased

* Red, green, and blue cannot be adjusted individually.

Image Quality when Canon Log gamma is set

- When Canon Log gamma is set, vertical noise stripes may appear in movies depending on subject or shooting conditions. It is recommended to shoot a few test movies and check before the actual shooting.
- Vertical noise stripes tend to appear when the subject is dark and flat or [**Peripheral illumin.**] is set to [**Enable**]. This noise may also appear when ISO speed is relatively low, such as at ISO 400. Additionally, the noise may become more noticeable when $\overline{1920} : \overline{160} / \overline{150}$ is set compared to when other movie-recording sizes are selected.
- When the noise is noticeable, it is recommended to set [**Peripheral illumin.**] to [**Disable**], shoot in brighter exposure, and perform brightness adjustment during color grading. Also, noise may be decreased when you shoot at ISO speed lower than ISO 320 (even though the dynamic range will be narrowed).



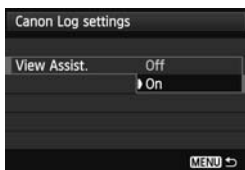

Setting View Assist

Canon Log gamma is a movie characteristic to attain wide dynamic range. As a result, the image displayed on the LCD monitor has low contrast and is somewhat dark compared to when a Picture Style is set. With View Assist, the movie image will be displayed on the LCD monitor with a conspicuous characteristic. This makes it easier to check the angle of view, details, etc.

Note that even if View Assist is set, it will not affect the movie recorded to the card. (The movie will be recorded to the card with Canon Log gamma.)



Select [View Assist.].

- Turn the <  > dial to select [**View Assist.**], then press <  >.
- Turn the <  > dial to select [**On**], then press <  >.
- ▶ The View Assist display will appear when you shoot a movie.

● View Assist display with HDMI output

If [**View Assist.**] is set to [**On**] and you shoot a movie in $\overline{4k}$, the View Assist will also apply to the HDMI output (p.53 to 54) image. Note that View Assist will not work with a movie-recording quality other than $\overline{4k}$.

- When [**Peripheral illumin.**] is set to [**Enable**], Canon Log gamma icon on the information display screen (p.26) blinks, since noise may appear in the movie image periphery.
- If you set Canon Log gamma, Picture Style, Auto Lighting Optimizer, and highlight tone priority cannot be set (not applied) for movie shooting. Also, still photo shooting during movie shooting is not possible.
- If you set Canon Log gamma, although AF is not possible, AF point (p.26) is displayed (when the lens focus mode switch is set to <AF>).
- Even if you switch [**Canon Log**] to [**Off**], you cannot revert to the original settings for shooting mode, AF mode, and ISO speed. Set them again if necessary.

- When Canon Log gamma is set, dynamic range will be approx. 800 % at ISO 320 or higher.
- If you use HDMI output and the movie-recording quality is other than 4K, the movie will be output without View Assist, regardless of the [**View Assist.**] setting. This makes it possible to record the HDMI movie to an external recording device with the Canon Log gamma without information (p.53 to 54).
- If 4K is set for the HDMI output, it will be output in Full HD (1080 60i/50i) with masking for indicating image area (4K output is not possible). Since the HDMI movie shot in 4K is mainly used for proxy editing or movie checking, the movie will be output with View Assist if [**View Assist.**] is set to [**On**].
- When the LCD monitor displays a movie output with View Assist, **VAssist** (p.26) will be displayed on the shooting information display screen. If View Assist cannot be used, **VAssist** will be dimmed even if [**View Assist.**] is set to [**On**].
- If [**View Assist.**] is set to [**On**] for 4K movie shooting, the A/V OUT (video OUT) movie will also have View Assist.
- View Assist is not displayed during movie playback.
- Canon Log gamma is applied to movies. Picture Style will be applied to the still photos shot with the viewfinder, regardless of the Canon Log gamma setting.

MENU Setting the Time Code

Time code	
Count up	Rec run
Start time setting	
Movie rec count	Rec time
Movie play count	Rec time
HDMI	
Drop frame	Enable
MENU →	

The time code is a time reference recorded automatically to synchronize the video and audio during movie shooting. It is recorded at all times in the following units: hours, minutes, seconds, and frames. It is mainly used during movie editing.

Set the time code with [CAMERA 5: Time code].

Count Up

- [Rec run] : The time code counts up only while you are shooting a movie. The time code will be continuous across sequential movie files recorded to the same card.
- [Free run] : The time code counts up whether you are shooting or not.

Start Time Setting

You can set the time code's start time.

- [Manual input setting] : You can freely set the hour, minute, second, and frame.
- [Reset] : The time set with [Manual input setting] and [Set to camera time] is reset to 00:00:00:00.
- [Set to camera time] : Sets hours, minutes, and seconds to match the camera's internal clock. "Frames" will be set to 00.



- If [Free run] is set and you change the time, zone, or daylight saving time ([iDx] p.40), the time code will be affected.
- "Regenerate" function is not available, that reads the last time code recorded in the old card and resumes the count in the new card when you replace or switch the card.

Movie Recording Count

You can select what to display on the movie-shooting screen.

[Rec time] : Indicates the elapsed time from the start of the movie shooting.

[Time code] : Indicates the time code during movie shooting.

 Shooting still photos during movie shooting will cause a discrepancy between the actual time and time code.

 Regardless of the **[Movie rec count]** setting, the time code will always be recorded to the movie file.

Movie Playback Count

You can select what to display on the movie playback screen.

[Rec time] : Displays the recording time and playback time during movie playback.

[Time code] : Displays the time code during movie playback.

With **[Time code]** set:



During movie shooting



During movie playback

- 
- If you change the setting for either **[Movie play count]** in **[CAMERA 5 (movie): Time code]** or for **[CAMERA 3: Movie play count]**, the other setting will also change automatically.
 - “Frames” are not displayed during movie shooting and movie playback.

HDMI

- **Time code**

You can append the time code to a movie that was output from HDMI. This is convenient for proxy editing after the movie output from HDMI is recorded to an external recording device (p.54).

[On]: Time code is appended to the HDMI output image.

[Off]: Time code is not appended to the HDMI output image.

- **Recording command**

When you record a movie that is output from HDMI to an external recording device, you can synchronize the camera's movie shooting start/stop with the external recording device's recording operation.

[On]: Synchronize external recording device's recording start/stop with camera's movie shooting start/stop.

[Off]: Control external device's recording start/stop from external recording device.



If the movie-recording quality's frame rate (p.54) and HDMI output frame rate are set manually to NTSC (60/30 fps) and PAL (50/25 fps) frame rates in a combination that does not function properly, the time code will not be appended to the HDMI output image.



For information on external recording devices compatible with [Rec Command], refer to Canon Web site, etc.

Drop Frame

If the frame rate setting is $\overline{30}$ (29.97 fps) or $\overline{60}$ (59.94 fps), the time code's frame count causes a discrepancy between the actual time and time code. This discrepancy can be corrected automatically. This correction function is called drop frame.

[Enable] : The discrepancy is corrected automatically by skipping time code numbers (DF: Drop frame).

[Disable] : The discrepancy is not corrected (NDF: Non-drop frame).

 If the frame rate is $\overline{24}$ (23.976 fps), $\overline{25}$ (25.00 fps), or $\overline{50}$ (50.00 fps), there will be no dropped frames. (If $\overline{24}$ is set or [**3: Video system**] is set to [PAL], [Drop frame] option will not be displayed.)

MENU Menu Function Settings

[CAMERA 4] Menu

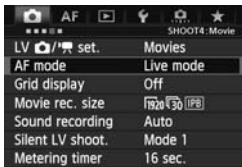

When you select **[Movies]** under **[CAMERA 4: LV set.]**, the **[CAMERA 4]** **[CAMERA 5]** tabs for movie shooting will appear. The menu options are as follows.

- **AF mode**

The AF modes are the same as described on [\[IDX\] pages 213 to 219](#). You can select **[Live mode]**, **[\downarrow Live mode]**, or **[Quick mode]**. Note that continuous focusing of a moving subject is not possible. Even if the AF mode is set to **[Quick mode]**, it will switch to **[Live mode]** during movie shooting.

- **Grid display**

With **[3x3]** or **[6x4]**, you can display grid lines to help you level the camera vertically or horizontally. Also, with **[3x3+diag]**, the grid is displayed together with diagonal lines to help you align the intersections over the subject for better balance in the composition.

- **Movie recording size**

You can set the movie recording size (image size, frame rate, and movie recording/compression method). For details, see pages 34 to 38.

- **Sound recording**

You can set sound recording settings. For details, see pages 39 and 40. Regarding headphones, see page 41.



If Canon Log gamma is set, AF is not possible. If **[4K]**, **[5-35]**, or **[1920:160/150]** is set, AF is not possible in the **AFQuick** mode.

- **Silent LV shooting**

This function applies to still photo shooting. For details, see [\[1DX\]](#) page 212.

- **Metering timer**

You can change how long the exposure settings are displayed (AE lock time).

[5] Menu

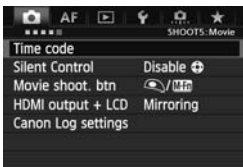

- **Time code**

You can set the time code. For details, see pages 47 to 50.

- **Silent Control**

When [**Enable**] is set, you can use the touch pad < > and Quick Control screen to change settings silently during movie shooting. For details, see page 42.

- **Movie shooting button**

The default setting is [/ **M-Fn**]. You can thereby start and stop the movie shooting not only with the <M-Fn> button, but also by pressing the shutter button completely or using Remote Switch RS-80N3 or Timer Remote Controller TC-80N3 (both sold separately). ([\[1DX\]](#) p.183)

Note that when [/ **M-Fn**] is set, still photo shooting (p.31) is not possible. The [**M-Fn**] setting will enable still photo shooting during movie shooting.

● HDMI output + LCD

Movies displayed on the LCD monitor as they are being recorded can also be displayed from the HDMI output. The default setting is **[Mirroring]**. Note that the video from the HDMI output will be displayed without the shooting information or masking for indicating image area (output without information overlay: through display). This makes it convenient to record the HDMI output image to a commercially-available external recording device.

If **[No mirroring]** is set, the movie will be displayed on the LCD monitor, but if there is HDMI output, the LCD monitor will turn off. With this setting, the movie from the HDMI output will also show the shooting information and masking for indicating image area. However, by pressing the <INFO.> button, you can eliminate the information from the output.



- If the HDMI movie is output without information, the card's remaining capacity, battery level, internal temperature increase (p.55) and other indicators will not appear on the HDMI output screen. Be aware of this if **[No mirroring]** is set. If **[Mirroring]** is set, you can check these indicators on the LCD monitor.
- Audio is not output during HDMI output.
- Even if **[Mirroring]** is set, movies being played back will not be displayed from the HDMI output when the image is played back or menu is displayed.
- Even if **[CAMERA 4: Movie recording size]** is set to Γ_{4k} , the HDMI movie will be output in Full HD (1080 60i/50i) with masking for indicating image area.
- When you stop movie shooting, the HDMI output image will pause (frame stop) while the movie is being recorded to the card. After the recording is completed, the movie will be displayed normally.
- Simultaneous output from both HDMI and A/V OUT is not possible. The movie will be output to the cable that was connected to the terminal last. During movie output, nothing will be displayed on the LCD monitor.
- The brightness of a movie shot by the camera and that of a recorded HDMI output image on the external recording device may differ depending on the viewing environment.



- By pressing the <INFO.> button, you can change the information displayed on the screen.
- You can append a time code to the HDMI output image (p.49).

- **Canon Log settings**

This is a gamma for attaining wide dynamic range in post-production. For details, see pages 43 to 46.

[F3] Menu

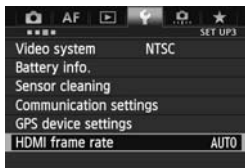

- **HDMI frame rate**

You can set the HDMI output frame rate to **[Auto]**, **[24p]**, or **[60i/50i]**. When you record movie from the HDMI output to a commercially-available external recording device, set the frame rate to match the external recording device's frame rate.

- If the frame rate set manually does not enable the external recording device to be connected, the frame rate will be set automatically.
- If **[Movie recording size]** is set to frame rate $\frac{1}{24}$ when **[HDMI frame rate: 60i]** is set, "2-3 pulldown" will be performed.

Movie Shooting Cautions

White and Red Internal Temperature Warning Icons

- If the camera's internal temperature increases due to prolonged movie shooting or under a high ambient temperature, a white icon will appear. Even if you shoot a movie while this icon is displayed, the movie's image quality will hardly be affected. However, if you shoot still photos, the image quality of the still photos may deteriorate. It is recommended to stop still photo shooting for a while and allow the camera to cool down.
- If the camera's internal temperature further increases while the white icon is displayed, a red icon will start blinking. This blinking icon indicates that movie shooting will soon stop automatically. If this happens, you will not be able to shoot again until the camera's internal temperature decreases. Turn off the power and let the camera rest for a while.
- Shooting a movie at a high temperature for a prolonged period will cause the and icons to appear earlier. When you are not shooting, turn off the camera.

Recording and Image Quality

- If the attached lens has an Image Stabilizer, the Image Stabilizer will operate at all times even if you do not press the shutter button halfway. The Image Stabilizer consumes battery power and may shorten the total movie shooting time or decrease the number of possible shots. If you use a tripod or if the Image Stabilizer is not necessary, it is recommended to set the IS switch to <OFF>.
- If there is a very bright light source in the picture, the bright area may appear black on the LCD monitor. In movies, the bright areas will be recorded in almost the same way you see it on the LCD monitor.
- In low light, noise or irregular colors may appear in the image. In movies, the bright areas will be recorded in almost the same way you see it on the LCD monitor.

Movie Shooting Cautions

Recording and Image Quality

- If you use a card with a slow writing speed, a five-level indicator may appear on the right of the screen during movie shooting. It indicates how much data has not yet been written to the card (remaining capacity of the internal buffer memory). The slower the card, the faster the indicator will climb upward. If the indicator becomes full, movie shooting will stop automatically.

If the card has a fast writing speed, the indicator will either not appear or the level (if displayed) will hardly go upward.

First, shoot a few test movies to see if the card can write fast enough.



Indicator

Still Photo Shooting During Movie Shooting

- Regarding the image quality of still photos, see “Image Quality” on [\[iDX\] page 221](#).

Playback and TV Connection

- In autoexposure shooting, shutter-priority AE, or aperture-priority AE modes, if the brightness changes during movie shooting, the movie may freeze temporarily. In such cases, shoot movies with manual exposure.
- If you shoot a movie in 4k resolution with ISO speed set to H2 (ISO 204800), the movie may look momentarily still when you play back the movie on the camera.
- If you connect the camera to a TV set ([\[iDX\] p.273, 276](#)) and shoot a movie, the TV will not output any sound during the shooting. However, the sound will be properly recorded.

Lens

- The focus preset function is possible for movie shooting only when using a (super) telephoto lens equipped with the focus preset mode marketed since the second half of 2011.

▶▶ Playing Movies

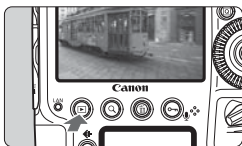

1 Play back the image.

- Press the <▶> button.
- ▶ The last captured image or last image viewed will appear.

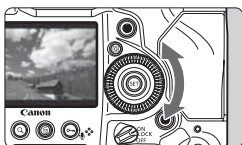

2 Select a movie.

- To play back images starting with the last image, turn the <◻> dial counterclockwise. To play back images starting with the first captured image, turn the dial clockwise.
- With the single-image display, the <SET> icon displayed on the upper left indicates a movie.
- Each time you press the <INFO.> button, the display format will change.

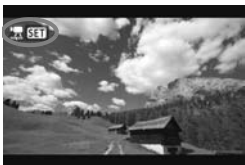

No information



Basic information

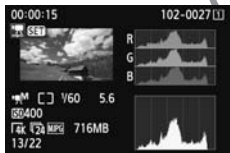

Histogram

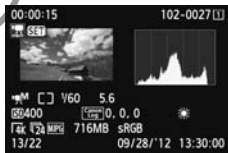

Shooting information display



Index display

- Press the $\langle Q \rangle$ button and turn the $\langle \text{DIAL} \rangle$ dial counterclockwise to display the index.
- In the index display, perforations at the left edge of a thumbnail indicate a movie. **As movies cannot be played on the index display, press $\langle \text{SET} \rangle$ to switch to the single-image display.**

3 In the single-image display, press $\langle \text{SET} \rangle$.

- ▶ The movie playback panel will appear at the bottom of the screen.







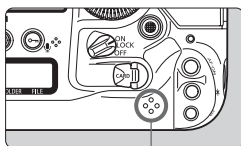





4 Play back the movie.

- Turn the $\langle \text{DIAL} \rangle$ dial to select $[\blacktriangleright]$ (Play), then press $\langle \text{SET} \rangle$.
- ▶ The movie will start playing.
- You can pause the movie playback by pressing $\langle \text{SET} \rangle$.
- During movie playback, you can turn the $\langle \text{DIAL} \rangle$ dial to adjust the sound volume.
- For more details on the playback procedure, see the next page.
- Press the $\langle \text{MENU} \rangle$ button to exit the image playback and return to shooting-ready state.



Speaker

When you edit out the first scene or last scene of a movie file which is one of multiple 4 GB movie files created by one successive shooting (IDEX p.268) and overwrite it, information for combining the files may be lost. In such a case, you may not be able to combine the file with other files into a single movie file and save it, using software such as EOS MOVIE Utility (p.95).

Function	Playback Description
 Exit	Returns to the single-image display.
 Play	Pressing <SET> toggles between play and stop.
 Slow motion	Adjust the slow motion speed by turning the <DIAL> dial. The slow-motion speed is indicated at the upper right of the screen.
 First frame	Displays the movie's first frame.
 Previous frame	Each time you press <SET>, the previous frame is displayed. If you hold down <SET>, it will rewind the movie.
 Next frame	Each time you press <SET>, the movie will play frame-by-frame. If you hold down <SET>, it will fast forward the movie.
 Last frame	Displays the movie's last frame.
 Edit	Displays the editing screen ( p.268).
	Playback position
hh:mm:ss	Playback time (minutes:seconds with [Movie play count: Rec time] set)
hh:mm:ss:ff	Time code (hours:minutes:seconds:frames with [Movie play count: Time code] set)
 Volume	Turn the <DIAL> dial to adjust the volume of the built-in speaker (p.58) or headphones.



- With a fully-charged Battery Pack LP-E4N, the continuous playback time at 23°C/73°F will be as follows: approx. 3 hr. 45 min.
- If you connect the camera to a TV set ( p.273, 276) to play back a movie, adjust the sound volume with the TV set. (Turning the <DIAL> dial will not adjust the sound volume.)
- If you took a still photo while you shot the movie, the movie image displayed will look still for approx. 1 sec. during movie playback.

INFO.: Shooting Information Display

Sample Information for Movies

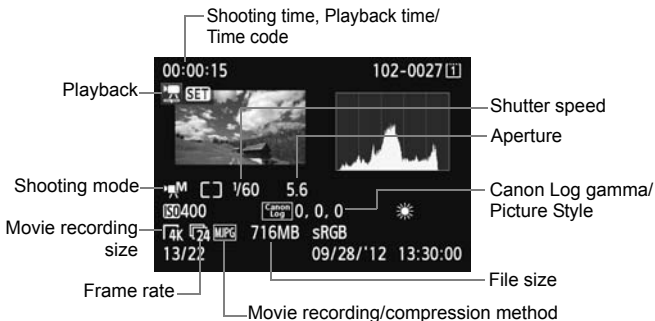

ⓘ If you use HDMI output to play a 4k movie, it will be played in Full HD (1080 60i/50i). However, using EOS MOVIE Utility (p.95) enables you to play the movie in 4k quality.

📖 For information not shown on this page, see “Sample Information for Still Photos” on [1DX](#) page 252.

2

Reference

This chapter covers other differences with the EOS-1D X's Instruction Manual, system accessories, and an FAQ.

Differences with the EOS-1D X Instruction Manual ■

As explained on page 3, the EOS-1D C Instruction Manual centers on movie shooting. Other differences between this manual and the EOS-1D X Instruction Manual (Firmware version 1.1.0 or later) are outlined below.

Nomenclature: Rear LCD panel (IDX p.26)

The EOS-1D C's rear LCD panel does not display the movie-recording size.

Reverting the Camera to the Default Settings (IDX p.58 to 60)

The EOS-1D C's default settings are as follows:

Shooting Settings

Shooting mode	M (Manual exposure)
ISO speed	400
White balance	Daylight

Movie Shooting Settings

LV / setting	Movie
Time code	
HDMI	Unchanged
Movie shooting button	/ M-Fn button
HDMI output + LCD	Mirroring
Canon Log settings	Off
View Assist.	Off
Sharpness/ Saturation/Hue	0
HDMI frame rate	AUTO

Saving and Loading Camera Settings (IDX p.351 to 353)

With the EOS-1D C, the following functions are added and saved.

5 (Movie)

HDMI output + LCD, and Canon Log settings

3

HDMI frame rate

C: Registering Custom Shooting Modes (IDX p.354 to 356)

With the EOS-1D C, the following functions are added and registered.

[CAMERA] 5 (Movie)]

HDMI output + LCD, and Canon Log settings

[CAMERA] 3]

HDMI frame rate



When [Canon Log] is set to [On] and Custom shooting mode <C1>, <C2>, or <C3> is set, the shooting mode will also be switched to <M>. Be aware that the shooting mode may be updated when [Auto update set.] is set to [Enable].

Function Availability Table According to Shooting Mode (IDX p.358, 359)

Differences with EOS-1D X are outlined below.

Function		Movie Shooting
Still photo: All image quality settings selectable		(Still photo)*4
Picture Style		○*5
Canon Log gamma		○
Auto Lighting Optimizer		○*5
Lens aberration correction *6	Peripheral illumination correction	○
	Chromatic aberration correction	○*5
Highlight tone priority		○*5
AF	AF mode	AF Live / AF / AF Quick *7
	One-Shot AF	
	AI Servo AF	

*4: When $\sqrt{4k}$, $\sqrt{35}$, or $\sqrt{1920}$: $\sqrt{60}/\sqrt{50}$ is set, still photo shooting is not possible.

*5: Not available when Canon Log gamma is set.

*6: Not corrected when an EF Cinema lens is used (correction data is not available).

*7: Cannot perform AF when Canon Log gamma is set.



Functions whose differences with the EOS-1D X are not specified are generally the same as the EOS-1D X's.

Setting the Image-Recording Quality: Guide to Image Size Settings (Approx.) (IDX)p.124)

Only the “Maximum Burst” numerals in bold frame are different from those of EOS-1D X.

Image Size	Pixels Recorded (megapixels)	Printing Size	File Size (MB)	Possible Shots	Maximum Burst
L	18M	Around A2	6.0	1200	100 (160)
M1	14M	A3 or larger	4.8	1470	150 (280)
M2	8.0M	Around A3	3.3	2170	290 (860)
S	4.5M	Around A4	2.1	3290	1190 (6310)
RAW	18M	Around A2	23.2	280	27 (29)
RAW + L	18M+18M	-	23.2+6.0	230	17 (17)
RAW + M1	18M+14M		23.2+4.8	240	17 (17)
RAW + M2	18M+8.0M		23.2+3.3	250	17 (17)
RAW + S	18M+4.5M		23.2+2.1	260	17 (17)
M RAW	10M	Around A3	18.3	350	25 (27)
M RAW + L	10M+18M	-	18.3+6.0	270	18 (18)
M RAW + M1	10M+14M		18.3+4.8	280	18 (18)
M RAW + M2	10M+8.0M		18.3+3.3	300	18 (18)
M RAW + S	10M+4.5M		18.3+2.1	320	19 (19)
S RAW	4.5M	Around A4	13.0	490	38 (40)
S RAW + L	4.5M+18M	-	13.0+6.0	340	18 (18)
S RAW + M1	4.5M+14M		13.0+4.8	360	18 (18)
S RAW + M2	4.5M+8.0M		13.0+3.3	400	19 (19)
S RAW + S	4.5M+4.5M		13.0+2.1	420	19 (19)

- The file size, possible shots, and maximum burst during continuous shooting are based on Canon's 8 GB testing card and Canon's testing standards (JPEG quality 8, ISO 100, and Standard Picture Style). **These figures will vary depending on the subject, card brand, ISO speed, Picture Style, Custom Functions, and other settings.**
- The maximum burst applies to H> high-speed continuous shooting. Figures in parentheses apply to an Ultra DMA (UDMA) mode 7, 128 GB card based on Canon's testing standards.

System Map

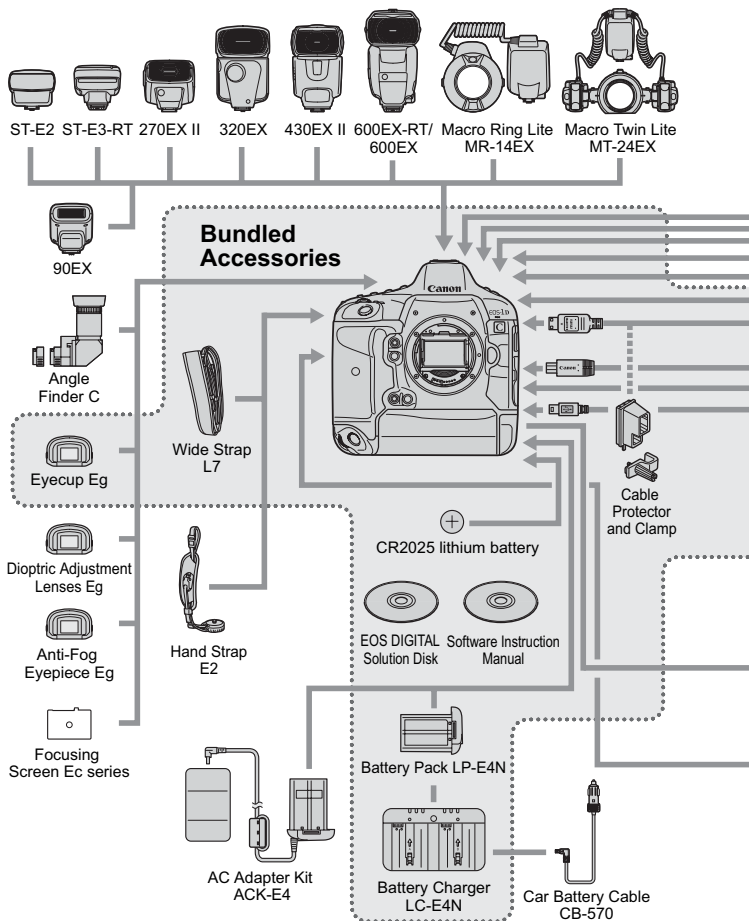

* Battery Pack LP-E4 and Battery Charger LC-E4 are also compatible.

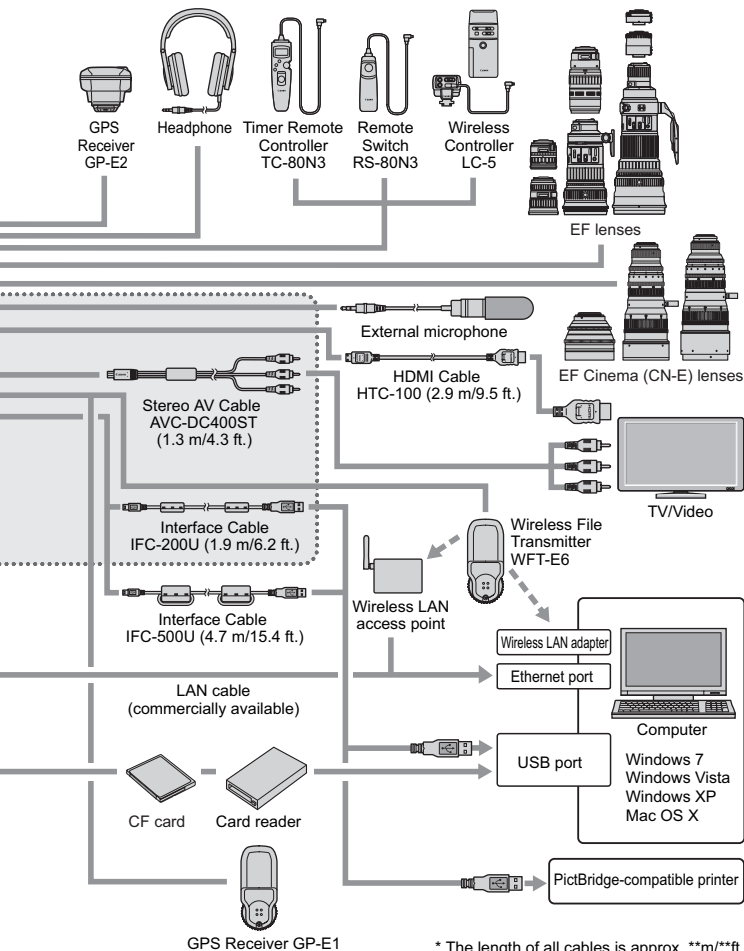



















* The length of all cables is approx. **m/**ft.

Menu Settings

For Movie Shooting





📷: Shooting 4 (Movie) (Red)

Page

LV 📷/📺 setting	Disable / Stills / Movies	16
AF mode	Live mode /  Live mode / Quick mode	51
Grid display	Off / 3x3  / 6x4  / 3x3+diag 	51
Movie recording size	 4K:4096x2160 () (MPEG)  35:1920x1080 ( /  / ) (ALL-I / IPB) 1920x1080 ( / ) (ALL-I) 1920x1080 ( /  / ) (ALL-I / IPB) 1280x720 ( / ) (ALL-I / IPB) 640x480 ( / ) (IPB)	34
Sound recording	Sound recording: Auto / Manual / Disable	39
	Recording level	
	Wind filter: Disable / Enable	
Silent LV shooting	Mode 1 / Mode 2 / Disable	52
Metering timer	4 sec. / 16 sec. / 30 sec. / 1 min. / 10 min. / 30 min.	52





 **Shooting 5 (Movie) (Red)**

Page

Time code	Count up / Start time setting / Movie rec count / Movie play count* / HDMI / Drop frame	47
Silent Control	Enable  / Disable 	42
Movie shooting button	 /  / 	52
HDMI output + LCD	Mirroring / No mirroring	53
Canon Log settings	Canon Log / View Assist. / Sharpness / Saturation / Hue	43



* The setting is linked to **[Movie play count]** under the **[▶ 3]** tab ( p.372).

 **Set-up 3 (Yellow)**

Video system	NTSC / PAL	 237  276
Battery info.	Power source / Remaining capacity / Shutter count / Recharge performance	 364
Sensor cleaning	Auto cleaning: Enable / Disable	 298
	Clean now	
	Clean manually	 301
Communication settings	Settings for wired LAN* and wireless LAN via WFT-E6 (sold separately)	Wired LAN Instruction Manual
GPS device settings	Settings available when the GPS Receiver GP-E1/GP-E2 (sold separately) is attached	—
HDMI frame rate	Auto / 24p / 60i or 50i	54

Troubleshooting Guide

A white icon or red icon is displayed.

- This indicates that the camera's internal temperature is high. If the white  icon is displayed, still photo image quality may deteriorate. If the red  icon is displayed, movie shooting will soon stop automatically (p. 55).

Movie shooting stops by itself.

- If the card's writing speed is slow, movie shooting may stop automatically. See page 17 for the writing/reading speed required (Required Card Performance) for the respective movie-recording quality. To find out the card's writing/reading speed, refer to the card manufacturer's Web site.
- Shoot a few test movies to see if movies can be recorded accurately with a movie-recording size you set (p.34) on the card.

The ISO speed cannot be set.

- If the shooting mode is **<P/Tv/Av/BULB>**, the ISO speed will be set automatically. In the **<M>** mode, you can freely set the ISO speed (p.24).

ISO 32000/40000/51200 cannot be set.

- Under [**2: ISO speed settings**], if [**ISO speed range**]'s [**Maximum**] is set to [**51200/H**] or higher, the manual setting range's maximum will be expanded to enable ISO 32000/40000/51200 to be set. However, since movie shooting at ISO 32000/40000/51200 may result in substantial noise, the expanded ISO speed ("**H**" displayed) will be used.

The manually set ISO speed changes when switching to movie shooting.

- If you shoot a movie when [Maximum: 51200] is set with [ISO speed range] and ISO speed is set to ISO 32000/40000/51200, the ISO speed will switch to ISO 25600 (during movie shooting with manual exposure). Even if you switch back to still photo shooting, the ISO speed will not revert to the original setting.
- If you shoot a movie when L (ISO 50) is set, the ISO speed setting will switch to ISO 100 (during movie shooting with manual exposure). Even if you switch back to still photo shooting, the ISO speed will not revert to the original setting.

The movie image periphery looks dark.

- If you use an EF Cinema zoom lens, set \overline{S}_{35} . Any setting other than \overline{S}_{35} will cause the movie image periphery to be dark.

The exposure changes during movie shooting.

- If you change the shutter speed or aperture during movie shooting, the changes in the exposure may be recorded.
- Zooming the lens during movie shooting can cause changes in the exposure regardless of whether the lens' maximum aperture changes or not. Changes in the exposure may be recorded as a result.

The subject looks distorted.

- If you move the camera to the left or right quickly (high-speed panning) or shoot a moving subject, the image may look distorted.

The screen flickers or horizontal stripes appear.

- Flickering, horizontal stripes (noise), or irregular exposures can be caused by fluorescent light, LED bulbs, or other light sources during movie shooting. Also, changes in the exposure (brightness) or color tone may also be recorded. In the <M> mode, a slow shutter speed may solve the problem.

When I shoot still photos during movie shooting, the movie shooting stops.

- To shoot still photos during movie shooting, using a card with a higher performance than the “Required Card Performance” on page 17 is recommended.
- Setting a smaller image size for the still photos and shooting fewer continuous shots may resolve the problem.

I cannot shoot still photos during movie shooting.

- Set [5: Movie shoot. btn] to [].
- You cannot shoot still photos during movie shooting if any of the following is set: Canon Log gamma, 4K, 15:35, 1920:160/150.
- Since the image circle of EF Cinema zoom lenses does not support the image size of 35mm full-frame size image sensor, still photo shooting is not possible. (The image periphery will look dark.)

Lens aberration correction is not applied for still photo shooting.

- When you shoot a still photo using an EF Cinema lens, peripheral illumination correction and chromatic aberration correction are not applied.

The time code is off.

- Shooting still photos during movie shooting will cause a discrepancy between actual time and time code. When you want to edit a movie using the time code, it is recommended not to shoot still photos during movie shooting.

Shooting mode is automatically set to <M> or cannot shoot with ISO Auto.

- When Canon Log gamma is set, shooting mode will be automatically switched to manual exposure. If ISO Auto is set, it will be automatically switched to manual ISO speed setting (p.43).

Vertical noise stripes appear.

- When Canon Log gamma is set, vertical noise stripes may appear in movies depending on subject or shooting conditions. For details, see page 44.

Highlight tone priority and other settings cannot be set.

- When Canon Log gamma is set, Picture Style, Auto Lighting Optimizer, and Highlight tone priority cannot be set (not applied) for movie shooting.

The movie looks dark or the contrast is low.

- Canon Log gamma has been set. If necessary, set View Assist (p.43 and 45).

View Assist is not displayed.

- View Assist will not be displayed with the HDMI output if a movie-recording quality other than 4K is set. (The movie will be output with Canon Log gamma.)
- View Assist is not displayed during movie playback.

Canon Log gamma icon blinks.

- When Canon Log gamma is set and [Peripheral illumin.] is set to [Enable], Canon Log gamma icon on the information display screen blinks, since noise may appear in the movie image periphery.

AF is not possible.

- AF is not possible when Canon Log gamma is set.
- If 4K, 35 or 1920:1080/50 is set, AF is not possible in the AF`Quick` mode. Even if the AF mode is set to AF`Quick`, it will switch to AF`Live` during movie shooting.

The time code cannot be appended during HDMI output.

- If the movie-recording quality's frame rate setting is set to a value that does not function properly in combination with the NTSC/PAL frame rate, the time code will not be appended to the HDMI output image.

The HDMI output image has a temporary frame stop.

- When the movie shooting ends, the HDMI output image pauses (frame stop). When writing to the card is completed, the movie is output normally.

Movie shooting stops if I connect or disconnect the HDMI cable.

- If you connect or disconnect the HDMI cable during movie shooting, the movie shooting will stop. If you shoot movies while using HDMI output, you should use the provided Cable protector and clamp to prevent the cable from disconnecting accidentally.

Movie Playback Problems

The movie cannot be played back.

- Movies edited with a personal computer cannot be played back with the camera.
- Movies shot with Canon Log gamma or shot in 4k, 1920:160/150 cannot be played back by another EOS DIGITAL camera.

When the movie is played back, camera operation noise can be heard.

- If you operate the camera's dials or lens during movie shooting, the operation noise will also be recorded. Using an external microphone (commercially available) is recommended (p.40).

The movie has still moments.

- During autoexposure movie shooting, if there is a drastic change in the exposure level, the recording will stop momentarily until the brightness stabilizes. If this happens, shoot in the <M> mode (p.23).

No image appears on the TV screen.

- Use the stereo AV cable that came with the camera (IDX p.276).
- Make sure the stereo AV cable or HDMI cable's plug is inserted all the way in (IDX p.273, 276).
- Set the video OUT system (NTSC/PAL) to the same video system as the TV set (IDX p.276).
- Even if you playback an image when [CAM 5: HDMI output + LCD] is set to [Mirroring], the image will not appear on the TV specified as HDMI output.

There are multiple movie files for a single movie shoot.

- If the movie file size reaches 4 GB for a single movie shoot (single clip), another movie file will be created automatically (p.37).

Specifications

• Type

Type:	Digital, single-lens reflex, AF/AE camera
Recording media:	Type I or II CF card, UDMA mode 7-compatible * Dual CF card slots
Image sensor size:	Approx. 36.0 x 24.0 mm
Compatible lenses:	1. Canon EF lenses (except EF-S and EF-M lenses) 2. Canon Cinema (CN-E) lenses (EF mount) * The effective angle of view is equivalent to the lens focal length. * Canon EF Cinema zoom lenses are compatible only with Super 35mm Crop movies. (Not compatible with still photo shooting, 4K, Full HD, HD, and SD movies.)
Lens mount:	Canon EF mount

• Image Sensor

Type:	CMOS sensor
Effective pixels:	Approx. 18.10 megapixels
Aspect ratio:	3:2
Dust delete feature:	Auto, Manual, Dust Delete Data appending

• Recording System

Recording format:	Design rule for Camera File System (DCF) 2.0
Image type:	JPEG, RAW (14-bit Canon original), RAW+JPEG simultaneous recording enabled
Recorded pixels:	L (Large) : Approx. 17.90 megapixels (5184 x 3456) M1 (Medium 1): Approx. 14.20 megapixels (4608 x 3072) M2 (Medium 2): Approx. 8.00 megapixels (3456 x 2304) S (Small) : Approx. 4.50 megapixels (2592 x 1728) RAW : Approx. 17.90 megapixels (5184 x 3456) M-RAW : Approx. 10.10 megapixels (3888 x 2592) S-RAW : Approx. 4.50 megapixels (2592 x 1728)
JPEG quality:	10 levels
Recording function:	Standard, Auto switch card, Record separately, Record to multiple
Create/select a folder:	Possible
File name:	Preset code, User setting 1, User setting 2
File numbering:	Continuous, Auto reset, Manual reset

• Image Processing During Shooting

Picture Style:	Auto, Standard, Portrait, Landscape, Neutral, Faithful, Monochrome, User Def. 1 - 3
White balance:	Auto, Preset (Daylight, Shade, Cloudy, Tungsten light, White fluorescent light, Flash), Custom, Color temperature setting (Approx. 2500-10000K), Personal white balance (5 settings), White balance correction, and White balance bracketing possible * Flash color temperature information transmission enabled
Noise reduction:	Applicable to long exposures and high ISO speed shots
Automatic image brightness correction:	Auto Lighting Optimizer
Highlight tone priority:	Provided
Lens aberration correction:	Peripheral illumination correction, Chromatic aberration correction

• Viewfinder

Type:	Eye-level pentaprism
Coverage:	Vertical/Horizontal approx. 100% (with Eye point approx. 20 mm)
Magnification:	Approx. 0.76x (-1 m ⁻¹ with 50 mm lens at infinity)
Eye point:	Approx. 20 mm (from eyepiece lens center at -1 m ⁻¹)
Built-in dioptic adjustment:	Approx. -3.0 - +1.0 m ⁻¹ (dpt)
Eyepiece shutter:	Built-in
Focusing screen:	Ec-C V provided, interchangeable
AF status indicator:	Provided
Grid display:	Provided
Electronic level:	Horizontal: 1° increments, ±6° Vertical: 1° increments, ±4° * During horizontal shooting
Mirror:	Quick-return type
Depth-of-field preview:	Provided

• Autofocus

Type:	TTL secondary image-registration, phase detection
AF points:	61 points (Up to 41 cross-type points) * Number of available AF points and cross-type points vary depending on the lens.
Focusing brightness range:	EV -2 - 18 (with center f/2.8 AF point, at 23°C/73°F, ISO 100)
Focus modes:	One-Shot AF, AI Servo AF, Manual focusing (MF)

AF area selection modes:	Single-point Spot AF (manual selection), Single-point AF (manual selection), AF point expansion (manual selection: up, down, left, and right), AF point expansion (manual selection: surround), Zone AF (manual selection), 61-point automatic selection AF
AF point automatic selection conditions:	Depending on EOS iTR AF setting (AF using color and face detection information possible) * iTR: Intelligent Tracking and Recognition
AF Configuration tool:	Case 1 - 6
AI Servo characteristics:	Tracking sensitivity, Acceleration/deceleration tracking, AF point auto switching
AF fine adjustment:	AF Microadjustment (All lenses by same amount or Adjust by lens)
AF-assist beam:	Emitted by the EOS-dedicated external Speedlite

• Exposure Control

Metering modes:	Approx. 100,000-pixel RGB metering sensor and 252-zone TTL metering at max. aperture EOS iSA (Intelligent Subject Analysis) system <ul style="list-style-type: none">• Evaluative metering (linked to all AF points)• Partial metering (approx. 6.5% of viewfinder at center)• Spot metering (approx. 2.5% of viewfinder at center)• Center-weighted average metering
Metering range:	EV 0 - 20 (at 23°C/73°F with EF50mm f/1.4 USM lens, ISO 100) * Spot metering: EV 2 - 20
Exposure control:	Program AE, Shutter-priority AE, Aperture-priority AE, Manual exposure, Bulb exposure
ISO speed: (Recommended exposure index)	Auto ISO, manually settable within ISO 100 - 51200 (1/3-stop or whole-stop increments), and expandable to L (Equivalent to ISO 50), H1 (Equivalent to ISO 102400), H2 (Equivalent to ISO 204800)
ISO speed settings:	ISO speed range, Auto ISO range, and Auto ISO minimum shutter speed settable
Exposure compensation:	Manual : ± 5 stops in 1/3- or 1/2-stop increments AEB : ± 3 stops in 1/3- or 1/2-stop increments (Can be combined with manual exposure compensation)
AE lock:	Auto : Applied in One-Shot AF mode with evaluative metering when focus is achieved Manual : By AE lock button

Standard exposure level adjustment: AE Microadjustment possible

• Multiple Exposures

Shooting method: Function/control priority, Continuous shooting priority

Number of multiple exposures: 2 to 9 exposures

Multiple-exposure control: Additive, Average, Bright, Dark

• Shutter

Type: Electronically-controlled, focal-plane shutter

Shutter speeds: 1/8000 sec. to 30 sec., Bulb (Total shutter speed range. Available range varies by shooting mode.), X-sync at 1/250 sec.

• Drive System

Drive modes: Single, High-speed continuous, Low-speed continuous, 10-sec. self-timer, 2-sec. self-timer, Silent single shooting, Super high-speed continuous

Continuous shooting speed: Super high-speed continuous shooting: Max. approx. 14 shots/sec.
High-speed continuous shooting: Max. approx. 12 shots/sec.
Low-speed continuous shooting: Max. approx. 3 shots/sec.

* At ISO 32000 or higher (or ISO 20000 or higher if the camera's internal temperature is low), the maximum high-speed continuous shooting speed will be approx. 10 fps.

Max. burst: JPEG Large: Approx. 100 shots (approx. 160 shots)
RAW: Approx. 27 shots (approx. 29 shots)
RAW+JPEG Large: Approx. 17 shots (approx. 17 shots)

* During high-speed continuous shooting

* Figures are based on Canon's testing standards (ISO 100 and Standard Picture Style) and an 8 GB card.

* Figures in parentheses apply to an UDMA mode 7, 128 GB card based on Canon's testing standards.

• External Speedlite

Compatible Speedlites: EX-series Speedlites

Flash metering: E-TTL II autofocus

Flash exposure

compensation: ± 3 stops in 1/3- or 1/2-stop increments

FE lock: Provided

Standard flash exposure

level adjustment: FE Microadjustment possible

External Speedlite control: Provided

* Compatible with radio wireless flash photography.

• Live View Shooting

Focus modes:	Live mode, Face detection Live mode (contrast detection), Quick mode (phase-difference detection), Manual focusing (approx. 5x / 10x magnification possible)
Focusing brightness range:	EV 1 - 20 (with contrast detection, at 23°C/73°F, ISO 100)
Metering modes:	Evaluative metering with the image sensor
Metering range:	EV 0 - 20 (at 23°C/73°F with EF50mm f/1.4 USM lens, ISO 100)
Silent shooting:	Provided (Mode 1 and 2)
Grid display:	Three types

• Movie Shooting

Recording format:	MOV
Movie:	4K: Motion JPEG Super 35mm Crop, Full HD, HD, SD: MPEG-4 AVC/H.264, variable (average) bit rate, IPB, ALL-I (I-only)
Audio:	Linear PCM
Recording size and frame rate:	4K: 4096 x 2160 24p Super 35mm Crop: 1920 x 1080 30p/25p/24p Full HD: 1920 x 1080 60p/50p/30p/25p/24p HD: 1280 x 720 60p/50p SD: 640 x 480 30p/25p * 60p: 59.94 fps, 50p: 50.00 fps, 30p: 29.97 fps, 25p: 25.00 fps, 24p: 23.976 fps * The lens crop factor for 4K and Super 35mm Crop is respectively approx. 1.3x and approx. 1.6x the lens focal length.
File size:	4K (24p) : Approx. 3.76 GB/min. Super 35mm Crop (30p/25p/24p) / IPB: Approx. 385 MB/min. Super 35mm Crop (30p/25p/24p) / ALL-I: Approx. 685 MB/min. Full HD (60p or 50p) / ALL-I : Approx. 1.36 GB/min. Full HD (30p/25p/24p) / IPB : Approx. 235 MB/min. Full HD (30p/25p/24p) / ALL-I : Approx. 685 MB/min. HD (60p/50p) / IPB : Approx. 205 MB/min. HD (60p/50p) / ALL-I : Approx. 610 MB/min. SD (30p/25p) / IPB : Approx. 78 MB/min.
Color sampling:	YCbCr 4:2:2 (8 bit): 4K YCbCr 4:2:0 (8 bit): Super 35mm Crop, Full HD, HD, SD
Color matrix:	Rec. ITU-R BT.601: 4K, SD Rec. ITU-R BT.709: Super 35mm Crop, Full HD, HD

Pixel range:	8 bit, 0 to 255 (with Canon Log Gamma: 8 bit, 16 to 254)
Movie characteristic:	1. Canon Log gamma, 2. Picture Style selectable * If Canon Log gamma is set, View Assist is possible.
Required card performance: (Writing/reading speed)	4K: UDMA7 100 MB/sec. or higher Full HD 60p/50p: 60 MB/sec. or higher Super 35mm Crop/IPB: 20 MB/sec. or higher Other than the above: IPB: 10 MB/sec. or higher, ALL-I: 30 MB/sec. or higher
Focus modes:	Same as focusing modes with Live View shooting * With Canon Log gamma: AF is not possible * With 4K, Super 35mm Crop, or Full HD 60p/50p: AF with Quick mode is not possible
Metering modes:	Center-weighted average and Evaluative metering with the image sensor * Automatically set by the focusing mode.
Metering range:	EV 0 - 20 (at 23°C/73°F with EF50mm f/1.4 USM lens, ISO 100)
Exposure control:	1. Autoexposure, 2. Shutter-priority AE, 3. Aperture-priority AE, 4. Manual exposure * With 1, 2, and 3, exposure compensation and AE lock are possible.
Exposure compensation:	1/3-stop increments, ±3 stops (±5 stops for still photos)
ISO speed: (Recommended exposure index)	P, Av, and BULB: ISO 100 - 25600 set automatically, or ISO expansion to H (equivalent to ISO 51200), H1 (equivalent to ISO 102400), H2 (equivalent to ISO 204800) Tv: ISO 100 - 25600 set automatically M: Auto ISO (ISO 100 - 25600 set automatically), ISO 100 - 25600 set manually (in 1/3- or whole-stop increments), or ISO expansion to H (equivalent to ISO 32000/40000/51200), H1 (equivalent to ISO 102400), H2 (equivalent to ISO 204800)
Time code:	Supported
Drop frames:	Compatible with 60p/30p
Sound recording:	Built-in monaural microphone, external stereo microphone terminal provided Sound recording level adjustable, wind filter provided
Headphones:	Headphone terminal provided
Grid display:	Three types
Still photo shooting:	Possible * If Canon Log gamma is set or 4K, Super 35mm Crop, or Full HD 60p/50p is set, still photo shooting is not possible.

Two-screen display:	Simultaneous display of LCD monitor and HDMI output image is possible.
HDMI output:	Image without information display can be output. * Selectable from Auto, 24p, 60i, and 50i.
Accessory attachment:	Camera bottom provides an alignment hole to prevent rotation.

• LCD Monitor

Type:	TFT color, liquid-crystal monitor
Monitor size and dots:	Wide, 8.1 cm (3.2-in.) (3:2) with approx. 1.04 million dots
Brightness adjustment:	Manual (7 levels)
Electronic level:	Provided
Interface languages:	25
Feature guide:	Displayable
Camera system status display:	Provided

• Playback

Image display formats:	Single-image display, Single-image + Info display (Basic info, shooting info, histogram), 4-image index, 9-image index display
Highlight alert:	Overexposed highlights blink
AF point display:	Possible
Grid display:	Three types
Zoom magnification:	Approx. 1.5x - 10x, starting magnification and position settable
Image browsing methods:	Single image, jump by 10 or 100 images, by shooting date, by folder, by movies, by stills, by rating
Image rotate:	Possible
Ratings:	Provided
Movie playback:	Enabled (LCD monitor, video/audio OUT, HDMI OUT) Built-in speaker
Slide show:	All images, by date, by folder, movies, stills, or by rating
Image protect:	Possible
Voice memo:	Recording/playback possible
Copying images:	Possible

• Post-Processing of Images

In-camera RAW image processing:	Brightness correction, White balance, Picture Style, Auto Lighting Optimizer, High ISO speed noise reduction, JPEG image-recording quality, Color space, Peripheral illumination correction, Distortion correction, and Chromatic aberration correction
Resize:	Possible

• Direct Printing

Compatible printers:	PictBridge-compatible printers
Printable images:	JPEG and RAW images
Print ordering:	DPOF Version 1.1 compatible

• Wired LAN

Ethernet:	10BASE-T, 100BASE-TX, 1000BASE-T
FTP transfer:	Automatic transfer upon shooting, Image selection/transfer, Transfer with SET button, Transfer with caption
EOS Utility:	EOS Utility's remote control works with wired LAN
WFT server:	Camera control, simple control, basic shooting, image viewing, and downloading
Media server:	DLNA-compatible
Multi camera time sync function:	Master camera can synchronize time with up to 10 slave cameras Time error of approx. ± 0.05 sec. between master and slave cameras

• Image Transfer

Transferrable images:	Still photos (JPEG, RAW, RAW+JPEG images), Movies
-----------------------	---

• Custom Functions

Custom Functions:	31
Save camera settings:	Up to ten sets can be registered in a card
Custom shooting modes:	Register under C1/C2/C3
My Menu registration:	Possible
Copyright information:	Entry and inclusion enabled

• Interface

Audio/video OUT/	Analog video (Compatible with NTSC/PAL)/stereo audio output
Digital terminal:	Personal computer communication, Direct printing (Hi-Speed USB or equivalent), GPS Receiver GP-E2 connection
HDMI mini OUT terminal:	Type C (Auto switching of resolution), CEC-compatible
External microphone	
IN terminal:	3.5 mm diameter stereo mini-jack
Headphone terminal:	3.5 mm diameter stereo mini-jack
Remote control terminal:	Compatible with N3-type remote controller
Ethernet terminal:	RJ-45 terminal, gigabit Ethernet compatible
System extension terminal:	For Wireless File Transmitter WFT-E6 and GPS Receiver GP-E1

• Power

Battery:	Battery Pack LP-E4N/LP-E4 (Quantity 1) * AC power can be supplied via AC Adapter Kit ACK-E4
Battery information:	Remaining capacity, Shutter count, and Recharge performance displayed
Battery life:	With viewfinder shooting: Approx. 1120 shots at 23°C/73°F, approx. 860 shots at 0°C/32°F
(Based on CIPA testing standards)	With Live View shooting: Approx. 290 shots at 23°C/73°F, approx. 250 shots at 0°C/32°F
Movie shooting time:	Approx. 1 hr. 25 min. at 23°C/73°F Approx. 1 hr. 15 min. at 0°C/32°F * With a fully-charged Battery Pack LP-E4N and 4K shooting.
Date/Time battery:	CR2025 lithium battery (Quantity 1)

• Dimensions and Weight

Dimensions (W x H x D):	Approx. 158.0 x 163.6 x 82.7 mm / 6.2 x 6.4 x 3.3 in.
Weight:	Approx. 1545 g / 54.5 oz. (CIPA Guidelines), Approx. 1355 g / 47.8 oz. (Body only)

• Operation Environment

Working temperature range:	0°C - 45°C / 32°F - 113°F
Working humidity:	85% or less

• Battery Pack LP-E4N

Type:	Rechargeable lithium-ion battery
Rated voltage:	11.1 V DC
Battery capacity:	2450 mAh
Dimensions (W x H x D):	Approx. 68.4 x 34.2 x 92.8 mm / 2.7 x 1.3 x 3.7 in.
Weight:	Approx. 185 g / 6.5 oz. (excluding protective cover)

• Battery Charger LC-E4N

Compatible battery packs:	Battery Pack LP-E4N, LP-E4
Recharging time:	LP-E4N: Approx. 130 min. (for 1 pack), LP-E4: Approx. 120 min. (for 1 pack)
Rated input:	100 - 240 V AC (50/60 Hz) 12 V / 24 V DC
Rated output:	12.6 V DC, 1.55 A
Power cord length:	Approx. 2 m / 6.6 ft.
Working temperature range:	0°C - 40°C / 32°F - 104°F
Working humidity:	85% or less
Dimensions (W x H x D):	Approx. 155 x 52.8 x 95 mm / 6.2 x 2.1 x 3.7 in.
Weight:	Approx. 350 g / 12.3 oz. (excluding power cord and protective covers)

- All the data above is based on Canon's testing standards and CIPA (Camera & Imaging Products Association) testing standards and guidelines.
- Dimensions, maximum diameter, length and weight listed above are based on CIPA Guidelines (except weight for camera body only).
- Product specifications and the exterior are subject to change without notice.
- If a problem occurs with a non-Canon lens attached to the camera, consult the respective lens maker.

Trademarks

- Adobe is a trademark of Adobe Systems Incorporated.
- Windows is a trademark or registered trademark of Microsoft Corporation in the United States and other countries.
- Macintosh and Mac OS are trademarks or registered trademarks of Apple Inc. in the United States and other countries.
- CompactFlash is a trademark of SanDisk Corporation.
- HDMI, HDMI logo, and High-Definition Multimedia Interface are trademarks or registered trademarks of HDMI Licensing LLC.
- All other corporate and product names and trademarks mentioned in this manual are the property of their respective owners.

About MPEG-4 Licensing

"This product is licensed under AT&T patents for the MPEG-4 standard and may be used for encoding MPEG-4 compliant video and/or decoding MPEG-4 compliant video that was encoded only (1) for a personal and non-commercial purpose or (2) by a video provider licensed under the AT&T patents to provide MPEG-4 compliant video. No license is granted or implied for any other use for MPEG-4 standard."

* Notice displayed in English as required.

Use of genuine Canon accessories is recommended

This product is designed to achieve excellent performance when used with genuine Canon accessories. Canon shall not be liable for any damage to this product and/or accidents such as fire, etc., caused by the malfunction of non-genuine Canon accessories (e.g., a leakage and/or explosion of a battery pack). Please note that this warranty does not apply to repairs arising out of the malfunction of non-genuine Canon accessories, although you may request such repairs on a chargeable basis.



Battery Pack LP-E4N is designed for Canon products only. Using it with an incompatible battery charger or product may result in malfunction or accidents for which Canon cannot be held liable.

Digital Camera Model DS126451 Systems

This device complies with part 15 of the FCC Rules.

DS126301 in EOS-1D X Instruction Manual (p.402) shall be deemed to be replaced with DS126451 for EOS-1D C.

Safety Warnings

Follow these safeguards and use the equipment properly to prevent injury, death, and material damage.

Preventing Serious Injury or Death

- To prevent fire, excessive heat, chemical leakage, and explosions, follow the safeguards below:
 - Do not use any batteries, power sources, and accessories not specified in this booklet. Do not use any home-made or modified batteries.
 - Do not short-circuit, disassemble, or modify the battery pack or back-up battery. Do not apply heat or apply solder to the battery pack or back-up battery. Do not expose the battery pack or back-up battery to fire or water. And do not subject the battery pack or back-up battery to strong physical shock.
 - Do not install the battery pack or back-up battery in reversed polarity (+ -). Do not mix new and old or different types of batteries.
 - Do not recharge the battery pack outside the allowable ambient temperature range of 0°C - 40°C (32°F - 104°F). Also, do not exceed the recharging time.
 - Do not insert any foreign metallic objects into the electrical contacts of the camera, accessories, connecting cables, etc.
- Keep the back-up battery away from children. If a child swallows the battery, consult a physician immediately. (Battery chemicals may harm the stomach and intestines.)
- When disposing of a battery pack or back-up battery, insulate the electrical contacts with tape to prevent contact with other metallic objects or batteries. This is to prevent fire or an explosion.
- If excessive heat, smoke, or fumes are emitted during battery pack recharging, immediately unplug the battery charger from the power outlet to stop the recharging and prevent a fire.
- If the battery pack or back-up battery leaks, changes color, deforms, or emits smoke or fumes, remove it immediately. Be careful not to get burned in the process.
- Prevent any battery leakage from contacting your eyes, skin, and clothing. It can cause blindness or skin problems. If the battery leakage contacts your eyes, skin, or clothing, flush the affected area with lots of clean water without rubbing it. See a physician immediately.
- During the recharging, keep the equipment away from the reach of children. The cord can accidentally choke the child or give an electrical shock.
- Do not leave any cords near a heat source. It can deform the cord or melt the insulation and cause a fire or electrical shock.
- Do not fire the flash at someone driving a car. It may cause an accident.
- Do not fire the flash near a person's eyes. It may impair the person's vision. When using flash to photograph an infant, keep at least 1 meter away.
- Before storing the camera or accessory when not in use, remove the battery pack and disconnect the power plug. This is to prevent electrical shock, heat generation, and fire.
- Do not use the equipment where there is flammable gas. This is to prevent an explosion or fire.

- If you drop the equipment and the casing breaks open to expose the internal parts, do not touch the internal parts due to the possibility of electrical shock.
- Do not disassemble or modify the equipment. High-voltage internal parts can cause electrical shock.
- Do not look at the sun or an extremely bright light source through the camera or lens. Doing so may damage your vision.
- Keep the camera from the reach of small children. The neck strap can accidentally choke the child.
- Do not store the equipment in dusty or humid places. This is to prevent fire and electrical shock.
- Before using the camera inside an airplane or hospital, check if it is allowed. Electromagnetic waves emitted by the camera may interfere with the plane's instruments or the hospital's medical equipment.
- To prevent fire and electrical shock, follow the safeguards below:
 - Always insert the power plug all the way in.
 - Do not handle a power plug with wet hands.
 - When unplugging a power plug, grasp and pull the plug instead of the cord.
 - Do not scratch, cut, or excessively bend the cord or put a heavy object on the cord. Also do not twist or tie the cords.
 - Do not connect too many power plugs to the same power outlet.
 - Do not use a cord whose insulation has been damaged.
- Occasionally unplug the power plug and use a dry cloth to clean off the dust around the power outlet. If the surrounding is dusty, humid, or oily, the dust on the power outlet may become moist and short-circuit the outlet to cause a fire.

Preventing Injury or Equipment Damage

- Do not leave equipment inside a car under the hot sun or near a heat source. The equipment may become hot and cause skin burns.
- Do not carry the camera around while it is attached to a tripod. Doing so may cause injury. Also make sure the tripod is sturdy enough to support the camera and lens.
- Do not leave a lens or lens-attached camera under the sun without the lens cap attached. Otherwise, the lens may concentrate the sun's rays and cause a fire.
- Do not cover or wrap the battery-recharging apparatus with a cloth. Doing so may trap heat within and cause the casing to deform or catch fire.
- If you drop the camera in water or if water or metal fragments enter inside the camera, promptly remove the battery pack and back-up battery. This is to prevent fire and electrical shock.
- Do not use or leave the battery pack or back-up battery in a hot environment. Doing so may cause battery leakage or a shorter battery life. The battery pack or back-up battery can also become hot and cause skin burns.
- Do not use paint thinner, benzene, or other organic solvents to clean the equipment. Doing so may cause fire or a health hazard.

If the product does not work properly or requires repair, contact your dealer or your nearest Canon Service Center.

3

Software Start Guide

This chapter gives an overview of the software in the EOS DIGITAL Solution Disk (CD-ROM) provided with the camera and explains how to install the software on a personal computer. It also explains how to view the PDF files on the Software Instruction Manual CD-ROM.



EOS DIGITAL Solution Disk
(Software)



Software Instruction Manual

Software Start Guide



EOS DIGITAL Solution Disk

This disk contains various software for EOS DIGITAL cameras.

EOS Utility

With the camera connected to a personal computer, EOS Utility enables you to transfer still photos and movies shot with the camera to the computer. You can also use the personal computer to set various camera settings and shoot remotely with the computer connected to the camera. When the EOS-1D C is connected to the personal computer, you can create optimum Picture Style files with Picture Style Editor while confirming their effects on the Remote Live View screen.

Picture Style Editor

You can edit Picture Styles and create and save original Picture Style files. This software is aimed at advanced users who are experienced in processing images.

Digital Photo Professional

This software is recommended for users who mainly shoot RAW images. You can view, edit, process, and print RAW images at high speed. You can also edit JPEG images while retaining the original images.

Downloading from Canon Web site

The following software can be downloaded from Canon Web site.

EOS MOVIE Utility for EOS-1D C

[On Windows]

You can play back movies you shot, consecutively play back separate movie files, and save them as a single movie file with this software.

Exporting still photos from movies is also possible.

[On Macintosh]

You can save separate movie files as a single movie file with this software.

Installing the Software



- Do not connect the camera to your computer before you install the software. The software will not be installed correctly.
- Even if a previous version of the software is installed, install the software by following the steps below. (The newer version will overwrite the previous version.)

1 Insert EOS DIGITAL Solution Disk (CD-ROM).

- For Macintosh, double-click to open the CD-ROM icon displayed on the desktop, then double-click on [Canon EOS Digital Installer].

2 Click [Easy Installation] and follow the on-screen instructions to install.

- If an install screen for Microsoft Silverlight is displayed during installation, install Microsoft Silverlight.

3 Click [Restart] and remove the CD-ROM after the computer restarts.

- When the computer has restarted, the installation is complete.



Software Instruction Manual

Contains the Software Instruction Manuals.

Copying and Viewing the Instruction Manual PDFs

- 1 Insert the [Software INSTRUCTION MANUAL] CD-ROM into your computer.
- 2 Double-click the CD-ROM icon.
 - For Windows, the icon is displayed in [(My) Computer].
 - For Macintosh, the icon is displayed on the desktop.
- 3 Copy the [English] folder to your computer.
 - Instruction Manual PDFs with the names below are copied.

	Windows	Macintosh
EOS Utility	EUx.xW_E_xx	EUx.xM_E_xx
Picture Style Editor	PSEx.xW_E_xx	PSEx.xM_E_xx
Digital Photo Professional	DPPx.xW_E_xx	DPPx.xM_E_xx

- 4 Double-click the copied PDF file.
 - Adobe Reader (most recent version recommended) must be installed on your computer.
 - Adobe Reader can be downloaded free from the Internet.

Index

Numerics

1280 (1280x720)	34
1920 (1920x1080)	34
1535 (1920x1080)	34
4k (4096x2160)	34
640 (640x480).....	34

A

AE lock	22
AF mode	51
ALL-I (I-only)	36
Aperture-priority AE	20
Audio/video OUT.....	13
Av (Aperture-priority AE).....	20

C

Cable.....	4, 66
Cable protector and clamp.....	14
Canon Log gamma	43
Card	9
Color sampling	36
Compression method	36
Contrast	30
Count	48
Crop	35

D

Digital terminal	13
------------------------	----

E

EF Cinema (CN-E) lenses	17
Electronic level.....	26

F

File size.....	37
Final image simulation	30
Frame rate	36

Free run.....	47
Full HD	34, 38
Full High-Definition (Full HD).....	34

G

Grid display	51
--------------------	----

H

HD	34
HDMI	14, 49, 54
Headphones	41
High-Definition (HD)	34

I

Image Area.....	35
Image size	17, 34
Index display	58
INFO. button.....	26, 57
IPB.....	36
ISO speed	21, 24

L

LCD monitor	9, 11
-------------------	-------

M

M (Manual exposure)	23
Malfunction	70
Manual exposure	23
MENU icon.....	5
Metering timer	52
M-Fn.....	18, 52
Microphone.....	18, 40
Motion JPEG	36
Movie.....	15
AE lock.....	22
AF mode	33, 51
Aperture-priority AE	20
Autoexposure shooting	18

- Compression method 36
 Count 48
 Drop frame 50
 External microphone 40
 File size 37
 Frame rate 36
 Grid display 51
 Information display 26
 Manual exposure shooting 23
 Metering timer 52
 Microphone 18
 Movie recording size 34
 Playback 57
 Quick Control 33
 Recording command 49
 Recording time 37
 Shutter-priority AE 19
 Silent control 42
 Sound recording 39
 Still photos 31
 Time code 47
 Wind filter 39
 Movie recording method 36
 Movie shooting button 52
 Multi-function 10, 11
- N**
- Nomenclature 10
 NTSC 36, 69
- P**
- P (Program AE) 18
 PAL 36, 69
 Playback 57
- Q**
- [Q] 33
 Quick Control 33
- R**
- Rec command 49
 Rec run 47
 Recording level 39
 Required Card Performance 17
- S**
- Safety warnings 88
 Shooting information 60
 Shooting mode 18
 Av (Aperture-priority AE) 20
 BULB 18
 M (Manual exposure) 23
 P (Program AE) 18
 Tv (Shutter-priority AE) 19
 Shooting time 37
 Shutter button 18, 52
 Shutter-priority AE 19
 Silent LV shooting 52
 Software 93
 Speaker 58
 Still photos 31
 Super high speed continuous
 shooting 52
 System map 66
- T**
- Temperature warning 55
 Time code 47
 Touch pad 42
 Tv (Shutter-priority AE) 19
- U**
- USB (Digital) terminal 13
- V**
- V.Assist 45
 Video system 34, 69
 View Assist 45
 Volume (Movie playback) 59
- W**
- Wind filter 39

Canon

CANON INC. 30-2, Shimomaruko 3-chome, Ohta-ku, Tokyo 146-8501, Japan

U.S.A. ——— **CANON U.S.A. INC.**

<http://pro.usa.canon.com>

<http://pro.usa.canon.com/support>

☎ (855) CINE-EOS (855-246-3367) (USA only)

CANADA ——— **CANON CANADA INC.**

<http://www.canon.ca/pro>

❖ Professional Product Support / Soutien des produits professionnels

☎ (800) 667-2666

EUROPE, ——— **CANON EUROPA N.V.**

AFRICA & Bovenkerkerweg 59-61, 1185 XB Amstelveen, The Netherlands

MIDDLE EAST **CANON FRANCE S.A.S.**

17, Quai du Président Paul Doumer, 92414 Courbevoie Cedex, France

CANON UK LTD.

Woodhatch Reigate, Surrey RH2 8BF, United Kingdom

CANON DEUTSCHLAND GmbH

Europark Fichtenhain A10, 47807 Krefeld, Germany

CANON ITALIA S.p.A.

Via Milano 8, 20097 San Donato Milanese, (MI), Italy

CANON Schweiz A.G.

Industriestrasse 12, 8305 Dietlikon, Switzerland

Canon GmbH

Zetschegasse 11, A-1230 Vienna, Austria

CANON España,S.A.

Av. De Europa, 6 Alcobendas 28108 Madrid, Spain

CANON Portugal S.A.

Rua Alfredo da Silva,14 Alfragide 2610-016 Amadora, Portugal

CENTRAL & ——— **CANON LATIN AMERICA, INC.**

SOUTH AMERICA <http://www.cla.canon.com>

ASIA ——— **CANON (China) Co., LTD.**

15F Jinbao Building No.89 Jinbao Street, Dongcheng District, Beijing 100005, China

CANON HONGKONG CO., LTD.

19/F., The Metropolis Tower, 10 Metropolis Drive, Hunghom, Kowloon, Hong Kong

CANON SINGAPORE PTE. LTD.

1 Harbour Front Avenue, #04-01 Keppel Bay Tower, Singapore 098632

CANON KOREA CONSUMER IMAGING INC.

Canon BS Tower 5F, #168-12 Samseong-dong, Gangnam-gu, Seoul, Korea

OCEANIA ——— **CANON AUSTRALIA PTY. LTD.**

☎ 13-13-83 (within Australia only)

☎ (61) 2-9805-2555

CANON NEW ZEALAND LTD.

☎ 0800-222-666 (within New Zealand only)

☎ (64) 9-489-0300

JAPAN ——— **CANON MARKETING JAPAN INC.**

16-6, Kohnan 2-chome, Minato-ku, Tokyo 108-8011, Japan

The lenses and accessories mentioned in this Instruction Manual are current as of October 2012. For information on the camera's compatibility with any lenses and accessories introduced after this date, contact any Canon Service Center.