

User Guide



HP Officejet Pro 8100



HP Officejet Pro 8100 ePrinter

User Guide

Copyright information

© 2014 Copyright Hewlett-Packard
Development Company, L.P.
Edition 2, 1/2014

Hewlett-Packard Company notices

The information contained in this document is subject to change without notice.

All rights reserved. Reproduction, adaptation, or translation of this material is prohibited without prior written permission of Hewlett-Packard, except as allowed under copyright laws.

The only warranties for HP products and services are set forth in the express warranty statements accompanying such products and services. Nothing herein should be construed as constituting an additional warranty. HP shall not be liable for technical or editorial errors or omissions contained herein.

Acknowledgements

Microsoft, Windows, Windows XP, Windows Vista, and Windows 7 are U.S. registered trademarks of Microsoft Corporation.

ENERGY STAR and the ENERGY STAR mark are registered U.S. marks.

Safety information



Always follow basic safety precautions when using this product to reduce risk of injury from fire or electric shock.

1. Read and understand all instructions in the documentation that comes with the printer.
2. Observe all warnings and instructions marked on the product.
3. Unplug this product from wall outlets before cleaning.
4. Do not install or use this product near water, or when you are wet.
5. Install the product securely on a stable surface.
6. Install the product in a protected location where no one can step on or trip over the line cord, and the line cord cannot be damaged.
7. If the product does not operate normally, see [Solve a problem](#).
8. There are no user-serviceable parts inside. Refer servicing to qualified service personnel.

Contents

1 Get started

Accessibility.....	6
Eco.....	7
Manage power.....	7
Conserve printing supplies.....	8
Understand the printer parts.....	8
Front view.....	8
Printing supplies area.....	9
Back view.....	9
Use the printer control panel.....	10
Overview of buttons and lights.....	10
Change printer settings.....	11
Print reports.....	11
Finding the printer model number.....	11
Select print media.....	11
Recommended papers for printing	12
Recommended papers for photo printing.....	13
Tips for selecting and using media.....	14
Load media.....	14
Load standard-size media.....	15
Load envelopes.....	16
Load cards and photo paper.....	17
Load custom-size media.....	18
Install the accessories.....	19
Install the automatic two-sided printing accessory (duplexer)	19
Install Tray 2.....	19
Configure trays.....	21
Turn on accessories in the printer driver.....	22
To turn on accessories (Windows).....	22
To turn on accessories (Mac OS X).....	23
Maintain the printer.....	23
Clean the exterior	23
Update the printer.....	23
Turn the printer off.....	24

2 Print

Print documents.....	25
Print documents (Windows).....	26
Print documents (Mac OS X).....	26
Print brochures.....	26
Print brochures (Windows).....	27
Print brochures (Mac OS X).....	27

Print on envelopes.....	28
Print on envelopes (Windows).....	28
Print on envelopes (Mac OS X).....	28
Print photos.....	29
Print photos on photo paper (Windows).....	29
Print photos on photo paper (Mac OS X).....	30
Print on special and custom-size paper.....	30
Print on special or custom-size paper (Mac OS X).....	31
Print borderless documents or photos.....	31
Print borderless documents or photos (Windows).....	32
Print borderless documents or photos (Mac OS X).....	32
Print on both sides (duplexing).....	33
View print resolutions.....	34
3 HP ePrint	
Set up HP ePrint.....	35
Set up HP ePrint using the HP printer software	35
Set up HP ePrint using the printer's control panel.....	36
Set up HP ePrint using the embedded web server.....	36
Use HP ePrint.....	37
Print using HP ePrint.....	37
Find the printer's email address.....	37
Turn off HP ePrint.....	37
Remove Web Services.....	38
4 Work with ink cartridges	
Information on ink cartridges and the printhead.....	39
Check the estimated ink levels.....	40
Printing with black or color ink only.....	40
Replace the ink cartridges.....	41
Store printing supplies.....	42
Anonymous Usage Information Storage.....	42
5 Solve a problem	
HP support.....	44
Obtain electronic support.....	45
HP support by phone.....	45
Before you call.....	46
Phone support period.....	46
Telephone support numbers.....	46
After the phone support period.....	48
General troubleshooting tips and resources.....	48
Solve printer problems.....	48
The printer shuts down unexpectedly.....	49
Alignment fails.....	49
The printer is not responding (nothing prints).....	49
The printer prints slowly.....	50
The printer is making some unexpected noises.....	51
Blank or partial page printed.....	51
Something on the page is missing or incorrect.....	52
Placement of the text or graphics is wrong.....	52

Contents

Print quality troubleshooting.....	53
Solve paper-feed problems.....	57
Solve problems using HP ePrint and HP websites.....	59
Solve problems using HP ePrint.....	59
Solve problems using HP websites.....	60
Solve Ethernet network problems.....	60
General network troubleshooting.....	60
Solve wireless problems.....	60
Basic wireless troubleshooting.....	61
Advanced wireless troubleshooting.....	62
Step 1: Make sure your computer is connected to your network.....	62
Step 2: Make sure that the printer is connected to your network.....	63
Step 3: Check to see if the firewall software is blocking communication.....	64
Step 4: Make sure the printer is online and ready.....	65
Step 5: Make sure the wireless version of the printer is set as the default printer driver (Windows only).....	65
Step 6: Make sure your computer is not connected to your network over a Virtual Private Network (VPN).....	66
After resolving the problems	66
Configure your firewall software to work with the printer.....	67
Solve printer management problems.....	68
Embedded web server cannot be opened.....	68
Troubleshoot installation issues.....	69
Hardware installation suggestions.....	69
HP software installation suggestions.....	70
Solve network problems.....	70
Understand the printer status report.....	71
Understand the network configuration page.....	73
Printhead maintenance.....	75
Clean the printhead.....	75
Align the printhead.....	76
Remove and reinstall the printhead.....	76
Clear jams.....	78
Clear paper jams.....	78
Avoid paper jams.....	80
Control panel lights reference.....	81
A Technical information	
Warranty information.....	89
Hewlett-Packard limited warranty statement.....	90
Ink cartridge warranty information.....	91

Printer specifications.....	92
Physical specifications.....	92
Product features and capacities.....	92
Processor and memory specifications.....	93
System requirements.....	93
Network protocol specifications.....	93
Embedded web server specifications.....	94
Media specifications.....	94
Understand specifications for supported media.....	94
Set minimum margins.....	97
Guidelines for printing on both sides of a page.....	98
Print specifications.....	98
HP ePrint and HP website specifications.....	98
HP ePrint specifications.....	99
HP website specifications.....	99
Environmental specifications.....	99
Electrical specifications.....	99
Acoustic emission specifications.....	100
Regulatory information.....	101
FCC statement.....	101
Notice to users in Korea.....	102
VCCI (Class B) compliance statement for users in Japan.....	102
Notice to users in Japan about the power cord.....	102
GS Declaration (Germany).....	102
Gloss of housing of peripheral devices for Germany.....	102
European Union Regulatory Notice.....	103
Regulatory information for wireless products.....	104
Exposure to radio frequency radiation.....	104
Notice to users in Brazil.....	104
Notice to users in Canada.....	104
Notice to users in Taiwan.....	104
Regulatory model number.....	105
Environmental product stewardship program.....	106
Paper use.....	106
Plastics.....	106
Material safety data sheets.....	106
Recycling program.....	106
HP inkjet supplies recycling program.....	106
Disposal of waste equipment by users in private households in the European Union.....	107
Power consumption.....	108
Chemical Substances.....	108
Battery information.....	108
Battery disposal in Taiwan.....	108
Attention California users.....	108
Battery disposal in Netherlands.....	108
EU battery directive.....	109
RoHS notices (China only).....	110
RoHS notices (Ukraine only).....	110
Third-party licenses.....	111

B HP supplies and accessories

Order printing supplies online.....	119
Supplies.....	119
Ink cartridges and printheads.....	119
HP media.....	120

C Network setup

Change basic network settings.....	121
View and print network settings.....	121
Turn the wireless radio on and off.....	121
Change advanced network settings.....	121
Set link speed.....	122
View IP settings.....	122
Change IP settings.....	122
Configure the printer's firewall settings.....	122
Creating and using firewall rules.....	123
Reset network settings.....	124
Set up the printer for wireless communication.....	124
Before you begin.....	125
Set up the printer on your wireless network.....	125
Set up the printer using the HP printer software (Recommended).....	125
Set up the printer using WiFi Protected Setup (WPS).....	125
To connect the printer using the Push Button Method.....	126
To connect the printer using the PIN Method.....	126
Set up the printer using the embedded web server (EWS).....	126
Change the connection type.....	126
To change from an Ethernet connection to a wireless connection.....	126
To change from a USB connection to a wireless connection.....	127
To change from a wireless connection to a USB or Ethernet connection.....	127
Test the wireless connection.....	127
Guidelines for ensuring wireless network security.....	127
Overview of security settings.....	128
Add hardware addresses to a wireless router (MAC filtering).....	128
Other wireless security guidelines.....	128
Guidelines for reducing interference on a wireless network.....	129
Uninstall and reinstall the HP software.....	129
Windows.....	129
Mac OS X.....	130

D Printer management tools

Toolbox (Windows).....	131
HP Utility (Mac OS X).....	131
Embedded web server.....	131
About cookies.....	132
To open the embedded web server.....	132

Index	142
--------------------	------------

1 Get started

This guide provides details about how to use the printer and how to resolve problems.

- [Accessibility](#)
- [Eco](#)
- [Understand the printer parts](#)
- [Use the printer control panel](#)
- [Finding the printer model number](#)
- [Select print media](#)
- [Load media](#)
- [Install the accessories](#)
- [Maintain the printer](#)
- [Update the printer](#)
- [Turn the printer off](#)

 **NOTE:** If you are using the printer with a computer running Windows XP Starter Edition, Windows Vista Starter Edition, or Windows 7 Starter Edition, some features might not be available. For more information, see [System requirements](#).

Accessibility

The printer provides a number of features that make it accessible for people with disabilities.

Visual

The HP software provided with the printer is accessible for users with visual impairments or low vision by using your operating system's accessibility options and features. The software also supports most assistive technology such as screen readers, Braille readers, and voice-to-text applications. For users who are color blind, colored buttons and tabs used in the HP software and on the printer control panel have simple text or icon labels that convey the appropriate action.

Mobility

For users with mobility impairments, the HP software functions can be executed through keyboard commands. The HP software also supports Windows accessibility options such as StickyKeys, ToggleKeys, FilterKeys, and MouseKeys. The printer doors, buttons, paper trays, and paper guides can be operated by users with limited strength and reach.

Support

For more details about the accessibility of this printer and HP's commitment to product accessibility, visit HP's website at www.hp.com/accessibility.

For accessibility information for Mac OS X, visit the Apple website at www.apple.com/accessibility.

Eco

Hewlett-Packard is committed to providing quality products in an environmentally sound manner. Design for recycling has been incorporated into this product. For more information, see [Environmental product stewardship program](#)

HP is committed to helping customers reduce their environmental footprint. HP has provided these features to help you focus on ways to assess and reduce the impact of your printing choices.

For more information about HP's environmental initiatives, visit www.hp.com/hpinfo/globalcitizenship/environment/.

Manage power

To conserve electricity, the printer comes with the following features:

Sleep mode

Power usage is reduced while in Sleep mode. After initial setup of printer, the printer will enter Sleep mode after 5 minutes of inactivity.

To change the setting, complete the following steps:

1. Open the EWS. For more information, see [Embedded web server](#).
2. Click the **Settings** tab.
3. In the **Preferences** section, click **Energy Save Mode** and select the desired option.
4. Click **Apply**.

Auto Power-Off

Auto Power-Off is automatically enabled by default when you turn on the printer. When Auto Power-Off is enabled, the printer will automatically turn off after 8 hours of inactivity to help reduce energy use. Auto Power-Off is automatically disabled when the printer establishes a network connection. You can change the Auto Power-Off setting from the printer software. Once you change the setting, the printer will maintain the setting that you choose. Auto Power-Off turns the printer off completely, so you must use the power button to turn the printer back on.

Windows: Open Toolbox. (For more information, see [Toolbox \(Windows\)](#).) In the **Advanced Settings** tab, click **Change**, and then select the preferred amount of time.

Mac OS X: Open HP Utility. (For more information, see [HP Utility \(Mac OS X\)](#).) In the **Printer Settings** section, click **Power Management**, and then select the preferred amount of time.

 **TIP:** If you are printing through an Ethernet connection over a network, Auto Power-Off should be disabled to ensure that print jobs do not get lost. Even when Auto Power-Off is disabled, the printer will enter a Sleep mode after 5 minutes of inactivity to help reduce energy use.

 **NOTE:** The printer's Sleep Mode and Auto Power-Off features are temporarily not available if one or more of the ink cartridges are missing. After the cartridge is reinstalled, these features resume.

 **CAUTION:** HP recommends that you replace any missing cartridges as soon as possible to avoid print quality issues and possible extra ink usage or damage to the ink system. Never turn off the printer when ink cartridges are missing.

Conserve printing supplies

To conserve printing supplies such as ink and paper, try the following:

- Change the print mode to a draft setting. Draft setting uses less ink.
- Do not clean the printhead unnecessarily. This wastes ink and shortens the life of the cartridges.
- Reduce paper usage by printing on both sides of the paper. If the printer has an automatic two-sided printing accessory (duplexer), see [Print on both sides \(duplexing\)](#). Otherwise, you can first print just the odd pages, flip the pages over, and then print just the even pages.

Understand the printer parts

This section contains the following topics:

- [Front view](#)
- [Printing supplies area](#)
- [Back view](#)

Front view

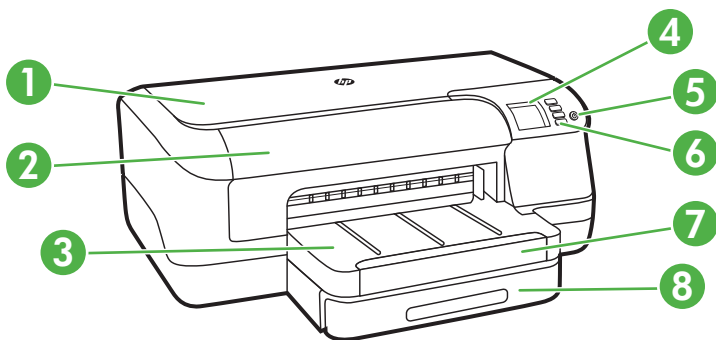

1	Top cover
2	Ink-cartridge access door
3	Output tray
4	Control panel display

(continued)

5	⏻ (Power) button
6	Control panel
7	Output tray extension
8	Tray 1

Printing supplies area

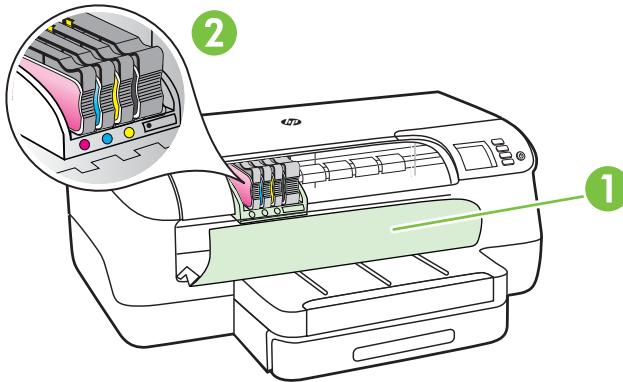

1	Ink-cartridge access door
2	Ink cartridges

Back view

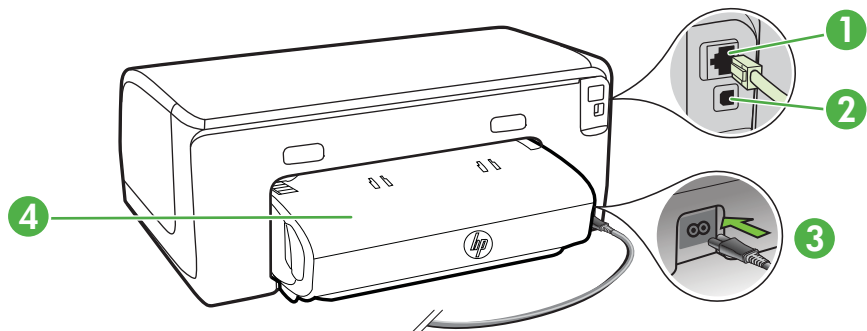

1	Ethernet network port
2	Rear universal serial bus (USB) port
3	Power input
4	Automatic two-sided printing accessory (duplexer)

Use the printer control panel

This section contains the following topics:

- [Overview of buttons and lights](#)
- [Change printer settings](#)
- [Print reports](#)

Overview of buttons and lights

For more information about control panel light patterns and messages, see [Control panel lights reference](#).

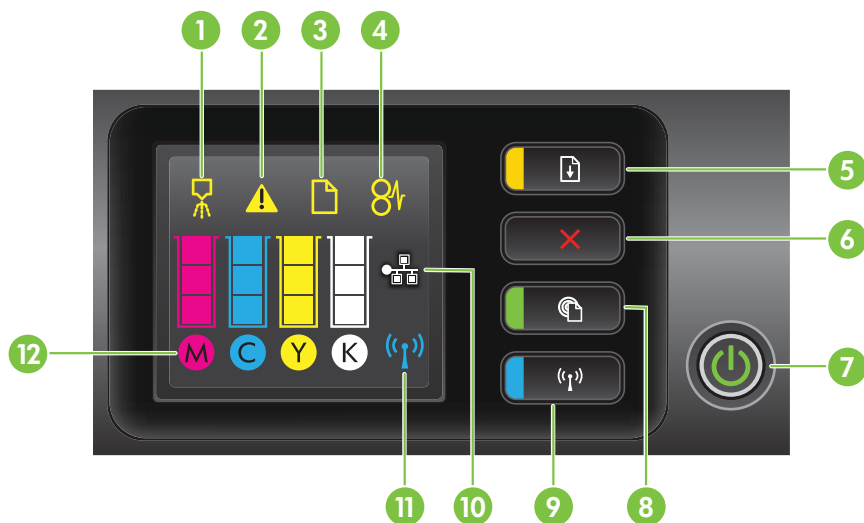

Label	Name and Description
1	Printhead align control panel icon. Shows that the printhead requires alignment.
2	Ink cartridge access door open icon. Shows that the printer's ink cartridge access door or top cover is open.
3	Out of paper icon. Shows that the printer is out of paper.
4	Paper jam icon. Shows that the printer has a paper jam.
5	Resume button and light. The Resume light blinks when the button must be pressed to resume printing. Press to continue a print job after clearing a paper jam, adding paper, or installing a cartridge. Press to cancel a print job when a media size mismatch occurs. Press and hold for three seconds to print a demo page.
6	Cancel button. Press once to stop a print job, or press and hold for three seconds to print a printer status report.
7	Power button and light. Press to turn the printer on or off. The light indicates whether the printer is on or off.

(continued)

Label	Name and Description
8	HP ePrint button and light. Press to turn on the HP ePrint function and print an information page. The light indicates whether the printer is connected to an HP ePrint server.
9	Wireless button and light. Press to turn the wireless network feature on or off. The button is lit when the wireless network is on.
10	Ethernet network icon. Shows that an Ethernet network connection exists.
11	Wireless network icon. Shows that a wireless network connection exists.
12	Ink cartridge information icons. Displays ink cartridge information, including fill levels. NOTE: Ink level warnings and indicators provide estimates for planning purposes only. When you receive a low on ink message, consider having a replacement cartridge available to avoid possible printing delays. You do not need to replace cartridges until prompted to do so.

Change printer settings

If the printer is connected to a computer, you can change the printer settings using HP software tools available on your computer — such as the HP printer software, HP Utility (Mac OS X), or the EWS. For more information about these tools, see [Printer management tools](#).

Print reports

Use the control panel to print the following reports for the printer.

- **Printer status report.** Press and hold the **X** (Cancel) button for three seconds.
- **Network configuration page** and **Wireless network test page.** Press and hold the **⏏** (Resume) button, and then press the **(^w)** (Wireless) button.
- **Demo page.** Press and hold the **⏏** (Resume) button for three seconds.

Finding the printer model number

In addition to the model name that appears on the front of the printer, the printer has a specific model number. You can use this number when obtaining support and to help determine which supplies or accessories are available for your printer.

The model number is printed on a label located near the ink-cartridge access door.

Select print media

The printer is designed to work well with most types of office media. It is best to test a variety of print media types before buying large quantities. Use HP media for

optimum print quality. Visit the HP website at www.hp.com for more information about HP media.



HP recommends plain papers with the ColorLok logo for printing and copying of everyday documents. All papers with the ColorLok logo are independently tested to meet high standards of reliability and print quality, and produce documents with crisp, vivid color, bolder blacks and dry faster than ordinary plain papers. Look for papers with the ColorLok logo in a variety of weights and sizes from major paper manufacturers.

This section contains the following topics:

- [Recommended papers for printing](#)
- [Recommended papers for photo printing](#)
- [Tips for selecting and using media](#)

Recommended papers for printing

If you want the best print quality, HP recommends using HP papers that are specifically designed for the type of project you are printing.

Depending on your country/region, some of these papers might not be available.

HP Brochure Paper HP Professional Paper	These papers are glossy-coated or matte-coated on both sides for two-sided use. They are the perfect choice for producing professional quality marketing materials such as brochures and mailers, as well as business graphics for report covers and calendars.
HP Premium Presentation Paper HP Professional Paper	These papers are heavy two-sided matte papers perfect for presentation, proposals, reports, and newsletters. They are heavyweight for an impressive look and feel.
HP Bright White Inkjet Paper	HP Bright White Inkjet Paper delivers high-contrast colors and sharp text. It is opaque enough for two-sided color usage with no showthrough, which makes it ideal for newsletters, reports, and flyers. It features ColorLok Technology for less smearing, bolder blacks, and vivid colors.
HP Printing Paper	HP Printing Paper is a high-quality multifunction paper. It produces documents that look and feel more substantial than documents printed on standard multipurpose or copy paper. It features ColorLok Technology for less smearing, bolder blacks, and vivid colors.
HP Office Paper	HP Office Paper is a high-quality multifunction paper. It is suitable for copies, drafts, memos and other everyday documents. It features ColorLok Technology for less smearing, bolder blacks, and vivid colors.
HP Office Recycled Paper	HP Office Recycled Paper is a high-quality multifunction paper made with 30% recycled fiber. It features ColorLok Technology for less smearing, bolder blacks, and vivid colors.
HP Premium Plus Photo Paper	HP's best photo paper is heavyweight for producing professional quality photos. Features an instant-dry finish for easy handling without smudging. It resists water, smears, fingerprints, and humidity.

(continued)

	It is available in several sizes, including A4, 8.5 x 11 inch, 10 x 15 cm (4 x 6 inch), 13 x 18 cm (5 x 7 inch), and two finishes – glossy or soft-gloss (satin matte). It is acid-free for longer lasting documents.
HP Advanced Photo Paper	This thick photo paper features an instant-dry finish for easy handling without smudging. It resists water, smears, fingerprints, and humidity. Your prints have a look and feel comparable to a store processed photo. It is available in several sizes, including A4, 8.5 x 11 inch, 10 x 15 cm (4 x 6 inch), 13x18 cm (5 x7 inch), and two finishes – glossy or soft gloss (satin matte). It is acid-free for longer lasting documents.
HP Everyday Photo Paper	Print colorful, everyday snapshots at a low cost, using paper designed for casual photo printing. This affordable, photo paper dries quickly for easy handling. Get sharp, crisp images when you use this paper with any inkjet printer. Available in semi-gloss finish in 8.5 x11 inch, A4, 4 x 6 inch and 10 x 15 cm. It is acid-free for longer lasting documents.

To order HP papers and other supplies, go to www.hp.com. Go to **Shop for Products and Services**, and select **Ink, toner and paper** .

 **NOTE:** At this time, some portions of the HP website are available in English only.

Recommended papers for photo printing

For the best print quality, HP recommends using HP papers that are specifically designed for the type of project you are printing. Depending on your country/region, some of these papers might not be available.

Depending on your country/region, some of these papers might not be available.

HP Premium Plus Photo Paper	HP's best photo paper is heavyweight for producing professional quality photos. Features an instant-dry finish for easy handling without smudging. It resists water, smears, fingerprints, and humidity. It is available in several sizes, including A4, 8.5 x 11 inch, 10 x 15 cm (4 x 6 inch), 13 x 18 cm (5 x 7 inch), and two finishes – glossy or soft-gloss (satin matte). It is acid-free for longer lasting documents.
HP Advanced Photo Paper	This thick photo paper features an instant-dry finish for easy handling without smudging. It resists water, smears, fingerprints, and humidity. Your prints have a look and feel comparable to a store processed photo. It is available in several sizes, including A4, 8.5 x 11 inch, 10 x 15 cm (4 x 6 inch), 13x18 cm (5 x7 inch), and two finishes – glossy or soft gloss (satin matte). It is acid-free for longer lasting documents.
HP Everyday Photo Paper	Print colorful, everyday snapshots at a low cost, using paper designed for casual photo printing. This affordable, photo paper dries quickly for easy handling. Get sharp, crisp images when you use this paper with any inkjet printer. Available in semi-gloss finish in 8.5 x11 inch, A4, 4 x 6 inch, and 10 x 15 cm. It is acid-free for longer lasting documents.
HP Photo Value Packs	HP Photo Value Packs conveniently package original HP ink cartridges and HP Advanced Photo Paper to save you time and take the guesswork out of printing affordable, lab-quality photos with your HP printer. Original HP inks and HP Advanced Photo Paper have been designed to work together so your photos are long lasting and vivid, print after print. Great for printing out an entire vacation's worth of photos or multiple prints to share.

To order HP papers and other supplies, go to www.hp.com. Go to **Shop for Products and Services** and select **Ink, toner and paper**.



NOTE: At this time, some portions of the HP website are available in English only.

Tips for selecting and using media

For the best results, observe the following guidelines.

- Always use media that conforms to the printer specifications. For more information, see [Media specifications](#).
- Load only one type of media at a time into a tray.
- When loading the trays, make sure the media is loaded correctly. For more information, see [Load media](#).
- Do not overload the tray. For more information, see [Load media](#)
- To prevent jams, poor print quality, and other printing problems, avoid loading the following media in the trays.
 - Multipart forms
 - Media that is damaged, curled, or wrinkled
 - Media with cutouts or perforations
 - Media that is heavily textured, embossed, or does not accept ink well
 - Media that is too lightweight or stretches easily
 - Media that contains staples or clips

Load media

This section provides instructions for loading media into the printer.

This section contains the following topics:

- [Load standard-size media](#)
- [Load envelopes](#)
- [Load cards and photo paper](#)
- [Load custom-size media](#)

Load standard-size media

To load media

Use these instructions to load standard media.

1. Pull out Tray 1.

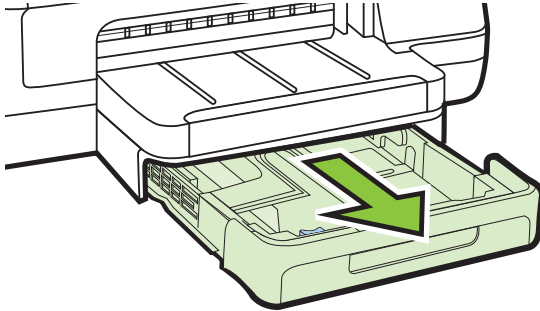

2. Insert the media print-side down in the center of the tray. Make sure the stack of media aligns with the line on the width guide, and is not higher than the paper stack line on the guide.



NOTE: Do not load paper while the printer is printing.

3. Slide the media guides in the tray to adjust them for the media size that you have loaded, and then reinsert the tray.

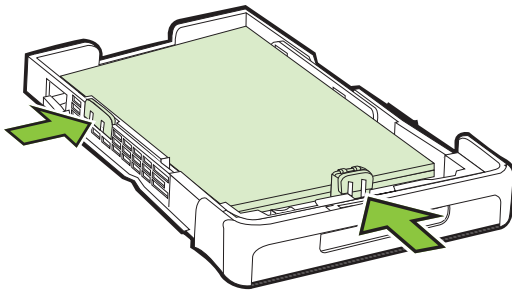

4. Pull out the extension on the output tray.

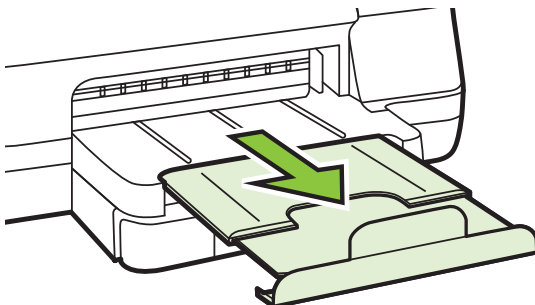

Load envelopes

To load envelopes

Use these instructions to load an envelope.

1. Pull out Tray 1.

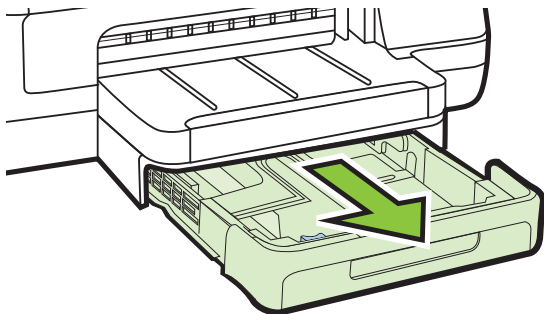

2. Insert the envelopes print-side down and load according to the graphic. Make sure the stack of envelopes does not exceed the line marking in the tray.

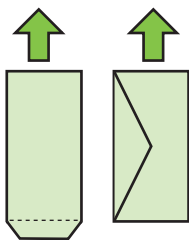

 **NOTE:** Do not load paper while the printer is printing.

3. Slide the media guides in the tray to adjust them for the media size that you have loaded, and then reinsert the tray.

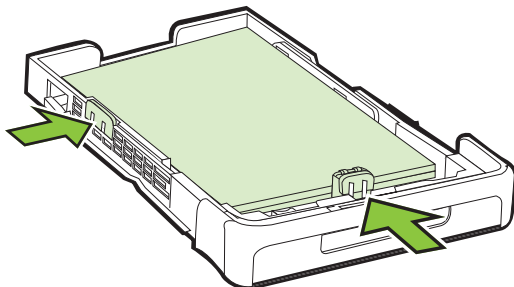

4. Pull out the extension on the output tray.

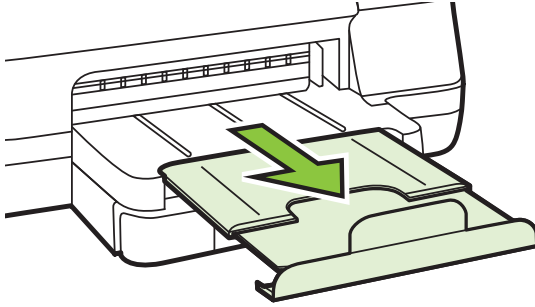

Load cards and photo paper

To load cards and photo paper

Use these instructions to load photo paper.

1. Pull out Tray 1.

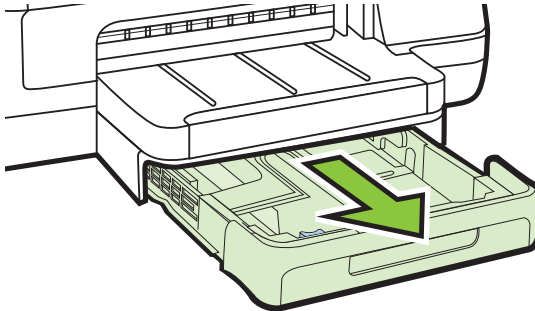

2. Insert the media print-side down in the center of the tray. Make sure the stack of media aligns with the line on the width guide, and is not higher than the paper stack line on the guide.

 **NOTE:** Do not load paper while the printer is printing.

3. Slide the media guides in the tray to adjust them for the media size that you have loaded, and then reinsert the tray.
4. Pull out the extension on the output tray.

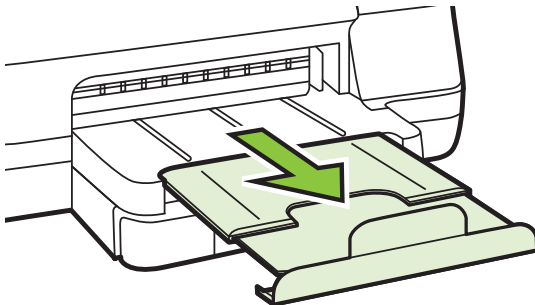

Load custom-size media

To load custom-size media

Use these instructions to load custom-size media.

⚠ CAUTION: Use only custom-size media that is supported by the printer. For more information, see [Media specifications](#).

1. Pull out Tray 1.

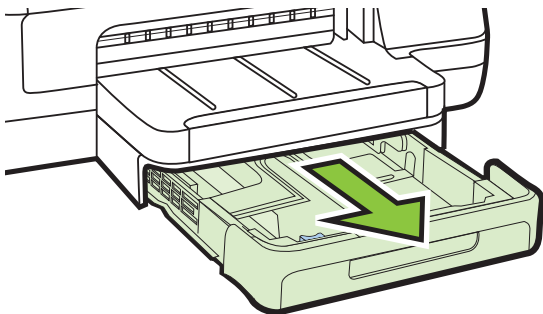

2. Insert the media print-side down in the center of the tray. Make sure the stack of media aligns with the line on the width guide, and is not higher than the paper stack line on the guide.

📄 NOTE: Do not load paper while the printer is printing.

3. Slide the media guides in the tray to adjust them for the media size that you have loaded, and then reinsert the tray.

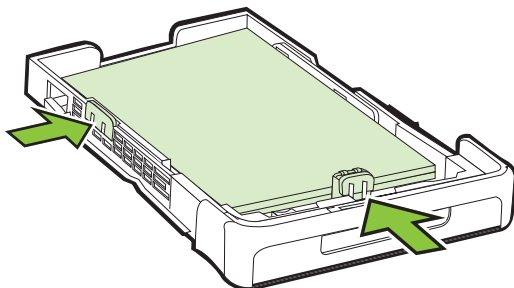

4. Pull out the extension on the output tray.

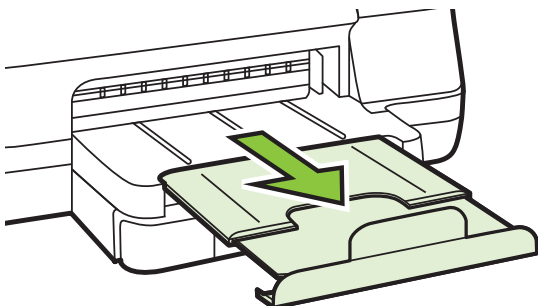

Install the accessories

This section contains the following topics:

- [Install the automatic two-sided printing accessory \(duplexer\)](#)
- [Install Tray 2](#)
- [Configure trays](#)
- [Turn on accessories in the printer driver](#)

Install the automatic two-sided printing accessory (duplexer)

You can print on both sides of a sheet of paper automatically. For information on using the duplexer, see [Print on both sides \(duplexing\)](#).

To install the duplexer

- ▲ Slide the duplexer into the back of the printer until the unit locks into place. Do not press the buttons on either side of the duplexer when installing the unit; use them only for removing the unit from the printer.

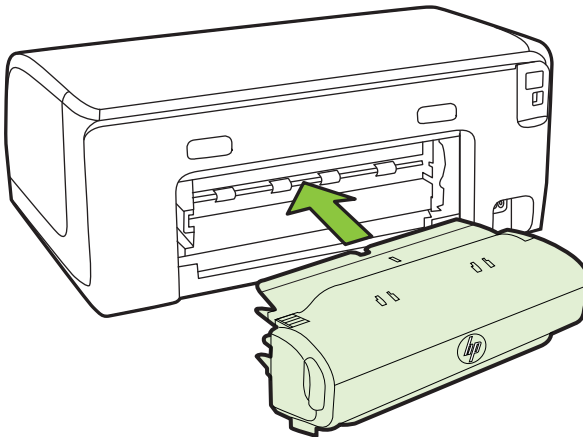

Install Tray 2

 **NOTE:** Tray 2 is available as an optional accessory.

Tray 2 can hold up to 250 sheets of plain paper. For ordering information, see [HP supplies and accessories](#).

To install Tray 2

1. Unpack the tray, remove the packing tapes and materials, and move the tray to the prepared location. The surface must be sturdy and level.
2. Turn off the printer, and disconnect the power cord.

3. Set the printer on top of the tray.

⚠ CAUTION: Be careful to keep your fingers and hands clear of the bottom of the printer.

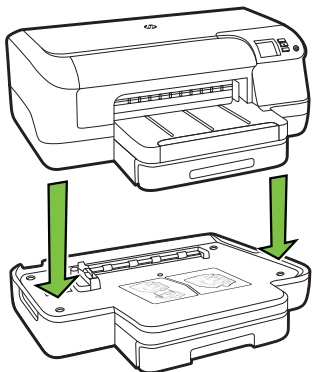

4. Connect the power cord and turn on the printer.
5. Enable Tray 2 in the printer driver. For more information, see [Turn on accessories in the printer driver](#).

To load Tray 2

1. Pull the tray out of the printer by grasping under the front of the tray.

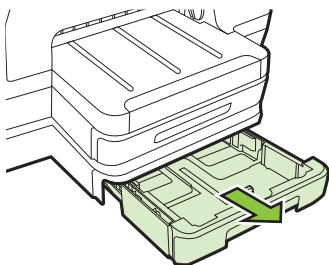

2. Insert the paper print-side down in the center of the tray. Make sure the stack of paper aligns with the line on the width guide, and does not exceed the line marking on the guide.

📄 NOTE: Tray 2 can be loaded only with plain paper.

3. Slide the media guides in the tray to adjust them for the size that you have loaded.

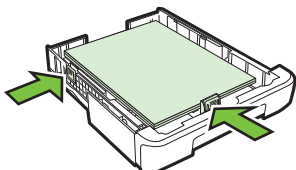

4. Gently reinsert the tray.
5. Pull out the extension on the output tray.

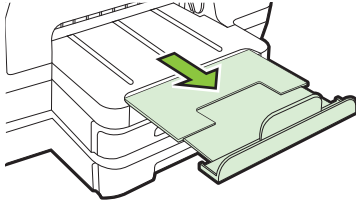

Configure trays

 **NOTE:** Tray 2 is an optional accessory. For ordering information, see [Order printing supplies online](#).

To configure the trays, you must have Tray 2 installed and turned on.

By default, the printer draws media from Tray 1. If Tray 1 is empty, the printer draws media from Tray 2 (if it is installed and loaded with media). You can change this default behavior by using the following features:

- **Tray Lock:** Use this feature to protect special media such as letterhead or preprinted media from accidental use. If the printer runs out of media while printing a document, it will not use media from a locked tray to complete the print job.
- **Default Tray:** Use this feature to determine the first tray from which the printer draws media.

 **NOTE:** To use the tray lock and default tray settings, you must select the automatic tray selection option in the printer software. Also, if the printer is on a network and you set a default tray, the setting will affect all users of the printer.

Tray 2 is designed to hold only plain paper.

The following table lists possible ways you can use the tray settings to meet your printing needs.

I want to...	Follow these steps
Load both trays with the same media, and have the printer pick media from one tray if the other one is empty.	<ul style="list-style-type: none"> • Load media in Tray 1 and Tray 2. For more information, see Load media. • Make sure tray lock is disabled.
Have both special media (such as letterhead) and plain paper loaded in the trays.	<ul style="list-style-type: none"> • Load special media in Tray 1 and plain paper in Tray 2. • Make sure the default tray is set to Tray 2. • Make sure tray lock is set to Tray 1.

(continued)

I want to...	Follow these steps
Load media in both trays but have the printer pick media from a specific tray first.	<ul style="list-style-type: none"> • Load media in Tray 1 and Tray 2. • Make sure default tray is set to the appropriate tray.

To configure the trays

1. Make sure the printer is turned on.
2. Perform one of the following:

Embedded web server

- ▲ Click the **Settings** tab and click **Paper Handling** in the left panel.

Print driver (Windows)

To configure default tray, complete the following steps:

- a. Click **Start**, and then click **Printers** or **Printers and Faxes** or **Devices and Printers**.
- Or -
Click **Start**, click **Control Panel**, and then double-click **Printers**.
- b. Right-click the printer icon, and then click **Printer Properties** or **Printing Preferences**.
- c. Click the **Paper/Quality** tab.
- d. In the **Tray Selection** group, select the desired tray from the **Paper Source** drop-down list.

HP Printer Utility (Mac OS X)

- ▲ Click **Paper Handling** from the **Printer Settings** panel.
3. Click **OK** or **Apply** after changing the desired tray settings.

Turn on accessories in the printer driver

- [To turn on accessories \(Windows\)](#)
- [To turn on accessories \(Mac OS X\)](#)

To turn on accessories (Windows)

1. Click **Start**, and then click **Printers** or **Printers and Faxes** or **Devices and Printers**.
- Or -
Click **Start**, click **Control Panel**, and then double-click **Printers**.
2. Right-click the printer icon, and then click **Printer Properties**.
3. Select the **Device Settings** tab. Click the accessory that you want to turn on, click **Installed** from the drop-down menu, and then click **OK**.

To turn on accessories (Mac OS X)

Mac OS X automatically turns on all accessories in the printer driver when you install the printer software. If you add a new accessory later, follow these steps:

1. Open the **System Preferences** and then select **Print & Fax** or **Print & Scan**.
2. Select the printer from list of printers, and then click **Options & Supplies**.
3. Click the **Driver** tab.
4. Select the options you want to install, and then click **OK**.

Maintain the printer

This section provides instructions for keeping the printer in top working condition. Perform this maintenance procedure as necessary.

- [Clean the exterior](#)

Clean the exterior

 **WARNING!** Before cleaning the printer, turn off the power and unplug the power cord from the electrical socket.

Use a soft, damp, lint-free cloth to wipe dust, smudges, and stains off of the case. Keep fluids away from the interior of the printer, as well as from the printer control panel.

Update the printer

HP is always working to improve the performance of its printers and bring you the latest features. If the printer is connected to a network and Web Services has been enabled, you can check for and install printer updates.

Update the printer

1. Open the EWS. For more information, see [Embedded web server](#).
2. Click the **Web Services** tab.
3. In the **Web Services Settings** section, click **Product Update**, click **Check Now**, and follow the onscreen instructions.
4. If the product update option is not available, follow these instructions:
 - a. In the **Web Services Settings** section, click **Setup**, click **Continue**, and follow the onscreen instructions.
 - b. If prompted, choose to allow the printer to check for and install printer updates.

 **NOTE:** If a printer update is available, the printer will download and install the update, and then restart.

NOTE: If prompted for proxy settings and if your network uses proxy settings, follow the instructions on the screen to set up a proxy server. If you do not have the details, contact your network administrator or the person who set up the network.

Turn the printer off

Turn the printer off by pressing the  (Power) button located on the printer. Wait until the power light turns off before unplugging the power cord or turning off a power strip.







 **CAUTION:** If you incorrectly turn the printer off, the print carriage might not return to the correct position causing problems with the ink cartridges and print quality issues.

CAUTION: HP recommends that you replace any missing cartridges as soon as possible to avoid print quality issues and possible extra ink usage or damage to the ink system. Never turn off the printer when ink cartridges are missing.

2 Print

Most print settings are automatically handled by the software application. Change the settings manually only when you want to change print quality, print on specific types of paper, or use special features. For more information about selecting the best print media for your documents, see [Select print media](#).

Choose a print job to continue:

	Print documents
	Print brochures
	Print on envelopes
	Print photos
	Print on special and custom-size paper
	Print borderless documents or photos

Print documents

Follow the instructions for your operating system.

- [Print documents \(Windows\)](#)
- [Print documents \(Mac OS X\)](#)

 **NOTE:** This printer includes HP ePrint, a free service from HP that allows you to print documents on your HP ePrint-enabled printer anytime, from any location, and without any additional software or printer drivers. For more information, see [HP ePrint](#).

Print documents (Windows)

1. Load paper in the tray. For more information, see [Load media](#).
2. On the **File** menu in your software application, click **Print**.
3. Make sure the printer you want to use is selected.
4. To change settings, click the button that opens the **Printer Properties** dialog box. Depending on your software application, this button might be called **Properties**, **Options**, **Printer Setup**, **Printer**, or **Preferences**.
5. Change the paper orientation on the **Layout** tab, and paper source, media type, paper size, and quality settings on the **Paper/Quality** tab. To print in black and white, click the **Advanced** button, and then change the **Print in Grayscale** option.



NOTE: If you want to print a black and white document using black ink only, click the **Advanced** button. From the **Print in Grayscale** drop-down menu select **Black Ink Only**, then click the **OK** button. If you see **Black and White** as an option on the **Paper/Quality** tab or the **Layout** tab, select it.

6. Click **OK**.
7. Click **Print** or **OK** to begin printing.

Print documents (Mac OS X)

1. Load paper in the tray. For more information, see [Load media](#).
 2. Select a paper size:
 - a. From the **File** menu in your software application, click **Page Setup**.
-
- b. Make sure the printer you want to use is selected in the **Format For** pop-up menu.
 - c. Select the paper size from the **Paper Size** pop-up menu, and then click **OK**.
 3. From the **File** menu in your software application, click **Print**.
 4. Make sure the printer you want to use is selected.
 5. Select the paper size from the **Paper Size** pop-up menu (if available).
 6. Change the print settings for the option provided in the pop-up menus, as appropriate for your project.



NOTE: If you do not see any options, click the disclosure triangle next to the **Printer** pop-up menu or click **Show Details**.

7. Click **Print** to begin printing.

Print brochures

Follow the instructions for your operating system.

- [Print brochures \(Windows\)](#)
- [Print brochures \(Mac OS X\)](#)

 **NOTE:** This printer includes HP ePrint, a free service from HP that allows you to print documents on your HP ePrint-enabled printer anytime, from any location, and without any additional software or printer drivers. For more information, see [HP ePrint](#).

Print brochures (Windows)

 **NOTE:** To set print settings for all print jobs, make the changes in the HP software provided with the printer. For more information on the HP software, see [Printer management tools](#).

1. Load paper in the tray. For more information, see [Load media](#).
2. On the **File** menu in your software application, click **Print**.
3. Make sure the printer you want to use is selected.
4. To change settings, click the button that opens the **Printer Properties** dialog box. Depending on your software application, this button might be called **Properties**, **Options**, **Printer Setup**, **Printer**, or **Preferences**.
5. Click the **Layout** tab, and change the paper orientation if necessary.
6. Click the **Paper/Quality** tab, select the appropriate paper type for brochure from the **Media** drop-down list, and then change the paper source, paper size, and quality settings if necessary.
7. To print in black and white, click the **Advanced** button, and then change the **Print in Grayscale** option.
8. Click **OK**, and then click **Print** or **OK** to begin printing.

Print brochures (Mac OS X)

1. Load paper in the tray. For more information, see [Load media](#).
2. Select a paper size:
 - a. From the **File** menu in your software application, click **Page Setup**.

 **NOTE:** If you do not see a **Page Setup** menu item, go to step 3.

 - b. Make sure the printer you want to use is selected in the **Format For** pop-up menu.
 - c. Select the paper size from the **Paper Size** pop-up menu, and then click **OK**.
3. From the **File** menu in your software application, click **Print**.
4. Make sure the printer you want to use is selected.
5. Select the paper size from the **Paper Size** pop-up menu (if available).
6. Click **Paper Type/Quality** from the pop-up menu, and then select the following settings:
 - **Paper Type:** The appropriate brochure paper type
 - **Quality:** **Normal** or **Best**

 **NOTE:** If you do not see these options, click the disclosure triangle next to the **Printer** pop-up menu or click **Show Details**.

7. Select any other print settings that you want, and then click **Print** to begin printing.

Print on envelopes

Avoid envelopes with the following characteristics:

- Very slick finish
- Self-stick adhesives, clasps, or windows
- Thick, irregular, or curled edges
- Areas that are wrinkled, torn, or otherwise damaged

Make sure the folds of envelopes you load in the printer are sharply creased.

 **NOTE:** For more information about printing on envelopes, see the documentation available with the software program you are using.

Follow the instructions for your operating system.

- [Print on envelopes \(Windows\)](#)
- [Print on envelopes \(Mac OS X\)](#)

Print on envelopes (Windows)

1. Load envelopes print-side down in the tray. For more information, see [Load media](#).
2. On the **File** menu in your software application, click **Print**.
3. Make sure the printer you want to use is selected.
4. To change settings, click the button that opens the **Printer Properties** dialog box. Depending on your software application, this button might be called **Properties**, **Options**, **Printer Setup**, **Printer**, or **Preferences**.
5. On the **Layout** tab, change the orientation to **Landscape**.
6. Click **Paper/Quality**, and then select the appropriate envelope type from the **Paper Size** drop-down list.

 **TIP:** You can change more options for the print job by using the features available on the other tabs in the dialog box.

7. Click **OK**, and then click **Print** or **OK** to begin printing.

Print on envelopes (Mac OS X)

1. Load envelopes in the tray. For more information, see [Load media](#).
2. Select a paper size:
 - a. From the **File** menu in your software application, click **Page Setup**.

 **NOTE:** If you do not see a **Page Setup** menu item, go to step 3.

 - b. Make sure the printer you want to use is selected in the **Format For** pop-up menu.
 - c. Select the appropriate envelope size from the **Paper Size** pop-up menu, and then click **OK**.
3. From the **File** menu in your software application, click **Print**.
4. Make sure the printer you want to use is selected.

5. Select the appropriate envelope size in the **Paper Size** pop-up menu (if available).
6. Select the **Orientation** option.

 **NOTE:** If you do not see these options, click the disclosure triangle next to the **Printer** pop-up menu or click **Show Details**.

7. Select any other print settings that you want, and then click **Print** to begin printing.

Print photos

Do not leave unused photo paper in the input tray. The paper might start to curl, which could impair the quality of your printout. Photo paper should be flat before printing.

Follow the instructions for your operating system.

- [Print photos on photo paper \(Windows\)](#)
- [Print photos on photo paper \(Mac OS X\)](#)

 **NOTE:** This printer includes HP ePrint, a free service from HP that allows you to print documents on your HP ePrint-enabled printer anytime, from any location, and without any additional software or printer drivers. For more information, see [HP ePrint](#).

Print photos on photo paper (Windows)

1. Load paper in the tray. For more information, see [Load media](#).
2. On the **File** menu in your software application, click **Print**.
3. Make sure the printer you want to use is selected.
4. To change settings, click the button that opens the **Printer Properties** dialog box. Depending on your software application, this option might be called **Properties**, **Options**, **Printer Setup**, **Printer**, or **Preferences**.
5. Click the **Paper/Quality** tab, and then select the appropriate photo paper type from the **Media** drop-down list.

 **NOTE:** Maximum DPI is only supported for color printing on HP Premium Plus Photo Paper and HP Advanced Photo Paper.

6. Click the **Advanced** button, and then select **Best** or **Maximum DPI** from the **Output Quality** drop-down list.
7. To print the photo in black and white, click the **Grayscale** drop-down menu and select the following option:
High-Quality Grayscale: uses all the available colors to print your photo in grayscale. This creates smooth and natural shades of gray.
8. Click **OK**, and then click **Print** or **OK** to begin printing.

Print photos on photo paper (Mac OS X)

1. Load paper in the tray. For more information, see [Load media](#).
2. Select a paper size:
 - a. From the **File** menu in your software application, click **Page Setup**.

 **NOTE:** If you do not see a **Page Setup** menu item, go to step 3.
 - b. Make sure the printer you want to use is selected in the **Format For** pop-up menu.
 - c. Select the paper size from the **Paper Size** pop-up menu, and then click **OK**.
3. From the **File** menu in your software application, click **Print**.
4. Make sure the printer you want to use is selected.
5. Select the appropriate paper size from the **Paper Size** pop-up menu (if available).
6. Click **Paper Type/Quality** from the pop-up menu, and then select the following settings:
 - **Paper Type:** The appropriate photo paper type
 - **Quality: Best or Maximum dpi**

 **NOTE:** If you do not see these options, click the disclosure triangle next to the **Printer** pop-up menu or click **Show Details**.
7. If necessary, change the photo and color options:
 - a. Click the disclosure triangle beside **Color Options** and select the appropriate **Photo Fix** options:
 - **Off:** Applies no automatic adjustments to the image.
 - **Basic:** Automatically focuses the image; moderately adjusts image sharpness.
 - b. To print the photo in black and white, click **Grayscale** from the **Color** pop-up menu, and then select the following option:

High Quality: Uses all the available colors to print your photo in grayscale. This creates smooth and natural shades of gray.
8. Select any other print settings that you want, and then click **Print** to begin printing.

Print on special and custom-size paper

If your application supports custom-size paper, set the size in the application before printing the document. If not, set the size in the printer driver. You might need to reformat existing documents to print them correctly on custom-size paper.

Use only custom-size paper that is supported by the printer. For more information, see [Media specifications](#).

 **NOTE:** Defining custom-size media sizes is only available in the HP printing software in Mac OS X.

Follow the instructions for your operating system.

- [Print on special or custom-size paper \(Mac OS X\)](#)

Print on special or custom-size paper (Mac OS X)

 **NOTE:** Before you can print on custom-size paper, you must set up the custom size in the HP software provided with the printer. For instructions, see [Set up custom sizes \(Mac OS X\)](#).

1. Load the appropriate paper in the tray. For more information, see [Load media](#).
 2. Select a paper size:
 - a. From the **File** menu in your software application, click **Page Setup**.
-
-  **NOTE:** If you do not see a **Page Setup** menu item, go to step 3.
-
- b. Make sure the printer you want to use is selected in the **Format For** pop-up menu.
 - c. Select the paper size from the **Paper Size** pop-up menu, and then click **OK**.
3. From the **File** menu in your software application, click **Print**.
 4. Make sure the printer you want to use is selected.
 5. Select the appropriate paper size from the **Paper Size** pop-up menu (if available).
 6. Click **Paper Handling** from the pop-up menu.
 7. Under **Destination Paper Size**, click **Scale to fit paper size**, and then select the custom size.
 8. Select any other print settings that you want, and then click **Print** to begin printing.

Set up custom sizes (Mac OS X)

1. Load paper in the tray. For more information, see [Load media](#).
 2. From the **File** menu in your software application, click **Page Setup**, and then make sure the printer you want to use is selected in the **Format For** pop-up menu.

- OR -

From the **File** menu in your software application, click **Print**, and then make sure the printer you want to use is selected.
 3. Select **Manage Custom Sizes** in the **Paper Size** pop-up menu.
-
-  **NOTE:** If you do not see these options in the **Print** dialog, click the disclosure triangle next to the **Printer** pop-up menu or click **Show Details**.
-
4. Click the **+** on the left side of the screen, double-click **Untitled**, and type a name for the new, custom size.
 5. In the **Width** and **Height** boxes, type the dimensions, and then set the margins, if you want to customize them.
 6. Click **OK**.

Print borderless documents or photos

Borderless printing lets you print to the edges of certain photo media types and a range of standard media sizes.

Before printing, open the file and make sure the size of the document or image matches the size of the media loaded in the printer.

 **NOTE:** Borderless printing is only available in some applications.

Follow the instructions for your operating system.

- [Print borderless documents or photos \(Windows\)](#)
- [Print borderless documents or photos \(Mac OS X\)](#)

Print borderless documents or photos (Windows)

1. Load paper in the tray. For more information, see [Load media](#).
2. On the **File** menu in your software application, click **Print**.
3. Make sure the printer you want to use is selected.
4. To change settings, click the button that opens the **Printer Properties** dialog box. Depending on your software application, this button might be called **Properties**, **Options**, **Printer Setup**, **Printer**, or **Preferences**.
5. Click the **Paper/Quality** tab, and then click the **Advanced** button.
6. From the **Borderless Printing** drop-down list, select **Print Borderless**.
7. From the **Output Quality** drop-down list, change the option if necessary, and then click **OK**.
8. From the **Media** drop-down list, select the appropriate paper type.
9. Click **OK**, and then click **Print** or **OK** to begin printing.

Print borderless documents or photos (Mac OS X)

1. Load paper in the tray. For more information, see [Load media](#).
2. Select a borderless paper size:
 - a. From the **File** menu in your software application, click **Page Setup**.

 **NOTE:** If you do not see a **Page Setup** menu item, go to step 3.
 - b. Make sure the printer you want to use is selected in the **Format For** pop-up menu.
 - c. Select an available borderless paper size from the **Paper Size** pop-up menu, and then click **OK**.
3. From the **File** menu in your software application, click **Print**.
4. Make sure the printer you want to use is selected.
5. Select the paper size from the **Paper Size** pop-up menu (if available).
6. Click **Paper Type/Quality** from the pop-up menu, and then select the following settings:
 - **Paper Type:** The appropriate paper type
 - **Quality:** **Best** or **Maximum dpi**

 **NOTE:** If you do not see these options, click the disclosure triangle next to the **Printer** pop-up menu or click **Show Details**.

7. Make sure the **Print Borderless** check box is selected.

8. If necessary, click the disclosure triangle beside **Color Options** and select the appropriate **Photo Fix** options:
 - **Off**: Applies no automatic adjustments to the image.
 - **Basic**: Automatically focuses the image; moderately adjusts image sharpness.
9. Select any other print settings that you want, and then click **Print** to begin printing.

Print on both sides (duplexing)

You can print on both sides of a sheet of media automatically by using the automatic two-sided printing accessory (duplexer).

 **TIP:** You can perform manual duplexing by first printing only the odd pages, flipping the pages over, and then printing only the even pages.

Perform two-sided printing (Windows)

1. Load the appropriate media. For more information, see [Guidelines for printing on both sides of a page](#) and [Load media](#).
2. Make sure the duplexer is installed correctly. For more information, see [Install the automatic two-sided printing accessory \(duplexer\)](#).
3. With a document open, click **Print** on the **File** menu, and then click the button that opens the **Printer Properties** dialog box. Depending on your software application, this button might be called **Properties**, **Options**, **Printer Setup**, **Printer**, or **Preferences**.
4. Under the **Print on Both Sides** options on the **Layout** tab, select either **Flip on Long Edge** or **Flip on Short Edge**.
5. Change any other settings, and then click **OK**.
6. Print your document.

Perform two-sided printing (Mac OS X)

1. Load the appropriate media. For more information, see [Guidelines for printing on both sides of a page](#) and [Load media](#).
2. Make sure the duplexer is installed correctly. For more information, see [Install the automatic two-sided printing accessory \(duplexer\)](#).
3. Select a paper size:
 - a. From the **File** menu in your software application, click **Page Setup**.

 **NOTE:** If you do not see a **Page Setup** menu item, go to step 4.

- b. Make sure the printer you want to use is selected in the **Format For** pop-up menu.
- c. Select the paper size from the **Paper Size** pop-up menu, and then click **OK**.
4. From the **File** menu in your software application, click **Print**.
5. Make sure the printer you want to use is selected.

6. Select the paper size from the **Paper Size** pop-up menu (if available).



NOTE: You might need to select the paper-size option labeled **Two-Sided margins**.

7. Click the **Two-Sided Printing** pop-up menu, select **Print Both Sides**, and then click the appropriate binding options for the document.

- OR -

Click the **Layout** pop-up menu, and then select the appropriate binding options for the document from the **Two-Sided** pop-up menu.



NOTE: If you do not see any options, click the disclosure triangle next to the **Printer** pop-up menu or click **Show Details**.

8. Select any other print settings that you want, and then click **Print** to begin printing.

View print resolutions

1. In printer driver, click the **Paper/Quality** tab, and then click the **Advanced** button.
2. Click the **Resolution** drop-down list for the print resolutions available.

3 HP ePrint

HP ePrint is a free service from HP that allows you to print to your HP ePrint-enabled printer anywhere you can send an email. Just send your documents and photos to the email address assigned to your printer when you enable Web Services. No additional drivers or software are needed.

Once you have signed up for an account on ePrintCenter (www.eprintcenter.com), you can sign in to view your HP ePrint job status, manage your HP ePrint printer queue, control who can use your printer's HP ePrint email address to print, and get help for HP ePrint.

 **NOTE:** To use HP ePrint, the printer must be connected to the Internet (either using an Ethernet cable or wireless connection). You cannot use these web features if the printer is connected using a USB cable.

This section contains the following topics:

- [Set up HP ePrint](#)
- [Use HP ePrint](#)
- [Remove Web Services](#)

Set up HP ePrint

To set up HP ePrint, complete the following steps.

- [Set up HP ePrint using the HP printer software](#)
- [Set up HP ePrint using the printer's control panel](#)
- [Set up HP ePrint using the embedded web server](#)

 **NOTE:** Before you set up HP ePrint, make sure you are connected to the Internet using either an Ethernet or wireless connection.

NOTE: If you encounter problems, see the HP ePrint light section in [Control panel lights reference](#).

Set up HP ePrint using the HP printer software

In addition to enabling key printer features, you can use the HP printer software that came with your printer to set up HP ePrint. If you didn't set up HP ePrint when you installed the HP software on your computer, you can still use the software to set up HP ePrint.

To set up HP ePrint, complete the following steps for your operating system:

Windows

1. From the computer desktop, click **Start**, select **Programs** or **All Programs**, click **HP**, click the folder for your printer, and then select the icon with your printer's name.
2. Double-click **Web Connected Solutions**, and then double-click **ePrint Setup**. The printer's embedded web server opens.

3. Click the **Web Services** tab.
4. In the **Web Services Settings** section, click **Setup**, click **Continue**, and follow the onscreen instructions to accept the terms of use.
5. If prompted, choose to allow the printer to check for and install printer updates.



NOTE: If a printer update is available, the printer will download and install the update, and then restart. You will have to repeat the instructions from step 1 to set up HP ePrint.

NOTE: If prompted for proxy settings and if your network uses proxy settings, follow the instructions on the screen to set up a proxy server. If you do not have the details, contact your network administrator or the person who set up the network.

6. When the printer is connected to the server, the printer prints an information page. Follow the instructions on the information page to finish the setup.

Mac OS X

- ▲ To set up and manage Web Services in Mac OS X, you can use the printer's embedded web server (EWS). For more information, see [Set up HP ePrint using the embedded web server](#).

Set up HP ePrint using the printer's control panel

1. On the printer control panel, press the  (HP ePrint) button. The printer prints an information page.
2. Follow the instructions on the information page.

Set up HP ePrint using the embedded web server

You can use the printer's embedded web server (EWS) to set up and manage HP ePrint.

To set up HP ePrint, complete the following steps:

1. Open the EWS. For more information, see [Embedded web server](#).
2. Click the **Web Services** tab.
3. In the **Web Services Settings** section, click **Setup**, click **Continue**, and follow the onscreen instructions to accept the terms of use.
4. If prompted, choose to allow the printer to check for and install printer updates.



NOTE: If a printer update is available, the printer will download and install the update, and then restart. You will have to repeat the instructions from step 1 to set up HP ePrint.

NOTE: If prompted for proxy settings and if your network uses proxy settings, follow the instructions on the screen to set up a proxy server. If you do not have the details, contact your network administrator or the person who set up the network.

5. When the printer is connected to the server, the printer prints an information page. Follow the instructions on the information page to finish the setup.

Use HP ePrint

HP ePrint allows you to print to your HP ePrint-enabled printer anytime, from any location.

To use HP ePrint, make sure to have the following:

- An Internet- and email-capable computer or mobile device
- An HP ePrint-capable printer on which Web Services has been enabled

 **TIP:** For more information about managing and configuring HP ePrint settings and to learn about the latest features, visit ePrintCenter (www.eprintcenter.com).

Print using HP ePrint

To print documents using HP ePrint, complete the following steps:

1. On your computer or mobile device, open your email application.

 **NOTE:** For information about using the email application on your computer or mobile device, see the documentation provided with the application.

2. Create a new email message, and then attach the file that you want to print. For a list of files that can be printed using HP ePrint, as well as guidelines to follow when using HP ePrint, see [HP ePrint and HP website specifications](#)
3. Enter the printer's email address in the "To" line of the email message, and then select the option to send the email message.

 **NOTE:** Make sure that the printer's email address is the only address listed in the "To" line of the email message. If other email addresses are listed in the "To" line, the attachments you are sending might not print.

Find the printer's email address

To obtain the printer's email address, visit ePrintCenter (www.eprintcenter.com).

Turn off HP ePrint

To turn off HP ePrint, complete the following steps:

1. Open the EWS. For more information, see [Embedded web server](#).
2. Click the **Web Services** tab, and then click **ePrint** in the **Web Services Settings** section.
3. Click **Turn Off ePrint**.

 **NOTE:** To remove all Web Services, see [Remove Web Services](#).

Remove Web Services

To remove Web Services, complete the following steps:

1. Open the EWS. For more information, see [Embedded web server](#).
2. Click the **Web Services** tab, and then click **Remove Web Services** in the **Web Services Settings** section.
3. Click **Remove Web Services**.

4 Work with ink cartridges

To ensure the best print quality from the printer, you need to perform some simple maintenance procedures. This section provides guidelines for handling the ink cartridges, instructions for replacing the ink cartridges, and aligning and cleaning the printhead.

This section contains the following topics:

- [Information on ink cartridges and the printhead](#)
- [Check the estimated ink levels](#)
- [Printing with black or color ink only](#)
- [Replace the ink cartridges](#)
- [Store printing supplies](#)
- [Anonymous Usage Information Storage](#)

Information on ink cartridges and the printhead

The following tips help maintain HP ink cartridges and ensure consistent print quality.

- The instructions in this user guide are for replacing ink cartridges, and are not intended for first time installation.
- **⚠ CAUTION:** HP recommends that you replace any missing cartridges as soon as possible to avoid print quality issues and possible extra ink usage or damage to the ink system. Never turn off the printer when ink cartridges are missing.
- Keep all ink cartridges in the original sealed packages until they are needed.
- Be sure to turn off the printer properly. For more information, see [Turn the printer off](#).
- Store ink cartridges at room temperature (15-35° C or 59-95° F).
- Do not clean the printhead unnecessarily. This wastes ink and shortens the life of the cartridges.
- Handle ink cartridges carefully. Dropping, jarring, or rough handling during installation can cause temporary printing problems.
- If you are transporting the printer, do the following to prevent ink leaking from the printer or other damage from occurring to the printer:
 - Make sure you turn off the printer by pressing  (Power). Wait until all sounds of internal motion stop before unplugging the printer. For more information, see [Turn the printer off](#).
 - Make sure you leave the ink cartridges and printhead installed.
 - The printer must be transported sitting flat; it should not be placed on its side, back, front, or top.

Related topics

- [Check the estimated ink levels](#)
- [Clean the printhead](#)

Check the estimated ink levels

You can check the estimated ink levels from the printer software or from the printer control panel. For information about using these tools, see [Printer management tools](#) and [Use the printer control panel](#). You can also print the Printer Status page to view this information (see [Understand the printer status report](#)).

 **NOTE:** Ink level alerts and indicators provide estimates for planning purposes only. When you receive a low on ink message, consider having a replacement cartridge available to avoid possible printing delays. You do not need to replace the ink cartridges until prompted to do so.

NOTE: If you have installed a refilled or remanufactured cartridge, or a cartridge that has been used in another printer, the ink level indicator might be inaccurate or unavailable.

NOTE: Ink from the cartridges is used in the printing process in a number of different ways, including in the initialization process, which prepares the printer and cartridges for printing, and in printhead servicing, which keeps print nozzles clear and ink flowing smoothly. In addition, some residual ink is left in the cartridge after it is used. For more information, see www.hp.com/go/inkusage.

Printing with black or color ink only

For regular usage, this product is not designed to print using only the black cartridge when the color cartridges are out of ink.

However, your printer is designed to let you print as long as possible when your cartridges start to run out of ink.

When there is sufficient ink in the printhead, the printer will offer you the use of black ink only when one or more of the color cartridges are out of ink, and the use of color ink only when the black cartridge is out of ink.

- The amount that you can print using black or color ink only is limited, so have replacement ink cartridges available when you are printing with black or color ink only.
- When there is no longer sufficient ink to print, you will get a message that one or more cartridges are depleted, and you will need to replace the depleted cartridges before you resume printing.

 **CAUTION:** While ink cartridges are not damaged when left outside of the printer, the printhead does need to have all cartridges installed at all times after the printer is set up and in use. Leaving one or more cartridge slots empty for an extended period may lead to print quality problems and possibly damage the printhead. If you have recently left a cartridge out of the printer for an extended period, or if you have had a recent paper jam, and have noticed poor print quality, clean the printhead. For more information, see [Clean the printhead](#).

Replace the ink cartridges

 **NOTE:** For information on recycling used ink supplies, see [HP inkjet supplies recycling program](#).

If you do not already have replacement ink cartridges for the printer, see [HP supplies and accessories](#).

 **NOTE:** At this time, some portions of the HP website are available in English only.

NOTE: Not all cartridges are available in all countries/regions.

 **CAUTION:** HP recommends that you replace any missing cartridges as soon as possible to avoid print quality issues and possible extra ink usage or damage to the ink system. Never turn off the printer when ink cartridges are missing.

Use these steps to replace the ink cartridges.

To replace the ink cartridges

1. Make sure the printer is turned on.
2. Open the ink-cartridge access door.

 **NOTE:** Wait until the print carriage stops moving before proceeding.

3. Press the front of the ink cartridge to release it, and then remove it from the slot.

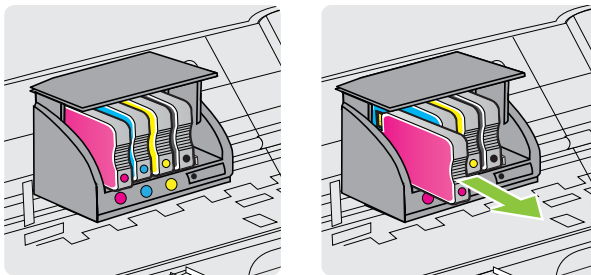

4. Remove the new ink cartridge from its packaging.
5. Using the color-coded letters for help, slide the ink cartridge into the empty slot until it is securely installed in the slot.

 **CAUTION:** Do not lift the latch handle on the print carriage to install the ink cartridges. Doing so could cause the printhead or ink cartridges to be incorrectly seated, which can cause errors or print quality problems. The latch must remain down to correctly install the ink cartridges.

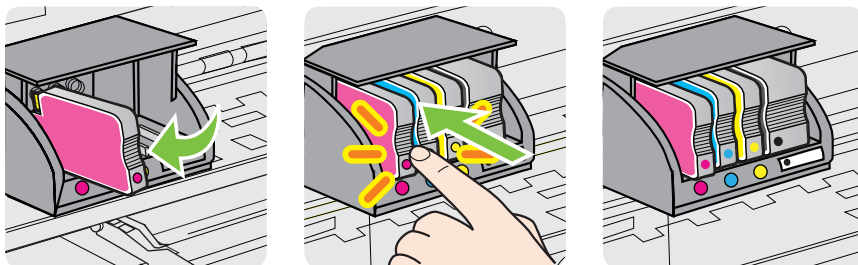

Make sure that you insert the ink cartridge into the slot that has the same colored letter as the color you are installing.



6. Repeat steps 3 through 6 for each ink cartridge you are replacing.
7. Close the ink-cartridge access door.

Related topics

[HP supplies and accessories](#)

Store printing supplies

Ink cartridges can be left in the printer for extended periods of time. However, to assure optimal ink cartridge health, be sure to turn off the printer properly. For more information, see [Turn the printer off](#).

Anonymous Usage Information Storage

The HP cartridges used with this printer contain a memory chip that assists in the operation of the printer. In addition, this memory chip stores a limited set of anonymous information about the usage of the printer, which might include the following: the date when the cartridge was first installed, the date when the cartridge was last used, the number of pages printed using the cartridge, the page coverage, frequency of printing, the printing modes used, any printing errors that might have occurred, and the printer model.

This information helps HP design future printers to meet our customers' printing needs. The data collected from the cartridge memory chip does not contain information that can be used to identify a customer or user of the cartridge or their printer.

HP collects a sampling of the memory chips from cartridges returned to HP's free return and recycling program (HP Planet Partners: www.hp.com/hpinfo/globalcitizenship/environment/recycle/). The memory chips from this sampling are read and studied in order to improve future HP printers. HP partners who assist in recycling this cartridge might have access to this data, as well.

Any third party possessing the cartridge might have access to the anonymous information on the memory chip. If you prefer to not allow access to this information, you can render the chip inoperable. However, after you render the memory chip inoperable, the cartridge cannot be used in an HP printer.

If you are concerned about providing this anonymous information, you can make this information inaccessible by turning off the memory chip's ability to collect the printer's usage information.

To disable the usage information function

1. Open the EWS. For more information, see [Embedded web server](#).
2. Click the **Settings** tab.
3. In the **Preferences** section, click the option that shows usage information or cartridge chip info.
4. Select the option to turn off and click **Apply**.

 **NOTE:** You can continue to use the cartridge in the HP printer if you turn off the memory chip's ability to collect the printer's usage information.

5 Solve a problem

The information in this chapter suggests solutions to common problems. If your printer is not operating correctly and those suggestions did not solve your problem, try using one of the following support services to obtain assistance.

This section contains the following topics:

- [HP support](#)
- [General troubleshooting tips and resources](#)
- [Solve printer problems](#)
- [Print quality troubleshooting](#)
- [Solve paper-feed problems](#)
- [Solve problems using HP ePrint and HP websites](#)
- [Solve Ethernet network problems](#)
- [Solve wireless problems](#)
- [Configure your firewall software to work with the printer](#)
- [Solve printer management problems](#)
- [Troubleshoot installation issues](#)
- [Understand the printer status report](#)
- [Understand the network configuration page](#)
- [Printhead maintenance](#)
- [Clear jams](#)
- [Control panel lights reference](#)

HP support

If you have a problem, follow these steps

1. Check the documentation that came with the printer.
2. Visit the HP online support website at www.hp.com/go/customer care. This website provides information and utilities that can help you correct many common printer problems. HP online support is available to all HP customers. It is the fastest source for up-to-date printer information and expert assistance and includes the following features:
 - Fast access to qualified online support specialists
 - HP software and driver updates for the HP printer
 - Valuable troubleshooting information for common problems
 - Proactive printer updates, support alerts, and HP newsgroups that are available when you register the printerFor more information, see [Obtain electronic support](#).
3. Call HP support. Support options and availability vary by printer, country/region, and language. For more information, see [HP support by phone](#).

Obtain electronic support

To find support and warranty information, go to the HP website at www.hp.com/go/customercare. This website provides information and utilities that can help you correct many common printer problems. If prompted, select your country/region, and then click **Contact HP** for information about calling for technical support.

This website also offers technical support, drivers, supplies, ordering information and other options such as:

- Access online support pages.
- Send HP an email message for answers to your questions.
- Connect with an HP technician by using online chat.
- Check for HP software updates.

You can also obtain support from the HP software for Windows or Mac OS X, which provide easy, step-by-step solutions to common printing problems. For more information, see [Printer management tools](#).

Support options and availability vary by printer, country/region, and language.

HP support by phone

The phone support numbers and associated costs listed here are those in effect at time of publication and are applicable only for calls made on a land line. Different rates may apply for mobile phones.

For the most current HP list of telephone support numbers and call costs information, see www.hp.com/go/customercare. This website provides information and utilities that can help you correct many common printer problems.

During the warranty period, you may obtain assistance from the HP Customer Care Center.

 **NOTE:** HP does not provide telephone support for Linux printing. All support is provided online at the following website: <https://launchpad.net/hplip>. Click the **Ask a question** button to begin the support process.

The HPLIP website does not provide support for Windows or Mac OS X. If you are using these operating systems, see www.hp.com/go/customercare. This website provides information and utilities that can help you correct many common printer problems.

This section contains the following topics:

- [Before you call](#)
- [Phone support period](#)
- [Telephone support numbers](#)
- [After the phone support period](#)

Before you call

Call HP support while you are in front of the computer and the printer. Be prepared to provide the following information:

- Model number (for more information, see [Finding the printer model number](#))
- Serial number (located on the back or bottom of the printer)
- Messages that appear when the situation occurs
- Answers to these questions:
 - Has this situation happened before?
 - Can you re-create it?
 - Did you add any new hardware or software to your computer at about the time that this situation began?
 - Did anything else occur prior to this situation (such as a thunderstorm or moving the printer)?

Phone support period

One year of phone support is available in North America, Asia Pacific, and Latin America (including Mexico).

Telephone support numbers

In many locations, HP provides toll free telephone support during the warranty period. However, some of the support numbers might not be toll free.

For the most current list of telephone support numbers, see www.hp.com/go/customer-care. This website provides information and utilities that can help you correct many common printer problems.



www.hp.com/support

Africa (English speaking)	(0027)112345872	Lietuva	8 800 10000 +370 5 2103333
Afrique (francophone)	0033 1 4993 9230	Jamaica	1-800-711-2884
021 672 280	الجزائر	日本	0120-96-1665
Algérie	021 67 22 80	0800 222 47	الأردن
Argentina (Buenos Aires)	54-11-4708-1600	한국	1588-3003
Argentina	0-800-555-5000	Luxembourg (Français)	900 40 006 0,15 €/min
Australia	1300 721 147	Luxemburg (Deutsch)	900 40 007 0,15 €/Min
Australia (out-of-warranty)	1902 910 910	Madagascar	262 262 51 21 21
Österreich	0820 874 417 doppelter Cristarif	Magyarország	06 40 200 629 7,2 HUF/perc vezetékes telefonra
Белоруссия	(375) 17 328 4640	Malaysia	1800 88 8588
172 12 049	البحرين	Maurice	262 262 210 404
België (Nederlands)	078 600 019 0,0546 euro/min piekuren 0,0273 euro/min daluren	México (Ciudad de México)	55-5258-9922
Belgique (Français)	078 600 020 0,0546 euro/min heures de pointe 0,0273 euro/min heures creuses	México	01-800-472-68368
България	0 700 1 0404	Maroc	0801 005 010
Hrvatska	0800 223213	Nederland	+31 0900 2020 165 0,10 €/min
Brasil (Sao Paulo)	55-11-4004-7751	New Zealand	0800 441 147
Brasil	0-800-709-7751	Nigeria	(01) 271 2320
Canada	1-(800)-474-6836 (1-800 hp invent)	Norge	815 62 070 starter på 0,59 Kr per min., deretter 0,39 Kr per min. Fra mobiltelefon gjelder mobiltelefonkostnader,
Central America & The Caribbean	www.hp.com/la/soporte	24791773	عمان
Chile	800-360-999	Panamá	1-800-711-2884
中国	800-820-6616	Paraguay	009 800 54 1 0006
中国	400-885-6616	Perú	0-800-10111
Colombia (Bogotá)	571-606-9191	Philippines	2 867 3551
Colombia	01-8000-51-4746-8368	Polska	(22) 583 43 73 Koszt połączenia - z tel. stacjonarnego jak za 1 impuls wg taryfy operatora. - z tel. komórkowego wg taryfy operatora.
Costa Rica	0-800-011-1046	Portugal	808 201 492 Custo: 8 cêntimos no primeiro minuto e 3 cêntimos restantes minutos
Česká republika	420 810 222 222 1,53 CZN/min	Puerto Rico	1-877-232-0589
Danmark	70 20 28 45 Opkald: 0,145 (kr, pr, min.) Pr. min. man-lar 06.00-19.30: 0,25 Pr. min. øvrige tidspunkter: 0,125	00974 - 44761936	قطر
Eesti	372 6813 823	República Dominicana	1-800-711-2884
Ecuador (Andinatel)	1-999-119 ☎	Reunion	0820 890 323
Ecuador (Pacifitel)	1-800-225-528 ☎ 800-711-2884	România	0801 033 390 (021 204 7090) 0,029 pe minut
02 691 0602	مصر	Россия (Москва)	(495) 777 3284
El Salvador	800-6160	Россия (Санкт-Петербург)	(812) 332 4240
España	902 010 059 Coste horario normal (de 8:00 a 20:00) 6,73 cts/min Coste horario reducido 4,03 cts/min Coste de establecimiento de llamada 6,33 cts	800 897 1415	السعودية
France	0969 320 435 Tarif local	Singapore	+65 6272 5300
Deutschland	01805 65 21 80 0,14 €/Min aus dem deutschen Festnetz - bei Anrufen aus Mobilfunknetzen können andere Preise gelten	Srbija	0700 301 301
Ελλάδα	801-11-75400 0,30 Ευρω/λεπτό	Slovenská republika	0850 111 256 miestna tarifa
Κύπρος	800 9 2654	Slovenija	01 432 2001
Guatemala	1-800-711-2884	South Africa (RSA)	0860 104 771 Calls at Local Rate
香港特別行政區	(852) 2802 4098	Suomi	0203 667 67 0,0147€/min
India	1-800-425-7737	Sverige	0771-20 47 65 0,23 kr/min
India	91-80-28526900	Schweiz (Deutsch)	0848 672 672 8Rp./Min
Indonesia	+62 (21) 350 3408	Suisse (Français)	0848 672 672 0,08CHF/min
+971 4 224 9189	العراق	臺灣	0800-010055 (免費)
+971 4 224 9189	الكويت	ไทย	+66 (2) 353 9000
+971 4 224 9189	لبنان	071 891 391	تونس
+971 4 224 9189	قطر	Trinidad & Tobago	1-800-711-2884
+971 4 224 9189	البحرين	Tunisie	23 927 000
00965 22423814	الكويت	Türkiye	0(212) 444 0307 Yerel numara: 444 0307 0,08 TL/Ük, yerel numara (Istanbul, Bursa, Ankara ve Izmir) ve 0,10 TL ulusal ücret
00961 1 217970	لبنان	Україна	38 (044) 230-51-06 الإمارات العربية المتحدة
		600 54 47 47	United Kingdom
			0844 369 0369 0,50 £ p/min
			United States
			1-(800)-474-6836
			Uruguay
			0004-054-177
			Venezuela (Caracas)
			58-212-278-8666
			Venezuela
			0-800-474-68368
			Việt Nam
			+84 88234530

After the phone support period

After the phone support period, help is available from HP at an additional cost. Help may also be available at the HP online support website: www.hp.com/go/customer-care. This website provides information and utilities that can help you correct many common printer problems. Contact your HP dealer or call the support phone number for your country/region to learn more about support options.

General troubleshooting tips and resources

 **NOTE:** Many of the following steps require HP software. If you did not install the HP software, you can install it using the HP software CD included with the printer, or you can download the HP software from the HP support website (www.hp.com/go/customer-care). This website provides information and utilities that can help you correct many common printer problems.

Check or do the following before you begin troubleshooting:

- Try turning the printer off and then on again.
- For a paper jam, see [Clear jams](#).
- For paper-feed problems, such as the paper skew and paper pick, see [Solve paper-feed problems](#).
- Power light is on and not blinking. When the printer is turned on for the first time, it takes approximately 12 minutes to initialize it after the ink cartridges are installed.
- Power cord and other cables are working, and are firmly connected to the printer. Make sure the printer is connected firmly to a functioning alternating current (AC) power outlet, and is turned on. For voltage requirements, see [Electrical specifications](#).
- Media is loaded correctly in the input tray and is not jammed in the printer.
- All packing tapes and materials are removed.
- The printer is set as the current or default printer. For Windows, set it as the default in the Printers folder. For Mac OS X, set it as the default in the **Print & Fax** or **Print & Scan** section of the **System Preferences**. For more information, see your computer's documentation.
- **Pause Printing** is not selected if you are using a computer running Windows.
- You are not running too many programs when you are performing a task. Close programs that you are not using or restart the computer before attempting the task again.

Solve printer problems

 **TIP:** You can visit the HP online support website at www.hp.com/go/customer-care for information and utilities that can help you correct many common printer problems.

This section contains the following topics:

- [The printer shuts down unexpectedly](#)
- [Alignment fails](#)
- [The printer is not responding \(nothing prints\)](#)
- [The printer prints slowly](#)
- [The printer is making some unexpected noises](#)
- [Blank or partial page printed](#)
- [Something on the page is missing or incorrect](#)
- [Placement of the text or graphics is wrong](#)

The printer shuts down unexpectedly

Check the power and power connections

Make sure the printer is connected firmly to a functioning alternating current (AC) power outlet. For voltage requirements, see [Electrical specifications](#).

Alignment fails

If the alignment process fails, make sure you have loaded unused, plain white paper into the input tray. If you have colored paper loaded in the input tray when you align the ink cartridges, the alignment fails.

If the alignment process fails repeatedly, you might have a defective sensor or ink cartridge. Contact HP support. Go to www.hp.com/go/customer-care. This website provides information and utilities that can help you correct many common printer problems. If prompted, select your country/region, and then click **Contact HP** for information on calling for technical support.

The printer is not responding (nothing prints)

There are print jobs stuck in the print queue

Open the print queue, cancel all documents, and then reboot the computer. Try to print after the computer reboots. For more information, refer to the Help system for the operating system.

Check the printer setup

For more information, see [General troubleshooting tips and resources](#).

Check the HP software installation

If the printer is turned off when printing, an alert message should appear on your computer screen; otherwise, the HP software provided with the printer might not be installed correctly. To resolve this, uninstall the HP software completely, and then reinstall the HP software. For more information, see [Uninstall and reinstall the HP software](#).

Check the cable connections

- Make sure both ends of the USB cable or Ethernet cable are secure.
- If the printer is connected to a network, check the following:
 - Check the Link light on the back of the printer.
 - Make sure you are not using a phone cord to connect the printer.

Check any personal firewall software installed on the computer

The personal software firewall is a security program that protects a computer from intrusion. However, the firewall might block communication between the computer and the printer. If there is a problem communicating with the printer, try temporarily disabling the firewall. If the problem persists, the firewall is not the source of the communication problem. Re-enable the firewall.

The printer prints slowly

Try the following solutions if the printer is printing very slowly.

- [Solution 1: Use a lower print quality setting](#)
- [Solution 2: Check the ink levels](#)
- [Solution 3: Contact HP support](#)

Solution 1: Use a lower print quality setting

Solution: Check the print quality setting. **Best** and **Maximum dpi** provide the best quality but are slower than **Normal** or **Draft**. **Draft** provides the fastest print speed.

Cause: The print quality was set to a high setting.

If this did not solve the issue, try the next solution.

Solution 2: Check the ink levels

Solution: Check the estimated ink levels in the ink cartridges.

 **NOTE:** Ink level alerts and indicators provide estimates for planning purposes only. When you receive a low on ink message, consider having a replacement cartridge available to avoid possible printing delays. You do not need to replace the ink cartridges until prompted to do so.

 **CAUTION:** While ink cartridges are not damaged when left outside of the printer, the printhead does need to have all cartridges installed at all times after the printer is set up and in use. Leaving one or more cartridge slots empty for an extended period may lead to print quality problems and possibly damage the printhead. If you have recently left a cartridge out of the printer for an extended period and have noticed poor print quality, clean the printhead. For more information, see [Clean the printhead](#).

For more information, see:

[Check the estimated ink levels](#)

Cause: The ink cartridges might have insufficient ink. Insufficient ink may cause the printhead to overheat. When the printhead overheats, the printer slows down to allow it to cool.

If this did not solve the issue, try the next solution.

Solution 3: Contact HP support

Solution: Contact HP support for service.

Go to: www.hp.com/go/customer-care. This website provides information and utilities that can help you correct many common printer problems.

If prompted, choose your country/region, and then click **Contact HP** for information on calling for technical support.

Cause: There was a problem with the printer.

The printer is making some unexpected noises

You might hear some unexpected noises made by the printer. These are the servicing sounds when the printer performs automatic servicing functions to maintain the health of the printheads.

 **NOTE:** To prevent any potential damage to your printer:



Do not turn off the printer while the printer is performing any servicing. If you are turning off the printer, wait for the printer to come to a complete stop before turning off using the  (Power) button. See [Turn the printer off](#).

Make sure all ink cartridges are installed. If any of the ink cartridge is missing, the printer will perform extra servicing to protect the printheads.

Blank or partial page printed

Clean the printhead

Complete the printhead cleaning procedure. For more information, see [Clean the printhead](#). The printhead may need to be cleaned if the printer was turned off incorrectly.

 **NOTE:** Incorrectly turning off the printer can cause print quality problems like blank or partial pages. Printhead cleaning can solve these problems, but turning off the printer correctly can prevent them in the first place. Always turn the printer off by pressing the  (Power) button on the printer. Wait until the  (Power) light goes out before unplugging the power cord or turning off a power strip.

Check the media settings

- Make sure you select the correct print quality settings in the printer driver for the media loaded in the trays.
- Make sure the page settings in the printer driver match the page size of media loaded in the tray.

More than one page is being picked

For more information on paper-feed problems, see [Solve paper-feed problems](#).





There is a blank page in the file

Check the file to make sure there is no blank page.

Something on the page is missing or incorrect

Check the Print Quality Diagnostic page

Print a Print Quality Diagnostic page to help you decide whether to run any maintenance tools to improve the print quality of your printouts. For more information, see [Print quality troubleshooting](#).

To print and evaluate the Print Quality Diagnostic page, hold down the  (Power) button, press the  (Cancel) button seven times, press the  (Resume) button two times, and then release the  (Power) button.

Check the margin settings

Make sure the margin settings for the document do not exceed the printable area of the printer. For more information, see [Set minimum margins](#).

Check the color print settings

Make sure **Print in Grayscale** is not selected in the printer driver.

Check the printer location and length of USB cable

High electromagnetic fields (such as those generated by USB cables) can sometimes cause slight distortions to printouts. Move the printer away from the source of the electromagnetic fields. Also, it is recommended that you use a USB cable that is less than 3 meters (9.8 feet) long to minimize the effects of these electromagnetic fields.

Placement of the text or graphics is wrong

Check how the media is loaded

Make sure the media width and length guides fit snugly against the edges of the stack of media, and make sure the tray is not overloaded. For more information, see [Load media](#).

Check the media size

- Content on a page might be cut off if the document size is larger than the media that you are using.
- Make sure the media size selected in the printer driver match the size of media loaded in the tray.

Check the margin settings

If the text or graphics are cut off at the edges of the page, make sure the margin settings for the document do not exceed the printable area of your printer. For more information, see [Set minimum margins](#).

Check the page-orientation setting

Make sure the media size and page orientation selected in the application match the settings in the printer driver. For more information, see [Print](#).

Check the printer location and length of USB cable

High electromagnetic fields (such as those generated by USB cables) can sometimes cause slight distortions to printouts. Move the printer away from the source of the electromagnetic fields. Also, it is recommended that you use a USB cable that is less than 3 meters (9.8 feet) long to minimize the effects of these electromagnetic fields.

If the above solutions do not work, the problem may be caused by the inability of the application to interpret print settings correctly. See the release notes for known software conflicts, refer to the application's documentation, or contact the software manufacturer for specific help.

Print quality troubleshooting

Try the solutions in this section to resolve print quality problems in your printout.

 **TIP:** You can visit the HP online support website at www.hp.com/go/customer-care for information and utilities that can help you correct many common printer problems.

- [Solution 1: Make sure you are using original HP ink cartridges](#)
- [Solution 2: Check the ink levels](#)
- [Solution 3: Check the paper loaded in the input tray](#)
- [Solution 4: Check the paper type](#)
- [Solution 5: Check the print settings](#)
- [Solution 6: Print and evaluate a print quality report](#)
- [Solution 7: Contact HP support](#)

Solution 1: Make sure you are using original HP ink cartridges

Solution: Solution 1: Make sure you are using original HP ink cartridges

HP recommends that you use original HP ink cartridges. Original HP ink cartridges are designed and tested with HP printers to help you easily produce great results, time after time.

 **NOTE:** HP cannot guarantee the quality or reliability of non-HP supplies. Printer service or repairs required as a result of using a non-HP supply are not covered under warranty.

If you believe you purchased original HP ink cartridges, go to:

www.hp.com/go/anticounterfeit

Cause: Non-HP ink cartridges were being used.

If this did not solve the issue, try the next solution.

Solution 2: Check the ink levels

Solution: Check the estimated ink levels in the ink cartridges.

 **NOTE:** Ink level alerts and indicators provide estimates for planning purposes only. When you receive a low-ink alert, consider having a replacement cartridge available to avoid possible printing delays. You do not need to replace the ink cartridges until prompted to do so.

 **CAUTION:** While ink cartridges are not damaged when left outside of the printer, the printhead does need to have all cartridges installed at all times after the printer is set up and in use. Leaving one or more cartridge slots empty for an extended period may lead to print quality problems and possibly damage the printhead. If you have recently left a cartridge out of the printer for an extended period and have noticed poor print quality, clean the printhead. For more information, see [Clean the printhead](#).

For more information, see:

[Check the estimated ink levels](#)

Cause: The ink cartridges might have insufficient ink.

If this did not solve the issue, try the next solution.

Solution 3: Check the paper loaded in the input tray

Solution: Make sure the paper is loaded correctly and that it is not wrinkled or too thick.

- Load paper with the print side facing down. For example, if you are loading glossy photo paper, load the paper with the glossy side down.
- Make sure the paper lays flat in the input tray and is not wrinkled. If the paper is too close to the printhead during printing, the ink might be smeared. This can happen if the paper is raised, wrinkled, or very thick, such as a mailing envelope.

For more information, see:

[Load media](#).

Cause: The paper was loaded incorrectly, or it was wrinkled or too thick.

If this did not solve the issue, try the next solution.

Solution 4: Check the paper type

Solution: HP recommends that you use HP papers or any other paper type with ColorLok technology that is appropriate for the printer. All papers with the ColorLok logo are independently tested to meet high standards of reliability and print quality, and produce documents with crisp, vivid color, bolder blacks and dry faster than ordinary plain papers.

Always make sure the paper you are printing on is flat. For best results when printing images, use HP Advanced Photo Paper.

Store specialty media in its original packaging inside a resealable plastic bag on a flat surface in a cool, dry place. When you are ready to print, remove only the paper you plan to use immediately. When you have finished printing, return any unused photo paper to the plastic bag. This prevents the photo paper from curling.

 **NOTE:** For this issue, there is not a problem with your ink supplies. Therefore, replacing the ink cartridges is not necessary.

For more information, see:

Select print media

Cause: The wrong kind of paper was loaded in the input tray.

If this did not solve the issue, try the next solution.

Solution 5: Check the print settings

Solution: Check the print settings.

- Check the print settings to see if the color settings are incorrect. For example, check to see if the document is set to print in grayscale. Or, check to see if advanced color settings such as saturation, brightness, or color tone, are set to modify the appearance of colors.
- Check the print quality setting and make sure it matches the type of paper loaded in the printer. You might need to choose a lower print quality setting if colors are running into each other. Or, choose a higher setting if you are printing a high-quality photo, and then make sure photo paper such as HP Advanced Photo Paper is loaded in the input tray.

 **NOTE:** On some computer screens, colors might appear differently than they do when printed on paper. In this case, there is nothing wrong with the printer, print settings, or ink cartridges. No further troubleshooting is required.

For more information, see:

Select print media





Cause: The print settings were set incorrectly.

If this did not solve the issue, try the next solution.

Solution 6: Print and evaluate a print quality report

Solution:

To print a print quality report

- **Control panel:** Press and hold the  (Power) button, press the  (Cancel) button seven times, press the  (Resume) button two times, and release the  (Power) button.
- **Embedded web server:** Click the **Tools** tab, click **Print Quality Toolbox** under **Utilities**, and then click **Print Quality Report**.
- **HP Utility (Mac OS X):** In the **Information And Support** section, click **Print Quality Diagnostics**, and then click **Print**.

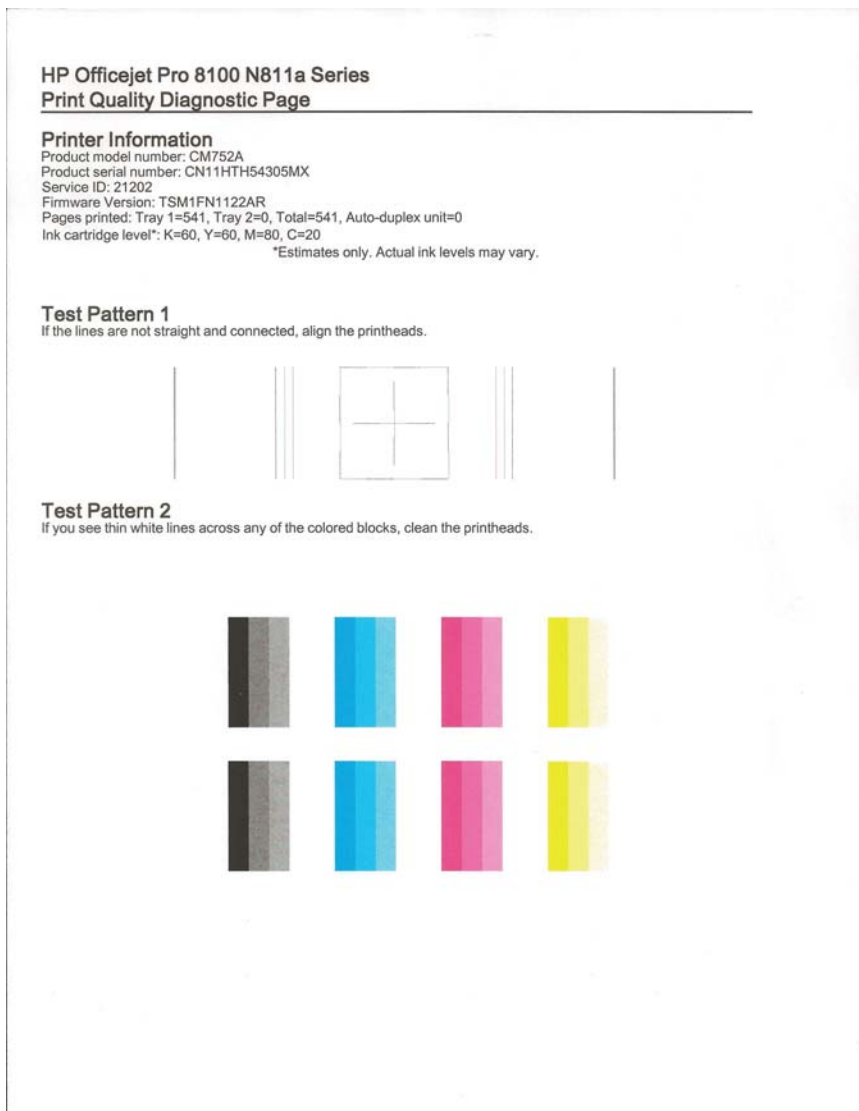

If defects are seen on the Print Quality Diagnostic report, follow the steps below:

1. If the Print Quality Diagnostic report shows faded, partial, streaked, or missing color bars or patterns, check for depleted ink cartridges, and replace the ink cartridge that corresponds to the defective color bar or color pattern. If there is no depleted ink cartridge, remove and reinstall all ink cartridges to make sure they are properly installed.
2. Align the printhead. For more information, see [Align the printhead](#).
3. Clean the printhead. For more information, see [Clean the printhead](#).
4. Replace the printhead. For more information, see [Remove and reinstall the printhead](#).

Cause: Print quality problems can have many causes: software settings, a poor image file, or the printing system itself. If you are unhappy with the quality of your prints, a Print Quality Diagnostic page can help you determine if the printing system is working correctly.

Solution 7: Contact HP support

Solution: Contact HP support for service.

Go to: www.hp.com/go/customer-care. This website provides information and utilities that can help you correct many common printer problems.

If prompted, choose your country/region, and then click **Contact HP** for information on calling for technical support.

Cause: There was a problem with the printhead.

Solve paper-feed problems

 **TIP:** You can visit the HP online support website at www.hp.com/go/customer-care for information and utilities that can help you correct many common printer problems.

Media is not supported for the printer or tray

Use only media that is supported for the printer and the tray being used. For more information, see [Media specifications](#).

Media is not picked up from a tray

- Make sure media is loaded in the tray. For more information, see [Load media](#). Fan the media before loading.
- Make sure the paper guides are set to the correct markings in the tray for the media size you are loading. Also make sure the guides are snug, but not tight, against the stack.
- Make sure media in the tray is not curled. Uncurl paper by bending it in the opposite direction of the curl.

Media is not coming out correctly

- Make sure the output tray extender is fully extended; otherwise, printed pages may fall off the printer.

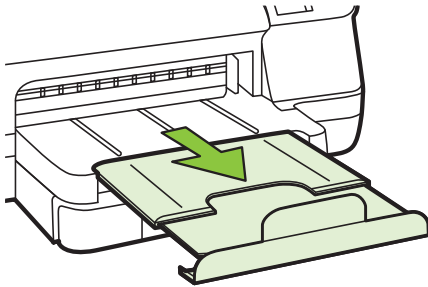

- Remove excess media from the output tray. There is a limit to the number of sheets the tray can hold.

Pages are skewing

- Make sure the media loaded in the trays is aligned to the paper guides. If needed, pull out the trays from the printer and reload the media correctly, making sure that the paper guides are aligned correctly.
- Load media into the printer only when it is not printing.
- Remove and replace the automatic two-sided printing accessory (duplexer).
 - Push the button on either side of the duplexer, and then remove the unit.

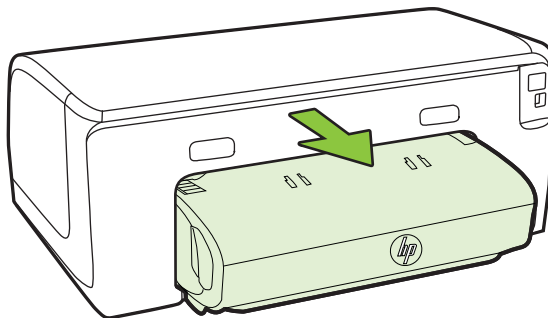

- Reinsert the duplexer into the printer.

Multiple pages are being picked up

- Fan the media before loading.
- Make sure the paper guides are set to the correct markings in the tray for the media size you are loading. Also make sure the guides are snug, but not tight, against the stack.

- Make sure the tray is not overloaded with paper.
- Use HP media for optimum performance and efficiency.

Solve problems using HP ePrint and HP websites

This section provides solutions to common problems using HP ePrint and HP websites.

- [Solve problems using HP ePrint](#)
- [Solve problems using HP websites](#)

Solve problems using HP ePrint

If you are having problems using HP ePrint, check the following:

- Make sure the printer is connected to the Internet using an Ethernet or wireless connection.

 **NOTE:** You cannot use these web features if the printer is connected using a USB cable.

- Make sure the latest product updates have been installed on the printer. For more information, see [Update the printer](#).
- Make sure HP ePrint is enabled on the printer. For more information, see [Set up HP ePrint using the printer's control panel](#).
- Make sure the network hub, switch, or router is turned on and working correctly.
- If you are connecting the printer using an Ethernet cable, make sure you are not connecting the printer using a phone cord or a crossover cable to connect the printer to the network and that the Ethernet cable is securely connected to the printer. For more information, see [Solve Ethernet network problems](#).
- If you are connecting the printer using a wireless connection, make sure the wireless network is functioning properly. For more information, see [Solve wireless problems](#).
- If you are using HP ePrint, check the following:
 - Make sure the printer's email address is correct.
 - Make sure that the printer's email address is the only address listed in the "To" line of the email message. If other email addresses are listed in the "To" line, the attachments you are sending might not print.
 - Make sure you are sending documents that meet the HP ePrint requirements. For more information, see [HP ePrint specifications](#).
- If your network uses proxy settings when connecting to the Internet, make sure the proxy settings you are entering are valid:
 - Check the settings being used by the Web browser you are using (such as Internet Explorer, Firefox, or Safari).
 - Check with the IT administrator or person who set up your firewall. If the proxy settings used by your firewall have changed, you must update these settings in either the printer's control panel. If these settings are not updated, you will not be able to use HP ePrint. For more information, see [Set up HP ePrint using the printer's control panel](#).

 **TIP:** For additional help on setting up and using HP ePrint, visit ePrintCenter (www.eprintcenter.com).

Solve problems using HP websites

If you are having problems using HP websites from your computer, check the following:

- Make sure the computer that you are using is connected to the Internet.
- Make sure the web browser meets the minimum system requirements. For more information, see [HP website specifications](#).
- If your web browser uses any proxy settings to connect to the Internet, try turning off these settings. For more information, see the documentation provided with your web browser.

Solve Ethernet network problems

If you are unable to connect the printer to your Ethernet network, perform one or more of the following tasks.

 **NOTE:** After correcting any of the following, run the installation program again.

 **TIP:** You can visit the HP online support website at www.hp.com/go/customer-care for information and utilities that can help you correct many common printer problems.

- [General network troubleshooting](#)

General network troubleshooting

If you are unable to install the HP software provided with the printer, verify the following:

- All cable connections to the computer and the printer are secure.
- The network is operational and the network hub is turned on.
- All applications, including virus protection programs, spyware protection programs, and firewalls, are closed or disabled for computers running Windows
- The printer is installed on the same subnet as the computers that use the printer.

If the installation program cannot discover the printer, print the network configuration page, and enter the IP address manually in the installation program. For more information, see [Understand the network configuration page](#) or you can download the HP Home Network Diagnostic Utility on the HP website.

Solve wireless problems

This section provides information about solving problems you might encounter when connecting the printer to your wireless network.

Follow these suggestions in order, starting with those listed in the “Basic wireless troubleshooting” section. If you still encounter problems, follow the suggestions provided in the “Advanced wireless troubleshooting” section.

- [Basic wireless troubleshooting](#)
- [Advanced wireless troubleshooting](#)
- [After resolving the problems](#)

 **TIP:** For more information about troubleshooting wireless problems, go to www.hp.com/go/wirelessprinting.

TIP: If you are using a computer running Windows, HP provides a tool called HP Home Network Diagnostic Utility that can help retrieve this information for some systems. To use this tool, visit the HP Wireless Printing Center (www.hp.com/go/wirelessprinting), and then click **Network Diagnostic Utility** in the **Quick Links** section. (At this time, this tool might not be available in all languages.)

 **NOTE:** After you resolve the problem, follow the instructions in [After resolving the problems](#).

Basic wireless troubleshooting

Perform the following steps in the order presented.

Step 1 - Make sure the wireless (802.11) light is turned on



If the blue light near the printer's wireless button is not lit, the wireless capabilities might not have been turned on. Press the  (Wireless) button to turn on the printer's wireless capabilities.

 **NOTE:** If your printer supports Ethernet networking, make sure that an Ethernet cable has not been connected to the printer. Connecting an Ethernet cable turns off the printer's wireless capabilities.

Step 2 - Restart components of the wireless network

Turn off the router and the printer, and then turn them back on in this order: router first and then the printer. If you still are unable to connect, turn off the router, printer, and your computer. Sometimes, turning off the power and then turning it back on recovers from a network communication issue.

Step 3 - Run the Wireless Network Test

For wireless networking issues, run the Wireless Network Test. To print a Wireless Network Test page, press and hold the  (Resume) button, and then press the  (Wireless) button. If a problem is detected, the printed test report includes recommendations that might help solve the problem.

 **TIP:** : If the Wireless Network Test indicates the signal is weak, try moving the printer closer to the wireless router.

Advanced wireless troubleshooting

If you have tried the suggestions provided in [Basic wireless troubleshooting](#) and are still unable to connect to your printer to the wireless network, try the following suggestions in the order presented:

- [Step 1: Make sure your computer is connected to your network](#)
- [Step 2: Make sure that the printer is connected to your network](#)
- [Step 3: Check to see if the firewall software is blocking communication](#)
- [Step 4: Make sure the printer is online and ready](#)
- [Step 5: Make sure the wireless version of the printer is set as the default printer driver \(Windows only\)](#)
- [Step 6: Make sure your computer is not connected to your network over a Virtual Private Network \(VPN\)](#)

Step 1: Make sure your computer is connected to your network

Make sure your computer is connected to your network—either your Ethernet network or your wireless network. If the computer is not connected to the network, you cannot use the printer over the network.

To check an Ethernet connection

- ▲ Many computers have indicator lights beside the port where the Ethernet cable from the router connects to your computer. Usually there are two indicator lights, one that is on and another that blinks. If your computer has indicator lights, check to see if the indicator lights are on. If the lights are not on, try reconnecting the Ethernet cable to the computer and the router. If you still do not see lights, there might be a problem with the router, the Ethernet cable, or your computer.



NOTE: Macintosh computers do not have indicator lights. To check the Ethernet connection on a Macintosh computer, click **System Preferences** in the Dock, and then click **Network**. If the Ethernet connection is working correctly, **Built-in Ethernet** appears in the list of connections, along with the IP address and other status information. If **Built-in Ethernet** does not appear in the list, there might be a problem with the router, the Ethernet cable, or your computer. For more information, click the Help button in the window.

To check a wireless connection

1. Make sure that your computer's wireless has been turned on. (For more information, see the documentation that came with your computer.)
2. If you are not using a unique network name (SSID), then it is possible that your wireless computer could be connected to a nearby network that is not yours. The following steps can help you determine if your computer is connected to your network.

Windows

- a. Click **Start**, click **Control Panel**, point to **Network Connections**, and then click **View Network Status and Tasks**.
– OR –
Click **Start**, select **Settings**, click **Control Panel**, double-click **Network Connections**, click the **View** menu, and then select **Details**.
Leave the network dialog box open while you continue to the next step.
- b. Disconnect the power cord from the wireless router. The connection status of your computer should change to **Not Connected**.
- c. Reconnect the power cord to the wireless router. The connection status should change to **Connected**.

Mac OS X

- ▲ Click the **AirPort** icon in the menu bar at the top of the screen. From the menu that appears, you can determine if the AirPort is turned on and which wireless network your computer is connected to.

 **NOTE:** For more detailed information about your AirPort connection, click **System Preferences** in the Dock, and then click **Network**. If the wireless connection is working correctly, a green dot appears next to AirPort in the list of connections. For more information, click the Help button in the window.

If you are unable to get your computer connected to your network, contact the person who set up your network or the router manufacturer as there might be a hardware issue with either your router or computer.

 **TIP:** If you are able to access the Internet and are using a computer running Windows, you can also use the HP Network Assistant for help in setting up a network. To use this tool, visit www.hp.com/sbso/wireless/tools-setup.html?jumpid=reg_R1002_USEN. (This Web site is only available in English.)

Step 2: Make sure that the printer is connected to your network

If your printer is not connected to the same network as your computer, you cannot use the printer over the network. Follow the steps described in this section to find out if your printer is actively connected to the correct network.

 **NOTE:** If your wireless router or Apple AirPort Base Station is using a hidden SSID, your printer cannot automatically detect the network

A: Make sure the printer is on the network

1. If the printer supports Ethernet networking and is connected to an Ethernet network, make sure an Ethernet cable is not plugged into the back of the printer. If an Ethernet cable is plugged into the back, then wireless connectivity is disabled.
2. If the printer is connected to a wireless network, print the network configuration page. For more information, see [Understand the network configuration page](#).
3. After the page has been printed, check the Network Status and URL:

Network Status	<ul style="list-style-type: none"> • If the Network Status is Ready, the printer is actively connected to a network. • If the Network Status is Offline, the printer is not connected to a network. Run the Wireless Network Test (using the instructions at the beginning of this section) and follow any recommendations.
URL	The URL shown here is the network address assigned to the printer by your router. You need this to connect to the embedded web server (EWS).

For information about connecting the printer to a wireless network, see [Set up the printer for wireless communication](#).

B: Check to see if you can access the EWS

- ▲ After you establish that the computer and the printer both have active connections to a network, you can verify if they are on the same network by opening the printer's EWS. For more information, see [Embedded web server](#).

To access the EWS

- a. On your computer, open the EWS. For more information, see [Embedded web server](#).



NOTE: If you are using a proxy server in your browser, you might need to disable it to access the EWS.

- b. If you can open the EWS, try using the printer over the network (such as to print) to see if your network setup was successful.
- c. If you cannot open the EWS or are still having problems using the printer over the network, continue to the next section regarding firewalls.

Step 3: Check to see if the firewall software is blocking communication

If you cannot access the EWS and are sure both the computer and printer have active connections to the same network, the firewall security software might be blocking communication. Temporarily turn off any firewall security software running on your computer and then try to open the EWS again. If you can open the EWS, try using the printer (for printing).

If you are able to open the EWS and use your printer with the firewall turned off, you need to reconfigure your firewall settings to allow the computer and printer to

communicate with each other over the network. For more information, see [Configure your firewall software to work with the printer](#).

If you are able to open the EWS, but are still unable to use the printer even with the firewall turned off, try enabling the firewall software to recognize the printer. For more information, see the documentation provided with your firewall software.

Step 4: Make sure the printer is online and ready

If you have the HP software installed, you can check the printer's status from your computer to see if the printer is paused or offline, preventing you from using it.

To check the printer's status, follow the instructions for your operating system:

Windows

1. Click **Start**, and then click **Printers** or **Printers and Faxes** or **Devices and Printers**.
- Or -
Click **Start**, click **Control Panel**, and then double-click **Printers**.
2. If the printers on your computer are not being displayed in Details view, click the **View** menu, and then click **Details**.
3. Do one of the following, depending on the printer status:
 - a. If the printer is **Offline**, right-click the printer, and click **Use Printer Online**.
 - b. If the printer is **Paused**, right-click the printer, and click **Resume Printing**.
4. Try using the printer over the network.

Mac OS X

1. Click **System Preferences** in the Dock, and then click **Print & Fax** or **Print & Scan**.
2. Select the printer, and then click **Open Print Queue**.
3. If the print job is on hold, click **Resume**.
4. If the printer is paused, click **Resume Printer**.

If you can use the printer after performing the steps above but find that the symptoms persist as you continue to use the printer, your firewall might be interfering. For more information, see [Configure your firewall software to work with the printer](#)

If you still cannot use the printer over the network, continue to the next section for additional troubleshooting help

Step 5: Make sure the wireless version of the printer is set as the default printer driver (Windows only)

If you install the HP software again, the installer might create a second version of the printer driver in your **Printers** or **Printers and Faxes** or **Devices and Printers** folder. If

you have difficulties printing or connecting to the printer, make sure the correct version of the printer driver is set as the default.

1. Click **Start**, and then click **Printers** or **Printers and Faxes** or **Devices and Printers**.
- Or -
Click **Start**, click **Control Panel**, and then double-click **Printers**.
2. Determine if the version of the printer driver in the **Printers** or **Printers and Faxes** or **Devices and Printers** folder is connected wirelessly:
 - a. To change settings, click the button that opens the **Printer Properties** dialog box.
 - b. On the **Ports** tab, look for a port in the list with a checkmark. The version of the printer driver that is connected wirelessly has **HP network re-discovery port monitor** as the Port description, next to the checkmark.
3. Right-click the printer icon for the version of the printer driver that is connected wirelessly, and select **Set as Default Printer**.

 **NOTE:** If there is more than one icon in the folder for the printer, right-click the printer icon for the version of the printer driver that is connected wirelessly, and select **Set as Default Printer**.

Step 6: Make sure your computer is not connected to your network over a Virtual Private Network (VPN)

A Virtual Private Network (VPN) is a computer network that uses the Internet to provide a remote, secure connection to an organization's network. However, most VPN services do not allow you to access local devices (like your printer) on your local network while your computer is connected to the VPN.

To connect to the printer, disconnect from the VPN.

 **TIP:** To use the printer while connected to the VPN, you can connect the printer to your computer with a USB cable. The printer uses its USB and network connections at the same time.

For more information, contact your network administrator or the person who set up the wireless network.

After resolving the problems

After you resolve any problems and have successfully connected the printer to your wireless network, complete the following steps for your operating system:

Windows

1. On the computer desktop, click **Start**, select **Programs** or **All Programs**, click **HP**, select your printer name, and then click **Printer Setup & Software**.
2. Click **Connect a new printer**, and then select the type of connection you want to use.

Mac OS X

1. Open HP Utility. For more information, see [HP Utility \(Mac OS X\)](#).
2. Click the **Applications** icon on the toolbar, double-click **HP Setup Assistant**, and then follow the onscreen instructions.

Configure your firewall software to work with the printer

A personal firewall, which is security software running on your computer, can block network communication between your printer and your computer.

If you are having problems such as:

- Printer not found when installing HP software
- Unable to print, print job stuck in queue or printer goes offline
- Unable to see printer status on your computer

The firewall might be preventing your printer from notifying computers on your network where it can be found.

If you are using the HP software on a computer running Windows and cannot find the printer during installation (and you know the printer is on the network)—or if you have already successfully installed HP software and experience problems—check the following:

- If you have just installed the HP software, try turning off your computer and the printer, and then turning them both on again.
- Keep your security software up to date. Many security software vendors provide updates that correct known issues and provide the latest defenses against new security threats.
- If your firewall has "High", "Medium", or "Low" security settings, use the "Medium" setting when your computer is connected to your network.
- If you have changed any firewall settings from default, try going back to the default setting.
- If your firewall has a setting called "trusted zone", use this setting when your computer is connected to your network.
- If your firewall has a setting to "not show alert messages", you should disable this. When installing the HP software and using the HP printer you may see alert messages from your firewall software that provide options to "allow", "permit" or "unblock". You should allow any HP software that causes an alert. Also, if the alert has a "remember this action" or "create a rule for this" selection, select it. This is how the firewall learns what can be trusted on your network.
- Do not have more than one firewall enabled at the same time on your computer. An example would be having both the Windows firewall provided by the operating system and a 3rd party firewall enabled at the same time. Having more than one firewall enabled at the same time will not make your computer any safer and may cause problems.

For more information about using your printer with personal firewall software, visit www.hp.com/go/wirelessprinting, and then click **Firewall Help** in the **Wireless Network Help** section.



NOTE: At this time, some portions of this site are not available in all languages.

Solve printer management problems

 **TIP:** You can visit the HP online support website at www.hp.com/go/customercare for information and utilities that can help you correct many common printer problems.

This section provides solutions to common problems that involve managing the printer. This section contains the following topic:

- [Embedded web server cannot be opened](#)
-

 **NOTE:** To use the EWS, the printer must be connected to a network using either an Ethernet or a wireless connection. You cannot use the embedded web server if the printer is connected to a computer with a USB cable.

Embedded web server cannot be opened

Check your network setup

- Make sure you are not using a phone cord or a crossover cable to connect the printer to the network.
- Make sure the network cable is securely connected to the printer.
- Make sure the network hub, switch, or router is turned on and working correctly.

Check the computer



Make sure the computer that you are using is connected to the network.

 **NOTE:** To use the EWS, the printer must be connected to a network using either an Ethernet or a wireless connection. You cannot use the embedded web server if the printer is connected to a computer with a USB cable.

Check your web browser

- Make sure the web browser meets the minimum system requirements. For more information, see [Embedded web server specifications](#).
- If your web browser uses any proxy settings to connect to the Internet, try turning off these settings. For more information, see the documentation available with your web browser.
- Make sure JavaScript and cookies are enabled in your web browser. For more information, see the documentation available with your web browser.

Check the printer IP address

- To check the IP address of the printer, obtain the IP address on the network configuration page. To print a network configuration page, press and hold the  (Resume) button, and then press the  (Wireless) button.
- Ping the printer using the IP address from the command prompt (Windows) or from Network Utility (Mac OS X). (Network Utility is located in the **Utilities** folder in the **Applications** folder at the top level of the hard disk.).
For example, if the IP address is 123.123.123.123, type the following at the command prompt (Windows):
C:\Ping 123.123.123.123
- OR -
In Network Utility (Mac OS X) click the **Ping** tab, type the 123.123.123.123 in the box, and then click **Ping**.
If a reply appears, the IP address is correct. If a time-out response appears, the IP address is incorrect.

Troubleshoot installation issues

 **TIP:** You can visit the HP online support website at www.hp.com/go/customer-care for information and utilities that can help you correct many common printer problems.

If the following topics do not help, see [HP support](#) for information about HP support.

- [Hardware installation suggestions](#)
- [HP software installation suggestions](#)
- [Solve network problems](#)

Hardware installation suggestions

Check the printer

- Make sure that all packing tape and material have been removed from outside and inside the printer.
- Make sure that the printer is loaded with paper.
- Make sure that no lights are on or blinking except the Ready light, which should be on. If the Attention light is blinking, check for messages on the printer control panel.

Check the hardware connections

- Make sure that any cords and cables that you are using are in good working order.
- Make sure that the power cord is connected securely to both the printer and to a working power outlet.

Check the printheads and ink cartridges

- Make sure that all of the printheads and ink cartridges are firmly installed in their correct, color-coded slot. Press down firmly on each one to ensure proper contact. The printer cannot work if they are not all installed.
- Make sure that the printhead latch is closed correctly.
- If the display shows a printhead error message, clean the contacts on the printheads.

HP software installation suggestions

Check the computer system

- Make sure that your computer is running one of the supported operating systems. For more information, see [System requirements](#)
- Make sure that the computer meets at least the minimum system requirements.
- In the Windows Device Manager, make sure that the USB drivers have not been disabled.
- If you are using a computer running Windows, and the computer cannot detect the printer, run the uninstallation utility (util\ccc\uninstall.bat on the installation CD) to perform a clean uninstallation of the printer driver. Restart your computer, and reinstall the printer driver.

Verify installation preliminaries

- Make sure to use the installation CD that contains the correct HP software for your operating system.
- Before installing HP software, make sure that all other programs are closed.
- If the computer does not recognize the path to the CD-ROM drive that you type, make sure that you are specifying the correct drive letter.
- If the computer cannot recognize the installation CD in the CD-ROM drive, inspect the installation CD for damage. You can download the printer driver from the HP website (www.hp.com/go/customer-care).



NOTE: After correcting any problems, run the installation program again.

Solve network problems

General network troubleshooting





- If you are unable to install the HP software, verify that:
You can access HP Home Network Diagnostic Utility on the HP website for help in setting up a network.
 - All cable connections to the computer and the printer are secure.
 - The network is operational and the network hub is turned on.
 - All applications, including virus protection programs, spyware protection programs, and firewalls, are closed or disabled for computers running Windows.

- Make sure the printer is installed on the same subnet as the computers that use the printer.
- If the installation program cannot discover the printer, print the network configuration page and enter the IP address manually in the installation program. For more information, see [Understand the network configuration page](#).
- If you are using a computer running Windows, make sure that the network ports created in the printer driver match the printer IP address:
 - Print the printer's network configuration page. For more information, see [Understand the network configuration page](#).
 - Click **Start**, and then click **Printers** or **Printers and Faxes** or **Devices and Printers**.
 - Or -
 - Click **Start**, click **Control Panel**, and then double-click **Printers**.
 - Right-click the printer icon, click **Printer Properties**, and then click the **Ports** tab.
 - Select the TCP/IP port for the printer, and then click **Configure Port**.
 - Compare the IP address listed in the dialog box and make sure it matches the IP address listed on the network configuration page. If the IP addresses are different, change the IP address in the dialog box to match the address on the network configuration page.
 - Click **OK** twice to save the settings and close the dialog boxes.

Problems connecting to an Ethernet network

- If the **Network** light on the printer control panel does not turn on, make sure that all of the “General network troubleshooting” conditions are met.
- Though it is not recommended that you assign the printer with a static IP address, you might resolve some installation problems (such as a conflict with a personal firewall) by doing so.

To reset the printer's network settings

1. To reset the administrator password and network settings, press and hold  (Wireless) button and  (Cancel) button for three seconds.
2. Press and hold the  (Resume) button, and then press the  (Wireless) button to print the network configuration page and verify that the network settings have been reset.

Understand the printer status report

Use the printer status report to view current printer information and ink cartridge status. Also use the printer status report to help you troubleshoot problems with the printer.

The printer status report also contains a log of recent events.

If you need to call HP, it is often useful to print the printer status report before calling.

To print the printer status report

On the printer control panel, press and hold the  (Cancel) button for three seconds.

Printer Status Report

1 **Product Information**

1. Model Name: HP Officejet Pro 8100 N811a
 2. Model Number: N811a
 3. Serial Number: CH0AC1L53805MX
 4. Product Number: CM752A
 5. Service ID: 210201
 6. Printer Zone (PZ): 0
 7. Firmware Version: TSL3FAperHX
 8. FW Patch Version: 0
 9. Country/Region: US / 1
 10. Duplexer: Installed

2 **Print Usage Information**

11. Total Pages Printed: 90
 12. Total Color Pages Printed: 5
 13. Borderless Pages Printed: 0

3 **Ink Delivery System Information**

18. Ink 27
 20. Ink Supply
 21. Estimated Ink Level:

	Magenta	Cyan	Yellow	Black
22. Ink Number:	HP 951XL	HP 951XL	HP 951XL	HP 950XL
23. End of Warranty Date (Y-MM-DD):	2012/10/07	2012/10/07	2012/10/07	2012/10/28
24. First Installation Date (Y-MM-DD):	2014/10/29	2014/10/29	2014/10/29	2014/07/18
25. Ink Zone:	1	1	1	1
26. USE:	0	0	0	0
27. HP:	1	1	1	1
28. Supported Ink Cartridges*:	HP 951XL HP 951	HP 951XL HP 951	HP 951XL HP 951	HP 950XL HP 950

*Not all cartridges are available in all regions.

4 **Print Head Information**

29. Pen ID: 0a0000000 0000000 00000000 4012801
 30. PNA Install Date in This Printer: 2011/01/05
 31. Non HP Ink: 0

5 **Additional Assistance**

For more information about how to change settings and diagnose problems, see the user documentation for your device. This documentation is available on your computer after you install the software—either from the HP Officejet Pro 8100 N811a Printer Software (Windows) or the Help Viewer (Mac OS).

6 **Wireless Network Test**

To verify your product is setup correctly for Wireless, run the Wireless Network Test. You can access this test from the device control panel.

- 1. Printer Information:** Shows printer information (such as the printer name, model number, serial number, and firmware version number), the accessories that are installed (such as the automatic two-sided printing accessory or duplexer), and the connectivity settings.
- 2. Print Usage Information:** Provides the total number of pages printed, as well as the number of borderless pages printed.
- 3. Ink Delivery System Information:** Shows the estimated ink levels (represented in graphical form as gauges) and the part numbers and warranty expiration dates of the ink cartridges.



 **NOTE:** Ink level warnings and indicators provide estimates for planning purposes only. When you receive a low on ink message, consider having a replacement cartridge available to avoid possible printing delays. You do not need to replace cartridges until prompted to do so.

- 4. Print Head Information:** Shows the pen ID number and first-installation date of the printhead.
- 5. Additional Assistance:** Provides information about available methods for finding more information about the printer.
- 6. Wireless Network Test:** Provides information about testing the wireless network connection to the printer.

Understand the network configuration page

If the printer is connected to a network, you can print a network configuration page to view the network settings for the printer. You can use the network configuration page to help troubleshoot network connectivity problems. If you need to call HP, it is often useful to print this page before calling.

To print the network configuration page

On the printer control panel, press and hold the  (Resume) button, and then press the  (Wireless) button.



The screenshot shows the HP Network Configuration Page with the following sections and callouts:

- 1** WPS PIN: 92059146 (good for 5 minutes from the time this report was printed)
- 2** General Information: Network Status (Ready), Active Connection Type (Wireless), IPV4 (x) for Firewalled Web Server (http://192.254.34.180), Firmware Revision (TSL3FA10H9R), Hostname (HP2010R), Serial Number (CNDAC1L51405MX)
- 3** 802.3 Wired: Hardware Address (MAC) (00:35:99:24:1d:fb), Link Configuration (None)
- 4** 802.11 Wireless: Hardware Address (MAC) (88:3f:00:3c:22:94), Status (Connected), Communication Mode (Ad-hoc), Network Name (SSID) (hp2010r), Access Point HW Address (02:1b:77:00:00:04), Signal Quality (1 - 5) (3), Channel (11), Authentication Type (Open System), Encryption (None), IPv4: IP Address (192.254.34.180), Default Gateway (0.0.0.0), Configuration Source (AutoIP), Primary DNS Server (0.0.0.0), Secondary DNS Server (0.0.0.0), Total Packets Transmitted (140), Total Packets Received (904), IPv6: Primary DNS Server (0), Secondary DNS Server (0), Address (FE80:5A85:999F:FE2C:2284), Prefix Length (64), Configured By (Self)
- 5** Port 9100 Status (Enabled), LPD Status (Enabled), Bonjour Status (Enabled), Service Name (Officejet Pro 8100 [2D] [DVB]), Bonjour Service Name (Officejet Pro 8100 [2D] [DVB]), Bonjour Status (Enabled), Microsoft Web Services: WS Discovery Status (Enabled), WS Print Status (Enabled), SNMP: Status (Read-write enabled), Get Version (v1), Get Community Name (Not Specified), Get Community Name (Not Specified), WINS: Status (Enabled), Primary Server (0.0.0.0), Secondary Server (0.0.0.0), Primary Server (None), Secondary Server (None), IPP Status (Enabled)

1. **WPS PIN:** Shows the WPS PIN for you to set up the printer on your wireless network using the PIN Method.
2. **General Information:** Shows information about the current status and active connection type of the network, and other information, such as the URL of the embedded web server.
3. **802.3 Wired:** Shows information about the active Ethernet network connection, such as the IP address, subnet mask, default gateway, as well as the hardware address of the printer.
4. **802.11 Wireless:** Shows information about your wireless network connection, such as the hostname, IP address, subnet mask, default gateway, and server.
5. **Miscellaneous:** Shows information about more advanced network settings.
 - **Port 9100:** The printer supports raw IP printing through TCP Port 9100. This HP-proprietary TCP/IP port on the printer is the default port for printing. It is accessed by HP software (for example, the HP Standard Port).
 - **LPD:** Line Printer Daemon (LPD) refers to the protocol and programs associated with line-printer spooling services that may be installed on various TCP/IP systems.



NOTE: The LPD functionality can be used with any host implementation of LPD that complies with the RFC 1179 document. The process for configuring printer spoolers, however, might differ. See your system documentation for information about configuring these systems.

- **Bonjour:** Bonjour services (which use mDNS, or Multicast Domain Name System) are typically used on small networks for IP address and name resolution (through UDP port 5353), where a conventional DNS server is not used.
- **SLP:** Service Location Protocol (SLP) is an Internet standard network protocol that provides a framework to allow networking applications to discover the existence, location, and configuration of networked services in enterprise networks. This protocol simplifies discovery and use of network resources such as printers, web servers, fax machines, video cameras, files systems, backup devices (tape drives), databases, directories, mail servers, calendars.
- **Microsoft Web Services:** Enable or disable the Microsoft Web Services Dynamic Discovery (WS Discovery) protocols or Microsoft Web Services for Devices (WSD) Print services supported on the printer. Disable unused print services to prevent access through those services.



NOTE: For more information about WS Discovery and WSD Print, visit www.microsoft.com.

- **SNMP:** SNMP (Simple Network Management Protocol) is used by network management applications for device management. The printer supports SNMPv1 protocol on IP networks.

- **WINS:** If you have a Dynamic Host Configuration Protocol (DHCP) server on your network, the printer automatically obtains its IP address from that server and registers its name with any RFC 1001 and 1002-compliant dynamic name services as long as a WINS server IP address has been specified.
- **IPP:** Internet Printing Protocol (IPP) is a standard network protocol for remote printing. Unlike other remote IP-based protocols, IPP supports access control, authentication, and encryption, allowing for more secure printing.

Printhead maintenance

If you are experiencing problems with printing, you might have a problem with the printhead. You should perform the procedures in the following sections only when directed to do so for resolving print quality issues.

Performing the aligning and cleaning procedures unnecessarily can waste ink and shorten the life of the cartridges.

This section contains the following topics:

- [Clean the printhead](#)
- [Align the printhead](#)
- [Remove and reinstall the printhead](#)

Clean the printhead





If your printed output is streaked or has any incorrect or missing colors, the printhead might need to be cleaned.

If print quality still seems poor after cleaning, try aligning the printer. If print quality problems persist after cleaning and aligning, contact HP support. For more information, see [HP support](#).

 **NOTE:** Cleaning uses ink, so clean the printheads only when necessary. The cleaning process takes a few minutes. Some noise might be generated in the process.

Not turning the printer off correctly can cause print quality problems. For more information, see [Turn the printer off](#).

To clean the printhead from the printer control panel

1. On the printer control panel, press and hold  (Power) button.
2. Press  (Cancel) button two times, and then press  (Resume) button once.
3. Release  (Power) button.

To clean the printhead from Toolbox (Windows)

1. Open Toolbox. For more information, see [Open the Toolbox](#).
2. From the **Device Services** tab, click the icon to the left of **Clean Printheads**.
3. Follow the onscreen instructions.

To clean the printhead from HP Utility (Mac OS X)

1. Open HP Utility. For more information, see [HP Utility \(Mac OS X\)](#).
2. In the **Information And Support** section, click **Clean Printheads**.
3. Click **Clean**, and then follow the onscreen instructions.

To clean the printhead from the embedded web server (EWS)



1. Open the EWS. For more information, see [To open the embedded web server](#).
2. Click the **Tools** tab, and then click **Print Quality Toolbox** in the **Utilities** section.
3. Click **Clean Printhead** and follow the onscreen instructions.

Align the printhead

The printer automatically aligns the printhead during the initial setup.

You might want to use this feature when the printer status page shows streaking or white lines through any of the blocks of color or if you are having print quality issues with your printouts.

To align the printhead from the printer control panel

1. Load letter, A4, or legal unused plain white paper into the main input tray.
2. On the printer control panel, press and hold the  (Power) button.
3. Press  (Resume) button three times.

To align the printhead from Toolbox (Windows)

1. Open Toolbox. For more information, see [Open the Toolbox](#).
2. From the **Device Services** tab, click the icon to the left of **Align Printheads**.
3. Follow the onscreen instructions.

To align the printhead from HP Utility (Mac OS X)

1. Open HP Utility. For more information, see [HP Utility \(Mac OS X\)](#).
2. In the **Information And Support** section, click **Align Printhead**.
3. Click **Align**, and then follow the onscreen instructions.

To align the printhead from the embedded web server (EWS)

1. Open the EWS. For more information, see [To open the embedded web server](#).
2. Click the **Tools** tab, and then click **Print Quality Toolbox** in the **Utilities** section.
3. Click **Align Printhead** and follow the onscreen instructions.

Remove and reinstall the printhead

 **NOTE:** This procedure should only be performed when a **Missing or Failed Printhead** message has been seen and the printer has first been turned off and then back on to try to resolve the message. If the message persists, try this procedure.

Remove and reinstall the printhead

1. Make sure that the printer is turned on.
2. Open the top cover and the ink-cartridge access door.

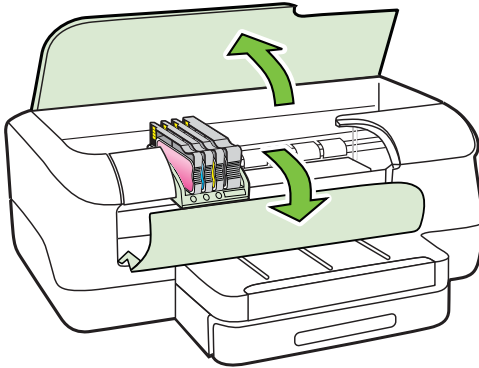

3. Lift the latch handle on the print carriage.

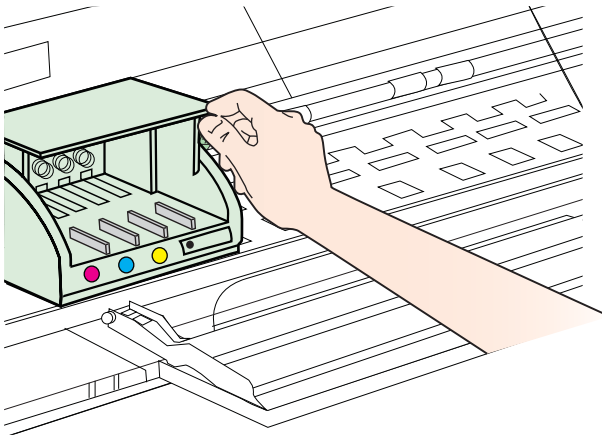

4. Remove the printhead by lifting it up and then pulling it out of the printer.

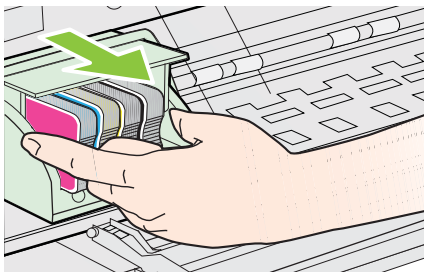

5. Make sure the latch handle is raised, and then reinsert the printhead.

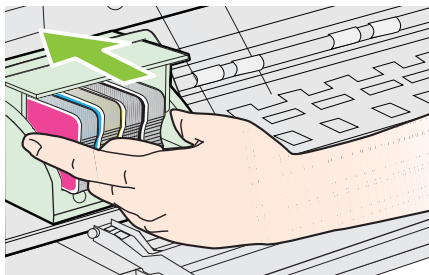

6. Carefully lower the latch handle.

 **NOTE:** Make sure you lower the latch handle before reinserting the ink cartridges. Leaving the latch handle raised can result in incorrectly seated ink cartridges and problems printing. The latch must remain down in order to correctly install the ink cartridges.

7. Close the ink-cartridge access door and the top cover.

Clear jams

Occasionally, media becomes jammed during a job.

This section contains the following topics:

- [Clear paper jams](#)
- [Avoid paper jams](#)

Clear paper jams

 **CAUTION:** To prevent possible damage to the printhead, clear paper jams as soon as possible.

 **TIP:** If you notice poor print quality, clean the printhead. For more information, see [Clean the printhead](#).

To clear a jam

Use these steps to clear a paper jam.

1. Remove all media from the output tray.

⚠ CAUTION: Trying to clear a paper jam from the front of the printer can damage the print mechanism. Always access and clear paper jams through the automatic two-sided printing accessory (duplexer).

2. Check the duplexer.

- a. Push the button on either side of the duplexer, and then remove the unit.

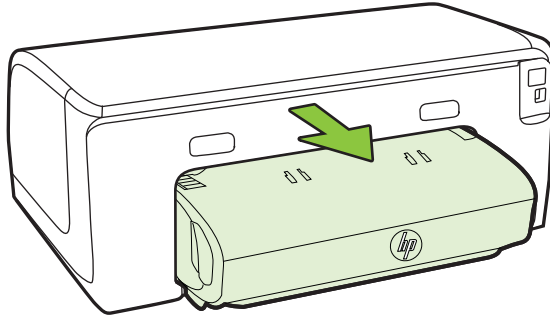

- b. Locate any jammed media inside the printer, grasp it with both hands and then pull it towards you.
- c. If the jam is not there, push the latch on top of the duplexer and lower the cover. If media is jammed inside, carefully remove it. Close the cover.

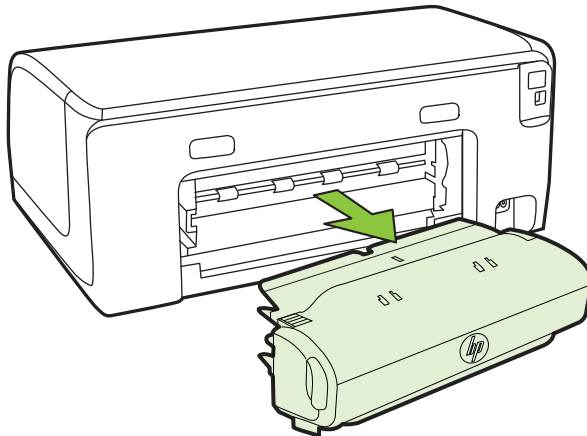

- d. Reinsert the duplexer into the printer.
3. Open the top cover and remove any debris.

4. If you have not found the jam and have Tray 2 installed, pull out the tray and remove the jammed media, if possible. If not, do the following:
 - a. Ensure the printer is turned off and disconnect the power cord.
 - b. Lift the printer off Tray 2.
 - c. Remove the jammed media from the bottom of the printer or from Tray 2.
 - d. Reposition the printer on top of Tray 2.
5. Open the print carriage access door. If there is paper remaining inside the printer, ensure the carriage has moved to the right of the printer, free any paper scraps or wrinkled media, and pull the media towards you through the top of the printer.

⚠ WARNING! Do not reach into the printer when it is on and the carriage is stuck. When you open the print carriage access door, the carriage should return to its position on the right side of the printer. If it does not move to the right, turn off the printer before you remove any jam.

6. After clearing the jam, close all covers, turn on the printer (if you turned it off) and resend the print job.

Avoid paper jams

To help avoid paper jams, follow these guidelines.

- Remove printed papers from the output tray frequently.
- Make sure that you are printing with media that is not wrinkled, folded, or damaged.
- Prevent curled or wrinkled paper by storing all unused paper flat in a resealable bag.
- Do not use paper that is too thick or too thin for the printer.
- Make sure that the trays are loaded correctly and are not too full. For more information, see [Load media](#).
- Ensure that paper loaded in the input tray lays flat and the edges are not bent or torn.
- Do not combine different paper types and paper sizes in the input tray; the entire stack of paper in the input tray must be the same size and type.
- Adjust the paper-width guide in the input tray to fit snugly against all paper. Make sure the paper-width guide does not bend the paper in the input tray.
- Do not force paper too far forward in the input tray.
- Use paper types that are recommended for the printer. For more information, see [Select print media](#).
- If the printer is about to run out of paper, allow the printer to run out of paper first and then add paper. Do not try to add paper while the printer is trying to pickup a sheet.
- If you are printing on both sides of a page, do not print highly saturated images on light weight paper.
- Make sure that the printer is clean. For more information, see [Maintain the printer](#).

Control panel lights reference

The control panel lights indicate status and are useful for diagnosing printing problems. This section contains information about the lights, what they indicate, and what action to take if necessary.

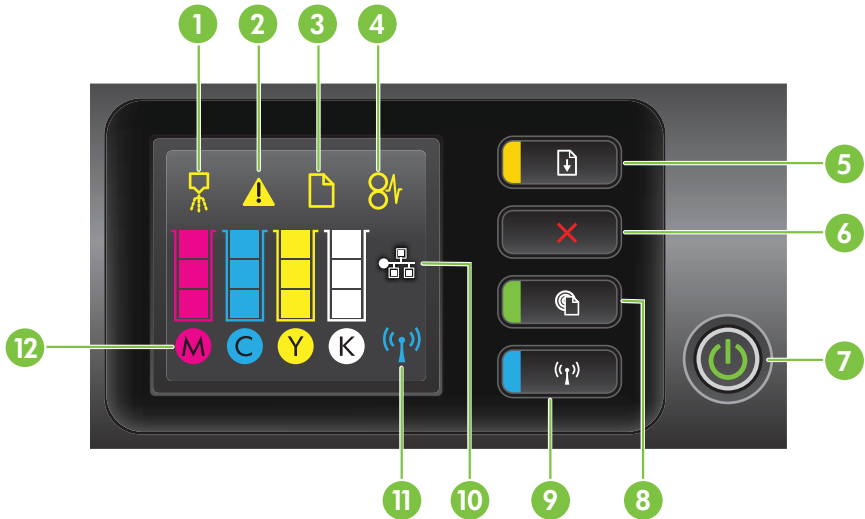

For more information about the printer control panel, see [Use the printer control panel](#).





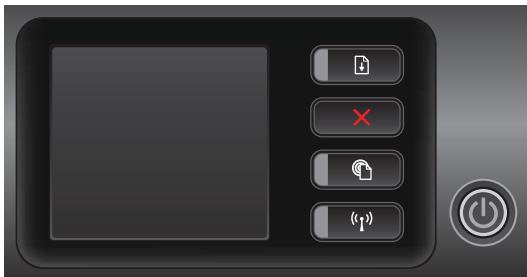

Label	Name and Description
1	Printhead align icon. Shows that the printhead requires alignment.
2	Ink cartridge access door open icon. Shows that the printer's ink cartridge access door or top cover is open.
3	Out of paper icon. Shows that the printer is out of paper.
4	Paper jam icon. Shows that the printer has a paper jam.
5	Resume button and light. The Resume light blinks when the button must be pressed to resume printing. Press to continue a print job after clearing a paper jam, adding paper, or installing a cartridge. Press to cancel a print job when a media size mismatch occurs. Press and hold for three seconds to print a demo page.
6	Cancel button. Press once to stop a print job, or press and hold for three seconds to print a printer status report.
7	Power button and light. Press to turn the printer on or off. The light indicates whether the printer is on or off.
8	HP ePrint button and light. Press to turn on the HP ePrint function and print an information page. The light indicates whether the printer is connected to an HP ePrint server.
9	Wireless button and light. Press to turn the 802.11 wireless feature on or off. The button lights when the wireless feature is on.

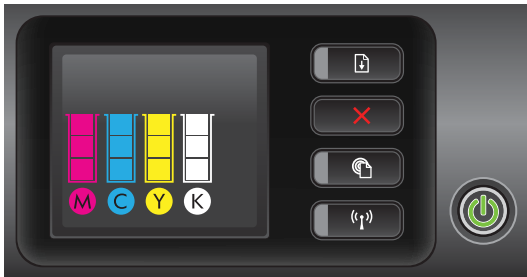

Label	Name and Description
10	Ethernet network icon. Shows that an Ethernet network connection exists.
11	Wireless network icon. Shows that a wireless network connection exists.
12	<p>Ink cartridge information icons. Displays ink cartridge information, including fill levels.</p> <p>NOTE: Ink level warnings and indicators provide estimates for planning purposes only. When you receive a low on ink message, consider having a replacement cartridge available to avoid possible printing delays. You do not need to replace cartridges until prompted to do so.</p>

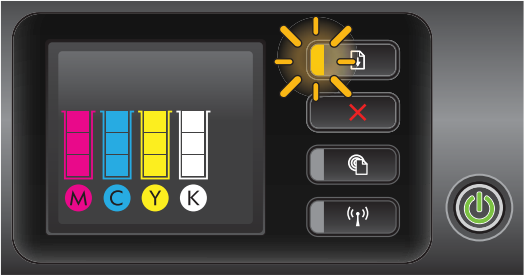
Interpreting control panel lights

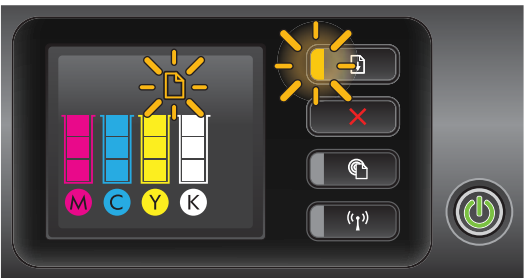
Light description/Light pattern	Explanation and recommended action
<p>All lights are off.</p>  <p>The image shows the printer's control panel with a dark screen and four buttons on the right: a document icon, a red 'X', a circular arrow, and a printer icon. The power button on the far right is not illuminated.</p>	<p>The printer is off.</p> <ul style="list-style-type: none"> • Connect the power cable. • Press  (Power) button.
<p>The Power light is on.</p>  <p>The image shows the printer's control panel with a dark screen. The power button on the far right is illuminated with a green light. Below the screen, four ink cartridge icons are visible: Magenta (M), Cyan (C), Yellow (Y), and Black (K).</p>	<p>The printer is ready.</p> <p>No action is required.</p>

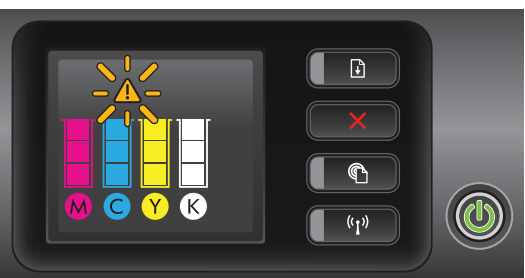
(continued)

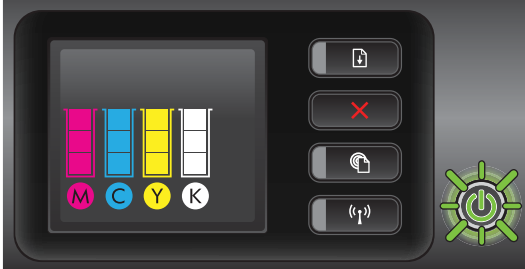
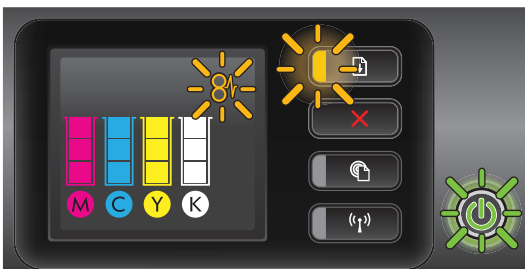
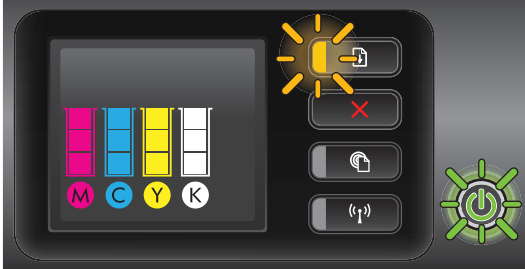
Light description/Light pattern	Explanation and recommended action
<p data-bbox="114 157 677 192">The Power light is on and the Resume light blinks.</p>  <p>The image shows a control panel with a screen displaying four ink levels (Magenta, Cyan, Yellow, Black) and their corresponding icons (M, C, Y, K). To the right of the screen is a glowing yellow sunburst icon with a document symbol, indicating a media width error. Below this icon are three buttons: a red 'X', a document with a right arrow, and a document with a left arrow. To the right of these buttons is a power button with a green power symbol.</p>	<p data-bbox="677 157 1169 210">The media width setting does not match the media loaded.</p> <p data-bbox="677 215 1169 296">Change the media setting in the print driver to match the media loaded. For more information, see Print on special and custom-size paper.</p> <p data-bbox="677 302 1169 354">Load paper and press  (Resume) button to cancel.</p> <p data-bbox="677 359 1169 394">Print the document again.</p>
<p data-bbox="114 527 677 579">The Power light is on, the Out of Paper icon blinks, and the Resume light blinks.</p>  <p>The image shows a control panel with a screen displaying four ink levels (Magenta, Cyan, Yellow, Black) and their corresponding icons (M, C, Y, K). To the right of the screen is a glowing yellow sunburst icon with a document symbol and a red 'X', indicating an out of paper error. Below this icon are three buttons: a red 'X', a document with a right arrow, and a document with a left arrow. To the right of these buttons is a power button with a green power symbol.</p>	<p data-bbox="677 527 1169 562">The printer is out of paper.</p> <p data-bbox="677 567 1169 602">Load paper and press  (Resume) button.</p>
<p data-bbox="114 914 677 966">The Power light is on, and the Access Door Open icon blinks.</p>  <p>The image shows a control panel with a screen displaying four ink levels (Magenta, Cyan, Yellow, Black) and their corresponding icons (M, C, Y, K). To the right of the screen is a glowing yellow sunburst icon with a triangle and exclamation mark, indicating an access door open error. Below this icon are three buttons: a document with a right arrow, a red 'X', and a document with a left arrow. To the right of these buttons is a power button with a green power symbol.</p>	<p data-bbox="677 914 1169 966">The access door or top cover is not closed completely.</p> <p data-bbox="677 972 1169 1024">Make sure the access door and top cover are completely closed.</p>





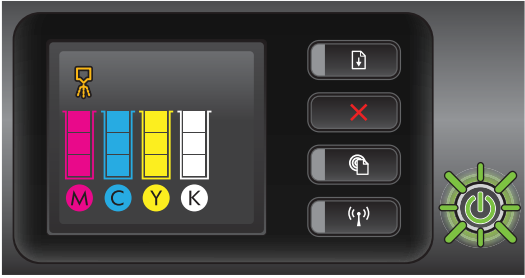
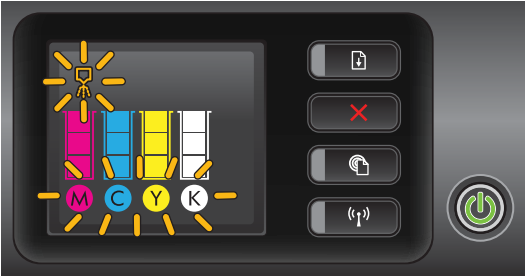
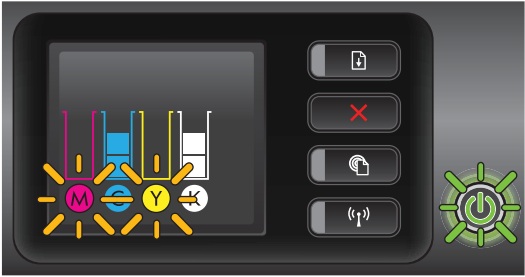

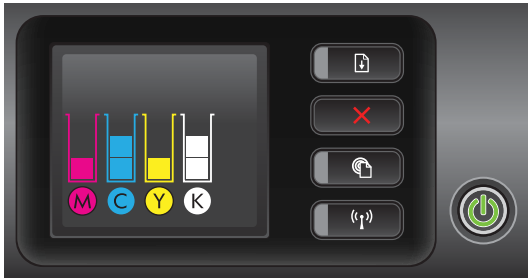
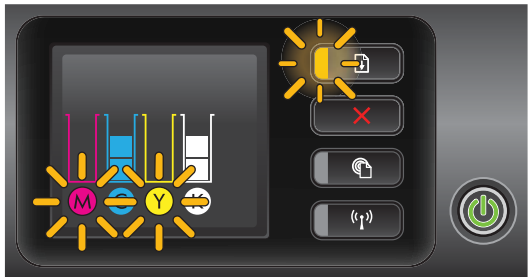
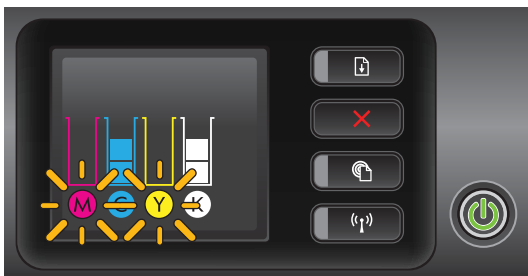
Light description/Light pattern	Explanation and recommended action
<p>The Power light blinks.</p> 	<p>The printer is turning on or off, or is processing a print job.</p> <p>No action is required.</p> <p>The printer is pausing for the ink to dry.</p> <p>Wait for the ink to dry.</p>
<p>The Power light, the Paper Jam icon, and the Resume light blink.</p> 	<p>Print media is jammed in the printer.</p> <p>Remove all media from the output tray. Locate and clear the jam. For more information, see Clear jams.</p>
<p>The Power light and the Resume light blink.</p> 	<p>The printer carriage has stalled.</p> <ul style="list-style-type: none">• Open the top cover and remove any obstructions (such as jammed media).• Press  (Resume) button to continue printing.• If the error persists, turn the printer off, and then on again.

(continued)

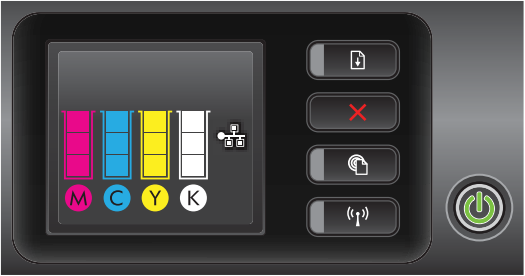
Light description/Light pattern	Explanation and recommended action
<p>The Power light blinks and the Printhead Alert icon is on.</p>  <p>The image shows a control panel with a central display. On the display, there is a yellow icon of a printhead with a lightning bolt, indicating a printhead alert. Below the display are four ink cartridge icons labeled M (magenta), C (cyan), Y (yellow), and K (black). To the right of the display are four buttons: a document icon, a red 'X', a circular arrow, and a power button. The power button is illuminated with a green light and is blinking.</p>	<p>The printhead is incompatible.</p> <ul style="list-style-type: none">• Ensure the printhead is properly installed.• If the error persists, replace the printhead. For more information, see Remove and reinstall the printhead.
<p>The Power light is on, the Printhead Alert icon blinks, and all ink cartridge icons blink.</p>  <p>The image shows the same control panel as above. The power button is now a solid green light. The printhead alert icon on the display is blinking. All four ink cartridge icons (M, C, Y, K) are also blinking.</p>	<p>The printhead is missing, not installed properly, or damaged.</p> <ul style="list-style-type: none">• Ensure the printhead is properly installed.• If the error persists, replace the printhead. For more information, see Remove and reinstall the printhead.
<p>The Power light and one or more of the ink cartridge lights blink.</p>  <p>The image shows the same control panel. The power button is a solid green light. The printhead alert icon is no longer present. One or more of the ink cartridge icons (M, C, Y, K) are blinking.</p>	<p>One or more of the ink cartridges need attention, or are damaged or incompatible.</p> <ul style="list-style-type: none">• Ensure the indicated ink cartridge is properly installed, and then try to print. Remove and reinsert the ink cartridge a few times if necessary.• If the error persists, replace the indicated ink cartridge.

Light description/Light pattern	Explanation and recommended action
<p>The Power light is on; and for one or more ink cartridge lights, only one segment of the ink indicator is on.</p> 	<p>One or more of the ink cartridges are low on ink and will need to be replaced soon.</p> <p>Get new ink cartridges and replace the existing cartridges when prompted to do so.</p> <p>NOTE: Ink level alerts and indicators provide estimates for planning purposes only. When you receive a low on ink message, consider having a replacement cartridge available to avoid possible printing delays.</p>
<p>The Power light is on, the Resume light blinks, and one or more ink cartridge icons blink.</p> 	<p>The original HP ink in one or more cartridges has been depleted.</p> <p>If they were sold to you as new, original HP cartridges, they might be counterfeit. For more information, see Used, Refilled or Counterfeit Cartridge Detected.</p>
<p>The Power light is on, and one or more ink cartridge icons blink.</p> 	<ul style="list-style-type: none"> • One or more ink cartridges must be replaced to resume printing. Get new ink cartridges and replace the existing cartridges when prompted to do so. • One or more of the ink cartridges are missing or incorrect. Install the indicated ink cartridge, and then try to print. Remove and reinsert the ink cartridge a few times if necessary. <p>NOTE: Ink level alerts and indicators provide estimates for planning purposes only. When you receive a low on ink message, consider having a replacement cartridge available to avoid possible printing delays.</p>

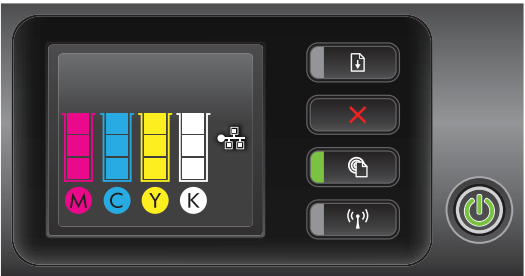
(continued)

Light description/Light pattern	Explanation and recommended action
<p data-bbox="114 154 677 190">The HP ePrint light is off.</p>  <p>The image shows the printer's control panel. On the left, there are four ink level indicators for Magenta (M), Cyan (C), Yellow (Y), and Black (K). To the right of the indicators are four buttons: a document icon, a red 'X', the HP ePrint button (a document with a cloud), and a power button. The HP ePrint button is currently unlit.</p>	<ul style="list-style-type: none">• HP ePrint has not been set up. To set up HP ePrint, press the  (HP ePrint) button, and then follow the instructions on the information page that prints.• HP ePrint has been set up but has been turned off. To turn on HP ePrint, press the  (HP ePrint) button.• HP ePrint is turned on but is unable to connect. HP ePrint is unable to connect, possibly because the server is unavailable or the network is not functioning properly. If your network uses proxy settings when connecting to the Internet, make sure the proxy settings you are entering are valid. For more information, see the getting started guide provided with the printer or check with the IT administrator or person who set up your network. Press the  (HP ePrint) button to try connecting again.<ul style="list-style-type: none">◦ If the printer can connect, the HP ePrint light turns on, and the printer prints an information page.◦ If the printer still cannot connect, the HP ePrint light blinks and then turns off.• HP ePrint has been set up but has been turned off because the printer has not been updated. If a mandatory update for the printer is available but has not been installed, HP ePrint is turned off. After the update has been installed, HP ePrint turns on automatically. For more information about installing the printer update, see Update the printer.
<p data-bbox="114 1185 677 1222">The HP ePrint light is on.</p>  <p>The image shows the printer's control panel. The HP ePrint button is now lit with a green light.</p>	<p data-bbox="680 1185 1166 1222">HP ePrint is turned on.</p> <p data-bbox="680 1225 1166 1333">If you press the  (HP ePrint) button once, the printer prints an information page which provides some instructions on setting up HP ePrint.</p> <p data-bbox="680 1336 1166 1426">To turn off HP ePrint, press and hold the  (HP ePrint) button. The light blinks for five seconds before turning off.</p>

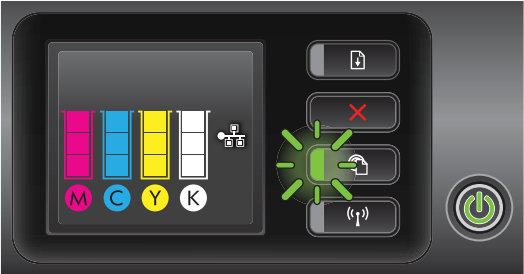
Light description/Light pattern	Explanation and recommended action
<p>The HP ePrint light blinks.</p>  <p>The image shows a close-up of the HP printer's control panel. On the left, there are four ink cartridges labeled M (Magenta), C (Cyan), Y (Yellow), and K (Black). To the right of the cartridges is a green ePrint light that is currently blinking. Further right are several buttons: a document icon, a red 'X' (cancel), a power icon, and a Wi-Fi icon. At the bottom right of the panel is a power button.</p>	<p>HP ePrint is trying to connect.</p> <p>The HP ePrint light blinks when you turn on or turn off HP ePrint.</p> <p>If HP ePrint is able to connect successfully, the light blinks and then turns on. If HP ePrint cannot connect, the light blinks and then turns off.</p>

A Technical information

This section contains the following topics:

- [Warranty information](#)
- [Printer specifications](#)
- [Regulatory information](#)
- [Environmental product stewardship program](#)
- [Third-party licenses](#)

Warranty information

This section contains the following topics:

- [Hewlett-Packard limited warranty statement](#)
- [Ink cartridge warranty information](#)

Hewlett-Packard limited warranty statement

HP product	Duration of limited warranty
Software Media	90 days
Printer	1 year
Print or Ink cartridges	Until the HP ink is depleted or the "end of warranty" date printed on the cartridge has been reached, whichever occurs first. This warranty does not cover HP ink products that have been refilled, remanufactured, refurbished, misused, or tampered with.
Printheads (only applies to products with customer replaceable printheads)	1 year
Accessories	1 year unless otherwise stated

A. Extent of limited warranty

- Hewlett-Packard (HP) warrants to the end-user customer that the HP products specified above will be free from defects in materials and workmanship for the duration specified above, which duration begins on the date of purchase by the customer.
- For software products, HP's limited warranty applies only to a failure to execute programming instructions. HP does not warrant that the operation of any product will be interrupted or error free.
- HP's limited warranty covers only those defects that arise as a result of normal use of the product, and does not cover any other problems, including those that arise as a result of:
 - Improper maintenance or modification;
 - Software, media, parts, or supplies not provided or supported by HP;
 - Operation outside the product's specifications;
 - Unauthorized modification or misuse.
- For HP printer products, the use of a non-HP cartridge or a refilled cartridge does not affect either the warranty to the customer or any HP support contract with the customer. However, if printer failure or damage is attributable to the use of a non-HP or refilled cartridge or an expired ink cartridge, HP will charge its standard time and materials charges to service the printer for the particular failure or damage.
- If HP receives, during the applicable warranty period, notice of a defect in any product which is covered by HP's warranty, HP shall either repair or replace the product, at HP's option.
- If HP is unable to repair or replace, as applicable, a defective product which is covered by HP's warranty, HP shall, within a reasonable time after being notified of the defect, refund the purchase price for the product.
- HP shall have no obligation to repair, replace, or refund until the customer returns the defective product to HP.
- Any replacement product may be either new or like-new, provided that it has functionality at least equal to that of the product being replaced.
- HP products may contain remanufactured parts, components, or materials equivalent to new in performance.
- HP's Limited Warranty Statement is valid in any country where the covered HP product is distributed by HP. Contracts for additional warranty services, such as on-site service, may be available from any authorized HP service facility in countries where the product is distributed by HP or by an authorized importer.

B. Limitations of warranty

TO THE EXTENT ALLOWED BY LOCAL LAW, NEITHER HP NOR ITS THIRD PARTY SUPPLIERS MAKES ANY OTHER WARRANTY OR CONDITION OF ANY KIND, WHETHER EXPRESS OR IMPLIED WARRANTIES OR CONDITIONS OF MERCHANTABILITY, SATISFACTORY QUALITY, AND FITNESS FOR A PARTICULAR PURPOSE.

C. Limitations of liability

- To the extent allowed by local law, the remedies provided in this Warranty Statement are the customer's sole and exclusive remedies.
- TO THE EXTENT ALLOWED BY LOCAL LAW, EXCEPT FOR THE OBLIGATIONS SPECIFICALLY SET FORTH IN THIS WARRANTY STATEMENT, IN NO EVENT SHALL HP OR ITS THIRD PARTY SUPPLIERS BE LIABLE FOR DIRECT, INDIRECT, SPECIAL, INCIDENTAL, OR CONSEQUENTIAL DAMAGES, WHETHER BASED ON CONTRACT, TORT, OR ANY OTHER LEGAL THEORY AND WHETHER ADVISED OF THE POSSIBILITY OF SUCH DAMAGES.

D. Local law

- This Warranty Statement gives the customer specific legal rights. The customer may also have other rights which vary from state to state in the United States, from province to province in Canada, and from country to country elsewhere in the world.
- To the extent that this Warranty Statement is inconsistent with local law, this Warranty Statement shall be deemed modified to be consistent with such local law. Under such local law, certain disclaimers and limitations of this Warranty Statement may not apply to the customer. For example, some states in the United States, as well as some governments outside the United States (including provinces in Canada), may:
 - Preclude the disclaimers and limitations in this Warranty Statement from limiting the statutory rights of a consumer (e.g., the United Kingdom);
 - Otherwise restrict the ability of a manufacturer to enforce such disclaimers or limitations; or
 - Grant the customer additional warranty rights, specify the duration of implied warranties which the manufacturer cannot disclaim, or allow limitations on the duration of implied warranties.
- THE TERMS IN THIS WARRANTY STATEMENT, EXCEPT TO THE EXTENT LAWFULLY PERMITTED, DO NOT EXCLUDE, RESTRICT, OR MODIFY, AND ARE IN ADDITION TO, THE MANDATORY STATUTORY RIGHTS APPLICABLE TO THE SALE OF THE HP PRODUCTS TO SUCH CUSTOMERS.

HP Limited Warranty

The name and address of the HP entity responsible for the performance of the HP Limited Warranty in your country is as follows:

United Kingdom: Hewlett-Packard Ltd Cain Road Bracknell GB-Berks RG12 1HN

Eire: Hewlett-Packard Ireland Limited, 63-74 Sir John Rogerson's Quay, Dublin 2

Malta: Hewlett-Packard International Trade B.V. Malta Branch, 48, Amery Street, Sliema SLM 1701, MALTA

You may have additional statutory rights against the seller based on your purchase agreement. Those rights are not in any way affected by this HP Limited Warranty.

Ink cartridge warranty information

The HP cartridge warranty is applicable when the product is used in its designated HP printing device. This warranty does not cover HP ink products that have been refilled, remanufactured, refurbished, misused, or tampered with.

During the warranty period the product is covered as long as the HP ink is not depleted and the end of warranty date has not been reached. The end of warranty date, in YYYY-MM format, may be found on the product as indicated:

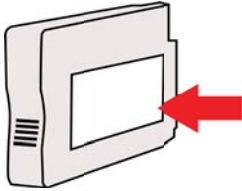

Printer specifications

This section contains the following topics:

- [Physical specifications](#)
- [Product features and capacities](#)
- [Processor and memory specifications](#)
- [System requirements](#)
- [Network protocol specifications](#)
- [Embedded web server specifications](#)
- [Media specifications](#)
- [Print specifications](#)
- [HP ePrint and HP website specifications](#)
- [Environmental specifications](#)
- [Electrical specifications](#)
- [Acoustic emission specifications](#)

Physical specifications

- **Size (with automatic two-sided printing accessory, without Tray 2, and with output tray extension closed) (width x height x depth):** 494 x 202 x 460 mm (19.5 x 8 x 18.1 inches)
- **With Tray 2:** Adds 82 mm (3.2 inches) to the height of the printer.
- **Printer weight (with automatic two-sided printing accessory or duplexer but without printing supplies):** 8.11kg (17.9 lb)
- **With Tray 2:** Adds 2.79 kg (6.2 lb)

Product features and capacities

Feature	Capacity
Connectivity	<ul style="list-style-type: none"> • USB 2.0 high speed compliant • Wireless 802.11b/g/n* • Ethernet (802.3) network <p>* The printer supports the 802.11n 2.4 GHz frequency band.</p>
Print method	Drop-on-demand thermal inkjet printing
Ink cartridges	<p>Four ink cartridges (one each for black, cyan, magenta, and yellow)</p> <p>NOTE: Not all ink cartridges are supported in all countries/regions.</p>
Printhead	One printhead
Supply yields	For more information on estimated ink cartridge yields, visit www.hp.com/go/learnaboutsupplies/ .
Printer languages	HP PCL 3
Font support	US fonts: CG Times, CG Times Italic, Universe, Universe Italic, Courier, Courier Italic, Letter Gothic, Letter Gothic Italic.

(continued)

Feature	Capacity
Duty cycle	Up to 25,000 pages per month

Processor and memory specifications

Printer processor

ARM R4

Printer memory

128 MB DDR2

System requirements



NOTE: For the most current information about supported operating systems and system requirements, visit www.hp.com/go/customer-care.

Operating system compatibility

- Windows XP Service Pack 3, Windows Vista, Windows 7
- Mac OS X v10.5, v10.6, v10.7
- Linux (For more information, see <http://hplipopensource.com/hplip-web/index.html>)

Minimum system requirements

- Microsoft® Windows® 7: 1 GHz 32-bit (x86) or 64-bit (x64) processor; 2 GB hard disk space, CD-ROM/DVD drive or Internet connection, USB port; Internet Explorer
- Microsoft Windows Vista®: 800 MHz 32-bit (x86) or 64-bit (x64) processor; 2 GB hard disk space, CD-ROM/DVD drive or Internet connection, USB port; Internet Explorer
- Microsoft Windows XP Service Pack 3 or higher (32-bit only): Intel® Pentium® II , Celeron®, or compatible processor; 233 MHz or higher; CD-ROM/DVD drive or Internet connection, USB port, Internet Explorer 6.0 or higher
- Mac OS X v10.5, v10.6, v10.7: PowerPC G4, G5, or Intel Core processor, 900 MB free hard disk space, CD-ROM/DVD drive or Internet connection, USB port

Network protocol specifications

Network operating system compatibility

- Windows XP (32-bit) (Professional and Home Editions), Windows Vista 32-bit and 64-bit (Ultimate Edition, Enterprise Edition and Business Edition), Windows 7 (32-bit and 64-bit)
- Windows Small Business Server 2003 32-bit and 64-bit, Windows 2003 Server 32-bit and 64-bit, Windows 2003 Server R2 32-bit and 64-bit (Standard Edition, Enterprise Edition)
- Windows Small Business Server 2008 64-bit, Windows 2008 Server 32-bit and 64-bit, Windows 2008 Server R2 64-bit (Standard Edition, Enterprise Edition)
- Citrix XenDesktop 4
- Citrix XenServer 5.5
- Mac OS X v10.5, v10.6, v10.7
- Microsoft Windows 2003 Server Terminal Services
- Microsoft Windows 2003 Server Terminal Services with Citrix Presentation Server 4.0
- Microsoft Windows 2003 Server Terminal Services with Citrix Presentation Server 4.5
- Microsoft Windows 2003 Server Terminal Services with Citrix XenApp 5.0
- Microsoft Windows 2003 Server Terminal Services with Citrix Metaframe XP with Feature Release 3
- Microsoft Windows 2003 Small Business Server Terminal Services
- Microsoft Windows Server 2008 Terminal Services

- Microsoft Windows Small Business Server 2008 Terminal Services
- Microsoft Windows 2008 Server Terminal Services with Citrix XenApp 5.0
- Novell Netware 6.5, Open Enterprise Server 2

Compatible network protocols

TCP/IP

Network management

Embedded web server (Ability to remotely configure and manage network printers)

Embedded web server specifications

Requirements

- A TCP/IP-based network (IPX/SPX-based networks are not supported)
- A web browser (either Microsoft Internet Explorer 7.0 or higher, Mozilla Firefox 3.0 or higher, Safari 3.0 or higher, or Google Chrome 3.0 or higher)
- A network connection (you cannot use the embedded web server connected directly to a computer with a USB cable)
- An Internet connection (required for some features)

 **NOTE:** You can open the embedded web server without being connected to the Internet. However, some features are not available.

NOTE: The embedded web server must be on the same side of a firewall as the printer.

Media specifications

Use these tables to determine the correct media to use with your printer, and determine what features work with your media.

- [Understand specifications for supported media](#)
- [Set minimum margins](#)
- [Guidelines for printing on both sides of a page](#)

Understand specifications for supported media

Use the tables to determine the correct media to use with your printer, and to determine what features work with your media.

- [Understand supported sizes](#)
- [Understand supported media types and weights](#)

Understand supported sizes

 **NOTE:** Tray 2 is available as an optional accessory.

Media size	Tray 1	Tray 2	Duplexer
Standard media sizes			
10x15cm*	✓		
2L	✓		
U.S. Letter (216 x 279 mm; 8.5 x 11 inches)	✓	✓	✓

(continued)

Media size	Tray 1	Tray 2	Duplexer
8.5 x 13 inches (216 x 330 mm)	✓		
U.S. Legal (216 x 356 mm; 8.5 x 14 inches)	✓	✓	
A4 (210 x 297 mm; 8.3 x 11.7 inches)*	✓	✓	✓
U.S. Executive (184 x 267 mm; 7.25 x 10.5 inches)	✓		✓
U.S. Statement (140 x 216 mm; 5.5 x 8.5 inches)	✓		
B5 (JIS) (182 x 257 mm; 7.17 x 10.12 inches)*	✓		✓
A5 (148 x 210 mm; 5.8 x 8.3 inches)*	✓		
6 x 8 inches	✓		
Edge-to-Edge A4*	✓		✓
Edge-to-Edge Letter*	✓		✓
Envelopes			
U.S. #10 Envelope (105 x 241 mm; 4.12 x 9.5 inches)	✓		
Monarch Envelope (98 x 191 mm; 3.88 x 7.5 inches)	✓		
Card Envelope (111 x 152 mm; 4.4 x 6 inches)	✓		
A2 Envelope (111 x 146 mm; 4.37 x 5.75 inches)	✓		
DL Envelope (110 x 220 mm; 4.3 x 8.7 inches)	✓		
C5 Envelope (162 x 229 mm; 6.4 x 9 inches)	✓		
C6 Envelope (114 x 162 mm; 4.5 x 6.4 inches)	✓		
Japanese Envelope Chou #3 (120 x 235 mm; 4.7 x 9.3 inches)	✓		
Japanese Envelope Chou #4 (90 x 205 mm; 3.5 x 8.1 inches)	✓		
Cards			
Index card (76.2 x 127 mm; 3 x 5 inches)	✓		
Index card (102 x 152 mm; 4 x 6 inches)	✓		

(continued)

Media size	Tray 1	Tray 2	Duplexer
Index card (127 x 203 mm; 5 x 8 inches)	✓		
A6 card (105 x 148.5 mm; 4.13 x 5.83 inches)	✓		
A4 index card (210 x 297 mm; 8.3 x 11.7 inches)	✓		
Hagaki** (100 x 148 mm; 3.9 x 5.8 inches)	✓		
Ofuku Hagaki** (200 x 148 mm; 7.8 x 5.8 inches)	✓		
Index Card Letter (216 x 279 mm; 8.5 x 11 inches)	✓		
Photo media			
Photo media (76.2 x 127 mm; 3 x 5 inches)	✓		
Photo media (102 x 152 mm; 4 x 6 inches)	✓		
Photo media (5 x 7 inches)	✓		
Photo media (8 x 10 inches)	✓		
Photo media (8.5 x 11 inches)	✓		
Photo L (89 x 127 mm; 3.5 x 5 inches)	✓		
Photo 2L (127 x 178 mm)	✓		
13 x 18 cm*	✓		
Other media			
NOTE: Defining custom-sized media sizes in the HP printing software is only available in Mac OS X.			
Custom-sized media between 76.2 to 216 mm wide and 127 to 356 mm long (3 to 8.5 inches wide and 5 to 14 inches long)	✓		
Custom-sized media between 127 to 216 mm wide and 241 to 305 mm long (5 to 8.5 inches wide and 9.5 to 12 inches long)			

* These sizes can be used for borderless printing.

** The printer is compatible with plain and inkjet hagaki from Japan Post only. It is not compatible with photo hagaki from Japan Post.

Understand supported media types and weights

 **NOTE:** Tray 2 is available as an optional accessory.

Tray	Type	Weight	Capacity
Tray 1	Paper	60 to 105 g/m ² (16 to 28 lb bond)	Up to 250 sheets of plain paper (25 mm or 1 inch stacked)
	Photo media	280 g/m ² (75 lb bond)	Up to 100 sheets (17 mm or 0.67 inch stacked)
	Envelopes	75 to 90 g/m ² (20 to 24 lb bond envelope)	Up to 30 sheets (17 mm or 0.67 inch stacked)
	Cards	Up to 200 g/m ² (110 lb index)	Up to 80 cards
Tray 2	Plain paper only	60 to 105 g/m ² (16 to 28 lb bond)	Up to 250 sheets of plain paper (25 mm or 1.0 inch stacked)
Duplexer	Plain and brochure	60 to 105 g/m ² (16 to 28 lb bond)	Not applicable
Output tray	All supported media		Up to 150 sheets of plain paper (text printing)

Set minimum margins

The document margins must match (or exceed) these margin settings in portrait orientation.

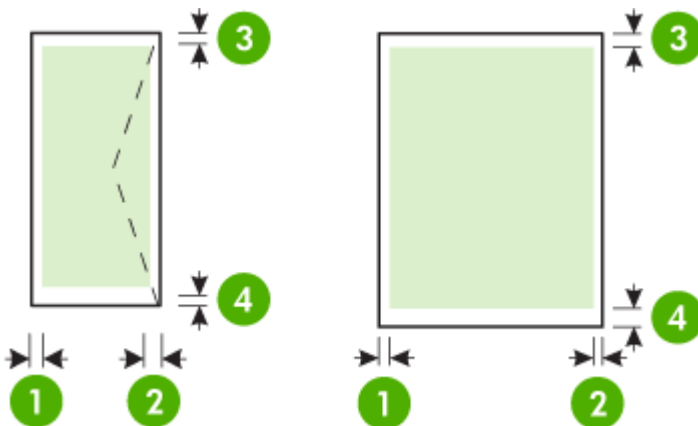

Media	(1) Left margin	(2) Right margin	(3) Top margin	(4) Bottom margin
U.S. Letter U.S. Legal A4 U.S. Executive U.S. Statement 8.5 x 13 inch B5 A5 Cards Custom-sized media Photo media	3.3 mm (0.13 inch)	3.3 mm (0.13 inch)	3.3 mm (0.13 inch)	3.3 mm (0.13 inch) Windows and 12mm (0.47 inch) Mac OS X and Linux
Envelopes	3.3 mm (0.13 inch)	3.3 mm (0.13 inch)	16.5 mm (0.65 inch)	16.5 mm (0.65 inch)

Guidelines for printing on both sides of a page

- Always use media that conforms to the printer specifications. For more information, see [Media specifications](#).
- Specify two-sided printing options in your application or in the printer driver.
- Do not print on both sides of envelopes, photo paper, glossy media, or paper lighter than 16 lb bond (60 g/m²) or heavier than 28 lb bond (105 g/m²). Jams might occur with these media types.
- Several kinds of media require a specific orientation when you print on both sides of a page. These include letterhead, preprinted paper, and paper with watermarks and prepunched holes. When you print from a computer running Windows, the printer prints the first side of the media first. Load the media with the print side facing down.
- For auto-duplexing, when printing finishes on one side of the media, the printer holds the media and pauses while the ink dries. Once the ink dries, the media is pulled back into the printer and the second side is printed. When printing is complete, the media is dropped onto the output tray. Do not grab it before printing is complete.
- You can print on both sides of supported custom-sized media by turning the media over and feeding it into the printer again. For more information, see [Media specifications](#).

Print specifications

- **Black print resolution**
600 x 600 dpi with pigmented black ink
 - **Color print resolution**
Up to 4800 x 1200 dpi Optimized on HP Advanced Photo Paper with 1200 x 1200 input dpi
- For more information, see [View print resolutions](#).

HP ePrint and HP website specifications

This section contains the following topics:

- [HP ePrint specifications](#)
- [HP website specifications](#)

HP ePrint specifications

- An Internet connection using either an Ethernet or wireless connection.
- Maximum size of email and attachments: 5 MB
- Maximum number of attachments: 10



NOTE: The printer's email address must be the only address listed in the "To" line of the email message.

- Supported file types:
 - PDF
 - HTML
 - Standard text file formats
 - Microsoft Word, PowerPoint
 - Image files, such as PNG, JPEG, TIFF, GIF, BMP



NOTE: You might be able to use other types of files with HP ePrint. However, HP cannot guarantee that the printer will print other types of files because they have not been fully tested.

HP website specifications

- A web browser (either Microsoft Internet Explorer 6.0 or higher, Mozilla Firefox 2.0 or higher, Safari 3.2.3 or higher, or Google Chrome 3.0) with the Adobe Flash plug-in (version 10 or higher).
- An Internet connection

Environmental specifications

Operating environment

Operating temperature: 5° to 40° C (41° to 104° F)

Operating humidity: 15 to 80% RH non-condensing

Recommended operating conditions: 15° to 32° C (59° to 90° F)

Recommended relative humidity: 20 to 80 % RH non-condensing

Shipping environment

Maximum shipping temperature: -40° to 60° C (-40° to 140° F)

Maximum shipping humidity: 5 to 90% RH non-condensing

Electrical specifications

Power supply

Universal power adapter (external)

Power requirements

Input voltage: 200 to 240 VAC (± 10%), 50/60 Hz (± 3 Hz)

Output voltage: 32 Vdc at 2000 mA

Power consumption

30 watts printing (Fast Draft Mode)

Acoustic emission specifications

Print in Draft mode, noise levels per ISO 7779

- Sound pressure (bystander position)
LpAm 57 (dBA) (mono Draft print)
- Sound power
LwAd 7.1 (BA)

Regulatory information

The printer meets product requirements from regulatory agencies in your country/region.

This section contains the following topics:

- [FCC statement](#)
- [Notice to users in Korea](#)
- [VCCI \(Class B\) compliance statement for users in Japan](#)
- [Notice to users in Japan about the power cord](#)
- [GS Declaration \(Germany\)](#)
- [Gloss of housing of peripheral devices for Germany](#)
- [European Union Regulatory Notice](#)
- [Regulatory information for wireless products](#)
- [Regulatory model number](#)

FCC statement

FCC statement

The United States Federal Communications Commission (in 47 CFR 15.105) has specified that the following notice be brought to the attention of users of this product.

This equipment has been tested and found to comply with the limits for a Class B digital device, pursuant to Part 15 of the FCC Rules. These limits are designed to provide reasonable protection against harmful interference in a residential installation. This equipment generates, uses and can radiate radio frequency energy and, if not installed and used in accordance with the instructions, may cause harmful interference to radio communications. However, there is no guarantee that interference will not occur in a particular installation. If this equipment does cause harmful interference to radio or television reception, which can be determined by turning the equipment off and on, the user is encouraged to try to correct the interference by one or more of the following measures:

- Reorient the receiving antenna.
- Increase the separation between the equipment and the receiver.
- Connect the equipment into an outlet on a circuit different from that to which the receiver is connected.
- Consult the dealer or an experienced radio/TV technician for help.

For further information, contact:

Manager of Corporate Product Regulations
Hewlett-Packard Company
3000 Hanover Street
Palo Alto, Ca 94304
(650) 857-1501

Modifications (part 15.21)

The FCC requires the user to be notified that any changes or modifications made to this device that are not expressly approved by HP may void the user's authority to operate the equipment.

This device complies with Part 15 of the FCC Rules. Operation is subject to the following two conditions: (1) this device may not cause harmful interference, and (2) this device must accept any interference received, including interference that may cause undesired operation.

Notice to users in Korea

B급 기기 (가정용 방송통신기기)	이 기기는 가정용(B급)으로 전자파적합등록을 한 기기로서 주로 가정에서 사용하는 것을 목적으로 하며, 모든 지역에서 사용할 수 있습니다.
-----------------------	--

VCCI (Class B) compliance statement for users in Japan

この装置は、クラスB情報技術装置です。この装置は、家庭環境で使用することを目的としていますが、この装置がラジオやテレビジョン受信機に近接して使用されると、受信障害を引き起こすことがあります。取扱説明書に従って正しい取り扱いをして下さい。

VCCI-B

Notice to users in Japan about the power cord

製品には、同梱された電源コードをお使い下さい。
同梱された電源コードは、他の製品では使用出来ません。

GS Declaration (Germany)

Geräuschemission
LpA < 70 dB am Arbeitsplatz im Normalbetrieb nach DIN 45635 T. 19

Gloss of housing of peripheral devices for Germany

Das Gerät ist nicht für die Benutzung im unmittelbaren Gesichtsfeld am Bildschirmarbeitsplatz vorgesehen. Um störende Reflexionen am Bildschirmarbeitsplatz zu vermeiden, darf dieses Produkt nicht im unmittelbaren Gesichtsfeld platziert werden.

European Union Regulatory Notice

Products bearing the CE marking comply with the following EU Directives:

- Low Voltage Directive 2006/95/EC
- EMC Directive 2004/108/EC
- Ecodesign Directive 2009/125/EC, where applicable



CE compliance of this product is valid only if powered with the correct CE-marked AC adapter provided by HP.

If this product has telecommunications functionality, it also complies with the essential requirements of the following EU Directive:

R&TTE Directive 1999/5/EC

Compliance with these directives implies conformity to applicable harmonized European standards (European Norms) that are listed in the EU Declaration of Conformity issued by HP for this product or product family and available (in English only) either within the product documentation or at the following web site: www.hp.com/go/certificates (type the product number in the search field).

The compliance is indicated by one of the following conformity markings placed on the product:

	For non-telecommunications products and for EU harmonized telecommunications products, such as Bluetooth® within power class below 10mW.
	For EU non-harmonized telecommunications products (If applicable, a 4-digit notified body number is inserted between CE and !).

Please refer to the regulatory label provided on the product.

The telecommunications functionality of this product may be used in the following EU and EFTA countries: Austria, Belgium, Bulgaria, Cyprus, Czech Republic, Denmark, Estonia, Finland, France, Germany, Greece, Hungary, Iceland, Ireland, Italy, Latvia, Liechtenstein, Lithuania, Luxembourg, Malta, Netherlands, Norway, Poland, Portugal, Romania, Slovak Republic, Slovenia, Spain, Sweden, Switzerland, and United Kingdom.

The telephone connector (not available for all products) is intended for connection to analogue telephone networks.

Products with wireless LAN devices

Some countries may have specific obligations or special requirements about the operation of Wireless LAN networks such as indoor use only or restrictions of the channels available. Please make sure that the country settings of the wireless network are correct.

France

For 2.4-GHz Wireless LAN operation of this product, certain restrictions apply: This product may be used indoors for the entire 2400-MHz to 2483.5-MHz frequency band (channels 1 to 13). For outdoor use, only the 2400-MHz to 2454-MHz frequency band (channels 1 to 7) may be used. For the latest requirements, see www.arcep.fr.

The point of contact for regulatory matters is:

Hewlett-Packard GmbH, Dept./MS: HQ-TRE, Herrenberger Strasse 140, 71034 Boeblingen, GERMANY

Regulatory information for wireless products

This section contains the following regulatory information pertaining to wireless products:

- [Exposure to radio frequency radiation](#)
- [Notice to users in Brazil](#)
- [Notice to users in Canada](#)
- [Notice to users in Taiwan](#)

Exposure to radio frequency radiation

Exposure to radio frequency radiation



Caution The radiated output power of this device is far below the FCC radio frequency exposure limits. Nevertheless, the device shall be used in such a manner that the potential for human contact during normal operation is minimized. This product and any attached external antenna, if supported, shall be placed in such a manner to minimize the potential for human contact during normal operation. In order to avoid the possibility of exceeding the FCC radio frequency exposure limits, human proximity to the antenna shall not be less than 20 cm (8 inches) during normal operation.

Notice to users in Brazil

Aviso aos usuários no Brasil

Este equipamento opera em caráter secundário, isto é, não tem direito à proteção contra interferência prejudicial, mesmo de estações do mesmo tipo, e não pode causar interferência a sistemas operando em caráter primário. (Res.ANATEL 282/2001).

Notice to users in Canada

Notice to users in Canada/Note à l'attention des utilisateurs canadiens

For Indoor Use. This digital apparatus does not exceed the Class B limits for radio noise emissions from the digital apparatus set out in the Radio Interference Regulations of the Canadian Department of Communications. The internal wireless radio complies with RSS 210 and RSS GEN of Industry Canada.

Utiliser à l'intérieur. Le présent appareil numérique n'émet pas de bruit radioélectrique dépassant les limites applicables aux appareils numériques de la classe B prescrites dans le Règlement sur le brouillage radioélectrique édicté par le ministère des Communications du Canada. Le composant RF interne est conforme à la norme RSS-210 and RSS GEN d'Industrie Canada.

Notice to users in Taiwan

低功率電波輻射性電機管理辦法

第十二條

經型式認證合格之低功率射頻電機，非經許可，公司、商號或使用者均不得擅自變更頻率、加大功率或變更設計之特性及功能。

第十四條

低功率射頻電機之使用不得影響飛航安全及干擾合法通信；經發現有干擾現象時，應立即停用，並改善至無干擾時方得繼續使用。

前項合法通信，指依電信法規定作業之無線電通信。低功率射頻電機須忍受合法通信或工業、科學及醫藥用電波輻射性電機設備之干擾。

Regulatory model number

For regulatory identification purposes, your product is assigned a Regulatory Model Number. The Regulatory Model Number for your product is VCVRA-1101. This regulatory number should not be confused with the marketing name (HP Officejet Pro 8100 ePrinter) or product number.

Environmental product stewardship program

Hewlett-Packard is committed to providing quality products in an environmentally sound manner. Design for recycling has been incorporated into this product. The number of materials has been kept to a minimum while ensuring proper functionality and reliability. Dissimilar materials have been designed to separate easily. Fasteners and other connections are easy to locate, access, and remove using common tools. High priority parts have been designed to access quickly for efficient disassembly and repair.

For more information, visit HP's Commitment to the Environment website at:

www.hp.com/hpinfo/globalcitizenship/environment/index.html

This section contains the following topics:

- [Paper use](#)
- [Plastics](#)
- [Material safety data sheets](#)
- [Recycling program](#)
- [HP inkjet supplies recycling program](#)
- [Disposal of waste equipment by users in private households in the European Union](#)
- [Power consumption](#)
- [Chemical Substances](#)
- [Battery information](#)
- [EU battery directive](#)
- [RoHS notices \(China only\)](#)
- [RoHS notices \(Ukraine only\)](#)

Paper use

This product is suited for the use of recycled paper according to DIN 19309 and EN 12281:2002.

Plastics

Plastic parts over 25 grams are marked according to international standards that enhance the ability to identify plastics for recycling purposes at the end of product life.

Material safety data sheets

Material safety data sheets (MSDS) can be obtained from the HP website at:

www.hp.com/go/msds

Recycling program

HP offers an increasing number of product return and recycling programs in many countries/regions, and partners with some of the largest electronic recycling centers throughout the world. HP conserves resources by reselling some of its most popular products. For more information regarding recycling of HP products, please visit:

www.hp.com/hpinfo/globalcitizenship/environment/recycle/

HP inkjet supplies recycling program

HP is committed to protecting the environment. The HP Inkjet Supplies Recycling Program is available in many countries/regions, and lets you recycle used print cartridges and ink cartridges free of charge. For more information, go to the following website:

www.hp.com/hpinfo/globalcitizenship/environment/recycle/

Power consumption

Hewlett-Packard printing and imaging equipment marked with the ENERGY STAR® logo is qualified to the U.S. Environmental Protection Agency's ENERGY STAR specifications for imaging equipment. The following mark appears on ENERGY STAR qualified imaging products:



ENERGY STAR is a U.S. registered service mark of the U.S. EPA. As an ENERGY STAR partner, HP has determined that this product meets ENERGY STAR guidelines for energy efficiency.

Additional ENERGY STAR qualified imaging product model information is listed at: www.hp.com/go/energystar

Chemical Substances

HP is committed to providing our customers with information about the chemical substances in our products as needed to comply with legal requirements such as REACH (*Regulation EC No 1907/2006 of the European Parliament and the Council*). A chemical information report for this product can be found at: www.hp.com/go/reach

Battery information

The printer has internal batteries that are used to maintain printer settings when the printer is turned off. These batteries might require special handling and disposal.

This section contains the following topics:

- [Battery disposal in Taiwan](#)
- [Attention California users](#)
- [Battery disposal in Netherlands](#)

Battery disposal in Taiwan

	<p>廢電池請回收</p> <p>Please recycle waste batteries.</p>
---	--

Attention California users

The battery supplied with this product may contain perchlorate material. Special handling may apply. For more information, go to the following website: www.dtsc.ca.gov/hazardouswaste/perchlorate.

Battery disposal in Netherlands

	<p>Dit HP Product bevat een lithium-manganees-dioxide batterij. Deze bevindt zich op de hoofdprintplaat. Wanneer deze batterij leeg is, moet deze volgens de geldende regels worden afgevoerd.</p>
---	--

EU battery directive



English	European Union Battery Directive This product contains a battery that is used to maintain data integrity of real time clock or product settings and is designed to last the life of the product. Any attempt to service or replace this battery should be performed by a qualified service technician.
Français	Directive sur les batteries de l'Union Européenne Ce produit contient une batterie qui permet de maintenir l'intégrité des données pour les paramètres du produit ou l'horloge en temps réel et qui a été conçue pour durer aussi longtemps que le produit. Toute tentative de réparation ou de remplacement de cette batterie doit être effectuée par un technicien qualifié.
Deutsch	Batterie-Richtlinie der Europäischen Union Dieses Produkt enthält eine Batterie, die dazu dient, die Datenintegrität der Echtzeituhr sowie der Produkteinstellungen zu erhalten, und die für die Lebensdauer des Produkts ausreicht. Im Bedarfsfall sollte das Instandhalten bzw. Austauschen der Batterie von einem qualifizierten Servicetechniker durchgeführt werden.
Italiano	Direttiva dell'Unione Europea relativa alla raccolta, al trattamento e allo smaltimento di batterie e accumulatori Questo prodotto contiene una batteria utilizzata per preservare l'integrità dei dati dell'orologio in tempo reale o delle impostazioni del prodotto e la sua durata si intende pari a quella del prodotto. Eventuali interventi di riparazione o sostituzione della batteria devono essere eseguiti da un tecnico dell'assistenza qualificato.
Español	Directiva sobre baterías de la Unión Europea Este producto contiene una batería que se utiliza para conservar la integridad de los datos del reloj de tiempo real o la configuración del producto y está diseñada para durar toda la vida útil del producto. El mantenimiento o la sustitución de dicha batería deberá realizarla un técnico de mantenimiento cualificado.
Česky	Směrnice Evropské unie pro nakládání s bateriemi Tento výrobek obsahuje baterii, která slouží k uchování správných dat hodin reálného času nebo nastavení výrobku. Baterie je navržena tak, aby vydržela celou životnost výrobku. Jakýkoliv pokus o opravu nebo výměnu baterie by měl provést kvalifikovaný servisní technik.
Dansk	EU's batteridirektiv Produktet indeholder et batteri, som bruges til at vedligeholde dataintegriteten for realtidsur- eller produktindstillinger og er beregnet til at holde i hele produktets levetid. Service på batteriet eller udskiftning bør foretages af en uddannet servicetekniker.
Nederlands	Richtlijn batterijen voor de Europese Unie Dit product bevat een batterij die wordt gebruikt voor een juiste tijdsaanduiding van de klok en het behoud van de productinstellingen. Bovendien is deze ontworpen om gedurende de levensduur van het product mee te gaan. Het onderhoud of de vervanging van deze batterij moet door een gekwalificeerde onderhoudstechnicus worden uitgevoerd.
Eesti	Euroopa Liidu aku direktiiv Toode sisaldab akut, mida kasutatakse reaajaja kella andmeihtsuse või toote sätete säilitamiseks. Aku on valmistatud kesma terve toote kasutajaja. Akut hoib hooldada või vahetada ainult kvalifitseeritud hooldustehnik.
Suomi	Euroopan unionin paristodirektiivi Tämä laite sisältää pariston, jota käytetään reaaliaikaisen kellon tietojen ja laitteen asetusten säilyttämiseen. Pariston on suunniteltu kestävänsä laitteen koko käyttöajan ajan. Pariston mahdollinen korjaus tai vaihto on jätettävä pätevänsä huoltohenkilön tehtäväks.
Ελληνικά	Οδηγία της Ευρωπαϊκής Ένωσης για τις ηλεκτρικές σήτες Αυτό το προϊόν περιλαμβάνει μια μπαταρία, η οποία χρησιμοποιείται για τη διατήρηση της ακεραιότητας των δεδομένων ρολογιού πραγματικού χρόνου ή των ρυθμίσεων προϊόντος και έχει σχεδιαστεί έτσι ώστε να διαρκεί όσο και το προϊόν. Τυχόν απόπειρες επίρρωθης ή αντικατάστασης αυτής της μπαταρίας θα πρέπει να πραγματοποιούνται από κατάλληλα εκπαιδευμένο τεχνικό.
Magyar	Az Európai unió telepek és akkumulátorok direktívája A termék tartalmaz egy elemet, melynek feladata az, hogy biztosítsa a valós idejű óra vagy a termék beállításainak adatintegritását. Az elem úgy van tervezve, hogy végig kitartson a termék használatá során. Az elem bármilyen javítását vagy cseréjét csak képzett szakember végezheti el.
Latvian	Eiropas Savienības Bateriju direktīva Produktam ir baterija, ko izmanto reāla laika pulksteņa vai produkta iestatījumu datu integritātes saglabāšanai, un tā ir paredzēta visam produkta dzīves ciklam. Jebkura arkope vai baterijas nomaiņa ir jāveic atbilstoši kvalificētam darbiniekam.
Lietuviškai	Eiropos Sąjungos baterijų ir akumuliatorių direktyva Šiame gaminyje yra baterija, kuri naudojama, kad būtų galima prižiūrėti realaus laiko laikrodžio veikimą arba gaminio nuostatas; ji skirta veikti visą gaminio eksploatavimo laiką. Bet kokius šios baterijos aptarnavimo arba keitimo darbus turi atlikti kvalifikuotas aptarnavimo technikas.
Polski	Dyrektywa Unii Europejskiej w sprawie baterii i akumulatorów Produkt zawiera baterię wykorzystywaną do zachowania integralności danych zegara czasu rzeczywistego lub ustawień produktu, która podtrzymuje działanie produktu. Przejąd lub wymiana baterii powinny być wykonywane wyłącznie przez uprawnionego technika serwisu.
Português	Directiva sobre baterias da União Europeia Este produto contém uma bateria que é usada para manter a integridade dos dados do relógio em tempo real ou das configurações do produto e é projetada para ter a mesma duração que este. Qualquer tentativa de consertar ou substituir essa bateria deve ser realizada por um técnico qualificado.
Slovenščina	Smernica Evropskej unie pre zaobchádzanie s batériami Tento výrobok obsahuje batériu, ktorá slúži na uchovanie správnych údajov hodin reálneho času alebo nastavení výrobku. Batéria je skonštruovaná tak, aby vydržala celú životnosť výrobku. Akýkoľvek pokus o opravu alebo výmenu batérie by mal vykonať kvalifikovaný servisný technik.
Slovenščina	Directiva Evropske unije o baterijah in akumulatorjih V tem izdelku je baterija, ki zagotavlja natančnost podatkov ure v realnem času ali nastavitev izdelka v celotni življenjski dobi izdelka. Kakršno koli popravilo ali zamenjava te baterije lahko izvede le pooblaščen tehnik.
Svenska	EU:s batteridirektiv Produkten innehåller ett batteri som används för att upprätthålla data i realtidsklockan och produktinställningarna. Batteriet ska räkna produktens hela livslängd. Endast kvalificerade servicetekniker får utföra service på batteriet och byta ut det.
Български	Директива за батерии на Европейския съюз Този продукт съдържа батерия, която се използва за поддържане на целостта на данните на часовника в реално време или настройките за продукта, създадена на издръж през целия живот на продукта. Сервизът или замяната на батерията трябва да се извършва от квалифициран техник.
Română	Directiva Uniunii Europene referitoare la baterii Acest produs conține o baterie care este utilizată pentru a menține integritatea datelor ceasului de timp real sau setărilor produsului și care este proiectată să funcționeze pe întreaga durată de viață a produsului. Orice lucrare de service sau de înlocuire a acestei baterii trebuie efectuată de un tehnician de service calificat.

RoHS notices (China only)

Toxic and hazardous substance table

有毒有害物质表						
根据中国《电子信息产品污染控制管理办法》						
零件描述	有毒有害物质和元素					
	铅	汞	镉	六价铬	多溴联苯	多溴联苯醚
外壳和托盘*	0	0	0	0	0	0
电线*	0	0	0	0	0	0
印刷电路板*	X	0	0	0	0	0
打印系统*	X	0	0	0	0	0
显示器*	X	0	0	0	0	0
喷墨打印机墨盒*	0	0	0	0	0	0
驱动光盘*	X	0	0	0	0	0
扫描仪*	X	X	0	0	0	0
网络配件*	X	0	0	0	0	0
电池板*	X	0	0	0	0	0
自动双面打印系统*	0	0	0	0	0	0
外部电源*	X	0	0	0	0	0

0: 指此部件的所有均一材质中包含的这种有毒有害物质, 含量低于SJ/T11363-2006 的限制
X: 指此部件使用的均一材质中至少有一种包含的这种有毒有害物质, 含量高于SJ/T11363-2006 的限制
注: 环保使用期限的参考标识取决于产品正常工作的温度和湿度等条件
*以上只适用于使用这些部件的产品

RoHS notices (Ukraine only)

Обладнання відповідає вимогам Технічного регламенту щодо обмеження використання деяких небезпечних речовин в електричному та електронному обладнанні, затвердженого постановою Кабінету Міністрів України від 3 грудня 2008 № 1057

Third-party licenses

LICENSE.aes-pubdom--crypto

/* rijndael-alg-fst.c

*

* @version 3.0 (December 2000)

*

* Optimised ANSI C code for the Rijndael cipher (now AES)

*

* @author Vincent Rijmen <vincent.rijmen@esat.kuleuven.ac.be>

* @author Antoon Bosselaers <antoon.bosselaers@esat.kuleuven.ac.be>

* @author Paulo Barreto <paulo.barreto@terra.com.br>

*

* This code is hereby placed in the public domain.

*

* THIS SOFTWARE IS PROVIDED BY THE AUTHORS "AS IS" AND ANY EXPRESS

* OR IMPLIED WARRANTIES, INCLUDING, BUT NOT LIMITED TO, THE IMPLIED

* WARRANTIES OF MERCHANTABILITY AND FITNESS FOR A PARTICULAR PURPOSE

* ARE DISCLAIMED. IN NO EVENT SHALL THE AUTHORS OR CONTRIBUTORS BE

* LIABLE FOR ANY DIRECT, INDIRECT, INCIDENTAL, SPECIAL, EXEMPLARY, OR

* CONSEQUENTIAL DAMAGES (INCLUDING, BUT NOT LIMITED TO, PROCUREMENT OF

* SUBSTITUTE GOODS OR SERVICES; LOSS OF USE, DATA, OR PROFITS; OR

* BUSINESS INTERRUPTION) HOWEVER CAUSED AND ON ANY THEORY OF LIABILITY,

* WHETHER IN CONTRACT, STRICT LIABILITY, OR TORT (INCLUDING NEGLIGENCE

* OR OTHERWISE) ARISING IN ANY WAY OUT OF THE USE OF THIS SOFTWARE,

* EVEN IF ADVISED OF THE POSSIBILITY OF SUCH DAMAGE.

*/

LICENSE.expat-mit--expat

Copyright (c) 1998, 1999, 2000 Thai Open Source Software Center Ltd

Permission is hereby granted, free of charge, to any person obtaining a copy of this software and associated documentation files (the "Software"), to deal in the Software without restriction, including without limitation the rights to use, copy, modify, merge, publish, distribute, sublicense, and/or sell copies of the Software, and to permit persons to whom the Software is furnished to do so, subject to the following conditions:

The above copyright notice and this permission notice shall be included in all copies or substantial portions of the Software.

THE SOFTWARE IS PROVIDED "AS IS", WITHOUT WARRANTY OF ANY KIND, EXPRESS OR IMPLIED, INCLUDING BUT NOT LIMITED TO THE WARRANTIES OF MERCHANTABILITY, FITNESS FOR A PARTICULAR PURPOSE AND NONINFRINGEMENT. IN NO EVENT SHALL THE AUTHORS OR COPYRIGHT HOLDERS BE LIABLE FOR ANY CLAIM, DAMAGES OR OTHER LIABILITY, WHETHER IN AN ACTION OF CONTRACT, TORT OR OTHERWISE, ARISING FROM, OUT OF OR IN CONNECTION WITH THE SOFTWARE OR THE USE OR OTHER DEALINGS IN THE SOFTWARE.

LICENSE.hmac-sha2-bsd--nos_crypto

/* HMAC-SHA-224/256/384/512 implementation

* Last update: 06/15/2005

* Issue date: 06/15/2005

*

* Copyright (C) 2005 Olivier Gay <olivier.gay@a3.epfl.ch>

* All rights reserved.

*

* Redistribution and use in source and binary forms, with or without

* modification, are permitted provided that the following conditions

* are met:

* 1. Redistributions of source code must retain the above copyright

* notice, this list of conditions and the following disclaimer.

* 2. Redistributions in binary form must reproduce the above copyright

* notice, this list of conditions and the following disclaimer in the

* documentation and/or other materials provided with the distribution.

* 3. Neither the name of the project nor the names of its contributors

* may be used to endorse or promote products derived from this software

* without specific prior written permission.

*

* THIS SOFTWARE IS PROVIDED BY THE PROJECT AND CONTRIBUTORS ``AS IS" AND

* ANY EXPRESS OR IMPLIED WARRANTIES, INCLUDING, BUT NOT LIMITED TO, THE

* IMPLIED WARRANTIES OF MERCHANTABILITY AND FITNESS FOR A PARTICULAR PURPOSE

* ARE DISCLAIMED. IN NO EVENT SHALL THE PROJECT OR CONTRIBUTORS BE LIABLE

* FOR ANY DIRECT, INDIRECT, INCIDENTAL, SPECIAL, EXEMPLARY, OR CONSEQUENTIAL

* DAMAGES (INCLUDING, BUT NOT LIMITED TO, PROCUREMENT OF SUBSTITUTE GOODS OR SERVICES; LOSS OF USE, DATA, OR PROFITS; OR BUSINESS INTERRUPTION)

* HOWEVER CAUSED AND ON ANY THEORY OF LIABILITY, WHETHER IN CONTRACT, STRICT

* LIABILITY, OR TORT (INCLUDING NEGLIGENCE OR OTHERWISE) ARISING IN ANY WAY

* OUT OF THE USE OF THIS SOFTWARE, EVEN IF ADVISED OF THE POSSIBILITY OF

* SUCH DAMAGE.

*/

LICENSE.open_ssl--open_ssl

Copyright (C) 1995-1998 Eric Young (eay@cryptsoft.com)

All rights reserved.

This package is an SSL implementation written
by Eric Young (eay@cryptsoft.com).

The implementation was written so as to conform with Netscapes SSL.

This library is free for commercial and non-commercial use as long as
the following conditions are aheared to. The following conditions
apply to all code found in this distribution, be it the RC4, RSA,
lhash, DES, etc., code; not just the SSL code. The SSL documentation
included with this distribution is covered by the same copyright terms
except that the holder is Tim Hudson (tjh@cryptsoft.com).

Copyright remains Eric Young's, and as such any Copyright notices in
the code are not to be removed.

If this package is used in a product, Eric Young should be given attribution
as the author of the parts of the library used.

This can be in the form of a textual message at program startup or
in documentation (online or textual) provided with the package.

Redistribution and use in source and binary forms, with or without
modification, are permitted provided that the following conditions
are met:

1. Redistributions of source code must retain the copyright
notice, this list of conditions and the following disclaimer.
2. Redistributions in binary form must reproduce the above copyright
notice, this list of conditions and the following disclaimer in the
documentation and/or other materials provided with the distribution.
3. All advertising materials mentioning features or use of this software
must display the following acknowledgement:

"This product includes cryptographic software written by
Eric Young (eay@cryptsoft.com)"

The word 'cryptographic' can be left out if the rouines from the library
being used are not cryptographic related :-).

4. If you include any Windows specific code (or a derivative thereof) from
the apps directory (application code) you must include an acknowledgement:
"This product includes software written by Tim Hudson (tjh@cryptsoft.com)"

THIS SOFTWARE IS PROVIDED BY ERIC YOUNG ``AS IS" AND
ANY EXPRESS OR IMPLIED WARRANTIES, INCLUDING, BUT NOT LIMITED TO, THE
IMPLIED WARRANTIES OF MERCHANTABILITY AND FITNESS FOR A PARTICULAR
PURPOSE

ARE DISCLAIMED. IN NO EVENT SHALL THE AUTHOR OR CONTRIBUTORS BE LIABLE
FOR ANY DIRECT, INDIRECT, INCIDENTAL, SPECIAL, EXEMPLARY, OR CONSEQUENTIAL
DAMAGES (INCLUDING, BUT NOT LIMITED TO, PROCUREMENT OF SUBSTITUTE GOODS
OR SERVICES; LOSS OF USE, DATA, OR PROFITS; OR BUSINESS INTERRUPTION)

HOWEVER CAUSED AND ON ANY THEORY OF LIABILITY, WHETHER IN CONTRACT, STRICT LIABILITY, OR TORT (INCLUDING NEGLIGENCE OR OTHERWISE) ARISING IN ANY WAY OUT OF THE USE OF THIS SOFTWARE, EVEN IF ADVISED OF THE POSSIBILITY OF SUCH DAMAGE.

The licence and distribution terms for any publically available version or derivative of this code cannot be changed. i.e. this code cannot simply be copied and put under another distribution licence [including the GNU Public Licence.]

=====
Copyright (c) 1998-2001 The OpenSSL Project. All rights reserved.

Redistribution and use in source and binary forms, with or without modification, are permitted provided that the following conditions are met:

1. Redistributions of source code must retain the above copyright notice, this list of conditions and the following disclaimer.
2. Redistributions in binary form must reproduce the above copyright notice, this list of conditions and the following disclaimer in the documentation and/or other materials provided with the distribution.
3. All advertising materials mentioning features or use of this software must display the following acknowledgment:
"This product includes software developed by the OpenSSL Project for use in the OpenSSL Toolkit. (<http://www.openssl.org/>)"
4. The names "OpenSSL Toolkit" and "OpenSSL Project" must not be used to endorse or promote products derived from this software without prior written permission. For written permission, please contact openssl-core@openssl.org.
5. Products derived from this software may not be called "OpenSSL" nor may "OpenSSL" appear in their names without prior written permission of the OpenSSL Project.
6. Redistributions of any form whatsoever must retain the following acknowledgment:
"This product includes software developed by the OpenSSL Project for use in the OpenSSL Toolkit (<http://www.openssl.org/>)"

THIS SOFTWARE IS PROVIDED BY THE OpenSSL PROJECT ``AS IS'' AND ANY

EXPRESSED OR IMPLIED WARRANTIES, INCLUDING, BUT NOT LIMITED TO, THE IMPLIED WARRANTIES OF MERCHANTABILITY AND FITNESS FOR A PARTICULAR PURPOSE ARE DISCLAIMED. IN NO EVENT SHALL THE OpenSSL PROJECT OR ITS CONTRIBUTORS BE LIABLE FOR ANY DIRECT, INDIRECT, INCIDENTAL, SPECIAL, EXEMPLARY, OR CONSEQUENTIAL DAMAGES (INCLUDING, BUT NOT LIMITED TO, PROCUREMENT OF SUBSTITUTE GOODS OR SERVICES; LOSS OF USE, DATA, OR PROFITS; OR BUSINESS INTERRUPTION) HOWEVER CAUSED AND ON ANY THEORY OF LIABILITY, WHETHER IN CONTRACT, STRICT LIABILITY, OR TORT (INCLUDING NEGLIGENCE OR OTHERWISE) ARISING IN ANY WAY OUT OF THE USE OF THIS SOFTWARE, EVEN IF ADVISED OF THE POSSIBILITY OF SUCH DAMAGE.

=====

This product includes cryptographic software written by Eric Young (eay@cryptsoft.com). This product includes software written by Tim Hudson (tjh@cryptsoft.com).

=====

Copyright (c) 1998-2006 The OpenSSL Project. All rights reserved.

Redistribution and use in source and binary forms, with or without modification, are permitted provided that the following conditions are met:

1. Redistributions of source code must retain the above copyright notice, this list of conditions and the following disclaimer.
2. Redistributions in binary form must reproduce the above copyright notice, this list of conditions and the following disclaimer in the documentation and/or other materials provided with the distribution.
3. All advertising materials mentioning features or use of this software must display the following acknowledgment:
"This product includes software developed by the OpenSSL Project for use in the OpenSSL Toolkit. (<http://www.openssl.org/>)"
4. The names "OpenSSL Toolkit" and "OpenSSL Project" must not be used to endorse or promote products derived from this software without prior written permission. For written permission, please contact openssl-core@openssl.org.
5. Products derived from this software may not be called "OpenSSL" nor may "OpenSSL" appear in their names without prior written permission of the OpenSSL Project.

6. Redistributions of any form whatsoever must retain the following acknowledgment:

"This product includes software developed by the OpenSSL Project for use in the OpenSSL Toolkit (<http://www.openssl.org/>)"

THIS SOFTWARE IS PROVIDED BY THE OpenSSL PROJECT ``AS IS" AND ANY EXPRESSED OR IMPLIED WARRANTIES, INCLUDING, BUT NOT LIMITED TO, THE IMPLIED WARRANTIES OF MERCHANTABILITY AND FITNESS FOR A PARTICULAR PURPOSE ARE DISCLAIMED. IN NO EVENT SHALL THE OpenSSL PROJECT OR ITS CONTRIBUTORS BE LIABLE FOR ANY DIRECT, INDIRECT, INCIDENTAL, SPECIAL, EXEMPLARY, OR CONSEQUENTIAL DAMAGES (INCLUDING, BUT NOT LIMITED TO, PROCUREMENT OF SUBSTITUTE GOODS OR SERVICES; LOSS OF USE, DATA, OR PROFITS; OR BUSINESS INTERRUPTION) HOWEVER CAUSED AND ON ANY THEORY OF LIABILITY, WHETHER IN CONTRACT, STRICT LIABILITY, OR TORT (INCLUDING NEGLIGENCE OR OTHERWISE) ARISING IN ANY WAY OUT OF THE USE OF THIS SOFTWARE, EVEN IF ADVISED OF THE POSSIBILITY OF SUCH DAMAGE.

=====

This product includes cryptographic software written by Eric Young (eay@cryptsoft.com). This product includes software written by Tim Hudson (tjh@cryptsoft.com).

=====

Copyright 2002 Sun Microsystems, Inc. ALL RIGHTS RESERVED.
ECC cipher suite support in OpenSSL originally developed by SUN MICROSYSTEMS, INC., and contributed to the OpenSSL project.

LICENSE.sha2-bsd--nos_crypto

/* FIPS 180-2 SHA-224/256/384/512 implementation
* Last update: 02/02/2007
* Issue date: 04/30/2005
*
* Copyright (C) 2005, 2007 Olivier Gay <olivier.gay@a3.epfl.ch>
* All rights reserved.
*
* Redistribution and use in source and binary forms, with or without
* modification, are permitted provided that the following conditions
* are met:
* 1. Redistributions of source code must retain the above copyright
* notice, this list of conditions and the following disclaimer.
* 2. Redistributions in binary form must reproduce the above copyright

* notice, this list of conditions and the following disclaimer in the
 * documentation and/or other materials provided with the distribution.
 * 3. Neither the name of the project nor the names of its contributors
 * may be used to endorse or promote products derived from this software
 * without specific prior written permission.
 *
 * THIS SOFTWARE IS PROVIDED BY THE PROJECT AND CONTRIBUTORS ``AS IS" AND
 * ANY EXPRESS OR IMPLIED WARRANTIES, INCLUDING, BUT NOT LIMITED TO, THE
 * IMPLIED WARRANTIES OF MERCHANTABILITY AND FITNESS FOR A PARTICULAR
 * PURPOSE
 * ARE DISCLAIMED. IN NO EVENT SHALL THE PROJECT OR CONTRIBUTORS BE LIABLE
 * FOR ANY DIRECT, INDIRECT, INCIDENTAL, SPECIAL, EXEMPLARY, OR
 * CONSEQUENTIAL
 * DAMAGES (INCLUDING, BUT NOT LIMITED TO, PROCUREMENT OF SUBSTITUTE
 * GOODS
 * OR SERVICES; LOSS OF USE, DATA, OR PROFITS; OR BUSINESS INTERRUPTION)
 * HOWEVER CAUSED AND ON ANY THEORY OF LIABILITY, WHETHER IN CONTRACT,
 * STRICT
 * LIABILITY, OR TORT (INCLUDING NEGLIGENCE OR OTHERWISE) ARISING IN ANY WAY
 * OUT OF THE USE OF THIS SOFTWARE, EVEN IF ADVISED OF THE POSSIBILITY OF
 * SUCH DAMAGE.
 */

LICENSE.zlib--zlib

 zlib.h -- interface of the 'zlib' general purpose compression library
 version 1.2.3, July 18th, 2005

Copyright (C) 1995-2005 Jean-loup Gailly and Mark Adler

This software is provided 'as-is', without any express or implied
 warranty. In no event will the authors be held liable for any damages
 arising from the use of this software.

Permission is granted to anyone to use this software for any purpose,
 including commercial applications, and to alter it and redistribute it
 freely, subject to the following restrictions:

1. The origin of this software must not be misrepresented; you must not
 claim that you wrote the original software. If you use this software
 in a product, an acknowledgment in the product documentation would be
 appreciated but is not required.
2. Altered source versions must be plainly marked as such, and must not be
 misrepresented as being the original software.
3. This notice may not be removed or altered from any source distribution.

Jean-loup Gailly Mark Adler

`jloup@gzip.org madler@alumni.caltech.edu`

The data format used by the zlib library is described by RFCs (Request for Comments) 1950 to 1952 in the files <http://www.ietf.org/rfc/rfc1950.txt> (zlib format), [rfc1951.txt](#) (deflate format) and [rfc1952.txt](#) (gzip format).

B HP supplies and accessories

This section provides information on HP supplies and accessories for the printer. The information is subject to changes, visit the HP website (www.hpshopping.com) for the latest updates. You may also make purchases through the website.

 **NOTE:** Not all cartridges are available in all countries/regions.

This section contains the following topics:

- [Order printing supplies online](#)
- [Supplies](#)

Order printing supplies online

To order supplies online or create a printable shopping list, open the HP software that came with your printer and click **Shopping**. Select **Shop for Supplies Online**. The HP software uploads, with your permission, printer information, including model number, serial number, and estimated ink levels. The HP supplies that work in your printer are pre-selected. You can change quantities, add or remove items, and then print the list or purchase online at the HP Store or other online retailers (options differ by country/region). Cartridge information and links to online shopping also appear on low on ink messages.

You can also order online by visiting www.hp.com/buy/supplies. If prompted, select your country/region, follow the prompts to select your printer, and then the supplies you need.

 **NOTE:** Ordering cartridges online is not supported in all countries/regions. However, many countries have information on ordering by telephone, locating a local store and printing a shopping list. In addition, you can select the 'How to Buy' option at the top of the www.hp.com/buy/supplies page to obtain information about purchasing HP products in your country.

Supplies

- [Ink cartridges and printheads](#)
- [HP media](#)

Ink cartridges and printheads

Ordering cartridges online is not supported in all countries/regions. However, many countries have information on ordering by telephone, locating a local store and printing a shopping list. In addition, you can select the 'How to Buy' option at the top of the www.hp.com/buy/supplies page to obtain information about purchasing HP products in your country.

Use only the replacement cartridges that have the same cartridge number as the ink cartridge you are replacing. You can find the cartridge number in the following places:

- In the embedded web server, by clicking the **Tools** tab, and then, under **Product Information** clicking **Ink Gauge**. For more information, see [Embedded web server](#).
- On the printer status page (see [Understand the printer status report](#)).
- On the label of the ink cartridge you are replacing.
- On a sticker inside the printer.

 **CAUTION:** The **Setup** ink cartridge that comes with the printer is not available for separate purchase. Check for the correct cartridge number through the EWS, on the printer status report, or on the sticker inside the printer.



NOTE: Ink level warnings and indicators provide estimates for planning purposes only. When you receive a low on ink message, consider having a replacement cartridge available to avoid possible printing delays. You do not need to replace cartridges until prompted to do so.

HP media

To order media such as HP Premium Paper, go to www.hp.com.



HP recommends plain papers with the ColorLok logo for printing of everyday documents. All papers with the ColorLok logo are independently tested to meet high standards of reliability and print quality, and produce documents with crisp, vivid color, bolder blacks, and that dry faster than ordinary plain papers. Look for papers with the ColorLok logo in a variety of weights and sizes from major paper manufacturers.

C Network setup

You can manage network settings for the printer through the printer control panel as described in the next section. Additional advanced settings are available in the embedded web server, a configuration and status tool you access from your web browser using an existing network connection to the printer. For more information, see [Embedded web server](#).

This section contains the following topics:

- [Change basic network settings](#)
- [Change advanced network settings](#)
- [Set up the printer for wireless communication](#)
- [Uninstall and reinstall the HP software](#)

Change basic network settings

The control panel options enable you to set up and manage a wireless connection and to perform a variety of network management tasks. This includes viewing the network settings, restoring the network defaults, turning the wireless radio on and off, and changing the network settings.

This section contains the following topics:

- [View and print network settings](#)
- [Turn the wireless radio on and off](#)

View and print network settings

The control panel allows you to see the network status of the printer. To view more details, you can print the network configuration page, which lists network settings such as the IP address, link speed, DNS, and mDNS. For more information, see [Understand the network configuration page](#).

Turn the wireless radio on and off

The wireless radio is on by default, as indicated by the blue light on the front of the printer. In order to stay connected to a wireless network, the radio must stay on. However, if your printer is connected to an Ethernet network or you have a USB connection, the radio is not used. In this case you might want to turn the radio off. To turn the wireless radio off, press and hold the  (Wireless) button.

Change advanced network settings

 **CAUTION:** Network settings are provided for your convenience. However, unless you are an advanced user, you should not change some of these settings (such as the link speed, IP settings, default gateway, and firewall settings).

This section contains the following topics:

- [Set link speed](#)
- [View IP settings](#)
- [Change IP settings](#)
- [Configure the printer's firewall settings](#)
- [Reset network settings](#)

Set link speed

You can change the speed at which data is transmitted over the network. The default is **Automatic**.

1. Open the embedded web server (EWS). For more information, see [To open the embedded web server](#).
2. Click the **Network** tab, and then click **Advanced** in the **Wired (802.3)** section.
3. In the **Link Settings** section, click **Manual**.
4. Click to select the link speed that matches your network hardware:
 - **2. 10-Full**
 - **3. 10-Half**
 - **4. 100-Full**
 - **5. 100-Half**

View IP settings

To view the IP address of the printer:

- Print the network configuration page. For more information, see [Understand the network configuration page](#).
- Or, open the HP software (Windows), double-click **Estimated Ink Levels**, click the **Device Information** tab. The IP address is listed in the **Network Information** section.

Change IP settings

The default IP setting for the IP settings is **Automatic**, which sets the IP settings automatically. However, if you are an advanced user, you might want to manually change settings such as the IP address, subnet mask, or the default gateway.

⚠ CAUTION: Be careful when manually assigning an IP address. If you enter an invalid IP address during the installation, your network components cannot connect with the printer.

1. Open the embedded web server (EWS). For more information, see [To open the embedded web server](#).
2. Click the **Network** tab, and then click **IPv4** in the **Wired (802.3)** section.
3. In the **IP Address Configuration** section, click **Manual**.
4. A message appears warning that changing the IP address removes the printer from the network. Click **OK** to continue.
5. Change the IP settings:
 - **Manual IP Address**
 - **Manual Subnet Mask**
 - **Manual Default Gateway**
6. Click **Apply**.

Configure the printer's firewall settings

Firewall features provide network-layer security on both IPv4 and IPv6 networks. The firewall provides simple control of IP addresses that are allowed access.

📄 NOTE: In addition to firewall protection at the network layer, the printer also supports open secure sockets layer (SSL) standards at the transport layer for secure client-server applications, such as client-server authentication or HTTPS web browsing.

For firewall operation on the printer, you must configure a firewall policy to apply to specified IP traffic. Firewall policy pages are accessed through the EWS and displayed by your web browser. After a policy is configured, it is not activated until you click **Apply** in the EWS.

Creating and using firewall rules

Firewall rules allow you to control IP traffic. Use firewall rules to allow or drop IP traffic based on IP addresses and services.

Enter up to ten rules, each rule specifying the host addresses, services, and the action to take for those addresses and services.

This section contains the following topics:

- [Create a firewall rule](#)
- [Change the priority of firewall rules](#)
- [Change firewall options](#)
- [Reset firewall settings](#)
- [Limitations to rules, templates, and services](#)

Create a firewall rule

To create a firewall rule, complete the following steps:

1. Open the embedded web server. For more information, see [Embedded web server](#).
2. Click the **Settings** tab, click **Firewall Rules**.
3. Click **New**, and then follow the onscreen instructions.

 **NOTE:** After clicking **Apply**, the connection to the EWS might be temporarily disrupted for a short period of time. If the IP address was unchanged, the EWS connection will be enabled again. However, if the IP address was changed, use the new IP address to open the EWS.

Change the priority of firewall rules

To change the priority in which a firewall rule is used, complete the following steps:

1. Open the embedded web server. For more information, see [Embedded web server](#).
2. Click the **Settings** tab, click **Firewall Rules Priority**.
3. Select the priority in which you want the rule to be used from the **Rule Precedence** list, with 10 having the highest priority and 1 having the lowest priority.
4. Click **Apply**.

Change firewall options

To change firewall options for the printer, complete the following steps:

1. Open the embedded web server. For more information, see [Embedded web server](#).
2. Click the **Settings** tab, click **Firewall Options**.
3. Change any settings, and then click **Apply**.

 **NOTE:** After clicking **Apply**, the connection to the EWS might be temporarily disrupted for a short period of time. If the IP address was unchanged, the EWS connection will be enabled again. However, if the IP address was changed, use the new IP address to open the EWS.

Reset firewall settings

To reset the firewall settings to the factory defaults, restore the printer's network settings.

To reset the printer's network settings, see [Reset network settings](#).

Limitations to rules, templates, and services



When creating firewall rules, note the following limitations to rules, templates, and services.

Item	Limit
Maximum number of rules.	10 (one default rule)
Maximum number of Address Templates.	12

(continued)

Item	Limit
Maximum number of user-defined address templates.	5
Maximum number of services you can add to a user-defined service template. NOTE: The predefined All Services template is not subject to this limitation and includes all services supported by the print server.	40
Maximum number of services you can add to the policy. For a given rule, only one address template and one service template can be added.	40
Maximum number of service templates in the policy.	10
Maximum number of user-defined custom service templates.	5

Reset network settings

To reset the administrator password and network settings, press and hold  (Wireless) button and  (Cancel) button for three seconds.



NOTE: Print the network configuration page and verify that the network settings have been reset. For more information, see [Understand the network configuration page](#).

NOTE: Resetting the printer's network settings also resets the printer's firewall settings. For more information about configuring the printer's firewall settings, see [Configure the printer's firewall settings](#).

Set up the printer for wireless communication

You may set up the printer for wireless communication.

This section contains the following topics:

- [Before you begin](#)
- [Set up the printer on your wireless network](#)
- [Set up the printer using the HP printer software \(Recommended\)](#)
- [Set up the printer using WiFi Protected Setup \(WPS\)](#)
- [Set up the printer using the embedded web server \(EWS\)](#)
- [Change the connection type](#)
- [Test the wireless connection](#)
- [Guidelines for ensuring wireless network security](#)
- [Guidelines for reducing interference on a wireless network](#)



NOTE: If you encounter problems connecting the printer, see [Solve wireless problems](#)



TIP: For more information about setting up and using the printer wirelessly, visit the HP Wireless Printing Center (www.hp.com/go/wirelessprinting).

Before you begin

Before you begin setting up the wireless connection, check the following:

- The printer is not connected to the network using a network cable.
- The wireless network is set up and functioning correctly.
- The printer and the computers that use the printer are on the same network (subnet).

While connecting the printer, you might be prompted to enter the wireless network name (SSID) and a wireless password:

- The wireless network name is the name of your wireless network.
- The wireless password prevents other people from connecting to your wireless network without your permission. Depending on the level of security required, your wireless network might use either a WPA key or WEP passphrase.

If you have not changed the network name or the security passkey since setting up your wireless network, you can sometimes find them on the back or side of the wireless router.

If you cannot find the network name or the security passkey or cannot remember this information, see the documentation available with your computer or with the wireless router. If you still cannot find this information, contact your network administrator or the person who set up the wireless network.

 **TIP:** If you are using a computer running Windows, HP provides a tool called HP Home Network Diagnostic Utility that can help retrieve this information for some systems. To use this tool, visit the HP Wireless Printing Center (www.hp.com/go/wirelessprinting), and then click Network Diagnostic Utility in the Quick Links section. (At this time, this tool might not be available in all languages.)

Set up the printer on your wireless network

To set up the printer on your wireless network, use one of the following methods:

- Set up the printer using the Wireless Setup Wizard (Recommended)
- Set up the printer using the HP printer software (Recommended)
- Set up the printer using WiFi Protected Setup (WPS)
- Set up the printer using the embedded web server (EWS)

 **NOTE:** If you have already been using the printer with a different type of connection, such as a USB connection, follow the instructions in [Change the connection type](#) to set up the printer on your wireless network.

Set up the printer using the HP printer software (Recommended)

In addition to enabling key printer features, you can use the HP printer software that came with your printer to set up wireless communication.

If you have already been using the printer with a different type of connection, such as a USB connection, follow the instructions in [Change the connection type](#) to set up the printer on your wireless network.

Set up the printer using WiFi Protected Setup (WPS)

Wi-Fi Protected Setup (WPS) allows you to quickly set up the printer on your wireless network, without having to enter the wireless network name (SSID), wireless password (WPA passphrase, WEP key), or other wireless settings.

 **NOTE:** Only set up wireless using WPS if your wireless network uses WPA data encryption. If your wireless network uses WEP or is not using any encryption at all, use one of the other methods provided in this section to set up the printer on your wireless network.

NOTE: To use WPS, make sure your wireless router or wireless access point supports WPS. Routers that support WPS often have a Wireless (WPS) button or a button labeled “WPS”.

You can use one of the following methods to set up the printer using WPS:

- Push Button Method: Use the Wireless (WPS) or WPS button, if available, on your router.
- PIN Method: Enter the PIN generated by the printer in the router’s configuration software.

To connect the printer using the Push Button Method

1. On the printer, press and hold the Wireless (Wireless) button for 3 seconds. The wireless light starts blinking.
2. On the wireless router or wireless access point, press and hold the WPS button for 3 seconds.

Wait for about 2 minutes. If the printer connects successfully, the wireless light stops blinking but remains lit.

To connect the printer using the PIN Method

1. Print the network configuration page and locate the pin for WPS. For more information, see [Understand the network configuration page](#).
2. On the printer, press and hold the Wireless (Wireless) button for 3 seconds. The Wireless light starts blinking.
3. Open the configuration utility or software for the wireless router or wireless access point, and then enter the WPS PIN printed on the network configuration page.



NOTE: For more information about using the configuration utility, see the documentation provided with the router or wireless access point.

Wait for about 2 minutes. If the printer connects successfully, the wireless light stops blinking but remains lit.

Set up the printer using the embedded web server (EWS)

If the printer is connected to a network, you can use the printer’s embedded web server (EWS) to set up wireless communication.

1. Open the EWS. For more information, see [Embedded web server](#).
2. On the **Home** tab, click **Wireless Setup Wizard** in the **Setup** box.
3. Follow the onscreen instructions.



TIP: You can also set up wireless communication by entering or changing individual wireless settings. To change these settings, on the **Network** tab, click **Advanced** in the Wireless (802.11) section on the left, change the wireless settings, and then click **Apply**.

Change the connection type

After you have installed the HP software and connected the printer to your computer or to a network, you can use the HP software to change the connection type (for example, from a USB connection to a wireless connection).

To change from an Ethernet connection to a wireless connection

Windows

1. On the computer desktop, click **Start**, select **Programs** or **All Programs**, click **HP**, select your printer name, and then click **Printer Setup & Software**.
2. Click **Connect a new printer**, and then select the type of connection you want to use.
3. Follow the display instructions to complete the setup.

Mac OS X

1. Open HP Utility. For more information, see [HP Utility \(Mac OS X\)](#).
2. Click the **Applications** icon on the HP Utility toolbar.
3. Double-click **HP Setup Assistant**, and then follow the onscreen instructions.

To change from a USB connection to a wireless connection

Follow the instructions for your operating system.

Windows

1. On the computer desktop, click **Start**, select **Programs** or **All Programs**, click **HP**, select your printer name, and then click **Printer Setup & Software**.
2. Click **Connect a new printer**, and then click **Convert a USB connected printer to wireless**.
3. Follow the display instructions to complete the setup.

Mac OS X

1. Open HP Utility. For more information, see [HP Utility \(Mac OS X\)](#).
2. Click the **Applications** icon on the HP Utility toolbar.
3. Double-click **HP Setup Assistant**, and then follow the onscreen instructions.

To change from a wireless connection to a USB or Ethernet connection

To change from a wireless connection to a USB or Ethernet connection, connect the USB or Ethernet cable to the printer.





NOTE: If you are using a computer with Mac OS X, add the printer to the print queue. Click **System Preferences** in the Dock, click **Print & Fax** or **Print & Scan** in the **Hardware** section, click **+**, and then select the printer.

Test the wireless connection

Print the wireless test page for information about the printer's wireless connection. The wireless test page provides information about the printer's status, hardware (MAC) address, and IP address. If the printer is connected to a network, the test page displays details about the network settings.

To print the wireless test page

- ▲ To print the wireless test page, press and hold the  (Resume) button, and then press the  (Wireless) button when the network is enabled.

Guidelines for ensuring wireless network security

The following information can help you keep your wireless network and wireless printer secure from unauthorized use.

For more information, visit www.hp.com/go/wirelessprinting.

This section contains the following topics:

- [Overview of security settings](#)
- [Add hardware addresses to a wireless router \(MAC filtering\)](#)
- [Other wireless security guidelines](#)

Overview of security settings

To help improve the security of the wireless network and prevent unauthorized access, the printer supports many common types of network authentication, including WEP, WPA, and WPA2.

- **WEP:** Provides security by encrypting data sent over radio waves from one wireless device to another wireless device. Devices on a WEP-enabled network use WEP keys to encode data. If your network uses WEP, you must know the WEP key(s) it uses.
- **WPA:** Increases the level of over-the-air data protection and access control on existing and future wireless networks. It addresses all known weaknesses of WEP, the original native security mechanism in the 802.11 standard. WPA uses the Temporal Key Integrity Protocol (TKIP) for encryption and employs 802.1X authentication with one of the standard Extensible Authentication Protocol (EAP) types available today.
- **WPA2:** Provides enterprise and consumer wireless users with a high level of assurance that only authorized users can access their wireless networks. WPA2 provides the Advanced Encryption Standard (AES). AES is defined in counter cipher-block chaining mode (CCM) and supports the Independent Basic Service Set (IBSS) to enable security between client workstations operating connected wirelessly without a wireless router (such as a Linksys wireless router or Apple AirPort Base Station).

Add hardware addresses to a wireless router (MAC filtering)

MAC filtering is a security feature in which a wireless router or wireless access point is configured with a list of hardware addresses (also called "MAC addresses") of devices that are allowed to gain access to the network through the router.

If the router filters hardware addresses, then the printer's hardware address must be added to the router's list of accepted hardware addresses. If the router does not have the hardware address of a printer attempting to access the network, the router denies the printer access to the network.

 **CAUTION:** This method is not recommended, however, because your MAC addresses can easily be read and falsified by unwanted users outside your network.

To add hardware addresses to a wireless router or wireless access point

1. Print the network configuration page, and then locate the printer's hardware address. For more information, see [Understand the network configuration page](#).



NOTE: The printer maintains separate hardware addresses for the Ethernet connection and for wireless connection. Both hardware addresses are listed on the printer's network configuration page.

2. Open the configuration utility for the wireless router or wireless access point, and add the printer's hardware address to the list of accepted hardware addresses.



NOTE: For more information about using the configuration utility, see the documentation provided with the router or wireless access point.

Other wireless security guidelines

To keep the wireless network secure, follow these guidelines:

- Use a wireless password with at least 20 random characters. You can use up to 64 characters in a WPA wireless password.
- Avoid any common words or phrases, easy sequences of characters (such as all 1s), and personally-identifiable information for wireless passwords. Always use random strings composed of uppercase and lowercase letters, numbers, and if allowed, special characters such as punctuation.
- Change the default wireless password provided by the manufacturer for administrator access to the access point or wireless router. Some routers let you change the administrator name as well.

- Turn off administrative access over wireless if possible. If you do this, you need to connect to the router with an Ethernet connection when you want to make configuration changes.
- Turn off remote administrative access over the Internet on your router, if possible. You can use Remote Desktop to make an encrypted connection to a computer running behind your router and make configuration changes from the local computer you are accessing over the Internet.
- To avoid accidentally connecting to another party's wireless network, turn off the setting to automatically connect to non-preferred networks. This is disabled by default in Windows XP.

Guidelines for reducing interference on a wireless network

The following tips will help reduce the chances for interference in a wireless network:

- Keep the wireless devices away from large metal objects, such as filing cabinets, and other electromagnetic devices, such as microwaves and cordless telephones, as these objects can disrupt radio signals.
- Keep the wireless devices away from large masonry structures and other building structures as these objects can absorb radio waves and lower signal strength.
- Position the access point or wireless router in a central location in line of sight with the wireless devices on the network.
- Keep all wireless devices on the network within range of one another.

Uninstall and reinstall the HP software

If your installation is incomplete, or if you connected the USB cable to the computer before prompted by the HP software installation screen, you might need to uninstall and then reinstall the HP software that came with the printer. Do not simply delete the printer application files from your computer. Make sure to remove them correctly using the uninstall utility provided when you installed the HP software.

Windows

To uninstall, method 1

1. Disconnect the printer from your computer. Do not connect it to your computer until after you have reinstalled the HP software.
2. On the computer desktop, click **Start**, select **Programs** or **All Programs**, click **HP**, click the printer name, and then click **Uninstall**.
3. Follow the onscreen instructions.
4. If you are asked whether you would like to remove shared files, click **No**. Other programs that use these files might not work correctly if the files are deleted.
5. Restart your computer.
6. To reinstall the HP software, insert the HP software CD into your computer's CD drive, and follow the onscreen instructions.
7. Connect the printer when the HP software prompts you to connect it to the computer.
8. Press the  (Power) button to turn the printer on. After connecting and turning on the printer, you might have to wait several minutes for all of the Plug and Play events to complete.
9. Follow the onscreen instructions.

To uninstall, method 2

 **NOTE:** Use this method if **Uninstall** is not available in the Windows Start menu.

1. On the computer desktop, click **Start**, select **Settings**, click **Control Panel**, and then click **Add/Remove Programs**.
- Or -
Click **Start**, click **Control Panel**, and then double-click **Programs and Features**.
2. Select the printer name, and then click **Change/Remove** or **Uninstall/Change**.
Follow the onscreen instructions.
3. Disconnect the printer from your computer.
4. Restart your computer.



NOTE: It is important that you disconnect the printer before restarting your computer. Do not connect the printer to your computer until after you have reinstalled the HP software.

5. Insert the HP software CD into your computer's CD drive and then start the Setup program.
6. Follow the onscreen instructions.

Mac OS X

To uninstall

1. Double-click the **HP Uninstaller** icon (located in the **Hewlett-Packard** folder in the **Applications** folder at the top level of the hard disk), and then click **Continue**.
2. When prompted, type the correct administrator's name and password, and then click **OK**.
3. Follow the onscreen instructions.
4. When the **HP Uninstaller** finishes, restart your computer.

D Printer management tools

This section contains the following topics:

- [Toolbox \(Windows\)](#)
- [HP Utility \(Mac OS X\)](#)
- [Embedded web server](#)

Toolbox (Windows)

The Toolbox provides maintenance information about the printer.

 **NOTE:** The Toolbox can be installed from the HP Software CD if the computer meets the system requirements.

Open the Toolbox

1. From the computer desktop, click the **Start** tab, select **Programs** or **All Programs**, click **HP**, click the folder for your printer, and then select the icon with your printer's name.
2. Double-click **Printer Preferences**, and then double-click **Maintenance Tasks**.

HP Utility (Mac OS X)

HP Utility contains tools to configure print settings, calibrate the printer, order supplies online, and find website support information.

 **NOTE:** The features available in HP Utility vary depending on the selected printer. Ink level warnings and indicators provide estimates for planning purposes only. When you receive a low on ink message, consider having a replacement cartridge available to avoid possible printing delays. You do not need to replace cartridges until prompted to do so.

Open HP Utility

To open HP Utility

Click **System Preferences** in the Dock, click **Print & Fax** or **Print & Scan** in the **Hardware** section, click **Open Print Queue**, and then do the following for your version of Mac OS X:

- Mac OS X v10.5: Click **Utility** on the toolbar.
- Mac OS X v10.6: Click **Printer Setup** on the toolbar, click the **Utility** tab, and then click **Open Printer Utility**.

– Or –

Double-click the **HP Utility** icon. This icon is located in the **Hewlett-Packard** folder in the **Applications** folder at the top level of the hard disk.

Embedded web server

When the printer is connected to a network, you can use the printer's home page (embedded web server or EWS) to view status information, change settings, and manage it from your computer.

 **NOTE:** For a list of system requirements for the embedded web server, see [Embedded web server specifications](#).

To view or change some settings, you might need a password.

You can open and use the embedded web server without being connected to the Internet. However, some features are not available.

This section contains the following topics:

- [About cookies](#)
- [To open the embedded web server](#)

About cookies

The embedded web server (EWS) places very small text files (cookies) on your hard drive when you are browsing. These files let the EWS recognize your computer the next time you visit. For example, if you have configured the EWS language, a cookie helps remember which language you have selected so that the next time you access the EWS, the pages are displayed in that language. Though some cookies are cleared at the end of each session (such as the cookie that stores the selected language), others (such as the cookie that stores customer-specific preferences) are stored on the computer until you clear them manually.

You can configure your browser to accept all cookies, or you can configure it to alert you every time a cookie is offered, which allows you to decide which cookies to accept or refuse. You can also use your browser to remove unwanted cookies.

 **NOTE:** Depending on your printer, if you disable cookies, you also disable one or more of the following features:

- Starting where you left the application (especially useful when using setup wizards)
- Remembering the EWS browser language setting
- Personalizing the EWS Home page

For information about how to change your privacy and cookie settings and how to view or delete cookies, see the documentation available with your web browser.

To open the embedded web server

 **NOTE:** The printer must be on a network and must have an IP address. The IP address and hostname for the printer are listed on the status report. For more information, see [Understand the network configuration page](#).

In a supported web browser on your computer, type the IP address or hostname assigned to the printer.

For example, if the IP address is 123.123.123.123, type the following address into the web browser: `http://123.123.123.123`

 **TIP:** After opening the embedded web server, you can bookmark it so that you can return to it quickly.

TIP: If you are using the Safari web browser in Mac OS X, you can also use the Bonjour bookmark to open the EWS without typing the IP address. To use the Bonjour bookmark, open Safari, and then from the **Safari** menu, click **Preferences**. On the **Bookmarks** tab, in the **Bookmarks bar** section, select **Include Bonjour**, and then close the window. Click the **Bonjour** bookmark, and then select your networked printer to open the EWS.

E How do I?

- [Get started](#)
- [Print](#)
- [Work with ink cartridges](#)
- [Solve a problem](#)

F Errors (Windows)

Unable to Communicate with Printer

The computer cannot communicate with the printer because one of the following events has occurred:

- The printer has been turned off.
- The cable connecting the printer - such as a USB cable or a network (Ethernet) cable – has been disconnected.
- If the printer is connected to a wireless network, the wireless connection has been broken.

To solve this problem, try the following solutions:

- Make sure the printer is turned on and that the  (Power) light is on.
- Make sure the power cord and other cables are working and are firmly connected to the printer.
- Make sure the power cord is connected firmly to a functioning, alternating current (AC) power outlet.
- If the printer is connected to a network, make sure the network is functioning properly. For more information, see [Solve Ethernet network problems](#).
- If the printer is connected to a wireless network, make sure the wireless network is functioning properly. For more information, see [Solve wireless problems](#).

Low on ink

The ink cartridge identified in the message is low on ink.

Ink level warnings and indicators provide estimates for planning purposes only. When you receive a low on ink message, consider having a replacement cartridge available to avoid possible printing delays. You do not need to replace cartridges until prompted to do so.

For information about replacing ink cartridges, see [Replace the ink cartridges](#). For information about ordering ink cartridges, see [Order printing supplies online](#). For information about recycling used ink supplies, see [HP inkjet supplies recycling program](#).

 **NOTE:** Ink from the cartridges is used in the printing process in a number of different ways, including in the initialization process, which prepares the printer and cartridges for printing. In addition, some residual ink is left in the cartridge after it is used. For more information see www.hp.com/go/inkusage.

Printhead problem

The printhead is missing, not detected, incorrectly installed, or incompatible.

If this error occurs at printer setup, try the following solutions.

Solution 1: Remove and reinstall the printhead.

 **CAUTION:** The printheads contain electrical contacts that can be damaged easily.

For more information, see [Remove and reinstall the printhead](#).

If the problem persists after you reinstall the printhead, contact HP support. For more information, see [HP support](#).

If this error occurs after the printer has been used for a period of time, try the following solutions.

Solution 1: Turn the printer off and on.

Turn off the printer, and then turn it on again.

If the problem persists, contact HP support for service or replacement.

Cartridge Problem

The ink cartridge identified in the message is missing, damaged, incompatible, or inserted into the wrong slot in the printer.

 **NOTE:** If the cartridge is identified in the message as incompatible, see [Order printing supplies online](#) for information about obtaining cartridges for the printer.

To solve this problem, try the following solutions. Solutions are listed in order, with the most likely solution first. If the first solution does not solve the problem, continue trying the remaining solutions until the issue is resolved.

- Solution 1: Turn the printer off and on
- Solution 2: Install the ink cartridges correctly
- Solution 3: Clean the electrical contacts
- Solution 4: Replace the ink cartridge

Solution 1: Turn the printer off and on

Turn off the printer, and then turn it on again.

If the problem persists, try the next solution.

Solution 2: Install the ink cartridges correctly

Make sure all of the ink cartridges are properly installed:

1. Gently pull open the ink cartridge cover.
2. Remove the ink cartridge by grasping it and pulling it firmly toward you.
3. Insert the cartridge into the slot. Press firmly on the cartridge to ensure proper contact.
4. Close the ink cartridge cover and check if the error message has gone away.

If the problem persists, try the next solution.

Solution 3: Clean the electrical contacts

To clean the electrical contacts in the printer

1. Lightly dampen a clean, lint-free cloth with bottled or distilled water.
2. Clean the electrical contacts in the printer by wiping with the cloth from top to bottom. Use as many fresh, clean cloths as necessary. Clean until no ink shows on the cloth.
3. Wipe the area dry with a dry lint-free cloth before proceeding to the next step.

Solution 4: Replace the ink cartridge

Replace the indicated ink cartridge. For more information, see [Replace the ink cartridges](#).

 **NOTE:** If your cartridge is still under warranty, contact HP support for service or replacement. For more information about ink cartridge warranty, see [Ink cartridge warranty information](#). If the problem persists after you replace the cartridge, contact HP support. For more information, see [HP support](#).

Paper Mismatch

The paper size or type selected in the printer driver does not match the paper loaded in the printer. Make sure that the correct paper is loaded in the printer, and then print the document again. For more information, see [Load media](#).

 **NOTE:** If the paper loaded in the printer is the correct size, change the selected paper size in the printer driver, and then print the document again.

The cartridge cradle cannot move

Something is blocking the ink cartridge cradle (the part of the printer that holds the ink cartridges).

To clear the obstruction, press  (Power) button to turn off the printer, and then check the printer for jams.

For more information, see [Clear jams](#).

Paper Jam

Paper has become jammed in the printer.

Before you try to clear the jam, check the following:

- Make sure that you have loaded paper that meets specifications and is not wrinkled, folded, or damaged. For more information, see [Media specifications](#).
- Make sure that the printer is clean. For more information, see [Maintain the printer](#).
- Make sure that the trays are loaded correctly and are not too full. For more information, see [Load media](#).

For instructions on clearing jams, as well as more information about how to avoid jams, see [Clear jams](#).

The printer is out of paper

The default tray is empty.

Load more paper, and then touch **OK**.

For more information, see [Load media](#).

Printer Offline

The printer is currently offline. While offline, the printer cannot be used.

To change the printer's status, complete the following steps.

1. Click **Start**, and then click **Printers** or **Printers and Faxes** or **Devices and Printers**.
- Or -
Click **Start**, click **Control Panel**, and then double-click **Printers**.
2. If the printers listed in the dialog box are not being displayed in Details view, click the **View** menu, and then click **Details**.
3. If the printer is Offline, right-click the printer, and click **Use Printer Online**.
4. Try using the printer again.

Printer Paused

The printer is currently paused. While paused, new jobs are added to the queue but are not printed.

To change the printer's status, complete the following steps.



1. Click **Start**, and then click **Printers** or **Printers and Faxes** or **Devices and Printers**.
- Or -
Click **Start**, click **Control Panel**, and then double-click **Printers**.
2. If the printers listed in the dialog box are not being displayed in Details view, click the **View** menu, and then click **Details**.
3. If the printer is paused, right-click the printer, and click **Resume Printing**.
4. Try using the printer again.

Document failed to print

The printer could not print the document because a problem occurred in the printing system. For information about solving printing problems, see [Solve printer problems](#).

Printer failure

There was a problem with the printer. Usually, you can resolve such problems by completing the following steps:

1. Press the  (Power) button to turn off the printer.
2. Unplug the power cord, and then plug in the power cord again.
3. Press the  (Power) button to turn on the printer.

If this problem persists, write down the error code provided in the message, and then contact HP support. For more information about contacting HP support, see [HP support](#).

Door or cover open

Before the printer can print documents, all doors and covers must be closed.

 **TIP:** When completely closed, most doors and covers snap into place.

If the problem persists after you've securely closed all doors and covers, contact HP support. For more information, see [HP support](#).

Previously used ink cartridge installed

The ink cartridge identified in the message was previously used in a different printer.

You can use ink cartridges in different printers, but if the cartridge was left outside of a printer for an extended period of time, the print quality of your documents might be affected. Also, if you use ink cartridges that have been used in a different printer, the ink level indicator might be inaccurate or unavailable.

If the print quality is unsatisfactory, try cleaning the printheads. For more information, see [Clean the printhead](#).

 **NOTE:** Ink from the cartridges is used in the printing process in a number of different ways, including in the initialization process, which prepares the printer and cartridges for printing, and in printhead servicing, which keeps print nozzles clear and ink flowing smoothly. In addition, some residual ink is left in the cartridge after it is used. For more information, see www.hp.com/go/inkusage.

For more information about storing ink cartridges, see [Supplies](#).

Ink cartridges depleted

The cartridges listed in the message must be replaced to resume printing. HP recommends that you do not remove an ink cartridge until a replacement is ready to install. For more information, see [Replace the ink cartridges](#).

Ink cartridge failure

The cartridges listed in the message are damaged or have failed. For more information, see [Replace the ink cartridges](#).

Printer supply upgrade

The cartridge listed in the message can only be used to upgrade one printer. Click OK to use it on this printer. If you do not wish to proceed with the supply upgrade for this printer, click Cancel Print and then remove the cartridge.

Printer supply upgrade successful

The supply upgrade was successful. The cartridges listed in the message can now be used in the printer.

Printer supply upgrade problem

The supply upgrade was not successful. The cartridges listed in the message can still be used in this printer. Replace the Supply Upgrade cartridge. For more information, see [Replace the ink cartridges](#).

Non-HP ink cartridges installed

HP cannot guarantee the quality or reliability of non-HP supplies. Printer service or repairs required as a result of using a non-HP supply will not be covered under warranty. If you believe you purchased original HP ink cartridges, visit HP at www.hp.com/go/anticounterfeit for more information or to report fraud.

Using Original HP Cartridges has its Rewards

HP rewards loyal customers for using original HP supplies. Click the button below the message to view Rewards online. Reward may not be available in all regions.

Counterfeit Cartridge Advisory

The installed cartridge is not a new, original HP cartridge. Contact the store where this cartridge was purchased. To report suspected fraud, visit HP at www.hp.com/go/anticounterfeit. To continue using the cartridge, click Continue.

Used, Refilled or Counterfeit Cartridge Detected

The original HP ink in the cartridge has been depleted. The solution for this problem is to replace the ink cartridge or click OK to continue using the cartridge. For more information, see [Replace the ink cartridges](#). HP rewards loyal customers for using original HP supplies. Click the button below the message to view Rewards online. Rewards may not be available in all regions.

⚠ WARNING! HP's ink cartridge warranty does not cover non-HP ink or cartridges. HP's printer warranty does not cover repairs or service due to use of non-HP cartridges or ink. HP does not guarantee the quality or reliability of non-HP ink. Information about ink levels will not be available.

Use SETUP cartridges

Use the SETUP cartridges that came with the printer for printer initialization. You must replace the cartridge with the setup cartridge to clear this message. For more information, see [Replace the ink cartridges](#).

Do not use SETUP cartridges

SETUP cartridges cannot be used after the printer has been initialized. Remove and install non-SETUP cartridges. For more information, see [Replace the ink cartridges](#).

New printhead low on ink

The used cartridges listed in the message might not have enough ink to complete one-time startup processes.

Solution: Install new cartridges that came with your replacement printhead or click **Continue** to use installed cartridges.

If startup cannot complete with installed cartridges, new cartridges will be needed. For information on how to install new cartridges, see [Replace the ink cartridges](#).

Use black ink only?

The cartridges listed in the message are low on ink.

Solutions: To print in color, replace the empty cartridges. For information about how to install new cartridges, see [Replace the ink cartridges](#).

To temporarily print using Black ink only, click **Use Black Only**. The printer will replace color with grayscale. The empty cartridges will need to be replaced soon.

⚠ CAUTION: Do not remove the empty cartridge to print in black-ink only mode.

Use color ink only?

The black cartridge is low on ink.

Solutions: To temporarily replace black with color, click **Use Color Only**. Black will be simulated. Text and photo quality will differ from those printed when using all cartridges. The black cartridge will need to be replaced soon.

⚠ CAUTION: Do not remove the empty cartridge to print in color-ink only mode.

To print with black, replace the black ink cartridge. For information about how to install new cartridges, see [Replace the ink cartridges](#).

Incompatible ink

The printer has detected that the type of ink in the cartridges listed in the message is incompatible with the ink system for the printer and can cause serious harm to the printhead.

Solution: Remove this cartridge immediately and replace with a compatible ink cartridge. For information about how to install new cartridges, see [Replace the ink cartridges](#).

Ink sensor warning

The ink sensor is reporting an unexpected condition. This could be caused by the cartridge, or the sensor may have failed. If the sensor has failed, it can no longer sense when your cartridges are low on ink. Printing with an empty cartridge will cause air to enter the ink system, which causes poor print quality. Significant amounts of ink will be used up to recover from this condition, which will deplete much of the ink supply for all cartridges.

Solution: Click **OK** to continue printing or replace the cartridge. For information about how to install new cartridges, see [Replace the ink cartridges](#).

Problem with printer preparation

The printer clock has failed and ink preparation may not be complete. The estimated Ink Level gauge might be inaccurate.

Solution: Check the print quality of your print job. If it is not satisfactory, running the printhead cleaning procedure from the toolbox might improve it. For more information about cleaning the printhead, see [Clean the printhead](#).

Color cartridge low on ink

The cartridges listed in the message are low on ink.

Solutions: To print in color, replace the empty cartridges. For information about how to install new cartridges, see [Replace the ink cartridges](#).

To temporarily print using black ink only, click Cancel Print and then re-send the print job. The **Use black ink only?** message appears before the job prints. The empty cartridges will need to be replaced soon.

 **CAUTION:** Do not remove the empty cartridge to print in black-ink only mode.

Black cartridge low on ink

The black cartridge is low on ink.

Solutions: Replace the black ink cartridge. For information about how to install new cartridges, see [Replace the ink cartridges](#).

To temporarily replace black with color, click Cancel Print and re-send the print job. The **Use color ink only?** message appears before the job prints. The black cartridge will need to be replaced soon.

 **CAUTION:** Do not remove the empty cartridge to print in color-ink only mode.

Startup routine ink alert

The cartridges listed might not have enough ink to complete one-time startup processes.

Use of installed cartridges may result in air left in the print system after one time startup routine, which causes poor print quality. Significant amounts of ink will be used to try to recover from this situation.

If you received cartridges with your replacement printer or printhead, use them for startup. Install new cartridges or click OK to use currently installed cartridges.

Problem with ink system

Please remove the ink cartridges and examine them for any sign of leaks. If any cartridges have leaks, contact HP. Do not use cartridges that are leaking.

If there are no leaks, re-install cartridges and close the printer cover. Turn the printer off then on again. If you get this message a second time, contact HP.

Replace the ink cartridge

Replace the indicated ink cartridge. For more information, see [Replace the ink cartridges](#).



NOTE: If your cartridge is still under warranty, contact HP support for service or replacement. For more information about ink cartridge warranty, see Ink cartridge warranty information. If the problem persists after you replace the cartridge, contact HP support. For more information, see [HP support](#).

Index

A

- accessibility 6
- accessories
 - installation 19
 - printer status report 72
 - turn on and off in driver 22
 - warranty 90
- acoustic emissions 100
- after the support period 48
- align printhead 76

B

- blank pages, troubleshoot
 - print 51
- both sides, print on 33
- buttons, control panel 10

C

- Cancel button 10, 81
- capacity
 - trays 96
- cards
 - sizes supported 95
 - tray supporting 96
- cartridges. *See* ink cartridges
- clean
 - exterior 23
 - printhead 75
- Configure
 - firewall 67
- connectors, locating 9
- control panel
 - buttons 10
 - illustration 82
 - lights 10
 - lights, understanding 82
- custom-size paper
 - Mac OS 31
 - print on 30
- custom-sized media
 - sizes supported 96
- customer support
 - electronic 45
- cut-off pages, troubleshoot 52

D

- diagnostic page 56
- double-sided printing 33
- driver
 - accessories settings 22
 - warranty 90
- duplexer
 - clear jams 78
 - installation 19
 - media sizes supported 94
 - media types and weights supported 96
 - turn on and off in driver 22
- duty cycle 93

E

- electrical specifications 99
- embedded web server
 - about 131
 - opening 132
 - system requirements 94
 - troubleshoot, cannot be opened 68
- envelopes
 - sizes supported 95
 - tray supporting 96
- environmental specifications 99
- environmental sustainability program 106
- EWS. *See* embedded web server

F

- Firewall
 - configure 67
- firewall settings 122, 123
- firewalls, troubleshoot 50
- fonts supported 92

H

- head 75
- Hewlett-Packard Company
 - notices 3
- HP software
 - uninstall from Windows 129

- HP Utility (Mac OS X)
 - opening 131
- humidity specifications 99

I

- ink cartridge door, locating 9
- ink cartridges
 - check ink levels 40
 - lights 82
 - locating 9
 - ordering online 119
 - part numbers 72, 119
 - replace 41
 - status 72
 - supported 92
 - tips 39
 - warranty 90
 - warranty dates 72
 - yields 92
- ink level icons 11, 82
- ink levels, check 40
- ink-carriage access door, locating 9
- installation
 - accessories 19
 - duplexer 19
 - hardware installation
 - suggestions 69
 - HP software installation
 - suggestions 70
 - tray 2 19
 - troubleshooting issues 69
- IP address
 - checking for printer 69
- IP settings 122

J

- jams
 - clear 78
 - media to avoid 14
 - paper 78, 80

L

- language, printer 92

Index

- lights on control panel
 - illustration 82
 - understanding 82
 - lights reference 81
 - lights, control panel 10
 - link speed, setting 122
 - load
 - photo 17
 - tray 15, 16
 - tray 2 20
 - load cards 17
 - load custom-size media 18
 - load envelopes 16
 - load media 15
 - locking trays 21
- M**
- Mac OS
 - custom-size paper 31
 - Print borderless 32
 - Print photos 30
 - print settings 26
 - turn accessories on and off in driver 22
 - Mac OS X
 - HP Utility 131
 - maintain
 - printhead 75
 - maintenance
 - align printhead 76
 - check ink levels 40
 - clean printhead 75
 - diagnostic page 56
 - print quality report 56
 - printhead 75
 - replace ink cartridges 41
 - margins
 - setting, specifications 97
 - media
 - clear jams 78
 - duplexing 33
 - HP, order 120
 - load tray 14
 - load tray 2 20
 - locking trays 21
 - print on custom-size 30
 - selecting 14
 - skewed pages 58
 - specifications 94
 - supported sizes 94
 - troubleshoot feeding 57
 - types and weights supported 96
 - memory
 - specifications 93
 - missing or incorrect information, troubleshoot 52
 - model number 72
 - multi-feeds, troubleshoot 58
- N**
- networks
 - advanced settings 121
 - connector illustration 9
 - firewall settings 122, 123
 - firewalls, troubleshoot 50
 - IP settings 122
 - link speed 122
 - operating systems supported 93
 - protocols supported 94
 - settings, change 121
 - solve problems 70
 - system requirements 94
 - view and print settings 121
 - wireless communication setup 124
 - wireless settings 73
 - noise information 100
- O**
- operating environment
 - specifications 99
 - operating systems
 - supported 93
 - output tray
 - locating 8
 - media supported 97
- P**
- pages per month (duty cycle) 93
 - paper
 - jams 78, 80
 - paper-feed problems, troubleshoot 57
 - PCL 3 support 92
 - phone support 45
 - phone support period
 - period for support 46
 - photo media
 - sizes supported 96
 - ports, specifications 92
 - power
 - specifications 99
 - troubleshoot 49
 - power input, locating 9
 - print
 - diagnostic page 56
 - double-sided 33
 - print quality report 56
 - printer status report 71
 - troubleshoot 48
 - Print borderless
 - Mac OS 32
 - Windows 32
 - Print brochures
 - print 27
 - Print envelope 28
 - Print envelopes
 - Mac OS 28
 - Print photos
 - Mac OS 30
 - Windows 29
 - print quality report 56
 - print settings
 - print quality 53
 - printer control panel
 - locating 8
 - network settings 121
 - printer driver
 - accessories settings 22
 - warranty 90
 - printer exterior
 - clean 23
 - printer software (Windows)
 - about 131
 - opening 131
 - printer status report
 - information on 71
 - print 71
 - printhead
 - clean 75
 - information 72
 - printhead latch, locating 9
 - printhead, align 76
 - printheads
 - lights 82
 - ordering online 119
 - supported 92
 - printing
 - slow, troubleshoot 50
 - processor specifications 93

- R**
- radio interference
 - reducing 129
 - regulatory information 104
 - radio, turn off 121
 - rear access panel
 - clear jams 78
 - illustration 9
 - recycle
 - print cartridges 106
 - regulatory information 101, 104
 - regulatory model number 105
 - replace ink cartridges 41
 - reports
 - diagnostic 56
 - print quality 56
 - printhead 75
 - Resume button 10, 81
- S**
- serial number 72
 - settings
 - network 121
 - shipping environment
 - specifications 99
 - skew, troubleshoot
 - print 58
 - software
 - accessories settings 22
 - warranty 90
 - sound pressure 100
 - specifications
 - acoustic emissions 100
 - electrical 99
 - media 94
 - network protocols 94
 - operating environment 99
 - physical 92
 - processor and memory 93
 - shipping environment 99
 - system requirements 93
 - status
 - network configuration
 - page 73
 - printer status report 72
 - supplies
 - ordering online 119
 - printer status report 72
 - yields 92
 - support 44
 - system requirements 93
- T**
- temperature specifications 99
 - text
 - troubleshoot 52
 - tray 1
 - capacity 96
 - media sizes supported 94
 - media types and weights
 - supported 96
 - tray 2
 - capacity 96
 - installation 19
 - load media 20
 - media sizes supported 94
 - media types and weights
 - supported 96
 - turn on and off in driver 22
 - trays
 - capacities 96
 - clear jams 78
 - installation tray 2 19
 - load media 14
 - locating 8
 - locking 21
 - media sizes supported 94
 - media types and weights
 - supported 96
 - paper guides illustration 8
 - setting default 21
 - troubleshoot feeding 57
 - turn on and off in driver 22
 - troubleshooting
 - blank pages printed 51
 - cut-off pages, incorrect text
 - or graphics placement 52
 - embedded web server 68
 - firewalls 50
 - jams, paper 80
 - media not picked up from
 - tray 57
 - missing or incorrect
 - information 52
 - multiple pages are
 - picked 58
 - network configuration
 - page 73
 - nothing prints 49
 - paper-feed problems 57
 - power 49
 - print 48
 - printer status report 71
 - skewed pages 58
 - tips 48
 - troubleshooting
 - Ethernet network 60
 - general network
 - troubleshooting 60
 - hardware installation
 - suggestions 69
 - HP software installation
 - suggestions 70
 - installation issues 69
 - lights 82
 - solve network problems 70
 - wireless problems 60
 - two-sided printing 33
- U**
- uninstall HP software
 - Windows 129
 - USB connection
 - port, locating 8, 9
- V**
- view
 - network settings 121
 - voltage specifications 99
- W**
- warranty 90
 - websites
 - accessibility information 6
 - customer support 45
 - environmental
 - programs 106
 - order supplies and
 - accessories 119
 - supply yield data sheet 92
 - Windows
 - borderless 32
 - print brochures 27
 - Print photos 29
 - print settings 26
 - system requirements 93
 - turn accessories on and off
 - in driver 22
 - uninstall HP software 129
 - wireless communication
 - advanced wireless
 - troubleshooting 62
 - basic wireless
 - troubleshooting 61
 - radio, turn off 121
 - reducing interference 129

Index

regulatory information 104
set up 124

© 2014 Hewlett-Packard Development Company, L.P.
www.hp.com

