



TEK-CoVOR 1300D

Steam Quality Meter

Instruction Manual

Document Number: IM-1300D

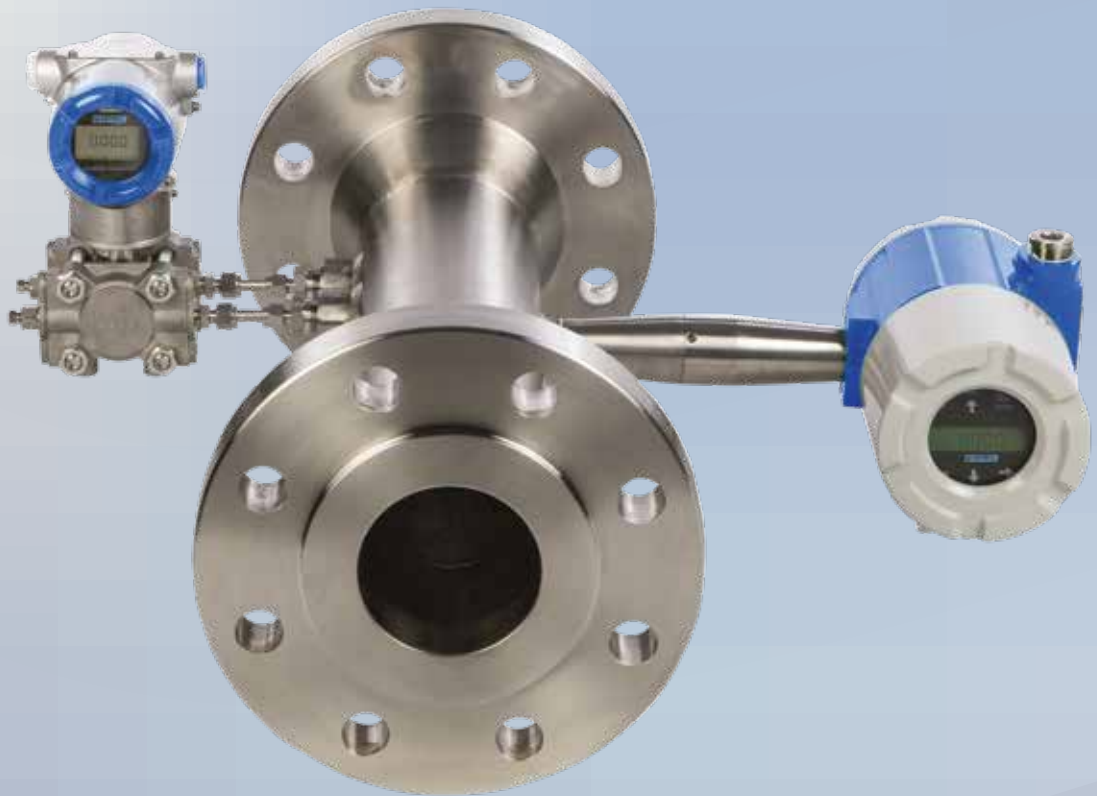

www.tek-trol.com

NOTICE

Read this manual before working with the product. For personal and system safety, and for optimum product performance, make sure you thoroughly understand the contents before installing, using, or maintaining this product.

For technical assistance, contact

Customer Support

796 Tek-Drive

Crystal Lake, IL 60014

USA

Tel: +1 847 857 6076, +1 847 655 7428

© COPYRIGHT Tek-Trol LLC 2020

No part of this publication may be copied or distributed, transmitted, transcribed, stored in a retrieval system, or translated into any human or computer language, in any form or by any means, electronic, mechanical, manual, or otherwise, or disclosed to third parties without the express written permission. The information contained in this manual is subject to change without notice.

Table of Contents

1	Safety Instructions.....	3
1.1	Intended Use	3
1.2	Certifications	3
1.3	Safety Instructions from the Manufacturer.....	3
1.3.1	Disclaimer.....	3
1.3.2	Product Liability and Warranty	3
1.3.3	Information Concerning the Documentation.....	3
1.4	Safety Precautions	3
1.5	Packaging, Transportation and Storage	4
1.5.1	Packaging.....	4
1.5.2	Transportation.....	4
1.5.3	Storage	5
1.5.4	Nameplate.....	5
2	Product Description	5
2.1	Introduction	5
2.2	Measuring Principle	5
2.3	Specifications	6
2.4	Dimensional Drawings	7
2.5	Model Chart	8
3	Steam Quality Meter Configuration	10
4	Installation	11
5	Tek-Trol DP Meters Wiring.....	14
5.1	HART Connection of DP Meters.....	14
5.1.1	External Analog Connection to DP meters.....	15
5.1.2	Optional External 4 to 20 mA Input Wiring.....	15
5.1.3	Power UP.....	16
5.1.4	Connection to LAN.....	16
5.2	Vortex Key Menu	16
6	Network Configuration	33
6.1	IPSetup Network Configuration Tool	33
6.1.1	Using IPSetup.....	34
6.1.2	IPSetup Does Not Display Your Device.....	34
6.1.3	IPSetup FAQ.....	34
7	Meter Web Pages	35
7.1	Main Web Page	36
7.2	Steam Web Page.....	36
7.3	Vortex Meter Web Pages	37
8	Web Configuration Interface.....	38
8.1	Configuration Options.....	43
9	Connection to meter from the Internet and Security Issues	43

10	Modbus or TCP Interface	45
10.1	Modbus Utilities	45
10.2	MBGUI. EXE Simple Modbus/TCP client	46
10.3	Console Modbus/TCP client MBUS. EXE.....	46
11	Data Logging.....	48
11.1	Dummy registers group 9000	51
11.2	Other methods of retrieving log files	53
11.2.1	WGET	53
11.2.2	FTP	54
12	Firmware Update.....	54

1 Safety Instructions

1.1 Intended Use

Tek-CoVor 1300D Steam Quality Meter is capable of predicting fluid density, volumetric flow rate and mass flow rate of gas and steam applications. The meter provides reliable steam quality (steam dryness) measurement.

1.2 Certifications

FM, FMC, ATEX, IECEx Approvals.

1.3 Safety Instructions from the Manufacturer

1.3.1 Disclaimer

The manufacturer will not be held accountable for any damage that happens by using its product, including, but not limited to direct, indirect, or incidental and consequential damages.

Any product purchased from the manufacturer is warranted in accordance with the relevant product documentation and our Terms and Conditions of Sale.

The manufacturer has the right to modify the content of this document, including the disclaimer, at any time for any reason without prior notice, and will not be answerable in any way for the possible consequence of such changes.

1.3.2 Product Liability and Warranty

The operator shall bear authority for the suitability of the device for the specific application. The manufacturer accepts no liability for the consequences of misuse by the operator. Wrong installation or operation of the devices (systems) will cause the warranty to be void. The respective Terms and Conditions of Sale, which forms the basis for the sales contract shall also apply.

1.3.3 Information Concerning the Documentation

To prevent any injury to the operator or damage to the device it is essential to read the information in this document and the applicable national standard safety instructions. This operating manual contain all the information that is required in various stages, such as product identification, incoming acceptance and storage, mounting, connection, operation and commissioning, troubleshooting, maintenance, and disposal.

1.4 Safety Precautions

You must read these instructions carefully prior to installing and commissioning the device. These instructions are an important part of the product and must be kept for future reference. Only by observing these instructions, optimum protection of both personnel and the environment, as well as safe and fault-free operation of the device can be ensured.

For additional information that are not discussed in this manual, contact the manufacturer.

Warnings and Symbols Used

The following safety symbol marks are used in this operation manual and on the instrument.



WARNING

Indicates a potentially hazardous situation which, if not avoided, could result in death or severe injury



CAUTION

Indicates a potentially hazardous situation which, if not avoided, may result in minor or moderate injury. It may also be used to alert against unsafe practices.



NOTE

Indicates that operating the hardware or software in this manner may damage it or lead to system failure.

1.5 Packaging, Transportation and Storage

1.5.1 Packaging

The original package consists of

- Tek-CoVor 1300D Steam Quality Meter
- Documentation



NOTE

Unpack and Check the contents for damages or sign of rough handling. Report damage to the manufacturer immediately. Check the contents against the packing list provided.

1.5.2 Transportation

- Avoid impact shocks to the device and prevent it from getting wet during transportation.
- Verify local safety regulations, directives, and company procedures with respect to hoisting, rigging, and transportation of heavy equipment.
- Transport the product to the installation site using the original manufacturer's packing whenever possible.

1.5.3 Storage

If this product is to be stored for a long period of time before installation, take the following precautions:

- Store your product in the manufacturer's original packing used for shipping.
- Storage location should conform to the following requirements:
 1. Free from rain and water
 2. Free from vibration and impact shock
 3. At room temperature with minimal temperature and humidity variation
- Properties of the instrument can change when stored outdoors.

1.5.4 Nameplate

The nameplate lists the order number and other important information, such as design details and technical data.



NOTE

Check the device nameplate to ensure that the device is delivered according to your order. Check for the correct supply voltage printed on the nameplate.

2 Product Description

2.1 Introduction

The Tek-CoVor 1300D Steam Quality Meter is used to measure the steam quality. It is a combination of two-meter, i.e., modified Vortex and Cone DP Meter. This hybrid system is based on the Boden principle, which gives the mass flow, volume flow, and fluid density outputs. The correlation between density and non-density sensitive metering removes the actual dependency of density in steam measurement. The hybrid system provides actual homogeneous density and volume measurement, which offer 100% steam quality in steam measurement. The density and volume measurements are used to calculate the total mass value. Tek-CoVor 1300D Steam Quality Meter can have the DP meter verification system prognosis applied, which provides reliable steam quality (steam dryness) measurement. It is a unique, cost-effective, and highly capable system.

2.2 Measuring Principle

The Tek-CoVor 1300D Steam Quality Meter with a single-phase flow, a Vortex Meter measures the actual volumetric flow rate (Q). The Vortex Meter reads the vortex shedding frequency of the bluff body (f) and relates it through the meter factor (K) to the volume flow rate (Q), as shown in equation 1. This volumetric flow rate measurement is density insensitive.

$$Q = \frac{f}{K} \quad \text{---} \quad \textcircled{1}$$

With a single-phase flow, a differential pressure (DP) flow meter measures the volumetric flow rate once the density is supplied from an external source. The DP meter volume flow rate

calculation is density (ρ) sensitive. Equation 2 shows the Cone DP Meter volumetric flow equation, where E and A_t are fixed geometry terms, C_d is the discharge coefficient, and ΔP_t is the Cone DP Meter primary signal.

$$Q = EA_t C_d \sqrt{\frac{2\Delta P_t}{\rho}} \quad \text{---} \quad \textcircled{2}$$

As described by Boden's work in the 1950's, if a density sensitive meter (Cone DP Meter) is cross referenced with a density insensitive meter (Vortex Meter) the density can be derived internally by the system as shown in equation 3.

$$\rho = 2\Delta P_t \left\{ \frac{K}{f} EA_t C_d \right\} \quad \text{---} \quad \textcircled{3}$$

The Tek-CoVor 1300D flow rate calculation is now calculated through equation 4, where the vortex meter volumetric flow prediction (Q) and this internal density prediction (ρ) are used. No external density measurement is required.

$$m = \rho Q \quad \text{---} \quad \textcircled{4}$$

2.3 Specifications

Accuracy	Steam Quality: $\pm 5\%$ of Reading Volumetric Flow Rate: $\pm 0.7\%$ of rate (for liquids); $\pm 1.5\%$ of rate (for Dry Gas or Steam); $\pm 3\%$ of rate (for Wet Gas or Steam) Mass Flow Rate: $\pm 1\%$ of rate or ± 5 to 10% of reading Temperature: $\pm 2^\circ\text{F}$ ($\pm 1^\circ\text{C}$) Calculated Density: $\pm 0.3\%$ of reading (for liquids); $\pm 0.5\%$ of reading (for Dry Gas or Steam) Predicted Density: $\pm 0.75\%$ of reading (for liquids); $\pm 1\%$ of Reading (for Dry Gas or Steam); $\pm 4\%$ of Reading (for Wet Gas or Steam)
Repeatability	Mass Flow Rate: $\pm 0.2\%$ of rate Volumetric Flow Rate: $\pm 0.1\%$ of rate Temperature: $\pm 0.2^\circ\text{F}$ ($\pm 0.1^\circ\text{C}$) Pressure: $\pm 0.05\%$ of full scale Density: $\pm 0.1\%$ of reading
Stability	Mass Flow Rate: $\pm 0.2\%$ of rate Volumetric Flow Rate: negligible Temperature: $\pm 0.9^\circ\text{F}$ ($\pm 0.5^\circ\text{C}$) (over 12 Months) Pressure: $\pm 0.1\%$ of full scale Density: $\pm 0.1\%$ of reading

Response Time	1 to 100Seconds (Adjustable)
Operating Temperature	-40 to 140°F (-40 to 60°C)
Process Temperature	-330 to 500°F (-200 to 260°C)
Storage Temperature	-40 to 185°F (-40 to 85°C)
Pressure Rating	Full Scale Operating Pressure: 30 to 1500psi (2 to 100bar) Maximum Over Range Pressure: 60 to 2750psi (4 to 175bar)
Output Signal	Analog: 4-20 mA Alarm: Solid state relay, 40 VDC Totalizer Pulse: 50 millisecond pulse, 40 VDC Volumetric or Loop Powered Mass: One Analog, One Totalizer Pulse, HART Multivariable option: Up to Three Analog Signals, Three Alarms, One Totalizer Pulse, HART Multivariable option: Modbus, Ethernet, or BACnet process monitoring
Power Supply	DCH option: 12-36 VDC, 300mA, 9W max, (multiple outputs) AC option: 100-240 VAC, 50/60Hz line power, 5W (multiple outputs)
Display	Alphanumeric 2 line x 16 character LCD digital display Six pushbuttons for full field configuration Pushbuttons can be operated with magnetic wand without removal of enclosure covers Display can be mounted in 90° intervals for better viewing
Wetted Material	Standard 316L Stainless Steel, plus <ul style="list-style-type: none"> • Optional Carbon Steel or Hastelloy C • DuPont Teflon® based thread sealant on models with pressure transducer
Approvals	FM, FMC, ATEX, IECEx

2.4 Dimensional Drawings

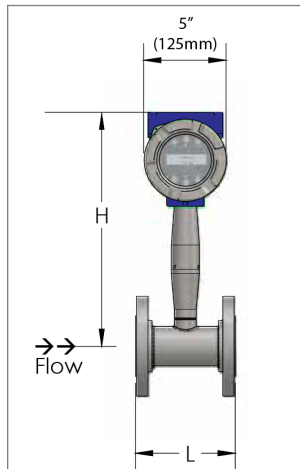

Fig 1: Front View

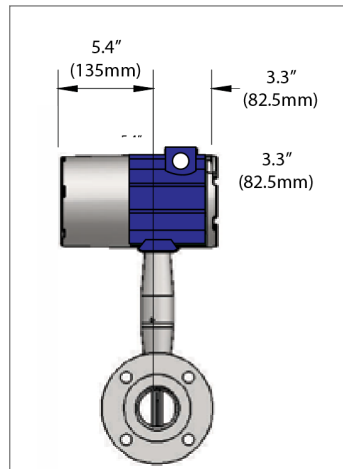

Fig 2: Side View

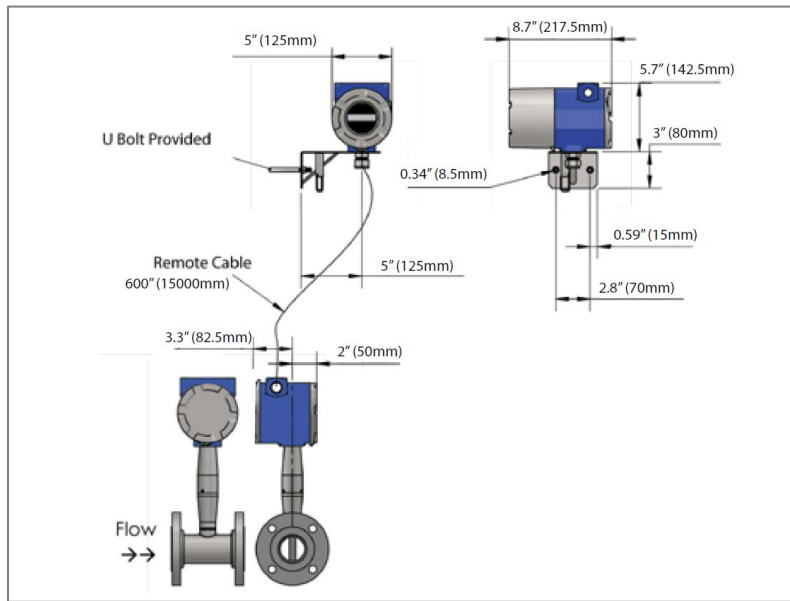

Fig 3: Tek-CoVor 1300D with FCA

2.5 Model Chart

Example	Tek-CoVor 1300D	V	050	A	A	L	DD	DCH	A	ST	01	TK	3M	2AZ	Tek-CoVor 1300D-V-050-A-A-L-DD-DCH-A-ST-01-TK-3M-2AZ
Series	Tek-CoVor 1300D														Steam Quality Meter
Multivariable Options	*For steam quality prediction must have at least a VT model vortex meter *For wet gas liquid loading prediction must have a VTP model vortex meter	V VT VTP													Mass, Density (No P & T) Steam Qv act, W/Temperature Steam Qv act, W/Pressure
Sizes			050 080 100 150 200 250 300												2" Nominal Bore 3" Nominal Bore 4" Nominal Bore 6" Nominal Bore 8" Nominal Bore 10" Nominal Bore 12" Nominal Bore
Meter Body Material				A B C											Carbon Steel 316 Stainless Steel Hastelloy
Process Connection				A B C D											ANSI 150# Flange ANSI 300# Flange ANSI 600# Flange ANSI 900# Flange
Enclosure						L									NEMA 4X IP66 Enclosure

3 Steam Quality Meter Configuration

Steam Quality Meter consists of the following measurement units:

- Tek-CoVor 1300D Meter with TCP/IP interface. Serve as a master to 3 DP meters.
 - Differential Pressure – DP1 - Primary DP Meter
 - Differential Pressure – DP2- Recovery Meter
 - Differential Pressure – DP3 - Permanent Loss Meter

Tek-CoVor 1300D Steam Quality Meter reads pressure measurements from DP meters through HART or analog interface. It calculates steam quality using DP1 values, Vortex Meter measures data and holds some constant data, such as meter geometry.

TCP meter is mounted on the Cone tube. The meter hardware and DP1 through DP3 connections are shown in figure 4.

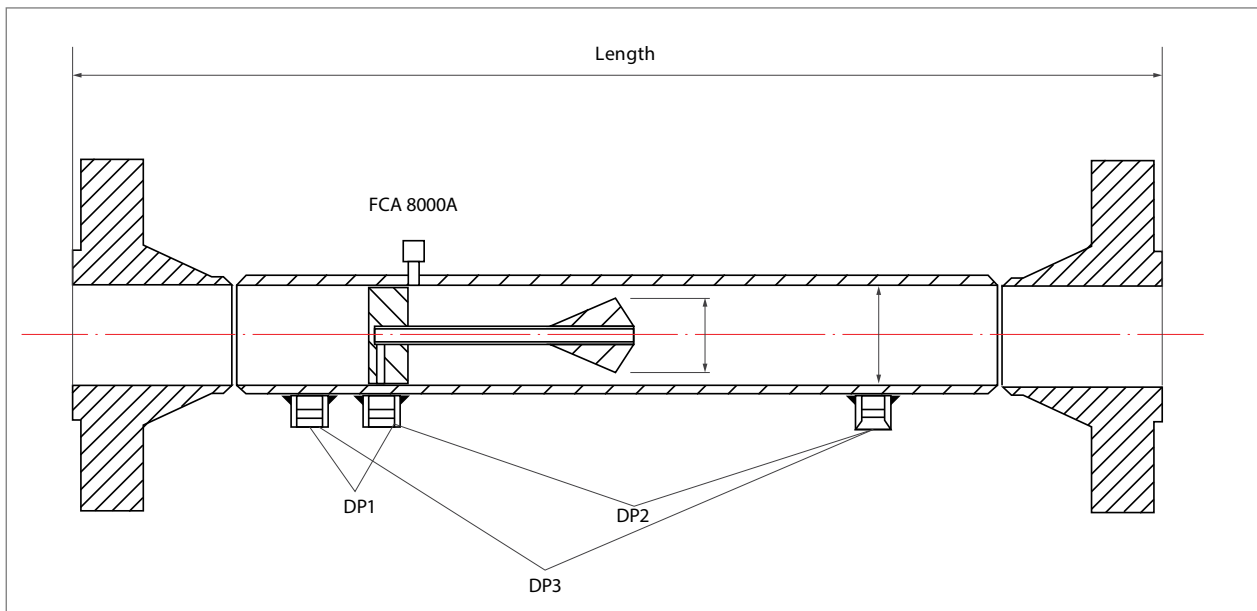

Fig 4: Meter Hardware and DP1 through DP3 Connections

4 Installation



NOTE

When the upstream pipeline is a T-type and the flowmeter and the valve downstream of the meter is shut, fluid will flow toward pipe B, however the meter may still show a reading, as it may be detecting a pulsating pressure. In this case, please close the upstream valve V1.

- Standard Installation

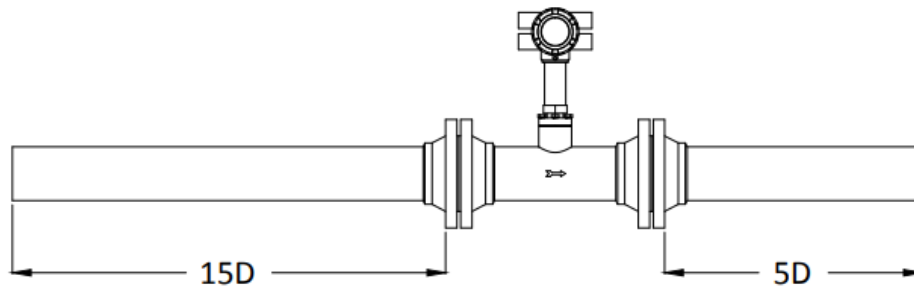

- Installation for the Pipe Reducer

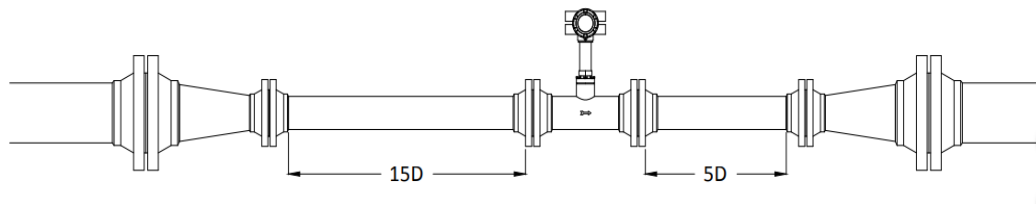

- Installation for the Pipe Expander

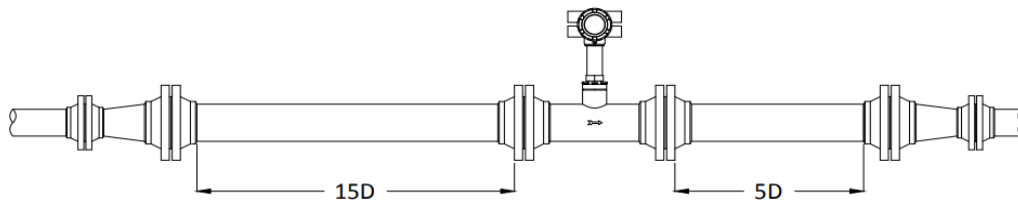

- Installation for Single Bend Pipeline

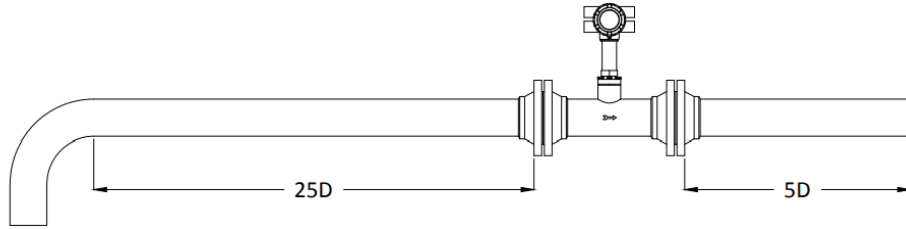

- Installation for Double Bend Pipeline

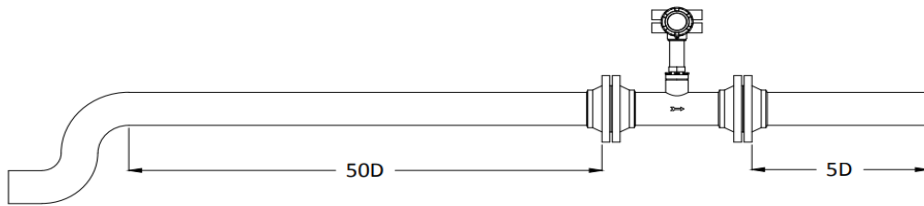

- Installation when Valve is at Downstream

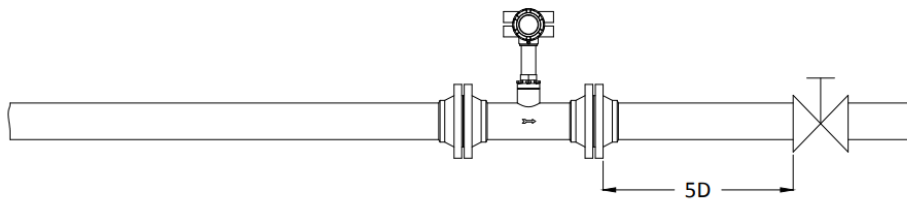

- Installation when Valve is at Upstream

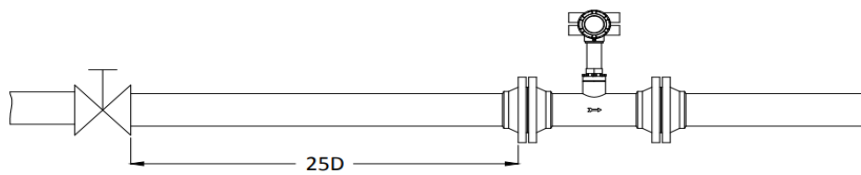

- Installation when Temperature and Pressure Sensors are at Downstream

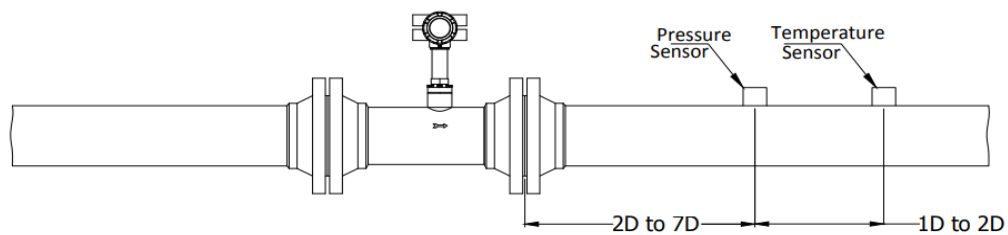

- Installation when Roots Blower, Piston Blower, or Compressor are at Upstream

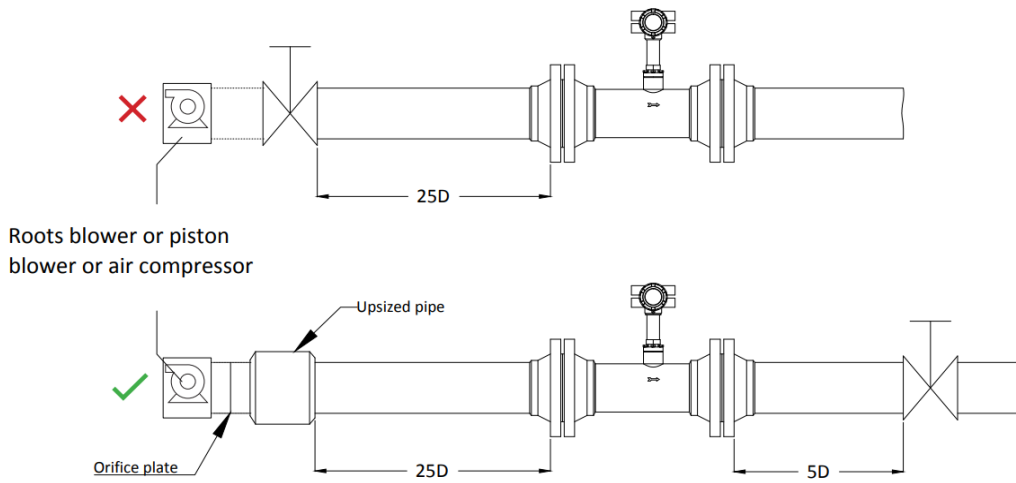

- Installation of a Flowmeter after a Piston Pump

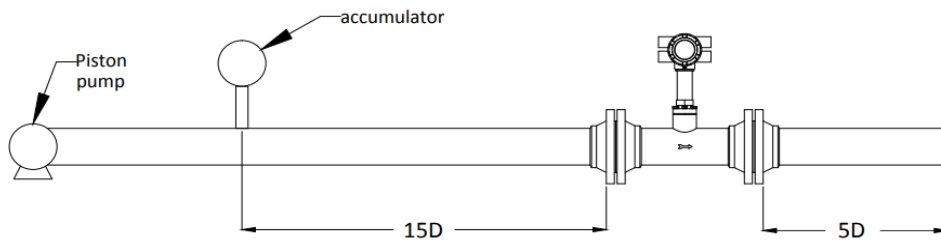

- Installation when T-type Pipeline is at Upstream

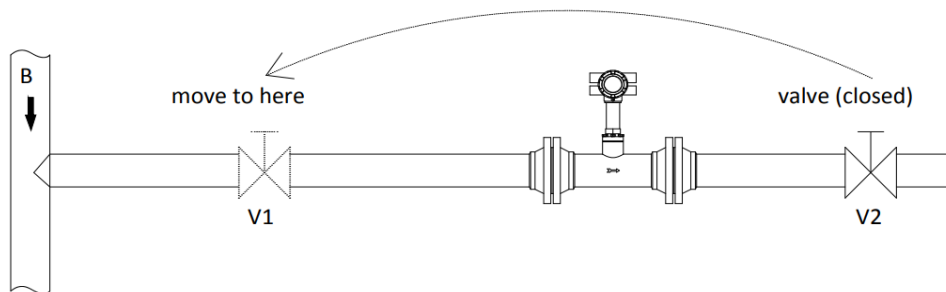

5 Tek-Trol DP Meters Wiring

Tek-Trol Tek-CoVor 1300D Steam Quality Meter consists of the following components:

- TCP meter
- Differential Pressure (DP) meters:
 - DP1
 - DP2
 - DP3

5.1 HART Connection of DP Meters

DP meters are connected to TCP meter with the HART link. Meter Option 1 connector pin 1 is connected to the DP S+ screw terminal. Options 1 connector pin 4 is connected to DP S- terminal. Pins on Option 1 connector are numbered from left to right. Pins 2 and 3 are connected. All three DP meters are connected in parallel (all S+ terminals and S- terminals are parallelly connected). For normal operation, DP1 meter is obligatory. DP2 and DP3 are optional. Terminal Block of DP meter is shown in figure 5.

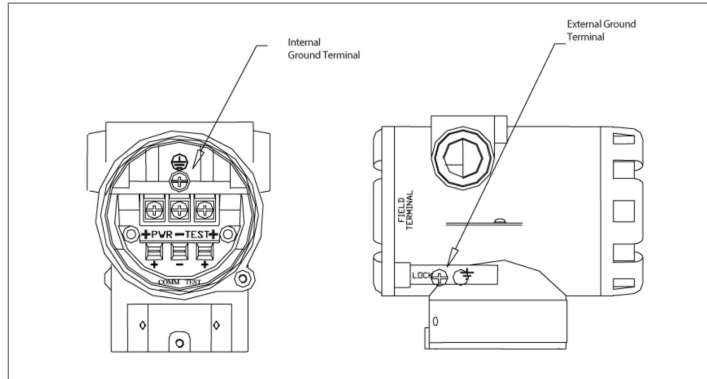

Fig 5: Terminal Block of DP Meter

Tek-Trol Meter Connectors. DC power and HART connections to DP meters is shown in figure 6:

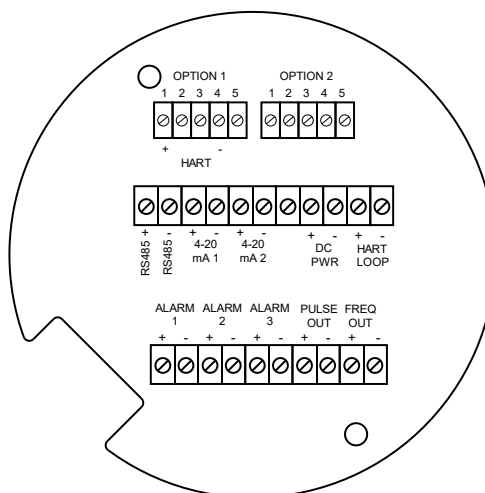

Fig 6: DC power and HART connections

5.1.1 External Analog Connection to DP meters

As an option, DP meters may be connected through analog 4-20mA input. There are two options of external analog connections:

- Using the External Input Board in the Tek-CoVor 1300D Steam Quality Meter, the board must be installed accordingly in the stack and firmware of the micro-board re-flashed. Additionally, External input must be calibrated using standard factory production procedures or external calibration input of 4 and 20mA. In this option, only DP1 can be connected. DP meter must be powered from an external power supply or the same power supply used to power the PoE. Analog 4 to 20mA output of DP should be connected to input pin 3 (-) and pin 4 (+) of Options2 connector. (pins a counted from left to right). Schematic will be provided later.
- Using external 8 channel ADC ADAM-4 117. ADC must be configured for 4-20 mA input on channels 0,2 and 2. Internal switches must be set in ADC for current measurements (in as-shipped configuration, these jumpers are in voltage configuration). Although all three DPs can be connected, only DP1 is used for quality calculations. ADC is read by the PoE RS485 link. It used default ADC settings of 9600 Baud, 1 stop, no parity. ADC must be configured to communicate Modbus/RTU and use address = 2.



NOTE

PoE does not need to be powered by DC input. It can use PoE.

5.1.2 Optional External 4 to 20 mA Input Wiring

The Tek-CoVor 1300D Steam Quality Meter is set to have Option 1 is used for the external input. Programming menus that pertain to the optional 4 to 20mA input are in the Hidden Diagnostic Menu.

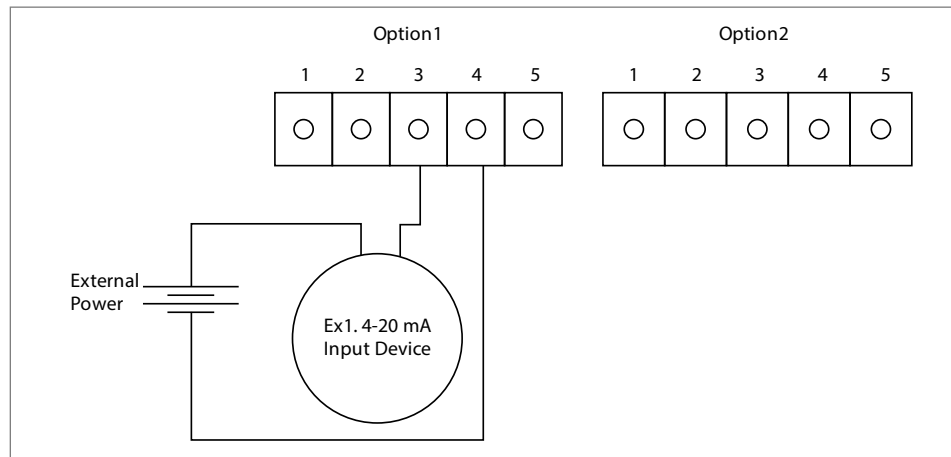

Fig 7: External 4 to 20mA Input Wiring for External Power Supply

Follow figure 7 to wire the external 4 to 20mA input into the flow meter using an external power supply.

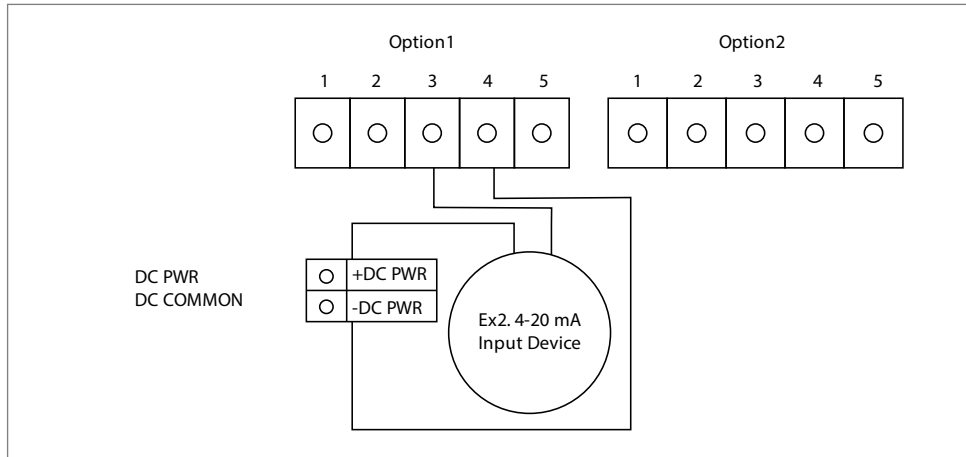

Fig 8: External 4 to 20mA Input Wiring for DC Powered Meter

5.1.3 Power UP

An external 24VDC power supply power the Tek-CoVor 1300D Steam Quality Meter. Connect +ve and -ve wires of power supply to TCP connector J1 to screw terminals marked appropriately as DC+ and DC-. External DC input must be used in the HART option because it is also used to power the HART modem and DP2. In the option of analog DP input meter may be powered by PoE. Just plug, Ethernet cable into PoE adapter or PoE enabled switch.

5.1.4 Connection to LAN

Plug Ethernet drop off the cable from your local area network switch to the RJ45 connector. As soon as you apply DC power, you should able to see LCD is showing information. You should also see the blinking yellow LED on the RJ45 connector when the CAT5 Ethernet cable is plugged and LCD of DP meters lit. DP meters show the pressure in inchH2O, which shows that system is ready for further configuration.

5.2 Vortex Key Menu



Do not open covers when an explosive atmosphere may be present.

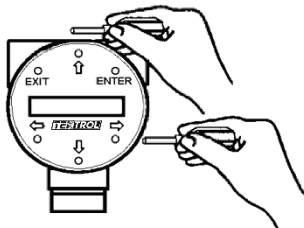

Operating Instructions

After installing the meter, you are ready to begin operation. The sections in this chapter explain the display/keypad commands, meter start-up and programming. The meter is ready to operate at start up without any special programming. To enter parameters and system settings unique to your operation, see the following pages for instructions on using the setup menus.

Flow Meter Display/Keypad

The flow meter's digital electronics allow you to set, adjust and monitor system parameters and performance. A full range of commands are available through the display/keypad. The LCD display gives 2 x 16 characters for flow monitoring and programming. The six push buttons are operable either directly on the display panel or with a hand-held magnet through the explosion-proof enclosure.

Display/Keypad Commands

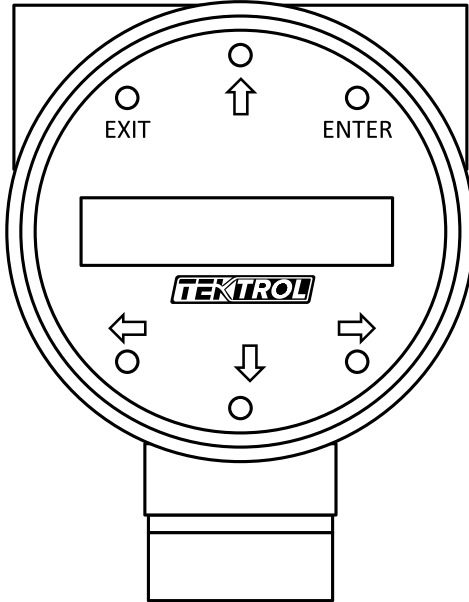

From the Run Mode, the **ENTER** key allows access to the Setup Menu (through a password screen). Within the Setup Menu, pressing **ENTER** activates the current field. To set new parameters, press the **ENTER** key until an underline cursor appears. Use the \uparrow \downarrow \leftarrow \rightarrow keys to select new parameters. Press **ENTER** to continue. (If change is not allowed, **ENTER** has no effect.) All outputs are disabled when using the Setup Menu.

The **EXIT** key is active within the Setup Menu. When using a Setup Menu, **EXIT** returns you to the Run Mode. If you are changing a parameter and make a mistake, **EXIT** allows you to start over.

The \uparrow \downarrow \leftarrow \rightarrow keys advance through each screen of the current menu. When changing a system parameter, all \uparrow \downarrow \leftarrow \rightarrow keys are available to enter new parameters.

Display Contrast Adjustment

The flow meter display contrast is set at the factory but if the display characters appear too dark or too light proceed as follows:

- 1) Hold down the "Exit" button on the front panel for 5 to 10 seconds. "Setting Contrast" will appear.
- 2) Push the "Up" arrow to darken the display or the "Down" arrow to lighten it.
- 3) Push the "Enter" button to save the contrast setting.

Start-Up

To begin flow meter operation:

1. Verify the flow meter is installed and wired as described in Chapter
2. Apply power to the meter. At start up, the unit runs a series of self-tests that check the program configuration and all flow sensing components. After completing the self-test sequence, the Run Mode screens appear.
3. The Run Mode displays flow information as determined by settings entered in the Display Menu (page 23). Press the \uparrow \downarrow arrow keys to view the Run Mode screens.

Press the ENTER key from any Run Mode screen to access the Setup Menu. Use the Setup Menu to configure the meter's multi-parameter features to fit your application.

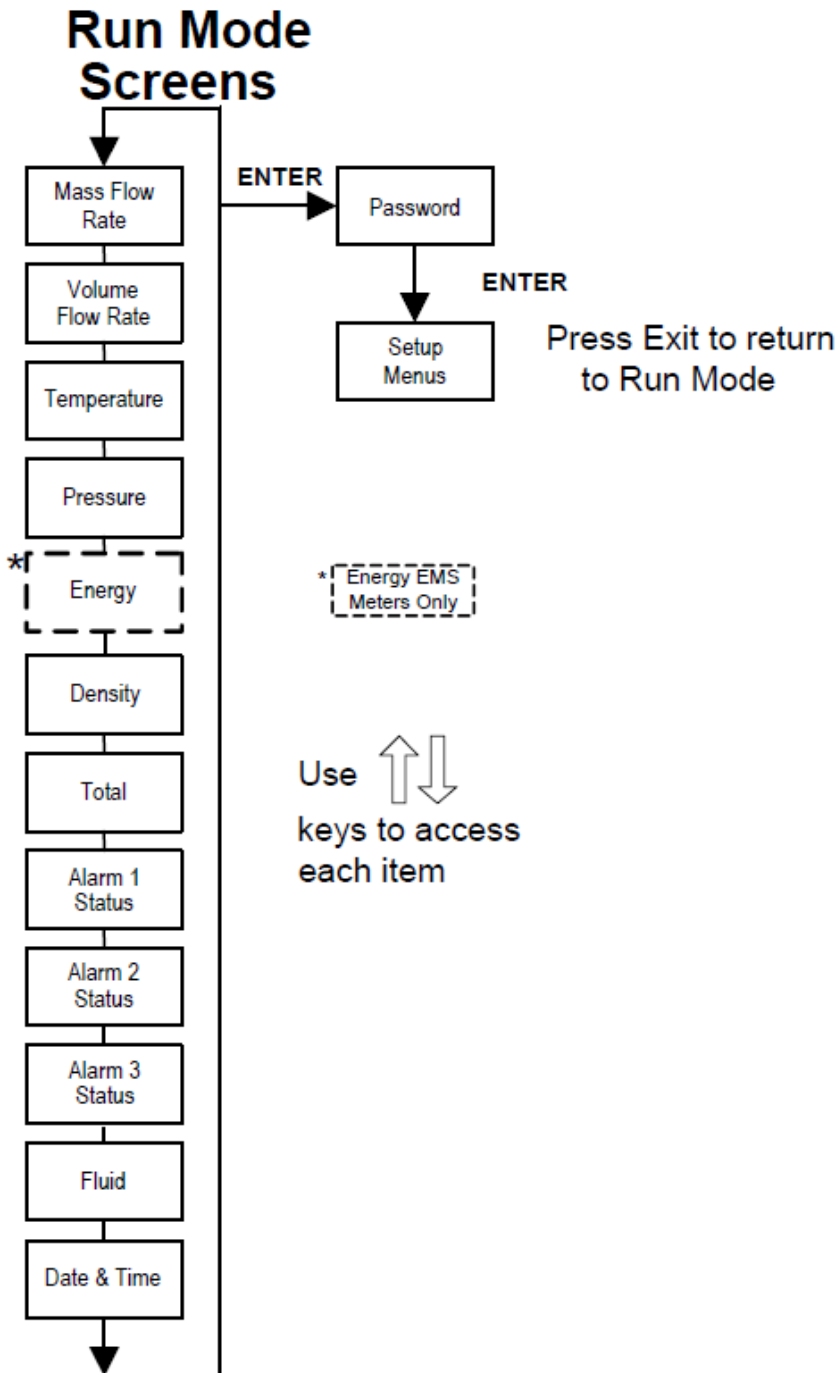

Using the Setup Menus

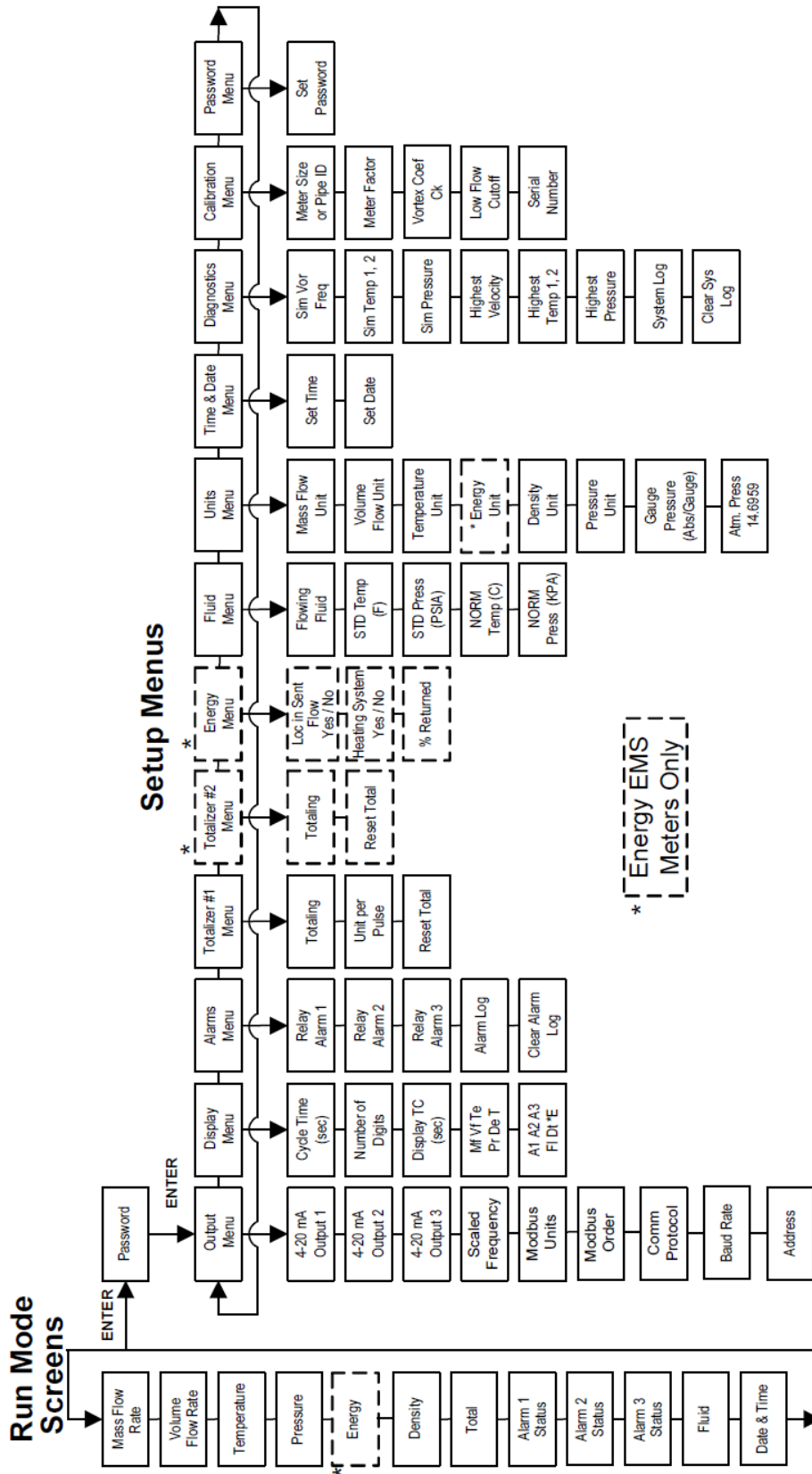

Programming the Flow Meter

1. Enter the Setup Menu by pressing the ENTER key until prompted for a password. (All outputs are disabled while using the Setup Menus.)
2. Use the $\leftarrow\rightarrow$ keys to select the password characters (1234 is the factory-set password). When the password is correctly displayed, press ENTER to continue.
3. Use the Setup Menus described on the following pages to customize the multiparameter features of your meter. (The entire lower display line is available for entering parameters.)
4. To activate a parameter, press ENTER. Use the $\uparrow\downarrow\leftarrow\rightarrow$ keys to make selections. Press ENTER to continue. Press EXIT to save or discard changes and return to Run Mode.

Output Menu

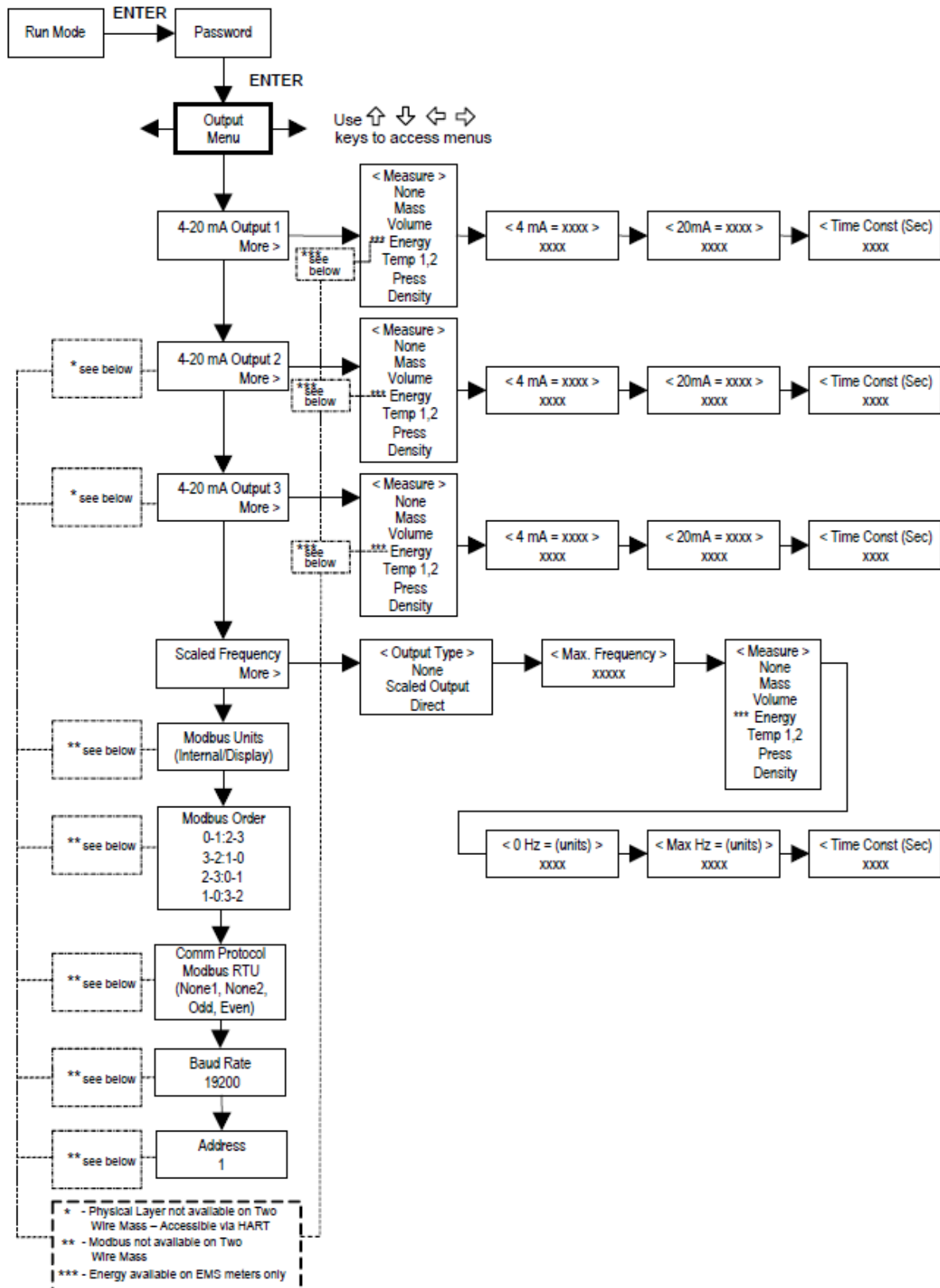

Example for Setting an Output

The following shows how to set Output 1 to measure mass flow with 4 mA = 0 lb/hr and 20 mA = 100 lb/hr with a time constant of 5 seconds. (All outputs are disabled while using the Setup Menus.)

First, set the desired units of measurement:

1. Use $\leftarrow\rightarrow$ keys to move to the Units Menu (see page 29).
2. Press \downarrow key until Mass Flow Unit appears. Press ENTER.
3. Press \downarrow key until lb appears in the numerator. Press \rightarrow key to move the underline cursor to the denominator. Press the \downarrow key until hr appears in the denominator. Press ENTER to select.
4. Press \uparrow key until Units Menu appears.

Second, set the analog output:

1. Use $\leftarrow\rightarrow$ keys to move to the Output Menu.
2. Press the \downarrow key until 4-20 mA Output 1 appears.
3. Press \rightarrow key to access Measure selections. Press ENTER and press the \downarrow key to select Mass. Press ENTER.
4. Press \rightarrow key to set the 4-mA point in the units you have selected for mass of lb/hr. Press ENTER and use $\uparrow\downarrow\leftarrow\rightarrow$ keys to set 0 or 0.0. Press ENTER.
5. Press \rightarrow key to set the 20-mA point. Press ENTER and use $\uparrow\downarrow\leftarrow\rightarrow$ keys to set 100 or 100.0. Press ENTER.
6. Press \rightarrow key to select the Time Constant. Press ENTER and use $\uparrow\downarrow\leftarrow\rightarrow$ keys to select 5. Press ENTER.
7. Press the EXIT key and answer YES to permanently save your changes.

Example for Calculating Output Current

Assume Output 1 is scaled as above for mass flow with 4 mA = 0 lb/hr and 20 mA = 100 lb/hr.

Output 1 current = $((\text{Flow rate} / 100) \times 16 \text{ mA}) + 4 \text{ mA}$

Display Menu

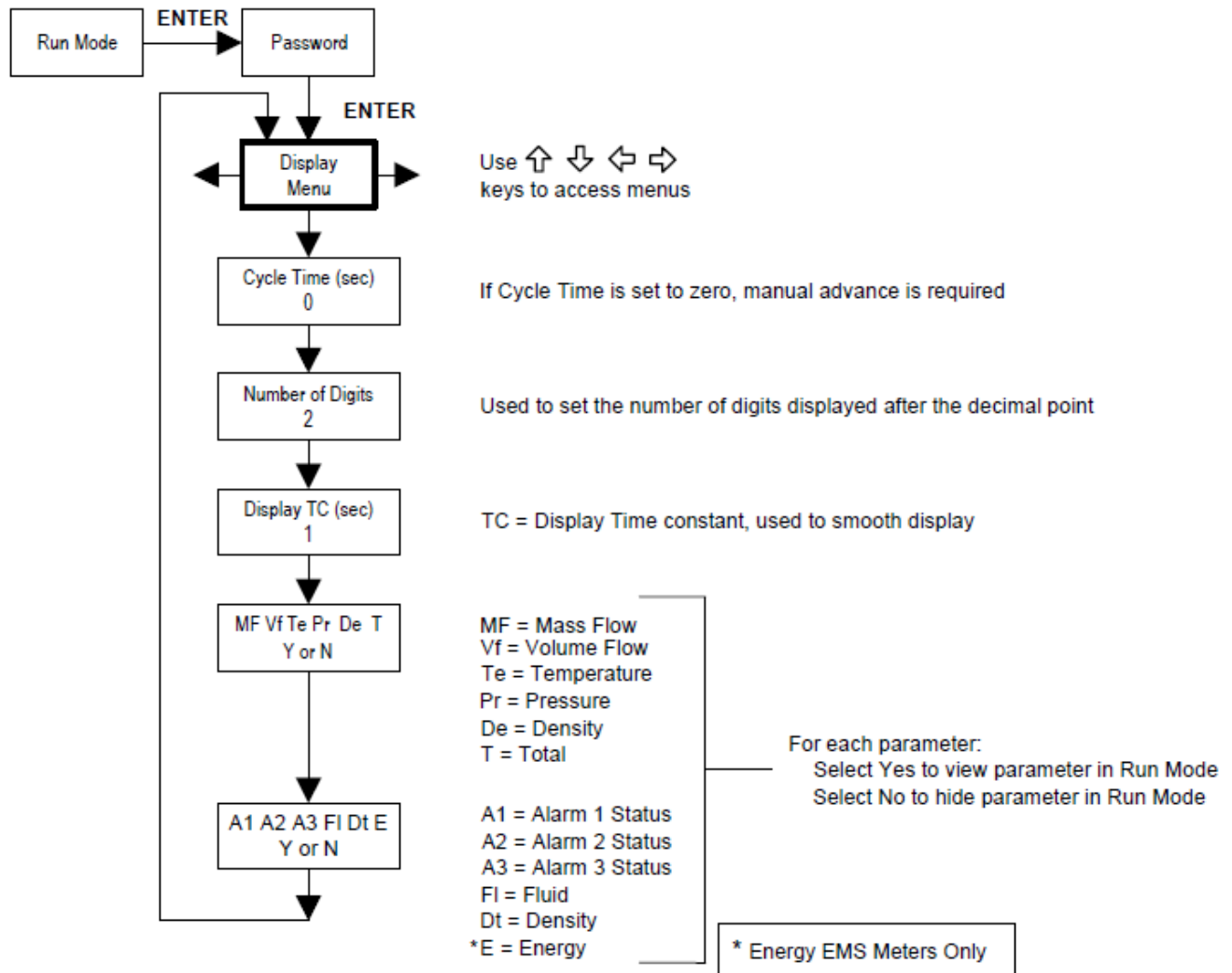

Use the Display Menu to set the cycle time for automatic screen sequencing used in the Run Mode, change the precision of displayed values, smooth the values or enable or disable each item displayed in the Run Mode screens.

Example for Changing a Run Mode Display Item

The following shows how to remove the mass flow screen from the Run Mode screens. Note: all outputs are disabled while using the Setup Menus.

1. Use ←→ keys to move to the Display Menu.
2. Press ↓ key until Display MFlow? appears.
3. Press ENTER to select.
4. Press ↓ key until N appears. Press ENTER to select.
5. Press EXIT and then ENTER to save changes and return to the Run Mode.

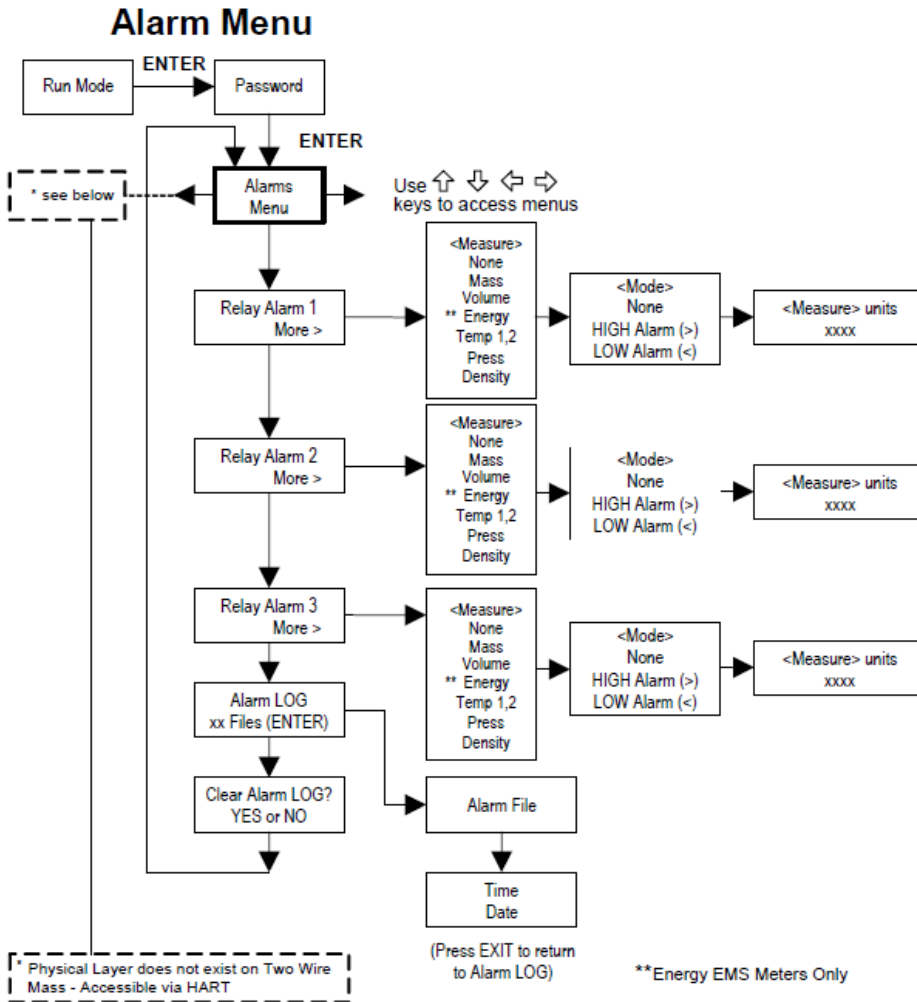

Example for Setting an Alarm

The following shows how to set Relay Alarm 1 to activate if the mass flow rate is greater than 100 lb/hr. You can check the alarm configuration in the Run Mode by pressing the ↑↓ keys until Alarm [1] appears. The lower line displays the mass flow rate at which the alarm activates. Note: all outputs are disabled while using the Setup Menus.

First, set the desired units of measurement:

1. Use ⇐⇒ keys to move to the Units Menu (see page 29).
2. Press ↓ key until Mass Flow Unit appears. Press ENTER.
3. Press ↓ key until lb appears in the numerator. Press ⇐ key to move the underline cursor to the denominator. Press the ↓ key until hr appears in the denominator. Press ENTER to select.
4. Press ↑ key until Units Menu appears.

Second, set the alarm:

1. Use ⇐⇒ keys to move to the Alarms Menu.
2. Press the ↓ key until Relay Alarm 1 appears.

3. Press ⇨ key to access Measure selections. Press ENTER and use the ↓ key to select Mass. Press ENTER.
4. Press ⇨ key to select the alarm Mode. Press ENTER and use ↓ key to select HIGH Alarm. Press ENTER.
5. Press ⇨ key to select the value that must be exceeded before the alarm activates. Press ENTER and use ↑ ↓ ⇐ ⇒ keys to set 100 or 100.0. Press ENTER.
6. Press the EXIT key to save your changes. (Alarm changes are always permanently saved.)
7. (Up to three relay alarm outputs are available depending on meter configuration.)

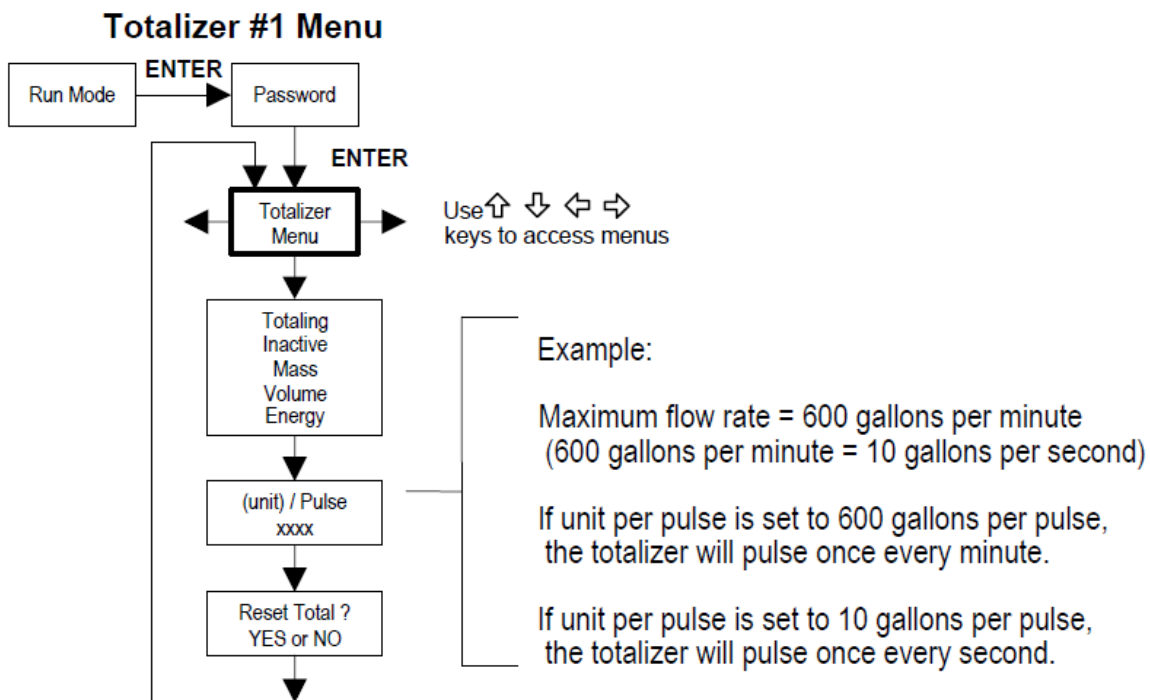

Use the Totalizer Menu to configure and monitor the totalizer. The totalizer output is a 50 millisecond (.05 second) positive pulse (relay closed for 50 milliseconds). The totalizer cannot operate faster than one pulse every 100 milliseconds (.1 second). A good rule to follow is to set the unit per pulse value equal to the maximum flow in the same units per second. This will limit the pulse to no faster than one pulse every second

Example for Setting the Totalizer

First, set the desired units of measurement:

1. Use ⇐ ⇒ keys to move to the Units Menu (see page 29).
2. Press ↓ key until Mass Flow Unit appears. Press ENTER.
3. Press ↓ key until kg appears in the numerator. Press ⇨ key to move the underline cursor to the denominator. Press the ↓ key until sec appears in the denominator. Press ENTER to select.
4. Press ↑ key until Units Menu appears.

Second, set the pulse output:

1. Use $\leftarrow\rightarrow$ keys to move to the Totalizer Menu.
2. Press the \downarrow key until Totalling appears.
3. Press ENTER and press the \downarrow key to select Mass. Press ENTER.
4. Press \downarrow key to set the pulse output in the units you have selected for mass flow of kg/sec. Press ENTER and use $\uparrow\downarrow\leftarrow\rightarrow$ keys to set the pulse value equal to the maximum flow in the same units per second. Press ENTER.
5. To reset the totalizer, press \downarrow key until Reset Total? appears. Press ENTER and the \downarrow key to reset the totalizer if desired. Press ENTER.

Press the EXIT key and answer YES to permanently save your changes

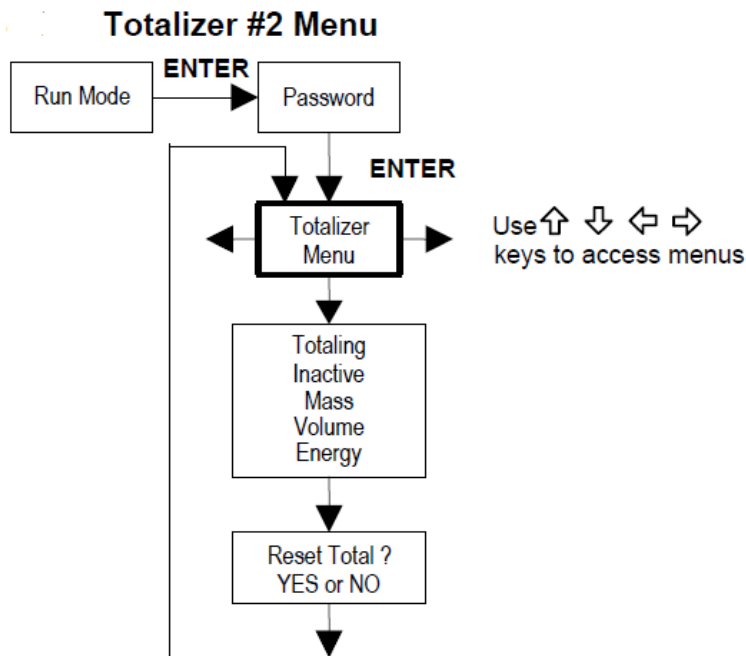

Use the Totalizer #2 to Monitor Flow or Energy. Note that Totalizer #2 does not operate a relay, it is for monitoring only.

Energy Menu – For EMS Energy Meters Only

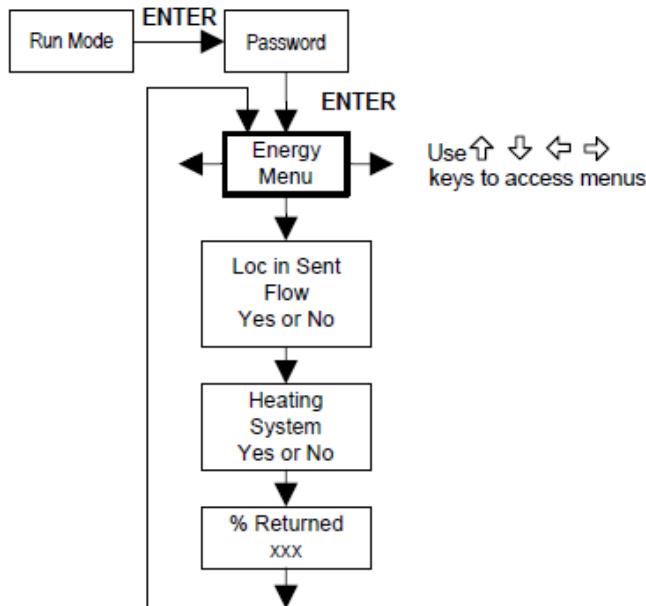

Configuration:

There are several possibilities regarding the measurement of water or steam energy given the location of the meter and the use of a second RTD. The table below summarizes the possibilities:

Fluid	Meter Location	Second RTD	Measurement
Water	"Sent" Flow Line	"Return" Flow Line	Change in Energy
Water	"Return" Flow Line	"Sent" Flow Line	Change in Energy
Water	"Sent" Flow Line	None	Outgoing Energy
Steam	"Sent" Flow Line	"Return" Flow Line (condensate)	Change in Energy
Steam	"Sent" Flow Line	None	Outgoing Energy

As above, you must properly configure the meter in the Energy Menu.

1. Loc in Sent Flow? Select Yes or No based on where the meter is located. Refer to the above table
2. Heating System? Select Yes for a hot water system used for heating. Select No for a chilled water system used for cooling. Always select Yes for a steam system.
3. % Returned. Select a number between 0% and 100%. Estimate the amount of water that returns. It is usually 100%, or can be less than 100% if historical data shows the amount of makeup water used. If a second RTD is not used, set to 0%. When 0% is selected, the energy calculation represents the outgoing energy only (no return energy is subtracted).

NOTE: the meter ships from the factory assuming 0% return and has a 1000ohm resistor installed in the RTD #2 wiring location. This needs to be removed if the meter is to be used in a manner other than with 0% return and with the customer supplied RTD in its place.

Fluid Menu

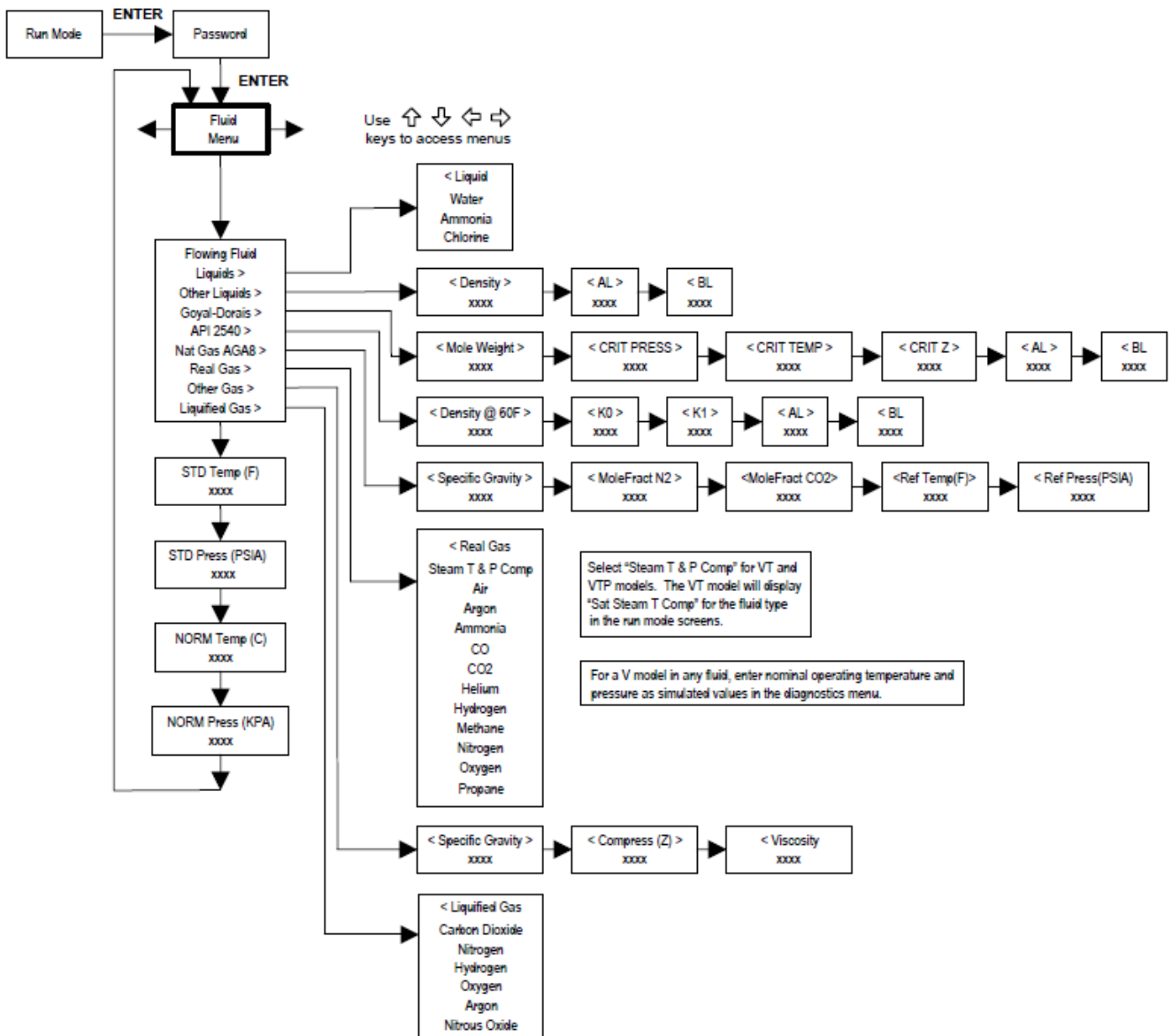

Use the Fluid Menu to configure the flow meter for use with common gases, liquids and steam. Your flow meter is pre-programmed at the factory for your application's process fluid.

The units of measurement used in the Fluid Menu are preset and are as follows:
Mole Weight = $\text{lb}_m/(\text{lb}_m \cdot \text{mol})$, CRIT PRESS = psia, CRIT TEMP = °R, Density = Kg/m^3 and Viscosity = cP (centipoise).

Units Menu

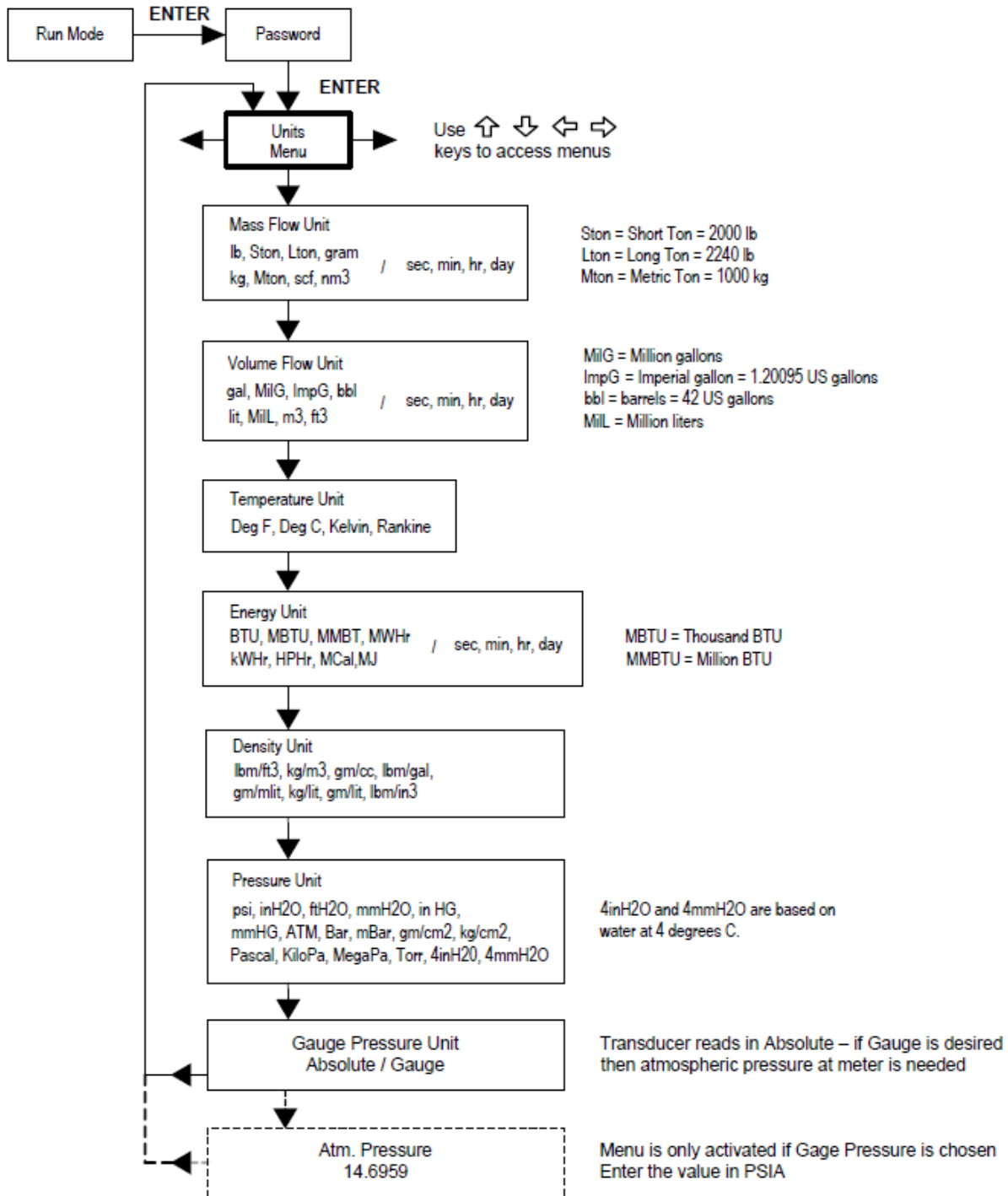

Use the Units Menu to configure the flow meter with the desired units of measurement. (These are global settings and determine what appears on all screens.)

Time & Date Menu

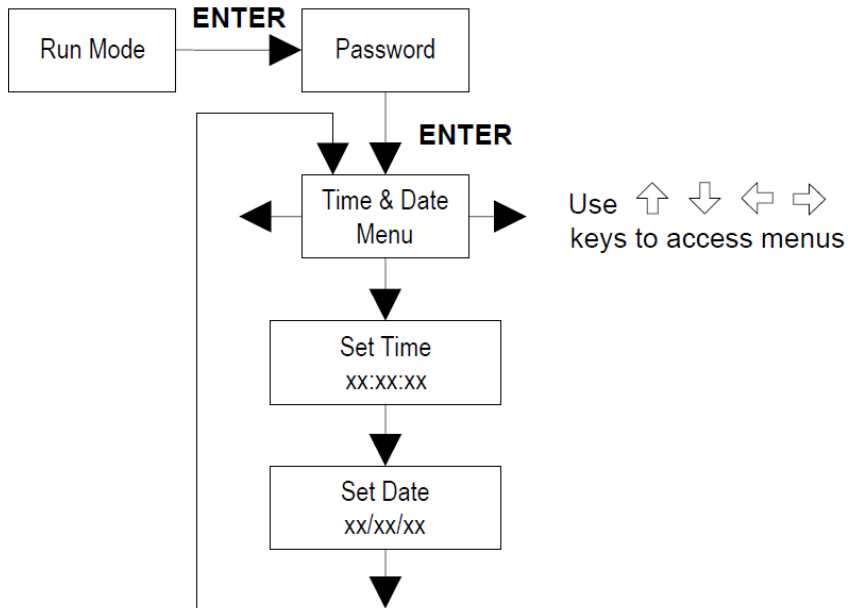

Use the Time and Date Menu to enter the correct time and date into the flow meter's memory. The parameters are used in the Run Mode and the alarm and system log files.

Note: Time is displayed in AM/PM format, but military format is used to set the time. For example, 1:00 PM is entered as 13:00:00 in the Set Time menu.

Example for Setting the Time

How to set the time to 12:00:00. You can check the time in the Run Mode by pressing the keys until the Time & Date screen appears. Note: all outputs are disabled while using the Setup Menus.

1. Use keys to move to the Time and Date Menu.
2. Press key until Set Time appears. Press ENTER.
3. Press key until 1 appears. Press key to move the underline cursor to the next digit. Press the key until 2 appears. Continue sequence until all desired parameters are entered. Press ENTER to return to the Time and Date Menu.
4. Press **EXIT** to return to the Run Mode.

Diagnostics Menu

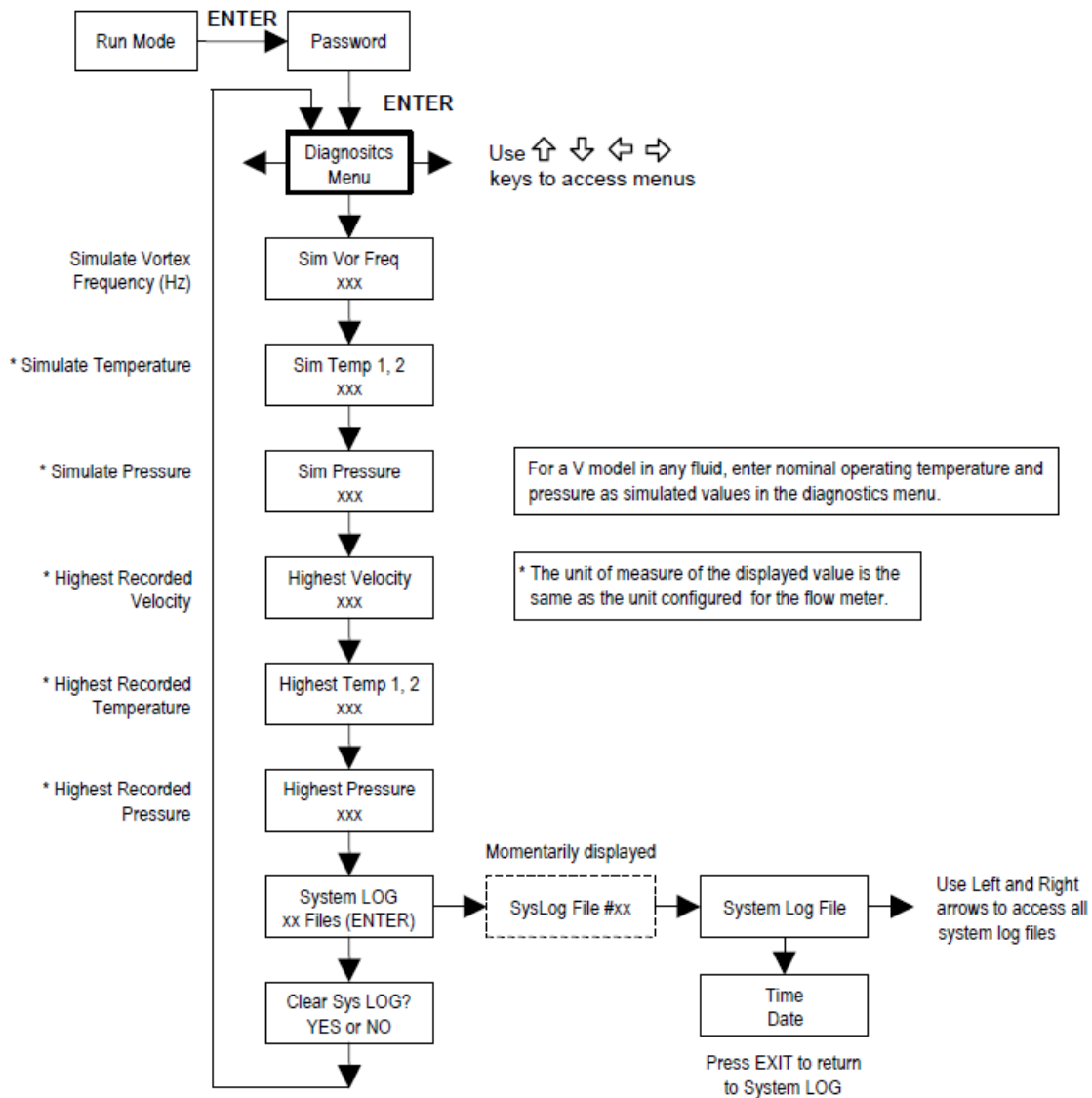

Use the Diagnostics Menu to simulate operation and review the system files. The system log files contain time/date stamped messages including: power on, power off, programming time outs, parameter faults, incorrect password entry and other various information relative to system operation and programming.

The simulated inputs are for testing the meter to verify that the programming is correct. They are also used to enter nominal operating temperature and pressure for the V only model. Simulated vortex frequency allows you to enter any value for the sensor input in Hz. The meter will calculate a flow rate based on the corresponding value and update all analog outputs (**the totalizer display and output is not affected by a simulated frequency**). The simulated pressure and temperature settings work the same way. The meter will output these new values and will use them to calculate a new density for mass flow measurement. Note: when your diagnostic work is complete, make

sure to return the values to zero to allow the electronics to use the actual transducer values. For the V only model keep the temperature and pressure at nominal operating conditions. If the meter display indicates a temperature or pressure fault, a substitute value can be entered to allow flow calculations to continue at a fixed value until the source of the fault is identified and corrected. The units of measure of the displayed values are the same as the units configured for the flow meter.

Menu Calibration

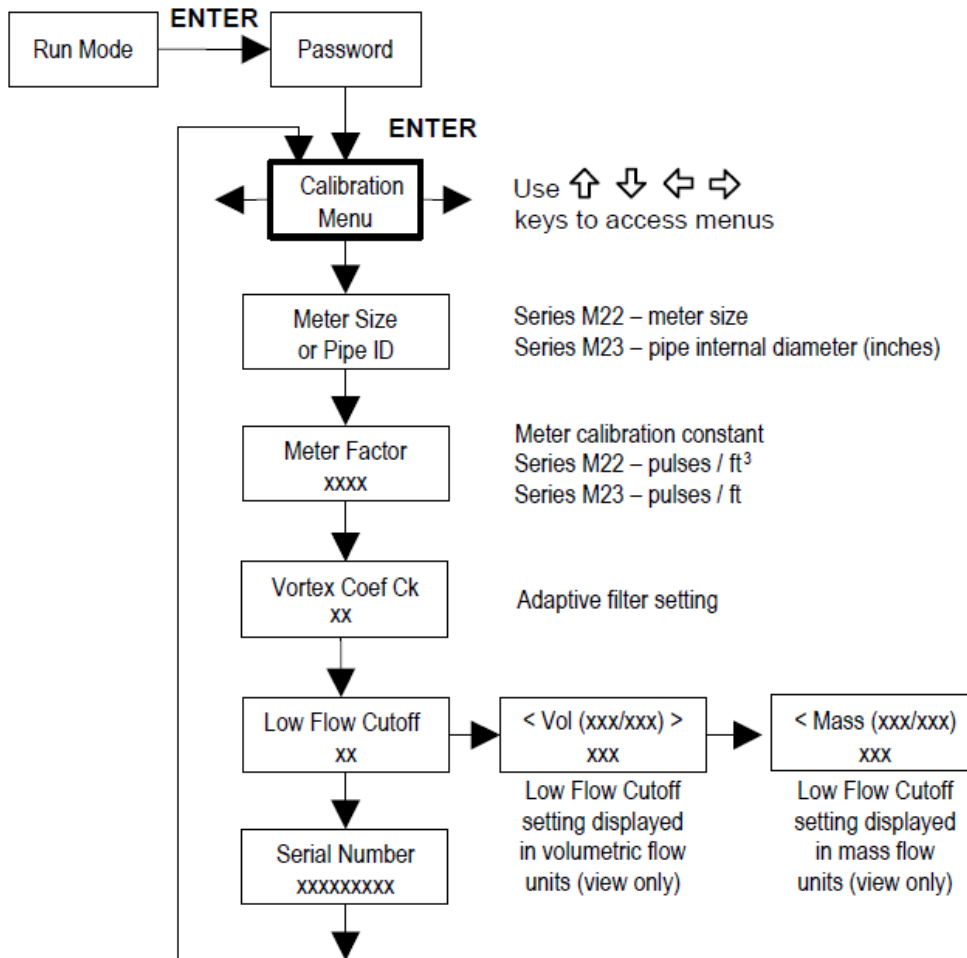

The Calibration Menu contains the calibration coefficients for the flow meter. These values should be changed only by properly trained personnel. The Coef Ck and Low Flow Cutoff are set at the factory. Consult the factory for help with these settings if the meter is showing erratic flow rate.

Password Menu

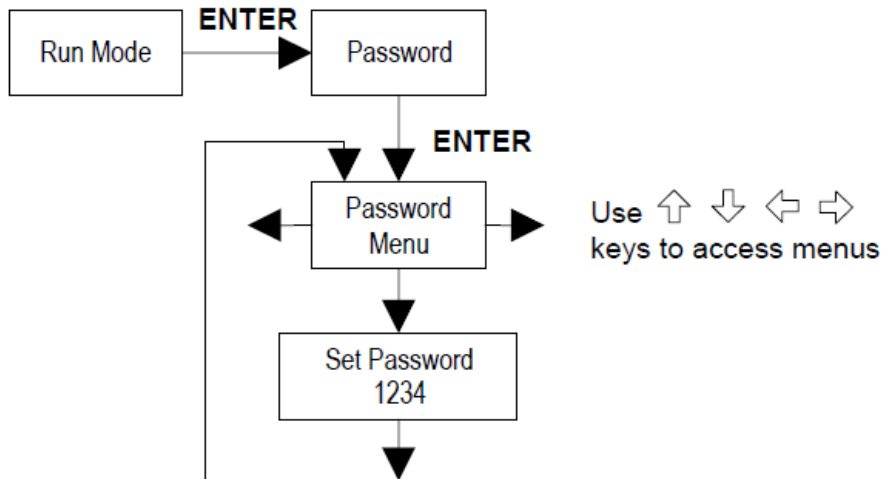

Use the Password Menu to set or change the system password. The factory-set password is 1234.

6 Network Configuration

The Tek-CoVor 1300D Steam Quality Meter needs to be configured to be "visible" on your local network. There are two methods of configuration:

- using static IP address
- using dynamically assigned IP address via DHCP (Dynamic Host Configuration Protocol)

For static configuration ask your network administrator which IP address to use. For industrial automation applications the preferable method is using static IP address.

6.1 IPSetup Network Configuration Tool

IPSetup is used to configure network settings on your device such as IP Address, Mask, Gateway, DNS Server. IPSetup uses a UDP broadcast on port 20034 to identify network devices when activated within your system. Routers do not forward UDP transmissions. Therefore, IPSetup can only be used on a local area network or the direct link. You need to run it on a PC connected to the same switch as your device. This is related to configuration only.

IPSetup is commonly used for:

- Determining the DHCP assigned IP address of your device.
- Configuring the network settings of your device.

IPSetup can be downloaded from the file system or we can provide on USB flash drive. It can be run on any Windows or Linux machine under Windows emulator WINE.

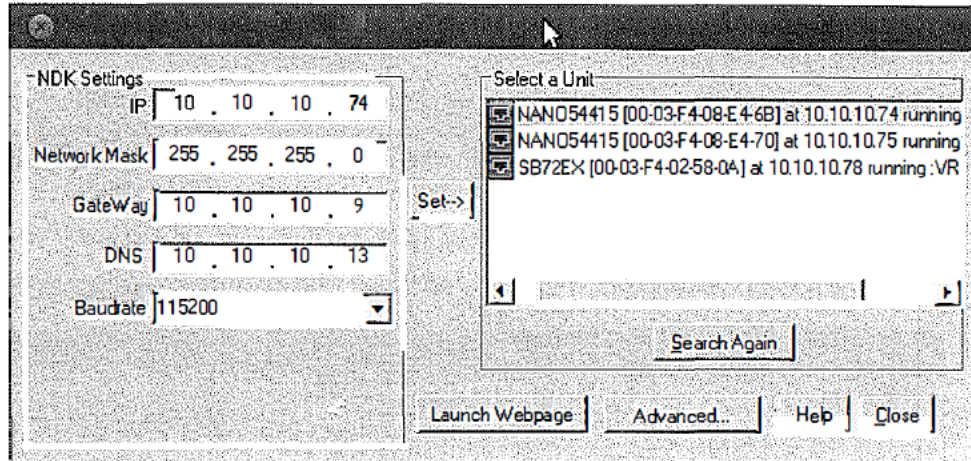

Fig 9: IPSetup Network Configuration

6.1.1 Using IPSetup

To configure a device with IPSetup steps are the following:

- The device must be on the same local area network or be a direct connection to your PC.
- Your PC's firewall must allow network traffic on port number 20034. If you do not see your device, then temporarily disabling your firewall first to see if that is the cause.
- Click on a device in the "Select a Unit" window.
- Enter your configuration settings in the "NDK Settings" group.
- An IP address of 0.0.0.0 instructs your device to use DHCP.
- Once you have specified all your configuration settings, click on the "Set" button to transmit them to your device.
- The DHCP assigned address or static IP address will appear in the description next to each device in selecting a unit window.

6.1.2 IPSetup Does Not Display Your Device

If IPSetup does not display your system, this is one of the following reasons:

- A firewall on your PC is blocking the network port number 20034. Try to disable your firewall temporarily to see if this is the cause.
- You are trying to talk to a device on the other side of a router. The PC and device must be on the same LAN.

6.1.3 IPSetup FAQ

- Setting the IP address to 0.0.0.0 forced the application to use DHCP instead of a static address.
- IPSetup shows the name of the application, as shown in figure 10. The name is composed of the last 4 HEX digits of the unit's MAC address, for example - E46B. This default Unit name is set as the so-called NetBios name. You may access the Unit by this name by typing it in the WEB browser's address field, like <http://E46B>. This name may be changed on the Configuration page of Unit's WEB Page.

- Besides IP, Network Mask, Gateway and DNS, do not change any other parameters, such as UART, delay, baud rate, etc.
- Gateway is necessary if you plan to access devices from the Internet or other subnets of your local network. It is recommended to provide the correct Gateway address. DNS is necessary only if access to the Internet is needed for the device in the case, for example, accessing Network Time Servers (not enabled in the current version of firmware). It may be set as 0.0.0.0.
- This configuration needs to be done only once at initial commissioning on the customer's network.
- The static configuration could be done with a direct connection with Ethernet crossover cable to your PC.

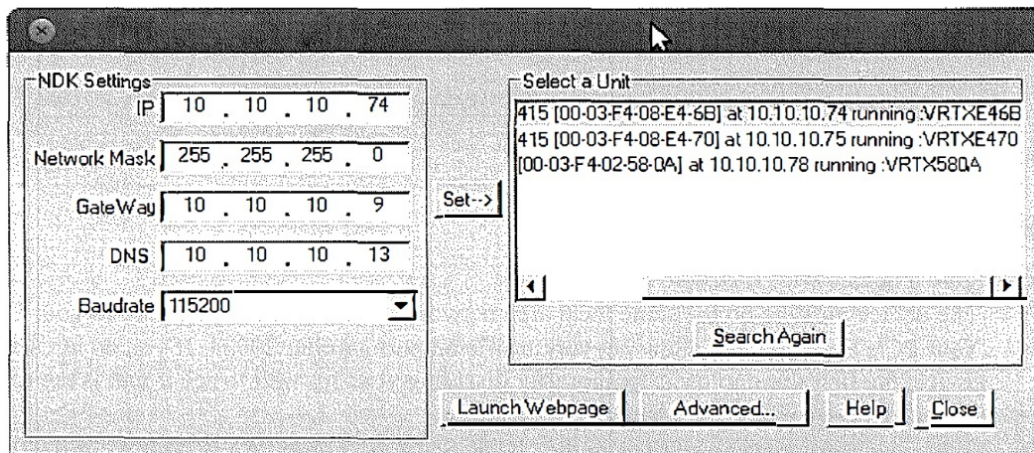

Fig 10: IPSetup for Static Address Setting

7 Meter Web Pages

The Tek-CoVor 1300D Steam Quality Meter has an internal WEB server to provide real-time measurement information and configuration interface.

The Tek-CoVor 1300D Steam Quality Meter supports two protocols for accessing the WEB pages as follows:

- HTTP - insecure connection to TCP port 80
- HTTPS - secure connection to configuration pages on TCP port 443

It is possible to connect to all pages using HTTPS instead of HTTP. The assumption is that measurement data does not need to be secure, while configuration must always be encrypted.

7.1 Main Web Page

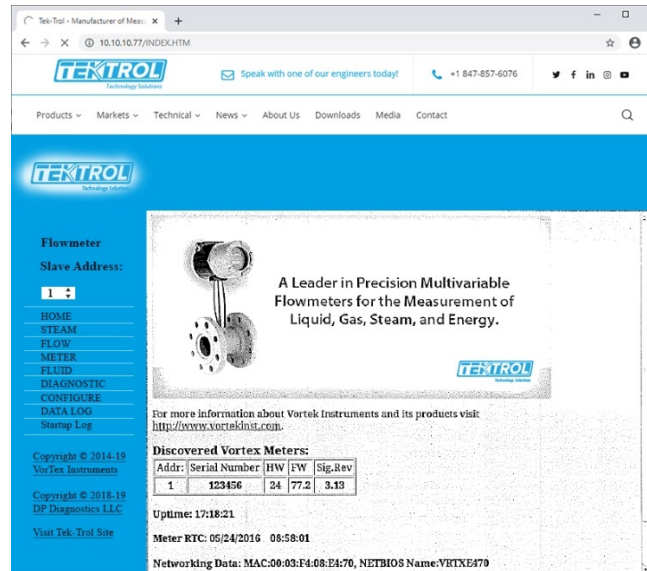

Fig 11: Main WEB Page

The main WEB page shows the menu on the left. When powered up the meter, it scans for connected meters first. This version is intended for master/slave configuration with multiple meters connected to a single gateway. Typically, this Slave Address selector is not used and there is always only one selection possible.

7.2 Steam Web Page

The main page for Steam Quality Meter is invoked by the menu link "STEAM".

This page shows readings from three Differential Pressure meters, i.e., DP1, DP2 and DP3. Only DP1 readings are essential for steam quality calculations. The meter scans the HART line for the presence of DP meters. In this table also shown variables read from Vortex Meter. The same values may be monitored on the FLOW page. All the steam values use fixed units. The units of all other Vortex values can be configured.

The page is automatically refreshed every 4 seconds. The calculations of steam values are done at about the same time interval.

Flowmeter
Slave Address:
1

HOME
STEAM
FLOW
METER
FLUID
DIAGNOSTIC
CONFIGURE
DATA LOG
Startup Log

Copyright © 2014-19
VorTex Instruments
Copyright © 2018-19
DP Diagnostics LLC
Visit Tek-Trol Site

TEK-TROL WEB Interface for Steam

Uptime	02:52:30		
Steam Values	Instant	Average	Units
DP1 Ext ADC	17.39	17.52	inH ₂ O
DP2 Ext ADC	13.41	13.41	inH ₂ O
DP3 Ext ADC	4.05	4.051	inH ₂ O
Sum of DP2 and DP3	17.46	17.46	inH ₂ O
Quality by Pressure	0	0	%
Quality by Temperature	0	0	%
Density of Mixture	0	0	lbm/ft ³
Mass Flow	0	0	lbb/day
Expansion Factor (Y)	0.9948	0.9948	
Density of Sat Steam [T]-[P]	0.001153	0.08336	lbm/ft ³
STDEV DP1 [T]-[P]	0	0.265	
Area of Throat (At)	0.0001267		m ²
Vortex Values			
Volume Flow	0		gal/min
Static Pressure	34.7		PSI (A)
Temperature	70		*F

Differential Pressure Meter

Fig 12: Steam Web Page

7.3 Vortex Meter Web Pages

Flowmeter
Slave Address:
1

HOME
STEAM
FLOW
METER
FLUID
DIAGNOSTIC
CONFIGURE
DATA LOG
Startup Log

Copyright © 2014-19
VorTex Instruments
Copyright © 2018-19
DP Diagnostics LLC
Visit Tek-Trol Site

Flow Parameters

Flowmeter WEB Interface	VRTX_0.42 SSL	
Calling IP	10.10.10.198	
Device IP	10.10.10.77	
Slave Address	== 1 ==	
Uptime	1 days 22:48:10	
Flow Values		
Mass Flow	19029.9	lb/hr
Volume Flow	52.5224	gal/min
Pressure	1233.8	PSI
Temperature 1	562.09	°F
Fluid Density	45.1724	lbm/ft ³
Fluid Viscosity	0.092644	
Flow Totalizer	0	
Flow Total Qty per Pulse	1000	

Fig 13: Vortex Meter Web Page1

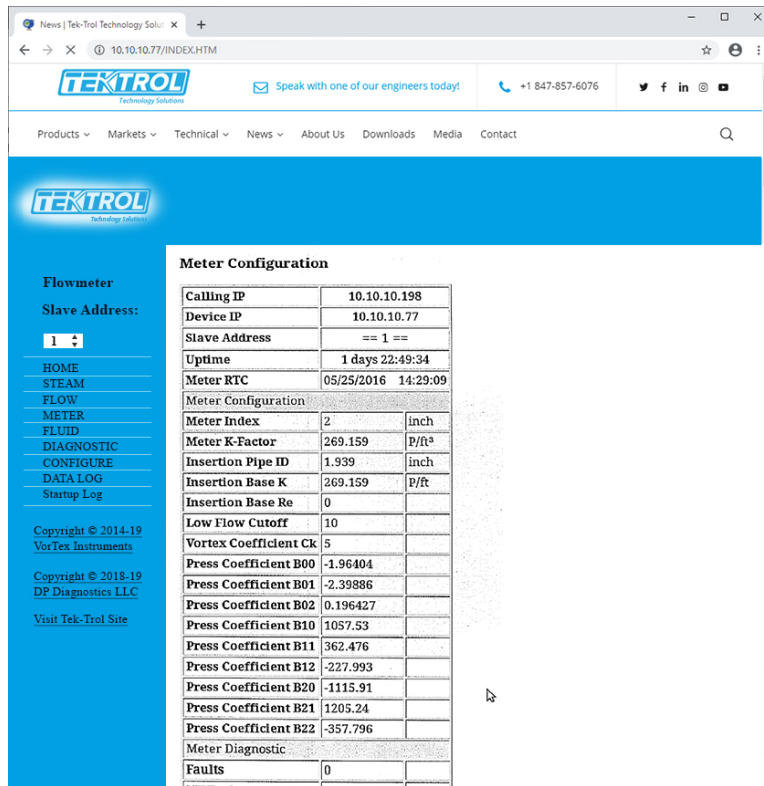

Fig 14: Vortex Meter Web Page2

Vortex Meter Web Pages, invoked by menu links: FLOW, METER, FLUID and DIAGNOSTIC provide real-time information about measured and configured parameters of Vortex Meter.

8 Web Configuration Interface

When clicking on the CONFIGURE Menu link opens the following page:

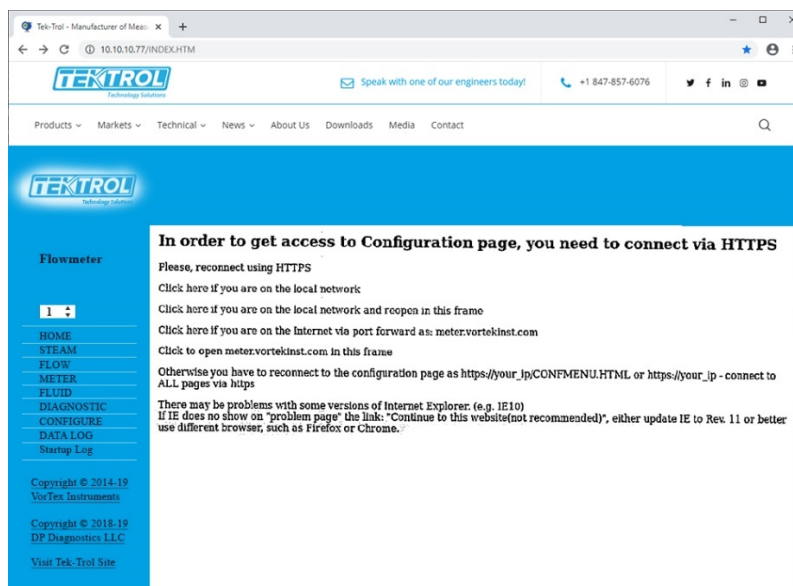

Fig 15: Web Configuration Interface

Connection to the Configuration interface is done using encrypted protocol HTTPS. When connected for the first time, your browser and the unit need to do some verification. This process is slightly different in different browsers. In Firefox, it looks as follows:

When the link "Click here if you are on the local network" is clicked, the page shown below is opened.

Please, note that there is a button called "Advanced". The next page is shown with the button "Add Exception" at the bottom if you click it. If you open this page in the right frame using the second link "Click here if you are on the local network and reopen in this frame", the browser does not show this "Add Exception" button. So, for the very first time connecting to new "unknown" to your browser meter use first link, after that you may use a more convenient second link and open configuration interface inside the frame.

By clicking "Add Exception" the following screen is opened:

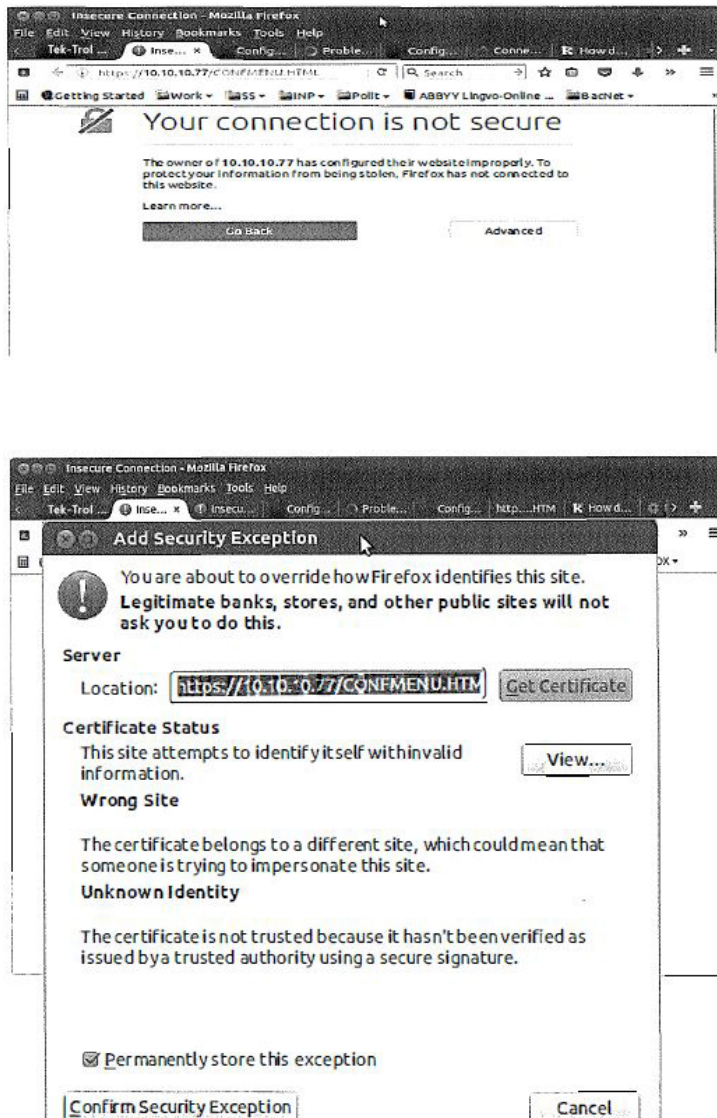

Fig 16: Web Configuration after Add Exception clicking

Browser complains about our Tek-Trol certificate because it expects, as it typically happens, the site's name, for example, myBank.org and getting instead just an IP address. You may view the certificate to make sure you are connecting to the meter, not something else. Click "Confirm Security Exception," and this certificate will be stored in your browser. The next time browser knows which certificate to use for this particular IP. If you change the meter's IP address, you will need to go through this procedure once again.

With other browsers, the procedure may be slightly different, but the final point is the same - you need to get to the point when the browser asks you to confirm the certificate's exception. On Windows IE Explorer, the browser will show page as shown in figure 17. You need to click the link "Continue to this website (not recommended)". In some versions of IE, it may not show this link. In such case upgrade IE to version 11 or better using a different browser, e.g., Firefox

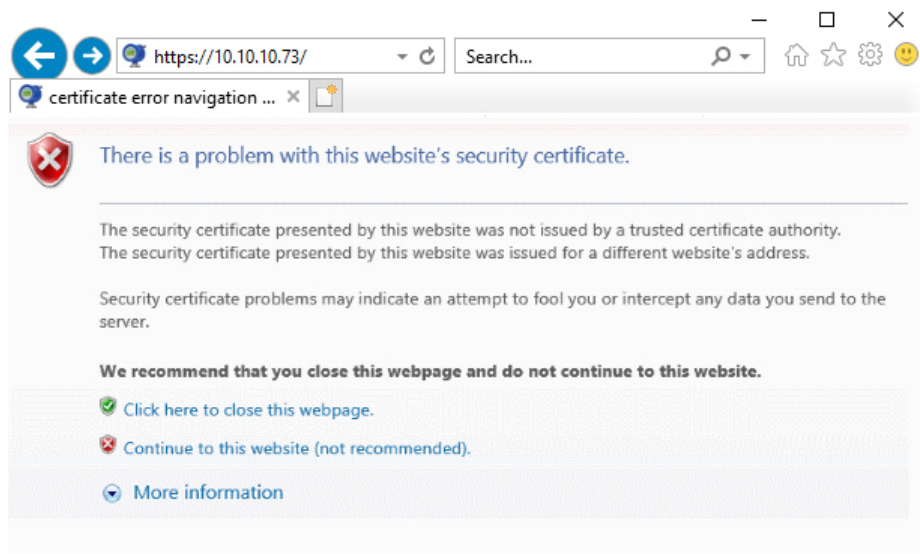
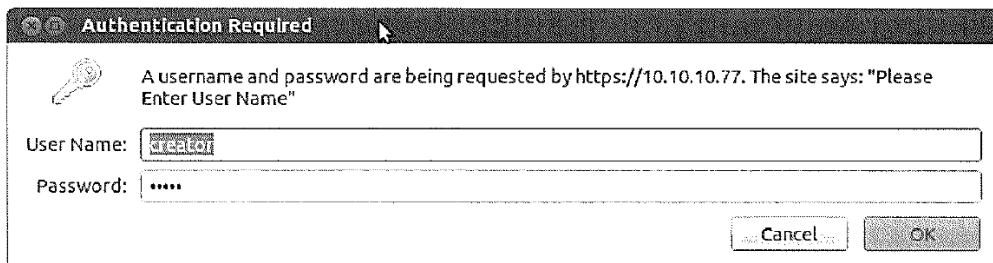

Fig 17: Internet Explorer HTTPS Warning Page

After certificate acceptance is done, you may enter the configuration page. It will ask for authentication. Use the Username "creator" for administrative access, allowing to change some additional parameters or use general Username "owner". The password for both cases is "16363".



It will show configuration page in full screen or in frame if second link is used.

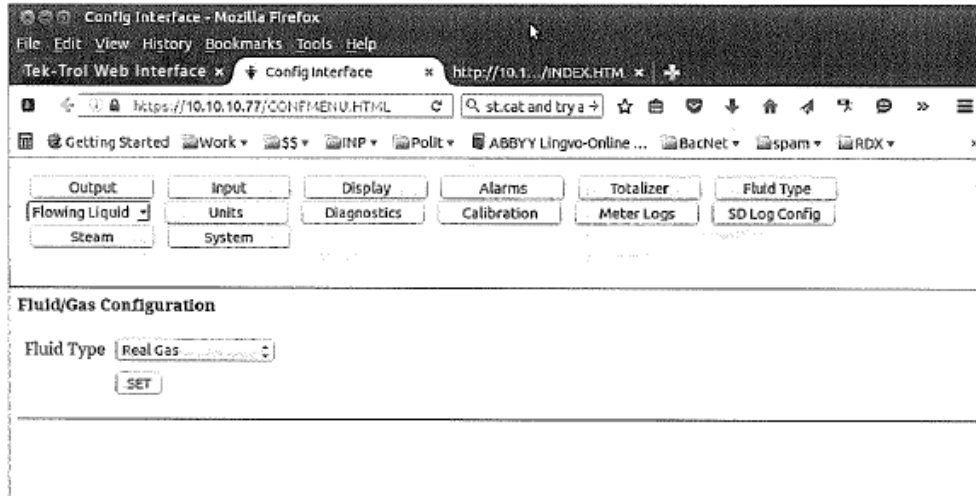

Fig 18: Configuration Page

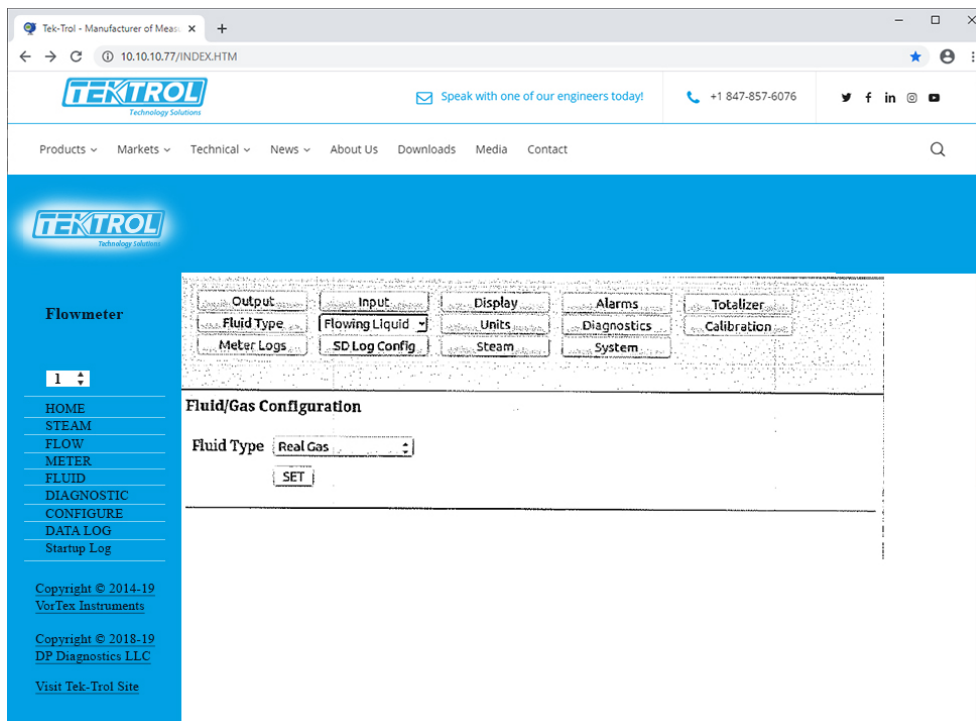

Fig 19: Fluid or Gas Configuration

All configuration forms are more or less self-explaining. Some explanation is needed for selecting Fluid Type. It has two forms, including the selection of Fluid Type and selection of specific fluid within selected Fluid Type.

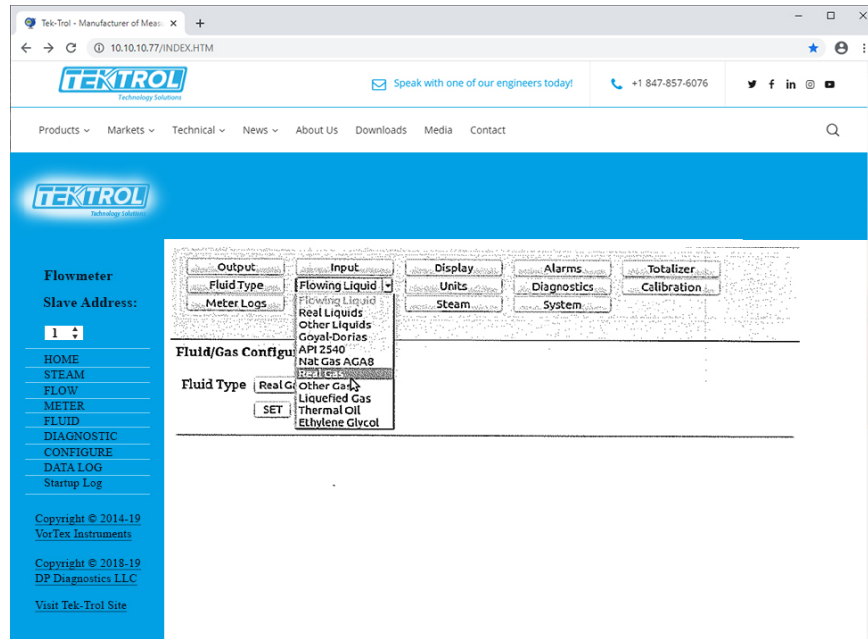

Fig 20: Fluid Type Selection

- You need first select the Fluid Type and then use the drop-down selector to select the particular fluid within that type.
- Set parameters for selected Flowing Liquid.
- Please pay attention that on the second form there are two lines:
 - Real Gas Configuration
 - Your selection of Fluid Type is: Real Gas
- These two lines remind you that use the same Fluid Type on both forms.

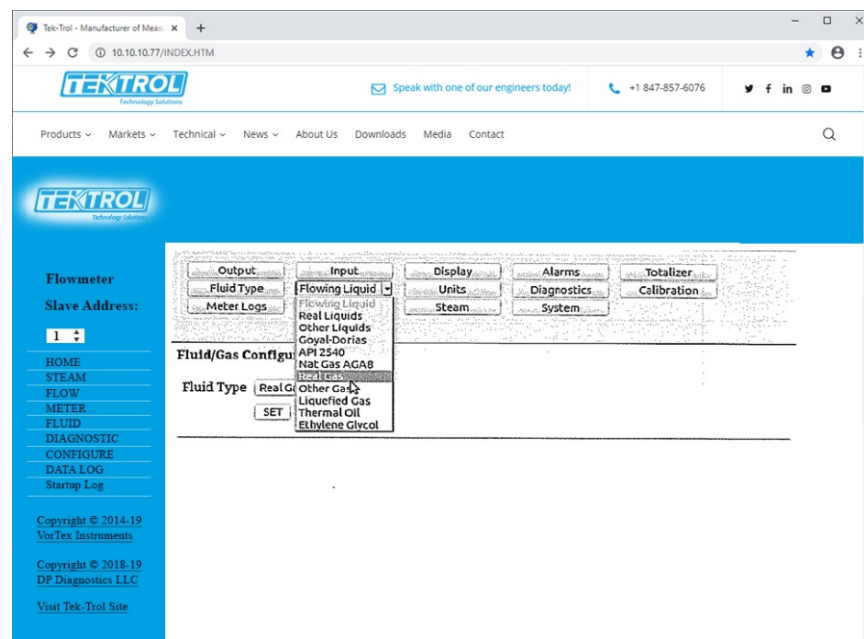

Fig 21: Real Gas Configuration

8.1 Configuration Options

The format of this form depends on version of PoE firmware: steam, standard PoE, Prognosis, etc.

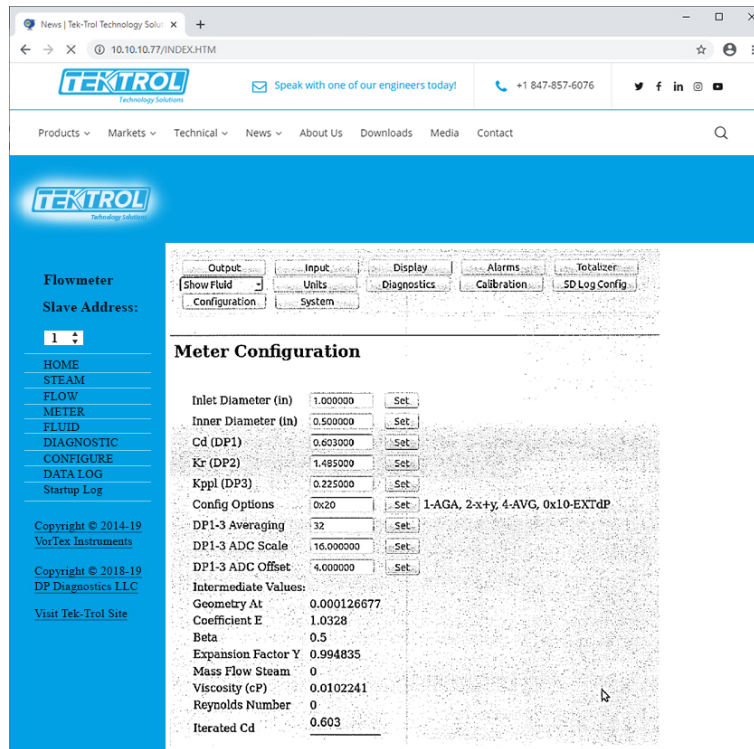

Fig 22: Configuration Options

Configuration Options allow you to select between different configurations. These are just bits set in 32 bits configuration word. All settings are retained between power cycles. Bits 1,2 and 4 are not used in Steam. Bit 16 (0x10) is selecting using of external analog DP read by Input board in Tek-Trol. Bit 32 (0x20) - selects using external ADAM ADC as 4-20 mA inputs for DP1 to DP3. Value DP1 to 3 Averaging setts number of counts to average. The main Steam page shows instant and averaged values of DPs as well as calculated values.

DP1 to 3 ADC Scale and Offset set scale and offset accordingly of ADAM ADC measurements. The calculated values used as DP input = $adc * scale / 0xffff + offset$. ADC is 16-bit value between 0 for 4mA input and 65535 (0xffff) for 20mA input. So, to scale 0 to 1 00 inH2O of DP meters use scale = 100 and offset = 0. To read actual 4-20 mA current used scale= 16 and offset=4.

9 Connection to meter from the Internet and Security Issues

Typically, your meter is connected to your Local Area Network (LAN) with non-routable Private Network Address (192.168.xx.xx, 10.xx.xx.xx, 172.16-31.xx.xx). For connection to the meter from anywhere on the Internet, two methods may be used:

- Connect through Virtual Private Network (VPN)
- Port Forwarding Technique

In case of VPN, your home PC is becoming part of your corporate network and you getting access to all resources on your corporate LAN. Usually, your home PC is assigned the IP address from the

different subnet that your meter and, therefore IPSetup program will not work. You need to know the IP address of the meter to connect. Contact your IT department about the availability of VPN and connection instructions.

The second method is configuring the corporate firewall in such a way that you are getting access to particular internal (LAN) IP by mapping it to your external corporate gateway IP and port number. This is usually done by mapping like following. Assuming your corporate gateway is 50.202. 79. 132 and your meter IP on LAN is 10. 10. 1 0.75.

Example of port forwarding:

External IP 50.202.79.132 Port 8080 ==>mapped to==> 10.10.10.75 Port 80

External IP 50.202.79.132 Port 10502 ==>mapped to==> 10.10.10.75 Port 502

External IP 50.202.79.132 Port 10443 ==>mapped to==> 10.10.10.75 Port 443

Your IT should know how to do such configuration in corporate routers. All you need is to provide information to IT on used network ports:

TCP port 80 Non secure access to main WEB pages. Read only. Protocol HTTP.

It is also possible to access meter using only secure connection via Port 443.

TCP port 443 Secure encrypted access to configuration pages. Protocol HTTPS, SSL.

Encryption 128 bit - does not require Export licensing.

User/password protected (secure)

TCP port 502 Access by automation software to Modbus/TCP server. Protocol Modbus/TCP

Optional:

TCP ports 20,21 Access to internal FTP server. Protocol FTP. User/password protected (insecure)

UDP port 20034 Broadcast discover protocol. Used to find units on the local Network.

It is not routable and therefore works only within the same subnet.

Used by IPSetup (discover/IP config) and Auto Update (flash) programs.

Auto Update works across Ethernet switches. It uses UDP with direct address.

It may be blocked by most routers.

TCP port 20034 Firmware update using TcpUpdate utility. (Not enabled in Rev 1.0 of firmware).

All corporate gateways which are more advanced than simple "home" routers can provide additional security-enhancing measures, like using "sourcing" addresses allowing access only from certain individual IPs or networks. If security concerns are high, you may limit access to the meter using encrypted protocol only: port 443, https. On special request, Tek-Trol can add the special capability of Access Control List (ACL) to insecure by definition Modbus protocol. Using ACL users may define a number of hosts or networks from which connection to Modbus port 502 can be accepted. Normally this function can be implemented in a corporate firewall. ACL in the meter may be needed when it is exposed to the Internet directly.

General information about Port Forwarding and instructions on how to set it up in simple home routers available everywhere. For example, <http://www.howtogeek.com/66214/how-to-forward-ports-on-your-router/>

10 Modbus or TCP Interface

Tek-Trol TCP meter supports industry standard automation protocol Modbus/TCP.

Table 1 : Modbus General Specifications

Protocol	TCP
Port	502
Number of simultaneous connections	Standard MSB first (big endian)
Format of 32 Long and Float values	Most significant word coming first (big endian)
Modbus Address	0
Supported Function Codes	3,4,16,5

10.1 Modbus Utilities

- We include for customer convenience two applications which may be used during integration into your automation system:
 - MbusGui.exe Windows GUI application for reading Modbus registers of the meter.
 - mbus.exe Generic DOS console application for reading Modbus/TCP registers.
- These two applications are stored on the SD card inside the meter.
- To download them click on the menu link "LOG DATA" and then select directory EXE.
- Right-click on MB US.EXE or MBGUI.EXE link to download it to your PC.

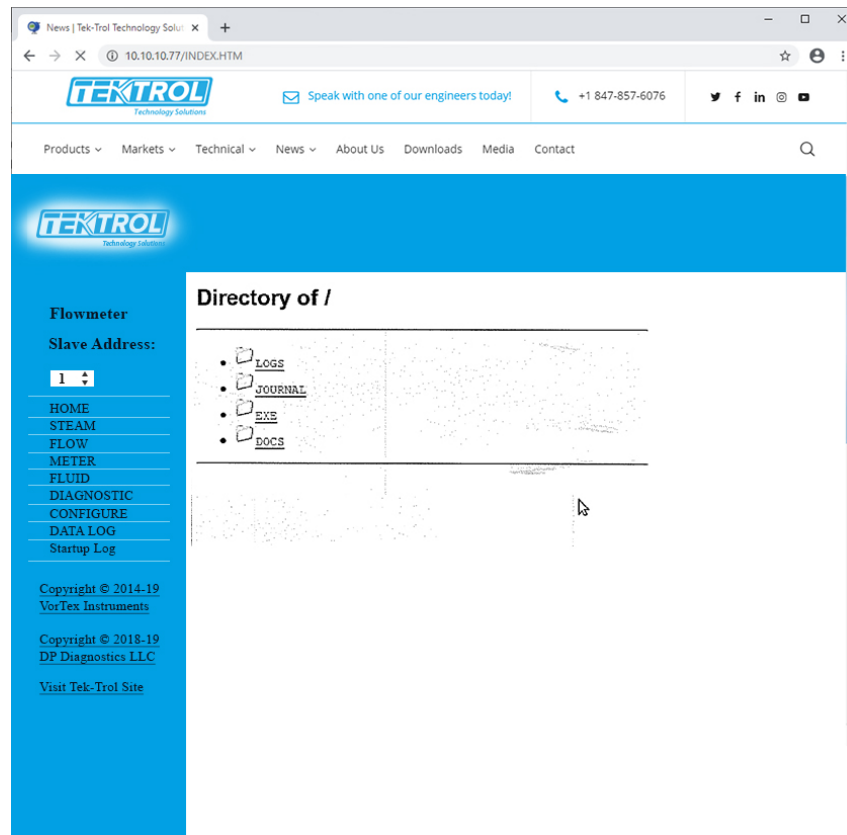

Fig 23: Modbus Utilities

10.2 MBGUI. EXE Simple Modbus/TCP client

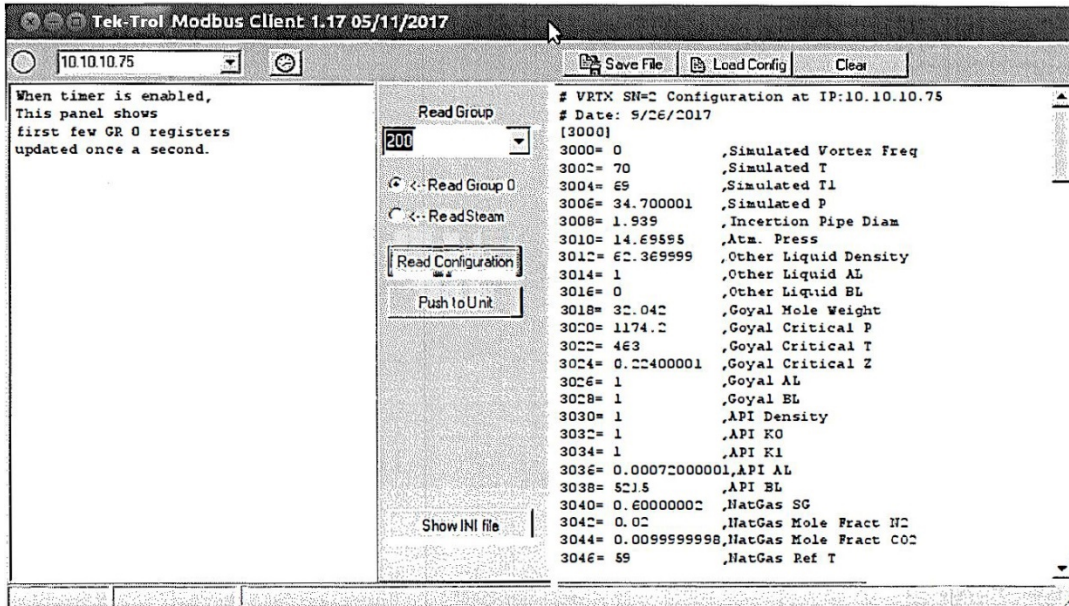

Fig 24: MBGUI. EXE Simple Modbus/TCP client

- Figure 24 shows the simple Modbus/TCP client configured for use with the meter. The names and locations of registers are stored in the mbgui.ini file.
- This file is created at startup and contains default definitions. The structure of the application uses the following approach accepted for meters supporting Modbus/RTU.
- All registers are grouped by data types: float, long, etc. Two groups of registers 0 contain most of the real-time data and Group 200 has steam-related data that can be viewed on a timer once in two seconds on the left panel.
- Selecting a group in the "Read Group" selector will show it in the right forum.
- You can rename the application to something more meaningful to you (please avoid spaces in the program name). In this case, it will rename as per the INI file. By this, you may create several clients for different meters.
- This application is compiled to run on the Windows machine. It also can be run on Linux or MAC machine with 586 architecture under Windows emulator WINE. (MAC case was not tested).
- Button "Read Configuration" read all configuration-related registers and shows them on the right panel. You can save it to a file by clicking the "Save File" button.
- Later you can load this or other saved configuration file and force it to the unit to reconfigure it. Before pushing the file to the unit, you may edit it and leave only the registers you want to change. Please, be careful using this option.

10.3 Console Modbus/TCP client MBUS. EXE

- This is simple Modbus/TCP client for reading Modbus registers and output data in specified format.

- It can be used for creating automation scripts in any scripting language, such as bash, Lab View, MATLAB, DOS batch, etc.
- Open in DOS window directory where you put the executable MB US.EXE.

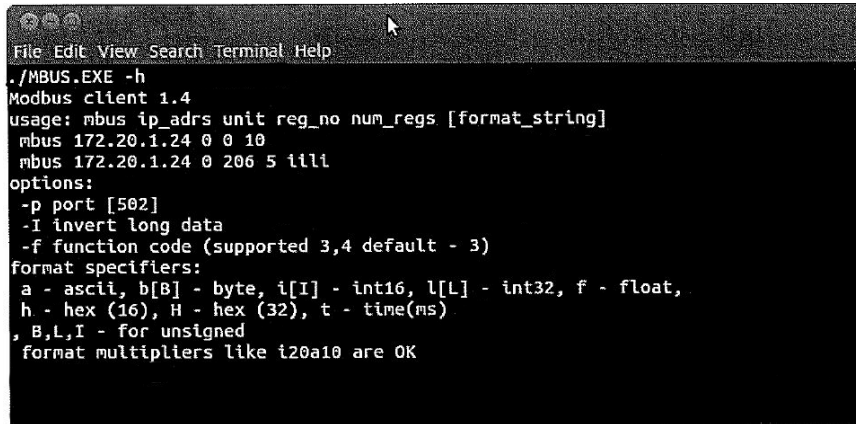

```
File Edit View Search Terminal Help
./MBUS.EXE -h
Modbus client 1.4
usage: mbus ip_adrs unit reg_no num_regs [format_string]
mbus 172.20.1.24 0 0 10
mbus 172.20.1.24 0 206 5 illi
options:
-p port [502]
-I invert long data
-f function code (supported 3,4 default - 3)
format specifiers:
a - ascii, b[B] - byte, i[I] - int16, l[L] - int32, f - float,
h - hex (16), H - hex (32), t - time(ms)
, B,L,I - for unsigned
format multipliers like i20a10 are OK
```

Fig 25: DOS Window Directory

- There is minimal help shown by command: MBUS.EXE-h
- It can read arbitrary Modbus registers. The only limitation is that it supports only "classic" order of bytes in 16 bit registers: big endian.

Example:



```
File Edit View Search Terminal Help
./MBUS.EXE 10.10.10.79 -I 0 0 6 fff
562.000000, 30.943373, 1233.000000
./MBUS.EXE 10.10.10.79 -I 0 0 6 f3
562.000000, 30.947727, 1233.000000
./MBUS.EXE 10.10.10.79 -I 0 1002 4 i4
158, 22, 6, 1
```

Fig 26: MBUS.EXE-h Command in Dos Window 1

- Read first 6 registers from group 0 and display as Float. Each "f" in first example corresponds for each read register or register pair for float. "fff" may be replaced by "f3"
- Switch "-I" telling that float format is inverted: MSW coming first. This option should always be used with the Meter.
- Line 3 reads 4 short integer registers from reg number 1002 and output as 16 bit integer.
- For debug purposes during integration you may format output as HEX.

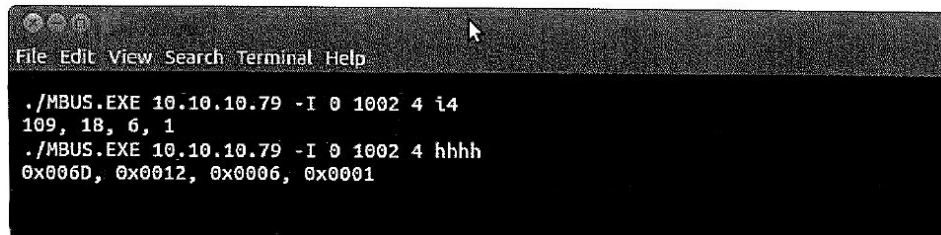

```
File Edit View Search Terminal Help
./MBUS.EXE 10.10.10.79 -I 0 1002 4 i4
109, 18, 6, 1
./MBUS.EXE 10.10.10.79 -I 0 1002 4 hhhh
0x006D, 0x0012, 0x0006, 0x0001
```

Fig 27: MBUS.EXE-h Command in Dos Window 2

11 Data Logging

- Tek-CoVor 1300D Steam Quality Meter has internal logging capability.
- The data is logged to a micro SD card inside the unit.
- The capacity of the SD card may vary from 4 to 32GB. The size of the card and free space are shown on the StartUp Log page.
- The card is formatted as FAT32 with a long file name disabled.
- All file names are in 8.3 formats. To access the log files, click the menu link "DATA LOG."

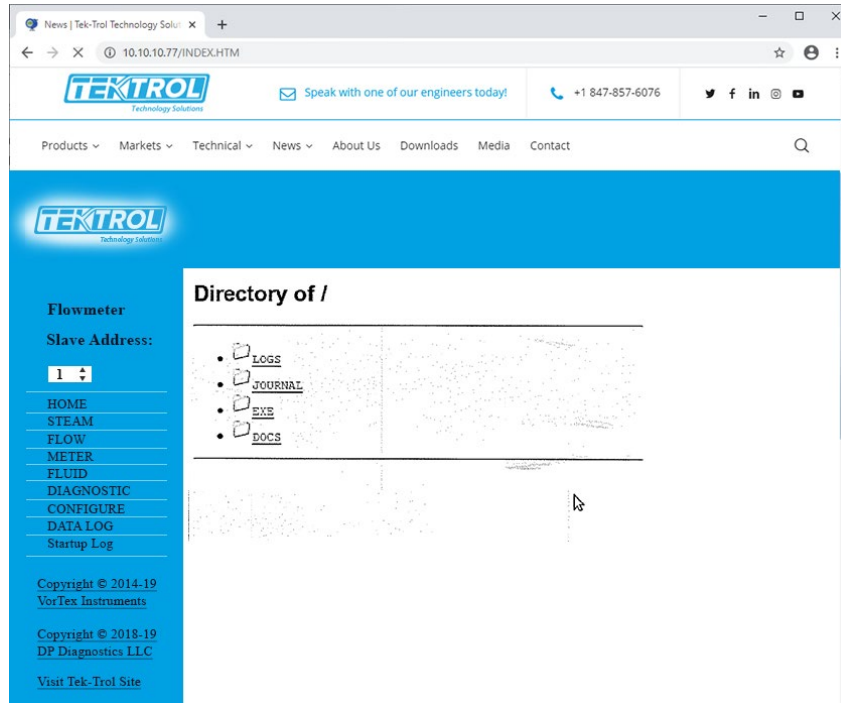

Fig 28: Data Logging

Table 2: Data Logger Folder and their Function

Data Logger Folders	Function
LOGS	Contain Log Files
JOURNAL	Log files of unit on/off states as well as operator's actions.
EXE	Folder with several executables
DOCS	Documentation

➤ Log files are arranged as a tree:

- LOGS
 - 2016 - Year
 - 01 - month
 - 02 – February
 -
 - 05 - May
 - ❖ 160501.CSV
 - ❖ 160502.CSV - Daily files in Comma Separated Variables text format

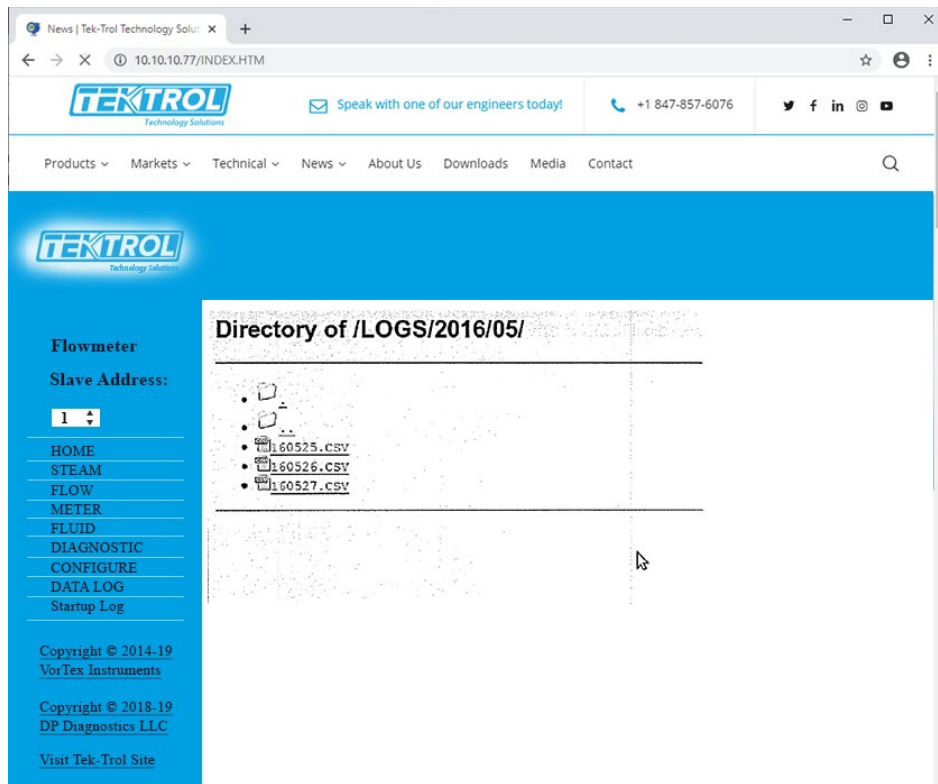

Fig 29: Datta Logging Example

- To download the file right-click on it and select "save" into your PC.
- You may also open it immediately.
- It will be opened as a text file or in EXCEL, depending on your used browser settings. You may change it - consult HELP of used browser to find out how to configure default application for file extension.CSV.
- Normally, the browser asks what to do with this file extension.

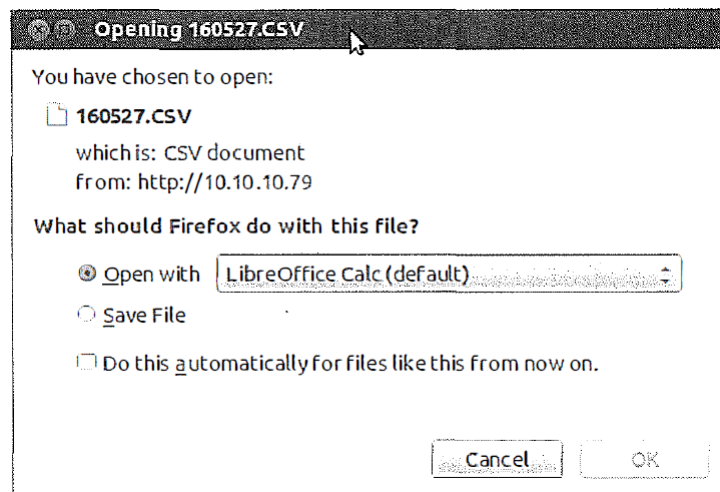

Fig 30: Configure Default Application for File Extension.CSV.

- An Example shown in figure 31, offers to open it in LibreOffice Calc - analog of Windows EXCEL.
- It is then asking about details of CSV format: what to use as field separators. Select "comma".

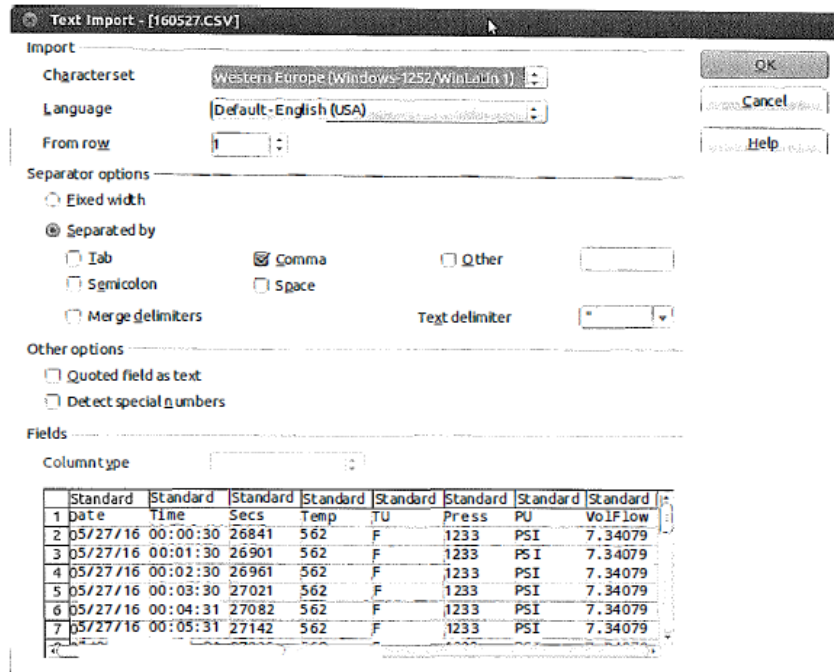

Fig 31: Data Logging Example in Excel Format

- Click OK and it will open the file in EXCEL (CALC)

	B	C	D	E	F	G	H	I	J	K	L	M	N	O	P
Date	Time	Secs	Temp	TU	Press	PU	VolFlow	VFU	MassFlow	FDens	Freq	Vrms	DP1	DP2	OP
2	05/27/16	00:00:30	26841	562	F	1233	PSI	7.34079	ft ³ /sec	1292.33	47.0001	31.06	0.000214668	0	0
3	05/27/16	00:01:30	26901	562	F	1233	PSI	7.34079	ft ³ /sec	1292.33	47.0001	31.06	0.000191446	0	0
4	05/27/16	00:02:30	26961	562	F	1233	PSI	7.34079	ft ³ /sec	1292.33	47.0001	31.06	0.000188224	0	0
5	05/27/16	00:03:30	27021	562	F	1233	PSI	7.34079	ft ³ /sec	1292.33	47.0001	31.06	0.000190800	0	0
6	05/27/16	00:04:31	27082	562	F	1233	PSI	7.34079	ft ³ /sec	1292.33	47.0001	31.06	0.000222446	0	0
7	05/27/16	00:05:31	27142	562	F	1233	PSI	7.34079	ft ³ /sec	1292.33	47.0001	31.06	0.000191335	0	0
8	05/27/16	00:06:31	27202	562	F	1233	PSI	7.34079	ft ³ /sec	1292.33	47.0001	31.06	0.000189779	0	0
9	05/27/16	00:07:31	27262	562	F	1233	PSI	7.34079	ft ³ /sec	1292.33	47.0001	31.06	0.000186001	0	0
10	05/27/16	00:08:32	27322	562	F	1233	PSI	7.34079	ft ³ /sec	1292.33	47.0001	31.06	0.000203779	0	0
11	05/27/16	00:09:32	27383	562	F	1233	PSI	7.34079	ft ³ /sec	1292.33	47.0001	31.06	0.000189779	0	0
12	05/27/16	00:10:32	27443	562	F	1233	PSI	7.34079	ft ³ /sec	1292.33	47.0001	31.06	0.000174224	0	0
13	05/27/16	00:11:32	27503	562	F	1233	PSI	7.34079	ft ³ /sec	1292.33	47.0001	31.06	0.000185113	0	0
14	05/27/16	00:12:33	27564	562	F	1233	PSI	7.34079	ft ³ /sec	1292.33	47.0001	31.06	0.000178889	0	0
15	05/27/16	00:13:33	27624	562	F	1233	PSI	7.34079	ft ³ /sec	1292.33	47.0001	31.06	0.000188224	0	0
16	05/27/16	00:14:33	27684	562	F	1233	PSI	7.34079	ft ³ /sec	1292.33	47.0001	31.06	0.000225557	0	0
17	05/27/16	00:15:33	27744	562	F	1233	PSI	7.34079	ft ³ /sec	1292.33	47.0001	31.06	0.000169557	0	0
18	05/27/16	00:16:33	27804	562	F	1233	PSI	7.34079	ft ³ /sec	1292.33	47.0001	31.06	0.000213113	0	0
19	05/27/16	00:17:33	27864	562	F	1233	PSI	7.34079	ft ³ /sec	1292.33	47.0001	31.06	0.000158668	0	0
20	05/27/16	00:18:34	27925	562	F	1233	PSI	7.34079	ft ³ /sec	1292.33	47.0001	31.06	0.000150800	0	0
21	05/27/16	00:19:34	27985	562	F	1233	PSI	7.34079	ft ³ /sec	1292.33	47.0001	31.06	0.000175779	0	0
22	05/27/16	00:20:34	28045	562	F	1233	PSI	7.34079	ft ³ /sec	1292.33	47.0001	31.06	0.000158668	0	0
23	05/27/16	00:21:34	28105	562	F	1233	PSI	7.34079	ft ³ /sec	1292.33	47.0001	31.06	0.000168001	0	0
24	05/27/16	00:22:35	28166	562	F	1233	PSI	7.34079	ft ³ /sec	1292.33	47.0001	31.06	0.000166446	0	0
25	05/27/16	00:23:35	28226	562	F	1233	PSI	7.34079	ft ³ /sec	1292.33	47.0001	31.06	0.000185113	0	0
26	05/27/16	00:24:35	28286	562	F	1233	PSI	7.34079	ft ³ /sec	1292.33	47.0001	31.06	0.000186668	0	0
27	05/27/16	00:25:35	28346	562	F	1233	PSI	7.34079	ft ³ /sec	1292.33	47.0001	31.06	0.000196002	0	0
28	05/27/16	00:26:35	28406	562	F	1233	PSI	7.34079	ft ³ /sec	1292.33	47.0001	31.06	0.000189779	0	0
29	05/27/16	00:27:36	28467	562	F	1233	PSI	7.34079	ft ³ /sec	1292.33	47.0001	31.06	0.000178889	0	0
30	05/27/16	00:28:36	28527	562	F	1233	PSI	7.34079	ft ³ /sec	1292.33	47.0001	31.06	0.000178889	0	0
31	05/27/16	00:29:36	28587	562	F	1233	PSI	7.34079	ft ³ /sec	1292.33	47.0001	31.06	0.000172668	0	0
32	05/27/16	00:30:36	28647	562	F	1233	PSI	7.34079	ft ³ /sec	1292.33	47.0001	31.06	0.000183557	0	0
33	05/27/16	00:31:36	28707	562	F	1233	PSI	7.34079	ft ³ /sec	1292.33	47.0001	31.06	0.000177335	0	0
34	05/27/16	00:32:36	28767	562	F	1233	PSI	7.34079	ft ³ /sec	1292.33	47.0001	31.06	0.000160224	0	0
35	05/27/16	00:33:37	28828	562	F	1233	PSI	7.34079	ft ³ /sec	1292.33	47.0001	31.06	0.000164668	0	0
36	05/27/16	00:34:37	28888	562	F	1233	PSI	7.34079	ft ³ /sec	1292.33	47.0001	31.06	0.000180446	0	0
37	05/27/16	00:35:37	28948	562	F	1233	PSI	7.34079	ft ³ /sec	1292.33	47.0001	31.06	0.000166446	0	0
38	05/27/16	00:36:37	29008	562	F	1233	PSI	7.34079	ft ³ /sec	1292.33	47.0001	31.06	0.000166446	0	0
39	05/27/16	00:37:38	29069	562	F	1233	PSI	7.34079	ft ³ /sec	1292.33	47.0001	31.06	0.000191335	0	0
40	05/27/16	00:38:38	29129	562	F	1233	PSI	7.34079	ft ³ /sec	1292.33	47.0001	31.06	0.000161779	0	0
41	05/27/16	00:39:38	29189	562	F	1233	PSI	7.34079	ft ³ /sec	1292.33	47.0001	31.06	0.000205335	0	0
42	05/27/16	00:40:38	29249	562	F	1233	PSI	7.34079	ft ³ /sec	1292.33	47.0001	31.06	0.000186668	0	0
43	05/27/16	00:41:38	29309	562	F	1233	PSI	7.34079	ft ³ /sec	1292.33	47.0001	31.06	0.000166446	0	0
44	05/27/16	00:42:39	29369	562	F	1233	PSI	7.34079	ft ³ /sec	1292.33	47.0001	31.06	0.000185113	0	0
45	05/27/16	00:43:39	29429	562	F	1233	PSI	7.34079	ft ³ /sec	1292.33	47.0001	31.06	0.000203779	0	0
46	05/27/16	00:44:39	29490	562	F	1233	PSI	7.34079	ft ³ /sec	1292.33	47.0001	31.06	0.000185113	0	0
47	05/27/16	00:45:39	29550	562	F	1233	PSI	7.34079	ft ³ /sec	1292.33	47.0001	31.06	0.000182001	0	0
48	05/27/16	00:46:39	29610	562	F	1233	PSI	7.34079	ft ³ /sec	1292.33	47.0001	31.06	0.000247335	0	0
49	05/27/16	00:47:40	29671	562	F	1233	PSI	7.34079	ft ³ /sec	1292.33	47.0001	31.06	0.000172668	0	0
50	05/27/16	00:48:40	29731	562	F	1233	PSI	7.34079	ft ³ /sec	1292.33	47.0001	31.06	0.000183557	0	0
51	05/27/16	00:49:40	29791	562	F	1233	PSI	7.34079	ft ³ /sec	1292.33	47.0001	31.06	0.000172668	0	0
52	05/27/16	00:50:40	29851	562	F	1233	PSI	7.34079	ft ³ /sec	1292.33	47.0001	31.06	0.000169557	0	0
53	05/27/16	00:51:41	29912	562	F	1233	PSI	7.34079	ft ³ /sec	1292.33	47.0001	31.06	0.000168001	0	0
54	05/27/16	00:52:41	29972	562	F	1233	PSI	7.34079	ft ³ /sec	1292.33	47.0001	31.06	0.000228668	0	0
55	05/27/16	00:53:41	30032	562	F	1233	PSI	7.34079	ft ³ /sec	1292.33	47.0001	31.06	0.000195113	0	0
56	05/27/16	00:54:41	30092	562	F	1233	PSI	7.34079	ft ³ /sec	1292.33	47.0001	31.06	0.000169557	0	0
57	05/27/16	00:55:41	30152	562	F	1233	PSI	7.34079	ft ³ /sec	1292.33	47.0001	31.06	0.000182001	0	0
58	05/27/16	00:56:42	30213	562	F	1233	PSI	7.34079	ft ³ /sec	1292.33	47.0001	31.06	0.000160224	0	0

Fig 32: Excel Sheet of Data Logging

- The first three columns in the Excel Sheet, A, B and C, are fixed and always present. All others are configurable on the SD Log Configuration page on the CONFIGURE form.
- The names of the columns are more or less self-explanatory. Column C (Secs) shows a number of seconds since the meter was restarted, Columns named PU, TU, VFU display Pressure, Temperature, Volume Flow Units accordingly.
- The new header is output whenever the operator changes the list of logged items.
- Log interval is set on the configuration page and can vary from as low as 5 seconds to whatever you choose.
- The SD Log Config page is the following. Just select desired items and click the SET button at the bottom of the form.

11.1 Dummy registers group 9000

- The client can read and write into Dummy Modbus registers 9000 to 9999.
- These registers may be used for storing some process variables and logged synchronously with other Meter Data.
- Text area MB9K Config contains the configuration of Dummy Modbus registers logging. Line beginning with "#" are comments and not used anywhere.

- The Format of the line: offset, number of items, forms.
- If MB9K checkbox at the bottom is selected, the logger will add to the end of the log line items described in MB10K Configuration.
- Each line describes a group of Dummy registers in Modbus regs 9000 to 9999.
- In each line, offset is the position of the group in 9000 registers.
- Number of items used as registers in case of 16-bit values or a pair of registers in Long and Float formats.
- The format is one character specifying fo1mat of items in the group:
 - i 16 bit signed integer
 - I 16 bit unsigned integer
 - l 32 bit signed integer
 - L 32 bit unsigned integer
 - f 32 bit floating-point values
- Customers may write into these registers with Function code 16 and read with function codes 3 and 4.
- Contents of registers are not retained at cycling the power. The registers in Log file are named as Mxxx for "i" format, MxxxL for "l" format and Mxxx f for "f" format. Where xxx is register offset from 10000.
- All Dummy registers are in the "reversed" format. The most significant word (MSW) is coming first.
- Min BM89K log selector. If checked it will log Dummy Registers 9000 according to format specifiers entered in M9K configuration area.

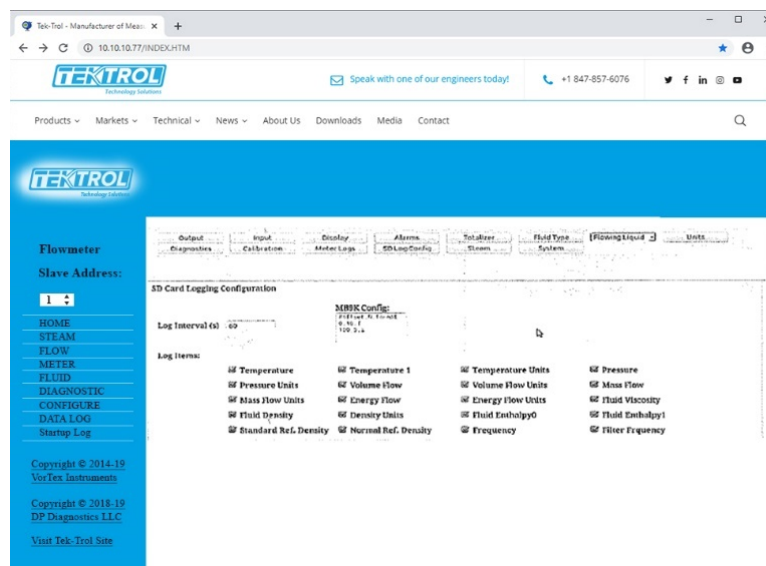

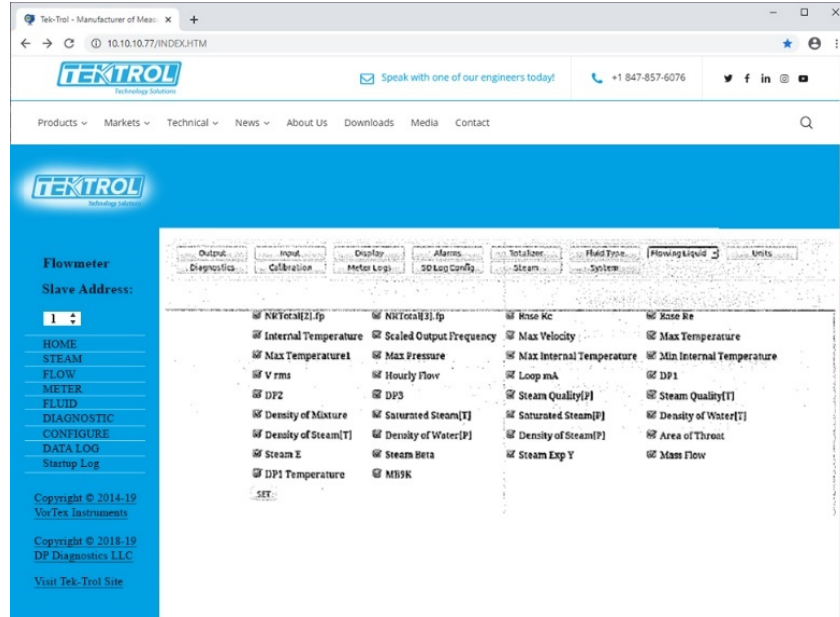

Fig 33: Dummy Registers Group 9000

Date	Time	Secs	Temp	Temp1	TU	PU	Press	PU	VolFlow	VPU	MassFlow	MPU	FDens	DU	Freq	Re	KI	Max Y	DPH	DP2	DP3	Q
06/24/16	14:58:01	70	-412.35	30.9231 F	0	0	0	0	0	0	0	0	0	0	0	0	0	0	0	0	0	0
06/24/16	14:58:22	100	-412.35	30.9405 F	0	0	0	0	0	0	0	0	0	0	0	0	0	0	0	0	0	0
06/24/16	14:58:42	120	-412.35	30.9309 F	0	0	0	0	0	0	0	0	0	0	0	0	0	0	0	0	0	0
06/24/16	14:59:02	140	-412.35	30.9506 F	-1	2	3	4	5	65535	2	0	0	0	0	0	0	0	0	0	0	0
06/24/16	14:59:22	160	-412.35	30.9309 F	-1	2	3	4	5	65535	2	0	0	0	0	0	0	0	0	0	0	0
06/24/16	14:59:43	181	-412.35	30.9412 F	-1	2	3	4	5	65535	2	0	0	0	0	0	0	0	0	0	0	0
06/24/16	15:00:03	201	-412.35	30.9463 F	-1	2	3	4	5	65535	2	0	0	0	0	0	0	0	0	0	0	0
06/24/16	15:00:23	221	-412.35	30.9261 F	-1	2	3	4	5	65535	2	0	0	0	0	0	0	0	0	0	0	0
06/24/16	15:00:43	241	-412.35	30.9066 F	-1	2	3	4	5	65535	2	0	0	0	0	0	0	0	0	0	0	0
06/24/16	15:01:04	262	-412.35	30.9405 F	-1	2	3	4	5	65535	2	0	0	0	0	0	0	0	0	0	0	0
06/24/16	15:01:24	282	-412.35	30.9309 F	-1	2	3	4	5	65535	2	0	0	0	0	0	0	0	0	0	0	0
06/24/16	15:01:44	302	-412.35	30.9376 F	-1	2	3	4	5	65535	2	0	0	0	0	0	0	0	0	0	0	0
06/24/16	15:02:04	322	-412.35	30.9463 F	-1	2	3	4	5	65535	2	0	0	0	0	0	0	0	0	0	0	0
06/24/16	15:02:24	342	-412.35	30.9347 F	-1	2	3	4	5	65535	2	0	0	0	0	0	0	0	0	0	0	0
06/24/16	15:02:45	363	-412.35	30.9426 F	-1	2	3	4	5	65535	2	0	0	0	0	0	0	0	0	0	0	0
06/24/16	15:03:05	383	-412.35	30.9426 F	-1	2	3	4	5	65535	2	0	0	0	0	0	0	0	0	0	0	0
06/24/16	15:03:25	403	-412.35	30.9281 F	0	PSI	885.616	1*3/sec	1.06443e+06	b/sec	149.849	bm*1*3	400.3	3.46721e+06	202.72	-40	0	0	0	0	0	0
06/24/16	15:03:45	423	-412.35	30.9281 F	0	PSI	885.616	1*3/sec	1.06443e+06	b/sec	149.849	bm*1*3	400.3	3.46721e+06	202.72	-40	0	0	0	0	0	0
06/24/16	15:04:06	444	-412.35	30.9383 F	0	PSI	885.616	1*3/sec	1.06443e+06	b/sec	149.849	bm*1*3	400.3	3.46721e+06	202.72	-40	0	0	0	0	0	0
06/24/16	15:04:26	464	-412.35	30.9303 F	0	PSI	885.616	1*3/sec	1.06443e+06	b/sec	149.849	bm*1*3	400.3	3.46721e+06	202.72	-40	0	0	0	0	0	0
06/24/16	15:04:46	484	-412.35	30.9535 F	0	PSI	885.616	1*3/sec	1.06443e+06	b/sec	149.849	bm*1*3	400.3	3.46721e+06	202.72	-40	0	0	0	0	0	0
06/24/16	15:05:06	504	-412.35	30.9383 F	0	PSI	885.616	1*3/sec	1.06443e+06	b/sec	149.849	bm*1*3	400.3	3.46721e+06	202.72	-40	0	0	0	0	0	0
06/24/16	15:05:26	524	-412.35	30.9318 F	0	PSI	885.616	1*3/sec	1.06443e+06	b/sec	149.849	bm*1*3	400.3	3.46721e+06	202.72	-40	0	0	0	0	0	0
06/24/16	15:05:47	545	-412.35	30.9361 F	0	PSI	885.616	1*3/sec	1.06443e+06	b/sec	149.849	bm*1*3	400.3	3.46721e+06	202.72	-40	0	0	0	0	0	0

Fig 34: Example of Dummy Registers Log

11.2 Other methods of retrieving log files

11.2.1 WGET

- Retrieving log files could be automated using Internet-standard utility WGET. This utility readily available on Linux machines and for Windows can be downloaded from here:
- <https://www.gnu.org/software/wget/> or install Linux simulator on Windows WinBash, which also contains WGET: <http://win-bash.sourceforge.net/>
- To read daily file for a specific date, use the following WGET command: WGET <http://10.10.10.79/LOGS/2016/05/160527.CSV> (where first 2 digits -year, next -month, next day). This instruction will download daily log file for date: 05/27/2016

11.2.2 FTP

- The meter has the capability of accessing the file system on the SD card via FTP protocol.
- For that, you may use any specialized FTP client or even File browser on Linux or Windows systems.
- In Windows Explorer, enter in address field ftp://10.10.10.79 or whatever is your meter's IP.
- You may be asked the first time for the Username and Password. Use Username: "owner" and Password: "16363".
- You will get almost full access to the file system on the SD card. You may copy files, delete files and directories. Creating directories is not allowed.

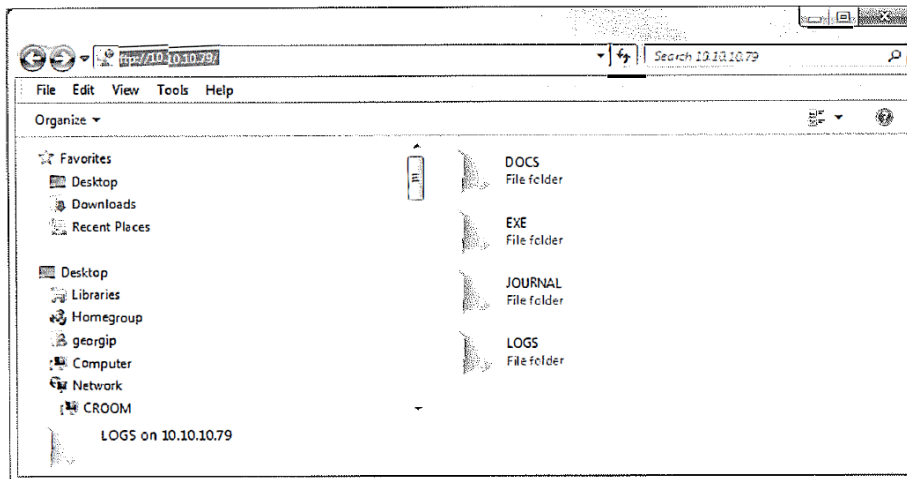

Fig 35: Data Log by FTP

- FTP access may be automated with mentioned above WGET application. The string to query single file is the following:
WGET ftp://owner: 16363@10.10.10.79/LOGS/2016/05/160527 .CSV
*Note how to supply username and password when accessing via FTP.

 NOTE

You may use FTP access to clean SD card by removing unnecessary data or wrong directories created due to misread real-time Clock of the meter.

12 Firmware Update

- Tek-CoVor 1300D Steam Flow Meter firmware can be updated on-line. For that, there are two applications:
 - Auto Update Standard update utility using UDP protocol. (Local network only)
 - TcpUpdate Update utility using TCP protocol allowing access from other systems.
- In revision 1.0 of TcpUpdate is disabled.
- The Auto Update should always be used.
- The Auto Update application can be downloaded from EXE directo1y on the SD file system of the unit.

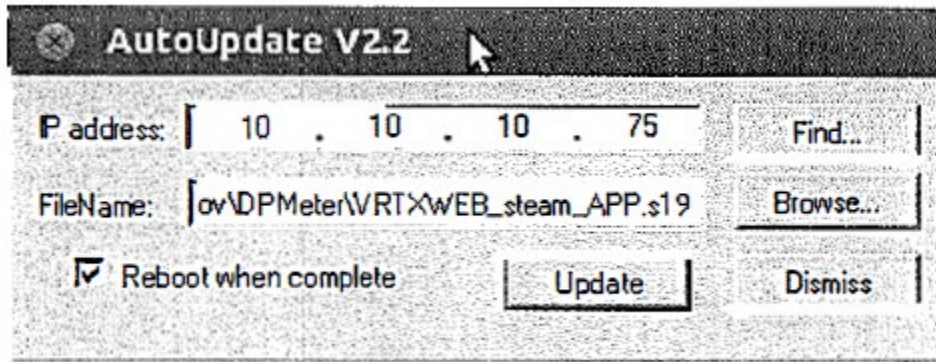

Fig 36: Firmware Update

- Usage is simple: enter the IP address of your meter (or find a meter on the local network)
- Browse for provided by Tek-Trol application file in xxx APP.s 19 format.
- Click on the update.
- Update with TcpUpdate is the same, except FIND may not work across routers/switches.

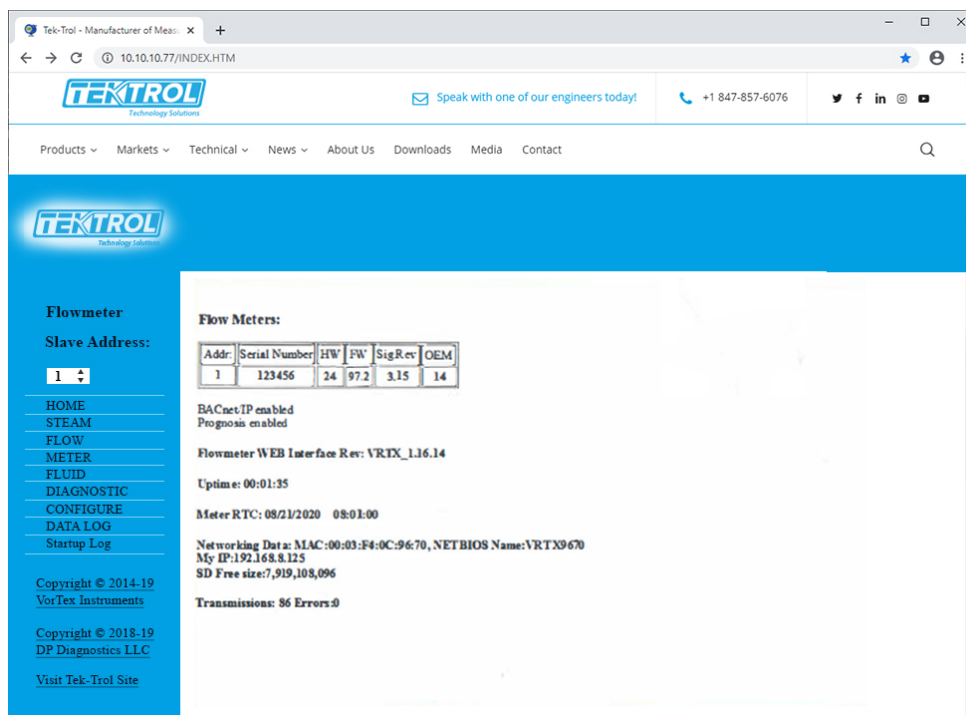

Fig 37: Data Log of Flow Meter



TEKMATION LLC reserves the right to change the designs and/or materials of its products without notice. The contents of this publication are the property of TEKMATON LLC and cannot be reproduced by any other party without written permission. All rights reserved. Copyright © 2013 TEKMATON LLC
DOC-TEK/PO/INN/201103/1300D/00
TEKMATION LLC



www.tek-trol.com

Tek-Trol is a fully owned subsidiary of TEKMATON LLC. We offer our customers a comprehensive range of products and solutions for process, power and oil & gas industries. Tek-Trol provides process measurement and control products for Flow, Level, Temperature & Pressure Measurement, Control Valves & Analyzer systems. We are present in 15 locations globally and are known for our knowledge, innovative solutions, reliable products and global presence.

Tek-Trol LLC

796 Tek Drive Crystal Lake, IL 60014,
USA
Sales: +1 847-655-7428

Tek-Trol Solutions BV

Florijnstraat 18, 4879 AH Etten-Leur,
Netherlands
Sales: +31 76-2031908

Tek-Trol Middle East FZE

SAIF Zone, Y1-067, PO BOX No.
21125, Sharjah, UAE
Sales: +971-6526-8344

Support: +1 847-857-6076

Email: tektrol@tek-trol.com

www.tek-trol.com

Flow | Level | Temperature | Pressure | Valves | Analyzers | Accessories | TekValSys