



Battenfeld®

Technologies, Inc.



2015

BUYER'S GUIDE

Caldwell®
Shooting Supplies

Frankford Arsenal®
Reloading Tools

Wheeler®
Engineering
Fine Gunsmithing Supplies

Tipton®
Gun Cleaning Supplies

LOCKDOWN®
VAULT ACCESSORIES

BOG-POD®
TRIPODS • BIPODS • MONOPODS • ACCESSORIES

Non-Typical
WILDLIFE SOLUTIONS

GOLDEN ROD®
Moisture Control

www.BTIbrands.com ■ 877.509.9160 TOLL FREE

TABLE OF CONTENTS

Caldwell Shooting Supplies	4-49
Shooting Rests	4-13
Shooting Bags	14-15
Hunting Platforms	24-32
PAST Recoil Protection	33
Hearing Protection	34-36
Bipods	40-41
Targets	37-39, 44-49
Frankford Arsenal Reloading Tools	50-63
Case Cleaning	50-53
Case Preparation	54-55
Reloading	56-63
Lockdown Vault Accessories	64-75
Security	64-67
Lighting	69
Golden Rod by Lockdown	70
Humidity Control	70-72
Organizers	72-74
Storage	74-75
Tipton Gun Cleaning Supplies	76-87
Gun Vises	76-77
Cleaning Tools	78-81
Jags & Brushes	82-85
Cleaning Supplies	86-87
Wheeler Engineering Delta Series AR Tools	88-95
Tool Kits	88-89
Wheeler Engineering Gunsmithing Supplies	96-105
Screwdrivers	96-97
Scope Mounting	98-100
Gunsmithing Tools	101-104
Miles & Gilbert Series by Wheeler	105
BOG-POD	106-115
SB Series	107
RLD Series	108
CLD Series	109
HD Series	110
TAC Series	111
ACCESSORIES	112-115
Non-Typical Wildlife Solutions	116-119

TERMS & CONDITIONS

Case Packs: Battenfeld Technologies uses a "case pack" system for our finished goods. Our case pack quantities help us and our customers with shipping and receiving efficiencies. We will only deliver case packaged items in their case pack quantities - orders for quantities outside of case pack quantities can no longer be accepted.

Our price lists have been updated to note quantity changes.

Freight Claims: Ownership passes to customer when carrier accepts and signs for shipment. Damage or shortages must be reported to carrier and claims must be filed through carrier.

Shipping: Battenfeld Technologies, Inc. Reserves the right to use its designated carriers on all shipments.

Drop Shipping: Battenfeld will drop ship to your customer at your request. The minimum for each order at one time to one location is \$2,000.

Backorders: Backorders ship once they are available, unless purchase orders state otherwise. Battenfeld pays freight on backorders originating from qualified invoices.

Shortages: All shortages must be reported to Battenfeld within 10 days of receipt.

Returns: All returns require a return authorization number from Battenfeld. All Battenfeld products have a one-year warranty against manufacturer's defects. Defective products may be repaired or replaced solely at the discretion of Battenfeld Technologies, Inc. If product received is not in resalable condition, it may be returned for exchange. If requested, Battenfeld will send materials that would enable the products to be resold (ex. Bags, header cards, labels, ext.).

SALES REP GROUPS

- (1) **Proactive Sales & Marketing NE, LLC** North-Midwest Territory
Phone: (800) 851-8354 / Email: donhanson@proactivesales.org
- (2) **Bruce Odle & Associates** Great Lakes Territory / Phone: (573) 875-5246 / Email: blmay@odle.biz
- (3) **H&G Marketing NE** New England Territory / Phone: (518) 583-9963 / Email: jackley@hgreprs.com
- (4) **The Giesecke Company** South-Midwest Territory / Phone: (281) 350-0197 / Email: lammyers@aol.com
- (5) **Proactive Sales and Marketing** Southeast Territory / Phone: (931) 490-7951 / Email: ProActiveS@aol.com
- (6) **H&G Marketing West** West Territory / Phone: (720) 851-5127 / Email: tmezeske@hgreprs.com
- (7) **Korth Group Ltd.** Eastern Canada (Quebec & Ontario) / Phone: (403) 938-3255
Email: sclouthier@korthgroup.com

Battenfeld Technologies, Inc.

2501 LeMone Industrial Dr.

Columbia MO. 65201

877.509.9160 Toll Free

573.446.6606 Fax

www.BTibrands.com

Specifications and availability are subject to change. Battenfeld Technologies, Inc. is not responsible for typographic, photographic or descriptive errors.

Savage® is a registered trademark of Savage Arms®

REMINGTON® and 700® are registered trademarks of Remington Arms Co., Inc.

AR-10® is a registered trademark of ArmaLite Inc®

Battenfeld Technologies, Inc. and its products are not in any way affiliated with, approved by, or sponsored by any of the above mentioned registered trademark companies.

BATTENFELD TECHNOLOGIES, CALDWELL, TIPTON, PAST, WHEELER, FRANKFORD ARSENAL, BOG-POD, THE LEAD SLED, E-MAX, TACK DRIVER, DEADSHOT, NXT, FIRE CONTROL, AMMO VAULT, STABLE TABLE, BR PIVOT, ORANGE PEEL, GUN BUTLER and F.A.T. WRENCH are registered trademarks of Battenfeld Technologies, Inc.

Other trademarks shown in this catalog are owned by Battenfeld Technologies, Inc. unless otherwise noted.

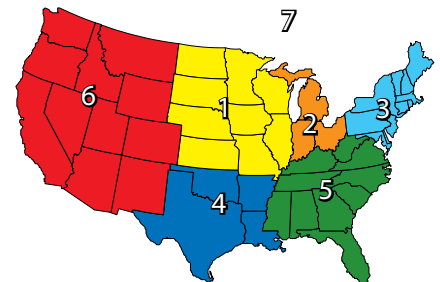

NEW PRODUCTS 2015



Ultimate Shooting Gloves
#151294 Pg. 36



Mag Charger Ammo Boxes
#397623 #397480
Pg. 20



Magnum Rifle Gong XL
#178953 Pg. 38

AR-500 Swinger Target
#758995 Pg. 39



AK Mag Charger
#397599 Pg. 20



DeadShot FieldPod MAX
#488029 Pg. 27



E-Max LoPro and Shooting
Glasses Combo
#487309 Pg. 35



Brass Retriever
#125789 Pg. 18



Picrail Action Camera Mount
#123905 Pg. 23



Picrail Smart
Phone Mount
#123906 Pg. 23



PS Powder Measure
#909292 Pg. 56



PS Brass Dryer
#909213 Pg. 52



PS 230V Rotary Tumbler
#909567 Pg. 50



PS Hand Deprimer
#909283 Pg. 54



AR Magazine Rack
#222972 Pg. 75



Super MAX
Gun Vaults
Pg. 64



Handgun/AR Upper Hanger
and Vault Organizers
Pg. 74



MAX Force Cleaning Rods
#658539 #658540
Pg. 78



1911 Maintenance Mat
#558680 Pg. 86



Compact Range Vise
#282282 Pg. 76



21 Piece Screwdriver Bit Set
#954671 Pg. 96



Ultra Scope Mounting Kit
#541010 Pg. 98

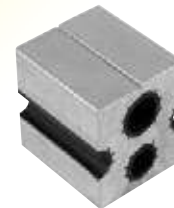

Universal Barrel Clamp
#672286 Pg. 103



300 AAC Blackout
Bore Guide
#777209
Pg. 94



Shooting Sticks
#735560
#735565
Pg. 107



SSA Window Mount
#735561 Pg. 113



SSM Swivel Mount
#735562 Pg. 115



SB-2C
#735563
Pg. 107



AR Armorer's
Bench Block
#156945
Pg. 90



SHOOTING RESTS

FIRE CONTROL



Downrange crosshair alignment is achieved via a multi-directional control arm.

HOW DOES IT WORK?

Simply move the control arm in any direction to precisely align the crosshairs on your target. The rest will hold the gun perfectly steady at any point with no additional adjustments. 60 MOA or approximately 5 feet of adjustment at 100 yards.



STEP 1



STEP 2



STEP 3

SHOOTING WITH A FIRE CONTROL

Step 1: Use threaded feet to raise rest off bench and to level the rest.

Step 2: Set and lock coarse elevation adjustment.

Step 3: Move control arm to align crosshairs, then fire.

FIRE CONTROL

Caldwell's team of engineers has developed a series of rifle rests that incorporate their new "Fire Control" mechanism. "Fire Control" is an advanced alignment system that allows the shooter continual, one-hand adjustment of downrange crosshair alignment via a multi-directional control arm. The Fire Control mechanism allows continuous adjustment of the front forend support by manipulating the control arm with your fingertips. Once the coarse adjustments have been made to position the rest, the control arm allows fluid movement for precise crosshair alignment without having to change shooting position to loosen or tighten rest components. The end result is unmatched control of crosshair alignment in a rock solid shooting platform which delivers better accuracy than any existing rest.

This revolutionary development allows accuracy and speed previously unavailable in conventional rifle rests. The continuous precision adjustment of Fire Control allows the crosshairs to easily and quickly be manipulated as the shooter maintains a perfectly relaxed shooting position. Fire Control will give you the confidence of knowing your crosshairs will be precisely aligned as the trigger breaks. Providing control right up to the point of trigger break greatly enhances accuracy potential. Rests with fixed adjustment systems require the last micro alignment to come from leaning, pushing or pulling slightly on the gun and or rest, thus greatly limiting accuracy.

Another inherent benefit of the Fire Control rests is ease and speed of realignment after recoil. No more moving the entire rest back into position or loosening knobs and turning screws to realign. With up to 60" of windage and elevation adjustment at 100 yards, getting back on target instantly after recoil from a previous shot is at your fingertips via the control arm.

In addition to the precision alignment mechanism, these rests are built to exacting tolerances and specifications to provide the rock solid performance Caldwell is known for.

Both shooting rests include: stainless steel leveling feet, forend stop, medium profile filled front bag and 3-lobe bag for wide forend rifles. The coarse elevation provides approximately 4" inches of adjustment at the rest. Adjustable tension of the control arm allows for customized resistance pressure via four nylon tipped set screws.



SHOOTING RESTS

FIRE CONTROL® FRONT REST™ - #746884 Case Pack of 1

Built with the Benchrest shooter in mind the Fire Control Front Rest utilizes a massive 15" x 11.5" cast iron base. Overall weight approximately 18 pounds.

Filled medium bag is held securely with threaded fasteners and can be changed out with the 3-lobe bag (included)

Machined hardened steel gear rack for coarse elevation adjustment

Elevation adjustment knob provides quick steady movement

Elevation lock knob quickly and securely locks into position



Fire Control Front Rest package: 16" wide x 13" high x 9" deep



The Medium-High Rear Bag makes an excellent compliment to the Fire Control Front Rest. See PAGE 13 for more details.

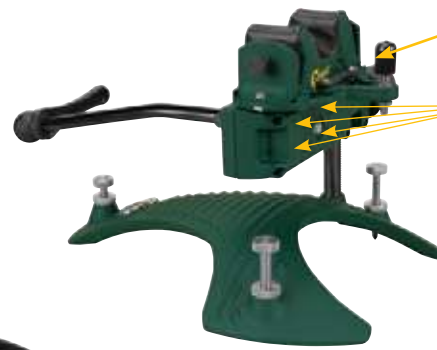

Forend stop for repeatable firearm positioning

Control arm lever micro-tension adjustments

Spiked stainless steel leveling feet

Precision design and manufacturing provide glass smooth motion

The palm lever can be positioned 360 degrees to the arm.

Cast iron base provides rock-solid stability

PATENT:
www.BTibrands.com/patents/

FIRE CONTROL® FULL LENGTH REST™ - #100259 Case Pack of 1

The one-piece design delivers maximum stability and the convenience of fast setup and transport. Dual steel tubes connect the non-marring overmolded rear support to the sturdy cast aluminum front base. Approximately 15 pounds and 32" overall length.

Custom logo badge on full-length version

Durable steel tubes connect front and rear bases

Non-marring rear pad

Adjustable cradle ear assembly for increased control and consistent clamping pressure

PATENT:
www.BTibrands.com/patents/



Fire Control Full Length Rest package: 24.8" wide x 12.6" high x 9.3" deep

FIRE CONTROL® DETACHABLE MAGAZINE CONTROL ARM - #100260 Case Pack of 1

An optional Control Arm is available for Fire Control rests that is optimized for use with detachable magazine rifles like the AR-15. It is slightly shorter than the standard control arm and has a more aggressive offset bend to provide maximum clearance around the magazine.

Detachable Magazine Control Arm is offset specifically so that you can still use it with extended capacity magazines

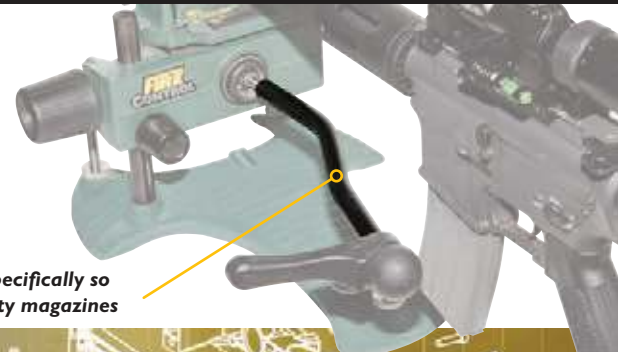

$$E = \frac{1}{2} MV^2$$

The Lead Sled® FAMILY

THE SCIENCE OF RECOIL REDUCTION

The Original Caldwell Lead Sled revolutionized the way shooters approach shooting firearms with heavy recoil. The ground breaking Recoil-Reduction Technology took the industry by storm and made the Lead Sled one of the most popular shooting rests of all time. Caldwell has continued to apply Recoil-Reduction Technology throughout an entire line of Lead Sled rests, offering value and features not available anywhere else.

Recoil anticipation is undoubtedly the biggest limiting factor in accuracy for most shooters. It can contribute to flinching and poor trigger pulls which in turn result in diminished accuracy. Lead Sled rests eliminate the recoil allowing the shooter to remain comfortable, relaxed and able to focus on proper trigger control. The team of engineers at Caldwell has done extensive research and testing on recoil forces and how to capture and dissipate the energy through the frame of a rest and into weighted media held on the rest. Each of the Lead Sled rests is designed to reduce felt recoil from even the heaviest magnum rifles to a comfortable and almost unnoticeable level. Test results show up to 95% recoil reduction. Heavy duty construction and durable components deliver dependable performance throughout the entire line.

The Caldwell Lead Sled rests continue to be the standard by which other rests are judged.

$$E = \frac{1}{2} MV^2$$

FREE RECOIL VELOCITY



- M = Mass
- V = Velocity
- E = Energy
- F = Force
- μ = Friction Between Lead Sled & Bench
- g = Gravitation Acceleration

$$F_{\text{friction}} = \mu \times M_{\text{gun} + \text{Lead Sled}} \times g$$

WHAT DOES THIS MEAN TO YOU?

Check Out These Examples of Felt Recoil (ft.-lbs.)*

*Actual felt recoil may vary due to key factors such as bullet weight, velocity, shooting surface, firearm stock and recoil pad design.

Firearm Type	30-06	300 Win Mag	375 H&H	460 Wthby.	12 Ga. 3.5"
Gun Only	22.6	36.8	4.9	140.3	75
With Lead Sled	1.1	1.8	2.7	7.0	3.8

The Lead Sled®
NO RECOIL
NO FLINCH
NO EXCUSES

Lead Sled® Family Comparison Chart	Lead Sled® Solo™	Lead Sled® Plus™	Lead Sled® DFT™	Lead Sled® FCX™
Dramatically reduces recoil	X	X	X	X
Accepts lead shot bags	X	X	X	X
Precision elevation adjustment	X	X	X	X
Weight tray capacity	25 lbs.	100 lbs.	100 lbs.	75 lbs.
Ideal for extreme magnum rifles & slug guns		X	X	X
Accepts plate (bar bell) weights		X		
Precision windage adjustment			X	X
Overall adjustable length			X	X
AR-15 / Lever action gun compatible	X		X	X
Fire Control system				X



SHOOTING RESTS

THE LEAD SLED® FCX™ - #820444 Case Pack of 1

The Fire Control FCX combines the two most innovative rest technologies into the industry's most advanced shooting platform. By incorporating the recoil reduction benefits of the Lead Sled system along with the ground-breaking performance of the Fire Control mechanism, ultimate accuracy and comfort come together in one rest.

The Fire Control mechanism is an advanced rest alignment system that is actuated by a "joystick" style control arm. The Control Arm can be moved in any direction to perfectly align the crosshairs and when it is released it holds the rifle in that exact position. This precision alignment of crosshairs to target allows the shooter to be perfectly relaxed when pulling the trigger, unlike conventional rests that require pushing, pulling or leaning into the gun to gain that final bit of alignment.

The rest is engineered and constructed for ultimate stability and durability. The adjustable length and front cradle height adjustment offer the versatility to accommodate almost any rifle, shotgun or muzzleloader. The FCX truly delivers maximum accuracy potential.

- At 100 yards, the control arm provides approximately 5 feet of adjustment on target
- 2-piece design and notched rear frame support allow user to adjust the overall length of the rest
- Cast aluminum weight tray can accommodate approx. 75 lbs. of lead
- Custom-fit weight bag (included) holds approx. 50 lbs. of lead shot
- Machined steel gear rack for coarse elevation adjustment
- Precision design and manufacturing provide glass-smooth motion
- The Lead Sled FCX weighs approx. 22 pounds and is 35" long by 13" wide

Includes two front bags with extra tall ears to keep the rifle forend from jumping out of the bag during recoil (one bag for standard forends and a second bag for wide forends)

Precision design and manufacturing provide glass-smooth motion

Control arm lever user-adjustable micro-tension screws

Cast aluminum weight tray holds the custom-fit weight bag which is included (unfilled)

PATENT:
www.BTibrands.com/patents/

At 100 yards, the control arm provides approximately 5 feet of adjustment on target

5 total positions provide 5.5" of adjustable length

Elevation lock knob quickly and securely locks into position

Contoured rear support protects gunstock

The control arm handle can be rotated or removed as desired

Adjustable height rear foot

2 piece design and notched rear frame support allow user to adjust the overall length of the rest

Elevation adjustment knob moves front cradle up and down

Machined steel gear rack for coarse elevation adjustment

The Lead Sled® FCX™
Fire Control Xtreme

Simply move the control arm in any direction to precisely align the crosshairs on your target. The rest will hold the gun perfectly steady at any point with no additional adjustments

Lead Sled FCX package:
24.25" wide x 8.75" high x 14.25" deep



SHOOTING RESTS

THE LEAD SLED® DFT™ - #336647 Case Pack of 1

The Lead Sled DFT (Dual Frame Technology) provides shooters with the industry's best recoil reduction system and the versatility to fit virtually any shotgun or rifle, all built around a precision shooting platform. A key feature of the DFT is the ability to slide the front cradle back and forth along the Dual Frame for optimal length adjustment. Whether you are trying to shoot the very tightest possible groups with your rifle or patterning your favorite shotgun, the Lead Sled DFT provides an optimal platform for shooting without nasty recoil.

- Dual frame design disperses a maximum amount of recoil energy
- 18" of adjustment to fit rifles and shotguns of virtually any size
- Extremely fine windage and elevation adjustments with finger tip control
- Enhanced recoil dispersion through unique baffle and tray system
- Maintain optimal shooting position with rear micro elevation adjustment
- Non-marring rubber feet
- Holds up to 100 pounds of lead shot
- Filled front forend support bag included
- Padded rear rest protects gun stock
- The Lead Sled DFT weighs approx. 24 pounds and is 30" long by 12" wide

PATENT:
www.BTlbrands.com/patents/

2.5" of elevation adjustment on smooth ball bearings

Filled bag specially designed for the DFT

Thick, foam-filled sides, as well as a channeled bottom similar to traditional rear bags

Dual frame technology absorbs recoil and allows for Hi-Cap magazine use on your AR Rifle

Windage adjustment

Fingertip rear elevation adjustment

Baffled tray keeps lead shot bags in place and holds up to 100 lbs. of lead shot - also holds weight bags full of sand or other media

Rubber tipped feet offer no-skid support on any surface



Lead Sled DFT package:
30" wide x 12.75" high x 5" deep

LEAD SLED® WEIGHT BAGS Case Pack of 4

These stout bags are designed to be placed in the shot tray of your Lead Sled, Lead Sled Plus or Lead Sled DFT and conveniently hold a 25 lb bag of lead shot, sand, or other weighted media. The durable handles make toting your weight bags to the range a snap. Available in Standard (5.5" x 10" x 3") and Large (10" x 16" x 2.5") size. The Standard Bag holds approximately 7 pounds of sand or 25lbs. of shot. The Large Bag holds approximately 20 pounds of sand. Standard available in one and four packs.

Standard Bag, Single - #428334

Standard Bag, 4 Bags - #533117

Large Bag, Single - #777800

Lead Sled Weight Bags package:
5.5" wide x 9.25" high x 2" deep



The Lead Sled[®] SHOOTING RESTS *Plus*

THE LEAD SLED[®] PLUS[™] - #820300 Case Pack of 2

The Lead Sled Plus is the next-generation of Lead Sled offering some key enhancements over the original. Like the original, the Plus reduces recoil by up to 95% while securely holding your gun on target. Key improvements include a newly-designed precision elevation shaft that eliminates wobble and play in front elevation, keeping you perfectly on target, as well as a new Universal Weight Tray. The unique new tray adjusts to accommodate a variety of weight types, including 25 pound barbell weights, sand or lead shot bags. These improvements along with all the other great features are sure to continue the legacy of the Lead Sled as the world's finest recoil reducing rest.

New, precision "no wobble" elevation ram keeps you on target.

Innovative adjustable weight tray accommodates a variety of weight types, including 25 lbs. barbell weights and lead shot bags.



The Lead Sled Plus weighs approx. 15 pounds and is 27" L x 12" W

- Innovative, adjustable weight tray slides to accommodate barbell weights as well as weight bags
- Ideal for magnum rifles & slug guns
- Holds up to two 25 lb. bar bell weights
- Holds up to 100 lbs. of lead shot
- Improved "no wobble" elevation ram
- Fingertip elevation adjustment
- Filled front forend support bag included
- Non-marring rubber feet
- Adjustable height rear foot
- Padded rear rest protects gun stock

PATENT:
www.BTIbrands.com/patents/

Lead Sled Plus package:
25.8" wide x
11.3" high x 3.9" deep

Weights not included

THE LEAD SLED[®] SOLO - #101777 Case Pack of 2

The Lead Sled[®] Solo features a smooth pivoting elevation system that is controlled by a single knob, making adjustments onto target fast and precise. Its unique offset frame is designed to accommodate all rifles, including detachable magazine rifles like the popular AR-15 platform or lever actions guns. The integrated weight tray will hold a single 25 pound bag of lead shot. The combination of the weight and a heavy duty spring, located between the frame members, all but eliminates recoil on non-magnum calibers and greatly reduces recoil on all calibers. The adjustable-height front cradle features a forend strap that easily secures your rifle onto the rest. Non-marring contact points protect your gun's finish.

- Heavy-duty steel construction
- AR-15 and Lever Action compatible
- Fast, precise pivoting elevation system
- Heavy-duty spring aids in recoil reduction
- Holds one 25 lb. bag of lead shot
- Forend strap secures rifle in the rest
- Adjustable front cradle height
- Non-marring, easy-turn front leveling feet
- Rubberized, non-marring front & rear cradle
- The Lead Sled Solo weighs approx. 14 pounds and is 26" long by 18" wide

PATENT:
www.BTIbrands.com/patents/



Lead Sled Solo package:
24" wide x 8.5" high
x 6.5" deep



The Lead Sled[®] Solo

AR-15s with 30 round mags work perfectly with a Solo



SHOOTING RESTS



MATRIX™ - #101600 Case Pack of 3

Designed for MAXIMUM RIGIDITY

Caldwell sets a new standard for Value, Performance and Features in a shooting rest. The highly versatile Matrix combines great new features and rock-solid stability in an affordable rest. Central to the design is the innovative, ultra rigid U-channel frame, quickly adjusting in length for the perfect fit with any gun while remaining completely stable. The two piece sliding frame incorporates an open central channel with plenty of clearance for hi-capacity detachable magazines (AR-15 style guns) as well as lever action guns. A convenient storage area incorporated into the front of the base features a removable lid that adds additional clearance when detached, but also doubles as a rubberized rear support surface for firing handguns when left in place.

Another key feature is the all new front elevation system. A spring-loaded tension mechanism and height adjustment knob allow for one-handed elevation adjustments, keeping the front cradle wobble-free throughout the entire vertical range. Overmolded front and rear supports protect the gun's finish but are firm enough to prevent any give or play.

Shooters will also enjoy the versatility of converting the Matrix into a compact front rest by removing the rear portion of the frame. Whether used as a front rest or as a full-length rest the Matrix provides stability that will deliver maximum accuracy potential.

PATENT:
www.BTibrands.com/patents/



The Matrix has multiple rigid supports molded into the frame.

4.5" of overall length adjustment

Matrix package:
16.5" wide x 6.5" high x 19.5" deep



The Matrix is an extremely versatile shooting rest

PISTOLERO™ - #562771 Case Pack of 4

The Caldwell Pistolero is the ideal handgun shooting rest. By combining 5 inches of horizontally adjustable hand support with 3 inches of vertically adjustable barrel support, this rest accommodates virtually every size handgun. The front and rear supports feature a non-marring material that is gentle on your firearm yet is firm enough to provide a stable shooting surface. In addition, the rugged construction of this rest is virtually impervious to the elements. This combination of versatility, stability and durability make the Pistolero the number one value in handgun rests.



The Pistolero accommodates a handgun like the 1911 as easily as the big Smith & Wesson 500.



Pistolero package:
16" wide x 8.4" high x 5.4" deep

Pistolero™



SHOOTING RESTS

STEADY REST NXT® - #548664 Case Pack of 4

The Steady Rest NXT gives you a steady, elevation-adjustable platform for sighting in rifles, pistols and patterning shotguns. The three-piece design allows the shooter to use the rest in one or two-piece configurations, allowing it to adjust to any length long gun as well as handguns. The front and rear supports feature a non-marring material that is gentle on your firearm's finish yet is firm enough to provide a stable shooting surface. Overall length of rest is 26". 3" of vertical cradle adjustment.



The front rest alone also doubles as a handgun rest. The neoprene pad provides a firm, cushioned base for your favorite pistol or revolver.



STEADY REST NXT

PATENT:
www.BTibrands.com/patents/



Steady Rest NXT package:
12.2" wide x 10.5" high x 5.4" deep

HANDY REST NXT® - #574662 Case Pack of 4

The Caldwell Handy Rest NXT is an extremely versatile front rest. It is designed with a full six feet of elevation adjustment at 100 yards (3" at cradle), a front sling stud clearance groove, and is constructed of durable, lightweight materials. The innovative design includes a removable handgun support attachment that easily converts this rifle rest into a handgun rest. The front rest and handgun supports feature a material that will not harm your valuable firearm yet also offers a steady shooting surface.



The removable handgun support allows you to use the Handy Rest NXT with a pistol and revolver, in addition to a rifle.

HANDY REST NXT



Handy Rest NXT package:
14.3" wide x 12.5" high x 4.8" deep



SHOOTING RESTS

"THE ROCK BR"

THE ROCK BR™ - #440907 Case Pack of 1

The Rock BR will help you discover the true potential of your rifle and ammunition. This high-quality rest is designed for the highest accuracy-minded shooters around; bench rest competitors. Now everyone who wants the best from their rifle can benefit from the advanced design, precision machining, and finely engineered features of the Rock BR.

- 13 lb. product weight dispersed along 14" cast-iron footprint
- Fine elevation adjustments are possible through our ball bearing rotational system
- Cradle features a sturdy bag tensing system for improved forend support
- Windage-adjustable cradle allows shooters to make smooth and precise corrections with fingertips and increased stability for refined accuracy
- Rest comes with both an unfilled 3-lobe bag for wide forends and filled Medium Varmint front bag for sporter style forends
- Accepts any of the Caldwell Deluxe Front Rest Bags
- 2-stage elevation adjustment up to 11.5"



Medium varmint front bag shown, for use with narrow forends.



Windage Adjustment

Forend Pressure Adjustable

Fine Elevation Adjustment Collar

Coarse Elevation Adjustment Knob

Independently Adjustable feet

MAX Adjustable height: 11.5"
The Rock BR raises high for use with guns that have detachable 30 round magazines.

The Rock BR also includes an unfilled 3-lobe front bag. We recommend filling the 3-lobe bag with case cleaning media.

The Rock BR package:
16.5" wide x 6.75" high x 10" deep

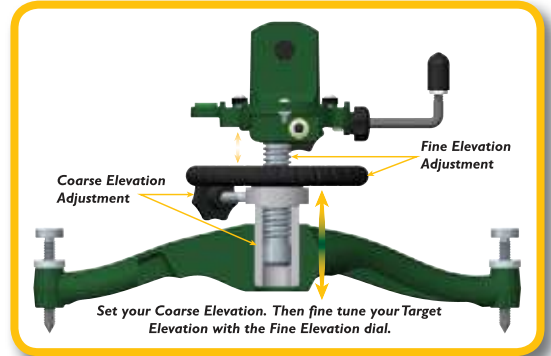

Coarse Elevation Adjustment

Fine Elevation Adjustment

Set your Coarse Elevation. Then fine tune your Target Elevation with the Fine Elevation dial.

New & Improved Windage System



Front Bag Forend Tension System



Fine Elevation Ram & Sliding Base Collar



BR FOOT PADS - #845221 Case Pack of 6

(3 BR Foot pads ONLY) (metal spikes not included)

BR Feet are designed to provide a stable, non-marring solution that keeps the spiked metal feet of your front rest from gouging or scratching the tabletop of your shooting bench. BR Feet are rubber-coated, metal washers that allow the shooting rest's spiked metal feet to nest in the washer to provide a firm, non-slip footprint while protecting your tabletop.



SHOOTING RESTS

THE ROCK™

The best way to determine the accuracy of your rifle and ammunition is to shoot them from a solid bench, with a quality shooting rest. With precise repeatability of shots as your goal, The Rock Deluxe Front Rest is the right tool for the job. The Rock helps eliminate the "human factor" in shooting and will help you shoot tighter groups.

- Wide and stable footprint dispersed over 8 1/2 lb. rest, 13" diameter base
- 7/8" diameter steel post provides smooth and quick elevation adjustments up to 8.25" height
- Use the 3 leveling feet to level your rest on most any surface
- Forend stop ensures consistent stock placement from shot to shot
- Forend cradle is designed to accept all Caldwell Deluxe Universal Front Rest Bags
- Filled Medium Varmint front bag included with rest

The Rock™ Shooting Rest - #383774

Case Pack of 4

The Rock™ Shooting Rest Combo - #383640

Case Pack of 4

("The Rock" and filled rear bag)



Filled rear bag made of durable water resistant fabric



Positive forend stop

Convenient finger-tip elevation adjustment

Built-in carrying handle

Durable powder coat finish

Vertical adjustment from 4.5" - 7.25"

Adjustable cradle conforms bag to forend

Rock solid extra wide 3 point iron base

"The Rock"™ SHOOTING REST COMBO



The Rock package:
13" wide x 4" high x 14" deep

Rock and Bag Combo Package:
15.25" wide x 12" high x 4.25" deep

THE ROCK JR.™ - #323225

Case Pack of 4

Many of the same features as The Rock, but in a sleeker and more economical package. For sighting-in, test firing, and informal competition, it's tough to beat a Rock Jr.

- Y-shaped base dispersed over 5 1/2 lb. rest
- 3/4" diameter steel post provides secure and smooth elevation adjustments up to 8" height
- Comes with interchangeable non-slip rubber feet or metal spike feet
- Filled Medium Varmint front bag included with rest
- 10" diameter base

The Rock Jr. package:
10" wide x 4.25" high x 9.75" deep



REAR SHOOTING BAGS

Case Pack of 4

These innovative, high-quality leather and polyester Rear Shooting Bags function with most brands of front rests. The leather gives you a secure rest and the polyester, which will not stretch or sag, allows the bag to hold its shape.

- Standard Rear: for use with the 4" Center Post on the Rock™ and other similar rests
- Medium-High Rear: for use with the Fire Control Front Rest and other similar rests
- Magnum Extended Rear Bag: for use with extended height shooting rests
- Unfilled bags should be filled with dry silica sand or other inert fillers

A. Standard Rear Bag Filled: #598458. Unfilled: #226645

B. Medium-High Rear Bag Filled: #800888

C. Magnum Extended Height Filled: #445389

Standard Bag weighs 2.5 lbs.
Medium Bag weighs 4.25 lbs
Magnum Bag weighs 7.37 lbs



Standard & Medium-High Rear Bag (unfilled) package:
3.875" wide x 8.25" high x 2.5" deep



SHOOTING BAGS

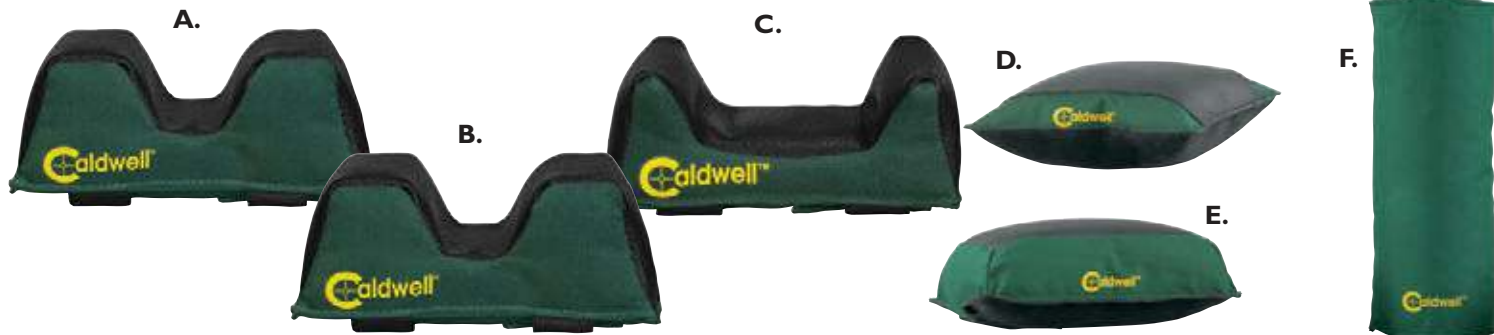

DELUXE UNIVERSAL FRONT BAGS AND BENCH ACCESSORY SHOOTING BAGS

These innovative, high-quality leather and polyester Front and Rear Shooting Bags function with most brands of front rests. The exclusive hook and loop tabs on the Front Rests allow quick installation and removal from the cradle without time-consuming need to lace them on. The leather gives you a secure rest and the polyester, which will not stretch or sag, allows the bag to hold its shape. This combination makes for the best shooting bag on the market.

- Narrow Bag is ideal for most sporting rifles
- Medium and Wide Bags are perfect for varmint and benchrest rifles
- Unfilled bags should be filled with dry silica sand or other inert fillers

What began as an improvement over the classic front rest bags has been expanded to include a variety of accessory bags for informal as well as competitive shooting. Blending the idea of combination leather and polyester rest bags with classic accessory bags has resulted in new shapes, new uses and a new look.

- A. Narrow Sporter Front Bag** Filled: #108325
 Case Pack of 4 Unfilled: #391981
- B. Medium Varmint Front Bag** Filled: #263234
 Case Pack of 4
- C. Wide Benchrest Front Bag** Filled: #576578
 Case Pack of 4 Unfilled: #489585

D. Elbow Bag Filled: #774317

Case Pack of 6
 7" square, approximately 13/4" tall:
 The Elbow Bag saves wear and tear on elbows / forearms.

E. Universal Bag Filled: #116375

Case Pack of 6
 8" long, 5" wide, 2 1/4" tall: The Universal Bag has many uses. It can be used as a forearm or elbow rest; to raise the height of the rear bag; between the buttstock and the shoulder with heavy recoil long guns; a heel rest for handgun shooting; or even as a practical front rest.

F. Cylinder Bag Filled: #368801

Case Pack of 6
 9 1/4" tall, 3 1/2" diameter: The cylinder bag can be used as a buffer bag between buttstock and shoulder for heavy recoil firearms; as an ankle support in the kneeling position; or even as a practical forend rest when the situation requires.

- 4 Bag Set:** Unfilled: #421196
 Case Pack of 4
 Includes Narrow (A), Medium (B), Wide Front (C) Bags & Standard Rear Bag

Accessory Bag Combination Filled: #343375

Case Pack of 6
 Bags D, E, and F offered together for a package price.

HUNTER'S BLIND BAG

Support and protect your rifle in almost any hunting situation. The Caldwell Blind Bag is the answer when other types of support are unavailable or inappropriate. Quick set-up for accurate shooting when the need for a stable rest is at a premium.

- Sits on any narrow surface such as; deer/turkey stands, fence posts, tree limbs, brick walls or truck bed side
- Bag is trim, lightweight, easy-filling and will not sag over time
- Dark green color blends well with natural surroundings
- Narrow contour of rest matches most sporter weight stocks

- Hunter's Blind Bag Filled: - #247261** Case Pack of 6
Hunter's Blind Bag Unfilled: - #740805 Case Pack of 6

Hunters Blind Bag Unfilled Package:
 8.25" wide x 4" high x 2" deep

Hunter's Blind Bag FILLED bag:
 5.75" wide x 9.5" high x 1.75" deep



SHOOTING BAGS

TACK DRIVER® SHOOTING REST

The most user-friendly and effective, one-piece shooting bag available. This convenient shooting bag takes the place of two. You can use the Tack Driver almost anywhere, from portable and permanent shooting benches to makeshift positions in the field.

- Self-tightening surface grips your rifle and reduces felt recoil
- Non-marring, non-slip surface will not harm your rifle's finish
- Supports almost any rifle or shotgun type
- Available filled and unfilled

Tack Driver Filled: - #569230 Case Pack of 1
Tack Driver Unfilled: - #191743 Case Pack of 6



Carrying handle for convenience and portability

Tack Driver Unfilled package:
6.8" wide x 14.8" high x 1.5" deep

Tack Driver filled bag:
11.4" wide x 8.85" high x 7.5" deep



DEADSHOT® SHOOTING BAGS

Every hunter and shooter is looking for a versatile and steady shooting system that can be set up almost anywhere, and at any time. Whether you have minutes or seconds to set up for your next shot, the DeadShot Shooting Bags are the answer. These inexpensive and functional bags continue to set the industry standard for quality and functional shooting bags.

- Place them on almost any shooting surface
- Made of durable, water-resistant 600 Denier polyester
- Front shooting bag is the industry's largest (approximately 8 lbs.)
- Quick-connect feature makes bag transport easy
- Front bag dimensions: 10" wide x 8 1/2" high x 6" deep
- Rear bag dimensions: 5" wide x 5" high x 4 1/2" deep
- Available filled and unfilled

DeadShot Front Shooting Rest Filled: - #516620
DeadShot PINK Front Shooting Rest Filled: - #516777
DeadShot Rear Shooting Rest Filled: - #640721
DeadShot Shooting Rest: Front & Rear Combo Filled: - #939333
DeadShot Shooting Rest: Front & Rear Combo Unfilled: - #248885

DeadShot Combo Filled package:
10.3" wide x 10.5" high x 6.8" deep

DeadShot Combo Unfilled package:
5.5" wide x 9.3" high x 2" deep



Case Pack of 6
 Case Pack of 6
 Case Pack of 6
 Case Pack of 4
 Case Pack of 4

Transport Front & Rear Bags easily using the exclusive Quick-Connect System.



DeadShot
SHOOTING BAGS



SHOOTING RESTS



7 REST™ SHOOTING REST - #101557 Case Pack of 4

The 7-Rest is a truly innovative shooting accessory that utilizes a unique design to deliver exceptional versatility and true value. The asymmetric frame provides great stability while maximizing length adjustability. By simply loosening the lock knob, the angle between the two parts of the frame can be adjusted to change the distance between the front and rear supports. Having the frame offset to the side of the gun also gives adequate clearance for extended magazines on semi-autos (AR-15), lever actions and rolling blocks. Another benefit of the frame design is the ability to reverse it for right or left handed shooting comfort. Fully adjustable overmolded front and rear supports hold your gun securely while protecting the stock and forend. All these features rolled into one rest result in a rock-solid, all-in-one shooting base with plenty of height and length adjustment to accommodate guns of virtually any length. Folds quickly for easy transport and storage.

- Works great with AR-15s and lever-action rifles
- Ambidextrous - folds to accommodate right or left-handed shooters
- Over-molded supports
- Folds compact for transport and storage



Ambidextrous design folds to accommodate right or left-handed shooters and varying lengths of firearms.



The 7 Rest folds flat for better transport.



7 Rest package:
8.5" wide x 25.5" high x 2" deep



ZEROMAX™ SHOOTING REST - #546889 Case Pack of 4

The Caldwell ZeroMax Shooting Rest is a full-length metal rest that comes packed with all of the features that today's shooters demand. This "no-frills" full-length rest offers the shooter a rock-solid platform for quick and convenient set-up without the expense and complexity of other rests.

- Durable tube steel frame fabrication
- Elevation adjustment
- Filled Medium Varmint front bag included
- Rock-solid shooting base for rifles and shotguns

ZeroMax™



ZeroMax package:
23.8" wide x 6.5" high x 5" deep



Ballistic Precision CHRONOGRAPH

SHOOTING ACCESSORIES

The Ballistic Precision Chronograph provides accurate velocity measurements across a wide range of shooting conditions. Higher accuracy was achieved by using a high speed 48 MHz processor and by designing a circuit with an advanced data interface that allows each unit to be computer calibrated at the factory after assembly. The end result is the ability to provide much better accuracy than other chronographs on the market (+/- .25%). Although technologically advanced, the unit is designed to be simple to operate, displaying velocity in Feet per second or Meters per second on the large built-in LCD screen. The Chrono can also deliver the shot string velocity data through the 15 foot audio jack cable (included) to an iPhone®, iPad®, or certain Android smartphones. A free App is available for download that displays the velocity of each shot on the phone screen and records it with other data identifying the load and environmental conditions. The App also automatically calculates Average Velocity, Standard Deviation, Min, Max and Velocity Spread for the shot string. The data is stored and can be exported via e-mail or simply recalled for reference at a later date. The sunshades are extra wide for better reliability on sunny days and are constructed of a durable synthetic material. Measures from 5 to 9,999 FPS. There is a 1/4-20 threaded insert on bottom of housing for tripod mounting, operates on a 9 Volt battery (not included).

- Each unit factory calibrated to within +/- 0.25% accuracy
- Ideal for firearms, archery, airgun and paintball
- Simple operation, large LCD screen
- Meters Per Second (MPS) or Feet Per Second (FPS) readings
- Extra wide sun screens for added shading in full sun operation
- Option to interface with smartphone via included 15' audio jack cable
- App displays velocity, logs data, notes, weather conditions, easily exports via SMS or Email
- Carry bag included in Premium Kit

Ballistic Precision Chronograph - #720001 Case Pack of 4
IR LED Light Kit - #721111 Case Pack of 4
B.P.C. Premium Kit - #721122 Case Pack of 2



Get real time readings off your Smart Phone from up to 15 ft. away with the included cord!



Works great with your Bow or Crossbow too!

Smart Phone Cradle Not Included



Chronograph package: 9.75" wide x 21.5" high x 4.75" deep

Smart Phone Not Included



FREE App to Download!

A free App is available for download that displays the velocity of each shot on the phone screen and records it with other data identifying the load and environmental conditions. The App also automatically calculates Average Velocity, Standard Deviation, Min, Max and Velocity Spread for the shot string. The data is stored and can be exported via Email or simply recalled for reference at a later date.



Interactive Display

Record Groups

Save Data

Set Custom Preferences

B.P.C. Premium Kit

Contains everything you need to capture reliable velocity data in one convenient kit. Includes Chronograph, IR LED Light Kit, Tripod and Custom Carry Case that conveniently holds all items.

- Tripod Height adjustable from 15"-42"
- Includes 1/4-20 dovetail plate to attach to the chronograph
- Custom Carry Case designed to store and transport Chronograph, Sunshades, Light Kit and Tripod
- Custom Carry Case constructed of Durable Ballistic Fabric with Heavy Duty dual zipper design



IR LED Light Kit

The Chronograph Light Kit is designed with high output IR LED lights which deliver the most reliable reading across a wide range of ambient light conditions. It works well indoors and increases performance outdoors in challenging light conditions when the sun is low in the sky. Easily installs in place of sunshades. Incorporates 36 IR LEDs in each strip and one visible red LED to indicate power is on. Operates on 4 AA batteries or the 110 volt AC adapter which is included.

- Improves Chronograph performance
- Ensures reliable readings in challenging or poor light conditions
- 120 VAC or Battery operation for convenient use indoors or out



SHOOTING ACCESSORIES



WIND WIZARD II™

WIND WIZARD II™

#102579 Case Pack of 4

The Caldwell Wind Wizard II has been re-designed to be the best value wind meter on the market and an ideal tool for indicating wind speed. Knowing wind speed gives the shooter the ability to judge shot placement in varying wind conditions. Both compact and portable, this wind meter reads wind and temperature in various units of measure. The non-slip rubber sleeve protects the unit and ensures it's easy to grip even with gloved hands. Operates on one CR2032 battery (included).

- Wind speed measures in mph, ft/min, km/h, m/s, or knots
- Temperature display in Celsius and Fahrenheit
- Non-slip protective rubber sleeve
- Wind chill display
- LCD backlight
- Auto power off



Wind Wizard II Package:
5.75" wide x 7.25" high x 2" deep

CROSSWIND™ PROFESSIONAL

WIND METER - #112500 Case Pack of 4

The Caldwell CrossWind Professional Wind Meter was designed to be the best wind meter on the market for ballistic application. Knowing wind speed gives the shooter the ability to more accurately judge shot placement in varying wind conditions. The 90° rotating anemometer head allows you to measure exactly how much cross wind will be applied on the side of your bullet without ever having to move the wind meter or do angle calculations. Both compact and portable, this wind meter reads Current Wind Speed, Average Wind Speed, Max Wind Gust, Temperature and even Density Altitude, Altitude or Barometric Pressure. The included holster protects the wind meter and makes it easy to keep handy. The Caldwell CrossWind Professional Wind Meter is the ultimate tool for indicating wind speed and calculating a reliable firing solution. Operates on one CR2032 battery (included)

- Wind Speed measurements in: mph, ft/min, km/h, m/s, or knots
- Measures Max Wind Gust, Average Wind Speed and Current Wind Speed
- Anemometer head rotates 90 degrees to calculate the applied crosswind
- Measures/Calculates: Temp, Station Pressure, Barometric Pressure, Altitude, Density Alt. and Wind Chill
- Features a Data Hold function
- Water resistant
- LCD backlight
- Auto power off



CrossWind Package:
7.5" wide x 8" high
x 1.5" deep

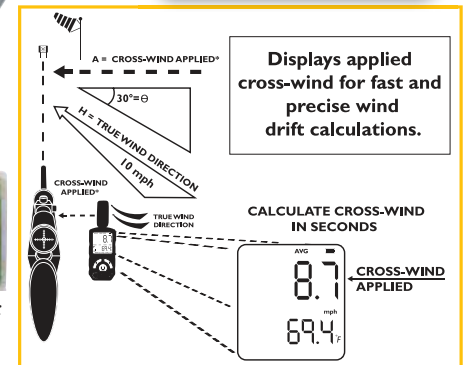

BRASS RETRIEVER - #125789 Case Pack of 4

Are you tired of spending more time bending over and picking up brass at the range than you do shooting? Try the NEW Caldwell Brass Retriever. Now picking up spent brass is as easy as pushing a mop. The Brass Retriever can pick up rifle and pistol brass quickly and efficiently. It even helps prevent stress on your back from bending over. The Brass Retriever works any where, even on grass and gravel. The retriever comes complete with a roll cage separator that allows you to dump the collected brass into a bucket quickly. It is collapsible as well, making it convenient to transport to and from the range.

- Designed to make picking up brass extremely easy
- Reduces time and saves your back
- Telescoping handle to customize the length
- Simply push down and roll the Brass Retriever over the brass
- End caps open to easily empty the Brass Retriever

Brass Retriever Package:
8" wide x 22" high x 6" deep



Expands from 28"
up to 57" tall



AR-15 ACCESSORIES

PIG RAIL BRASS CATCHER

The AR-15 Pic Rail Brass Catcher mounts to the Pic Rail of any AR with its quick detach anodized aluminum clamp and captures the ejected brass during firing. The clamp and wire frame are fully adjustable to work with a wide variety of rail/optic configurations and allow brass to enter bag without any disruption to bolt function or cycling. The quick detent locking attachment feature allows for quick installation and removal of the brass catcher; which allows for quick checking or clearing of the rifle chamber. The large 100 round capacity (.223) prevents brass from being scattered around your shooting area and works great in preventing hot brass from landing on the shooter or spotter. Convenient zipper at bottom of mesh bag makes emptying simple.

- Mounts to any AR-15 rifle with a flat top or Picatinny rail hand guard
- Compatible with most AR-10/LR-308 models as well
- Ideal for reloaders, no more lost brass and it never hits the ground
- Fully adjustable, mounts virtually anywhere on a pic rail, riser of to rear of hand guard with pic rail
- Quick two-piece system with detent locking
- Prevents hot brass from landing on shooter
- Heat resistant mesh won't melt

Picrail Brass Catcher Package: 7" wide x 9.85" high x 3.5" deep

Pic Rail Brass Catcher - #530143

Case Pack of 4

Pic Rail Spare Mount - #123904

Case Pack of 4

Internal wire frame maintains catchers shape even when full of brass

Brass Catcher quickly separates from Pic Rail for easy AR cleaning and inspection



AR-15 BRASS CATCHER - #122231 Case Pack of 4

Tired of picking up .223 brass from your AR? The AR-15 Brass Catcher attaches to the forearm of any AR with hook and loop webbing and captures the ejected brass. It prevents brass from being scattered around your shooting area. Also works great in preventing hot brass from landing on shooter or other people next to the shooter. Wire frame holds fabric in correct shape and allows brass to enter bag without disruption to bolt function or interrupt cycling. Captures and holds approximately 30 rounds. Convenient zipper at bottom of mesh bag makes emptying simple.

- Quickly attaches to any AR-15
- Holds approx. 30 rounds of spent brass
- Zipper for easy emptying
- Won't interfere with gun's cycling

Adjustable Hook & Loop closure accommodates many different sized Forends.



Internal wire frame holds shape even when catcher is full.

Mesh catch bag allows you to see how much brass has been collected

Zippered bottom allows you to remove brass without removing catcher from your AR

Brass Catcher Package: 6" wide x 10.125" high x 1.875" deep

BRASS TRAP - #122560

Case Pack of 4

Are you tired of spending as much time sifting through grass looking for brass as you do shooting at the range? Look no more with the Caldwell Brass Trap. It is specifically designed to catch the brass in most shooting environments with any gun. The Brass Trap quickly assembles to be set on a bench and catch all or your rifle brass or it can be mounted on tripod to catch all of your pistol brass. When you are done shooting simply unzip the zipper for quick brass removal and break it down to store in your range bag. Spend more time shooting and less time looking for brass with the Caldwell Brass Trap. Carry bag included.

- Use on bench top or attach to any tripod with a 1/4-20 male threaded stud (tripod not included)
- Keeps shooting area clean
- Heat resistant mesh
- The durable bag has a zippered bottom for easy emptying
- Ideal for reloaders, no more lost brass, the cases never hit the ground
- Designed for use with rifles and pistols.
- Collapses easily to fit in a range bag
- Carry bag included

The entire Brass Trap collapses and folds up into a storage bag small enough to fit in your range bag!

Mount to a tripod for use with your handgun



Brass Trap Package: 6.75" wide x 19.75" high x 2" deep



AR & AK ACCESSORIES

AK MAG CHARGER™ - #397599 Case Pack of 4



Caldwell brings the same revolutionizing ammo loading process of the AR-15 Mag Charger to the AK Platform. Introducing the NEW AK (7.62x39) Mag Charger! Designed to hold 50 rounds from any common 50 round ammo box or 50 round manufacturers box. Align the bullet tips in the 50 round box with holes in the Mag Charger and dump them in. Specially designed indexing tabs align all the rounds in the loader at the same time. No more need to handle each around. Then simply insert your AK magazine into Mag Charger, operate the plunger back and forth and with each stroke you will load 5 rounds until the magazine is full. Now you can load 50 rounds into 2 AK magazines in less than 15 Seconds! Highly durable polycarbonate construction, compatible with 7.62x39 ammo.

- Compatible with all AK platform mags both mil spec and molded plastic
- Instant transfer system from ammo box directly to Mag Charger
- Accepts 50 rounds of 7.62 x 39 loaded ammo
- Loads 5 rounds per "stroke" with auto advance
- Load AK magazines in just seconds
- Durable polycarbonate construction

PATENT:
www.BTlbrands.com/patents/



NEW
2015



AK Mag Charger Package:
13.5" wide x 15.5" high
x 4.375" deep



Top down view of 50 rds. of ammo in the Mag Charger

A MUST HAVE for Any AK Enthuslast

MAG CHARGER™ AMMO BOXES 5 PACK

AR-15 MAG CHARGER AMMO BOX 5 PACK

#397623 Case Pack of 6

- Optimized to drop ammo into the Caldwell AR-15 Mag Charger
- Lid is removable and nests with the bottom cavity
- Holds 50 rounds of .223, 5.56 x 45, and .204
- Durable polymer designed to be extremely tough
- Great for long term storage

AK MAG CHARGER AMMO BOX 5 PACK

#397480 Case Pack of 6

- Optimized to drop ammo into the Caldwell AK Mag Charger
- Lid is removable and nests with the bottom cavity
- Durable polymer designed to be extremely tough
- Holds 50 rounds of 7.62x39
- Great for long term storage

Mag Charger Ammo Box Package:
7" wide x 13" high x 3.5" deep



NEW
2015

AR-15 MAG CHARGER™

AR-15 ACCESSORIES

AR-15 MAG CHARGER™ - #397488 Case Pack of 4

Simply put, the Caldwell AR Mag Charger revolutionizes the way ammo is handled and loaded into AR-15 magazines. It is designed to accept 50 loaded rounds directly from any common 50 round ammo manufacturer box or from aftermarket 50 round plastic storage boxes. Simply align bullet tips and dump a box of ammo into the Mag Charger. The ammo is automatically aligned without touching a single round. Once filled with ammo, insert any AR magazine into the Mag Charger just as you would into a rifle. Then actuate the plunger back and forth loading 5 rounds per stroke as the spring loaded ammo carrier automatically advances aligning the next five rounds until magazine is fully loaded. The entire process of filling the Mag Charger with ammo and loading all 50 rounds into two magazines takes less than 15 seconds! An Ammo Transfer Tray is included to invert ammo that is positioned in boxes with the bullet tips oriented down or to stage bulk ammo for dumping into Mag Charger. Highly durable polycarbonate construction, compatible with all .223, 5.56, .204 and most 300 AAC Blackout ammo.

- Load AR magazines in just seconds
- Accepts 50 rounds of .223, 5.56, .204 or 300 AAC Blackout loaded ammo
- Instant transfer system from ammo box directly to Mag Charger
- Loads 5 rounds per "stroke" with auto advance
- Compatible with all AR platform mags both mil spec and molded plastic
- Durable polycarbonate construction

PATENT:
www.BTibrands.com/patents/

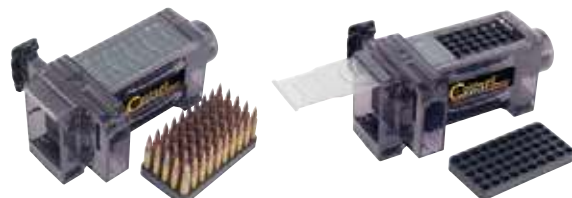

A MUST HAVE for Any AR-15 Owner

AR-15 Mag Charger works on almost all mags from Milspec to Aftermarket



Top down view of 50 rds. of ammo in the Mag Charger

AR-15 Mag Charger Package:
11.25" wide x 12.5" high x 4.75" deep



For more information and a video



AR-15 ACCESSORIES

SEE PAGES 88-95
FOR AR TOOLS
Wheeler Engineering
DELTA SERIES

AR DEADSHOT® TACTICAL BAG SET - #934693 Case Pack of 4

The DeadShot Tactical Bag Set was designed to deliver an optimal, stable shooting platform for all AR-15 and LR 308 style rifles. The innovative dual configuration rear bag can be oriented for M4 carbine style stocks or reversed for an ideal fit with A2 style stocks. The tall profile front bag is an ideal height for AR's allowing clearance for 30 round magazines. Both bags feature an extremely heavy ballistic nylon on the contact surfaces designed to hold up to abuse from hand guards with sharp-edged picrails. Bags are pre-filled and ready for use. Weight approx. 7.5 lbs.

- Specifically designed for AR-15 and LR 308 rifles
- Perfect shooting height with plenty of clearance for 30 round magazines
- Rear bag is designed to fit collapsible M4 stocks on one side and fixed A2 stocks on the other
- Rifle can easily be rotated for fast magazine changes
- Works great with tactical style bolt action rifles as well
- Extremely heavy duty Ballistic Nylon fabric holds up to rough edged pic rail hand guards

Simply rotate AR to facilitate quick 30 round magazine changes

Extremely heavy duty ballistic nylon resists scuffing from sharp edged Picrails



Tactical Bag Package:
13.25" wide x 9" high x 5.25" deep



Rear bag can change orientation to accommodate M4 fixed and A2 collapsible stocks

MAG COUPLERS 2 PACK - #390504 Case Pack of 6

The Caldwell Mag Couplers are designed out of high strength polymer to easily couple 2 Mil-Spec Style 10 round AR-15 magazines together and not add weight. The coupling of magazines brings your capacity up to 20 rounds for faster reloads when seconds matter. The coupler is a 2 piece design that is bolted together to be extremely rigid without permanently modifying your magazines. The couplers hold the 2 magazines end to end to maintain the overall shape of a 30 round magazine to fit in all of your existing gun cases, mag pouches, etc...

- Easily couples 2 Mil-Spec Style 10 round AR mags together
- Maintains the profile of a 30 round mag to fit mag pouches, gun cases, etc...
- Quickly assembles/disassembles without magazine modification
- Contains 2 couplers to couple a total of 4 magazines
- Contains 2 dust covers to keep dust out and protect bullet tips

Couples 2 Mil-Spec Style 10 round AR Mags together

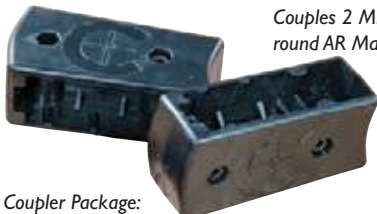

Mag Coupler Package:
4" wide x 8" high x 2" deep



MAG CAPS 6 PACK - #390522 Case Pack of 6

The Caldwell Mag Caps are designed to securely fit on top of 10, 20 and 30 Round Mil-Spec AR-15 magazines to keep dust out and protect bullet tips. When not in use they easily slip on the bottom of the magazine so they aren't misplaced. Made of non-marring flexible rubber to seal the magazine and intended for years of use.

- Made of non-marring flexible rubber
- Keeps dust out and protects bullet tips
- Slip on the bottom of the magazine for storage while not in use



Slip Rubber caps on onto Magazines to protect from dust



Mag Caps Package:
4" wide x 8" high x 2" deep



SINGLE POINT TACTICAL SLING

Single attachment point slings have quickly become the new standard for field carry of AR platform guns as well as many other firearms. This heavy duty bungee sling easily attaches to the gun with its steel carabiner clip. The nylon strap with quick-release buckle adjusts for length. Gun is held in a safe and convenient muzzle-down ready position. Available in Black or Flat Dark Earth color.

- Heavy duty bungee construction with nylon cover
- Durable steel carabiner clip for easy attachment
- Allows safe and convenient muzzle down carry position

Black Single Point Tactical Sling - #156215

Case Pack of 4

Flat Dark Earth Single Point Tactical Sling - #390662

Case Pack of 4



AR-15 ACCESSORIES



PIG RAIL SMARTPHONE MOUNT

#123906 Case Pack of 6

- Use your smartphone on any Picatinny rail as a camera or to display ballistics calculators
- Unique, padded adapter allows virtually any smartphone to be used, with or without a case, and in portrait or landscape mode
- Mount your smartphone for unique action footage or turn it around for third-person perspective shots
- Detachable mount allows bracket to be removed for carrying or transport
- Adjustable bracket with screw allows camera angle to be easily adjusted and locked into place
- Aluminum construction makes this mount extremely durable and easily resists recoil of even large magnums or shotguns



PIG RAIL ACTION CAMERA MOUNT

#123905 Case Pack of 6

- Easily attaches all action cameras to a standard Picatinny rail
- Mount your camera to your rifle for unique action footage or turn it around for third-person perspective shots
- Quick detach mount allows camera bracket to be removed for carrying or transport
- Adjustable bracket with screw allows camera angle to be quickly adjusted and locked into place
- Includes custom, extended length Action Camera mounting screw for easy adjustment even with heavy gloves
- Aluminum construction makes this mount durable and easily resists recoil of even large magnums or shotguns



DeadShot® POD FAMILY

ACHIEVE BENCHREST ACCURACY WHEN IT COUNTS MOST...

The Caldwell DeadShot POD Family of products are the industry's first and only True Hunting Rests. They are designed to deliver reliable accuracy when it counts most... in the field. All rests feature an upper frame that is adjustable to accommodate and fully support any rifle, shotgun or crossbow. Smooth 360° rotation and full tilt function allow you to acquire targets quickly and hold the weapon stable for an accurate shot every time. Standing, sitting, or from the ground, in a blind or treestand get a DeadShot Rest and make every shot count.



- Fully supports weapon, front and rear
- Adjustable to accommodate any Rifle, Shotgun or Crossbow
- Get maximum accuracy and extend your effective shooting range



– Ralph Cianciarulo –
 "Innovation, quality and dependability, that's what comes to mind when I think Caldwell. Vicki and I have been working with the team at Caldwell Shooting Supplies for years. We're proud to be associated with such a great company."



ANY WEAPON, ANY SHAPE, WIDTH OR LENGTH



...IN THE FIELD

**DeadShot[®]
FieldPod[™]**



COMBINING TROPHIES & MEMORIES FOR THE FUTURE

HUNTING RESTS

DEADSHOT® FIELDPOD™ - #488000 Case Pack of 4

DeadShot® FieldPod™

Achieve benchrest accuracy when it counts most - in the field. Caldwell is known for producing rock solid shooting rests; the FieldPod is a highly portable Hunting Rest that allows you to bring that same stability along on the hunt. Its innovative design and versatility make it perfect for a variety of hunting applications. Height adjustment ranges from 20" to 42" ensure your gun can be precisely positioned and supported whether sitting on the ground or in a chair. Get ideal position and stability for your shotgun, rifle or crossbow while shooting from a stool inside a ground blind. Improve predator hunting success with the perfect gun position on every set, minimize movement, speed up target acquisition and increase effective shooting range. Take advantage of the portable and stable design on western hunts that frequently offer long range shot opportunities. Length and pivot point adjustments ensure a perfect fit and balance for any weapon. Cast aluminum hub provides tension adjustable rotation and tilting for fast and stable target acquisition. Precision cast aluminum hub system allows gun to pivot up/down and rotate left/right. Carry strap included.

- Lightweight aluminum construction, under 6 pounds
- Innovative design easily adjusts to any gun or crossbow, supporting both forend and stock
- Quickly collapses for transportation
- Great for: Ground Blinds, Predator Calling, Long-Range Rifle Shooting and Turkey Hunting
- Adjusts from 20" high up to 42"
- Dual tube frame is fully compatible with detachable magazine rifles like the popular AR-15
- Pivots up/down and rotates left/right for quick target acquisition
- Durable cast aluminum hub for maximum stability and smooth movement
- Enhances success and safety for a beginner by supporting the weight of a gun and provides that extra stability and confidence for the experienced shooter to take a long shot.

ANY WEAPON



ANY SHAPE, WIDTH, LENGTH



Adjusts up to 42" in Height

Ground Blind: Perfect for use inside a ground blind while seated on a stool or chair



Quickly folds compact for easy transport, detachable carry strap included



DeadShot FieldPod Package: 24.25" wide x 7" high x 6.25" deep

Predator Hunting: Get perfect gun position for any predator calling set, reduce movement and increase accuracy

HUNTING RESTS

DEADSHOT® FIELDPOD™ MAX - #488029 Case Pack of 4

Caldwell is known for producing rock solid Hunting Rests and the DeadShot FieldPod MAX is no exception. This highly portable Hunting Rest allows you to bring the same stability as the Original DeadShot FieldPod along with you on the hunt. Its innovative design and versatility make it perfect for a variety of hunting applications. Get ideal position and stability for your shotgun, rifle or crossbow while shooting from a chair inside a ground blind. Take advantage of the portable and stable design on western hunts that frequently offer long range shot opportunities. Independently adjustable legs allow you to set up on rough terrain or a hillside and still maintain a level shooting platform. Length and pivot point adjustments ensure a perfect fit and balance for any weapon. Cast aluminum hub provides tension adjustable rotation and tilting for fast and stable target acquisition. Carry strap included.

- Enhances success and safety for a beginner by supporting the weight of a gun and provides extra stability and confidence for the experienced shooter to take a long shot.
- Innovative design easily adjusts to any gun or crossbow, supporting both forend and stock
- Dual tube frame is fully compatibility with detachable magazine rifles like the popular AR-15
- Lightweight aluminum construction, weighs 6.5 pounds
- Independent leg adjustment for quick leveling
- Screw out spiked feet for secure purchase
- Adjusts from 20" high up to 48"
- Bubble level for reference



DeadShot FieldPod MAX



Perfect height for shooting out of a ground blind.

DeadShot FieldPod MAX Package:
28.5" wide x 7" high x 6.25" deep



Overmolded front forend support

Independent height adjustable front and rear supports

Dual frame for maximum stability and length adjustment

Upper frame balance point adjustment

Overmolded rear stock support

Upper frame length adjustment

Cast aluminum hub design

Durable, lightweight extruded aluminum frame

Tension knob for rotation of upper frame

ANY WEAPON



ANY SHAPE, WIDTH, LENGTH

Fast adjustment for leg height

Independent spreading and adjusting legs

Adjusts up to 48" in Height

DeadShot FieldPod MAX Package:
28.5" wide x 7.25" high x 6" deep



Screw out spike feet



HUNTING RESTS

DeadShot FieldPod MAGNUM

DEADSHOT® FIELDPOD™ MAGNUM - #488111 Case Pack of 2

The Original DeadShot FieldPod was the first true "Hunting Rest" on the market. The Magnum FieldPod brings the same benchrest accuracy to the field with some great new added features. With a maximum deployed height of over 60 inches it can be used from a standing position. This rest also works superbly from a sitting position directly on the ground or from a chair. It can even be used in a prone position with the legs spread to a wide base position. The Dual-Framed upper legs and oversized extrusion profile of the lower legs lock rigidly with a quick cam lever. Independent angle adjustment of the legs and spiked foot inserts ensure a solid grip on any terrain. An integrated bubble level in the aluminum hub allows rest to be precisely leveled. Ultra smooth rotation and tilt adjustment allow fast and precise target acquisition. At approximately 13 pounds and collapsed to 30" the Magnum FieldPod remains highly portable for easy transport. Carry strap included.

- Maximum height adjustment range (18" to 60")
- Configure for use in Grounded, Sitting or Standing position
- Lightweight aluminum construction
- Ultra-stable Dual-Frame construction
- Quickly folds to a compact carry position
- Innovative design fully supports any gun or crossbow



Standing Position



Seated Position

The Magnum is fully adjustable and stable from a standing, sitting or grounded position.

Grounded Position

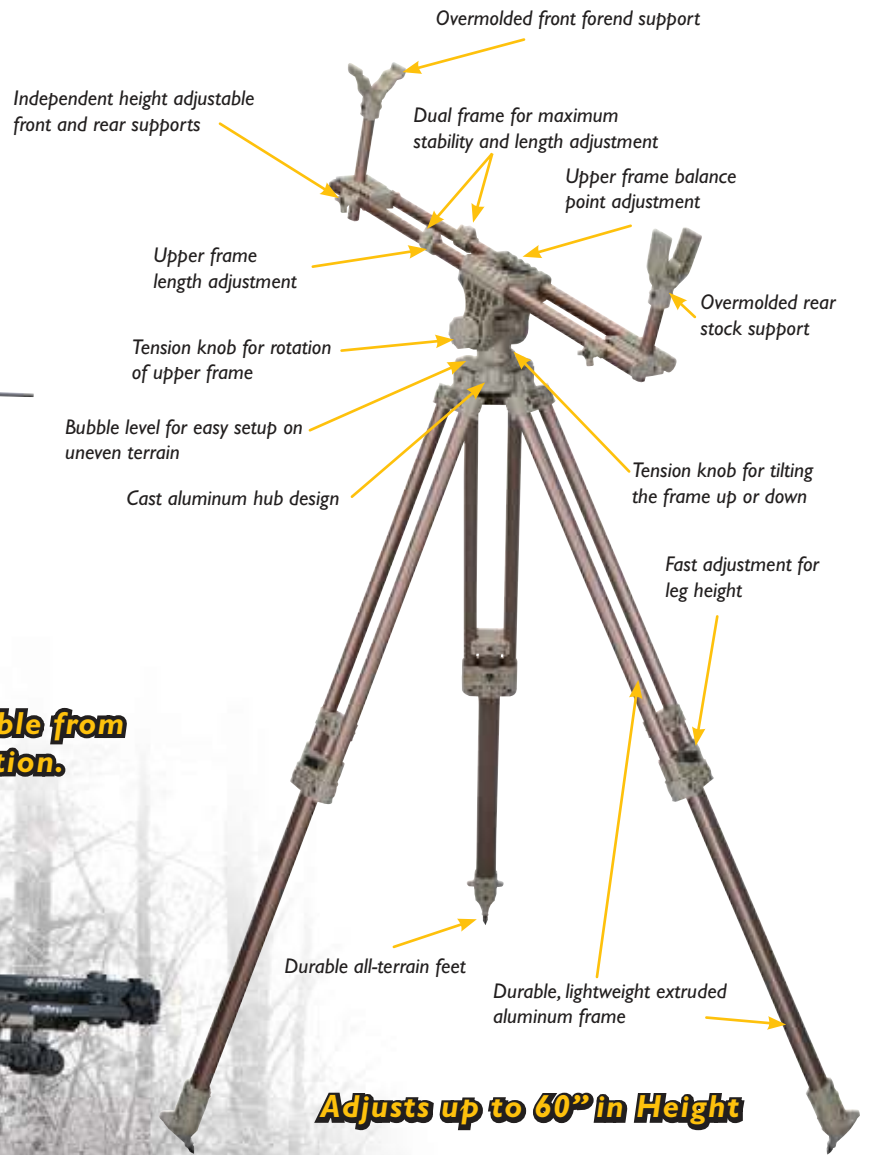

Adjusts up to 60" in Height

ANY WEAPON



ANY SHAPE, WIDTH, LENGTH

Magnum DeadShot FieldPod Package: 39" wide x 7.75" high x 7" deep



HUNTING RESTS



DEADSHOT® CHAIRPOD™ - #795234 Case Pack of 2

The DeadShot ChairPod provides true benchrest accuracy from a single shooting unit. No need to bother with carrying chairs and separate rests out to the ground blind or the range to sight-in your weapon. The ChairPod provides all of that in one package; it has a comfortable heavy duty chair with a built-in post and swing arm assembly that fully supports your weapon front and rear. Extend your effective shooting range by stabilizing the entire weight of your gun or crossbow with this convenient package. The ChairPod holds your weapon securely in the ready position while freeing up hands for binoculars, range finder or warm pockets. The innovative multi-bearing swing arm system provides smooth and stable movement from extreme angles left to right with minimal body movement and the chair silently spins 360° to get you on the target no matter where it is. Combined with a tension adjustable up/down tilt function the rest easily allows for precise alignment across the entire range of possible shooting angles. The upper portion of the rest adjusts in length and balance point to accommodate any gun or crossbow. Rubber overmolded front and rear forks along with a retention strap ensure your weapon is held securely at all times. Approx. weight 22 pounds.

- Finally, get true benchrest accuracy in one package
- Ultra-stable design provides maximum accuracy
- Fully supports any gun or crossbow
- Swing-arm system and 360° chair allows for maximum range of movement
- Great for hunting from ground blinds, field edges or shooting at the range
- Keeps gun in the Ready Position while freeing up hands
- ChairPod weight limit 300 lbs.



Folds up and conveniently packs away. Easy to wear it to and from your blind with the included backpack straps.



Benchrest Accuracy and a full size comfortable chair all in one ChairPod!



Chair and Rest rotate together for 360° Coverage



180° Pan with 360° Spin!

DeadShot ChairPod Package:
24.5" wide x 16.5" high x 8" deep



ANY WEAPON



ANY SHAPE, WIDTH, LENGTH

Adjusts up to 40" in Height



HUNTING RESTS



DEADSHOT® TREEPOD™ - #484148 Case Pack of 2

The DeadShot TreePod provides true benchrest accuracy from any tree stand. Don't rely on a shooting rail or flimsy branch that only supports the barrel of your gun. Extend your effective shooting range by fully supporting the entire weight of your gun or crossbow with this ultra-stable rest. Holds your gun securely in the ready position while freeing up hands for binoculars, rangefinder or warm pockets. The innovative multi-bearing swing arm system provides smooth and stable movement from extreme angles left to right with minimal body movement. Combined with a tension adjustable up/down tilt function the rest easily allows for precise alignment across the entire range of possible shooting angles. The upper portion of the rest adjusts in length and balance point to accommodate any gun or crossbow. Rubber overmolded front and rear forks along with a retention strap ensure your weapon is held securely at all times. The universal mounting base consists of two steel plates and a height adjustable center support shaft that securely attach to most any tree stand platform. The upper rest with swing arm assembly easily detaches from the mounting base for transport. Additional bases are available to allow the rest to be used on multiple stands. Constructed of anodized aluminum and powder coated steel for maximum stability and durability. Approx. weight 15 pounds.

- Finally, get true benchrest accuracy from your tree stand
- Ultra-stable design provides maximum accuracy
- Fully supports any gun or crossbow
- Multi-piece swing-arm system allows maximum range of movement
- Universal mounting plate is compatible with a wide variety of tree stands
- Keeps gun in the ready position while freeing up hands



Height: approx 31" - 47"
 Base Plate Size: 6" x 8.5"
 Weight, Overall: 14.6 lb
 Weight, Upper Assembly: 6.5 lbs
 Weight, Base Lower: 8.1 lbs



ANY WEAPON



ANY SHAPE, WIDTH, LENGTH



DS TreePod Package:
 23.75" wide x 12.5" high x 6.5" deep

Adjusts up to 49" in Height

DeadShot TREEPOD ADD-A-BASE

Additional Support Base for the DeadShot TreePod

HUNTING RESTS

DEADSHOT® TREEPOD™ ADD-A-BASE - #785468 Case Pack of 4

Now you can use the DeadShot® TreePod™ from multiple Tree Stands without remounting the whole assembly! The Caldwell® ADD-A-BASE additional support base allows you to mount extra bases to more than one tree stand. You now have the ability to change deer stands based on wind direction or weather condition and still get benchrest accuracy when you need it.

- Mount to any tree stand
- Works with the DeadShot TreePod
- Constructed of powder coated steel
- Use multiple bases on different stands

Height: approx. 31" - 47" (with Upper)
Base Plate Size: 6" x 8.5"
Weight: 8.1 lbs

ADD-A-BASE Contains: 1 base mount,
1 upper post, 1 base plate, 5 bolts,
5 wing nuts

ADD-A-BASE Package:
21" wide x 9" high x 6.5" deep

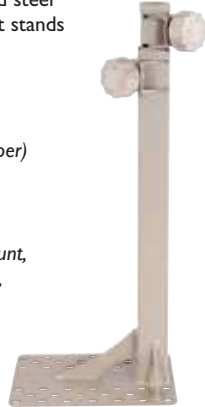

ADD-A-BASE to most any treestand!



DEADSHOT® TREEPOD™ BLIND WALL CLAMP - #803412 Case Pack of 4

Now you can easily mount a DeadShot TreePod in your box blind. The Blind Clamp is designed to work on a variety of blind types. The two steel plates of the clamp can be used to "sandwich" around the wall material of a blind or a single plate can be attached with lag screws if wood walls or framing are exposed. Once mounted the clamp receives the upper swing arm assembly of the TreePod eliminating the need to use the original base and center support shaft. You now have the ability to hunt from your stand or box blind and still get benchrest accuracy when you need it.

- Mounts to the inside of a box blind
- Works with DeadShot TreePod Upper
- Constructed of powder coated steel
- Use multiple clamps for more than one blind

Base Plate Size: 6" x 8.5"
Weight: 5 lbs

Blind Clamp Contains: 1 upper post with
plate, 1 back plate, 5 bolts, 5 wing nuts



DEADSHOT® UNIVERSAL ACCESSORY TRAY - #759432 Case Pack of 6

The DeadShot Universal Accessory Tray was designed to be used with the entire family of DeadShot Pods; Original, MAX, Magnum, TreePod and ChairPod. Never again worry about where to place that box of ammo, extra magazine, range finder or binoculars. The Universal Accessory Tray is constructed of vinyl dipped steel and durable fabrics. It snaps on the upper rails of any FiledPod rest to provide you that "third" hand for holding your accessories. If you need to adjust the position of your shooting rest don't worry about the tray falling off, it was designed with a snug fit to provide a secure storage platform and cut down on noise. When you're not shooting the tray easily come off the rest and folds flat for convenient storage.

- Works with all DeadShot Pod Hunting Rests
- Holds: ammo boxes, loose ammo, empty brass casings, binoculars, range finder, cell phone, spare magazines, wind meter or any small accessory
- Rigid quick attach frame allows for fast installation and removal from any FieldPod
- Collapses flat to fit compact in a range bag, rifle case or backpack
- Nylon mesh construction prevents the tray from holding moisture

Universal Acc. Tray Package:
7.75" wide x 12" high x 2" deep



**The PERFECT Accessory
for Any DeadShot Pod!**

HUNTING RESTS

DeadShot®

All DeadShot FieldPod Accessories are compatible with ALL DeadShot Pod Hunting Rests.

DEADSHOT® FIELDPOD™ OPTICS ADAPTER - #488333 Case Pack of 4

The DSFP Optics Adapter attaches onto your existing DeadShot FieldPod and provides multiple different mounting options for accessories. A full featured tripod head with a quick detach plate allows any device with a standard 1/4-20 threaded hole to be quickly attached and detached. A spotting scope, video camera or still camera can be attached and used alongside or in place of a gun. You can even capture video of your hunt by aligning a camera with your sights or scope on the gun. At the opposite end from the tripod head there is another quick detach plate that can be used for an additional device or will accept the included Pic rail. The Pic rail is the perfect way to mount a flashlight or night vision illuminator to enhance your weapon system's night time performance works great for hog or predator hunting! Once mounted to the FieldPod the Adapter can be adjusted left and right for a customized fit. The Adapter rotates 90 degrees and allows the FieldPod to collapse to a compact position for easy transportation. Weight is approximately 1.5 pounds; constructed of high strength injection molded polymer.

- Mounts to any existing DeadShot FieldPod
- Includes a full function tripod head with quick detach plate
- Accepts additional quick detach plate and Pic rail (included)



Optics Adapter Package:
12" wide x 4.25" high x 4" deep

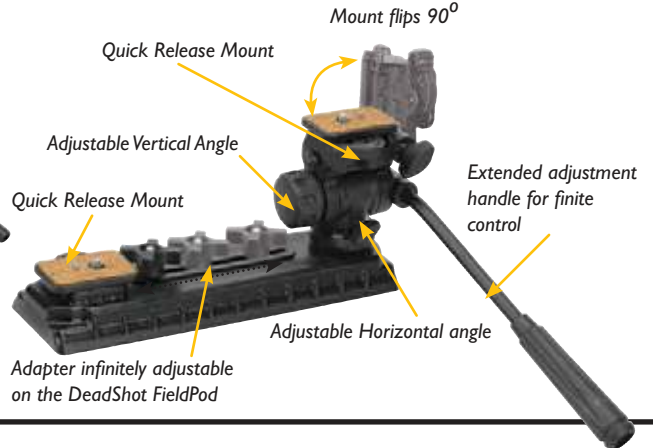

DEADSHOT® FIELDPOD™ DIGISCOPING KIT WITH SMART PHONE CRADLE - #488444 Case Pack of 4

This kit is the perfect addition to a DSFP outfitted with an Optics Adapter Kit or it can be used on any spotting scope on any tripod. The Digiscoping bracket attaches to nearly any spotting scope (eyepiece must be between 27mm and 58mm in diameter). Once attached to a spotting scope, the 1/4-20 threaded bolt will mount any camera with standard threaded hole. Micro adjustments allow the camera to be perfectly aligned with the spotting scope's eyepiece for viewing or capturing photos. The Smartphone Cradle included with the kit allows a phone to be used on the digiscoping bracket and easily aligned with the micro adjustments. The Cradle can also be mounted to a quick attach plate and then used on top of the tripod head in the Optics Adapter Kit to capture photos, video or display ballistics data for precise firing solutions. Digiscoping bracket is constructed of cast aluminum and weighs approximately 13oz, the phone cradle is powder coated steel, includes protective pad and elastic cords for securing phone; weighs approx. 8oz.

- Capture close up images through a spotting scope.
- Micro adjustments allow fast and precise alignment
- Phone cradle with 1/4-20 mount included
- Capture photos, video or display ballistics data

Mount your Smartphone to a spotting scope and film your hunt.

With the Smartphone cradle, conveniently display bullet ballistics or other information

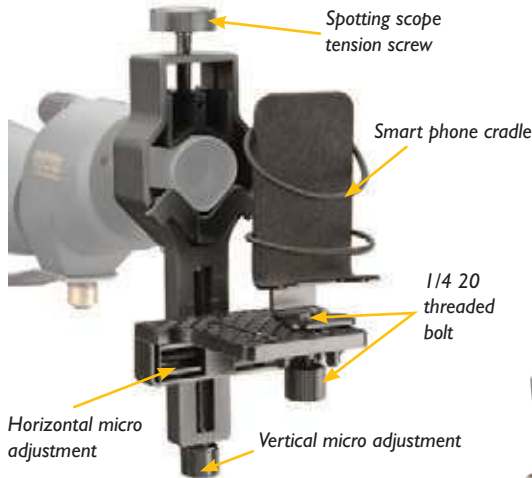

Even mount a camera to a spotting scope for long range shots or film.



DEADSHOT® FIELDPOD™ PREMIUM ACCESSORY KIT - #488555 Case Pack of 2

Turn your DeadShot® FieldPod™ into a Complete Hunting System with the Premium Accessory Kit. Get all the items and features of both the Optics Adapter Kit and the Digiscoping Kit in on package. Capture photos, video, or display smartphone App ballistics with the DigiScoping Kit. Combine that with the accessory mounting options of the Optics Adapter Kit and you have a compact, versatile, and easy-to-use shooting platform that is guaranteed to improve your hunting or shooting experience!



Premium Kit Package:
14.75" wide x 4.75" high x 4.25" deep

RECOIL PROTECTION

The PAST product line is based on a high-performance foam material that dramatically reduces the felt recoil of rifles, shotguns, and handguns. This foam pad absorbs and spreads the recoil impulse, significantly reducing the recoil felt by the shooter. Other styles of recoil protection tend to bounce into your shoulder, which can create an unstable feeling while offering inadequate protection. The PAST recoil protection system allows a shooter to concentrate on hitting the target instead of fearing the punishment of recoil. Concentration helps to create good shooting habits, and more importantly, prevents developing bad ones.

Felt Recoil from a 7mm Remington Magnum
7 1/2 lb. gun, 175 grain bullet

With Mag or Mag-Plus Shield

Without Shield

Energy in Foot Pounds 0 50 100 150 200 250 300

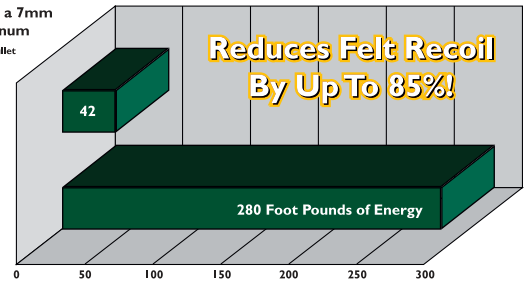

MAG SHIELD™ - #300010 Case Pack of 6

- Soft leather front and back provides ample friction to keep gun locked into the shield and the shield locked into your shoulder.
- Ambidextrous
- 1/2" thick energy-absorbing pad
- Approx. 20" cubic inches of coverage
- Weighs 4oz.



MAG PLUS SHIELD™ - #310010 Case Pack of 6

- Soft leather front and back provides ample friction to keep gun locked into the shield and the shield locked into your shoulder.
- Ambidextrous
- 1/2" thick heart shaped energy-absorbing pad
- Approx. 32" cubic inches of coverage
- Weighs 6oz.



SUPER MAG PLUS SHIELD™ - #330110 Case Pack of 6

- Soft leather front and back provides ample friction to keep gun locked into the shield and the shield locked into your shoulder.
- Highest protection level of any PAST Shield
- Ambidextrous
- 1" thick heart shaped energy-absorbing pad
- Approx. 40" cubic inches of coverage
- Weighs 10oz.



FIELD SHIELD™ - #350010 Case Pack of 6

- Soft leather front and back provides ample friction to keep gun locked into the shield and the shield locked into your shoulder.
- Perfect choice for shotgun use or use in the field.
- Ambidextrous
- 1/4" thick energy-absorbing pad
- Approx. 37" cubic inches of coverage
- Weighs 4oz.



HIDDEN COMFORT RECOIL SHIELD FOR WOMEN™

#360000 Case Pack of 6

- Designed to give the female shooter a customized, competitive edge. Worn under clothing, this patented recoil protection has a comfortable cotton blend cover that easily attaches to a bra strap without removing the blouse or shirt, and stays in place with its hook and loop closure system.
- Ambidextrous
- 1/4" thick energy-absorbing pad
- Approx. 30" cubic inches of coverage
- Weighs 2oz.



All PAST Shield clamshell packages: 8.9" wide x 11.6" high x 1.5" deep



HEARING PROTECTION

Platinum Series **G3**

PLATINUM SERIES™ G3 ELECTRONIC HEARING PROTECTION - #864446 Case Pack of 4

The Caldwell Platinum Series G3 earmuffs provide a new level of performance. They offer crystal clear amplification of low level sounds while compressing and blocking out harmful noise. The advanced circuitry delivers constant sound amplification without cutting out, allowing you to hear clearly even as a gun is being fired. The dual microphones deliver true stereo sound improving ability to localize sound. Independent volume adjustment allows for compensation between left and right ears. Dual Density Foam (DDF) Technology delivers 21 NRR to provide a high degree of passive sound protection from gunfire and other loud noise. Headband is padded and lined with Soft Fleece fabric to remain comfortable during extended use. Run time approximately 250 hours. Dual LED lights indicate power on status. Battery compartments in each ear cup are easily accessible and hold 3 AAA batteries each (not included). Low profile design and durable soft touch finish helps protect against gun stock contact. Compact, collapsible design allows for convenient storage and transport.

- Advanced “no-cut-out” circuitry delivers unsurpassed performance
- True stereo amplification delivers maximum volume and clarity
- Significantly enhances hearing while protecting at the same time
- Dual Density Foam (DDF) Technology delivers 21 NRR
- Padded Soft Fleece headband for maximum comfort
- Compact, collapsible low profile design and soft touch finish
- Extended runtime of 250 hours with power on LED indicator

G3 package:
7.3” wide x 8.5” high x 4” deep



E-MAX® BTH ELECTRONIC HEARING PROTECTION - #487605 Case Pack of 6

The new E-Max Behind-the-Head hearing protection combines great circuitry with a low profile ear cup that's ideal for shotgun shooters and action shooters. The E-Max amplify sounds up to 20dB, controlled by the volume dial on the right ear cup. This is beneficial for normal communication, range commands, and environmental sounds. With sounds above 85 decibels, the speakers shut off for a split second to protect the shooter's hearing. Two microphones, one in each cup, give the user true stereo function and help the user to localize sound.

- Adjustable volume control
- Audio input jack
- Stereo sound
- Cushioned foam ear cups
- Power indicator light

21
NRR
Noise Reduction Rating



E-MAX BTH Package:
9.25” wide x 11” high x 5.5” deep



Audio Jack

E-MAX BTH
BEHIND-THE-HEAD



Caldwell
Shooting Supplies

E-MAX[®] Low Profile

HEARING PROTECTION

E-MAX[®] LOW PROFILE ELECTRONIC HEARING PROTECTION

The low-profile E-Max™ hearing protection combines great circuitry with a low profile earcup that's ideal for shotgun shooters and action shooters. The two microphones in the E-Max™ amplify sounds below 85 decibels, which includes normal communication, range commands, and environmental sounds. Above 85 decibels, the microphones instantly shut off to protect the shooter's hearing. Two microphones - one in each cup - give the user true stereo sound and allow the user to identify the directional source of a sound. Runs on 2 AAA batteries. (not included)

E-MAX[®] Low Profile Green - #487557

E-MAX[®] Low Profile Mossy Oak Breakup[®] CAMO - #487200

E-MAX[®] Low Profile Pink - #487111

NEW! E-MAX[®] LP with Shooting Glasses COMBO - #487309

Case Pack of 6

Case Pack of 6

Case Pack of 6

Case Pack of 6



NEW 2015

COMBO PACKAGE!

Now you can purchase the E-MAX Low Profile and Professional Shooting Glasses as one package

Check Out pg. 36 for information on the Shooting Glasses



Audio Jack

This product has been CE certified.
CE
CE 89/339CEE
CE 89/606EEC



E-MAX Lo Profile packages:
9" wide x 10" high x 4" deep

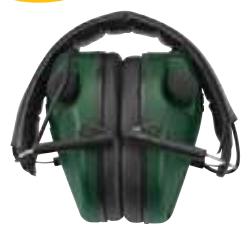

Folds up compact



E-MAX[®] ELECTRONIC HEARING PROTECTION - #497700 Case Pack of 6

Standard profile E-Max™ hearing protection combines great circuitry with a standard earcup for better protection. The two microphones in the E-Max™ amplify sounds below 85 decibels, which includes normal communication, range commands, and environmental sounds. Above 85 decibels, the microphones instantly shut off to protect the shooter's hearing. Two microphones - one in each cup - give the user true stereo sound and allow the user to identify the directional source of a sound. Runs on 2 AAA batteries (not included). 25 NRR.

E-MAX[®]

This product has been CE certified.
CE
CE 89/339CEE
CE 89/606EEC



E-MAX packages:
9" wide x 10" high x 4" deep



HEARING PROTECTION

RANGE PLUGS

Never lose your ear plugs again with Caldwell Range Plugs with cord and clip. Caldwell designed these Range Plugs to have a tapered shape, made of a polyurethane foam to make them easy to insert and comfortable for hours of use. The cord can be used in conjunction with the provided clip to snap on the back of your hat or the collar of your shirt so you always know where your ear plugs are.

- NRR 31
- Tapered design makes the plugs easy to insert
- Polyurethane Foam makes the plugs comfortable to wear
- Cord and Clip make it extremely easy to keep track of
- Screw Cap bottle makes storage of un-used plugs extremely convenient



Range Plugs 10pk Bottle - #568231
Case Pack of 12

Range Plugs 50pk Bottle - #685442
Case Pack of 6

RANGE MUFFS

The Caldwell Range Muffs were designed to be very comfortable and protective. They feature foam filled ear cups with padded ear cushions to be extremely comfortable so you can wear them all day. The adjustable padded band provides great adjustment so anyone can wear them and they can provide that customized fit. The pivoting ear cups fold compactly so they are conveniently stored for whenever they are needed.

- Range Muff features NRR 33
- Low Profile Range Muff NRR 25
- Padded, adjustable headband
- Cushion foam ear cups
- Folds compact
- Ultra Lightweight

Range Muff Package:
6.5" wide x 8.25" high x 4" deep
LoPro Range Muff Package:
6" wide x 7" high x 4" deep



Range Muff - #489204

Case Pack of 6

Low Profile Range Muff - #498024

Case Pack of 6

ULTIMATE SHOOTING GLOVES

- Padded Palms reduce felt recoil, especially from handguns while customized padding layout allows full range of movement
- Lightweight, breathable material is extremely durable yet prevents hands from overheating
- Elastic backing and fingers provides a custom grip for extreme dexterity
- Leather reinforcement patch protects against "Slide Bite"
- Touch-sensitive finger tips allow full use of smartphones
- Rubberized palm provides extreme grip



Small/Medium Shooting Gloves
#151293 Case Pack of 6

Large/XL Shooting Gloves
#151294 Case Pack of 6



SHOOTING GLASSES - #320040 Case Pack of 12

The Caldwell Pro Range Glasses feature a stylish wrap-around design and are a great choice for all shooters. They feature an adjustable nose piece and temples for all day comfort. The scratch resistant lens meets ANSI Z87.1 standards and offer 99.9% UV protection.

- Adjustable nose piece and temples
- Blocks 99.9% of harmful UV rays
- Impact resistant
- Meets ANSI Z87.1 standards



Shooting Glasses Package:
3.75" wide x 9.25" high x 3" deep

EYES & EARS BELT CLIP - #417600 Case Pack of 6

The Caldwell Eyes and Ears Belt Clip offers shooters a secure, convenient location to store both eye and ear protection when not in use. Ideal for on the range, at the clay stand or in the field, the Eyes and Ears Belt Clip puts an end to the old question of where did those glasses or ear muffs go? Constructed of durable, flexible polymer, the Eyes and Ears Belt Clip will survive years of use. Accepts hearing protection with bands up to 2 inches wide.

- Fits up to a 2 1/4" wide belt
- Material bends but won't break



Belt Clip package:
3" wide x 6.75" high x 1" deep



STROBE FLASH HIT INDICATOR - #720015 Case Pack of 4

The Strobe Flash Hit Indicator might be the most useful tool to confirm long range target hits out there. It has a specially designed strobe flash that can be easily seen with the naked eye out to 1000 yards. The Strobe Flash Hit Indicator will flash every time the metal target is hit to confirm an accurate shot; misses in the dirt will not flash at all. It was designed to set up quickly with a spring clamp that works with almost any metal target frame. Simply set up the light and tripod off to the side of the target, plug in the cable, clamp the sensor on the target frame and you are ready for some long-range fun. Spend more time shooting and less time spotting or driving down range with the Strobe Flash Indicator. Operates on 4 AA batteries (not included).

- Tripod included, adjusts from 14"- 42" in height for the best view of the Strobe Flash Indicator
- Easy setup with spring clamp sensor; works on a wide variety of steel targets
- Instant flash to confirm a hit on the target
- Ideal for use with Caldwell Magnum Rifle Gong
- Flash is visible with naked eye up to 1,000 yards.
- Reset time approximately 1-2 seconds between shots



**The PERFECT Accessory for shooting
Magnum Gong Targets at long range!**

SHOOTIN' GALLERY™ Case Pack of 1

Have a youngster in your life that you'd like to take shooting? The Shootin' Gallery's combination of an endless supply of moving targets and interactive confirmation of shot placement will bring grins to your face and the face of the future shooter alike. The Shootin' Gallery is the first of its kind: an affordable, portable, motor-driven, interactive system that allows you to shoot a steady stream of moving targets with a rimfire firearm at your shooting range or in your backyard. The design of the Gallery gives you a never-ending supply of fresh targets – targets that are hit fall over, only to re-emerge from the side of the gallery! Get your trigger finger ready for fast-paced shooting action with Caldwell's Shootin' Gallery! The Gallery includes a 12-volt rechargeable battery and charger that power a motor which drives targets left-to-right across the length of the gallery.

- Targets topple when hit and reset automatically
- Targets travel left-to-right
- Includes rechargeable battery and charger
- Weighs approximately 55 pounds for easy transportation
- Great for practicing shooting at moving targets
- Runs 4 to 6 hours on a single charge
- The Gallery is intended for use only with standard velocity (1200 ft/second) .22 rimfire cartridges at a distance of 75 feet.



The warranty on the Shootin' Gallery does not cover damage to the gallery resulting from the use of high-velocity rimfire ammunition, including high-velocity .22 Long Rifle ammunition, .22 Magnum, or any .17 caliber rimfire cartridges.

- Shootin' Gallery™ - Standard Rimfire - #558978**
- Replacement 2" Round Targets and Couplers, 4 Pack - #344000**
- Replacement Duck Targets and Couplers, 4 Pack - #344111**
- Replacement 12 Volt Sealed Lead Acid Battery - #558900**
- Replacement Battery Charger - #558800**

SHOOTIN' GALLERY



Shootin' Gallery package:
37" wide x 8.5" high x 12" deep

The 2" steel targets automatically reset after impact so you always have a fresh supply of targets for endless fun! The heavy weight of the targets prevents them from bouncing back after being knocked down.



- Heavy-duty Motor
- Steel Chain
- Heavy-duty Steel Sprockets
- Ball Bearings
- Sturdy Steel Legs
- Angled Front Plate
- Reinforced Steel Impact Plate
- Protected Steel Battery Box



STEEL TARGETS

AR-550 Steel Targets are the most durable metal targets on the market.

- Provides unsurpassed target durability, capable of withstanding nearly all centerfire rifle & handgun cartridges*
- Mill certified hardness of 550 Brinell (HBW) for AR-550 and 500 Brinell for AR-500 targets
- Specialized "Through-Hardening" achieved from proprietary quenching & tempering processes
- Finely tuned & tightly controlled chemical composition produce highly reliable toughness & resistance to pitting, cracking or bending



MAGNUM RIFLE GONG

- AR-550 Steel construction for professional grade durability
- Designed to withstand impacts of all high power rifles and handguns
- Complete with freestanding frame, chains and 9.25" gong
- Entire system is collapsible for easy transport
- NO tools required for assembly or disassembly
- Frame made from steel tubing
- Gong hangs 18" above the ground
- Overall size 38" wide x 33" tall
- Gong is 9.25" dia. and 3/8" thick
- Weighs approx. 25lbs.



MAGNUM RIFLE GONG XL

- AR-550 Steel construction for professional grade durability
- Designed to withstand impacts of all high power rifles and handguns
- Complete with freestanding frame, chains and 17 1/2" gong
- Entire system is collapsible for easy transport
- NO tools required for assembly or disassembly
- Frame made from steel tubing
- Overall size 38" wide x 33" tall
- Gong is 17 1/2" x 9 1/4" and 3/8" thick
- Weighs approx. 25lbs.



9.25" Dia. TARGET

Magnum Rifle Gong package:
36" wide x 4" high x 12" deep



17"x9" Dia. TARGET

- Magnum Rifle Gong - #223375
- Magnum Rifle Gong Only (no frame) - #178951
- Magnum Rifle Gong XL - #178953
- XL Gong Only (no frame) - #206060

- Case Pack of 2
- Case Pack of 1
- Case Pack of 2
- Case Pack of 1

MAGNUM DUAL SPINNER TARGET

- AR-550 Steel construction for professional grade durability
- Designed to withstand impacts of all high power rifles and handguns
- Complete with freestanding frame, 2 plates and stakes
- Entire system is collapsible for easy transport
- NO tools required for assembly or disassembly
- Hardened steel rotating shaft
- One 4" plate and one 6" plate
- Frame made from steel tubing
- Overall size 38" wide x 33" tall
- Weighs approx. 25lbs.



6" Dia. TARGET

4" Dia.

Magnum Dual Spinner Target package:
36" wide x 4" high x 12" deep

- Magnum Dual Spinner - #309713
- Case Pack of 2

MAGNUM TARGET CARRY BAG - #894050 Case Pack of 2

The Magnum Target Carry Bag is designed to transport and store the Caldwell Magnum Series Targets: Magnum Rifle Gong, Kill Zone Magnum Gong and Magnum Dual Spinner. Heavy duty construction and internal compartments keep target components protected and organized.

- Inner compartments for gong, ground stakes, chains & other components
- Convenient carry bag designed for Magnum Rifle Gong, Kill Zone Magnum Rifle Gong or Magnum Dual Spinner Target
- Heavy-duty construction



STEEL TARGETS

*Although Caldwell AR-550 target plates are capable of withstanding IMPACT velocities over 3,000 fps from most bullets, for maximum life expectancy we recommend IMPACT velocities at or below 3,000 fps and IMPACT energies at or below 3,500 ft-lbs. Due to limitations of other components, some model targets may have recommendations for lower impact velocities and energies for maximum life expectancy.

IMPACT RATINGS FOR MAXIMUM LIFE EXPECTANCY OF MAGNUM RIFLE GONG

- Impact Velocity 3000 fps
- Impact Energy 3500 ft-lbs

Common Cartridge Examples of Impact Velocity & Energy

Caliber	Bullet Wt.	Muzzle Vel. / Energy	100 yd. Vel. / Energy	200 yd. Vel. / Energy	300 yd. Vel. / Energy
.204 Ruger	32 grain	4050 fps / 1164 ft-lb	3482 fps / 860 ft-lb	2983 fps / 631 ft-lb	2537 fps / 456 ft-lb
.223 Rem	55 grain	3240 fps / 1280 ft-lb	2871 fps / 1005 ft-lb	2531 fps / 781 ft-lb	2215 fps / 598 ft-lb
.22-250	50 grain	3810 fps / 1610 ft-lb	3341 fps / 1237 ft-lb	2919 fps / 945 ft-lb	2535 fps / 712 ft-lb
.300 Win Mag	150 grain	3290 fps / 3601 ft-lb	2950 fps / 2894 ft-lb	2634 fps / 2308 ft-lb	2340 fps / 1812 ft-lb
.338 Win Mag	225 grain	2800 fps / 3913 ft-lb	2634 fps / 3461 ft-lb	2473 fps / 3053 ft-lb	2319 fps / 2683 ft-lb
.416 Rem Mag	400 grain	2400 fps / 5110 ft-lb	2188 fps / 4227 ft-lb	1987 fps / 3500 ft-lb	1797 fps / 2865 ft-lb

Recommended = ■
Not Recommended = ■

MAGNUM RESETTING POPPER TARGET

- AR-550 Steel construction for professional grade durability
- Designed to withstand impacts of all high power rifles and handguns
- Complete with freestanding frame, popper plate and stakes
- Spring-loaded resetting plate
- Popper plate is 14" tall x 4"
- Base of frame sits approx 7" off the ground
- Frame made from thick steel stock
- Overall size 14" wide x 21" tall
- Weighs approx. 25lbs.

2"x14" x 4" Dia. TARGET



Magnum Resetting Popper Target package: 23.6" wide x 4.5" high x 3.75" deep



Magnum Resetting Popper - #713309 Case Pack of 2

MAGNUM SPEED PLATE WITH RESET

- AR-500 Steel construction for professional grade durability
- Designed to withstand impacts of all high power rifles and handguns
- Heavy duty frame supports the target and allows the presentation angle to be adjusted for the preferred knock over force.
- Complete with freestanding frame, speed plate and stakes
- Recommended for pistols at a minimum of 15yds.
- Recommended for rifles at a minimum of 100yds.
- Frame made from thick steel stock
- Overall size 12" wide x 28" tall
- Weighs approx. 25lbs.
- Innovative reset mechanism
- 15 meter reset rope included

12"x28" Dia. TARGET



Magnum Speed Plate - #554122 Case Pack of 1

AR-500 SWINGER TARGET - #758995 Case Pack of 2

- 3/8" Through-hardened AR-500 Steel rated up to .308 Winchester at 150 yards
- Extremely durable cast urethane frame connectors provide a rigid frame yet allow bullets to pass right through
- Solid steel legs and crossbar provide a rigid frame but can be replaced by 1/2" re-bar if damaged
- Target frame is 18" off the ground
- Swinger target is 10.5" to the center
- Highly portable for ease of use



Cast urethane frame connectors



Replace the steel legs with 1/2" rebar cut to length



4 ground stakes included

AR-500 Swinger Package: 20" wide x 4.33" high x 4.33" deep

IMPACT RATINGS FOR MAXIMUM LIFE EXPECTANCY OF AR-500 STEEL TARGETS
IMPACT VELOCITY: 2,900 fps
IMPACT ENERGY: 2,000 ft-lbs.



BIPODS

XLA BIPOD® Case Pack of 6



The Caldwell XLA Bipods provide a stable shooting support that conveniently attaches to almost any firearm with a sling swivel stud. The lightweight aluminum design adds minimal weight and deploys quickly, with legs that instantly spring out to the shooting position with the touch of a button. The legs are notched for easy indexing to a specific height. There is a connection point for sling attachment and multi-section legs that collapse forward allowing for convenient carry of the firearm. Soft rubber feet provide enhanced stability, while the padded bipod base protects the firearm's forend. XLA Bipods are available in 4 heights, black or camo and in both standard and pivoting models.

What are the benefits of having a pivoting model bipod? In the real world of hunting, the chances of the ideal shot opportunity occurring while on a level ground are slim-to-none. A pivoting bipod will allow the shooter to compensate for ground that is not level by up to 20 degrees. The lower portion of the bipod pivots independently from the upper stock mount, allowing the firearm to be quickly leveled on uneven ground. The tension knob can be adjusted to control the resistance of the pivoting motion.

Black Bipod	Fixed	Weight	Pivot	Weight	Camo Bipod	Pivot	Weight
6" - 9"	#379852	9 oz.	#247142	12 oz.	6" - 9"	#445011	12 oz.
9" - 13"	#403215	11 oz.	#571429	13 oz.	9" - 13"	#445033	13 oz.
13" - 23"	#591336	14 oz.	#701417	16 oz.	13" - 23"	#445066	16 oz.
13.5" - 27"			#635705	19 oz.	13.5" - 27"	#445088	19 oz.



Bipod XLA clamshells:
 6" to 9" and 9" to 13" Models
 5.8" wide x 11.8" high x 2.4" deep
 13" to 23" and 13.5" to 27" Models
 5.8" wide x 18.3" high x 2.4" deep

BIPOD PIVOT LOCK - #535881 Case Pack of 6

The Caldwell® Bipod Pivot Lock works on all XLA Pivot model bipods. It also fits most other brand bipods and includes a #10-32 threaded adapter for SAE threaded pivot model bipods. Easily adjust the tension of your pivot mount without tools!

- Easily adjust pivot tension on all your XLA Pivot model bipods
- Spring loaded "Pull" out for easy handle positioning
- Second adapter for SAE #10-32 threaded external spring bipods
- "C" identifies the Caldwell adapter from the SAE adapter



Pivot Lock Package:
 3.25" wide x 5.5" high x 1" deep

"C" identifies the Caldwell adapter from the SAE adapter



Easily adjust pivot tension while still shouldering your rifle



BIPOD ADAPTER FOR PICATINNY RAIL

#535423 Case Pack of 6

The Bipod Adapter quickly and easily attaches to a picatinny rail. Any standard bipod or sling can then be attached to the integrated swivel stud. A curved "forend style" profile assures the perfect fit for the bipod to mate with. Lightweight yet durable machined anodized aluminum construction provides durable and reliable performance. Two integrated fasteners ensure a secure attachment that won't rattle loose during heavy use.

- Attach any traditional bipod or sling to a Picatinny rail
- Light weight, durable machined aluminum construction
- Won't rattle loose

Bipod Adapter clamshell:
3.75" wide x 7.25" high x 1.5" deep



AR BIPODS

The AR Bipods combine a quick attach system for securing to any Picatinny rail with all the other outstanding features you have come to expect from Caldwell. Built-in systems for both pivot and cant movements give the shooter maximum range of alignment without having to reposition the bipod. The unique internal spring system is both low profile and quiet. The unique leg adjustment mechanism delivers fast and secure, no-wobble height positioning. Rubber feet ensure good grip on all surfaces. Lightweight and durable anodized aluminum construction. Choose from sitting or prone models. Available in Black finish or new Desert Tan.

- Quickly attaches/detaches to any Picatinny rail
- Lightweight and durable anodized aluminum construction
- Available in Matte Black finish or new Desert Tan

AR Bipod Package:
Sitting 4.75" wide x 22" high x 3" deep
Prone: 4.75" wide x 13.75" high x 3" deep

- AR Bipod Prone Model Black - #531123** Case Pack of 4
- AR Bipod Prone Model Tan - #534455** Case Pack of 4
- AR Bipod Sitting Model Black - #532255** Case Pack of 4
- AR Bipod Sitting Model Tan - #534466** Case Pack of 4

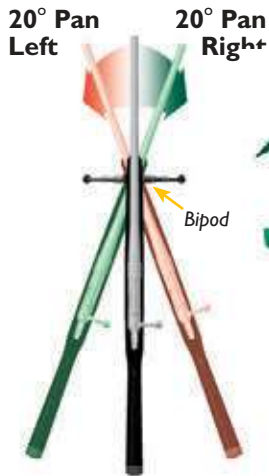

Min-Max height adjustments
Prone Model: 7.5" - 10"
Sitting Model: 14.5" - 30.5"

SHOOTING BIPODS

Designed with all of the features necessary for steady, accurate shooting, regardless of the range or terrain. Now you have extreme motion ranging capability with our exclusive wide-pan and stock canting features that come standard with our bipod design. Two models available for adapting to any shooting situation. Folds out of the way when not in use.

- Easily attachable and detachable from the front swivel stud
- Lightweight aluminum design for quiet, weatherproof performance
- Built-in swivel pan feature left or right 20 degrees combined with an 18 degree bi-directional cant
- Stud for sling attachment

Prone Model Black - #457855 Case Pack of 4
Prone Weighs 10.5 oz., 8 3/4"-12" height adjustment for prone and bench shooting

Sitting Model Black - #335235 Case Pack of 4
Sitting Weighs 15 oz., 14"-30" height adjustment for prone and sitting

Bipod, Sitting package: 6" wide x 22.2" high x 2.3" deep
Bipod, Prone package: 6" wide x 15" high x 2.3" deep



SHOOTING BENCHES



STABLE TABLE® DELUXE SHOOTING BENCH - #252552 Case Pack of 1

The Stable Table is purpose-built to be the finest value-priced shooting bench in the market. The tripod design is more rigid and has fewer joints than folding-style benches and is appropriate for a wider variety of shooting conditions and disciplines. A T-knob in the base allows position adjustment of a single leg, aligning the tabletop so that it is parallel with the horizon. The central shaft, seat and tabletop are able to pivot around a center axis as a single unit while keeping the tabletop parallel to the horizon. This allows the user to make shots at any angle from a single setup – ideal for varmint hunting. The bench can easily be locked into a single shooting position if desired. The table top is made from molded plastic with a rigid metal under-frame. The top measures 34" x 23" and it includes holes that function as handles for easy transport or as holders for the included cleaning forks, as well as a perimeter rail that keeps ammunition from rolling off the bench top. The entire frame is made from welded steel. The padded seat adjusts from 16" to 22" and rotates in tandem with the tabletop or independently. The Stable Table breaks down into seven pieces and weighs a total of 60 pounds when assembled. The weight limit of the Stable Table is 275 pounds and doesn't include the weight of the shooting rest, firearm and accessories.

Two cleaning forks are included. The left one is designed to be used with forends while the one on the right is designed for buttstocks

Highly durable, weatherproof synthetic table top

Quick-release pin for easy seat height adjustment

Table top and feet pivoting can be locked

Reinforced welded steel frame

Padded seat for prolonged shooting comfort

Molded carrying handles also serve as holders for cleaning forks

Adjustable leg angle for use on uneven terrain

Quick-release pin for easy takedown

Tubular steel construction

For increased stability on grass or dirt, use these holes to insert stakes or anchors (not included)

Stable Table package: 34.7" wide x 23.4" high x 7" deep

The tabletop features convenient transport handles which are also compatible with the included cleaning forks for easy cleaning after a day of shooting. Simply insert the cleaning forks, rotate the table to a safe direction and the shooting bench is transformed into a handy cleaning table. The polymer tabletop is resistant to cleaning solvents and other chemicals.

The Stable Table works great with shooting rests of all shapes and sizes. The table top is reinforced with a steel frame creating a sturdy shooting surface plenty strong for those heavy recoil-reducing rests. The adjustable leg angle ensures a level shooting surface on uneven terrain. This feature cannot be found on other shooting benches. The seat height is easily adjustable to ensure a comfortable position for any shooter.



STABLE TABLE® CARRY BAG - #777810 Case Pack of 10

This heavy-duty carrying bag will hold all pieces of your Stable Table and allows for convenient transport to the range or field. Full wrap shoulder straps, double layer fabric, heavy duty zipper and padded lower portion ensures maximum durability and protection for your Stable Table.

- Carries Caldwell Stable Table conveniently
- Heavy-duty construction with double layer fabric and padded lower portion
- Inner bag for the table hub included

Stable Table Carry Bag package:
13" wide x 17.5" high x 3.5" deep



CUSTOM PRODUCTS

Caldwell Custom Products are only sold via our Drop Ship Program. Please contact our sales department at 877-509-9160 for pricing and details on the program.



BR PIVOT® PREMIUM SHOOTING BENCH - #300015 Case Pack of 1

The BR Pivot™ is the finest shooting bench available. It combines the best materials, an unparalleled design and years of thinking, field use and continuous development into a complete package that is ready for a lifetime of service. There's nothing newfangled about the BR Pivot – it's bombproof, foolproof, and ready for users who are serious about accuracy. The "Pivot" part of the name references the most useful feature – use the bolts at the base of the bench to align the bench stem and tabletop so that the top is parallel with the horizon. The seat and bench top then pivot on center and maintain a constant tabletop attitude. You can spin 360° to make shots and your tabletop will always be parallel to the horizon! The padded seat can be adjusted for any height between 16" and 27", and the pivoting function can be locked rigidly in a single shooting position if desired.

The top is made from edge-glued American hardwood with a durable finish; the top measures 45" x 26". This top is attractive, traditional and functional. It's particularly good for those who prefer to use rests with spiked feet. The wood top can be installed for right-handed or left-handed shooters. The bench breaks down into four pieces and weighs a total of 65 pounds when assembled. The weight limit of the BR Pivot is 250 pounds and doesn't include the weight of the shooting rest, firearm and accessories.



Bench Leveling

The BR Pivot features 3 adjustable height legs for when finding level ground is difficult. Up to 5" of travel on each leg.



Ultimate Versatility

The tabletop and seat will rotate independently. This will allow the user the broadest possible range of shooting angles for both right and left-handed shooters.



Unified Rotation

Lock the table and seat together on the center post allowing 360° rotation as a unit. This is an ideal setup for varmint shooting.



Flip the Hardwood Maple top and mount it for Left handed Shooters!

- Hardwood Top Model
- Solid wood
 - 1" thick
 - Ambidextrous
 - Polyurethane finish

METAL TARGETS

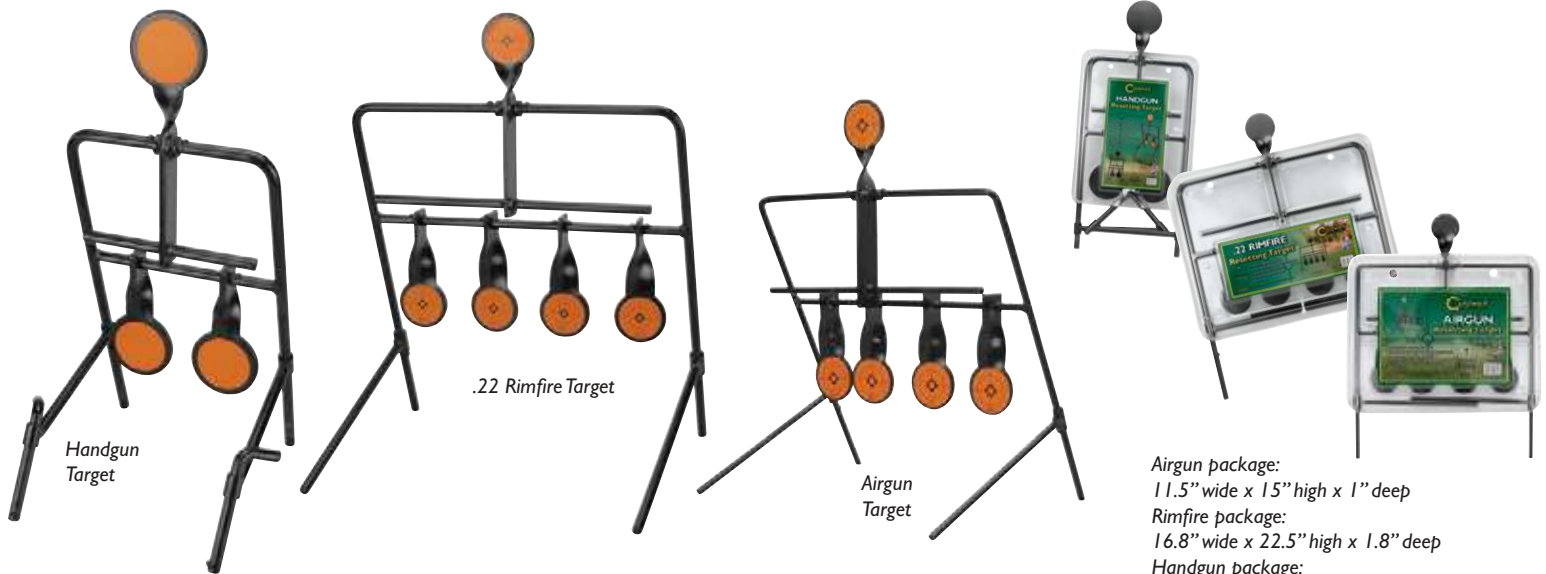

Airgun package:
11.5" wide x 15" high x 1" deep
Rimfire package:
16.8" wide x 22.5" high x 1.8" deep
Handgun package:
12" wide x 26.8" high x 1.8" deep

RESETTING TARGETS

Caldwell Resetting Targets are easily portable and create an interactive shooting experience that makes plinking and target practice fun. Made of heavy-duty steel, these targets are built to last. All of our resetting targets come packaged in sturdy, partial clamshells. Holes are punched in the clamshells for hanging the product on peg hooks. The rimfire and handgun models are reinforced with zip ties to ensure the heavy product is secured inside.

Handgun Resetting Target (for up to 45 ACP, 44 Special) Target size: 3.5" - #103654 Case Pack of 2
.22 Rimfire Resetting Target size: 2.5" - #902365 Case Pack of 4
Airgun Resetting Target size: 1.5" - #820585 Case Pack of 4

Shooting spots are included with Resetting Targets and the Plink n' Swing™ Targets. Should you wish to purchase additional shooting spots, you can find them on page 47.

PLINK N' SWING™ ACTION SWINGING TARGETS

Shooting is just plain fun when you can see and hear the impact of your bullets. Next time you go to the range, take the Caldwell Plink N' Swing Targets to bring fun and fast action back to your shooting.

- Swingers and frames are made of durable steel for long life
- Audible feedback makes shooting fun for all ages
- Great instructional tool for beginners.

Plink N' Swing Centerfire Handgun Double Spin - #133565 Case Pack of 4
 Target sizes: 3" & 4.5" (for up to 45 ACP, 44 Special)

Plink N' Swing .22 Rimfire Triple Spin - #147072 Case Pack of 4
 Target sizes: 1.75", 2.5" & 3.5"

Plink'n Swing Handgun Target



Plink 'n Swing Target package, Rimfire:
13" wide x 18.25" high x 1.5" deep
Plink 'n Swing Target package, Handgun:
9.5" wide x 24.5" high x 1.75" deep



Ultimate TARGET STAND

The durable all-weather design and user-friendly features truly make this the Ultimate Target Stand. The stand features an oversized backer to hold multiple large targets (two 15" targets side by side) and is constructed of an all-weather moisture resistant material. The large size makes sighting in easy; no more bullets missing the target. The modular frame design collapses to occupy much less space during transport & storage. The frame arms are constructed of durable steel rod and hold the backer securely in place. Removable ground stabilizer adds support from wind during use and conveniently stows onto the feet. The base of the stand is open, allowing you to use your foot to drive the molded-in spikes into the ground. It even has an integrated storage container for holding miscellaneous range supplies such as staples or target pasters.

Ultimate Target Stand - #707055

Case Pack of 4

Replacement Backer (2 Pack) - #707100

Case Pack of 6

PATENT:
www.BTibrands.com/patents/

(4) splines keep the tri-fold backer rigid while in use



Use your foot to drive the spike into the ground.



Built-in storage holds range supplies.

Extra large backer board easily holds (2) 15" x 15" targets (targets sold separately)

All-weather backer is resistant to moisture and rotting

Removable stabilizer holds backer secure in the wind

The integrated storage compartment is handy for holding your extra staples, target pasters, etc.

Removable stabilizer provides extra front to back stability from the wind

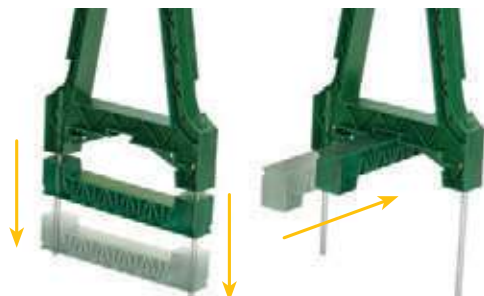
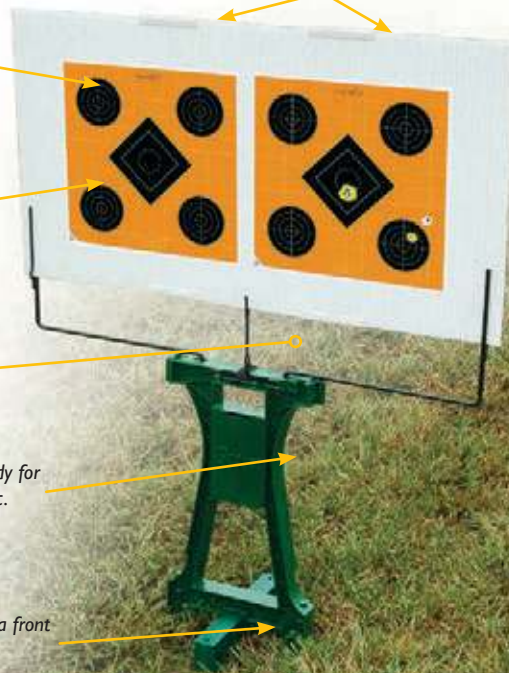

Removable stabilizer adds support while in use and stows away for easy transport.

5.75" long spikes

2 Ultimate Target Stands can hold a 2" x 4" for an easy plinking target shelf.



Ultimate Target Stand package: 10.5" wide x 24" high x 2" deep

COLLAPSES FOR EASY TRANSPORT!

Metal target frame arms can be snapped in the upright position to hold the target backer, or secured in compact position for transport.

2 Pack of replacement backers



FLAKE-OFF TARGETS

Orange Peel
FLAKE OFF TARGETS



ORANGE PEEL® FLAKE OFF SHOOTING TARGETS

Get on target with Orange Peel Targets by Caldwell! Orange Peels let you see hits ON and OFF the bullseye with dual-color flake-off technology that makes your hits look like colorful explosions. If your shot happens to miss the bullseye, you will know exactly where your bullet strayed...instantly. To make things even easier, the vibrant, contrasting colors make the target stick out like a sore thumb with any background, even at long distances. Caldwell makes these great targets in almost every size and shape imaginable at a price that anyone can afford. Orange Peels are clearly the best way to get on-target.

- Adhesive-backed, sticks to any surface
- Huge array of target options to fit all of your shooting season needs
- Hits in the bullseye: explode in neon green
- Hits outside the bullseye: explode in white
- Instant target feedback-you can see from the bench
- 25 included Flake Off orange and black pasters

PATENT:
www.BTibrands.com/patents/



SELF-ADHESIVE!
Just stick it and shoot it

FLAKE-OFF TARGETS



BULLSEYE SHOOTING TARGETS

- Bullseye Variety Pack, 5 sheets #345582 Case Pack of 10
- 2" Bullseye Target, 10 sheets #686444 Case Pack of 10
- 3" Bullseye Target, 15 sheets #391984 Case Pack of 10
- 3" Bullseye Target, 75 sheets #345468
- 4" Bullseye Target, 5 sheets #405515 Case Pack of 10
- 4" Bullseye Target, 10 sheets #410864 Case Pack of 10
- 4" Bullseye Target, 25 sheets #425824 Case Pack of 5
- 4" Bullseye Target, 100 sheets #410058
- 5.5" Bullseye Target, 10 sheets #550010 Case Pack of 10
- 5.5" Bullseye Target, 50 sheets #555050 Case Pack of 5
- 8" Bullseye Target, 5 sheets #805645 Case Pack of 10
- 8" Bullseye Target, 10 sheets #810894 Case Pack of 10
- 8" Bullseye Target, 25 sheets #825915 Case Pack of 5
- 8" Bullseye Target, 100 sheets #810099
- 12" PINK Bullseye Target, 5 sheets #317536 Case Pack of 5
- 12" Bullseye Target, 5 sheets #120556 Case Pack of 5
- 12" Bullseye Target, 10 sheets #121066 Case Pack of 5
- 12" Bullseye Target, 50 sheets #125094 Case Pack of 1
- 12" Bullseye Target, 100 sheets #121005
- 16" Bullseye Target, 5 sheets #172505 Case Pack of 5
- 16" Bullseye Target, 10 sheets #172510 Case Pack of 5

SHOOTING SPOTS & SQUARES Case Pack of 10 Non flake off shooting spots & squares.

- 1" Shooting Spots, 12 sheets (216 ct) #754883
- 1.5" Shooting Spots, 12 sheets (96 ct) #652710
- 2" + 1" Shooting Spots, 12 sheets (36-2" + 72-1" ct) #754110
- 3" Shooting Spots, 12 sheets (24 ct) #271050
- 1" Shooting Squares, 12 sheets (216 ct) #711236

NEW PASTERS!

Maximize your target life with our included adhesive pasters. 1" diameter pasters in orange and black are included with each package of Caldwell Orange Peel targets. Combined with our FLAKE OFF Hi-Vis Shot Indicator system, these targets become the most comprehensive paper target on the market!

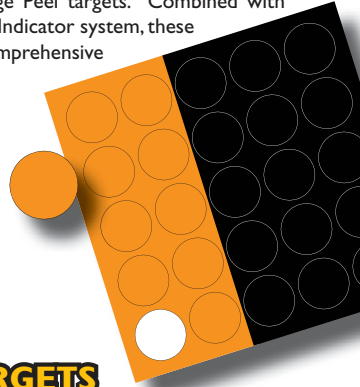

SIGHT-IN SHOOTING TARGETS

- 8" Sight-In Target, 5 sheets #522357 Case Pack of 5
- 12" Sight-In Target, 5 sheets #244561 Case Pack of 5
- 12" Sight-In Target, 100 sheets #861579
- 16" Sight-In Target, 5 sheets #495253 Case Pack of 5
- 16" Sight-In Target, 12 sheets #492603 Case Pack of 5

OVAL AND SILHOUETTE SHOOTING TARGETS

- 7" Oval Target, 10 sheets #878998 Case Pack of 10
- 7" Oval Target, 50 sheets #951845 Case Pack of 1
- 9" Oval Target, 5 sheets #861558 Case Pack of 10
- 9" Oval Target, 25 sheets #564887 Case Pack of 5
- 12"x18" Silhouette, 5 sheets #488789 Case Pack of 1
- 12"x18" Silhouette, 100 sheets #123665

ANIMAL SHOOTING TARGETS

- 7" Vermin Target, 10 sheets #554558 Case Pack of 10
- 12" Turkey Target, 5 sheets #586485 Case Pack of 5



FLAKE-OFF TARGETS

SILHOUETTE FLAKE OFF TARGETS

The Caldwell Silhouette Flake Off Targets are perfect for honing your defensive shooting skills. They feature high visibility Flake Off technology making it easy to see bullet impact. The high contrast silhouettes with bright red aiming points make acquiring a good sight picture fast and intuitive. 12" x 18" printed on heavy card stock paper. Available in Center Mass version or Dual Zone model. The Dual Zone target has 2:1 size ratio (target at 5 yards represents 6' tall target at 10 yards)

- Hi Visibility Flake Off technology
- Ideal for defensive shooting skill development
- Heavy card stock paper
- 12" x 18"



Dual Zone target has a 2:1 size ratio
Placing the target at 5 yards represents
a 6' tall sized target at 10 yards

- DualZone Flake Off Target 8pk - #308214 Case Pack of 10
- DualZone Flake Off Target 25pk - #280341 Case Pack of 5
- CENTER MASS Flake Off Target 8pk - #412803 Case Pack of 10
- CENTER MASS Flake Off Target 25pk - #128034 Case Pack of 5

Center Mass and Dual Zone target package:
 12" wide x 18" tall x 0.25" deep



HIGH Contrast target package:
 16" wide x 16" tall x 0.25" deep

Caldwell® Shooting Supplies HIGH-CONTRAST

HIGH-CONTRAST SIGHT-IN PAPER TARGETS

- High visibility color to see at long ranges
- Diamond shaped targets for easy crosshair alignment
- 1" grid for simple scope adjustments
- Large 16" x 16" target size to help get on paper
- Recycled paper construction

- 16" Blue 9 Diamond Target 10pk - #966893 Case Pack of 10
- 16" Blue Target 10pk - #198604 Case Pack of 10
- 16" Black & Orange Target 10pk - #195781 Case Pack of 10

HIGH CONTRAST Blue is easier to see at longer distances

Orange bullseyes are easily recognizable when finding the target

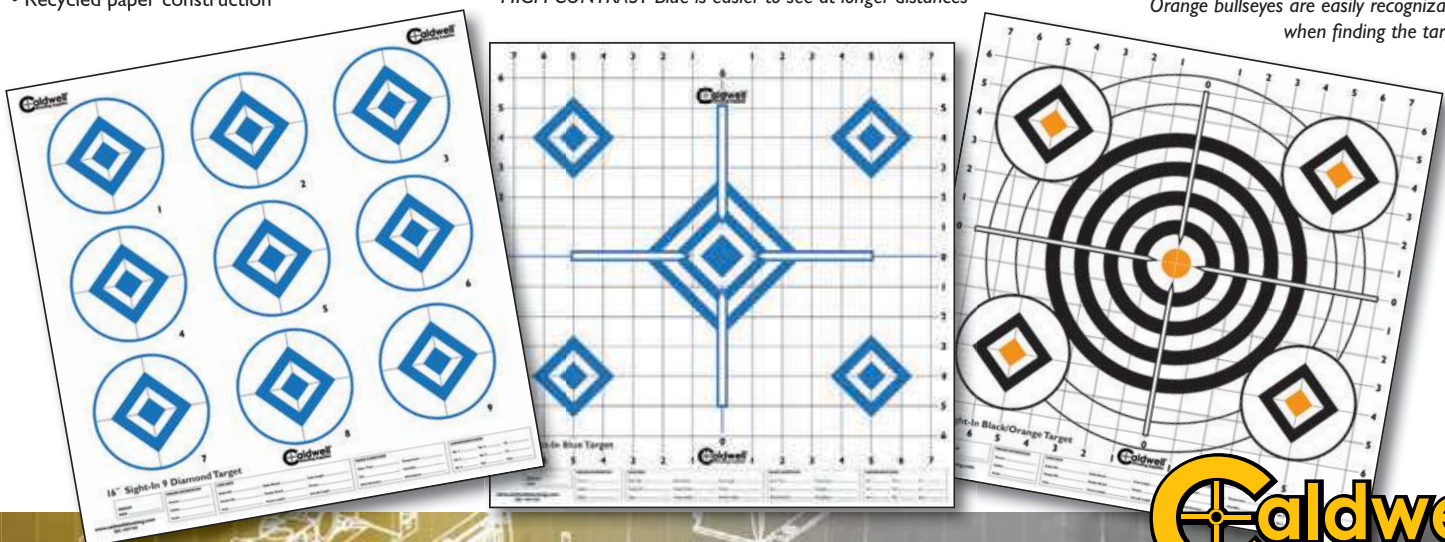

The Natural Series™

THE NATURAL SERIES™ WHITETAIL DEER TARGET

#234412 Case Pack of 6

"Aim for the point of the shoulder"... Ever try to teach a new hunter where to shoot a deer? Caldwell's Natural Series Targets are the answer to this age-old problem. These cardboard backed, life-size color photographs illustrate both the vital organs and skeletal structure of the animals. These illustrations can be easily viewed up close, yet disappear at a distance, allowing the hunter to practice not only accuracy but shot placement selection.

- Target features a sturdy 48" x 36" cardboard backer
- Includes two adhesive-backed replacement vital targets



Includes two adhesive-backed replacement vital targets



Natural Series Target package:
16" wide x 36" high x .5" deep

CLAY LAUNCHERS

The Caldwell Clay Launcher is designed to provide hours of shooting entertainment. The one-piece design is simple to use and makes it easy for anyone to throw clay birds. Great for teaching beginners or for sharpening any sportsman's wing-shooting skills. Works both right and left handed. Compatible with standard size clay targets (108-110mm). Durable molded plastic construction will hold up to aggressive use for years.

- Portable and affordable handheld clay target launcher
- Works with all standard size clay targets
- Launches right or left handed

Clay Launcher Single Thrower - #505501 Case Pack of 6

Clay Launcher Doubles Thrower - #505502 Case Pack of 6

Doubles thrower features 2 single throwers mounted to an adapter handle

Clay Launcher Extreme Thrower - #505503 Case Pack of 6

Extreme thrower features a single thrower with an extension rod



Extreme Thrower

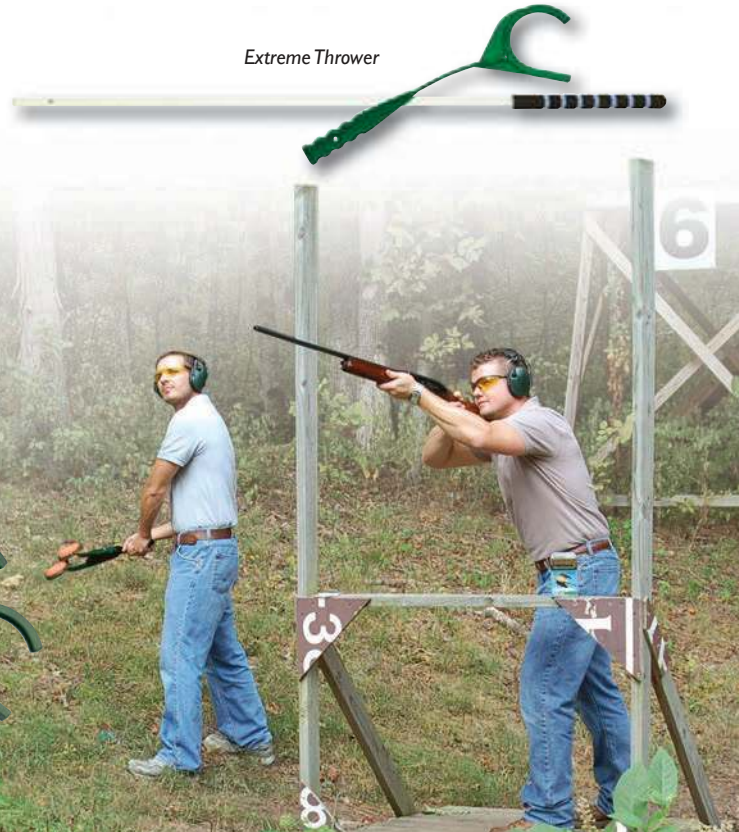

BRASS CLEANING

Cleans up to 1,000 pieces of .223 Brass at once!

Platinum
SERIES

ROTARY TUMBLER

The Platinum Series Rotary Tumbler delivers a new level of brass cleaning performance. Rotary tumbling with stainless steel media in a liquid bath gets brass much cleaner, and works much faster than ultrasonic or vibratory tumbling methods. The small stainless pins easily penetrate inside cases and into primer pockets to deliver unbeatable cleaning power. The large volume drum holds up to 1000 pieces of .223 brass and has a molded-in rubber lining to protect brass and dampen noise during operation. A built-in timer in the base can be set to run from 0 to 3 hours, shutting off automatically. The drum features clear end caps to allow visibility to the brass while tumbling. A set of sifting end caps is also included to assist in separating the stainless media once tumbling is complete. The tumbler can effectively clean without the use of stainless media pins with a mixture of Frankford Brass Cleaning Solution and water (use of media pins ensures primer pockets and inside of cases are perfectly clean). Five pounds of 304 stainless steel media pins and a sample packet of Frankford Brass Cleaning Solution are included.

- Most effective brass cleaning process available
- Brass comes out cleaner than brand new brass
- Large 7 liter capacity, Tumble up to 1000 cases of .223 brass
- Dual-layer drum with noise dampening rubber lining
- Includes 5lbs of stainless steel media pins (\$49.99 value)
- Includes a sample packet of Frankford Arsenal Brass Cleaning Concentrated Solution
- Maintenance-free geared drivetrain (No belts to replace!)

INTERNATIONAL
230 volt

NEW
2015

Rotary Tumbler - #909544
230V Rotary Tumbler - #909567

Case Pack of 1
Case Pack of 2

Includes 5lb. of Stainless Steel Tumbling Media

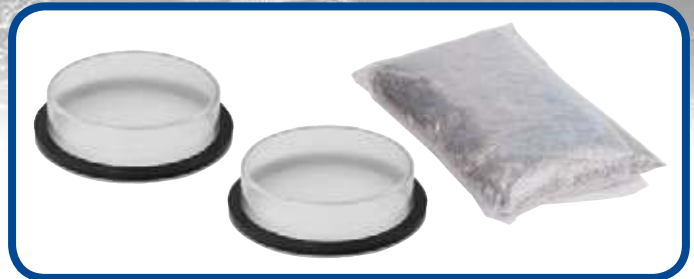

Clear cleaning caps and 5lb. of Magnetic Stainless Steel Media included!



Rotary Tumbler Package:
15" wide x 15.75" high x 10.75" deep

Frankford Arsenal
Reloading Tools

BRASS CLEANING

STAINLESS STEEL MEDIA PINS - #909191 Case Pack of 4

The Stainless Steel Media Pins are ideal for rotary tumbling brass. When combined with a liquid bath they deliver unmatched cleaning performance. Constructed of high quality 304 stainless steel, the media pins effectively penetrate inside of cases and into primer pockets. Five pounds.

- 304 Stainless Steel
- 1mm x 7mm pin size
- Ideal for Rotary Tumbling
- Magnetic for convenient handling
- Lifetime use



Stainless Steel Media Package:
4.75" wide x 4.75" high x 2.25" deep



MEDIA TRANSFER MAGNET - #909271 Case Pack of 4

The Transfer Magnet is ideal for handling stainless media pins. It effectively gathers and then releases pins with a pull of the handle. Makes separating pins from brass fast and convenient.

- Easily handle and transfer 304 stainless media pins
- Gathers then releases when handle is pulled
- Ideal accessory for rotary tumbling

A MUST HAVE for the Rotary Tumbler!

Media Transfer Magnet Package:
4.75" wide x 9" high x 4.5" deep



CLEANING SOLUTIONS

These Cleaning Solutions were scientifically formulated to quickly remove carbon buildup, tarnish, and oxidation on brass and gun parts. They were also specially designed to be used with the Frankford Arsenal line of Ultrasonic Cleaners and Rotary Tumbler. Our Cleaning Solutions are so strong that they can be used for multiple cleaning cycles before having to mix new solution. Get the best cleaning results possible with the Frankford Arsenal Cleaning Solutions!

- 32oz bottles
- 40:1 mix ratio
- Scientifically formulated solutions for brass and gun parts

Brass Cleaning Solution - #878787 Case Pack of 4
Parts Cleaning Solution - #898989 Case Pack of 4

Cleaning Solutions Bottle:
3" diameter x 10" high



SPARE ROTARY TUMBLER DRUM - #909789 Case Pack of 1

Need more capacity? Pick up a spare Tumbler drum. The Platinum Series Spare Rotary is the perfect addition for the high capacity reloader.

- Brass comes out cleaner than brand new brass
- Large 7 liter capacity, Tumble up to 1000 cases of .223 brass
- Dual layer drum with noise dampening rubber lining
- 2 clear end caps included



Spare Tumbler Drum Package:
14.75" wide x 9.25" high x 9.25" deep



BRASS CLEANING

Platinum
SERIES

BRASS DRYER - #909213 Case Pack of 4

The Frankford Arsenal® Platinum Series Brass Dryer is a quick, convenient, and efficient system for drying your brass. This dryer is the perfect tool for drying your rifle and pistol brass after wet case cleaning processes such as rotary tumbling or ultrasonic cleaning. The separate and removable trays let you dry different calibers at the same time without mixing them together. The Brass Dryer is a high-capacity unit that can dry up to 1000 pieces of .223 rifle brass or up to 2000 pieces of 9mm pistol brass. This dryer can dry your brass cases inside and out in under an hour. The forced air convection heating lessens the chance of watermarks on your newly clean brass. The powerful 500 Watt heating system heats air quickly and consistently, which reduces drying time. The forced air flow design ensures that heat and air are evenly distributed throughout the separate trays, drying the cases inside and out. The top mounted fan ensures that no moisture from the cleaning process can accumulate in the circuitry. The drying trays have fine grated bottoms and retaining ribs to keep your brass separated on different layers. Combined with a Platinum Series Rotary Tumbler, dirty corroded range brass will be as shiny as new.

- Specifically designed to dry brass after Rotary Tumbling or Ultrasonic cleaning
- Vented trays provide the best airflow to minimize drying time
- Top-mounted fan, circulates up to 160°F air to quickly dry the brass inside and out
- 5 removable trays easily dry up to 1,000 pieces of .223 brass in less than 1 hour
- Heavy Duty 500 watt unit

**DRIES
1,000 PIECES OF
.223 BRASS
LESS THAN
1 HOUR**

**NEW
2015**



Brass Dryer Package:
13.6" wide x 13.6" high x 9.85" deep



Inner Lip

Specially designed vented trays increases air flow. Inner lip prevents brass from dropping down the center air flow channel.



Adjust your temperature from 90° - 160°

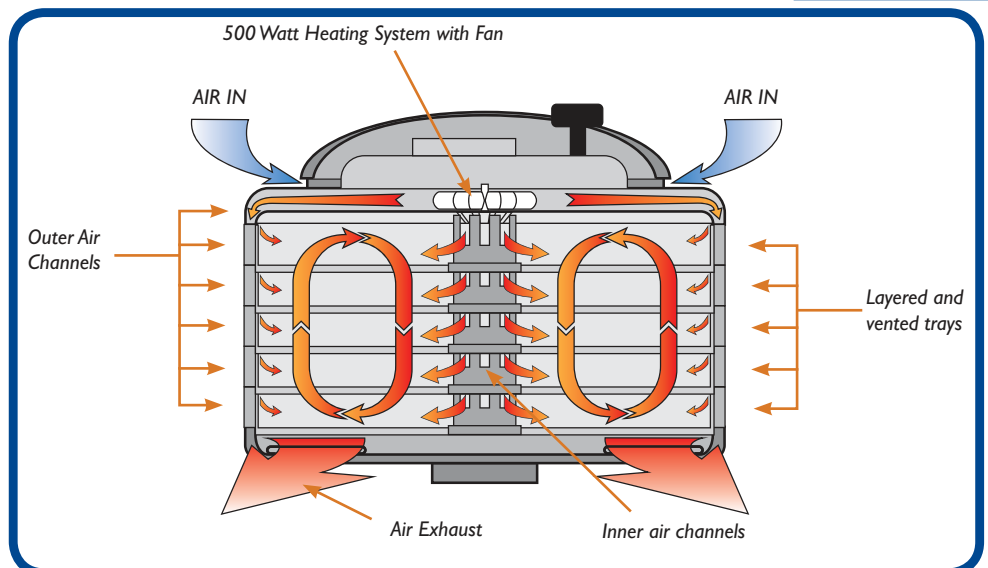

Forced Air Convection Drying System

The Frankford Arsenal Platinum Series Brass Dryer is specifically designed for maximum airflow. Vented trays, inner and outer layered air flow channels and a large 500 Watt Heating System were engineered to reduce drying time and maximize efficiency. Forced air convection ensures that the brass gets the maximum amount of airflow available. Air is heated to 160° F then blown through the channels and circulated throughout the trays before being exhausted out the bottom of the dryer.

**Frankford
Arsenal**
Reloading Tools

Quick-N-EZ™

BRASS CLEANING

QUICK-N-EZ™ CASE TUMBLER

The Frankford Arsenal Case Tumbler provides a quick, easy, and economical means to clean your brass. Used in conjunction with Frankford Arsenal Walnut and Corn Cob Medias, the Quick-N-EZ Case Tumbler removes fouling, lube, and oxidation quickly and conveniently. It will hold up to 600 9mm or 350 .223 cases.

Case Tumbler - #855020

220V Case Tumbler - #515667

Spare Tumbler Bowl - #183007

Case Pack of 1

Case Pack of 1

Case Pack of 1



Quick-N-EZ Case Tumbler package:
10.5" wide x 7" high x 10.5" deep



QUICK-N-EZ™ CASE TUMBLER KITS

Includes Quick-N-EZ Case Tumbler, Quick-N-EZ Rotary Media Separator, 4 oz Brass Polish, 3 lbs Cleaning Media, and Plastic Bucket.

Case Cleaning Kit - #645880

Case Pack of 1

220V Case Cleaning Kit - #799534

Case Pack of 1



MEDIA SEPARATORS AND KITS

Quick-N-EZ Rotary Separator - #683551

Case Pack of 1

(NO plastic bucket) Includes Quick-N-EZ Rotary Separator, 2 Bucket supports, 2 Splash fins.

Quick-N-EZ Rotary Separator Kit - #507565

Case Pack of 1

(with Plastic Bucket) includes Quick-N-EZ Rotary Separator, Plastic Bucket, 2 bucket supports, and 2 splash fins.

Quick-N-EZ Standard Separator - #121925

Case Pack of 4

Sits conveniently on top of most 3 1/2 or 5 gallon plastic buckets. Side walls are 4 3/4" in height, giving it the capacity to hold a tumbler full of brass and media. Perforated bottom lets the media fall through, leaving clean brass behind.



CLEANING AND POLISHING SUPPLIES

Walnut cleans better than corn. Corn polishes better than walnut

Corn Cob Media:

4.5 lb. in Plastic Tub	#287178	Case Pack of 6
7 lb. in Box	#108729	Case Pack of 1
15 lb. in Box	#446063	Case Pack of 1
15 lb. in 3.5 Gal. Bucket	#687756	Case Pack of 1

Treated Corn Cob Media:

4.5 lb. in Plastic Tub	#194524	Case Pack of 6
------------------------	---------	----------------

Walnut Hull Media:

5 lb. in Plastic Tub	#881538	Case Pack of 6
18 lb. in Box	#496169	Case Pack of 1
18 lb. in 3.5 Gal. Bucket	#636314	Case Pack of 1

Treated Walnut Hull Media

5 lb. in Plastic Tub	#347338	Case Pack of 6
7 lb. in Box	#331177	Case Pack of 1

Brass Polish

4 oz. Bottle	#845677	Case Pack of 6
8 oz. Bottle	#887335	Case Pack of 6
32 oz. Bottle	#321901	Case Pack of 6





HAND DEPRIMER - #909283 *Case Pack of 4*

Introducing the Frankford Arsenal Platinum Series Hand Deprimer. The Hand Deprimer is made of robust die cast aluminum and features our (patent pending) Universal Collet System. In just 4 easy steps you can deprime your spent brass by hand. No need to set up your press and reset your dies to deprime a few cases. This system is fully contained. It even captures the spent primers in a collection tube so you can dump them later. Our Universal Collet System can handle brass from .20 cal all the way up to .338 Lapua. This deprimer can even deprime pistol brass. Military crimped primers are easily removed as well with the full length ergonomic grip.

- Extremely efficient design for ease and speed of depriming
- Universal collet system to deprime brass from .20 cal up to .338 Lapua
- Robust die cast aluminum construction for extended use
- Auto-ejecting case holder for easy removal of deprimed cases
- Comes with 3 different collets for different diameter cases
- Features an easily removable spent primer catch tube
- Easily deprime crimped primers
- Works on pistol and rifle brass
- Ergonomic grip

PATENT:
www.BTibrands.com/patents/

Hand Deprimer Package:
10.8" wide x 13" high x 3.5" deep

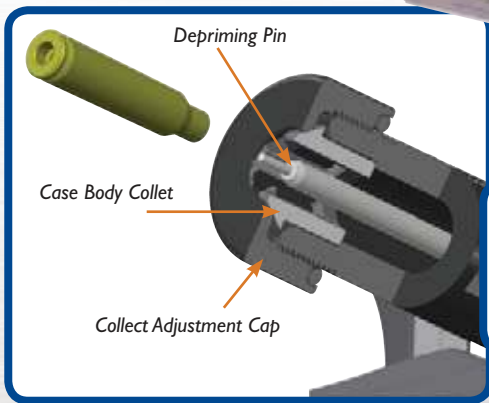

UNIVERSAL COLLET SYSTEM
deprimes brass from
.20 cal up to .338 Lapua



Collect all spent primers in the primer collection tube for easy disposal.

4 EASY STEPS



INSERT



SET



DEPRIME



EJECT

CASE TRIM & PREP CENTER - #903156 Case Pack of 2

Frankford Arsenal's Case Trim & Prep Center accurately trims brass in seconds. An innovative Case Holder with Adjustable Collet and Bushing System indexes the case shoulder and can be set to precisely trim brass to the exact desired case length. Once the case holder is adjusted simply insert brass into the case holder as a collet aligns the case squarely with the hi-speed cutter. As the case mouth contacts the cutter it is trimmed until the case shoulder stops on an internal bushing. A series of three collets and five bushings (all included) accommodate any shouldered case from .17 Remington® to .460 Weatherby®. In addition to the cutter, the station operates up to three additional tools at the same time. Inside and outside chamfer tools and primer pocket cleaners are included to fully prepare cases for loading. The heavy duty motor and drivetrain are optimized for durability and performance. Cutters and Chamfer tools are constructed of high quality hardened steel. A convenient built in storage box holds spare collets, bushings and tools. Patent Pending



- Adjustable Collet System works with all cases from .17 Remington® to .460 Weatherby® (Cases must have a shoulder)
- Indexes cases on the shoulder for speed and precision
- Makes trimming and chamfering cases fast and easy with no need for shell holders
- VLD Inside Chamfering Tool makes loading easier and prevents damage to bullets
- Outside Chamfer Tool, Large and Small Primer Pocket Cleaning tools included
- 3 Output shafts accept all case trimming accessories with 8-32 threads
- Aluminum and steel construction for extreme durability and long life
- Ultra-hard HSS cutters stay sharp for thousands of rounds to make trimming quick and easy
- Can be operated in a variety of positions with included adjustable stand and non-skid feet
- Built-in storage box holds extra tools and keeps everything ready and organized

Case Trim & Prep Center Package:
11" wide x 7" high x 7.25" deep



PATENT:
www.BTlbrands.com/patents/

Innovative Adjustable Collet System!

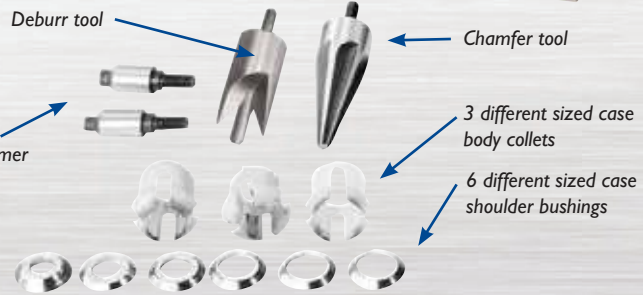
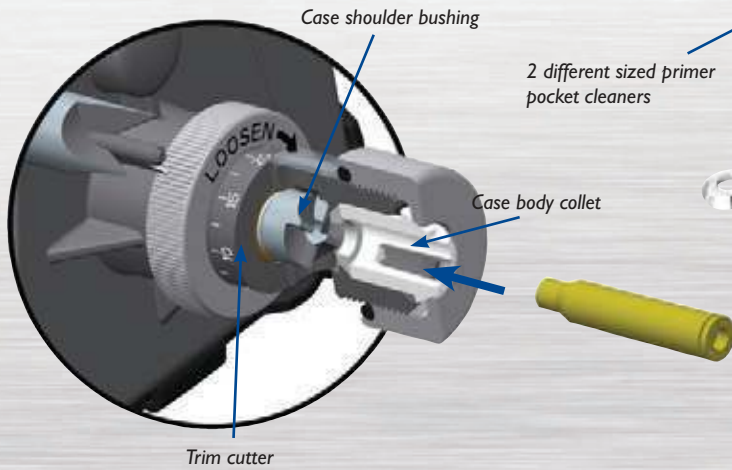

1. Trim

2. Chamfer

3. Debur

4. Pocket clean



TOOLS & ACCESSORIES

Platinum
SERIES

POWDER MEASURE - #909292 Case Pack of 2

The Platinum Series Powder Measure is precision machined to extremely tight tolerances to deliver perfectly smooth operation and highly accurate powder charges. The advanced powder meter design covers a wide range of charges without sacrificing accuracy and eliminates the need for multiple metering units. It measures from 0.8 grains up to 120 grains. The Powder Measure provides accurate measurement of all powder types, ball, cylinder, extruded and flake. A tight sealing hopper cap and powder baffle included. Unlike other common powder measures, the Platinum Series Measure includes 2 mounting stands: A high clearance Bench top top and a side-mounting end version. Both are solid steel construction.

- Precision machined surfaces for precise fit and function
- Universal Meter with precise reference marks
- Works with ball, flake, cylinder and extruded powder
- 7/8-14 threads for mounting to a press
- Quick disconnect for quick powder pour into jug
- 2 different Mounting Stands included



Precise meter gauge with universal marks



Solid Cast metal with precision machined parts



2 INCLUDED MOUNTING STANDS

The 2 included robust solid steel mounting stands will easily set the Powder Measure up high enough to slide reloading trays with brass under it or off the edge of a bench for quick access.



Index lines on powder tube

Can be set up for right or left handed use

Universal dispenser funnel

A "Quick Disconnect" screw allows you to take the powder measure off the mounting assembly quickly. This lets you pour excess powder back into the powder jug easily and without tools.

Powder Measure Package:
7.4" wide x 8.25" high x 4.75" deep

POWDER TRICKLER - #903535 Case Pack of 6

The Frankford Arsenal Powder Trickler allows very small amounts of powder to be dispensed to achieve precise load weights. Dust/moisture covers protect powder while in the trickler. The Frankford Arsenal Powder Trickler is designed to work for all powder types, scales and supporting reloading equipment.

- Synthetic Dust Cover that doubles as a non-skid base
- Increased height to fit almost all powder scales
- Large powder capacity
- Heavy machined steel to prevent tip overs

A MUST HAVE for the Precision Scale!

Increased trickler height to fit almost all powder scales



Powder Trickler Package:
6.25" wide x 8" high x 3" deep

Platinum
SERIES



Dispenser cover sits on knob when not in use

Synthetic dust cover doubles as non-skid base

Frankford Arsenal
Reloading Tools

PRECISION SCALE - #909672 Case Pack of 4

Platinum
SERIES

The Frankford Arsenal Platinum Series Precision Scale delivers extreme accuracy for precise measurement of powder, bullets, cases or loaded rounds. Featuring 1500 grain capacity with 1/10 grain accuracy, you will be able to achieve the maximum potential of your handloads. The large hi-contrast backlit display is easy to read. Simple controls allow for easy changes of units or tare weights. Includes scale, calibration weights, powder pan, clear cover, storage case, 110V power supply and 220V adaptor. Can be operated on 4'AAA' batteries or 110V/220V power supply. The performance and features of this scale make it the best value on the market, making it a welcome addition to any loading bench!

- Storage case holds scale, pan and calibration weights
- Includes 2 calibration weights for a 3 point calibration
- Podium indentations easily index arrows shafts
- Measures in: grains, grams, ounces and carats
- Power: 110V/220V or 4 'AAA' batteries (included)
- Auto shutoff after 180 seconds
- Stability Indicator
- Capacity: 1500 grain (100 gram)
- Accuracy: 0.1 grain (0.01 gram)
- LCD display with blue backlight
- Integrated protective cover
- Tare Function

**Works perfectly with the
Platinum Series Powder Trickler!**

ADAPTER INCLUDED

INTERNATIONAL
*220 volt

Hard storage case packs everything away



Precision Scale Package: 10.75" wide x 9" high x 3.25" deep

DS-750 DIGITAL SCALE - #205205 Case Pack of 4

The Frankford Arsenal DS-750 delivers extreme accuracy for precise measurement of powder, bullets, cases or loaded rounds. With 1/10th grain accuracy you will be able to achieve the maximum potential of your handloads. An integrated clear plastic cover protects the scale during storage and transport. The large, high-contrast backlit display is easy to read. Simple controls allow for easy changes of units, tare weights or counting. Powder pan, carry bag and calibration weight included. The performance and features of this scale make it a great value and will be a welcome addition to your loading bench.

- Capacity: 750 grain (50 gram)
- Accuracy: 0.1 grain (0.01 gram)
- LCD display with blue backlight
- Integrated protective cover
- Carry pouch holds scale, pan and calibration weights
- Auto Calibration
- Measures in: grains, grams, carats and ounces
- Tare Function and Counting Function
- Overload protection
- Auto shutoff after 60 seconds
- Power: 2 AAA batteries (included)

Kit contents include: The DS-750 Scale with built-in cover, powder tray, calibration weight, batteries and storage case.



DS-750 package: 4.75" wide x 9.75" high x 1.75" deep

QUICK-N-EZ™ IMPACT BULLET PULLER

When you need to pull some bullets, for whatever reason, an impact-style tool is the easiest method. Just one stern "whack" and the bullet is separated from the brass. It is as easy as that. Three different collets are included allowing you to pull bullets from just about every caliber from 22 Hornet to 45-70, whether rimmed or rimless. Versatility like that makes this bullet puller the only one to have. Don't wait until you need it!

Quick-N-EZ Impact Bullet Puller - #836017

Case Pack of 6

Replacement Aluminum Collet Set for Bullet Puller, Set of 3 - #737910

Case Pack of 2



Quick-N-EZ Bullet Puller package: 6" wide x 14" high x 2" deep

**Frankford
Arsenal**
Reloading Tools

Quick-N-EZ

RELOADING

VIBRA-PRIME™ - #855712 Case Pack of 4

Platinum
SERIES

Who spends the money on a progressive press to sit there and slowly load primer tubes one primer at a time? Progressive presses are designed to load lots of ammunition quickly. That's why Frankford Arsenal designed the Vibra-Prime™ Automatic Primer Tube Filler. To save time. The Vibra-Prime can load 100 primers into a primer tube in a matter of seconds with its unique motorized agitation mechanism. Filled tubes are then easily transferred into any model progressive press tube. A set of simple universal tube adapters and the drop pin ensure efficient transfers. Runs on 2 'AA' batteries (not included).

- Automatically fills primer tubes in seconds
- Compatible with all progressive presses
- Works with Large and Small primers



- Includes:
- Vibra-Prime
 - 1 Primer Tray
 - 1 Small Primer Tube
 - 1 Large Primer Tube
 - 2 Universal Tube Adaptors

Auto-Indexing Ridges:

The Vibra-Prime tray has circular Auto-Indexing ridges to quickly index your primers for insertion into the tube.

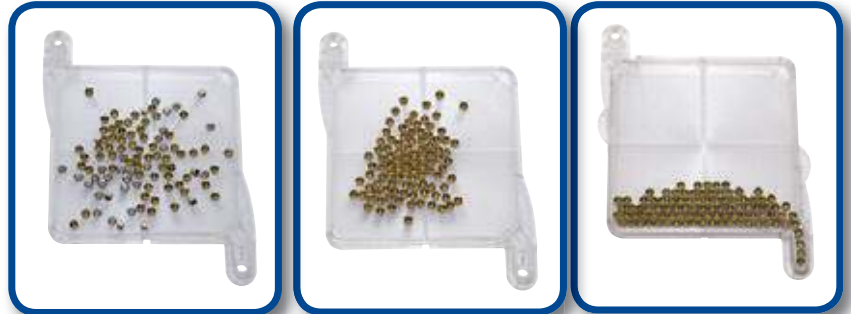

Simply shake the tray full of primers and watch them flip to the correct side!

Primer Tube Adapter:

The Vibra-Prime uses a flexible adapter to align the dispenser tube with the Primer tube on your progressive press. This makes alignment of the tubes and removal of the drop pin quick and painless. No more scattered primers on the floor.

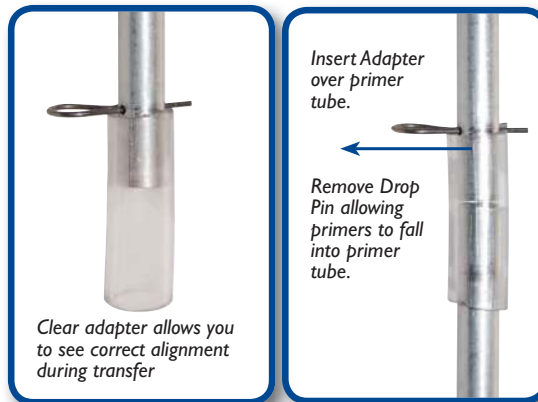

Clear adapter allows you to see correct alignment during transfer

Insert Adapter over primer tube.

Remove Drop Pin allowing primers to fall into primer tube.



Vibra-Prime Package:
7.5" wide x 21" high
x 1.25" deep



CLEANCASST LEAD FLUXING COMPOUND - #441888

Lead fluxing made easy. No more using rosin, paraffin, tallow, bullet lube, and other homemade concoctions. CleanCast is non-smoking, odor-free, and it really works. Only a small amount is necessary to prepare even a 20 pound lead pot for bullet production. Separates dross from your valuable bullet alloy and improves the consistency of the melted lead to eliminate variability during your casting session.



CASE LUBRICANT 8 OZ SPRAY PUMP #460478

#460478

This convenient, fast-drying liquid provides quick lubrication of the case body before re-sizing.



DROP OUT

#763758

Case Pack of 12

The modern way to "smoke" your bullet molds. Applied to the cavities of a cold, clean bullet mold, Frankford Arsenal Drop Out literally allows the just-cast bullets to "drop-out" with no tapping or pounding. 6 oz aerosol.



TOOLS & ACCESSORIES

CALIPERS

Reloading ammunition requires attention to many critical cartridge dimensions, including case length, neck and base diameters, overall length, primer pocket depth, etc. Verifying these dimensions is quick and convenient with the Frankford Arsenal Calipers. The calipers are accurate to within .001". The calipers allow you to measure inside and outside diameters, plus depths. You will find them useful for many measuring tasks on and off the reloading bench. Packaged in a convenient, protective case.

Electronic Calipers (A) - #672060

Case Pack of 6

Stainless Steel Dial Caliper (B) - #516503

Case Pack of 6

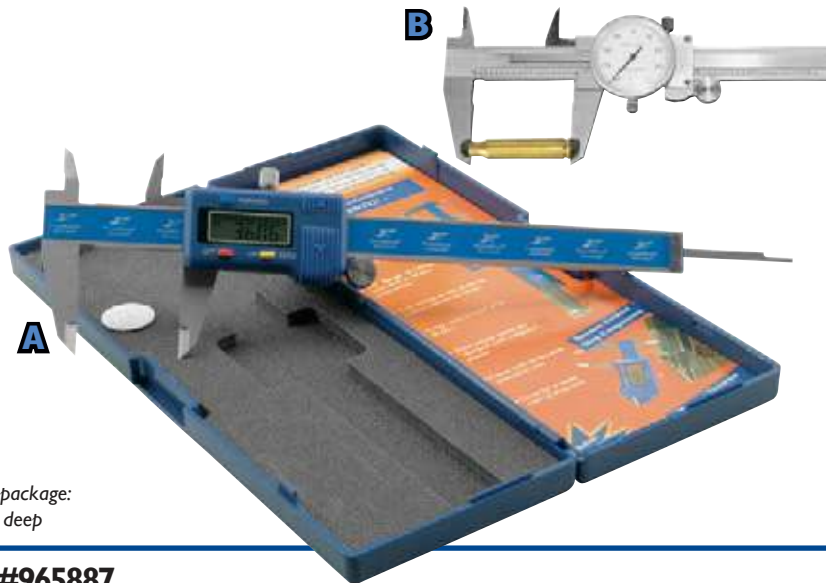

Dial Calipers Package:

9.75" wide x 3.5" high x 1.25" deep



Electronic Calipers clamshell package:

8" wide x 12.25" high x .75" deep

CARTRIDGE OVERALL LENGTH GAUGE - #965887

If you have a cleaning rod and a set of calipers, you can now determine the optimum OAL for any bullet in less than two minutes. This simple kit consists of two clamps that easily attach to any cleaning rod, 1/4" in diameter, or less. Simply install the appropriate size tip on the end of your cleaning rod, insert the cleaning rod to the bolt face, install one clamp, remove the bolt and drop in a bullet (projectile only) into the chamber. Hold the bullet against the rifling with a pencil, touch the bullet tip with the cleaning rod tip and install the other clamp. Now measure the inside distance between the two clamps with a calipers and record, or use as a gauge to check the seating depth set-up during your reloading sequence. Works on all rifles. Complete instructions are included.

Clamshell package: 4" wide x 7.8" high x .8" deep

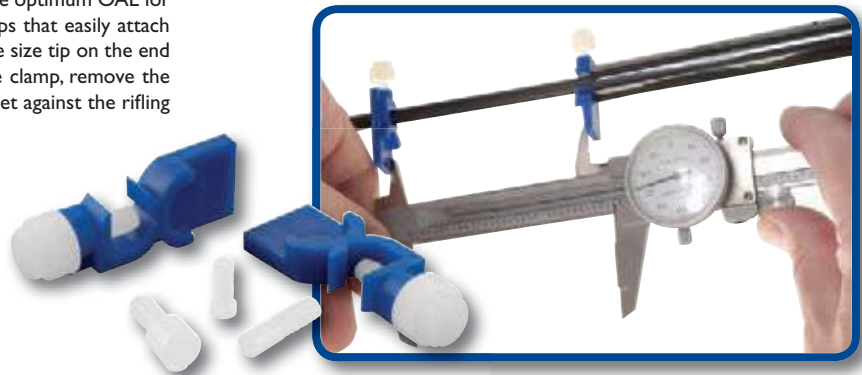

POWDER FUNNEL KIT

#832516

Case Pack of 4

Sixteen quick-change, caliber specific nozzles, 17-45 caliber, to minimize powder spillage. Also includes large funnel and extension tube. Packaged in a plastic case with marked cavities.



CASE NECK LUBRICATOR

Case Pack of 1

Using fine powdered mica to lubricate the inside of the case mouth is faster and more convenient than using a liquid lubricant. After the body of the case has been lubricated, simply dip the case mouth in the mica, run it over the brush, and it is ready for the sizing die. Includes 1/10th oz of fine powdered mica.

Case Neck Lubricator - #132530

Fine Powdered Mica 1/10th oz. packet - #595942

Fine Powdered Mica 4 oz jar - #757780



TOOLS & ACCESSORIES



RELOADING STAND - #489621 *Case Pack of 1*

The Frankford Arsenal Platinum Reloading Stand is a must-have for anyone with limited space. The tabletop and frame are foldable to store in compact spaces. The frame is made of 1-1/2" tube steel and opens to 34" x 21" to provide an extremely rigid work station. The frame is height adjustable from 28.5" to 45" to suit reloading from a sitting or standing position. The tabletop is width adjustable from 13" x 12" to 39" x 12" so it can accommodate all types of reloading processes. The durable wood center section is ideal for mounting a press, powder measure or other fixed position tools while the side shelves easily accommodate any free-standing trimmers, scales or almost any reloading tools. The stand includes two side bins for holding components or small tools to suit any task. Weight 30 lbs.



- Extremely stable and rigid work platform
- Steel frame construction
- Tabletop height adjustable 28.5" to 45" tall
- Tabletop width adjustable 13" x 12" to 39" x 12"
- Folds compactly for storage
- Includes two storage bins



Platinum Series Reloading Stand Package:
26.5" wide x 26.5" high x 4.5" deep



**Reload Comfortably
Sitting or Standing!**

RELOADING STAND *Case Pack of 1*

Mount a press, a powder measure, a trimmer, or almost any reloading tool on this portable reloading stand. The removable 9" x 9" top plate can be drilled for a variety of applications (templates for popular presses included) and the two side bins will hold components or tools to suit the task. The Reloading Stand features a Heavy Duty Plastic top and center stand with a hollow plastic base. Overall height is 26.5".

- Portable Reloading Stand - #155024**
- Extra Top Plate for Reloading Stand - #188071**
- Spare Bin for Reloading Stand - #525752**

Reloading Stand Package:
17.75" wide x 21" high x 6.5" deep



TOOLS & ACCESSORIES

UNIVERSAL RELOADING TRAY - #393939

Case Pack of 6

The Universal Reloading Tray is highly versatile. It can be used with a wide variety of rifle cartridges from .17 caliber up to .458 caliber. Also works well for handgun cartridges 9 mm to 500 S&W. 50 round capacity. Conveniently holds brass during different stages of reloading process.

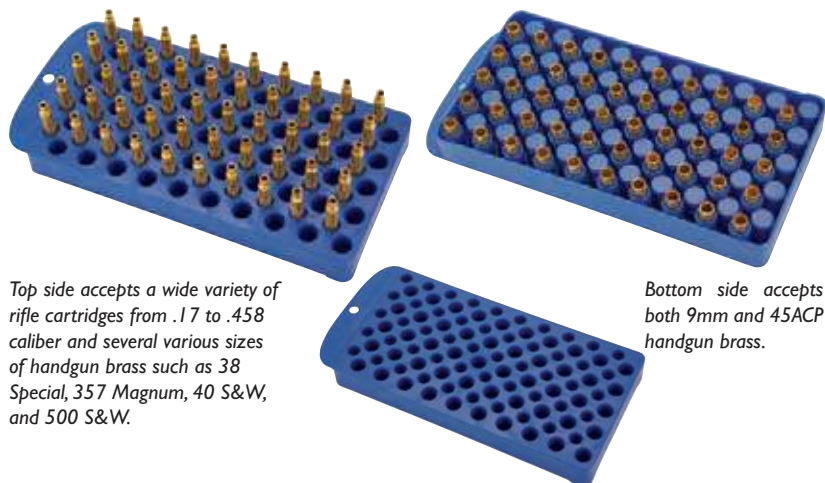

Top side accepts a wide variety of rifle cartridges from .17 to .458 caliber and several various sizes of handgun brass such as 38 Special, 357 Magnum, 40 S&W, and 500 S&W.

Bottom side accepts both 9mm and 45ACP handgun brass.

Unique stepped cavity accommodates several different brass cartridges in the same hole



PERFECT-FIT RELOADING TRAYS

Case Pack of 6

Frankford Arsenal Perfect-Fit Trays are sized for individual calibers or a family of calibers for a precise fit. Perfect-Fit trays are an essential tool for reloading efficiency and organization. Twelve tray sizes are available for 25 ACP through 500 Nitro. Each tray holds 50 cases (tray number 9 holds 45). A lip around the outside edge provides a sure grip on the tray.



Product #	Tray #	Hole Diameter	Hole Depth
#335196	1	0.31	0.3
#695795	2	0.375	0.595
#292930	2s	0.375	0.3
#824257	3	0.401	0.4
#163246	4	0.44	0.625
#853739	4s	0.44	0.4

Product #	Tray #	Hole Diameter	Hole Depth
#844786	5	0.486	0.65
#153092	5s	0.486	0.4
#713498	6	0.53	0.65
#663641	7	0.56	0.65
#290487	8	0.615	0.65
#250083	9	0.665	0.65

Caliber	Tray #	Caliber	Tray #	Caliber	Tray #	Caliber	Tray #	Caliber	Tray #
Rifle		7mm BR	5	7.62x39	4	416 Weatherby Mag	8	357 Sig	4s
		7mm-08	5	7.62x54R Russian	8	44-40 WCF	6	38 Super	4s
17 Remington	2	7x57 Mauser	5	32-20 WCF	4s	444 Marlin	6	38 Special	4
22 Hornet	2	284 Winchester	6	32-40 WCF	6	45-70 Government	8	357 Magnum	4
218 Bee	4s	280 Remington	5	32 Winchester Spl	6	450 Marlin	7	38-40 WCF	6
221 Remington	2	7mm Remington Mag	7	8x57 Mauser	5	45 Sharps	8	40 S&W	4s
222 Remington	2	7mm Weatherby Mag	7	8mm Remington Mag	7	458 Winchester Mag	7	10mm Auto	4s
223 Remington	2	7mm WSM	7	33 WCF	8	460 Weatherby Mag	8	41 Magnum	6
22-250 Remington	5	7mm Remington Ultra Mag	7	338 Winchester Mag	7	470 Nitro	9	44 Special/Magnum	6
220 Swift	5	30 MI Carbine	2	338 Ultra Mag	7	50-70 Government	9	44-40 WCF	6
6mm PPC	4	30 Remington	4	348 Winchester	8	500 Nitro	9	445 Super Mag	6
243 Winchester	5	30-30 Winchester	6	35 Remington	5			45 ACP	5s
6mm/244 Remington	5	300 Savage	5	35 Whelen	5	Pistol		45 Colt	6
25-20 WCF	4s	30-40 Krag	7	375 Winchester	6	25 ACP	1	454 Casull	6
257 Roberts	5	308 Winchester	5	375 H&H Mag	7	32 ACP	2s	45 Auto Rim	6
250 Savage	5	30-06 Springfield	5	378 Weatherby Mag	8	32 S&W/S&W Long	2s	45 Winchester Mag	5
25-06 Remington	5	300 WSM	7	38-55 WCF	6	32 Colt	2s	480 Ruger	7
6.5x55mm		300 H&H	7	38-56 WCF	8	32 Colt	2s	475 Linebaugh	8
Swedish Mauser	5	300 Winchester Mag	7	40-65 WCF	8	32 H&R Mag	2s	50 AE	7
264 Winchester Mag	7	300 Ultra Mag	7	40-82 WCF	8	380 Auto	2s		
270 Winchester	5	300 Weatherby Mag	7	405 Winchester	7	9x19mm Luger	3		
270 WSM	7	303 British	7	416 Remington Mag	7	9x18 Makarov	3		
						38 S&W	4s		



STORAGE

AMMO VAULT®

The Most Advanced Ammo Storage System Available

The Frankford Arsenal Ammo Vault takes ammo storage and transportation to a whole new level. By combining tough, impact-resistant materials and an innovative locking design the Ammo Vault offers unsurpassed protection for your rifle cartridges. No more rattling, no more rubber bands, no more cracked and broken boxes. Give your ammunition the protection it deserves. **Two sizes fit nearly all rifle cartridges, see page 63 for fit chart.**

- Securely holds 20 rounds of ammunition
- Simply squeeze & pull to unlock the two halves to access your ammo
- Highly durable material with overmolded soft-touch top & bottom
- Rubber molded bottom cushions ammo cartridges
- Fit chart on the bottom identifies the most popular cartridges that fit

Ammo Vault® RMD-20 - #912600 Case Pack of 4

Ammo Vault® RLG-20 - #912610 Case Pack of 4



Yes, that's a truck tire driving over the Ammo Vault. The impact-resistant material won't break & protects ammo

- Locks closed with push button release - locking mechanism keeps lid from coming off even if dropped
- Impact-resistant material won't break & protects ammo if dropped
- Foam insert holds cartridges securely, prevents rattling & protects bullet tips
- Overall adjustable height accommodates a wide variety of cartridges

Simply squeeze here to release the two halves to access your ammo

Foam insert holds cartridges securely and prevents rattling

Highly durable material with overmolded soft-touch top and bottom

Rubber molded bottom cushions ammo cartridges

Adjustable height accommodates several different cartridges

Integrated locking mechanism keeps the lid from coming off even if dropped

Molded fit chart on the bottom identifies the most popular cartridges that fit



Adjustable height allows the Ammo Vault to fit a wide range of cartridges.



Ammo Vault package: 6.25" wide x 6" high x 2" deep

PEEL & STICK RELOADER'S LABELS

These Peel & Stick Labels help you record all of the important data about your pistol, rifle, or shotgun handloads for future reference and replication. These labels have an adhesive which makes them easy to remove. Works great with plastic ammo boxes.

Reloader's Labels 100 pack - #202364 Case Pack of 6

Reloaders Labels Package: 3.75" wide x 5.75" high x 1" deep

Reloader Labels: 2" wide x 2.5" tall



22 Hornet	
Caliber	
46 gr. W-W HP	
Bullet Weight, Brand & Style	
10.5 gr. IMR 4227	
Powder Weight & Brand	
WSR	R-P
Primer	2
Case Length	1.393"
Trimmed Length	1.215"
O.A. Length	9.2.02
Date	
Notes:	
Frankford Arsenal Reloader's Label	

12	
Gauge	
1-1/8 oz. #9	
Shot Weight & Size	
18.0 gr. Red Dot	
Powder Weight & Brand	
W209	WAA12
Primer	AA
Case Length	9.2.02
Date	
Notes:	
Frankford Arsenal Shotshell Label	



NEW Plastic Formulation for Enhanced Durability!

Frankford Arsenal
Reloading Tools

PLASTIC AMMO BOXES

Case Pack of 10

See-through plastic ammo boxes make storing and identifying your reloaded ammunition a snap. Available in 2 different colors and twelve different sizes to fit most calibers. Our system allows you to get organized and stay organized! Our ammo boxes fit a full variety of calibers, often many more than the description allows for. Please refer to the chart below to determine which box is appropriate for your application.

50-ROUND HINGE-TOP BOXES

Box	Blue	Gray
501	#114596	#340663
503	#642557	#354668
504	#698582	#441440
505	#690047	#264395
506	#369645	#414965
507	#349962	#398657
508	#718498	#860416
509	#160880	#122804
510	#513329	#450302
511	#162882	#803479
512	#791979	#801326
514	#563412	#118960
515	#296112	#312874

100-ROUND HINGE-TOP BOXES

Box #	Blue	Gray
1001	#688397	#713196
1003	#930447	#185116
1005	#554106	#631312
1007	#912544	#107025
1008	#419448	#515120
1009	#562778	#651533

20-ROUND SLIP-TOP BOXES

Box	Blue	Gray
205	#205111	#205222
209	#533573	#351167
210	#184625	#151242
211	#877991	#227289

	100 Round Box	50 Round Box	20 Round Box	Ammo Vault®		100 Round Box	50 Round Box	20 Round Box	Ammo Vault®		100 Round Box	50 Round Box	20 Round Box		
RIFLE					PISTOL										
17 Remington	1005	505	205		30-06 Springfield	510	210	RMD	25 ACP	1001	501				
22 Hornet		504			300 H&H Mag	511	211	RLG	32 ACP	1001	501				
22 Remington Jet		504			300 Winchester Mag	511	211	RLG	32 S&W/32 S&W Long	1003	503				
218 Bee		504			300 Ultra Mag	511	211	RLG	32 H&R Magnum	1003	503				
221 Remington		504			300 Remington				380 Auto	1001	501				
22 BR		512			Short Ultra Mag	511	211	RLG	9x19mm Luger	1001	501				
22 PPC		512			300 SAVM	515			9x18 Makarov	1001	501				
222 Remington	1005	505	205	RMD	300 WSM	515	211	RLG	38 S&W	1003	503				
223 Remington	1005	505	205	RMD	300 Weatherby Mag	511	211	RLG	38 Special	1003	503				
222 Remington Mag	1005	505	205	RMD	303 British	510	210	RMD	38 Super	1003	503				
22-250 Remington	1009	509	209	RMD	7.62x39mm	1009	512	209	RMD	357 Magnum	1003	503			
220 Swift	1009	509	209	RMD	32-20 WCF	1003	503		357 Maximum		505	205			
243 Winchester	1009	509	209	RMD	32 Winchester Spl	509	209	RMD	357 Auto Mag		507				
6mm BR		512			325 WSM 515 RLG				10mm Auto	1008	508				
6mm Remington	1009	509	209	RMD	8x57 Mauser	510	210	RMD	40 S&W	1008	508				
240 Weatherby Mag		210	210	RMD	8mm Remington Mag	511	211	RLG	41 Long Colt	1007	507				
25-20 WCF	1003	503			338 Winchester Mag	511	211	RLG	41 Magnum	1007	507				
257 Roberts	1009	509	209	RMD	338 Lapua Mag	511	211	RLG	44 S&W Russian	1007	507				
250 Savage	1009	509	209	RMD	340 Weatherby Mag	511	211	RLG	44 Colt	1007	507				
25-06 Remington		510	210	RMD	338 Rem Ultra Mag	511	211	RLG	44 Special	1007	507				
6.5mm Swedish Mauser		510	210	RMD	35 Remington	1009	509	209	RMD	44-40 WCF	1007	507			
6.5mm Remington Mag		511	211	RLG	350 Remington Mag	511	211	RLG	44 Magnum	1007	507				
6.8mm SPC		512		RMD	35 Whelen	510	210	RMD	445 Super Mag	1009	509	209			
270 Winchester		510	210	RMD	375 H&H Mag	511	211	RLG	44 Auto Mag	1007	507				
270 Weatherby Mag		511	211	RLG	375 Rem Ultra Mag	511	211	RLG	45 S&W Schofield	1007	507				
270 WSM		515		RLG	378 Weatherby Mag	511	211	RLG	45 ACP	1008	508				
7x57 Mauser		510	210	RMD	38-40 WCF	507			45 Auto Rim	1008	508				
7mm BR	1009	512	209	RMD	38-56 WCF	514		RLG	45 Colt	1007	507				
7mm SAUM		515			38-70 WCF	514		RLG	45 Winchester Magnum	1007	507				
7mm WSM		515		RLG	40-65 WCF	514		RLG	454 Casull	1007	507				
7mm-08	1009	509	209	RMD	40-65 Ballard	514			460 S&W		514				
280 Remington		510	210	RMD	404 Jeffrey	511	211	RLG	480 Ruger		506				
7mm Remington Mag		511	211	RLG	405 Winchester	510	210	RLG	475 Linebaugh		506				
7mm Rem Ultra Mag		511	211	RLG	416 Taylor	511	211	RLG	50 AE		506				
7mm Remington					416 Rigby	511	211	RLG	500 Linebaugh		506				
Short Ultra Mag		511	211	RLG	444 Marlin	1009	509	209	RLG	500 S&W					
30 M1 Carbine		504			45-70 Govt.	1009	514	209	RLG						
30 Remington	1009	509	209	RMD	45-90 WCF	511	211	RLG	SHOTGUN						
30-30 Winchester	1009	509	209	RMD	45-110 Sharps	511	211	RLG	.410 Gauge 2.5" Shells		509				
300 Savage	1009	509	209	RMD	458 Winchester Mag	511	211	RLG	.410 Gauge 3" Shells		510				
30-40 Krag		510	210	RLG	50-70 Govt.	514		RLG	28 Gauge		514				
308 Winchester	1009	509	209	RMD	50 110 WCF	514		RLG							





The NEW Lockdown SUPER MAX handgun vaults bring an added level of security to your firearms. Made of robust 16 gauge steel construction, once it is locked down there is no way it's getting out. Choose between a conventional key lock or an innovative 5 button mechanical combination lock vault. An added feature is an LED light on the inside to illuminate your gun if you need to access your vault in the dark. A gas piston strut assists in opening the SUPER MAX vault and keeps the lid open while you access your gun. California DOJ Compliant, these are among the most secure vaults on the market!

MECHANICAL LOCK

- 5 button Mechanical Lock with 1081 password combinations
- EMP Proof, No keys or batteries ever needed
- Heavy Duty 16 gauge steel construction
- Features a gas strut to open the vault lid
- Includes an LED light to easily see into the vault
- External dimensions: 8.5" x 13.25" x 2.5"

KEY LOCK

- Keyed vault with dual locking bolts
- Heavy Duty 16 gauge steel construction
- Features a gas strut to open the vault lid
- Includes an LED light to easily see into the vault
- External dimensions: 8.5" x 13.25" x 2.5"

CALIFORNIA DOJ COMPLIANT



Both Vaults can accommodate most magnum sized handguns with a 6" barrel.

Internal dimensions:
12" x 7.75"

Built in LED light automatically comes on when lid is lifted. Access your gun without needing to turn on a light.



MECHANICAL LOCK!
No keys or batteries needed

Mechanical Lock Vault - #222905
Keyed Lock Vault - #222820

Case Pack of 4
Case Pack of 4

Super MAX Vault Package:
13.5" wide x 8.5" high x 3.5" deep

5 button Mechanical Lock with 1081 possible password combinations

SUPER MAX™ READY VAULT - #222933 Case Pack of 4

The NEW lockdown SUPER MAX READY VAULT is a unique and innovative way to secure and hide your handgun while still keeping it close by. The READY VAULT is designed to be mounted under a desk or to the side of an end table or cabinet. Keep your handgun "At The Ready" with a 5 Button Mechanical Locking mechanism. Made of robust thick gauge steel, this vault gives you an added level of security. An LED light illuminates the gun if you need to access the vault in the dark. Once unlocked the door swings down and gives you "ready" access to your pistol. California DOJ Compliant.

- 5 button Mechanical Lock with 1081 password combinations
- No keys or batteries ever needed, EMP Proof
- Heavy Duty 16 gauge steel construction
- Holds the firearm in the Ready Position
- Multiple mounting configurations
- Features a gas strut to open the vault lid
- Includes an LED light to easily see into the vault
- Holds pistols or revolvers with barrel length up to 5"
- Mounting hardware included

CALIFORNIA DOJ COMPLIANT



MECHANICAL LOCK!
No keys or batteries needed

Mountable from the top, left or right sides with the included hardware.

Remove diamond plate to access right or left side mounting holes

Auto ON/OFF LED light shines into vault for access in the dark



Super MAX Ready Vault Package: 13.5" wide x 8.5" high x 3.5" deep

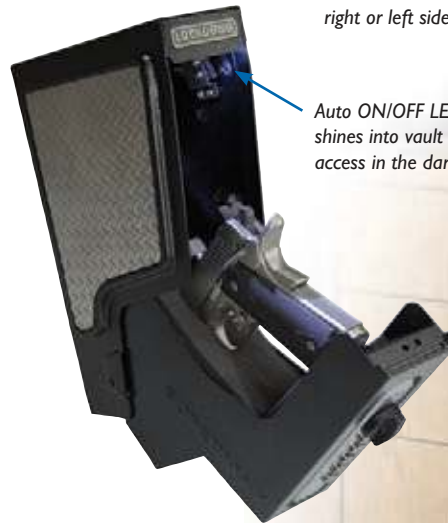

CALIFORNIA DEPARTMENT OF JUSTICE STANDARDS

California DOJ has some of the most stringent standards for security vaults in the U.S.A. Lockdown engineers have worked with the California DOJ to manufacture compliant handgun vaults for your security and the security of your family. All Lockdown Handgun Vaults pass California DOJ standards and are fully compliant.



HANDGUN SECURITY VAULTS



Ultra Compact Handgun Vault dimensions:
6.5" wide x 5.1" high x 1.6" deep

Compact Handgun Vault dimensions:
5.75" wide x 8.5" high x 2" deep

Large Handgun Vault dimensions:
6.5" wide x 10" high x 2" deep



Pre-drilled mounting holes inside vault



Lockdown Handgun Security Vaults provide a secure storage solution for handguns and other valuables at home, in the car or when traveling. Designed to provide an additional level of security for conceal carry permit holders. Durable 18 gauge steel construction with extra heavy 12 gauge reinforced side and bottom plate allow these vaults to be secured to any flat surface with the included mounting hardware. A heavy duty 43", 1500 lb steel cable is included and allows the vaults to be secured to a stationary object or the internal frame of a piece of luggage (NOTE: Ultra Compact model does not include a cable). Available in three sizes to accommodate most handguns.

- Perfect for securing handgun in a vehicle or night stand
- 18 gauge walls with an additional 12 gauge side and bottom reinforcement plate
- Variety of sizes available lets you choose the right size vault for your gun
- Meets TSA airline guidelines
- Certified California DOJ Approved

Ultra Compact Handgun Vault - #222747 Case Pack of 6
Compact Handgun Vault - #222133 Case Pack of 6
Large Handgun Vault - #222144 Case Pack of 6

**CALIFORNIA DOJ
COMPLIANT**

Ultra Compact Handgun Vault display box: 8" wide x 8" high x 14.25" deep
 Ultra Compact Handgun Vault individual clamshell: 7.75" wide x 8" high x 2" deep
 Compact Handgun Vault individual clamshell: 9.5" wide x 7.5" high x 1" deep
 Compact Handgun Vault display box: 11" wide x 5.5" high x 14" deep
 Large Handgun Vault individual clamshell: 11" wide x 9.5" high x 1" deep
 Large Handgun Vault display box: 12.5" wide x 6.25" high x 14.125" deep

**Shipped in Case Pack
Display Box!**



BEING SOCIALLY RESPONSIBLE ABOUT GUNS

Owning a gun is our 2nd Amendment right. With that right comes responsibility. A responsibility to use and to store our gun(s) effectively and responsibly. It is estimated that almost half of the U.S. population owns at least 1 gun and in 2013 the NICS checks were up approximately 30% from the previous year. What does that mean? It means that more people are buying guns and a significant portion of those are First Time Owners. This is where being Socially Responsible comes into play. Many people own 1 or 2 guns but buying a big gun cabinet or vault is cost-prohibitive. Personal Gun Vaults like the Lockdown Handgun Vaults and Super MAX Handgun Vaults are a convenient, cost-effective, and Socially Responsible option.



The Lockdown Night Guardian is an ideal solution for keeping a home defense weapon at the ready in the bedroom. The vinyl-coated wire form frame fits securely between the bed mattress and box spring. A universal fabric holster attached to the wire form holds most any handgun along with a spare magazine and a small flashlight. The innovative shape also allows two Guardians to be used in conjunction to hold a long gun. Available in single Guardian for a Handgun or a set of two that accommodate two handguns or a long gun. Always practice responsible gun ownership by properly securing all weapons outside of your immediate possession. This product is NOT intended to prevent access to weapons.

Handgun Holster

- Conveniently holds a handgun, spare magazine and flashlight
- No more fumbling in the night stand. Keep a firearm within arm's reach when time matters most
- Easily hides the firearm from view under the comforter of the bed
- Waved steel bar keeps Night Guardian in place while drawing the firearm
- Universal holster for use with any size pistol or revolver
- Universal pouches for single or double stack magazines and most flashlights
- Additional defender can be used for the storage of a long gun

Night Guardian Handgun Holster - #222502 Case Pack of 5

Rifle/Shotgun Holder

- Set of two mounts conveniently holds a shotgun or other long gun
- Mounts also feature holsters, spare magazine and flashlight pouches
- No more fumbling in the closet. Keep a firearm within arm's reach when time matters most
- Easily hides the firearm from view under the comforter of your bed
- Waved steel bar keeps Night Guardian in place while drawing the firearm
- Universal pouches for single or double stack magazines and most flashlights
- Can be used separately to hold two handguns

Night Guardian Rifle/Shotgun Holder - #222503 Case Pack of 5

Handgun Night Guardian Package:
6.5" wide x 16.75" high x 4.25" deep

Rifle/Shotgun Night Guardian Package:
6.5" wide x 18.5" high x 4.5" deep

Convenient home defense

Pouch orientation can be reversed to position the handgun pouch or accessories pouch on the inside.

The dual mounts easily hold a shotgun or rifle for quick and easy deployment.

Easily conceal your shotgun under a comforter.

GUN CONCEALMENT MAGNET - #222501

The Lockdown Gun Concealment Magnet can be mounted conveniently in a variety of locations to securely hold a handgun in place. The powerful magnets easily support full size pistols and revolvers. A durable rubber coating protects the finish on the gun. Perfect for securing a gun out of sight but within easy reach under a desk or night stand shelf. Multiple magnets can be used to support rifles or shotguns. Includes two wood screws as well as two drywall screws and anchors.

Hang a pistol from under your desk!

Use 2 Magnets and mount a Rifle/Shotgun on the wall!

- Full frame pistols hang securely, even upside down
- Attach your gun under a desk for quick and convenient access
- Works on most handguns with metal slide or metal barrel
- Mounts anywhere: vertical, horizontal, hanging upside down, or at an angle
- Use one magnet for handguns or multiple magnets for a shotgun or rifle
- Overmolded non-marring rubber coating
- Low profile for easy concealment

Gun Concealment Clamshell:
5.75" wide x 7.5" high x 1.25" deep

AR Mag Well Lock & Lock with Wall Mount

AR MAG WELL LOCK

#222818 Case Pack of 6

The AR-15 Mag Well Lock conveniently locks into the magazine well of any AR-15 platform gun to secure the gun in a non-firing condition. It engages into the bolt raceway while holding the bolt carrier partially open, completely disabling the firing mechanism. This also prevents the upper from being disassembled from the lower. A high-strength coated steel cable and pin are included that allow the lock and gun to be anchored to any stationary object such as a frame member in a vehicle. Glass-reinforced Nylon construction is durable and robust, yet is non-marring or damaging for inserting in your magazine well. Two keys included.

- Works with any Mil-Spec AR-15
- Fully disables the firing mechanism
- Prevents disassembly of the upper and lower
- Prevents a magazine from being loaded into the firearm
- Comes with theft deterrent steel anchoring cable

CALIFORNIA DOJ COMPLIANT



AR MAG WELL LOCK WITH WALL MOUNT - #222819

Case Pack of 4

The AR-15 Mag Well Lock conveniently locks into the magazine well of any AR-15 platform gun to secure the gun in a non-firing condition. It engages into the bolt raceway while holding the bolt carrier partially open, completely disabling the firing mechanism. This also prevents the upper from being disassembled from the lower. The Wall Mount base is designed to receive the bottom of the Mag Well Lock while it is inserted into the gun. Once in place, the Mag Well Lock engages a steel pin on the base and secures the gun to the Wall Mount. A vinyl coated I bolt adds additional security by locking the barrel in position. The Wall Mount has four possible mounting configurations to fit ideally for any application.

Additional features of the Mag Well Lock: A high strength coated steel cable and pin are included that allow the lock and gun to be anchored to any stationary object such as a frame member in a vehicle. Glass reinforced nylon construction is durable and robust, yet is non-marring or damaging for inserting in your magazine well. Two keys included.

NOTE: This product is a "Theft Deterrent" but may not provide an appropriate level of security for all applications.

- Works with any Mil-Spec AR-15
- Fully disables the firing mechanism
- Prevents disassembly of the upper and lower
- Prevents a magazine from being loaded into the firearm
- Comes with theft deterrent steel anchoring cable
- Wall mounting system allows for convenient display and storage
- Multiple mounting configurations



CALIFORNIA DOJ COMPLIANT

Mount the Mag Lock to your wall studs to truly secure your AR.

Mag Well Lock Clamshell:
6.125" wide x 10" high x 3.5" deep



Mag Well Lock w/ Wall mount box:
10.25" wide x 6.25" high x 4.8" deep

Steel cable works great for locking your AR under the back seat of your truck or in the trunk of our car.



Mag Lock Wall Mount kit includes:
steel cable, Mag Lock, Wall Mount, 2 barrel Mount I Bolts



Magazine holder included

Wall Mount System allows you to mount your AR flat against the wall or Perpendicular.

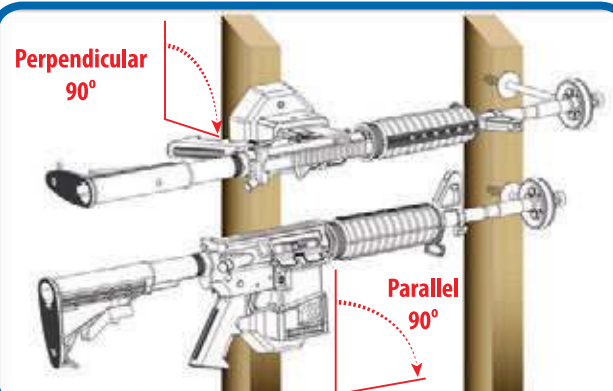

Perpendicular
90°

Parallel
90°

LOCKDOWN
VAULT ACCESSORIES

ORGANIZATION

VAULT ACCESSORY ESSENTIALS KIT - #222714 *Case Pack of 4*

The Lockdown Vault Accessory Essentials Kit is perfect for setting up a new safe. The Dehumidifier Rod eliminates moisture and protects from rust, corrosion and mildew, which are harmful for all firearm collections. The Handgun Hanger makes great use of the lost space on the door, letting you hang handguns where you desire. The Hygrometer is great for visually monitoring the humidity level inside your safe. The Automatic Cordless Vault Light allows you to position exactly where more light needs to be shed. Lockdown is the most comprehensive line of vault accessories available today. A wide variety of items designed to enhance organization, control climate and generally improve the usability of your vault.

- Positional light for dark spots under shelves with Automatic Cordless Vault Light
- Protects from rust, corrosion and mildew with the Dehumidifier Rod
- Makes use of lost space with the Handgun Hanger
- Monitor safe humidity levels with the Hygrometer

Kit contains:
 12" Dehumidifier Rod
 Handgun Hanger,
 Hygrometer
 Automatic Cordless Vault Light

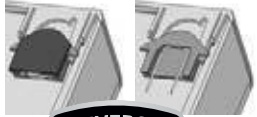

UNIVERSAL ATTACHMENT SYSTEM

Essentials Kit Package:
 13" wide x 5.75" high x 2.25" deep



VAULT ACCESSORY DELUXE KIT - #222498 *Case Pack of 4*

The Lockdown Vault Accessory Deluxe Kit is perfect for setting up your safe with everything you need. The Dehumidifier Rod eliminates moisture and protects from rust, corrosion and mildew, which are harmful for all firearm collections. The Large Hanging Organizer makes great use of the lost space on the door, letting you hang handguns, magazines and knives where you desire. The Hygrometer is great for visually monitoring the humidity level inside your safe. The Automatic Cordless Vault Light allows you to position exactly where more light needs to be shed. The Barrel Rest provides a safe place for your firearms while accessing your safe. The Lag Screws rigidly lock your safe to studs in the wall or floor for an extra level of protection. Lockdown is the most comprehensive line of vault accessories available today. A wide variety of items designed to enhance organization, control climate and generally improve the usability of your vault.

- Protects from rust, corrosion and mildew with the Dehumidifier Rod
- Makes use of lost space with the Large Hanging Organizer
- Monitor safe humidity levels with the Hygrometer
- Positional light for dark spots under shelves with Automatic Cordless Vault Light
- Safely hold firearms while accessing your safe with the Barrel Rest
- Rigidly bolt safe to the wall with the provide Lag Screws

Kit contains:
 12" Dehumidifier Rod
 Large Hanging Organizer
 Hygrometer
 Automatic Cordless Vault Light
 Magnetic Barrel Rest
 4 - Lag Screws with Bolt Head Covers

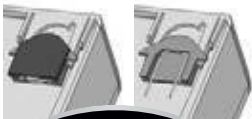

UNIVERSAL ATTACHMENT SYSTEM

Deluxe Kit Package:
 13" wide x 7.5" high x 4.75" deep



LOCKDOWN
 VAULT ACCESSORIES

VAULT LIGHTING KIT - #222020 Case Pack of 4

The Lockdown Vault Lighting Kit can be easily installed in any vault and is designed to provide illumination throughout the entire interior. The flexible rope design can be routed to provide superior light coverage, regardless of shelf configuration inside the vault. The kit includes a 12' section of super bright white LED lights housed in a durable clear tube, along with a 6' power cord and in-line on/off switch. A quick install plug allows the power cord to be easily routed through the vault wall. Mounting clips and screws provided.

- LED Rope Light is durable and extremely bright
- Provides maximum illumination throughout entire vault
- Simple to install, mounting hardware included
- Power cord with ON / OFF switch and easy-install plug

Clamshell package:
8.125" wide x 8.625" high x 3.5" deep



Easy-Install Electrical Plug



CORDLESS VAULT LIGHT 6 LED

#222777 Case Pack of 4

Cordless Vault Light can be easily installed to provide illumination inside any vault, no wiring required. Rotating head allows the light from 6 ultra-bright LEDs to be directed where needed. Multiple mounting options: internal magnets for metal interiors, detachable mounting plate and screws, or adhesive-backed hook & loop pads included.

- Battery operated for easy install, runs on 3 AAA batteries (not included)
- Multiple mounting options including internal magnets, screws or hook & loop
- Ultra bright 6 LEDs delivers light to vault interior
- 90° rotating light head directs light where you want it
- Cordless, no wiring needed



Clamshell package:
5" wide x 13" high x 1.5" deep

STEALTH ENTRY LIGHT - #222444 Case Pack of 6

The Lockdown Stealth Entry Light is ideal for placement above a combination dial on your vault, for obtaining entry to your vault in a dimly lit or dark room. Magnet base sticks to vault door while flexible head allows user to bend and twist the head to desired location. Rod retains shape and holds the head in place.

- Illuminates combination dial, allows fast entry into vault in a dark room
- Convenient for adding extra light inside a vault
- Battery operated, runs on 3 button cell batteries (included)
- Ultra bright 3 LED light
- Magnetic base & flex head

Clamshell package:
6.75" wide x 11.625" high x 1.25" deep



AUTOMATIC CORDLESS VAULT LIGHT - #222809 Case Pack of 4

The Automatic Cordless Vault Light is the perfect way to easily add extra light inside any vault or cabinet. The 5 super bright LED's can be set to automatically turn on as the vault door is opened and ambient light is detected. A selectable manual on/off mode is incorporated as well. Hook and loop tape or screws are included for easy mounting. Light head pivots and swivels to give you light where you need it. Runs on three 'AAA' batteries (not included).

- Battery operated, no wires or installation required
- Light sensing mode allows light to turn on automatically when vault door is opened
- Five super bright long lasting LED's run on 3 'AAA' (not included)

Cordless Vault Light Package:
4.75" wide x 6.75" high x 1.75" deep

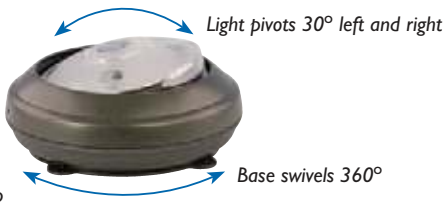

Built-in auto ON / OFF light sensor



GOLDEN ROD Moisture Control

DEHUMIDIFIER RODS

The Golden Rod Dehumidifier works by slightly increasing the air temperature inside the gun safe or other enclosure. This allows the warm air to circulate throughout the safe on a continual basis, thus eliminating humidity, mildew, and condensation, all of which are dangerous to your expensive firearm collection.



12" - 12 Watt dries up to 100 cubic feet
 18" - 18 Watt dries up to 200 cubic feet
 24" - 25 Watt dries up to 300 cubic feet
 36" - 38 Watt dries up to 500 cubic feet

- Made in USA
- Removes moisture from gun safe interior
- Protects firearm investment
- Guards against rust
- Easy-install quick plug attachment
- Mounting brackets included
- 110/120 volt AC
- Lifetime Warranty



- 12" Dehumidifier Rod - #725721 Case Pack of 4
- 18" Dehumidifier Rod - #725731 Case Pack of 4
- 24" Dehumidifier Rod - #725741 Case Pack of 4
- 36" Dehumidifier Rod - #725751 Case Pack of 4



GUN SAVER DEHUMIDIFIER RODS

The GUN SAVER Dehumidifier works by slightly increasing the air temperature inside the gun safe or other enclosure. This allows the warm air to circulate throughout the safe on a continual basis, thus eliminating humidity, mildew, and condensation, all of which are dangerous to your expensive firearm collection.



12" - 8 Watt dries up to 100 cubic feet
 18" - 12 Watt dries up to 200 cubic feet

- Removes moisture from gun safe interior
- Protects firearm investment
- Guards against rust
- Easy-install quick plug attachment
- Mounting brackets included
- 110/120 volt AC

- 12" Dehumidifier Rod - #725761 Case Pack of 4
- 18" Dehumidifier Rod - #727771 Case Pack of 4

12" & 18" Golden Rod and Gunsaver Packages:
 12" - 5.25" wide x 18" high x 1.25" deep
 18" - 5.25" wide x 24" high x 1.25" deep

24" & 36" Golden Rod Package:
 4.5" wide x 39" high x 1.25" deep

WIRELESS HYGROMETER - #222532 Case Pack of 4

The Golden Rod Wireless Hygrometer was designed to display the humidity in your vault without ever opening it. The wireless LCD display clearly shows the in-vault and in-room humidity and temperature levels through its two-piece sensor design. Simply place the sensor in your vault and put the display screen on your vault with its built in kick stand support or magnetic back. The Hygrometer measures and displays humidity from 20% to 90% and while also recording minimum and maximum records. This battery operated Hygrometer is a must-have for every vault owner.

- Wireless Sensor
- Displays Temp. & Humidity for inside vault and outside room
- Easy to read LCD Display



Digital Hygrometer Package:
 7" wide x 7.25" high x 1.25" deep



In-vault transmitter



LCD Display Unit

Back of Display Unit



Magnetic back or flip out stand up base allows you to stick the Wireless Hygrometer to the door of your safe or set it on top.



HUMIDITY CONTROL

DEHUMIDIFIER RODS

The LOCKDOWN Dehumidifier Rods work by slightly increasing and stabilizing the air temperature inside any gun safe or other enclosure. When mounted at a low point in the vault, the rod will radiate heat up through the entire vault interior on a continual basis. The result is warm stable air thus eliminating humidity, mildew and condensation, all of which are dangerous to your expensive firearm collection. The rods are constructed of durable extruded aluminum and come with mounting brackets and fasteners. The rods also feature an "easy-install" AC plug for the power cords. This allows the user to route the cord through a small opening in a vault and then install the plug. Protect your investment with Lockdown!

- Removes moisture from gun safe interior
- Protects firearm investment
- Guards against rust
- Dries approx. 100 cubic ft. (12") or 200 cubic ft. (18")
- Mounting brackets included
- Easy-install plug attachment for 110/120 volt AC

12" Dehumidifier Rod - #222000 Case Pack of 4
(12" 8 Watt 100 cu ft.)

12" Dehumidifier Rod, 220V - #222666 Case Pack of 4
(12" 8 Watt 100 cu ft.)

18" Dehumidifier Rod - #222010 Case Pack of 4
(18" 12 Watt 200 cu ft.)

18" Dehumidifier Rod, 220V - #222667 Case Pack of 4
(18" 12 Watt 200 cu ft.)



Dehumidifier Rod installs horizontally at the lowest point in a gun safe.

Applications:
Gun Safes
Closets

Storage cabinets
Boat compartments



18" Rod dimensions:
18.25" w x 1.25" h x 2.5" d

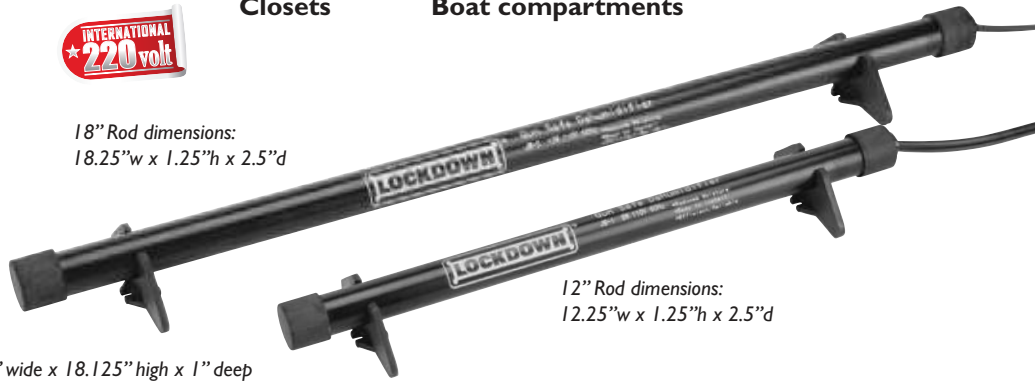

12" Rod dimensions:
12.25" w x 1.25" h x 2.5" d

12" Rod clamshell package: 5.125" wide x 18.125" high x 1" deep
18" Rod clamshell package: 5.125" wide x 24.25" high x 1" deep

Don't risk damage to your valuable gun collection. Install a dependable Lockdown Rod Today!

HYGROMETER - #222111 Case Pack of 4

Managing humidity is critical to protecting and preserving the condition of your firearms. The Lockdown Hygrometer provides accurate relative humidity readings at a glance. Excessive moisture in a vault or storage area can cause rapid corrosion and pitting on metal surfaces. It is important to monitor and control the relative humidity in your storage area to be sure your guns are properly protected.

- Mounts easily with included fastener and/or hook & loop
- Large easy to read numbers
- 2 3/4" diameter

Clamshell package:
4.25" wide x 7.25" high x 1.25" deep



Controlling Humidity:

Humidity control is an essential factor in storing and protecting firearms. Don't expose your valuable firearms to the damaging effects of humidity, moisture and condensation. Maintaining consistent humidity and temperature is very important because fluctuations in either can lead to condensation and corrosion. Extremely low humidity levels can potentially pull too much moisture from wood stocks leading to small cracks. 50% relative humidity and 70 degrees F is considered ideal storage conditions for firearms. Choose a humidity control product and monitoring system that best suits your application.



HUMIDITY CONTROL

SILICA GEL

Lockdown Silica absorbs moisture from the air inside a vault or storage area preventing condensation, mildew and rust from damaging valuable firearms. Crystals change color once fully saturated and can be easily recharged in the oven.

- Absorbs moisture from the air
- Easily recharged in oven
- Durable vented 750 gram can provides protection for up to 57 cubic feet
- Breathable bag provides protection for up to 33 cubic feet
- 40 gram can is ideal for small handgun vaults

Silica Gel Can, 750 grams - #222178 Case Pack of 4

Silica Gel Bag, 450 grams - #222179 Case Pack of 8

Silica Gel Can, 40 grams - #222555 Case Pack of 6



Silica Gel Can 750g package:
6.5" wide x 4.5" high x 4.5" deep
Silica Gel Bag 450g package:
4.5" wide x 6.5" high x 2" deep
Silica Gel Can 40g package:
3" wide x 7.5" high x 1" deep

Silica Can 750g dimensions: 4.25" w x 5.75" h x 4.25" d

Silica Gel Bag 450g dimensions: 8" w x 5.5" h x 1.5" d

Silica Gel Can 40g dimensions: 2" wide x 4" high x .5" deep

Recharging Silica: The silica beads are a light orange color when recharged. They will turn to a darker green color as they absorb moisture. The silica will continue to absorb moisture after they have changed color. Generally, the silica will protect 57 cubic feet (for the Silica Can) and 33 cubic feet (for the Silica Bag) for about 3 to 6 months in normal conditions before recharging is required. Simply use an oven and the instructions on the package to recharge the Silica Gel.



Fully Recharged

Needs Recharging

EXTERNAL 10" HANGER - #222454 Case Pack of 4

The External 10" Hanger is the perfect solution for adding storage capacity to the outside of your gun vault. It works great for hanging empty gun cases, holster belts, cleaning rods or other miscellaneous items. It mounts securely to the outside of any vault with high strength vinyl coated magnets that completely protect the vault finish from scratches. Four separate hooks can securely hold up to 30 pounds total. At 10" in width most vaults can accommodate multiple hangers for even more storage capacity. Heavy Duty powder-coated steel construction provides maximum durability.

- Perfect for adding storage to the exterior of a vault
- Organizes miscellaneous items that don't fit inside the vault
- Holds up to 30 pounds
- Integrated vinyl coated magnets for no-hassle installation



External 10" Hanger clamshell package:
10.75" wide x 9.75" high x 1.5" deep

MAGNETIC BARREL REST - #222177 Case Pack of 4

Accessing a gun deep in the back of a vault can be challenging. Rather than juggling an armful of long guns, deploy the Lockdown Magnetic Barrel Rest. It conveniently secures to the outside of any vault and provides a perfect staging location. Overmolded contact points protect your gun's finish.

- Serves as an extra hand when moving guns in and out of vault
- Holds 3 guns securely when leaned against vault
- Overmolded rubber contact points to protect firearm finish
- Secures to vault with strong magnets
- Rubber-backed magnets protect vault's finish



Product dimensions: 10.25" w x 3" h x 3" d

Clamshell package:
11.5" wide x 7" high
x 3.625" deep





Large Hanging Organizer

Handgun Hanger

Small Hanging Organizer

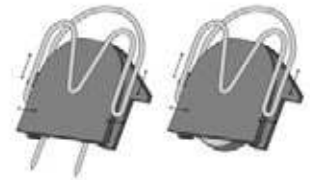

The Universal Attachment System varies slightly for use on the fabric hanging organizers. All hanging accessories still come with both Vampire Clip style inserts for use with carpeted interior vaults as well as High-Strength Magnet inserts for bare metal interiors. For fabric hanging organizers, the vampire clips and magnets feature a bent wire that captures the attachment device and provides two U-shaped bends that tuck into the fabric band that is sewn onto the back of the organizer. The interchangeable inserts can quickly be removed and installed for any particular application.



LARGE HANGING ORGANIZER

#222168 Case Pack of 5

The Large Hanging Organizer is perfect for organizing all the loose items that tend to clutter the shelves of a vault. With a variety of pocket sizes and configurations, it will easily hold handguns, knives, electronics, jewelry or a just about any other small valuables. The three larger pockets feature zippers that can be opened to allow a handgun barrel to protrude through or closed to contain smaller items. A rigid back panel adds support to the organizer. Mesh pockets make it easy to see contents

- Secure & organize small valuables, handguns, knives, etc.
- Universal Attachment System includes hooks for carpeted interiors & magnets for metal interiors
- Mounts to inside of vault door
- 6 pockets with elastic band and durable mesh fabric



Large Hanging Organizer dimensions:
19.75" w x 12" h x .75" d

Clamshell package:
8.5" wide x 14.5" high
x 1.875" deep

HANDGUN HANGER

#222172 Case Pack of 5

This universal Handgun Hanger will hold a variety of pistols or revolvers. The wedge shape with open bottom allows the barrel to protrude through. Elastic bands and a rigid back panel provide the structure to hold guns securely in place.

- Universal Attachment System includes hooks for carpeted interiors & magnets for metal interiors
- Mounts to inside of vault door & holds handgun securely
- Fits most compact, medium-frame & large-frame handguns

Handgun Hanger dimensions:
8.6" w x 5" h x .75" d



Clamshell package:
7.125" wide x 7" high
x 1.125" deep

Fits most handguns from compact to large-frame



SMALL HANGING ORGANIZER

#222170 Case Pack of 5

The compact size of the Small Hanging Organizer allows it to be easily added to small spaces in any vault. A mesh pocket with elastic band keeps small valuables secure and easy to access. Add multiple Small Hanging Organizers for additional storage.

- Secure and organize a variety of small valuables, personal documentation or even vehicle titles
- Universal Attachment System includes hooks for carpeted interiors & magnets for metal interiors
- Elastic band keeps items secure
- Mesh pocket allows visibility of small items

Small Hanging Organizer dimensions:
8.25" w x 6" h x .75" d

Clamshell package:
8.9375" wide x 8.125" high
x 1.125" deep



Also works for small electronics, large jewelry, treasured sporting event tickets, CD & DVD jewel cases and so much more.

HANGING STORAGE

HANDGUN / AR UPPER HANGER

#222817 Case Pack of 5



Reclaim unused space in your vault or gun cabinet. The AR Upper Hanger is the perfect addition to the door or free hanging space in your vault. Designed specifically to hold multiple AR Upper assemblies, you can now reclaim floor space where a rifle should go. Dual sided configuration can accommodate 1 Upper on one side and 3 handguns on the other.

- Holds up to two spare AR Upper receivers, T/C Encore barrels or shotgun barrels
- Holds up to 6 handguns of any size from subcompact to large revolvers
- Pockets are all Heavy Duty mesh with elastic bands for a secure hold to pistols
- Includes hardware for mounting to carpeted vault door, metal cabinet door, or to be mounted underneath vault shelf

3 different mounting options: Hook screws, wallboard hooks, and Door clips



Handgun/AR Upper Hanger Package:
9" wide x 19" high x 1.5" deep

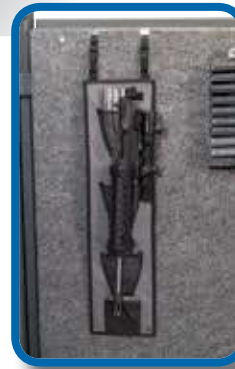

3 hook & loop closures to hang multiple Uppers from on each side

3 mesh pistol hangers per side

Hang freely inside a cabinet and use both sides to store items

Overall dimensions:
8" wide x 30.5" tall

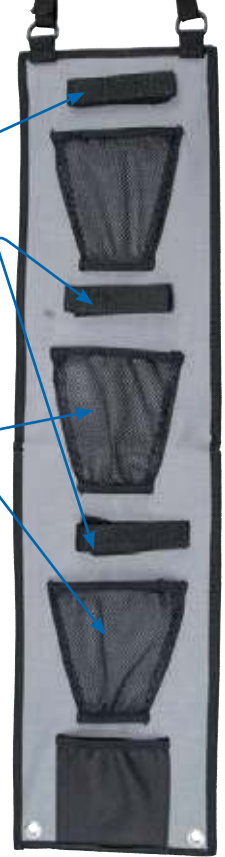

UNIVERSAL VAULT DOOR ORGANIZERS



- Pockets are all 600D polyester with elastic bands for a secure hold to pistols or other items
- Includes hardware for mounting to carpeted vault door or metal cabinet door
- Large holds up to three handguns of any size, from subcompact to large revolvers
- Medium holds up to two handguns of any size, from subcompact to large revolvers
- Both sizes feature additional accessory pockets

Large and Regular Door Hanger Package:
8" wide x 17" high x 1.5" deep



Large Organizer overall dimensions: 20" wide x 12" tall



Regular Organizer overall dimensions:
14" wide x 12" tall

3 different mounting options: Hook screws, wallboard hooks, and door clips

Large Universal Vault Door Organizer - #222315 Case Pack of 5
Regular Universal Vault Door Organizer - #222316 Case Pack of 5



VAULT DRAWER - #222155 Case Pack of 3

Vault space is always a premium! With limited shelf space, try using this Vault Drawer which mounts to the underside of any shelf. It provides 11.5" w x 12" d x 2" h worth of previously unused space. Perfect for a variety of loose valuables and documents. The wire form frame slides over any shelf up to 1" thick. The frame's retaining bar butts up against the tray's molded lip to keep the user from pulling the drawer out too far and spilling its contents.

- Quickly attaches to any vault shelf
- Takes advantage of unused space under shelves
- Organizes jewelry, handguns, small valuables, etc.
- No tools needed to install

Vault Drawer package: 17" wide x 16" high x 3.75" deep

Product dimensions:
14" w x 14" h x 4" d



HANDGUN RACKS

These vinyl-coated metal handgun racks are extremely handy for use in your gun vault or at the shooting range to provide a safe place to rest your handguns. The individual channels are specially designed to cradle the grip and barrel of the gun and are wide enough to accommodate most wide body pistols or magnum revolvers.

- Holds 1, 2, 4, 6, 8 or 12 handguns (pistols and/or revolvers)
- Vinyl coating won't scratch or mar handgun's finish
- Free up room in your gun safe or cabinet
- Use at range to hold handguns while not in use
- Single rack includes fasteners to keep racks securely in place

Single Handgun Rack fits .22 caliber and larger guns



4 Gun dimensions:
9.5" w x 5.25" h x 6.5" d



6 Gun dimensions:
14.25" w x 5.25" h x 6.5" d



4+4 Gun dimensions:
9.5" w x 11.5" h x 6.5" d



6+6 Gun dimensions:
9.5" w x 11.5" h x 6.5" d

STACKABLE HANDGUN RACKS 4+4 & 6+6

- Holds 8 or 12 handguns (pistols and/or revolvers)
- Free up room in your gun vault or cabinet
- Use independently or stacked
- Vinyl coating won't scratch or mar handgun's finish

4+4 Stackable Handgun Rack - #222504 Case Pack of 6
6+6 Stackable Handgun Rack - #222514 Case Pack of 6

AR MAGAZINE RACK - #222972 Case Pack of 4

- Robust steel frame can hold 10 fully loaded 30 round magazines
- Vinyl coated to protect magazines from scratching and marring
- Compatible with all in-line mags from 10 round up to 30 round
- Organize and free up room in your vault or gun room
- Holds up to ten, AR-15 magazines
- Free-standing or wall mountable

Mag Rack can be set on a shelf or nested and hung on a peg for display!

Mag Rack Package:
4.25" wide x 16" high x 5.5 deep



NEW
2015



LOCKDOWN
VAULT ACCESSORIES

Front support adjustable for height

Three independent supports move the length of the vise on extruded aluminum track

Separate cam blocks move independently to accommodate any stock shape

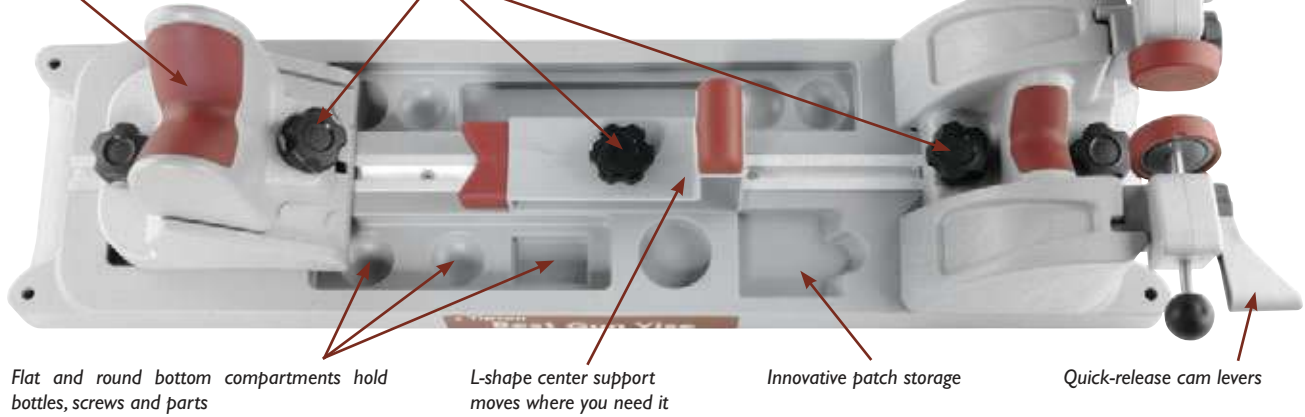

Flat and round bottom compartments hold bottles, screws and parts

L-shape center support moves where you need it

Innovative patch storage

Quick-release cam levers

BEST GUN VISE™ - #181181 Case Pack of 4

Tipton's Best Gun Vise is the Best tool you can own for working on your guns. The vise was designed to accommodate the widest possible array of firearms for cleaning, maintenance, or gunsmithing, and is easily configurable to handle bolt-action rifles, break-open shotguns, AR-15's, and handguns. A central aluminum channel lets the user move individual components to the ideal position for their firearm. Each individual component then adjusts to the perfect position for secure support. The rear base features two adjustable offset clamps for a tight grip on a wide range of buttstock configurations. The Best Gun Vise is extremely stiff and is made from a high-quality, solvent-resistant polymer material that will stand up to years of hard use.



Exposes the breech on any break-open shotgun for easy cleaning or inspection



Holds hinged-receiver rifles open to gain access to bore, receiver and fire control components.



Versatile clamp and support system accommodates pistols and revolvers

- Non-marring contact surfaces
- Every component adjusts to accommodate different firearms and projects
- Stiff, solvent-resistant polymer stands up to years of hard use
- Innovative, off-set clamping mechanism on rear base

Best Gun Vise package:
36" wide x 12" high x 8" deep

PATENT:
www.BTibrands.com/patents/



**CHECK OUT
THE 1911
MAG WELL
VISE BLOCK
ON PAGE 86!**



COMPACT RANGE VISE - #282282 Case Pack of 6

The Tipton Compact Range Vise offers a completely new level of performance, securely holding the widest array of guns possible while collapsing to fit in a range bag. The compact design is a convenient solution to gun cleaning at the range. The Compact Range Vise collapses to 11-1/4" and fully expands to 17-3/4", making it easily carried but full functioning when completely expanded. Six rubber feet provide the vise a very rigid, non-slip base. Two non-marring forks protect your guns' finish while holding them securely in place for cleaning, light maintenance or as an extra set of hands. The Compact Range Vise is extremely durable and is made from high-quality, solvent-resistant nylon that will deliver years of lasting performance. Serious shooters know keeping their guns clean is essential to performance, making the Compact Range Vise the perfect range accessory.

- Solvent-resistant nylon delivers lasting performance
- Adapts to securely hold all types of firearms
- Expands from 11-1/4" to 17-3/4"
- Non-marring contact surfaces

**NEW
2015**



Compact Range Vise package:
13.5" wide x 10.5" high x 7.5" deep



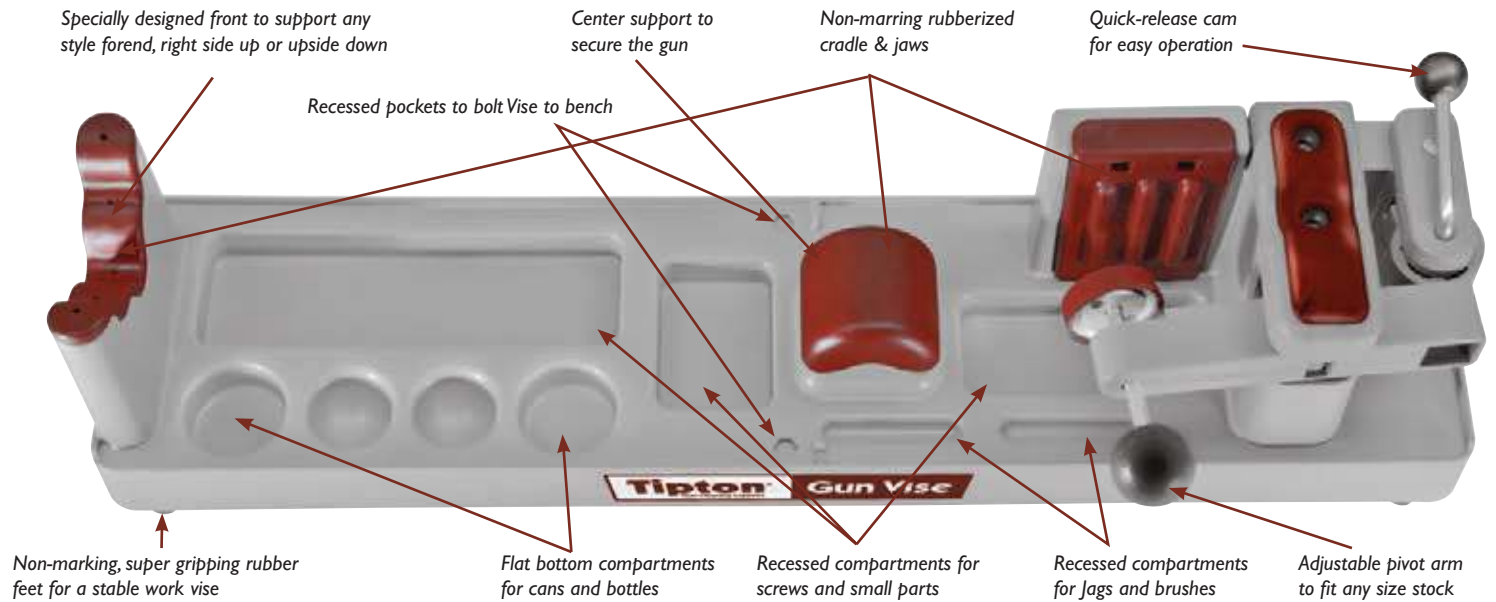

GUN VISE™ - #782731 Case Pack of 3

Secure your rifle or shotgun for just about any work you want to perform on it. The Tipton Gun Vise is an ideal "third hand" for cleaning and gunsmithing. It features a rubberized cradle and jaws to protect and grip your gun, a quick-release cam action for easy access, molded-in compartments for solvents and small parts, and is made of tough, solvent-resistant polymers.

Gun Vise Package:
34" wide x 11" high x 9" deep



GUN BUTLER® - #100333 Case Pack of 6

The Gun Butler offers a convenient all-in-one solution to all your cleaning/carrying/storage needs. Two removable non-marring forks (which snap into the base for easy storage) hold the gun securely in place, while thoughtfully-planned compartments and slots hold bore solvent, jags, brushes, mops, a cleaning rod, spray lubricant, and tools. The Gun Butler can store everything a shooter needs to clean a gun – all with a convenient carrying handle for easy transport.

For many hunters and shooters, gun cleaning is enough of a chore without having to keep track of all the tools and supplies it takes to clean a gun properly. Serious shooters who clean on a regular basis, often clean both at the shop and on the range. The Gun Butler offers an affordable, convenient solution for storage and transportation of supplies as well as a secure gun holder for the actual cleaning process.

Gun Butler product:
23.5" wide x 4.25" high x 9.5" deep



We took retail shelf space into mind when designing the new Gun Butler. The nested design allows multiple units to rest on top of each other, taking up 70% less space than a stand-alone product would. How's that for innovation!

This overhead view shows you all the designated cavities for your bore solvents, brushes, screws, cleaning rod, and countless other cleaning station supplies.



Rifle and contents not included.

CLEANING RODS

DELUXE CARBON FIBER CLEANING ROD™

Hang hole for easy storage. Also allows for reasonable hammer blows to clear a stubborn patch.

Two sets of high quality bearings that won't bind under pressure and allows the shaft to follow the rifling.

Comfortable ergonomic shape. Handle remains fixed in your hand while the shaft rotates on the bearings to follow rifling.

Shank-through construction for working tight patches.

Carbon fiber shaft won't embed particles that could damage your rifle bore.

DELUXE CARBON FIBER CLEANING ROD

Carbon fiber is well-suited to the tough tasks assigned to cleaning rods. It combines the best features of stainless steel and coated cleaning rods, then adds valuable properties of its own. Stainless steel rods can scratch or wear barrels if they're used carelessly - though they won't pick up potentially damaging small abrasive particles. "Coated" rods get part of the job done - they keep the stainless steel shaft from damaging your barrel's rifling, but the coating will pick up small abrasive particles, which means you're effectively running fine-grit sandpaper through your bore. Carbon fiber rods are the best of both: the carbon fiber can't scratch your bore like stainless steel, and they won't embed like coated rods. Plus, Carbon Fiber rods can be bent to an extreme degree and return to their original straightness. During Operation Iraqi Freedom, US military armorers called on Tipton to provide cleaning rods that would clean service rifles in demanding conditions. It made sense to us: Carbon fiber is an ideal material for cleaning rods. We call these cleaning rods "deluxe" because they feature an ergonomically designed handle that spins on two sets of ball bearings - the result is a cleaning rod that smoothly follows the rifling both pushing and pulling, even while under pressure. The "shank-through" construction also allows the user to apply "reasonable" hammer blows to the end of the cleaning rod to get a tight patch through a bore. Available in four diameters and six lengths to fit most rifles, pistols, and shotguns. Rifle and handgun rods are threaded for 8-32 accessories, except 17 caliber and 20 caliber rods which are threaded 5-40. Shotgun rods are threaded 5/16"-27.



Retail Packaging for Deluxe Carbon Fiber Cleaning Rod

	Case Pack of 4			Case Pack of 1			
	12"	26"	36"	40"	44"	50"	62"
17 Caliber (dia. .158")		#146468R	#107486R				
20 Caliber (dia. .189")				#175401R			
22 - 26 Caliber (dia. .208")	#658675R	#216411R	#430886R	#182978R	#783485R		
27 - 45 Caliber (dia. .250")	#303569R	#376252R	#720747R	#413662R	#509320R	#751235R	
40+ Caliber (dia. .375")			#654574R		#189446R		
50 BMG (dia. .375")							#157379*
Shotgun (dia. .375")			#713415R				

*This product not available in Retail Packaging. ONLY available in cardboard tube.

MAX FORCE™ CLEANING ROD

Tired of bending or breaking your small diameter cleaning rods? The answer is here: Tipton's MAX Force Cleaning Rod. Tipton has created a cleaning rod with a patent pending sliding handle. Now you can put the force you need right next to the bottle neck section you need it applied to. The sliding handle still allows the rod to rotate freely even while clamped down. Available in 2 multi-caliber sizes.

- Allows you to quickly and easily position handle at any point along the rod with just the press of your thumb. This allows Maximum Force to be applied without fear of bending or breaking cleaning rod
- Patent Pending clamp mechanism instantly clamps handle to rod at any location and still allows the rod to spin freely on ball bearings
- 40" usable rod length coupled with the adjustable handle allows cleaning of small pistols all the way up to long-barreled magnum rifles
- Ergonomic handle positions your hand for maximum force on the cleaning rod
- Highly durable design is lightweight and fully solvent-resistant
- Two versions: 17/20 Caliber (w/ 5-40 threads) and 22-45 Caliber (w/ 8-32 threads)



Apply force where you need it. Just slide the handle forward or backward.

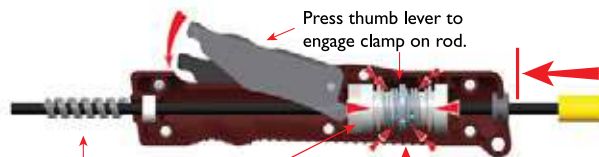
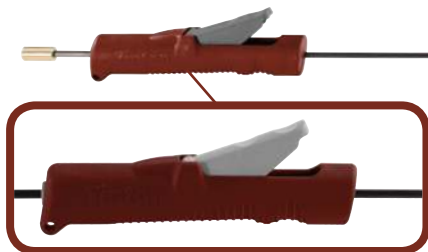

Ball bearings in clamp allow rod to rotate freely even when clamp is engaged.

Innovative clamp design engages, holding rod and handle securely



PATENT:
www.BTibrands.com/patents/

.17-.20 Cal. MAX Force Rod - #658540
.22-.45 Cal. MAX Force Rod - #658539

Case Pack of 4
Case Pack of 4

ULTRA CLEANING KIT - #554400 Case Pack of 2

The Tipton Ultra Cleaning Kit was designed for the shooter who wants the absolute highest quality cleaning accessories available in one convenient portable kit. The heart of the kit is a Premium 3 piece Stainless Steel Cleaning Rod with multi-bearing handle. The .205 dia, 40" usable length rod is constructed of 17-4 PH stainless to be extremely durable and resist taking a bend (the problem that plagues most multi section rods). The kit features Tipton's 13 pc. Ultra Jag Set and 13 pc. Best Bore Brush which both deliver industry leading performance. Also included is Tipton's innovative RAPID Deluxe Bore Guide Set, which enhances the ability to clean any rifle. A variety of picks and cleaning brushes round out the assortment in the kit. All components are neatly contained in the molded plastic case with custom die cut foam for organization. For use with .22 cal and larger rifles.

- Highest quality cleaning kit available
- Contains
 - 3 piece rod constructed of extremely high strength 17-4 PH Stainless Steel
 - RAPID Deluxe Bore Guide
 - 13 piece Ultra Jag Set with case
 - 13 piece Best Bore Brush Set with case
 - Two general purpose brushes, 1 nylon, 1 bronze
 - AR-15 bolt carrier and action brushes
 - 4 polymer cleaning picks
- Customized case with die cut closed cell foam with room to hold liquids, patches and other accessories
- Easy to transport

For use with .22 cal and larger rifles



Ultra Cleaning Kit package:
16.85" wide x 10.5" high x 3.25" deep



PREMIUM STAINLESS STEEL 3 PIECE CLEANING ROD - #429954 Case Pack of 5

The Tipton Premium 3 Piece Cleaning Rod was designed to be the highest quality most durable multi-section cleaning rod on the market. The 17-4 PH Stainless construction has extremely high yield strength which allows it to flex without permanently deforming like other multi-section rods. It is precision surface-ground for a perfectly smooth surface that will not scratch or mar rifle chambers or bores. The ergonomic handle has a shank-through construction with two bearing sets that provide ultra-smooth rotation even under pressure. The .205" diameter is ideal for any caliber .22 or larger. Compatible with standard 8-32 thread accessory tips.

- .22 Cal and up (.205" diameter)
- Constructed of extremely high-yield strength 17-4 PH Stainless Steel
- Convenient 3-pc. design packs down to 16" length
- High-polish precision-ground surface
- 40" usable length



3 Piece Rod Package:
17.5" long x 1.8" diameter

Get one for your Range Bag!



17-4 Precipitation Hardened Stainless is much stronger than typical stainless steel rods.



CLEANING ACCESSORIES

RAPID[™] Deluxe Bore Guide Kit



Demonstration shown of the RAPID in action, as well as the bore guide and RAPID inserted into a bolt action rifle.

RAPID[™] DELUXE BORE GUIDE KIT - #777999 Case Pack of 4

The Tipton RAPID Deluxe Bore Guide Kit contains several great tools that ensure the safest, easiest, and most effective cleaning possible.

RAPID allows you to easily align and secure a patch for solvent application, then holds it with the correct amount of tension for perfect jag penetration. When the rod is pushed into the RAPID, it automatically releases the patch. It also keeps harmful solvents off your gun's finish in the process.

A bore guide will help protect the bore and action of your rifle by properly aligning the cleaning rod and reducing solvent overflow. Cleaning without a bore guide can allow the rod to "bow" and rub or gouge the chamber and throat of the bore causing real damage and loss of accuracy. Keeping the rod properly aligned not only protects your barrel, it properly directs the force exerted on the cleaning rod handle, allowing tight patches to be pushed safer and easier. (Will not fit .22 Rimfire)

- Features new RAPID patch insertion device that aligns and holds patch in place
- RAPID cuts cleaning time and reduces solvent mess
- Reduces solvent leakage into gun's action
- Ensures proper rod alignment for easier cleaning
- Bore guides protect chamber & bore from damage
- Anodized aluminum tube for durability
- Integrated solvent port
- Kit includes 4 muzzle guides
- Inserts & secures into the bolt position
- Fits most bolt action rifles & AR-15s
- Convenient storage case included

RAPID Deluxe Bore Guide Kit package:
7" wide x 17.25" high x 3" deep

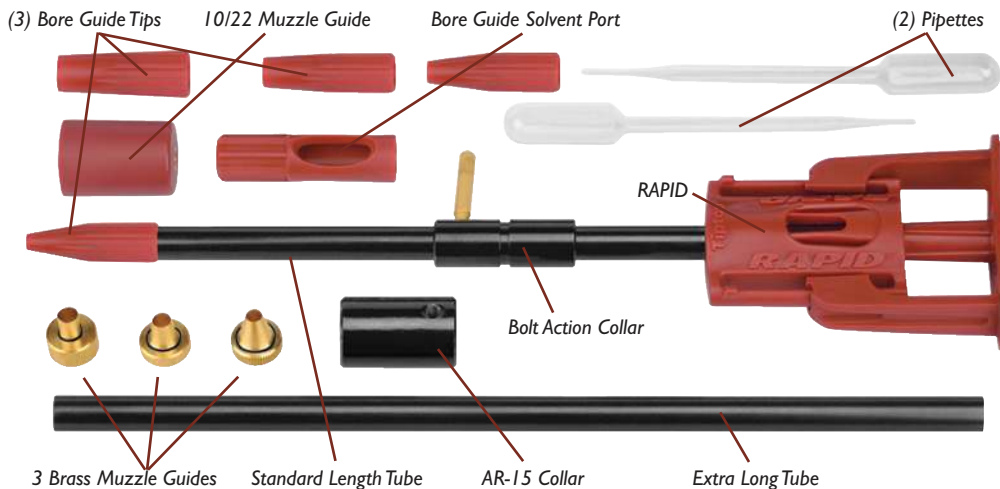

1. With the sliding rear guide pulled out, center the patch with access hole



2. Push the sliding rear guide forward, securing the patch



3. Use the built-in solvent port to apply solvent to the cleaning patch



4. Insert cleaning rod with jag, penetrating patch and releasing it

CLEANING ACCESSORIES

UNIVERSAL BORE GUIDE KIT - #777888 Case Pack of 4

The Tipton universal bore guide will help protect the bore and action of your rifle by properly aligning the cleaning rod and reducing solvent overflow. Cleaning without a bore guide can allow the rod to "bow" and rub or gouge the chamber and throat of the bore, causing real damage and loss of accuracy. Keeping the rod properly aligned not only protects your barrel, it directs the force exerted on the cleaning rod handle allowing tight patches to be pushed more easily.

- Protects chamber & bore from damage
- Ensures proper rod alignment for easier cleaning
- Reduces solvent leakage into gun's action
- Anodized aluminum tube for durability
- Integrated solvent port
- Fits most bolt action rifles & AR-15s
- Inserts & secures into the bolt position

Universal Bore Guide Kit package:
4.75" wide x 16.5" high x 1.5" deep

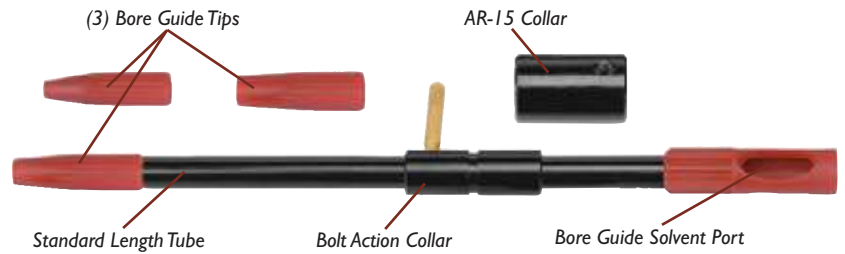

PATCH TRAP™ - #777890 Case Pack of 4

The Patch Trap safely captures solvent splatter, drips and dirty patches. When you're finished cleaning the barrel, simply discard the used water bottle in a safe location. It is constructed of a solvent resistant material and uses a durable rubber strap to secure it in position. The Patch Trap makes cleaning quicker and eliminates the mess.

Its simple to use:

- 1) Attach the patch trap to the muzzle of any gun
- 2) Screw an empty water or soda bottle into the threaded end
- 3) Dirty patches and solvent are safely and cleanly contained
- 4) Dispose of used bottle

Patch Trap package:
8" wide x 10.75" high x 4" deep



Patch Trap

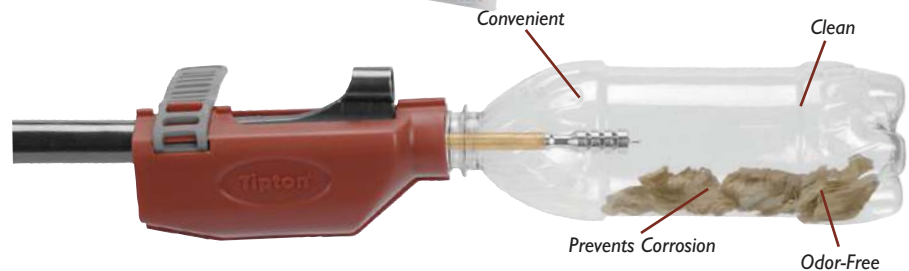

ROD RACK - #100335 Case Pack of 4

Want to organize and keep all your cleaning rods handy? The Tipton Cleaning Rod Rack will hold a wide variety of cleaning rods in various shapes and sizes. Accommodates up to six rods with hanging hooks on either end for additional accessories. The Rod Rack even has molded in bumpers designed for securing T-handle rods. Constructed of a durable molded material. Mounting holes and screws included.

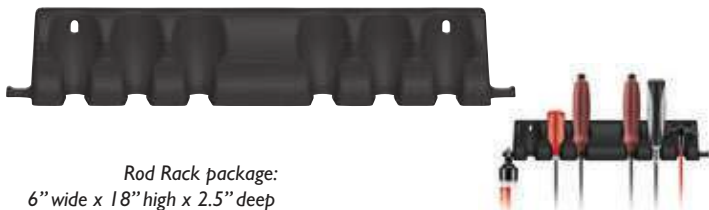

Rod Rack package:
6" wide x 18" high x 2.5" deep

RANGE BOX - #458509 Case Pack of 1 with Empty Cleaning Kit

The Tipton Range Box is the ultimate in convenience for shooters and hunters. It organizes everything you need, cleaning supplies, rifle rest bags, targets and more. It is available with an empty cleaning kit box.

- Removable cleaning kit
- Compartmentalized storage spaces
- Rubberized forks to hold most firearms
- Solvent resistant polymer construction

Range Box Package:
21" wide x 11" high x 10" deep



TRULY REMARKABLE BORE SOLVENT™ #746275 Case Pack of 6

The Tipton Truly Remarkable Bore Solvent is the most aggressive bore solvent currently available. By combining today's advanced chemicals we have developed a bore solvent that quickly works to remove all types of stubborn fouling from your barrel, yet it remains gentle on your bore. You'll be sure to enjoy less time cleaning and more time shooting with the amazingly fast cleaning action of this revolutionary solvent. In fact, this solvent is so good, it is a winner of the prestigious Blue-Patch test!



ULTRA JAGS

What Is Behind Ultra Technology?

Take a modern bore solvent and squirt it on a brass cleaning jag. The liquid will turn blue as it drips off the jag - it's working so fast, it starts to dissolve your cleaning jag in front of your eyes! If you're following conventional wisdom "clean until you get a clear patch" you might be in for a long night. Tipton's Ultra Jags feature a patent-pending technology that covers the surface of a traditional push-type jag with solvent-proof material, keeping aggressive modern bore solvents from creating false blue stains that normally indicate copper fouling. Before Ultra Jags, these false blue stains caused users to over-clean their barrels - and that's been demonstrated to destroy accuracy over time. When you use Ultra Jags, you'll get better, faster cleaning results because you'll know you're getting blue stains from copper fouling from your barrel and not from the surface of your jag. In addition, you will increase the life of your jag by protecting the jag's brass core from the aggressive modern solvents with the nickel-plated coating.

Ultra Jag™

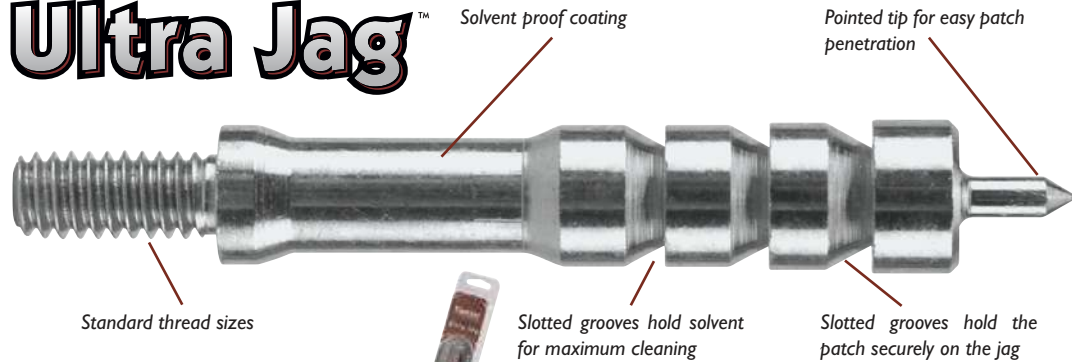

17 Caliber	#175543
20 Caliber	#589546
22 Caliber	#225659
243 / 6mm Caliber	#243865
25 / 6.5mm Caliber	#255684
270 / 7mm Caliber	#277555
30 / 32 Caliber	#303033
338 / 8mm Caliber	#338338
35 / 9mm Caliber	#348359
375 Caliber	#375375
40 / 416 Caliber	#404169
44 Caliber	#444444
45 Caliber	#454545

ULTRA JAGS™

Case Pack of 5



Single Ultra Jag clamshell package: 2" wide x 7" high x 0.75" deep

PATENT:
www.BTibrands.com/patents/

We believe that the Tipton Ultra Jags are the finest jags ever offered. They use an innovative technology of nickel plating to satisfy the shooter who wants the best tools to maintain his or her guns. The nickel plating will not scratch or in any way harm the finest bore. This solvent-proof material makes this the ultimate jag and the only way to truly get an accurate reading of how clean your bore really is.



13 PIECE ULTRA JAG™ SET

#500012 Case Pack of 6

Conveniently packaged 13 piece caliber-specific set of Ultra Jags means you always have the right jag at hand. Contained in a durable, hinged box with marked cavities, it's easy to select the correct Ultra Jag for your particular application. Because they are caliber-specific, you can be assured of an optimum fit to your firearm's bore for efficient and thorough cleaning. 17 to 45 caliber. All jags have 8-32 threads (17 and 20 caliber have 5-40 threads).



The Ultra Jag shows no sign of copper blueing, even after soaking in bore solvent overnight.



It's apparent that brass jags ultimately contribute to false blueing on your cleaning patches.

THE BEST OF BOTH WORLDS

Ultra Jag™ + Best Bore Brush™

26 PIECE ULTRA JAG & BEST BORE BRUSH SET

Combining the Ultra Jags and Best Bore Brushes into one convenient 26 piece set gives you the ultimate storage system for your brushes and jags. Neatly organized in two mating hinged boxes with marked cavities, it's easy to select the correct jag and brush for your particular application. Because they are caliber-specific, you can be assured of an optimum fit to your firearm's bore for efficient and thorough cleaning. 17 to 45 caliber. All jags and brushes have 8-32 threads (17 & 20 caliber have 5-40 threads and is a standard bore brushes). Case Pack of 6.

26 pc. Ultra Jag & Best Bore Brush Set - #444777



13 Piece Ultra Jag clamshell package: 6.5" wide x 5.5" high x 1" deep

Best Bore Brush™

BEST BORE BRUSHES



Single Best Bore Brush clamshell package:
2" wide x 7" high x 1.75" deep



All components are non-marring

20% more bristles than standard brushes

Wire-through coupler for maximum strength

BEST BORE BRUSHES™ Case Pack of 5

We believe that the Tipton Best Bore Brushes are the finest brushes ever offered. They meet or exceed military specifications and are designed to satisfy the shooter who wants the best tools to maintain his or her guns. The components of Tipton Best Bore Brushes will not scratch or in any way harm the finest bore. The core is a single piece of brass wire that passes through the threaded brass coupler, guaranteeing that the core will never separate from the coupler in the barrel. Bristles are made from high-quality bronze, which is much softer than barrel steel but more than aggressive enough to scour away lead fouling, copper fouling, and powder residue. Each brush contains the maximum number of bristles that can be inserted for the caliber. 20% more than standard brushes! You will feel the difference. Because of their density we recommend that Tipton Best Bore Brushes only be used with a quality one-piece rod and an appropriate bore guide.

	3 pack	10 pack
17 Caliber	#212009	
20 Caliber	#669638	
22 Caliber	#140337#882927
243 / 6mm Caliber	#758284	
25 / 6.5mm Caliber	#657930	
270 / 7mm Caliber	#622858	
30 / 32 Caliber	#868556#634045
338 / 8mm Caliber	#427343	
35 / 9mm Caliber	#606367	
375 Caliber	#127759	
40 / 416 Caliber	#317183	
44 Caliber	#629958	
45 Caliber	#211233	
50 BMG Caliber	#561865	



13 PIECE BEST BORE BRUSH™ RIFLE SET - #402173 Case Pack of 6

Conveniently packaged 13 piece caliber-specific set of Best Bore Brushes means you always have the right brush at hand. Contained in a durable, hinged box with marked cavities, it's easy to select the correct Best Bore Brush for your particular application. Because they are caliber-specific, you can be assured of an optimum fit to your firearm's bore for efficient and thorough cleaning. 17 to 45 caliber. All brushes have 8-32 threads (17 and 20 caliber have 5-40 threads and are standard bore brushes.) See page 84 for the complete line of bronze and nylon Tipton Bore Brush Sets for handguns, rifles and shotguns.

ALL IN ONE CONVENIENT KIT



13 Piece Best Bore Brush clamshell package:
7.5" wide x 7" high x 1" deep

Jag and Brush cases can be snapped together or used separately.



26 pc. Ultra Jag / Best Bore Brush clamshell package: 7.5" wide x 8.5" high x 2" deep



INDIVIDUAL SOLID BRASS JAGS

Case Pack of 5

17 Caliber (5-40 threads)	#154070	338 / 8mm Caliber	#485467
20 Caliber (5-40 threads)	#589555	35 / 9mm Caliber	#434832
22 Caliber	#356987	375 Caliber	#272744
243 / 6mm Caliber	#696435	40 / 416 Caliber	#412599
25 / 6.5mm Caliber	#584696	44 Caliber	#301110
270 / 7mm Caliber	#768059	45 Caliber	#239013
30 / 32 Caliber	#193225	50 Caliber	#505050

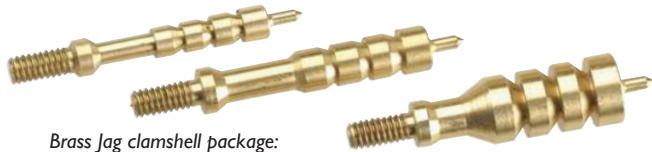

Brass Jag clamshell package:
2" wide x 7" high x 1.75" deep



13 Piece Jag clamshell package:
6.5" wide x 5.5" high x 1" deep

13 PIECE JAG SET - #749245

Case Pack of 6

These 13 solid brass cleaning jags are the fastest way to thoroughly clean, dry, or oil the bore. Each jag is designed to provide a tight fit between the patch and the bore. A pointed tip keeps the patch centered and allows it to drop off when the jag exits the muzzle. Made with 8-32 threads (17 and 20 caliber have 5-40 threads), they will fit most brands of cleaning rods, and should provide years of service.

Kit includes 17, 20, 22, 243/6mm, 25/6.5mm, 270/7mm, 30, 338/8mm, 35/9mm, 375, 40, 44 and 45 jags. Convenient storage box features marked cavities for each caliber.

INDIVIDUAL SOLID BRASS SLOTTED TIPS

Case Pack of 5

For flooding the barrel with solvent or wiping the bore with oil or preservatives, nothing beats a patch in a Slotted Tip. Tipton offers an assortment of four caliber range specific rifle/pistol tips for your convenience, or they can be purchased separately. Solid brass is softer than barrel steel so there is no worry of damaging your bore, plus they will last much longer than the typical synthetic plastic tips. Rifle/Pistol Tips are threaded 8-32 and the Shotgun Tip 5/16"-27.

Slotted Tip clamshell package:
2 wide x 7" high x 1.75" deep



Rifle/Pistol Set of 4 . . .	#554428
22 - 29 Caliber	#428953
30 - 35 Caliber	#211422
35 - 44 Caliber	#777753
45+ Caliber	#400385
Universal Shotgun	#339005

CLEANING PATCHES

Case Pack of 5



100% Cotton Flannel Patches, precisely cut to the correct size for use with Tipton Jags. When used with slotted tip, choose the next size larger for optimum performance.

Description

Qty.

17-22 Caliber, .75" Square	100	#476217
17-22 Caliber, .75" Square	1000	#652376
22-270 Caliber, 1.13" Square	100	#359811
22-270 Caliber, 1.13" Square	1000	#618061
27-35 Caliber, 1.75" Square	100	#444068
27-35 Caliber, 1.75" Square	1000	#279375
35-50 Caliber/20 Gauge, 2.25" Square	100	#192431
35-50 Caliber/20 Gauge, 2.25" Square	500	#364206
10, 12, 16 Gauge, 3" Square	500	#470796
45-58 Caliber Black Powder, 2.50" Round	250	#784909

ACTION / CHAMBER CLEANING TOOL SET

These tools are made specifically for those hard to reach areas inside the receiver of your bolt action rifle. The action cleaning tool utilizes cylindrical swabs to clean and lubricate the locking lug recesses. The chamber cleaning tool uses a mop to remove carbon and powder residue that is often left in the chamber during conventional bore cleaning. Includes both tools, a small and a large rifle chamber mop, 10 swabs, and a nylon cleaning brush.

Action / Chamber Cleaning Tool Set - #368628 Case Pack of 12
Replacement Swabs, Pack of 100 - #115373 Case Pack of 12



Cleaning Tool Set clamshell package:
5.75" wide x 16.5" high x 1" deep

CLEANING SUPPLIES

1911 MAG WELL VISE BLOCK - #558080 Case Pack of 4

The Tipton 1911 Mag Well Vise Block is quite possibly the handiest tool a 1911 owner could ask for. Designed for use with the Tipton® Best Gun Vise™, this center support slides into the magazine well and provides a steady base for cleaning or light gunsmithing on your 1911. Users without a Best Gun Vise can mount the Mag Well Vise Block directly to their bench top with the included fasteners. Loaded with handy features, this tool is a must-have for anyone with a 1911.

- Designed for use with Tipton® Best Gun Vise™, mounts to center rail with included fasteners
- Center section rotates 180° (in 15° increments) and locks into place at desired location
- Mag well arm is removable for clamping in a bench vise when additional rigidity is required
- Solvent-resistant polymer provides durability and is non-marring to surfaces
- Also designed to mount to your bench top, with the included fasteners
- Supports 1911 for cleaning & light gunsmithing operations
- Locks into place using magazine lock on your receiver
- Built-in barrel bushing wrench



Built in barrel bushing wrench makes removal easy.

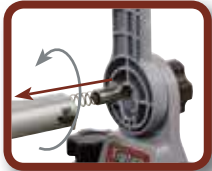

Insert, push, rotate, extract. It's that easy.



Center section rotates 180° making in infinitely adjustable

Shown on the Best Gun Vise



A MUST HAVE for M1911 maintenance

1911 Mag Well Vise Block Package: 8" wide x 13" high x 2.5" deep



SNAP CAPS

It is generally accepted that one shouldn't drop the firing pin on an empty chamber - which is the primary reason to have Snap Caps for your favorite guns. You should always use Snap Caps when checking or adjusting the trigger pull. If you prefer to release the tension on the hammer springs, when storing your guns, Snap Caps are ideal.

Shotgun	Case Pack of 6
12 Gauge, 2 qty.	#280986
16 Gauge, 2 qty.	#878078
20 Gauge, 2 qty.	#191808
410 Bore, 2 qty.	#358983

Rifle	Case Pack of 6
22 Rimfire Long Rifle, 10 qty.	#831787
22 Rimfire Long Rifle, 25 qty.	#486758
223 Remington, 2 qty.	#415091
243 Winchester, 2 qty.	#270693
270 Winchester, 2 qty.	#709600
308 Winchester, 2 qty.	#134402
30-06 Springfield, 2 qty.	#391320
7.62x39mm Russian, 2 qty.	#787336

Pistol	Case Pack of 6
32 ACP, 5 qty.	#647663
380 ACP, 5 qty.	#337377
9mm Luger, 5 qty.	#303958
40 S&W, 5 qty.	#745435
45 ACP, 5 qty.	#146331

Revolver	Case Pack of 6
38 Special, 357 Magnum, 6 qty.	#321398
44 Magnum, 6 qty.	#347873
45 Colt, 6 qty.	#612637



NEW 2015

MAINTENANCE MATS

1911 Maintenance Mat has an exploded view of a 1911 screen printed on it.

The perfect material to lay on your workbench while cleaning or disassembling firearms. Padded neoprene construction protects firearm finishes while helping keep track of small parts. Excess oils and solvents are absorbed into the mat, keeping the surface clean and dry. The Tipton Maintenance Mat rolls easily to fit in your range box. Hand washable

NEW! 11" x 17" 1911 Maintenance Mat - #558680	Case Pack of 6
12" x 24" Maintenance Mat - #602557	Case Pack of 6
16" x 54" Maintenance Mat - #380861	Case Pack of 6

MAGAZINE CLEANING BRUSH - #557575 Case Pack of 4

- Magazine Takedown Tool easily remove bottom plate from a magazine
- Works on all single and double stack Magazines including AR mags, 1911 mags, and most double stack pistol magazines
- Solvent resistant nylon bristles



Magazine Take Down tool easily removes bottom plate using the detent hole

Magazine Cleaning Brush Package: 3.25" wide x 13.75" high x 1.75" deep

CLEANING SUPPLIES

SILICONE CLOTH

#502260 Case Pack of 6

Protect your fine firearms from corrosive fingerprints and the elements. The soft cloth, impregnated with pure silicone, provides the perfect wipe-down for your guns before putting them away. Protects metal surfaces from rust and corrosion at extreme temperatures, and leaves a shiny, well-preserved appearance. Will not evaporate or dry out. 14" x 15".



6" PIPETTES

12 PACK

#146527 Case Pack of 6

All-plastic, disposable "eye droppers" are just the ticket for measuring and transferring liquid products. Great for cold bluing solutions, cutting oils, solvents, preservatives, etc. Put the product just where you want it.



METAL MAGIC GUN CLOTH

#292640 Case Pack of 6

Non-abrasive metal cleaning cloth designed to remove carbon, lead, and burn marks from stainless and nickel-plated firearms. Use as part of regular maintenance to keep your revolver or pistol looking like new. Handy 6-3/4" x 4" size, in easy-close bag. Caution: continual rubbing can remove conventional bluing and case colors.

GUN BRIGHT - #439502 Case Pack of 6



Scrub off grease, grime, and rust without damaging your firearm. Amazing, all stainless steel pad is tough on rust, but gentle on bluing. Used with a penetrating oil and a gentle touch, the Gun Bright Pad is capable of sweeping away surface rust from your firearms while leaving any remaining original bluing intact.

DOUBLE ENDED CLEANING BRUSHES 3PK.

#654866 Case Pack of 6



Pick Set clamshell package: 4.125" wide x 11" high x 0.5" deep



GUN CLEANING PICKS Case Pack of 6

Here's a clever idea that belongs in every cleaning kit, Gun Cleaning Picks. This set of four picks with different configurations on each end provide eight different combinations to get into those tight, hard to reach places. One set is made of high-strength polymer so they won't scratch the finest surface. The other set is made of stainless steel. Set of four picks.

- Helps you reach the most important, tightest spots in your firearms
- Set of 4 Picks, each has a different shaped tool at each end

Polymer Gun Cleaning Picks set of 4 - #549864

Stainless Steel Gun Cleaning Picks set of 4 - #324770



Clamshell Package: 4.85 wide x 11" high x 0.75" deep



FLIP-TOP SOLVENT BOTTLES 3 PACK

#197624 Case Pack of 6

Set of 3 High Density Polyethylene 4 oz bottles are the perfect size for use on the bench or taking to the range. Hold solvents, oils, and many other liquid products. Each bottle comes with two caps, one Flip-Top, one standard.



SHOOTERS SWABS



Wire-handled swabs are perfect for applications of lubes and preservatives. They also work well with solvents to scrub out recesses in receivers, bolt bodies, and other hard-to-reach areas. Dozens of uses. 4" long.

Shooters Swabs, 50 qty. - #757554 Case Pack of 6

Shooters Swabs, 100 qty. - #350379 Case Pack of 6

CLEAN AND OIL BRUSH

#375777 Case Pack of 5

Fine natural bristle cleaning and oil application brush. Hundreds of soft 1-3/4" bristles, do a great job cleaning and carrying oil and preservatives to the exterior of your guns, and the hard-to-reach areas like under vent ribs.



AR ARMORER'S ESSENTIALS KIT - #156111 Case Pack of 2

The Wheeler Delta Series AR Armorer's Essentials Kit contains all of the essential tools a gunsmith or armorer needs to complete a full rifle build, make repairs or perform normal maintenance on AR-15/M16 platform rifles. Each of these Delta Series tools is designed with application specific features to perform specific functions with precision and ease. Each tool is constructed of the highest quality materials to deliver the best performance at a great value. All of the tools fit inside the durable carry case for convenient storage and transport. This 7 piece Armorer's Kit contains the best tools available and will enhance any user's ability to work on any AR.

Essentials Kit includes:

- AR-15 Combo Tool
- Torque Wrench
- Upper Vise Block Clamp w/ Gas Tube Alignment Tool
- Pivot Pin and Roll Pin Installation Tool
- Mag Well Vise Block
- AR -15 Adjustable Receiver Link
- Custom Fitted Carrying Case



PATENT:
www.BTibrands.com/patents/

AR Armorer's Essentials Kit Package:
21" wide x 7.25" high x 3.5" deep

Work on Carrier Bolts



Pivot Pin Installation



Lower assembly work and
Hammer Stop function



Barrel Nut Alignment and correct Torque

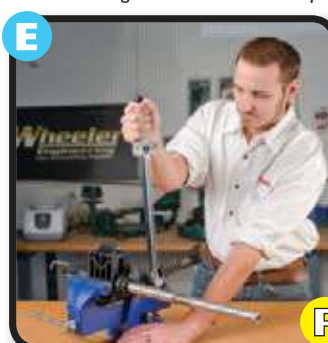

Buffer Tube Wrench



Buttstock nut wrench



Stabilize your upper for cleaning

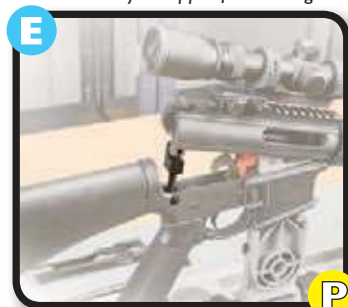

Work on your lower in any position



Roll Pin Installation

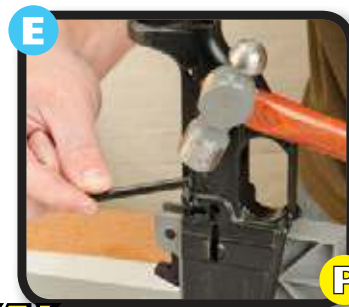

Upper Barrel Nut Assembly



E Available in
Essentials Kit

P Available in
Professional Kit

AR ARMORER'S PROFESSIONAL KIT

#156555 Case Pack of 2

The Wheeler Delta Series AR Armorer's Professional Kit contains all of the tools a gunsmith or armorer needs to complete a full rifle build, make repairs or perform maintenance on AR-15/M16 platform rifles. Each of these Delta Series tools is designed with application specific features to perform specific functions with precision and ease. Each tool is constructed of the highest quality materials to deliver the best performance at a great value. This all-inclusive 19 piece Armorer's Kit has some of the most innovative AR-15 tools on the market today, making it the most advanced kit out there. All of the tools fit inside the durable carry case for convenient storage and transport.



Professional Kit includes:

- AR Armorer's Vise
- AR-15 Combo Tool
- Torque Wrench
- Upper Vise Block Clamp w/ Gas Tube Alignment Tool
- Maintenance Mat with Exploded View AR-15
- Pivot Pin and Roll Pin Installation Tool
- AR Front Sight Tool
- Delta Ring Tool
- Strap Wrench
- AR-15 Bore Guide
- AR -15 Adjustable Receiver Link
- Bore Brush, .22 Cal
- Bolt Carrier Brush
- Chamber Brush
- Magazine/Upper Receiver Brush
- Nylon Brush Handle
- Double-ended General Cleaning Brush
- Cleaning Pick Set
- Custom Fitted Carrying Case

PATENT:
www.BTlbrands.com/patents/



AR Armorer's Professional Kit Package:
22" wide x 10.25" high x 6.75" deep

E Available in Essentials Kit

P Available in Professional Kit

Strap Wrench for forend attachment



Bore Guide & AR Vise for cleaning



Delta Ring Tool



.22 cal. Bore Brush



AR Armorer's Vise



Bore Guide centers cleaning rod in chamber



Chamber Brush



Bolt Carrier & Chamber Neck Brush



AR Maintenance Mat



Wheeler
Engineering



DELTA SERIES

AR ARMORER'S VISE - #156224 Case Pack of 2

The AR-15 platform has become the mainstay of today's Modern Sporting Rifle market. The popularity and modularity of this platform has created the need for specific tools that allow users to build, maintain and reconfigure AR's. The Delta Series Armorer's Vise provides users an ideal foundation for all AR tasks. The integrated mag well insert securely engages the lower receiver and adjusts in angle to accommodate any task. The innovative front support is angle adjustable, allowing the barrel portion of the upper or a forend portion to be secured in its tapered profile. Both front and rear supports have multiple positions in the base and are reversible for maximum customization. The base is constructed of rigid steel with non-slip rubber feet. Feet can be removed for permanent bench-top mounting as well. Depressions formed into the base keep spare parts or tools contained. Additional features in the mag well insert include a hammer stop and a bolt service station that secures the bolt face for disassembly/assembly. The vise works great for assembled guns in closed or break-open state but also is ideal for holding a lower receiver only, for assembly and maintenance. Whether you are building an AR from the ground up or just looking for the ideal cleaning vise, the AR Armorer's Vise is simply the best choice available.

- Highly adjustable to secure any AR in any configuration
- Rigid construction delivers a solid work platform
- Ideal for cleaning, maintenance and gunsmithing

PATENT:
www.BTlbrands.com/patents/



Easily rotate the lower receiver for assembly and other maintenance. The built-in Hammer Block makes lower receiver assembly and "dry fire" simple and safe.



AR Armorer's Vise Package:
21.25" wide x 7.75" high
x 5" deep

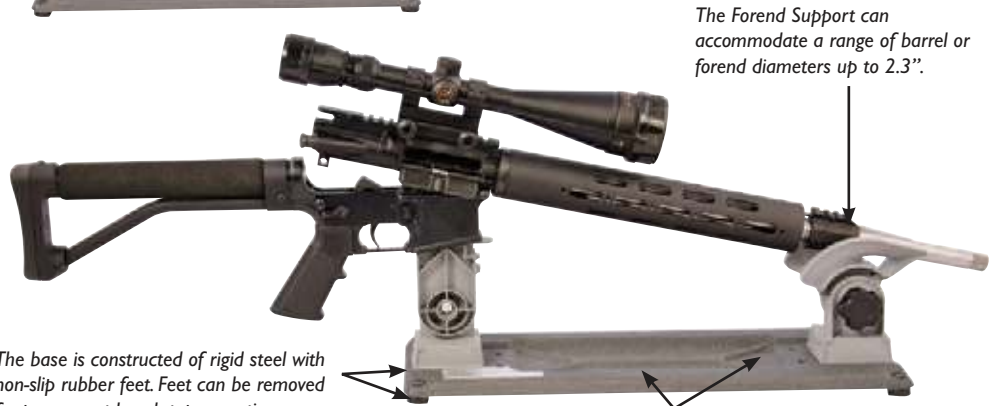

The Forend Support can accommodate a range of barrel or forend diameters up to 2.3".

The base is constructed of rigid steel with non-slip rubber feet. Feet can be removed for permanent bench-top mounting.

Depressions formed into the base keep spare parts or tools contained



Mag well insert includes a hammer stop and a bolt service station that secures the bolt face for disassembly/assembly.

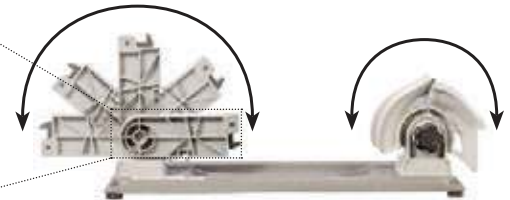

Both front and rear supports have multiple positions in the base and are reversible for maximum customization.

AR ARMORER'S BENCH BLOCK - #156945 Case Pack of 4

Tired of trying to secure your AR parts while installing a pin, detent, or spring? The AR-15 Bench Block is the answer! Specifically designed for AR-15 assembly and disassembly, the AR-15 Bench Block is the perfect tool. Made of extremely durable, non-marring urethane to protect the finish of your firearms and last for years. It features a variety of notches, grooves, and holes on both sides and is ideally suited for the upper receiver, lower receiver, front sight and charging handle of an AR-15.

- Positions the upper receiver, lower receiver, front sight, and charging handle for maintenance or assembly
- Durable non-marring urethane material to protect gun finish
- Designed to assist in all aspects of an AR-15 build
- Ideal for changing or adjusting triggers



Bench Block Package:
6.25 wide x 9" high
x 1.25" deep

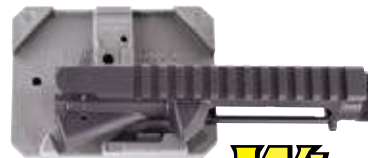
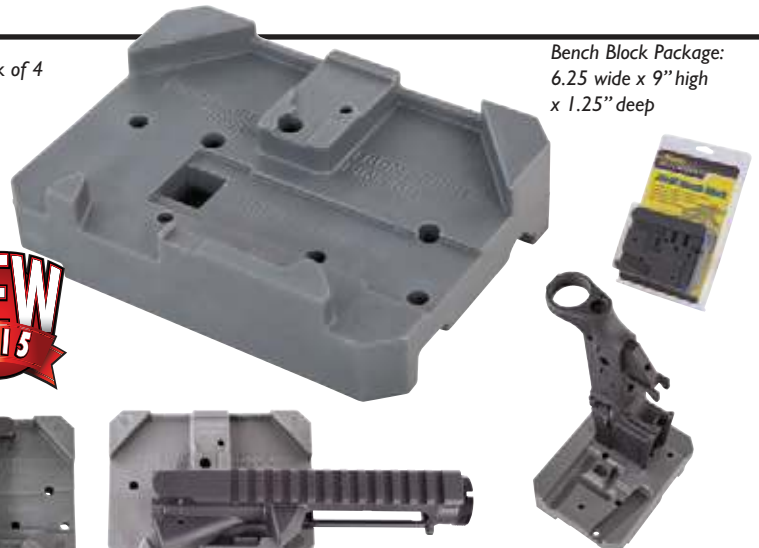

Wheeler
Engineering

DELTA SERIES

AR-15 & LR/308 MAG WELL VISE BLOCK

The Delta Series AR-15 & LR/308 Mag Well Vise Block is quite possibly the handiest tool an AR owner could ask for. Designed for use with the Tipton® Best Gun Vise™, this center support slides into the magazine well and provides a steady base for cleaning or light gunsmithing on your AR, in either breech or closed position. Users without a Best Gun Vise can mount the MagWellVise Block directly to their bench top with the included fasteners. Loaded with handy features, this tool is a must have for anyone with an AR.

- Supports AR-15 for cleaning & light gunsmithing operations
- LR/308 version is compatible with SR25 type lowers:
 - DPMS® LR308 •KAC® SR25 •LWRCI REPR® •LaRue OBR®
 - Bushmaster® .308 ORC® •LMT® .308 MWS •Remington® R-25
 - POR® P-308 •JP Enterprises® LRP-07 •Les Baer® .308 •Colt® LE901-165
 - The *NEW* Armalite® AR-10A
- Designed for use with Tipton® Best Gun Vise™, mounts to center rail with included fasteners
- Also designed to mount to your bench top, with the included fasteners
- Innovative bolt service station locks bolt in for servicing extractor pin
- Locks into place using magazine lock on your receiver
- Built-in hammer stop prevents damage to lower receiver
- Center section rotates 180° (in 15° increments) and locks into place at desired location
- Solvent-resistant polymer provides durability and is non-marring to surfaces
- Mag Well arm is removable for clamping in a vise

AR-15 Mag Well Vise Block - #156211 Case Pack of 4
LR/308 Mag Well Vise Block - #146200 Case Pack of 4

PATENT:
www.BTBrands.com/patents/



AR-15 Mag Well Vise Block clamshell:
 8" wide x 13" high x 2.5" deep
 LR/308 Mag Well Vise Block clamshell:
 8" wide x 13" high x 2.5" deep



AR COMBO TOOL & TORQUE WRENCH

Cover most of your AR-15 service needs with a single tool. An innovative layered and laminated stamped steel construction makes the Delta Series Combo Tool the most durable AR tool available. This construction method allows the use of hardened steel barrel nut pins designed to hold up to heavy torque requirements. A cut out for a 1/2" drive allows the tool to be used with a torque wrench or ratchet driver. Profiles for buffer tube lock nut and 3/4" flash hider are included. The addition of a bit driver and bit holder with six common bits adds to the versatility.

AR Combo Tool - #156999 Case Pack of 4
AR Combo Tool with Torque Wrench - #156700 Case Pack of 4
 Same as above but includes a torque wrench to ensure proper barrel nut torque for maximum accuracy



AR Combo Tool clamshell: 4" wide x 16.5" high x 1.375" deep
 AR Combo Tool with Torque Wrench clamshell: 7.5" wide x 21" high x 2.5" deep



DELTA SERIES

AR-15 UPPER VISE BLOCK CLAMP - #156444 Case Pack of 4

The Delta Series AR-15 Upper Vise Block is optimized for left hand and right hand Mil Spec A2 upper receivers with carry handles, as well as flattop style receivers. Other AR-15 variants may be adapted with special attention to potentially non-conforming surfaces or features. The Block allows you to safely clamp on to your AR-15 upper receiver in a vise holding it securely without twisting, crushing or marring the finish. This Block is the perfect product for torquing a barrel on, removing a stubborn barrel nut or for simple gun maintenance and cleaning. It is made of a high-pressure, solvent-resistant polymer material which can withstand almost anything you can throw at it. The Delta Series AR-15 Upper Vise Block truly is the all-around product for your AR-15 gunsmithing, maintenance or cleaning needs. As an added bonus it includes a receiver insert with a gas tube alignment system, making sure your gas tube is always in line when installing a barrel and torquing a barrel nut.



- Durable design holds receiver securely
- Fits left and right-hand Mil Spec A2 upper, as well as flat top receivers
- Receiver insert with gas tube aligner included

Does NOT work with left handed Uppers that have a dust cover that flips upward

AR-15 Upper Vise Block Clamp clamshell:
7" wide x 15" high x 2" deep



AR PIVOT & ROLL PIN INSTALL TOOL - #156243 Case Pack of 4

- For the AR-15, M4 or M-16
- Makes pivot spring and detent work fast and effortless
- Roll Pin Punch and starter for all lower receiver roll pins
- Comes with handy key ring for storage
- Black electro-coated steel

AR Pivot Pin Install Tool Package:
5.25" wide x 4" high x 1.5" deep



AR-15 FREE-FLOATING HANDGUARD TOOL - #567839 Case Pack of 4

The Wheeler Delta Series AR-15 Free-Floating Handguard Tool was designed with an ergonomic handle and a durable nylon reinforced rubber strap that fits around handguards of any shape. The strap is easily adjustable to tighten, loosen or hold handguards in place without marring or scratching the surface. The handle also features rubberized grips for easy handling no matter what the situation.

- Durable nylon reinforced 24" x 3/4" rubber strap
- Won't mar or scratch surfaces
- Rubberized no-slip grips
- Ergonomic handle
- Easily adjustable



AR-15 Free-Floating Handguard Tool Package:
4" wide x 15" high x 1.5" deep



Perfect Accessory for Handguard Installation

Wheeler Engineering
DELTA SERIES

AR UPPER/PIC RAIL VISE BLOCK - #156888 Case Pack of 4

This innovative AR vise block is designed to securely hold basically any AR upper receiver. It will secure AR-15 uppers by engaging the takedown lugs on the bottom of the receiver. By reversing the direction it will secure most AR-10/LR style uppers in the same manner. In addition it will secure any Pic rail on a hi-rise, standard flat top or many other integrated rail guns by sliding onto and clamping the rail. The durable machined aluminum construction and precise tolerances ensure a secure hold essential for removal and installation of stubborn barrel nuts as well as a variety of other tasks.

Works great for aligning free floating tubes with Pic rails to flat top upper receivers

- Multi-function design holds AR-15 and most AR-10/LR uppers
- Can secure any Pic rail receiver by clamping the rail
- Durable extruded and machined aluminum construction

AR Upper Pic Rail Vise Block clamshell:
7" wide x 14.75" high x 1.75" deep



Mounts AR-10/LR and AR-15 Uppers



Mounts an AR-15 Upper with carry handle



Use the Pic Rail of an AR Upper or other device to mount into your bench vise

AR-15 RECEIVER LAPPING TOOL - #156757 Case Pack of 4

Lapping a receiver ensures a perfectly square and true surface for the barrel to mate against, thus enhancing accuracy. Also, honing the surface can produce optimal positioning of barrel nut so ideal torque can be achieved along with proper gas tube hole alignment.

- Use with a battery powered or electric drill to square the receiver face on an AR-15
- Helps align the gas tube through the barrel nut holes
- Helps align front and rear A2 style sights
- Flex driver shaft
- 220 Grit lapping compound
- Steel construction with a Black oxide finish

AR-15 Receiver Lapping Tool clamshell:
4.5" wide x 11.5" high x 1.25" deep



Showing a poor lapping job vs. a good lapping job.



AR-15 DELTA RING TOOL - #209943 Case Pack of 4

- Makes removing mil-spec AR-15 and M16 handguards easy by compressing the Delta Ring with one hand
- 100% vinyl coating protects the gun's finish from damage but is very durable
- Custom formed wire fits securely around Delta Ring
- Welded steel bracket for durability even with stuck or broken Delta Rings



AR-15 Delta Ring Tool clamshell:
4.75" wide x 16.5" high x 1.5" deep



AR BORE GUIDES

The AR-15 & AR-10/LR Bore Guides are precision CNC machined aluminum with a durable anodized finish. They fit securely in any AR-15 or LR/308 upper and can be retained in place by closing the dust cover on the upper which engages a groove in the guide. The bore guides also have chemical resistant O-rings for retention in uppers without dust covers. The AR-15 Bore Guide works well with .223 and .204, while the AR-10 works well on .308. The NEW AR-15 300 AAC Blackout Bore Guide works on any 30 caliber, 6.5 or 6.8 AR-15. The Nozzle extends inside the chamber to prevent solvent from leaking into the action. A solvent port is conveniently located to the rear of the guide which extends out of the upper making it easily accessible during cleaning. **AR-15 Bore Guide Inner tube diameter .250" (not intended for 6.8mm jag)**



- Protects chamber & bore from damage
- Ensures proper rod alignment for easier cleaning
- Reduces solvent leakage into gun's action
- Anodized aluminum for durability
- Integrated solvent port
- Secures in place with dust cover engagement
- AR-15 Bore Guide fits .223 and .204
- LR/308 Bore Guide fits .308
- 300 AAC Blackout Bore Guide fits all AR-15 Calibers up to .30 Cal.

AR-15 Bore Guide - #156213

AR-10/LR Bore Guide - #156777

NEW! 300 AAC Blackout Bore Guide - #777209

Case Pack of 4

Case Pack of 2

Case Pack of 4

AR-15 Bore Guide clamshell: 4" wide x 13.375" high x 1.5" deep

AR-10/LR Bore Guide clamshell: 4" wide x 15" high x 1.5" deep

300 AAC Blackout Bore Guide clamshell: 4" wide x 13.5" high x 1.5" deep



AR-15 MAINTENANCE MAT - #156824 Case Pack of 4

The Wheeler Delta Series AR-15 Maintenance Mat is perfect for any AR-15 lover, featuring a screen printed exploded view of an AR-15 Carbine. The mat is made of a dark gray no-mar, padded neoprene surface with a durable non-skid rubber backing to protect firearm finishes while helping to keep track of small parts. Excess oils and solvents are absorbed into the mat, keeping the surface clean and dry. Each mat is machine or hand washable with mild detergent and water and it rolls up easily to fit in your range box.

- Screen printed exploded view of an AR-15 for easy part identification
- Perfect for cleaning and disassembling firearms
- No-mar, padded neoprene surface protects the firearms finish
- Absorbs oils and solvents keeping surface dry
- Helps keep track of small gun parts
- Rolls up easily to fit in your range box
- 20" x 47"

AR-15 Maintenance Mat Package:
5.5" wide x 22.75" high x 3.5" deep



AR-15 COMPLETE BRUSH SET - #156715 Case Pack of 4

The Wheeler Delta Series AR-15 Complete Brush Set is specifically designed for cleaning your AR-15. The brushes are made of a high quality stiff Nylon, spun around steel cores for added stability. The brushes feature an 8 x 32 threads that fit on the included cleaning handle or any 8 x 32 cleaning rod. The brush set has everything you need to clean your rifle, plus everything you need to keep your magazines clean and running reliably.

The Brush Set Includes:

- Magazine/Upper Receiver Brush with Magazine Takedown Tool
- Bolt Carrier Brush
- Chamber Brush
- .22 Cal Bore Brush
- Handle for action and chamber cleaning

AR-15 Complete Brush Set Package:
13.75" wide x 5.5" high x 1.5" deep



Caldwell
Shooting Supplies

AR-15
ACCESSORIES

Wheeler
Engineering

DELTA SERIES

MULTI-HEIGHT PIC RAIL SET - #156503 Case Pack of 4

Wheeler understands the need for precision in today's world of advanced shooting systems. Calculating total optic height above a receiver rail is difficult due to varying specifications from a variety of ring manufacturers. This set of risers eliminates the guess work, assuring you will have an ideal fit for any setup. The necessity to mount optics and accessories at a precise height above a Picatinny rail led us to the development of the new Multi-Height Pic Rail Set. The set consists of six risers varying by 1/10th inch increments; .5", .6", .7", .8", .9" and 1". Being able to select a riser that fits the particular application allows for perfect co-witness alignment of a scope and forward mounted Night Vision Device (NVD). Proper alignment of the scope with the NVD is critical in maintaining the same zero point with a day/night system. Configuring a custom riser height can enhance the performance of many fixed-mount (no ring) optics as well. Proper height positioning of optics and other rail mounted accessories not only enhances usability but can also be critical to obtaining maximum accuracy. Durable CNC machined aluminum construction with anodized finish ensures precision fit and function. Each riser is 5.75" in length and incorporates three T15 fasteners for absolute maximum mounting strength. A second set of fasteners is included so two of the six risers can be utilized independently.

- Ideal for aligning day scope with forward mounted Night Vision Device
- Set includes six risers in 1/10th inch height increments
- Lightweight and durable CNC machined aluminum construction
- Allow perfect height alignment for optics and accessories
- Two sets of fasteners included



Multi-Height Pic Rail Set Package:
8.875" wide x 11.35" high x 1.6" deep



Achieve perfect Optics Alignment with the Multi-Height Pic Rail Set



AR-15 ADJUSTABLE RECEIVER LINK - #156000 Case Pack of 4

The AR-15 Adjustable Receiver Link will quickly become your go-to tool when performing routine cleaning operations or making those anticipated performance upgrades. The Adjustable Receiver Link is designed to maintain and secure the opened position of your AR-15 upper and lower assembly. The kit comes with one upper link and two threaded lower links (one short, one long) to provide a total adjustment of approx. 3/4". The upper link utilizes an integral pin to engage the upper receiver and the threaded lower portion utilizes the existing lower takedown hole and pin. The short lower link provides a minimum opened position of 1.2" pin to pin, enough room to insert a bore guide, and the maximum opening is 1.5" from pin to pin. The longer threaded link will provide a minimum opening of 1.4" and a maximum opening of 1.8" from pin to pin. All three components are constructed of corrosion resistant plated steel. The precise tolerances and durable materials will ensure years or reliable service from this handy device.

AR-15 Adjustable Receiver Link clamshell:
4" wide x 8.5" high x 1" deep



AR FRONT SIGHT TOOL - #156437 Case Pack of 4

This 4-prong front sight tool is designed to adjust the A2 front sight found on the AR-15, M16, and M4. It is machined from steel and has a black zinc finish to last for years. The key ring serves as a handle and helps keep the small tool accounted for.

- Install and adjust standard Mil-Spec A2 front sights on AR-15, M16, and M4
- Can be used with any 1/4" hex driver
- Key ring for storage serves as a handle also
- Black zinc-plated steel

AR Front Sight Tool Package: 5.25" wide x 4" high x 1.5" deep



PAGES 19-23

Wheeler Engineering



DELTA SERIES

SCREWDRIVER SETS

PROFESSIONAL GUNSMITHING SCREWDRIVER SETS

Screwdrivers are the most important and most-used gunsmithing tools. Wheeler's Deluxe Gunsmithing Screwdriver Sets belong on every gunsmithing bench. The well thought-out bit selection will put an end to burred, buggered, busted up screw slots on any gun that comes your way. These bits are made from S2 tool steel and hardened to 56-58 Rockwell "C". Unlike other screwdriver suppliers, Wheeler's engineers measured the screws on over one hundred modern and antique firearms to make sure that we offered bits for every situation. Whether you're working on a Browning® Superposed, a Remington® 700, a Smith & Wesson® revolver, or a Colt® single action, you'll find that there's a bit to fit every screw on your gun. Any gunsmith will tell you that you're occasionally going to break the ultra-thin bits on stubborn screws. The 89 and 72 Piece sets include two each of the very thinnest bits, which means you'll never be stuck in the middle of a job without the proper bit. The sets also include a complete selection of Phillips, Allen, and Torx bits to cover scope rings, bases, recoil pads, and the like. The difference in the 72 pc. and the 89 pc. set lies in the 15 ingenious "specialty bits" that are included in the 89 pc. set. These bits are great for installing scope bases, getting you out of a pinch by providing a small pin punch when you really need it, and keeping once-in-a-while lifesaver tools at your fingertips.

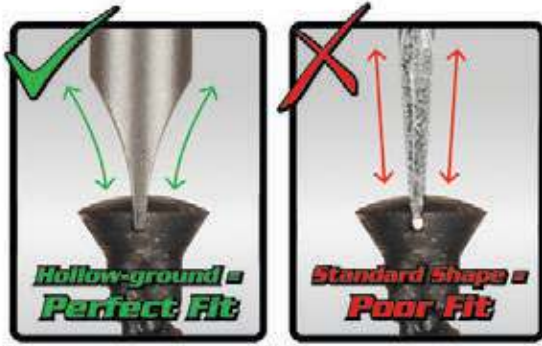

Replacement bits are available in three packs on our website for a very modest price.



89 Piece Set

- 54 Hollow Ground flat bits
- Doubles in the thinnest sizes
- Complete selection of Phillips, Allen, Torx bits
- 15 Specialty Bits
- Durable S2 tool steel
- 2 No-slip overmolded handles
- 2 1/4" shaft extension
- Hex to square drive adapter
- Convenient hinged storage case

The Deluxe Set contains: 8 Allen Bits, 4 Phillips Bits, 3 Torx Bits, 15 Specialty Bits and Accessory Tools for Colt®, Remington®, Smith & Wesson®, Mauser, Glock®, Garand, Ruger®, and more!

PATENT:
www.BTibrands.com/patents/

Deluxe Screwdriver Set package:
8.3" wide x 12.3" high x 3.1" deep

Deluxe 89 Piece Screwdriver Set - #562194



72 Piece Set

- 54 Hollow Ground flat bits
- Doubles in the thinnest sizes
- Complete selection of Phillips, Allen, Torx bits
- Durable S2 tool steel
- Two No-slip overmolded handles
- Convenient hinged storage case

The Basic Set contains:
8 Allen Bits, 4 Phillips Bits, 3 Torx Bits, and more!

PATENT:
www.BTibrands.com/patents/

Basic Screwdriver Set packages
8.3" wide x 12.3" high x 3.1" deep

Basic 72 Piece Screwdriver Set - #776737



43 Piece Set

- Hollow ground flat bits
- Durable S2 tool steel
- No-slip overmolded handle
- Most popular bits for gunsmithing
- Convenient storage case
- Magnetic bit retention in driver

43 pc. Screwdriver set package:
9.25" wide x 8.5" high x 3" deep

PATENT:
www.BTibrands.com/patents/



43 Piece Screwdriver Set - #954621 Case Pack of 4



21 Piece Expansion Set

- Great addition to the 72 or 89 piece Screwdriver Sets
- Hollow ground flat bits
- Durable S2 tool steel
- Features plastic storage tray
- 1/2" x 1/4" socket driver
- 2.5mm, 3mm, 3.5mm, 4mm, 4.5mm, 4.5mm 5mm, 5.5mm, 6mm, 7mm, and 8mm Hex Bits
- T6, T7, T8, T9, T10, T15, T20, T27, T30 Torx Bit

21 Piece Set Package:
2.75" wide x 9" high x 2" deep

21 Piece Screwdriver Set - #954671 Case Pack of 4

Upgrade 17 Piece Screwdriver Set - #748555 Case Pack of 1
Contains the 15 Specialty Bits, shaft extension, and square to hex adapter found in the Professional Set.



**If you only have room for 1 driver in your kit,
make it the F.A.T. Wrench!**

Wheeler's F.A.T. Wrench brings perfect consistency to every screw on your rifle! This amazing handheld torque wrench lets you apply repeatable, accurate torque settings to scope rings, guard screws and other screws, which aids in accuracy and decreases the opportunity for problems in the field. Detailed instructions and torque recommendations included.

The F.A.T. Wrench is a perfect compliment to the Deluxe Gunsmithing Screwdriver Sets. Together, they can ensure accurate tightening of most every screw on any gun in your collection. Bits are made from S2 tool steel and hardened to 56-58 Rockwell "C".

- Torque adjustment range from 10 inch/pounds to 65 inch/pounds
- Accuracy plus/minus 2 inch/pounds up to 40 inch/pounds; 40 - 65 is +/- 5%
- Convenient storage case included

The F.A.T. Wrench® - #553556

Case Pack of 4

Empty F.A.T. Wrench® Storage Case - #550001

Case Pack of 1

No guessing Torque in. Lb. with the Adjustable F.A.T. Wrench



FAT Wrench clamshell package:
7.75" wide x 9.75" high x 3" deep

SCREWDRIVER SETS

THE FAT WRENCH
FIREARM ACCURIZING TORQUE WRENCH

PATENT:
www.BTibrands.com/patents/



F.A.T. Wrench now comes standard with a convenient storage case



SPACE SAVER GUNSMITHING SCREWDRIVER SET - #664507

Less than half the size of comparable gunsmithing screwdriver sets! The Wheeler Space Saver Gunsmithing Screwdriver Set takes up very little space on your bench, but contains a durable and comprehensive set of 26 bits chosen to meet most of your gunsmithing needs. Includes a selection of the same high quality bits found in the Professional Gunsmithing Screwdriver Sets. It's also the perfect size to include on your trips to the range and the field. Included with the standard, Phillips, hex, and torx bits, is a 2" long #2 Phillips bit which is ideal for recoil pad installation, and a hex-to-square conversion bit which allows you to use 1/4" square drive sockets and other attachments. The magnetic handle is perfectly sized for gunsmithing needs and is made of comfortable overmolded plastic.



Space Saver GSS package:
9.75" wide x 7.5" high x 1.25" deep

PRECISION MICRO SCREWDRIVER SET - #564018 Case Pack of 4

The Wheeler Engineering Precision Micro Screwdriver Set features high quality, chrome-plated steel bits to hold up to heavy use and the comprehensive 58 piece set meet all of your precision screwdriver needs. The set includes a handle that extends from 3-3/4" to 5-1/2" and a 5-3/4" flexible extension shaft to get you into those hard to reach places. The set comes organized with individual bit markings and a convenient carry/storage case. All bits are precision formed for maximum fastener engagement.

- Chrome plated steel bits
- Extendable Handle from 3-3/4" to 5-1/2"
- 5-3/4" flexible extension shaft
- 58 piece set
- Organized carry/storage case



Precision Micro Set Package:
5.25" wide x 11.5" high x 1" deep

Wheeler
Engineering
Fine Gunsmithing Supplies

SCOPE ALIGNMENT

ULTRA SCOPE MOUNTING KIT - #541010 Case Pack of 2

The ULTRA Scope Mounting Kit from Wheeler Engineering puts all the best Wheeler scope mounting accessories into one perfect package. With this kit you can level your rifle, level your scope, mount your scope to the rifle, and then coarse sight in your scope with precision and accuracy. No more guess work and "that's good enough". The ULTRA Scope Mounting Kit even provides thread locker and a lens pen to keep your scope clean and your optics secure on even the largest caliber guns.

- Features the Professional Reticle Leveling System to make sure the scope is level and your crosshairs are perfectly perpendicular
- Features the Professional Laser Bore Sighter to align your crosshairs and get you on paper faster
- Features the FAT Torque Wrench to apply precise inch-lb. pressure on all of your screws
- Includes 9 bits, 1 socket and a bit holder for all your maintenance needs
- Comes with thread locker so your screws won't work their way loose

Professional Laser Bore Sighter

Kit includes:
 Professional Reticle Leveling System
 Professional Laser Bore Sighter
 F.A.T. Wrench
 9 bits and socket
 Thread Locker
 Lens Pen

Ultra Scope Mounting
 Kit Package:
 11.25" wide x 9.25" high
 x 3.35" deep



THE FAT WRENCH

PATENT:
www.BTibrands.com/patents/

NEW 2015

Professional Reticle Leveling System

LEVEL



MOUNT



SIGHT



THE 3 BEST OPTICS MOUNTING TOOLS ON THE MARKET IN ONE ULTIMATE KIT!

PROFESSIONAL SCOPE MOUNTING KITS

Proper contact, alignment, and attachment are key to precise accuracy from your scope and rifle. The Wheeler Professional Scope Mounting Kit and Scope Alignment Kit will properly align, attach and level your scope on your gun. Alignment and lapping bars make ring alignment simple and easy. The Level-Level-Level provides precise linear leveling for your scope and the F.A.T.Wrench guarantees exact torque specs on your scope rings. A flex driver is included for use with a power drill and an instructional video is available at: www.BTibrands.com. Increase your accuracy and precision with a Wheeler Scope Mounting and Lapping Kit.

Professional Scope Mounting Kits:

Includes: F.A.T.Wrench, 10 bits, 1/2" socket, Level-Level-Level, Flex driver, lapping bar(s), alignment bars, lapping bar handle, lapping compound, thread locker, carrying case, instructional video on: www.BTibrands.com

Professional Scope Mounting Kit 1"
Professional Scope Mounting Kit Combo
 (1" & 30mm Alignment and lapping bars)

#540127 Case Pack of 4
#545454 Case Pack of 4

Empty Storage Case Scope Ring Alignment Kits:

Includes: alignment bars, lapping bar, lapping bar handle, 220 grit lapping compound and complete instructions

Scope Ring Alignment and Lapping Kit - 1" Rings
Scope Ring Alignment and Lapping Kit - 30mm Rings
Scope Ring Alignment and Lapping Kit Combo (1" and 30mm)
Lapping Compound Kit (1 each 220, 320, and 600 grit compound)
Scope Ring Alignment Bar - 1"

#1017566 Case Pack of 10
#204061 Case Pack of 1
#633266 Case Pack of 1
#305172 Case Pack of 1
#342303 Case Pack of 1
#781366 Case Pack of 1

PATENT:
www.BTibrands.com/patents/



SCOPE ALIGNMENT

PROFESSIONAL RETICLE LEVELING SYSTEM - #119050 *Case Pack of 4*

Technological advances in today's modern firearms, ammunition and optics have enhanced the potential for long range accuracy. However, precision mounting and alignment of your system's scope is critical to realizing the accuracy. A scope's reticle must be precisely aligned with the weapon to ensure holdover or turret adjustments for bullet drop produce true vertical compensation for point of impact. If the crosshairs are canted left or right both elevation and windage bullet impact error will occur.

The Wheeler Professional Reticle Leveling System is a precision tool and technique designed to allow a scope to be perfectly leveled on any firearm with ease. CNC machining, factory adjusted calibration set screws, anodized aluminum construction and protective molded case put this instrument in a class of its own.

The system is comprised of two machined aluminum level housings calibrated to their integrated levels. The Barrel Clamp Level is attached to the gun's barrel while the smaller Reference Level is placed on scope base, bottom half of a ring or other flat surface perpendicular to the vertical axis of the gun. The gun is then rotated until the Reference Level is aligned. The tuning adjustment knob on the Barrel Clamp Level is then turned until its level is centered to match the Reference Level. At this point the Barrel Clamp Level is calibrated to the guns axis. The Scope can be installed loosely and the Reference Level placed on top of the scope's turret cap. The scope is rotated until the Reference Level is aligned with the Barrel Clamp Level and then simply secured in place. The Wheeler PRLS is the most effective instrument available for precision scope alignment.

- Precision tool for scope reticle alignment
- Factory calibrated Reference Level
- Maximize accuracy potential
- Tunable Barrel Clamp Level
- CNC machined aluminum level housings
- Protective storage case



Reference Level



Barrel Clamp Level

Professional Reticle Leveling System clamshell: 6" wide x 11" high x 3" deep

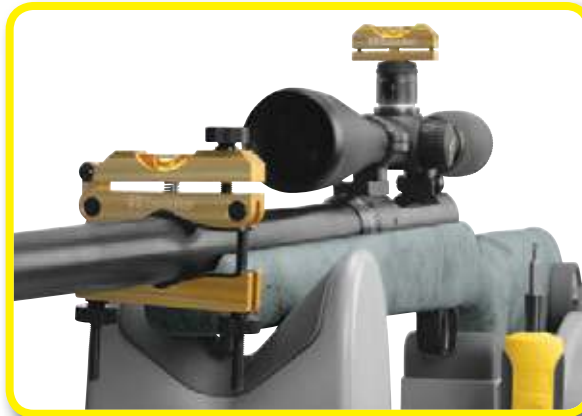

LEVEL-LEVEL-LEVEL - #113088 *Case Pack of 4*

The simplest, most accurate scope leveling system ever devised. Misaligned crosshairs rob you of accurate bullet placement, especially at long range, where it counts. Crooked crosshairs cause your scope adjustments to be unreliable, and even make zeroing your rifle a frustrating and costly experience. The Level-Level-Level works because the scope is leveled to your receiver. An accurate rifle requires level crosshairs, and the Level-Level-Level gives you the means to level your scope perfectly in only minutes. Level your scope as you mount it on your rifle. The magnetic base in the rifle level bridges the bolt raceway, allowing you to position your rifle perfectly level. Then level the scope, tighten the rings, and the job is done. Works with practically any bolt-action rifle, and is adaptable to other designs

Scope Turret Level (not magnetized)



Action Level (magnetized)



Package: 4" wide x 7.5" high x .5" deep



SCOPE ALIGNMENT

PROFESSIONAL LASER BORE SIGHTER

1 Bore Sighter can be used with most any caliber rifle or handgun!

The PLBS uses a high power daylight-visible laser and a high-strength magnetic connection to the barrel to deliver fast accurate bore sighting. This system works with virtually all firearms; rifles, shotguns, handguns. The magnetic connection to the end of the muzzle provides more precise alignment with the bore without the risk of damaging the bore, compared to arbor-style bore devices. A machined aluminum body with soft rubber over-molding houses the laser module. Each unit is hand tuned during the manufacturing process with an innovative calibration mechanism. This allows for maximum precision ensuring the best bore/optic alignment possible. Once precision calibration is completed, the laser module is permanently secured in place insuring reliable performance and durability. Molded plastic storage case included. Runs on a single Lithium 123A battery (included). Reflective Sighting Grid included for enhanced visibility in bright daylight conditions.

- Makes initial scope adjustment simple, fast and precise
- Compatible with a wide variety of guns
- High power daylight visible red or green laser

Professional Laser Bore Sighter Green - #589922 Case Pack of 4
Professional Laser Bore Sighter Red - #580022 Case Pack of 4

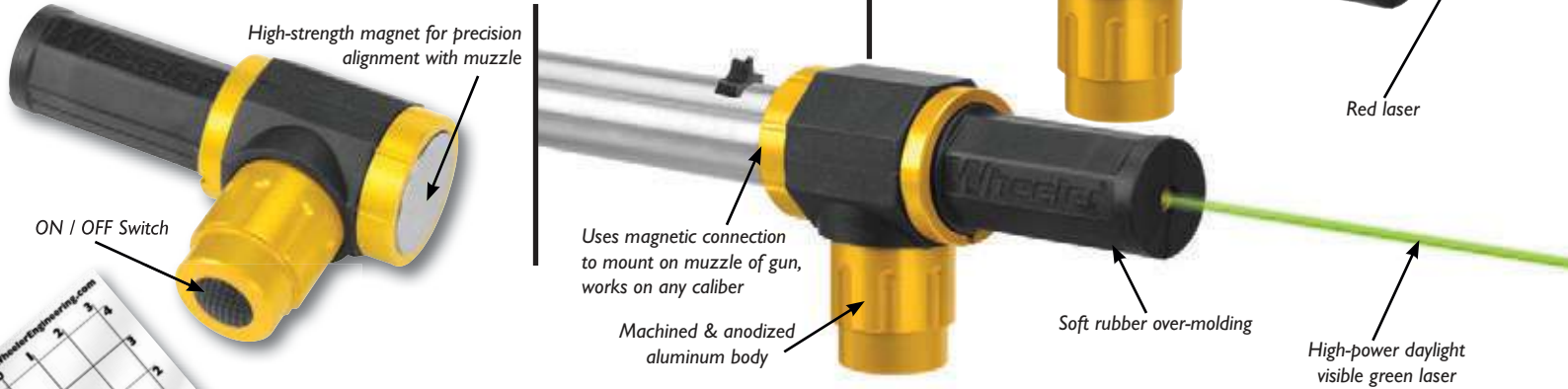

NEW! Reflective Bore Sighter Grid included with the Professional Laser Bore Sighter.



PROFESSIONAL OPTICS FASTENER KIT - #142434

This kit is a must-have for anyone who mounts optics or works on guns. Many fasteners included with bases and rings are of inferior quality and can be easily damaged or lost. These Grade 8 high strength quenched and tempered alloy steel fasteners will hold up to any application. Durable black zinc surface finish for corrosion resistance. Commonly requested Ring Windage 10-32 x 7.5mm slotted head fasteners included. 6-48 and 8-40 taps included to repair damaged threads on guns or ring sets. Convenient storage case included.



Optics Fastener Kit Package:
 10" wide x 8.5" high x 1.5" deep

158 Piece Set

- Replace damaged or missing fasteners
- Includes common slotted and Torx fasteners
- Grade 8 strength, quenched and tempered alloy steel for maximum durability
- Durable black zinc surface finish
- 6-48 and 8-40 taps included for repairing damaged threads



TYPE	SIZE		QTY
SLOTTED FILLISTER	• 6-48x1/8"	• 6-48x7/16"	6 EACH
	• 6-48x3/16"	• 6-48x1/2"	
	• 6-48x1/4"	• 8-40x3/16"	
	• 6-48x5/16"	• 8-40x1/4"	
	• 6-48x3/8"	• 8-40x3/8"	
SLOTTED OVAL	• 6-48x1/8"	• 6-48x7/16"	6 EACH
	• 6-48x3/16"	• 6-48x1/2"	
	• 6-48x1/4"	• 8-40x3/16"	
	• 6-48x5/16"	• 8-40x1/4"	
	• 6-48x3/8"	• 8-40x3/8"	
T-15 TORX	• 6-48x5.5mm	• 8-40x7mm	6 EACH
PLUG	• 6-48	• 8-40	6 EACH
WINDAGE	• 10-32X7.5mm		6 EACH
TAP	• #6-48	• #8-40	1 EACH

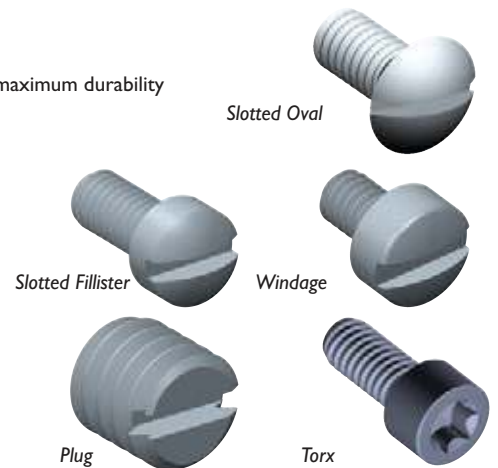

ANTI-CANT INDICATOR

Keeping your scope perfectly aligned is critical to long-range accuracy. Canting your scope, even just a couple of degrees, can cause error in point of impact. With modern "Drop-Compensating" scopes, an Anti-Cant Indicator is a necessity. If your gun isn't aligned correctly dialing up the turrets, or using hold-over marks will just throw your shot off. This error can easily be enough to cause misses. The Wheeler Anti-Cant Indicator ensures that your rifle is always held near perfectly vertical, eliminating any chance for "Cant Error" to cause a miss.

- Indicates precise, repeatable level gun position
- Increases accuracy by insuring proper gun alignment, which is critical for turret adjustment and hold-over for bullet drop compensation
- Easy-to-view from shooting position
- Attaches to scope, folds in when not in use
- Pic Rail Attachment attaches to any Pic Rail
- Precision machined aluminum with anodized finish

Anti-Cant Indicator, 1 inch - #755712

Case Pack of 4

Anti-Cant Indicator, 30mm - #766112

Case Pack of 4

Anti-Cant Indicator, 34-35mm - #585555

Case Pack of 4

(Included bushings for 34mm & 35mm Tubes)

Anti-Cant Indicator Pic Rail - #580033

Case Pack of 4

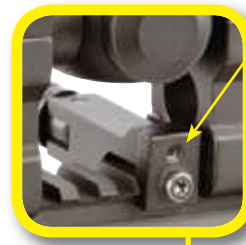

Locking set screw to adjust level for perfect alignment



Anti Cant Indicator clamshell: 5.4" wide x 7" high x 1" deep



TRIGGER PULL SCALE - #309888

Case Pack of 4

The Trigger Pull Scale accurately measures trigger pull weight from 8 ounces to 8 pounds. It features an ergonomically shaped handle for consistent direction of pull. Highly visible increment markings and an easy-to-read sliding indicator that stays on the maximum weight registered, make it easy to use. It measures in 2 oz. increments and is accurate to +/- 2 oz. The Trigger Pull Scale is an excellent tool for use when adjusting triggers to ensure accuracy and maintain safe performance.

- Accurately measures trigger pull
- Easy-to-read sliding indicator
- Range from 8 oz. to 8 lbs.



Trigger Pull Scale Clamshell: 4.5" wide x 14.75" high x 1.25" deep



GUNSMITHING TOOLS



ROLL PIN PUNCH SET - #204513 Case Pack of 4

The Wheeler Engineering Roll Pin Punches are machined from hardened steel to prevent bending or breaking while driving any size roll pin. The punches are designed with a hemispherical tip to provide proper alignment of the roll pin to prevent damage to the firearm and the roll pin.

The 9 piece set includes: 5/16\", 1/4\", 7/32\", 3/16\", 5/32\", 1/8\", 3/32\", 5/64\", 1/16\" punches in a nylon pouch.

- 9 piece set 1/16\" through 5/16\"
- Hardened steel construction
- Hemispherical tip
- Fitted nylon storage pouch

Roll Pin Punch Set Package:
8\" wide x 10.75\" high x 1\" deep



Ball profile tip prevents damage to roll pin

HAMMER AND PUNCH SET - #951900 Case Pack of 1

The Wheeler Hammer and Punch Set includes a polymer/brass combination hammer, eight precision brass punches, four steel punches, and two plastic punches. It comes in a handy molded case. It makes a great tool for driving pins, drifting sights, at the shooting range or on your gunsmithing bench.

Hammer and Punch package:
5.25\" wide x 11\" high x 1.75\" deep

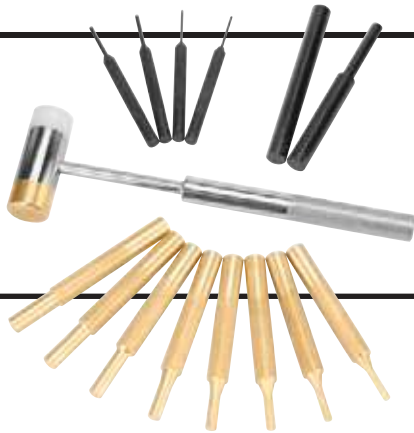

NYLON/BRASS HAMMER - #711016 Case Pack of 1

Likely to become your favorite hammer at the bench or on the range. Nylon face is non-marring and is great for alignment and other uses where a steel hammer is not appropriate. Brass face can be used for driving pins and punches, and a multitude of other uses. 11\" overall. Weighs 8 oz.



BRASS PUNCH SET - #780194 Case Pack of 1

Quality crafted Brass Punch Set assists the gunsmith in assembly and disassembly of all kinds of firearms. Reduce the chances of marring and burring that can occur with improperly sized or makeshift punches.

Brass Set contains eight precision crafted pin punches in sizes you can use: 1/8\", 9/64\", 5/32\", 3/16\", 7/32\", 1/4\", 9/32\", 5/16\". The larger non-marring brass punches are particularly useful for drifting sights. Handy roll-up pouch keeps your punches clean and in order. Overall length 4\".



BORE LAPPING KIT

Lap your barrels to make them shoot better and easier to clean. Lapping polishes out the tool marks left in rifle barrels during manufacturing. Traditional hand-lapping is very labor intensive and requires pushing lead slugs down the bore by hand. The Wheeler kit allows you to embed lead or jacketed bullets with abrasive and fire them through your barrel. Lapping is as easy as roll, load, and shoot. Works in everything from old .22 rimfires to neglected hunting rifles. Works to improve all but the very roughest bores. The results in appearance and performance can be surprising. Kit includes three jars of high quality abrasive pastes, two steel embedding plates, and complete instructions.

Bore Lapping Kit - #299849 Case Pack of 5

220 Grit Lapping Compound, 1 oz. jar - #885040 Case Pack of 5

320 Grit Lapping Compound, 1 oz. jar - #378413 Case Pack of 5

600 Grit Lapping Compound, 1 oz. jar - #395155 Case Pack of 5

Lapping Compound Kit - #342303 Case Pack of 5

(1 each 220, 320, and 600 grit compound)



UNIVERSAL BARREL CLAMP - #672286 *Case Pack of 5*

The Wheeler Engineering Universal Barrel Clamp is precision extruded from aircraft grade aluminum and bonded with non-marring urethane. The urethane coating is specially designed to provide a protective layer for the barrel's finish while providing extraordinary gripping abilities. Three different barrel openings of .85", .66" and .53" will accommodate anything from an AR pencil barrel up to a bull barrel. When inserted in a vise the urethane coating squeezes down tightly on the barrel to fully secure it for the forces needed for installation/ removal.

Universal Barrel Clamp Package: 5.5" wide x 9.75" high x 2.75" deep

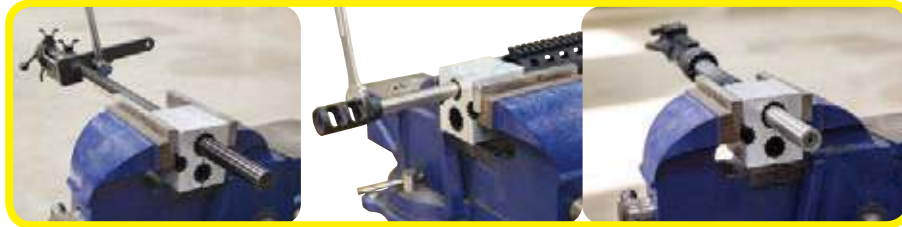

Three different barrel openings of .85", .66" and .53"

UNIVERSAL I911/PISTOL BENCH BLOCK - #672215 *Case Pack of 5*

For firearm assembly and disassembly, the Universal Bench Block is your best friend. It features a variety of notches, grooves, and holes on both sides and is ideally suited for M1911 style pistols. Need to install a pin, detent, or spring? The Universal Bench Block is the answer. 1-5/16" high, 4" in diameter. Non-marring urethane for long use.

- Made of non-marring urethane
- Perfect for use on M1911 pistols as well as other firearms such as 10/22s
- Main spring removal recess and boss
- Barrel link removal V channel
- Rear sight drift channel
- Front sight staking channel
- Hammer and Sear pin removal holes
- Ejector port dressing channel
- Rail dressing round bottom channel
- 1 1/4" high x 4" in diameter

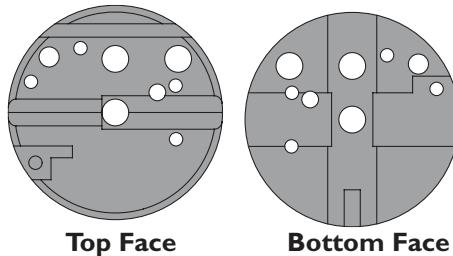

Top Face

Bottom Face

Universal Bench block Package:
5" wide x 9.25" high x 1.5" deep



ACTION WRENCHES AND BARREL VISE

Heavy-duty tools to deliver the strength and rigidity required for proper barrel removal and installation. The Action Wrench safely surrounds and supports the receiver ring. The 15" long, 1" diameter steel handle will overcome even the tightest assemblies. The double-ended Savage Barrel Nut Wrench fits both early and late model nuts on the 110 and 10 series rifles, and features two 1/2" square drive holes for a swing bar or torque wrench. The BarrelVise provides plenty of holding force to securely clamp your barrel for removal or installation. The Vise includes two pre-drilled oak blocks, 1" and 3/4", and a solid block for custom drilling.

- | | |
|---|-----------------------|
| Action Wrench #1 (<i>Mausers with Flat-Bottomed Receivers</i>) - #808771 | <i>Case Pack of 1</i> |
| Action Wrench #2 (<i>Remington® 700</i>) - #414521 | <i>Case Pack of 1</i> |
| Savage® Barrel Nut Wrench - #123038 | <i>Case Pack of 4</i> |
| Barrel Vise with 3 Oak Bushings - #465185 | <i>Case Pack of 1</i> |
| Set of 3 Replacement Oak Bushings - #844879 | <i>Case Pack of 1</i> |
| Lead Barrel Vise Shims (4 Pack) - #239444 | <i>Case Pack of 1</i> |



Cerama-Coat is a specially formulated finish for firearms that provides an extremely durable coating. The key to the super hard finish is ultra-fine ceramic molecules that actually crosslink and bond to the base material. A heating process after application forms the bond and hardens the finish. Highly resistant to scratching, chipping and gun solvents. Bonds to ferrous metals, alloys, stainless steel and synthetics that can be heated to 200 degrees F. Can be applied over bare metal or existing blued, anodized or parkerized finish. Available in four popular matte finish colors to customize any gun or accessory.

- Ceramic infused formulation that crosslinks with the base material to create the most durable finish on the market
- Compatible with ferrous metals, alloys, stainless steel and synthetics
- Highly resistant to scratching, chipping and gun solvents
- Non reflective matte finish colors
- Customize any gun or accessory
- Weatherproof any gun's finish

BLACK Cerama-Coat - #468993

FOLIAGE GREEN Cerama-Coat - #567843

FLAT DARK EARTH Cerama-Coat - #492304

OLIVE DRAB Cerama-Coat - #567312

Case Pack of 4

Case Pack of 4

Case Pack of 4

Case Pack of 4



BLACK

FOLIAGE GREEN

FLAT DARK EARTH

OLIVE DRAB

Colors match popular stocks and handguards

Convenient Aerosol Spray Can



BEFORE

AFTER

Often "black" parts from different manufacturers won't match up. With Cerama-Coat you can color match all your parts for that perfect look.

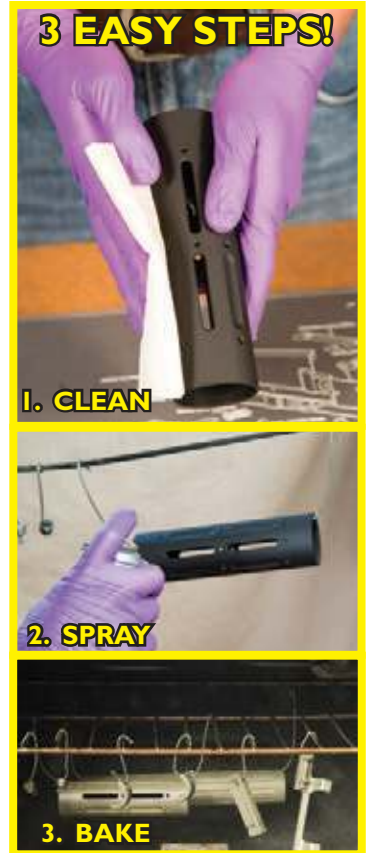

3 EASY STEPS!

1. CLEAN

2. SPRAY

3. BAKE



Cerama-Coat Package:
4.75" wide x 8.5" high x 3" deep

Miles Gilbert
SERIES



BEDROCK™ GLASS BEDDING KIT

#190274 Case Pack of 4

Miles Gilbert Bedrock is the choice to unlock the accuracy potential of your rifle. A rifle's accuracy is dependent on the fit of its barreled action to its stock. Bedrock makes your rifle's stock and metal components fit together to eliminate shift and pressure points caused by recoil and changes in temperature and humidity. Removing the contact points of the stock where the barreled action meets, and replacing them with Bedrock assures you of a perfect, stress-free fit. The stock and barreled action becomes a unit, not just two components fitting arbitrarily together. Ideal for wood, laminated, and synthetic stocks, the Bedrock Kit contains all the necessary components to achieve the perfect fit: 2 oz each of Resin and Hardener, Release Agent with two applicators, Measuring Spoons and Mixing Cups, brown and black dyes, Micro balloons for customizing the viscosity, modeling clay, surgical tubing, and the most comprehensive, illustrated instructions ever offered to take you from start to finish with your bedding project. With a 24-hour cure, you're only a day away from a perfect fit and a more accurate rifle. For use with wood or synthetic stocks, 30 minute working time, 24-Hour Full Cure. Volume: approximately 1.5 cups.

Kit Includes:

- 4 oz Bedrock (2oz resin, 2oz hardener)
- Brown & Black dye for wood or synthetic gunstocks
- Release Agent
- 2 Release Agent Applicators
- 2 fl oz Micro balloons
- Modeling Clay
- 3 Mixing Cups
- Surgical Tubing
- 3 Mixing/Applicator Sticks
- Illustrated Instruction Booklet

Bedrock Epoxy-Bedding Kit:
4.5" wide x 9" high x 2" deep



MAGNIFIER VISOR - #639552 Case Pack of 1

Perfect for checkering, inletting, action work, assembly, or any projects requiring close observation. Two magnification levels, 1.8X or 2.3X. Accessory loupe for really close inspection comes standard. Adjustable padded head strap. You can use with or without prescription glasses.

Miles Gilbert
SERIES



Wheeler®
Engineering
Fine Gunsmithing Supplies



ADVANCED STOCK RE-FINISH KIT

Refinishing a gunstock can be a satisfying and rewarding experience. Removing the years of wear or neglect and replacing them with a beautiful, durable finish with your own hands provides a deep sense of fulfillment, and may increase the value of your favorite firearm. The Gunstock Re-Finish Kit matches the very finest finishing materials and supplies with an easy to follow, professionally produced instructional DVD to allow even the first time user the opportunity to produce a masterpiece. Formula #5 Classic American Oil Finish is the absolute top of the line hand-applied oil finish for walnut gunstocks. It creates a tough, protective, yet attractive appearance that includes options for low, medium or high gloss. We recommend this kit for all hunting and target guns. Kit includes finish remover, sandpaper, sealer, filler with stain, finish and polishing compounds, and the instructional DVD.

Stock Re-Finishing Kit - #139021 Case Pack of 4
Finish Remover - #618231 Case Pack of 1

Advanced Stock Re-finish Kit:
5.5" wide x 9" high x 2" deep



Kit Includes: Heavy Duty Finish Remover, Industrial Grade Sand Paper, Stock Sealer, Wood Filler, Walnut Stain, Classic Oil Finish, Pumice & Rottenstone, Synthetic Steel Wool, Instructional DVD

RECOIL PAD INSTALLATION FIXTURE

#184528 Case Pack of 1

Miles Gilbert
SERIES

Accurately transfers the toe-line angle and the comb line from the stock to the new recoil pad; also serves as a stable work holding fixture for off-the-stock sanding of the pad. Designed for use with any table-mounted belt or disc sander. Rigid, cast aluminum base and aluminum pad mounting bar.



VERSATILITY DEFINED

BOG-POD®

TRIPODS • BIPODS • MONOPODS • ACCESSORIES

We have the platform to fit your specific needs.

The standard in shooting sticks
Our great line of sticks in CAMO
Tactical black for Stealth Ops
Heavy Duty for long maximum stability

- RLD**
- CLD**
- TAC**
- HD**

switcheroo® SHOOTING SYSTEM

Now you can switch out your standard shooting rest with a spotting scope, camera, binoculars, or even one of our advanced shooting systems. The SWITCHEROO Shooting System allows you to quickly and easily switch between shooting heads or accessory heads.



PROFESSIONALS USE BOG-POD®

TRIPODS • BIPODS • MONOPODS • ACCESSORIES



SB SERIES

SB-2 BIPOD - #735544 Case Pack of 4

The SB-2 is a lightweight, compact bipod designed to provide sportsmen with a steady shooting platform in all conditions. The SB-2 can be used either kneeling or sitting.

- Three-section, lightweight aluminum legs with matte black finish
- High-strength ABS plastic head and leg connectors
- Universal Shooting Rest swivels 360° and rubber covered to prevent damage to gun stocks
- Rapid-adjust twist locks loosen or tighten legs with just a couple of turns
- Removable rubber feet unscrew to a reveal carbide tip for better grip on ice

PATENT:
www.BTlbrands.com/patents/

Usable Adjustable
Height: 21"-40"
Weights: 19 oz.

SB-2 Package:
6.25" wide x 38.5" high x 2.5" deep



SB-2C BIPOD - #735563 Case Pack of 4

The SB-2C is a lightweight, compact bipod designed to provide sportsmen with a steady shooting platform in all conditions. The SB-2C can be used either kneeling or sitting. The added Camo pattern to the legs provide more concealment and a NEW rubber retention strap holds the SB-2C to the gun for quick gun and bipod repositioning.

- Three-section, lightweight aluminum legs with matte camo finish
- High-strength ABS plastic head and leg connectors
- Rubber retention strap to attach the bipod to your gun
- Rapid-adjust twist locks loosen or tighten legs with just a couple of turns
- Removable rubber feet unscrew to a reveal carbide tip for better grip on ice



PATENT:
www.BTlbrands.com/patents/

Usable Adjustable
Height: 21"-40"
Weights: 19 oz.

SB-2C Package:
6.25" wide x 38.5" high x 2.5" deep



DSS DEAD SILENT SHOOTING STICKS

The Dead Silent Shooting Sticks bring the same trusted BOG-POD® stability and durability to a collapsible shooting stick platform. The DSS are made of robust 9/16" dia. aluminum and non-marring weather resistant surfaces. The Leg Section Retention clips are movable and adjustable to allow the shooter to fold and clip a leg section to the Shooting Stick. This adjusts the platform to a lower height and keeps the folded leg sections secure and out of the way during transport.

Standing Model - #735565 Case Pack of 4
Sitting Model - #735560 Case Pack of 4

- Improves shooter accuracy
- Durable 9/16" diameter aluminum tubing
- Elastic strap keeps collapsed sticks bound tight and quiet
- Innovative Leg Section Retention Clip allows the shooter to lower the shooting height of the DSS for a kneeling or sitting position



Sitting Extended Height: 39"
Weights: 11 oz.
Standing Extended Height: 72"
Weights: 16 oz.

Sitting Sticks Package:
4.25" wide x 21.25" high x 2" deep

Standing Sticks Package:
5.25" wide x 20.25" high x 2.5" deep

Leg Section Retention Clip allows the shooter to fold up the legs, lowering the DSS



RLD SERIES

The RLD Series is the standard for shooting sticks. Decked out in the original flat black finish with cushioned grips, this series of shooting pods will be rock steady and perform in even the toughest environments.



Larry Wieshun

PROFESSIONALS
USE BOG-POD

PATENT:
www.BTibrands.com/patents/

RLD & BLD Pods:

- Switcheroo Shooting System - Easily switch between accessories in the field using the same platform
- Three-section, high-strength, lightweight aluminum leg with matte black finish
- Universal Shooting Rest swivels 360° and rubber covered to prevent damage to gun stocks
- Rapid-adjust twist locks loosen or tighten legs with just a couple of turns
- Inch markers on middle leg sections help to quickly reach a set height
- Removable rubber foot unscrews to a reveal carbide tip for better grip on ice
- Includes weather resistant carry bag with allen wrench for adjustments
- Integrated leg stops prevent over extension

BLD-1 MONOPOD

- #735553 Case Pack of 4
- Height approximately 29" to 68"
 - Weighs approximately 12 oz.
 - Includes removable snow disc

RLD-2 BIPOD

- #735532 Case Pack of 4
- Height: 22" - 68" usable height when legs are spread
 - Weighs approximately 24 oz.
 - Legs adjust independently out to 40° angle with adjustable tension
 - Use in sitting, kneeling, or standing positions
 - Hook & Loop strap for securing legs during transport

RLD-3 TRIPOD

- #735533 Case Pack of 4
- Height: 22" - 68" usable height when legs are spread
 - Weighs approximately 33 oz.
 - Legs adjust independently out to 40° angle with adjustable tension
 - Use in sitting, kneeling, or standing positions
 - Hook & Loop strap for securing legs during transport

switcheroo
SHOOTING SYSTEM



RLD Package:
7" wide x 38.5"
high x 2.5" deep

BLD-1 Package:
7" wide x 38.5"
high x 2" deep

CLD SERIES

The CLD Series builds upon the standard for shooting sticks. Decked out in camouflage with black cushioned grips, and Rapid Lock leg adjustment, this tripod will be rock steady with the screw out spike feet and perform in even the toughest environments.

PATENT:
www.BTlbrands.com/patents/

switcheroo
SHOOTING SYSTEM

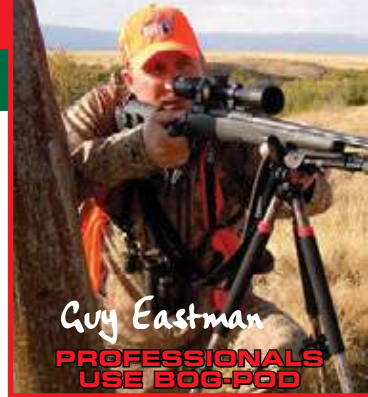

Cuy Eastman
**PROFESSIONALS
USE BOG-POD**

CLD Series Pods

- Switcheroo Shooting System - Easily switch between accessories in the field using the same platform
- Three-section, high-strength, lightweight aluminum leg with matte Camo pattern finish
- Universal Shooting Rest swivels 360° and rubber covered to prevent damage to gun stocks
- Rapid-adjust lever locks with adjustable tension
- Inch markers on middle leg sections help to quickly reach a set height
- All-terrain foot system with rubber feet that screw up to reveal a steel tip for better grip on ice
- Includes weather resistant carry bag with allen wrench for adjustments
- Integrated leg stops prevent over extension

CLD-2 BIPOD

#735536 Case Pack of 4

- Height: 22" - 68" usable height when legs are spread
- Weighs approximately 32 oz.
- Legs adjust independently out to 40° angle with adjustable tension
- Use in sitting, kneeling, or standing positions

CLD-3S SHORT TRIPOD

#735542 Case Pack of 4

- Height: 6" - 42" usable height when legs are spread
- Legs adjust independently out to 75° angle with adjustable tension
- Use in prone, sitting, or kneeling positions
- Weighs approximately 32 oz.

CLD-3 TRIPOD

#735535 Case Pack of 4

- Height: 22" - 68" usable height when legs are spread
- Weighs approximately 40 oz.
- Legs adjust independently out to 40° angle with adjustable tension
- Use in sitting, kneeling, or standing positions

CLD Package:
7" wide x 38.5" high x 2.5" deep

CLD-3S Package:
7" wide x 36" high x 3" deep



INCH MARKERS

NUMBERED INCH MARKINGS PROVIDE QUICK ADJUSTMENTS THAT ALLOW YOU TO LEVEL YOUR BOG-POD EVENLY.

ALL TERRAIN FOOT SYSTEM

RUBBER FEET RETRACT TO REVEAL A METAL SPIKE FOR ADDED TRACTION ON HARD SURFACES

CUSHIONED BLACK GRIPS

CUSHIONED GRIPS ARE GREAT FOR COLD WEATHER AND OFFER SECURE HAND HOLDS FOR WET WEATHER CONDITIONS.

RAPID ADJUST LEVER LOCKS

QUICK LEVER LOCK LEG ADJUSTMENT WITH NOISE REDUCING RUBBER RING GUARDS

USR™

UNIVERSAL SHOOTING REST™ SWIVELS 360°

BOG-POD
TRIPODS • BIPODS • MONOPODS • ACCESSORIES



Melissa Bachman
PROFESSIONALS USE BOG-POD

HD SERIES

The HD Series is more rigid and robust than our other BOG-POD lines. 5mm Thicker legs with HD Aluminum connectors make the HD Series rock solid when absolute stability is needed. Screw out spiked feet and textured rubber hand grips make sure you get maximum purchase to Heavy Duty stability.

switcheroo
SHOOTING SYSTEM



PATENT:
www.BTibrands.com/patents/

HD Series Pods

- Switcheroo Shooting System - Easily switch between accessories in the field using the same platform
- Three-section, beefed-up, lightweight aluminum legs with matte black finish 5mm larger leg tube sizes than standard BOG-POD shooting platforms
- Universal Shooting Rest with quick-change stem swivels 360° and rubber covered to prevent damage to gun stocks
- Custom lever locks with ultra smooth and quiet operation and adjustable tension
- Includes weather resistant carry bag with allen wrench for adjustments
- Integrated leg stops prevent over extension

HD-1 MONOPOD

#735556 Case Pack of 2

- Height: 28" - 68"
- Weighs approximately 21 oz.
- Includes removable snow disc for deep snow and soft terrain

HD-3S SHORT TRIPOD

#735558 Case Pack of 2

- Height: 6" - 42" usable height when legs are spread
- Weighs approximately 45 oz.
- Legs adjust independently out to any angle up to 75° with adjustable tension for better control of leg spread
- Inch markers on middle leg sections to quickly reach a desired height
- All-terrain foot system with rubber feet that screw up to reveal a steel tip for better grip on ice
- Use in prone, sitting or kneeling positions

HD-3 TRIPOD

#735557 Case Pack of 4

- Height: 22" - 68" usable height when legs are spread
- Weighs approximately 56 oz.
- Legs adjust independently out to any angle up to 40° with adjustable tension for better control of leg spread
- Inch markers on middle leg sections to quickly reach a desired height
- All-terrain foot system with rubber feet that screw up to reveal a steel tip for better grip on ice
- Use in sitting, kneeling, or standing positions



HD-1 Package:
 7.5" wide x 39"
 high x 2" deep

HD-3 Package:
 7.5" wide x 39"
 high x 3.5" deep

HD-3S Package:
 7.5" wide x 38"
 high x 3.5" deep



TAC SERIES

The TAC Series is the standard for Tactical shooting sticks. Decked out in flat black **VEL-COAT™** with black cushioned grips, **AND HD Aluminum connectors**, this tripod will be rock steady and perform in even the toughest environments.



Matt Hughes
PROFESSIONALS USE BOG-POD

TAC Series Pods

- Switcheroo Shooting System - Easily switch between accessories in the field using the same platform
- Three-section, high-strength, lightweight aluminum legs with matte black finish
- Universal Shooting Rest swivels 360° and rubber covered to prevent damage to gun stocks
- Rapid-adjust lever locks with adjustable tension
- Inch markers on middle leg sections help to quickly reach a set height
- All-terrain foot system with rubber feet that screw up to reveal a steel tip for better grip on ice
- Includes weather resistant carry bag with allen wrench for adjustments
- Integrated leg stops prevent over extension

PATENT:
www.BTibrands.com/patents/



TAC-3 Package:
9.5" wide x 34" high x 2.5" deep

TAC-3S Package:
7" wide x 36" high x 3" deep



switcheroo
SHOOTING SYSTEM



TAC-3 TRIPOD

#735540 Case Pack of 4

- Height: 22" - 68" usable height when legs are spread
- Weighs approximately 40 oz.
- Legs adjust independently out to 40° angle with adjustable tension
- Use in sitting, kneeling, or standing positions

TAC-3S SHORT TRIPOD

#735541 Case Pack of 4

- Height: 6" - 42" usable height when legs are spread
- Weighs approximately 32 oz.
- Legs adjust independently out to 75° angle with adjustable tension
- Use in prone, sitting or kneeling positions



CUSHIONED BLACK GRIPS

CUSHIONED GRIPS ARE GREAT FOR COLD WEATHER AND OFFER SECURE HAND HOLDS FOR WET WEATHER CONDITIONS.



INCH MARKERS

NUMBERED INCH MARKINGS PROVIDE QUICK ADJUSTMENTS THAT ALLOW YOU TO LEVEL YOUR BOG-POD EVENLY.



RAPID ADJUST LEVER LOCKS

QUICK LEVER LOCK LEG ADJUSTMENT WITH NOISE REDUCING RUBBER RING GUARDS



USR™ UNIVERSAL SHOOTING REST™ SWIVELS 360°

UNIVERSAL SHOOTING REST™ SWIVELS 360°



ALL TERRAIN FOOT SYSTEM

RUBBER FEET RETRACT TO REVEAL A METAL SPIKE FOR ADDED TRACTION ON HARD SURFACES



VEL-COAT™ FINISH

ON OUTSIDE TUBES PROVIDES NON-GLARE AND NOISE DAMPENING SURFACE WITH ADDED GRIP

Q-STIK MONOPOD #735543 Case Pack of 4

The Q-STIK is the most comprehensive monopod system designed for the outdoor sportsman. The Monopod is robust and has a specially designed ergonomic grip for secure hold and comfort for hiking. A wrist strap keeps the Q-STIK secure in rough terrain. The included Snow Foot helps give purchase on loose ground or deep snow. The Carbide foot is for ice or solid rock.

- Height: 29.5" - 68"
- Weighs approximately 15 oz.
- Switcheroo Shooting System - Easily switch between accessories in the field using the same platform
- Three-section, high-strength, lightweight aluminum leg with matte black finish
- Hiker's grip provides comfortable hand support
- Rapid-adjust twist locks loosen or tighten legs with just a couple of turns
- Inch markers on middle leg sections help to quickly reach a set height
- Removable rubber foot unscrews to reveal carbide tip for better grip on ice
- Includes weather resistant carry bag with allen wrench for adjustments

Q-STIK Package:
10.25" wide x 18.25" high x 4.5" deep

PATENT:
www.BTibrands.com/patents/



switcheroo
SHOOTING SYSTEM



Included accessories:

- USR
- Binocular Rest Non-marring
- Camera adapter
- Compass top
- Removable snow disc

BOG-POD
TRIPODS • BIPODS • MONOPODS • ACCESSORIES



Pat Reeve
PROFESSIONALS
USE BOG-POD

switcheroo SHOOTING SYSTEM ACCESSORIES

XSR XTREME SHOOTING REST - #735539 Case Pack of 4

- Switcheroo Shooting System - Easily switch between accessories in the field using the same platform
- Made of lightweight aluminum
- Two USRs that adjust laterally to accommodate most rifles and shotguns
- Designed for gun to be perfectly balanced over tripod
- Two Hook & Loop safety straps to keep firearm firmly secured to XSR
- Rotates 360 degrees to track target easily
- Size: approximately 15 1/2" long x 2" wide
- Weighs approximately 18 oz.



switcheroo SHOOTING SYSTEM

PATENT:
www.BTlbrands.com/patents/

XSR Package:
8" wide x 22" high x 3" deep



SSC SUPER STEADY COMBO - #735550 Case Pack of 2

The SSC features three of our most popular items in one Super Steady Combo pack:
RLD-3 + XSR + USR

Combine all 3 of our most popular products into one super steady shooting platform. The RLD-3 has red cushioned grips, independently adjustable legs with inch markers and is built of lightweight but durable aluminum. The XSR has 2 laterally adjustable USRs to accommodate most any rifle or crossbow. The USRs on the XSR are wide to accept most any stocks and have non-marring rubber inserts to keep the rifle from sliding around.



switcheroo SHOOTING SYSTEM



SSC Package:
11" wide x 38.5" high x 3.25" deep

PATENT:
www.BTlbrands.com/patents/

PSR PRECISION SHOOTING REST - #735545 Case Pack of 4

Perfect for use with Handguns, Crossbows, AR-style Rifles

- Rubber mat on base of plate provides non-slip surface
- Removable rubber pad in riser allows for larger firearm barrels and fore-ends
- Dual-lock system prevents riser from moving for added security
- Base plate and riser made of lightweight aluminum
- Handgrip allows user to rotate the PSR 360 degrees while tracking target
- Easily installs on any BOG-POD tripod with its quick-change stem
- Weighs approximately 26 oz.



PATENT:
www.BTlbrands.com/patents/

PSR Package:
9.5" wide x 20" high
x 4.5" deep

switcheroo SHOOTING SYSTEM



SCA STANDARD CAMERA ADAPTER - #735549 Case Pack of 4

- Bubble level on top of head
- Adjustable SCA head rotates easily with smooth action
- Quick-change stem on bottom attaches to BOG-POD shooting sticks with Switcheroo Shooting System
- Notch in base for rotating camera to a vertical position
- Top Lever release lock to prevent accidental lever release
- Accessory plate has 1/4"-20 and 3/8"-16 thread bushings to fit most mounts
- Includes USR shooting cradle
- Weighs approximately 14 oz.

INCLUDED!



switcheroo SHOOTING SYSTEM

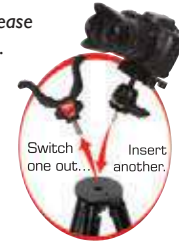

Nicole Reeve
PROFESSIONALS
USE BOG-POD

PERFECT FOR

CAMERAS



CAMCORDERS



PCA PROFESSIONAL CAMERA ADAPTER - #735546 Case Pack of 4

- Bubble level on top of head
- Pistol-grip style ball head allows for one-hand operation
- Quick-change stem on bottom attaches to BOG-POD shooting sticks with Switcheroo Shooting System
- Top Lever release lock to prevent accidental lever release
- Rotating collar for rotating camera to a vertical position
- Accessory plate has 1/4"-20 and 3/8"-16 thread bushings to fit most mounts
- Includes USR shooting cradle
- Weighs approximately 21 oz.

INCLUDED!



switcheroo SHOOTING SYSTEM



SCA Package:
6" wide x 17" high
x 3" deep

SSA SPOTTING SCOPE ADAPTER - #735561 Case Pack of 4

The BOG-POD® SSA clamps securely to a vehicle window to provide a steady viewing platform. The two way rotating camera head allows you to tilt up and down and pan left and right. The adjustment handle allows the SSA to glide smoothly and can be locked down securely. The accessory plate is 1 5/8" x 2" in size and comes with a standard 1/4"-20 camera screw and a 3/8"-16 adapter screw. The SSA clamp is wide enough to attach to Treestands, in box blind windows and on security bars up to 1" thick. The rotating head has the BOG-POD Switcheroo System incorporated so it can easily be installed to any BOG-POD Tripod.

- Two way camera head to adjust the pan and tilt
- 2 piece design allows you to put a USR on the clamp base or mount the 2 Way head any BOG-POD tripod
- Padded clamping surfaces
- Accessory plate fits most common camera mounts
- 3/16-24 and 1/4-20 thread bushings

NEW
2015



Window Clamp
Non-marring material
inside clamp for
protection



SSA Package:
10" wide x 12.5" high x 3.5" deep



switcheroo SHOOTING SYSTEM



PERFECT FOR
SPOTTING
SCOPES





Scott Haugen
PROFESSIONALS
USE BOG-POD



PATENT:
www.BTibrands.com/patents/

USR UNIVERSAL SHOOTING REST - #735538 Case Pack of 4

The USR or Universal Shooting Rest is designed to be an alternate or replacement shooting rest for any BOG-POD shooting stick. The USR will provide the very same 360° head rotation that your original USR offered. Switcheroo System compatible, it is designed to fit very snugly into the center hole of the shooting stick's head for no wobble performance. Weighs 4 oz.

USR Package: 9.5" wide x 10" high x 1.5" deep

MUSR MINI UNIVERSAL SHOOTING REST

#735551 Case Pack of 4

The MUSR or Mini Universal Shooting Rest is intended to be a shorter more low profile alternative or replacement shooting rest for any BOG-POD shooting stick. It is designed for those who prefer a low-profile/compact shooting rest. This MUSR will provide the very same 360° head rotation that your original USR offered. Switcheroo System compatible, it will fit very snugly into the center hole of any BOG-POD head. Weighs 2.5 oz.

MUSR Package: 6" wide x 9" high x 1.5" deep

switcheroo
SHOOTING SYSTEM



WMUSR WIDE BODY UNIVERSAL SHOOTING REST - #735555 Case Pack of 4

The WMUSR or WIDE BODY Universal Shooting Rest is an extra long and wide version of the Mini Universal Shooting Rest. It is designed for those who prefer a low-profile shooting rest that's extra wide for additional stability. The WMUSR will give the added stability needed to take that longer shot. The WMUSR will provide the very same 360° head rotation that your original USR offered. Switcheroo System compatible and will fit very snugly into the center hole of the shooting stick's head. Weighs 7.9 oz.

WMUSR Package: 6" wide x 10" high x 4.25" deep

BSB SUPER STEADY SADDLEBAG - #735559 Case Pack of 4

- Made of high density nylon to hold up in harsh conditions
- Two, velcro-secured side pockets to hold weight/filling
- Removable, aluminum base plate which can be directly secured to various surfaces with screws or zip ties
- Exterior mesh pocket for holding extra ammo or BOG-POD accessories
- Rubber mat on bottom prevents saddlebag from slipping
- Weighs approximately 16 oz. with mounted USR

BSB Includes:

- BSB outer nylon bag
- USR Universal Shooting Rest
- Adapt-a-pod for mounting any BOG-POD Switcheroo System accessory
- Heavy duty plastic bags for use with your choice of filling
- Internal thick aluminum mounting plate

Included Adapt-A-Pod allows the BSB to be used with all BOG-POD Switcheroo accessories

PATENT:
www.BTibrands.com/patents/

Exterior mesh pocket holds extra ammo, or other equipment



360° Rotation

Removable Aluminum center plate.

Water resistant "Saddle Bag" pockets

BSB Package:
7" wide x 14" high x 3" deep

Mount BOG-POD accessories for more stability

Hang over bars and railings for impromptu stability

Shoot out of blind windows

Glass from the cab of your truck

switcheroo
SHOOTING SYSTEM



Mounting notches



Remove the mounting plate and attach it to any surface using screws or zip ties



ADAPT-A-POD

#735554 Case Pack of 4

The ADAPT-A-POD allows you to use BOG-POD accessories with any standard monopod, bipod, or tripod.

ADAPT-A-POD
Package:
4.5" wide x 6.5"
high x 2.5" deep
Standard Tripod



Adapt-a-Pod
secures BOG-POD
accessories

switcheroo
SHOOTING SYSTEM



Switch one out... Insert another.

ADAPT₂ - #735537 Case Pack of 8

The ADAPT₂ quick release plate is 1 5/8" x 2" in size and comes with a standard 1/4"-20 camera screw and a 3/8"-16 adapter screw. This 2 pack is a great addition to the SCA or PCA Switcheroo System adapters. You can attach them to any number of other accessories making them easily usable with the SCA or PCA.

2 PACK!

ADAPT₂ Package:
4.5" wide x 10" high x 1.5" deep



switcheroo
SHOOTING SYSTEM



Switch one out... Insert another.

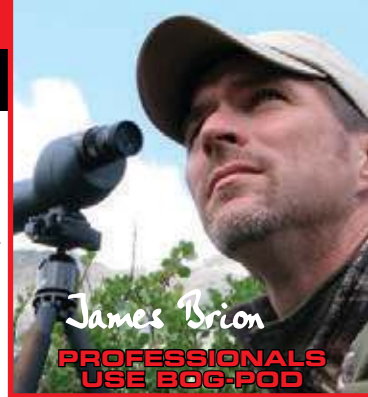

BBR BOG-POD BINOCULAR REST

#735547 Case Pack of 4

PATENT:
www.BTlbrands.com/patents/

- Made of high-strength, lightweight ABS plastic
- Rubber-covered platform protects binoculars and prevents slipping
- Adjustable Heavy Duty rubber strap secures binoculars to platform
- Fits most brands of binoculars ranging in size from 7x to 20x
- Works with any tripod, bipod, or monopod with a mounting bolt
- Includes a 3/8"-16 thread and 1/4"-20 size bushing
- Includes a Switcheroo System stem for mounting BOG-POD platforms
- Can be mounted on SCA or PCA accessory
- Size: approximately 3 1/4" deep x 6" wide x 3/4" tall
- Weighs only 7 oz.

BBR Package:
10" wide x 8.5" high x 4" deep

Attach an accessory plate to the bottom for use on the PCA, SCA or SSA Adapters

switcheroo
SHOOTING SYSTEM



SSM SLING SWIVEL MOUNT - #735562 Case Pack of 4

The SSM mounts directly to your rifle sling swivel stud. One end of the SSM can be mounted to any switcheroo® compatible BOG-POD®. The other end is a sling swivel stud, allowing you to mount your sling while the SSM is attached. Once the SSM is mounted to a BOG-POD it will stay mounted even if you pick up your rifle. The POD and SSM will not detach. Now you can move your rifle, POD attached, for quick target re-acquisition.

NEW
2015

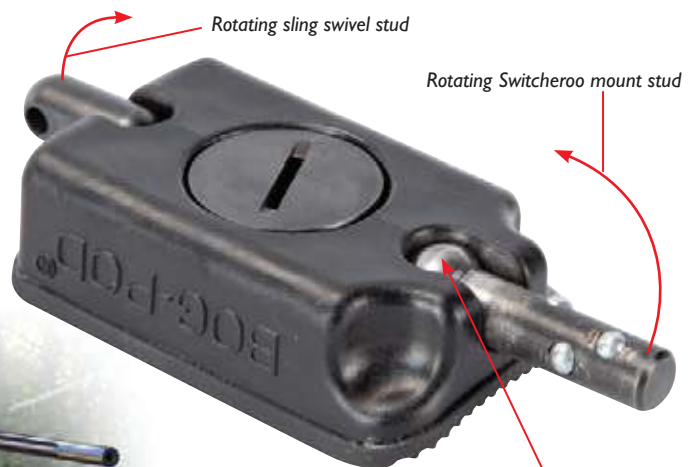

Ball joint allows gun to be leveled on BOG-POD

SSM fits standard round swivel studs ONLY.

SSM Package:
5" wide x 5.75" high x 1.25" deep



switcheroo
SHOOTING SYSTEM



Switch one out... Insert another.



BOG-POD
TRIPODS • BIPODS • MONOPODS • ACCESSORIES

Protect your investment with the BEST



Hot Zone[™] DEER EXCLOSURE SYSTEM

- Protects up to 3/4 acre
- System sets up and takes down quickly
- Includes all components except 12 volt deep cycle battery
- Integrated solar charging system allows for use in remote area
- Dual perimeter electrification reliably deters deer with minimal material investment



The Hot Zone Deer Exclosure System is a complete kit that allows you to manage browse pressure on your food plots to ensure maximum plot success. Over browsing can cause limited plot production or even complete plot failure. Protect your investment of time, money and labor in plot establishment. Maintain control over when deer can access any particular food source. Once a food plot reaches proper maturity and can withstand heavy browse pressure, the system can be easily deactivated to allow deer access.



Dual Perimeter Fence on the Market!



HotZone Deer Exclusion System 220 yard perimeter

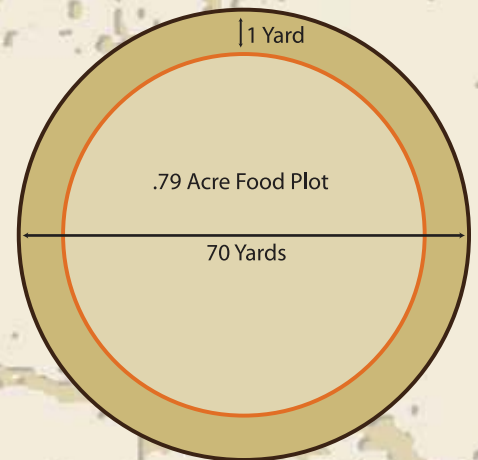
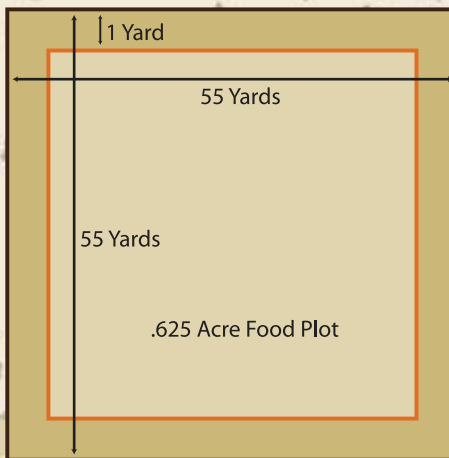

DEER EXCLOSURE SYSTEM

#717100 Case Pack of 1
HotZone DES Includes:

- Energizer 1
- Solar Panel 1
- 7/8" Post 8
- 1/2" Post 32
- Wire 460 yards
- Tape 230 yards
- Post Pins 65
- Wire Tensioners 3
- Ground Rod 1
- Voltage Tester 1
- Instructions 1

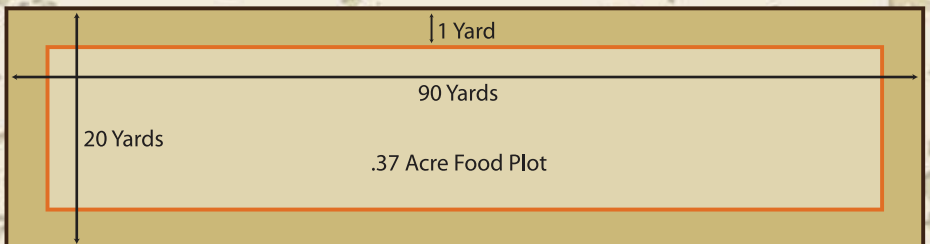

**HotZone DES Package: 49" wide x 9" high x 12.5" deep
Weighs 57lbs.**



HotZone Expansion Kit

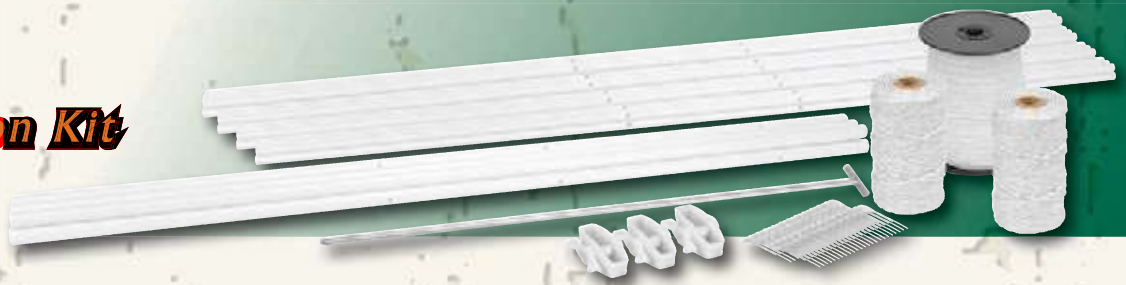

420 yard perimeter

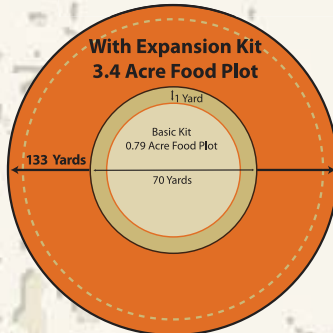
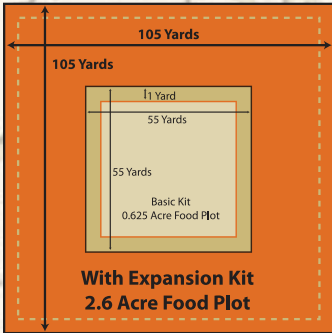

Need more coverage? The HotZone™ Expansion Kit can add up to 3 acres (420yds perimeter) of coverage depending on your food plot shape. The kit comes complete with everything you need to add more fencing to your existing HotZone™ Deer Exclusion System. Use your existing Energizer (included in the HotZone Deer Exclusion System) to power up to 20 acres of Deer Exclusion Fencing.

- Allows you to add coverage to your HotZone Deer Exclusion System
- Expansion Kit can increase the total coverage of the Initial Kit to 1.5 - 3 acres (420yds. perimeter) depending on plot shape
- Your existing Energizer can power expanded systems up to 20 acres
- To help with conductivity an additional ground rod is included in each Expansion Kit

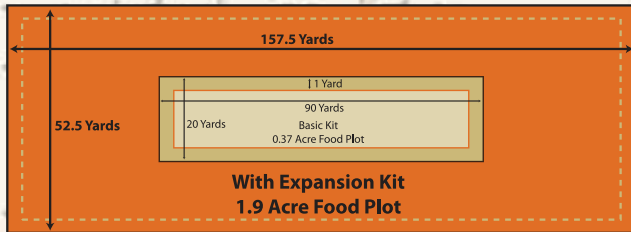

HOTZONE EXPANSION KIT - #717122 Case Pack of 1

HotZone Expansion Kit Includes:

- 7/8" Post 8
- 1/2" Post 32
- Wire..... 400 yards
- Tape..... 200 yards
- Post Pins 60
- Wire Tensioners 3
- Additional Grd. Rod, wire, clamps..... 1
- Instructions 1

HotZone Expansion Kit Package:
48" wide x 9.25" high x 8.25" deep

Weights 52lbs.

Interested in supplying your own fencing materials? We offer the Energizer as a stand alone item as well!

HOTZONE ENERGIZER UNIT - #717133 Case Pack of 21

- 12,000 volt output, 2.7 Joules
- LED lights show voltage and status of the battery
- 1.5 and 2.5 second pulse interval modes
- Automatic switch between day and night modes
- Powered by either a 12 volt battery or 110 volt AC
- Power up to 20 acres of Exclusion Fencing

Energizer Package:
11.5" wide x 12" high x 4" deep

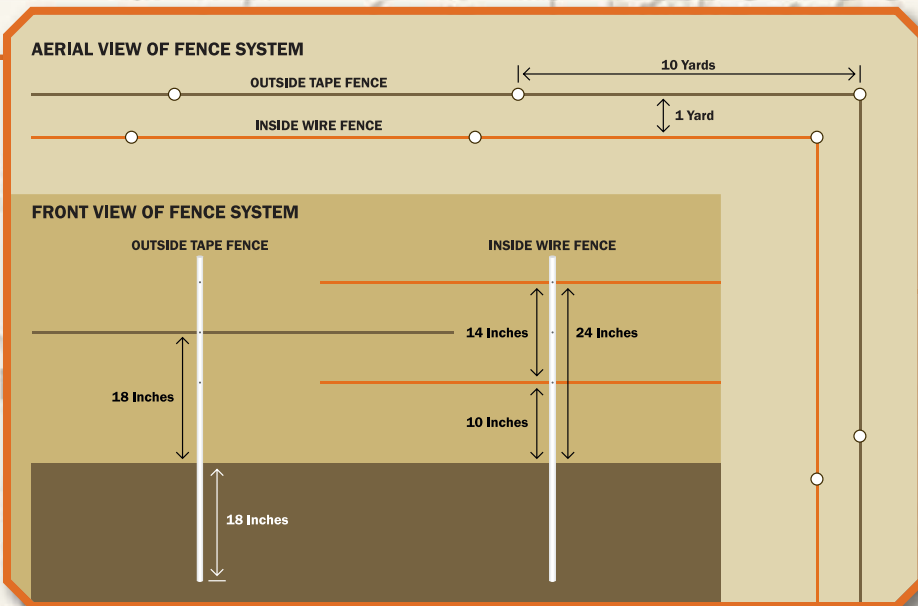

Dual perimeter design
deters deer with minimal
material and setup time.



Control access to your food plot with the HotZone

DES as well as protect it from over browsing.

By opening a section of fence on a mature food plot you can control how the deer access it. This is great for setting up the perfect trail camera, stand, or blind location. Open a section of fence that gives you the optimal angle.

The deer enter from the open section of fence yet the fence stays live to ensure the deer only access the plot from the sections you choose to open.

Be sure to check local regulations for use during hunting season.

How does the Hot Zone Deer Exclusion System keep deer out the food plot?

The Hot Zone Deer Exclusion System's dual perimeter design is what keeps the deer out of food plots. If the system was just a single row of electric wire or tape a deer could easily jump over it. The dual perimeter forces the deer to get really close to the outer tape to think about jumping both fences or ducking under the tape. At this point the deer comes in contact the outer tape and is shocked and deterred from trying to enter the food plot.

How big of a food plot can I protect?

The energizer provided in the Hot Zone Deer Exclusion System can safely and effectively power up to 20 acres of electric fencing, although the initial kit only comes with 220 yards of perimeter fencing, which will protect .39 to .79 acres depending on the shape of the food plot. The addition of one expansion kit will be an extra 200 yards of perimeter fencing and components giving a total of 420 yards of fencing, which will protect 1.9 to 3.4 acres depending on the shape of the food plot. Multiple expansion kits can be added to obtain 20 acres of coverage.

How do I power my Hot Zone Deer Exclusion?

The Hot Zone expansion Kit can powered in one of two ways. Included in the Hot Zone Deer Exclusion System (717100) and The Energizer alone (717133) is a 110AC plug-in and a Battery Clamp plug-in. Only one of these plug-ins can be installed in the energizer at one time. If 110AC is desired, select the plug-in with 110AC plug and insert it in the back of the energizer; then plug into a wall outlet or extension cord that is plugged into a wall outlet. If a battery is desired, select the plug-in with 2 battery clamps and insert it into the back of the energizer. Then Clamp the red clamp to the positive post on the battery and the black clamp on the negative post of the battery. Then take the solar panel clamps and attach the red clamp to the positive post of the battery and the black clamp to the negative post on the battery. The use of the solar panel will keep the battery charged during normal use and your energizer running.

We recommend the use of a deep cycle battery if using the battery/solar panel method of powering your energizer

Heavy browsing prevents plant growth and seed pod development.



Trail camera photos of a HotZone DES with an open section. Notice how you can direct the location and angle deer access your mature food plot.



Battenfeld® Technologies, Inc.

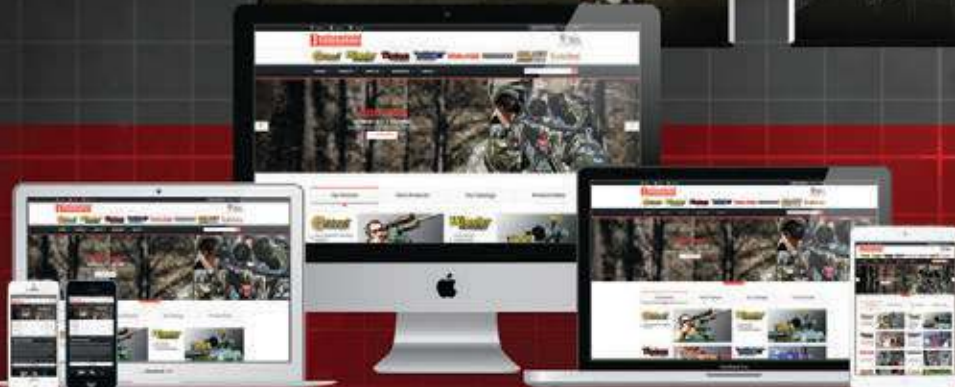
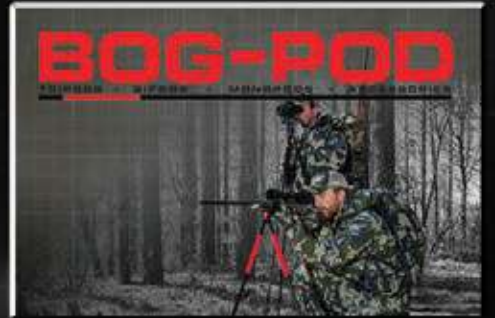

NEW WEBSITE

The BTI family of brands are showcased on a NEW website! Go to www.BTIbrands.com and easily navigate through our products, find information, pricing, and even Hi Resolution Images for use quickly and easily.

To find the new Hi Res images feature: locate the product on our website, click the DOWNLOADS icon, and a list of thumbnails will open showing you all our available production images. Simply download them to your desktop!