

WIN A CHEVY TRACKER SEE PAGE 47

AUDIO

THE EQUIPMENT AUTHORITY

**THETA CASA NOVA
SURROUND PREAMP**

**A Hunka Hunka
Burnin' Love!**

**POLK AUDIO'S RMDS-1
High-End Home Theater
For Regular People**

**NAD'S CLASSY,
CLASSIC C340
AMPLIFIER**

**EXTREME AUDIO
The Ultimate
Cable Upgrade**

THETA Casa Nova
POLK AUDIO
NAD
EXTREME AUDIO

0 27063 1

CAN \$4.99

ONE GOOD DENON LEADS TO ANOTHER.



D·D·S·C
DIGITAL

 DOLBY
DIGITAL

DIGITAL

SURROUND

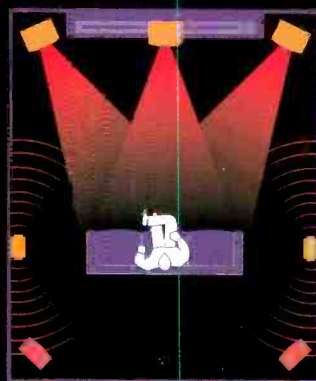

MOVIE SURROUND



MUSIC SURROUND

"This receiver gets my highest recommendation."

— Joe Hageman, Home Theater



FROM DENON'S AVR-5700 COMES THE MASTERFUL AVR-3300.

Denon's AVR-3300 — affordable surround sound without compromise. Like our critically acclaimed AVR-5700, the new AVR-3300 lets you choose between two surround speaker types and placements for discrete multi-channel music and movie surround soundtracks. Powered by the newest Analog Devices 32 bit SHARC DSP processor with real 24 bit/96 kHz D/A conversion, the AVR-3300 includes state-of-the-art features such as component video switching, along with 8 channel external input and 8 pre-amp outputs for future sound format and system upgrade capability. Denon's AVR-3300 A/V receiver — the finest sound you've ever experienced, for far less than you'd ever imagine.

DENON
the first name in digital audio

Denon Electronics, 222 New Road, Parsippany, NJ 07054 • 973-396-0810 • www.del.denon.com
Download AVR-3300 product information (including the owner's manual) from our website.

Definitive's ProCinemas® Deliver "Monstrous Sound From Tiny Speakers"

—Joe Hageman, *Home Theater Magazine*

"Truly incredible speakers at an unbelievable price!"

—Jeff Cherun, *Home Theater Magazine*

"A new standard for sub/sat systems" —*Home Theater*

Now you can get Definitive's high-end leading-edge technology and world-class sound quality at an incredibly affordable price. Beginning at only \$575 (for the 3-piece Pro 80.6 system) all our highly-acclaimed ProCinema® sub/sat systems are elegantly styled, remarkably compact and will deliver absolutely state-of-the-art performance for stunning music and movie perfection. They are clearly your number one choice for unmatched quality and value.

"They sound like monster towers" —*Home Theater*

With their awesome 250 watt-powered 8", 10" or 12" subwoofers, non-resonant NROC™ curved PolyStone™ cabinets, high-definition diecast-basket drivers and precision Linkwitz-Riley crossover networks, Definitive ProCinema systems will make performances really come alive in your room and literally put you right in the concert hall or into the movie itself. They are, as *Time Magazine* raves, "phenomenal." Hear them at a Definitive dealer today!



ProCinema 100.6 System \$1349



ProCinema 80.6 System \$999



ProCinema 200.6 System \$1746

Definitive Technology®
The Leader in High-Performance Loudspeakers

11433 Crunridge Drive • Owings Mills, MD 21117 • (410) 363-7148
Visit us at www.definitivetech.com

See our dealer list on page 65

AUDIO

DECEMBER 1999 VOL. 83, NO. 11



DEPARTMENTS

ABOUT OUR CONTRIBUTORS *The people behind the pages* 6

CROSSTALK *Thorny contradictions, CD snafus, and big horns* 8

AUDIO CLINIC Joseph Giovanelli
That tube sound and hot amps 12

NEW GEAR *A DVD player/Dolby Digital receiver, THX speakers from M&K, and a roomy software storage cabinet.* 14

SPECTRUM *Sound in the home office.* 21

POST-PRODUCTION Michael Riggs
Saving the future of component audio 120



FEATURES

SPEAKER DESIGN MASTER CLASS
David Lander
Lessons from PSB's Paul Barton 24

THE ULTIMATE CABLE UPGRADE:
AN OBSESSIVE'S GUIDE Ken Kessler
Getting really wired 30

1999 ANNUAL INDEX 107



RECORDINGS

DVD *Bustin' out all over* 97

CD *Luther Allison plays on* 103

TZ-F700 Reference Standard Speakers What you're looking at is the IRIS midrange-tweeter array of our home theater reference speakers. The unique design allows sound to radiate from a single point for precise imaging. The IRIS can also be turned, so the sweet spot can move to almost anywhere you are. The seven-ply, low-resonance cabinet houses a 300 watt powered woofer to ensure that the low end sounds high-end, as well. We invite you to experience the system at your Pioneer® Elite® dealer. Because while **ELITE** the design definitely catches your eye, it can only be truly appreciated with your ears.

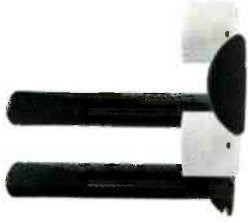

**They're just as startling
with your eyes closed.**



Pioneer

AUDIO

REVIEWS

THETA DIGITAL CASA NOVA SURROUND PREAMP

Corey Greenberg
Can the child outshine the parent? 37

POLK AUDIO RMDS-1 HOME THEATER SYSTEM

Doug Newcomb
Breaking home-theater-in-a-box out of the box . . . 45

LINN GENKI CD PLAYER Ken Kessler
A CD player for grownups. 53

PSB STRATUS SILVERⁱ SPEAKER D. B. Keele, Jr.
Not "sliver" but Silver, despite its tall, thin front . . . 61

VIENNA ACOUSTICS MAHLER SPEAKER
Anthony H. Cordesman
Color it musical 67

NAD C340 INTEGRATED AMP Paul Tatara
Classic NAD, updated. 73

LEXICON DC-2 A/V PREAMP Edward J. Foster
Fourth-generation digital surround processing. . . . 79

CASTLE SEVERN 2 SPEAKER Ken Kessler
Traditionally British in the very best sense 91



73



79



61



91



67

Cover: Photographer: Bill Kourinis Studio. Cover Equipment: Polk Audio RMDS-1 home theater system and Theta Digital Casa Nova surround preamp. Audio Publishing, Editorial, and Advertising Offices: 1633 Broadway, New York, N.Y. 10019. Editorial Email: audiomag@aol.com. Subscription Inquiries: phone, 303/604-1464; fax, 303/604-7455; email, hachette@neodata.com (must include magazine title, your name, and old and new addresses).

ABOUT OUR CONTRIBUTORS

COREY GREENBERG is editor of *Audio*. The close of this century marks the ninth year he's spent writing about high-end audio for such publications as *Sound & Vision*, *Stereophile*, *Rolling Stone*, *Spin*, and *Wired*. Nine years. There they were, and there they went. Nearly a decade of youth and vigor and endless possibility, and he spent it all writing about @%#\$ stereos. Does he wish he could have those years back? Sure he does. Wouldn't you? But he can't have them, not for all the money in the world. Now look at him, hunched over his keyboard like some monkey in a lab, pawing endlessly at banana-shaped buttons so the trap door keeps spilling saltpeter-laced feed pellets. Well, at least it beats working at *Home Theater*.

RAD BENNETT hails from Chapel Hill, North Carolina, where he saw absolutely every movie that ever played on the town's two screens, even the ones, such as *Picnic*, that were forbidden by his parents. A former music critic for the *Washington Star*, his articles and reviews have appeared in *Sound & Vision*, *High Fidelity*, *The Absolute Sound*, *The Perfect Vision*, *Home Theater*, and *Fi*. Bennett also publishes *The Laser Disc Gazette's DVD & CD Report*, a bimonthly newsletter devoted to DVD and CD reviews, which can be reached at dvd@citynet.net.

PAUL TATARA comes to *Audio* from CNN.com, where he enjoys skewering the sad state of American movies as one of the site's regular film critics. Also a screenwriter, he is currently revising his original screenplay for the film *The Almost Perfect Game*, which Woody Harrelson is set to produce and star in for Paramount Pictures. Growing up in Arab, Alabama (pop. 6,800), Tatara became obsessed with rock and jazz, particularly the music of Bruce Springsteen, The Beatles, Bob Dylan, Randy Newman, Lou Reed, Miles Davis, and Thelonious Monk. Tatara married the awe-inspiring Jill Hilycord on October 16th of this year.

DOUG NEWCOMB is executive editor of *Car Stereo Review*. He has written about audio for such publications as *Rolling Stone*, *Men's Journal*, and *Playboy*. Newcomb detoured into audio journalism from a background as a music reviewer, and he still gets out to hear live music (everything from alternative to zydeco) at every opportunity. He blames his lifelong obsession with music on having been born in the Mississippi Delta and raised in Louisiana's bayou country. Newcomb lives and works in L.A.'s Topanga Canyon and divides his time between his family, music, and surfing, though he admits that the surf usually dictates which one gets top priority.

AUDIO

EDITOR-IN-CHIEF MICHAEL RIGGS

EDITOR COREY GREENBERG

ART DIRECTOR CATHY CACCHIONE
ASSOCIATE ART DIRECTOR LINDA ZERELLA

TECHNICAL EDITOR IVAN BERGER
SENIOR EDITOR ALAN LOFFT
MANAGING EDITOR KAY BLUMENTHAL

MUSIC EDITOR SCOTT VAN CAMP

ASSISTANT MANAGING EDITOR WARREN L. MEISLIN
EDITORIAL ASSISTANT MICHAEL RAZ

SENIOR CONTRIBUTING EDITORS
EDWARD J. FOSTER, D. B. KEELE, JR.,
DAVID LANDER

TRUE TECHNOLOGIES
BOB TRUE, DAVID PRINCE

CONTRIBUTING EDITORS/ARTISTS
RAD BENNETT, TED COSTA, ANTHONY H. CORDESMAN,
JOHN DILIBERTO, JOHN EARGLE, JOHN GATSKI,
JOSEPH GIOVANELLI, WILLIE GLUCKSTERN,
DAWN JONIEC, KEN KESSLER, DANIEL KUMIN,
ROBERT LONG, DOUG NEWCOMB,
PAUL TATARA, JIM WILLCOX



V.P./GROUP PUBLISHER TONY CATALANO
V.P./PUBLISHER SCOTT CONSTANTINE 212/767-6346

REGIONAL ACCOUNT AD MANAGERS

JERRY STOECKIGT 312/923-4804
PAUL C. SMITH 212/767-6077
GABRIELLE DiFOLCO 212/767-6063

REGIONAL V.P./AD DIRECTOR, WEST COAST

BOB METH 323/954-4831

NATIONAL RECORD LABEL AD SALES

MAG INC. MITCH HERSKOWITZ 212/490-1715
CLASSIFIED ADVERTISING 800/445-6066

HACHETTE INTERNATIONAL

V.P., GLOBAL ADVERTISING AUDE DE ROSE 212/767-6369

DIRECTOR OF MARKETING ROB SABIN
PROMOTIONS MANAGER MARIA COPPOLA
ASSISTANT TO THE PUBLISHER ANIKA WILLIAMS
OPERATIONS MANAGER/AD COORDINATOR LINDA NEUWEILER

GENERAL MANAGER GREG ROPERTI
BUSINESS MANAGER SAL DEL GIUDICE
PRODUCTION DIRECTOR MICHAEL ESPOSITO
PRODUCTION MANAGER LYNN O. SCAGLIONE
SR. PRODUCTION ASSISTANT EUGENIA SLUBSKI
SUBSCRIPTION DIRECTOR JOHN DAGNEY
NEWSSTAND SALES DIRECTOR MEGAN JENKINS
DIRECTOR OF CIRCULATION SERVICES ROCCO P. CHIAPPETTA

CHAIRMAN Daniel Filipacchi
PRESIDENT & CHIEF EXECUTIVE OFFICER Jack Kliger
SR. EXECUTIVE V.P. & EDITORIAL DIRECTOR Jean-Louis Ginibre
EXECUTIVE V.P. & CHIEF OPERATING OFFICER John Fennell
SR. V.P., CHIEF FINANCIAL OFFICER & TREASURER John T. O'Connor
SR. V.P., DIRECTOR, GROUP PUBLISHING & CORPORATE SALES Nicholas J. Matarazzo
SR. V.P., GROUP PUBLISHING DIRECTOR John J. Miller
SR. V.P., GENERAL COUNSEL Catherine Flickinger
SR. V.P., MANUFACTURING & DISTRIBUTION Anthony R. Romano
V.P., CIRCULATION David W. Leckey
V.P., COMMUNICATIONS & SPECIAL PROJECTS Keith Estabrook
V.P., CORPORATE STRATEGY Charles McCullagh
V.P., HACHETTE FILIPACCHI NEW MEDIA Donald Perri

SONY

DUB YOUR MUSIC 4X'S FASTER

RE-RECORDABLE
DIGITAL
PORTABLE
VIRTUALLY UNSHOCKABLE



THE SONY MINIDISC HIGH SPEED DECK IS A FASTER WAY TO DIGITALLY RECORD YOUR CDS TO MDs. MAKE A MIX FOUR TIMES FASTER AND LEAVE EVERYONE ELSE IN THE DUST.* FOR MORE INFORMATION, LOG ON TO WWW.SONY.COM/MD HEAR HUNDREDS OF YOUR FAVORITE ARTISTS ON MD. VISIT YOUR LOCAL MUSIC RETAILER AND CHECK OUT WWW.SONYMUSIC.COM/MINIDISC

*Compact Disc condition may hinder high speed dubbing capability. Speed measured against real-time recording.

SONY M O THE ABSOLUTE BEST WAY TO RECORD YOUR MUSIC™

MUSIC AND HOME THEATER
SYSTEM
NINE

*"a remarkable reproducer...
 extraordinary... outstanding"*

—Andrew Marshall, Audio Ideas Guide, on the Monitor 90P

WORRIED ABOUT WHERE YOU'RE GOING
 TO HIDE A SUBWOOFER? DON'T BE —
 PARADIGM MAKES IT EASY!

WHETHER YOU'RE INTO ROCK 'N' ROLL,
 DRUM 'N' BASS, OR BRAHMS 'N'
 BEETHOVEN, SUBWOOFERS ARE AN
 IMPORTANT PART OF ANY LISTENING
 EXPERIENCE — THEY'RE NOT JUST
 FOR HOME THEATER.



\$2527

PARADIGM SYSTEM NINE	
FRONTS:	MONITOR 90P
CENTER:	CC-350
SURROUNDS:	ADP-350
POWERED SUB:	BUILT-IN

AND NOW WE'VE BUILT SUBWOOFERS
 RIGHT INTO OUR MONITOR 70P AND
 90P SPEAKERS. THE BEST OF BOTH
 WORLDS: CRYSTAL-CLEAR, NATURAL
 SOUND AND DEEP, TIGHT BASS!

DROP IN ON YOUR LOCAL AUTHORIZED
 PARADIGM DEALER TODAY AND ASK TO
 HEAR THE PARADIGM SYSTEM NINE.

\$2527 PUTS THE BASS IN YOUR FACE —
 AND KEEPS IT OUT OF SIGHT.

Paradigm

THE ULTIMATE IN HIGH-PERFORMANCE SOUND™

CROSSTALK

A Tad Overboard?

I enjoy your magazine, but a couple of the equipment reviews in your September issue overpraise their subjects. First, the Krell KAV-300r receiver has mediocre FM performance compared to the Marantz SR-880 (reviewed in your November 1997 issue), a more complete receiver at less than half the price. Second, Ken Kessler says the B&W DM605 is one of the best buys on the market, at \$2,200 a pair. You jest! Consider the VMPS Tower II Special Edition at \$1,876 a pair—taller and much heavier, big bass! Or the Klipsch KLF 30—also bigger and heavier and priced at \$1,800 per pair. A Paradigm Reference Servo-15 powered subwoofer with a pair of Studio/20s is \$2,200—huge bass and flexibility. Then there's the Von Schweikert VR 2100 or the Paradigm Reference Studio/100. The B&W is very good, but it is not a best buy in terms of value.

The comparisons are maddening, confusing, and, ah, please keep up the excellent writing!

Brian Paulsen
 Grand Forks, N.D.

Test and Verify!!

FM reception is poor where I live, in the hills of northwest Connecticut. I've been looking for a tuner to replace my ancient Nakamichi ST-100, which has served me well for many years. Although I was in the market for a stand-alone tuner, I thought that Krell's KAV-300r receiver would let me upgrade all of my electronics at once without having to settle for mass-market receiver sound. Therefore, Daniel Kumin's review in your September issue was particularly intriguing to me.

Kumin says he found the KAV-300r's tuner unsatisfactory in several aspects, despite it coming from Day/Sequerra, which has the reputation of making very fine front ends. It is not clear what was wrong with the tuner, however. Was it a matter of poor sensitivity, poor selectivity, poor capture ratio, or what? Kumin was using antennas that are far inferior to mine, so I don't know whether I will have a problem or not. Apparently there were no lab tests made on the tuner at all!

Although I'm not really interested in the Rotel RSX-965, there were no tuner tests in

that review, either, so I guess that's your policy. How can you call yourself "The Equipment Authority" when you don't test the tuner portions of receivers?

Alfred A. Gader, III
 Falls Village, Conn.

Thorny Contradictions

The new *Audio* looks great, and I appreciate having more reviews, which is the main reason I buy *Audio*. I have trusted your reviews and reviewers in the past, but I am not sure I can continue to do so. For example, I cannot understand how Willie Gluckstern could find the Marantz PM-17 amplifier's sound quality so sadly lacking while Michael Riggs reviewed the test data and said that the amplifier met a high performance standard and was nicely done. Frankly, I believe Riggs more than Gluckstern because test data seldom lies, Riggs's credentials are self-evident, and Gluckstern seems woefully ignorant of audio. There is nothing in his biography that qualifies him as an audio reviewer. I would not trust him as a wine critic, either, since he seems to have so many potential conflicts of interest. I'm shocked *Audio* would hire such a person.

Paul Tataro, meantime, may be a film critic, but does that qualify him to review audiophile gear? If integrated amps confuse him as much as he says, how can he be trusted to review one? He seems to love the Acurus DIA 150, but the test data doesn't seem impressive.

The distortion is far higher in the Acurus than in the Marantz, but the Acurus got a rave review and the Marantz was condemned. I don't get it, and I won't be getting *Audio* much longer if this keeps up. Please fix it!

Russell A. Long
 New York, N.Y.

CD Snafu

I have multiple audio systems in my home (both tube and transistor) that I enjoy very much. Sometimes I think I have more fun assembling the components in each system than actually sitting down and listening to them!

My latest system is still incomplete because I refuse to purchase a DVD player/decoder until the dust settles and a more uni-

DON'T LET THE PRICE FOOL YOU

"I'VE HEARD HIGHLY REGARDED
\$2,000 2-WAY 6-INCHERS THAT
COULD NOT KEEP UP..."

- Cory Greenberg, Audio, on the Paradigm Mini Monitor

NOW, SPECTACULAR HIGH-PERFORMANCE
SPEAKERS CAN BE YOURS FOR AS LITTLE
AS \$149 PER PAIR. COMPLETE HOME
THEATER SPEAKER SYSTEMS - POWERED
SUBWOOFER AND ADP™ REVERBERANT
SURROUNDS INCLUDED - BEGIN AT A
SHOCKING \$816. BUT DON'T LET THE
PRICE FOOL YOU. SPENDING MORE MAY
ACTUALLY GET YOU LESS.

HEAR THE MOST AWARD-WINNING
SPEAKERS OF THE '90S AT YOUR LOCAL
AUTHORIZED PARADIGM DEALER TODAY.

www.paradigm.ca



In the US, contact ALPIDSYSTEM, 1460 Bay St., Niagara Falls, NY 14301 tel 905-320-1100

In Canada, contact PARADIGM, 215 Arden Rd., Mississauga, ON L5T 2Y1 tel 905-502-8888

Copyright ©1998 Paradigm Electronics Inc. and Baxan Corp.

Prices reflect manufacturer's Full

Paradigm

Paradigm®

THE ULTIMATE IN HIGH-PERFORMANCE SOUND™

versal format is released. I considered purchasing the Sony DVP-C600D but decided to hold off so I would not get caught short on capabilities.

This same system of mine includes a Sony GA7ES receiver and CDP-CX205 and CDP-CX260 200-disc CD changers. Incidentally, I would like to compliment Sony for its forethought to include 400-disc I.D. display memory locations in its CX260 to cover the lack of them in the earlier-released CX205. It really works out very nicely.

However, this is where I discovered a problem with disc manufacturers and their new text-embedded CDs. The CX260 allows you to manually load 13 characters in each of the 400 I.D. display memory locations, so you can see on the player display and your remote which CD is about to play. This function works fine on any CD that is *not* text-embedded. The new discs override the manual input and automatically display their text I.D. information. At first, you might think that this feature is

wonderful in saving you from manually entering your own CD I.D. information. But I have already found three of my text-embedded CDs displaying the same title information—one example being “Greatest Hits”—so I would rather know what disc is loading in my player and enter my own I.D. information. *Michael Cummings via e-mail*

Patent Uncertainty

In “Solid-State Centennial,” in the June “Spectrum” column, Ivan Berger wrote, “Unofficially, [solid-state electronics] hits the century mark this year, the anniversary of Ferdinand Braun’s 1899 patent for a crystal detector.” I did not know about this. Is this a German patent? What is the patent date, title, and number?

Shih-Ming Hu via e-mail

Author’s Reply: It probably was a German patent, but I have no further details. My original source was an article entitled “The

middle age of the transistor” in *The Economist’s* January 3, 1998, issue.—*I.B.*

In Big Horns We Trust

I have been a fan of Paul Klipsch and his Klipschorn since it was introduced in the late ’40s. Back then Klipsch used small midrange drivers. Now, with the Jubilee, he is really playing “catch-up” to the JBL Hartsfield, which used a D375 driver (4-inch diaphragm, 2-inch throat) as midrange. Although the Hartsfield speaker was derived from the Klipschorn, there was more air behind the 15-inch driver. I am glad to see that Paul Klipsch finally recognizes the advantage of a large mid-range horn and driver.

Incidentally, I have had one of Jim Hartsfield’s handmade experimental models (possibly the first) for many years, and it is still in my extended family. Both Paul Klipsch and Jim Hartsfield made notable and vital contributions to the field of sound reproduction.

*Edgar E. Price
Nokomis, Fla.*

Over Three Decades of Acclaim

1969: “In short, a really good speaker” – Hi-Fi News, UK

1972: “...in the elite class of small monitor speakers” – Audio, USA

1976: “If you want a winner...then it must be the Mordaunt-Short” – Practical Hi-Fi, UK

1990: “...a four star value rating” – Hi-Fi Sound, Europe

1995: “...a remarkable design” – Hi-Fi News, UK

1996: “Best Center Speaker” – Home Entertainment, UK

1997: “...a speaker with more refinement than previously possible” – Audio Video, Singapore

1998: “Highly Recommendable” – Stereophile, USA

2000: *The Declaration Series*

marantz®



Marantz proudly presents our Reference Series DVD player, the DV-18. It is one of the very few DVD players to have earned Lucasfilm's prestigious THX Ultra certification - your assurance of the highest performance standards obtainable.

The DV-18 features premium parts and construction throughout, including our exclusive copper shielded High Definition Amplifier Modules (HDAM) and audiophile grade internal components.

Of course, the DV-18 is state-of-the-art in every respect, taking full advantage of all the DVD format capabilities. The 10-bit digital video processing is output through gold plated connectors including component video, and Dolby Digital or DTS encoded surround sound is delivered via both coaxial and optical digital outputs.

The DV-18 is designed for the most discriminating admirers - those who expect spectacular home theater performance. And best of all, it's available now from your Marantz audio/video specialist.



Only For The Most Discriminating

Marantz America, Inc., 440 Medinah Road, Roselle, IL 60172 Telephone: 800-270-4533, Ext. 101
www.MarantzAmerica.com

"DOLBY DIGITAL" is a trademark of Dolby Laboratories Licensing Corporation. DTS is a registered trademark of DTS Technology. THX Ultra is a registered trademark of Lucasfilm Ltd.

because music matters

That Tube Sound

Q *I am using a tube preamp with a solid-state power amplifier. Although the combination seems to work well, I feel I may be missing that characteristic tube sound because of this unconventional match.—Name withheld*

A The tubes-versus-solid-state issue is highly subjective, at best. What I can tell you is that if you are unhappy with the overall sound of your system for any reason, you should consider getting different equipment. It isn't even a question of proper matching of components; it's a matter of what sounds right to you. I can't think of many amp/preamp compatibility issues, except that the power amplifier's input impedance should be at least 10 times greater than the preamp's output impedance. Since tube preamps tend to have relatively high output impedances and transistor power amps sometimes have quite low input impedances, this can be an issue in a system like yours.

HDCD-Encoded Discs

Q *It seems like every CD I buy lately is HDCD-encoded. But why are there so few CD players that have HDCD decoding? How different is the sound when an encoded disc is used with a CD player lacking this feature? Is it like listening to a Dolby-encoded cassette tape with Dolby noise reduction turned off? Many people I talk to have never heard of HDCD.—Glenn Bennett, San Diego, Cal.*

A I suppose somebody's gonna jump on my case, but I think that if you listen to an encoded disc on a player that doesn't have HDCD (High Definition Compatible Digital) decoding, you will get a reasonably accurate representation of what was on the original master source. I say "reasonably accurate" because though several studies and listening tests have shown that HDCD-encoded CDs do sound "better" than—or certainly different from—nonencoded discs, it means that an HDCD disc is no longer a faithful reproduction of the original program.

The sonic differences between HDCD and non-HDCD discs aren't nearly as bla-

tant as listening to a Dolby-encoded tape with Dolby noise reduction turned off. Indeed, they're quite subtle, so much so that in some cases the only way to hear any difference at all is to switch back and forth between two CD players, one loaded with an HDCD-encoded disc and the other of the same recording but not encoded.

The fact that the differences are simply too difficult to detect except under experimental conditions may help explain why HDCD hasn't been embraced by the mass market. However, since HDCD was introduced some years ago, the decoding IC has been used in a fair variety of CD players, and prices have fallen for players so equipped.

Some CDs Play, Some Don't

Q *My CD transport is behaving oddly. It reads some CDs but sometimes not others. Yet after playing a CD it can read, it then reads and plays the discs it previously couldn't handle! I also discovered that if I hit the CD tray hard, my transport will play the stubborn discs that were previously unreadable. What is wrong?—Joe Truong, via e-mail*

A Given your efforts, I suspect that CDs are not always seating properly. Perhaps there is a tiny plastic projection that prevents discs from settling. Hitting the drawer may permit a disc to slip past the defect. Maybe the drawer does not close perfectly on the first try. Subsequent cycling of the drawer mechanism may free it up so that it works properly. I have seen players in which the belt that moves the laser pickup assembly had stretched, preventing the pickup from reaching its proper start position. When this happens, the transport does not receive the table-of-contents track information that enables a CD to play. If there are variations among discs, some may work while others won't. When the player runs for a while, perhaps the drawer mechanism tends to free itself a bit and lets the laser transport move more easily. Replacing the belt should solve the problem. Also check with the transport's manufacturer to see if this is a

common problem for the particular model and if there is a simple way to fix it.

New Speakers, Hot Amps

Q *I'm worried about how hot my amplifiers are running now that I've replaced my old speakers with a new pair, which I've biamped. My new Paradigm Monitor 9s sound great, but I have to set volume higher to obtain the same level I got with my old speakers. I've tried specialty speaker cables and interconnects, to no avail. Will the extra heat shorten the life of my amps? Would rack-mounting the amplifiers with a quiet cooling system help?—John Sokolowski, Davenport, Iowa*

A If your new speakers are considerably less efficient than your old ones (and they probably are), then you will have to turn up the volume to get comparable sound levels. This demands more electrical power from your amplifier, which increases heating of the output stages as more current flows through them. If you are not driving your amp beyond its rated power output, it should be able to withstand the added heat. Some amplifiers produce quite a bit of heat when they are driven hard, even though they are not run to their limit. If you are in doubt, use a muffin fan to cool the heat sinks. I have no specific recommendations about quiet fans, however. Frankly, I think you should use a fan even if you do not rack-mount your amplifiers. For safety's sake, you probably should not enclose them. Under circumstances like those you have described, I always recommend using a fan. Cooling will not shorten the life of an amp, and it may well prolong it because excess heat does affect an amp's longevity. Changing your interconnects will have no effect on the situation. **A**

If you have a problem or question about audio, write to Mr. Joseph Giovanelli at AUDIO Magazine, 1633 Broadway, New York, N.Y. 10019, or via email at joegio@cstone.net. All letters are answered. In the event that your letter is chosen by Mr. Giovanelli to appear in Audio Clinic, please indicate if your name or address should be withheld. Please enclose a stamped, self-addressed envelope.

Do Loudspeakers Reproduce?

Sure they do, but how well they reproduce music and adapt to their environment means the difference between prosperity and extinction. It's natural then, for our new LM-1 loudspeakers to thrive everywhere. With B&W's world-renowned acoustic engineering and superb styling they're the perfect species for any room. Available in five colors, LM-1's blend into nearly any environment and can live perfectly on bookshelves, affixed to walls, or hung from the ceiling via their integral stand. This new breed of speakers reproduces music accurately and they are perfectly suited to their surroundings. We predict a world-wide population explosion.



B&W

Tel. 978.664.2870
Fax 978.664.4109
www.bwspeakers.com

LISTEN AND YOU'LL SEE

Myryad M-Series

Dedicated rear-panel My-Link connectors enable one remote to operate any of the M-Series components, which include (top to bottom) the MCD500 CD player, MP100 preamp, and MA120 power amp. The power amp's cross-coupled, cascaded, double-complementary, current-mode feedback circuit is said to lower distortion and enhance musicality. The preamp is a Class-A design; when headphones are plugged in, it reconfigures its circuitry to become a Class-A headphone amp. The CD player contains a 24-bit delta-sigma DAC and has 13 separately regulated power supplies. Prices: CD player, \$1,795; preamp, \$995; power amp, \$795. (Myryad Systems, c/o Artech Electronics, 800/631-6448)



Toshiba DVD Player/Receiver

Combining a DVD player and Dolby Digital A/V receiver in one chassis, the SD6109C also decodes DTS and Dolby Pro Logic. The DVD section uses a 10-bit video D/A converter and a 27-MHz digital filter, which are said to yield

resolution greater than 500 lines with no visible artifacts. Besides coaxial and optical digital inputs, the SD6109C has composite- and S-video inputs, component-video outputs, a line-level subwoofer output, and 96-kHz/24-bit audio D/A converters. The five amps are rated at 50 watts each into 6 ohms, and the AM/FM tuner has 30 station presets. Price: \$599.95. (Toshiba, 800/631-3811)



Sony Portable CD Player

The D-EJ01 is said to be the first portable CD player to have a motorized disc slot. Sony claims that this player, which is made of lightweight magnesium, has extraordinarily long battery life—up to 62 hours when powered by two AA cells and two supplied nickel metal-hydride rechargeable batteries. Its backlit LCD remote, attached to the headphone cord, displays disc and track names (for CD Text-encoded discs). Price: \$349.95. (Sony, 201/930-6136)



M&K Sound THX Speakers

Offered in a dark cherry (pictured) or blond cherry finish, the S-150THX satellites each have two 5¼-inch woofers and three 1-inch dome tweeters in an acoustic-suspension enclosure. Frequency response is rated at 80 Hz to 22 kHz, ±2 dB, with sensitivity of 89 dB/1 watt/1 meter. The MX-150THX acoustic-suspension subwoofer has a 150-watt amp that feeds two 12-inch woofers operating in push-pull configuration. The frequency range is stated as 18 to 125 Hz. Prices: Satellites, \$2,000 per pair (matching stands, \$700 per pair); subwoofer, \$1,650. (M&K Sound, 310/204-2854)

Onkyo CD-R/RW Recorder

In addition to recording write-once CD-Rs and erasable CD-RWs, the DX-RD511 functions as a two-disc CD changer, even permitting cross-fading alternate disc playback in its DJ mode. An

integral sampling-rate converter accepts digital sources with frequencies of 32 to 48 kHz. The dual disc trays and mechanisms enable automated real-time or double-speed recording and dubbing from CD to CD-R/RW of tracks or entire discs. The auto-finalizing mode is said to simplify recording functions. Distortion is specified at less than 0.006%. Price: \$649.95. (Onkyo, 201/825-7950)



Marantz DVD Player

A 10-bit video D/A converter in the DVD-930 enhances video resolution and increases video signal-to-noise, says Marantz. The player detects and passes Dolby Digital and DTS soundtracks and has 96-kHz/24-bit audio capability.

Moreover, its built-in Dolby Digital 5.1 decoder enables direct multichannel analog connection to a receiver or amplifier. Other features include component-, composite-, and S-video outputs, virtual surround sound two-speaker playback, and an icon-based on-screen function menu. Price: \$849.99. (Marantz, 630/307-3100)



DiMarzio Interconnects



Supplied with gold-plated, locking RCA plugs, the EP1901BKRD Teflon-insulated interconnects are made of 16-gauge, oxygen-free copper with

silver-soldered termination. Prices: \$89.95 to \$109.95 per pair, in 1½-, 3-, 4½-, and 6-foot lengths. (DiMarzio, 718/981-9286)

HK A/V Receiver

A Crystal Semiconductor IC inside the AVR 7000 decodes Dolby Digital and DTS and performs digital signal processing. The AVR 7000 also incorporates Logic7 processing, to improve reproduction of multichannel sources and generate multichannel sound from two-channel sources, and has component-, composite-, and S-video switching. The receiver is rated at 100 watts per channel into 8 ohms. There are five A/V and four audio inputs, coaxial and optical digital inputs and outputs, HDCD decoding, and an AM/FM tuner. Price: \$1,799. (Harman Kardon, 516/496-3400)



Infinity Home Theater Speaker System

Using diaphragms of two rigid ceramic layers anodized to an aluminum core (Ceramic Metal Matrix technology), the Prelude MTS System's drivers are said to banish audible resonances, thereby yielding a level of sonic accuracy and musicality unattainable with conventional drivers. The



Prelude System comprises MTS front left and right speakers with 850-watt powered woofers, the MTS Center, and MTS Towers for the surround channels. Also included is Infinity's Room Adaptive Bass Optimization System (RABOS), to cancel low-frequency standing waves. Prices: Prelude MTS, \$7,000 per pair; MTS Center, \$1,000; Prelude MTS Tower, \$2,500 per pair. (Infinity, 800/553-3332)

Bel Canto D/A Converter

By automatically upsampling the 16-bit/44.1-kHz data stream from conventional CDs to 24 bits and 96-kHz sampling, the DAC1 is said to

eliminate jitter, lower quantization noise by 40 dB, and yield sound quality comparable to that of much more expensive D/A converters. It accepts digital inputs (via RCA coaxial or Toslink optical connectors) with sampling rates of 32 to 96 kHz at word lengths of 16 to 24 bits. S/N ratio is specified as 112 dB. Price: \$1,295. (Bel Canto Design, 612/317-4550)

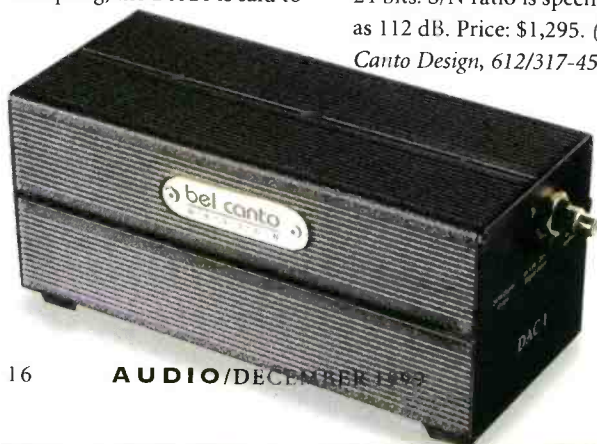

JVC MD/CD Mini System

Compact Discs load vertically in the FS-V9MD: A motor-driven glass door, equipped with a backlit LCD

panel, opens and closes to accept a disc. The MiniDisc record/playback section has 1-bit A/D and D/A converters and a sampling-rate converter. The built-in AM/FM tuner has 15 AM and 30 FM presets, with an auto-preset function. Power output of the integral amp is rated at 17 watts per channel, 80 Hz to 20 kHz, at 10% THD. Price: \$550. (JVC, 800/526-5308)



© 1999 Bose Corporation

One is right for you, but which one?

As you may know, our reputation stems from our research into new technologies for better sound reproduction. This research has resulted in many products for almost every application.

Which product is right for you depends upon your listening habits and environment. A selection made without considering these factors too often results in spending more than necessary or getting less than desired.

How can you decide? Call us. Our consultants will recommend the best product for your particular needs and budget. We can send you literature

and direct you to one of our thousands of dealers worldwide who is closest to you and who carries that particular product. Once you hear it, then you can decide if it's just right for you.

Call toll-free: 1-800-ASK-BOSE (1-800-275-2673)
Ask for Ext. 808.

Visit us on the web at ask.bose.com/ca808

BOSE[®]
Better sound through research[®]



Per Madsen Storage Cabinet

The File 19-25, for the modular Rackit System 19, has three drawers—one for CDs, DVDs, and VHS tapes; another for audio cassettes; and one for hanging files. Made of red oak and Finnish birch and said to be lightweight yet sturdy, the cabinet is 25 inches tall, 20¾ inches wide, and 16 inches deep. Prices: \$330 to \$395 each, depending on finish and drawer-front material. (*Per Madsen Design*, 800/821-4883; www.rackittm.com)

Cambridge Audio D/A Converter

In addition to performing D/A conversion with HDCD PMD-100 digital filtering, the S700 Isomagis is said to eliminate vibration through the use of

decoupling polymers in its base. Digital inputs include Toslink optical and gold-plated BNC coaxial connectors; output is via gold-plated RCA jacks. The S700 has an external power supply, 15 separately regulated power-supply rails, and a jitter-reduction circuit. Price: \$800. (*Cambridge Audio*, c/o Audio Plus Services, 800/663-9352)



RCA DVD/CD Changer

Besides reverse and forward scan modes for cueing specific scenes, the RC5910P plays and changes five DVDs or CDs. Moreover, DVDs and CDs can be randomly mixed in the changer. Picture resolution is rated at 720 pixels per horizontal line, said to yield twice the definition of standard VHS videotape.

The RC5910P has full front-panel controls plus a learning remote, a jog/shuttle control, component-video outputs, and coaxial and optical digital audio outputs. Price:

\$499. (*RCA*, Thomson Consumer Electronics, 317/587-4450)



German Physiks Speaker

The Windspiel uses a Bendingwave Radiator (a refined version of the original Walsh driver), which is said to excite sound waves directly using bending waves, radiating them horizontally over a 360° pattern with constant phase. Recommended for small living rooms, the Windspiel is a 4-ohm system with sensitivity rated at 85 dB/1 watt/1 meter, maximum output at 108 dB SPL (at 90 Hz), and frequency range at 32 Hz to 19 kHz. The speaker is 46 inches tall and 11¾ inches square at its base. Price: From \$10,500 per pair. (*German Physiks*, c/o AXISS Distribution, 310/329-0187)

B E T T E R S O U N D T H R O U G H R E S E A R C H .

BOSE

At its best, technology can be virtually indistinguishable from magic. So it is with our two newest Lifestyle® systems. The Personal™ music center replaces an entire rack of components. Yet you can hold it in your hand. Jewel Cube® speakers use neodymium iron boron magnets and spiral ports. They're about the size of a computer mouse. These, and other unique Bose® proprietary technologies are part of the reason we're the most respected name in sound. The bottom line? If you get something that doesn't have Bose technology, you're paying for something that doesn't have Bose sound.

TECHNOLOGY

To discover which Bose product is best for you, please call
1-800 ASK BOSE
please request ext. 772
or visit us at
ask.bose.com lca772

For your home. Your car.
Your business. Your life.

©1999 Bose Corporation JN00254

PRODUCTS SHOWN APPROXIMATELY 1/2 SIZE

CAN EARS STARE?



AVR 500, AVR 300 and AVF 100 models also available.

Absolutely. In fact, you won't be able to take your ears off the AVR 7000. It's the most powerful in the new line of audio/video receivers from Harman Kardon, creator of audio's greatest innovations for more than 40 years, including the world's first stereo receiver. The AVR 7000's high-current amplifier (± 75 Amps) and advanced digital processing deliver the very best Dolby® Digital, DTS® and HDCD® sound. Component-video switching, multiple digital inputs and outputs, and complete multi-room capability combined with on-screen menus and icon-based displays make this one of the most versatile, easy-to-use Harman Kardon receivers ever. For information, call 1-800-422-8027 or visit www.harmankardon.com.

AVF 7000



Power for the digital revolution.™

Harman Kardon is a registered trademark, and Power for the digital revolution is a trademark, of Harman Kardon, Inc. Dolby is a trademark of Dolby Laboratories. DTS is a registered trademark of Digital Theater Systems, Inc. HDCD is a registered trademark of Pacific Microsonics. © 1997 Harman Kardon, Inc.

harman/kardon®

A Harman International Company

Home Office Harmonies



The Monsoons

But I'm thinking about moving my dubbing gear to my desk, which will enable me to use the PC for sound editing and CD recording, probably with a USB drive like the Hewlett-Packard CD-Writer Music. If I do this, I may not have room for either pair of AR speakers, which will force me to fall back on the speakers hooked up to my computer.

And do you know what? That won't be a major hardship. I wouldn't rank any of the multimedia speakers I've heard as highly as either AR system, but even so, these suckers are getting good. And some of them (systems from Sonigistix and Eminent Technology, for example) are planar di-

poles—among the very few good planar small enough for desktop use. (I'm aware of desktop speakers with NXT drivers, but the only system I've heard, the Benwin multimedia setup, did not impress me; I have higher hopes for the forthcoming Mission X-Space.)

Not everyone shares my taste for planar speakers, and justifiably so. Their sound is highly dependent on the spaces and surfaces behind them, they tend to beam, and they overload less gracefully than dynamic drivers. All they have to offer is spaciousness and sound that's lifelike even when you're outside the room.

What's more, those virtues scale down nicely. The \$229 Monsoon MM-1000 three-piece system from Sonigistix (877/722-8346) is a lot smaller than the pair of Martin-Logan SL3s in my living room and no more than a

distant cousin of the SL3s sonically, though it obviously stems from the same evolutionary branch. On paper, the \$179 MM-700 speakers lack only a bit of low bass and 3 dB of output compared to the MM-1000s. To me, they did not sound *quite* as smooth, but let me qualify that judgment. The buzzy reeds I heard on the title track of *Some Cats Know: Jeanie Bryson Sings Songs of Peggy Lee* (Telarc CD-8391) turned out to be on the recording, but the 700s did exaggerate that buzz ever so slightly and subtracted a bit of smoothness from Bryson's voice. Even so, the effects were so subtle that without the Martin-Logans in the next room for comparison, I'd have blamed the Monsoons for the buzz and missed their effect on the vocal. I heard a similar effect with Andrea Marcovicci's voice (*Marcovicci Sings Movies*, Cabaret/DRG 91405): a bit less warmth than on my living room speakers and definite overloading on the loud piano chords at the end of "Let's Not Talk About Love." On the other hand, the Monsoons pinned down the center image better. The brass on Stan Kenton's *Standards in Silhouette* (Capitol Jazz CDP 7243 4 94503 2 5, a 20-bit remastering of a 1959 original) was appropriately smooth but not overcreamy, with just the right degree of bite. On this recording, bass seemed boosted a bit, but pleasantly so (and I could have tamed that by turning down the Monsoon's woofer level).

The best thing I can say about the Monsoon 700s is that the day after my main listening session, I ran into a CD I wanted to hear and popped it into the computer without a second thought. These are speakers I can actually listen to music on.

There are limits, however, to the scalability of planar dipoles. That's why the Sonigistix Monsoon MH-500 (\$119) has hybrid satellites; each has a planar tweeter and a small cone driver. The jazzily styled woofer box is

Photos: Michael Groen

My home office is an odd kind of multimedia center: dubbing equipment on the desk behind me, a 9-inch Zenith TV on the shelf above my computer desk, a little JVC FS-2000 "executive" desktop sound system off to one side, and computer speakers on and under the desk itself. And my Dell PC plays DVDs.

The dubbing equipment is mostly golden oldies: a Dual CS-5000 turntable, an Onkyo Integra P-3030 preamp with 78-rpm EQ, a Sony 500ES DAT machine, a Tandberg TD-20A open-reel deck, a Philips CDR765 CD recorder, and a pair of AR Powered Partners speakers. If I leave it all on the desk behind me, I'll switch to my passive AR M-1 speakers, powered by my old Dynakit Stereo 35 tube amp.

quite compact (about 7 x 7 x 6½ inches), despite its containing a driver and triamplified electronics. The 500s sounded warmer and more intimate; they added a faint touch of nasality to Marcovacci and dulled the edge of both her voice and Bryson's. The overall effect was a bit less spacious, though I noticed less overload on the piano. Kenton kept his creaminess on these speakers, but his brass lost its bite. The sonic dropoff from the 700s to the 500s was greater than that from the 1000s to the 700s; nevertheless, the junior Monsoons outperformed the few other speakers I've heard in their agreeably low price range.

But, as I'm admittedly prejudiced toward planars (and, like most audiophiles, toward the more expensive spreads), I felt it was time to check my perceptions with a higher-priced dynamic system. I chose the AMR5 from Polk Audio (800/377-7655), which costs \$209.95 and is configured a bit differently from most computer speakers. In the usual setup, your PC's sound card connects to the woofer box, which contains all the amps and crossovers, and both satellites connect to that. With the AMR5, your PC connects to one two-way satellite, which contains the amps for both satellites and feeds the powered woofer through a separate cable. This makes for neater wiring and allows the satellites (rated at 80 Hz to 20 kHz) to operate on their own; indeed, they're available that way, as the AMR2 speakers (\$109.95 per pair), as is the AMR Subwoofer (\$109). There's no indication which satellite is for the right or left channel, but I assumed that the one with the volume, bass, and treble controls should go by my right hand.

I initially tried the satellites alone. They took up a bit more space on my desk (and looked much bulkier) than even the Monsoon MM-1000s. With the bass control (oddly, to the right of the treble knob) at its detent, the Kenton sound was rich and full. Turning the bass up past the detent did not do much, but turning it down thinned the sound. In the treble, I found the detented position best, too. Marcovacci's voice had a hint of extra brightness on these speakers; Bryson's did not, but it did have a touch of excess sibilance.

Next I added the Polk subwoofer, a tall, rounded design that could be mistaken for a vase. The manual suggested that I should connect the control satellite to the woofer's "Lo" rather than its "Hi" input but said nothing about which of its two crossover settings I should use. The buzzy saxophone on "Some Cats Know" seemed a bit rough, but Bryson's voice was smooth and intimate. The piano chords at the end of Marcovacci's "Let's Not Talk About Love" were almost free of distortion. Where the sub made a big difference, of course, was on the Kenton CD, where the bass now took on a real solidity. I liked the Polks. But the top Monsoons remain my standard.

With those speakers back in place, I tried the WOW Thing, a spatiality and bass enhancer from SRS Labs (949/442-1070). It's available in two forms, as a free software plug-in for the popular Winamp MP3 program and as a \$29.95 box with mini-jack input and outputs. Because the software version works only with MP3 files, cluttered up my screen, and seemed to have less effect, I concentrated on the hardware version. The translucent blue box has five controls: "Off/On," "Bypass/WOW," "WOW," "TruBass," and "Volume." I couldn't use the "Bypass" switch for A/B comparisons, as the volume rose considerably in the "WOW" position.

SRS says that the WOW Thing's "TruBass" feature adds "deep, rich bass without a subwoofer" by emphasizing harmonics of frequencies that might be too low for small speakers or headphones to reproduce. With the Monsoon



Polk's AMR5

MM-1000, which has a subwoofer, this circuit did raise the bass level a bit—but overloaded the satellites (which cross over at about 80 Hz). With a pair of cheap headphones, the effect was far more worthwhile; the 'phones seemed to have more extended bass and did not distort unless I really pushed them. (Plugging in headphones, incidentally, does not kill the box's feed to your speakers.)

The "WOW" effect is said to process spatial cues to "surround the listener with a holographic representation of the performance" and improve "image size, dynamics, and immersion." With headphones, it spread the image away from the center of my head, placing most of the instruments outboard of my ears. The spread effect was just as noticeable with the Monsoons, and there was a slight increase in depth. I was mildly impressed—here was a sonic "enhancer" that did what it claimed without screwing things up uncontrollably—but not entranced. (If you're interested, I'd recommend downloading the software from www.wowthing.com or your favorite shareware source and trying it with MP3 files; if you want these effects with other sources, go for the box.)

Meanwhile, my system is now back to normal, the MM-1000s hooked up to the computer and the room rigged for just about every audio format I can think of (well, except cassette; my old deck's out getting fixed) plus TV and DVD. Not that I will use that as an excuse to loll around my office and just watch or listen—the listening's still best in my living room. But it does make working at my desk more fun.

Ivan Berger





**PUT SOME SPACE BETWEEN
YOU AND THE NEIGHBOURS**



VALDUS

With over 67 years experience in producing loudspeakers for recording, for rock concerts, for discos, for instruments ranging from the wickedest rock guitar to thunderous church organs; only Wharfedale has the ability to give your music the power, the realism, the drama that you really deserve. VALDUS speakers are efficient so you get more sound out into the room for each watt of power delivered by the amplifier. VALDUS takes loudspeaker design into a new era; a new age; a new dimension. Connect-up; Power-up; Volume-up; and say goodbye to your neighbours.



100
\$179.98

200
\$299.98

300
\$399.98

400
\$699.98

500
\$899.98

Are you empowered for the new millennium?
Don't get left out of the action.
Wharfedale at uBid.com

uBid
OnlineAuction

Wharfedale

BRITAIN'S MOST FAMOUS LOUDSPEAKERS

Speaker Master

How PSB's Paul Barton converts science

by *David Lander*

Some encounters are far more defining than others. Had he not met one specific person, Paul Barton might never have made it to the Stratusphere.

Barton, who founded PSB Speakers (the initials stand for Paul Barton and his wife, Sue) and went on to design the company's highly regarded Stratus series, had just begun his career when he met fellow Canadian Dr. Floyd E. Toole. Toole was then a staff scientist and psychoacoustician with the prestigious National Research Council (NRC), which comprises about a thousand Ph.D.s across Canada.

Ian G. Masters, a Canadian audio writer, had put Barton in touch with Toole (who is now Harman International's corporate vice president of engineering) shortly after Barton started PSB in 1972. At the time, Masters was editing *AudioScene Canada* magazine, and Barton had approached him to audition his new two-way speaker. In a *Toronto Star* column published about a year ago, Masters reminisced about "a very pleasant lunch, during which Paul asked me if I would agree to take a pair of speakers home and give him my opinion on how they sounded. He thought he had made a pretty good speaker."

After listening to a pair of PSB Avantés, Masters concurred. In his *Star* column, he recalled that the bookshelf Avantés were "a far cry from the usual Canadian



Design Class

to great sound

Photo: H. Turner (National Research Council Canada)

Paul Barton, who founded PSB and designs its speakers, with a Stratus Silver speaker in the National Research Council's anechoic chamber in Ottawa

clunkers" of their day. Although "a couple of things" needed improvement, "they were an excellent start."

Toole, who was then reviewing speakers for *AudioScene Canada*, heard the Avantés at Masters' Toronto apartment, and he, too, felt they had potential. Toole suggested that the NRC's facilities could help Barton take the design a couple of steps further. Masters recounted that it wasn't long before "Barton arranged to take his speaker to Ottawa, where, with the aid of Toole's equipment and expertise, he turned it into the Avanté II, arguably the first good Canadian speaker."

One essential test facility at the NRC's Ottawa campus was—and is—its anechoic chamber. Unlike most environments, anechoic chambers are eerily silent, with massive absorptive pads covering all four walls, the ceiling, and the floor. (Researchers and engineers must perform their tasks on a catwalk.) These thick wedges of rigid fiberglass angle inward and stifle the echoes that most people never realize are always present in our surroundings. Both the spatial and sonic effects one experiences in an anechoic chamber are otherworldly. The surface of the moon might feel friendlier.

To Barton, though, the NRC's anechoic chamber has been a veritable bank vault, a repository of psychoacoustic treasure. The reams of data Toole gathered there closely correlated specific anechoic measurements with a speaker's ability to please listeners, and this information has become a core element in Barton's designs. He cites three important lessons he learned in the NRC's



The National Research Council's 380-acre Ottawa facility comprises more than 85 buildings. Funded from general tax revenues, the NRC employs scientists who conduct rigorous research in a variety of fields, including acoustics.

anechoic chamber and listening room over the years:

•In double-blind listening tests conducted separately from the in-chamber measurements, the speakers under scrutiny were concealed behind a screen. No one, neither the listeners nor the technician switching from one system to another, knew which speakers were playing. But the listeners (who also did not know the results of the technical measurements) tended to prefer the same speaker systems. When this came to light two decades ago, Barton says, the fact that “most of the people, most of the time, agreed on the relative merits of a speaker when comparing a group of them” seemed utterly remarkable.

•“Musical taste and musical experience,” Barton is quick to add, “are not prerequisites for being a good judge of sound.” The participants in the listening tests had to have normal hear-

ing, of course, and Barton notes that some of them took longer to catch on because “they didn’t understand the lingo. But once you gave them a vocabulary and a little bit of time, they learned to listen and make consistent judgments.” (To help less-experienced listeners express their thoughts about what they heard, Toole drew up forms that provided terms describing sound.)

•“A properly interpreted set of anechoic measurements, provided those measurements are both correct and meaningful,” Barton learned, “correlate with listener preferences.”

For an aspiring speaker manufacturer, the anechoic chamber can be nightmarish—hell’s hot breath on Orpheus descending. Here lies psychoacoustic information that separates skilled designers from mere poseurs. Yet upon entering NRC’s chamber, Barton claims to have felt delight rather than trepidation. “I was like a kid in a candy store. When I started building loudspeakers, I never dreamed I could experience a place like that.”

Not only did the NRC provide an environment in which the fledgling designer could “begin to understand what needed to be done to improve [his] loudspeaker,” it also gave him access to a database Toole

had created while evaluating speakers for *AudioScene Canada*. “A body of work from the double-blind subjective tests that Floyd had been conducting for the magazine already existed. I could compare results, and I could obtain knowledge about how this process worked,” Barton affirms.

In the years that followed, Barton spent many hours pursuing “this process,” in the anechoic chamber and in a listening room the NRC had set up for double-blind comparisons in a separate building on its campus. Barton almost shivers as he recalls trekking from one place to the other “through cold, stormy Ottawa winter days,” carrying his prototype speakers protected by plastic bags. Burdensome as it seemed at times, his work paid off. It

spawned the Project B-2, a speaker that evolved into the original Stratus and eventually led to an entire Stratus line. Those speakers catapulted PSB to prominence among serious home music listeners.

Paul Barton was just 21 when, along with a couple of friends, he started PSB. At the same time, he was an engineering student at the University of Waterloo, where he pursued a cooperative work/study curriculum. Though it was unusual, the company at which he completed the program’s employment obligations was his own.

Gradually, however, work replaced study altogether; Barton dropped out of school and made PSB a full-time endeavor. That, of course, meant its chief designer had to create products

The Stratus Goldⁱ, PSB’s flagship speaker, has a 10-inch woofer, a 6½-inch midrange, and a 1-inch tweeter and sells for \$2,599 per pair.



Photos: H. Turner (National Research Council Canada)

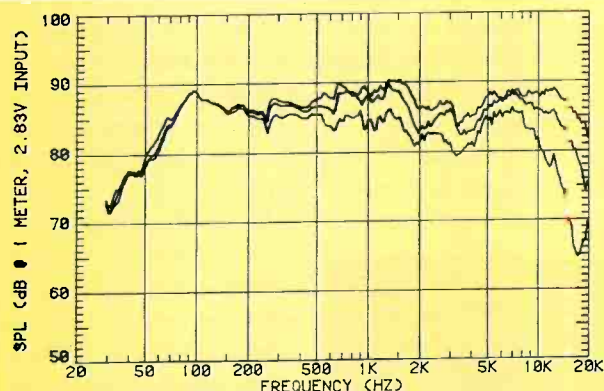
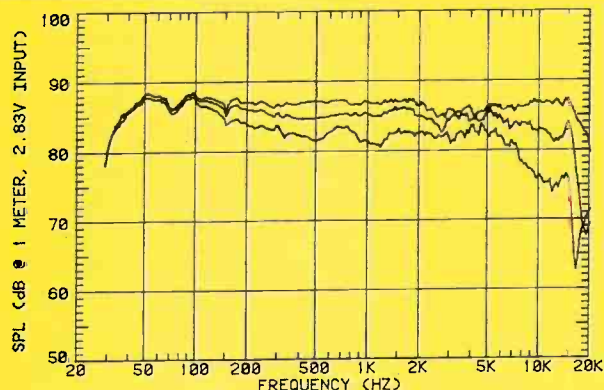

Anechoic measurements of the PSB Stratus Gold's on- and off-axis frequency responses, taken in 1990 at the NRC for a Canadian audio magazine (top graph). The Stratus Gold's impressively smooth curves contrast sharply with the jagged, irregular curves of a competing speaker, measured at the same time (bottom graph). In double-blind listening tests, the Stratus Gold was ranked high and was judged a natural, smooth, and open-sounding speaker; the other speaker received a low score and was judged timbrally colored and unpleasant.

Anechoic measurements have become a core element in Barton's speaker design process.

would improve the loudspeaker's sonic characteristics." After "18 months of focused work," he felt he had achieved it, and he unveiled the PSB Project B-2.

A fundamental aspect of the B-2's design was a simple reversal of conventional driver positioning; Barton placed the woofer above, rather than below, the tweeter to which it crossed over. "I base all my designs on response at the seated-to-standing position," he explains. "That's the ear's domain, a place where you want to make sure you're not getting any cancellation between drivers."

In the Project B-2's first iteration, Barton had mounted the tweeter above the woofer, getting "good on-axis response. But when I measured the B-2 at 15° up in the vertical plane, there was this great big notch in the response curve because of cancellations at the crossover frequency." He also noticed that the frequency response 15° below the axis—the invisible line aimed at a seated listener's ear—"was practically the same as it was on axis." That turned on a light bulb in his brain. "I said, 'Well, why not just invert the woofer and the tweeter.'" When he did, his prototype's response at the crossover point was now the same for a hypothetical standing listener as for a seated one.

Barton also paid close attention to the Project B-2's en-

closure. "I started to do a lot of bracing, because I discovered that stored energy reradiated by a resonating panel can be heard, even though it's of a fairly low order and doesn't show up visually on a frequency response curve," he relates. Of the three factors he could manipulate to suppress cabinet resonance—mass, stiffness, and damping—he says that increasing cabinet rigidity seemed to be the best way to proceed. "When you start doing a lot of damping and absorbing or when you add a lot of mass, you lose driver sensitivity," he observes, adding that this was "one of the first attempts I made at doing some pretty extraordinary bracing inside an enclosure."

Project B-2 was "a fairly tall speaker, with its height much greater than the other two dimensions"—so much so that its acoustic behavior was akin to that of a pipe, which resonates at a particular frequency determined by its length. That creates internal standing waves and attendant frequency aberrations. To prevent those nulls and peaks, Barton built braces—rectangular frames with crossmembers, resembling four-paned windows without glass—and placed them in his speaker cabinet as one would fit shelves in a bookcase. The designer further stiffened his enclosure by running diagonal steel struts along its side walls.

people would buy in some quantity. Those are not necessarily the speakers that fulfill the dreams of young, idealistic designers.

Along with meat-and-potatoes models, Barton did produce an esoteric motional-feedback speaker, the Beta II, which in 1973 cost \$600 per pair. The Canadian audio press approved, and the praise gratified the speaker's creator, who proudly reports that loyal owners continue to bring units in

for repair. Barton understood, however, that motional-feedback technology had little appeal outside audiophile circles. So in 1980, he set out to design a flagship product without the added complexity of an AC-powered comparator circuit.

Barton's goal was "to incorporate things—based on the hundreds of measurements done on our previous products, and all the hundreds and hundreds of measurements I'd seen on competitive product—that

Inverting the drivers resulted in the woofer being near the top of the cabinet, and subsequent testing indicated that this "really pumped up the standing waves inside the loudspeaker." When his measurements revealed uneven response in the 100-Hz region, Barton decided to incorporate some cabinet damping.

After experimenting with the placement of fiberglass damping and taking more measurements, Barton "discovered something about damping material in a loudspeaker. The wrong place to put it is on the walls. The right place to put it is in the middle of the box." The reason, he relates, is that there's

not much moving air at the outer boundaries of a speaker enclosure, which are high pressure points, whereas the cabinet's more central spaces—vertically, horizontally, and in terms of depth—are low pressure points at which moving air has considerably higher velocity. "You put the damping material where the velocity of air is highest," states Barton. "That's where standing waves are most easily cancelled."

Resonance, of course, doesn't exist until mass is excited, which is why Barton looked for a mechanical way to keep his speaker's woofer from agitating its cabinet walls. The device he ultimately selected to decouple

driver from baffle was a Rawl nut, which is commonly used to isolate high-vibration motors, such as air compressors. Essentially, a Rawl nut is a rubber cylinder lined with a threaded metal sleeve and "a flange around one end that makes it look a bit like a top hat," the speaker designer explains.

After drilling four holes in the Project B-2's baffle, Barton inserted Rawl nuts, allowing their flanges to hold them in place. He then installed the woofer and screwed it down. Bingo. Pressure on the nuts squeezed and expanded their rubber component. The woofer was thus isolated, and its vibrations couldn't excite the cabinet.

"I was really proud of the Project B-2," Barton recounts. "It had by far the flattest frequency response and the lowest distortion of any speaker I had built." Those weren't its only virtues; the Project B-2 also fattened PSB's bottom line.

Despite this success, business matters, not design issues, sidetracked Barton. He subsequently "went through several distributors, had some other business partners, and never really got back to flagship product. I continued to build mainstream product until 1987, when I introduced a speaker based on the Project B-2: the Stratus."

In part, the Stratus stemmed from support by Canada's Lenbrook Industries, a diversified company with a special interest in audio. Lenbrook (which moved further into hi-fi manufacturing when it acquired NAD earlier this year) teamed up with Barton in 1985. That relationship "relieved me of a lot of administrative and financial things as well as distribution," he states. "After two years of orientation," after "the backing and the help that Lenbrook had injected into the PSB brand name, it was time I got back to developing the flagship. And what better way to start than where I left off, with the Project B-2?"

Even after the PSB-Lenbrook marriage, Barton continued to rely on the NRC's Ottawa facilities. ("I can't prove it, but I suspect I've used their anechoic chamber more than any other individual," he remarks.) While his speaker components, supplied by outside vendors, were put together in-house, he wanted tighter control of cabinet as-

ESSENTIAL MEASUREMENTS

For PSB's Paul Barton, measuring a speaker's on-axis performance in an anechoic chamber is only the beginning. Next he takes readings at 60° to 75° off axis. Sound waves radiating at those angles tend to bounce off a listening room's side walls and become the first reflections to arrive at a listener's ear, he relates.

If, as is commonly the case, side-wall reflections arrive within 2 milliseconds of a speaker's direct, on-axis waves, the ear/brain mechanism integrates the direct and reflected sounds; they merge and are perceived as a single sound, says Barton. Therefore, he continues, when the frequency response of side-wall reflections differs from that of a speaker's direct sound in the critical bandwidth areas near crossover points, timbre seems unnatural.

Barton then takes measurements 15° above axis in the vertical plane, because energy radiating at this angle projects toward the ears of standing listeners. If the results vary significantly from on-axis frequency response, a listener who stands up and then sits down (or the reverse) will hear changes in the sound. Good speakers, Barton has long been convinced, will have nearly identical frequency response on and off axis.

When he approves of the frequency response data he sees to this point, Barton does a series of measurements that reveal a speaker's total sound power, the sum of energy radiating in a 360° pattern around it. Total sound power is important because it determines what will be perceived in a home listening room, where there is a mix of direct and reflected sound.

Though listeners will be using PSB speakers in a variety of rooms, the company founder points out that measurements taken at enough points in an actual listening room can approach the total sound power measured in an anechoic chamber. (Barton's anechoic sound power measurements include full-band sweeps from 20 Hz to 20 kHz, gathered at 32 points around the speaker, then weighted and summed.)

Barton's next step is to measure power compression by increasing amplitude (the speaker's sound pressure level), notch by notch. He then scrutinizes distortion, specifically THD. Finally, once he's satisfied with all his measurements, he transfers his prototype to the NRC's listening room for double-blind listening tests. Those sessions determine whether final adjustments are required. When they are, Barton emphasizes, they're invariably subtle. *D.L.*

sembly. That led him to devise a cabinet of separate enclosure panels—sides, fronts, backs, tops, and bottoms—bought in finished form, delivered on skids, and assembled at Lenbrook. Barton's blueprint enabled PSB "to match panels and do the quality control right here. It gave us complete in-house control over the final product."

Barton's Stratus enclosures (except for the Bronze) have extruded aluminum corner posts that extend from speaker top to base. The corner posts have tongues, shaped like saw-toothed arrowheads. When assemblers, wielding rubber mallets, hammer those protrusions into edge grooves cut into the four side panels, they bite, holding the panels firmly in place until an applied glue sets. Stratus tops and bottoms also lock into grooves in the enclosure's side panels.

The construction method offers several advantages, according to Barton. For one thing, "We could assemble a very high-quality product right here in our facility." For another, because the operation doesn't require expensive machinery, it's extremely cost-effective and "enables us to build loudspeakers in reasonably small runs economically. We're not dealing with empty boxes and the large areas required to store them. Or a factory that needs to be fed all the time." Moreover, the process is accomplished "in a clean, quiet, dust-free, chemical-free environment."

When Barton combined his panel-based enclosure with the Project B-2's principal elements—a woofer crossing over to a tweeter mounted below it,

Barton's speaker measurements are complemented by double-blind listening comparisons.

sturdy cabinet bracing, damping material strategically placed (in central, low-pressure areas of the box), and a mechanically isolated low-frequency driver—he had his Stratus, the first speaker in the long-running hit series. These signature design traits have made subsequent Stratus models readily identifiable as a clan, even though they have varied in size, the number and nature of their drivers, and some other secondary elements.

Barton stresses that all the measuring he does while creating speakers is both time- and cost-intensive. That, he reasons, is why many manufacturers choose to omit it. As for listening sessions less rigorous than double-blind tests, their ability to delude speaker designers is no mystery to him.

"Here are people who [have] worked hard all day, who thought they had something good, who sat down and are

staring at their speaker, comparing it with the competition. They say, 'Ours sounds better.' Well, of course it sounds better. They worked hard on it. It's the speaker they designed. It can't sound worse than the other guy's. . . . Then there are the people who came to the National Research Council for one reason or another and subjected their speakers to double-blind listening tests," Barton continues. "On many occasions. . . people came in saying their speaker was going to blow everything away. And as soon as you put it in a double-blind test and they listened to it, it was the one they hated most.

"There's been many a sweaty palm in that listening room," Barton notes. **A**



PSB's Stratus speaker line (from left): the Stratus Silverⁱ, the Stratus Goldⁱ, the Stratus Bronze, and the Stratus Mini

The Ultimate

by Ken Kessler

A couple of dozen years ago, when I was an audio civilian, I used to pore enviously over the monthly feature in *Stereo Review* that showcased readers' sound systems. This, of course, was long before "custom install" and "CEDIA" and "multiroom" were key terms in hi-fi patois, an era when there was no such thing as a magazine dedicated to the interior design aspects of home entertainment. More admirably, it was a time when remote control wasn't taken for granted, nor were computers seen as mere appliances. I dreamed that one day I, too, would have a room with hidden panels and indirect lighting and all sorts of other sub-James Bond/sub-*Playboy* lounge toys.

In a world where well-heeled audiophiles possess dream-level listening rooms, it's hard coming up with something worthy of discussion in an audio magazine. In New York City, Los Angeles, Rome, Kuala Lumpur, Hong Kong, Tokyo, Paris, London—indeed, anywhere that high-end audio has a following—there are those whose names are not part of the global audio community's consciousness but whose systems are housed in rooms beyond the imagination, rooms commensurate with the goodies they contain. Designed by top architects and styled by top interior designers, they're perfect showcases for cutting-edge hardware.

Because travel is a major part of my work (I cover hi-fi shows for a number of foreign magazines), I've been privileged to see systems otherwise hidden from view. One home I visited in Italy held a half-dozen installations, any one of which I'd consider myself lucky to own. This particular villa had been converted from a vast medieval slaughterhouse, with huge rooms just begging to

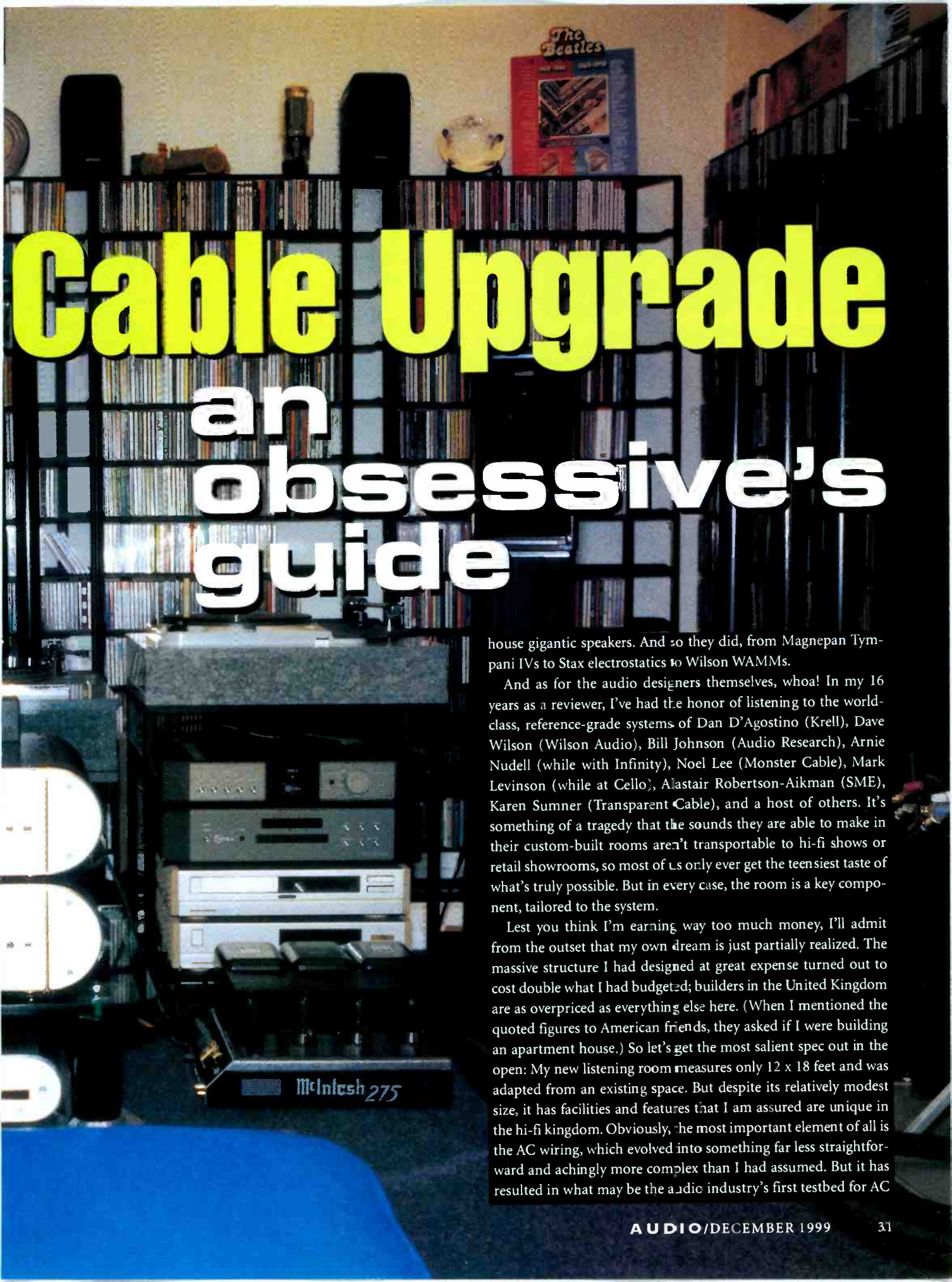

Cable Upgrade

an obsessive's guide

house gigantic speakers. And so they did, from Magnepan Tympani IVs to Stax electrostatics to Wilson WAMMs.

And as for the audio designers themselves, whoa! In my 16 years as a reviewer, I've had the honor of listening to the world-class, reference-grade systems of Dan D'Agostino (Krell), Dave Wilson (Wilson Audio), Bill Johnson (Audio Research), Arnie Nudell (while with Infinity), Noel Lee (Monster Cable), Mark Levinson (while at Cello), Alastair Robertson-Aikman (SME), Karen Sumner (Transparent Cable), and a host of others. It's something of a tragedy that the sounds they are able to make in their custom-built rooms aren't transportable to hi-fi shows or retail showrooms, so most of us only ever get the teensiest taste of what's truly possible. But in every case, the room is a key component, tailored to the system.

Lest you think I'm earning way too much money, I'll admit from the outset that my own dream is just partially realized. The massive structure I had designed at great expense turned out to cost double what I had budgeted; builders in the United Kingdom are as overpriced as everything else here. (When I mentioned the quoted figures to American friends, they asked if I were building an apartment house.) So let's get the most salient spec out in the open: My new listening room measures only 12 x 18 feet and was adapted from an existing space. But despite its relatively modest size, it has facilities and features that I am assured are unique in the hi-fi kingdom. Obviously, the most important element of all is the AC wiring, which evolved into something far less straightforward and achingly more complex than I had assumed. But it has resulted in what may be the audio industry's first testbed for AC



Plastic wall trunking holds the main AC feed cable neatly in place.

house wiring and its effect on components of various types.

America, I believe, pioneered the use of AC line conditioners and filters long before other countries absorbed that particular tweak. I see, for example, that Paul McGowan's recently revived PS Audio takes this a stage further, with a new line of components described not as filters or conditioners but as "power generating stations." Though there are Japanese, Italian, British, and German firms that will sell you boxes to clean up your AC power, it's pretty much a U.S.-focused phenomenon. No one can tell me definitively whether or not the U.S. has "dirtier" AC lines than Europe, but the consensus seems to be that you guys need filtering and conditioning a lot more than the rest of us do. (Did someone say ConEd brownouts?)

Despite relatively trouble-free AC power in the U.K., its audiophile community has developed a subculture obsessed with the cleanliness and purity of AC sources. However, stand-alone conditioners or filters aren't that popular. This is partly because of the sheer stinginess of British audiophiles (compounded by ripoff pricing) and partly because of the intrinsically high integrity of the AC lines here. I have heard a number of power-line conditioners demonstrated around the world, and I've found them to provide the greatest benefit in mainland China, followed by Hong Kong, Malaysia, New York City, Portugal, and Greece. In the U.K., such demos are almost an anticlimax outside of high-electricity-demand

areas like central London and except at times of peak demand—say, during a soccer final. Yes, the improvements are measurable and audible even in the U.K., but, hey, \$7,500 for Acuphase's line conditioner is a lot of money.

Instead, the British have opted for far more fundamental optimization of their AC lines. Sadly, D.I.Y. is as much of a disease in the United Kingdom as it is in the United States, so the country is riddled with unqualified idiots all too willing to rip apart their plumbing or house wiring or to install their own central heating to save a few bucks. Typically, undoing the damage they inflict costs more than it would have hired a professional electrician or plumber in the first place, but after all, without 'em we'd never have had the delights of Tim Allen's *Home Improvement*. Anyway, there

My underlying purpose for this project was to create a listening environment that no manufacturer of audio equipment could criticize.

are nightmarish visions in every British hi-fi magazine's office of readers tampering with 240-volt/50-Hz lines, which they've ripped out to replace with higher grade wire or to install deluxe, gold-plated AC outlets in place of the junk that the original builder fitted. In this day and age, though, few magazines can actually afford to have their readers killed off.

The AC cables I used were (left to right): Siltech, Transparent, Kimber, and conventional.

Me? I'm particularly blessed because I live out in the country, and the distribution transformer for my area is, well—it happens to be in my back yard. Hence there's a delightfully short path from the electricity supplier's distributing lump to my house, all via overhead cables. And my electrician was pleased to confirm that I have a clean, constant, and robust supply.

When it came time to build my "dream room," I had initially planned to isolate it from the supply feeding my house, but I didn't realize just what size can of worms I was about to open. Face it: Most of us don't get involved in rewiring our homes more than once or twice in our lifetimes, so I hadn't exactly paid too much attention to the continuing rumblings of the hi-fi underground. And while I knew that I was going to need a plethora of unswitched AC outlets along the front edge of the listening area—never again would I run out of sockets or need to run an extension cord—I had assumed that the work would be straightforward and involve the cable used for standard house wiring.

Sure, the room would use the best available AC sockets (in the U.K., the MK Logic 7), and I had already planned on two separate circuits, one for the audio system and one



It will do
for music what
DVD-Video did
for movies.

Introducing the **pure sound** of Technics



Meg Okura
Shot live at Tonic
New York City 7/7/99



SB-T300



SA-AX7N

•Improved high frequency playback (96kHz vs. 20kHz for a CD) •Expanded maximum

DVD-Audio.

Pure **Classical.**

Pure Okura.

Juilliard-trained Meg Okura brings such personal passion and intensity to her playing, you feel you're drowning in her music. She wants her violin to thrill you with pleasure, and maybe even a little fear. Even her moments of silence have as much force as every frenzied flurry of sixteenth notes. And if you can't be right there watching Meg's spirit soar, we think you should still hear her as if you were. Introducing the Technics DVD-Audio/Video player. It's the sound of the future, now.



DVD-A10

DVD
AUDIO/VIDEO

Technics
The science of sound
pure sound

dynamic range (144dB vs. 96dB for a CD) • More data (4.7GB vs. 650 MB)

DVD-Audio.

What is it?

It's the **Future** of Audio

DVD-Audio is a new world standard format for high-performance audio. It is perhaps the closest thing to truly pure sound that technology has yet achieved. And just as important, it is a stunning expression of Technics lasting commitment to the pursuit of excellence, on behalf of music lovers and music creators everywhere. Hear it for yourself today at your Technics dealer.



specifications:

Technics DVD-A10 DVD Audio/Video **Player**

for Extreme Fidelity with Technics Silence Technology

- Newly-developed multibit D/A conversion system
- R-core transformer - effective proof against magnetic flux leakage
- Audiophile quality TA-KE II electrolytic capacitors
- THCB isolates the music signal from vibrations

SA-AX7 DVD Audio Ready **Receiver**

- 110dB S/N, ready for DVD Audio fidelity
- Variable Gain Control Amplifier (VGCA)
provides a pure signal path for super high quality sound
- Frequency response: 10Hz-100kHz, ± 3 dB

SB-T300 DVD Audio Ready **Speaker** System with Leaf Tweeter

- Leaf tweeter for super-high frequency extension
- Frequency response: 36Hz-70kHz (-16dB)
- input power (200W/music)

• For more information call 1-800-211-7262

Technics[®]
The science of sound
pure sound
www.technicsusa.com/dvdaudio

for everything else, but with a shared meter separate from the house itself. This way, I could ensure that the audio/home theater usage would still be completely isolated from the lights, burglar alarm, heating, and so forth. Intuitively or by conditioning, I knew that I wanted a 3-foot-thick, poured concrete floor, with underfloor heating. The walls? I wanted them to be 18 inches thick—a 9-inch brick outer wall, a moisture-proofing cavity, and an inner wall of 9-inch concrete blocks covered with plaster. A tall, pitched roof meant no ceiling to worry about, and the architect insisted on massive, upright steel girders to support the roof itself. After I specified everything, it turned out that I would have forty-two AC outlets solely for the audio/video system, fully variable lighting, special ventilation arrangements, a fireproof door, a seven-lever lock, and storage for 10,000 LPs and a similar number of CDs.

Attention to detail was paramount because my listening pleasure and protection from thieves were not the only concerns to address. The underlying purpose for this project was to create a listening environment that no audio equipment manufacturer could criticize; they could all rest assured that any product entrusted to me for review would enjoy the most favorable conditions possible, with every single aspect of performance optimized in terms of the room, the power source, resistance to external vibration—you name it. I even went so far as to ensure that the room was perfectly symmetrical, with the wall storage for CDs and LPs mirroring each other and speakers stored opposite each other. If the words “retentive” and “anal” spring to mind, think of it from a manufacturer’s viewpoint: no more worries about leaving products with a reviewer suffering bouncy floors, grunge-riddled AC, thin walls, or a nearby subway rumbling past every five minutes. The only thing they could challenge would be my hearing or my taste—and lacking those, I shouldn’t be a reviewer in the first place.

And then I spoke with Russ Andrews, the U.K. distributor for Kimber Kable.

Russ is a British audio guru who has made a mini-career out of audiophile house wiring. Along with fellow travelers like audio journalist Ben Duncan (who’s responsible for an ongoing series of articles

about over-the-top house wiring), Russ has alerted the audio community to the importance of the quality of the cable itself, the integrity of the sockets, and more. He is, moreover, an advocate of myriad U.S.-made magic potions and fixatives, such as DeoxIt and Wonder Solder.

Before I knew it, I was specifying Kimber for the actual in-the-wall AC wiring. You’ve likely seen this stuff offered for replacement AC cords but perhaps not for installation

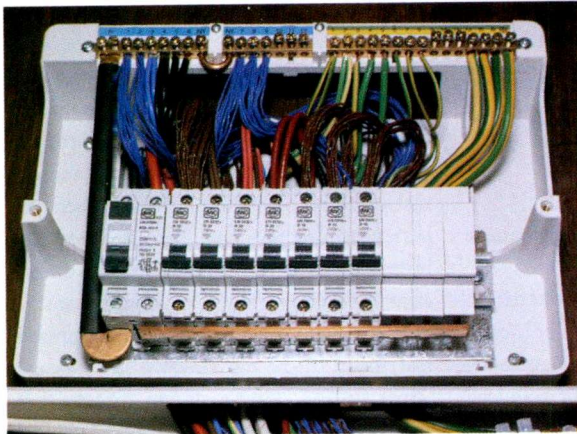

My audio system’s dedicated circuit-breaker box

Behind the turntables lie twenty-eight of my room’s forty-two AC outlets.



in walls. Each conductor has eight separately insulated strands plus a single strand for grounding. (All AC sockets in the U.K. are three-pin grounded.) My electrician laughed, probably calculating the extra labor fee he’d charge me, because it meant seventeen wires instead of three for every socket connection. It later turned out that fully two days’ worth of the total labor charge was for the Kimber-wired sockets alone.

Then, just after the construction work started, I had a visit from Absolute Sounds, the U.K. distributor for Transparent and

Siltech cables. Seeing a couple of 40-meter rolls of Kimber, Pedro looked mildly hurt. “Ken, why didn’t you tell me? You could have used Siltech or Transparent.”

And then it dawned on me: I was perfectly placed to be the first ever to test “audiophile” AC wiring. My electrician had already told me that I needed to split up the forty-two AC outlets (made up of twenty-one plates and boxes, each with a pair of sockets) over a range of separate circuits.

We had planned on two spurs for the surround channels (with two sockets each, in case I needed to audition electrostatics with their own monoblocks at the back, plus two spares) and three or four AC “ring” circuits at the front, with up to eight sockets per ring. Quick thinking: Why not do one circuit with Kimber, one with Siltech, one with Transparent, and one with normal house wiring as the reference? That way, I could perform blind listening tests to determine not just which wire performed better than the other (or if they sounded different from each other) but, more important, if they of-

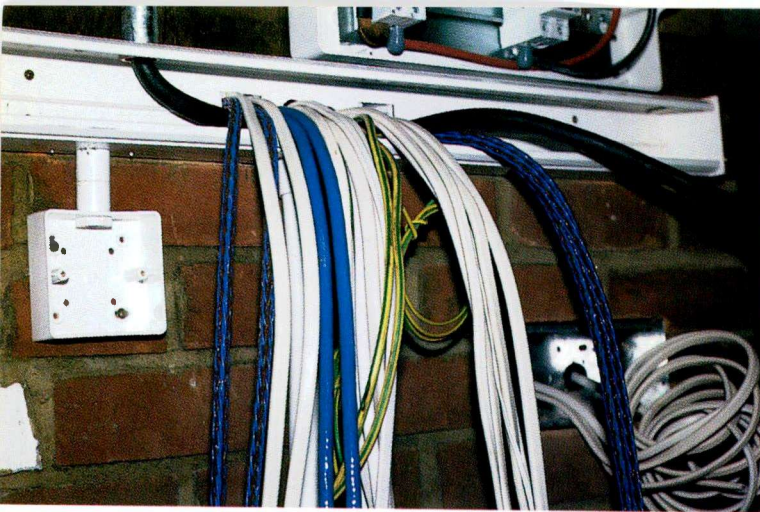

The new wires, just before they enter the circuit-breaker box

ferred anything at all over standard house wiring.

Blessed with an open-minded electrician who rose to the challenge instead of merely writing me off as a crank, I now have a listening room with one circuit for standard wiring and three for different audiophile brands, every connection made with Wonder Solder and every socket treated with De-oxIt. Over the next few months, I will ask pairs of listeners to audition the same, minimal solid-state system (CD player and integrated amp) fed by each of the circuits in turn. Then, there'll be afternoon sessions using tube electronics. And if we're still talking to each other, I'll hold sessions comparing straight-out-of-the-box AC cords with each brand's own deluxe offering.

It's gonna be tedious, possibly fun, definitely revealing. And in case you can't wait for the results, I can tell you now that I had my electrician measure the impedance of each circuit and its loop resistance; all three audiophile cables bettered the standard wiring. So at this very early stage, it was Audiophiles 1, Naysayers 0. When the electrician returned three months later to check everything, I asked him to measure the circuits once more. To my astonishment, the resistance in every circuit had dropped by 0.01 to 0.05 ohm, while the voltage available for each socket increased by a volt. What this demonstrated to me, confirmed by my electrician and others, is that the "burning-in" period we talk about in using new equipment applies

equally to actual house wiring. Now it's Audiophiles 2, Naysayers 0.

Being an impatient sort, though, I have corralled every visitor into suffering a quickie A/B demonstration. To make it painless and to remove the possibility that the observer's aural memory might be affected by my taking too long to make changes, I change only the AC source to the CD player, which takes less than 30 seconds. In every instance, now involving nearly a dozen experienced listeners, the changes have been noted instantly. And in every case, the difference has been greeted with astonishment.

It was during the first session, organized not to audition my room but to assess Super Audio CD in my system, that the first revelatory experience took place. I and

This experience has proved to me that the "burning-in" period we talk about for new equipment also applies to house wiring.

three others listened to Sony's SCD-1 player through Musical Fidelity's Nu-Vista pre-amp and power amp, driving Sonus Faber Guarneri speakers. All agreed that this system was suitably high-end, revealing enough to demonstrate the differences between SACD and its ancestor. After the session, I offered to change the power source of just the SACD player from the one I had used for the auditioning to the other three.

The changes were noted with descriptions ranging from "more solid bass" to

"faster transients" to "better dynamics." Just so you'll know the caliber of the listeners: One was my editor at *Hi-Fi News*, while the others were top-ranking employees of a major electronics firm and had a couple of decades apiece of hi-fi experience. They are not the types to be easily impressed, especially not by something that skates perilously close to the borders of hi-fi mumbo jumbo. When one of these listeners said that the differences between the power sources were greater than those he had detected between two CD players, I knew that the effort made to create this testbed was worthwhile.

In thirteen out of fourteen sessions, the standard house wiring was judged the least satisfactory: less detailed, less open, less dynamic. So convincing are these results that I have no qualms about recommending top-grade AC wiring in place of the standard stuff, provided that the wiring is professionally installed. But, you might be wondering, which wire should you use? Was there a clear victor? What happens if you optimize the wiring for one system and upgrade parts of it a few years later?

Let me assure you of one thing: All of the audiophile wiring was sonically superior to the standard copper. The results so far strike me as pretty much conclusive, despite the one aberrant who preferred the regular wire. What also emerged, though, was that there was no clear winner among the audiophile cables. Rather, I learned that one worked better with solid-state equipment, another with tubes. One was outstanding with digital sources but not with turntables. It went on and on, such that it has made my working life more complicated: Instead of plugging in a review product, warming it up, and plunging straight into listening tests, I now have to try each component four times before settling on the appropriate AC circuit.

My advice? Have your room rewired with a couple of separate circuits, and choose a couple of different types of wire—say, one in solid copper and one in silver or one braided and one straight. Sounds crazy? Maybe. But it also sounds better.

As I once feared, I've now joined the ranks of those Japanese audiophiles who used to employ different cartridges depending on the record label. **A**

all theater. no gimmicks.



Funny, with all the synthetic effects and gimmicks available on today's A/V receivers - no one is talking about what really counts - delivering the best sound for the dollar. The NAD T770 surround sound receiver's unique design provides everything you need to enjoy a great movie or music. And, as with all NAD products, it maintains a reputation for true value, performance and simplicity.

NAD - to the rescue.

NAD T770 Surround Sound Receiver

70 watts into 8 ohms (all 5 channels), Motorola DSP processors, Dolby Digital® and Pro Logic decoding, pre outs (all 5 channels), S.1 input for external decoder, 5 video inputs, 2 video outputs, 3 digital inputs, 4 audio inputs, 2 tape outputs, E.A.R.S. (Enhanced Ambient Recovery System), Impedance Sensing Circuit (ISC) topology, remote control with NAD Link.

pure. and simple.



KEF SOUNDRAVES

KEF RDM one SPEAKER

As reviewed in

AUDIO

September 1997



Some notable quotes from Edward M. Long in *Audio's* September issue:

"...KEF has gained an enviable reputation for producing excellent loudspeakers."

"...clear, precise imaging."

"The RDM one reminds me of the classic BBC LS3/5a, but with deeper bass and higher output."

"...the KEF RDM ones are an excellent value—and very good looking, too."

Designed by the same engineers as our legendary Reference Series, the RDM one features KEF's patented Uni-Q® technology. Uni-Q places the tweeter at the exact acoustic center of the woofer cone to create a single point source for the entire frequency range—the ideal to which all speakers aspire—producing a flawless soundstage over a much wider listening area. Whether on a bookshelf or stand, the RDM one no longer confines you to sitting in a central sweet spot to enjoy exceptional performance. Audition them for yourself by contacting us for the name of the authorized KEF dealer nearest you. Ask for a full reprint of the RDM one review when you call.



COREY GREENBERG

Theta Digital Casa Nova Surround Preamp



Photos: Michael Groen

T rue story: Back in my radio days in Texas, the station hired a shrieky, high-strung program director from New York named Tina, who wore freakish clown makeup and a screaming-yellow North Beach Leather jacket with a big black eight-ball on the back and did nothing but whine about how poor a job “these Mexicans” did whenever she went to get her nails done. One week she had to fill in on air, and since Tina Santucci wasn’t exactly a Southwestern-flavored on-air handle, she asked me for advice on a name that would go over well with our listeners. “How about Sue Casa?” I suggested, and Tina, not knowing a lick of Spanish except “I, Chihuahua” (could’ve been her motto, actually) went for it. And thus it came to pass

that the station’s switchboards nearly melted down during her first on-air shift, after which Sue Casa entered the annals of radio history, never to be heard from again.

When it comes to high-end audio, though, the Casa name means money in

THETA DIGITAL

Dimensions: 19 in. W x 4½ in. H x 14½ in. D (48.3 cm x 11.4 cm x 36.8 cm).

Weight: Approximately 20 lbs. (9 kg).

Price: Approximately \$3,000 to \$4,200 (depending on options selected).

Company Address: 5330 Derry Ave., Suite R, Agoura Hills, Cal. 91301; 818/597-9195; www.thetadigital.com.

the bank. Particularly at Theta Digital, whose awesome \$5,745 (though figure on adding another couple grand for must-have options like Dolby Digital, higher-grade D/As, and video switching) Casablanca digital preamp set new standards for He-Man surround sound when it was introduced a few years ago. Now the company has come up with the new Casa Nova, a more affordable version of its flagship processor that rings in at a paltry \$3,000 (plus or minus, depending on selected options). But even though the price is lower, Theta has added a few tricks to the mix, which look to push Poco’s performance past Poppy’s.

Like the Casablanca, the Casa Nova features a PC-like motherboard design with internal plug-in cards for the video, digital, and analog circuits. While owners of most competing high-end surround processors are forced to trade up to a whole new model when time marches on, the Casa Nova owner will be able to keep his unit up to date with future upgrade boards. (Already, Theta has come out with several such options for Casablanca owners, including higher-quality D/A boards and a digital EQ upgrade featuring the widely lauded Z-Systems technology.)

At first glance, the Casa Nova looks like a smaller version of the Casablanca, with a shorter profile more reminiscent of conventional audiophile preamps than the Casablanca’s almost comically imposing bulk. So what do you lose? Metal buttons on the front panel, for one—the Casa Nova’s are rubber, and not a “classy” rubber at that. Of course, this isn’t something that affects sound quality, but I have to admit it’s much nicer punching the metal buttons on the Casablanca than the rubber nubbies on the newer Theta.

Theta says the Casa Nova’s digital audio circuitry is quite similar to the Casablanca’s but that the new preamp’s dual power supplies—one for the digital circuitry and one for the analog side, to keep digital noise out

of the audio signal path—aren't quite as monstrous as the flagship's. Still, popping the smaller preamp's hood revealed a pair of supplies considerably beefier than in most A/V controllers in this class. Theta has long advocated the use of heavy, oversize power supplies in its digital gear, claiming that such overkill makes for better bass and cleaner sound across the board. I know that in my own DIY audio projects, the more current the supply can source the audio circuit, the more effortless the sound from top to bottom.

The Theta has room to run six sources, be they analog or digital. Six RCA coaxial and two Toslink optical digital inputs come standard, with room for optional AT&T and Theta's own Laserlinque optical inputs. (The company says a FireWire input will be offered as an upgrade when DVD-Audio players with matching digital outputs hit the market.) Vinyl obsessives should be forewarned that all analog sources are first converted to 20-bit/48-kHz PCM with a Crystal delta-sigma analog-to-digital converter; unlike its big brother, the Casa Nova has no straight analog pass-through. Even its straight stereo mode converts analog sources to digital and then back to analog

again at the output D/As. However, just as in the Casablanca, Theta gave the Casa Nova an analog six-channel volume control at the very end of the signal chain, claiming that this approach to level control offers better sound quality than the DSP volume controls found in many other digital processors.

New to the party this time around are Burr-Brown 24-bit/96-kHz DACs as

standard issue, versus the stock 18-bit and optional 20-bit D/As found in the Casablanca. (New 24/96 DACs are now also available for the older processor, but the sample I have on hand uses the older 20-bit "Superior" grade D/A board for the three front channels.) In addition to straight two-channel stereo and mono modes, the Casa Nova's standard configuration incorporates Dolby Pro Logic decoding, Theta's own version of Pro Logic called Special Matrix (which sports faster logic steering and stereo surrounds), and a thankfully subtle matrix-derived surround mode for stereo

Theta's Casa Nova serves up tremendously dynamic sound.

music that approaches neither the all-out sophistication of those found in Meridian and Lexicon processors or the low-rent, echo-soaked cheese found in everybody else's. We're talking simple L + R for the center channel and L - R for the surrounds—in other words, kickin' it old school, with much love and props to David "Puffy" Hafler, whose original analog DynaQuad circuit from the '70s is replicated here in high-rez digital.

An interesting new twist Theta brings to the table with the Casa Nova is a much expanded subwoofer crossover menu. In addition to the Casablanca's classic 12-dB/octave Butterworth and 24-dB/octave Linkwitz-Riley crossover functions, Theta offers selectable slopes and its own "Phase Perfect" mode meant for well-matched systems using speakers with good low-bass extension and subwoofers that have extended upper-bass response. Theta says the "Phase Perfect" crossover setting makes for the most "audiophile" overlap, but the fact that it sends quite a bit of localizable mid and upper bass to the subwoofer means that it should probably be used only with systems employing a pair of very high-quality subs, located very close to the front left and right speakers.

Custom configuration is the natural advantage of an open-architecture A/V preamp like the Casa Nova, and Theta's portfolio of options is plenty fat. Obviously, anyone shelling out the big bucks for something like the Casa Nova is going to want the optional Dolby Digital and dts processing cards installed before the seal on the shipping carton is razored, so my review sample came fitted with both (an optional RF demodulator board for Dolby Digital laserdisc playback is also available). The stock Casa Nova ships without any provision for video switching, but an optional video board allows for as many as six RCA composite- and four S-video inputs, as well as two outputs of each type. Any composite- or S-video connection can be assigned to any of the audio inputs. Another option for those seeking more interesting music surround synthesis is called CircleSurround, a mode offering more aggressively steered surround synthesis with full-range stereo rear channels, which can be used with either CircleSurround-encoded software (what there is of it) or any straight stereo or Dolby Surround-encoded program material.

I listened to the Casa Nova in my reference system, comparing it to both its big brother, the Theta Casablanca, and Meridian's new 561 digital surround preamp (which I reviewed in November). A Toshiba SD-3107 spun DVDs, while a Theta Data III transport handled CDs and CD-Rs. Analog sources included an RCA S-VHS deck, a Rega Research Planar 3 turntable fitted with a Grado Reference cartridge and a McCormack Audio phono stage, and the stereo analog outputs of my Dell PC's Event Gina 20-bit sound card playing my own original recordings. Bryston's five-channel (120 watts per) 9B-ST power amp drove a quartet of NHT 3.3 full-range speakers—you gotta love having a built-in 12-inch subwoofer at all four speaker positions—coupled with the company's matching Audio-Center-1 center-channel speaker sitting atop a Pioneer Elite widescreen rear-projection TV. Cabling included Canare L-2B2AT analog interconnect and 75-ohm digital/video cable, along with Kimber 8TC speaker cable. All electronics were plugged into API PowerPack AC filters.

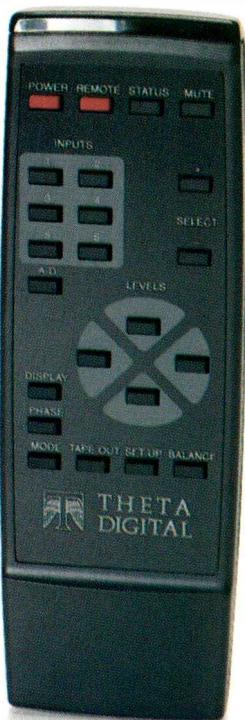



The stunning new 1000-watt PV1000 subwoofer in matching cherry veneer completes your VR-M theater.

Just who is this Amy B. Leavitt? Professional photographer. Ardent Jazz listener. Theater enthusiast. Classic car aficionado. An appreciator of details, student of aesthetics. In other words, a real, live person with irreproachably high standards — perhaps just like you. When she first heard the VR-M60's, she was undeniably taken by their accuracy, refinement and musicality. No wonder. VR-M monitors contain our most advanced components. And represent thousands of engineer hours, tweaking, tuning, listening and retweaking. The result: warmth, transparency, true three dimensionality. (Plus their rich cherry exterior is no less refined.) Ever been asked to endorse a loudspeaker? Now you have: Please listen to the VR-M series at your Boston dealer.



The New **VR-M** Series Monitors. Endorsed by Amy B. Leavitt.



DISCOBOLOS.

PROCEED

Proceed®
Modular DVD Transport



When Athenian sculptor, Myron created Discobolos in the fifth century B.C., he captured a moment in time and a classical beauty that have endured for more than 2400 years.

Today, performing arts captured on CD and DVD can be brought to life in your home. The world's finest component systems recreate them with athletic grace and beauty. And while the ancient discus thrower carefully selected his disc, the Proceed Modular DVD Transport is happy playing the entire range of CD and DVD discs available today.

Like Discobolos, the PMDT was created for pleasure. It has been designed to make DVD-based systems easier and more enjoyable to use. While we can't guarantee it will be around for 2400 years, its software updatability and modular chassis achieve the highest performance and ensure an extended useful life.

Visit your Proceed dealer to see and hear Madrigal's first DVD transport.

- ▲ Proceed Modular DVD Transport by Madrigal Design Team.
- ▼ Roman copy of Discobolos by Athenian sculptor, Myron.

Proceed® products are designed and manufactured by Madrigal Audio Laboratories, Inc.
P.O. Box 781
Middletown, CT 06457 U.S.A.
Fax: (860) 346-1540
www.madrigal.com



A Harman International Company

As a longtime, enthusiastic user of Theta's Casablanca A/V preamp, I was eager to hear what the Casa Nova could do. At first listen, it sounded broadly similar to its

elder sibling—the characteristically big, bold, and upfront sound of the Casablanca is definitely preserved in the new preamp. The Casa Nova serves up a tremendously

ballsy, hugely dynamic sound that is the very definition of what Howlin' Wolf meant when he moaned, "three hundred pounds of muscle-y man."

TEST RESULTS

T rue Technologies measured the Casanova's frequency response with the five main channels set to full-range. As you can see from Fig. 1, the curves are essentially identical and, apart from a tiny jog near 60 Hz and a rolloff of about 0.3 dB at 20 kHz, extremely flat. Maximum channel imbalance is less than

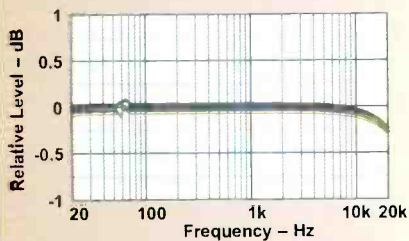

Fig. 1—Frequency response, five main channels.

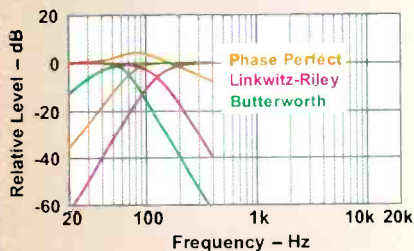

Fig. 2—Crossover characteristics. Butterworth filters were set to 40-Hz, 12-dB/octave high-pass and 60-Hz, 24-dB/octave low-pass. Linkwitz-Riley filters were set to 120 Hz, 24 dB/octave and "Phase Perfect" crossover to 80 Hz, 18 dB/octave.

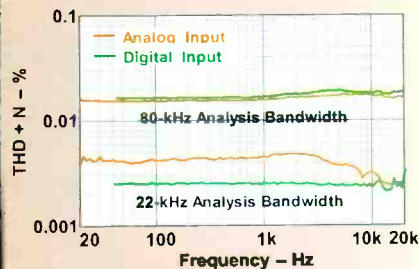

Fig. 3—THD + N vs. frequency.

0.2 dB. Shown in Fig. 2 are characteristics of the three crossover types Theta provides. The Linkwitz-Riley crossover is quite lovely, with nice, steep 24-dB/octave slopes in this example. It should work especially well in systems using small satellite speakers. More flexible is the classic Butterworth crossover, which allows different slopes and cutoff frequencies for the low- and high-pass sections. The curves were taken with a high-pass setting of 40 Hz at 12 dB/octave and a low-pass setting of 60 Hz at 24 dB/octave. The high-pass section of the "Phase Perfect" crossover behaves as advertised, with an 18-dB/oct-

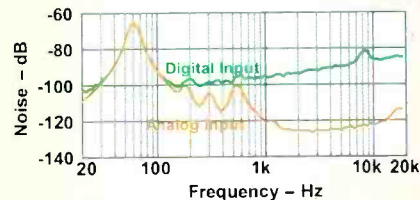

Fig. 4—Noise spectra.

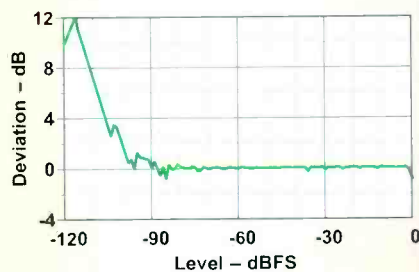

Fig. 5—DAC linearity error vs. level.

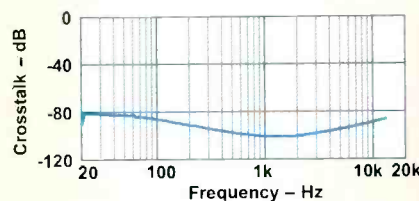

Fig. 6—Crosstalk vs. frequency, left and right front channels.

tive cutoff below 80 Hz, but the low-pass section is distinctly odd. Bumping up a few decibels through the mid and upper bass and rolling off very gradually above, it will not do a lot to keep high frequencies out of a subwoofer.

Distortion is delightfully low. Measurements of total harmonic distortion plus noise (THD + N) versus frequency (Fig. 3) come in at less than 0.005% across the board with a 22-kHz measurement bandwidth, even for analog input. Through the digital inputs, the THD + N is less than 0.003%. The readings climb a good bit with an 80-kHz measurement bandwidth, mainly reflecting out-of-band noise and clock artifacts, but they're still less than 0.02%, which would do most amplifiers proud. The only concern one might have about distortion arises from the Casanova's 2-volt analog input overload level, which may be exceeded by the outputs of some sources on signal peaks.

Even the noisiest of the channels (center) is reasonably quiet (Fig. 4), except for a hum spike at 60 Hz, which might be audible on some systems. The digital-input curve was made with a Dolby Digital feed, but True Technologies says that the same results were obtained using 20-bit PCM dither. True also notes that the noise appeared to be independent of output gain. A-weighted noise relative to a 0.5-volt output measured -80.9 dB except on the subwoofer output, where it was -77.3 dB. As one might expect from Theta, D/A converter linearity (Fig. 5) is very good. And interchannel crosstalk is extremely well controlled. The curve in Fig. 6 is for right front versus left front, with a PCM input. True reports that it couldn't measure the crosstalk between any other channels because the Dolby Digital signal for this purpose is at -20 dBFS rather than 0 dBFS, and at the lower level, the crosstalk was lost in the noise!—Michael Riggs



Clear

Sweet

Natural

Sound

THE ENERGY MICROSTAR™

is the latest success story in powerful, compact subwoofers. Designed to occupy just one cubic foot of space, this speaker has an incredible output of 1500 watts. Loud, without that all too common distortion, the Microstar delivers musical bass, with a natural sound that is both sweet and colorful. To fully appreciate the power of the Microstar Series, come in and hear it at your nearest authorized Energy® dealer today.



ENERGY

LOUDSPEAKERS

MUSICAL TRUTH™

But while the Casa Nova preserves the impact and sheer, unrestrained power of the Casablanca, I was pleasantly surprised to hear it take things up a notch and actually improve upon the sound of the more expensive preamp in several important areas. The biggest difference was in the treble range—the Casa Nova had a smoother, more liquid high end than the 20-bit-upgraded Casablanca I've been living with, making for a noticeably more natural and "analog" sense of ease and refinement on top. The Casa Nova still sounds a bit brighter and more forward than the exquisitely musical and similarly priced (when both are similarly equipped) Meridian 561 A/V preamp I reviewed last month, but it comes closer to that unit's standard of pure, relaxed treble presentation than the older Casablanca.

I heard a significant improvement in the bass, as well. The Casa Nova may have a smaller power supply than its big brother, but its newer and more advanced 24/96 D/As give it a sense of thrust and definition in the low end that the 20-bit Casablanca can't quite match. The Casa Nova's Dolby Digital performance was cleaner and more richly detailed than the older Theta's, too—the trippy and enjoyably bass-happy mix on the very cool 5.1-remixed *Yellow Submarine* DVD rocked my living room with extraordinary punch and an iron-fisted authority that went far beyond what I'm used to hearing from the older Theta (again, this was with the Casablanca's 20-bit D/A board). For sheer low-end excitement, the Casa Nova delivered a much more potent wallop than its more expensive stablemate. (As with other recent A/V preamps and processors, I didn't evaluate the Theta's dts performance; with new releases slowing to a halt and manufacturers already starting to whisper its obit, this format is fast on its way to Divx-ville.)

It was a much tighter race with the \$4,995 Meridian 561 A/V preamp. The 561 has rewritten the rulebook in my system, taking it to a higher level than even the Casablanca had previously. In level-matched comparisons with the new Casa Nova, however, it was a closer call. The Theta's low end was slightly more powerful and aggressive than the Meridian's, but the

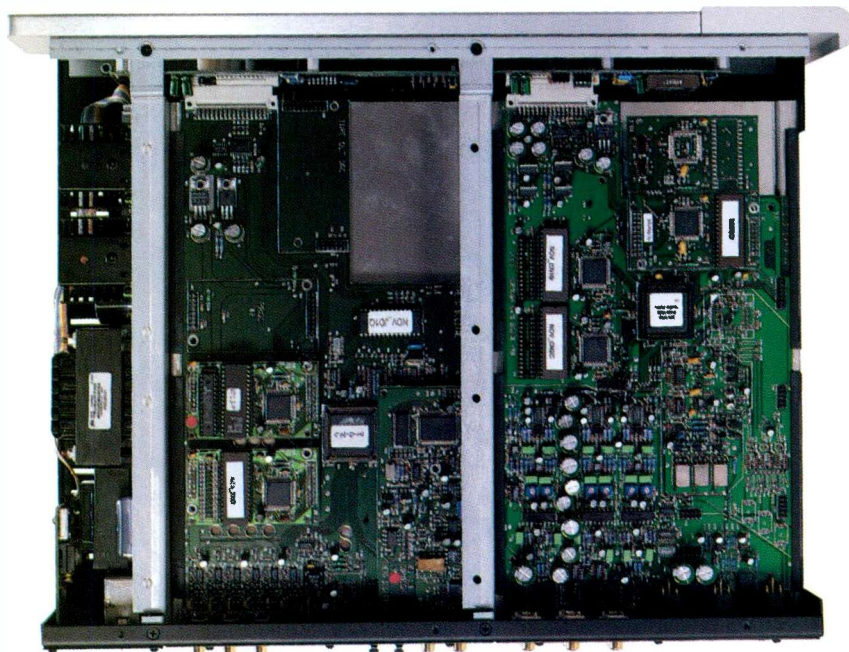

561 had a greater sense of ease and smooth, natural musicality across the midrange and highs. Both the Casa Nova and the 561 sounded great in straight stereo: No matter what CD I listened to, I heard cleaner and more detailed sound than I had ever heard

New to the party are Burr-Brown 24-bit/96-kHz DACs as standard issue.

in the past with any of the analog preamps and onboard D/As I've had in my rig. The Casa Nova sounds markedly better than its big bro', the Casablanca, but when it came to two-channel music especially, I preferred the sound of the Meridian. The 561's state-of-the-art music surround modes are quite a bit more advanced than the Casa Nova's, and even in straight two-channel stereo mode I heard a more focused and tangible soundstage from the British preamp.

These two A/V preamps represent a significant move by each manufacturer toward the sonic middle ground, somewhere between the up-front and lively Theta sound and the more relaxed, refined Meridian presentation. The 561 takes the Meridian fami-

ly sound a step closer to Theta's, with a bigger and ballsier sound than any of the previous Meridians I've heard over the years, while the Casa Nova's smoother, more laid-back treble character might easily get it mistaken for a Meridian in many systems. Though many high-end speaker designers seem to be going off even further into the woods in every direction but toward accuracy, it's nice to see two such radically different digital design houses improving their products' performance to the point where they come closer than ever to meeting in the middle.

Given its approximately \$3,000 base price, you'd expect the Theta Casa Nova to deliver, like many "junior" versions of flagship products, a healthy chunk of the more expensive model's performance but to fall short in enough important areas to keep the flagship's place at the top of the food chain secure. Instead, the Theta Casa Nova delivers a quality of sound that's all out of proportion to its asking price, with the result that it performs considerably better than the 20-bit version of the company's flagship Casablanca. If you've lusted after the Casablanca, which can cost upwards of eight grand once you load it down with options, you should definitely check out the Casa Nova—it sounds much better and costs much less. What else do you want, a rose on your pillow? **A**

Tower of Power.

What is hip?

How about 380 watts per channel into 8 ohms and 700 watts into 4 ohms? Rotel's new RB1090 delivers high-octave performance. No matter what the style of music. Of course, brawn alone doesn't make a great amplifier. Pinpoint soundstaging, stable imaging and the ability to reveal delicate nuances in music are the keys to a spine tingling listening session.

We begin by custom winding our own toroidal transformers. In the case of RB1090, they're twin 1.25kVA toroidals in a dual mono design. This "over-engineering" of the power supply isn't applied only to our premium designs though. In fact, all of our amplifiers feature rugged oversized power supplies and select premium grade components obtained from around the world. From our five channel RB985 home theater amplifier to the massive two channel RB1090, each of our power amplifiers will satisfy even the most demanding users.

Need even more power? Some of our amplifiers can be bridged to mono for three times their rated output into stereo, or, stack two stereo amplifiers together for bi-amplification of your loudspeakers. What is hip? Rotel's "Tower of Power" choice of eight superb amplifiers for home hi-fi, home theater or custom installation. Hear them at your authorized dealer.



RB985 interior shown with massive power supply and select grade components. 5 x 110 watts per channel into 8 ohms.

ROTEL

54 Concord Street
N. Reading, MA 01864-2699
Phone: 978.664.3820
Fax: 978.664.4109
www.rotel.com



DOUG NEWCOMB

Polk Audio RMDS-1 Home Theater System



About half the people on my block work in the movie business, and the fact that I live in Los Angeles but can't name a single film Jennifer Lopez has appeared in makes me something of an anomaly around here. Don't get me wrong: I love watching movies. It's just gotten harder and harder to drag myself down to a movie theater—on time, no less. Besides, I feel I have better ways to spend my ever-dwindling spare time than standing in line at the local cineplex box office, standing in line at the concession stand, and jockeying for a decent seat, only to listen to some sugar-charged brats chat all through the film.

So the concept of setting up a home theater system—where I can watch what I want, when I want, and how I want—intrigued me for years. But I've been reluc-

tant to jump on the bandwagon because my limited experience with home theater hasn't always been very positive. I've been phoned more than once by frantic friends and family members who have just bought a system and found themselves in over their heads when it came to hooking it up. And I've sat through many bland movies after said friends and relatives got their systems going and wanted to show them off. Sure, I've experienced a few of those transcendent moments that come from watching a classic movie on a good home theater system, though not nearly enough. And I've witnessed many a mind-blowing demonstration at trade shows, press conferences, or manufacturers' facilities. But I've also suffered through The Eagles performing "New York Minute" so many times that I don't want to see Don Henley's smug mug

or hear the band again until hell really does freeze over. All of this kept me from changing my two-channel lifestyle.

Man, was I stupid.

Maybe the Polk Audio representative who first contacted me about reviewing the company's new RM Digital Solution System-1—RMDS-1, for short—sensed that when he mentioned the system was designed so that "any idiot" could set it up. I certainly qualified. Polk bills the \$2,699 RMDS-1 as "everything you need for Dolby Digital home theater audio except for a source device and a TV"; it's the company's first foray into electronics (not counting powered subwoofers). Polk's goal in bringing out the RMDS-1 system is to capture the hearts, minds, and discretionary income of discriminating listeners who don't want the hassle of a complicated mix-and-match approach to home theater but won't

POLK AUDIO

Rated System Frequency Range: 30 Hz to 24 kHz; -3 dB at 38 Hz and 20 kHz.

Rated Impedance: 4 ohms, all speakers.

Rated Total Amplifier Power: More than 500 watts continuous (700 watts dynamic power), at 0.05% distortion, 20 Hz to 22 kHz, all six channels driven.

Dimensions: Tuner/preamp/processor, 17¼ in. W x 4½ in. H x 14 in. D (43.8 cm x 11.4 cm x 35.6 cm); main and surround satellite speakers, 4 in. W x 6½ in. H x 5 in. D (10.2 cm x 17.1 cm x 12.7 cm); center-channel speaker, 11½ in. W x 4½ in. H x 5½ in. D (29.2 cm x 11.4 cm x 14.6 cm); subwoofer, 15½ in. W x 18½ in. H x 19½ in. D (39.4 cm x 47.6 cm x 49.5 cm).

Weight: Tuner/preamp/processor, 13.1 lbs. (6 kg); main and surround satellite speakers, 4 lbs. (1.8 kg); center-channel speaker, 6.8 lbs. (3.1 kg); subwoofer, 77 lbs. (35 kg).

System Price: \$2,699.

Company Address: 5601 Metro Dr., Baltimore, Md. 21215; 800/377-7655; www.polkaudio.com.



No purchase necessary. Sweepstakes open to U.S. (except Puerto Rico) and Canadian (except Quebec) residents, 18 or older with valid driver's license. Void where prohibited. For eligibility, entries must be submitted via a complete Internet transmission, or if mailed, postmarked no later than 3/31/00. ©1999 GM Corp. Buckle up, America!

WHERE'S THE TRACKER?

IF YOU CAN FIND IT, YOU COULD WIN IT. HERE ARE SOME CLUES:

Head east from the Colosseum. Follow the rugged path of centurions and you will come to an amazing imperial estate built by a second-century Caesar. You will see the ruins of great temples and baths. You will ride over the ruts of chariots.

When the road gets this rough, you'll be glad you're driving the Chevy Tracker. Its 5-link rear suspension, brawny ladder-type frame and available truck-based four-wheel drive can absorb considerable punishment. If the agile and durable Chevy Tracker can handle these ancient roads, driving back home will be a walk in the park.

Know where it is? If you can name that place, you could win a Tracker.

For more Tracker information or to enter, visit WWW.CHEVYTRACKER.COM or send entry (specify location and country) to: Where's the Tracker, P.O. Box 4921, Blair, NE 68009-4921 USA. See next page for rules.

THE CHEVY TRACKER. IT GETS AROUND.



RMDS-1 SPEAKERS



**Polk RMDS-1
center-channel
speaker, subwoofer,
and satellite**



design to do the home-theater-in-a-box thing, either.

The heart of the system is a handsome Dolby Digital A/V preamp/processor with an AM/FM tuner. The gun-metal-gray front panel is crossed by a swath of plastic that holds the display, a power switch and standby indicator, and a large rotary volume knob. Below the display are 10 tiny function buttons, and concealed behind a rubber plug beneath the volume knob are three auxiliary inputs. On the back is a gaggle of inputs: three for digital audio (coaxial, optical, and RF for Dolby Digital laserdiscs), six for analog audio, and five for video (composite- and S-video connectors on each). There are also hookups for AM and FM antennas, a remote-control extension, a multiroom output, and switched and unswitched AC outlets. A DB-25 cable links the processor via an "Audio Out" terminal to a subwoofer cabinet, which also holds the system's 500-watt, six-channel power amplifier. The speaker outputs (on gold-plated five-way binding posts) for the main satellites, center channel, and surrounds are arrayed on the back of the subwoofer cabinet, below the amplifier's heat-sink fins. Just above the main speaker

outputs is the "Audio Input" jack for the DB-25 cable from the back of the pre-amp/processor.

The ported sub enclosure, made from ¾-inch MDF finished in black wood-grain vinyl, houses a 10-inch polymer-cone driver with a 1½-inch voice coil and butyl-rubber surround. The four palm-size satellite speakers each contain a ¾-inch poly-cone

**From unpacking to
powering up, it took
less than two hours
to start enjoying
the RMDS-1.**

midrange and a ¾-inch polymer-treated silk-dome tweeter; in the slightly larger center channel, two of the same midrange drivers flank another ¾-inch silk-dome tweeter. The enclosures for the satellites and center are made of molded NuStone, and the drivers are mounted on raised bezels that, according to Polk, press against the removable grilles to reduce diffraction effects. The RMDS-1 system employs active filtering for

WHERE'S THE TRACKER? SWEEPSTAKES

OFFICIAL RULES - NO PURCHASE OR ONLINE ENTRY NECESSARY

HOW THE SWEEPSTAKES WORKS: A Chevy Tracker has been photographed in a specific place somewhere in the world. During the months of November and December 1999 and January, February and March 2000, three clues will be given in magazine, newspaper, mailings, TV and the Chevy Tracker web site (<http://www.CHEVYTRACKER.COM>) advertisements as to what specific place and country the Tracker is located in. From these three clues, you must guess the specific place and country where the Tracker is located in order to be eligible for the sweepstakes drawing. If you wish to obtain all three clues, you may request such by sending a stamped, self-addressed envelope (VA and VT residents need not affix return postage) to: Where's the Tracker Clues, P.O. Box 4908, Blair, NE 68009-4908 USA. All requests for clues will be mailed back on March 1, 2000, and requests received after that date will not be honored.

HOW TO ENTER: Either access the Where's the Tracker web site (<http://www.CHEVYTRACKER.COM>) and follow on-screen instructions to enter your name, address (including zip code), work and home telephone numbers (optional), your e-mail address (optional) and your guess as to the specific place and country where the Tracker is located, or hand print the same requested information on a 3" x 5" card and mail it via first-class mail (limit: one entry per outer mailing envelope) to: Where's the Tracker Sweepstakes, P.O. Box 4921, Blair, NE 68009-4921 USA. For eligibility, entries must be submitted either via a completed Internet transmission, or if mailed, postmarked no later than 11:59 p.m. Central Standard Time, March 31, 2000. Mail-in entries must be received by April 7, 2000. Limit: one (1) e-mail entry per person/per e-mail address/per home address per day. (E-mail entries will be deemed made by the authorized account holder of the e-mail address submitted at the time of entry.)

WINNER SELECTION AND PRIZE: One (1) winning entry will be selected on or about April 15, 2000, under the supervision of D.L. Blair, Inc., an independent judging organization whose decisions are final, in a random drawing from among all correct entries submitted. In the unlikely event no one entrant correctly guesses the specific place and country location of the Tracker, winner will be determined in a random drawing from among all entries submitted. Winner will receive a brand-new Four-Door 2000 Chevy Tracker (approx. prize value: \$19,000 US). No cash equivalent or substitution of prize will be permitted. Winner will be notified by overnight express service and must sign and return an Affidavit of Eligibility and Release of Liability within 15 days of notification, via the return mailer provided. Noncompliance within that time period may result in awarding of the prize to an alternate winner. If prize winner is selected from an Internet entry, winner may be required to provide proof that he/she is the authorized account holder of the e-mail address associated with the winning entry.

ELIGIBILITY: Sweepstakes open only to residents of the United States including Hawaii and Alaska (except Puerto Rico) and Canada (except Quebec), 18 years of age or older, who possess a valid driver's license. Employees of General Motors, Campbell-Ewald Advertising, D.L. Blair, Inc. and members of their immediate families are not eligible. All applicable laws and regulations apply. Sweepstakes void wherever prohibited by law. Taxes, title, license and registration fees, where applicable, are the sole responsibility of the winner. Odds of winning are determined by the number of correct and incorrect entries submitted. Sponsor is not responsible for any error, omission, interruption, deletion, defect, delay in operations or transmission, theft or destruction, or unauthorized access to, or alterations of entry materials, or for technical malfunctions of any kind, or inaccurate, misrouted, garbled transmission of, or failure of Sponsor to receive entry information on account of technical problems or traffic congestion on the Internet or any web site or any combination thereof. Sponsor is also not responsible for any injury or damage to entrant's or any other person's computer related to or resulting from playing or downloading any materials in the sweepstakes, or for mail or entries that are late, lost, misdirected, damaged, incomplete, illegible or postage due. In the event any portion of this sweepstakes becomes technically corrupted or compromised by virus, bugs, non-authorized human intervention or other causes beyond the control of Sponsor, which, in the sole opinion of the Sponsor, corrupts, or impairs the administration, security, fairness or proper play of the sweepstakes, Sponsor reserves the right, at its sole discretion, to (a) suspend or cancel the sweepstakes in its entirety, or only the Internet portion; (b) cancel any method of entry; and/or (c) select winner from all eligible entries received prior to Sponsor exercising its rights to suspend or cancel the sweepstakes. Online entries made with multiple e-mail addresses, under multiple identities or through the use of any other device or artifice to enter multiple times will be deemed invalid. Sponsor reserves the right to disqualify entrants who violate the rules or interfere with the promotion in any manner. If disqualified, Sponsor reserves the right to terminate entrant's eligibility to participate in the sweepstakes. Prize is guaranteed to be awarded.

By acceptance of prize, winner consents to use of his/her name, photograph and other likeness for purpose of advertising, trade and promotion on behalf of General Motors without further compensation, unless prohibited by law. Rules are subject to any requirements/limitations imposed by the Federal Communications Commission.

For the name of winner (available after May 15, 2000), send a separate, stamped, self-addressed envelope to: Where's the Tracker Winner, P.O. Box 4936, Blair, NE 68009-4936 USA.

Sweepstakes Sponsor: Chevrolet Motor Division, General Motors Corporation, 100 Renaissance Center, Renaissance Drive, Detroit, Michigan 48265.

TEST RESULTS

The Polk system's frequency response is shown in Fig. 1. The match between the center-channel and satellite speakers is pretty good, although the center speaker's output is greater over much of the spectrum, by about 6 dB at some frequencies. (Note, however, the center speaker's dip at 2.3 kHz, the result of interference between its two midrange drivers, and its broad peak centered at about 7 kHz.) With grilles on, response rolls off noticeably above 10 kHz or so, but although the grille roughens the center speaker's output a bit between 4 and 10 kHz, it actually smooths the satellites' response. When levels are equal, there's a fairly substantial gap between the subwoofer's response and that of the other

speakers, which may make the subwoofer too easy to localize; running the woofer at a higher level (which many people will) or careful placement will fill some of that hole. Extending the center and satellite speakers' response down further would have eliminated this gap but would probably have required bigger speakers.

Not too surprisingly, considering their different driver configurations, the satellites and center speaker have different off-axis characteristics. The center speaker's 2.3-kHz notch deepens and broadens at horizontal angles farther off axis (Fig. 2A), where distances between the test mike and the two midrange drivers become increasingly different. Around the vertical axis (Fig. 3), this problem goes away for the

center speaker but now afflicts the satellites, with their stacked drivers. The center and satellite speakers' impulse responses (Fig. 4) match quite closely, as you'd expect from systems using identical drivers.

The owner's manual says the RMDS-1 should deliver up to 105 dB SPL in an IEC-standard listening room. True Technologies' distortion tests were run at a slightly higher effective level, which probably accounts for the center speaker's tweeter blowing, limiting the distortion measurements for it to 2 kHz. As distortion was fairly high at this point (not surprising, considering the small size of the center and satellite speakers), most listeners would likely have turned the level down before this occurred.—*Ivan Berger*

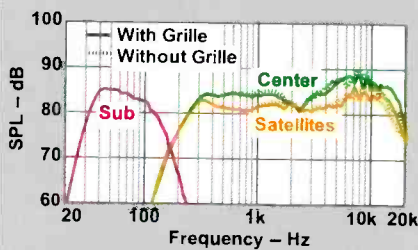

Fig. 1—Frequency response.

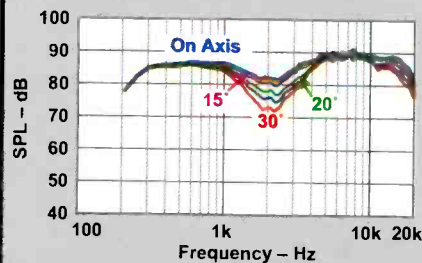
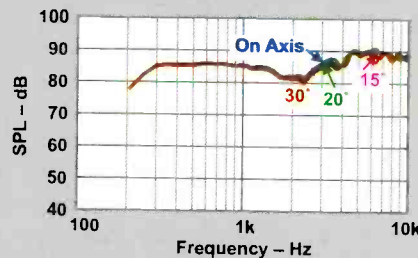

Fig. 2—Horizontal off-axis responses for center speaker (A) and satellites (B).

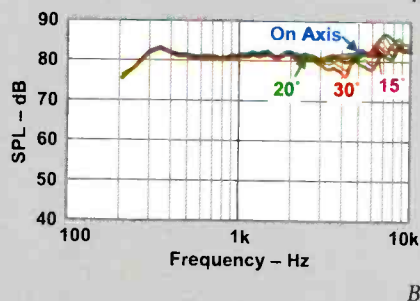

Fig. 3—Above-axis responses for center speaker (A) and satellites (B).

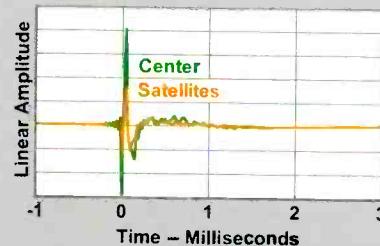
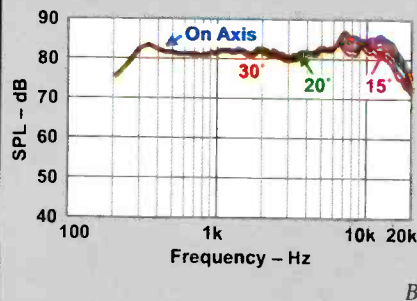

Fig. 4—Impulse response of satellite and center-channel speakers.

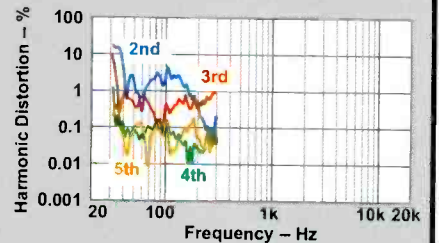
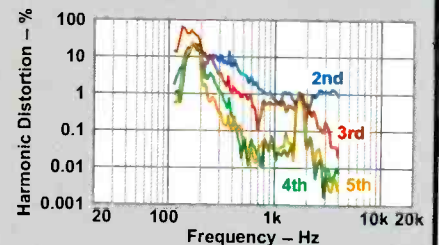
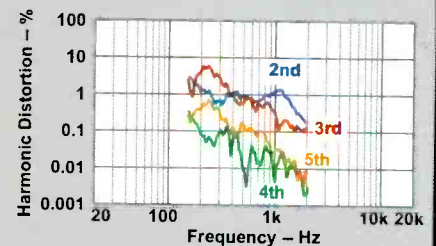

Fig. 5—Harmonic distortion at 100 dB SPL for center speaker (A), satellites (B), and subwoofer (C).

the crossover between the subwoofer and the other speakers; the low-pass signal for the sub rolls off at 24 dB per octave, while the high-pass side has a 12-dB/octave slope. The rated crossover point is 150 Hz. A Mylar-film capacitor splits the signal between the midrange and tweeter in each satellite at 3.1 kHz and between the mids and tweeter in the center channel at 2.5 kHz. All drivers are shielded, and the satellites are supplied with handy wall-mount brackets. The system comes with 140 feet of 16-gauge, oxygen-free-copper speaker cable that's precut into three 20-foot lengths and two 40-foot lengths, all terminated with gold-plated spade lugs.

Polk went to great lengths in the literature that accompanied my review samples to explain that the RMDS-1's raison d'être is to provide the non-hobbyist solid performance from a system that's easy to set up and use. On both counts, the company has succeeded. (If my ill-fated relatives who called me up for advice in hooking up their component-based systems had bought Polk's RMDS-1, maybe I'd hear from them only at Christmas, per usual.) From unpacking the boxes to powering up, it took me less than two hours to start enjoying the system. The only glitch I encountered was a mispatched video input, but after correcting that I was watching the only DVD I owned, a lame surf movie someone had given me. The source components I used were a Panasonic DVD-120 DVD player and a Panasonic CT-32XF55 32-inch TV.

Within a few days, I got around to snaking the speaker cables for the surrounds through the crawl space beneath my living room floor (my wife could no longer abide them running across the floor). I followed most of Polk's recommendations regarding speaker placement. However, it wasn't practical to follow the manual's suggestion that I place the front left and right speakers as far apart as I would be sitting from them (about 12 feet), so I ended up placing them approximately 7 feet apart. Greatly aiding system setup and operation was the RMDS-1's instruction manual. The one I received was obviously not the final version, and my editor's eye picked out some glaring typos. But the manual was very well written and easy to understand,



Get This **FREE** Catalog Before You Buy!

Discover the fun, comfortable alternative to shopping in crowded stores. Relax at home with the Crutchfield catalog and find out why *Catalog Age* magazine calls Crutchfield the "King of Service."

In-depth descriptions

You'll love the detailed coverage of each model's features and specs, the complete product descriptions, the color photos, and our exclusive comparison charts.

You won't believe the selection

You'll find discount prices on top brands, including Sony and Sony ES, Onkyo, Pioneer, Yamaha, Kenwood, Panasonic, Technics, JVC, Polk Audio, NHT, Infinity, JBL, Bose, Monster Cable and more.



Fantastic service seven days a week

Days, nights, week-ends — whenever you call, you'll be talking with sales and technical advisors who know the products inside and out!

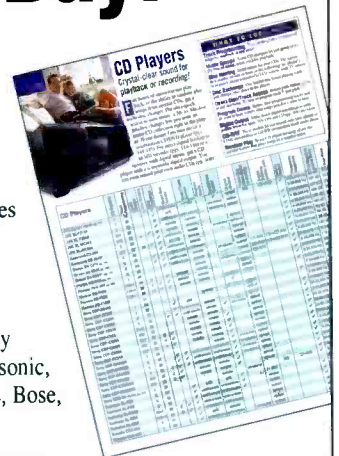

Our comparison charts make it easy to find the equipment you want.

Get your free catalog now!

1-888-739-5932

Toll-free • Ask for extension "AU"

or visit **www.crutchfield.com**

Shop online • Request a free catalog • Browse our Info Center



CRUTCHFIELD

The Complete Car Stereo and Home Audio/Video Catalog

and it even had some humorous touches (well, audio humor).

After setting up the Polks and watching a few movies on DVD, I followed the setup and calibration instructions in the owner's manual. I first used the system's built-in test signal to verify that all speakers were operating correctly. Then, with a Radio Shack sound level meter, I adjusted channel balance by lowering the level of the main speakers 1 dB. Next I tweaked Dolby Digital delay to the center-channel and surround speakers according to their distance from my listening location. Though I occasionally switched back to the default factory settings, the slight modifications I made improved the sound. Polk provides only six delay settings for the center channel (0, 1, 2, 3, 4, and 5 milliseconds) and three for the satellites (5, 10, and 15 milliseconds). This was enough to dial the system in for my listening environment, but it could be a hindrance if you have an odd-sized room.

I used the remote for setup and finished the process in a matter of minutes. Other operations were just as easy. The buttons on the remote are logically laid out, with the four for volume and subwoofer level most prominent and centered at the top.

I watched more movies in the six weeks or so I spent testing the RMDS-1 than I had in the previous six months—and I loved every minute of it. In *Das Boot*, the claustrophobic atmosphere of the German U-boat was tangible. Voices of crew members off screen came from outside the soundstage, and in the tense deep-water scenes I distinctly heard creaks and pops emanate a good 3 feet or so outboard of the front left and right speakers. Additionally, the depth charges that set the intensity level from the outset of the film were re-created with ominous authority by the subwoofer. In *Elizabeth*, I was amazed at how the system was able to faithfully portray the nuance of voices in a wide variety of settings—from someone making a loud proclamation in a large, resonant room of a castle to the intimate environment of a confessional. One lightning strike was so forceful and lifelike that it caused me to jump from my seat, and the ensuing thunder sounded real and decayed naturally. In *Apollo 13*, the liftoff scene had my living room shaking with

earthquake-like force. Even some of the really bad movies I watched were made tolerable by the surround effects. In *Alien Resurrection*, for example, the only thing that kept me from switching to cable was the hope that another spaceship would blast by with the sensation that it had just passed over the top of my house.

Even better than movies was watching music DVDs. I screened *The Best of Sessions at West 54th, Volume 1* (a compilation from the acclaimed public television show) so many times that my wife threatened to hide the disc from me. On Shawn Colvin's compelling performance of "Diamond in the Rough," the electric guitar had a soaring,

The RMDS-1 reproduced musical performances on DVD in all their passionate detail.

authentic sound that one would expect to hear at a live performance—and that regular ol' two-channel listening just cannot deliver. Richard Thompson's solo version of "I Feel So Good" simply smokes the original version from his '91 *Rumor and Sigh* album, transforming the song from a tongue-in-cheek ditty to an unplugged punk rave-up. The Polk RMDS-1 reproduced the performance in all its passionate detail.

For conventional two-channel playback, the RMDS-1 performed very well—not as well as my reference stereo system but commendably for a system of its size and design. One thoughtful feature is a subwoofer memory that enables you to set separate bass levels for stereo and surround modes. Another feature I particularly appreciat-

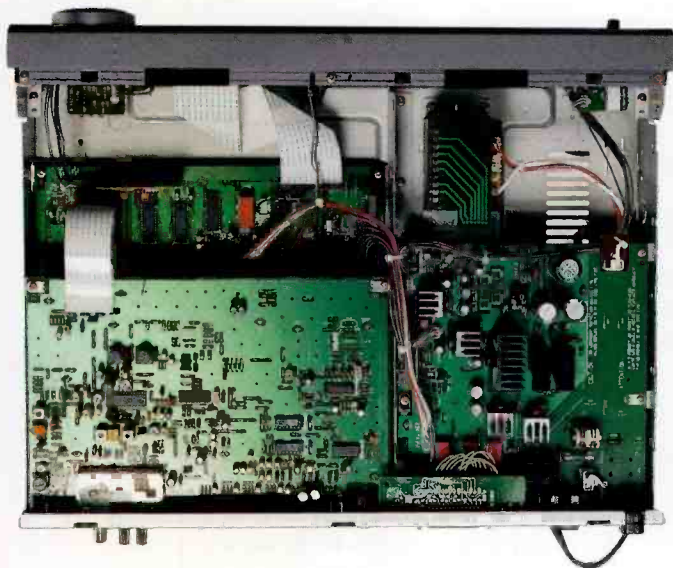

ed was the "Late Night" function, which reduces dynamic range on Dolby Digital sources so as not to disturb others in the house; this allowed me to stay up late watching movies without waking my wife and baby daughter.

The RMDS-1's FM radio reception was surprisingly good. Living in a canyon, I've unfortunately come to accept poor reception as a fact of mountain life—along with brush fires, mudslides, and flooding. Now at least I can listen without static to the innovative public radio station KCRW-FM in Santa Monica and "America's jazz station," KLON-FM, in Long Beach. And I can get emergency info in case of a natural disaster, which happens every few months in this chunk of Southern California.

Polk's intention with the RMDS-1 is to fill the gap between the hobbyist/component crowd looking for the 'nth degree of sonic performance and flexibility and the home-theater-in-a-box mass market. But after living with the RMDS-1 for a couple of months, I say the designers overshot that goal. Although the system's closed architecture will turn off some serious audiophiles who want to mix and match components, its performance leaves little to quibble about, given the price. And the RMDS-1 is an absolute godsend for folks who want to get component-style performance without suffering the usual setup and operation headaches. Good show, Polk. Now I'm off to Blockbuster to find some Jennifer Lopez DVDs. **A**

The
BELL'OGGETTI *Difference*

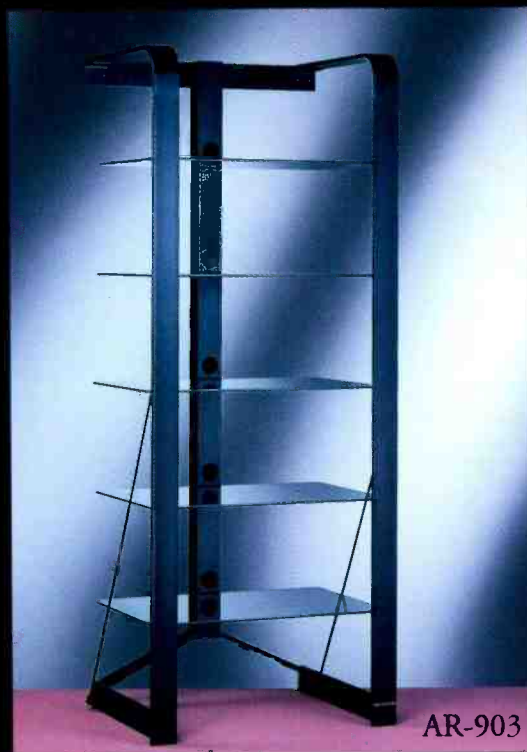
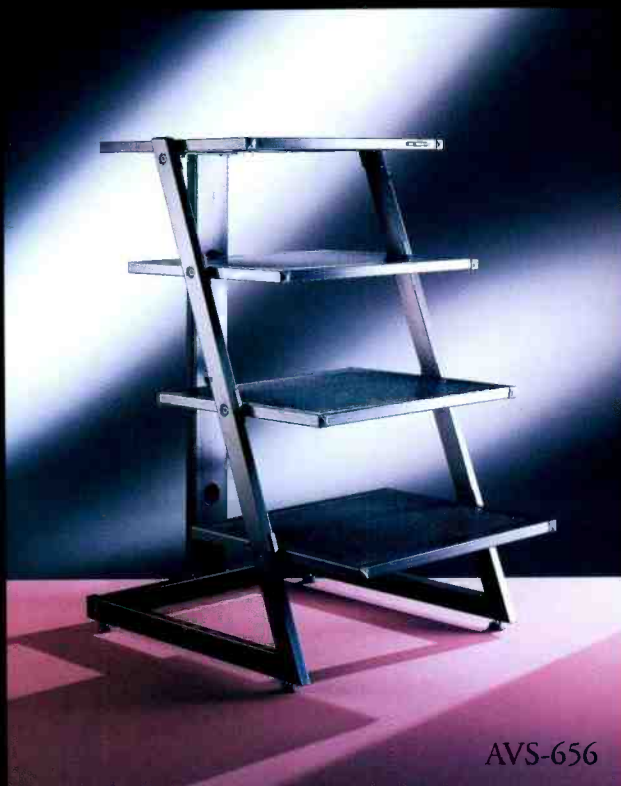

BELL'OGGETTI®

HOME THEATER/HOME OFFICE FURNITURE

711 GINESI DRIVE, MORGANVILLE NJ 07751, TEL. 732-972-1333, FAX 732-536-6482

In Canada: TEAC Canada Ltd., TEL 905-890-8008, FAX 905-890-9888

web site: <http://www.bellogetti.com>

ART AND SCIENCE MEET.
FALL MADLY IN LOVE.
AND MAKE BEAUTIFUL
MUSIC TOGETHER.

Introducing Prelude™ MTS from Infinity. Rarely has sonic accuracy been realized in a form so beautiful. It is indeed a remarkable meeting of art and science.

Prelude MTS includes more than a dozen cutting-edge transducer technologies, most notable of which is Infinity's own Ceramic Metal Matrix Diaphragms (C.M.M.D.™). They are three times as rigid as other cones, which results in minimized internal resonances and maximized sonic accuracy.

Brushed and anodized aluminum extrusions contain midbass, midrange and high-frequency drivers which are mounted atop a real-wood veneer, 850-watt powered subwoofer. The towers can be used as side or surround channels along with the center channel to create a complete multichannel music and theater system.

Prelude MTS adapts well to any decor and, through our innovative Room Adaptive Base Optimization System (R.A.B.O.S.™) bass output can be electronically tailored to the unique dimensions and characteristics of any listening room.

Immerse yourself today in the sonic art and science that is Prelude MTS from Infinity. Contact us at 1-800-553-3332 or www.infinitysystems.com.



Photos: Michael Groen

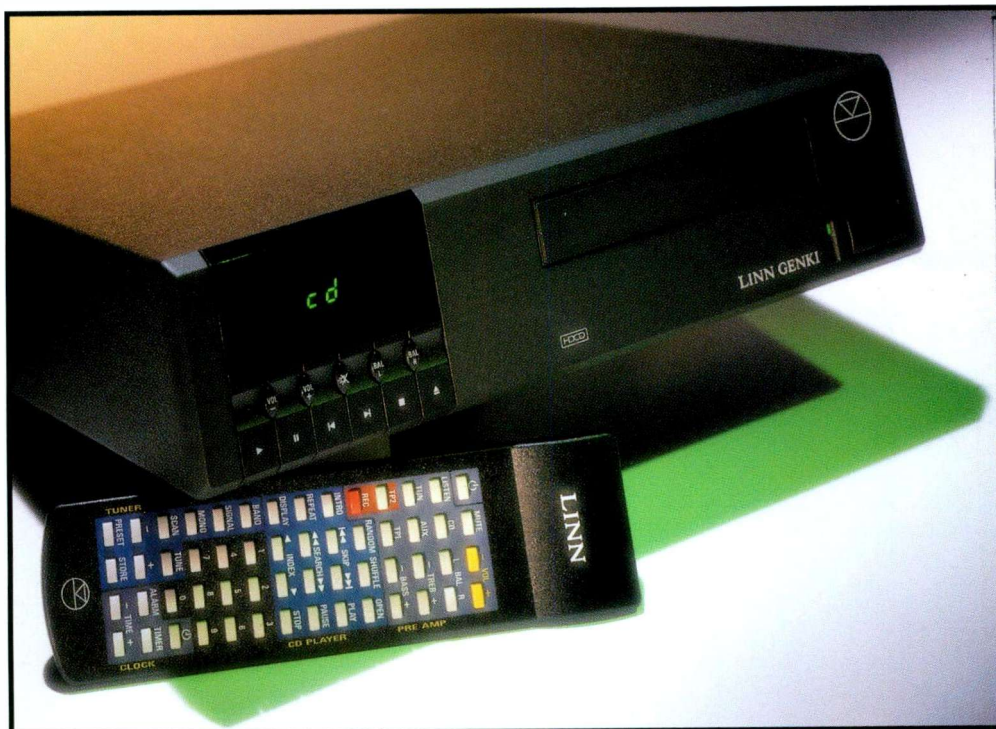

KEN KESSLER

Linn Genki CD Player

Linn's new just-above-entry-level CD player, the Genki, follows in the wake of the no-compromise, \$20,000 Linn Sondek CD12, which the company described as "the last great CD player." Quite a few people agreed; basking in the glow of the reception its exquisite CD12 received, Linn is now regarded as a coven of digital mavens. (Oh, the irony! Remember: Linn was rabidly opposed to CD for nearly the entire first decade of the format's life. Its conversion to CD is akin to Clinton's moving to a monastery. And a further irony: Linn's digital glory comes just as CD is being crushed by DVD.)

Linn is now firmly in the multiroom/custom installation camp, and the Genki interfaces with an assortment of Linn systems. This is immediately apparent when you look at its remote control. Instead of a

CD-only commander, as supplied with most stand-alone players (even from companies that make whole systems), the Genki's remote boasts 56 buttons to operate a full Linn stack—preamp, tuner, you name it. If this is a subliminal inducement to go all-Linn, then one must admire the Scots' clever, if not quite devious, salesmanship. Trouble is, it makes life difficult because the buttons are tiny and identical and the color-

LINN

Dimensions: 12 $\frac{1}{2}$ in. W x 3 $\frac{1}{8}$ in. H x 12 $\frac{3}{4}$ in. D (32 cm x 8 cm x 32.5 cm).
Weight: 7.3 lbs. (3.3 kg).
Price: \$1,700.
Company Address: 4540 Southside Blvd., Suite 402, Jacksonville, Fla. 32216; 904/645-5242;
www.linninc.com.

coding ineffectual. If you don't own an all-Linn system and have no intention of getting one, you will eventually crave a simpler remote with just the necessary buttons.

Linn's systems approach also accounts for the Genki's plethora of outputs, including four single-ended pairs of gold-plated RCA analog jacks, two fixed-level and two variable. So equipped, the Genki can feed conventional preamps, multi-zone systems, or power amps. Because the variable output lets the Genki feed a power amp directly, a cost-conscious audiophile who wants a purist CD-only system can buy a Genki for half the cost of a CD player plus a separate preamp and get both in one box (minus, of course, a

preamp's extra inputs). The variable outputs also give painless remote volume control for a system that lacks it—a system built around vintage tube equipment, for example. But full marks to Linn for also offering a fixed-level output to reassure the purist that the Genki's sound won't be compromised.

The Genki's flexibility doesn't stop there. Its outputs can control a simple two-room system through proprietary Linn Knekt remote-in/remote-out connections; an optional extra is an RS-232 port to provide an easy, convenient link for custom installations and to accept software upgrades. However, the Genki's only digital output is a BNC-type coaxial S/P DIF terminal, which some may find a bit restrictive in an era where digital control units are becoming common currency. Linn not only denies us the most popular of all digital outputs, RCA-style coaxial (I had to compromise by using an adaptor when connecting the Genki to DACs without BNC sockets), but also a Toslink optical output.

Just over a foot square, the Genki's chassis is finished in a textured, semi-gloss black, complemented by a matte-black front panel. The key numbers, if not the tiny legends in its green display, were perfectly visible from across the room to these

CCRadio

Finally ...

**A Great
AM Radio**

**Talk
News
Sports**

And They All Agree!



“Getting reliable reception of distant [AM] signals requires more than luck. It requires a good receiver, like ... the CCRadio from C. Crane, a specialty radio company.

“Add in the CCRadio’s FM, VHF-TV, and NOAA weather-band reception, and you have an all-around high-performance portable that you don’t have to be a radio hobbyist to love.”

— **Brian C. Fenton**
Stereo Review’s Sound & Vision

“Overall, the CCRadio is a keeper.”

— **Bruce Conti**, *Popular Communications*

“... the CCRadio pulls in stations with an accuracy [Marconi] would have envied.”

— **Wayne Thompson**, *The Oregonian*

“The radio’s sensitivity and selectivity are unmatched by anything I have ever seen. It is the best AM radio I have ever had the pleasure of trying.”

— **Gary Krakow**, *MSNBC*

“The Crane radio is an AM Champ.”

— **Alan Peterson**, *Radio World*

“Using only CCRadio’s built-in antenna, AM reception ... surpassed that of both a high-quality portable and a hi-fi receiver connected to an external antenna. ... the CCRadio netted a dozen more [stations] – including six whose signal had been overwhelmed by more powerful stations.”

— **Stephen A. Booth**, *Popular Science*

SANGEAN
AMERICA, INC.
www.sangean.com

\$159.95
Includes FREE
UPS Ground
Shipping



800-522-8863 or ccrane.com
Call for FREE CATALOG

spectacle-assisted eyes. A button on the remote scrolls the display through every track and time permutation, while the panel also indicates transport function mode, the presence of an HDCD disc, and (when you're using the variable outputs) level, muting, and balance.

Below the display are two rows of buttons. The lower six perform the standard transport functions of play, pause, track skip (forward and reverse), stop, and open/close; the five above control volume, muting, and balance. Other functions—such as search, shuffle play, random track access, programming, and the setting of custom functions for all-Linn systems—require the remote, alone or in combination with the front panel's keys.

Linn has long been an advocate of switching power supplies, recognizing years ago that the laws of the European Community (CE) were going to make life hell for everyone. Thus, the Genki contains Linn's proprietary Brilliant Silent Power Supply, first seen in the models higher up the Linn ladder, to eliminate myriad forms of unwanted (and probably harmless) radiation. All of the Genki's electronics meet or surpass the unnecessarily paranoid and, indeed, litigation-encouraging Continental requirements. (I swear, some U.S.-lawyer DNA has infected the Brussels gene pool.) The transport is, I hear, a Linn-tweaked, Sanyo-sourced, servo-controlled mechanism with improved error correction "to manage imperfect disc quality." If you crave the more solid, sexy smoothness of an entirely Linn-machined transport, you have to look to the company's Ikemi, which is a bit more than twice the Genki's price and whose innards are more akin to the CD12's lavish disc spinner. The Genki's DAC chip is the new Burr-Brown PCM1732, a 96/24-ready delta-sigma converter with HDCD compatibility. Linn's designers, as is now their wont, paid close attention to signal routing and layout and to surface-mount technology.

The U.S. price of this slice of Scottish audiophilia is \$1,700 (almost identical to its price in the Mother Country). I auditioned the Genki against players on either side of its price and directly against my own reference at this level, the Roksan Caspian, at

only \$10 less. The others included Krell's KAV-300cd (\$4,200), Pioneer's DVL-919 DVD/laserdisc combi-player (\$1,200), and Musical Fidelity's delicious XRAY (\$1,295). The D/A converters I used were Theta Digital's Balanced Chroma 396, the DAC section of the Lexicon MC-1, Musical Fidelity's X-DAC, and Theta's DS Pro Generation Va. Amplifiers were the Roksan Caspian integrated, two of the three channels in the Acurus A200X3, and two channels of Roksan's new five-channel power amp. The speakers I used were Apogee LCRs, B&W DM602 S2s, and Wilson Audio Specialties' WATT/Puppy 5.1s.

First I listened for differences between the Genki's fixed- and variable-level outputs. (Linn went overboard to ensure that there would be no audible consequence when opting for the latter. The Genki level control is a switched-resistor network in the analog domain; here, the company certainly remembered its analog roots.) To make comparisons, I connected the Genki using

Digital expertise? Home theater jacks? Linn is not your father's turntable company anymore.

both outputs, set the variable output to maximum, and rechecked levels with a digital SPL meter for each preamp or amp I tried (call it paranoia, but I don't like to take chances). I switched back and forth for a couple of days, but the differences I could detect when A/B switching did not even equal the variance between allegedly identical interconnects. As my own tendency is to opt for fixed output, I used it most of the time. But being able to remove an entire preamp from the chain is tempting: greater transparency, lower noise—you name it. I would advise those who really will use no



source but CD to feed the Genki directly into a power amp. The greater openness and enhanced clarity available from bypassing a whole component's circuitry are enough to make you want to revive the craze for the minimal circuitry of passive preamps.

Having experienced Linn's CD12 for a few weeks and being the lucky host to a Ken Ishiwata-modified Marantz CD12 (note the nomenclature) and a rare California Audio Labs Tempest II SE, I am not unfamiliar with how good conventional CD can be. So it was a minor shock to discover that this relatively affordable featherweight (just over 7 pounds) could rock with the best of 'em. I still remain immune to Linn's dogma about rhythm-pace-timing—that elusive, nay, *imaginary* imposition of fifth-dimensional values on a real-time event of known duration—but I must say that the Genki let me feel the funk.

The Castle label in the U.K. has, for some reason, decided that the '70s was a decade worth remembering and has released a flood of disco "classics." The Real Thing's "Can You Feel the Force"—with its driving bass lines, party noises, phasy effects, punchy brass, and (I think) machine-originated percussion—revealed the Linn's ability to sort out low-frequency information (no doubt to ensure that those on the dance floor don't suffer, uh, "arrhythmia"). Just tight enough to offer sublime control and attack, the Linn's bottom octaves sounded delightfully "analog-ish" despite exhibiting

THIS ISN'T YOUR MOTHER'S END TABLE!



Subwoofer performance to the **Xtreme!**



800-283-4644

www.legacy-audio.com

wholly digital virtues. The bass had the weight and substance you'd expect from a 12-inch single, while speed and punch were almost reason enough to make me stop bitching about the death of analog. (But I did say "almost.")

Midband clarity and warmth were present in abundance, especially on vocals. However, a slightly analytical chill affected the Genki's upper frequencies. Not a sizzle,

not sibilance, just a hint of artifice that carried over into the decoding of HDCD.

Even so, the Genki's performance with HDCD discs was among the best I've heard, though that might be merely because this is the latest-generation HDCD-compatible player I've tried. I listened to the the remastered Buffalo Springfield CDs on Atco, probably because they're my favorite albums of all time, and I must nod to Linn

for the Genki's smooth HDCD implementation. There were some curious artifacts I could not pin down, a hint of nasality in Steve Stills' voice the most obvious, but I cannot deny hearing even more low-level information, tiny details, and a better sense of "air" than with older HDCD players. Alas, I could make no true comparisons of HDCD discs versus regular CDs because HDCD versions are usually remastered. But even though I couldn't directly compare the HDCD Buffalo Springfield with the earlier CD, I can say it sounded very good on the Genki.

Spatial concerns did lessen my enjoyment of the Genki somewhat, especially af-

TEST RESULTS

Frequency response (Fig. 1) is impressively flat except for some high-end rolloff, -2 dB at 20 kHz. Some difference is visible between the fixed and variable outputs' noise (Fig. 2), crosstalk (Fig. 3), and total harmonic distortion plus noise (Fig. 4). Noise is gratifyingly low, with no sign of hum or other problems. Crosstalk between the left and right fixed-level outputs is also quite low, and crosstalk between the channels' vari-

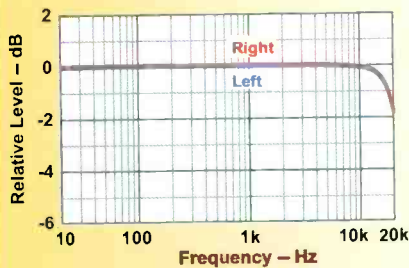

Fig. 1—Frequency response, taken with variable-level outputs.

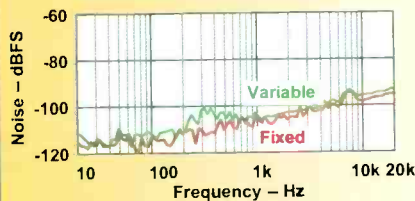

Fig. 2—Noise spectra.

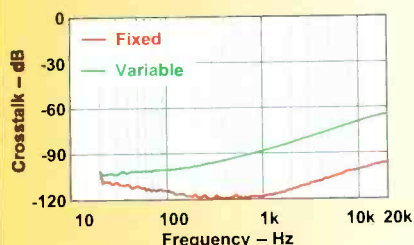

Fig. 3—Crosstalk.

able outs, though as much as 15 dB higher, is still nothing to worry about. Switching to the variable outputs does increase THD + N from an outstanding 0.003% to about 0.01%, which is only average performance. This measurement's noise component creeps up slowly from about 30 to 80 kHz, which accounts for the much higher curves with the 80-kHz bandwidth filter; however, results with the 22-kHz bandwidth filter give a more realistic picture of actual in-band performance. Byproducts of the 44.1-kHz sampling frequency (not shown) were evident at -90 dBFS but, again, no cause for alarm.

The Genki's DACs performed very well. Their linearity (Fig. 5) was almost perfect for signal levels as low as -94 dBFS.—*Bob True*

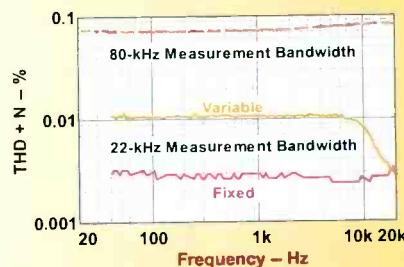

Fig. 4—THD + N vs. frequency.

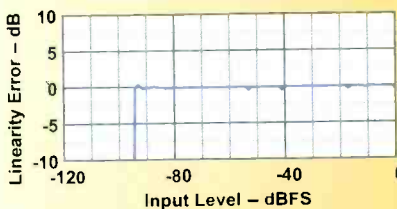

Fig. 5—DAC linearity.

It was a minor shock to discover that this affordable CD player could rock with the best of them.

ter tiptoeing through the vistas projected by Linn's CD12. Whatever the speaker, whatever the amplification, the Genki's soundstage, while deep, was narrower than what I know is possible. Was I imagining this? Uh-uh. Switching to the like-priced Roksan brought the same CDs' sound beyond the outer edges of the speakers.

Leaving aside the obvious appeal of the Genki to owners of Linn systems, it has so much going for it that it seems it will be a tonic for certain people. Yet what it has going for it applies more to "lifestyle" needs than to hard-core audiophile demands. In purely sonic terms, the Linn has clear rivals, not least the silkier, bigger-sounding Caspian. For user friendliness and absolute flexibility, however, the Genki might be the most obsolescence-resistant CD player on the market. (I mean, software upgrades? Precious few system-hookup limitations?) Aside from the absence of Toslink optical and RCA coax digital connections, this is a pretty sensible design. I kinda think that grownups, like those who admit that riding a Harley when you're over 50 is pretty sad, will be sorely tempted by the Genki's sheer intelligence. **A**

PICTURE PERFECT SYSTEM



For seventeen years, LEGACY has set the performance standard in home entertainment.

We've just raised the bar again.



Led by renowned designer, Bill Duddleston, LEGACY has developed a new system architecture unlike anything the world has ever seen; directivity controlled towers matched with dual center speakers, dipolar surrounds that hide in corners, and a subwoofer we could only call Xtreme.

An adventure powered with more than 2 kilowatts and navigated by a state-of-the-art digital surround processor.



For your FREE Catalog call
800-283-4644

www.legacy-audio.com

3023 E. Sangamon Ave., Springfield, IL 62702 • 217-544-3178 • Fax: 217-544-1483

Come experience your dream *Home Theater* in the following cities:

Newport Beach-October 30th & 31st, Home Entertainment Show, Hyatt Newporter

Cincinnati-November 5th - 7th, Best Western Conf. Center Springdale

Minneapolis-November 12th-14th, Minneapolis Convention Center

Denver-December 3rd-5th, Denver Convention Complex

Phoenix-December 10th-12th

In January/February, 2000 – Los Angeles, Pasadena, New York City, and Long Island.

Call the factory or visit us on the web for dates and times of these shows

Simultaneously Superb



MX132 A/V Control Center

Anything, built by McIntosh, is designed around the idea of reproducing a Great Experience. Because there is no spec for pleasure, McIntosh "Believers" sometimes find it difficult to explain their passion. It's even difficult for us to explain, other than to say that every individual McIntosh component is designed from the ground up to fit a need - not a market niche - a synergistic sensory experience that is superb, on many levels, simultaneously.

MX132 A/V Control Center

With three 24-bit processors and eight DAC's, the MX132 is a hybrid audio/video component that handles video fidelity with the same faithfulness to signal that audio purists have always loved. **Home Theater Magazine** calls it "an amazing stereo music performer." Composite and S-video switching happens in a whole new way, and with multi-zone capability, you get Whole Home Theater that's simultaneously superb.

without distortion, and Sentry Monitor ensures safe operation. A DB25 connector allows single-cable connection of all inputs. Dolby Digital, THX, DTS and multichannel audio are driven by 200 Watts x 5 channels. Our signature blue meters show the output, purely, powerfully, simultaneously.



MVP831 DVD/CD/Video CD Player

We had this in mind from the very spec of Dolby Digital, so this unit goes way beyond "state-of-the-art". Our DVD player is no private-label cosmetic job like so many out there. You get 96kHz/24-bit CD player, a rock-solid McIntosh power supply, a specially-engineered drive system, Burr Brown 24-bit DAC's and decoding that gives more film-like resolution of greater than 500 lines. Has both composite and S-video outputs. Worth having even if your discs don't have pictures on 'em.

When you buy McIntosh, you get more than tonnage, more than prestige, more than investment grade collectibles - you get the immensely-satisfying performance of components that are Simultaneously Superb as an audio purist system, HT system, or BOTH, simultaneously, with multi-zone capabilities.



MC7205 5-Channel THX® Power Amplifier

Our best multichannel amplifier is an audio purist piece with a taste for action. Power Guard® circuits allow full power



McIntosh
THE GREAT AMERICAN POWERHOUSE

Call 1-888-979-7009 or visit our website at www.mcintoshlabs.com.

Dolby Digital is a registered trademark of Dolby Laboratories Licensing Corporation. DTS Digital Surround is a registered trademark of DTS Technology. THX is a registered trademark of Lucasfilms, Ltd.

D. B. KEELE, JR.

PSB Stratus Silverⁱ Speaker



Photos: Michael Groen

When Paul Barton came up with a name and designed a logo for his future company, PSB, he was still in eleventh grade. But he'd been building speakers as a hobby for two years and planned to build them for the rest of his life. (That wasn't the only aspect of his future he had planned: The "S" in PSB is not for Barton's middle name but for the first name of his then sweetheart, Sue; he married her in 1974, two years after PSB opened for business.) For a number of years, the Stratus series has been the top of the PSB line.

The superscript in its name indicates that the Stratus Silverⁱ is an upgrade of an earlier model (in this case, the Stratus Silver), just as the Stratus Goldⁱ 1 reviewed for the January 1998 issue was an upgrade of the Stratus Gold. The Silverⁱ is a floor-standing, 2½-way vented tower that has two 6½-inch drivers and a 1-inch tweeter. Because there are two small bass drivers, the cabinet is narrower than it might have been if one large woofer of equivalent area had been used.

In PSB's Stratus speakers, the tweeters are below, rather than above, the midrange drivers (or, in the Silverⁱ's case, the mid-

range/woofer). This ensures that any lobing will aim the sound upward, at standing listeners' ears, not toward the floor. A second large driver below the tweeter gives the Silverⁱ the look of a classic D'Appolito array, in which a tweeter is between two midranges. In this speaker, however, while the driver above the tweeter handles midrange and bass, the bottom driver handles only bass and is rolled off above 500 Hz. The woofer and midrange/woofer do share an enclosure, which is vented through a 6-inch-long tube that's generously flared at both ends. All drivers are flush-mounted on the front panel, to minimize diffraction effects.

The Silverⁱ's 1-inch, aluminum-dome tweeter, built to PSB specifications by Vifa, is the same driver used in the Stratus Goldⁱ. The beefy, long-throw woofers have unusually large ferrite magnets (4½ inches in diameter, ¾ inch thick, and weighing 28 ounces) with rear-vented pole pieces. Each woofer has a 1½-inch-diameter voice coil, a polypropylene-cone diaphragm with a rubber surround, and a cast-iron frame.

The crossover point between the Silverⁱ's upper woofer and tweeter is specified as 2.1 kHz, with a 24-dB/octave slope. The lower woofer is rolled off above 500 Hz at 18 dB/octave. The low-pass filters for the two woofers have large, laminated U-shaped iron cores; the tweeter's high-pass filter has an air-core inductor. High-quality, heavy-

PSB

Rated Frequency Response: 35 Hz to 21 kHz, ±3 dB; 40 Hz to 20 kHz, ±1.5 dB.

Rated Sensitivity: 89 dB at 1 meter, 2.83 V rms applied.

Rated Impedance: 4 ohms, nominal.

Recommended Amp Power: 15 to 250 watts.

Dimensions: 39 in. H x 9½ in. W x 13 in. D (99.1 cm x 24.1 cm x 33 cm).

Weight: 56 lbs. (25.4 kg) each.

Price: \$1,799 per pair in black ash or dark cherry veneer, \$1,999 per pair in high-gloss black.

Company Address: 633 Granite Court, Pickering, Ont., Canada L1W 3K1; 905/831-6555; www.psbSpeakers.com.

TEST RESULTS

The PSB Silveri's anechoic on-axis frequency response (Fig. 1) is quite smooth and flat, fitting a tight, 4-dB, window over a wide range (43 Hz to 18.2 kHz) and rolling off at 12 dB/octave below 45 Hz. Above 2 kHz, the grille causes fairly significant changes.

The speaker's sensitivity, averaged from 250 Hz to 4 kHz, was 86.7 dB, 2.3 dB lower than specified. The right and left speakers' outputs matched very closely, within ± 1 dB from 20 Hz to 20 kHz.

PSB says the Silveri's crossover is a Linkwitz-Riley type, which should be perfectly in phase at the crossover point. However, when I reversed my connections to the speaker's woofer, the output dipped instead of producing the deep null I'd expect from a Linkwitz-Riley crossover. The dip was moderate, 10 dB, and extended about one-third octave on each side of the 2.1-kHz rated crossover point. This implies that the midrange/woofer and tweeter will be somewhat out of phase at crossover when the drivers are connected normally. When this occurs, a speaker's radiation lobe tilts up or down rather than facing straight ahead. This may have been why PSB placed the Silveri's tweeter below its midrange/woofer—to tilt the lobe upward. The phase and group-delay responses of the Stratus Silveri (not shown) were well behaved and contained no surprises.

The Silveri's horizontal off-axis frequency responses (Fig. 2) are extremely uniform and flat within $\pm 15^\circ$ of the axis, the main listening window, all the way to 20 kHz. Farther off axis, high-frequency rolloff is evident and response narrows in the upper midrange, between 600 Hz and 2 kHz.

Reponse above and below the axis is also very uniform to 20 kHz, within $\pm 15^\circ$ of the axis, but there's significantly more variation at crossover and below, especially 45° above and below the axis. The differences between response above axis (Fig. 3A) and below it (Fig. 3B) indicate some lobing. If the crossover behaved like a pure



Linkwitz-Riley design, the above- and below-axis curves would be identical.

A speaker's room response is never as smooth as its anechoic response, and the Silveri's (Fig. 4) is no exception. From 200 Hz up, the smoothed curve fits a fairly tight, 12-dB, window. Despite this curve's relative roughness, I don't see any major problems.

As usual for a vented-box speaker, the Stratus Silveri's curve of impedance magnitude (Fig. 5A) has two peaks straddling its tuning frequency. Here, that frequency

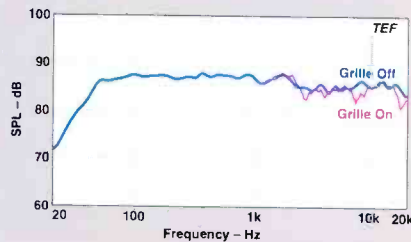

Fig. 1—One-meter, on-axis frequency response.

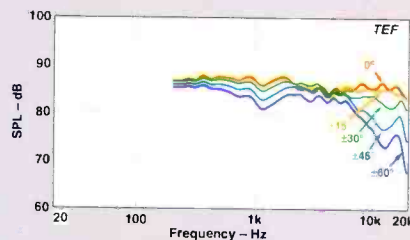
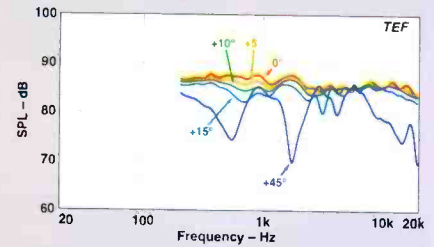
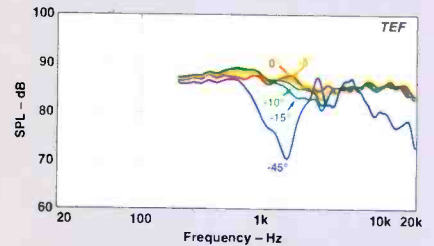

Fig. 2—Horizontal off-axis frequency responses.



A



B

Fig. 3—Responses above axis (A) and below it (B).

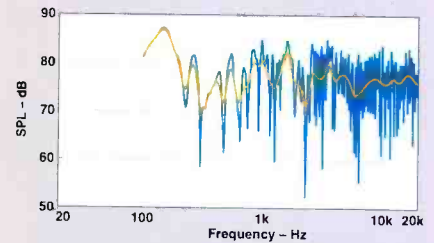

Fig. 4—Three-meter room response.

is 28 Hz, significantly lower than the speaker's -3 dB point of 43 Hz. The low tuning point accounts for the PSB's rolling off in the bass at a rate of 12 dB/octave rather than the 24 dB/octave one would normally expect from a vented enclosure. The minimum impedance, 3.2 ohms, will make the Silveri a somewhat demanding load for most amplifiers, and a pair should not be paralleled on a single amplifier channel. To limit response variations caused by cable-drop effects to 0.1 dB or less, you would need to keep cable series resistance to a maximum of about 0.053 ohm (cable no lighter than 14-gauge for a typical 10-foot run). The Silveri's impedance phase (Fig. 5B) is well behaved, ranging no farther than $\pm 33^\circ$.

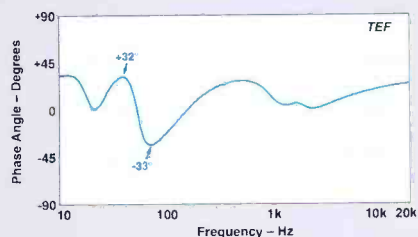
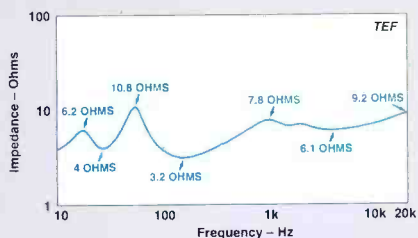

Fig. 5—Impedance magnitude (A) and phase (B).

When I subjected the Silver's cabinet to a high-level sine-wave sweep, it was pretty quiet, although the top and the upper third of the rear panel did vibrate a bit at around 335 Hz. From 26 Hz up, the PSB's output was impressively clean. Woofer excursion was fairly large, reaching about 0.5 inch, peak to peak, before distortion became objectionable. Excursion was smallest at 28 Hz, the cabinet's tuning frequency, and greatest at 40 Hz. Port noise was quite low. I noticed no dynamic offset in the woofer's cone motion.

Harmonic distortion is shown in Fig. 6 for the first five harmonics of E_1 (41.2 Hz), together with the total harmonic distortion calculated from only those harmonics. The high third-harmonic distortion was caused by the woofers reaching their symmetrical displacement limits. Distortion would be lower if my standard test frequency were not so close to the Silver's maximum displacement point (40 Hz), where a speaker's distortion normally increases. Indeed, the Silver's distortion dropped at lower frequencies, nearer its tuning point. Distortion was also quite low at A_2 (110 Hz)—less than 1.8% at all frequencies at full power—and very low

at A_4 (440 Hz), where the only measurable harmonics were 0.3% second and 0.7% third. The Stratus Silver's IM distortion for 440- and 41.2-Hz tones of equal power (not shown) rose smoothly, reaching 5% at an input level of about 40 watts and an audible but moderate 12.5% at 100 watts.

A hump in the Silver's curve of peak input power (Fig. 7) marks the speaker's 28-Hz tuning frequency. Also note the slight drop in input power capacity just below the 2.1-kHz crossover point. Although the peak input power starts somewhat low, 20 watts at 20 Hz, it eventually reaches 10 kilowatts, a very high level that was achieved by no speaker I tested until the PSB Stratus Gold. The peak acoustic output with room gain (also in Fig. 7) starts moderately loud, 93 dB, at 20 Hz and then rises quickly to a strong 110 dB at 32 Hz. Between 100 and 400 Hz, it hovers around 120 dB before rising to very loud levels above 800 Hz. The Silver's bass output is solidly in the top third of all speakers I have tested.—D.B.K., Jr.

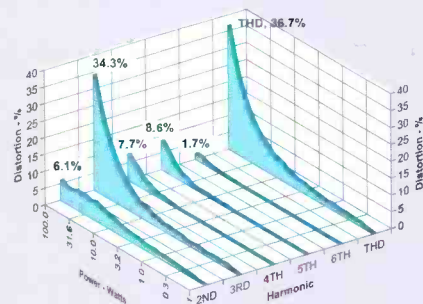

Fig. 6—Harmonic distortion for E_1 (41.2 Hz).

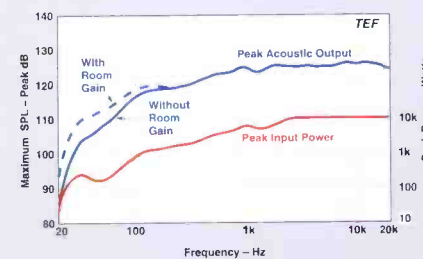

Fig. 7—Maximum peak input power and sound output.

gauge cables with push-on clips connect the crossovers to the drivers. The gold-plated, five-way binding posts at the bottom rear of the cabinet can handle wires up to 0.15 inch in diameter and are spaced for double-banana plugs.

Internally, the enclosure is heavily braced by three shelves and is constructed of heavy 3/4-inch MDF. The grille, framed in 3/8-inch HDF, plugs solidly into the front panel.

Externally, the Silver is elegant, with gracefully rounded corners and curved corner extrusions of anodized aluminum flanking the front panel. A pedestal base of inch-thick MDF provides additional stability as well as attachment points for the adjustable spikes or rubber leveling feet. The wood-veneered top panel can be special-ordered to match your furniture. Everything about the cabinets conveys the best craftsmanship and design. My review samples, in high-gloss black, were so well finished that their sides and tops acted as near-distortion-free mirrors, nicely counterpointed by the matte black of the front panel and the rounded corner moldings.

At 56 pounds each, the PSBs were relatively heavy, but I could still move them without assistance. I aimed them at my listening position and kept their grilles off for most of my listening. Although the Silver's separate tweeter and woofer terminals enable bi-wiring, I used single StraightWire Maestro cables between the PSBs and my Crown Macro Reference amplifier. Other equipment I used included an Onkyo CD player, a Krell preamp, and, for comparison, a pair of B&W 801 Matrix Series 3 speakers.

I was particularly impressed with the Silver's smooth, extended bass response, and I found them able competitors for my 801s. There were definite tonal differences; the Silver's were, for example, slightly brighter and a bit more forward-sounding. But the differences were so small that it was sometimes hard to tell when I had switched from one system to the other. I found myself tending to prefer the sound of whichever one I had most recently listened to, a sure sign that two speakers sound quite a bit alike.

On male speaking voice, the PSBs sounded quite natural and produced no barrel-chested boominess. Female vocals came through very smoothly, without harshness

9B ST



Hearing is Believing... Feel the Emotions

Bryston's 9B ST delivers extraordinary quality to your entire home theatre surround sound experience. Feel the emotions: be shocked, be happy, feel sad, scared out of your wits, surprised, be moved, be excited, feel like you want to cry with joy. The Bryston 9B ST amplifier will awaken all of your emotions in a simple elegant package designed to provide 5 channels of uncompromised sound quality.

Tel 1-800-632-8217 Fax 705-742-0882 www.bryston.ca

BRYSTON



FLIP SIDE

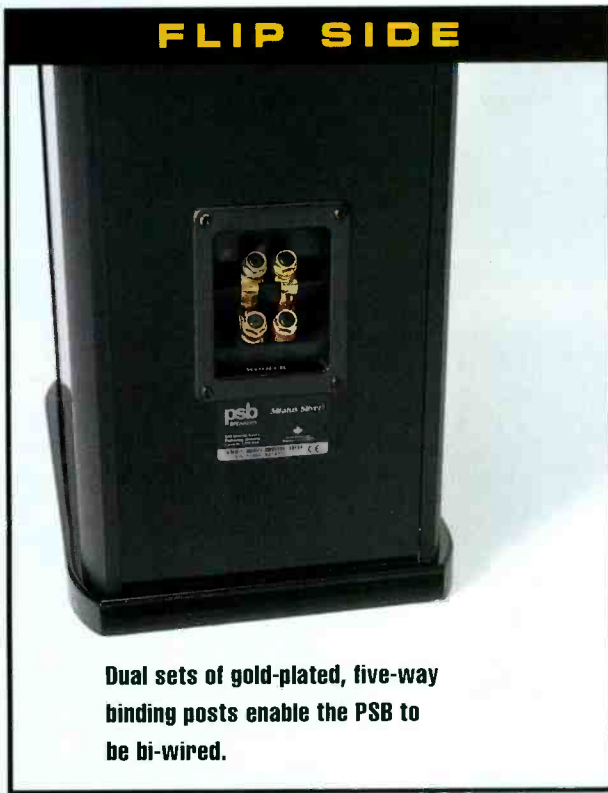

Dual sets of gold-plated, five-way binding posts enable the PSB to be bi-wired.

On the stand-up/sit-down test with pink noise, the Stratus Silver's vertical coverage was nearly perfect, keeping upper-midrange tonal changes to a minimum when I stood up. Laterally, the PSB's coverage was extremely uniform over the full width of the couch in my listening room.

On pop-frequency band-limited pink noise, the PSBs performed quite well; however, the B&Ws played louder and cleaner at the lowest frequencies. The Silver's had some usable output at 20 Hz and could play quite strongly at 25 and 32 Hz, albeit with some port wind noise. Although the 801s

or undue sibilance. In a cappella choral music, individual voices and choral sections were very well defined.

One of the first CDs I played through the Silver's was *Little Hatch: Goin' Back* (Analogue Production Originals APO 2007, distributed by Acoustic Sounds), a new audiophile direct-to-analog two-track recording of harmonica bluesman Province Hatch, Jr. The harmonica and the guitar accompaniment sounded astonishingly realistic, as if they were right there in the room with me. Blues doesn't get much better than this!

The Stratus Silver's were equally adept on complex classical music, such as Stravinsky or Mahler pieces. The wide, accurate soundstage was coupled with smooth and extended frequency response. The PSBs also handled percussion superbly, as evidenced on *Mondo Beat: Masters of Percussion* (Narada 72438-45788-2-4, highly recommended). On my favorite track, Tito Puente's "Ti Mon Bo" (recorded in 1957 and transferred to CD with 20-bit mastering), the Silver's' quick and sure response extended from bass drum, through bongos, up to the tip-top Latin percussion instruments.

could generate significantly higher fundamental levels at 20 Hz, their ports produced significant wind noise, too. At higher bass frequencies, the Stratus Silver's' maximum output was quite good, just about equaling the 801s'.

I was impressed with the Silver's' smooth, extended bass and natural voice reproduction.

On pop/rock, pipe organ with heavy bass, and other music that should be played loud, the Silver's didn't wimp out. Their bass output did not equal the 801s' at high levels but was still very satisfying, louder and deeper than you might expect from a speaker of its size.

At \$1,799 per pair, the PSB Stratus Silver's offer considerable value. Their great sound gave my B&W 801s a very good run for the money, and their appearance is of the same high caliber. I highly recommend them.

Definitive Technology® The Leader in High-Performance Loudspeakers® Authorized Dealers

- AK - Pyramid: Anchorage.
- AL - Cohen's Electronics: Montgomery • Hooper's: Birmingham • Kincaid's TV: Tuscaloosa • Palm Audio Video: Huntsville.
- AR - Custom Audio Video: Little Rock.
- AZ - Jerry's Audio Video: Phoenix, Scottsdale • Warehouse Electronics: Yuma.
- CA - Access to Music: Larkspur • Accurate A/V: S. Lake Tahoe • Ahead Stereo: Los Angeles • Audio Concepts: Long Beach, San Gabriel • Audio Video City: San Luis Obispo, Santa Maria • Bay Area Audio: San Jose • Big Screen City: San Diego & Suburbs • Boots Camera: Fresno • Century TV: Garden Grove • CH Automation & Theater: West LA • Creative Stereo: Santa Barbara • David Rutledge Audio: Palm Desert • Digital Ear:ustin • Dynamic Entertainment: Danville • Leigh Adams Disc. Sls.: Ontario • Monterey Stereo: Monterey • Paradyme: Sacramento • Performance Audio: San Francisco • Shelley's Stereo Video: Santa Monica, Woodland Hills • Systems Design: Redondo Beach • Videotek: Westminster.
- CO - Soundtrack: Denver & Suburbs, Boulder, Ft. Collins, Colorado Springs • Advantage Sight & Sound: Montrose.
- CT - Al Franklin's: Greenwich • Audio Etc. Orange • Carstons Stereo/Video: Danbury • Roberts Audio Video: New London • The Sound Room: Westport • Stereo Shop: Hartford.
- DC & Washington Suburbs - Myer-Emco.
- DE - Hi Fi House: Wilmington.
- FL - Absolute Sound: Winter Park • Audio Advice of NW Florida: Pensacola • Audio Advisors: West Palm Beach • Audio Center: Deerfield Beach • The Audiohouse: Vero Beach • Cooper for Stereo: Clearwater • Hoyt Stereo: Jacksonville • Palm Audio: Destin • Sound Components: Coral Gables • Sound Ideas: Gainesville • Sound Insights: Ft. Pierce • Sound Waves: Lakeland • Stereotypes: Daytona Beach.
- GA - Access DVD: Atlanta • Merit TV: Columbus • Stereo Connections: Valdosta • Stereo Festival: Atlanta • Stereo Shop: Martinez.
- HI - Honolulu Home Theater: Honolulu.
- IA - Ultimate Electronics: Cedar Rapids, Des Moines • Archer Audio Video: Ft. Dodge • Audio Video Logic: Des Moines • Audio Visions: Sioux City • Hawkeye Audio: Iowa City, Cedar Falls • Renier's: Dubuque.
- ID - Ultimate Electronics: Boise.
- IL - Absolute Audio: Rockford • United Audio Centers: Chicago & Suburbs • Good Vibes: Bloomington, Champaign • Jon's Home Ctr.: Quincy • Sound Forum: Crystal Lake • State Line Satellite: Rockford • Sterling Electronics: Sterling.
- IN - Classic Stereo: Ft. Wayne, Mishawaka • Kings Great Buys: Evansville • Dvation Audio: Clarksville, Indianapolis, Lafayette.
- KS - Accent Sound: Overland Park • Advance Audio: Wichita • Audio Junction: Manhattan.
- KY - King's Great Buys: Owensboro • Ovation Audio: Lexington, Louisville.
- LA - Allerman Audio: Metairie • Home Theater Concepts: Slidell • Mike's Audio: Baton Rouge • Wright's Sound Gallery: Shreveport.
- MA - Goodwins Audio: Boston, Shrewsbury • Nantucket Sound: Hyannis • Northampton Audio: Northampton • Pittsfield Radio: Pittsfield.
- MD - Gramophone: Baltimore, Ellicott City • Myer-Emco: Frederick, Gaithersburg, Beltsville, Rockville • Soundscape: Baltimore.
- MI - Contemporary Audio: Okemos • Pecos's (Detroit) Troy • Classical Jazz Holland • Court St. Listening Room: Saginaw.
- MN - Audio King: Minneapolis & Suburbs, Rochester, St. Cloud • Audio Designs: Winona.
- MO - Creative Audio: Sedalia • Independence A/V: Independence • Sound Central: St. Louis.
- MS - Ideal Acoustics: Starkville • McLelland TV: Hattiesburg • Players A/V: Ridgeland.
- MT - Rocky Mt. Hi Fi: Great Falls.
- NC - Audio Video Systems: Charlotte • Audio Visions: Wilmington • Now Audio Video: Durham, Greensboro, Raleigh, Winston Salem • Tri City Electronics: Conover.
- NE - Custom Electronics: Omaha, Lincoln • Midwest Audio: Kearney.
- NE - Camera and TV Shop: Medford, Egg Harbor • Manmouth Stereo: Shrewsbury • Wondbridge Stereo: West Caldwell, Woodbridge.
- NM - Ultimate Elect.: Albuquerque • Sound Ideas: Albuquerque.
- NV - Ultimate Elect.: Las Vegas.
- NY - Audio Breakthroughs: Manhasset • Audio Den: Lake Grove • Clark Music: Albany, Syracuse • Stereo Exchange: Manhattan • Hart Elect.: Vestal • Listening Room: Scottsdale • Media Room: Mt. Kisco • Park Ave. Audio: Manhattan • Rowe Camera: Rochester • Speaker Shop: Amherst.
- OH - Absolute Theater: Powell • Audio Craft: Akron, Cleveland, Mayfield Hts., Westlake • Audio Etc.: Dayton • Beiden Audio: Canton • Classic Stereo: Lima • Ohio Valley Audio: Cincinnati • Paragon Sound: Toledo • Stereo Visions: Columbus • Threshold Audio: Heath • Unique Home System: Cincinnati.
- OK - Audio Dimensions: Oklahoma City • Ultimate Electronics: Tulsa.
- OR - Bradford's Home Ent.: Eugene • Kelly's Home Ctr.: Salem • Magnolia HiFi: (Portland) Beaverton, Clackamas • Stereo Plant: Bend.
- PA - Audio Junction: Pittsburgh • Audio Lab: Fairless Hills • Gary's Elect.: State College • GNT Stereo: Lancaster • Hart Elect.: Blakely • Hi Fi House: Abington, Broomall, Camp Hill, Harrisburg • Listening Post: Pittsburgh • Palmer Audio: Allentown • Stereo Shoppe: Selinsgrove, Williamsport • Stereoland: Natrona Heights • The Stereoshop: Greensburg.
- RI - Stereo Discount Ctr.: Providence.
- SC - Custom Theater & Audio: Myrtle Beach • Music Masters: Greenwood • Upstairs Audio: Columbia.
- SD - Audio King: Sioux Falls • Sound Pro: Rapid City.
- TN - College HiFi: Chattanooga • Hi Fi Buys: Nashville • Now Audio Video: Knoxville • Modern Music: Memphis • Sound Room: Johnson City.
- TX - Audio Video: College Station • Bunkley's Sound Systems: Abilene • Bjorn's: San Antonio • High Fidelity: Austin • Home Theater Store: Houston, Dallas • Krystal Clear: Dallas • Marvin Electronics: Ft. Worth • Sound Box: San Angelo • Sound Quest: El Paso.
- UT - AudioWorks: Salt Lake City • Ultimate Elect.: Layton, Murray, Orem, Salt Lake City.
- VA - Myer-Emco: Falls Church, Tyson's Corner, Fairfax • Audio Connection: Virginia Beach • Audiotech: Roanoke • Home Media Store: Richmond.
- WA - Bunch-Finnegan TV: Kennewick • Magnolia HiFi: Seattle & Suburbs, Tacoma, Silverdale, Spokane • Pacific Sight & Sound: Wenatchee.
- WI - Planner's A/V: Milwaukee • Hi-Fi Heaven: Appleton, Green Bay • Sound World: Wausau.
- Puerto Rico - Precision Audio: San Juan.
- Canada - Advance Electronics: Winnipeg • Air Waves Radio & TV: Moosejaw, SK • Audio Shop: Ottawa • Bay Blood Radio: Toronto • Canadian Sound: Brampton, Ont. • Digital Dynamics: Clearbrook • Harrington Audio: Peterborough, Ont. • K&W Audio: Calgary • Keshesson: Montreal • Lipton's Elect.: Newmarket, Ont. • Sound Decisions: Duncan, B.C. • Sound Room: Vancouver • StereoLand: Windsor.
- Mexico - Contact Grupo Volumen: Mexico City.



B A B Y G R A N D

Don't be fooled by its space-saving dimensions – this compact FS-8000 Component System delivers stunning, big component sound. A powered subwoofer provides rich deep bass, while a built-in electronic crossover provides clean vocals and crisp highs. The FS-8000 is designed to complement any decor from the

living room to the dining room. With its solid European cherrywood speakers, it's beautiful enough to be displayed on your finest furniture. Make a statement in design and performance with this powerful JVC system. Stop ... Look ... Listen!



[60 Watt, 8" Subwoofer Included for Room Filling Sound]

JVC

FS SERIES

FOR YOUR NEAREST AUTHORIZED JVC DEALER
CALL 1-800-252-5722
OR VISIT OUR WEB SITE AT: WWW.JVC.COM

ANTHONY H. CORDESMAN

Vienna Mahler Speaker



Photos: Len LaGriva

What strikes me most about the Mahler is the way it makes music more fun to listen to than many speakers that are technically more accurate. I don't mean that it's highly colored: It has excellent transparency and one of the most accurate and detailed soundstages of any speaker around. But its tuning gives it a rich, warm sound (with a touch too much bass) and a dip in the upper midrange at precisely the point where

far too many recordings and solid-state components add more than a little glare.

Listening to the Mahler reminds me in many ways of hearing concerts in Vienna. On visit after visit, I have been struck by the pleasure I get from listening to music in that city's older, warmer concert halls and to hearing performers who care about timbre as well as detail. Far too many of my listening experiences in the United States and Asia have been in modern, bright halls, hearing ensembles and orchestras that

seemed determined to emphasize upper-midrange information at the cost of music's richness and soul.

Recommending a speaker that has much the same richness and warmth as a great concert hall may sound mildly heretical. Let me remind you, however, that the purpose of audio equipment isn't to provide the best measured performance but the most convincing illusion that you're actually listening to a musical performance—and to do so, usually, in a room where no one would normally perform. If you don't understand that the overall illusion is more important than each component's technical performance, you can wind up with an expensive system of top-quality individual components that never quite achieve the synergy they need to sound real. All speakers suffer to some degree from sonic trade-offs; the Mahler's advantage is that with the right components its trade-offs can bring you something very close to the sound of a live concert.

The Mahler is simply styled, and its narrow front minimizes its visual impact. The cabinet front is raked back, which provides some degree of time compensation and helps avoid the "upright coffin" look of most floor-standing speakers. The veneers (beech or rosewood) and finish are excellent, and the overall woodworking is furniture-grade—which, at this speaker's price of \$9,800 per pair, it should be. There are also sophisticated touches that you can't see, such as separate enclosures for the individual drivers, excellent internal bracing, and front and rear baffles that are about 1½ inch thick for extra rigidity.

The front-panel drivers, a 1.2-inch silicone-layered silk-dome tweeter and two 7-inch cone midranges with carbon-fiber-

VIENNA ACOUSTICS

Rated Frequency Range: 22 Hz to 25 kHz.

Dimensions: 51¼ in. H x 8½ in. W x 18¾ in. D (130 cm x 21.8 cm x 46.5 cm).

Weight: 150 lbs. (68.2 kg) each.

Price: \$9,800 per pair.

Company Address: c/o Sumiko, 2431 Fifth St., Berkeley, Cal. 94710; 510/843-4500.

filled paper diaphragms, are made by ScanSpeak. The lowest frequencies are handled by two side-firing 10-inch Eton woofers with honeycomb cones. The first-order (6-dB/octave) crossover contains high-quality resistors, capacitors, and air-core coils. Small switches on either side of the speaker terminals can cut the treble slightly or boost the bass a touch if needed to suit your room.

The Mahler's frequency range is specified as 22 Hz to 25 kHz and its sensitivity as 90 dB. Although its impedance is said to average 6 ohms, the measurements that accompanied my review samples indicate that its impedance is relatively low below 100 Hz. Further, my listening tests suggest that it's a bit of a difficult load.

Set up properly—that is, spaced farther apart than most speakers and angled toward the listener—the Mahlers had truly excellent imaging and depth. They sounded coherent, detailed, and natural. Overall transparency was equally good, and the soundstage was unusually realistic and musically natural.

Even at levels well in excess of 100 dB (about as loud as I care to listen), the Mahler preserved this excellent soundstage and accurately resolved detail without audible distortion. It did equally well in soft passages, unlike those speakers that seem to come alive only at a relatively high volume. Timbre and sound character were unaffected by volume, and the speaker reproduced subtle dynamics exceptionally well. At all practical listening levels, it sounded live and articulate.

The Mahler had no vertical dispersion problems at normal listening distances, and horizontal dispersion was wide enough to create a relatively large listening area without sacrificing detail or focus. The tweeter and midrange drivers are high enough to prevent floor bounce and provide a natural listening angle with a slightly elevated soundstage. In short, I found the Mahler easy to listen to in every respect.

The Mahler's timbre is what leads me to describe it as being more "musical" than technically accurate. The upper octaves were very flat and extended, with a great deal of smooth energy and no feeling of edginess. The midrange was exceptionally

warm and sweet, and the upper midrange was a bit soft where most contemporary speakers tend to be a bit dry and hard. The middle and upper bass were also a bit warm; no matter how I placed the Mahlers, there was always a bit of a rise from about 100 Hz down to around 50 Hz. Low bass energy was very good. The bass rolled off gently below 45 Hz, yet there was still some useful output down below 25 Hz. The bass was more powerful than taut, however, and sacrificed a little detail to gain unusual drama and impact.

Odd as it may seem to say about a speaker, the Mahler's frequency response, timbre, and dynamics were much the same as a classic tube power amplifier's, with all the strengths and weaknesses that implies. Like the best tube amps, the Mahler could provide a great deal of upper-octave information without edginess or hardness. Throughout my long auditioning period, it neither softened nor hardened the upper octaves. Cymbals, female voices, harpsichords, flutes, and upper strings were consistently as musical and realistic as my

The Mahler comes surprisingly close to putting you in the best seat in Vienna's best hall.

recordings permitted. Vienna Acoustics and its U.S. importer, Sumiko, credit this mix of sweetness and detail to the specially modified silk-dome tweeter and to the fact that the tweeter is completely decoupled from the cabinet, secured only by silicone gel. These factors may account for treble detail that was close to what I've heard from some ribbon tweeters, the life and focus I expect from the best dynamic tweeters, and the warm, effortless highs of the best tube amps.

Although the two 7-inch drivers can each handle a great deal of power with very little apparent distortion, they perform different roles. One is tasked with covering nearly six octaves, from 70 Hz to 4 kHz. The other driver's range is narrower; it also begins at

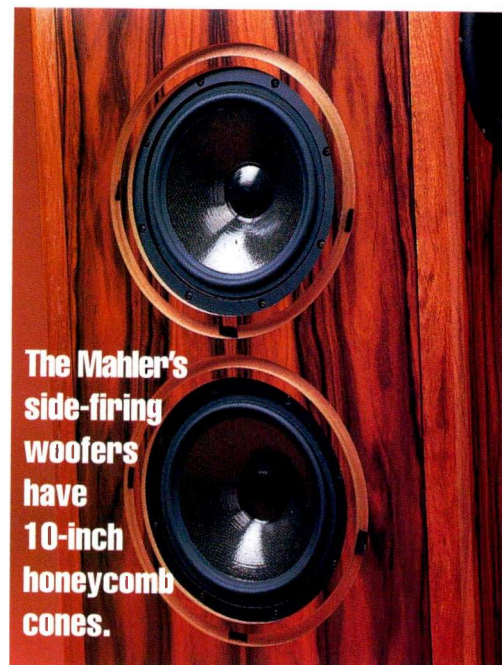

The Mahler's side-firing woofers have 10-inch honeycomb cones.

70 Hz but has a gradually rolled off high end. At the bottom of their range, these drivers reinforce each other; as frequency increases, however, the total driven surface area gradually decreases to ensure uniform dispersion through the middle frequencies.

The Mahler's midrange was very clean, and its high quality seemed to be a key reason for the speaker's excellent imaging and power handling. The use of two midrange drivers may have contributed to a dip in the upper midrange that imparted the slightly warm coloration I mentioned earlier, but that coloration was euphonic. It gave the Mahler exceptionally realistic timbre on violin and cello, lent woodwinds and piano a warmth they lack through far too many competing speakers, and contributed to a more natural musical balance in baritone, tenor, and most female voices. To harken back to my Viennese listening experiences, I was struck by the way the Mahler's midrange gave me the sound I hear in older and warmer halls and the timbre I hear in live music. This speaker may be a bit colored, but it corrects for the dryness and close-miked character of many CDs (and LPs made from digital tapes, for that matter).

The Mahler's woofers, which handle the range from 70 Hz down to 22 Hz, have honeycomb diaphragms that Vienna Acoustics claims are 70 times more rigid, yet 30% lighter, than conventional cones. Each of

Define

NEW AGE

THE NEW MILLENNIUM IS ALL ABOUT VALUE, PERFORMANCE AND INTEGRITY. FOR 34 YEARS CAMBRIDGE AUDIO HAS BEEN MAKING HIGH QUALITY, DEPENDABLE HI-FI MUSIC SYSTEMS FOR THE NO-NONSENSE MUSIC LOVER.

BE PART OF THIS NEW WAVE AND SHOW A LITTLE MUSICAL INTEGRITY YOURSELF!

FOUND ONLY AT QUALITY HI-FI STORES.



cambridge audio

U.S.A. : Audio Plus Services P.O. Box 3047 Plattsburgh, NY 12901
Tel.: 1-800-701-9229 Ext.: C4 / 1-800-663-9352 Fax: (450) 585-5862
www.audioplusservices.com
Canada : Plurison C.P. 537 Station Youville Montréal Qc H2P 2W1
Tel.: (450) 585-0098 Fax: (450) 585-5862
www.plurison.com

the two woofers operates in a complex, rear-vented subcabinet whose walls are all nonparallel. The result is considerably deeper, more powerful bass than the Mahler's size might suggest.

I found that the Mahlers needed an amp whose power in the lowest frequencies was slightly reduced or, if it had deep bass extension, one with every bit of damping and control an amplifier can provide. Deep bass, for example, was much tighter and slightly deeper with a Krell 300-watt power

amplifier than with the normally superb Pass Labs X600. And while I normally find differences between speaker cables to be fairly subtle, using Kimber Bifocal and Select cables with the Mahlers gave me considerably better overall bass response and control than the other cables I tried (though Dunlavy and Wireworld cables seemed to allow just a touch more deep-bass extension). Such sensitivity to amps and cables is scarcely unusual in speakers in this price range, but it does mean you will

need to choose these components rather carefully.

The deeper and more powerful the bass response, the more sensitive a speaker is to the listening room and its placement in that room. The Mahler's low end was no more sensitive to placement than that of any other speaker with good bass—except below 50 or 60 Hz, where it was unusually touchy. I could never get the bass to sound *quite* right, in spite of playing around with different locations and rooms. Nevertheless, the

TEST RESULTS

True Technologies' measurements of the Vienna Mahler's on-axis frequency response (Fig. 1), with and without its grille, were gathered from near-field data and spliced with ground-plane data taken at 2 meters and normalized to 1 watt/1 meter. Apart from a moderate 3-dB hump in bass output between 80 and 110 Hz, the curve is fairly smooth from 40 Hz to 2.5 kHz—albeit with a gentle downward tilt toward the midrange. An abrupt 7-dB notch is evident between 3 and 4.5 kHz. This dip's severity is lessened a few dB by removing the Mahler's grille; still, the notch remains the most visible anomaly in the on-axis curves and will

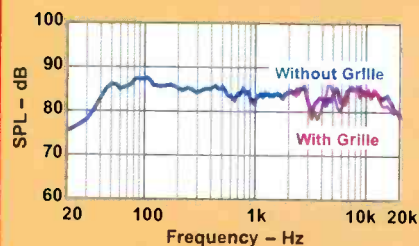

Fig. 1—On-axis frequency response.

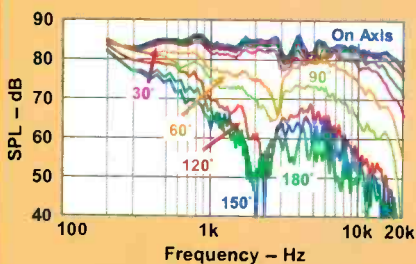

Fig. 2—Horizontal off-axis frequency responses.

likely affect the speaker's sound. Between 5 and 7 kHz, some irregularity is apparent. The highs then smooth out to 14 kHz, where they begin to gradually roll off. By 20 kHz, high-frequency output is 5 dB down from midrange levels.

Off axis, the Mahler's frequency response holds up very nicely to the left and right (Fig. 2). This is true out to fairly extreme angles, which should help the speaker project a wide and three-dimensional soundstage. The response gully at 3 kHz, so apparent in the on-axis response, is also present in the off-axis curves, which suggests it will be a significant part of the speaker's character. In the vertical off-axis responses (Fig. 3), things ain't so pretty—there are, for example, several dramatic dips between 1 and 3 kHz. But no matter: It is a speaker's horizontal dispersion, not its vertical, that contributes to early side-wall reflections in a listening room. These reflections signal our ear/brain mechanism that a speaker is spacious and open-sounding.

The Mahler's impedance (Fig. 4) hovers in the 3-ohm region from the deep bass to almost 100 Hz, which indicates you should use a stable amp with lots of current capability at low impedances to drive these Vienna Acoustics speakers. Above 200 Hz, the impedance never dips below 6 ohms and remains higher than that for much of the spectrum.

Figure 5 shows harmonic distortion generated when the Mahlers were driven to an output of 100 dB SPL. The advantage of using multiple drivers to share the

acoustical load is apparent. All harmonic distortion components are 1% or considerably less; indeed, the fourth and fifth harmonics are 0.1% or less, except in the deep bass. The Vienna Acoustics Mahlers should be capable of reproducing concert-hall dynamics unsoftened by edginess or gritty distortion.—Alan Lofft

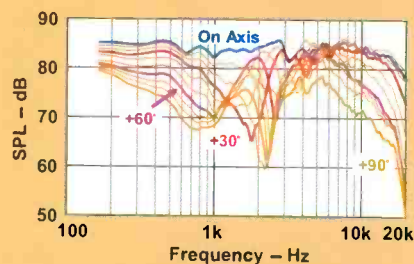

Fig. 3—Vertical off-axis frequency responses.

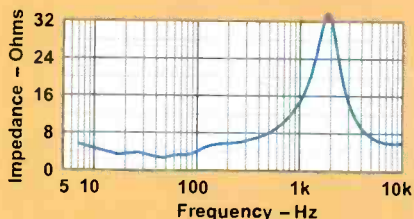

Fig. 4—Impedance magnitude.

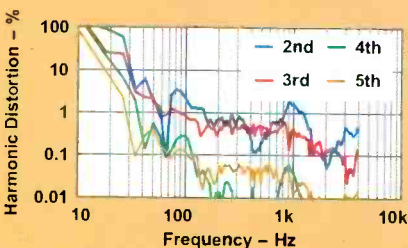

Fig. 5—Harmonic distortion.



bass was very good in most respects. It was very dynamic and had the drive and power of a live performance—something many high-priced monitors lack. The deep bass could really rock. If anything, there was a bit too much low end: Bass strings had just a bit of overhang, low organ notes sometimes had more power than nuance, and I could never get the tightness and transient speed I expected from bass drums. My listening panel split on the Mahler's bass performance. Some members found the Mahler's life and power in the deep bass preferable to the detail and control they heard from other speakers; other members did not. Personally, I would have opted for less energy and more tightness and control. Although the coloration in the midrange provided a more realistic illusion with most recordings, I did not find the Mahler's deep bass conveyed such realism.

Vienna Acoustics' importer feels that this coloration may be caused by interaction between the Mahlers and my particular listening rooms. This may well be true. Certainly, room interaction is always a major problem in evaluating a speaker's bass performance, whether you're writing a review or hearing a dealer demonstration. Below 150 Hz, there is no such thing as a typical or neutral listening room, and performance below 80 Hz will always be highly room-dependent.

The Vienna Acoustics Mahler is not a perfect speaker, but it is a damn good one and is exceptionally musical. It provides a high level of performance from an enclosure that's not so massive as to visually dominate a room or require that you be a weightlifter to move it. I would strongly advise a listen, particularly if you are tired of sound that tends to the dry, bright, and hard. The Mahler may not take you to the best seat in the best concert hall in Vienna, but it will take you surprisingly close. **A**

SOMETIMES INNOVATION COMES FROM THINKING INSIDE THE BOX.

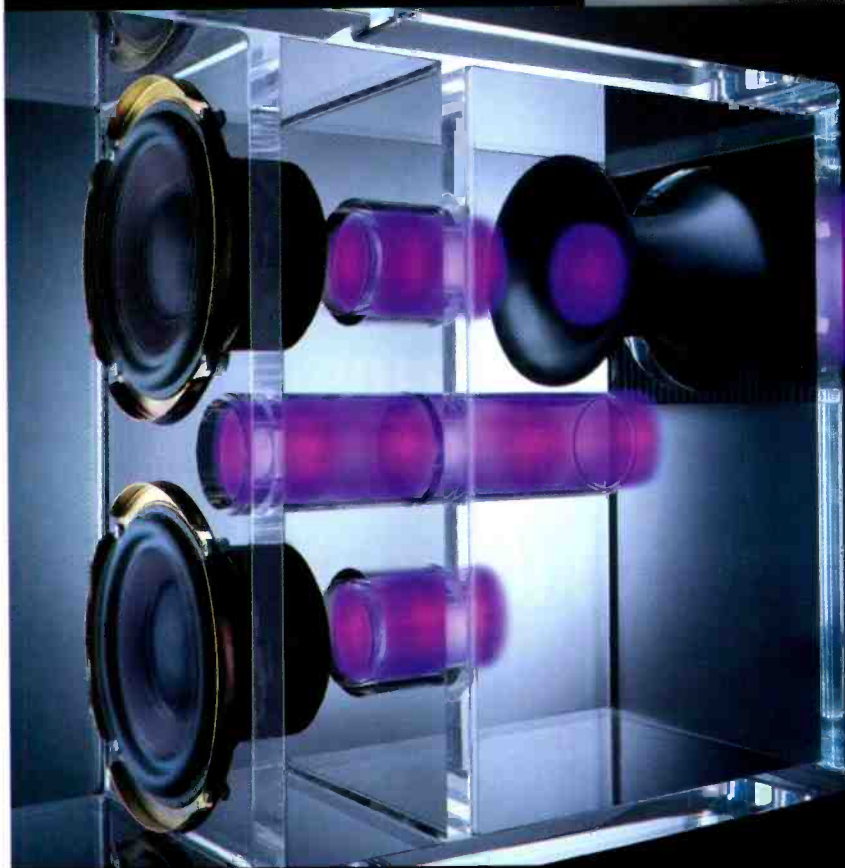

ACOUSTIMASS® 15 HOME THEATER SPEAKERS.

Since their introduction, Acoustimass speakers have set a standard conventional speakers cannot match.

The patented Acoustimass module captures energy from both sides of the transducers. This improves efficiency, enabling it to reproduce—without audible distortion—a wider range of frequencies than conventional 'subwoofers'. Only Bose® has this technology. Technology that also allows the cube speakers to be much smaller—without sacrificing performance. Today, with a host of



improvements, including dedicated amplification, this breakthrough technology

is even better, delivering what *Sound & Vision* calls "a surprisingly thunderous home theater experience without devastating your decor." Hear the new Bose standard for yourself.

For dealers near you, call:

1.800.444.BOSE

Please Ask For Ext. 745

BOSE®
Better sound through research™

www.bose.com/am745

"marvelous speakers"

CS7.2 / Stereo Sound, Japan, Winter '98/99

"dream speaker"

CS7.2 / Image HiFi, Germany, March/April '99

"all-time great"

CS6 / Fi Magazine, October '97

"truly amazing"

CS1.5 / Revue du Son, France, January '97

"superb"

MCS1 / The Perfect Vision, May/June '99

"a breakthrough"

CS7.2 / Audio, December '98

"outstanding"

CS2.3 / The Absolute Sound, December '98

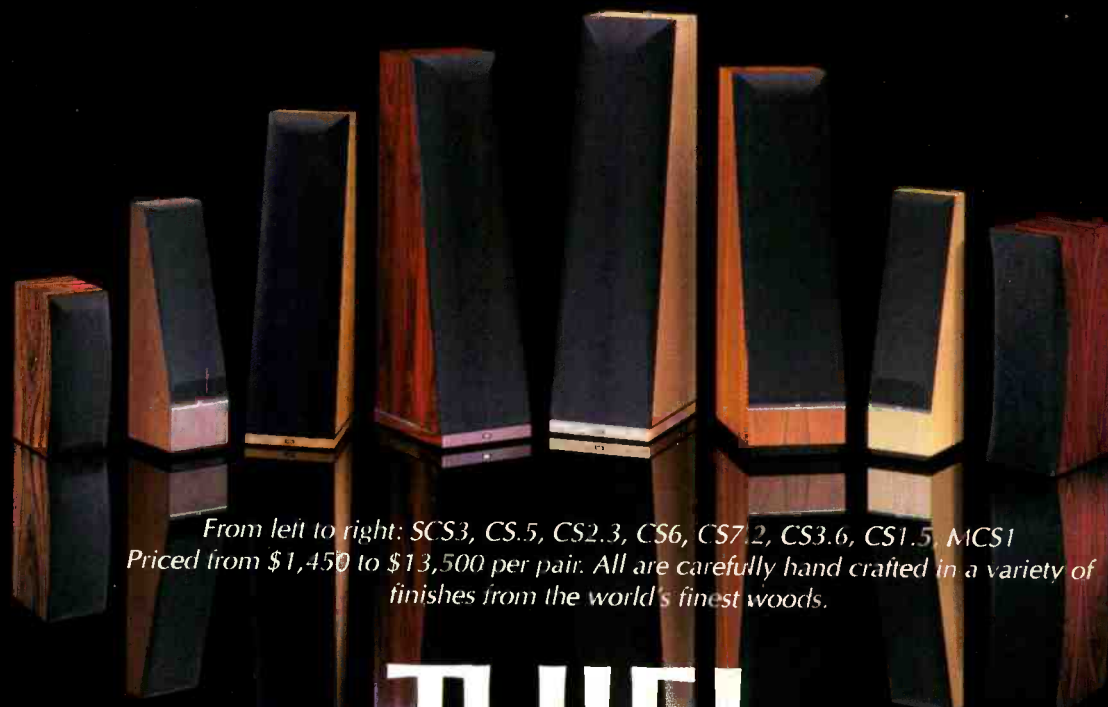

*From left to right: SCS3, CS.5, CS2.3, CS6, CS7.2, CS3.6, CS1.5, MCS1
Priced from \$1,450 to \$13,500 per pair. All are carefully hand crafted in a variety of
finishes from the world's finest woods.*

THIEL

Ultimate Performance Loudspeakers

For home music and video sound systems

Call or write for our 36-page brochure, review reprints, and the name of your nearest **THIEL** dealer.

THIEL • 1026 Nandino Boulevard, Lexington, Kentucky, 40511 • Telephone: 606-254-9427 • e-mail: mail@thielaudio.com • Web: www.thielaudio.com

PAUL TATARA

NAD C340 Integrated Amp



Photos: Michael Groen

It's gotten to be something of a running joke around my house that I'm an unwavering traditionalist. I don't need Cherry Coke when the real thing, loaded with fizzy syrup and old-fashioned, blood-pumping additives, is still readily available. I also applaud teams that plant living sod in their stadiums in lieu of injury-inducing AstroTurf. And, during my 1970s Catholic upbringing, I refused to abide the dreaded Folk Mass, which featured a hip (i.e., bearded) parishioner playing "You've Got a Friend" on an acoustic guitar. Even as a kid, I recognized the foolishness of this. James Taylor was way too relaxed for a world that cried out for organized religion.

I don't like fixing things that aren't broken, so the allure of simplicity and sheer common sense is what I find endearing

about the folks at NAD. They have no qualms whatsoever about admitting that their equipment doesn't look all that fancy, but it sure gets the job done. Their stuff is built to do what it's supposed to do, easily and cheaply, like a solid character actor who somehow manages to steal a scene from Julia Roberts. If you're looking for a CD player that pumps out soft-serve ice cream at the touch of a button, NAD doesn't make one. It does, however, make components (for very little money) that show off your music to great advantage.

NAD's C340 stereo integrated amplifier is a prime example of this no-frills philosophy, delivering as it does highly serviceable sound for a mere \$399 (not to be confused with the far more intimidating \$400). You can't beat the price—hell, I just bought a coffee table for \$170—and your neighbors

will sit slack-jawed at the splendid sound blasting from your speakers.

The "C" in C340 denotes the Classic series, which (in NAD speak) means "two-channel, high-performance hi-fi gear," and that's exactly what the C340 is. It just isn't all that expensive. Go ahead and lie; tell everyone you paid \$700. I promise they'll never know the difference. The C340's warm, enveloping bass, in particular, will suggest that you're an audiophile of discerning taste and unlimited bank account. Sit up straight and floss daily, and you could even pass for refined.

The C340 replaces the 314 in NAD's new lineup, and the company has added a couple of perfectly reasonable new features. There's now a remote control that lets you adjust volume and select sources from the comfort of your favorite chair, though you still have to walk over to turn the amp on or off. (That's a bummer, but I once saw a guy on TV drag a train 100 yards with his teeth. Quit complaining.) NAD has also upped the power on the new amp from 35 to 50 watts per channel, continuous. According to my admittedly primitive calculations, that means 15 more watts than before. This is a moderate continuous power rating. NAD feels that continuous power ratings are, um, overrated because most music requires short bursts of energy, not a constant flow. NAD aims for

NAD

Rated Power: 50 watts per channel, both channels driven, into 8 or 4 ohms.

Rated Distortion: 0.03% THD, 20 Hz to 20 kHz.

Dimensions: 17½ in. W x 4¾ in. H x 11½ in. D (43.5 cm x 11.1 cm x 29.2 cm).

Weight: 16½ lbs. (7.5 kg).

Price: \$399.

Company Address: 6 Merchant St., Sharon, Mass. 02067; 800/263-4641; www.nadelectronics.com.

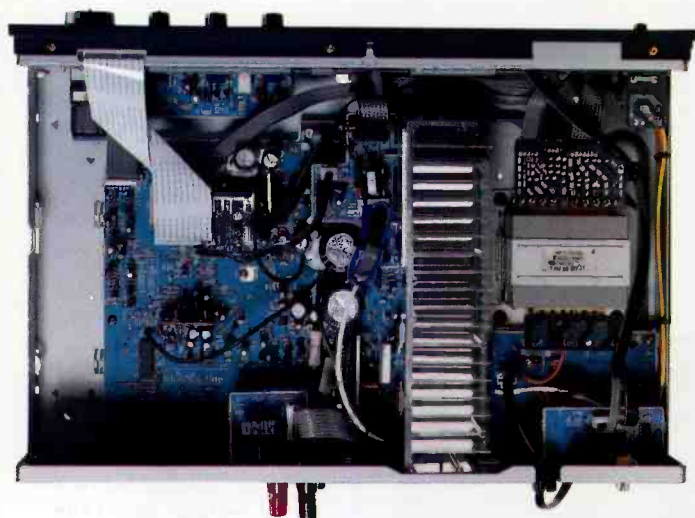

transient capability without the overkill characteristic of a lot of high-end gear. That way, we don't have to settle for lesser sound quality simply because we don't have the disposable income of an NBA forward.

NAD says it keeps the cost down with Impedance Sensing Circuit (ISC) topology, which automatically recognizes a speaker's impedance characteristics and then adjusts the amp's power supply to best cope with that specific load. In other words, it sets the amp's power-supply voltage so that the loudspeaker cannot draw more current than the C340's output transistors can safely deliver.

The C340 really is a plain Jane. It's dark gray, with the single exception of a green power button at the upper left corner. There's a headphone jack and a remote-control sensor, followed by a neat little row of source buttons—tape 1, tape-2 monitor, tuner, auxiliary, video, CD, and disc. (NAD has dispensed with a phono stage, but it sells the PP-1 preamp as a \$129 add-on.) The row is topped off by a soft-clipping indicator. To the right you've got larger bass, treble, and balance controls and a defeat button for those who trust the amp to give them the best possible sound without the tone controls' help. There's also the customary extra-large volume control for inducing extra-large volume.

I'm not about to suggest that the C340 is equal to the Acurus DIA 150 that I usually listen to, but it costs \$1,200 less than the Acurus and still does a marvelous job. I've hooked it up to an NAD 522 20-bit CD player and extremely kissable NHT Super-

Two floor-standing speakers. I also use Kimber 4TC speaker cables. Because that's the kind of guy I am.

But enough of that; let's play some music.

Tom Petty & The Heartbreakers, *Great-est Hits*. It took me several years to latch onto Tom Petty, and I'm still not completely sold. One reason is that he often sounds like he's

winding drive around the Hollywood Hills. The bottom end lingers longer than it does on the Acurus, but that creates the illusion that you're listening to nice warm tubes rather than cold-hearted transistors.

The drawback of the C340 (on "Free Fallin'," anyway) is that the treble is a tad screechy in places. You can doctor this by turning off the tone defeat and fiddling with the controls, but Petty's plaintive cries during the chorus remain somewhat shrill. Still, it's not that big of a problem. The acoustic guitars ring loud and clear, and the bass cradles them graciously. All in all, it's pretty impressive.



**NAD makes components
(for very little money)
that show off
your music
to great advantage.**

shaking off a sleeping pill, but his good stuff (and there's more of it than I ever would've imagined) is pretty damn good. I'm focusing on what I consider to be his hit-single masterpiece, the hugely overplayed "Free Fallin'." The song evokes my favorite Angelino vibe, the one where beautiful, apparently content ciphers strangle to death on seductive ambience. It's "Born To Run" for people who can't be bothered to leave because there's a mall nearby.

The C340 does somewhat brittle justice to the production values of "Free Fallin'." On the very positive side, the low end is full and well-rounded; those swoops up and down the bass guitar's neck sound like a

Ben Folds Five, *The Unauthorized Biography of Reinhold Messner*. Before now, Folds's early Elton John-meets-Randy Newman approach to songwriting hadn't been very consistent. The group's first two albums contain a handful of catchy tunes, but the only one that seems remotely heart-felt is the gorgeous hit single "Brick." The band's often hilarious rock opera leanings have finally reached maturity, though, with *The Unauthorized Biography of Reinhold Messner*. This is a brilliantly conceived album, and it sounds terrific.

The first track, "Narcolepsy," is a striking piece of wise-guy pop bombast. A narcoleptic's quiet, piano-accompanied confession alternates with roaring instrumental passages that contain everything from a fuzz bass to trap drumming. Oh, yeah—there's also a sarcastic Gregorian chant mixed up in there. Honest, there is. I sometimes show off my Acurus with this tune, but the C340 handles it like a feisty younger brother. That's no mean feat, given this track's arrangement.

The wild, aural mood swings of "Narcolepsy" can test anybody's equipment. On

TIME TO UPGRADE TO A LEXICON.



RECEIVE UP TO \$2,000 IN TRADE-IN VALUE TOWARD THE PURCHASE OF THE LEXICON MC-1.*



If you've always wanted to own a Lexicon, here's an opportunity you won't want to miss. For a limited time, bring in your used A/V gear to a participating Lexicon dealer and receive up to \$2,000 trade-in value toward the purchase of the new flagship digital controller – the MC-1.*

The MC-1 includes *Dolby Digital*®, *DTS*®,

THX Ultra® certification and Lexicon's proprietary *Logic 7*® decoding, delivering unrivaled playback realism from any source. The MC-1 reaffirms Lexicon's pre-eminence in the universe of multi-channel digital audio.

The MC-1 also features a broadcast-quality video switcher, a state-of-the-art 8-channel D/A converter, and an audiophile-

quality preamplifier to place it in a class of its own. And as new technologies emerge, your investment is protected: the MC-1's digital system architecture allows for future upgrades.

So, bring in your used A/V gear to your dealer and take home the exceptional MC-1. Experience for yourself what everyone is raving about!

*Program valid from September 15, 1999 through December 15, 1999. Lexicon dealer determines final trade-in value and actual trade-in amounts vary. Lexicon dealer reserves the right to refuse any trade-in offer. Quantities are limited; prior sales excluded. Terms and conditions are subject to change without notice. Contact your authorized Lexicon dealer for full program details.

www.lexicon.com



A Harman International Company



Lexicon, Inc. • 3 Oak Park, Bedford, MA 01730-1441 • Tel: 781/280-0300 • Fax: 781/280-0490 • Email: info@lexicon.com

the C340, Folds's solo piano is surprisingly clean, considering the amp's previously displayed problems with higher pitches (Caleb Southern's solid production certainly doesn't hurt matters). The shocking instrumental crescendos get somewhat cluttered, but that's probably Southern's intention; even the Acurus wrestles with them. The cymbals push their way into the foreground on the

C340, but Folds gets his sardonic point across on both amplifiers, loud and (usually) quite clearly.

Neil Young, *Eldorado*. This stunning Japanese import EP contains three tracks that eventually wound up on Young's 1989 masterpiece, *Freedom*. Two of the tracks, however, can't be found anywhere else, and they're prime examples of Mr. Chameleon

The C340's remote also controls other NAD components—hence its abundance of buttons.



in his "hail to the feedback" mode. The altogether frightening, live-in-the-studio opening cut, "Cocaine Eyes," is as rip-snorting as anything he's ever recorded. It starts off memorably, with someone pointing out the audible hum of a particularly grouchy amp. Young responds with, "Yeah, that sounds good, though." He strums his guitar to test it and then decides, "Let's try one like that." At this point you should get the dog out of the room, because Neil and the boys proceed to slam out a pile-driving hissy fit that could kill small animals.

The C340 is perfect for this kind of thing. The raucous nature of the recording is fully evident; you can sense the musicians getting excited as they realize that the track is falling into place. The bass (played by Rick Rosas, who's anti-cryptically listed in the credits as Rick "The Bass Player" Rosas) slams down hard, and the amp's tendency to push the low end turns his booming into solid bedrock. Yes, the treble is still a little bit testy, but Young has never been one to overproduce his music. You get exactly what he got when he played it, the way God intended us to hear rock 'n' roll. If you're a reggae or punk fan who has stacks of bills to pay (we know you're out there), you could do much worse than the NAD C340. Crank it up and try to rattle out a filling.

Again, we're not talking about a Mercedes here. The C340 is like a solid little Honda: There's enough pickup to get you where you're going, and you save some serious bucks in the process. Not everyone is rolling in dough, you know. The NAD C340 can make you feel like a fairly rich man, at least until the song fades out.

TEST RESULTS

True Technologies' measurements reveal absolutely classic NAD performance. In particular, the amp comfortably exceeds its 50-watt power spec, delivering 58 watts (17.6 dBW) per channel continuously into 8 ohms and 66 watts (18.2 dBW) into 4 ohms. ("Soft Clipping" was turned off for this and all other tests.) Dynamic power was even more impressive, clocking in at 100 watts

(20 dBW) into 8 ohms and 155 watts (21.9 dBW) into 4. And as you can see from Fig. 1, distortion remained comfortably low at any output level below clipping. Figure 2 shows that this remains so across the entire audio band. (Results for 4 ohms were only marginally different from those into 8 ohms and therefore are not shown.)

Frequency response with the tone controls defeated (Fig. 3) is quite flat, exhibiting just a slight droop at the very bottom (-0.3 dB at 20 Hz). Channel imbalance is a mere quarter decibel, and interchannel crosstalk (Fig. 4) is much more than adequately suppressed, even at high frequencies. Finally, Fig. 5 shows a nice, low noise floor for both channels, with just a hint of a hum bump at 60 Hz. A-weighted noise measured -87.1 dBW. All in all, excellent performance for a modestly priced analog amplifier.—Michael Riggs

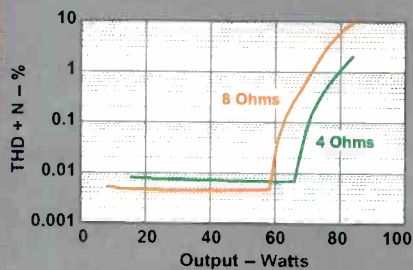

Fig. 1—THD + N vs. level at 1 kHz.

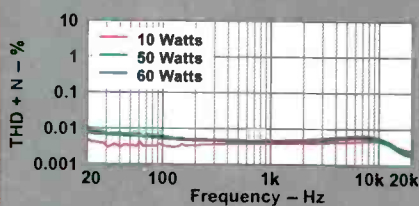

Fig. 2—THD + N vs. frequency, 8-ohm load.

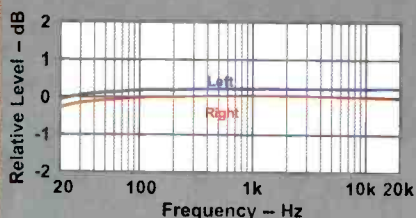

Fig. 3—Frequency response.

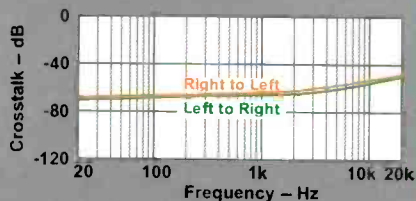

Fig. 4—Crosstalk vs. frequency.

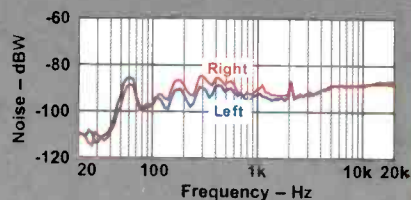

Fig. 5—Noise spectra.

“I was losing all my friends!”

Matt Polk, Speaker Specialist

When friends needed an audio system, they would turn to me for advice. I was happy to help; nothing thrills me more than helping someone discover the joy of great sound. I make no apologies: I'm an audiophile. When friends asked my advice, I steered them to the highest performance components they could afford, which was easy when things were just 'stereo.' I would recommend components, give some quick set-up advice, and everybody was happy.

Things got complicated when digital home theater came along.

The phone calls would come just as we were sitting down to dinner: 'Hey Matt, what the %\$#&! is bass management and how do I turn it on?' Or, 'Matt you creep, I need an electronics degree to hook this contraption up!' Creep? Me? *Ouch!*

Obviously things aren't as simple as they used to be.

Don't get me wrong, I love digital surround technology, and nothing beats the excitement of a slick action flick on a great home theater system. But I got tired of making after-dinner house calls to hook up, set up, and explain how to use complicated home theater systems. Yet I couldn't bring myself to recommend one of those 'home theater-in-a-box' systems. They may be easy to operate, but they fall far short of a 'spine-tingling' home theater performance.

I got to thinking, 'It doesn't have to be this way. There's no reason why you can't have an easy to use, high performance home theater that quickens your pulse, tugs on your heartstrings, and gives you goosebumps.'

Shameless plug

So we set out to design a system that's easy to choose, easy to set up, and easy to use—and *still* delivers no-compromise performance. Introducing something entirely new: the RM Digital Solution. It features award-winning satellite/subwoofer speakers, a Dolby® Digital preamp/processor, and a 500 watt multi-channel amplifier—integrated into a single system. We engineered the 'high-end' component electronics to work specifically with the speakers. By optimizing the complete system—from input to speakers—we not only made it easy, we also made it sound spectacular.

So now my friends get the simplicity and high performance they want, and I get to eat dinner.



NEW! The Polk™ RM Digital Solution system combines award-winning loud speakers with a high-end, separates-quality Dolby Digital preamp/processor, and a 500 watt multi-channel power amplifier to bring you high performance, easy to use home theater.

Free stuff

Seriously, I'm really proud of the RMDS-1. It does so much—and does it so well—that I could talk about it for hours! Instead, call (800) 377-7655 ext. 101 for a brochure. I'll also send you a **free** copy of the *Home Theater Handbook*. It's full of unbiased advice on selecting and optimizing a component system, if that's what you want."

5601 Metro Drive
Baltimore, MD 21215
Customer Service (800) 377-7655
Monday - Friday 9:00am to 6:00pm E.S.T.
"Polk Audio," "The Speaker Specialists" and "Polk" are trademarks of Britannia Investment Corporation used under license by Polk Audio Incorporated.

www.polkaudio.com

polkaudio
The Speaker Specialists®



FURNITURE SHOULD BE SEEN, NOT HEARD.

Acoustic resonance in audio/video furniture can make your high-end system sound like a waste of money. While some furniture makers turn a deaf ear to acoustic performance, Sanus gives it top priority. Our innovative Component Furniture is a perfect example of bringing form and function together at the highest level. Sanus' Resonance Damping Mechanism (patent pending) and superior materials isolate your components from acoustic vibration and provide rock-solid support. Plus, we give form equal billing producing a beautiful design that's as easy on your eyes as it is on your ears. So unless you prefer furniture that hums along with your music, complement your system with the OF line from Sanus Systems.



RESONANCE DAMPING MECHANISM

- Three points of damping
- Accurate shelf leveling
- Locks shelves in place

BUT, HOW DOES YOUR FURNITURE SOUND?

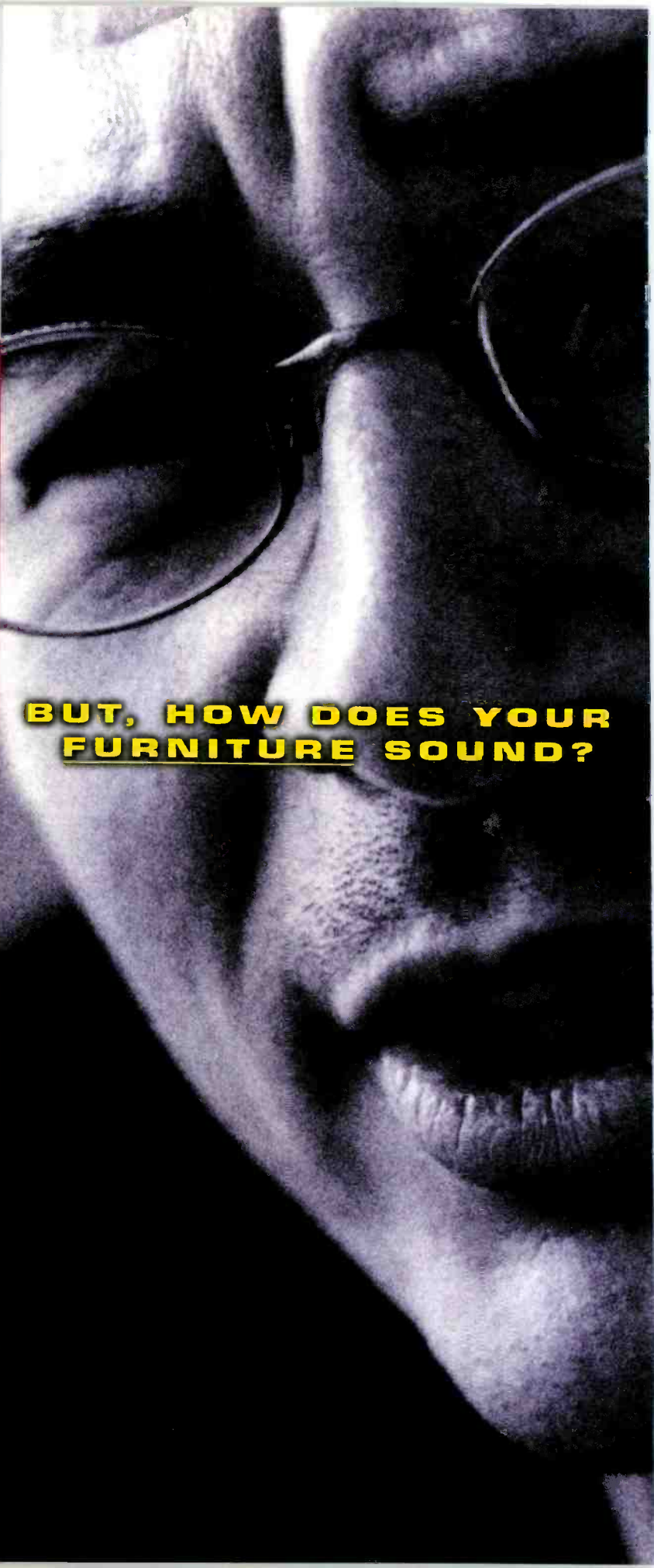

SANUS
SYSTEMS

THE UNION OF FORM AND FUNCTION

WWW.SANUS.COM • 800.359.5520

EDWARD J. FOSTER

Lexicon DC-2

A/V Preamp



Photos: Michael Groen

Lexicon shouldn't remind me of the Jolly Green Giant. It's not green, and it's not a corporate giant (although its parent, Harman International, certainly is). But it does! It's not a matter of size or color. No, it's because just like the big guy towers over the vegetable patch, so Lexicon stands with one foot squarely in consumer audio and the other planted in professional audio and is a tower of technical strength in each. Not many companies can claim such distinction; technologically advanced products like the DC-2 Digital Controller are why Lexicon has such a magic reputation.

The DC-2 is an eight-audio/five-video switcher wrapped around an eight-channel DSP-based system controller. Come again? Eight-channel system? You got it: left, cen-

ter, and right front; left and right sides; left and right rears; and subwoofer. The idea of 7.1-channel sound may be new to many of us, but it's old hat to Lexicon, whose Logic7 technology has been deriving such fare from standard meat-and-potatoes recordings for quite some time. You can use the

LEXICON

Dimensions: 17 $\frac{3}{8}$ in. W x 3 $\frac{3}{8}$ in. H x 11 $\frac{1}{2}$ in. D (44 cm x 9.2 cm x 29.2 cm)

Weight: 11.3 lbs. (5.1 kg).

Prices: DC-2 THX, \$2,495; DC-2 AC-3, \$3,495; DC-2 dts, \$3,995.

Company Address: 3 Oak Park, Belford, Mass. 01730; 781/280-0300; www.lexicon.com.

side channels alone (as in a conventional 5.1-channel system), the rears alone, or both together. If there's not something for both sides and rears (and there usually won't be, until there are a lot more Surround EX soundtracks on DVD), the DC-2 synthesizes what it thinks you're missing. And if you do play a Surround EX movie, current production DC-2s will correctly decode its third surround channel and feed it to the rear speakers.

The DC-2's eight audio inputs are ambidextrous. All are outfitted with gold-plated RCA jacks for analog stereo; five of the eight handle S/P DIF digital audio in wired form on RCA jacks, and the other three accommodate optical S/P DIF digital audio via Toslink. Any of the digital inputs can be assigned to any source via the setup menus. So one way or the other, all audio bases are covered. The five video inputs handle composite- and S-video but not component-video, which is a real shame for a modern high-end product.

In addition to the main audio outputs, there's a stereo pair to drive a second zone and another stereo pair to feed an audio recorder. And to supplement the video-monitor outputs, the Lexicon has composite- and S-video feeds for a VCR. You'll need a Y connector (not supplied) to feed sound to the audio recorder at the same time as the VCR. Y-connecting video is a no-no, so don't try it.

The DC-2 has an RS-232 serial port to handle automation and control in a custom installation and a $\frac{1}{8}$ -inch mini-jack to accept data from industry-standard infrared sources. Low-voltage triggers to activate power amps, video screens, and the like are provided on a five-pin DIN jack and four-pin removable screw terminals. The triggers are programmable on a source-by-source

basis to behave appropriately for each component. Except for lacking component-video interfaces, the DC-2 is a pretty complete controller. There's even a bunch of expansion ports for those mysterious "future upgrades" that everyone talks about and few deliver on.

As with some other of today's upscale controllers, the analog audio sources are named (VCR, DVD, V-DISC, TV, AUX, CD, TUNER, and TAPE) and the digital audio and video inputs initially are unassigned. If you don't like the names, you can edit them (eight-character limit) during initial configuration. Video and digital audio are married to the analog audio when configuring the system. The DC-2 permits you to assign video sources to more than one analog audio input, so you can, for example, use a VCR tuner to feed both the VCR and a TV by assigning the VCR video input to both analog audio channels. You can even assign video sources to the three channels that normally are audio-only (the last three listed above), should you experience an uncontrollable urge to watch TV while listening to FM.

The DC-2 is available in three versions: THX (meaning music plus THX-enhanced Dolby Pro Logic), Dolby Digital, and DTS. One builds upon the other in that order, with lesser versions dealer-upgradable to the ones above. Now that Lucasfilm has created the watered-down THX Select certification, I guess I should point out that the DC-2 qualifies at the original level (now called THX Ultra).

A DC-2 can provide as many as 24 processing modes, some of which are dedicated to stereo music, some to matrix-encoded soundtracks, and others to Dolby Digital and DTS recordings, music or flicks. All versions of the DC-2 include Lexicon's pro-derived "Nightclub," "Concert Hall," "Church," and "Cathedral" synthetic ambience; "Music Logic" and "Music Surround" ambience extraction; and Lexicon's proprietary Logic7 derived 7.1-channel system. There's also Lexicon's well-regarded "Panorama" processing to enhance the spaciousness of stereo recordings and of some 5.1-channel soundtracks. Although

"Panorama" sends derived signals to center and surround speakers, its primary characteristic is a crossfeed of inverted, delayed signals between the left and right front speakers to cancel the sound of the left speaker as it arrives at the right ear and vice versa. This technique, known as interaural crosstalk cancellation, can be remarkably

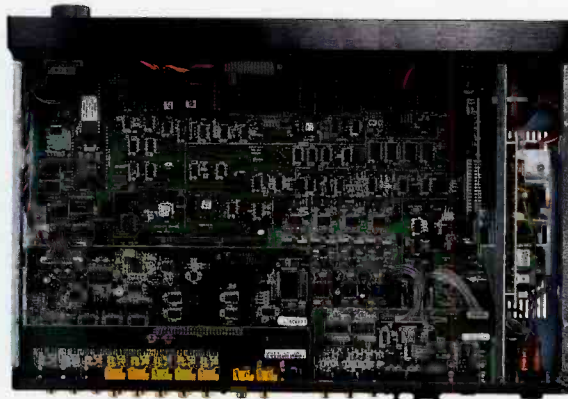

Technologically advanced products like the DC-2 are why Lexicon has such a magical reputation.

effective if the system is properly adjusted and you're sitting in the sweet spot.

Default modes are assigned to inputs during initial configuration, so if you usually prefer THX Cinema to plain-vanilla Pro Logic, you can set up an input to default to THX Cinema when presented a matrix Dolby Surround signal. The same goes for Dolby Digital or DTS. You needn't select the same modifications for all types of signals. You can have the system default to THX with Pro Logic and to Logic7 with Dolby Digital and have no modification whatsoever with DTS if thens your druthers. All is done on an input-by-input basis, and, since you can override the defaults with the remote whenever you want, the default settings are more a matter of convenience than necessity.

When configuring a digital audio input, you can have the DC-2 automatically identify the incoming bit stream and select the appropriate decoder, or you can restrict

that input for use with only one type of signal (PCM, for example). Since the DC-2 processes everything digitally, analog audio is converted to digital immediately upon entering the box. Normally the DC-2 automatically adjusts input gain to optimize the A/D converter's dynamic range, but you can opt for manual gain control and adjust the input gain of the channel in 1-dB increments when configuring the system. When you adjust input gain, input level meters pop up to help out. Lexicon's "Auto Gain" setting adjusts dynamically and does an excellent job of it, so I see no reason to concern yourself about manual adjustment.

The DC-2 is configured and adjusted using on-screen and front-panel displays, which can be turned on and off independently. Although the video display is preferable in that it shows all menu choices at once rather than sequentially, the DC-2's panel display is detailed and legible enough to actually be useful in the absence of a monitor. That's more than I can say for many products of this ilk!

You'll either love or hate Lexicon's remote. Personally, I think it's first-rate: one of the most intuitive, yet comprehensive, controls around. A lot of that can be credited to Lexicon's choice of nomenclature and the arrangement of the control menus. Menus nest logically, with the most commonly used functions on the top layer. Probe deep enough, however, and you can get to adjust a remarkable array of functions—even the contrast of the front-panel display and the volume setting at turn-on (separately for each zone)!

The other reason I *like* the DC-2 remote is that Lexicon didn't load it down with a lot of tiny buttons. Instead of a button for everything under the sun, there are relatively few pads, and each is large enough for a real human male to use. To operate alternate functions, you press and hold a shift key to remap the pad layout (or to control the recording and second zone output, you press and hold the "Record/Zone-2" key to remap the pads).

The reason some people will *hate* the DC-2 remote is that Lexicon didn't load it down with a lot of tiny buttons, and to oper-

Your DVD player is missing something.

So is your satellite system. Or HDTV. All provide wonderfully accurate pictures that, thanks to digital technology, can be accompanied by equally wonderful sound. You simply need superior loudspeakers to reveal it. Why JBL? Well, we deliver great sound in many of the world's most prestigious concert halls, nightclubs and recording studios. All three Woodstock music festivals featured JBL sound systems. And today, the majority of movie theaters around the world with surround sound are equipped with our speakers. Enjoy the best sound in your home with speakers from the company with the most impressive professional audio resume in the world: JBL. Our Northridge (shown here), Studio or Performance Series superbly reproduce the remarkable sound made possible through digital technology. For more information: 1-800-336-4JBL or www.jbl.com.



The Northridge Series speakers.
Perfect for home theater and music.

DVD | Satellite | HDTV
PLAYER | SYSTEM

Complete the picture with JBL speakers.



TEST RESULTS

The Lexicon DC-2's placid exterior belies the complexity of what goes on inside. In typical Lexicon fashion, the DC-2 operates exclusively in the digital domain, so analog signals immediately are converted to digital for processing. To get an adequate technical handle on the DC-2, I tested stereo performance using both the analog and PCM-digital inputs, the Dolby Pro Logic performance from the analog inputs, and the Dolby Digital (AC-3) characteristics from the digital input. (DTS was not tested because no suitable test disc is available.)

One expects a Lexicon processor to have fine DACs, and as the data clearly reveals, the DC-2 does. Even more impressive is how extraordinarily competent the DC-2 is at handling analog signals. Bandwidth is strictly limited by anti-aliasing considerations, but that's true of any digital system. There are better and worse ways of quantizing analog signals, howev-

er, and the DC-2 definitely takes the high road.

When auto-ranging, the analog inputs are overload-proof; even with manual gain setting, they can handle nearly 9 volts if you lock the gain to minimum. That's quite remarkable in a digital controller, most of which are far less adroit than the DC-2 at navigating between the Charybdis of input overload and the Scylla of quantization noise. The stereo channels are well balanced, and input impedance is unusually high, so there's never a worry about loading down the program source. (Shaving input impedance to reduce noise is a trick Lexicon seems to find no need for.)

As far as response is concerned, Lexicon's 24-bit delta-sigma A/D converters are so nearly perfect that the curves taken using the analog inputs match those taken using direct PCM and Dolby Digital inputs *within the width of the printed line!* Consequently, to save space, I've plotted only the analog-input stereo response curves in Fig. 1; consider the rest identical within the limits of measurement error!

The DC-2's handling of analog signals is so good that technically astute readers may question some of the numbers. For example, how is it possible for total harmonic distortion plus noise (THD + N) to be less over much of the spectrum through the analog input than through the digital one, when analog signals must experience both A/D and D/A conversion while digital signals only go through the second step? (See Fig. 2.) And how is it possible for dynamic range (see "Measured Data") to be slightly *better* through the analog inputs than through the digital ones? The answer probably lies in a difference in test methodology, specifically in setting the volume control.

The analog preamp measurement standard calls for testing distortion with a voltage gain of 12 dB. Although that's not possible with the DC-2 (maximum gain is just shy of 10 dB), I had the volume up all the way for the stereo and Pro Logic distortion measurements. In both cases, the input was adjusted to produce a 2-volt output, and, as you can see in Fig. 2, the THD + N is almost the same for them below 10 kHz. Distortion measurements made using PCM and Dolby Digital signals were taken with the volume control adjusted 10 dB lower, because that was the setting that produced as close to a stand-

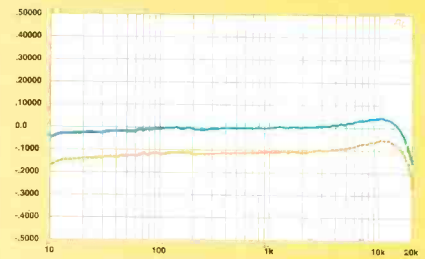

Fig. 1—Frequency response, stereo mode, analog input. Left, aqua; right, orange.

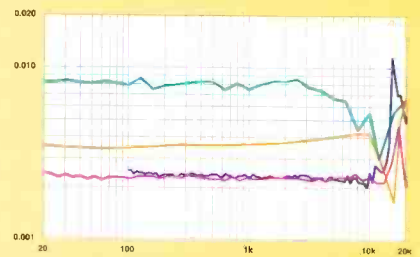

Fig. 2—THD + N vs. frequency. Dolby Digital input at -10 dBFS, aqua; PCM input at 0 dBFS, orange; analog Dolby Surround input, left front channel output, purple; analog stereo input, magenta.

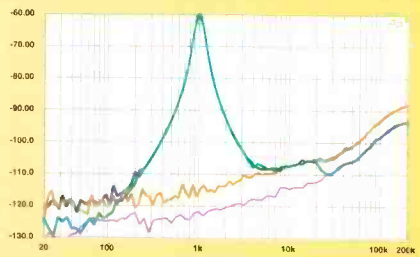

Fig. 3—Noise spectra. For -60 -dBFS, 1 -kHz input, digital is aqua and analog is purple; for silent input, digital is magenta and analog is orange.

MEASURED DATA

Maximum Output Level: 4.3 V or more.

Maximum Gain, Analog Input, Stereo Mode: 9.9 dB.

Analog Input Overload Level (1% THD): 8.9 V at 1 kHz.

Sensitivity, Analog Input, Stereo Mode: 160 mV for 0.5 V output.

Analog Input Impedance: 69.4 kilohms.

Analog Output Impedance: Main, 100 ohms; recording, 510 ohms.

Channel Balance: ± 0.05 dB.

Muting: 10.1, 20.1, 30.1, or 40.1 dB or total.

S/N re 0 dBFS, Stereo Mode: Analog input, 99.6 dB A-weighted and 90.7 dB CCIR-weighted; digital input, 106.1 dB A-weighted and 97.3 dB CCIR-weighted.

Quantization Noise: Analog or digital input, -97.1 dBFS.

Dynamic Range, Stereo Mode: Unweighted, 97.5 dB for analog input and 97.4 dB for digital input; A-weighted, 100 dB for analog input and 99.4 dB for digital input; CCIR-weighted, 90.7 dB for analog input and 89.6 dB for digital input.

LOOK NO FURTHER.



The new Sunfire Theater Grand tuner/preamp/processor is the latest innovation from Bob Carver. It is easy to set up, simple to operate, and delivers superb performance. Features include Dolby Digital® and DTS® decoding, Holographic Imaging, automatic signal sensing, and a versatile LCD remote. The Sunfire Theater Grand is state-of-the-art now and fully upgradable, so it is poised for the future.

It is no wonder that Home Theater magazine concluded: "If you're in the market for a full-featured controller for your system, look no further than the amazing value you get with the Theater Grand." — Jeff Cherun, Home Theater, February, 1999

Bob Carver's
Sunfire

...from his mind & soul

www.sunfire.com

TEST RESULTS

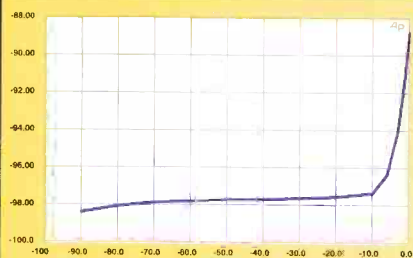

Fig. 4—THD + N vs. level, PCM digital input.

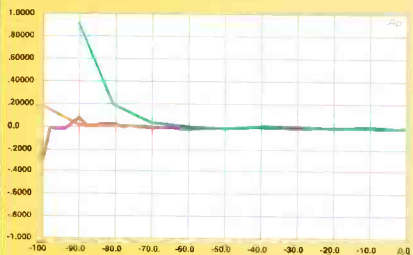

Fig. 5—Linearity error. Undithered PCM input, aqua; dithered PCM input, orange; analog input, magenta.

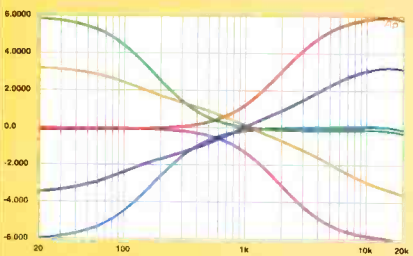

Fig. 6—Tone-control characteristics. “Tilt” control response shown in orange and blue.

en at -10 dBFS (the only level available on the THX test disc used for this measurement), not 0 dBFS, and so contains proportionately more noise.

Signal-to-noise ratio (referenced to 0 dBFS) measures better using the digital inputs because Lexicon’s DACs, like most, mute on digital silence. You can see that in the lowest curve of Fig. 3. Real-world A/D converters never produce digital silence, so the noise through the analog-to-digital-to-analog chain is always greater than it is through a DAC that has muted on an artificially constructed silent track. What’s interesting is how small the difference is here—only about 6.5 dB. That testifies to excellent analog input electronics and an excellent A/D converter. Figure 3 displays spectral analyses made using a -60 -dBFS

signal at 1 kHz. For the most part, you can’t tell the analog- and digital-input curves apart. Quite amazing! And just note the total—and I mean *total*—absence of hum components! Lexicon sure does know how to design and lay out circuitry.

Figure 4 shows the THD + N of the D/A converter as a function of level, while Fig. 5 shows the linearity error of the DAC alone (measured with dithered and undithered signals) and of the A/D/A chain measured from analog input to analog output. These curves represent state-of-the-art conversion, with the one for analog-in to analog-out particularly outstanding. Quantization noise, an indicator of overall converter linearity, is the same through the analog and digital inputs. This suggests that Lexicon’s A/D converters certainly don’t limit performance in this regard.

Lexicon implements the tone controls and bass management in the digital domain. In addition to fairly conventional bass and treble controls that boost and cut in a shelving manner, Lexicon adds a “Tilt” function that slopes the response smoothly, gradually, and fairly linearly from bass to treble or the other way about. None of these controls has an overwhelming effect. As you can see in Fig. 6, the bass and treble alteration maxes out at ± 6 dB at the ends of the spectrum, while “Tilt” boosts and cuts the response at 20 Hz and 20 kHz by 3.3 to 3.5 dB at most. The DC-2’s (optional) loudness-compensation function corrects for diminution in the ear’s low-frequency sensitivity at low volume settings. The degree of correction varies with volume setting, which should be advantageous. The correction curve with a volume setting of -30 dB is plotted in Fig. 7.

The DC-2 offers three choices of bass-management crossover frequency: 40 , 80 , and 120 Hz. The filters are sharp (12 dB/octave on the high-pass, 24 dB/octave on the low-pass), and the designated frequencies match the -3 -dB points of the high-pass section and the -6 -dB points of the low-pass section quite accurately. The DC-2 defaults to the 80 -Hz setting, which is the one that meets THX specifications vis-à-vis filter shape, crossover point, and slope. The corresponding response curves are plotted in Fig. 8 on a truncated frequency scale. The slight level boost in the deep bass region of the 40 - and 120 -Hz

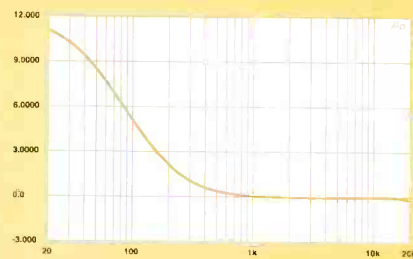

Fig. 7—Loudness-compensation characteristic at volume setting of -30 dB.

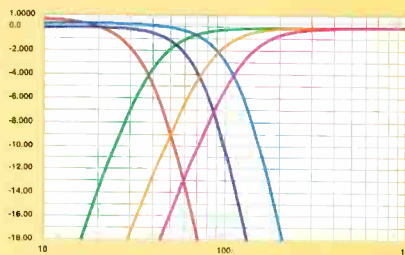

Fig. 8—Crossover characteristics at 40 -, 80 -, and 120 -Hz settings.

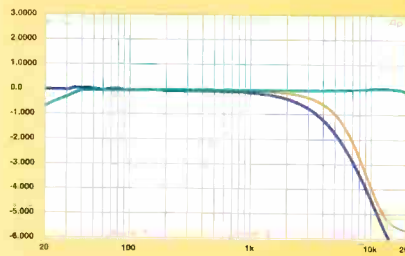

Fig. 9—Frequency response, Dolby Pro Logic mode. Center channel, aqua; center channel with THX re-equalization, orange; surround channel, purple.

curves is unusual, but my plots agree with those published in the Lexicon manual, so I guess that’s what they want. I see no reason for the oddity, but I’m not concerned about it, either.

Figure 9 shows the frequency response of the front and surround channels with Pro Logic decoding. The only front channel actually plotted is the center, but the left and right channels were essentially the same except below 40 Hz, where data becomes inaccurate because of the way Dolby Pro Logic handles low-frequency sinusoids. Where measurement was accurate, response in Pro Logic mode is equivalent to that in stereo or Dolby Digital, which is as good as it gets. Of course, in Pro Logic the treble response of the surround chan-



It's Coming

Loudspeaker technology living up to the promise. A new way.

Breakthrough advances in both electrostatic transducer and dynamic driver implementation unfold the audio experience to new holographic levels—effortlessly.

It's coming in January, but you can find out about it now.

Contact your MartinLogan dealer or visit our website for a glimpse of the future—the uncompromised heart of any system.

c l s e l e c t r o s t a t i c

MARTIN LOGAN

785.749.0133
www.martinlogan.com

TEST RESULTS

nels should and does roll off, and the DC-2 adheres to Dolby standards quite closely in this respect. The -3 -dB point (7.35 kHz) is close to the 7-kHz target. Figure 9 also shows center-channel response with THX re-equalization. Once again, the DC-2 adheres to standard exceedingly well—within a few tenths of a decibel, in fact.

Dolby Digital performance is exemplary. The five main channels are well balanced among themselves and to the LFE.

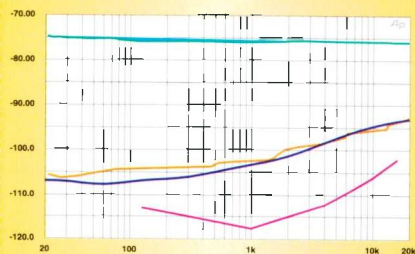

Fig. 10—Crosstalk vs. frequency. Dolby Digital, worst case in aqua and best case in orange. Worst-case stereo, analog input in purple and digital input in magenta.

Main-channel response is exceedingly flat—the same as in stereo (see Fig. 1)—and the LFE response is flat in the range below the selected crossover frequency. Distortion measurements are similarly impressive, coming in at less than 0.009% at -10 dBFS (see Fig. 2) and less than 0.005% at 1 kHz at 0 dBFS. LFE distortion is greater, but that's normal and nothing to worry about. Best- and worst-case separation in Dolby Digital mode is shown in Fig. 10, along with the worst-case stereo separation.

Although it varies from mode to mode and from channel to channel, there's always more than enough output to drive any power amp into clipping. Output impedance is low, too, which is nice to see. Noise on an absolute basis—i.e., in dBV—is also exceptionally low, with a worst-case A-weighted reading of -97.8 dBV. Even the four choices of mute level are accurate. The only technical oddity I found was a stereo interchannel time error of one clock period (22.7 microseconds). With Dolby Digital decoding, the maximum interchannel time error grew to 187.5 microseconds. Since the time differential remained constant over the audio band, it's equivalent to moving the speakers by just a few inches (at most), so it shouldn't be anything to get concerned about.—E.J.F.

ate alternate functions, you press and hold a shift key to remap the control layout—and the remapping can get pretty weird. VCR and AUX end up being bass level adjustments, while DVD and CD serve the same function in the treble. V-DISC and TUNER tilt the response up and down, while TV and TAPE toggle the loudness compensation. Bizarre? Yes, but you can see what you're doing on that large, legible panel display and on your TV if you've activated the on-screen display. Given some time with the DC-2, I'm sure I could program my fingers to remember which pad does what with the shift key held. The zone-2 remap is a bit more logical but not entirely so. The displays still bail you out, however.

Although I'm not big into tone controls, the DC-2's come as close to pleasing me as any I've used. I like my tonal alterations soft and subtle; the DC-2 controls fit the bill. Both bass and treble contours shelf (which is unusual) and have a maximum range of only ± 6 dB, less than half that usually inflicted on the unwary. They adjust in steps of 0.5 dB, which is really nice when you're trying to make a small change.

Add to the basic tone controls a really nifty "Tilt" function that hinges at 1 kHz and slopes the response down or up in a quasi-linear manner over the whole audio band. Maximum alteration is ± 3 dB at 20 Hz, accompanied by a simultaneous ± 3 dB change at 20 kHz, adjustable in 0.2-dB increments. I found "Tilt" far more helpful than conventional bass and treble controls in taming overly bright (or dull) soundtracks (or acoustics). Last, but not least, the DC-2 offers a loudness-compensation function whose effect varies with volume setting. As usual, tonal modifications are applied only in the front channels.

As a 7.1-channel THX-certified system, the DC-2 offers independent setup of the side and rear speakers. If you set up for "Large" or "Small" dipoles on the side, the rears are disabled in the THX modes to comply with the Lucasfilm dictum. If you choose "Large" or "Small" standard side speakers and are using rear speakers, all seven main channels are active. (In Logic7 mode, all channels are active regardless of what kind of speakers are used for the sides.) The DC-2 offers a full range of bass-

management options in that you have a choice of "Large" or "Small" for speakers in all seven main locations, and bass energy routes accordingly. You can set up without a center, in which case center information divides between the left and right fronts (phantom center), or set up without sides and rears, in which case the surround channels fold back into the fronts.

There are three choices of crossover frequency—40, 80, and 120 Hz—with filter slopes that meet THX standards, and the default is the 80 Hz Lucasfilm specifies for THX systems. The DC-2 makes provision for only one subwoofer, so all bass energy from speakers set up as "Small," along with the LFE (low-frequency effects) channel,

Dolby Digital performance is exemplary in every respect.

ends up in one place. One could argue that a processor of this caliber should offer an option for using stereo subwoofers. (I know bass ain't directional, but at 120 Hz, it is.) The LFE channel's signal passes through the subwoofer low-pass filter, so the filter setting affects what is delivered—i.e., the DC-2 second-guesses the movie producer.

If you have a sound level meter, speaker levels can be adjusted and balanced to 75 dB SPL at the listening position using either the DC-2's own internal noise generator or an external noise source. You also can adjust the subwoofer peak limiter from -5 dB (maximum limiting) to $+35$ dB or defeat it altogether. Interchannel delays (time balance, if you will) are adjusted in terms of the distances from the speakers to the listening position in the usual manner; there's a special setup operation to calibrate the sweet spot for the "Panorama" mode. The DC-2 also provides adjustable audio delay of 1 to 30 milliseconds on all channels simultaneously ("A/V Sync Delay"). This realigns audio and video when the latter has been put through a scan converter or other processing device that delays it.

KIMBER SELECT

- 20 YEARS IN THE MAKING -



KS 1030

Borrowing technology from the Model 88 loudspeaker cable, the KS-1030 single ended interconnect utilizes our unique Black Pearl silver in our new orthogonally braided geometry. This superior conductor works in conjunction with other proprietary technologies to shield against signal distorting influences—both electrodynamic and acoustic. The KS-1030 brings the color and passion of music to a higher plane of authenticity.

-One Meter Pair \$1,200-

 KIMBER KABLE

Select

*A comprehensive line of loudspeaker cables - Digital & analog interconnects
Designed and manufactured in house - By our finest craftsmen*

the choice of professionals

M&K PRO USERS INCLUDE:

20TH CENTURY FOX

BUENA VISTA SOUND/
WALT DISNEY PICTURES

PIONEER DVD MANUFACTURING

SKYWALKER SOUND

DOLBY LABORATORIES
LA / NYC / SAN FRANCISCO

MAURICE WHITE'S KALIMBA STUDIOS

MASTERPHONICS/THE TRACKING ROOM

4MEDIA COMPANY (4MC)

DTS

LUCASFILM

NARAS

SONY MUSIC

TREVOR RABIN

SONY PICTURES

PACIFIC OCEAN POST

KEITH OLSEN'S GOODNIGHT LA

AND OVER 100 MORE...

These world-class studios chose M&K speakers - shouldn't you?

A Who's Who of the professional audio world—numbering well over 100 film, music, mastering and broadcast studios—trusts its livelihood to M&K's Multichannel Pro Solutions systems, reference monitors, and powered subwoofers.

These cutting-edge pros are launching a 5.1 channel revolution in audio—and the common element is M&K.

Just ask *EQ* magazine, whose reviewer concluded:
"For a professional surround sound system, I think the M&K MPS-150THX is the one to beat."

The very same technology and speaker elements used in these pro systems are found in every M&K loudspeaker and powered subwoofer—ranging from state-of-the-art THX home theaters to remarkably affordable systems.

To hear every element of sound created by the world's leading artists and producers, shouldn't you use the same speakers?

Hear the professional experience—choose M&K Sound.



THX is a registered trademark of Lucasfilm LTD.

10391 Jefferson Blvd. Culver City, CA 90232 · 310/204-2854 · fax 310/202-8782 · fax back 800/414-7744 · www.mkksound.com

Miller & Kreisel Sound Corporation



In addition to a straight stereo two-channel mode, the DC-2 offers 13 effects modes for PCM (stereo or matrix-surround) signals, five more for Dolby Digital, and a parallel group of five for DTS. The modes are named either for the effect they're trying to achieve ("Nightclub," "Concert Hall," and so forth) or for the suggested application ("TV Matrix," Pro Logic, THX, etc.). Lexicon's tool kit of possible modifications to these modes is vast. Needless to say, not all are applicable in every mode, but I've never seen a more complete assortment of goodies to play with. The manual lists 34 different effects parameters for the PCM modes alone!

I was particularly intrigued to find out how the Lexicon DC-2 would get along with the Mirage OM-8s in my main listening room. Being quasi-omnidirectional, the OM-8s are probably not the best choice of speaker for "Panorama" processing, the only mode (besides straight stereo) that I used in the music room. Regular readers probably know that I'm not all that sold on synthetic effects for the kind of music listening I do, and I removed the surround speakers from my music room ages ago. I do surround listening—be it to music or movies—in my home theater, about which more later.

Lexicon's "Panorama" mode worked far better with the OM-8s than I had thought it would. I do keep the OM-8s rather far from the walls and have them toed in to the listening position so that I sit pretty much on axis, which emphasizes the direct sound. Depending on the recording, the "Panorama" effect varied from "oh, that's nice" to "wow." The "wows" came with the most simply recorded material, in particular with live recordings that I made using a simple pair of cardioid microphones in an NOS or ORTF array. Recordings I made with a pair of spaced omnis also benefited, although seemingly not to the same extent. (I hesitate to get categorical on this because you don't know what the effect will be on a particular recording until you try it. That's especially true with commercial recordings, which can vary all over the lot.)

Perhaps the most exciting improvement was to a recording I made last spring of the Westport Madrigal Singers in Trinity Episcopal Church, Southport, Connecticut. Trinity Episcopal is a relatively small stone church with a fairly live acoustic. I used a high flying NOS array of AKG cardioids



The idea of 7.1-channel sound may be new to many of us, but it's old hat to Lexicon.

placed about 4 meters from the group. The singers were arrayed in a semicircle around a small harpsichord and viola da gamba. Although the recording sounds pretty decent just as it is, depth, breadth, and realism improved markedly in the sweet spot with "Panorama" crossfeed. The performance took on a palpable presence, and the placement of the singers with respect to the instruments was remarkably accurate. Most definitely an improvement, especially in image depth and breadth!

I checked out the DC-2 tone controls in the music room, too, and I must say I'm really sold on Lexicon's "Tilt" modification. Recordings that have always been a little too edgy or harsh for my taste—the strings of the Swedish Radio Symphony Orchestra on the Nielsen third and sixth symphonies (Esa-Pekka Salonen, conductor, Sony Classical SK 46500), for example—smoothed out beautifully with a slight downward slope on the "Tilt." The great thing is that you can take the edge off without dropping a veil over the sound. As bass and treble controls go, I'll take Lexicon's any day; anyone who wants a lot of boom and sizzle will find them lacking, however, so be warned.

My home theater is outfitted with full-range Paradigm speakers in front, larger-than-usual Paradigm bipolars above and to the sides of the primary listening area, and a sub where I've found it does the most good. To expand this to 7.1 channels while maintaining reasonably uniform voicing, I mounted a pair of Paradigm Mini MKIIs on the rear wall, about as far behind the viewing position as the main speakers were in front of it. (It's a long, narrow room.)

To be perfectly blunt, I'm still not sold on ersatz surround for the kind of music that I listen to (classical, for the most part). Things can get weird even on solo piano, and that's a stationary instrument. When you get a violinist doing the inevitable pirouette, you can end up with flying strings. Anne-Sophie Mutter's performance of the Bartók Second is a case in point (Violinkonzert No. 2, Boston Symphony Orchestra, Seiji Ozawa, conductor, DGG D 143994). Interestingly, the Emerson String Quartet fared much better (*American Originals*, DGG 435 864-2).

Maybe it's a boy/girl thing and the Emerson violinist doesn't shimmy as much as Mutter. Or maybe I'm just spoiled. A few days ago I heard a multichannel SACD demo disc at the Audio Engineering Society convention. Erdo Groot was the recording engineer, and the piece was some Sarasate violin warhorse that I ought to know (I've heard it enough). It was played by the Budapest Festival Orchestra and some I-can't-read-music-but-boy-can-I-fiddle gypsy violinist. He pivoted and pirouetted up a storm, but he pivoted in place, right between the center and left front speakers. Uncanny! Absolutely real! Now this is multichannel audio as it ought to sound, and once you've heard it, ersatz don't cut the mustard.

At least not for classical music. Most pop and rock stuff never existed in real time in a real space anyway. Play with the ersatz surround sound to your heart's content. If you like the results, that's all that matters. I will say that Lexicon gives you a play chest that is chock-full of better toys than any other surround processor I know of provides, and I recommend the DC-2 most highly! **A**



Elegant Surroundings

The Meridian Compact Theatre
M33 Active Loudspeakers
M1500 Active Subwoofer
561 Surround Controller
MSR System Remote

BOOTHROYD STUART
MERIDIAN

Meridian America Inc
3800 Camp Creek Parkway Building 2400
Suite 122 Atlanta GA 30231
T (404) 344 7111 F (404) 346 7111

Meridian in Canada
Aralex Acoustics Ltd
106-42 Fawcett Road, Coquitlam BC V3K 6X9
T (604) 528 8965 F (604) 527 3886

<http://www.meridian-audio.com>

KEN KESSLER

Castle Severn 2 Speaker



Photos: Michael Groen

Like a red rag to a bull, hearing that a speaker is a “floor-stander” is guaranteed to create problems in certain domestic situations. Floor-standing means “too damned big” to many, and there are life partners who will forever insist that hi-fi, unlike children, should be heard and not seen. While the battle between the sexes may be history in the workplace, the marketplace, and in a few other arenas, the henpecked male still

exists in many homes. And at no time is this more evident than when a wife prevents a husband from indulging in the hi-fi of his dreams because of its size or price. So any company producing a floor-standing speaker that seems smaller than the term implies deserves our thanks.

Castle, as a traditional British speaker manufacturer in the best sense, produces systems that run the gamut, from small to large. Its specialty, if it’s possible to have

one in the hackneyed world of wood-veneered box enclosures with cone drivers, has of late been building furniture-grade speakers at affordable prices. Every Castle speaker I’ve seen in recent years has oozed Olde Worlde craftsmanship, and the company has been sharp enough to offer finishes that are a welcome break from run-of-the-mill veneers like walnut. But Castle is one of quite a few dozen brands pursuing the same customers—those who want conventional speakers at sensible prices—so build quality isn’t always enough.

With the Severn 2, we have a delicious form of subterfuge: sleight-of-hand that places a floor-standing design within the grasp of those who might otherwise be forced to consider smaller two-ways. (Note, please, that nearly all intelligent individuals recognize immediately, and without the assistance of a tape measure, that a small two-way speaker placed on a 24-inch stand will occupy the same amount of space as a floor-stander. But the eye looking at the front of a floor-stander sees a wood slab measuring, for example, 36 inches tall and 8 inches wide, whereas a box 12 inches tall and 8 inches wide on a spindly stand seems less imposing. Use this argument with a wife hell-bent on preventing your buying a floor-stander, however, and you will lose. End of sexist sermon.) At \$1,399 per pair, the Severn 2 costs more than a beer budget would allow yet hardly qualifies as a bank-

CASTLE ACOUSTICS

Rated Frequency Response: 47 Hz to 20 kHz, ± 3 dB.

Rated Impedance: 8 ohms, nominal.

Rated Sensitivity: 87 dB SPL/1 watt/1 meter.

Dimensions: 32 in. H x 8 $\frac{1}{4}$ in. W x 9 in. D (81.3 cm x 21 cm x 23 cm).

Weight: 33 lbs. (15 kg) each.

Price: \$1,399 per pair with black, cherry, or mahogany finish; \$1,599 per pair with rosewood, yew, or walnut finish.

Company Address: c/o Audiophile Systems, 8709 Castle Park Dr., Indianapolis, Ind. 46256; 888/272-2658; www.aslgroup.com.

Rarified air.

Riveting Acoustics.

Introducing the

Reference Series,

inspired by the mind of a legend.

This revolutionary system embodies

five decades of innovative engineering,

innumerable patents and hundreds of industry accolades.

THE POWER
OF KLIPSCH.



It's Alive.

And ahead of its time. Our new Reference Series incorporates the most advanced electronics and materials technology available to create the richness of a "command performance." To produce sound of this caliber, Reference boasts cerametallic drivers featuring cast polymer frames and Strontium[®] magnet structures for unprecedented transient response and bass articulation. Our phase-aligned titanium compression tweeter, mated to the incomparable 90° x 60° Tractrix[®] Horn, delivers unsurpassed clarity and dynamic range. And, to breathe the utmost realism into your movies and music, we employ phase-coherent, bi-wirable crossover networks to deliver seamless driver integration. Visit your local Klipsch audio specialist to hear, feel and experience the distinctive Klipsch difference. The Power of Klipsch. It's Alive.

Learn more about the heart and science of the Klipsch sound by calling 1-800-KLIPSCH,
or for the surfing savvy, visit us online at www.klipsch.com.

 **Klipsch**[®]
A LEGEND IN SOUND.

©1999 Klipsch, Inc. All rights reserved.

FLIP SIDE



Low-mounted connecting terminals minimize the unsightliness of dangling cables.

breaker. Its price, though, suggests that it will most likely partner decent, entry-level electronics—better-than-mass-market integrations, good-quality A/V receivers, or the less costly preamp/power amp combinations. But because the Severn 2 is in the middle of one of the most crowded sectors of the marketplace, its deceiving size and superb finish just ain't enough to make it stand out from the pack. Sonically, it has to cook.

Castle enjoyed great success with carbon-fiber technology in the Avon's woofer; in the Severn 2 this technology is applied to a smaller driver. Changing the driver, however, forced the designers to change the Severn cabinet as well as most other elements. The downward resistive reflex loading with a stabilizing plinth (as used in the Avon) enabled the designers to use more of the speaker's internal volume than in the original Severn, while the new driver provides greater linear excursion with less distortion.

The Severn 2's new woven carbon-cone bass driver, built on a new Castle-designed cast chassis, is 6 inches in diameter (the original Severn had a 5-inch woofer). The cone has a rubber surround and is driven by a 1½-inch voice coil wound on a Kapton former. The woofer crosses over at 3.1 kHz to a 1-inch soft-dome tweeter; polypropylene capacitors are used in the crossover. The drivers are in a slightly staggered array on the baffle, creating true left- and right-handed speakers, with asymmetric grilles indicating the mirror-imaging. The woofer

is at the very top of the baffle, the tweeter immediately below it. Despite their relatively small size, these speakers pretty much focus at ear height.

Beautifully finished in real wood veneers (yew, in the case of my review samples), the Severn 2's cabinet is divided by an interior panel that slopes down from front to back. This is said to optimize the upper enclosure volume for reflex loading of the woofer. It serves as an asymmetric brace for the side panels, front baffle, and rear panel, to minimize cabinet resonances. Additionally, the slope helps break up standing waves in the enclosure and enables the crossover to be placed in the lower part of the cabinet, "outside the acoustic enclosure and its changing air pressures."

The connecting terminals are in a recessed area at the bottom of the rear panel. Castle points out that this helps "avoid unsightly cables dangling down the back of the loudspeaker." The reflex loading is accomplished by a port tube passing through the lower enclosure to a vent in the base of the speaker, about a quarter-inch above the plinth, and here's where Castle shows some nifty lateral thinking.

This technique of adding a resistive element to the reflex loading, which first appeared in the Avon, contributes in a big way to the Severn 2's superlative bass performance. It avoids having an unattractive port on the front while keeping it away from the back. So, even though Castle recommends that the Severn 2 be positioned in free space, away from all walls, the port's location precludes the sort of cupped, nasal effect and destruction of bass integrity experienced when you position a rear-ported speaker too close to the wall behind it.

The Severn 2 falls into the "some assembly required" category. But because putting a pair together shows you how they work, try to resist letting your dealer do it for you. Stand the speaker upside down, and the bottom panel will be exposed to reveal the port. Four threaded inserts are fitted to each corner. Over these you position pairs of spacers. Next, find the ¾-inch-thick wooden slab that forms the base and bolt it down. (The slab also accepts four long spikes supplied by Castle.) Upend the speaker back to the correct position, and it

will look like it's actually floating a fraction of an inch above its baseplate.

As mentioned before, the cabinet is finished in glorious veneers over ¾-inch-thick, medium-density fiberboard, and there's a thin groove around the baffle's edge to provide an attractive detail; it complements the enclosure's radiused edges and corners, designed to minimize diffraction effects. The look is completed by the curved bottom grille and Castle's rich-looking logo at the bottom of the front panel.

The Severn 2 is an easy load, inviting the use of medium-powered amplifiers. But its 130-watt rated power handling and maximum output of 110 dB SPL suggest that you can get away with beefy amplification to fill a decent-sized (read: American) room. Gold-plated multiway terminals enable bi-wiring; the pairs are connected by a couple of stout links for those who prefer single wiring.

The Severn 2 has silky-smooth midband behavior and convincing three-dimensionality.

Perhaps I went over the top by using the rather astonishing and costly Linn Sondek CD12 for my program source, but it was too irresistible. This CD player fed the remarkable Pathos Twin Towers integrated amplifier, Musical Fidelity's Nu-Vista pre-amp and Nu-Vista 300 power amp, or, for something closer in market position, the Myryad T-40 integrated amp.

My first impressions of the Severn 2 were of a classic British speaker with some tenuous link, wa-a-ay back in its DNA, to BBC designs of yore. You can tell that Castle is staffed by veterans of the Great British Speaker Wars, for the Severn 2 is first and foremost an exercise in silky-smooth midband behavior, with realistic vocal reproduction and convincing three-dimensionality. Particularly impressive—given that a generation of British speaker and amp manufacturers denied its existence—was hearing utterly realistic stage depth of the

When our DSP-A1 debuted last year, it wasn't only its distinctive amber gold finish that created an instant classic. Its proprietary Yamaha technology inspired reviewers to

hail it as their personal favorite—the best home theater integrated amplifier they'd ever heard.

This tour de force of power, versatility and Digital Sound Field Processing stunned critics and enthusiasts alike. Offering Dolby Digital and DTS processing, plus seven channels of spectacular sound. The DSP-A1's sonic impact set a new benchmark for the industry.

Now this coveted component has a perfectly matched companion.

Introducing the DVD-C900. A five-disc DVD changer that plays your DVD, Video CD or music CD titles with the same uncompromising standards, commanded by a multi-function remote and on-screen menus.

Sophisticated 10-bit video D/A conversion delivers pristine S-Video and Component Video output. And 96 kHz/24-bit compatible audio D/A conversion sets the stage for equally incredible sound. Whether it's internally decoded Dolby Digital or externally decoded DTS 5.1-channel audio. Or any

popular two-channel format.

See and hear the DVD-C900 at your Yamaha dealer. Once you've experienced it, we think you'll agree. There's never been a better time to invest in gold.



Also available in black to complement all traditional Yamaha home theater components.



WHERE HOME THEATER LIVES

ONE OF THE GREATEST
PERFORMERS IN HOME THEATER
HAS MET ITS MATCH.

www.yamaha.com

© 1999 Yamaha Electronics Corporation, USA. Dolby and Dolby Digital are trademarks of Dolby Laboratories Licensing Corporation. DTS Digital Surround is a registered trademark of DTS Technology. Yamaha Electronics Corporation, USA, P.O. Box 6660, Buena Park, CA 90622

TEST RESULTS

Although Castle recommends that the Severn 2s be placed well away from walls, the anechoic on-axis frequency response (Fig. 1) suggests that their low end would benefit from some judicious boundary reinforcement. If they are not placed reasonably close to a wall, they may sound a bit thin on some material. Above about 1 kHz, the response becomes rather ragged. The grille affects the treble response somewhat, but not to the extent of significantly altering its character.

Horizontal off-axis response (Fig. 2) tracks nicely out to almost 10 kHz, above which the rolloff at extreme angles becomes marked. This is typical behavior for a 1-inch dome tweeter. Also typically, the vertical off-axis responses (Fig. 3) are quite a bit messier, as a result of interaction between the drivers' outputs in the

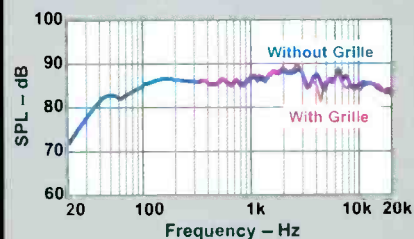

Fig. 1—On-axis frequency response.

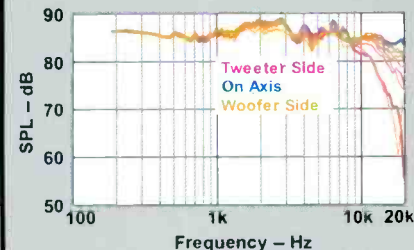

Fig. 2—Horizontal off-axis frequency responses.

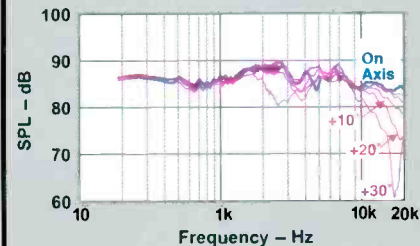

Fig. 3—Vertical off-axis frequency responses (above-axis shown).

vicinity of the crossover frequency. You can see the pronounced notching that appears between about 2 and 4 kHz at 30° above axis. (The discrepancies are slightly greater below axis, but the response is essentially symmetrical above and below axis, so only the former is shown.)

Distortion (Fig. 4) is consistent with what you'd expect from a relatively small woofer pushed pretty hard, as this one is at the 100-dB SPL level used for the measurement. Still, it doesn't really take off until below the port tuning frequency, as will happen with any reflex speaker.

The Severn 2's impedance characteristic (Fig. 5) is quite mild, dipping to a comfortable minimum of about 5 ohms just below 200 Hz. This loudspeaker should not be a demanding load for any competent amplifier.—*Michael Riggs*

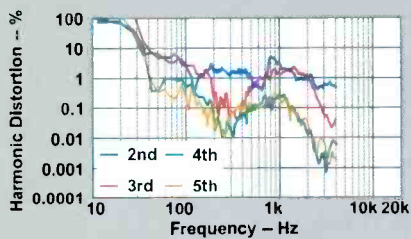

Fig. 4—Harmonic distortion vs. frequency, 100 dB SPL output.

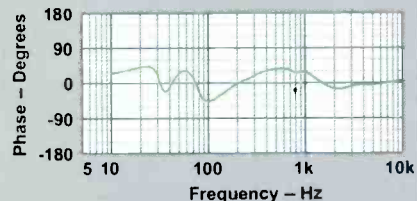
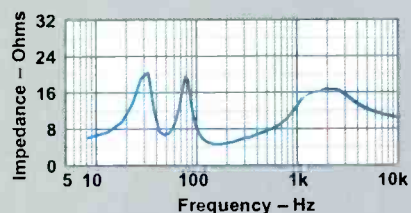

Fig. 5—Impedance magnitude(A) and phase (B).

sort one usually associates with large dipole speakers.

This is emphatically *not* a big speaker. But it certainly behaves like one, with two key qualities creating the illusion. The first is image size; height remains convincing even when you're standing, your ears way above the top of the speakers. Of course, the only way to judge the Severn 2s fairly is when you're sitting down, for they are designed to be at the ear height of someone sofa-bound. And it is there that you find the Severn 2 capable of filling the space in front of you. If you've been looking for something to torture with that Chesky test disc and its image height challenge, try the Severn 2s. These babies sound *big*. Their other blessed characteristic is what I can describe only as "sane" bass. The usual downfall of too many small monitors is the sleight-of-hand used to give the impression of more bass than the speakers are capable of reproducing. This Castle system appears to have no artificial bumps or humps. Its bass impresses because of quality, not quantity. Its low end is extended enough to suggest a large system, solid enough to avoid tubbiness and unwanted overhang, fast enough to cope with the transients of home theater, and clean enough to sound like the speaker is not working too hard to achieve what it does. What it will not do is pretend to be the ultimate hip-hop companion, so head-bangers should look elsewhere.

For the rest of us, including those with space or budget constraints, the Severn 2 is an object lesson in surpassed expectations. It does precisely what it should, belying its price without conning the listener. What you hear is what you get, and you will not feel cheated after weeks or months of listening. You will not discover any sonic trickery, any deception. You will not, for example, suffer listener fatigue because of an artificially extended high end that wasn't exposed during a short burst at your dealer. You will not discover to your horror that the bass is artificially enhanced. The Castle Severn 2 is a fundamentally honest speaker that just happens to look like it costs more than it does and to sound bigger than it is. It's like Goldilocks' reaction to the baby bear's porridge: not too hot, not too cold—just right.



REACHING BEYOND.

Again and again reviewers rate the performance of the PSB Stratus Series equal to that of loudspeakers many times their price - an out of this world value.

"The midrange was clean and uncolored, the stereo imaging well defined and stable, and the bass generous without being boomy.... This is one fine design.... The Goldⁱ is going to put a serious crimp in the sales of its more expensive competitors. Enthusiastically recommended."

John Atkinson, Stereophile, Vol.20 No.10



psb
SPEAKERS

888 772 0000
www.psbSpeakers.com

DVD

Music & Movies



Photos: Columbia (Courtesy Kobal)

THE ECTOPLASMATICS

Ghostbusters: Collector's Series 1984; PG rating; one-sided, dual-layer (2.35:1 aspect ratio); English Dolby Digital 5.1; English subtitles; includes storyboards, production photos, "live" video commentary by Ivan Reitman and Harold Ramis, conceptual drawings, cut scenes, 1999 featurette, trailers, SFX featurette, subtitled scene-specific production notes, and additional DVD-ROM features. COLUMBIA TRISTAR 04139, 107 minutes (feature run time), \$29.98

Ghostbusters II 1989; PG rating; two-sided (one side 2.35:1 aspect ratio, the other 1.33:1 pan-and-scan); English Dolby Digital 5.1; English and Spanish Dolby Digital two-channel matrix surround; Portuguese Dolby Digital mono; English, Spanish, Portuguese, Mandarin, Cantonese, Korean, and Thai subtitles; includes trailers. COLUMBIA TRISTAR 50169, 108 minutes (feature run time), \$29.98

Bill Murray and his fellow Ghostbusters are back "protecting"—and wreaking havoc on—New York. Only this time they're on DVD, first in a deluxe Collector's Series disc that has hours of extras to keep viewers thoroughly amused and interested. The story about onetime college investigators of the paranormal who form a ghostbusting squad when their university bounces them



out on the street is laced with humorous sight gags and expensive, spectacular special effects.

A second release, *Ghostbusters II*—gentler, longer on character development, and perhaps more interesting overall than the first—follows up with more adventures; it's one of the few sequels to unite almost the entire cast and production crew. But this DVD doesn't offer any extra features beyond biographies, production notes, and an amazing variety of subtitles.



The original film's disc, though, compensates with an abundance of them. Its menu is an elaborate overview of a city street. As you highlight and click a labeled function, the angles change and rotate to take you to a part of the street or a skyscraper that will then display the menu for the set of features chosen. It

takes a little getting used to. Cut scenes (a whopping 10 of them), for example, are located in the "Scene Cemetery." And when you choose "Tricks and Trivia" from the "Spook Central" menu, located atop the tallest skyscraper, you actually get a scene-specific, movie-length set of written production notes, shown as subtitles in the black space below the letterboxed film! The spoken scene-specific commentary is accessed at yet another site and also has unusual features. You can either hear writer/actor Harold Ramis, director Ivan Reitman, and associate producer Joe Medjuck discussing the movie or simultaneously hear them and see their silhouettes, à la *Mystery Science Theater 3000*. (If you try to operate this feature from the remote, you'll find that it's a function of the subtitle button, not an alternate video, as you might expect.) Not all features are available at all the larger menus. You have to hunt around, and with this release, that's all part of the fun.

The picture on both movies is clean and clear, if not as crisp and sharply etched as some other recent widescreen transfers. Color is outstanding, as is the Dolby Digital 5.1 remix. If you liked these movies, you'll love the DVDs.

Rad Bennett



GRAVEYARD SMASH

Frankenstein 1931; no rating; black-and-white; one-sided, dual-layer (1.33:1 aspect ratio); Dolby Digital two-channel mono; closed-captioned, French subtitles; includes reissue trailer, scene-specific commentary, photo gallery, and Universal short (Boo). UNIVERSAL 20325, 71 minutes feature run time, \$24.98

Universal's horror films are treasures to collectors and fans, so there has been much speculation as to how they would be handled for DVD release. This issue of *Frankenstein* is reassuring; these movies apparently are going to be treated like the classics they are. Fittingly, they will be part of a series called the Classic Monster Collection. By the time you read this, *The Mummy* (1932) and *The Bride of Frankenstein* (1935) should also be on the street.

Frankenstein has been issued as a dual-layer DVD for the highest possible video quality. And indeed, there are no artifacts in the feature, though some creep into the documentary footage. This is the best

Frankenstein has ever looked on home video, and all the censored sections have been restored. The audio has also been cleaned up quite a bit.

Among the extras is an original and interesting photo gallery that shows poster art and then goes into a still-photo montage of the whole movie, accompanied by appropriate soundtrack clips. (There's really no need to have a still-frame gallery when DVD enables every frame to be stopped.) Other extras are an excellent 45-minute documentary on the making of the movie and a period comedy short, *Boo*, that uses—or perhaps misuses—scenes from the movie in a contrived effort to produce laughs. And finally, there is Rudy Behlmer's terrific scene-specific commentary.

Thanks, Universal; the monster truly walks again!
R.B.



Hollywood thought to have ties to the Communist Party. It was impossible for anyone on that list to find work without using a pseudonym. Despite the list and opposition from Howard Hughes and the House Un-American Activities Committee, *Salt of the Earth* was produced in 1953 by blacklisted filmmakers Michael Wilson, Herbert Biberman, Paul Jarrico, and Will Geer. It was no easy task, as is pointed out so thoroughly in the fascinating production notes that accompany this DVD. The emotional movie itself, based on an actual New Mexico miner's strike, looks really good, with excellent definition and high contrast. In addition to the extensive notes and biographies, a short, clandestine period film, *The Hollywood Ten*, is included. It's an impressive package.
R.B.



Classic Albums: Fleetwood Mac—Rumours 1997; one-sided (1.33:1 aspect ratio); PCM stereo. RHINO R2 4465, 75 minutes, \$24.98

Classic Albums: Stevie Wonder—Songs in the Key of Life 1997; one-sided (1.33:1 aspect ratio); Dolby Digital two-channel stereo. RHINO R2 5663, 75 minutes, \$24.98

Here's a fresh idea for a rock music documentary: Select a classic album, conduct interviews with the artists, producers, and sound engineers, and mix these in with whatever historic footage might exist. The result is an in-depth look into the studio process, including mixing and song-selection decisions.

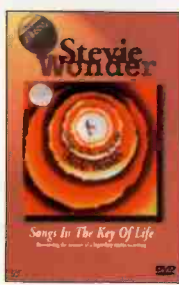

These two releases are quite different in feeling. Fleetwood Mac's *Rumours* was made under the worst of circumstances, when the band members' personal relationships were shattering, whereas the lyrical and upbeat Stevie Wonder set

Shostakovich: Lady Macbeth of Mtsensk 1992; no rating; one-sided (1.33:1 aspect ratio); Russian Dolby Digital two-channel stereo; English subtitles. CARLTON/IMAGE ID5655, 100 minutes, \$29.98

This DVD presents an opera film, as opposed to a filmed opera—a hybrid in which a movie is fashioned around a previously recorded soundtrack. Using a large portion of the 1990 EMI recording of *Lady Macbeth of Mtsensk*, which featured Galina Vishnevskaya and Nicolai Gedda, director Peter Weigl has fashioned a realistic, no-holds-barred film noir, with sexy young Marketa Hrubeyova playing the bored housewife and Michael Dlouhy as her aggressive lover. Freed of stage convention and unphotogenic singers, Weigl presents lots of nudity. The love scenes might have earned it an NC-17 rating had it been made in Hollywood instead of for European television. There's also a brutally realistic flogging.



The movie is effective, and the video quality is as good as I've seen. It's also the best-sounding opera on DVD, since the already excellent studio recording has been carefully transferred. On the debit side, the lip-synching, though skillfully done, is still noticeable at times. But the overall approach is engaging, and if you aren't bothered by steamy sex scenes with your arias, you'll probably find this production of *Lady Macbeth* quite engaging. There are also easy-to-read subtitles that you can turn on or off at will.
R.B.

Salt of the Earth 1953; no rating; black-and-white; one-sided (1.33:1 aspect ratio); Dolby Digital two-channel mono; includes short film (*The Hollywood Ten*), trailer, and extensive historical and production notes. PIONEER DVD1005, 95 minutes (feature run time), \$29.98

One early result of the Communist witch hunts in the late 1940s and '50s was the jailing of 10 of Hollywood's brightest talents, now known as the Hollywood Ten. This led to the blacklisting of anyone working in



SUPER AUDIO CD

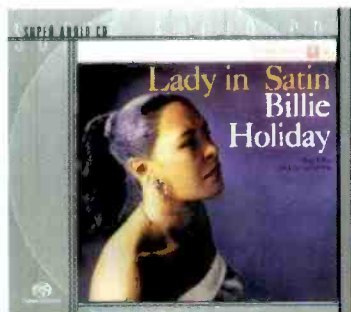

BILLIE HOLIDAY
Lady in Satin



DUKE ELLINGTON
Blues in Orbit



LOUIS ARMSTRONG
Armstrong Plays W.C. Handy



MONTY ALEXANDER
Stir It Up

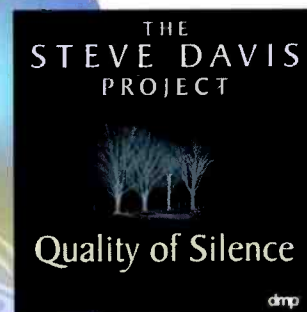

THE STEVE DAVIS PROJECT
Quality of Silence



ISAAC STERN
Mendelssohn, Tchaikovsky

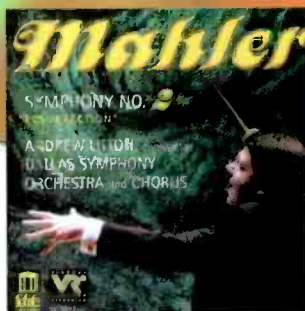

MAHLER
Symphony No. 2 "Resurrection"



IGOR STRAVINSKY
Firebird Suite and Rite of Spring



Because there's so Much More to
NOW AVAILABLE ON SUPER AUDIO

Hear.[™]
COMPACT DISC

To find out how much more there is to hear, visit select locations of
TOWER RECORDS/WOW • VIRGIN MEGASTORE • HMV
Call 1-800-222-SONY or visit www.sony.com/SACD/

SONY



© 1999 Sony Electronics Inc. All rights reserved. Reproduction in whole or in part without written permission is prohibited.
Sony, DSD, Direct Stream Digital, Super Audio CD, the DSD logo and the Super Audio CD logo are trademarks of Sony.

seems to have been made in a more happy frame of mind. The interviews support this observation; Fleetwood Mac's members seem cool, calculating, and deadly serious in discussing their memories, while the *Songs in the Key of Life* participants joke, kid around, and laugh a lot. The picture on each DVD is rock-steady, and the studio sound is quite good.

Future releases in this series will include Jimi Hendrix's *Electric Ladyland*, from Rhino, and *The Band* and Paul Simon's *Grace-*

land, from Image Entertainment. All will probably be on the shelves by press time.

Oh, I almost forgot. Rhino has placed a commercial at the beginning of the Wonder program, but its *Ode to Rhino* is such a gas, not many will mind. R.B.

The Last Starfighter: Collector's Edition 1984; PG-13 rating; one-sided, dual-layer (2.35:1 aspect ratio); Dolby Digital 5.1; English and French subtitles; includes scene-specific commentary and documentary

(Crossing the Frontier: The Making of the Last Starfighter), production stills and notes, and trailers. UNIVERSAL 20519, 101 minutes (feature run time), \$34.98

The Last Starfighter was the first movie to use computer-generated special effects throughout. Though released just 15 years ago, one must stand in awe of the rapid development of special effects since then. Still, it looks great, especially in this visually stunning new transfer done in the cor-

EURO STAR



THE MERCURY M1.

1998-99 EUROPEAN LOUDSPEAKER OF THE YEAR.

When audio magazine writers from 17 European countries voted on their Loudspeaker of the Year, Tannoy's Mercury M1 outshone the rest. In their words: 'True hi-fi performance is rarely so affordable'. Visit your local hi-fi specialist to judge the Mercury range for yourself.

TANNOY



Tannoy/TGI North America • 300 Gage Avenue, Unit 1 • Kitchener, Ontario, Canada • N2M 2C8
• 519 745 1158 • Fax: 519 745 2364 •

Web site: <http://www.tannoy.com>

THE WAR OF THE WORLDS

1953; no rating; one-sided (1.33:1 aspect ratio); English and French Dolby Digital mono; closed-captioned. PARAMOUNT HOME VIDEO 053-037, 85 minutes, \$29.98

This landmark science fiction movie was produced by George Pal, who spared neither imagination nor money in re-creating its many special effects. The still-awesome miniatures, which are quite preferable to some of the more recent digital effects I've seen, are sharper than ever on this new DVD. Paramount has a good print of this movie, and the various laserdisc versions have always looked excellent, but this disc is even sharper and the colors more stable and true. Contrast is better, too; you can really see what's going on in that darkened farmhouse, not to mention being able to freeze-frame and study that spooky Martian during its brief appearance. The sound is decent as well.



The musical score, by Leith Stevens (who is incorrectly identified on the DVD jacket as Stephens), has plenty of well-defined bass, and the sound effects have effective presence, if not the oomph and in-your-face qualities of the digital age. It's a genuine thrill to see this classic film come to life again. R.B.

rect aspect ratio. But one can also now view it, with reverence, as a pioneering effort. The plot is greatly enhanced by the effects, yet its strength rests in the simple story, its



human characters, and the good-guy aliens who seem human.

Alex, the film's teen hero, is locked into a nowhere existence at the Starbrite Starlite trailer park when he is given an opportunity to venture into space and become a starfighter. While traversing the galaxy, however, he realizes the true value of what was right under his nose back home. He comes back to get his girl and take her up to the stars with him.

This hi-tech movie depicts human emotions that all can relate to, hammered home by Craig Safan's sweet and noble music. This very good but nondefinitive edition includes a disappointingly dry commentary by director Nick Castle and production designer Ken Cobb. That is offset, however, by an informative, if short, documentary on the making of the film. What is most important are the movie itself and its superb transfer, which, in addition to the excellent video, contains an ideal 5.1 remix of the soundtrack. R.B.

family, followed by his music video "April Fools."

Other segments include a live performance from The Roots, which features a choice of four different video angles, and music videos by Natacha Atlas. The information is cool, but the menu is not; the introductory gimmicks before each section become an irritation when you want a quick search, and there is no way to skip them. Be prepared for commercials that pop up here and there, no doubt sold, as

with any magazine, to fund the pressing. Two of them, both for BMW, sport the best black-and-white video on any DVD. These will dazzle you so much you won't mind, but you might feel differently about a badly reproduced pitch for *The Shining*.

Although the retail price is low, you can get an even lower subscription rate if you contact *Circuit* at 888/DVD-MAGS or visit its Web site at www.quickband.com. *Circuit* is a great idea, reasonably well executed but with room for improvement. R.B.

Circuit, Vol. II 1999; color and black-and-white; one-sided (1.33:1 aspect ratio with some letterbox); Dolby Digital 5.1 and two-channel matrix surround. WARNER HOME VIDEO 36795, 117 minutes, \$14.98

This is volume two of *Circuit*, a DVD video magazine devoted to current pop music. It contains a healthy mix of interviews, live performances, and music videos. The performers covered are quite diverse. The two original members of XTC, Andy Partridge and Colin Moulding, discuss their new album while each gets a haircut; Sebadoh's Lou Barlow gives a tour of his house and discusses his guitars; Wilco's Jeff Tweedy talks about his new CD; and there's a major interview with Rufus Wainwright and his musical

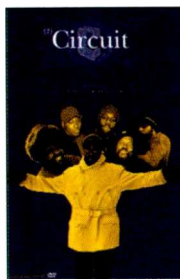

100% value

A supremely elegant, neat and complete, CD music system combining power, performance and style.

a classik by Linn®



LINN
the only sound®

J&R MUSIC WORLD®



WALK IN



PHONE IN



LOG IN

Park Row
NYC

800-221-8180
ANYTIME

www.jandr.com
AOL Keyword:

EXCITING NEW AMPLIFIER!

AudioSource



AudioSource Amp 5.3

250-Watt Monoblock Amp
•High current design •Fan cooled •All discreet output devices •Abundant headroom, while staying stable into loads as low as 2 ohms
•Balanced & unbalanced inputs

BONUS: BUY THREE MODEL 5.3 AMPLIFIERS & GET A FREE SERIES 5 CHASSIS (ASO AMP5.3)

\$249.99/each (ASO AMP5.3)

Receivers

harman kardon

Harman/Kardon AVR5
Audio/Video Receiver
•45w 2 or 35w x 5 •High current capability •Dolby Pro Logic •Dolby 3 Stereo •6-channel discrete inputs •30-AM/FM presets •Remote

\$249.99 (HK AVR5)

TEAC AG-360
•50 watts/channel, 24-AM/FM presets, LCD display **'99"**

Sony STR-DE135
•A/V, 100 watts/channel, 30-AM/FM presets, A/V remote **'149"**

Technics SA-AX530
•A/V, 80w x 2 or 80w x 5, Dolby Pro Logic Surround, Dolby 3 Stereo remote **'179"**

Aiwa AV-DV95
•A/V, 120w x 5, Dolby Digital & DTS decoders, 32-AM/FM presets, remote **'299"**

CD Players/Changers

JVC

JVC XL-MC222
200 Disc CD Changer
•Play exchange system allows 25 discs to be changed without stopping play •32-track programming •Jog shuttle •Remote

\$179.99 (JVC XL-MC222)

TEAC CD-P1120
•Single CD Player, 16-track programming, headphone jack with volume control, remote **'89"**

Aiwa XC-35M
•5-CD Changer, 20-track music calendar, optical digital output, remote **'129"**

Philips CDC7517
•5-CD Changer, CD-RW disc compatible, remote **'149"**

Dynaco CDV-PRO
•Single CD Player, HDCD, vacuum tube output stage, 20-track programming, remote **'499"**

Speakers

JBL

JBL CF100
Floorstanding Speakers
•3-way •10" cast-frame woofer
•4" cast-frame midrange
•Titanium laminate tweeter
•175 watts max, 8Ω •Black woodgrain

\$199.98/pr (JBL CF100)

JBL D38
•Bookshelf, 3-way, 8" woofer, 175 watts max, black **'99"**

Bose® 201™ Series IV
•Bookshelf, "Direct/Reflecting", 10-120 watts black or rosewood vinyl **'198"**

Cerwin-Vega E710
•Floorstanding, 3-way, 10" woofer, 200 watts max, black woodgrain **'359"**

JBL HLS820
•Floorstanding, 2-way, dual 8" woofers, horn with dome tweeter, 200 watts max, black pr. **'399"**

Digital Recorders

PHILIPS

Philips CDR765BK
Dual Deck CD Recorder
•Tray #1: records CD-recordable & CD-rewritable discs; playback •Tray #2: playback •2x speed recording •Remote

(PHI CDR765)

Call 1-800-221-8180

Sony MDS-JE530
•MiniDisc Recorder, records up to 74 minutes, jog dial, playback pitch control, remote **CALL**

Philips MD BUNDLE6
•MDS-1E330 Home MiniDisc Recorder + MZ-E33 Portable MiniDiscs: Player Package Special **CALL**

JVC XU-301
•3-CD Changer/MD Recorder, 3 independent CD trays, pitch control, Mixed CD/MD play **'299"**

Marantz CDR630
•CD Recorder, CD-R & CD-RW compatible, uses both professional & consumer discs **'849"**

DVD Players

TOSHIBA

Toshiba SD2109
DVD Player
•Plays DVD, video & audio CDs
•DTS & Dolby Digital compatible
•Composite/S-video outputs
•24/96 PCM audio compatible
•Picture zoom •Remote

(TOS SD2109)

\$259.99

Samsung DVD709
•Composite video & S-video output terminals, Dolby Digital/DTS compatible, remote **'229"**

Panasonic DVD-A120
•Component video out, output for DTS & Dolby Digital decoders, virtual surround sound **'279"**

Aiwa XD-VB300
•96kHz/24-bit Delta-Sigma audio D/A converter, DTS/Dolby Digital outputs **'299"**

Sony DVP-57700
•Dolby Digital & DTS outputs for external decoder, optical/coaxial digital outputs, remote **CALL**

Cassette Decks

TEAC

TEAC W-518R
Dual Cassette Deck
•Deck #1 features auto-reverse playback •Dolby B •High-speed dubbing •Continuous playback

(TEA W518R)

\$79.99

TEAC W-790R
•Dual auto-reverse, pitch control, full logic, Dolby B/C/HX-Pro **'149"**

JVC TD-W354BK
•Dual auto-reverse, pitch control, full logic, Dolby B/C/HX-Pro **CALL**

Technics RS-TR575
•Dual auto-reverse record & play, full logic, Dolby B/C/HX-Pro **'219"**

TEAC AD-500
•CD Player/Cassette Recorder Combo, cassette auto-reverse record/play & pitch control **'249"**

Hi-Fi Stereo VCRs

Panasonic

Panasonic PV-9450
Hi-Fi Stereo VHS VCR
•4 heads •Auto clock set with 24 hour backup •Auto daylight saving time •Universal Light Tower illuminated remote

(PAN PV9450)

\$129.99

Samsung VR8609
•4 heads, quick-start mechanism, auto fit recording, auto clock set, Y2K compliant, remote **'119"**

Sony SLV-679HF
•4 heads, auto clock set, VCR Plus+, Adaptive Picture Control II, remote **'149"**

JVC HR-S9600
•5-VHS, Digital Pure technology with 4MB frame memory, TimeScan & Pro-Slow, VCR Plus+ **CALL**

Portable CD Players

Panasonic

Panasonic SL-S265
Rechargeable Portable CD Player
•10-sec. Anti-Shock Memory II
•24-track programming
•Headphones, AC adaptor & rechargeable battery

(PAN SL-S265)

\$59.99

Aiwa XP-V70
•E.A.S.S. Plus 40-second electronic anti-shock memory, 24-track programming **'69"**

Sony D-E451 SILVER
•Super Electronic Shock Protection, 22-track programming, metallic silver, headphones **'79"**

Sony D-E565
•Rechargeable, Super ESP SteadySound Electronic Shock Protection, 22-track programming **'129"**

A/V Add-Ons

BELL'OGGETTI

BELL'OGGETTI BAS302C
Audio Tower
•Solid maple rack with 5 tempered glass shelves plus top
•Cherry finish •60" h x 27" w x 24" d

(BLG BAS302C)

\$649.99

Furniture Works 100AH
•Speaker Stands, adjustable height from 16" to 30", black metal **'54"**

One-For-All homeDirector™ 8
•Universal IR/RF Remote, works through walls for up to 8 components (CFA UKR8090) **'59"**

AudioSource EQ-11
•10-Band Graphic Equalizer, 10-bands/ch, LEDs on sliders, analyzer display **'99"**

For The Audiophile

harman kardon

65% OFF
at \$899.00

Harman/Kardon PA5800
5-Channel Home Theater Power Amp
•High-current design with 80 watts x 5 at 8 ohms; 110 watts x 5 at 4 ohms •All-discrete output circuitry

\$349.99 (HK PA5800)

Harman/Kardon PT2500
•A/V Tuner/Controller, 30-AM/FM presets, Dolby 3 stereo Mtr. Sug. Retail \$479 **'149"**

AudioSource PreAmp/Tuner Two
•AM/FM tuner with 18 station memory, 2 main outputs, phono & video inputs, remote **'349"**

Terk AMFMQ
•Powered Indoor Stereo AM/FM Antenna with selectable modes **'79"**

Sennheiser HD580/DSP
•Circumaural Headphones with Dolby Surround Sound System **'199"**

Mini Systems

JBL Harmony

JBL Harmony™
Compact Audio System
•Elegant system combines CD player, AM/FM tuner, 2-way speakers with powered woofer
•Dual alarm •Remote

(JBL HARMONY)

\$249.99

Aiwa NSX-A115
•25 watts/ch, 3-disc CD changer, dual cassette, EQ, 32-AM/FM presets, remote **'149"**

Sony MHC-RXD3
•50 watts/ch, 3-disc CD changer, dual cassette with auto-rev., 30-AM/FM presets, remote **'199"**

Panasonic SC-AK27
•70 watts/ch, 5-CD changer, dual auto-rev. cassette, 24-AM/FM presets, EQ, remote **'229"**

TEAC REF-100
•20 watts/ch, CD player, 30-AM/30-FM presets, timer, 2-way speakers, remote **'299"**

Classical

Renee Fleming Strauss Heroines

DEC 466314

\$11.99 CD

Yo-Yo Ma: Solo
COL 64114 CD **\$12.99**

Christine Schäfer:
Bach: Wedding Cantatas CD **\$11.99**
DG 459621

Boulez/Chicago Symphony:
Strauss: Also Sprach Zarathustra,
Mahler: Totenfeier CD **\$11.99**
DG 457649

Sarah Chang: Sweet Saraw
AHG 56791 CD **\$11.99**

Tilson Thomas/London Symphony:
Mahler: Symphony No. 7
RCA 63510 CD **\$12.99**

CALL TO ORDER MUSIC REVIEWED IN THIS ISSUE!

CALL US TOLL FREE FOR ITEMS NOT LISTED IN THIS AD

SE HABLE ESPANOL

SEND MONEY ORDER, CERTIFIED OR CASHIER'S CHECK, MASTERCARD, VISA, AMERICAN EXPRESS OR DISCOVER CARD (include Interbank No., expiration date & signature) To: J&R Music World, 59-50 Queens Midtown Expwy, Maspeth, Queens, NY 11378. Personal & business checks must clear our Authorization Center before processing. Shipping, handling & Insurance Charge (Continental US) is 5% of the total order with a \$4.95 minimum for orders up to \$500; 4% for orders over \$500 to \$1,000; 3% for orders over \$1,000 to \$1,500; 2% for orders over \$1,500 to \$2,000; 1% for orders over \$2,000. For heavyweight/over-sized items, shipment by air, or to Canada, Hawaii, Alaska, Virgin Islands & Puerto Rico please call for information. DO NOT SEND CASH. Sorry, no C.O.D.'s. NY residents please add sales tax. ORDERS SUBJECT TO VERIFICATION & ACCEPTANCE. NOT RESPONSIBLE FOR TYPOGRAPHICAL OR PICTORIAL ERRORS. ALL MERCHANDISE SHIPPED BRAND NEW, FACTORY FRESH & 100% GUARANTEED. Some quantities may be limited. Copyright 1999 J&R Music World
City of N.Y. Dept. of Consumer Affairs License Nos. 0900310/0900615/0900616/0900617

Order Code AU912



Visit **J&R MUSIC WORLD** on Park Row, NY, NY
Shop By Phone or to order a FREE
CATALOGUE •24 Hours A Day, 7 Days A Week
1-800-221-8180
www.jandr.com
AOL Keyword: J&R

CD

Recordings

Luther Allison

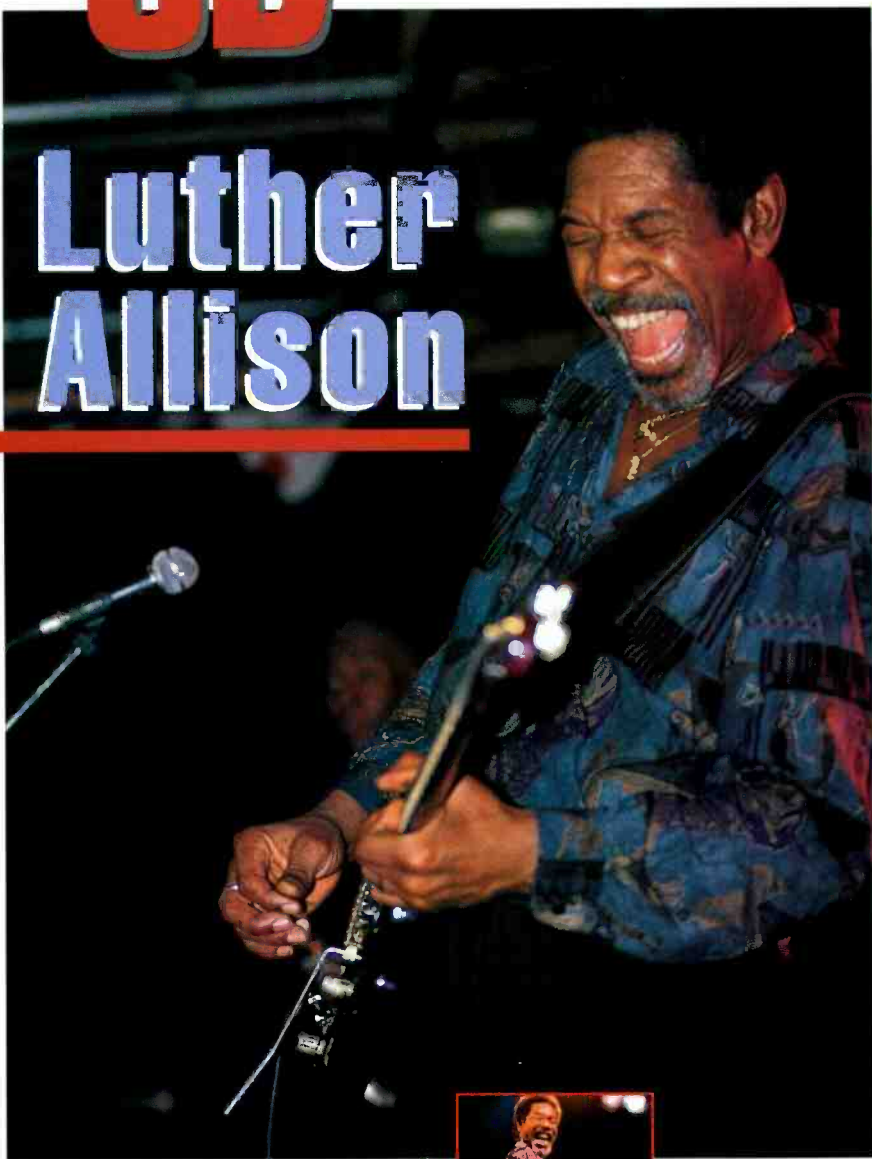

Photo: Fred Sevede

TREASURED SOUL

Live in Chicago

Luther Allison

ALLIGATOR ALCD 4869, two CDs, 2:11:41

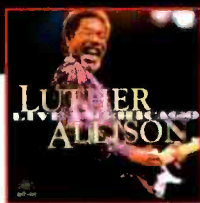

year, he swept the W.C. Handy Awards with five wins, including Entertainer of the Year. *Blues Revue* magazine even called him "the new king of the blues." At the apex of his career, Allison appeared unstoppable, at the top of the blues game, until cancer struck him down in August 1997.

Listening to *Live in Chicago*, an album recorded two years before his passing, makes Allison's death seem all the more regrettable. It's two solid discs of searing Stratocaster and soul-soaked singing, evoking

The release of 1994's *Soul Fixin' Man*, his first American album in seven years and following his emergence as a superstar in Europe, demonstrated that Luther Allison had matured into an impressive electric blues-rocker, and folks outside the blues community began to take notice. *Reckless*, his 1997 set, earned a Grammy nomination for Best Contempo-

rary Blues Album, and a flood of national exposure followed. That same year, he swept the W.C. Handy Awards with five wins, including Entertainer of the Year. *Blues Revue* magazine even called him "the new king of the blues." At the apex of his career, Allison appeared unstoppable, at the top of the blues game, until cancer struck him down in August 1997.

Listening to *Live in Chicago*, an album recorded two years before his passing, makes Allison's death seem all the more regrettable. It's two solid discs of searing Stratocaster and soul-soaked singing, evoking

ZYGOTE

John Popper

A&M 0694904082, 61:37

Change one element of anything as volatile as a band, and the whole thing becomes unstable. Blues Traveler now faces such upheaval, as its bassist, Bobby Sheehan, recently died at age 29. Now its remaining members must wrestle with the question: Do we disband, or do we continue?

Blues Traveler's future is made more complex by the release of lead singer John Popper's *Zygote*, an album that surpasses anything he ever did with the band. While retaining his status as pop music's preeminent harmonica player, Popper leaves room for listeners to appreciate his other instrument, one of the great rock voices of the '90s. He stretches from a plaintive tenor to a guttural roar reminiscent of Captain Beefheart, yet never to scabrous effect. Every note feels right.

And Popper's words are as succinct as his notes. "Growing in Dirt" has some remarkably poetic passages, while "Evil in My Chair" is a sinister riot. Popper takes us for a cruise downtown, with Evil flicking ashes and putting out cigarettes in his backseat: "He keeps the speed down low/But he don't like driving slow/He knows just where to go/He's always in the know/Evil's gonna drive you wild."

This album covers the musical waterfront, from the jammy, acoustic "His Own Ideas" to the frightening organ-grinder funk of "Miserable Bastard," from the chiming "Open Letter" to the flat-out rocking "Tip the Domino." The nastier the lyrics, the more adventurous the music. "Lunatic," a strange, twisted tune in a minor key, must have been hell to sing both lyrically and musically, but Popper handles it with aplomb. Conversely, "Fledgling" finds him passionately exploring the upper ends of his tenor, imbuing the song with enormous tenderness.

In the great jam-band tradition, all the songs have ample space for Popper and his group to stretch out. The amiably offhand recording adds to this effect. Little asides from the studio also augment the album's appealing rawness.

Quo vadis, Blues Traveler? That's up in the air now. But *Zygote* proves one thing: John Popper sounds just as good without them.

Hank Bordowitz



the West Side Chicago style of Magic Sam and Jimmy Dawkins. His playing burns with urgency and passion on horn-studded, Stax-inspired ballads (“Think with Your Heart”), affecting mid-tempo trots (“Walking Papers” and the stinging “Cherry Red Wine”), and white-hot rockers (“Soul Fixin’ Man” and the excellent slide-guitar celebration “Give Me Back My Wig”). At the same time, his gut-wrenching vocals on such tracks as “Big City” and “It Hurts Me Too” come from a deep-down source of classic blues pain.

It’s a fact that bluesmen get better with age; when Allison died at a young 58, we lost a legend in the making. On his way out he left us *Live in Chicago*, a coda to a tragically short blues career. *Bob Gulla*

Jason and the Argonauts, *Sinfonia of London*; Bruce Broughton, conductor
INTRADA MAF7083, 61:49

Hot dang! Bernard Herrmann was a great film composer, even compared to a dude like Erich Korngold. Film snobs think

Bernie did his best work for Welles or Hitchcock, but it was in the fantasy/sci-fi realm where he cut loose and left everyone else eating his stardust. *Jason* may be the best score of the bunch—it is certainly Herrmann’s

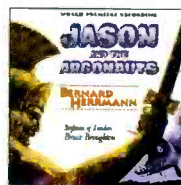

most neglected—and the nice folks at Intrada have done what should have been done 25 freakin’ years ago.

No sissy strings here, just brass and percussion. Bronze Age hairy-chest music. It growls, barks, groans, and shimmers—big-time. Music to fight harpies by? Yep. Music to fight sword-wielding skeletons by? Yep. You want Row L, Seat 1 at Royce Hall sound? Forget it. This is a mike-down-the-throat-or-up-the-nose-of-every-instrument, fix-it-in-the-mix recording. It works for me. Metalheads reading this by mistake, listen up: Herrmann wrote ruder music than Black Sabbath. *Mal Alcalá*

Stars Forever, *Momus*

LE GRAND MAGISTERY 61665-60010
Two CDs, 2:09:31

Maybe he should open an old Fotomat booth and call it “Songs To Go.” Nicholas Currie, a.k.a. Momus, financed his latest recording by offering to write “portraits” of anyone who sent him \$1,000. Within two weeks, he had received commissions to write 30 songs, and several months later came the two-disc *Stars Forever*. This set is packed with songs named for the people who underwrote the project, among them “Steven Zeeland” (this song’s a homoerotic thriller not fit for young children), “Natsuko Tayama,” and “Brent Busboom”—all recorded in Momus’s inimitable space-keyboard style, with hummable melodies as sneakily catchy as TV theme songs. These appear alongside the eight winners of Momus’s Karaoke Parody Contest: His last album, *The Little Red Songbook*, included instrumental versions of his songs so fans could submit their own renditions.

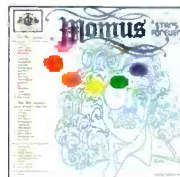

In lesser hands, all this gimmickry would likely have failed. But *Stars Forever* stands as another example of Momus’s prodigious talents. He has been weaving intricate tales,

Easy Chair Registration

The world of consumer technologies starts at www.CESweb.org.
Register online, connect with exhibitors, set up your personal show planner,
download floor plans and get up to speed on conference sessions.
And you can do it wherever and whenever you want to.

January 6-9, 2000
Las Vegas, Nevada USA
Register now!
Visit www.CESweb.org

furniture by Decorators Walk

2000 International
CES

Your Source for Workstyle
and Lifestyle Technology™

rewriting the Bible and the Marquis de Sade with equal ease, for more than a decade. And it's about time the world took notice of this sly genius. *Rob O'Connor*

Slap-Happy, L7

WAX TADPOLE/

BONG LOAD BL43, 38:49

Diamonds in the Belly of the Dog

Other Star People

A&M 06949-0384, 37:20

The debate over style versus substance is as old as the hills and as hotly argued as the "tastes great/less filling" feud. Some modern rock bands have something to say and search desperately for a musical way to express it. On the other hand, most new bands, in a desperate quest for radio airplay, have found style but not substance, going skin-deep and no further.

L7 and Other Star People are on opposite sides of this philosophy, and their albums get opposite results because of it. Other Star People, which features former L7 girl Jennifer Finch, falls on the wrong side with its debut album. The problem is

there are no substantial songs here for producer Roy Thomas Baker (Queen, Devo, The Cars) to work with. Most amount to stitched-together swatches of style: cutesy harmonies, punk-pop riffs, and a thump-thud rhythm section. Baker's heavy-handed production drapes a glittering blanket



over everything, from the fa-la-la vocals to the crisp-but-bland guitar work, making the record sparkle with a blinding sheen. "The Half of You I Love," with its dual-guitar tracks, strings, power chords, and synths, ends up a gooey mess. "California Shine" and the Toni Basil-meets-Loverboy "Go To" are so flimsy that they end up all frosting and no cake. Occasionally something memorable slips in, such as the opening passage of "Oceanway Sunday," but it's diluted by generic frills and unnecessary textures.

The L7 record, on the other hand, has problems on the opposite end: The group's

got plenty to say but struggles to find interesting ways to say it. The former quartet, now a trio after Finch's departure, loves the distorted power chord, but instrumental limitations hold it back. *Slap-Happy*, L7's fifth album, starts out promisingly with the anvil-heavy "Crackpot Baby" and the seething "On My Rockin' Machine," while the clever "Little One" and the edgy "Mantra Down" salvage the end of the recording. But this group's musical well runs dry a little too soon. Then again, it's better to have had a well half full than no well at all. *Bob Gulla*

Hours. . . , *David Bowie*

VIRGIN 7243 8 48157 0 7, 47:03

David Bowie, a.k.a. the Thin White Duke, a.k.a. that guy in the dress on *Saturday Night Live*, has always been one step ahead of the pop star game. From seminal glam rock to brooding '70s work to 1997's groundbreaking jungle album, *Earthling*, he has consistently positioned himself as



VANDERSTEEN AUDIO Model 5

A Timeless Masterpiece!

In loudspeaker design, state-of-the-art is never static; it is inevitable that the best of tomorrow will surpass the best of today. In the deep bass, state-of-the-art is seldom realized; even in the best rooms, every placement is a compromise.

The **VANDERSTEEN Model 5** is the only loudspeaker with adjustable, active multi-band low-frequency room compensation for perfect bass in every room. It is the only fully modular loudspeaker, completely upgradable in your home using just a phillips screwdriver and soldering pencil. The **Model 5s** are built to be the best today and engineered to be the best tomorrow.

Call, write, or visit us on the web for complete information and the name of your nearest carefully selected Model 5 dealer. www.vandersteen.com

DIMENSIONAL PURITY®

116 West Fourth Street, Hanford, CA 93230 (559)582-0324

In Canada, call Justice Audio (905) 780-0079



FREE DJ & PRO AUDIO CATALOG!

THE PRO AUDIO / DJ AND STAGE LIGHTING CATALOG

PRO SOUND
AND STAGE LIGHTING
Est. 1977



1-888-247-6300

ORDER ONLINE!
Visit Our Website: www.pssl.com

The #1 Choice of DJs Since 1976!

The Pro Sound & Stage Lighting catalog is jam packed with all the hottest products. Huge selection of pro audio, DJ gear, recording, keyboards, groove gear, software, lighting effects, books & videos, cases, cables, hard-to-find accessories, mics and much more!

- ◆ Compare Thousands Of Top Name Brand Products Side-By-Side!
- ◆ 45-Day Price Protection!
- ◆ 45-Day Trial Exchange!
- ◆ 95% Of All Orders Shipped Same Day!
- ◆ 136 Page Color Catalog!

CALL TODAY FOR YOUR FREE COPY!

1-888-247-6300

Outside the U.S.A. 1-714-891-5914

Mon.- Fri. 6am - 10pm
Sat. & Sun. 8am - 5pm (PST)

Online Catalog - www.pssl.com

Fax Toll Free 1-888-PSSL-FAX (777-5329)

PRO SOUND
AND STAGE LIGHTING

The Pro Audio / DJ And Stage Lighting Catalog

11070 Valley View Street, Cypress, CA 90630
Since 1976

savant and seer, trendsetter and trendmonger. Until now.

Hours... finds Bowie in an unusually reflective mood. Dramatic and deliberate, the album sketches a bittersweet memoir. He may be acting a role, as in albums past, but some lyrics are so heartfelt it's difficult to believe they're totally fiction. "Where's the morning in my life? Who says time is on my side?" he croons in the memorable acoustic "Survive." Other tunes have a vague familiarity. "The Pretty Things Are Going to Hell" recalls Tin Machine, and "What's Really Happening?" is a queasy Ziggy Stardust.

"New Angels of Promise" and "The Dreamers" close the album on an audacious note. Even as an aging Bowie gets misty (proclaiming himself "the last of the dreamers"), he can't resist slipping into the future.

Ken Micallef

Hoochie Coochie Man, Muddy Waters
JUST A MEMORY JAM 9142, 60:32

Ah, yes, if you like your Muddy Waters blues stripped-down raw, this live set from 1977 will get you goin'. We're talkin' monobasic with nasty distortion, but it puts you right up front in the Rising Sun, a small club in Montreal, as Waters tosses out just another one-nighter. He was 62 years old but still dangerous and inspired by songs he'd played most of his life. Here he rips off a mean, compact slide solo on "Highway 41," gets a little jazzy on "They Call It Stormy Monday," and then rolls out an amazingly tasty 11-minute version of "Kansas City."



Waters' band includes Pinetop Perkins on piano, Calvin Jones on bass, Willie "Big Eyes" Smith on drums, Jerry Portnoy on harp, and Luther "Guitar Junior" Johnson and Bob Margolin on guitars. Their fluency and rock-steady support give Waters everything he needs.

Steve Guttenberg

Brand New Day, Sting
A&M 0694904432, 48:49

Tantric sexpert Sting returns with music that reflects his learned pop-star-of-the-world image. The former Police bassist has always pattered with styles—jazz, country, reggae, even show tunes. But *Brand New*

NAT KING COLE

Live from the Circle Room
CAPITOL JAZZ 7243 5 21859, 49:19

Reissues of classic recordings flood the bins, but seldom are we treated to new releases by classic artists. Considering the vast studio discography of Nat King Cole, it is particularly eventful that this live recording—a 1946 club date broadcast from the Hotel LaSalle in Milwaukee—has now appeared. Half a century later, we're treated to telling documentation of Cole's classic trio, which included guitarist Oscar Moore and bassist Johnny Miller.

The repertoire, including up-tempo instrumentals "I Found a New Baby" and "Sweet Georgia Brown," showcases Cole's



pro prowess on the piano, unfortunately downplayed as he gained stardom as a singer. The vocals range from the now-standard "I'm in the Mood for

Love" to the short-lived, hip jargon of "My Sugar Is So Refined." Though Cole was just 26 at the time, his voice rings clearly over this well-recorded set of superbly arranged, polished ensemble work.

James Rozzi

Day is his most organic, ethnic-influenced album ever. Accompanied by simmering hand percussion, glowing acoustic guitars, and gurgling keyboards, he sings resplendently of universal love and transvestite hookers and manages to make an analogy between lustful women and gas tanks.

In the hypnotic "A Thousand Years," Sting murmurs poetic lyrics over a haunting synth melody. Bossa-nova rhythms give "Big Lie Small World" a warm halo effect, matched by dreamy strings, droll lyrics, and Sting's burnished voice. "Desert Rose" and "After the Rain Has Fallen" use the sounds of Algerian Rai music, while hip-hop fills



"Perfect Love. . .Gone Wrong." The country two-step "Fill Her Up" (with James Taylor) transforms peeling guitars and guffaws into a

blazing drum and keyboard blowout. The title track, which sounds like a Stevie Wonder tribute (complete with the R&B legend himself on harmonica), contains verses that are very similar to his classic "I Was Made To Love." Sting, too, is a lover and a scholar, sexpert notwithstanding.

Ken Micallef

AUDIO

ANNUAL INDEX

SUBJECT
INDEX**AC POWER & ELECTRICAL NOISE**

Dedicated Listening Room Power, Anthony H. Cordesman, Jan., 87.

Spectrum (reducing wasted power), Ivan Berger, March, 15.

Spectrum (Tributaries GroundGuard hum suppressor), Ivan Berger, March, 15.

The Ultimate Cable Upgrade: An Obsessive's Guide, Ken Kessler, Dec., 30.

ACOUSTICS

Bass vs. Space: Room Acoustics and Good Sound, David J. Weinberg and Howard W. Ferstler, July/August, 28.

AMPLIFIERS

Spectrum (testing amplifiers), Ivan Berger, Feb., 18.

The Audio Interview: Bob Carver of Sunfire, Ivan Berger, Feb., 40.

Spectrum (Kenwood K-Stat output transistors), Ivan Berger, March, 15.

Mondo Audio (classic component reissues), Ken Kessler, July/August, 23.

CABLES & CONNECTORS

Spectrum (Tributaries GroundGuard hum suppressor), Ivan Berger, March, 16.

The Ultimate Cable Upgrade: An Obsessive's Guide, Ken Kessler, Dec., 30.

CAR STEREO

Spectrum (surround sound in cars), Ivan Berger, June, 21.

COMPUTERS & AUDIO

Convergence Gets Convincing: The Synergy of Home Theater and Home Computing, Ivan Berger, May, 39.

MP3: What Does It Really Sound Like?, Corey Greenberg, June, 30.

Spectrum (computer speakers), Ivan Berger, Dec., 21.

CONSTRUCTION PROJECTS

Monster Bass: Do-It-Yourself Subwoofers, Tom Nousaine, Jan., 36.

DVD

Spectrum (James Taylor live on DVD), Alan Lofft, Jan., 22.

Fast Fore-Word (DVD-Audio update), Michael Riggs, May, 4.

Spectrum (DVD recorders), Ivan Berger, June, 23.

DVD-Audio Gets the Green Light, Edward J. Foster, Sept., 30.

DIGITAL TECHNOLOGY & TECHNIQUES

Front Row (DSP and home studio recording), Corey Greenberg, Jan., 33.

Fast Fore-Word (digital recording and frequency response), Michael Riggs, Feb., 6.

Front Row (the art of remastering), Corey Greenberg, Feb., 27.

Home Recording for the Digital Millennium, Daniel Kumin, Feb., 32.

Spectrum (IEEE-1394 bus), Ivan Berger, May, 19.

Spectrum (IEEE-1394 vs. USB 2.0), Ivan Berger, July/August, 21.

DVD-Audio Gets the Green Light, Edward J. Foster, Sept., 30.

Super Audio CD: Evolutionary or Revolutionary?, Edward J. Foster, Nov., 40.

DIRECTORY

Annual Equipment Directory, October Introduction, 29; CD & DVD Players, 32; D/A Converters, 48; Amplifiers, 52; Pre-amplifiers, 80; Tuners, 100; Receivers, 102; Turntables, 106; Tonearms, 108; Phono

Cartridges, 109; Headphones, 114; Cassette Decks, 118; Digital Player/Recorders, 120; Equalizers, 123; Surround Sound & Ambience Processors, 124; Signal Processors, 130; Crossovers, 132; Speaker Cables, 134; Loudspeakers, 146; Company Addresses, 260.

EMERGING TECHNOLOGIES

Fast Fore-Word (Parametric Acoustic Modeling speaker design), Michael Riggs, March, 6.

Spectrum (blue lasers), Ivan Berger, April, 19.

Deep Thoughts on Shallow Speakers, Ivan Berger, April, 37.

Spectrum (IEEE-1394 bus), Ivan Berger, May, 19.

Convergence Gets Convincing: The Synergy of Home Theater and Home Computing, Ivan Berger, May, 39.

Spectrum (IEEE-1394 vs. USB 2.0), Ivan Berger, July/August, 21.

Spectrum (songs by cellular), Ivan Berger, Sept., 29.

Spectrum (new microphone designs), Ben P. Stein, Nov., 27.

EQUIPMENT REVIEWS

ADA Cinema Reference A/V Preamp, July/August, 45.

Acurus DIA 150 Integrated Amplifier, Sept., 36.

Adcom GCD-750 CD Player, March, 66.

Anthem MCA 5 Five-Channel Power Amplifier, Sept., 101.

Arcam Alpha 9 CD Player, April, 59.

Arcam Alpha 9C Preamplifier, July/August, 64.

AudioControl C-101SE Equalizer/Analyzer, June, 48.

Audio Refinement Complete Integrated Amplifier, April, 55.

B&W Nautilus 802 Speaker, Feb., 51.

US UNCLE'S STEREO

**You Want It
We've Got It!**

Audio

The lowest prices and best selection on Tuners, Amps, CD Players, Speakers, Turn Tables. You name it!



Video

Need a TV, VCR, or DVD Player? How about a Combination TV/VCR? No problem. And we ship anywhere.



Home Theater

Need help keeping up with the latest technology? Let our Home Theater pros help you design the system of your dreams - from as little as \$500.



Accessories

Looking for those little extras that really round out a system? We've got everything from Remote Controls, to Cables, to Headphones, Telephones, Blank Recording Media...



& Much More!

800-978-6253

www.unclestereo.com
info@unclestereo.com

IT'S EASY TO ORDER!

Call Toll-Free, Fax, or E-Mail Your Order.
Or Send Your Personal Check to Order by Mail. International Orders Are Welcome.



Visit Our Retail Store!

216 W 72ND ST.
NEW YORK, NY 10023
212-721-7500 FAX 212-721-7587

Store Hours: M-F 10-8 Sat 10:30-7:30 Sun 11-5:30

Some Restrictions Apply. Mail Order: M-F 10-12AM Sat 10:30-7:30 Sun 11-5:30

NYC Consumer Affairs LIC.# 0904418

Member BETTER BUSINESS BUREAU

ANNUAL INDEX

B&W WP1 Indoor/Outdoor Speaker ("Play-Back"), July/August, 88.
B&W DM605 S2 Speaker, Sept., 41.
Bag End MM-8H Satellites and Infrabass-18 Powered Subwoofer, Jan., 59.
Blaupunkt Alaska Car CD Receiver, May, 63.
Bryston 9B-ST Five-Channel Power Amplifier, June, 58.
Cambridge SoundWorks Model 88 Table Radio ("PlayBack"), Jan., 108.
Cambridge SoundWorks Desktop Theater 5.1 ("PlayBack"), March, 88.
Castle Severn 2 Speaker, Dec., 91.
Cinepro Professional PowerPro 20 Line Conditioner, Jan., 86.
Coincident Speaker Technology Triumph Signature Speaker, July/August, 51.
conrad-johnson Premier 12 Mono Amplifier and Premier 16LS Preamplifier, June, 63.
Creek 4330SE Integrated Amplifier, Feb., 77.
DeHavilland Aries SE Mono Amplifier ("PlayBack"), April, 88.
Denon AVR-3300 A/V Receiver, Nov., 76.
Dunlavy Audio Labs SC-V Speaker, March, 69.
E.A.R. V20 Tube Integrated Amplifier, Jan., 71.
Eminent Technology LFT-11 Computer Sub/Sat System ("PlayBack"), May, 88.
Fostex CR-200 CD Recorder ("PlayBack"), March, 88.
Grado Labs Reference Phono Cartridge ("PlayBack"), April, 88.
Grado Reference RA-1 Headphone Amplifier, Nov., 82.
Hales Design Group Transcendence Eight Speaker, July/August, 68.
Harman/Microsoft Take Control Remote ("Front Row"), March, 23.
Hsu Research VTF-2 Powered Subwoofer, Nov., 59.
JMLab Cobalt 820 Speaker, March, 49.
Jolida JD 301A Integrated Amplifier ("Play-Back"), May, 88.
Kenwood VR-2090 A/V Receiver, Feb., 59.
Krell KPS 25s CD Player/Preamp, Jan., 79.
Krell KAV-300r Receiver, Sept., 71.
Legacy Audio Studio Speaker ("PlayBack"), June, 88.
Mark Levinson No. 360S D/A Converter, June, 66.
Lexicon MC-1 A/V Preamp, Sept., 63.

Lexicon DC-2 A/V Preamp, Dec., 79.
Linn Genki CD Player, Dec., 53.
MSB Technology Link D/A Converter, Feb., 75.
MSB Technology Digital Director Jitter Reducer ("PlayBack"), July/August, 88.
Mackie HR824 Powered Speaker, Sept., 86.
Marantz DR700 CD Recorder, Jan., 51.
Marantz RC2000 Mk. II Remote ("Front Row"), March, 23.
Marantz PM-17 Integrated Amplifier, Sept., 82 (*Addendum*, Nov., 13).
Meridian 557 Amplifier, March, 57.
Meridian M33 Powered Satellites and M-1500 Powered Subwoofer, Sept., 76.
Meridian 561 Surround Preamp, Nov., 49.
Mirage OM-8 Speaker, July/August, 55.
Mirage MRM-1 Speaker, Nov., 105.
Mission 774 Speaker, July/August, 40.
Monster Cable M1000sv S-Video Interconnect ("PlayBack"), June, 88.
Musical Fidelity X-A200 Mono Amplifier, Jan., 83.
Musical Fidelity X-Ray CD Player ("Play-Back"), Feb., 96.
Myryad T-40 Integrated Amplifier, June, 70.
NAD S200 Amplifier and S100 Preamplifier, July/August, 35.
NAD C340 Integrated Amplifier, Dec., 73.
NHTPro A-20 Speaker System, Nov., 91.
Neutrik Minirator MR1 Portable Audio Generator ("PlayBack"), Feb., 96.
Onkyo Phantom Cinema Virtual Surround System ("PlayBack"), April, 88.
PSB Stratus Silver¹ Speaker, Dec., 61.
Paradigm Atom Speaker ("Front Row"), April, 27.
Pass Laboratories D1 D/A Converter ("PlayBack"), Feb., 96.
Pass Laboratories X600 Mono Amplifier, July/August, 59.
Philips DVD855AT DVD Player, April, 49.
Philips Pronto Remote Control ("Play-Back"), June, 88.
Platinum Audio Studio 2 Speaker, May, 58.
Polk Audio RT5000 Multichannel Speaker System, April, 68.
Polk Audio Signature Reference Surround Speaker ("PlayBack"), July/August, 88.
Polk Audio RMDS-1 Home Theater System, Dec., 45.
Proceed AVP A/V Preamp and AMP 5 Five-Channel Amp, April, 64.
Quicksilver Audio Silver 60 Mono Amplifier, Feb., 69.

ANNUAL INDEX

Rotel RP-955 Turntable ("PlayBack"), Jan., 108.

Rotel RSX-965 A/V Receiver, Sept., 94.

Ruark Acoustics Log-Rhythm Powered Subwoofer, Nov., 111.

Sharp MD-R3 MD Recorder/CD Changer ("PlayBack"), May, 88.

Snell Acoustics XA 90ps Speaker, June, 42.

Sonic Foundry Acoustic Mirror Recording Software ("Front Row"), May, 27.

Sony MDM-X4 Mk II Four-Track MiniDisc Recorder ("PlayBack"), Jan., 108.

Sony TA-E9000ES A/V Preamp, March, 40.

Sony DVP-S7700 DVD Player, June, 34.

Sony SCD-1 Super Audio CD Player, Nov., 65.

TacT Audio Millennium Digital Amplifier, June, 52.

Tannoy Churchill Speaker, March, 63.

Tannoy R1 Speaker, May, 73.

Theta Digital Jade CD Transport, May, 70.

Theta Digital DaViD DVD Transport and Voyager DVD/Laserdisc Transport, Nov., 98.

Theta Digital Casa Nova Surround Preamp, Dec., 37.

Thule Audio Spirit CD100 CD Player, Nov., 85.

Toshiba SD-9000 DVD Player, Sept., 50.

Vandersteen 2Ce Signature Speaker, Sept., 56.

Vienna Acoustics Mahler Speaker, Dec., 67.

Westlake Audio Surround Speaker System, July/August, 62.

Whise Profunder 320 Subwoofer, Sept., 106.

Wyetech Topaz 211A Single-Ended Tube Amplifier ("PlayBack"), March, 88 (*Addendum*, May, 8).

Yamaha RX-V2095 A/V Receiver, May, 43.

HEADPHONES

Spectrum (Sony MDR-DS5000 Virtual Dolby Digital headphones), Ivan Berger, Oct., 24.

HOME STUDIO

Front Row (DSP and home studio recording), Corey Greenberg, Jan., 33.

Home Recording for the Digital Millennium, Daniel Kumin, Feb., 32.

HOME THEATER & SURROUND SOUND

Spectrum (Tributaries GroundGuard hum suppressor), Ivan Berger, March, 16.

The Audio Interview: Laurie Fincham of THX, David Lander, March, 34.

Spectrum (Dolby and THX introduce Surround EX), Len Schneider, April, 17.

The Magic of Film Sound, Ian G. Masters, May, 30.

Convergence Gets Convincing: The Synergy of Home Theater and Home Computing, Ivan Berger, May, 39.

Currents (10-channel surround sound), John Eargle, June, 25.

Spectrum (Sony Virtual Dolby Digital headphones), Ivan Berger, Oct., 24.

INTERNET

Audio Site-Seeing on the Web, Gordon Brockhouse, March, 28.

MP3: What Does It Really Sound Like?, Corey Greenberg, June, 30.

Spectrum (copy protection for downloading music), Ivan Berger, July/August, 19.

Spectrum (copy protection for downloading music), Ivan Berger, Sept., 25.

Spectrum (copy protection for downloading music), Ivan Berger, Oct., 21.

INTERVIEWS

Ivor Tiefenbrun of Linn Products, Steve Guttenberg, Jan., 42.

Bob Carver of Sunfire, Ivan Berger, Feb., 40.

Laurie Fincham of THX, David Lander, March, 34.

Jerry VanderMarel, Bill VanderMarel, and Scott Bagby of Paradigm, David Lander, April, 42.

LISTENING & LISTENING ROOMS

Fast Fore-Word (blind vs. open listening tests), Michael Riggs, April, 6.

Point/Counterpoint: Objective vs. Subjective Evaluation, Steve Guttenberg and Mark Block, April, 30.

The Ultimate Cable Upgrade: An Obsessive's Guide, Ken Kessler, Dec., 30.

LOUDSPEAKERS

Monster Bass: Do-It-Yourself Subwoofers, Tom Nousaine, Jan., 36.

Fast Fore-Word (Parametric Acoustic Modeling), Michael Riggs, March, 6.

Deep Thoughts on Shallow Speakers, Ivan Berger, April, 37.

The Audio Interview: Jerry VanderMarel, Bill VanderMarel, and Scott Bagby of Paradigm, David Lander, April, 42.

SHOP SMART ONLINE!

INTERNET Authorized DEALER

SONY Velodyne
Technics ONKYO
NILES audioquest

JVC
Harman
harman/kardon

Hafler
ALL

OR TOLL FREE! 1-800-542-7283

SOUNDCITY.COM is one of the country's leading full-service dealers of high performance Audio, Video, Mobile Electronics and Home Theater systems, SOUNDCITY.COM has unmatched selection, service and expertise.



Mondo Audio (classic component reissues), Ken Kessler, July/August, 23.
Bass vs. Space: Room Acoustics and Good Sound, David J. Weinberg and Howard W. Ferstler, July/August, 28.
Speaker Dispersion, Edward J. Foster, July/August, 57.
Spectrum (computer speakers), Ivan Berger, Dec., 21.
Speaker Design Master Class: Lessons from PSB's Paul Barton, David Lander, Dec., 24.

MEASUREMENT TECHNIQUES

Spectrum (testing amplifiers), Ivan Berger, Feb., 18.
Spectrum (testing FM tuner quieting), Ivan Berger, March, 17.
Speaker Design Master Class: Lessons from PSB's Paul Barton, David Lander, Dec., 24.

MULTICHANNEL AUDIO

Spectrum (James Taylor live on DVD), Alan Lofft, Jan., 22.
Currents (10-channel surround sound), John Eargle, June, 25.
DVD-Audio Gets the Green Light, Edward J. Foster, Sept., 30.
Super Audio CD: Evolutionary or Revolutionary?, Edward J. Foster, Nov., 40.

MUSIC PERFORMANCE & RECORDING

Spectrum (James Taylor live on DVD), Alan Lofft, Jan., 22.

OBITUARY

Jon R. Sank, Jan., 24.

PSYCHOACOUSTICS

Fast Fore-Word (blind vs. open listening tests), Michael Riggs, April, 6.
Point/Counterpoint: Objective vs. Subjective Evaluation, Steve Guttenberg and Mark Block, April, 30.
Currents (10-channel surround sound), John Eargle, June, 25.

RECORDING

Fast Fore-Word (digital recording and frequency response), Michael Riggs, Feb., 6.
Home Recording for the Digital Millennium, Daniel Kumin, Feb., 32.
Spectrum (DVD recorders), Ivan Berger, June, 23.
Spectrum (copy protection for downloading music), Ivan Berger, July/August, 19.

Spectrum (copy protection for downloading music), Ivan Berger, Sept., 25.
Spectrum (copy protection for downloading music), Ivan Berger, Oct., 21.

REISSUED RECORDINGS

Front Row (the art of remastering), Corey Greenberg, Feb., 27.
Mondo Audio (audiophile CDs), Ken Kessler, May, 23.

SHOWS & CONFERENCES

Mondo Audio (TOP Audio show in Milan), Ken Kessler, Jan., 26.

TUNERS

Spectrum (testing FM tuner quieting), Ivan Berger, March, 17.

AUTHOR INDEX

Berger, Ivan, *Spectrum* (testing amplifiers), Feb., 18; *The Audio Interview: Bob Carver of Sunfire*, Feb., 40; *Spectrum* (reducing wasted power), March, 15; *Spectrum* (Kenwood K-Stat output transistors), March, 15; *Spectrum* (Tributaries GroundGuard hum suppressor), March, 16; *Spectrum* (testing FM tuner quieting), March, 17; *Spectrum* (blue lasers), April, 19; *Deep Thoughts on Shallow Speakers*, April, 37; *Spectrum* (IEEE-1394 bus), May, 19; *Convergence Gets Convincing: The Synergy of Home Theater and Home Computing*, May, 39; *Spectrum* (surround sound in cars), June, 21; *Spectrum* (DVD recorders), June, 23; *Spectrum* (copy protection for downloading music), July/August, 19; *Spectrum* (IEEE-1394 vs. USB 2.0), July/August, 21; *Spectrum* (copy protection for downloading music), Sept., 25; *Spectrum* (songs by cellular), Sept., 29; *Spectrum* (copy protection for downloading music), Oct., 21; *Spectrum* (Sony MDR-DS5000 Virtual Dolby Digital headphones), Oct., 24; *Spectrum* (computer speakers), Dec., 21.
 Block, Mark and Steve Guttenberg, *Point/Counterpoint: Objective vs. Subjective Evaluation*, April, 30.
 Brockhouse, Gordon, *Audio Site-Seeing on the Web*, March, 28.

Cordesman, Anthony H., *Dedicated Listening Room Power*, Jan., 87.
 Eargle, John, *Currents* (10-channel surround sound), June, 25.
 Ferstler, Howard W. and David J. Weinberg, *Bass vs. Space: Room Acoustics and Good Sound*, July/August, 28.
 Foster, Edward J., *Speaker Dispersion*, July/August, 57; *DVD-Audio Gets the Green Light*, Sept., 30; *Super Audio CD: Evolutionary or Revolutionary?*, Nov., 40.
 Greenberg, Corey, *Front Row* (DSP and home studio recording), Jan., 33; *Front Row* (the art of remastering), Feb., 27; *MP3: What Does It Really Sound Like?*, June, 30.
 Guttenberg, Steve, *The Audio Interview: Ivor Tiefenbrun of Linn Products*, Jan., 42; with Mark Block, *Point/Counterpoint: Objective vs. Subjective Evaluation*, April, 30.
 Kessler, Ken, *Mondo Audio* (TOP Audio show in Milan), Jan., 26; *Mondo Audio* (audiophile CDs), May, 23; *Mondo Audio* (classic component reissues), July/August, 23; *The Ultimate Cable Upgrade: An Obsessive's Guide*, Dec., 30.
 Kumin, Daniel, *Home Recording for the Digital Millennium*, Feb., 32.
 Lander, David, *The Audio Interview: Laurie Fincham of THX*, March, 34; *The Audio Interview: Jerry VanderMarel, Bill VanderMarel, and Scott Bagby of Paradigm*, April, 42; *Speaker Design Master Class: Lessons from PSB's Paul Barton*, Dec., 24.
 Lofft, Alan, *Spectrum* (James Taylor live on DVD), Jan., 22.
 Masters, Ian G., *The Magic of Film Sound*, May, 30.
 Nousaine, Tom, *Monster Bass: Do-It-Yourself Subwoofers*, Jan., 36.
 Riggs, Michael, *Fast Fore-Word* (digital recording and frequency response), Feb., 6; *Fast Fore-Word* (Parametric Acoustic Modeling speaker design), March, 6; *Fast Fore-Word* (blind vs. open listening tests), April, 6; *Fast Fore-Word* (DVD-Audio update), May, 4.
 Schneider, Len, *Spectrum* (Dolby and THX introduce Surround EX), April, 17.
 Stein, Ben P., *Spectrum* (new microphone designs), Nov., 27.
 Weinberg, David J. and Howard W. Ferstler, *Bass vs. Space: Room Acoustics and Good Sound*, July/August, 28.

NEW SERIES B
 MODULAR HARDWOOD
 CABINET SYSTEM



PROVIDES UNLIMITED STORAGE
 FOR CDS, DVDS, VIDEOS, LPs,
 LASERDISCS, CASSETTES & COMPONENTS.

DOESN'T YOUR COLLECTION DESERVE THE BEST?
 FIND OUT JUST HOW AFFORDABLE TOP QUALITY IS.
 REQUEST INFO KIT 1 & GET ALL THE FACTS...

CALL: 800-432-8005
 FAX: 973-667-8688
 E-MAIL: SORICEAV@AOL.COM

SORICÉ
 PO BOX 747-1A, NUTLEY, NJ 07110
 HTTP://WWW.SORICE.COM



solve your
 storage
 problems
 now!

Modular, stackable,
 CD/DVD Drawers,
 Tape Drawers,
 Disc Cabinets,
 Component Racks
 and more

www.rackittm.com
 Free mail order brochure
 (please mention Audio)

Per Madsen Design
 PO Box 882464, San Francisco, CA 94188
 Call (800) 821-1883 or visit www.rackittm.com

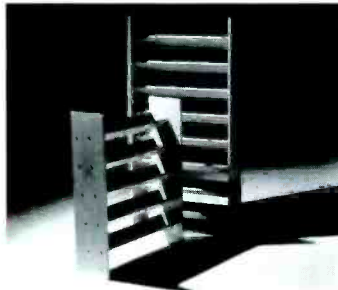

STORADISC™. See why CD Review picked our Library Series as their "top choice". Fine furniture quality in a variety of finishes and sizes. Call or write DAVIDSON - WHITEHALL, 290 Martin Luther King Jr. Dr., SE, Suite A-5, Atlanta, GA 30312. 1-800-848-9811.

PRO-STANDS™
 DESIGNED BY *Billy Bags*

ANY SIZE ANY PLACE

▼ #PRO-34 (Twin Towers) Audio Racks

THE NEW #8248 LP Storage Rack

#6650 LP Audio Rack

#PRO-1000 Holds 1000 CDs/DVDs or Tapes

THE NEW #LPD/DVD Storage Rack

NEW Computer Furniture

▲ NEW TRI #PRO-6 Audio Rack TRI #PRO-1 AMP Stands

▲ #PRO-44 TV Component Table

4147-A Transport St. Ventura, CA 93003

#PRO-60 Entertainment Center

805/644-2185
 Contact us today for a copy of our detailed newsletter
THE NEW BAGS REPORT #IX
 For your local dealer visit
www.billybags.com

FOR ADVERTISING INFORMATION CALL 1-800-445-6066 9AM-5PM EST

CD STORAGE CONNECTION



This configuration holds 2700 CDs

Infinite Capacity

* Imagine 270 CDs, 120 DVDs or 60 videos, per drawer. Imagine modular media cabinets you can't outgrow. Go ahead, design your own media center.

* Give us a call for a free catalog or visit our website for details.

CAN-AM
 1-800-387-9790

www.cd cabinet.com

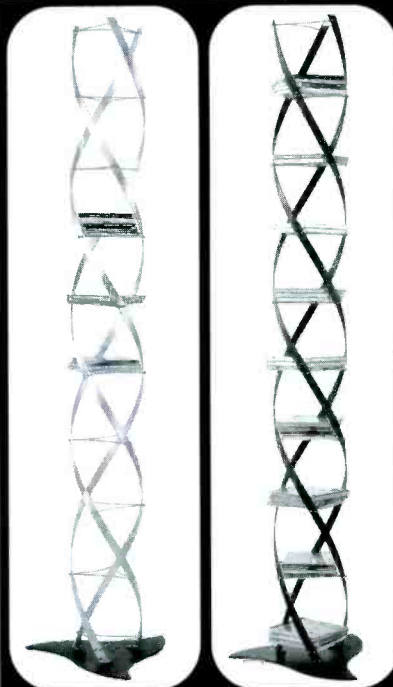
at last, an elegant solution
www.brmdesign.com
 800-639-1868
 130 cds
 or, inquire at your high-end audio store

BRM Design & Metalworks
 180 Flynn Avenue
 Burlington, Vermont 05401

FOR ADVERTISING INFORMATION, CALL 1-800-445-6066, 9AM-5PM EST

the CUBE
The Ultimate STORAGE CABINET
by Lorentz Design

Featuring our patented ALLSTOP STORAGE SYSTEM, no wasted space. Full-extension drawer slides. Made from high quality oak veneers and hardwoods. 23"H x 19 1/2"W x 17 1/2"D. Ships fully assembled. Stackable.

Stores 306 CD's or any combination of CD's, DVD's, CD-ROM's, HiFi's, Cassettes, etc.

MasterCard VISA

Call **800-933-0403** or visit www.lorentzdesign.com to order or for a free, color brochure detailing all our disc, tape & component storage CUBES. LDI, Inc. • P.O. Box 277 • Lanesboro, MN 55949 • Fax: 507-467-2468

To place a classified ad in the industry leading titles of **Hachette Filipacchi Magazines, Inc.**, simply call Toll-Free and reserve your space today!
1-800-445-6066 (9am-5pm EST)
Fax: 212-767-5624

Audio-Video & Home Theater Furniture

Celebrating Our 10th Year!

www.StudioTech.com

We also offer name brand components, speakers and accessories at great prices!

Check out our web-site and quality to win a Free DVD player!

Call today to receive a catalog 800-887-8834, or check out our website!

Component Storage +

Combo 3R

- + Quick, no tool assembly.
- + Solid steel support system.
- + 15 standard models.
- + Custom units available.
- + Flexible shelf spacing.
- + Solid oak, walnut, cherry or black MDF shelves.

Combo 4R

Combo 8R

Get your free information kit today!

SORICÉ PO Box 747-71
Nutley, NJ 07110
Call: 800-432-8005 Fax: 201-667-8688
e-mail: soriceav@aol.com

The **AUDIO CD STORAGE CONNECTION**

puts manufacturers of CD storage units in touch with the ideal audience... CD purchasers unsurpassed in size, buying activity & the need for storage of their ever-growing CD collections!

For advertising information call:
1-800-445-6066
(Monday-Friday, 9-5 EST)
or Fax 212-767-5624

DEALER SHOWCASE

GEORGIA

Audible Illusions
Audio Research
Mark Levinson
Theta Digital
Pass Labs
Proceed

Revel
Aerial
ProAc
Avalon
Paradigm
Paradigm Reference

Sound and Cinema
5576 Chamblee Dunwoody Rd.
Dunwoody, Georgia 30338
(770)804-8977
<http://www.soundandcinema.net>

VPI
Grado
Graham
Tara Labs
Benz-Micro
McCormack
Kimber Kable
Magnum Dynalab

Pioneer Elite
Faroudja
Marantz
Lexicon
Aragon
Acurus
Denon
ATI

GEORGIA

High Performance Audio & Video

Audio Forest

www.audioforest.com

Uniquely Qualified..Experienced..Professional
Informative..Friendly..Serviceable
No Sub-Contractors..Interface-able..
Installation..Up-Gradeable..Design

WIRED FOR THE FUTURE!

6900 Peachtree Ind. Blvd Atlanta, Ga. 30360-2339
Telephony 770.729.0550 Tariff Free 800.488.9672
Facsimile 770.447.8478
Email Chip@audioforest.com

ILLINOIS

Abt
Est. 1936

For Much More
Visit Our Website @ www.abtelectronics.com

1998
Better Business Bureau
Winner for
Marketplace Ethics

ADA
BOSE
CANTON
INFINITY
JMLAB
JVC
KENWOOD
LEXICON
MB QUART
MIRAGE
MITSUBISHI
M&K
ONKYO
PANASONIC
PARAOUND
PROSCAN
SONY ES
SONANCE
TOSHIBA
UNITY MOTION

1-888-228-5800
MORTON GROVE, IL.

DEALER SHOWCASE

IOWA

hawkeye audio video

www.hawkeyeaudio.com

Acurus	Lovan
Anthem	Marantz
Arcam	Mitsubishi
ATI	Niles
Audioquest	Nordost
B & K	Paradigm
Balanced Audio Tech.	Paradigm Ref
Black Diamond Racing	Rega
Chang Lightspeed	Rogue Audio
Creek	Sumiko
Definitive Technology	Tara Labs
Grado	Teac
JM Lab	Vantage Pt
JoLida	Yamaha

(319) 337-4878

401 S. Gilbert St. Iowa City, IA 52240
6322 University Ave. Cedar Falls, IA 50613

MASSACHUSETTS

The Best Values In Hi End Hi-Fi.

audio studio

Authorized sales and service for:
Audible Illusions, Audioquest, B&K, Beyerdynamic, Counterpoint, Dual, Klyne, Maplenoll, Marantz, Mirage, Mission, Monster Cable, Morel, NAD, Nakamichi, Oideion Products, Ortofon, Project, Proton, QUAD, Renaissance Audio, Revox, Sennheiser, SME, Shure, Stax, Straight Wire, Sumiko, Thorens, Velodyne, VPI, and many more.

414 Harvard St., Brookline, MA 02446

(617) 277-0111

FAX (617) 277-2415

www.theaudiostudio.com

INTERNATIONAL BUSINESS ACCEPTED

NEW YORK

AUDIO VIDEO CREATIONS

"HOOKED ON SONICS"

AMPRO	MITSUBISHI
ANGSTROM	NHT
ANTHEM	NILES
APOGEE	ONKYO
BASIS	PIONEER ELITE
B&K	PSB
BELL'OGGETTI	SONANCE
CONRAD JOHNSON	SONY
DWIN	SONIC FRONTIERS
FAROUDJA	STRAIGHTWIRE
HARMON/KARDON	STEWART
JBL	SUNFIRE
KRELL	TRANSPARENT
MARTIN-LOGAN	TRIAD
MAGNUM DYNALAB	VPI
MIRAGE	XLO

AND MORE:

999 NORTHERN BLVD.
MANHASSET, NY 11030

Phone 516-365-4434 • Fax 516-365-6285

OHIO

...AND THE OTHER
HALF WENT INTO
THE TUITION FUND.



Superbly performing products.
Sensibly priced.

ARCHIVE AUDIO

Columbus, Ohio
614-237-5699

Copland • EDGE • Monarchy • ROGUE • MSB • Totem
Meadowlark • Stanley • Mordaunt Short • Audio Magic
Music Metre • Chang • T.G. Audio • Creek • Jamo
Harmonic Technology • Reference 3A
Audio Refinement • Audio Specialiste
WISDOM AUDIO - THE ADRENALINE

WISCONSIN

the Happy Medium

www.HappyMedium.com

• ARCHITECTURAL AUDIO	• FIELD RECORDERS
• DAT	• DSS
• MINIDISC	• SONY DST
• WORLD BAND RADIO	• CUSTOM INSTALLATION
• PRO WALKMAN	• HOME THEATER
• CABLES	• ACCESSORIES

• a/d/s/l	• NAKAMICHI
• AMC	• NILES AUDIO
• CARVER	• ONKYO
• GRADO	• PANAMAX
• HARMAN KARDON	• PSB SPEAKERS
• JAMO	• SANUS SYSTEMS
• JVC	• SHERWOOD NEWCASTLE
• KEF	• SUNFIRE
• LEXICON	• SONY ES
• MONSTER CABLE	• TARGET
• NAD	• THORENS

430 State Street • Madison, WI 53703 • FAX 1(608) 255-4425

1-800-906 HI-FI (4434)

TEXAS

AUDIO BY DESIGN

PROUDLY REPRESENTING
THE FOLLOWING MANUFACTURERS!

Acurus	Jolida
Aerial Acoustics	Kimber
Alon	Meadowlark
Alpha-Core	Niles
Anthem	Paradigm
Aragon	Rega
AudioQuest	Synergistics
Bryston	Sonic Frontiers
CAL Audio	Stand Design
CLASSE Audio	Velodyne
Creek	Von Schweikert
Denon	VPI
Enlightened Audio Design	Wharfedale
Epos	

FACTORY AUTHORIZED
3-DAY FEDEX SHIPPING

(512) 458-1746

911 W. Anderson Ln. #116
Austin, TX 78757

VIRGINIA

The people

Alcantara • Audio Note • B&K • Billy Bags • Aloia •

with the

Cardas • Chiro • DH Labs • Dunlavy •

best sound

Audio Tekne • Grado • Joule Electra • Kharmo • Kora •

systems in

Lamm • Magnan • Magnum/OCM • Hakro •

the world

Metronome • MIT • Plinius • Quad • Roksan •

listen to

Arcam • Spendor • TAG (Technik Avant Garde) • Orade •

Steve Davis.

VansEvens • dcs (Edgar & Purcell) • VPI • & Others

Why? Because he listens to them. Gets to know them. Learns their musical tastes, their priorities, their budgets. So when Steve makes recommendations, his customers trust his advice. They know they're getting the best equipment for their needs. Sound good? You bet it does. And your system will, too. Just listen to Steve.

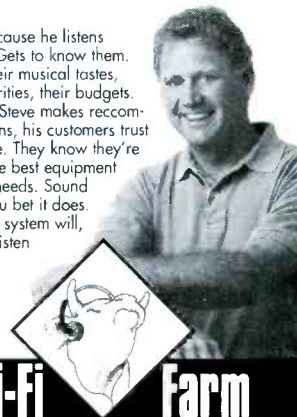

Hi-Fi Farm

New & Used Audio Since 1978

800-752-4018 or 540-721-4434 ext. 108 • www.hifiform.com

AUDIO's Dealer Showcase is the easiest way for you to locate a specialty retailer in your area that can meet your high-end audio needs.

These experienced high-end dealers are ready to help with everything from equipment purchasing decisions to setting up your home theater.

Look to the **AUDIO** "Dealer Showcase" for the best in high-end audio dealers!

AUDIO

THE
EQUIPMENT
AUTHORITY

CLASSIFIED ADVERTISING

PLEASE NOTE: It is impossible for us to verify all of the claims of advertisers, including product availability and existence of warranties. To confirm that an advertiser is authorized to sell a product, we suggest you contact the manufacturer directly. Please review our *Tips for Mail Order Purchasers* in this section.

FOR SALE

RADAR CITY

SAVE BIG IN THE CITY!
SHOP ONLINE!
www.radarcity.com

Receivers • CD Players • MiniDisc • DVDs
Mini Systems • Car Stereo • Subwoofers • Speakers
Radar Detectors • Scanners • Telephones

1-800-419-2323
3550 Lawson Blvd. • Oceanside, NY 11572

AUDIO CONNECTION NEW JERSEY'S BEST SELECTION

- Vandersteen
- B and W
- Proac
- Kimber Cable
- Cardas
- Rotel
- Sonic Frontiers
- Audible Illusions
- AudioQuest
- Quicksilver
- Wadia
- Cary
- Arcam
- Briston
- Ayre

* No mailorder: B&W, Rotel

615 Bloomfield Avenue, Verona New Jersey 07044
Phone (973) 239-1799 • Fax: (973) 239-1725
<http://www.audioconnect.com>

USED & DEMO HIGH-END & HOME THEATER EQUIPMENT AT UNBELIEVABLE SAVINGS! CALL OR E-MAIL OR FAX FOR FREE CATALOG ---- VOICE/FAX: 609-799-9664. WWW.SavantAudio.com E-MAIL: Savant@SavantAudio.com

SATURDAY AUDIO EXCHANGE—Chicago's source for discontinued, demo, used & new home audio equipment for 17 years. For information call 773-935-U-S-E-D or see our online catalog at <http://saturdayaudio.com>

2A3 TRIODE HIGH QUALITY STEREO SYSTEM, Totally Rebuilt & Updated \$6500.00. Owner / Designer retiring nursing home. Send \$5.00 for brochure: H.L. Hemken, 183 Glover Avenue, Chula Vista, CA 91910.

FREE SHIPPING!

FRIENDLY ADVICE! MIRAGE, KEF, PARASOUND, KINERGETICS, NAD, AUDIOQUEST, KIMBER, STRAIGHTWIRE, MORE!! READ BROTHERS, 593 KING, CHARLESTON, SC 29403. (843) 723-7276. RBS@charleston.net www.readbrothers.com

FOR SALE

Order early for great holiday savings!

abstereo.com

Call 1-800-354-1324

FAX ORDERS:
732-294-7480

sales@abstereo.com

CUSTOMER SERVICE:
732-780-6600

RECEIVERS



RX-V7950	CALL
RX-V2095	dots
STR-DE935	449
AVR2800	CALL
AVP3300	dots
AVRS700	CALL
RX1028VBK	CALL
AV10	999
AV8	CALL

SEPARATES

AMC	CALL
AUDIOSOURCE	dots
B & K	dots
PARASOUND	dots
REVOX	dots
MANY MORE	CALL

SUBWOOFERS

BU-120	INFINITY	224
S112HO	ACOUSTIC RESEARCH	299
KSW-15	KLIPSCH	CALL
BIG BOOM 10	OMAGE	349
SP200mkII	SIGNET	699
SP100mkII		CALL

SPEAKERS

PINNACLE



Top Rated in
Consumer
Magazine

AC400	KLIPSCH	159
QUINTET	INFINITY	CALL
OVERTURE	PSB	CALL
STRATUS GOLD	CALL	NEW
STRATUS MINI	SOLILOQUY	CALL
All Models	KLH	499
HTA-1000 SYSTEM		

DVD PLAYERS



SD2109	TOSHIBA	249
XV-DS11	JVC	299
DVP-SS30	SONY	329
DVD-A120	PANASONIC	279

CD PLAYERS

DCA370	DENON	CALL
CD675	HDCD	239
XL-HC334	YAMAHA	200 DISC
	JVC	

BIG SCREEN TV

HITACHI	AUTHORIZED DEALER
TOSHIBA	AUTHORIZED DEALER
SONY	CALL
MITSUBISHI	CALL
SAMSUNG	CALL
JVC	AUTHORIZED DEALER

IF IT'S NOT LISTED, CALL FOR GREAT PRICE!

Visit our close-out page on internet, abstereo.com

5 YEAR WARRANTIES AVAILABLE ON ALL PRODUCTS

All products are new USA merchandise covered by the manufacturers warranty or ABC's exclusive limited warranty.

abstereo.com

3440 ROUTE 9 • FREEHOLD, NJ 07728

American Theater Systems



Look No Further!

EXTRAORDINARY THEATER SYSTEMS...
UNBELIEVABLE PRICE...
DESIGN TO INSTALL...
NO ONE DOES IT BETTER!

- ACCUSONIC • ADCOM • ADS • AMPRO • AR • ATLANTIC TECH • ATI • BIC • B&K • CELESTION • CINEPRO • CITATION
- DENON • DWIN • ELITE • ENERGY • FAROUDJA • HITACHI • H/K
- INFINITY • JAMO • JOLIDA • JVC • KEF • KENWOOD • KLIPSCH
- LEXICON • MARANTZ • MIRAGE • MISSION • MITSUBISHI • M&K • NAD
- NAK • NHT • NILES • ONKYO • PANAMAX • PIONEER • RUNCO • SHARPVISION • SONNANCE • SONY ES • TOSHIBA
- TRIAD • VELODYNE • VMPS • VIDIKRON • YAMAHA • XLO • AND MANY MORE!!

1-800-889-5845

Visit our web site

www.amsound.com

- Professionally designed theater rooms
- Front projection/HDTV experts
- Reference high-end audio
- 22 yrs. experience
- LOW PRICE GUARANTEE

TRUTH, JUSTICE & THE AMERICAN WAY!

STEVE'S CONSIGNMENT

SHOP HI-FI FARM AND STEVE'S AUDIO ADVICE NOW OFFERS CONSIGNMENT OPPORTUNITIES FOR THE USED AUDIO MARKET. TOP DOLLAR OFFERED. CALL FOR INFORMATION. NEW EQUIPMENT ALSO. CALL 1-800-752-4018.

usedcable.com

The online, used cable clearing house. Buy, sell, trade.

FOR SALE

Wholesale Connection



www.wholesaleconnection.com

- A/R
- AIWA
- B.I.C.
- CANON
- COBRA
- HARMON/KARDON
- INFINITY
- JBL
- JVC
- KENWOOD
- ONKYO
- PANASONIC
- PIONEER
- SHARP
- SONY TAPE
- TECHNICS
- TOSHIBA
- ...AND MORE!!

We Are Your Ultimate Source
For Home Theater Entertainment!

Call Us Now! 1-800-226-2800

1-800-226-2800



24-Hour Fax: (516) 564-9593
P.O.'s Welcome! • We Ship FedEx

Call For Brands & Models Not Listed
361 Charles St. • West Hempstead, NY 11552

AUTHORIZED ELECTRONICS

NEW WORLD AUDIO



- | | | |
|--|---|--|
| ADS
ALPINE
ATL TECH
BOSE
CARVER
DENON
HK
INFINITY | KENWOOD
KLIPSCH
LEXICON
MB QUART
MARANTZ
M&K
NILES
ONKYO | PARASOUND
PIONEER ELITE
SONANCE
SONY ES
SUNFIRE
VELODYNE
YAMAHA
AND MANY MORE |
|--|---|--|

DON'T SEE IT?
CALL US
WE CAN GET IT!

Celebrating Over 100 Years
ALL ITEMS ARE
BRAND NEW!

FACTORY SEALED EQUIPMENT
ITEMS COME WITH MANUFACTURER'S OR OWNER'S EXCLUSIVE WARRANTY!

(800) 311-0392

ALL ITEMS COVERED BY 14 DAY DEFECT EXCHANGE POLICY.
SEE WEBSITE FOR FULL DETAILS.

VISIT US ON THE WEB

WWW.NEWWORLDAUDIO.COM

Buy-Sell-Trade

All brands of
High End Audio Since 1979

AUDIO CLASSICS

-Limited-

FREE condensed catalog!

8AM-5PM ET Monday-Friday

Phone/Fax

607-766-3501

www.audioclassics.com

3501 Old Vestal Rd.

Vestal, NY 13850

FAMOUS JAPANESE NAME BRAND ELECTRONICS WORLDWIDE SHIPPING & INSURANCE Since: 1967 RAMSONS CORPORATION (JAPAN) LTD. EMAIL: info@ramsons.co.jp WEBSITE: WWW.ramsons.co.jp TEL: 81-6-6271-6185-7 FAX: 81-6-6271-6183

ATTENTION: S.A.E.—G.A.S.—SUMO OWNERS! Original designer is now offering a Modernization Program. Why pay today's megabuck prices? Consider the alternative. JAMES BONGIORNO: (805) 963-1122. sstinc@earthlink.net

RECORDS

HALF MILE VINYL. Large Inventory Quality Preowned LP's cleaned and graded. Send SASE for catalog to Box 98, East Wareham, MA 02538. Call 508-295-2508.

KAB ELECTRO-ACOUSTICS
Preserve + Enhance + Restore™

"Serving The Record Collector and Sound Enthusiast!" FREE CATALOG • 908-754-1479 • www.KABusa.com • P.O. Box 2922 • Plainfield • NJ 07062-0922 Visa/MC/AmEx.

TIPS FOR MAIL ORDER PURCHASERS

It is impossible for us to verify all of the claims of advertisers, including product availability and existence of warranties. Therefore, the following information is provided for your protection.

1. Confirm price and merchandise information with the seller, including brand, model, color or finish, accessories and rebates included in the price.
2. Understand the seller's return and refund-policy, including the allowable return period, who pays the postage for returned merchandise, and whether there is any "restocking" charge.
3. Understand the product's warranty. Is there a manufacturer's warranty, and if so, is it from a U.S. or foreign manufacturer? Note that many manufacturers assert that, even if the product comes with a U.S. manufacturer's warranty card, if you purchase from an unauthorized dealer, you are not covered by the manufacturer's warranty. If in doubt, contact the manufacturer directly. In addition to, or instead of, the manufacturer's warranty, the seller may offer its own warranty. In either case, what is covered by warranty, how long is the warranty period, where will the product be serviced, what do you have to do, and will the product be repaired or replaced? You may want to receive a copy of the written warranty before placing your order.
4. Keep a copy of all transactions, including cancelled checks, receipts and correspondence. If you pay by credit card, you may have a greater recourse in the event the advertiser does not perform. (Check the complaint procedures of your credit card companies). For phone orders, make a note of the order including merchandise ordered, price, order date, expected delivery date and salesperson's name.
5. If the merchandise is not shipped within the promised time or if no time was promised, 30 days of receipt of the order, you generally have the right to cancel the order and get a refund.
6. Merchandise substitution without your express prior consent is not allowed.
7. If you have a problem with your order or the merchandise, write a letter to the seller with all the pertinent information and keep a copy.
8. If you are unable to obtain satisfaction from the seller, contact the consumer protection agency in the seller's state or your local Post Office.

If, after following the above guidelines, you experience a problem with a mail order advertiser that you are unable to resolve, please let us know. WRITE to Susan Ross, Special Marketing, 45th floor, Hachette Filipacchi Magazines, 1633 Broadway, NY, NY 10019. Be sure to include copies of all correspondence.

CABLE TV

CABLE TV DESCRAMBLERS/CONVERTERS
LOWEST PRICES AROUND. 30 DAY MONEY
BACK GUARANTEE. 1 YEAR WARRANTY.
HIGHEST QUALITY EQUIPMENT. CALL
1-800-785-1145

CABLE DESCRAMBLER KIT. Only \$14.95!
(SATELLITE: \$19.95). Gets ALL the channels!
Why pay hundreds more? 24 hour info:
1-800-752-1389.

TRADE YOUR CABLE BOX FOR 135 CHANNEL UNIVER-
SAL CABLE BOX! DECODES EVERYTHING \$159.00. TEST
CHIP ACTIVATORS \$14.95. CALL TOLL FREE
1-888-675-3687. 1-201-386-1145.

CABLE TEST CHIPS and DESCRAMBLERS 1-800-743-5350 Wolverine Electronics

ALL CABLE TV BOXES. WE'LL BEAT ANY PRI-
CE. 30 DAY TRIAL. 1 YEAR WARRANTY.
QUANTITY DISCOUNTS. FREE CATALOG!
www.galaxydescramblers.com 1-800-538-
CABLE (2225)

SATELLITE TV

FREE DSS TEST CARD Information package. Turns
on all channels. Write SIGNAL SOLUTIONS, 2711
Buford RD. Suite 180, Richmond, VA 23235.

DSS SATELLITE TEST CARDS. Authorizes
all channels including Pay-Per-View. For
Visa/MC orders, call 1-877-223-5637.
www.satellitetestcard.com

SATELLITE DESCRAMBLER. PROGRAMMING PACKAGE
AUTHORIZES ANY SATELLITE TO RECEIVE ALL CHAN-
NELS AVAILABLE, INCLUDING PREMIUMS & PAY-PER-
VIEWS. \$99.95 + S/H 800-333-6150
www.satellite2000.net

DSS DESCRAMBLER. Programming Package
Authorizes all channels available including
Pay-Per-View. SATISFACTION GUARANTEED
\$99.95 + S/H. 800-461-3992 [www.one-
sat.com](http://www.one-
sat.com)

WANTED TO BUY

FOR BEST PRICES PLEASE CALL DAVID YO: I'd buy tube
type Marantz, McIntosh, Western Electric equipments. Old
speakers, units, from Tannoy, Altec, JBL, Jensen, EV, W.E.,
POB 80371 San Marino, Ca. 91118-8371 Tel: 626/441-3942

**CASH for USED AUDIO & HOME THEATER
EQUIP. BUYING and SELLING by PHONE.**
CALL for HIGHEST QUOTE. (215) 886-1650
Since 1984. The Stereo Trading Outlet, 320 Old
York Road, Jenkintown, PA 19046. WEB SITE
Catalog: www.tsto.com

AUDIO CLASSICS BUYS-SELLS-TRADES-REPAIRS High
End Audio Components. CALL for a quote. See our ad at the
beginning of the classifieds. **AUDIO CLASSICS, LTD.**, 3501
Old Vestal Rd., Vestal, NY 13850. Phone: 607-766-3501
8am-5pm EST Mon-Fri.

WANTED: TUBE HI FI, CORNER/HORN SPEAKERS! Altec,
Jensen, Marantz, Leak, Quad, McIntosh, Western Electric, EV,
JBL, Tannoy ETC. Sonny (405)737-3312. Fax 3355.

AUTHORIZED

Straight Talk...is a result of 40 years of straight thinking!



A Speciality Store with 15 Showrooms of Audio, Video, Car Stereo DVDs & CDs.

"One of America's Finest Audio/Video Stores"

For over
**10 years Kief's
has earned
over 1/2 million
customers
thanks to the
continued
support of the
Kansas University
students and alumni.**



Member of the
Better Business Bureau

Adcom
a/d/s
Alon
Alpine*
ATI
Atlantic Tech
Avance
Audio Control
Audio Technica
B&K
Boston Acoustics*
Cal Audio Lab
Canton
Celestion
Denon*
Dunlavy*
ELITE* by Pioneer
harman/kardon
Integra* by Onkyo

JVC
Kimber Kable
KEF
Klipsch
Lexicon*
Lovan
Magnum-Dyna
Mirage*
Mission
Mitsubishi
Monitor Audio*
Monster Cable
Newcastle by Sherwood
NAD
NHT
Nakamichi
Niles Audio
Onkyo
Panamax

Parasound
Pioneer
Pioneer Elite*
PSB
Rega
Sanus
Sennheiser
Sharp Vision*
Snell
Sonic Frontiers
Sony
Sony ES*
Tara Labs
Target
Tributaries
Velodyne*
&
More

*Kief's in store demonstrations....Mon-Sat 10 am-6pm CST

AUDIO/VIDEO

2429 Iowa St., Lawrence, KS 66046

785-842-1811 e-mail:sales@kiefsav.com

OUR 24TH YEAR! CALL 1(800) 826-0520 ★
ATI ★ a/d/s ★ ADCOM ★ AMC ★ AUDIO-
CONTROL ★ BELLES ★ BELLOGETTI ★ CE-
LESTION ★ GRADO LABS ★ HARMON KAR-
DON ★ JAMO ★ KEF ★ LEXICON ★ MONSTER
CABLE ★ NAD ★ NAKAMICHI ★ NILES AUDIO
★ OMNIMOUNT ★ ONKYO ★ PANAMAX ★
PSB SPEAKERS ★ SANUS FURNITURE ★
SONY ES ★ SONY VIDEO ★ SOUND ANCHORS
★ TARGET STANDS ★ THORENS ★ TICE AU-
DIO ★ VELODYNE ★ SOUND SELLER ★ BOX
224 ★ 2808 CAHILL ★ MARINETTE, WI
54143-0224.

AUDIO UNLIMITED

From Colorado we offer novice and serious audiophiles an
alternative to mass market high end equipment. We represent
only musical products that offer the highest performance to dol-
lar value. In keeping with this philosophy, we present a careful
selection of components from around the world, of interest to
audiophiles who listen to music and appreciate what it adds to
the quality of life. Authorized Dealer For: ACCUPHASE,
Acoustic Energy, Acrotec, Aesthetix, AIR TIGHT, ASC, Audio
Aristry, AudioCraft, Audio Mecca by Pierre Lume, AudioNote,
AVALON ACOUSTICS, BASIS, Benz-Micro, Cabasse,
Cambridge Audio, CARY, Chang, CODA Conrad-
Johnson, Continuum, Day Sequerra, Dynavector, Ear,
Electrocompaniet, Ensemble, Graaf, Grado, Graham,
Hovland, JPS, Koetsu, Kuzma, Last, Lehman, Magnum
Dynamab, MUSE, Musical Design, Music Metre, NAGRA,
Onix, Orade, Pathos, Rega, Spondor, Symphonic Line, TAN-
NOY, Totem, Transfiguration, Western Electric, Wheaton,
YBA, XLO, Zoethecus, and more...Call, Write or Fax John
Barnes for more information: Audio Unlimited, 2343 West Yale
Ave., Englewood, Colorado 80110. Phone 303-691-3407, Fax
303-922-0522. E-mail: audio@henge.com

AUDIOPHILE & SCHOLAR

UNIVERSITY AUDIO SHOP, MADISON, WI
AUDIO RESEARCH, KRELL, ARAGON, MARTIN LOGAN,
THIEL, Acurus, B&K, YBA, JmLab, Paradigm, Totem, EAD,
CAL, Golden Tube, Tara, Lexicon, Vidikron, Harman Kardon,
Rega. (608) 284-0001.

LOUDSPEAKERS



HAL COX



\$350 EACH

WORLD'S FINEST MONITOR

FOR UNDER \$2000. HAL COX RECOMMENDS: \$350.00/EA.
JBL 3412C(BK), JBL 4312C(WAL) \$999/PR CONTROL
MONITORS(NEW!) EMPLOYED BY 70% OF RECORDING
STUDIOS FOR MIXING/EVALUATION. 12db X-OVER NET-
WORK, 3-WAY WITH 12" WOOFER, 5" MIDRANGE & DOME
TWEETER, 100 WATT CAPACITY, LOWEND 27K hrtz TO 20k
hrtz, 3" COIL-1.1LBS. ALSO, NEW JBL ST125 COMPRES-
SION DRIVER & HORN W/15" WOOFER \$299EA.; JBL 4425
\$995 EA.; JBL 4652 12" W/COMPRESSION DRIVER
\$769EA.; JBL 4655 15" W/COMPRESSION DRIVER
\$867EA.; PARAGONS (CALL); HARTSFIELD (CALL); OLYM-
PUS S8-R \$3,999/PR, L300-333 \$2,999/PR. CATALOG \$10.
SHIPPED WORLDWIDE. VISA/MC. HAL COX, SINCE 1947
(415) 388-5711, FAX:(415) 389-6097, 164 TAMALPAIS AVE.,
MILL VALLEY, CA 94941. SAN FRANCISCO AREA.

SOLEN

EUROPEAN SPEAKER
DRIVER UNITS CATALOG

AIRBORNE

LA PASSION DU HAUT-PARLEUR

AUDAX

DYNAUDIO®

FEON

LPG

Peerless

scan-speak

seas

vifa

SOLEN CROSSOVER
COMPONENTS CATALOG

HEPTA-LITZ INDUCTORS
PERFECT LAY HEXAGONAL
WINDING

STANDARD INDUCTORS
PERFECT LAY HEXAGONAL
WINDING

FAST CAPACITORS
METALLIZED
POLYPROPYLENE

SOLEN CROSSOVER &
SPEAKER PARTS



SOLEN INC.
4470 Ave. Thibault
St-Hubert, QC J3Y 7T9
Canada

Tél.: 514-656-2759

Fax: 514-443-4949

E-mail : solen@quebec.net

WWW : http://www.quebec.net/solen/

Catalog US\$8.00 Refundable

'101dB at 12.5 Hz, 110dB at
16 Hz, 114dB at 20 Hz..'

Don Keele, Audio, August 1998

'Bargain of the Century'

Tom Nousaine, CSR, May 1998

'An Absolute Must Buy'

R. Thompson, Sensible Sound, #67

HSU RESEARCH

True Subwoofers

Offer:

- Unparalleled Value
- Unparalleled Flexibility
- Unique User Support
- Smallest footprint of any subwoofer
- Garnered more rave reviews than anyone

Website: www.hsuresearch.com

Email: hsures@earthlink.net

Hsu Research, Inc.

3160 E. La Palma Ave, #D

Anaheim, CA 92806

(800)554-0150/(714)666-9260

(714)666-9261 (FAX)

Available through select dealers, or factory-
direct with 30-Day money-back guarantee

PARTS EXPRESS ELECTRONICS & MORE

The Parts Express catalog is a must for the serious speaker enthusiast! We are a nationally known electronics distributor that takes pride in our huge selection of products and our first rate customer service. We stock a dizzying array of audio related components including raw loudspeaker drivers for home and car, home theatre products, connectors, wire, test equipment, plus numerous accessories. So what are you waiting for ... call for your FREE 268 page catalog today!



Source
Code: AUM

1-800-338-0531

Parts Express™
725 Pleasant Valley Dr., Springboro, Ohio 45066-1158
Phone: 513/743-3000 ♦ FAX: 513/743-1677
E-mail: sales@parts-express.com

1-800-NEW-FOAM

Satisfaction Guaranteed or your money back* Worldwide Speaker Repair since 1979

Fix Speaker foam rot problems.
Ask about VIDEO TAPE instructions
Read about the famous NEWFOAM® D.I.Y. Speaker
Repair process in "Stereo Review" June 1996

NEWFOAM® • 3047 West Hennietta Road • Rochester, NY 14623-2531 USA
voice (716) 424-3680 fax (716) 427-9339 video (716) 427-9277
"It (NEWFOAM) looks like a good value and a darn good idea." Dr Allan
Powell, Host "Tech Talk" radio program KAMU-FM Texas A & M University

As seen in the WALL STREET JOURNAL "Business on the Web" January 22, 1998

Phone Toll Free	FAX Toll Free
1-800-NEW-FOAM	1-800-2FX-FOAM
1-800-639-3626	1-800-239-3626

www.NEWFOAM.com

The Solist

Madisound is pleased to offer **Solist**, the latest addition to our high end speaker kits. We are confident that we have achieved a speaker that meets or exceeds the expectations of today's discerning Audiophile.

The **Solist** is very precise, capable of delivering the most demanding passage without losing the delicacy of every nuance. The **Solist** has an immediacy about it that elicits excitement in the listener, yet is never fatiguing. We have listened to the **Solist** on both transistorized amplifiers and tube amplifiers and found both to be pleasing.

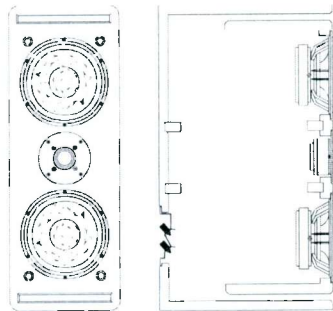

Width 8 3/4" Height 24" Depth 13 1/2"

The **Solist** is designed around the popular **Scan-speak** 18W/8545K carbon/paper cone 7" woofer and the new D2905/9500 1" textile dome tweeter.

The **Scan-speak** woofer has a specially coated carbon impregnated paper cone and the patented SD-1 magnet system. The SD-1 magnet system minimizes modulation and dynamic distortion.

The **Scan-speak** tweeter features a textile dome, hand coated several times to produce a unique combination of dynamic linearity and damping of resonance.

The **crossover** network was designed using our anechoic chamber, Audio Precision and the Linearx Leap software. The 18dB bi-wire network yields a seamless response from 40Hz to 20KHz.

The cabinets are fully assembled oak veneered MDF with solid rounded oak corners in clear coat or black painted finish. The front and back are black and the front is covered by a full black grill. The kit can be assembled in an evening.

Price per pair \$1140.00

MADISOUND SPEAKER COMPONENTS, INC.
8608 UNIVERSITY GREEN
P.O. BOX 44283
MADISON, WI 53744-4283 U.S.A.
TEL: 608-831-3433 FAX: 608-831-3771
e-mail: info@madisound.com
Web Page: http://www.madisound.com

LOUDSPEAKERS

The newest audio breakthrough... direct from the Ancient Egyptians!

DENHAM PYRAMIDAL SPEAKERS

A rich, more omni-directional sound that brings a broad soundstage and live presence to your music.

The unique 3-sided design works with the acoustics of your room to deliver true 360° "wraparound" sound.

Hand-crafted and hand-finished from the finest woods, these amazing speakers turn any room into a concert-hall!

Let us share this exciting new revelation with you on our no-risk home trial. Call today.

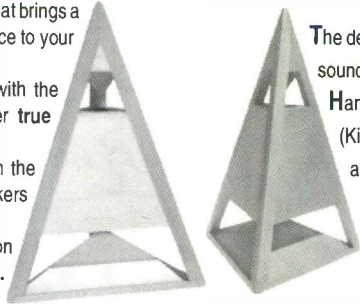

The design may be ancient, but the sound is distinctly cutting-edge.

Hand-made of elegant woods.

(King Tut didn't use pressboard, and neither do we.)



For information or to order call: (219) 946-4072

P.O. Box 126, Winamac, IN 46996 www.denhamcorp.com

CUSTOM ACTIVE ELECTRONIC CROSS-OVERS, 6 to 36 dB/Oct. Snell, Magnepan versions. DB SYSTEMS, POB 460, RINDGE, NH 03461. dbsystems@ibm.net (603) 899-5121

SERVICES

Audio Equipment Built, Repaired, Modified and Restored by Richard Modafferi, independent consultant to Audio Classics, Ltd., inventor, and former Senior Engineer at McIntosh. **AUDIO CLASSICS, LTD.** 3501 Old Vestal Rd., Vestal, NY 13850. Phone: 607-766-3501, 8am-5pm EST Mon-Fri.

PARTS AND ACCESSORIES



...audible results with the finest in connecting components!

SOUND CONNECTIONS INTERNATIONAL, INC.
203 Flagship Dr.—Lutz, FL USA 33549
PH: 813-948-2707 Fax: 813-948-2907

FOR SALE

HIGH-END COMPONENTS AT DISCOUNT PRICES - AERIAL, B&W, BRYSTON, CLASSE, DYNAUDIO, E.A.D., EGG-ELSTON, HALES, LEXICON, MARTIN-LOGAN, MERIDIAN, PROCEED, REVEL, THIEL, TOTEM, KRELL, AND OTHER EXCLUSIVE PRODUCTS. HELM MUSIC COMPANY (888) 519-9800.

ADVERTISERS...

Reach proven mail order buyers!

They turn to us when they are looking for purchasing information and advice.

Advertise your products and services in a low-cost environment that sells. Millions of your prime prospects can be found in the industry leading titles of *Hachette Filipacchi Magazines, Inc.*

To place a classified ad, simply call us *Toll-Free* and reserve your space today!

1-800-445-6066 (9am-5pm EST)

or Fax your order to 212-767-5624.

AUDIO DESIGN

PROUDLY REPRESENTING THE FOLLOWING MANUFACTURERS

Acurus
Aerial Acoustics
Alon
Alpha-Core
Aragon
AudioQuest
Bryston
CAL Audio
Classe Audio
Denon

Enlightened Audio
Grado
JM Labs
JVC
Kimber Select
Magnum-Dynalab

Monitor Audio
Monster Cable
Niles
Nordost
Parasound
Rega Research

Ruark
Sharpvision
Sonic Frontiers
Sound Anchors
Speakercraft
Target
Velodyne
VPI
Xantech

FACTORY AUTHORIZED

800-285-5884

911 W. Anderson Ln. #116, Austin, TX 78757

STATEMENT OF OWNERSHIP, MANAGEMENT, AND CIRCULATION

1. Publication Title: Audio.
2. Publication Number: 0513-6100.
3. Filing Date: September 30, 1999.
4. Issue Frequency: Monthly, except bimonthly in February/March and July/August.
5. Number of Issues Published Annually: 10.
6. Annual Subscription Price: \$26.00.
7. Mailing Address of Known Office of Publication: 1633 Broadway, New York, N.Y. 10019; Contact Person, Vesta P. Cordero, 212/767-6531.
8. Mailing Address of Headquarters or General Business Office of Publisher: 1633 Broadway, New York, N.Y. 10019.
9. Names and Mailing Addresses of Publisher, Editor, and Managing Editor: Publisher, Tony Catalano, 1633 Broadway, New York, N.Y. 10019; Editor, Michael Riggs, 1633 Broadway, New York, N.Y. 10019; Managing Editor, Kay Blumenthal, 1633 Broadway, New York, N.Y. 10019.
10. Owner: Hachette Filipacchi Magazines, Inc., 1633 Broadway, New York, N.Y. 10019; 100% of the stock is owned by Hachette Filipacchi Magazines (Delaware) Holdings I, Inc.
11. Known Bondholders, Mortgagees, and Other Security Holders Owning or Holding 1% or More of Total Amount of Bonds, Mortgages, or Other Securities: Hachette Filipacchi Magazines (Delaware) Holdings I, Inc., 1633 Broadway, New York, N.Y. 10019.
12. For Completion by Nonprofit Organizations Authorized to Mail at Special Rates: Does not apply.
13. Publication Title: Audio.
14. Issue Date for Circulation Data Below: September 1999.
15. Extent and Nature of Circulation
 - Average No. Copies Each Issue During Preceding 12 Months:
 - A. Total No. of Copies, 137,391; B. Paid and/or Requested Circulation, 1. Paid/Requested Outside-County Mail Subscriptions Stated on Form 3541, 0; 2. Paid In-County Subscriptions, 0; 3. Sales Through Dealers and Carriers, Street Vendors, Counter Sales, and Other Non-USPS Paid Distribution, 13,255; 4. Other Classes Mailed Through the USPS, 79,190; C. Total Paid and/or Requested Circulation, 92,445; D. Free Distribution by Mail, 3,461; E. Free Distribution Outside the Mail, 0; F. Total Free Distribution, 3,461; G. Total Distribution, 95,906; H. Copies Not Distributed, 41,485; I. Total, 137,391; J. Percent Paid and/or Requested Circulation, 96.39.
 - No. Copies of Single Issue Published Nearest to Filing Date:
 - A. Total No. of Copies, 117,434; B. Paid and/or Requested Circulation, 1. Paid/Requested Outside-County Mail Subscriptions Stated on Form 3541, 0; 2. Paid In-County Subscriptions, 0; 3. Sales Through Dealers and Carriers, Street Vendors, Counter Sales, and Other Non-USPS Paid Distribution, 12,000; 4. Other Classes Mailed Through the USPS, 61,333; C. Total Paid and/or Requested Circulation, 73,333; D. Free Distribution by Mail, 3,639; E. Free Distribution Outside the Mail, 0; F. Total Free Distribution, 3,639; G. Total Distribution, 76,972; H. Copies Not Distributed, 40,462; I. Total, 117,434; J. Percent Paid and/or Requested Circulation, 95.27.
16. This Statement of Ownership will be printed in the December 1999 issue of this publication.
17. I certify that all information furnished on this form is true and complete. I understand that anyone who furnishes false or misleading information on this form or who omits material or information requested on the form may be subject to criminal sanctions and/or civil sanctions.

David W. Lecky
Vice President, Circulation

AD INDEX

PAGE	ADVERTISER	WEB SITE/E-MAIL	TELEPHONE
36	Adcom	www.adcom.com	732-390-1130
51	Bell'Oggetti	www.belloggetti.com	732-972-1333
17	Bose Corporation	www.bose.com/ca 808	800-275-BOSE Ext. 808
19	Bose Corporation	www.bose.com/ca 722	800-444-BOSE Ext. 722
71	Bose Corporation	www.bose.com/am 745	800-444-BOSE Ext. 745
39	Boston Acoustics	www.bostonacoustics.com	978-538-5000
C3	Brown-Forman/Canadian Mist	www.canadianmist.com	
64	Bryston Ltd.	www.bryston.ca	800-632-8217
13	B&W Loudspeakers of America	www.bwspeakers.com	978-664-2870
54	C.Crane	www.ccrane.com	800-522-8863
69	Cambridge Audio	www.audiopluservices.com	450-585-0098
46,47	Chevy Tracker	www.chevytracker.com	
49	Crutchfield	www.crutchfield.com	800-955-9009 Ext. AU
104	CES	www.CESweb.org	
2,65	Definitive Technology	www.definitivetech.com	410-363-7148
C2-1	Denon	www.del.denon.com	973-396-0810
42	Energy Loudspeakers	www.energy-speaker.com	416-321-1800
20	Harman Kardon	www.harmankardon.com	800-422-8027
23	IAG America	www.wharfedaleusa.com	781-440-0888
52	Infinity	www.infinitysystems.com	800-553-3332
102	J&R Music World	www.jandr.com	800-221-8180
81	JBL	www.jbl.com	800-336-4JBL
66	JVC	www.jvc.com	800-252-5722
87	Kimber Kable	www.kimber.com	801-621-5530
92	Klipsch	www.klipsch.com	800-KLIPSCH
56,58-9	Legacy Audio, Inc.	www.legacy-audio.com	800-283-4644
75	Lexicon	www.lexicon.com	781-280-0300
101	Linn Products, Ltd.	www.linninc.com	888-671-LINN
88	M&K Sound Corporation	www.mksound.com	310-204-2854
40	Madrigal	www.madrigal.com	860-346-0896
10,11	Marantz America, Inc.	www.marantzamerica.com	800-270-4533 Ext. 101
85	Martin Logan	www.martinlogan.com	785-749-0133
60	McIntosh	www.mcintoshlabs.com	888-979-7009
90	Meridian America, Inc.	www.meridian-audio.com	404-344-7111
C4	Mirage Speakers	www.miragespeakers.com	416-321-1800
35	NAD Electronics of America	www.NADelectronics.com	800-263-4641
8,9	Paradigm	www.paradigm.ca	905-632-0180
58-59	Parliament		
4	Pioneer Home	www.pioneerelectronics.com	800-421-1404
77	Polk Audio	www.polkaudio.com	800-377-7655
106	Pro Sound Stage and Lighting	www.pssl.com	800-945-9300
96	PSB Speakers	www.psbSpeakers.com	888-772-0000
44	Rotel	www.rotel.com	978-664-3820
78	SanusSystems	www.sanus.com	800-359-5520
7	SONY Minidisc	www.sony.com/md	
99	SONY	www.sony.com	
109	Sound City	www.soundcity.com	800-525-3325
83	Sunfire	www.sunfire.com	425-335-4748
100	Tannoy	www.tannoy.com	519-745-1158
72	Thiel	www.thielaudio.com	606-254-9427
108	Uncle's Stereo	www.unclestereo.com	800-978-6253
105	Vandersteen Audio	www.vandersteen.com	559-582-0324
94	Yamaha	www.yamaha.com	

AUDIO, December 1999, Volume 83, Number 11. **AUDIO** (ISSN 0004-752X, Dewey Decimal Number 621.381 or 778.5) is published (10x year) monthly except bimonthly in February/March and July/August by Hachette Filipacchi Magazines, Inc., a wholly owned subsidiary of Hachette Filipacchi USA, Inc., at 1633 Broadway, New York, N.Y. 10019. Printed in U.S.A. at Dyersburg, Tenn. Distributed by Curtis Circulation, Inc. Periodicals postage paid at New York, N.Y. 10019 and additional mailing offices. One-year subscription rate for U.S. and possessions, \$26.00; Canada, \$34.00 (includes 7% GST tax; Canadian Business Number 126018209 RT, IPN Sales Agreement Number 929344); and foreign, \$34.00.

AUDIO® is a registered trademark of Hachette Filipacchi Magazines, Inc. ©1999, Hachette Filipacchi Magazines, Inc. All rights reserved. The Editor assumes no responsibility for manuscripts, photos, or artwork. The Publisher, at his sole discretion, reserves the right to reject any ad copy he deems inappropriate.

Subscription Service: Postmaster, please send change of address to **AUDIO**, P.O. Box 52548, Boulder, Colo. 80321-2548. Allow eight weeks for change of address. Include both old and new address and a recent address label. If you have a subscription problem, please write to the above address or call 303/604-1464; fax, 303/604-7455.

Back Issues: Available for \$6.95 each (\$8.25 Canada; \$13.25 other foreign) in U.S. funds. Please add \$1.00 for the Annual Equipment Directory (October issue). Send a check or money order to ISI/AUDIO Magazine, 30 Montgomery St., Jersey City, N.J. 07302, or call 201/451-9420.

Occasionally we share our information with other reputable companies whose products and services might interest you. If you prefer not to participate in this opportunity, please tell the operator at the following number: 303/604-1464.

AUDIO SUBSCRIBER SERVICE

PLACE LABEL HERE

MOVING? Please give us 8 weeks advance notice. Attach label with your old address, and write in new address below.

NAME _____

ADDRESS _____

CITY _____

STATE _____

ZIP _____

**1(303)604-1464
FAX 1(303)604-7455**

AUDIO

P.O. Box 52548, Boulder CO 80322

Attack of the Killer Systems

One of the ways we find out about interesting new products is by attending trade shows. These days, there are two that are important to us: the Consumer Electronics Show (CES) in January and the CEDIA Expo in the fall. CES has been the big daddy essentially forever, back to the days when it originated as the IHF (Institute of High Fidelity) Show. For the last year or two, however, the CEDIA Expo has been more useful, which is interesting because CEDIA stands for Custom Electronic Design and Installation Association. Its members are people who put A/V and multiroom audio systems into people's homes.

So why would an installer's convention be better for us than CES?

Because just about every audio and video manufacturer of consequence exhibits there—and nobody else. All under one roof. Pure protein! CES, on the other hand, has morphed over the years into a gargantuan, unmanageable sprawl embracing all things electronic.

The key point, however, is that most of the stuff we're interested in covering and most of the people we need to talk to come to CEDIA now, which is a significant change from even a few years ago. And

since it's not cheap to exhibit at any of these shows, that in turn means the audio business has changed in a very substantial way. We're used to thinking of high-performance audio in terms of selecting a well-matched set of components, taking it home, setting it up, and tweaking it into shape. That's really hobbyist think, but for many years it applied well to a broad range of people shopping for music systems. The selection and setup steps weren't particularly onerous. Typically you needed two to perhaps five or six electronic components plus two identical speakers. The electronic pieces required a couple of wires for each connection, all of the same kind; hooking up the speakers was only marginally more complicated. Fast-forward to today: Looking at the back of a DVD player, you may find four different ways of getting audio out of it and three ways of getting video. One manufacturer did a survey a while back of home theater owners and discovered that more than half the respondents were convinced their systems weren't working exactly the way they were supposed to. Not a pretty statistic.

The upshot is that the high (and, increasingly, the upper-middle) end of the audio business has divided into two parts: old-fashioned cash-and-carry, where we hobbyists still hang our hats, and custom installation, where the not-inconsiderable carriage trade has mostly migrated. What about the nonaudiophile who isn't prepared to go the custom-installation route? For many of the same reasons, that market has gone more and more to integrated solutions of one sort or another—most prominently the ubiquitous shelf, or mini, system. Buy one box, take it home, unpack it, put one plug in the wall, and you're done. Such systems tend to have more gizmos on them than most

people want, and few of them really sound very good. But they do serve a market completely unprepared to deal with component audio.

Something interesting has started to stir in this realm lately, however. A number of American speaker companies with roots in the component business have taken a fresh look at how integrated packages should be done, with a particular eye to home theater. You can see one result in Doug Newcomb's review of the Polk RMDS-1 (page 45), which provides almost everything required for a high-quality, easy-to-install, easy-to-use home theater system. Other examples would include the Boston Acoustics Digital Theater systems and the Bose Lifestyle systems, and no doubt I am forgetting one or two others. Looking (and listening) to some of them, it gets harder to make the argument for components as universally as I used to. A lot of people really will be better off with one of these packaged systems.

I was particularly struck by the new Bose Lifestyle 40 and 50 systems, which are built around a two-way, RF LCD remote called the Personal Music Center. They take the human engineering of A/V gear to a new level of sophistication. Setting up a remote zone involves running a single cable from a tiny central control box to a powered speaker system wherever in the house you want it. You can have multiple zones within the house, and every Personal Music Center remote you have will know about every zone, including its configuration, as soon as the speakers are plugged in. More important, running the system is dead easy. You may have heard the phrase "home theater in a box"; these things might well be called "custom install in a box."

If you're like me, though, you want to choose components, install them yourself, and have them work as desired without going through ridiculous contortions. You don't want a custom installation or a whatever-in-a-box. The question raised by the growth of CEDIA and the emergence of this new category of integrated systems is, where is our world headed? To a very diminished role, I suspect, unless the folks in the component audio business quickly address the ease-of-installation and ease-of-use issues that beset current high-performance A/V gear. The good news is that manufacturers are taking these problems more seriously than ever before. Madrigal, for example, has made upgradability and ease of use core elements of its product engineering, with very promising results. And the near-universal acceptance of IEEE-1394 (FireWire) as the next-generation digital interface opens the possibility of home theater setup as easy as stereo system setup used to be, despite the underlying complexity. The all-digital system of the future could give us all the fun we crave with an absolute minimum of the drudgery we abhor. All I can say is, hurry!



I'm Dreaming of a Light Christmas.



*Smooth, mellow Canadian Mist.
A taste for the lighter side of life.*

*Please enjoy Canadian Mist responsibly.
Visit our web site at www.canadianmist.com*

Imported and Bottled by Brown-Forman Beverages Worldwide, Canadian Whisky, A Blend, 40% Alc. by Volume, Louisville, KY © 1999

Excuse us for being... Simply Spectacular



We're Mirage®. We're known for our Bipolar and Omnipolar® speaker designs that revolutionized the high-end speaker industry. Now, Mirage® introduces the FRx-Series, once again establishing a new standard in performance and styling in the affordable speaker arena. See it. Hear it. At your Mirage® dealer today.

The New FRx-Series...

**SIMPLY SPECTACULAR
IN PERFORMANCE.**

**SIMPLY ELEGANT
IN STYLING.**

**SIMPLY AFFORDABLE
IN PRICE.**

Mirage®

SEE THE MUSIC!

AUDITION THE FRx-SERIES AT THE AUTHORIZED MIRAGE DEALER IN YOUR AREA OR LOOK US UP ON THE WEB: www.miragespeakers.com
A DIVISION OF AUDIO PRODUCTS INTERNATIONAL CORP., 3641 MCNICOLL AVENUE, SCARBOROUGH, ONTARIO, CANADA M1X 1G5
TELEPHONE (416)321-1800 FAX (416)321-1500