



Installation Operation Maintenance

CXB HT air-to-water scroll heat pumps

Cooling capacity 19-32 kW

Heating capacity 23-38 kW



June 2020

CG-SVX046B-GB

Original instructions

TRANE
TECHNOLOGIES



INDEX

1	OVERVIEW	3
2	SAFETY REGULATIONS	4
3	OPERATING LIMITS	8
4	INSTALLATION	11
5	ACOUSTIC PROTECTION.....	13
6	ELECTRICAL POWER SUPPLY	13
7	WATER CONNECTIONS	14
8	ELECTRICAL PANEL.....	23
9	OPERATOR RESPONSABILITIES	24
10	START-UP PRELIMINARY PROCEDURES.....	24
12	CHECK LIST – MANDATORY OPERATION CONTROL BEFORE START-UP	25
13	START-UP	31
14	MAINTENANCE	32
15	RECOMMENDED SPARE PARTS	36
16	TROUBLESHOOTING	37
17	IMPROPER USES	39

1 OVERVIEW

1.1 WARRANTY

Warranty is based on the general terms and conditions of the manufacturer. The warranty is void if the equipment is repaired or modified without the written approval of the manufacturer, if the operating limits are exceeded or if the control system or the electrical wiring is modified. Damage due to misuse, lack of maintenance or failure to comply with the manufacturer's instructions or recommendations is not covered by the warranty obligation. If the user does not conform to the rules of this manual, it may entail cancellation of warranty and liabilities by the manufacturer.

B. Warranty is twelve (12) months as from the date of first start up at installation place or eighteen (18) months after delivery at the project or other delivery location indicated by the customer. The date the unit is operated for the first time means the date reported in the "1st start up form" contained into the "unit log book". This form should be filled in and sent, within 8 days from the start up, to Trane.

C. The warranty is valid if all the installation and start-up instructions have been adhered to (both those which may have come from Trane and those coming from current practice), and if the "1st start up form" has been filled in and sent to the Trane after sales department.

D. The warranty is subject to any faults or defects being reported within eight days from their discovery. The warranty will only be applied if and when the purchaser suspends use of the equipment as soon as a defect has been found.

E. The warranty is valid in case the commissioning and the first start-up of the CGB/CXB unit is carried out by a Trane authorized assistance center.

F. The warranty is subject to regular maintenance of the unit which is appropriately indicated in the "unit log book" located inside the electrical panel.

G. Warranty automatically ends in case of payments not fulfilled, non-performance of the contract and even if the units show tampering without written approval of Trane.

1.2 RECEIVING THE UNIT

On receiving the unit, it is up to the customer to check that there is no obvious damage or pieces missing. If this is the case, an immediate complaint must be made to the carrier for damage or for not-delivery and the Receiving Card to be found inside the unit electrical panel must be filled in. Photographic evidence must be provided for macroscopic damage. The card must be sent to Trane within 8 days of receiving the goods: if it is not sent back or delayed, the complaint will not be accepted.

1.3 FACTORY INSPECTION

Trane units are inspected in the factory, in appropriate areas, in accordance with internal procedures. Each performance test carried out on the unit is possible only if the same conditions are reproduced and maintained (charge consistency, constant temperature and evaporation - condensation and recovery capacity, quality and tolerance of the measuring instruments etc.) in the test rooms.

The inspection conditions are those indicated by the customer during the ordering phase: if not otherwise specified, reference should be made to the nominal performance indicated in the technical bulletin in force at the date of the Confirmation of the Order.

2 SAFETY REGULATIONS

2.1 DEFINITIONS

Owner:

The legal representative of the company, body or natural person who owns the plant in which the Trane unit is installed: he or she is responsible for the control and respecting all the health and safety regulations indicated in this manual as well as the national ones in force.

Installer:

The legal representative of the company appointed by the owner to position and hydraulically, electrically etc. connect the Trane unit to the plant: he or she is responsible for moving and the correct installation of the unit in accordance with the indications in this manual and with the national regulations in force.

Operator:

A person authorized by the owner to carry out all the operations of regulation and control on the Trane unit which are specifically mentioned in this manual. He or she should keep to actions described in the manual and limit his or her action to what is explicitly allowed.

Technician:

A person who is directly authorized by Trane or, secondarily, for all EU countries except for Italy, by the distributor of the Trane product, under their own responsibility, to carry out all ordinary or extraordinary maintenance operations, as well as regulations, controls, repairs and parts replacement which may be necessary during the lifetime of the unit.

2.2 ACCESS TO DANGEROUS AREAS

The access to the unit dangerous areas is usually obstructed with protection panels, which are only removable by using a tool. Axial fans are protected with accident prevention grilles.

For all the units which allow access to the cooling piping without security gratings (optional) or closing paneling, the following precautions must be taken:

- mark the areas with contact risks.
- apply warning signs.

The danger zone must be of a suitable size to avoid any contact, even accidental contact.

Trane declines any responsibility for damage to things and unauthorized personnel in case of absence of clear and static limiting systems of the risk areas and of the relevant warning and danger signs.

2.3 GENERAL PRECAUTIONS

The operator must only intervene on the unit controls; he or she must not open any panels except for the one which gives access to the command module.

The installer must only intervene on the connections between the plant and the machine; he or she must not open any machine panels nor carry out any commands.

The following precautions should be made when approaching or working on the unit:

- Do not wear jewelry, baggy clothes or any other accessory which can get caught up.
- Use appropriate protection (gloves, glasses etc.) when using an open flame (welding) or compressed air.
- If the unit is located in a closed environment, wear hearing protection.
- Before disconnecting, removing tubes, filters, joints or other line parts intercept the connection tubes, empty them until the pressure reaches that of the atmosphere.
- Do not use your hands to check for possible pressure losses.
- Always use tools which are in good condition; make sure the instructions have been fully understood before using them.
- Make sure that any tools, electrical cables or other loose objects have been removed before closing the unit and starting it up again.

2.4 GENERAL AGAINST RISKS DUE TO THE REFRIGERANT

Safety data	
Toxicity	Not important
Risks for skin touching	Splashes or sprinkles can cause chill burns. The risk of absorption through the skin is not relevant.
	R410a refrigerant could take some lightly irritating effects and in liquid stage it has a strong skinning effect. In this case it is necessary to rinse with fresh water the contaminated parts of the skin The refrigerant in liquid stage in contact with wet fabrics cause freezing and adherence to the skin. In this case it is necessary to put off the contaminated clothes to avoid freezing. Please contact a doctor in case of irritation of the contaminated parts.
Risks for contact with the eyes	Vapors don't take any effect. Splashes or sprinklers can cause chill burns. In those cases it is necessary to rinse the eyes with water or with solution for ocular washings for 10 minutes. The intervention of a doctor is needed.
Risks for ingestion	Should it happen, it causes chill burns. It does not cause vomiting. The person must be kept awake. It is needed to rinse the mouth with fresh water and to drink almost 0.25 liters. The intervention of a doctor is needed.
Risks for inhalation	High concentration of vapors in air can lead to anesthetic effects up to a loss of conscience. Long exposures could give rise to cardiac arrhythmia and sometimes even to death.
	High concentrations can create a reduction of oxygen in air, with consequent possibility of suffocation. Should it happen the person must be taken to the open air and let him take a rest.
	Administer oxygen if needed. In case the breathing has interrupted or become irregular, it is necessary to apply the artificial breathing. In case of cardiac arrest a heart massage must be applied. Contact a doctor immediately.
Conditions to avoid	Use in presence of exposed flames, and of high levels of humidity.
Dangerous reactions	Possibility of violent reactions with the sodium, the potassium, the barium and with other alkaline substances, incompatible materials and all the alloys containing more than 2% of magnesium.
Protection wearing - Behavior in case of losses or escapes	Wear protection apparel and self respirators. Insulate the source of the loss, if this operation can be done in safety conditions. Small quantitative of refrigerant escaped at liquid state can be allowed to evaporate only if the room is well ventilated. In case of great losses ventilate the room immediately. Plug the loss with sand, soil or other absorbent material; avoid that the liquid refrigerant can enter in water-drainages or losing pools.
Dismantlement	The best procedure is the recovery and the recycle. If this is not possible the refrigerant must be conferred to an accredited system for its destruction in order to neutralize acid and toxic by-products.

2.5 PRECAUTIONS AGAINST RESIDUAL RISKS

Prevention from risks due to the control system

- make sure the instructions for use have been understood before carrying out any work on the control panel.
- always keep the instruction manual close at hand when working on the control panel.
- start up the unit only after having certified that it is correctly connected to the plant.
- inform the technician promptly of any alarms which appear on the unit.
- do not reset the alarms to manual restart without having first identified the root cause(s) and removed these.

2.6 PREVENTION AGAINST RESIDUAL MECHANICAL RISKS

- install the unit in accordance with the provisions of this manual.
- carry out all the maintenance operations provided by this manual regularly.
- wear a protective helmet before entering inside the unit.
- before opening a machine panel make sure that it is firmly connected by means of a hinge.
- do not touch the air condenser coils without protective gloves.
- do not remove the protections to the moving parts while the unit is running.
- before restarting the unit make sure that the moving part protections are in the correct position.

2.7 PREVENTION AGAINST RESIDUAL ELECTRICAL RISKS

- connect the unit to the mains in accordance with the provisions of this manual.
- carry out all maintenance operations regularly.
- before opening the control panel disconnect the unit from the mains by means of the external knife switch.
- check that the unit has been earthen correctly before starting it up.
- control all the electrical connections and the connection cables paying particular attention to the state of isolation; replace the cables which are clearly worn or damaged.
- carry out periodic checks of the wiring inside the panel.
- do not use cables with an inappropriate section or flying connections not even for a limited period or in an emergency.

2.8 PREVENTION AGAINST RESIDUAL RISKS OF A DIFFERENT NATURE

- the residual risks due to pressure are mainly coming from a failure of the safety devices. To prevent them it is necessary to check and replace them when required
- carry out the plant connections to the unit by following the indications reported on the following manual and on the panels of the unit itself.
- if a part is disassembled, make sure that it is correctly reassembled before restarting the unit.
- do not touch the discharge line of the compressor, the compressor itself or any other tube or component which is inside the machine without protective gloves.
- keep a fire extinguisher which is able to put out fires on electrical equipment near the machine.
- on units installed inside, connect the refrigerant circuit shut off valve to a network of tubes which are able to lead the possible spillage of refrigerating fluid outside.
- eliminate any fluid loss inside or outside the unit.
- collect the discharge liquid and clean up any possible oil leakage.
- periodically clean the compressor casing of the accumulated dirt deposits.
- do not keep inflammable liquids near the unit.
- do not dispose of the refrigerant fluid and the lubricating oil in the environment.
- welding should only be carried out on empty tubes; do not approach the tubes containing refrigerant fluid with flames or other sources of heat.
- do not bend or strike tubes containing pressurized fluids.

2.9 PRECAUTIONS TO BE OBSERVED DURING MAINTENANCE OPERATIONS

Only authorised technicians may carry out maintenance operations. Before carrying out any maintenance the following must be performed:

- isolate the unit from the mains electricity by using the external knife switch.
- place a notice on the external knife switch which says “**do not use - maintenance in progress**”.
- make sure that any possible on-off controls are disabled.
- use appropriate safety equipment (helmet, isolating gloves, protective glasses, safety shoes etc.).

If measurements or controls must be carried out which require the machine to be running the following observations must be followed:

- operate with the electrical panel open for as short a time as is possible.
- close the electrical panel as soon as the individual measurement or control has been carried out.
- for units which are located outside, do not carry out interventions in dangerous atmospheric conditions such as rain, snow, fog etc.

The following precautions should also be taken at all times:

- never dispose of fluids contained in the refrigerant circuit into the environment.
- when replacing the electronic card always use appropriate equipment (extractor, anti-static bracelet, etc.).
- if a compressor, the evaporator, the condensation batteries or any other heavy part is to be replaced, make sure that the lifting equipment matches the weight to be lifted.
- if the unit has an independent compressor compartment, do not open the ventilator compartment without having first isolated the machine using the knife switch on the side of the panel and only after having placed a sign which says “do not use - maintenance in progress”.
- if modifications must be carried out to the cooling, hydraulic or electrical circuit of the unit, as well as to its command logic, contact Trane.
- if particularly complicated assembly or disassembly operations are to be carried out contact Trane.
- always use original spare parts bought directly from Trane or from official dealers of the companies reported in the list of recommended spare parts.
- if the unit is to be moved after a year of being in the site or if it has to be dismantled contact Trane.

IMPORTANT

No high pressure safety valve is installed on the unit. The unit fail safe is assured by cut-out of the electrical power supply to the coils of the compressors contactors. The cut-out action is carried out by the electrical contact of the dedicated high pressure switch PA highlighted in the figure below “*Part of the refrigerant circuit drawing which includes the high pressure switch PA*”.

Due to the fact that no Schrader valve is installed in the pressure port the dedicated high pressure switch is plugged into, it is absolutely forbidden to pull out the high pressure switch PA if the unit is not completely void of refrigerant.

Failure to follow these instructions could result in death or serious injury.

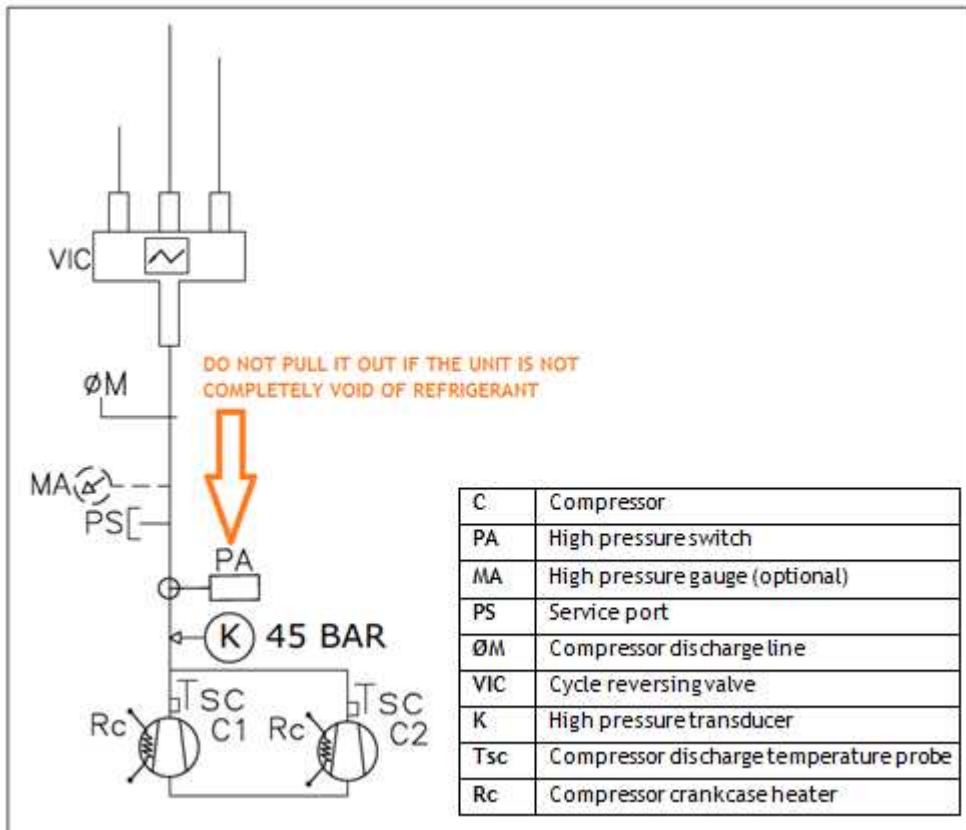

Part of the refrigerant circuit drawing which includes the high pressure switch PA

2.10 MANUAL ALARM RESET

If there is an alarm the unit must not be manually reset before having located and eliminated the root cause of the fault. Repeated manual resets may result in the warranty be void.

3 OPERATING LIMITS

3.1 STORAGE

The units can be stored within the following environmental conditions:

Min ambient air temperature	: -10°C
Max ambient air temperature	: +53°C
Max relative humidity	: 95% not condensable

CAUTION: Storage in very high humidity (risk of condensation) can damage electronic components.

3.2 OPERATING LIMITS

Unit operation is permitted within the limits indicated in the diagram provided in 3.3.

CAUTION: The operation outside the limits specified may cause the activation of the protections and disrupt the operation of the unit and, in extreme cases, damage the unit. In case of doubt, consult the factory.

These operating limits apply to units operating at full load.

3.3 OPERATING RANGE

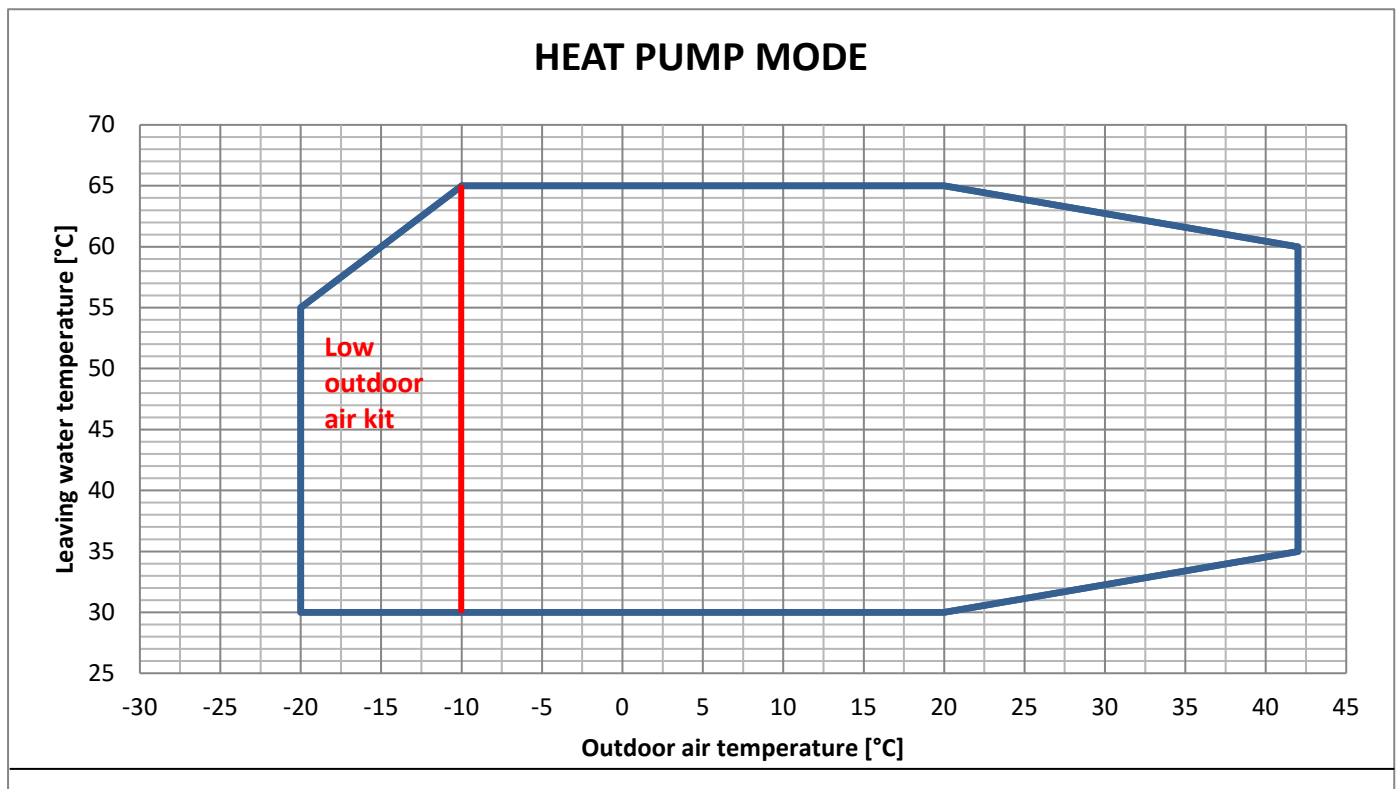
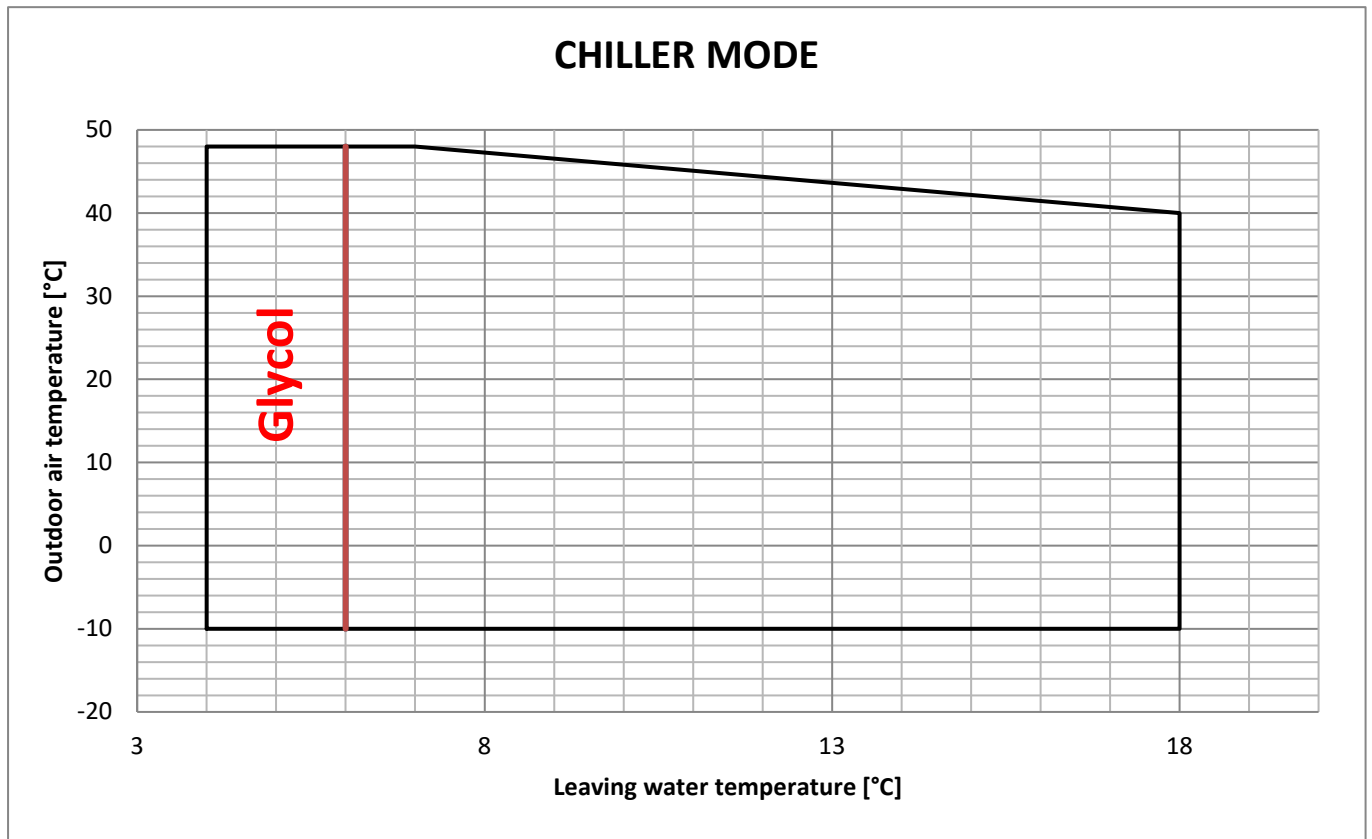

Low outdoor air kit: mandatory for outdoor air temperatures from -20 °C to -10 °C.

- Electric heater in the control box
- Low temperature resistant electrical cables
- Hydrofill treated coil
- Additional coil heater

ETHYLENE GLYCOL CORRECTION TABLE

% Ethylene glycol weight		5%	10%	15%	20%	25%	30%	35%	40%
Freezing temperature	°C	-2	-3,9	-6,5	-8,9	-11,8	-15,6	-19	-23,4
Suggested security limit - cooling	°C	3	1	-1	-4	-6	-10	-14	-19
Capacity coefficient	-	0,995	0,99	0,985	0,981	0,977	0,974	0,971	0,968
Power input coefficient	-	0,997	0,993	0,99	0,988	0,986	0,984	0,982	0,981
Flow rate coefficient	-	1,003	1,01	1,02	1,033	1,05	1,072	1,095	1,124
Pressure drop coefficient	-	1,029	1,06	1,09	1,118	1,149	1,182	1,211	1,243

In order to calculate performance with glycoled solutions, multiply main sizes by respective coefficients.

GLYCOL PERCENTAGE DEPENDING ON FREEZING TEMPERATURE

% glycol according to freezing temperature		0°C	-5°C	-10°C	-15°C	-20°C	-25°C
Freezing temperature							
% Ethylene glycol		5%	12%	20%	28%	35%	40%
Flow rate coefficient		1,02	1,033	1,05	1,072	1,095	1,124

In order to calculate the unit performance, flow rate and pressure drop when operating with a certain percentage of ethylene glycol multiply with the above provided correction coefficients.

IMPORTANT: Oversized water pump as on board unit pump is required for operation with glycol > 25%. If any doubt please contact Trane.

4 INSTALLATION

4.1 MOVING AND POSITIONING THE UNIT

The units have been designed to be lifted from above by means of eyebolts and holes in the base frame. Use retractor bars to keep the lifting wires or chains away from the unit. Lifting procedures provided with the unit have to be respected.

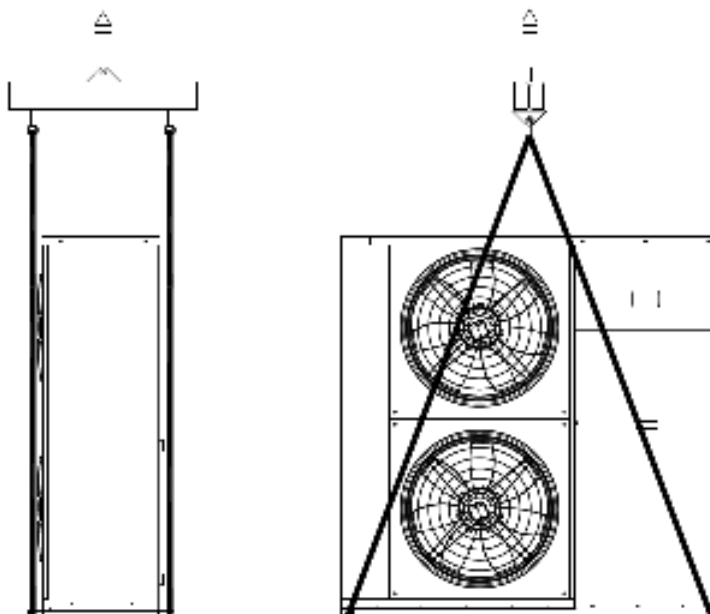

Correct lifting procedure

CAUTION!

Do not use forklift trucks to lift the unit from below. If equipment for lifting from above is not available, using rollers may move the unit. The surface on which the unit is placed must be flat and strong enough to withstand the weight of the unit while running. In order to reduce the transmission of vibrations to the supporting structures, fit shock absorbers in every fastening point. Rubber shock absorbers are recommended for units installed on the ground, spring shock absorbers for units installed on roofs. Open spaces around the unit must be provided to allow for the passage of necessary airflow and to allow normal maintenance to be carried out.

IMPORTANT: Make sure that during transport the unit ALWAYS remains in the correct position!

Horizontal positioning of the unit can lead to irreversible damage to the compressors.

Damage arising from incorrect transport will not be under warranty by the manufacturer.

Immediately report an incorrect receipt of goods.

An arrow positioned upward indicates the vertical position of the unit.

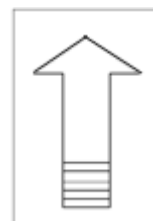

4.2 MINIMUM SPACE REQUIREMENTS

Dimensional drawings and minimum distances shall be respected to avoid:

- Noise
- Incorrect heat exchange and ventilation
- Difficult maintenance or inaccessibility to components

Limited installation space could reduce the normal air flow, thus significantly reducing unit performance and considerably increasing consumption of electrical energy.

CAUTION! In case two units have to be installed side by side, the distance to respect must be doubled.
After the unit has reached the final position, fix the anti-vibration bolts.

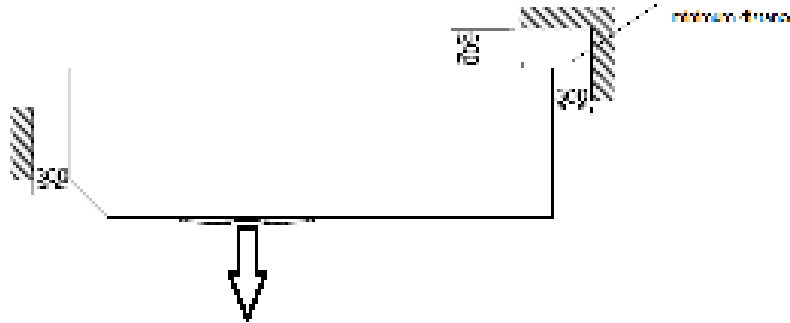

4.3 PRECAUTIONS FOR DOMINANT WINDS

Avoid obstacles on suction and discharge sides of the units. In case of presence of dominant winds in the installation area, it is strictly necessary to avoid (for units with horizontal flow fans) that such winds blow in front of the unit (fans discharge side). In case of unit with vertical flow fans, it is strictly necessary to avoid installations where the dominant winds could cause rejected hot air to come back to the condensing coils.

4.4 PRECAUTIONS AGAINST DIRECT SUNSHINE

Direct solar radiation can raise the temperature of condensation until it causes the unit shut down or failure of start-up of the same by action of the high pressure switch.

4.5 PRECAUTIONS AGAINST THE PRESENCE OF FIREPLACES AND EXHAUST HOT AIR

Avoid installation of the machines downwind of chimneys, smokestacks and different effluent discharges.

4.6 PRECAUTIONS AGAINST THE PRESENCE OF FOLIAGE AND FOREIGN BODIES

Avoid installing the unit in the immediate vicinity of plants that can prevent proper intake and discharge air.

4.7 CONTROL OF COMPRESSOR FASTENING

The scroll compressors are fitted on shock absorbers. For fixing through spring anti-vibration mounts, remove blockages put to fasten the compressors, as indicated on the label on compressors body.

5 ACOUSTIC PROTECTION

When the sound level must be checked, pay maximum attention to isolate the unit base frame properly applying the anti-vibration mounts (provided optionally). Also, install flexible joints on the water connections.

6 ELECTRICAL POWER SUPPLY

The mains power supply characteristics must match the unit's absorption. The mains power supply tension must correspond to the nominal value $\pm 10\%$, with a maximum difference between the phases of 2%.

6.1 POWER CONNECTIONS

Protect the unit electric box power supply circuit with protection devices (not included in the supplied equipment). Connect the line terminals with a three-core cable of a section which is appropriate to the machine absorption. The switch and the fuses like all the power connections must comply with the regulations in force.

6.2 IMBALANCE BETWEEN THE SUPPLY TENSION PHASES

Do not run the electrical motors when the voltage unbalance between the phases is more than 2%. Use the following formula to check:

$$\% \text{ Imbalance} = [(V_x - V_{ave}) \times 100 / V_{ave}]$$

$$V_{ave} = (V_1 + V_2 + V_3) / 3$$

V_x = phase with greatest difference from V_{ave} (without regard to the sign)

IMPORTANT: If the mains voltage has an imbalance of above 2%, contact the company, which distributes the electrical energy. If the unit functions with a unit voltage imbalance between the phases of above 2% the warranty is invalid.

6.3 UNIT VOLTAGE PHASING

It is important that proper rotation of the compressors be established before the unit is started. Proper motor rotation requires confirmation of the electrical phase sequence of the power supply. The motor is internally connected for clockwise rotation with the incoming power supply phases A-B-C.

7 WATER CONNECTIONS

7.1 EVAPORATOR

Piping must be adequately supported so that their weight does not damage the heat pump. The following parts must be installed on the evaporator water circuit and represent necessary conditions for the warranty to be valid:

- Two pressure gauges of adequate scale (in and out of the unit)
- Two shock-absorbing joints (in and out of the unit)
- One shut off valve (normal one in input)
- One setting valve (in output)
- Two thermometers (in and out)
- One circulation pump
- One safety valve on the water buffer
- One automatic air vent valve
- One expansion tank
- One inlet water filter placed as close as possible to the evaporator flange.
- One flow switch (mandatory to check if the flow switch well functions before the “start-up” of the unit)

Trane is at your disposal to examine any different requirements, which have to be approved before starting up the chiller. It is necessary that the water flow rate to the unit is compatible with the evaporator one. It is also necessary that the water flow rate is kept uniform while the unit is running: it is suggested to use always a pump system dedicated to the unit and independent from the remaining part of the plant.

Before storing units in temperatures around 0°C, evacuate the exchanger with compressed air in order to avoid breakings due to ice.

If the unit is installed in order to replace another, the entire hydraulic system must be emptied and cleaned before the new unit is installed. Regular tests and proper chemical treatment of water are recommended before starting up the new unit.

In the event that glycol is added to the hydraulic system as anti-freeze protection, pay attention to the fact that intake pressure will be lower, the unit's performance will be lower and water pressure drops will be greater. All unit-protection methods, such as anti-freeze, and low-pressure protection will need to be reset. Before insulating water piping, check that there are no leaks.

CAUTION! Install a mechanical water filter at the water inlet of each heat exchanger. Failure to install the filter allows access of solid particles and / or welding slag inside the heat exchanger. We recommend the installation of a filter having filtering net with holes not exceeding 0.5 mm in diameter.

Trane cannot be held responsible for any damage to heat exchangers due to the lack of good quality water filters.

7.1.1 Calculation of total minimum water content and flow rates

For optimal operation calculate the required water content using the following table:

CXB HT	cold water heat production				hot water heat production			
	V [m ³]	K	Q min [m ³ /h]	Q max [m ³ /h]	V [m ³]	K	Q min [m ³ /h]	Q max [m ³ /h]
120	-	565.5	2.0	5.3	0.6	565.5	1.9	6.5
125	-	510.6	2.5	6.8	0.7	510.6	2.5	8.4
130	-	522.0	3.4	9.1	0.9	522.0	3.2	10.8

LEGEND:

V: recommended water content of the plant

Q min: minimum water flow to the heat exchanger

Q max: maximum water flow to the heat exchanger

$\Delta T_{\text{max chiller}} = 8 \text{ } ^\circ\text{C}$

$\Delta T_{\text{max heat pump}} = 10 \text{ } ^\circ\text{C}$

$\text{dppw} = K \cdot Q^2 / 1000 Q = 0,86 P/\Delta T$

IMPORTANT: in heat pump mode with leaving water temperatures $\geq 55^\circ\text{C}$ the ΔT at the condenser must not be lower than 8°C .

IMPORTANT: If pump driven by an inverter (either unit onboard pump or external pump) in every working condition the variation of the water flow rate must be as low as possible. Variation must be less than 10% of the nominal flow rate per minute.

7.2 WATER CIRCUIT REGULATION EQUIPMENT

Centrifugal motor pump block - Assures the discharge and the prevalence necessary to supply tube nest evaporator, the tank and the utility.

Automatic filling unit - Assures the water pressure in the plant is maintained at least 1.5 bar, automatically resetting it when necessary.

Safety valve - Takes care of opening the plant in atmosphere if the pressure exceeds the value of 6 bar.

Expansion tank - Takes care of compensating small water hammering and variations of volume for different temperatures.

Check valves - Take care of intercepting the pump for possible maintenance.

7.3 WATER TREATMENT

Before putting the unit into operation, clean the hydraulic circuit. Dirt, scales, corrosion residue and other extraneous material can accumulate inside the heat exchanger and reduce its heat exchanging capacity. Pressure drops can increase as well, and thus reduce the water flow. Proper water treatment therefore reduces the risk of corrosion, erosion, scaling, etc. The most appropriate water treatment must be determined locally, according to the type of system and to the local characteristics of the process water.

Trane is not responsible for damage to or malfunctioning of equipment caused by failure to treat water or by improperly treated water.

Acceptable water quality limits

PH (25°C)	6,8÷8,0	Total Hardness (mg CaCO ₃ / l)	< 200
Electrical conductivity S/cm (25°C)	< 800	Iron (mg Fe / l)	< 1.0
Chloride ion (mg Cl ⁻ / l)	< 200	Sulfur ion (mg S ₂₋ / l)	None
Sulphate ion (mg SO ₂₄₋ / l)	< 200	Ammonium ion (mg NH ₄₊ / l)	< 1.0
Alkalinity (mg CaCO ₃ / l)	< 100	Silica (mg SiO ₂ / l)	< 50

7.4 PRECAUTION AGAINST FROST RISK OF THE HYDRAULIC PIPES

It is necessary to insulate pipes in the plant to avoid extreme heat loss and to protect them from weather conditions. The problem of water pipes freezing could appear in two different situations:

1. Stand by, with mode on, but electrically connected: in this case, the unit has frost resistances, which protect the weather locally contained in the exchangers and in the pipes from ice formation. These resistances do not warranty the protection against the frost in the outdoor connection pipes, to be prevented by frost protection systems. Trane suggests to insert frost thermostatic resistances on every outdoor pipe, according to the indicative electric power per pipe linear meter in the table below.

Heating cable required power

dn	inch	W / m
8	1/4"	5
10	3/8"	5
15	1/2"	5
20	3/4"	10
25	1"	13
40	1" 1/2	30
50	2"	50
65	2" 1/2	80
80	3"	120
100	4"	200
125	5"	300
150	6"	450

2. Electrically unconnected unit: in this case the frost resistances of the unit could not warranty the protection. It is necessary to add the correct glycol quantity indicated in the chapter: "ethylene glycol correction table" (§3.3). Please consult Trane service for % of glycol required.

7.5 PRECAUTION FOR VERY LOW OUTDOOR TEMPERATURES

In case of installation conditions with a lower temperature:

If there are storages, insert electric resistances to be calculated by:

$$PrWatt = V \times (10 - t_{min}) / 860$$

where: *PrWatt* is the resistance power (Watt) and *tmin* is the lower temperature (°C)

If there are not storages, maintain the water temperature higher than 10°C by inserting thermostatic resistance with power calculated as in case 1.

7.6 ANTIFREEZE PROTECTION ON THE HEAT EXCHANGER

Two or more protection methods should be foreseen when designing the system:

1. Continuous water flow circulation inside piping and exchanger when ambient air temperature is holding below 5 °C. This implies what follows:

- if the water flow inside piping and exchanger of the unit is due to an external pump installed by the customer, the on/off command of this pump must always be the one provided by the unit controller through the relevant free potential contact in the electrical cabinet.

- As long as the ambient air temperature is holding below 5 °C the unit must always be electrically supplied. Moreover the customer pump, if present, must always be electrically supplied alike and functioning properly.

2. Addition of an appropriate amount of glycol inside the water circuit.

3. Additional heat insulation and sufficient heating of exposed piping and any component such as valves, temperature/pressure probes etc. which can result damaged by very low temperature.

4. Emptying and cleaning of the heat exchanger during the winter season.

It is the responsibility of the installer and/or of local maintenance personnel to ensure two or more of the described antifreeze methods. Continuously verify, through routine checks, that appropriate anti-freeze protection is maintained.

Failure to follow the instructions above could result in damage to some of the unit's components. Damage from freezing is not covered by the warranty.

CAUTION: The unit water pipes are not protected against the risk of water freeze-up when the unit is not electrically powered or when the unit is electrically powered but power supply and control of the external water pumps are not managed by the CXB HT unit controller. The owner or local maintenance personnel must provide appropriate solutions to prevent freezing.

7.7 HYDRAULIC VERSIONS

Units are available in two hydraulic versions characterized by complete kits of all major hydraulic components for an easier installation, with reduced time, cost and space.

- 1 pump without tank
- 1 pump with tank

Hydronic accessories on request

- "Y" water strainer (sold separately), consists of body and stainless steel mesh, with replaceable filter through the inspection cap.
- Automatic water filling (sold separately).

IMPORTANT: Water strainer with meshes not over 0.5mm is obligatory in order to keep the warranty

7.7.1 Hydraulic diagram for CXB HT units with 1 pump without tank

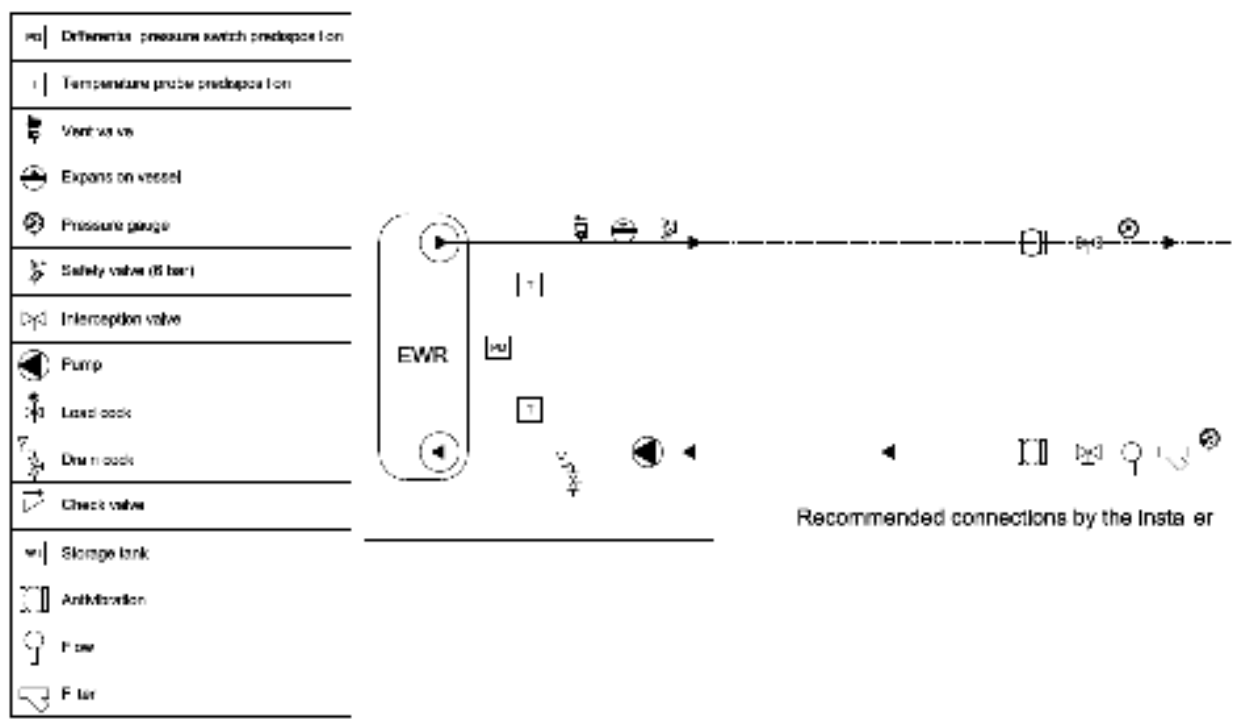

7.7.2 Hydraulic diagram for CXB HT units with 1 pump with tank

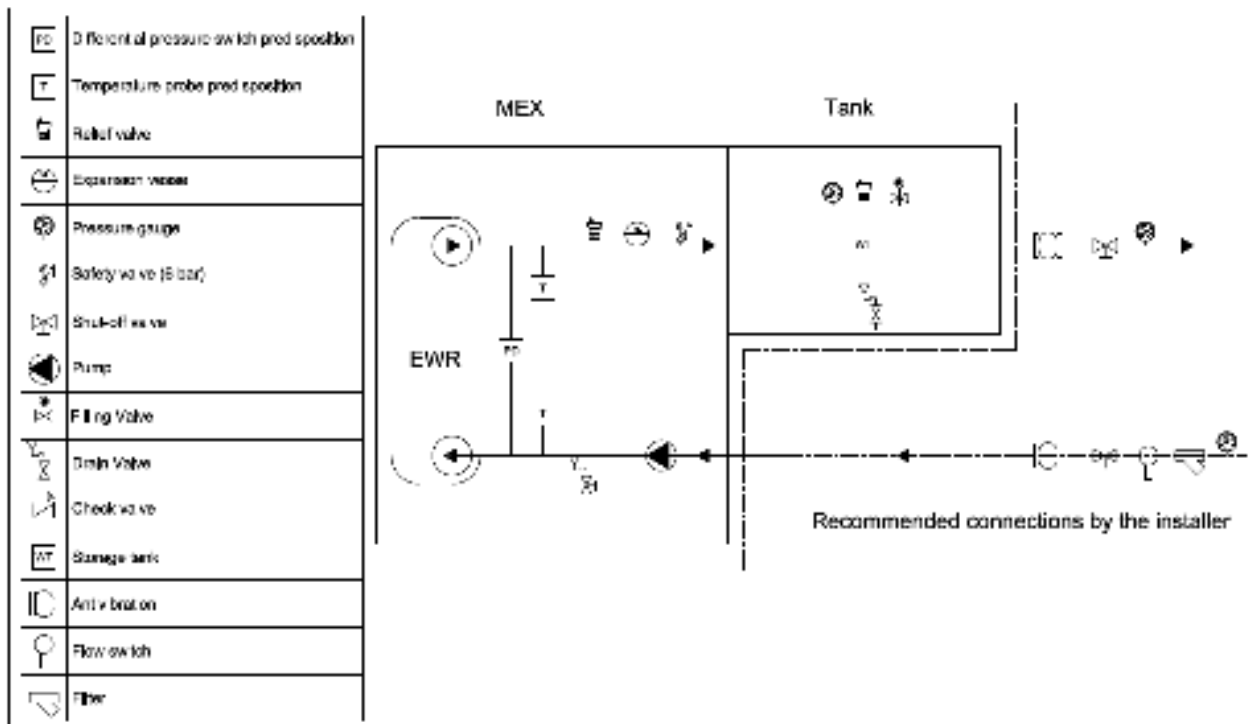

7.8 TANK MOUNTING INSTRUCTIONS

The water tank, if required, is supplied as a loose accessory and to be mounted by the customer/contractor based on the following instructions:

A. Remove the two inspection panels of the water tank.

B. With the unit in lifting phase, positioning the drain path pipes as shown in the figure below.



C. Position the unit in the group with water tank, lining up the holes of the upper bracket of the tank with the drilling of the underside of the foot, making sure to route the drain path pipes inside the holes on the base of the hydronic kit.

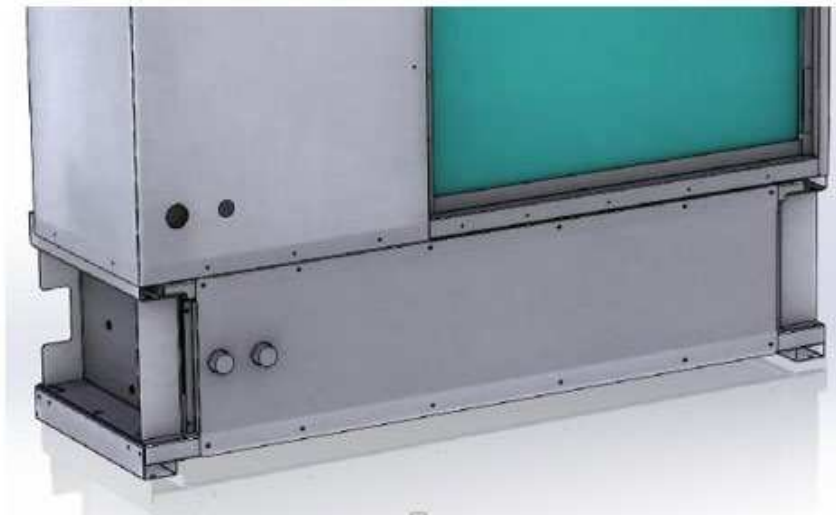

D. Carry out by coupling bolts.



E. Mount the two inspection panels of the water tank.



7.9 CUSTOMER PLANT SKETCHES

7.9.1 Customer plant sketch with primary pump

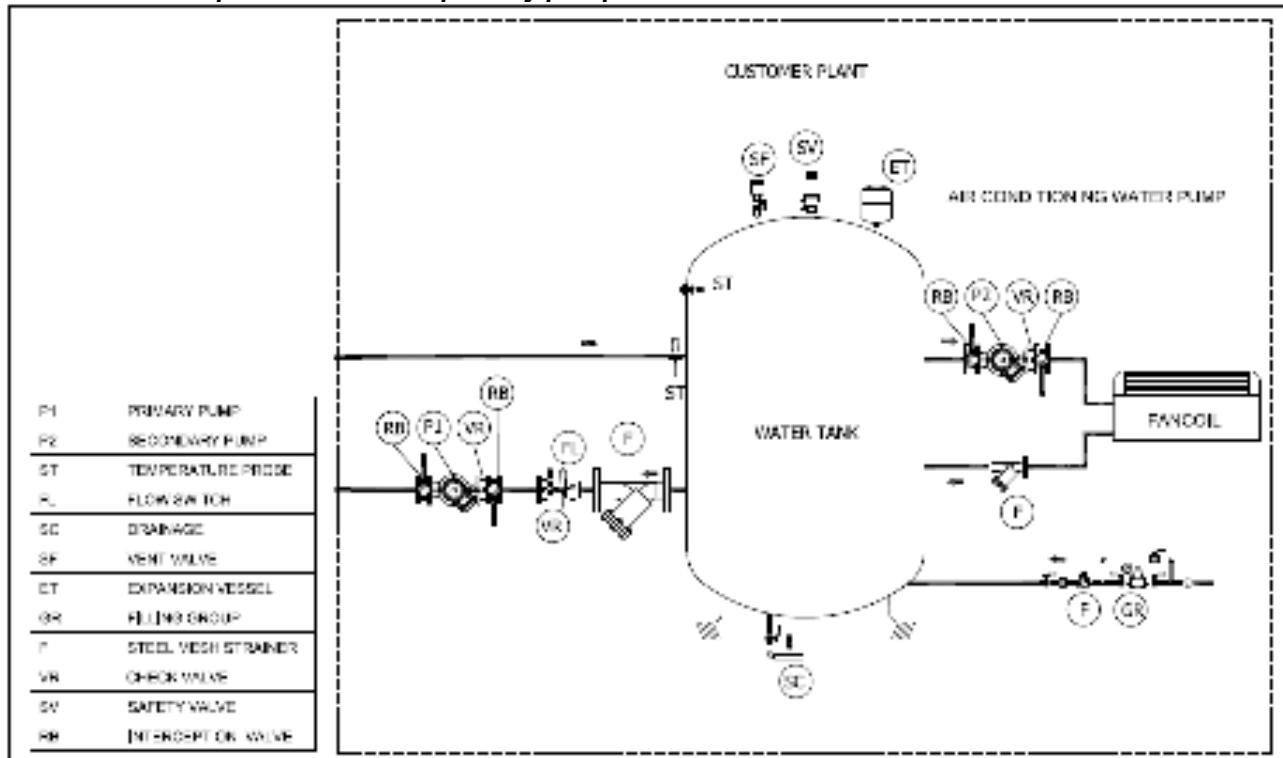

IMPORTANT: the flow switch in the customer plant is obligatory in order to keep the warranty

7.9.2 Customer plant sketch without primary pump (pump on board the unit)

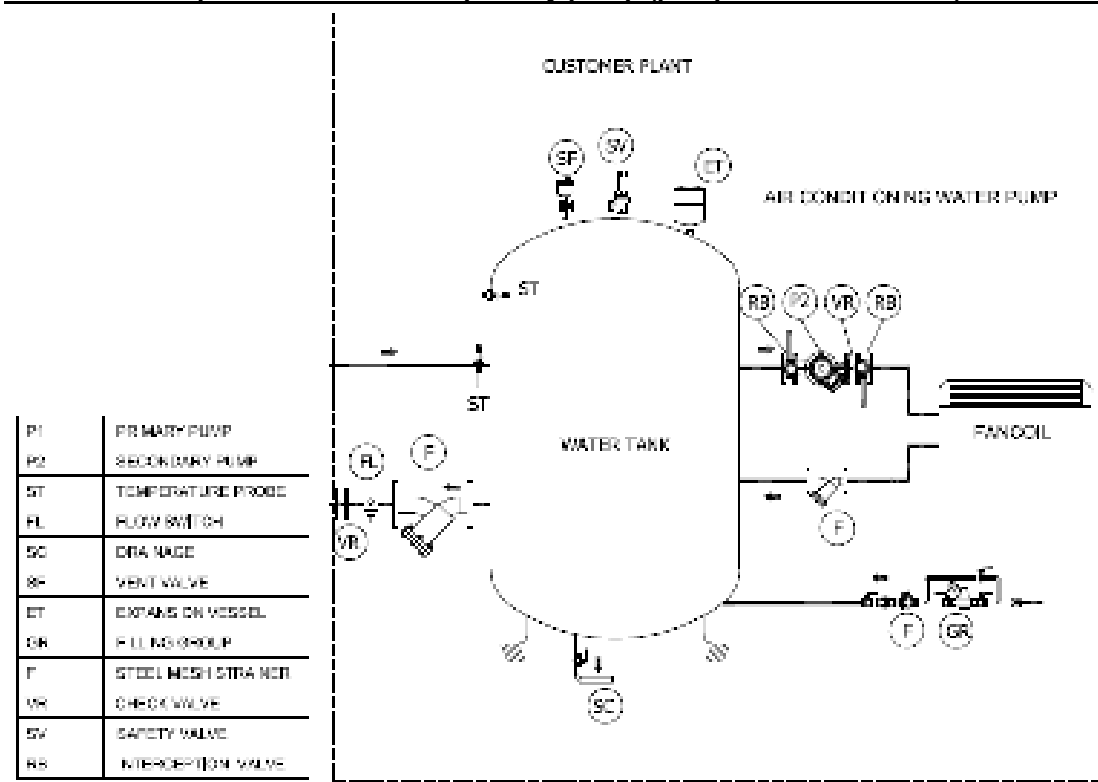

IMPORTANT: the flow switch in the customer plant is obligatory in order to keep the warranty

7.9.3 Flow switch installation

To ensure adequate water flow through the evaporator the installation of a water flow switch is mandatory. The purpose of the flow switch is to stop the unit in case of an interruption of the water flow while protecting the evaporator from freezing. The flow switch can be mounted in any position far from elbows or bottlenecks and with the arrow in the direction of the water flow. For installations on vertical piping it is necessary to calibrate the device to compensate for the weight of the headstock. If the unit is mounted to the bottom, note that deposits can form. The appliance **must** be installed in a straight pipe with no filters, valves, etc.,

Have at least 5 times its diameter, both upstream and downstream.

Blade type flow switches are available as loose accessories and are suitable for harsh environments and for pipes with diameters from 1" to 8". The flow switch has a contact which must be wired, by the contractor, on the jobsite. Check the unit wiring diagram for more information. See the instruction sheet inside the flow switch box for information about positioning and settings.

Dimensions (mm)

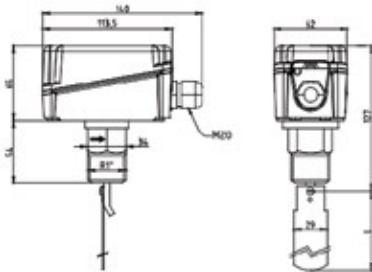

Mounting instructions

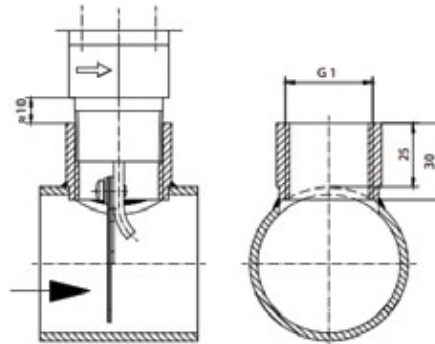

Paddle (model without "T" piece)

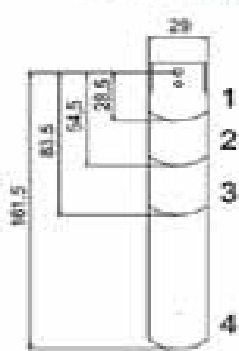

PIPES	PADDLES
1"	1
1 1/4"	1
1 1/2"	1
2"	1,2
2 1/2"	1,2
3"	1,2,3
4"	1,2,3
4" Z	1,2,3,4
5"	1,2,3
5" Z	1,2,3,4
6"	1,2,3
6" Z	1,2,3,4
8"	1,2,3
8" Z	1,2,3,4

8 ELECTRICAL PANEL

General

- All field-installed wiring must be in accordance with local regulations, CE directives and guidelines. Be sure to satisfy proper equipment grounding requirements according CE
- The following standardized values - Maximum Amps –Maximum kW are displayed on unit nameplate.
- All field-installed wiring must be checked for proper terminations, and for possible shorts or grounds.

Ensure total protection against the possible penetration of water into the connection point.

All the cables and the terminals are univocally numbered according to the electrical scheme in order to avoid possible misinterpretation. The identification system of the cables connected to the components allow also an easy and intuitive recognition of the component. Each component of the electrical panel is provided with an identification plate according to what is shown on the electrical scheme. All the connection to the electrical panel are made from the bottom and are equipped with cover preventing from break. The electrical panel supply is 400V/3ph+n/50Hz (TN-S system) and no additional power supply is necessary. The entrance for the power cables is provided on the bottom of the box where a dismountable flange suitable for the purpose is provided. The electrical power supply without neutral 400V/3ph/50Hz is available as option.

The control circuit is powered with 24 VAC. Each unit is provided with auxiliary transformer control circuit 230/24V. It requires no additional power cable for the control equipment.

The unit has an antifreeze heater installed directly into the evaporator. The circuit also has an electric resistance installed in the compressor in order to keep warm the oil and thus avoid the transmigration of the refrigerant in its interior. Obviously the operation of the electrical resistors is warranted as long as the unit is power supplied.

The unit is equipped with an alarm relay, which changes state every time an alarm occurs in one of the cooling circuits. Connect the terminals as per the wiring diagram on the unit - terminal "X" - a visual or audible alarm or any external supervision system.

BMS to monitor its operation is allowed. See the wiring diagram of the unit.

WARNING Hazardous Voltage with Capacitor! Disconnect all electric power, including remote disconnects and discharge all motor start/run and capacitors before servicing. Follow proper lockout/tag out procedures to ensure the power cannot be inadvertently energized.

For variable frequency drives or other energy storing components provided by Trane or others, refer to the appropriate manufacturer's literature for allowable waiting periods for discharges capacitors. Verify with an appropriate voltmeter that all capacitors have discharged.

After disconnecting input power, wait five (5) minutes for units which are equipped with EC fans and wait twenty (20) minutes for units which are equipped with variable frequency drive (0V DC) before touching any internal components. Failure to follow these instructions could result death or serious injury.

9 OPERATOR RESPONSIBILITIES

It is important that the operator is properly trained and familiar with the equipment before working on the unit. In addition to reading this manual, the operator must study the manual operation of the microprocessor and the wiring diagram to understand the sequence of start-up, operation, shutdown sequences, and the criterion of operation of all safety devices. During the initial start-up of the unit an authorized technician is available to answer any questions and educate on the proper functioning. We recommend the operator to maintain a record of the operating data for each unit installed and all maintenance activities and periodic service. If the operator observes abnormal or unusual operating conditions, consult the authorized service technician.

10 START-UP PRELIMINARY PROCEDURES

10.1 STARTING CHECK

Before starting the unit, even only momentarily, all the machinery supplied by the chilled water, like the air handling units, pumps, etc. have to be checked. The pump auxiliary contacts and the flow switch have to be connected to the control panel as indicated in the electrical diagram. Before carrying out interventions on the valve regulations, loosen the relevant valve gland. Open the discharge valve of the compressor. Open the liquid shutoff valve placed on the liquid line. Measure the suction pressure. If it is lower than 0.42 MPa jumper and strain the solenoid valve on the liquid line. Bring the suction pressure to 0.45 MPa, then remove the jumper. Charge all the water circuit progressively. Starts up the water pump of the evaporator with the calibration valve shut and then slowly open it.

Discharge the air from the high points of the water circuit and check the direction of the water flow. Carry out calibration of the flow by using a measurer (if present or available) or by means of a combination of the readings of the manometers and the thermometers. In the starting phase calibrate the valve on the pressure difference read on the manometers, carry out drainage of the tubes and then carry out fine calibration on the temperature difference between the water in and the water out. The regulation is calibrated in the factory for water in to the evaporator at 12°C and water out at 7°C. With the general switch open, check that the electrical connections are tightly clamped. Check for any possible refrigerant leaks. Check that the electrical data on the label correspond to those of the mains supply. Check that the thermal charge available is appropriate for starting.

10.2 REFRIGERANT SEALS CONTROL

Trane units are sent with the complete charge of refrigerant and are at a sufficient pressure to check the seal after installing. If the system were not under pressure, blow refrigerants (vapour) into it until pressure is reached and look for leakage.

After having eliminated the leakage, the system has to be dehydrated with a vacuum pump up to at least 1mm Hg - absolute pressure (1 Torr o 133.3 Pa). This is the minimum recommended value to dehydrate the plant.

Danger Do not use the compressor to vacuum the system.

10.3 REFRIGERANT CHARGE CHECK

Trane units are supplied with a complete charge of refrigerant. If bubbles can be seen through the peephole with the compressor running with a full charge and steadily, the refrigerant charge is insufficient.

12 CHECK LIST - MANDATORY OPERATION CONTROL BEFORE START-UP

DATE		N.	
UNIT			

CUSTOMER:	SITE: ADDRESS: POSTCODE: COUNTRY:
------------------	--

GENERAL

		COMPLIANCE	
		YES	NO
1	<p>THE HYDRAULIC CIRCUIT IS COMPLETE AND READY TO BE USED AND THE THERMAL LOAD IS AVAILABLE.</p> <p>PLEASE NOTE THAT THE FIRST START-UP SHALL NOT BE CARRIED OUT UNLESS THE PLANT IS READY AND THE WATER LOAD IS AVAILABLE.</p>		
2	<p>THE UNIT DISPLAYS DENTS OR DAMAGES ON THE EXTERNAL CASING OCCURRED DURING THE TRANSPORTATION OR POSITIONING.</p> <p>IF ANY, SPECIFY BELOW:</p> <p>WARNING: PLEASE BE AWARE THAT RELEVANT DAMAGES CAUSED BY THE QUOTED CIRCUMSTANCES MAY RESULT IN THE CALL-OFF OF THE WARRANTY.</p>		
3	<p>THE UNIT HAS BEEN INSTALLED IN ACCORDANCE WITH THE MINIMUM DISTANCE PROVIDED IN THE DIMENSIONAL DRAWING AND TECHNICAL DOCUMENTATION PROVIDED.</p>		
4	<p>THE UNIT IS INSTALLED NEXT TO THE: PHOTOVOLTAIC SYSTEM, ELECTRONIC TRANSMITTERS, ANTENNAS OR SIMILAR DEVICES.</p>		
5	<p>THE UNIT IS POSITIONED ON A PERFECTLY FLAT (NOT INCLINED) SURFACE.</p>		
6	<p>ANTI-VIBRATIONS DAMPERS HAVE BEEN INSTALLED BETWEEN THE UNIT AND THE FLOOR.</p>		
7	<p>THE UNIT DISPLAYS DEFECTS OR DAMAGES RESULTING FROM MODIFICATIONS OR CHANGES (UNIT TAMPERING / UNAUTHORIZED MODIFICATIONS TO THE REFRIGERANT CIRCUIT OR THE HYDRAULIC CIRCUIT OR THE ELECTRICAL PANEL OR CHANGES TO THE UNIT OPERATING PARAMETERS) MADE BY A THIRD PERSON WITHOUT A WRITTEN AUTHORIZATION ISSUED BY TRANE. THE UNIT SHALL BE CONFORM TO TRANE WIRING DIAGRAMS AND TECHNICAL DOCUMENTATION) IN CASE OF RELEVANT DIFFERENCE BETWEEN THE UNIT AND TRANE STANDARD CONFIGURATION PLEASE CONTACT TRANE.</p> <p>WARNING: PLEASE BE AWARE THAT RELEVANT DAMAGES CAUSED BY THE QUOTED CIRCUMSTANCES MAY RESULT IN THE CALL-OFF OF THE WARRANTY.</p>		
8	<p>THE UNIT HAS BEEN INSTALLED VERY CLOSE TO A MARINE ENVIRONMENT OR AN AGGRESSIVE INSTALLATION ENVIRONMENT (HIGHLY CORROSIVE CHEMICAL AGENT).</p> <p>WARNING: PLEASE BE AWARE THAT RELEVANT DAMAGES CAUSED BY THE QUOTED CIRCUMSTANCES MAY RESULT IN THE CALL-OFF OF THE WARRANTY.</p>		
9	<p>SPOTTED PRESENCE OF MOLD, MUSHROOMS, BACTERIA, MICROBIAL OF ANY TYPE.</p>		
10	<p>THE UNIT DISPLAYS DAMAGES CAUSED BY: FLOODS, LIGHTNING, FIRE, ANY ACCIDENT BEYOND TRANE CONTROL.</p>		

ELECTRIC AND ELECTRONIC

		COMPLIANCE	
		YES	NO
11	THE UNIT IS ELECTRICALLY POWERED AND ALL THE RELEVANT ELECTRICAL WIRES ARE PROPERLY CONNECTED.		
12	ELECTRICAL SUPPLY HAS BEEN INSTALLED IN ACCORDANCE WITH THE INSTRUCTIONS PROVIDED IN THE NAME PLATE AND IN THE TECHNICAL DOCUMENTATION. (ELECTRICAL POWER SUPPLY: 230V/400V +/- 10% - MAXIMUM "% OF PHASE IMBALANCE: +/- 2%) . IT IS RECOMMENDABLE TO CHECK BY USING A TESTER THE VOLTAGE VALUE (BETWEEN PHASES AND BETWEEN PHASE AND NEUTRAL)		
13	PHASES ARE CONNECTED IN THE PROPER SEQUENCE.		
14	ELECTRICAL CABLES SIZE ARE CONFORM TO FLA MAX VALUE.		
15	BOTH EXTERNAL AND INTERNAL ELECTRICAL WIRES ARE WELL TIGHTENED.		
16	THE COMPRESSOR CRANCKCASE HEATERS HAVE BEEN POWERED AND HEATED AT LEAST 8 HOURS BEFORE THE START-UP		
17	AN ELECTRONIC SUPERVISOR (OR ANY ADDITIONAL CONTROLLER) HAS BEEN INSTALLED.		
18	THE CONNECTION WIRES ARE SHIELDED.		
19	REMOTE CONTROL DEVICES OR INTERFACES ARE CONNECTED TO THE ELECTRICAL PANEL IN CONFORMITY WITH TRANE WIRING DIAGRAMS		
20	ELECTRIC DEVICES ARE INTACT AND DON'T DISPLAY ANY DAMAGE.		
21	AN EXTERNAL WATER PUMP IS ELECTRICALLY CONNECTED TO THE ELECTRICAL PANEL IN ACCORDANCE WITH THE WIRING DIAGRAMS PROVIDED BY TRANE		
22	THE ELECTRICAL ABSORPTION AND THE WATER PUMP OVERHEATING ARE STANDARD.		

REFRIGERANT CIRCUIT

		COMPLIANCE	
		YES	NO
23	ALL CONNECTIONS ON THE REFRIGERANT CIRCUITS ARE WELL TIGHTENED.		
24	THE ELECTRONIC LEAKAGE DETECTOR OR THE PRESSURE GAUGE LEVEL INSTALLED ON THE REFRIGERANT CIRCUIT HAVE DETECTED ANY LEAKAGE. IF ANY, SPECIFY BELOW:		
25	THE COMPRESSOR OIL INDICATOR LIGHT POINTS THE MAXIMUM LEVEL.		
26	THE FILTER INDICATOR LIGHT ON THE LIQUID LINE IS GREEN. WARNING: THE YELLOW INDICATOR LIGHT INDICATES PRESENCE OF MOISTURE IN THE CIRCUIT. IN THIS CASE PLEASE CONTACT TRANE.		

WATER CIRCUIT

		COMPLIANCE	
		YES	NO
27	<p>THE FILTER IS INSTALLED ON THE HEAT EXCHANGER INLET PIPES, AT A MAXIMUM DISTANCE OF 2 METERS FROM THE UNIT.</p> <p>PLEASE NOTE THAT THE FILTER INSTALLATION IS MANDATORY. FOR FURTHER TECHNICAL INFORMATION RELATING THE FILTER PLEASE REFER TO THE TECHNICAL DOCUMENTATIONS.</p>		
28	<p>THE FLOW SWITCH HAS BEEN INSTALLED AND ELECTRICALLY CONNECTED. PLEASE NOTE THAT FLOW SWITCH INSTALLATION IS MANDATORY.</p>		
29	<p>THE VALVES ON THE WATER PLANT MUST BE OPENED. PLEASE BE AWARE THAT IF THE MACHINE IS POWERED (OR IN STAND-BY MODE) PUMPS WILL START IF THE WATER TEMPERATURE IS EQUAL OR BELOW 4°C. CLOSING THE VALVES MAY THEREFORE CAUSE SEVERE DAMAGES.</p>		
30	<p>DRAINAGE VALVES ARE INSTALLED. THE DRAINAGE VALVES ARE INSTALLED ON THE LOWEST POINT. THE UTILIZATION OF AUTOMATIC DRAINAGE VALVES IS RECOMMENDED.</p>		
31	<p>AUTOMATIC OR MANUAL PURGE VALVES ARE INSTALLED.</p> <p>AUTOMATIC OR MANUAL PURGE VALVES ARE INSTALLED ON THE HIGHEST POINT.</p>		
32	<p>THE HYDRAULIC CIRCUIT HAS BEEN FILLED AND PURGED.</p> <p>THE PLANT SHALL BE PURGED SEVERAL TIMES BEFORE STARTING UP THE UNIT. THE FILTER INSTALLED NEXT TO THE HEAT EXCHANGER SHALL BE CLEANED SEVERAL TIMES BEFORE STARTING UP THE UNIT, UNTIL THE CORRECT DELTA T IS ASSURED AND THE HYDRAULIC PRESSURE IS CONFORM TO THE PLANT AND TO THE WATER PRESSURE DROPS. FOR FURTHER TECHNICAL INFORMATIONS PLEASE REFER TO TRANE DOCUMENTATIONS AND PROCEDURE FOR THE FIRST START UP.</p>		
33	<p>HYDRAULIC CONNECTIONS TO THE UNIT ARE COMPLIANT WITH THE UNIT NAME PLATE AND DIMENSIONAL DRAWINGS (HOT WATER INLET, HOT WATER OUTLET, COLD WATER INLET, COLD WATER OUTLET, EXT.).</p>		
34	<p>RUBBER JOINTS ARE INSTALLED ON THE HYDRAULIC CONNECTIONS, IN ORDER TO MINIMIZE VIBRATIONS BETWEEN THE UNIT AND WATER PIPES.</p>		
35	<p>SHUTOFF VALVES ARE INSTALLED ON THE HYDRAULIC CIRCUIT.</p>		
36	<p>THE EXPANSION TANK IS INSTALLED ON THE HYDRAULIC CIRCUIT. EXPANSION TANK CAPACITY CONCURS WITH THE WATER PLANT CAPACITY.</p>		
37	<p>TEMPERATURE PROBES AND PRESSURE GAUGES ARE INSTALLED ON THE HYDRAULIC CIRCUIT, BOTH INLET AND OUTLET SIDE.</p>		
38	<p>THE HYDRAULIC CIRCUIT IS FREE FROM OBSTRUCTION OR ANY KIND OF CONSTRAINT.</p>		
39	<p>BUFFER TANK IS INSTALLED IN THE HYDRAULIC CIRCUIT. THE BUFFER TANK INSTALLATION IS STRONGLY RECOMMENDED IN ORDER TO WARRANTY THE OPTIMAL UNIT OPERATION.</p>		
40	<p>THE PRESSURE RELIEF VALVE IS INSTALLED BETWEEN DELIVERY AND RETURN PIPES.</p> <p>WARNING: IN ORDER TO AVOID WATER-HAMMER, THE RELIEF VALVE PRESSURE SHALL BE SET UP IN ACCORDANCE WITH THE STANDARD OPERATING PRESSURE OF THE WATER CIRCUIT.</p>		
41	<p>THE AUXILIARY HEATING SYSTEM IS INSTALLED IN THE WATER CIRCUIT IN ORDER TO AVOID THE START-UP OF THE UNIT WITH WATER TEMPERATURE BELOW 18°C. BEFORE STARTING UP THE UNIT THE INLET WATER TEMPERATURE MUST BE EQUAL OR HIGHER THAN 18°C.</p> <p>WARNING: THE UNIT SHALL NEVER WORK (NOT EVEN FOR SHORT PERIODS) WITH AN INLET WATER TEMPERATURE LOWER THAN 18°C.</p>		
42	<p>ANTIFREEZE PROTECTIONS ARE INSTALLED IN THE WATER CIRCUIT (ELECTRICAL HEATERS ARE INSTALLED ON WATER PIPES AND TANKS).</p> <p>FOR FURTHER TECHNICAL INFORMATION PLEASE REFER TO TECHNICAL DOCUMENTATION PROVIDED. PLEASE NOTE THAT ANTIFREEZE PROTECTIONS ARE MANDATORY FOR OUTDOOR AIR TEMPERATURE LOWER THAN</p>		

	3°C.		
43	THE WATER CIRCUIT IS FILLED WITH ETHYLENE GLYCOL. ETHYLENE GLYCOL “%” SHALL CONFORM WITH THE DATA PROVIDED IN THE TECHNICAL DOCUMENTATION.		
44	ALL WATER PIPES ARE GROUND CONNECTED (IN ORDER TO AVOID ABNORMAL VOLTAGES THAT CAN CAUSE DANGEROUS CORROSIONS).		
45	THE EVAPORATOR WATER FLOW IS COMPLIANT TO THE TECHNICAL DOCUMENTATION PROVIDED BY TRANE.		
46	THE WATER PUMPS ARE CORRECTLY SET UP IN ACCORDANCE WITH THE PLANT WATER FLOW, AVAILABLE HEAD PRESSURE AND PRESSURE DROP.		
47	THE PUMP IMPELLERS ARE MECHANICALLY UNBLOCKED AND UNCLOGGED (FREE FROM ANY KIND OF CONSTRAINTS.)		

DATE:	<u>AUTHORIZED SERVICE:</u> <u>NAME AND SIGNATURE</u>	<u>CUSTOMER:</u> <u>NAME AND SIGNATURE</u>
--------------	---	---

12.1 REFRIGERANT CHARGE

12.1.1 Refrigerant replacement procedure with unit stopped and in vacuum (refrigerant charge in the liquid phase)

Open the shut off valve as far as possible so that it closes the service coupling. Connect the refrigerant cylinder to the service coupling without tightening the coupling. Half close the liquid shut off valve. If the circuit has been dehydrated and is in vacuum, charge the liquid by turning the cylinder upside down. Weigh and charge the appropriate quantity. Open the valve completely. Start up the unit and leave it running at full charge for some minutes. Check that the indicator is clear with no bubbles. Make sure that the transparency condition without bubbles is due to the liquid and not to the vapour. Correct functioning of the unit allows for overheating of 4 - 7° C and subcooling of 4 - 8°C. Values of overheating which are too high may be caused by a lack of refrigerant, whereas high subcooling values may mean an excess of charge. After intervention on the charge, it is appropriate to check that the unit runs within the declared values: with unit steadily running on a full charge, measure the temperature of the suction line downstream of the thermostatic valve bulb; read the balance pressure to the evaporator on the low pressure manometer and the corresponding saturation temperature. Overheating is equal to the difference between the temperatures measured in this way. Then measure the temperature of the liquid line coming out of the condenser and read the balance pressure to the condenser on the high -pressure manometer and the corresponding saturation temperature. The subcooling is the difference between these temperatures.

WARNING! While refrigerant is being added, do not exclude any control system and let the water circulate in the evaporator to avoid the formation of ice.

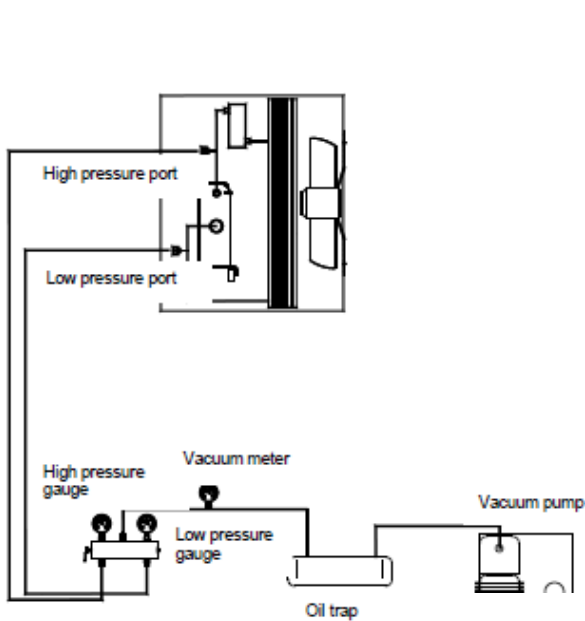

Cooling circuit diagram with connection to vacuum pump

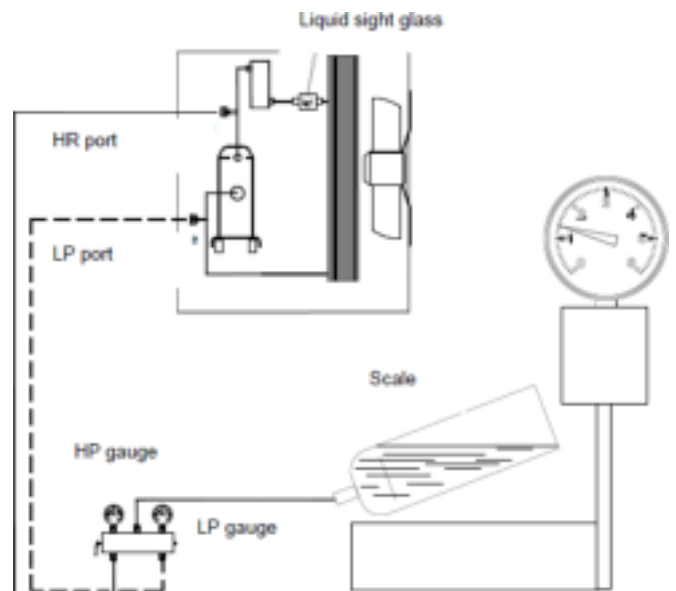

Refrigerant charge in the liquid phase

12.1.2 Refrigerant replacement procedure with unit running (refrigerant charge in the vapour phase)

CAUTION! charge vapour only. Do not charge liquid because it may damage the compressor.

Connect the refrigerant cylinder to the service valve without tightening the coupling. Drain the connection piping and tighten the coupling. Charge each circuit until the indicator indicates liquid without bubbles. Now the unit has the required charge. Make sure not to overcharge the circuit. Charging more than necessary leads to a higher delivery pressure, greater power consumption and possible damage to the compressor.

The symptoms of a low refrigerant charge are:

Low evaporation pressure.

High superheat the intake and exhaust (outside the above limits).

Low value of subcooling.

In this case, add refrigerant R410A. The system has a charging port between the expansion valve and the evaporator.

Charge refrigerant until conditions return to work normal. Remember to replace the cap closing the valve at the end.

IMPORTANT!

If the unit has not been provided with integrated pump on board, do not turn off the external pump before 3 minutes have elapsed after turning off the last compressor. The early shutdown of the pump causes a water flow alarm failure.

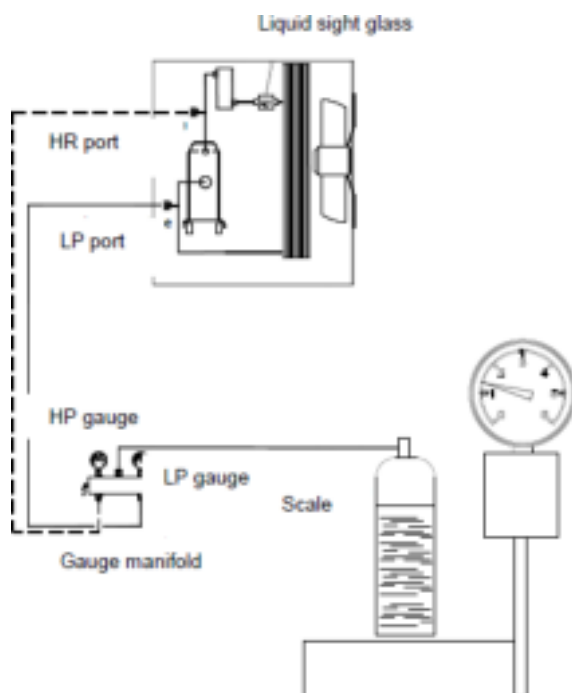

Refrigerant charge in the vapour phase

13 START-UP

13.1 PRELIMINARY CONTROLS

Before starting up the equipment it is very important to check that all the operations described in the paragraph "CHECK LIST – MANDATORY OPERATION CONTROL BEFORE START UP" have been carried out correctly.

Moreover check that all the mechanical and electrical connections have been correctly mounted and tightened. Particular attention should be paid to the main components (compressors, heat exchangers, fans, electrical motors, and water pump). In case loose connections are found tighten them well before starting up the unit.

The oil heaters have to be activated at least 8 hours before starting up. Ensure that the compressors' carter is hot. Open the compressor valve and the cooling circuit valve, which may have been shut for charging. Control all the machinery connected to the unit.

13.2 STARTING UP

Start up the unit by pressing the ON/OFF button. About 20 seconds pass from the moment in which the startup request of the unit is given to the moment in which the (first) compressor starts. Three hundred and sixty seconds will pass from the last shut down to the next startup of the same compressor.

Check the rotation direction of the fans. If it is not the right one, invert two supply phases. Ensure that all the safety and control equipment is functioning correctly. Control the temperature of the water coming out of the evaporator and regulate the control setting if necessary. Control the oil level. The oil type is OIL-ICI EMKARATE RL32-3MAF.

13.3 WARM UP OF THE PLANT

In order to keep all the unit components in good condition and to optimize their use, during the warm up it is necessary to bring the circuit to the right temperature before releasing cooling energy to the utilities.

The following steps must be followed for this to be carried out:

- * start up the unit
- * wait for the water in temperature to reach the running temperature set
- * start up the consumers

Follow the above mentioned procedure every time the plant is stopped long enough for the water temperature contained in it to rise.

13.4 CONTROL OF THE OIL CHARGE

All the compressors mounted on Trane units are factory charged with oil whose chemical characteristic of stability are very good, so it is not necessary to change the lubricant oil frequently.

The scroll compressors are equipped with an oil sight glass from which you can control the level. In tandem or trio performances, pay particular attention to oil level.

In case of burns for the electrical motor or fault of the compressor, it is necessary to make a test to check the acidity of the lubricant oil and, eventually, clean the circuit to reduce the acidity to correct values, mounting for instance an anti-acid filter and changing the oil in the circuit.

13.5 START UP PROCEDURE

- 1) With the switch closed, open the electrical panel and exclude compressor (refer to the wiring diagram on the unit). Close the panel, set switch to "ON" (to give power to the unit).
- 2) Wait for the start of the microprocessor and control. Make sure that the temperature of the oil is hot enough. The oil temperature must be at least 5°C higher than the saturation temperature of the refrigerant inside the compressor.
- 3) Place the unit in the "ON" and wait until the unit is indicated on the display-On.
- 4) Turn on the pump, at max speed if with inverter.
- 5) Verify that the loss of load of the evaporator is equal to that of the project and correct if necessary. The loss must be recorded attacks on the charge placed on the evaporator piping and supplied as standard. Do not measure the load losses in points where any valves and / or filters are interposed.
- 6) Check for air in cleaning filters, and then drain the system.
- 7) Return the pump to the factory setting.
- 8) Turn off the power (into standby mode) and make sure the pumps stop after about 2 minutes.

Verify that the local temperature set point is set to the required value by pressing the Set button.

9) Turn the main switch to "OFF". Open the cabinet. Reactivate the compressors. Close the cabinet. Turn the main switch to "ON" (to give power to the unit).

10) Wait for the start of the microprocessor and control.

11) When the compressor is started, wait about 1 minute for the system begins to stabilize.

12) Check the pressure of evaporation and condensation of refrigerant.

13) Verify that, after a period of time necessary for the stabilization of the refrigerant circuit, the liquid indicator placed on the inlet pipe to the expansion valve is completely filled (no bubbles), and that the moisture indicator displays 'Dry'. The passage of bubbles within the liquid indicator, it may indicate a low amount of refrigerant, or an excessive pressure drop through the filter drier, or an expansion valve blocked at the maximum opening position

14) In addition to checking the sight glass, check the operating parameters of the circuit controlling:

a) - Overheating compressor

b) - Overheating compressor discharge

c) - Sub-cooling of the liquid exiting the condenser coil

d) - Evaporation pressure

e) - Condensing pressure

15) Measure the values of pressure and temperature by means of the suitable instrumentation and make comparison by reading the corresponding values directly on the display of the microprocessor on board

16) To temporarily turn off the unit put on standby the unit key or open the remote contact (terminals shown in the wiring diagram provided with the unit) of the terminal X (by means of a remote switch installed by the customer) or set time zones. The microprocessor will activate the shutdown procedure that will take a few seconds. Two minutes after switching off the compressor the microprocessor will turn off the pump. Do not remove the main power to not turn off the electrical resistances of the compressor and the evaporator.

17)

14 MAINTENANCE

Maintenance operations are fundamental in order to keep the units running properly, both purely functional and energetically points of view.

Every Trane unit comes with a logbook, in which the user or the person delegated to machine maintenance can keep all the required notes, in order to keep a historical log of the Trane unit.

A lack of notes in the logbook could be considered proof of careless maintenance.

14.1 GENERAL

IMPORTANT!

Beyond the cadences of checks recommended in the following, in order to keep the unit at optimum levels of performance and efficiency and prevent incipient failures, we recommend periodic visits of inspection and control of the unit by qualified personnel.

In particular, we recommend:

4 annual visits to units that operate about 365 days / year (quarterly)

2 visits per year for units with seasonal operation about 180 days / year (one start seasonal and a mid-season)

1 annual visit for units with seasonal operation of about 90 days / year (starting seasonal)

It's important that during the initial start-up and periodically during operation, carry out the checks and routine checks.

Among them we must also check the suction and condensation as well as the sight glass located on the liquid line. Check through the microprocessor installed on the unit, the unit is working within normal parameters of superheating and subcooling. A routine maintenance program recommended is shown at the end of this chapter while a card collection of operating data is at the end of this manual. It is suggested to record on a weekly basis all the operating parameters of the unit. The collection of these data will be very useful to technicians, in case it is requested technical assistance.

Compressor Maintenance

IMPORTANT! This inspection must be performed by qualified and trained personnel.

The analysis of vibration is a great tool for checking the mechanical conditions of the compressor.

It is recommended to check the value of the vibration immediately after starting and periodically on an annual basis.

Compressor Electrical Connections

It is very important that all the compressors are wired correctly for proper rotation. These compressors will not tolerate reverse rotation. Verify correct rotation/phasing using a rotation meter.

If wired incorrectly the compressor will make excessive noise, will not pump and will draw about half the normal current. It will also become very hot if allowed to run for an extended period.

NOTE: Do not "bump" the compressor to check rotation as incorrect rotation could cause compressor motor failure in as little as 4 to 5 seconds!

Improper rotation of the compressors is indicated by a compressor module trip, noisy operation, no pressure difference on manifold gauges and low amp draw.

Compressor Replacement

If the chiller suffers a failed compressor, follow these steps for replacement:

Each compressor has lifting eyes. Both lifting eyes must be used to lift the failed compressor.

After a mechanical failure of a compressor, it is necessary to change the oil in the remaining compressor and also replace the liquid line filter drier. After an electrical failure of a compressor, it will also be necessary to change the oil in the remaining compressor, replace the filters driers and add a suction filter drier with clean-up cores.

Make sure that a heater is correctly installed on the compressor. The heater helps prevent dry starts.

Note: Do not alter the refrigerant piping in any way as this can affect compressor lubrication.

Refrigerant System Open Time

The units use POE oil and therefore refrigerant system open time must be kept to a minimum. The following procedure is recommended:

Leave a new compressor sealed until it is ready to be installed in the unit. Maximum system open time is dependent upon ambient conditions, but do not exceed one hour open time.

Plug the open refrigerant line to minimize moisture absorption. Always change the liquid line filter drier.

Do not leave POE oil containers open to the atmosphere. Always keep them sealed.

14.2 SIGHT CHECK OF THE LIQUID RECEIVER

The risks due to the pressure inside the circuit have been eliminated or (when it is not possible) reduced by means of safety devices. It is important to check periodically the status of these devices and to carry out the components inspections and repositioning as follows.

Check the liquid receiver state at least once a year.

It is important to check that the surface does not get rusty and that neither corrosion nor deformations are visible.

In case the superficial oxidation and the corrosion are not properly controlled and stopped in time, cause a thickness reduction with a consequent reduction of the receiver mechanical resistance.

Use antioxidant paint or products to protect.

14.3 STANDARD CONTROLS

It is mandatory to clean regularly the coils for a proper unit operation. Pollution and other residual material clearing helps extend the life of the coils and the whole unit

Operations description	Recommended basis
Compressors oil level check	monthly
Inlet temperature check (overheating)	monthly
Water circuits filling check	monthly
Fans and compressors motors electrical input check	monthly
Power supply and auxiliary power voltage check	monthly
Refrigerant charge check through sight glass	monthly
Compressors carter heaters operation check	monthly
Tightening all electrical connections	monthly
Coils cleanliness	monthly
Compressors and liquid circuit solenoid valve check	semiannual
Safety pressure switch PA check	quarterly
Fans and compressors contactors state check	quarterly
Evaporator heater operation check	quarterly
Motor and fan bearing noise check	semiannual
Pressure vessels conditions check	yearly

Temperature and pressure probes – The unit comes factory-equipped with all the sensors listed below. Periodically check that their measurements are correct by means of sample instruments (manometers, thermometers); correct readings if necessary using the microprocessor keyboard. Well- calibrated sensors ensure better efficiency for the unit and a longer lifetime.

Note: refer to the microprocessor use and maintenance manual for a complete description of applications, setting and adjustments.

All sensors are preassembled and connected to the microprocessor. The descriptions of each sensor are listed below:

Outgoing water temperature sensor –This sensor is located on the evaporator outgoing water connection and is used for antifreeze protection.

IMPORTANT

In case a temperature control based on ingoing water temperature is needed please contact Trane before carrying out any trying to set it autonomously.

Ingoing water temperature sensor –This sensor is located on the evaporator ingoing water connection and is used for monitoring the return water temperature.

External air temperature sensor –This sensor allows to monitor the external air temperature on the microprocessor display.

High pressure transducer –This allows to monitor the delivery pressure and to control the ventilators. Should an increase in condensation pressure occur, the microprocessor will control the circuit load in order to allow it to function even if choked. It contributes to complementing the oil control logic.

Low-pressure transducer –This allows to monitor the compressor suction pressure along with low pressure alarms. It contributes to complementing the oil control logic.

Compressor discharge temperature sensor – This allows to monitor compressors tandem discharge temperature and oil temperature. The microprocessor shuts down the compressors in case of alarm in the event that the discharge temperature reaches 120°C.

14.4 ORDINARY MAINTENANCE

Activities list	week	Month (note 1)	Year (note 2)
General:			
Data collection operation (3)	X		
Visually inspect the unit for any damage and / or looseness		X	
Verifying the integrity of the thermal insulation			X
Clean and paint where needed			X
Water Analysis (6)			X
Electric:			
Check the correct operation of the equipment on the unit			X
Check the wear of contactors - Replace if necessary			X
Check tightness of all electrical terminals - Tighten if necessary			X
Clean the inside of the electrical panel			X
Visual inspection of the components for signs of overheating		X	
Check the operation of the compressor and the electric resistance		X	
Measurement using a Megger insulation of the compressor motor			X
Refrigerant circuit:			
Perform a test of refrigerant leaks		X	
Check through the sight glass coolant flow - Full Indicator	X		
Check the pressure drop of the filter drier		X	
Check the pressure drop of the oil filter (5)		X	
Carry out the analysis of the vibrations of the compressor			X
Carry out the analysis of the acidity of the oil of the compressor (7)			X
Condensing section:			
Cleaning the condenser coils (4)			X
Check that the fans are tightened			X
Check the fins of coils – comb it if necessary			X

Notes:

- 1) The monthly activities include all those weekly.
- 2) The annual activity (or earlier in the season), include all activities weekly and monthly.
- 3) The values of the unit should be recorded each day for a high level of observation.
- 4) The coil cleaning may be required more frequently in areas with a high percentage of particles in the air.
- 5) Replace the oil filter when its pressure drop reaches 2.0 bar.
- 6) Check for dissolved metals.
- 7) TAN (Total Acid Number):

0.10:	No action
From 0.10 to 0.19:	Repositioning filters antacid and occurs after 1000 hours of operation. Continue to replace the filters until the TAN not falls below 0.10.
> 0.19:	Changing the oil, oil filter and the filter drier, Refer to regular intervals.

15 RECOMMENDED SPARE PARTS

There follows a list of the recommended parts for several years' running. Trane is at your disposal to recommend a specific list of accessories according to the commissioned order, including the part number of the equipment.

1 YEAR		2 YEAR		5 YEAR	
COMPONENTS	QUANTITY	COMPONENTS	QUANTITY	COMPONENTS	QUANTITY
fuses	(all)	fuses	(all)	fuses	(all)
filter dryers	(all)	filter dryers	(all)	filter dryers	(all)
solenoid valves	(1 per type)	solenoid valves	(all)	solenoid valves	(all)
electronic expansion valves	(1 per type)	electronic expansion valves	(all)	electronic expansion valves	(all)
pressure switches	(1 per type)	pressure switches	(all)	pressure switches	(all)
gas gauges	(1 per type)	gas gauges	(all)	gas gauges	(all)
contactors and relays	(1 per type)	contactors and relays	(all)	contactors and relays	(all)
thermal protectors	(1 per type)	thermal protectors	(all)	thermal protectors	(all)
carter electric heaters	(1 per type)	carter electric heaters	(all)	carter electric heaters	(all)
4-way valve	(1 per type)	4-way valve	(1 per type)	4-way valve	(1 per type)
check valve	(1 per type)	check valve	(1 per type)	check valve	(all)
sight glass	(1 per type)	sight glass	(1 per type)	sight glass	(all)
fans and engines	(1 per type)	fans and engines	(1 per type)	fans and engines	(all)
		electrical components	(all)	electrical components	(all)
		compressors	(1 per type)	compressors	(all)
				heat exchanger	(1 per type)

16 TROUBLESHOOTING

Symptom	Cooling	Heating	Who can take corrective action U = User S = specialised personnel	Probable cause	Possible remedy
A The unit does not start	X	X	S	Probe faulty service	Check and replace if necessary.
	X	X	S	Lack of consent of the high or low pressure	See points D-E
	X	X	S	Defective compressor	See point B.
B The compressor does not start	X	X	S	Compressor burnt or seized	Replace the compressor.
	X	X	S	Compressor contactor de-energized	Check the voltage across the coil of the compressor contactor and the continuity of the coil.
	X	X	S	Power circuit open	Investigate the cause of the protection, and check if there are any short circuits in the wiring or in the windings of the motors of pump, fan, compressor and transformer
	X	X	S	Motor thermal protection open	The compressor has operated in critical condition or there is a lack of charge in the circuit: Make sure that working conditions are within the limits of operation. Loss of coolant: see section G.
C The compressor starts up and stops repeatedly	X	X	S	Intervention of the minimum	See point E.
	X	X	S	Compressor contactor defective	Check and replace if necessary.
	X	X	U	Calibration values of the set-point or differential	Modify them as reported in the in the tables.
	X	X	S	Lack of coolant	See point G
D The compressor does not start because the maximum pressure switch has tripped	X	X	S	Pressure switch out of order	Check and replace.
	X	X	S	Overcharge of refrigerant	Download the excess refrigerant
	X		U	Finned coil clogged, air flow rate is too low	Remove dirt from the coil and obstructions to the air flow
	X		S	Fan not working	See point F.
		X	S	Water pump circulation blocked	Unblock the pump.
		X	X	Water circulation pump and defective	Check and replace if necessary.
	X	X	S	Presence of non condensable gases in the refrigerant circuit	Prime the circuit after it has been downloaded and put under vacuum.
X	X	S	Refrigerant filter clogged	Check and replace.	

Symptom	Cooling	Heating	Who can take corrective action		Probable cause	Possible remedy
			U = User	S = specialised personnel		
E The compressor does not start because the minimum pressure switch has tripped	X	X	S		Pressure switch out of order	Check and replace.
	X	X	S		Machine completely void of refrigerant	See point G.
			X	U	Finned coil clogged, airflow rate is too low	Remove dirt from the coil.
	X			U	Water circulation pump blocked	Unlock the pump
	X			S	Water circulation pump blocked and defective	Check the pump and replace if necessary
			X	S	Presence of frost on the evaporator coil	See point N.
			X	S	Evaporator fan not working	See point F.
	X	X		S	Refrigerant filter clogged	Check and replace.
	X	X		S	Expansion device that is not working properly	Check and replace if necessary.
X	X		S	Presence of moisture in the refrigerant circuit	Replace the filter, dry and recharge	
F The fans do not start	X	X	S		Fan contactor de-energized	Check the voltage across the coil of the contactor and the continuity of the coil.
	X	X	S		Lack of output voltage from the control fan speed	Check the contacts, replace if necessary.
	X	X	S		Thermal protection inside the fan	Check the condition of the fan and the air temperature during operation of the unit.
	X	X	S		Fan motor faulty	Check and replace.
	X	X	S		Loose electrical connections	Check and replace.
G Lack of gas	X	X	S		Loss in the refrigerant circuit	Check the cooling circuit using a leak detector after pressurising the circuit to approximately 4 bars. Repair, evacuate and refill.
H Frost in the liquid line downstream from a filter	X	X	S		The filter is clogged	Replace the filter
I The unit works continuously without ever stopping	X	X	S		Lack of refrigerant gas	See item G.
	X	X	U		Incorrect tuning of the operating thermostat	Check and set.
	X	X	S		Excessive thermal load	Reduce the thermal load
	X	X	S		Compressor does not give the thermal output	Check, change or revise
	X	X	S		The liquid filter is clogged	Replace.
L The unit works regularly but with an insufficient capacity	X	X	S		Low refrigerant charge	See point G.
	X	X	S		4-way reversing valve defective	Check the power supply and the coil of the valve and replace the valve

Symptom	Cooling	Heating	Who can take corrective action		Probable cause	Possible remedy
			U = User	S = specialised personnel		
M Frost in the compressor intake pipe	X	X		S	Expansion device that is not working properly	Verify and replace.
	X	X		S	Water circulation pump blocked	Unlock the pump.
	X	X		S	Water circulation pump defective	Check the pump and replace if necessary.
	X	X		S	Low refrigerant charge	See point G.
	X	X		S	The liquid filter is clogged	Replace.
N Abnormal noise detected in the system	X	X		S	Compressor noisy	Check and replace if necessary.
	X	X		S	The panel vibrates	Fasten properly.
O The unit does not start	X	X		S	Phases of the supply network reversed	Invert two phases.

17 IMPROPER USES

The unit is projected and built up to grant the maximum safety in its proximity, as well as to resist to the aggressive environmental conditions. The fans are protected by grilles.

Residual risks are indicated with warning labels.

SAFETY SYMBOLS



DANGER:
General danger



DANGER:
Temperature



DANGER:
Moving parts



DANGER:
Cutoff voltage

Trane - by Trane Technologies (NYSE: TT), a global climate innovator - creates comfortable, energy efficient indoor environments for commercial and residential applications. For more information, please visit trane.eu or tranetechnologies.com.
Trane has a policy of continuous product and product data improvement and reserves the right to change design and specifications without notice.

CG-SVX046B-GB_0620
Supersedes CG-SVX046A_1018

©2020 Trane