

Amateur 2s 6d

Tape Recording

Video and Hi-fi Volume 7 Number 2 September 1965

ATR SOUND TOUR

A full photo report by travel correspondent **Bob Danvers-Walker** on the **Sound Tour Number One to Denmark**

CIRCUITS

Two-page circuit and components list for a transistorised 8-channel mixer. With two further pages of construction details and lay-out diagrams to help you build this useful piece of equipment yourself



PLUS..

features from audio experts **Gordon J. King**, continuing his series on the marriage of tape and slide and **Russ Allen** reviewing the latest pre-recorded tape releases. See how a Truvox recorder is made; discover how your club can help itself by helping the local community



**YOUR TAPE RECORDER
DESERVES THE BEST...**

**IN MICROPHONES
that means the
PHILIPS P.31**

This superb hypercardioid moving coil microphone offers the quality performance needed to complement Philips recorders manufactured since 1960, and most other makes of high class recorder. It has a level frequency response to ensure your recorder gets the finest input possible. It has a directional response to minimize unwanted extraneous noise, and permits substantially increased amplification without fear of acoustic feedback. It has a protected microphone insert and is extremely robust and insensitive to shocks and vibration, to ensure a lifetime of perfect, trouble-free use.

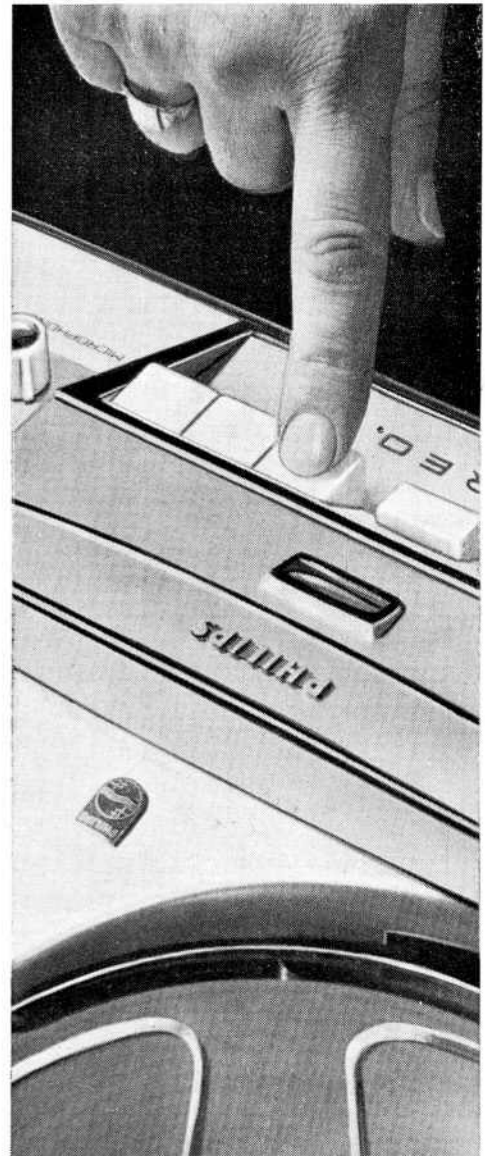

The Philips P.31 is supplied with flexible shaft, silent on/off switch, built-in matching transformer (giving adjustable impedances of 500Ω and 25,000Ω) and elegantly designed non-scratching stand. See it at your hi-fi dealer *today!*

The high quality Philips P.31 is supplied complete for only 18 gns.

***Peto Scott for all Philips
Professional Sound equipment***



PETO SCOTT LTD

Addlestone Road, Weybridge, Surrey
Telephone: Weybridge 45511

Amateur Tape Recording

Video and Hi-fi

Feature	Author	Page
Cover: Recorders and ancillary equipment produced by Truvox Ltd. For details of how these recorders were made, see page 18		
BTR Contest Results	ATR	7
ATR Sound Tour	B. Danvers-Walker	10
The Things You Say	ATR readers	14
The Marriage of Tape and Slide	G. J. King	15
Tape Recorders in the Making	ATR	18
Russ Allen's Tape Reviews	R. Allen	21
8-channel Mixer - constructional circuit	R. Spriggs	23
Mixers to Buy	ATR	27
Audio View Test Report: Pye HFS 30T	G. J. King	28
Audio View New Products	ATR	31
Club and Community	M. Dagnall	32
Recording Diary	ATR	33
Sound Scene	ATR	35
Tape Club News	Kim Cook	42
Classified Advertisements		44

A full year has gone by since the last BBC 'Sound' programme for tape recording, radio and hi-fi enthusiasts went out on Network 3. This was taken off the air to make way for extended 'pop' music programmes on other broadcast channels. In our opinion a poor excuse for taking off cultural, educational, call it what you will, material enjoyed by thousands of enthusiasts and well supported by the technical press.

Most other hobbies are covered by BBC sound radio and even television, and practically every European broadcaster has a programme devoted to tape recording and hi-fi. Surely we are not asking too much for a half-hour programme once a month on a subject which is so closely related to sound broadcasting? It is,

however, with regret we have to report that, again owing to re-arrangements of BBC programmes, 'Sound' will not be coming back. In this issue of ATR we carry a report by Bob Danvers-Walker on the sound tour of Denmark. One week after filing his copy on this, Bob Danvers-Walker was on his way to Israel on a BBC assignment to tape material for two travel programmes. This will be the basis of an interesting contribution to ATR along with an article on notable events in Great Britain which offer good material for all tape recording enthusiasts. Our technically minded readers have not been forgotten, for this issue contains the first of a series of constructional features on useful pieces of equipment for studio and workshop. F.C.J.

Editor: F. C. Judd, A.Inst.E. Assistant Editor: Kim Cook. Art Editor: Robert Morley. Production Director: Denis Curtis. Production Manager: Roy Dennis. Advertisement Director: Lindsay Masters. Advertisement Manager: E. McKeown. Circulation Manager: David Hughes. Editorial, Advertising and Subscriptions: Amateur Tape Recording, Haymarket Press Ltd, 86/88 Edgware Road, London W2, Ambassador 3200. Amateur Tape Recording is published by Haymarket Press Ltd. © 1965 Printed by The Sidney Press Ltd, Bedford. Title registered at Stationers' Hall. Subscription rates throughout the world 30s. post paid for twelve issues.

**Does 18,000 c.p.s. at $3\frac{3}{4}$ i.p.s.
sound interesting?**

Meet the Akai Crossfield Head



Akai M8



Akai X4

... the best head for sound in the business

No other tape recorders can throw about claims like full frequency range at $3\frac{3}{4}$ i.p.s. and expect to be believed! Whatever other recorders do have, there's one thing they haven't—that's the ex-

clusive Akai Crossfield Bias Head—an advance so important that it opens a whole new world of high fidelity recording and only Akai has the key. Look at this picture.

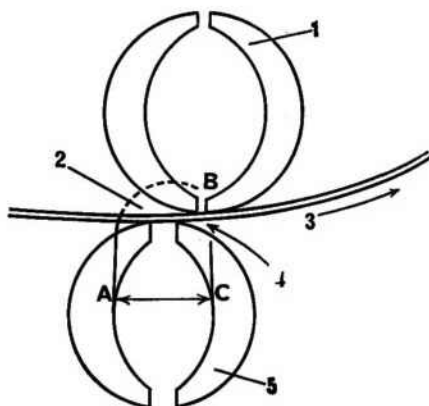

This is the Crossfield Head—only Akai has it.
 1 signal head. 2 bias field. 3 direction of tape travel. 4 signal head. 5 bias head. 6 bias head retracts automatically on playback.

On conventional heads the high frequency components of the signal recorded tend to be attenuated or erased by the effect of bias fields. On the exclusive Akai Crossfield Head the signal head and the bias head are mounted in opposition with their centres slightly off. The tape is pre-magnetized between points A and C and recorded with the signal at point B. The recorded signal is completely free from the effect of prevailing bias fields and can be retained on the tape without loss.

It will be seen from the construction of the Akai Crossfield Head assembly that, as the signal head is arranged obliquely apart from the bias

head, across the tape, the amount of bias may be selected without regard to the functioning of the signal head. This means that the tape can be modulated over the entire frequency spectrum with maximum fidelity since the recorded signal is entirely unaffected by the bias field.

The maximum audio frequency that can be recorded on tape is usually around 790 c/s. at a tape speed of 1 centimetre per second, rising to about 2,000 c/s. at 1 inch per second. For Standard tape speeds: 9.5 cm/s. ($3\frac{3}{4}$ i.p.s.) —7,500 c/s. and for 19 cm/s. ($7\frac{1}{2}$ i.p.s.) —15,000 c/s.

The Akai Crossfield head makes possible the recording of a signal frequency of up to 2,750 c/s. at a tape speed of 1 cm/sec. or 7,000 c/s. per inch. In other words, the Akai Crossfield head—makes it possible to record 18,000 c/s. at a speed of $3\frac{3}{4}$ i.p.s. or 21,000 c/s. at $7\frac{1}{2}$ i.p.s. With the low speed of $1\frac{1}{2}$ i.p.s. (4.75 cm/sec.) now available on the M8 and X4 models, it is practicable to record up to 11,000 c/s.

Employing this Akai technique, it is now possible to record four continuous hours on a standard 1,200 ft. tape without the need for professional 10½ in. reels.

That's for the real buffs! And explains just one feature of the amazing M8 and X4 Akai tape recorders. But we know you tape recorder experts—gluttons for information—especially if it's about the biggest recording advance of the decade! So we've written down everything you want to know about the Akai range, just clip the coupon and we'll send it to you.

To Pullin Photographic Ltd., 11 Aintree Road, Perivale, Middlesex. Please send me details of the Akai range.

Name _____

Address _____

ATR.1



(A Company within The Rank Organisation)

THE HI-FI RECORDER WITH A TEST CERTIFICATE AND ORIGINAL FREQUENCY RESPONSE CURVE SHEET FOR HI-FI SYSTEMS....

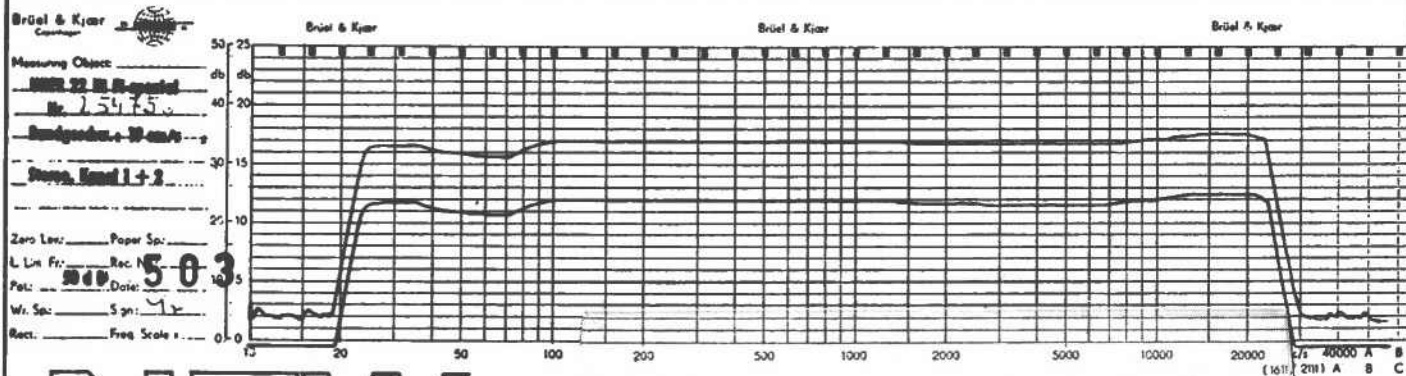

NEW FROM UHER

THIS exciting—and in some ways quite unique—recorder from the UHER factory satisfies the most exacting demands of a normal home sound studio. Both the 22 HI-FI SPECIAL (two track) and the 24 HI-FI SPECIAL (4 track) embody vast engineering knowledge and technical experience and as documentary evidence of quality a Test Certificate and an Original Frequency Response Curve Sheet accompany every model which leaves the factory.

The HI-FI SPECIAL is an all-transistor recorder for mains operation, featuring push button control, mono or stereo recording and playback, multiplay two track or (in the case of the HI-FI 24) four track recording. Tape speeds $3\frac{3}{4}$ ips and $7\frac{1}{2}$ ips; reel sizes up to 7"; Equalization: CCIR 70 microseconds, CCIR 100 microseconds, NARTB 50 microseconds ($3\frac{3}{4}$ ips); push-pull r-f generators. Frequency ranges: 20 to 20,000



cps ($7\frac{1}{2}$ ips), 20 to 15,000 cps ($3\frac{3}{4}$ ips).

The many refinements incorporated include an ingenious tape cleaner associated with the tape-tension control, equalizer switching facilities (from CCIR to NARTB) and vernier adjustment of playback head.

JUST LOOK AT THESE SPECIFICATION DETAILS

Wow and flutter: max. $\pm 0.1\%$ (max. $\pm 0.08\%$ rms) at $7\frac{1}{2}$ ips, max. $\pm 0.15\%$ (max. $\pm 0.11\%$ rms) at $3\frac{3}{4}$ ips.

Deviation of average tape speed from nominal speed: max. $\pm 0.2\%$ at $7\frac{1}{2}$ ips.

Monitoring: Straight monitoring and off-the-tape monitoring also for stereophonic operation.

The 22/24 HI-FI SPECIAL is supplied in an attractive Teak veneer finish case, and with transparent Plexiglass cover. Price—to be announced. Literature and full specification details are available on request.

and introducing . . .

THE NEW UHER 724 STEREO

A four track all-mains recorder—attractively priced at only 75 gns—and specially designed to satisfy the demand for an instrument particularly easy to understand and to handle. Please send for fully descriptive literature and specification.

BOSCH LIMITED

Radio & Domestic Appliance Division

205, Gt. Portland Street, London W.1. LAN 1809 · 1100 · 6708



1965 BTR Contest

Five 19-year-old physics students from Hertford College, Oxford, share the honour of being the originators of the 1965 'Tape of the Year'. Their excellently recorded, and very moving recording 'Mushrooms' won them the unanimous approval of the judges.

With what one judge described as 'typical undergrad thinking' they evolved a beautiful script on the possibilities of a final, disastrous nuclear war. The subject, though solemn, never got emotionally out of hand, and the fading and mixing of the interviews with the public, the voice from the future and that of the narrator were very well balanced indeed. The tape won for them the Amplett Shield for the best recording submitted by a club, as well as the Emitape Challenge Cup and £50 for being the most outstanding tape of the whole contest.

Hard on the heels of this tape was one of a completely different nature. Winner of the Music section, and hailed as the best tape submitted by an amateur recordist, was a brilliant recording of an old folk song 'Henry' by Peter Cox, a 41-year-old schoolmaster from Billacombe, Plymouth. The judges had a very difficult task in disregarding the outstanding quality of the performers on this tape, but the arrangement and recording technique, as well as the choice of material and artist, made this tape a real gem. To Mr Cox goes the Acos Cup for Music, and the Agfa Cup and £25 for the best amateur tape.

Judging in the Novices' and Professional classes aroused a little embarrassment, for in each case one of the judges had a tape which had won through to the finals. Consequently in each case the entrant/judge had to leave the judging area to enable the remaining judges to speak their mind.

Winner in the Novice section was Mr A. Freeman, described as '37-year-old broadcaster of London W9'. This of course was none other than disc-jockey Alan Freeman, who first took up tape recording nine months ago when he was asked to be a judge in this year's contest. Feeling that if he was to make a good job of being a judge he should know more of what it was all about, he decided to have a go himself. Although there was perhaps one other novice tape of comparable recording quality, Mr Freeman's effort was the only one in this section which showed any signs of enterprise. He and a friend completely 'ad-libbed' a scene showing the sort of trials a famous personality has to undergo when spotted by a member of the public. The recording was good, the subject well chosen and well handled. So to Alan Freeman goes the Philips Shield and a cash prize of £25.

ATR followers present at the judging, and in particular Editor Fred Judd, had cause for rejoicing, for Mr Judd's tape 'Tempo-Tone' received the unanimous vote of the other judges in the Professional section. The tune, which was composed by Mr Judd and produced entirely electronically, took over 100 hours to record, and was (needless to say) excellently recorded as well as being really tuneful and most agreeable to listen to. Mr Judd is to be awarded the Scotch trophy and £25.

In the Schools' section undoubtedly the best tape, and one which incidentally came in for

consideration as tape of the year, was 'A Day at Grange School' produced entirely by the 12- and 13-year-old pupils of Form 2a at Grange County Secondary School at Stourbridge, Worcestershire. The pupils had thought out all the ideas themselves, and had been given permission to do all the recording during their English classes. They started very logically by welcoming a new pupil to the school, introducing boys' and girls' voices to illustrate the co-educational nature of the school. One brilliant touch was the inclusion of a whispering scene between two pupils at the back of a class, which was brought to an abrupt end by the inevitable shout from the teacher. So to the pupils of Form 2a Grange School goes the BASF Shield. The Stereo section was most disappointing. The only tape which came in for considerable praise was a recording of a 'Thomas Mortier Organ' made by P. Lawson-Smith, of Bourne End, Bucks. But even this, the judges felt, did not really show true stereo, and it was almost decided that no award could be made in this section. However, on hearing the tape again, the judges finally decided that it did in fact show some of the dimensions of stereo, and so awarded Mr Lawson Smith, a 39-year-old caterer, the BTRC Shield.

The Documentary/Actuality section was well supported, but a common fault with tapes in this section was an apparent fear of editing down. Many of the entries were far too long for the judges to sit through in comfort and the listeners' interest was often lost well before the half-way mark. Top marks here went to Albert C. Watt, a 31-year-old general practitioner from Sunderland, for his 'Portrait of Calella'. Even here there could have been more severe editing, but the various items in this portrait of a Spanish resort were so well recorded and thoughtfully put together that the judges unanimously awarded it the Kodak Shield for the best Documentary.

The Humour class too was well supported, but oh what a lack of imagination! A number of entrants (including Ray King himself) had done little more than copy or adapt the idea of last year's winning 'Sink Symphony'. In fact Mr King, of Oxford, was awarded the Mastertape Trophy for Humour, and was considered for the Tape of the Year award, but a second-time-around idea is as dead as

yesterday's newspapers. His tape, entitled 'The Nose', though brilliantly thought out and very well recorded showed an unwillingness to depart from his award-winning formula of last year. What came off last year seemed much more forced, and consequently less impressive this year.

All the tapes which won through to the finals will receive a certificate to this effect, but even among these, the judges singled out one in particular for favourable mention. This was a recording of electronic music 'No Title' by Trevor F. Holmes of Redditch, Worcester. This 21-year-old tool maker was very strongly recommended for a prize for electronic music, but the judges felt that they would not be justified in creating a section for this as there had been only two or three entries which could possibly fit into this category. However, in view of the special interest we, at ATR and in particular Mr Judd, have in this kind of recording, we have agreed to award Mr Holmes a consolation prize. This will consist of a complete set of Castle sound effects records, as well as a free subscription to ATR.

RESULTS

Tape of the Year: 'Mushrooms' by Hertford College, Oxford. 9m 15s at 7½ ips. Equipment used: Repts R 10, Ferrograph 5 AN, Philips EL 3541, Reslo mic.

Amateur: 'Henry' by Peter Cox, Billacombe, Plymouth, Devon. 2m 19s at 7½ ips. Ferrograph.

Novice: 'Fan Club' by Alan Freeman, London W9. 3m 55s at 1½ ips. Philips.

Professional: 'Tempo Tone' by F. C. Judd, South Woodford, London. 1m 30s at 15 ips.

Schools: 'A Day at Grange School' by Grange School, Stourbridge, Worcs. 7m 0s at 3½ ips. Ferrograph.

Stereo: 'Thomas Mortier Organ' by P. Lawson-Smith, Bourne End, Bucks. 3m 0s.

Music: 'Henry' by Peter Cox, Billacombe, Plymouth, Devon. 2m 9s at 7½ ips. Ferrograph.

Clubs: 'Mushrooms' by Hertford College, Oxford. 9m 15s at 7½ ips. Repts R 10, Ferrograph 5 AN, Philips EL 3541, Reslo mic.

Documentary/Actuality: 'Portrait of Calella' by Dr Albert C. Watt, Sunderland, Co Durham. 9m 50s at 7½ ips.

Humour: 'The Nose' by Ray S. King, Oxford. 5m 20s at 7½ ips. Fi-Cord, Vortexion.

Mr Eric Robinson of the BBC and disc-jockey Alan Freeman discuss one of the tapes during the judging of the 1965 British Tape Recording Contest.





LOEWE OPTA

Hi-Fi Tape Recorders

FOR PERFECTION IN SOUND

THE NEW OPTACORD 408

THE MOST COMPACT MAINS AND BATTERY RECORDER

Single speed 3 1/2 i.p.s. twin track for use on mains, batteries and car batteries.

39 GNS

THE LATEST OPTACORD 416

OPTACORD 416

Specifications as Optacord 408 plus dig. counter, tone and volume controls, 2 speeds 3 1/2 i.p.s. and 1 7/8 i.p.s. Twin Track.

51 GNS

OPTACORD 416 DIA

As Optacord 416, with built-in Synchronisation for Automatic Slide Projector.

62 GNS

THREE-IN-ONE MAINS - BATTERIES - CAR BATTERIES

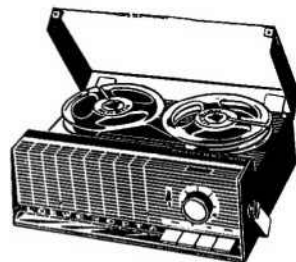

HIGHGATE ACOUSTICS

71/73 Great Portland Street,
London, W.1.

London, W.1

Approved Loewe-Opta Stockists

Alexanders,
Holburn Street,
Aberdeen.

Queensway Radio,
97, Queensway,
Petts Wood,
Kent.

Arding & Hobbs,
Ltd., Clapham
Junction, S.W.11.

Audiocraft,
20, Kettering Road,
Northampton.

Barkers Ltd.,
31, Oxford Road,
Worthing.

Barretts
of Canterbury.

Battys (Rhyl) Ltd.,
Rhyl. (Tel. 2621.)

Wilf Plant,
Asfordby, Melton
Mowbray, Leics.

Bon Marche,
Northgate Street,
Gloucester.

Leonard Booth,
35, South Street,
Eastbourne.

Courtney Davies,
12, Station Road,
Harpenden.

Bristol & Cardiff
Tape Recorder
Centres.

A. Brown & Son
Ltd., 24/28, George
Street, Hull.

Brown, Muff's,
Bradford, I.

Camera Thorpe,
6/8, Osmaston Rd.,
Derby.

Campkins Audio,
21, Harkett Street,
Cambridge.

Chelsea Record
Centre, 203, Kings
Road, S.W.3.

Chiesmans Ltd.,
Lewisham, S.E.23.

City & Essex Tape
Recorder Centres,
228, Bishopsgate,
E.C.2.

Radio Maintenance
(Leicester) Ltd.,
111, Queens Road,
Leicester.

Crosdales
(Nelson) Ltd.,
41 & 58, Every St.,
Nelson, Lancs.

Dingles, Royal
Parade, City
Centre, Plymouth.

Francis of
Streatham, 169,
Streatham High St.,
S.W.16.

Gilbert Pianos Ltd.,
37, Southchurch
Road, Southend.

Grimes Ltd.,
King Street,
Wigan, Lancs.

Guildhall Tape
Recorders, 33,
Guildhall Street,
Folkestone.

J. E. Hargreaves
Ltd., 1 Railway Rd.,
Blackburn.

Harveys,
High Street,
Guildford, Surrey.

Hamilton
Electronics,
35, London Road,
Southampton.

J. Harris,
231, Baker Street,
N.W.1.

House & Son Ltd.,
Blake Street, York.

Howard Tape
Recorders, 218, High
St., Bromley, Kent.

R. H. O. Hills Ltd.,
Bank Hey Street,
Blackpool.

Imhofs Ltd.,
New Oxford St.,
W.C.2.

Jones & Higgins,
1-41, Rye Lane,
Peckham, S.E.15.

Joplings Ltd.,
John Street,
Sunderland.

Kendal Milne & Co.,
Deansgate,
Manchester, 3.

John King Ltd.,
East Street,
Brighton.

R. S. Kitchen Ltd.,
22, King Edward
Street, Leeds 1.

Lancashire Hi-Fi Ltd.,
Tape Centre,
8, Deansgate,
Manchester, 3.

Loech & Haig Ltd.,
112, London Road,
Oxford.

Massey's,
121/3, High Road,
Chiswick, W.4.

James Mackenzie Ltd.,
Grange Road West,
Birkenhead.

Misons, Hi-Fi
Specialist Citadel Row
Carlisle.

Fairbotham
& Co. Ltd.,
58-62, Lower Hillgate,
Stockport, Cheshire.

Aldridges (Music) Ltd.,
14-16 Houghton Street,
Southport.

Parish & Co.,
130, Union Street,
Torquay.

Piercy's,
63, Lupus Street,
S.W.1.

Rackhams Ltd.,
Corporation Street,
Birmingham, 2.

Recording
Machines Ltd.,
119, Victoria St.,
S.W.1.

Tom Reekie Ltd.,
10, Bridge Street,
Stafford.

The Music Centre,
103 Risbygate St.,
Bury St. Edmunds.
Tel: 4324

Ryland Huntley,
15, Old Bond Street,
Bath.

Selfridges Ltd.,
Oxford Street, W.1.

Sheen Tape
Recorder Centre,
8, Station Parade,
Sheen, S.W.14.

J. V. Robinson Ltd.,
91, High Street,
Huntingdon.

J. Smith & Son,
184, The Rock,
Bury, Lancs.

Stanwood Radio Ltd.
(All branches.)
London—Essex—
Herts—Suffolk

Sport & Radio,
26/29, Aldwich Road,
Bognor Regis.

G. H. Steel,
141, St. Georges
Road, Glasgow.

Tape Recorder Centre,
82, High Holborn
W.C.1.

Tape Recorder Centre,
30, King Cross St.,
Halifax.

J. H. Tate & Co. Ltd.,
45, Crowtree Road,
Sunderland.

K. A. Cheesman Ltd.,
32, Crouch Street,
Colchester, Essex.

Teletape,
33, Edgware Road,
W.2.

The Recorder Co.,
188, West End Lane,
N.W.6.

Turners
Photographic Ltd.,
9, The Walk,
Ipswich.

Radio Maintenance
(Leicester),
111, Queens Road,
Leicester.

Lloyd & Keyworth,
26, Downing Street,
Farnham.

Bristol Hi-Fi,
28, Upper Maudling
Street, Bristol.

J. W. Mansfield,
18, Liverpool Road,
Worthing.

LOEWE OPTA

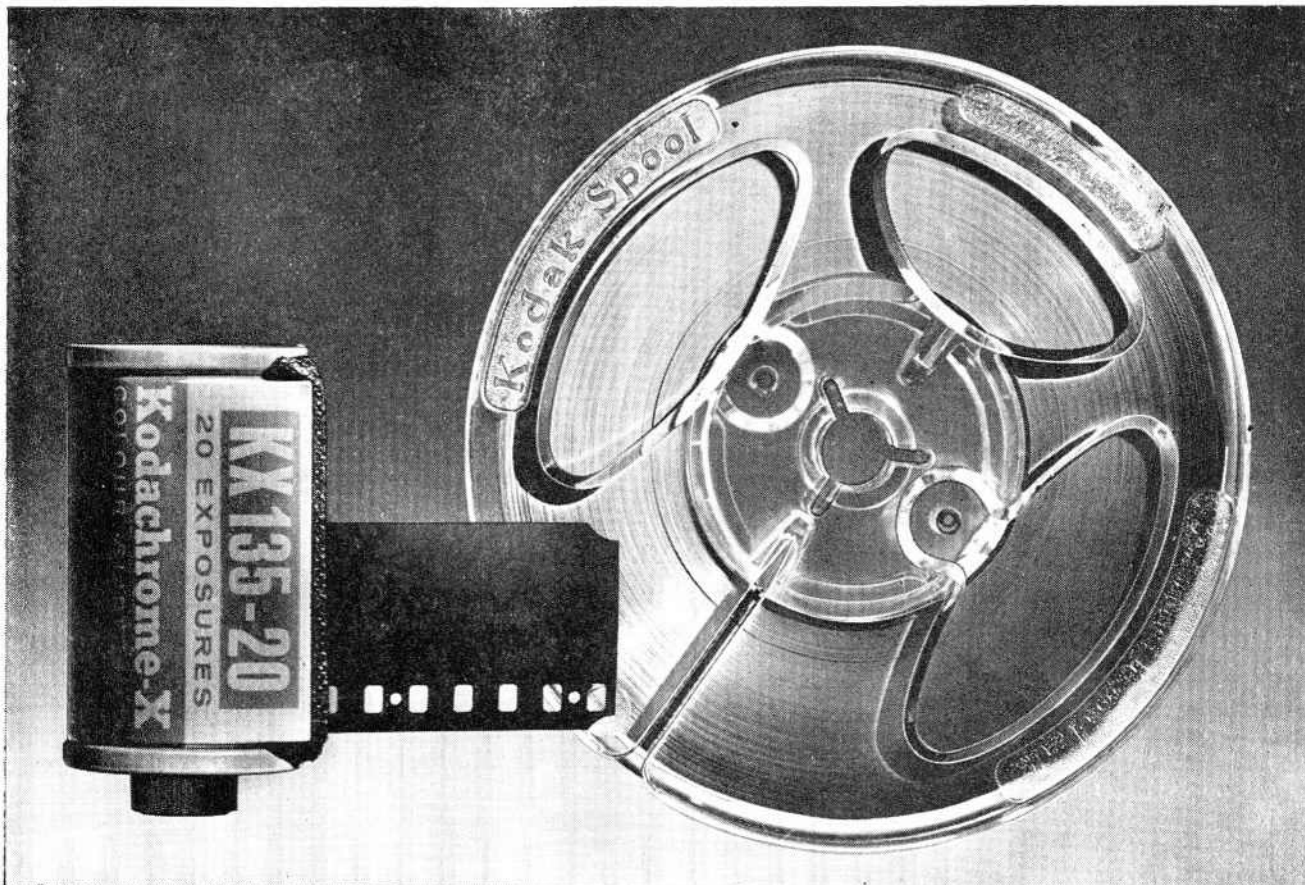

How Kodak's film-coating skills set today's highest standard in tape

Kodak know a lot about surface coating. More than any other manufacturer in the world, in fact. This isn't really surprising, because one of the reasons for the unrivalled high quality of Kodak colour films is the unique evenness of their emulsion coatings.

Now, Kodak have applied these advanced coating skills to the manufacture of sound recording tape. The result is a tape whose magnetic oxide layer is accurate to within *millionths* of an inch. No wonder that sound recording engineers all over the world have acclaimed it as the finest tape ever made.

Play it as soon as you can. You'll be getting a higher signal-to-noise ratio, better frequency response, a remarkable freedom from drop-out and print-through, and, above all, a *total* uniformity in performance.

There's a Kodak Tape for every recorder, of course, including the world's only Quadruple Play tape, for use

with battery portables (5½ hours playing time on a single 3¼" reel!). So next time you buy tape, do the sensible thing and specify Kodak Tape. It will do full justice to your equipment. And it costs no more.

© Eastman Kodak Company MCMXXI



Post this coupon today.
Please send me full details of Kodak Sound Recording Tapes.

NAME.....

ADDRESS.....

.....

Kodak Ltd., Dept. 70, Kodak House, Kingsway, London W.C.2

Kodak sound recording tapes... the best tapes in the world



The Skyways hostess welcomes the group aboard. Reading from top to bottom: Bob Danvers-Walker, tour leader, Bruce Hall, Fi-Cord representative, Mrs Eileen Daintree, Dr John Daintree, Terry Morris and Michael Dagnall. ATR Editor Fred Judd stands this side of the boarding steps. The missing 'Robbie' Robin was retrieving his mislaid camera when this picture was taken.



L to R: Terry, Robbie and Michael record river steamer sounds beside the Alster. The flags are of shipping lines using the busy waters of Hamburg's two famous lakes.

While a German ump-pa-pa band plays drinking songs in the Zillertahl, Hamburg's well-patronised Bierhalle, steins of beer go down well. This was on the night of the day of departure.

ATR SOUND TOUR



Exactly one year ago, in August 1964, I returned from Denmark after a fourteen-day assignment taping sounds for a broadcast about that fascinating country. It was then that I got the idea of organizing a sound tour in which Tape Club members, ATR readers or anyone with a flair for capturing sound might make special excursions abroad on a 'package deal' basis. In last January's edition of ATR details of my plan were advertised and the first Sound Tour was announced. It was to be a holiday, an escorted 'sound seminar' and a competition, with chances to win a Fi-Cord portable tape recorder or a year's free subscription to ATR, all rolled into a six-day excursion costing 31 guineas. Clarkson's Travel Agency and Fi-Cord International came in on the scheme and

with Editor Fred Judd representing the publishers of ATR, the pioneer excursion was launched. Our visit to Denmark and Germany was to be by one of Clarkson's regular scheduled tours. So in a sense we were to be a group within a group. It was my job to try to arrange as much of interest to the members of my party without interfering unduly with the other holiday-makers on the tour. In this four-page picture spread you will see a photographic diary of our activities recorded by ace photographer Eric Rowell, who came with us for this express purpose. On Sunday, 30 May, all seven of us who had been booked on the Clarkson's Tour met at Lympne Airport and introduced ourselves. Fred Judd had

come down to present to each member spoils of BASF tape and complimentary copies of the *Amateur Tape Recording* issue referred to above. The Fi-Cord representative, Bruce Hall, allocated to four of the party new 202a portable recorders to use freely during the tour and the Clarkson hostess greatly facilitated our departure. My responsibility as guide and mentor was (a) to seek facilities and, where possible, make special arrangements through my good friends in Denmark and especially in the National Travel Association in London and Copenhagen for visits to places where sounds might be recorded; (b) provide personal guidance and, where needed, instruction in the use of the Fi-Cord 202a and suggest recording techniques; (c) offer suggestions in the designing of a



The Nimble Restaurant in Copenhagen's fabulous Tivoli Gardens. Since my last visit there a ban on tape recorders has been imposed by the authorities in deference to the wishes of musicians playing there. This was a big disappointment as I had counted on the Tivoli providing a lot of material in the way of atmosphere for backing tracks, snippets of sound and snatches of music from side shows, band stands, cafe music and open air performances. So that I might keep faith with the schedule I had drawn up for the group I obtained special permission for the recorders to be brought in.

travelogue in sound.

So with all this in mind, there came the moment when the rules of the competition had to be made clear. These were put to the members of the party prior to boarding the Skyways aircraft so that zero hour for the contest could start straight away. Each member was invited to gather material on tape with which to construct a fifteen-minute travelogue narrated and illustrated with original sounds recorded during the tour, the object of the exercise being to simulate the proceedings adopted by travel broadcasters such as myself in the building of a holiday programme. When eventually the time comes for a panel of judges to select the best entry, points will obviously be scored for originality, ingenuity, a good sense of occasion, entertainment value and novelty. Technical perfection need not necessarily notch up high marks, since it will be fairer to assess on programme content rather than quality. Remember, too, that two members had never used a tape recorder before and would be competing with experienced users. Conditions were such that one had frequently to snatch at unexpected sounds – just as the professional recordist has to more often than not. Provided his sound quality is good 'actuality', the quick-on-the-trigger man is often far more successful than the operator who seeks studio quality and hesitates to switch on because of slight extraneous noises.

This fact could well level out the chances of success by the competitors. Anyway, a second prize will go to the person who turns in the sound which, in the opinion of the judges, is outstanding, original and representative

(continued overleaf)



Else Kjoerby's Flea Circus gave a special performance of her amusing side show, doing the entire running commentary in English for our benefit. I presented a copy of last January's issue of ATR to her because it was in this that I first wrote about her circus. If you have a copy, compare the photographs.

Michael Dagnall believes in getting the story of 'The Little Mermaid' straight from the, er . . . the little mermaid herself. Behind the statue to Hans Christian Andersen's fairy tale character are the shipbuilding yards of Burmeister & Wain, the biggest industrial establishment in Denmark.

Mrs Daphne Bray, the Englishwoman who founded the first Pony Riding School in Denmark in 1949 took the morning off from her forty Shetland, Exmoor and Dartmoor ponies and came into Copenhagen from her home outside the capital to give interviews to group members. In the background stands Eric Rowell who, with the exception of this one, took all the photos during the tour.

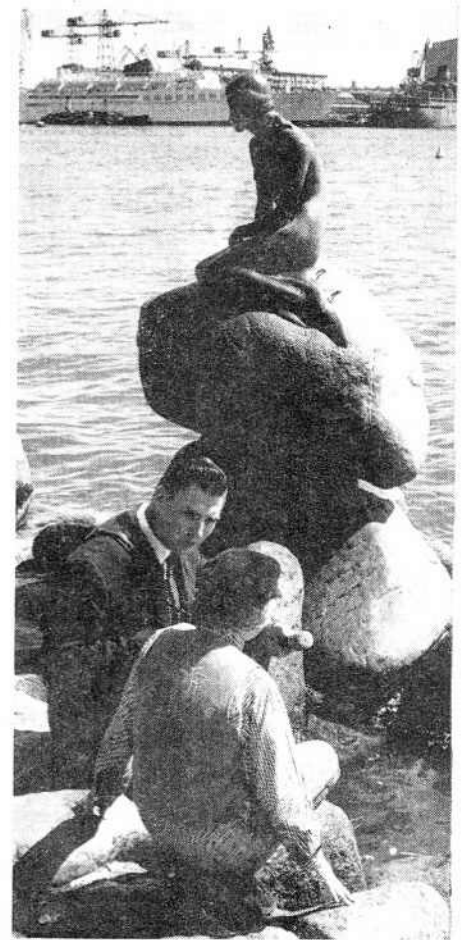



ATR Sound Tour (continued)

of the tour. All that's needed then is a little introductory piece telling what it is, where it was recorded, etc., and then follow this with the sound itself. It is going to be most interesting to hear what each contestant submits. Dr Daintree and his mother, Mrs Daintree had never recorded like this before. They have exchanged taped correspondence (he is a doctor in Aden and took Mrs Daintree with him on this 'working' holiday) but outside of that taping sound on a portable recorder meant starting from scratch. But it's my bet that they will do a lot more from now on - they're dead keen on it. By contrast there was Mr R. T. Robin from Morden, Surrey. 'Robbie' brought his own recorder and is no novice. Bird songs and organ music; those are the sounds that send him off on a lone prowl of woodlands and

cathedrals. Goes to no end of trouble does Robbie; sets up a tripod for his microphone to record a fountain or lays yards of mike lead for the sheer pleasure of coping carefully with a sound. Then there's Michael Dagnall and Terry Morris close friends from Birmingham. Michael is Vice-Chairman of B-TRAC, the clever abbreviation for Birmingham Tape Recording and Audio Club. Mike owns a fine range of technical equipment at home and is enthusiastic about synchronizing sound with photographic slides. By profession he is assistant manager to a firm making architectural metalwork. He celebrated his twenty-seventh birthday during the tour. Terry Morris - like Robbie - is a lover of organ music too. He actually owns a Hammond organ and being classically minded he is a keen collector of good music. He is a material controller at a famous motor firm. Also a member of B-TRAC, he and Mike worked closely together yet each would occasionally sneak off on his own if a scoop presented itself. You will appreciate the interest and practical help given me by Mrs Jeanne Steinmetz, Public Relations Officer of the National Travel Association of Denmark in Copenhagen, when I tell you that when I appealed to her for help in providing us with transportation so that we might be independent of the

other excursionists for one day she laid on a thirty-seater coach for the seven of us to go where we pleased. I have had previous experience of the generosity and helpfulness of Mrs Steinmetz. In the interests of Mr Morris and Mr Robin, I asked her whether she could persuade Kynne Fransden, the celebrated Danish organist at Fredericksborg Castle, to play the famous Compenius Organ for the group to record. Built in 1612, it is said to be the only one of its kind in the world on which the music of Bach can be played as the composer would have played it. Unfortunately, Per Kynne Fransden had an appointment in Copenhagen on the day we were in Fredericksborg. A press picture and story of our presence in Denmark was reported in the *Berlingske Tidende*.

So there you have it. Quite a cross-section of personalities whom you see in operation on the accompanying pages. Me? - I'm really proud to have been responsible for the first Sound Tour. I don't think I would have wanted it to have started big because when the next ones come along (and it's my bet they will) I want to see them grow from the veteran few who went on the first ATR Sound Tour. Let's have your comments in the 'Things You Say' columns.

Morning coffee break at the picturesque Inn 'Skovriderkroen'. This was on the day when we broke loose from the main party and went in search of sound. Kro is the Danish word for Inn. And nothing is more lovely than these buildings which dot the countryside throughout Denmark.



Aboard the car ferry steamer on the crossing between Puttgarden, Germany and Rodbyhaven on Denmark's southernmost island of Falster, a little private tuition for Eileen Daintree. Dr John Daintree spent five months as ship's surgeon on runs to Japan and Red China. His hobbies are flying and photography.



Heads down for some of that mouth-watering Danish food. The lunch break at the Bondegarden restaurant at Hornbaek, an old fishing village and the most fashionable seaside resort in Zealand rolled into one. It is also near Elsinore.

Terry struck trouble with a microphone lead. Repairs were effected as he and I squatted on the doorstep to an ancient Swedish-type cottage in the Frilands-Museet or Open Air Museum where original old farmsteads and cottages from different parts of Denmark are preserved in a beautiful parkland. The tape recorders didn't get much here, but what a field day for the cameras.

Planning tomorrow's programme. On the other hand I think I was pointing out on the map the last place I had seen Robbie. I remember he said something about going off on his own in search of some birds. . . . Oh well.



The Vikingbus generously provided for us by the Danish National Tourist Office. Our driver (beside Mrs Daintree) had a fine sense of humour which was much appreciated on the journey.



THE THINGS YOU SAY

Tapes on loan

I have in recent years been sending tapes of classical music regularly to friends in the Forces overseas. These people have now returned to this country and, as my efforts seemed to be quite popular with them, I wondered if you could put me in touch with anyone in England who has a wide taste in classical music who would be interested in receiving tapes on loan.

I have a large collection of tapes and can record at any speed, two or four track, using a Grundig TK 35 and Tandberg 74 B. I am not particularly interested in tape correspondence as such, as I have no microphone! The idea is simply to give someone the enjoyment of good music who could not otherwise afford large numbers of tapes or records of their own, but who has, nevertheless, a tape recorder of reasonable quality. Perhaps you know of someone who is incapacitated and cannot get out easily who would like to hear music in this way. The cost to them would be only the return postage on the tapes.

Hull, Yorkshire
K. Nutbrown
Any reader wishing to take advantage of Mr Nutbrown's offer, or anyone who knows of someone who would appreciate such a service, please write to Mr Nutbrown, care of ATR.

Wanted - oriental tapes

I am an ardent fan of Oriental, African and Greek music and dancing, but I am finding it impossible to obtain pre-recorded tapes of these.

I have written to two pre-recorded tape organizations but they have been unable to help. Are such tapes available in this country, other than by borrowing them from the appropriate embassies?

If any other reader can help me with this I would be very pleased to hear from them. I have a Telefunken Magnetophon 300 recorder.

Sunningdale, Berkshire
Miss J. Westley

Service sheet wanted

I have a Venus Veritone tape recorder and am having trouble with erase oscillator and the drive for the bias-oscillator. As the manufacturers went out of business some time ago, and I have no service sheet of my own, I wondered if another reader would be prepared to loan me a copy of the service sheet. I would be glad to pay all out-of-pocket expenses and a fee for the use of the sheet.

Chingford, E4
L. V. Elliott

Service Sheet (2)

I have a Minivox Challen portable recorder which has developed a fault and am unable to get it repaired as no service sheet seems to be available. I understand that the manufacturer closed down some three years ago. Can any other reader help me with information or suggestions?

Beckenham, Kent

N. D'Alquen

Service Sheet (3)

I am having difficulty with my Korting Mk 112 tape recorder and would like to get hold of a circuit diagram and service sheet for this machine. So far I have had no luck - can any of your readers help?

Ruislip, Middx

P. J. Morgan

Thanks!

Many thanks to ATR for publishing my letter re Gavioli organs in the June issue, and also to the many readers who took the trouble to write to me with interesting and helpful information. All the letters have been answered, and several will be followed up as and when I have blank tapes available. As a result of everyone's help I have been in contact with the famous Murphy family and have been assured that the organ I have been trying to trace was a 110-key Gavioli. Another member of the Murphy family travelled a 112-key Merengi which incorporated tuned bells and violin effects. The music book for the William Tell overture as played by this organ stood, when folded, in the region of four feet high and took two men to lift into position for playing.

Sad to say neither of these organs now exists. Anyone who has at some time in the past heard this mammoth type of fairground organ play Zampa overture will agree with me that they were the mighty Wurlitzers of their class.

Middlesbrough

A. W. Mann

Sounds of Britain

As a recent immigrant to this country from Southern England, I would like to fill gaps in my collection of sounds of the British Isles.

If any readers have anything interesting to offer I would be pleased to hear from them. I am particularly interested in obtaining recordings of poems, humour, dialogue, etc., in the dialects of Yorkshire, Cornwall, Scotland, Ireland, Wales, Liverpool and Cockney London.

Other sounds I would like are steam trains, trams, barrel and hurdy-gurdy organs, polyphon, bells and chimes, the changing of the Guard, bird songs, animal noises, etc. Although I have a Fi-Cord 202, any speed (the higher the better) would be acceptable. In return I will send a 3 in tape of Montreal sounds collected over several months.

Unfortunately, tape recording as a serious hobby is almost non-existent over here, but I hope to be able to promote interest as opportunity affords.

Montreal, Canada

R. G. Jones

One man's meat . . .

I have just been comparing recent issues of your magazine with the corresponding editions of the other two tape magazines, as well as with your own earlier issues. It is patently obvious that the new format of the magazine is much better value than hitherto, and although I had been considering giving up my regular order, having seen the vast improvement in your recent issues I shall continue to place my monthly order for ATR.

May I take this opportunity of asking that in the not-too-distant future you will publish (a) readers' tape problems and your comments; (b) fearless reviews of tape equipment; and (c) do-it-yourself servicing hints.

Sheffield, Yorks

Ted Kent

. . . is another man's poison

After comparing your magazine with others during the months March to August, I am of the opinion that for 2s 6d (6d more than the others) you waste space. Take for instance the July issue, page 8, heading 'Tape Correspondence', which would have looked better all in one line to save wasting the space at the side. Space was also wasted on many other pages, and as for page 39 . . . ! For my money, future issues will need to give more value.

Stoke-on-Trent

M. A. Christie

Well, what do the rest of our readers think?

THE MARRIAGE OF TAPE AND SLIDE

Gordon J. King

Last month we discussed a unit designed for operating a slide projector from deliberate pauses introduced between the taped commentaries. It was shown that audio signal from the tape recorder (either from the external loudspeaker socket or monitor output) is fed into the slide-change unit so as to 'hold-in' a relay, except during deliberate pauses, when the relay 'falls-out' and operates the slide projector.

This device can, in fact, be worked without any electrical connection from the tape recorder. The idea is to connect a microphone to the input of the slide-change unit so that the signal output from this, due to the taped commentary, does exactly the same thing as the signal applied direct from the recorder. The microphone, of course, 'listens' to the commentary from the speaker of the tape recorder. For adequate limiting, however, it is generally necessary to connect the microphone to the unit through a microphone amplifier, as shown in Fig.1.

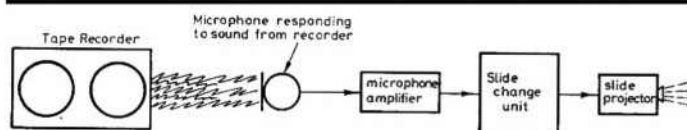

Fig.1. The microphone is connected to the unit through a microphone amplifier to ensure adequate limiting.

The great advantage of this type of system is that no special arrangements at the tape recorder are required. Indeed, any kind of tape recorder (or disc record player, for that matter) can be used to change the slide automatically. The only requirement is that a pause of specific period be introduced between each commentary section. The pause need not be zero sound, for, provided the commentary signal pushes the unit well into limiting, a soft background (of music, for instance) can be tolerated during the pause periods without affecting the correct operation of the unit. See last month's article for details.

Educational and industrial authorities are more and more coming to realize the economic desirability of integrating colour slide transparencies with synchronous taped commentaries as a complete substitute for the colour cine film and sound accompaniment.

Tape/slide versus film

Such a film may cost in the order of thousands of pounds to produce and process, while a comparable programme with slides and tape can be costed in terms of hundreds of pounds. There are cases, of course, where the moving picture is essential, but there are a great many applications where the still picture is equally suitable and, sometimes, more advantageous than the moving picture.

In industry, where techniques change very rapidly, a costly cine film illustrating a specific process, for instance, may fall out of date in part after only a few showings. The solution, then, is either to cut out the redundant parts and introduce new sections or run a completely new film. Both methods are costly.

Where the programme is produced on slides and tape, however, any alteration to bring up to date is relatively inexpensive. The exercise simply resolves to the substitution of the out-of-date slides and taped commentary. Makers who issue slide and tape

programme facilities to their agents, therefore, need only send a new tape (with the affected sections only replaced) and exchange slides to their agents from time to time to keep the whole thing in line with what processes are actually in use at any time.

Educational aspects

I have been engaged in testing the possibility of translating the written word and illustrations from books to the spoken word and colour transparencies, via the medium of tape and slides. Results have been most encouraging, and tests have shown that students are generally able to absorb information much more readily when it is presented in this manner than when they themselves have to extract it from books and so forth.

Moreover, it has been discovered that still pictures detailing specific points and reinforced by the spoken word appear, under certain conditions, to possess a greater power of 'penetration' than an ordinary cine film carrying the same information. It seems, also, that there is an optimum in terms of the time that the slide is displayed on the screen, depending upon detail to be absorbed. A 'learning rhythm' is thus established, which can be destroyed if the display period is too long or too short.

Books already in existence can be translated in this way and the original pictures or illustrations used to make the transparencies. Sometimes, however, it pays to have the illustrations redrawn in colour and the text modified just a little to suit the spoken word. The speaker is also an important factor in the equation, and he (or she) should be chosen with a good deal of care.

Purely on an experimental basis, I have been concerned in the translation of both technical and non-technical books to tape and slide. It would certainly seem that this mode of teaching has a great potential, at least equal to that of television, for the definition and colour rendering of the latter is not yet up to the standard of that possible from colour slides and good-quality projectors.

A back-projection system, complete with tape player and auto-control unit, can be accommodated in a semi-portable console cabinet, giving the impression of a television set. The use of such a device avoids the necessity of darkening the room to run the slide display.

It is not intended in this article to detail the various types of projectors and units now available to tie tape to slides, as these were the subject of a very comprehensive article which appeared in the August 1964 issue of *ATR*. However, it is worth noting that there are available automatic remote-controlled slide projectors with 'rotary' slide carriers (see the article mentioned above). Such a projector could be integrated, via the medium of an automatic slide-change unit, with a tape recorder running from a tape loop. This set-up would then give a continuous display of slides synchronized with the sound on the tape, and would represent an ideal advertising medium or information service.

For the experimenter

For those enthusiasts who feel that they would like to experiment with the tone pulse method of slide changing, we conclude this short series of articles with a couple of circuits. The first one (Fig.2) is of an audio oscillator for producing the tone pulse.

(continued overleaf) 15

AT LAST!

Automatic slide/sound synchronisation at a realistic price!

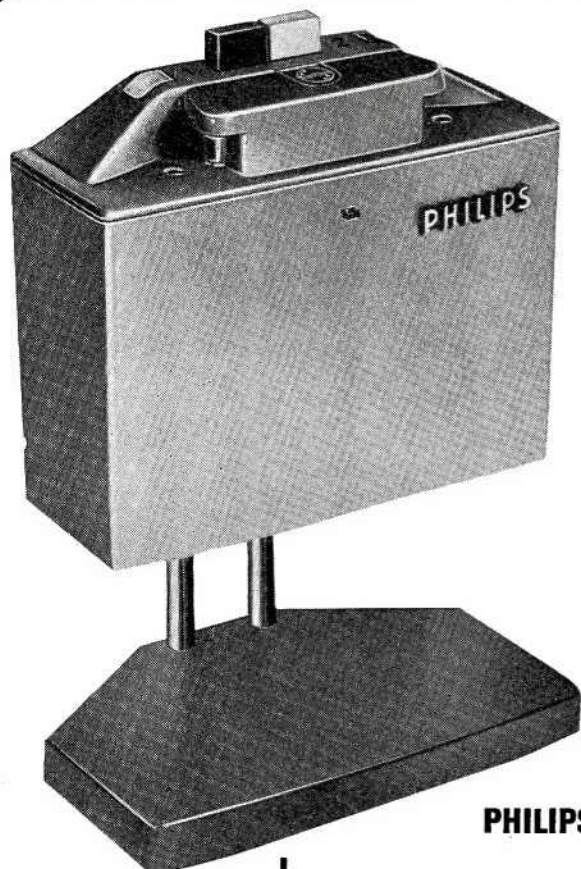

Lucky you – now you can liven up your slide shows with a professionalism that all your friends will admire. Now your running commentaries can be *automatically* synchronised with every slide you show – not only will your audience enjoy themselves more, but you too, are able to sit back and relive the occasion! And this undeniable luxury costs so little—only 15 gns. With Philips Slide Synchroniser your automatic slide projector is operated by impulses on the tape. The height of the Synchroniser can be adjusted to match that of your tape recorder. It's simple to use—only two push-buttons. For details of all the other features and uses that make Philips Slide Synchroniser such superb value for money, write to the address below. It could open the door to a whole world of entertainment for you, your friends and your family!

**PHILIPS SLIDE SYNCHRONISER ONLY 15 GNS
FOR AUTOMATIC ENTERTAINMENT**

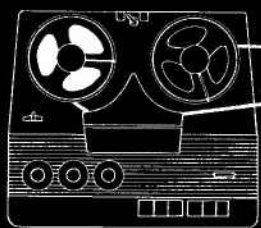

PHILIPS
-the friend
of the family

PHILIPS ELECTRICAL LIMITED (DEPT. TR), CENTURY HOUSE, SHAFTESBURY AVENUE, LONDON, W.C.2.

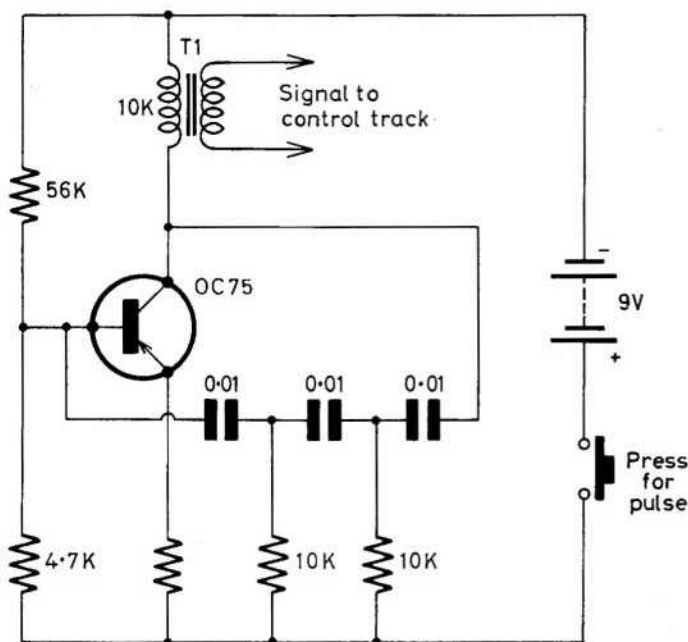

Fig.2. Circuit for a phase shift oscillator used to produce a tone pulse.

This is a simple, though effective, phase shift oscillator using a single transistor. The oscillator frequency is in the order of 800 c/s.

The resistor-capacitor network between the collector and base of the transistor provides the phase shift at the particular oscillator frequency, and the oscillator is switched on by the 'press for pulse' press switch in supply positive circuit.

The transformer in the collector should have a turns ratio to give a reasonable match to the head section to which the signal is applied so that an impedance of about 10,000 ohms is reflected across the primary winding at the collector.

The turns ratio is equal to the square-root of 10,000 ohms divided by the head impedance in ohms (step-up ratio from the head to the collector) or the square-root of the head impedance in ohms divided by 10,000 ohms (step-down ratio from the head to the collector). The oscillator signal will generally be of sufficient amplitude to modulate the tape control track fully.

So much, then, for recording the pulse on the control track. Now let us see how this pulse can be caused to operate a relay which in turn will operate the slide projector (see Part 1 of the series).

A suitable circuit for this operation is given in Fig.3. The first transistor, Tr1, is a voltage amplifier. This amplifies the pulse signal picked up by the head section corresponding to the control track. T1 matches the head to the base circuit of Tr1. This is generally a step-down transformer from the head to the base circuit, with a ratio of about 5 to 1, depending upon the impedance of the head and based on about 1,000 ohms input impedance to Tr1.

T2 couples the signal at the collector of Tr1 to the signal rectifier diode, D1. This has a step-up ratio of about 3 to 1. Any ordinary driver transformer can be used in this position. D1 is connected so that its negative end is connected to the base of Tr2.

Tr2 and Tr3 form a voltage amplifier which energizes the relay winding in Tr3 collector. Normally, these transistors are non-conducting. However, in the event of the occurrence of a tone pulse, a dc voltage is developed across the 56 k resistor at the base of Tr2. This causes the dc connected transistors to conduct. Current then flows in the relay winding, the relay energizes and the contacts close, thereby operating the projector.

A small time-constant is provided by the 10 μ F electrolytic capacitor across the 56 k resistor, so that the relay will remain energized for a usable period of time even though the tone pulse may be of very short duration. However, too much delay should be avoided, as this may cause two slides to change instead of one. If the relay 'holds-on' for too long a period, the value of the electrolytic mentioned should be reduced.

The diode, D2, across the relay winding prevents switching transients from damaging the transistor.

The circuit is simple to get going, but if the audio signal from the head fails to produce sufficient level of dc signal to work the relay, an extra stage of amplification should be incorporated between the head and Tr1.

One is not bothered with quality of signal for this application, of course, so quite a few liberties can be taken over the amplifier and signals levels. Record bias is not necessary.

The two circuits (Figs.2 and 3) can be combined into a single unit if required. The 'press for pulse' button could have a ganged switch section to operate the projector during the making of a tape/slide programme. A changeover switch will, of course, be needed to change the head from the oscillator to the amplifier to provide manual/auto facilities.

So we have seen even more applications to which the tape recorder can be put. Now that colour photography is becoming popular, it is quite feasible to programme during the summer months with both tape recorder and camera, allowing the winter months to be spent in editing and playing back the activities of the summer. There is a great deal of interest obtainable from tape/slide integration, both from the point of view of entertainment and education.

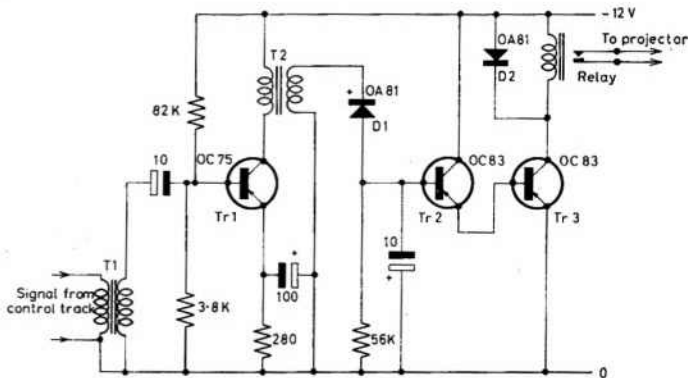

Fig.3. Circuit to enable the pulse to operate a relay which will operate the slide projector.

RECORDERS IN THE MAKING

Part 2: The Truvox Story

Fig.1. A sixty-ton power press stamps the top plates for the language deck. These decks are now incorporated in language teaching laboratories throughout the world.

Fig.2. Motor pinions for every recorder must be turned extremely accurately.

Fig.3. After the main deck panel die-casting has been sprayed it enters a thermostatically controlled drying and hardening tunnel. This method ensures an absolutely even finish throughout.

Fig.4. The complete deck assembly and electronics are integrated and the recorder really begins to take shape.

Many audio equipment manufacturers can look back on the past few years and feel justifiably proud of the progress achieved. Certainly the 'sixties have been very formative years in the standards of the mechanics, electronics and design of audio equipment.

For the Truvox company this has been particularly so. Bold planning, thoughtful designing and use of the finest possible materials have really made their mark. Since 1961, sales of Truvox equipment have increased by 600 per cent!

That year of 1961 can, in retrospect, be seen as the great turning point in the development of Truvox. The company was already quite well known for quality tape recorders which were virtually hand built, but the sudden sharpening of competition from abroad made the directors acutely aware of the need for positive reorganization.

In both production techniques and designs, British companies were almost reactionary, but Truvox decided to step up production by using modern methods and machinery. This, they hoped, would avoid any sacrifice to the high standards of quality which Truvox owners had come to expect. A designer was also employed with the sole responsibility for designing accurate, neat and functional equipment.

The first results of these steps were seen in the Series 80 recorders. The rugged, functional styling of these machines won both admiration and criticism. For the first time a British company had produced a tape unit as opposed to a complete recorder – that is, without the output stage and loudspeaker, so that the unit could be incorporated into existing hi-fi units. So it was that 1961 ended on an optimistic note for Truvox. The Series 80 recorders were

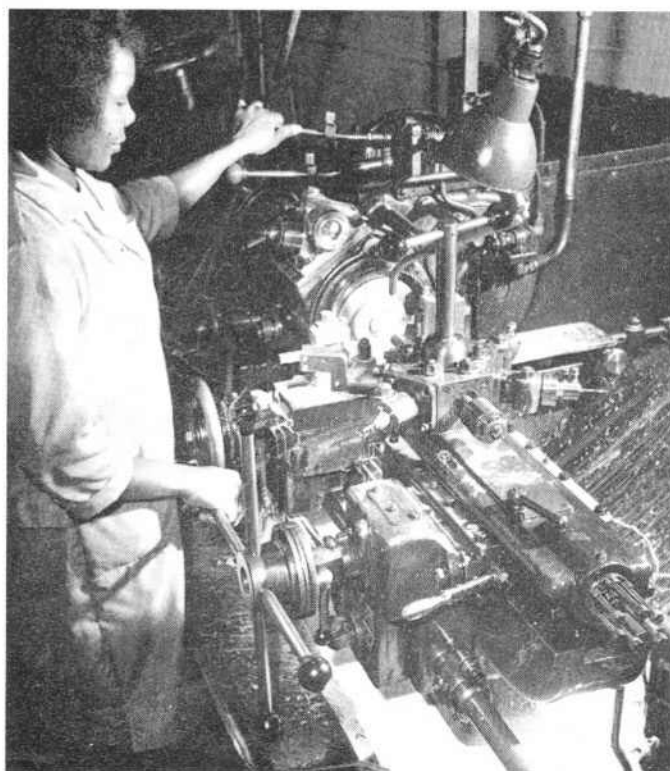
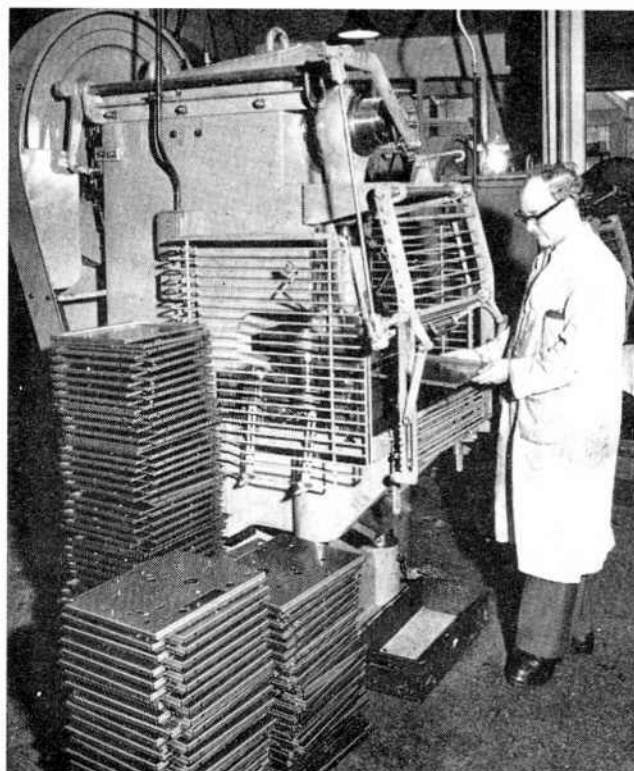

well and truly established, and even more advanced designs for future models were already on the drawing board. December sales figures had been higher than ever, but in January and February of the following year these figures were first equalled and then surpassed. The boom had begun.

Once more Truvox speeded up. More machines were produced and, more important, more ideas and designs were being thrashed out. The laboratory forged ahead with the first-ever British stereo tape unit, the Model PD 86. Details of the project were hushed up and the grand unveiling was planned for the 1962 Audio Festival. But in March, news leaked out, and although no one outside the company had ever set eyes on the machine or even the plans, advance orders poured in! Such had been the success of Truvox that the PD 86 was a sure winner before it was even completed. Meanwhile, the Series 80 machines continued to flourish. Every day new uses were found for these versatile machines. Language teaching and automation in razor blade manufacture both benefited from use of the Series 80. The reliability of the Series 80 deck was such that it would work solidly for days on end throughout the year without showing any signs of developing faults. Even in the United States, a special version of the PD 86 was selling well in the face of stiff continental and Japanese competition.

The early months of 1963 saw the introduction of several further new projects at the Neasden factory. Truvox was approached by the Rank Organization and asked to design and produce tape recording equipment and control consoles for use in language laboratories. Once more good designing and meticulous engineering brought success, and the Truvox language

teaching equipment has now been installed in schools and colleges throughout the world. In Fig.1 you can see a 60-ton power press stamping top plates for the language teaching deck.

Visitors to the Audio Festival that year were, for the first time, treated to a practical demonstration of the audio fidelity of Truvox PD 86. Live performances on the harpsichord had been arranged, each performance being followed by playback through the PD 86 unit. Certainly, after this convincing demonstration, no one could deny that Truvox had produced a machine that was capable of responding excellently to even the most stringent audio demands.

On 1 November 1963 Truvox launched the Series 90 recorders. The decks on these machines were very similar to the Series 80 decks, but had a number of important refinements.

For the first time Truvox employed printed circuitry in these machines. Piano key control was also incorporated for the first time, and a dual meter, instead of a single switchable one, was added to the stereo models.

Previous model tape units had always had recording level meters, while the magic eye system had been used with the complete recorders. However, with the Series 90 models the magic eye was scrapped and metering was used on all models.

Other minor but important refinements included the addition of a hinged splicing plate and a four digit counter.

Again Truvox had found the formula for success and orders for their new machines poured in.

However, even these magnificent successes were soon to be overshadowed. The launching of the Series 100 at the 1965 Audio Festival won

unprecedented acclaim. The unique tape/source comparison switching system, new styling and amazing audio fidelity were admired by enthusiasts the world over and sales rocketed even further.

* * *

Thus the success story of Truvox unfolds. But although we have seen, in general terms, what made such success possible, the ultimate responsibility for success rests with the machine. Even with the careful thought, planning and designing that went into the development of Truvox, had there been any fault with any of their machines, whether it had been one that showed up immediately or one that reared its ugly head after months of use, the foregoing hard work would have been completely in vain. Perhaps the factor most directly responsible for the reliability of Truvox machines was the re-shaping of their assembly lines. This reorganization meant that from conception to final stages of production each stage of the machine could be checked, tested and re-checked, without interrupting the flow of the production lines.

The actual manufacture of a tape recorder can be divided into two distinct sections – mechanical and electrical. At Truvox the two production lines work in parallel, merging in the final stages. The forethought that has already gone into the design ensures maximum efficiency. All Truvox Series 90 machines, for example, have the same basic deck, the only difference being in the number and type of heads. In this way the same production line

(continued overleaf)

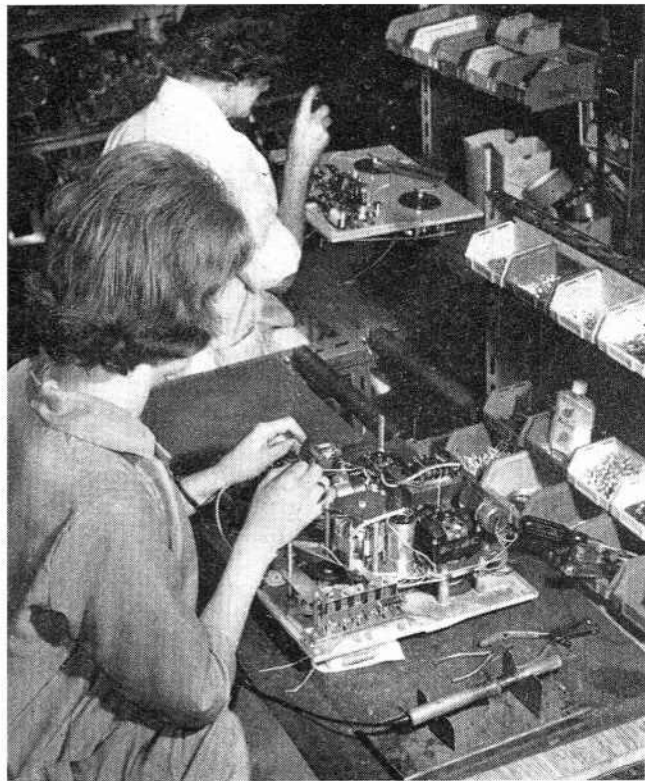
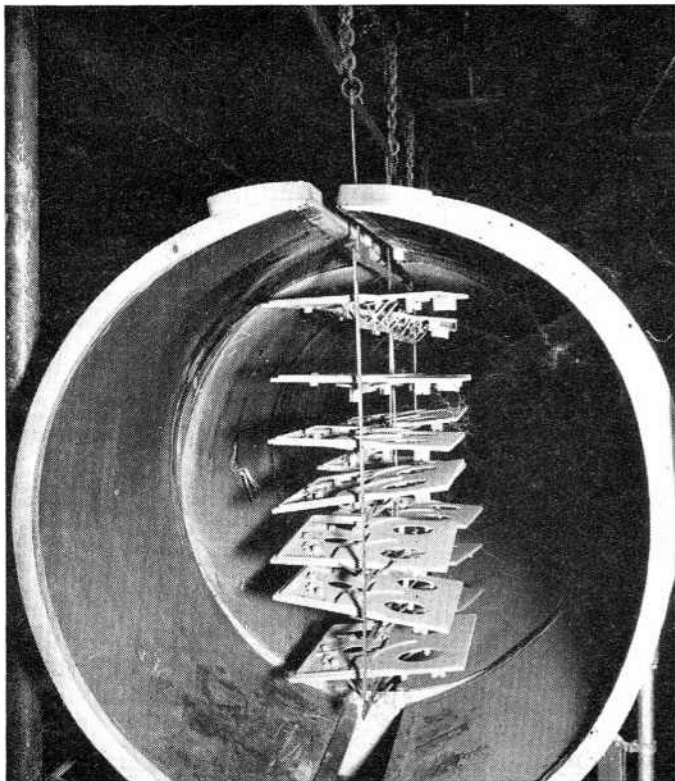

Recorders in the Making *(continued)*

can cope with all models without any difficulty, right up to the stage where the actual heads are inserted.

One of the first stages in the mechanical production line is the manufacture of capstans. This is done on the premises where the fine turning and grinding of the capstan wheels can be checked at every stage. Fig.2 shows the capstan lathe operator at work turning out components that are accurate to tens of thousandths of an inch. The slightest deviation could mean that a machine would have to be rejected at a later stage – in this case the wow and flutter test would probably be the one to show up any fault.

One of the most spectacular processes (not illustrated) is the spraying of metal at a temperature of approximately 3,000°C on to the perimeter of the heavy balanced flywheels. This gives a $\frac{2}{1000}$ in thick keyed surface to the periphery of the flywheel to ensure that idler life is extended to the maximum possible amount. To this end, too, the drive pinion is anodized, giving the obvious advantage of speed stability under all conditions, including vertical operation.

The main deck panels are die-cast and are then primed and sprayed. To give quick drying without ruining the smooth finish, Truvox employ a special drying and hardening tunnel. Racks of deck castings are carried slowly through this tunnel which is kept at a constant heat to ensure even drying (Fig.3). Meanwhile, on the electrical production line, components are being assembled and tested ready for insertion into the completed deck assembly. Fig.4 shows

the complete deck assembly being integrated with the electronics of the recorder, while Fig.5 shows the push-pull oscillator coils and other components being assembled. You will notice that throughout everything is kept scrupulously clean and very strict supervision is given to the mounting of electronic components. This, together with double inspection, has virtually eliminated the old bogey of the dry joint.

The final stages of the assembly are not, however, the final stages of production. Everything is tested, checked, adjusted if necessary and then tested and checked again. Wow and flutter tests are conducted using meters specially designed by Truvox themselves. Mean speed tests are also applied to every machine as it comes off the assembly lines, and, of course, the frequency response is carefully checked and adjusted, as can be seen in Fig.6.

Another test is that for head alignment to international standards. There are a number of accepted ways of doing this, and Truvox tried four ways of listening and a combination of alignment procedures. Each method was rejected. Into each system had crept one disturbing factor – the human element. An operative's listening can vary according to general conditions prevailing at the time of the test, according to the amount of ambient noise present, and according to whether he has a cold in the head or not! To ensure absolute rigidity of standards, Truvox relies on none of these variable factors. Instead, their head alignment system employs a specially made head divided into two segments so that

it actually measures the safety margins between the tracks recorded on the tape. After the complete performance tests have been made, the machine is placed on an asbestos mat and soak tested for a period of as much as twelve hours, after which it is re-tested to ensure that none of the characteristics has altered in any way.

The next stage is to mount the tested deck into its appropriate cabinet or plinth, before the final tests are made. A special operative runs through all the functions of the finished recorder, including winding, braking, recording and playing back, until the machine is ready to leave the factory and be delivered to the customer. But even the delivery has not been left to chance. After so much care and attention to detail has been given to the machine, the last thing anyone would want would be for it to be damaged in transit. As each new Truvox model reaches the final stages of development, a number of machines are assembled in their final pack and given the only realistic test possible – that is, to be sent by different forms of carrier to Glasgow and returned to Neasden. Once back at the factory, they are immediately tested to make sure that they are still within the same rigid specification as they were when they left. This test will highlight any packing or component mounting weaknesses much more accurately than any amount of artificially controlled testing, since no one can be sure that the controlled dropping heights and angles used in testing will not be exceeded in practice.

Thus it is that, after careful design, accurate assembly and meticulous testing, a Truvox machine reaches the customer with a built-in guarantee of reliability. In view of all this, is it really so surprising that Truvox sales have increased by 600 per cent?

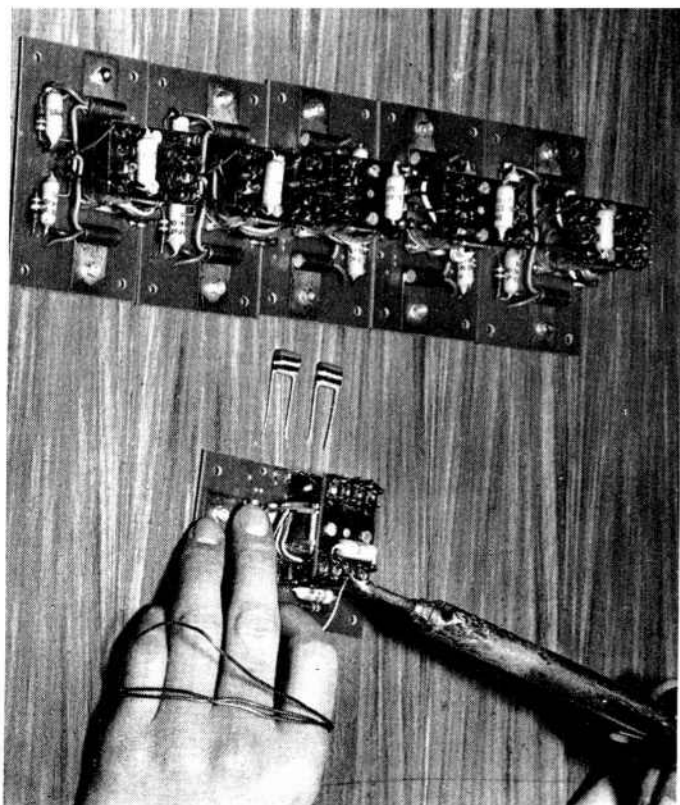
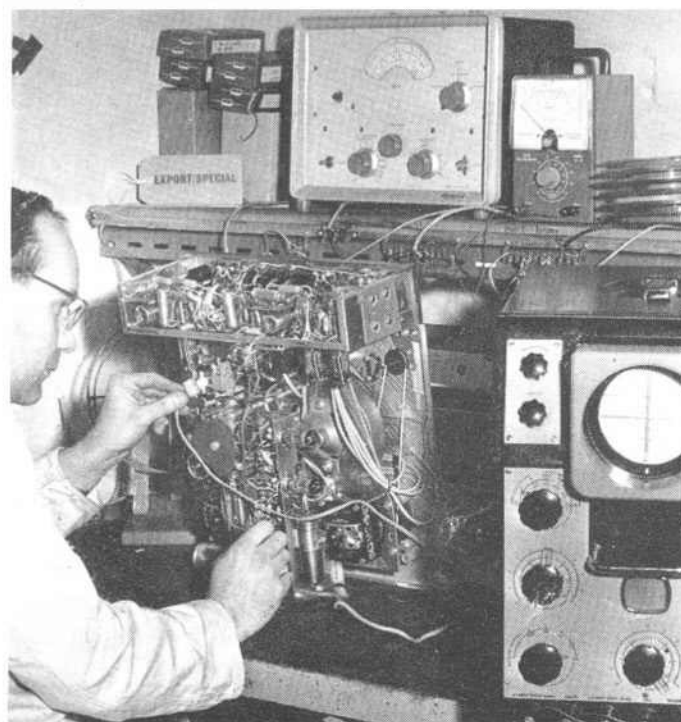

Fig.5. Assembly of push/pull oscillator coils and other component parts prior to insertion in the tape deck.

Fig.6. Testing, checking and adjusting the frequency response prior to inserting the unit in its cabinet.



Russ Allen, the well-known musician and writer, returns with a pot-pourri of

T A P E R E V I E W S



Like the rain of British summer, I have returned. My function from now on will be to review each month a selection of pre-recorded tapes, both mono and stereo. The material under review this month has been kindly loaned by the Marble Arch branch of Teletape, from where these and many others may be obtained.

Certainly the only reel out of this lot I would wish to keep is 'Love Duets', Maria Callas and Giuseppe di Stefano. Col. TA-33CX 1725. £2 0s 0d.

The controversial star of stage and life, Callas, is aided and abetted by a superb cast, Stefano and the Orchestra of La Scala Opera House, Milano, conducted by either Tullio Serafin, Antonino Votto or Victor de Sabata.

Stefano is truly magnificent and Callas, while not my favourite soprano, is really most impressive.

The chosen music, from Tosca, Cavalleria Rusticana and La Boheme, is superb. Over fifty minutes of sheer delight.

From one controversial singer to another! 'I am P. J. Proby'. Liberty TA-SL 10112. £1 15s 0d.

Of all the characters on the pop scene, P.J. and the Stones are the most notorious. Both have talent but suffer from an unfortunate method of presentation.

Personally I am an anti-Stone, but P.J., who has annoyed me by his stupid antics, both vocal and physical, does have a good voice and a lot of most infectious enthusiasm.

The twelve tracks of this tape have the excellent direction and production of Charles Blackwell. As splendid a cross-section of Proby's talents as you could wish. My only complaint is that too many tracks fade out too soon.

Great Themes from Great Movies. Tempotape 11. £1 1s 0d.

Tempotape is a new name on the p-r tape market and they claim double the amount of tape, recorded on one track only, leaving the rest for your own recording. This particular issue has well over 600 ft and the music occupies 32½ minutes of it.

Unnamed orchestras play pleasantly arranged, lush versions of what the label says.

The 'As Time Goes By' track has some very rough recording and it is evident that most, if not all the tracks have been dubbed from discs. There is hiss, rumble and other extraneous noise consistent with that gained from not-so-new surfaces.

'The Real R & B'. Stateside TA-S1 10112. £1 15s 0d.

I am always suspicious of anything that

assumes the label 'genuine' or 'real', etc. Rhythm and Blues, like folk singing, has come to be what it is not. Those battered old workworn negroes of history who sat out front of their shacks with a mean old 'getar' waiting to be discovered by John Hammond or Alan Lomax have sadly given way to sharp-suited, flashy-tied, diamond-pinned, plump sweaty-faced gentry with Cadillacs, managers and the rest.

The R & B here is this vintage. Nevertheless, there are some fine items, with Earl Gains coming out as top man for my money. Sixteen tracks altogether, with some terrible fades. Track B of side one cuts out in the fourth bar of a new chorus. Why? Track C cuts out on the fifth bar of a new chorus! Crazy. Perhaps someone should learn how many bars there are to a twelve-bar blues.

Maybe it's not 'real' R & B (to my mind), but I'll say its as good a selection of the new thing as you'll find. So, why not get it?

'Hansel and Gretel', Humperdinck. HMV TA-CLP 1815 and 1816. £1 15s 0d each.

Sadler's Wells Orchestra and Chorus conducted by Mario Bernardi.

The complete work on both sides of two tapes with a total running time of approximately 110 minutes.

The story you must know from your childhood. It has been changed but little and comes complete with witch and gingerbread house.

Commendably well sung and played. Not great music, but good. But, at who is it aimed? At children? Scene 1 of Act 2 starts as typical 'Listen with Mother', but as the other characters join in, it becomes, I'm sure, far too complicated for tiny ears. It can't have been meant for adults. Perhaps, not being a father (yet!), I underestimate the musical appreciation and understanding of children.

If your tots are 'A' level, then this will be a highbrow treat for them.

The duet, Act 2, Scene 2, is quite beautiful, but I was jolly glad when the witch died.

Memo to p-r tape purveyors. Something I miss very much is the informative sleeve notes usually given on LP sleeves. Also, I am certain that the customer likes to know what orchestra is performing, who is conducting, etc. Please may we be given a little more information?

IN ATR

- ★ Sound for science fiction by F. C. Judd
- ★ A guide to turntables by D. J. Barnett
- ★ Inquest on the Contest by Kim Cook
- ★ Volume compressor and pre-amplifier circuit for constructors
- ★ Test report on the Akai X-IV by G. J. King

NEXT MONTH

All in the October issue of *ATR*

On sale 24 September

Price 2s 6d

Order your copy now!

— *Vortexion* quality equipment

12-WAY ELECTRONIC MIXER

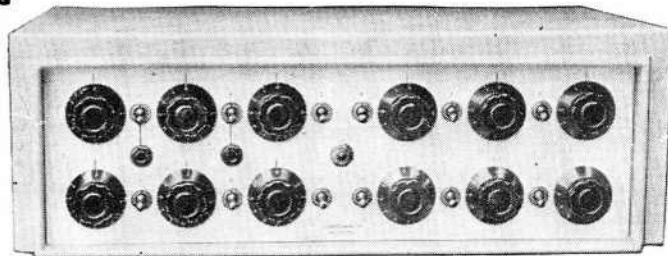

The 12-way electronic mixer has facilities for mixing 12 balanced line microphones. Each of the 12 lines has its own potted mumetal shielded microphone transformer and input valve, each control is hermetically sealed. Muting switches are normally fitted on each channel and the unit is fed from its own mumetal shielded mains transformer and metal rectifier.

FOUR-WAY ELECTRONIC MIXER

This unit provides for 4 independent channels electronically mixed without "spurious break through" microphony hum and background noise have been reduced to a minimum by careful selection of components. The standard 15-50 ohm shielded transformers on each input are arranged for balanced line, and have screened primaries to prevent H.F. transfer when used on long lines.

The standard 5 valve unit only consumes 18.5 watts. H.T. is provided by a selenium rectifier fed by low loss, low field, transformer in screening box. The ventilated case gives negligible temperature rise with this low consumption assuring continuance of low noise figures.

20,000 ohms is the standard output impedance, but the noise pick-up on the output lines is equivalent to approximately 2,000 ohms due to the large amount of negative feedback used.

For any output impedance between 20,000 ohms and infinity half a volt output is available. Special models can be supplied for 600 ohms at equivalent voltage by an additional transformer or 1 milliwatt 600 ohms by additional transformer and valve.

The white engraved front panel permits of temporary pencil notes being made, and these may easily be erased when required. The standard input is balanced line by means of 2 point jack sockets at the front, but alternative 3 point connectors may be obtained to order at the rear.

Mixer for 200-250 V AC Mains	£40 8 6
Extra for 600 ohm output model	£1 18 6
Extra for 600 ohm 1 milliwatt output	£3 0 6
Size 18½ in. wide × 11½ in. front to back (excluding plugs) × 6½ in. high.		
Weight 22 lb.		

THREE-WAY MIXER and peak programme meter, for recording and large sound installations, etc.

This is similar in dimensions to the 4-Way Mixer, but has an output meter indicating transient peaks by means of a valve voltmeter with a 1 second time constant in its grid circuit.

The meter is calibrated in dBs, zero dB being 1 milliwatt-600 ohm (0.775 V) and markings are provided for + 10 dB and - 26 dB. A switch is provided for checking the calibration. A valve is used for stabilising the gain of this unit. The output is 1 milliwatt on 600 ohms for zero level up to + 12 dB maximum. An internal switch connects the output for balance unbalance, or float. This output is given for an input of 40 microvolts on 15 ohm.

An additional input marked "Ext. Mxr." will accept the output of the 4-Way Mixer converting the unit into a 7-Way controlled unit. This input will also accept the output of a crystal pick-up, but no control of volume is available.

The standard input is balanced line by means of 3 point jack sockets at rear, but alternative 2 point connectors may be obtained to order at the front or rear as desired.

The 8 valves and selenium rectifier draw a total of 25 watts.

P.P.M. for 200-250 V AC Mains	Price on application.
Size 18½ in. wide × 11½ in. front to back (excluding plugs) × 6½ in. high.		
Weight 23 lb.		

10/15 watt Amplifier with built-in mixers.

30/50 watt Amplifier with built-in mixers.

2 × 5-way stereo mixers with outputs for echo chambers, etc.

Full details and prices on request.

VORTEXION LTD, 257-263 The Broadway, Wimbledon, S.W.19

Telephone: LIBerty 2814 and 6242-3-4

Telegrams: "Vortexion London S.W.19"

8 CHANNEL MIXER UNIT

During the long winter evenings I started to wade through the assortment of recordings collected on my battery tape recorder during the summer months.

As I worked, making up a coherent tape from various disjointed recordings, I became more and more aware of the need for a mixer unit that could be used in a variety of locations with my battery portable.

The mixer unit would have to be battery operated and transistorized, both for economy and lightness. It should also be small in size, but not too small for the control knobs to be difficult to operate, through being too close together.

I already owned an eight-channel mains-operated valve mixer unit, which had been used regularly for many purposes. This unit had four high-impedance microphone inputs and four high-level inputs; there was also a master gain control which was seldom used.

Bearing in mind how useful the valve mixer had been, it was decided to incorporate the same eight channels into a transistor unit, thus allowing one mixer to be used for all purposes. The only changes made to the basic features were that the master volume control was deleted and the microphone inputs were made low impedance. This was no disadvantage to me as all my microphones are low impedance, a matching transformer being used with the valve mixer. If it is required to use crystal microphones with this transistor mixer an impedance converting pre-amp. will be necessary. One other requirement was that the output must be at least 200 mV.

The circuit (Fig.1)

The mixer is very simple in design, as I believe that a simple, stable design is preferable to a complex, very high gain circuit in which results can differ widely from model to model due to production spread in transistors.

The microphone inputs have an impedance of 2.2 k ohms, and need approximately 0.15 mV for full output. Each feeds into a pre-amplifier using a single low-noise transistor, with negative feedback applied to improve quality, and also to raise the input impedance. The four input transistors, T1-T4, are run at a low collector current to minimize noise.

From here the signal passes via R8, 16, 24 and 32 to the volume controls. The actual mixer circuit is rather unconventional but works very well and does not introduce much loss. The signal is then applied to an emitter follower stage, T5, with a high

input impedance and this prevents the next stage, T6, from damping the mixing circuit. T6 also has feedback applied via R40 and feeds into a similar stage, T7, with a very high gain. C24 conveys the signal to the output transistor, T9, which has negative feedback applied via R54.

Both the input pre-amp. stages and the microphone amplifier circuits are adequately decoupled by R33-C13 and R47-C20 respectively. These components are chosen to have different time constants to eliminate any tendency of the design to oscillate at very low frequencies.

The four high-level inputs are fed through resistors to the controls VR5-8. These resistors can be changed in value to alter the input sensitivity and impedance. The input impedance is equal to $R + 15\text{ K ohms}$ and the sensitivity decreases as the resistance increases. The values used in the prototype were for the following inputs; R56 = 1 meg, gram. R57 = 1 meg, radio. R58 = 470 K, tape 1, R59 = 270 K, tape 2.

The signal from VR5-8 proceeds via emitter follower T8, to the output stage.

Construction

The mixer is constructed in an aluminium chassis 12 in \times 8 in \times 2½ in, marked out as shown in Fig.2. Miniature group boards are used to support the components, these being fitted in the positions shown in Fig.3.

The chassis should be drilled as shown, and the controls and input sockets fitted. When this has been done, the plate to steady the battery can be cut out and fitted with a long 4 BA bolt. This bolt will then support the decoupling components, R47 and C20, which are mounted on a tag board.

Next an earth 'bus' is connected across all the input sockets and to the chassis ends of the volume controls and the on/off switch. This 'bus' should be connected to the chassis at only one point to reduce the possibility of any hum loops being formed.

The 1,000 mFd capacitor, C27, can then be mounted on its group board and fitted as shown. This capacitor prevents instability as the internal impedance of the battery rises with age.

Three of the four microphone pre-amplifiers are constructed on an eighteen-way group board, the fourth is mounted on a six-way board. The decoupling components, R33 and C13, can also be mounted on the larger board. Small, right-angle

R. Spriggs describes how he built a portable eight-channel mixer, and gives you all the information and instructions you need to make one for yourself.

brackets are cut from aluminium to support these boards. Care should be taken to ensure that none of the components touches the chassis or these brackets. Resistors R8, 16, 24 and 32 are wired from the boards to the controls VR1-4.

Another eighteen-way miniature group board holds the three transistors T5, T6 and T7. This is fitted to the front wall of the chassis on spacers or with several washers to prevent the tags touching the chassis. Spacers are used again to support the final board which carries T8, T9 and their associate components. Two bolts through the side of the chassis near the output socket hold this board in place. The signal connection from the microphone amplifier board to the output stage may need to be made before the latter board is fixed in place. All other connections can be made with the boards fixed in position. Although only a single bolt was used to hold each of the microphone boards, no trouble has been encountered as the connecting wires are stiff enough to prevent them from twisting.

The resistors R56-59 are then wired from the input sockets to their respective controls and the output from these taken to the capacitor C21.

Details of the exact layout of the boards have not been given because if components of a different physical size are used these could not be fitted as in the original model and this might lead to confusion.

Testing

The wiring should be very carefully checked, special attention being given to the polarity of transistors and electrolytic capacitors.

The battery may then be connected. It is a good policy to connect a milliammeter in series with the battery when first switching on. The mixer consumes approximately 5 mA and any meter reading which differs greatly from this should be taken as a warning that there is a fault in the wiring and this should be re-checked.

An input can then be connected to the mixer and the mixer plugged into the tape recorder. The volume control on the recorder is used as the master gain control. This should be turned ¾ full on and the mixer, if working correctly, will now give full modulation without any audible distortion.

If the recorder to be used with the mixer requires more than 200 mV for full modulation, the value of R54 can be reduced

(continued on pages 24, 25 and 26)

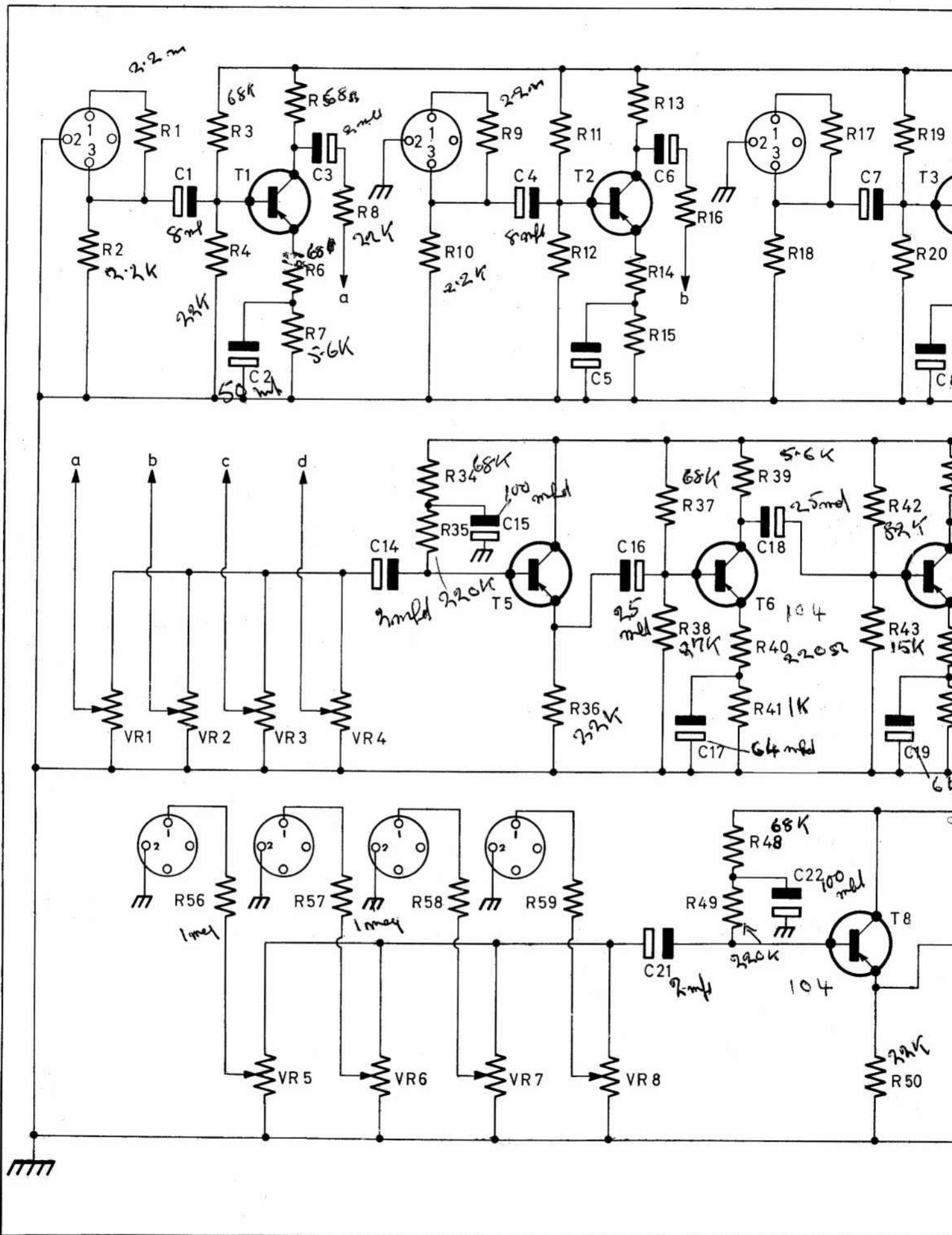

8 CHANNEL MIXER CIRCUIT

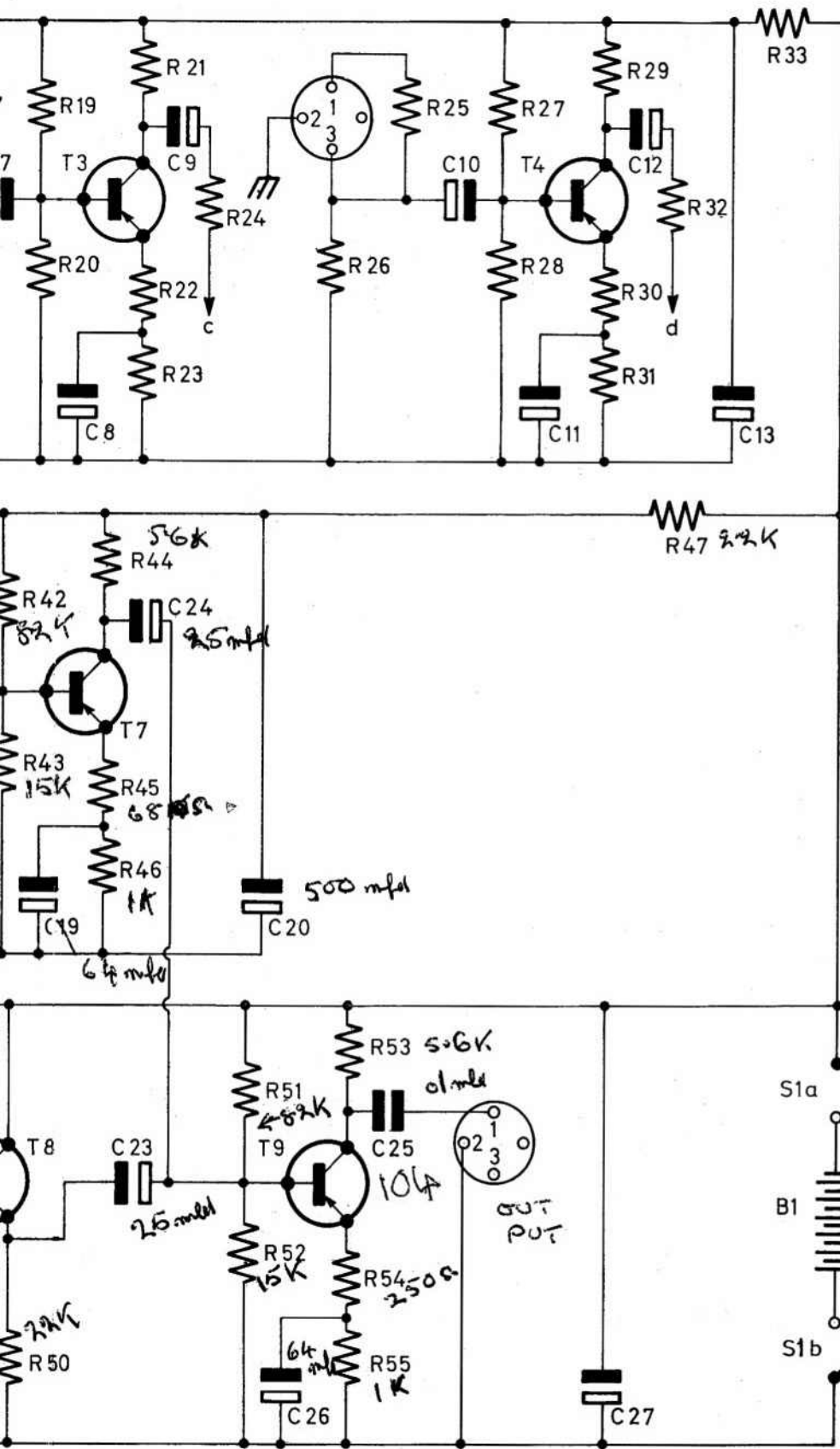

Components List

R1, R9, R17, R25	2.2 megohms
R2, R10, R18, R26	2.2 Kohms
R3, R11, R19, R27	68 Kohms
R4, R12, R20, R28	22 Kohms
R5, R13, R21, R29	10 Kohms
R6, R14, R22, R30	68 ohms
R7, R15, R23, R31	5.6 Kohms
R8, R16, R24, R32	22 Kohms
R33	3.3 Kohms
R34, R48	68 Kohms
R35, R49	220 Kohms
R36, R50	22 Kohms
R37	68 Kohms
R38	27 Kohms
R39, R44, R53	5.6 Kohms
R40	220 ohms
R41, R46, R55	1 Kohms
R42, R51	82 Kohms
R43, R52	15 Kohms
R45	68 ohms
R47	2.2 Kohms
R54	250 ohms
R56, R57	1 megohm
R58	470 Kohm
R59	270 Kohms
C1, C4, C7, C10	8 mfd
C2, C5, C8, C11	50 mfd
C6, C6, C8, C12	2 mfd
C13, C20	500 mfd
C14, C21	2 mfd
C15, C22	100 mfd
C16, C18, C23, C24	25 mfd
C17, C19, C26	64 mfd
C25	0.1 mfd
C27	1000 mfd
VR1, VR2, VR3, VR4, VR5, VR6, VR7, VR8	100 Kohms log.
T1, T2, T3, T4	8723 2GT102
T5, T8	103 2GT174
T6, T9	104 2GT182
T7	170 OC170
S1, a and b.	Double pole on/off switch.
	4 eighteen-way miniature group boards.
	8 control knobs.
	9 sockets (to match those on recorder in use).
B1	Vidor VT9 battery.

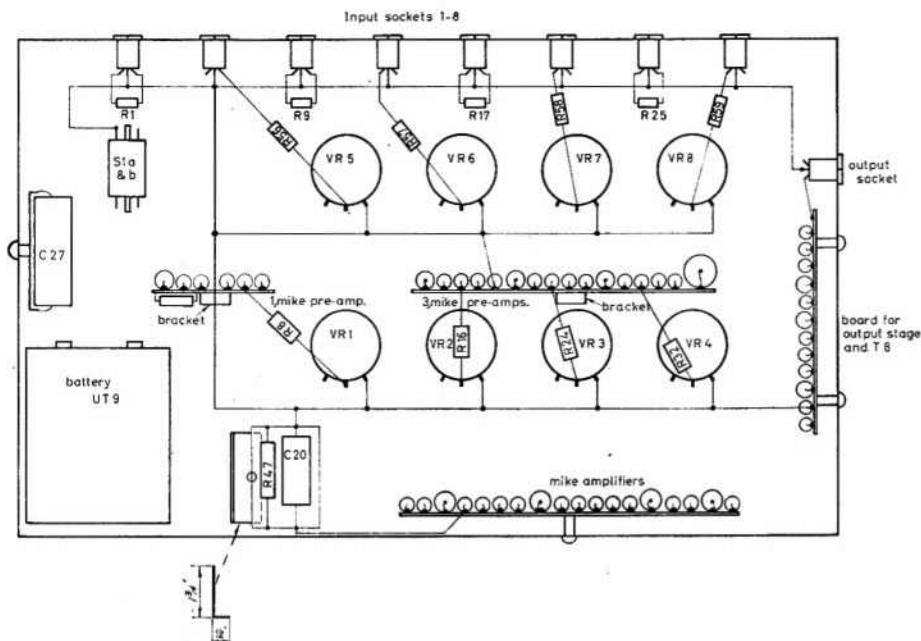
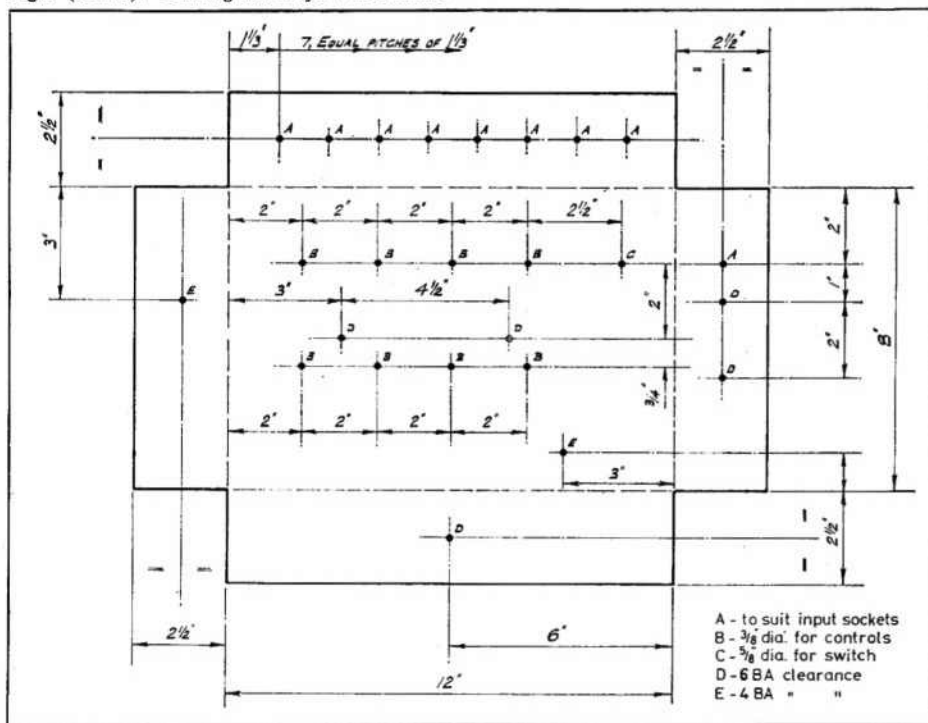

Fig.2 (above). Guide to the interior layout.
Fig.3 (centre). Drilling details for the chassis.



to give a larger output. Although I have no testing facilities for frequency response curves, the mixer has been used to mix high quality signals with no apparent loss of quality.

A further reduction in noise level on the microphone inputs might be obtained if AC107 transistors are used instead of 2GT102 types. With the exception of T7, which is a Mullard OC170, all the transistors are Radiospares types.

The bottom cover of the mixer was cut from hardboard, covered with aluminium foil to give complete screening. Four rubber feet were fitted and a small fillet of wood to hold the battery firmly.

The layout of the mixer is in no way critical, and no doubt enthusiasts will alter the layout to suit their own needs (see Figs.4 and 5). The only points to remember are

Fig.4 (below left). The completed mixer.
Fig.5. Interior of the completed mixer.

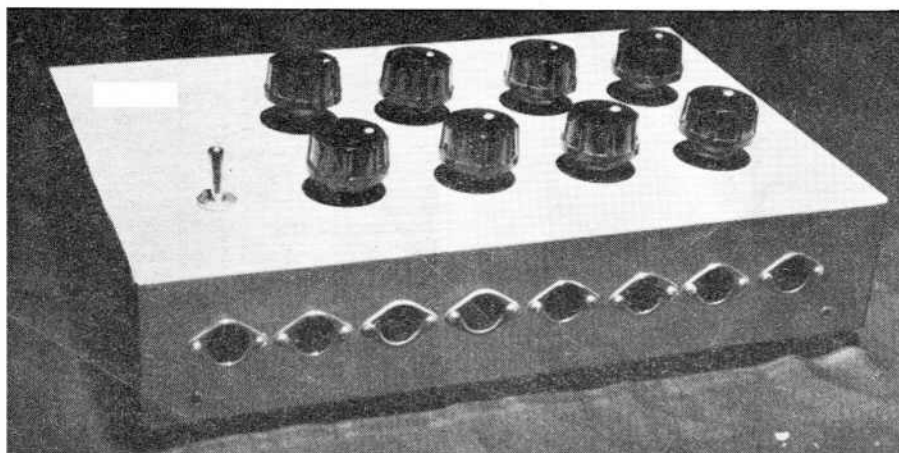
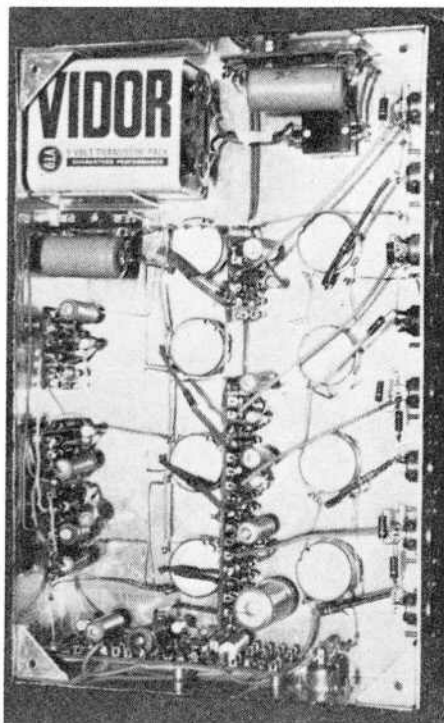

to screen input leads well and keep the input and output circuits well apart. As the unit only consumes 5 mA, a smaller battery such as the VT3 could be used. Even this should give several months' use. The input sockets on my mixer are the continental DIN types; if any other type of socket is fitted, the resistors R1, R9, R17 and R25 will have to be deleted. These resistors were fitted in the original to allow high impedance inputs to be plugged into the microphone sockets, enabling the mixer to mix up to eight high-level signals.

The mixer has proved successful in every respect and no difficulties have been encountered to date.

MIXERS TO BUY

Please send me details of the following mixer units mentioned in the September issue of *ATR*.

Name.....

Address.....

For the creative sound enthusiast a good microphone mixer is perhaps the most important audio accessory. By taking sounds from two or more different sources and merging them on to the same track a mixer opens up a whole vista of sound possibilities, making the compilation of good programme tapes relatively simple.

The 8-channel mixer described in the previous article has proved a boon to its owner, and will doubtless fill the bill for many keen enthusiasts who like to build their own equipment. However, not everyone has the time, ability, or even the inclination to spend patient hours constructing their own units, and certainly there is no shortage of ready-built mixer units to suit every purpose. There's no need to spend enormous sums of money on a mixer, although the real enthusiast (with well-lined pockets) can pay as much as £200 for one. At the other end of the price scale are the units which sell for as little as two or three pounds. The facilities offered by various mixers are as diverse as the prices. Many are portable, while others are decidedly too heavy to carry around for location work. Channel facilities range from simple two-channel mono to switchable twelve-channel mono/six-channel stereo.

Impedance-wise, most mixer units are high input impedance, a few low, some switchable high/low. Some too, can be bought in alternative versions so that you can often have the mixer of your choice made with input impedances to match your present equipment. Many manufacturers are also prepared to make 'one-off' units to the customer's own specification, although this does of course work out rather more expensive.

If you want to use a high-impedance microphone with a mixer of low input impedance, or vice versa, this can be done, but you'll need a transformer unit. These can be bought quite cheaply, some for as little as £1 10s 0d. Listed below are most of the mixer units at present available in this country, with brief details of each. If you want further details, why not fill in the form at the top of the page and send it to *ATR*? We'll see that you get all the information you want from the manufacturer mentioned below.

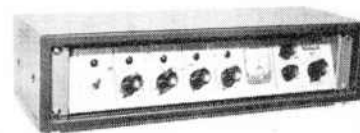
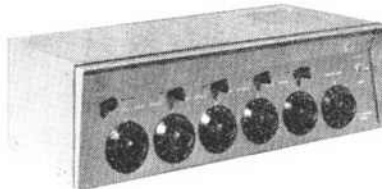
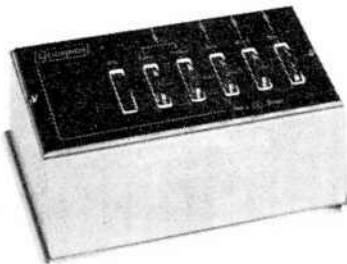
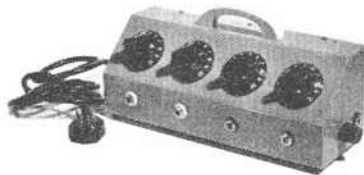

Top left: *Esimix Minor*; Middle left: *Grampian Mike 3*; Lower left: *Sound Coverage SCM/5 WBM*; Below: *Audix MXT 6*; Bottom: *TSL Mixer*.

Manufacturer	Product	No of Channels	Input Impedances	Size (in)	Weight (lbs)	Price
Audix BB Ltd	MXT 6	2	4 low/2 high	5½ × 19 × 5½	24	£176 0s 0d
Ampex GB Ltd	MX 10	2	4 low/2 high	5½ × 19 × 5½	24	£176 0s 0d
Ampex GB Ltd	MX 35	2	high/low	11 × 8 × 2	—	£45 10s 0d
Bosch	Uher A121	5	high	4½ × 2½ × 2	1	£2 18s 0d
Brenell Engineering	Mixer Unit	3	high	13 × 5 × 5	4	£19 19s 0d
Esisolder Iron Co	Esimix Major	4	high	10 × 4 × 4	3	£12 12s 0d
Esisolder Iron Co	Esimix Minor	4	high	5½ × 4½ × 2½	4	£11 5s 0d
Fi-Cord	TM 11	3	2 low/1 high	8½ × 5½ × 3½	—	£22 12s 6d
Grampian	Mike 3	3	low	9½ × 8 × 3	3½	£18 18s 0d
Grundig	Stereo 608	3	—	—	—	£22 0s 0d
Lustraphone	MU 577	3	low	15½ × 5½ × 8	8	£40 10s 0d
Pamphonic	SW 600	5	2 low/1 high	12 × 4 × 3	4	£16 16s 0d
Penco	Epigram MIX4	3	low/1 high	12 × 4 × 3	4	£27 6s 0d
Penco	Epigram MIX35	3	high/low	14 × 10 × 7	18	£96 0s 0d
Plantex Electronics	SM 6/12	12	high/low	14 × 10 × 7	18	£76 0s 0d
Plantex Electronics	SM 4/8	8	high/low	14 × 10 × 7	18	£76 0s 0d
Plantex Electronics	SM 2/4	4	high/low	14 × 10 × 7	18	£56 0s 0d
Plantex Electronics	M 12	12	high/low	14 × 10 × 7	18	£86 0s 0d
Plantex Electronics	M 10	10	high/low	14 × 10 × 7	18	£76 0s 0d
Plantex Electronics	M 8	8	high/low	14 × 10 × 7	18	£66 0s 0d
Plantex Electronics	M 6	6	high/low	14 × 10 × 7	18	£56 0s 0d
Plantex Electronics	M 4	4	high/low	14 × 10 × 7	18	£46 0s 0d
Philips (Peto Scott)	ET 1042	4	low	13½ × 7 × 3½	5	£35 0s 0d
Sound Coverage	SCM/5WBM	5	high/low	17 × 9½ × 5½	18	£61 0s 9d
Sound News Productions	Unimixer 1	3	high/low	—	—	£15 15s 0d
Stern-Clyne	Duvidal TM4	4	high	6 × 2½ × 2½	1½	£2 19s 6d
Stern-Clyne	Duvidal SM5	4	high	6 × 3 × 2½	1½	£3 12s 6d
Stern-Clyne	Duvidal AM3	2	high	2½ × 2 × 1½	1½ ozs	19s 6d
Stern-Clyne	Duvidal AM5	2	high	3½ × 2 × 1½	2 ozs	19s 6d
Technical Suppliers	TSL Mixer	3	high/low	—	—	£2 7s 6d
Vortexion	12-way electronic mixer	12	low or high	18½ × 11½ × 6½	28	£98 0s 0d
Vortexion	10-way electronic mixer	10	low	18½ × 11½ × 6½	—	£87 10s 0d
Vortexion	8-way electronic mixer	8	low	18½ × 11½ × 6½	—	£72 5s 0d
Vortexion	6-way electronic mixer	6	low	18½ × 11½ × 6½	—	£57 0s 0d
Vortexion	4-way electronic mixer	4	low	18½ × 11½ × 6½	22	£40 8s 6d
Vortexion	3-way electronic mixer	3	low	18½ × 11½ × 6½	23	£60 0s 0d
Weimec (Telefunken)	Twin-channel mixer	2	high/low	—	—	£5 0s 0d
Weimec (Telefunken)	Tric mixer	3	high/low	—	—	£17 10s 0d
Weimec (Telefunken)	Reverberation mixer	3	high/low	—	—	£52 0s 0d

AUDIOVIEW TEST REPORT PYE HFS 30T

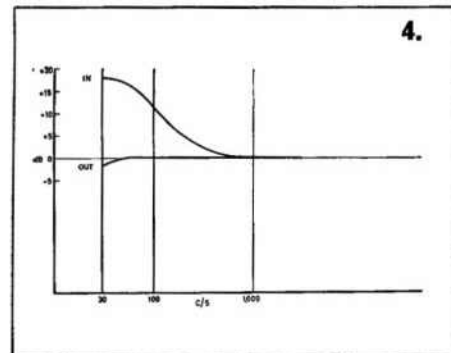
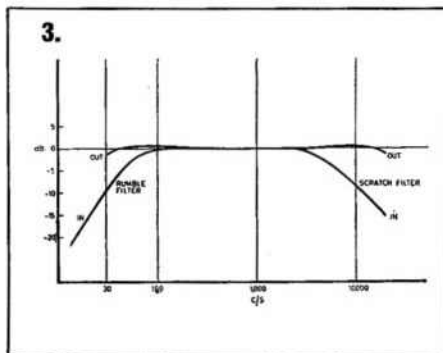

Gordon J. King

Although this amplifier is not one recently released, it is definitely worth looking at in view of the expanding interest in transistorized audio equipment and the fact that the amplifier has passed through several stages of small internal modification since its inception at the beginning of last year.

In spite of its remarkably small dimensions of 11½ in × 3½ in × 8½ in, with a 12 in × 4 in front panel, this stereo amplifier is capable of delivering a healthy two times 15 watts into loads ranging from 15 ohms down to about 4 ohms at a total harmonic distortion below 1 per cent. Indeed, the amplifier is smaller than some stereo control units of the valve variety!

Small size, of course, is one of the advantages of transistor equipment, and just how much smaller solid-state equipment can be relative to comparable valve equipment can be realized by working out the dimensions of two 15-watt valve channels complete with stereo control unit, mains power pack and so forth and then setting them down by the side of the dimensions of the Pye equipment.

Transistors also have other advantages over valves. They are much more efficient than valves because they demand no heater power and because no power is lost in heating an anode. Hum problems in high gain circuits are very much reduced and microphony — a problem with valves running at high gain — is virtually eliminated.

28 Probably one of the biggest advantages

hi-fi-wise is the elimination of transformers. Like all recent hi-fi transistor audio amplifiers, the Pye HFS30T has neither an output transformer nor a driver transformer. Hence, one of the major quality determining components — the output transformer — of the valve amplifier is removed.

Nevertheless, valves do have certain advantages over transistors. On the whole, valves are more robust. They can deal with overloads and peaky transients better than transistors. They give fewer design problems concerning circuit high-frequency performance. However, these things should not be taken to imply transistor shortcomings. They are inherent characteristics, as compared with the valve, and they are taken fully into account in the design of transistor circuits and networks.

The HFS30T features a pair of printed circuit board amplifiers mounted flat one above the other. The bass, treble and volume controls are of the two-gang variety. These three controls, along with the selector switch and balance control, are nicely arranged over the left-hand two-thirds of the front panel. The remaining third on the right-hand side accommodates the various switches. Here we have the on/off switch, a loudness switch and switches for rumble and scratch filters. Also located in this area is the pilot bulb, indicating whether or not the amplifier is energized.

Each amplifier channel incorporates nine transistors and one semiconductor diode, the circuit of a single channel being

shown in Fig.2. It may be noticed that, like some other transistor amplifiers, the Pye is based on a *Wireless World* design by Tobey and Dinsdale (October 1961).

The first three transistors operate primarily as pre-amplifiers. The first gives RIAA pick-up correction by switched frequency-selective negative feedback between the collector and base circuits. The second transistor gives variable bass and treble control in a 'Baxandall' tone control network, while the third transistor is associated with the filters.

The power amplifier section starts with a voltage and driver amplifier VT4 and VT5, along with the diode to assist with thermal stability, the output of which drives the low power complementary pair (VT7 p-n-p and VT6 n-p-n) which in turn drives the push/pull output transistors, VT8 and VT9, both p-n-p types. It will be noted that the six transistors of the power amplifier section are all directly coupled (no coupling capacitors). This technique leads to good thermal stability and very small phase shift.

The amplifier features three major feedback loops, one to balance the output impedance, another to correct transistor phase shift and the third is the ordinary loop which controls overall gain and distortion. Local frequency-selective feedback loops are also used in the equalizing and tone control circuits.

The main supply section is incredibly small when it is considered that the total audio power exceeds 30 watts at full drive. A small mains transformer

Fig.1 (left). The Pye HFS30T mounted in walnut case.

Fig.2 (below). Circuit diagram of the amplifier. This is described in the text.

Fig.3 (lower left). Characteristics revealing the cut-off of the scratch and rumble filters.

Fig.4 (lower centre). Characteristic response of the loudness compensation filter.

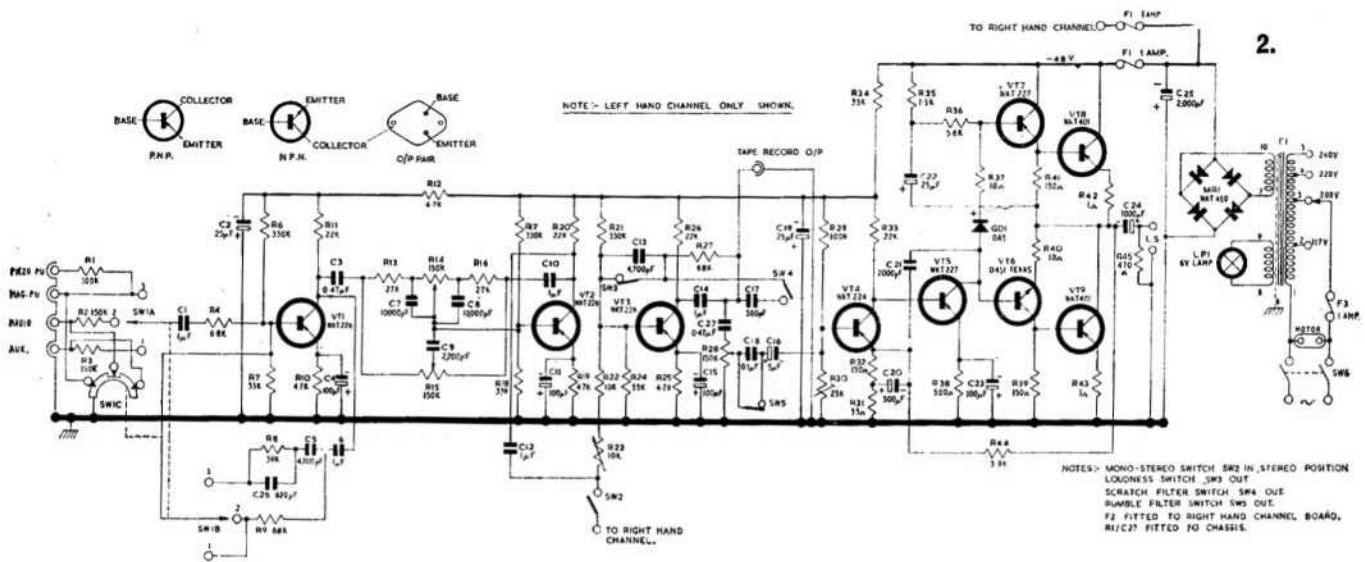

works into a bridge-type rectifier system and a 2,000 μF electrolytic capacitor eliminates all signs of ripple.

The amplifier consumes only about 25 mA quiescent, but on peak drive signals the current may rise to around the half-ampere mark. Each channel is protected power-wise by a 1 A fuse. The ht line voltage is 48 volts negative.

As will be seen, the amplifier has provision for piezo and magnetic pick-ups, for radio and for an auxiliary signal input. With the test amplifier, the author's Deram pick-up was found to work best into the magnetic input. Here the input impedance is sufficiently low to endow the Deram with velocity characteristics, the output of which is then approximately equal to a magnetic pick-up. Equalization under these conditions was handled admirably by the magnetic equalizing feedback loop, referred to earlier.

The input sensitivity of the earlier Mark I version was 7 mV on magnetic pick-up, but the latest models have various component value changes which put the overall gain of the amplifier up, resulting in a magnetic pick-up sensitivity of 2½ mV (for 15 watts output). This sort of sensitivity would almost allow the direct connection of a suitable impedance tape head, but then, of course, some modification would have to be made to the equalization for tape, as distinct from disc records.

Sensitivities at the other inputs are now piezo pick-up 70 mV, radio 35 mV and auxiliary 35 mV, compared with the early model sensitivities which were respec-

tively 120 mV, 100 mV and 100 mV. The modifications leading to the increase in sensitivity have resulted in an improvement in the overall performance of the amplifier and a slight extension of the pre-amplifier frequency response. Readers with the early Mark I amplifier can have the current modifications incorporated by a Pye dealer. These consist mainly of a change in value of five resistors.

Tape facilities

For tape enthusiasts, the amplifier has a tape record output delivering 100 mV at the sensitivities given above. This socket provides a 'record' programme signal, while the 'auxiliary' input socket will accept the signal present at the 'monitor' socket of a tape recorder for replay at hifi.

One outstanding feature of the amplifier is the very low background level. Hum is virtually non-existent, and hiss is many times below the level of the programme signals. Indeed, the power amplifier section has a signal/noise ratio in the order of -90 dB, while under the worse pre-amplifier condition, namely magnetic pick-up input, the ratio is still -60 dB.

There is virtually no breakthrough from one channel to the other from a full-gain listening test, and the crosstalk figure was found to be around 400 times down - measured at 1,000 c/s.

The rumble and scratch filters are preset to take over at about 100 c/s and 3,500 c/s respectively (at 3 dB points), the charac-

teristics of these relative to the normal amplifier response being shown in Fig.3.

Another interesting feature of the amplifier is the loudness compensation filter. With this switched in, a maximum boost in the order of 15 dB occurs at around 30 c/s as shown in Fig.4. This bass boost effect increases as the volume control is retarded, and its purpose is to maintain the apparent bass loss which occurs at lower output levels.

The amplifier power output is rated at nominally 15 watts per channel. But this is a 'music rating' and not a sine wave one. If the amplifier was driven to sustain a power of 15 watts from a sine wave signal source, then two things would happen. One, the power requirements would soon draw all the power from the supply reservoir capacitor, resulting in a fall of voltage and a consequent fall in audio power and rise in distortion, and two, the output transistors would dissipate more heat than could quickly be removed by the heat sinks resulting in probable failure of the output transistors.

Music-power rating

Fortunately, music may incite a peak power of, say, 15 watts but only for a very short period of time, the rest of the time the power being very much below this. From these factors has evolved the music-power rating, which is common to many transistor audio amplifiers - not only the Pye. After all, we are interested

only in programme sounds; it is only when we test that we may wind an amplifier up to full output on a sine wave. But we should never do that on transistor equipment.

The power output is somewhat dependent on the impedance of the speaker load. At a load of 15 ohms, the output power can be taken up to 15 watts for just a little below 1 per cent total harmonic distortion, while at a load of 8 ohms, the power can be taken up to about 18 watts for the same amount of distortion.

The impedance of speakers tends to rise with increase in high frequency signal, which means that the amplifier is presented with a load that rises in value towards the treble end of the spectrum. Thus, it would seem likely that the output power of the amplifier falls as the result of this increasing load impedance. But much here depends on just how a particular speaker behaves over the audio spectrum. This problem is brought up by the authors in the *Wireless World* articles referred to earlier.

The proof of the pudding . . . on test under ordinary domestic conditions the HSF30T is a joy to use and listen to.

The author has now had the opportunity to try the amplifier under a great diversity of conditions both mono and stereo, radio, disc, tape and with quite a selection of speaker systems.

Probably the best speaker system tried so far employs a pair of Wharfedale Super 8/RS/DD units loaded into a pair of somewhat special corner horn cabinets. The amplifier has been driven at high levels on all sorts of music, and that music with a wide dynamic range is adequately handled. Even on sustained peaks there was literally no apparent distortion. This would indicate a very long power-unit time-constant and good transistor sink action.

The amplifier accepted the stereo outputs from an Akai 44S tape recorder with no trouble at all and complete freedom from hum-loops over which no special precautions were made. It operated equally well from programme signals provided on the one hand by a simple transistor radio and on the other by a considerably more elaborate valve FM tuner. Both low and high output piezo and magnetic pick-ups, both for mono and stereo, were used with the amplifier and no undue problems were at any

time encountered.

The Pye HFS30T is a worthy hi-fi amplifier and at the new price of £55 13s 0d (walnut case, if required, £4 14s 6d extra) can be thoroughly recommended to those readers who are contemplating going solid-state.

G.J.K.
Manufacturer's specifications. All-transistor stereo hi-fi amplifier. *Output:* 15 watts per channel at 15 ohms. *Mains supply:* 110-127, 190-210, 211-230 and 231-250V ac only, 50/60 c/s. *Controls:* Volume continuously variable; bass ± 10 dB at 100 c/s; treble ± 10 dB to -15 dB at 10,000 c/s; balance range 9 dB each channel; loudness $+10$ dB at 100 c/s; scratch filter roll-off from 5,000 c/s at 6 dB/octave; rumble filter roll-off from 50 c/s, reaching 12 dB/octave below 20 c/s; stereo/mono switch parallels both pre-amplifiers. *Magnetic input:* $2\frac{1}{2}$ mV; *Piezo input:* 70 mV; radio 35 mV; auxiliary 35 mV. *Output:* 100 mV (for tape recording, etc.). *Frequency responses:* piezo PU and magnetic PU correct to within $1\frac{1}{2}$ dB of published RIAA replay curves; radio and auxiliary 30-20,000 c/s $\pm 1\frac{1}{2}$ dB (power amplifier up to 35,000 c/s). *Signal/noise ratios:* relative to 15 watts into 15 ohms, piezo PU and magnetic pickup -60 dB, radio and auxiliary -65 dB, main power amplifier section -90 dB. *Damping factor:* 50. *Crosstalk:* Better than -50 dB. *Distortion:* typically less than 0.35% at 1,000 c/s.

SOUND EFFECTS RECORDS Now available from Amateur Tape Recording

CASTLE, 7" 45 rpm records, approximate playing time 5 minutes. Each contains selection of sound effects in separate tracks. Complete with sleeve and paper inner jacket. Sleeve includes description of each sound effect and playing time in seconds

A ABX/1—BELLS AND SIRENS Price 7/6

Side 1—Fire engines with bells Fire engine—alarm and sirens
S.S. Queen Mary siren Factory siren Telephone bell Door bell
Side 2—Clock chime Alarm clock Westminster chime Bow bells

B AFX/1—WILD ANIMALS Price 7/6

Side 1—Male and female lions Gibbons Chimpanzees Bell bird
Rattlesnake Baboon Viper Emperor geese Fish eagles Mountain lion (puma) Kookaburra (laughing jackass)
Side 2—Elephante Mississippi alligator Indian tiger Sea lions
Male lion In the jungle (a background of typical sounds)

C BGX/1—BACKGROUND SOUND EFFECTS Price 7/6

Side 1—Sea (breakers) Wind (howling—eerie) Thunder (light rain)
Side 2—Rain (heavy shower) Factory sounds (industrial) Traffic (busy street)

D MFX/1—ELECTRONIC SOUNDS AND MUSIC Price 7/6

Side 1—Space ship—take off Space vehicle—imaginary take-off
Space vehicle—imaginary landing Ring modulation—tonal Modulated tone glide (descending) Modulated tone glide (ascending)
Sibilation—white noise (pitch octave low)

Side 2—Sibilation—white noise (pitch) Sibilation—white noise (pitch octave high) Three-tone modulation Filtered tone Stridor (tonal) Ring modulation and sibilation

E EFX/2—ELECTRONIC THEMES AND MUSIC CONCRETE Price 7/6

Side 1—Delta F Study in Sine-tones
Side 2—Sound object Montage

F HMX/1—HAUNTED HOUSE, MYSTERY SOUNDS AND MUSIC Price 7/6

Side 1—Thunderstorm Mysterious Fright
Side 2—Spooks Intruder Creaks Fright Dungeon Ghosts Ghouls Maniac laughter

G MFX/1—AUTHENTIC HIGH-FIDELITY SOUND EFFECTS Price 7/6

Side 1—Lion roaring Twin piston aircraft landing Building and debris falling Road drills and compressor Ship's siren Steam train leaving station Small steam loco and whistle Cell door, keys and locks

Side 2—Police car and bell, chase Police launch and siren Steam goods train and whistle Car door slam, and starter Storm at sea, thunder, wind and gulls Tube train, stop, doors and start

H MFX/2—AUTHENTIC HIGH-FIDELITY SOUND EFFECTS Price 7/6

Side 1—American police car with siren—arriving American police car with siren—departing American police car escort with sirens—passing American police motor-cycle patrol with siren—stopping Applause (hand clapping) Orchestra tuning up Car crash Glass breaking (repeat)

Side 2—City and Waterloo tube train—arriving City and Waterloo tube train—departing Footsteps (continuous track) In subway (mixed) In narrow streets (female) On pavement (mixed) Running in street (female) Running in street (male) Up and down (wooden stairs) Workmen hammering and sawing

I MPX/1—MILITARY PARADE AND WARFARE SOUNDS Price 7/6

Side 1—March past—Guards and crowd sounds, etc. Royal Salute—Parade commands and National Anthem Drums and pipes—with parade commands

Side 2—Aircraft—low level attack (bombs, machine-gun fire, aircraft) Artillery—tanks—rifle fire, etc.

J TFX/1—AUTHENTIC BRITISH TRAIN SOUNDS Price 7/6

Side 1—Train departure—main line Train arrival—main line Express train passing—with whistle Fast goods train passing—with whistle Express train passing Small tank loco—passing

Side 2—Local passenger—arrive and depart Fast goods train—passing Central London tube train—arrive and depart Train over points and crossing Slow goods train passing—with whistle

K MFX/3—HORSES Price 7/6

(10 effects) Trotting Walking Jumping Composite recording of foxhounds, calls, horns, etc. Cows Cate Pigs Blacksmith's shop

WALLACE HEATON
(CITY SALE) LIMITED

We have a large selection of high quality tape-recorders and radios in our special department. If you are unable to call, please send for our illustrated folder on tape-recorders.

- We offer top allowances for Part Exchanges.
- Write for preliminary offer.
- Easy Payment facilities.

93 Fleet St., London, E.C.4
Telephone: FLE 9311

Please send me the following records
Please indicate with a tick in the appropriate squares

<input type="checkbox"/>	<input type="checkbox"/>	<input type="checkbox"/>	<input type="checkbox"/>	<input type="checkbox"/>	<input type="checkbox"/>	<input type="checkbox"/>	<input type="checkbox"/>
<input type="checkbox"/>	<input type="checkbox"/>	<input type="checkbox"/>	<input type="checkbox"/>	<input type="checkbox"/>	<input type="checkbox"/>	<input type="checkbox"/>	<input type="checkbox"/>

I enclose postal order/cheque for to cover the cost of record/s, plus 1s 2d post and packing for first record and 4d. for each additional record ordered.

NAME

ADDRESS

ATR9

ATR, HAYMARKET PRESS LTD,
86-88 EDGWARE ROAD, LONDON W2

AUDIOVIEW NEW PRODUCTS

Grundig introduce the TK 400

This two-speed, four-track automatic tape recorder incorporates the now famous Grundig 'Magic Ear' recording level control, has two tape speeds of $3\frac{3}{4}$ and $7\frac{1}{2}$ ips, and allows the use of 7 in spools (below).

A speech/music switch is fitted to select the most perfect conditions for recordings, whilst the TK 400 adjusts the recording level automatically. A digital tape position indicator is fitted and tone and volume controls, a loudspeaker on/off switch and fast wind inching control round off the extremely useful facilities of this outstanding machine in the medium-price class.

Recordings can be monitored through earphones and synchronous recordings can be made through the Grundig MA2 monitoring amplifier and SE 3 earphone. As in the case of all other Grundig four-track recorders, two separate tracks can be played back simultaneously.

Connecting sockets are provided for the microphone and other inputs; output sockets are available for connection to an external loudspeaker, the MA 2 monitoring amplifier and earphones.

The TK 400 is sleek and neat in appearance, measures $13\frac{3}{8}$ in \times $11\frac{3}{8}$ in \times $6\frac{7}{8}$ in and weighs approximately 20 lb. It is finished in graphite and cream with silvered trim and retails at 47 gns.



Goodmans introduce new loudspeaker

As enthusiastically received this year as was the Maxim last, the Goodmans Magnum-K gives a really generous and accurate sound; its efficiency is such that, although it will handle an input of 25 watts, for normal domestic use an amplifier handling 10-12 watts is ample. Designed to a very high standard for monitoring studios, its release brings these same standards to the audio enthusiast at home.

The Magnum-K covers a range of 30-20,000 c/s and measures only $11\frac{1}{4}$ in \times 15 in \times 24 in - very compact indeed for such a full-blooded sound; every detail that could contribute to really accurate sound reproduction has been included.

It contains a unique 12 in bass loudspeaker, operating on an air cushion suspension, a newly developed direct radiator mid-range unit (closed diecast chassis) and precision-built back-loaded high-frequency unit with outstandingly smooth performance. A multiple section crossover network operates at 1,500 c/s and 6,000 c/s.

The mid- and high-frequency units are controlled by variable attenuators of the constant impedance type - a feature that allows the system to be tailored to individual rooms and individual tastes - giving virtually a 'made-to-measure' sound system. Retail price of the Magnum-K is 35 gns.

West Hyde standard printed circuit boards

These boards have been developed by West Hyde Developments Ltd for actual use rather than as a theoretical device. The idea is based on a standard board fitting a very good, but reasonably priced, connector with three of the terminations traversing the board at right-angles to provide the positive, negative and earth rails. It is also appreciated that virtually all transistor circuits require four connections, i.e. input, base, + and -.

For the PC boards a high packing density should be possible and intermediate spots for holes are provided. Connections may be broken by using a drill. Where boards are interconnected, a chassis is necessary and this has been provided in the lowest possible cost way with twenty slots in just over 10 in. The chassis fits into WHD's standard 1277 Contil case. It is not expected that more than ten boards would be fitted and input and output connections are put in to the smallest board which is used as a connector with a cable clamp in the hole provided.

With every board there will be a sheet of translucent paper which is printed full size with the five basic boards. This is to allow people to draw circuits out from either the component or the wiring side. Boards will be packed in polythene envelopes and will normally be plated gold on contact areas and a special new nickel process (non-electrolytic) to ease soldering after some months' storage. Further details from West Hyde Developments Ltd, 30 High Street, Northwood, Middlesex.

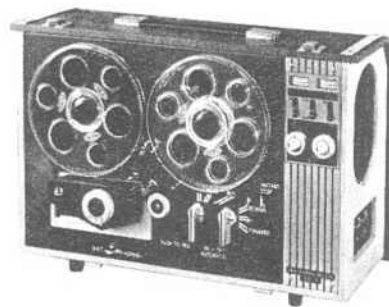

The New Akai ST-1 Stereo/Mono Tape Recorder

Latest introduction to the Akai range of stereo/mono tape recorders distributed in the UK by Pullin Photographic Ltd is the ST-1 (above). A portable two-speed machine, it utilizes a specially designed microgap head, professional-quality hysteresis synchronous motor and 6-watt amplifier (3 watts per channel) with a fully transistorized pre-amp stage. The result is frequency responses of 40-1,500 cps \pm 3 dB at $7\frac{1}{2}$ ips and 40-9,000 cps \pm 3 dB at $3\frac{3}{4}$ ips, wow and flutter less than 0.17% rms at $7\frac{1}{2}$ ips and 0.28% rms at $3\frac{3}{4}$ ips and total harmonic distortion within 2% at 1,000 cps OVU.

The Akai ST-1 has many advanced features including illuminated twin VU meters; built-in matched 5 in \times 7 in speakers; 'sound-on-sound' facilities for language study and multi-recording techniques; and automatic cut-off (including disconnection of power input at the end of a tape as required). A novel 'bass boost' push/button gives greater than usual flexibility to tonal quality on replay. Fast forward and rewind time is 150 sec for 1,200 ft of tape; maximum reel size is 7 in diameter. The new recorder is housed in an attractive two-tone case ($13\frac{1}{2}$ in \times 21 in \times 9 in) and weighs 41.8 lb. It will operate on all supplies 100-245 volts ac 50/60 cps. Complete with two dynamic microphones, it is priced at £129 3s 0d.

Distributors: Pullin Photographic Ltd, 11 Aintree Road, Perivale, Greenford, Middlesex.

CLUB AND COMMUNITY

Mike Dagnall, vice-chairman of B-TRAC, explains how a club can benefit from helping the community

Whatever else is plentiful in a tape club, time is not. This at least was the experience of B-TRAC and, for many years, the club tended to shy away from contact with other causes and organizations which might make demands on its time. It was largely contented with a quite satisfying and full internal life and had no interest in playing any part in the community in general.

However, times change and a new spirit began to pervade the club. Slowly at first, but with increasing speed, the club began to wake up and take an interest in things outside itself. That there was a need for a tape club to concern itself with such things, and the fact that B-TRAC had been failing the community was shown by the rapidity with which requests for help were received, once it was known that B-TRAC was willing to help. There is no half way house in this sort of work. Once started you are completely committed; each request for help seems as important as another and cannot be refused.

As a result of this, B-TRAC has become involved in quite a lot of 'extra-mural' work. We have been able to bring pleasure and comfort to people by assisting in the exchange of tapes between members of families who, for various reasons, were not able to meet.

Realising how important a part of a blind person's life a tape recorder can be, the club has undertaken to give assistance to any blind person who is having trouble with his machine.

Hospital Work

For several years, B-TRAC has been pleased, at Christmas time, to be able to present a tape programme to the inmates and staff of a local hospital. Last year, as visitors left the hospital, they were invited to record messages to be played back on Christmas morning to their friends and relations in the hospital. Everyone was very surprised and many tears of happiness were wept.

Recordings have been made of the city's cathedral choir and these hymns have been edited into seasons of Easter, Epiphany, etc. A minister, often the Provost of Birmingham, attends the hospital each Sunday and these recordings are used for church services. A nurse wrote a 3½-minute poem to commemorate the retirement of Mr Naylor Strong, a consultant at the hospital. Everyone was so impressed with the poem, that B-TRAC were called in to tape it as a permanent record for Mr Naylor Strong.

Social Service

One project in social service concerned the 'Shrewsbury Experiment'. Mr Nunn, who is concerned with social work in the Shrewsbury area gave a talk at the Birmingham branch of the British Council for Social Service. Then



Fig. 1. At a social function one member makes the most of a good opportunity to record a message from the Mayor. This kind of interview makes good material for hospital programmes, tape news letters for the blind, etc.

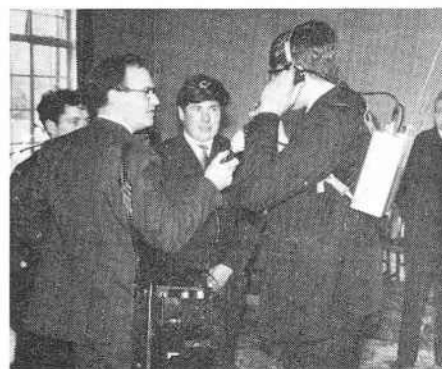

Fig. 2. After helping out at a local amateur radio mobile rally, another member interviews a rally contestant.

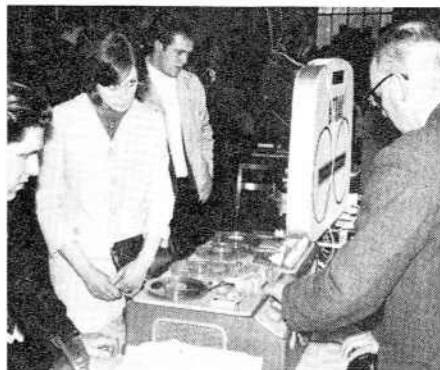

Fig. 3. B-TRAC are always there in force at local hobbies exhibitions, etc. Here members of the community listen attentively while a B-TRAC member demonstrates some of the machines on show.

Fig. 4. During the last moments before the doors open and everyone crams in, two club members make a final check on the equipment on display to make sure that demonstrations (like the one above) go smoothly.



young social workers commented on the talk and gave some account of their experiences. This meeting was recorded and B-TRAC volunteered to edit and produce the tape, so that it could be used as a recruitment programme for the BCSS to play in schools.

Club Exchanges

No matter how resourceful club members may

be, a club tends to get stale without new ideas. In this sense B-TRAC's increasing contacts with other clubs have been very valuable. We now exchange visits and speakers with a number of clubs, and very enjoyable these meetings are.

One B-TRAC member, in particular, travels great distances to give talks, play recordings and show films on several subjects. He has

modified a recorder to play back four-channel stereo and is now touring Austria to collect more material for his programmes. He never charges for his work and refuses to accept expenses from the club. Another group of members gave a programme of slides with synchronized sounds and commentary to a large audience at Halesowen Christadelphian Church. The proceeds went to charity.

Midland Association

B-TRAC has from the very first been a keen supporter of the Association of Midland Tape Clubs and was fortunate enough to win the Evergreen Cup for the best tape of the year in the first regional competition held in 1964. This year the cup was won by Kidderminster Club but B-TRAC were lucky enough to share second place with Stoke. Two years ago, the club was able to assist at the founding of a new junior tape club at the Bishop Vesey Grammar School in Sutton Coldfield. B-TRAC has continued to develop relations with this young and vigorous society.

Other Societies

The assistance which B-TRAC was able to give to the Midland Amateur Radio Society at its Trentham Garden Rallies by recording incoming messages and by producing for the Society a taped record, is only one example of the many ways in which the club is becoming involved in the life of other types of societies. Our initial contact with MARS two years ago, has led to an exchange of speakers and to enquiries from other radio and cine societies in the area. This year B-TRAC were invited to take part in the 6th International Mobile Rally of the Amateur Radio Mobile Society held at the USAF Base of Barford St. John, Oxfordshire, during May. We were asked to record radio signals at the airport control tower and also to provide something entertaining for the anticipated 10,000 visitors.

This was quite a problem but, with a display of recorders and hi-fi equipment, one member built a back projection screen and showed films with synchronised sound. Highlight of the stand was a stereo recorder continually repeating a five-minute commentary giving details of all Midland clubs and general tape activities. Fifty synchronized impulse tones on the lower track were made to actuate a relay connected to a uniselector. In this way, whenever a club was mentioned, a corresponding bulb illuminated itself on a large map to indicate the geographical position and, when each activity was discussed a set of small illustrations lit up.

Christmas is always a busy time. Two years ago members provided the sound track for a nativity play which was performed at many churches. Despite very bad weather B-TRAC was always there when wanted, though at times it was a very near thing. Following this, the club was requested to supply sound effects for a religious play presented by a blind institution at Solihull. Another amateur dramatic society now calls on B-TRAC regularly for their effects. Members have helped with productions of 'Murder Mistaken', 'Breath of Spring', 'Blithe Spirit' and many other plays. Our four-channel stereo expert came into his own at a production of 'The Insect' when he had war sounds everywhere and even dropped bombs at the back of the audience.

Last year, at the request of the Sutton Coldfield Carnival Committee, B-TRAC produced a tape record of the carnival. This year, a similar tape was produced about the work involved and the organization of this annual event.

B-TRAC have had several requests from pop-groups to make recordings so that they could be submitted to the record companies. None of these groups is yet in the top ten and it has not been discovered whether this is the

fault of the artists or of our recordings!

At Stourbridge Town Hall, a group of members recently recorded a 2 hour 40 minute show called 'Them Thar Hills' written, produced and musical score composed by Ken Allen and Doug Yardley and presented by the North Worcestershire Operatic Society. The tape has now been submitted to music publishers in London.

One of our members was asked to give a series of lectures on tape recording at a city night school and he is also making a sound track to accompany a film describing the activities of the evening institutes in Birmingham.

Publicity

Although for some time B-TRAC attached little value to the publicizing of its activities, it has now realised the value of this two-way traffic. The Club News section of the *Amateur Tape Recording* magazine is perhaps the finest vehicle for inter-club communication at a national level and B-TRAC now takes a keen interest in its place in the League Table. The local press is kept informed of our activities and publicity leaflets have been distributed.

Not strictly in the field of social service or inter-club activity, but certainly symptomatic of B-TRAC's new outward-looking approach was the club's sponsoring of a public showing of the excellent slide and tape show presented by Gevaert Ltd. The club has ideas for further public activities of this sort, and indeed has long-term plans for a very ambitious method of introducing tape recording to the enthusiast and to the general public.

We have given an outline of the ways in which B-TRAC is now beginning to participate in communal life. Although only on a small scale at the moment, it will grow, and illustrates how important a part tape clubs can play in the life of the community. It also shows that, although time may be short... enthusiasm is not.

RECORDING DIARY

when and where to record in September

Anniversaries and celebration pageants seem to cover most of the country this month. In London there is the Admission of the Sheriffs Elect at the Guildhall (28), followed by the election of the Lord Mayor (29). Bristol has the Pie Poudre Court Opening Ceremony (30), while Avening, Nr Stroud, has the Avening Feast and Queen Matilda Pageant (14). The inhabitants of the Abbots Bromley area in Staffordshire celebrate with The Horn Dance (6), and literary fans from Lichfield can enjoy the Johnson Celebrations and Supper (18). There are Military Tattoos in Handsworth Park, Birmingham (9-11), Clipping the Church at Wirksworth, Derbyshire (12), and the Sheriffs Ride at Lichfield (4).

The Morris dancing season is still with us. There are Ring Gatherings at Oxford (3-5) and Sheffield (17-19). The East Kent Morris Men really go to town with a Hop Hoodening in the Precincts of Canterbury Cathedral (4).

Music and Drama festivals are again in full swing with the Three Choirs Festival at Gloucester (5-10), the Richmondshire Music and Drama Festival at Richmond, Yorks (5-12),

the Pendley Shakespeare Festival at Tring, Herts (27 Aug-4), and the Cornish Gorsedd service (in Cornish!) at Truro (4).

Sporting events in September include the ASA Centralized Swimming Championships at Derby Baths, Blackpool (30 Aug-4), Northern Counties Archery Championships at Dore, Nr Sheffield (3-5), National Surf Life Saving Championships at Woolacombe Sands, Devon (4, 5), the National Scottish Small Bore Rifle Meeting at Ayr (4-10) and the area finals of the All England Croquet Handicap at Roehampton (16-18).

Motor racing in one form or another is also prevalent this month. At Sherrington Airfield, Nr Stratford-upon-Avon, the RAC are holding the British Kart Championship (4, 5) while the more conventional car racing is in evidence at the Oulton Park Gold Cup Race meeting (18). Motor cycling is spread over many venues, with the Carrowdore 100 Road Race in Co Down (4), Manx Grand Prix, Isle of Man (7, 9) and the International Motor Cycle Races at Scarborough (17, 18).

EXPERTS
CHOOSE
PHILIPS
MAGNETIC
TAPE

—for perfect recordings
of every sound

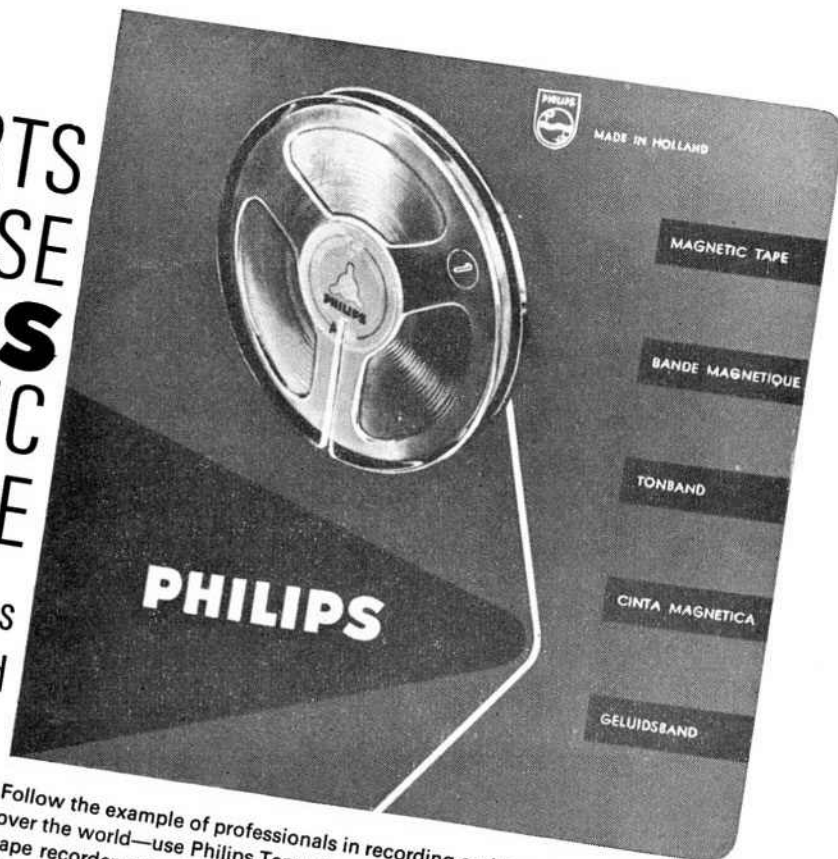

Follow the example of professionals in recording and broadcasting studios all over the world—use Philips Tape, the tape that's made by the world's leading tape recorder manufacturer! A product of Philips unrivalled experience and know-how, Philips Tape has all the qualities needed to make your recordings perfect every time—excellent sensitivity, low noise level, uniform frequency response, and powerful adhesion of the magnetic coating. It's tough, too—resists stretching, snapping and tearing. Philips Tape is available in four types and in all current reel sizes; apart from the special Audio Letter message tapes all types have metallized switching foil and leader tape with writing surfaces. What's more, each type comes in a colour-coded box for easy identification. Ask for Philips Tape next time you buy a new reel.

GREEN for standard
RED for longplay
BLUE for doubleplay
GREY for tripleplay

More fine products from **PHILIPS** —the friend of the family
Philips Electrical Ltd • Electro-Acoustics Div • Century House • Shaftesbury Ave • London WC2



(PTA0065A)

SOUND SCENE . . . looks around at the world of audio

New Agfa/Gevaert Depot

Following the successful merger of Agfa and Gevaert on the Continent last year, the two companies have now jointly opened a new depot in Manchester. This important move marks another step towards the merger in this country. The newly built depot (43 North Street, Cheetham, Manchester 8) will house the full range of products currently marketed by both firms, and will supply customers in Lancashire, Yorkshire and Cheshire.

New Private Theatre

Films & Art Theatres Ltd are offering a unique service at their theatre at 6 Hanover Street, London W1. Ideal as a centre for audio demonstrations, the theatre boasts luxury seating for over 140 persons, fitted stage with acoustic damping, all projection facilities and full catering for up to 350 persons. Charges for hiring the theatre are very reasonable, particularly on week days, and anyone interested in this facility should contact Films & Art Theatres Ltd at the above address, telephone MAYfair 4196.

Grundig Schools Competition

A competition for school children involving the use of a tape recorder as an educational aid is being organized by Grundig (GB) Ltd. The children, with the aid of a teacher if required, should record, for a maximum of ten minutes, a tape on any subject showing the recorder as an educational aid. Entries will be judged in three sections - infants, juniors, and seniors. Closing date is 20 December 1965 and a TK 18L automatic recorder with accessories will be awarded to the winning school in each section. There will also be the Grundig Silver Trophy for the overall winner. Free entry forms and rules are available to schools on request from Grundig (GB) Ltd, Newlands Park, Sydenham, London SE26, telephone SYDenham 2211.

D & M Import New Mic Range

Denham & Morley Ltd are now importing a new range of high quality microphones and headphones from Germany's largest microphone manufacturing company, M B Electronic. Prices range from 3 gns for a directional microphone suitable for domestic use, to 21 gns for a studio ribbon directional mic that can compare with the most expensive microphones at present on the market.

Other items in the range include stereo headphones with or without boom-mounted microphones and a range of studio-quality moving-coil stick microphones. Further details from Denham & Morley Ltd, Denmore House, 173-175 Cleveland Street, London W1, telephone EUSton 3656.

New Philips Specialists

Philips Electrical Ltd have appointed a team of tape and tape recorder specialists responsible for the promotion of products in every possible aspect. The five-strong team is geographically split as follows: Scotland - Mr James Wilson; North - Mr K. Hall; Midlands - Mr I. S. Marchant; Northern Home Counties and East Anglia - Mr L. Newitt; Southern Home Counties and West - Mr R. Livingstone.

Gevasonor Message Tape

Omitted from our July issue list of message tape manufacturers was Gevaert Ltd. Gevaert do in fact produce a Gevasonor 3 in message spool containing 150 ft of standard play tape. This comes complete with packing box and address space and sells at 5s 3d.



Prize Akai at work. Mr A. R. Chantler, winner in our Audio Fair Akai competition, has been putting his prize recorder to good use. He is seen here experimenting with stereo recording of river traffic on the Thames near his home at Isleworth.

ELECTRONIC WORLD

BY FAR THE CHEAPEST FULL RANGE OF PREMIUM QUALITY TAPE

De Villiers (Electronic World) Ltd., 16c Strutton Ground, London SW1

STANDARD PLAY (PVC Base)		DOUBLE PLAY (Prestressed Polyester Base)	
3" / 150 ft.	4 for 18/-	3" / 375 ft.	2 for 20/-
do.	48/- doz.	do.	108/- doz.
4" / 300 ft.	4 for 26/-	4" / 600 ft.	2 for 30/-
5" / 600 ft.	2 for 26/-	5" / 1,200 ft.	27/-
5½" / 900 ft.	16/-	5½" / 1,800 ft.	35/-
7" / 1,200 ft.	19/-	7" / 2,400 ft.	45/-
LONG PLAY (Prestressed Polyester Base)		TRIPLE PLAY (Prestressed Polyester Base)	
3" / 225 ft.	4 for 22/-	3" / 475 ft.	2 for 26/6
do.	60/- doz.	do.	150/- doz.
4" / 450 ft.	2 for 21/-	3½" / 650 ft.	17/-
5" / 900 ft.	2 for 35/-	4" / 900 ft.	23/6
5½" / 1,200 ft.	24/-	5" / 1,700 ft.	40/-
7" / 1,800 ft.	31/-	5½" / 2,300 ft.	52/6
		7" / 3,300 ft.	80/-
		Enclosed £	s. d.

NAME

ADDRESS

BLOCK CAPITALS PLEASE

CASH WITH ORDER

POST FREE · SEND COUPON NOW



**In 12 minutes you can record
on this reel of Ilford Zonatape a
1500-word letter it would take
you an hour and a half to write**



What's more, when you use Ilford Zonatape you get a recording of your voice up to professional standards. Ilford Zonatape gives you this flawless reproduction

because it's made by Zonal, the people who made the sound track for such films as *The Yellow Rolls-Royce* and *Lord Jim*. Ask your supplier for Ilford Zonatape message Tape.

ILFORD ZONATAPE

(A PYRAL SA PROCESS)



Zonal Film (Magnetic Coatings) Limited
A subsidiary of Ilford Limited, Ilford, Essex.



IT'S A COMPLETELY NEW APPROACH TO HI-FI

SEEN IT YET?

If not, fill in the coupon below so we can send you details
about the exciting new developments in Pye Hi-Fi



PYE LIMITED

**HIGH FIDELITY
DIVISION**

To Pye Limited, High Fidelity Division, P.O. Box 49, Cambridge.
Please send me details of new Pye Hi-Fi Developments.

Name.....

Address

Please put me on your mailing list.

ATR9/65



the
"MIKE 3"
 mixer gives
 control over
 sound

Completely mobile, the fully transistorised and battery operated "Mike 3" Mixer puts the amateur or semi-professional fully in control of sound. All the subtleties of tone, are within the range of this excellent mixer with its built-in, tone controls. Mains interference, earth loop problems and other sources of "hum" are completely eliminated. Available in three ranges of Impedance. Obtainable from your local dealer.



SOUND EQUIPMENT
 INTEGRITY THAT YOU HEAR

For fullest details ask:

GRAMPIAN REPRODUCERS LTD.

**"WHENEVER THE DEMAND IS FOR
 PRECISION RELIABILITY AND
 NATURAL SOUND REPRODUCTION—
 THE CHOICE MUST BE TANDBERG"**

SERIES

6

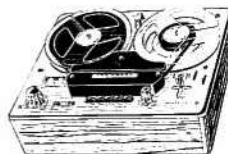

Model 64 4 track
 Model 62 2 track
 Price 110 gns. each.
 Semi professional
 Stereo/mono tape
 recorders with cathode
 follower output. Three
 speeds — Three heads
 — Four amplifiers —
 "Sound on sound" etc.

Model 74 4 track
 Model 72 2 track
 Price 93 gns. each.

Build-it-in or carry-it-
 around. Complete stereo/
 mono record and playback
 with own power
 amplifiers and speakers.
 Three speeds — dual
 record indicators — output
 for hi-fi pre-amps—
 centre channel for
 language teaching or cine work.

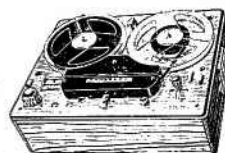

SERIES

7

SERIES

8



Model 823 2 track
 (teak case) 54 gns.
 Model 822 2 track
 (Portable with lid) 57 gns.
 Model 843 4 track
 (teak case) 59 gns.
 Model 842 4 track
 (Portable with lid) 62 gns.

High class monaural tape recorders suitable for
 home, business, education, photo sound, etc.
 (3 $\frac{3}{4}$ and 1 $\frac{7}{8}$ I.P.S. speeds — 7" reels).

Model 92 2 track only
 (teak case) 69 gns.

High class monaural 3
 speed (7 $\frac{1}{2}$, 3 $\frac{3}{4}$, 1 $\frac{7}{8}$ I.P.S.)
 tape recorder, with quality
 comparable to the famous
 Stereo models. Extremely
 reliable machine
 recommended for all
 home and educational
 purposes, etc.



SERIES

9

Tandberg

Send for further information and specifications stating the model
 number you are interested in, to:-
 Dept. A.T.

Elstone Electronics Limited, Edward Street, Templar Street,
 Leeds 2. Telephone: Leeds 3-5111 (7 lines)

LOWER THE COST OF FUN WITH SUPER HIGH FIDELITY



PROFESSIONALS who use RECOTAPE say it is the finest you can buy. The price is standard—NOT CHEAP—but there are more than a few side benefits you get from buying RECOTAPE RECORDING TAPE.

Such as, higher frequency response, greater sensitivity, wide bias latitude which provides professional results on all types of recorders. Lower print-through—no echo, after many months of storage.

Then there's greater tensile strength—all but standard play is on tensilised Mylar to withstand rough handling. Standard is on P.V.C. base. Lower noise level—no hissing or popping. Effective lubrication, no squeaking. Laboratory monitored rigid quality control and, with every reel value 24/- or more, you get a FREE MUSIC TAPE—plus an unconditional guarantee.

FREE! NEW
MONO or STEREO
MUSIC TAPE with every purchase to the value of **24/-** or more



COMPARE THESE PRICES

	Standard	Long Play	Double Play	Triple Play
3in	5/-	7/6	11/-	25/-
5in	19/-	24/-	37/6	63/-
5½in	24/-	30/-	57/-	69/6
7in	30/-	42/-	63/-	118/6

THE LOWEST PRICED
HIGH QUALITY TAPE ...

GO FOR QUALITY AND SAVE MONEY



NOW go for **QUALITY**
and SAVE MONEY

EVERY REEL UNCONDITIONALLY GUARANTEED FREE MUSIC TAPE — Fabulous arrangements of Capriccio Italien, Granada and Hora Staccato with every purchase value 24/- or more.

POST THIS COUPON TO DAY

To Recotape Recordings Ltd.,
10 Wells Avenue, Southend-on-Sea, Essex.

Please send me reel/s of Recotape Magnetic Recording Tape together with my free music Tape/s. I enclose £..... (not less than 24/-) plus 1/6 for post and packing. Please send my music tape in 3¼ MONO/3¼ 4 TRACK STEREO, delete as inapplicable.

Name

Address

TRADE ENQUIRIES INVITED

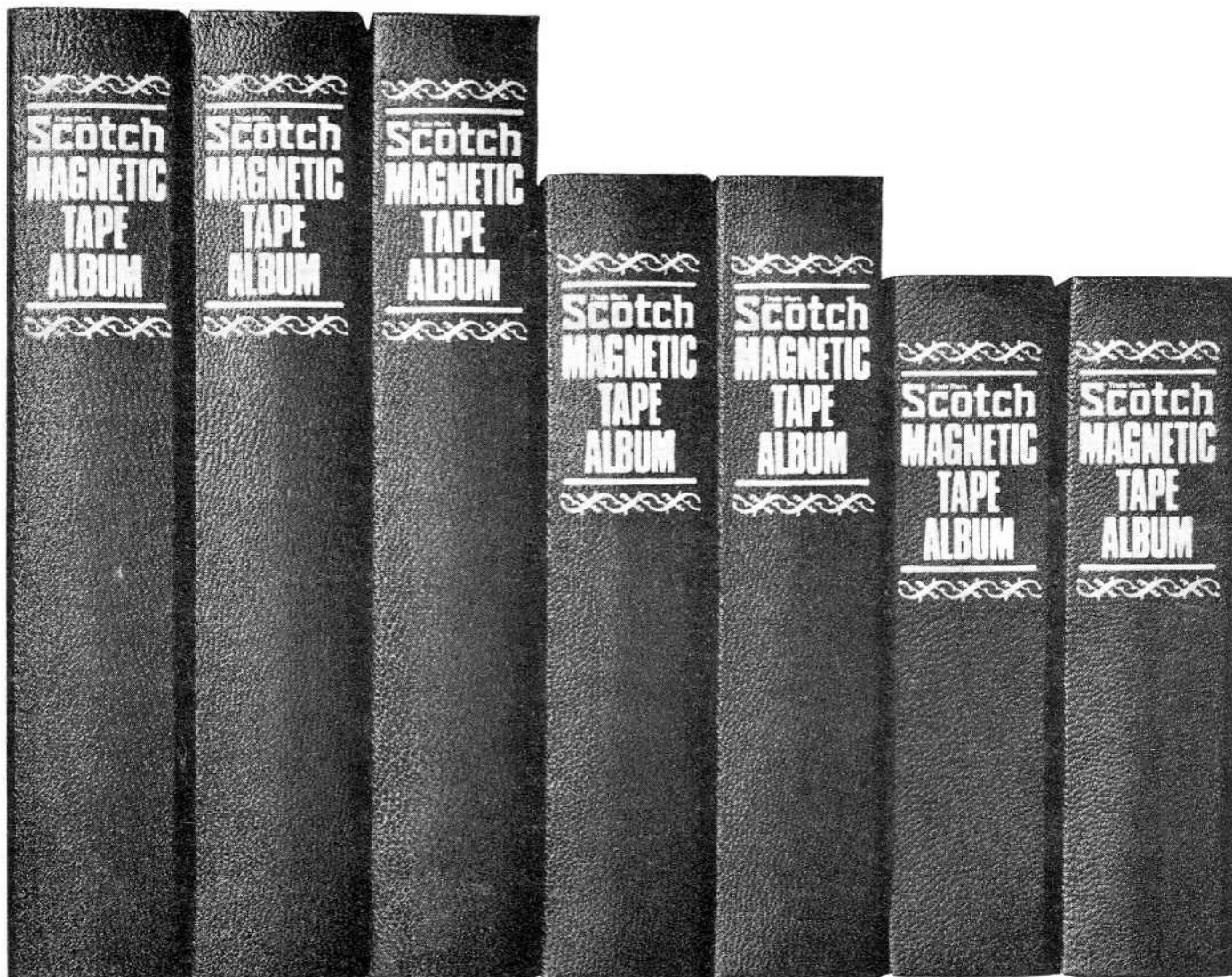

These Albums will speak for themselves...

Shortly you will be able to buy these magnificent 'SCOTCH' Magnetic Tape Album packs at your favourite 'SCOTCH' stockist. The Album, complete with one tape and with room for another, is handsomely bound in green leatherette with real gold block lettering. Included are a set of self-adhesive labels for spine and spool identification. This is more than a fancy cover. 'SCOTCH' Magnetic Tape Albums are built like books to last a lifetime, and look really elegant in your book case—

keeping your tape stored in the correct upright position. They will be available in 5", 5½" and 7" spool sizes for all types of 'SCOTCH' Magnetic Tape. So, wait for them! Or to avoid disappointment, ask your 'SCOTCH' Magnetic Tape stockist to reserve some of them for you now. * Remember too! All Polyester based 'SCOTCH' Magnetic Tape has Superlife coating.

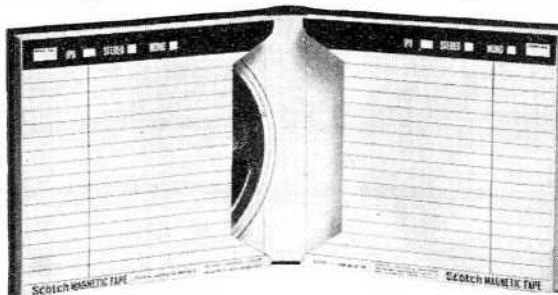

Trade Mark
Scotch
MAGNETIC TAPE

3M
COMPANY

Minnesota Mining & Manufacturing Co. Ltd., 3M House, Wigmore St., London, W1. HUN 5522. 3M and SCOTCH are trademarks of the Minnesota Mining & Manufacturing Co

FI-CORD IS EVERYTHING IN SOUND REPRODUCTION

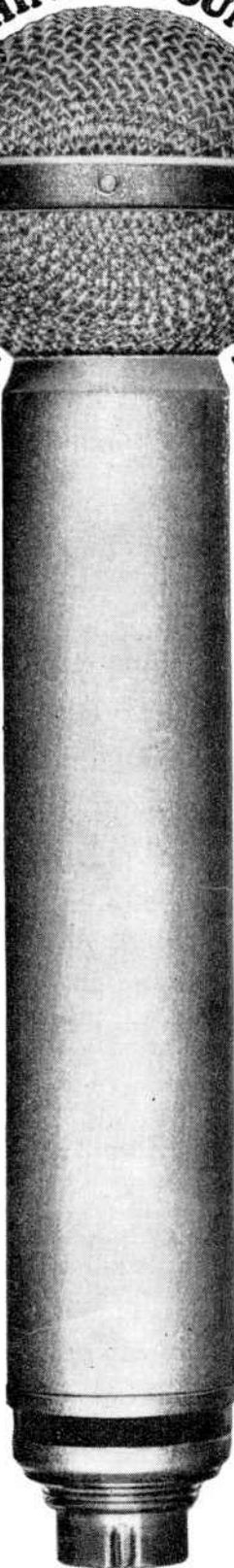

FI-CORD



202A

Built to the same specification which made the Fi-Cord 202 the first choice of broadcasting and film companies. The new Fi-Cord 202A offers still more refinements. Among these are a button-operated battery tester with separate indicator scale, and a redesigned control panel, giving greater ease of operation. With a frequency response of 50—12000 c.p.s. \pm 3db at 7½ i.p.s., this hand portable battery/mains recorder captures every sound as faithfully as studio equipment: rechargeable batteries: long life mercury batteries: power pack for use with 12 v. car battery: power pack for use with AC mains 110-240 v.



FI-CORD 801

Omni-directional studio microphone (dynamic moving coil). Shockproof and proof against changes in temperature. Frequency response 50 to 18,000 c.p.s.



BEYER M119

Moving coil omni-directional microphone very good for interviewing and general background recordings smooth response. Frequency response 50-16000 c.p.s.



BEYER M260

Dynamic Ribbon Microphone. A cardioid pattern studio quality microphone at a price the amateur can afford. Frequency response 50—18000 c.p.s.

Please send information and literature on the full range of microphones and the Fi-Cord 202A.

NAME

ADDRESS

.....

For further details, please complete and post this coupon to:

FI-CORD INTERNATIONAL

Charlwoods Road • East Grinstead • Sussex
 Telephone: East Grinstead 21351

tape club news

Club of the month

This month's tape winner is the Lincolnshire club, **Boston Soundhunters**. Their big event was the organisation of the Soundhunter Pop Ball. This was sponsored by the Lincolnshire Standard group of newspapers, who invited a pop group from each of their six circulation areas to take part in a dance presented by the Soundhunters. The hall was packed for what could best be described as a very rousing evening, and all performances were taped. Each group was then to select its two best numbers for audition by an independent jury, but after hearing the preliminary playback, two groups promptly withdrew! The prize eventually went to the Mergers group from Louth and their tape was sent to EMI's Norrie Parramor for consideration. The group are also recording an EP for the Soundhunters on their own Guildhall label.

The club has received an extremely interesting and informative tape from the Thornton Heath club and hopes to reciprocate shortly. Drama-tape experiments are continuing under the expert eye of Douglas Stainer, and successful concert recordings have been made at Nottingham, King's Lynn and Holbeach.

Wit in Worcestershire

Members of **Birmingham - TRAC** recently visited Kidderminster club to hear a talk with recordings given by Mr Peter Bastin. I am told that Mr Bastin's unusual brand of humour can be appreciated only in the dark, and that he certainly lived up to his title 'the wit from Worcester'. The club has also been exchanging tapes with the Kidderminster club and sharing in other joint activities. Two B-TRAC members who were previously the best of friends are now direct opponents in a competition as a result of the *ATR* Sound Tour, for both are aiming to win the Fi-Cord 202A offered as the prize for the best tape travelogue of the tour. The first of the club's six bi-monthly contests has also been held, and the club member gaining most points over the year will be awarded a plaque and a prize.

Late summer visits by the club include a tour of Hams Hall, a visit to a power station, and a recording session at a motor cycle rally.

Encouraged

After receiving their tape for being top club a few months ago, members of the **Newcastle and District** club have been encouraged to try their hand at more varied activities. A recent brains trust discussion by members covered subjects ranging from jazz to local government, and was recorded for the club archives. Taking advantage of the prevailing fair weather, club members scrapped a recent indoor meeting and sallied forth for an outdoor session armed with two Telefunken portables and a small Philips. On this occasion they visited the Hoppings, a mammoth fair held on Newcastle Town Moor which attracts travelling shows from all over the country. Following the

Now that most clubs are settling in again for the new winter season, it is encouraging to note that there is a definite livening up of the pace. No less than twenty-five clubs managed to send details of their activities this month, and I hope that this increase is a trend which will continue.

As it is some time since I last explained what you can gain from joining the *ATR* league, many new clubs probably don't realise what an asset this can be. First and foremost, the top club each month gets a free 5 in reel of BASF long play tape, and is also awarded 15 points which count towards the League Championship. The next nine clubs are awarded points ranging from 14 down to 6, and any other club mentioned earns 4 points. Reports which are not printed earn 2 points. At the end of the year the club with the most points wins the *ATR* League Trophy, which it

success of this session, the club decided to hold some extra outdoor meetings. At the first of these members recorded traction engines and a Gavioli organ at a nearby rally, while at the second they recorded racing at Colt aerodrome. A club magazine is now being produced, at first only on tape, but later it is hoped that this can be extended to a duplicated publication along the lines of Rugby club's *Tape Life*.

The address of Newcastle secretary David Wright is 10 Elsdon Road, Grange Estate, Whickham, and not as stated in the July issue of *ATR*.

Rugby's aim

Members of **Rugby ATRS** are hopefully rearranging their shelf room to accommodate the *ATR* Trophy for the coming year, and have been working at a number of projects to help them get it. Recent visits from Mastertape and 3Ms produced very interesting meetings. The club has also just completed its first tape exchange with the Newcastle club and is still taping regularly with the Palmerston North Tape Club and Joyce Lawson, both in New Zealand, and with the Ulster Club.

Since the large-scale feature on the Society appeared last December in the *Rugby Review*, club secretary Mike Brown has frequently supplied club news for inclusion in editions of this local advertising paper. These have taken the form of hints on various aspects of tape recording topics, linking wherever possible with details of current club activities. The publishers of *Rugby Review* have now issued a companion paper covering the Warwick and Leamington area and Mike Brown has also been writing in this to promote the Warwick and Leamington tape club with a view to boosting membership.

Buying spree

New equipment has been flowing into the **Thornton Heath TRC**, most of it as a result of purchases by individual members. Recent acquisitions include two Brenells, two Fi-Cord 202s, a Uher Report and a Fi-Cord 1a, the last a lovely job in mint condition.

Younger members are now taking a much more active part in club life, three of them having taken over responsibility for the club magazine 'Contact'. They also helped in providing the tape programme sent to the Boston Soundhunters, and are looking forward to hearing the return tape.

As a direct result of the recent visit to the club of Ken Smith and Albert Freeman, the club was able to arrange the loan of three Truvox R102s for use by its associated group, the Croydon Sound Recording Group.

Round their necks

Members of the **Leeds and District TRC** recently brought all their machines along to a club meeting devoted to editing. This had been designed to take the form of a jigsaw tape,

holds for a year. So, if you'd like to see this handsome cup adorning a shelf in your club room, tell your club secretary or publicity officer to get cracking!

But in spite of the encouraging trends in club work generally there is great disappointment over lack of club response to competitions. This year's British Tape Recording Contest which was judged in London recently (see report on page 7) attracted tapes from only four clubs. Four out of about three hundred is a pretty poor showing, and on the strength of this I wouldn't be surprised to see some of the sponsors of this competition pull out. And if you're left with no national standards to aim for, no central comparison possibilities, and no participation in the international competition, I know who'll be the first to complain! So start making the effort for the next contest right away - before it's too late. - K.C.

comprising news and music jumbled up by the club's treasurer Peter Smith. Each member received a copy of the tape to sort out - with disastrous results! In the ensuing chaos members were seen tripping over tape on the floor, trying to extricate themselves from tape tangles and even trying to unwind it (or rewind it?) round their necks! One of the evening's visitors was Jasen C. Atkinson, local organiser of Tapeworms International, who, not unnaturally, preferred to watch and give advice rather than get entangled.

The club also provided PA and background music at the Chapel Allerton Hospitals Garden Party, and recorded a full-day conference for the National Society for Handicapped Children at the Civic Theatre in Leeds. One of the speakers at the latter event was Mr Segul, JP, who had just returned from Russia and was able to provide some very interesting information.

Shy ones transformed

Thanks to the generosity of the Recorded Sound Department of the British Council, the **Overseas Students' TR Group** have acquired a Fi-Cord, a Grampian DP 4, and a battery charger. The arrival of the Fi-Cord in particular has transformed club members from shy individuals to bold members of sound reporting teams. To help members get the feel of the new portable, they were sent out in pairs for a maximum of ten minutes and asked to record what they liked and not to tell anyone what they had taped when they returned, to ensure that no two pairs recorded the same thing. Playback revealed that they had been emboldened to make some extraordinary requests of the general public. One couple stopped a man in the street and asked if he would sing for them - and he did! Another pair pretended that they had to get to Yorkshire, and as they were broke would have to walk - could someone tell them the way! They were ably directed as far as Camden Town (North London) with apologies for their guide not knowing the rest of the route!

Tunnel under the Thames

To celebrate the first anniversary of the Dartford Tunnel, members of the **Dartford tape club** followed up their tunnel opening tape with a first-year report.

The general manager Captain Milne met the members at the entrance to the offices and took them up to the control room. Here they were given a very interesting talk on how the first ideas of building a tunnel under the Thames were evolved over 167 years ago, outlining the development of this idea up to the present tunnel adding that if the present increase in traffic continues a second tunnel may be built in the near future. Another interesting fact gleaned during the interview was that the pilot tunnel was used by Whittle during the war for testing jet engines. The whole evening was recorded on two machines, one a Fi-Cord

202, the other a special made by chairman G. A. Pulham using a Brenell deck. Demonstrations in co-operation with local cine clubs have included a visit from Mr Greenland of Grundig and one from Mr Pontzen of Lustraphone.

The sound of the pipes

When the Edinburgh City Police Pipe Band visited Montrose recently members of the Montrose and District TC were not tardy in getting some good recordings of the pipes. These recordings were played back to members of the band later that day. Two members of the club subsequently made further successful recordings the following week when the Pipe Band Championships were held at Forfar. In fact it was felt that these recordings made on Philips battery portables, compared quite favourably with those broadcast by the BBC. Some interesting (but unprintable) sound effects and comments were recorded by members who attended a motor cycle grass-track meeting in which no less than six competitors were injured in one event.

Doubled space

Being already lucky in having very good club premises of their own, Radio Scotland tape section members now consider themselves doubly lucky in that their accommodation has been doubled. This will now allow them to expand their weekly meetings, and whereas in the past it has sometimes been difficult to arrange meetings of interest to both technical buffs and newcomers, it will now be possible to incorporate two sessions in one evening if required. Consequently a really full winter programme is being planned.

Location recording sessions however, are not being overlooked. One of the club's planned outdoor visits is to the Museum of Transport in Glasgow, which houses horse-drawn trams, vintage cars and all kinds of transport including present-day ones. Permission has been obtained for the recordings to be made, and the club has also applied for permission to record the Festival of Commonwealth Arts, which is being held in Glasgow this month.

Premises wanted

One club not as fortunate as Radio Scotland is the Brighton TRC. At present they are meeting in a school-room which is not acoustically good, and as a result they are looking for somewhere a little better but not too expensive. Meanwhile the club is pressing on and is at present preparing its entry for next year's national contest. (Am I glad to hear that! - K.C.)

Experiment in drama

Two members of the Croydon Sound Recording Group have been kept very busy recording the whole of the dialogue, sound effects and background music for a production of Rattigan's 'Adventure Story' by a London repertory company (as mentioned in last month's issue). Now that it is all over they have assessed that the final speech tape was 1½ miles long at 7½ ips, while the music, effects and interval music tapes accounted for another ¾ mile. Equipment used included three Truvox R 102s, kindly lent by Ken Smith of Truvox, a 25-watt amplifier and 100-volt line speaker system made available by Jack Hedge of Clark and Smith for the performance. Monitoring and dressing room speakers were fed by a separate 4/5 linear amplifier allowing independent control. Much of the tape was donated by Roy Wrycraft of 3 Ms, and Roger Aslin of the FBTRC gave much advice and assistance. The final result was three very successful evenings of entertainment.

Ferrograph tapers

Members of the British Ferrograph Owners' Club are being kept busy in their various centres. Jack Talling has been engaged in recording the Chester Mystery Plays, while Bob Littler and George West are finding every-

one most co-operative in their documentary tape on the proposed closing down of the New Brighton to Liverpool ferry. A library of sound effects will soon be made available to members from Headquarters.

Tapesponding

The Derby TRC is hoping to extend its tapesponding activities with other clubs. Its first contact has been with a club in Canada, but any other clubs interested in taping with Derby should contact chairman D. Flecknoe at 464 Osmaston Road, Derby.

Still keen

Members of the London TRC are once again very keen, in more than one sense of the word. Attendances at meetings are on the increase, and the club has once again had an evening of demonstration and practice with Richard Keen.

Bird in the hand

The old adage 'A bird in the hand is worth two in the bush' formed the title of a competition held recently by the North London Tape and Hi-Fi Club. After every club competition entrants are awarded points according to the merit of the tape they submitted. Champion competition winners at the moment are Ron and Den Goodwin, but there is still time for someone else to give them a good run for their money in the race for the club's annual trophy. Following some strong discussion in a recent debating evening, the club decided that stereo is worth-while (ten votes to four votes), that transistors are better than valves (nine votes to two votes) and that two-track recording is better than four-track (ten votes to four votes).

Programme planning

Committee members of the Reading Cine and Tape Recording Society have been busy planning the club's programme for the coming winter. Meanwhile, club members have been completing their own pet sound and cine projects which in due course may be entered for the appropriate annual club competitions. The Grosvenor Cup is awarded for the best tape of the year and the Bournes Cup for the best film.

New club for Manchester

Although there are many clubs in the Manchester area, one or two enthusiasts in the St Helens area are finding difficulty in travelling to clubs in other parts of Manchester. They hope therefore to start a club in St Helens itself and would be interested in hearing from other local enthusiasts. Organizer of this venture is Mr A. Highcock of 41 Lowe Street, St Helens, Lancs.

Many changes

During recent months many changes have been taking place within the Sheppey Tape Club. The club has changed its name to the Sheppey Tape Recorder and Hi-Fi Club and has also elected a new committee. The new secretary is Mr F. Harrison of 100 Unity Street, Sheerness, Kent. Club members are also looking forward to having new clubrooms before the winter sets in. In the past they have had to use members' own homes as meeting places, and it is hoped that the new arrangements will lead to an increase in membership.

First centenarian

Gordon Furneaux, secretary of the South Devon TRC, has now attended over one hundred meetings of the club, after having missed only two since its inauguration. Other members are approaching this number and the club hopes to announce more 'centenarians' during the coming year. The club's recent questionnaire to members has elicited much useful information on the organization and general running of the club. Most popular night for meetings is Wednesday and most members prefer these to be occupied with demonstrations and talks by visiting speakers.

Southall show

Members of the Southall TRS determined that the club's display at this year's Southall Show (held over the August holiday weekend) should be bigger and better than ever before. Whole meetings were devoted to planning the organization and layout of the stand and deciding on the main features. Much work has been put into the sound/slide demonstration, one of the main attractions at the show. Extracts from recordings of lectures given to the club over the year have also been incorporated into the programme.

Social success

Although by its very title a tape recording club, the Uxbridge and District TRC has been indulging in one or two social events to pep up the club programme and hold the continuing interest of fringe members. One recent non-recording event was a car rally. Thirty cars competed over a specially planned route of twenty-five miles, mostly through narrow country lanes. Each driver was issued with a route card (taped?) giving various roadside clues and all vehicles carried at least one co-driver. On the real working side members worked very hard at a local road safety fete and have also compiled a tape for the South African Audio League.

Red Cross pageant

Following this year's re-shuffle of the London boroughs, the recent Red Cross pageant at Melbourne Park, Chelmsford, was attended by people from all over the London Borough of Essex, including the Walthamstow and District TRS. The club supplied all the sound effects for the pageant, which told the story of the Red Cross from the battle on the plains of Solferino, Italy, to the present-day work throughout the world. The commentary for this was recorded by Michael Flanders (of Flanders and Swan fame). The club has also recently started a series of lessons in recording technique for members and all-comers who are interested.

Busy tape section

The Westbury-on-Trym Cine and Photographic Club has recently formed its own tape section. The new section is already very busy, as it will be having its own stand at the club's annual exhibition. This is to be held at St John's Church Hall, Whiteladies Road, Bristol, on Wednesday, 22 September, from 6.30 pm to 10.00 pm. Members of the tape section will be demonstrating tape equipment with special reference to adding sound to cine and colour slide shows.

Gigantic task

The recently formed sound section of the Widescreen Association has taken upon itself the gigantic task of compiling a complete index of all available tape recorders (mains and portable), microphones, loudspeakers and other ancillary equipment. If any members of other clubs have spare leaflets, catalogues or other information they may no longer require these would be much appreciated. Any information should be sent to Jeff Rich at 12 Blanche Street, Roath, Cardiff, or to Phillip Howell at 103 Pearl Street, Roath, Cardiff.

Copy dates for forthcoming issues

October issue (out 24 September) - 23 August.
November (out 22 October) - 20 September.
Copy for inclusion in these columns should be sent to Mrs Cook, ATR, Haymarket Press, 86-88 Edgware Road, London W2.

Top Ten

- | | |
|-------------------|----------------------|
| 1. Boston | 6. Leeds |
| 2. B-TRAC | 7. Montrose |
| 3. Newcastle | 8. Overseas Students |
| 4. Rugby | 9. Dartford |
| 5. Thornton Heath | 10. Radio Scotland |

FRANCIS OF STREATHAM

include among their customers many who call personally from all over the country, because of the stocks and service in **TAPE AND HI-FI EQUIPMENT** to be found there. With so many shops to choose from, there must be excellent reasons why people prefer to buy from Francis. Perhaps you would care to find out by calling or writing to us about your requirements.

- ★ VERY LARGE STOCKS OF TAPE AND HI-FI EQUIPMENT
- ★ NO EXTRA FOR CREDIT UP TO 18 MONTHS
- ★ OWN SERVICE DEPARTMENT
- ★ FREE SERVICE DURING GUARANTEE PERIOD

FRANCIS OF STREATHAM

169-173 STREATHAM HIGH RD., LONDON, S.W.16

Between St. Leonards
Church and Streatham Stn.

Open all day
Saturday

Phone STR
0192 / 0466

Purchasing a Hi Fi Tape System?



TRADE-INS—
ATTRACTIVE TERMS
UP TO 3 YEARS

TANDBERG ★ SABA ★ BANG & OLUFSEN
UHER ★ AKAI ★ GRUNDIG ★ REVOX ★ SANYO
BRENELL ★ PHILIPS ★ REPS RIO ★ STELLA
COSSOR ★ OPTACORD ★ TELEFUNKEN
TRUVOX ★ VORTEXION ★ FERROGRAPH

Pre-recorded tape mono stereo 2 and 4 track; Tape of every brand; Accessories; Microphones; Leads for every combination; Amplifiers and Tuners; Speakers, etc.

Send us
your requirements

MASSEY'S

CENTRE OF SOUND

121-123 HIGH ROAD, CHISWICK, W.4

Showrooms open 9.30-6.30 daily except Thursday, 1 p.m.

Telephone: CHISWICK 2082

YOUR LOCAL

WIMBLEDON'S TAPE RECORDER CENTRE

Agents for: TRUVOX, FERROGRAPH, VORTEXION, REVOX, BRENELL, GRUNDIG, PHILIPS, COSSOR, REFLECTOGRAPH, ETC.

Get it Taped the Expert Way—By letting us install your apparatus

TEL-LEE-RADIO

220 The Broadway, WIMBLEDON, S.W.19

LIBerty 4946

WORTHING, SUSSEX



1 Becket Buildings, Littlehampton
Road, Worthing 5142

Stocking Ferrograph, Revox, Sony, Tandberg, Truvox, Philips, EMI, Luxor, Bang & Olufsen, etc., on fully comparative Demonstrations

TAPE RECORDER CENTRE (HX)

AGENTS FOR ALL THE LEADING MAKES OF RECORDERS AND HI-FI including:— B&O, BRENELL, BRAUN, DUAL, FERROGRAPH, FI-CORD, GRUNDIG, KORTING, OPTA-CORD, PHILIPS, REVOX, ROBUK, SABA, SONY, TANDBERG, TELEFUNKEN, TRUVOX, ETC.

30 KING CROSS STREET, HALIFAX

Halifax 66832

PART EXCHANGE WITH PLEASURE

SHEEN TAPE RECORDER HI-FI CENTRE

ANNOUNCE THEIR NEW PREMISES ARE
NOW OPEN

3 & 4 STATION PARADE, SHEEN LANE,
SHEEN, LONDON, S.W.14

Specialists in Tape Recorders - Accessories - Hi-Fi
Stereo - Pre-recorded Tapes - Mics - Tuners
Amplifiers - Speakers - Etc.

Showrooms open until 7 p.m. PRO 0985 Opp. Mortlake Station, S.R.

ADVERTISERS IN THIS ISSUE

	Page		Page
Agfa Ltd	2	Minnesota Mining & Manufacturing Co Ltd	40
Akai	4, 5	G. L. Morton & Co Ltd	45
L. Bishop Ltd	45	Phillips Electrical Ltd	16
Bosch Ltd	6	Pullin Photographic Ltd	4, 5
Bowers & Wilkins Ltd	44	Pye Ltd	37
A. Brown & Sons Ltd	46	Recotape Recordings Ltd	39
Cussins & Light Ltd	45	Sheen Tape Recorder Centre	44
De Villiers (Electronic World)	35	Sound Effects Records	30
Elstone Electronics Ltd	38	Southern Recorder Service	45
Fj-Cord International Ltd	41	Tandberg	38
Fittall Plugs	46	Tape Recorder Centre (Halifax)	44
Francis of Streatham	44	Tel-Lee-Radio	44
Grampian Reproducers Ltd	38	Thistleboon Enterprises Ltd	46
Highgate Acoustics	8	Vortexion Ltd	22
Ilford Ltd	36	Wallace Heaton (City Sale) Ltd	30
Kodak Ltd	9	Wharfedale Wireless Works Ltd	47
Lambda Record Company	45	Worthing Tape Recorder Centre	45
LEC (Leyton) Electrical Co	45	Zonatape	36
Lustraphone Ltd	46		
Mallory Batteries Ltd	48		
Massey's Centre of Sound	44		

DEALERS

Visit the North's Finest Tape Recorder Showroom. All leading makes in stock, ready for demonstration. Tape, Mics., Mixers, all accessories, Tape Records. Separate Hi-Fi and constructors showrooms. Full Technical Service.



KINGS SQUARE, YORK. Tel. 55666

L.E.C. (Leyton) ELECTRICAL CO.

120 HIGH ROAD, LEYTON, E.15
LEYtonstone 6814

Stockists of: Ferrograph, Vortexion, Brenell, Revox, Rogers, Armstrong, Leak, Goodmans, KEF, Record Housing Furniture, etc. TAPES by BASF, AGFA, ZONAL 3" to 10". Demonstrations in the Home. Tape to Disc Service.

SOUTHERN RECORDER SERVICE

2 ST. GEORGE'S STREET
WINCHESTER, HANTS

LAMBDA RECORD CO. LTD.

Suppliers of Fine Tape Recording and Hi-Fi equipment, Microphones and Accessories.

Specialist Technical Service Department.

Part Exchange and H.P. welcome. Suppliers to Schools, Universities, Atomic Energy Authority, Leading Architects and Broadcasting Organisations.

70 LIVERPOOL ROAD, LIVERPOOL 23

Tel. GREAt Crosby 4012

WORTHING TAPE RECORDER CENTRE

Tape and Hi-Fi Experts. Agents for all types of machine and equipment. Servicing and Repairs.

22 New Broadway,
Tarring Road, Worthing,
Sussex.

Telephone: WORTHING 3630

G. L. MORTON & CO LTD

12 OXFORD STREET
NEWCASTLE UPON TYNE

Tape recorder service in the

BIRMINGHAM AREA

L. BISHOP LTD.

1708 BRISTOL ROAD, SOUTH, REDNAL
BIRMINGHAM

Telephone: RUBery 2709

GRUNDIG SPECIALISTS

CLASSIFIED ADVERTISEMENTS

Classified advertisements in 'Amateur Tape Recording' cost 1s per word, minimum 10s. Box Nos. 1s 6d extra. Advertisements and remittances should be sent to Advertisement Manager, 'Amateur Tape Recording', 86-88 Edgware Road, London W2.

PERSONAL

Speedy and Expert Tape Recorder and Hi Fi Repairs by England's leading Hi Fi Specialists. Telesonic Ltd, 92 Tottenham Court Road, London W1. MUS 8177.

Highest cash prices offered for good quality Tape Recorders, Hi-Fi Equipment and LP Records. REW. Earlsfield Ltd, 266/8 Upper Tooting Road, London SW17. Tel BAL 9174.

The Arden Marriage Bureau, 82 Links Drive, Solihull, Warks. For a personal and confidential service.

Pre-Sleep Study. Learn difficult lessons or parts or improve your mental powers while you sleep! Send now for Price List of materials; including the perfect Tape Machine, Time Switch, Pillow Speaker, Endless Tape Cassettes, Pre-recorded Tapes for Learning or Therapy, Language Courses, etc. Psychology Tapes Ltd (ATR), 16 Kings College Road, London NW3. PRI 3314.

The perfect companion to ATR is 8mm Magazine—an unbeatable combination for the sound and cine enthusiast. 8mm tells you all you need to know on how to take cine films and where to look for subjects. Packed with news of the latest cine developments, unbiased test reports and hints on sound and cine. All for only 2s 6d a month, or special introductory subscription offer of 25s a year from Subscription Dept, 8mm, Haymarket Press Ltd, 86-88 Edgware Road, London W2.

Good news for 'ATR' readers! You can have your copy of 'ATR' delivered by the postman on publishing day each month at no extra cost. The postage—yes, even at the increased postal rates—is paid by the publishers. The annual subscription rate is now only 30s. So send your name and address today, with 30s to: Subscription Department, Amateur Tape Recording, 86-88 Edgware Road, London W2.

Could you spare an hour of your time once a month to help Oxfam? Extra voluntary helpers urgently needed to collect 2s 6d Pledged Gifts from eight friends or neighbours. You could easily raise £1 a month. A Devon helper writes: 'Everyone has been so kind and willing and I've made new friends through collecting.' Please write for explanatory leaflet to Miss Joan Chapman, Room 50, Oxfam, Oxford.

Learn while you sleep. Learn languages, memorise speeches and sales presentations, absorb business statistics or the highway code while asleep with Learnasleep Equipment. Details from Sleep Learning Supplies, (Dept ATR), 245 Capworth Street, Leyton E.10

The A. T. Hill Correspondence Club for friendship/marriage. £1 membership. SAE for details. 61 Old Lansdowne Road, Manchester 20.

Test report on the Akai X-IV portable. Room acoustics. Sounds for science fiction. Inquest on the BTR Contest. Volume compressor preamplifier for constructors. All this and much more in October ATR.

MISCELLANEOUS

Listen and learn in record time. LP Discs and Tape Records. Courses on Book-keeping, Banking, Economics, English Law, Income Tax, Statistics, Secretarial Subjects and FOREIGN LANGUAGES. Write now for the FREE Catalogue Handbook to: Student Recordings Ltd. (Dept. ATR), 15 Devon Square, Newton Abbot, S. Devon.

MAGNETIC TAPE

A Unique Buy! Recording tape top brand, 7 in 2400 ft DP 25s; 5½ in 1200 ft 19s 6d; P & P 1s 6d per spool. Bargains in all sizes. Sae for list. We repair, buy and sell recorders. E. C. Kingsley & Co Ltd, 132 Tottenham Court Road, London W1. EUSton 6500.

Lafayette 'International' Tape. Polyester—7 in 2400 ft 22s 6d; 5½ in 1800 ft 20s; 5 in 1200 ft 14s; 7 in 1800 ft 19s; 7 in 1200 ft 12s. Acetates—7 in 1800 ft 14s 9d; 5 in 900 ft 10s 6d; 5 in 600 ft 8s. Refund guarantee. 'Bib' Tape Slicer 14s 11d. We also have a full range of Message Tapes and Triple Play Tapes all at lowest ever prices. P & P 2s per order. SAE List. Leda Tapes, 30 Baker Street, W1.

PRE-RECORDED TAPES

American 4 rack stereo tapes covering most famous labels at realistic prices. Why pay more? Imported directly by us, saving distributors' profits. Vast selection at 75s each—send SAE for free lists or call at London showrooms. Teletape of Marble Arch, 33 Edgware Road, W2.

Temp Tapes—music (3½ ips mono tapes). Castle Sound Effects (45 rpm discs). 6d stamp for catalogue—wide selection. Recorded Tuition Ltd, 174 Maybank Road, South Woodford, E18. BUCKhurst 9315.

Tape Record Centre. The new tape record centre at Kew is now open to supply tapes by Capitol, Columbia, Liberty, MGM, Music On Tape, Parlophone, Stateside and a wide selection of imported American labels. Send 1s in stamps for list to: Magnetic Tracks Ltd (ATR), 9 Kew Green, Richmond-on-Thames.

TAPE TO DISC

J & B Recordings. Tape/disc. Mobile unit. Wedding experts. 14 Willows Avenue, Morden, Surrey, Mitcham 9952.

Tape to Disc Recording. Finest professional quality: 10 in LP, 42s; 12 in LP, 48s; 7 in EP, 28s; 40 ft recording studio; 48 hour postal return service. Any speed tapes. SAE for leaflet. Deroysound Service, 52 Hest Bank Lane, Hest Bank, Lancaster.

John Hassell Recordings. Tape to Disc. Studio and mobile services. 21 Nassau Road, London SW13. Riverside 7150

Rapid Recording Service. Records made from your own tapes (48-hour service). Master Discs and pressings. Recording Studio—Demo Discs. Mobile recordings, any distance. Brochure from 21 Bishops Close, E17.

If quality and durability matter (especially with LPs from your precious tapes), consult Britain's oldest transfer service. Our mobile units attend anywhere for mono/stereo master recording. Records published tax free for schools, choirs, orchestras. Sound News Productions, 10 Clifford Street, London W1.

EQUIPMENT FOR SALE

Don't Buy A Tape Recorder until you have visited the Barden/Grundig Centre opposite Dalston Junction Station. All Grundig models are available on easy terms with generous part-exchange allowances. The Grundig Centre, 21 Dalston Lane, E8. CLIssold 8811.

'Somerset' 10 and 30 watt output transformer. Transformer Equipment Limited, Railway Place, London SW19.

Unbiased guide. Our latest sixty-page, photographically illustrated hi-fi catalogue (4s 6d). Unbiased advice, preferential terms to Members. You'll be glad to have consulted Audio Supply Association, 10 Clifford Street, London W1.

Sony Tape Recorder TC500A. Latest model, 4-track stereo. New. £100. Box No 222.

AMATEUR TAPE RECORDING SUBSCRIPTION FORM

Make certain you receive your copy of AMATEUR TAPE RECORDING Video and Hi-Fi by completing this form and sending it, with your annual subscription to:

AMATEUR TAPE RECORDING, SUBSCRIPTION DEPT,
86-88 EDGWARE ROAD, LONDON W2

Please send AMATEUR TAPE RECORDING Video and Hi-Fi for one year, commencing with the next (.....) issue, to the address below. I enclose the annual subscription of thirty shillings (30s). ATR will pay the postage.

Name

Address

.....

..... Date

Tape Club members wishing to avail themselves of the special Club Subscription rate of 25s per annum should apply to their local Club Secretary. All Club orders must bear the Club Secretary's signature and be sent to the Subscription Department.



TAPE RECORDER COVERS

Smart waterproof cover to give complete protection to your tape recorder. Made from rubberised canvas in navy, wine, tan and bottle green with white contrasting pipings, reinforced base, handy zip microphone pocket and name panel.

GRUNDIG TK 1 with pocket	49/6
GRUNDIG TK 5 with pocket	55/-
GRUNDIG TK 6	67/6
GRUNDIG TK 8 with pocket	63/-
GRUNDIG TK 14, 18 & 23	59/6
GRUNDIG 14L, 17L, 18L & 23L	67/6
GRUNDIG TK 20 with pocket	52/6
GRUNDIG TK 24 with pocket	55/-
GRUNDIG TK 25 with pocket	55/-
GRUNDIG TK 30 with pocket	60/-
GRUNDIG TK 35 with pocket	63/-
GRUNDIG TK 40 & 41	66/-
GRUNDIG TK 46 with pocket	82/-
GRUNDIG TK 60 no pocket	75/-
TELEFUNKEN 85 with pocket	65/-
TELEFUNKEN 75/15 & 76K with pocket	55/-
TELEFUNKEN 95 & 96 with pocket	69/6
PHILIPS 8108 with pocket	57/6
PHILIPS EL3534 with pocket	87/-
PHILIPS EL3536 with pocket	70/-
PHILIPS EL3538 with pocket	63/-
PHILIPS EL3541/15 with pocket	57/6
PHILIPS 3541H	72/-
PHILIPS EL3542 with pocket	63/-
PHILIPS EL3548	79/6
PHILIPS EL3549 with pocket	79/6
PHILIPS STARMAKER	66/-
COSSOR 1605 with pocket	84/-

COSSOR 1602 with pocket	57/6
COSSOR 1601 with pocket	63/-
COSSOR 1604	79/-
STELLA ST455 with pocket	63/-
STELLA ST454 with pocket	57/-
STELLA 459 with pocket	84/-
STELLA 458	79/-
STUZZI TRICORDER with pocket	58/-
SABA 2305 with pocket	79/6
ELIZABETHAN FTI with pocket	66/-
ELIZABETHAN LZ 29	75/-
BRENELL MK. 5 with pocket	77/-
ROBUK RK3	67/6
SONY 521	90/-
FERROGRAPH	80/-
REVOX	84/-
OPTACORD 412, 414 & 416	63/-
TRUVOX R92 & R94	99/-
TANDBERG 72, 74, 62, 64, 92, 843 & 823	hard case 141/6 soft case 112/6

CALL, SEND MONEY OR REQUEST C.O.D. WITH YOUR ORDER TO:

A. BROWN & SONS LTD.

24-28 George Street, Hull
Tel. 25413/5

EVERY TAPE RECORDER NEEDS AN INDEX

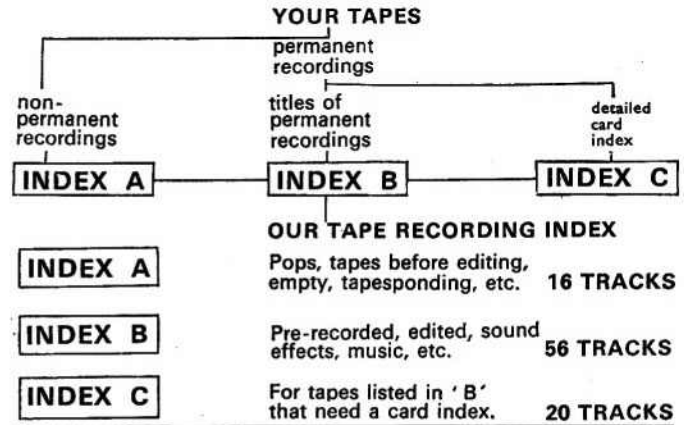
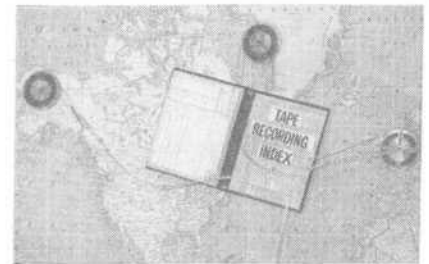

Immediately changeable. Seen at a glance. All contained in a beautiful 6" x 8" folder. Easy to slip on your tape rack or under the lid of your machine. From your local dealer or send 25/- plus 1/6 p. & p. to:

THISTLEBOON ENTERPRISES LTD., 13 THISTLEBOON RD., MUMBLES, SWANSEA



IDEAL FOR TAPE RECORDERS

JUST ONE PLUG
adjusted in seconds to fit any of **5 SOCKETS!**

Fits 13 Amp fused, 15 Amp or 5 Amp, 3 and 2 pin sockets.

COSTS... ONLY 12/6

Get one now from any good electrical or radio dealer, hardware store, etc., or if in difficulty write to:-

FITTALL PLUGS
Coastguard Road, Larne, N. Ireland

CINÉ PROJECTORS

The Lavalier



What a difference a really good microphone can make to your recording - a Lustraphone microphone will enable you to enhance the quality with first class sound. Send for full details.

LUSTRAPHONE

the foremost name in microphones
Lustraphone Ltd., St. George's Works,
Regents Park Road, London, N.W.1.
PRImrose 8844

STAYING POWER!



HERE'S WHY MAKERS AND OWNERS OF TAPE RECORDERS ARE CHOOSING MALLORY BATTERIES



Powerful *new* Mallory alkaline manganese batteries get their muscle into the longest recording/playback session—and stay fresh-as-new to the end. No distortion troubles. No loss of volume. Even after lying idle they'll spring into fresh-battery action the instant called upon. And their powerful capacity for work goes on long after others would have been replaced.

Try them yourself when replacement time is due—you'll be pleased you made the change!

MALLORY

for new ideas in batteries

MALLORY BATTERIES LIMITED CRAWLEY SUSSEX Crawley 26041



ON **BASF** LETTER TAPES SPECIALLY PACKED FOR MAILING



BASF LETTER-TAPE enables you to talk to relatives and friends anywhere in the world. **BASF** insistence on highest quality production makes the Letter-Tape extra sensitive to capture every shade of expression. Delight your friends far away—let them *hear* your news on the 150 feet long-play tape specially made for mailing. The lightweight **BASF** Letter-Tape comes complete with mailing carton and reply labels, and costs only 5/6d.



—SYMBOL OF
AUTHENTIC SOUND



BASF CHEMICALS LIMITED, 5a GILLESPIE ROAD, LONDON, N.5. TEL: CANonbury 2011