



**Sales manual**

Hansgrohe bathroom and kitchen range

**The complete guide to  
Hansgrohe mixers, showers  
and installation systems**

# Everything for thrilled customers



Consumers are becoming more and more discerning. As a trade partner, we at Hansgrohe make every effort to support you in your quality work as a

professional in the bathroom industry. This includes innovative products that you can use to convince your customers. As well as everything you need for your daily work as a craftsman and adviser for our products. For this reason, we have created this sales manual as a new and hopefully practical tool that is intended to support you in your customer presentations. The sales manual presents a structure that offers you added value for every sales situation. Each product category starts with an overview page that lists the range according to function and price. A helpful basis for your advice. The subsequent, easy to follow, range pages give you the details of each product group. In addition,

you are provided with the advantages and selling points for many products and their innovative technologies. So you can convince your customer, down to the last detail. Should you have any new ideas about the sales manual, simply contact us. We are always interested in how we can work together make things even better. So that advice and sales become even easier for you. We wish you every success – and thrilled customers every day.

Yours,  
Richard Grohe

## Also use the Hansgrohe iPad catalogue to illustrate and advise – your emotionally appealing and interactive sales aid:

- Camera function that can be used to place every product in your own bathroom
- Videos on technology
- Configurator for matching basin mixer combinations
- Favorites wish list for printing out
- Search function for finding products quickly



Download now for free at [www.hansgrohe-int.com/catalog](http://www.hansgrohe-int.com/catalog)  
or directly from iTunes at  
<http://itunes.com/app/hansgrohecatalog>

# Contents

---

## **8 Showers and shower control**

- 10** Spray modes
  - 12** Shower technologies
  - 16** Hand showers and shower sets
  - 28** Overhead and side showers
  - 34** Raindance® Rainmaker® and Raindance® Rainfall®
  - 36** Showerpipes
  - 46** Showerpanel®
  - 48** Exposed thermostats
  - 56** Concealed installation iBox® universal
  - 60** Concealed finish sets
  - 65** Concealed thermostats
  - 66** Concealed valves
  - 67** Shower control RainBrain®
  - 68** Example installations
- 

## **74 Bath mixers**

- 76** ComfortZone
  - 78** ComfortZone test/technologies
  - 84** Bathroom mixers - overview
  - 88** PuraVida®
  - 94** Metris®
  - 98** Talis®
  - 102** Focus®
  - 105** Style overview
  - 106** Metris® Classic
  - 108** Talis® Classic
  - 110** Care mixers
  - 112** Electronic basin mixer
  - 114** Accessories Logis®/Accessories Logis® Classic
  - 115** Style overview
  - 116** Waste systems
- 

## **120 Kitchen mixers**

- 121** ComfortZone
  - 122** Kitchen mixers - overview
  - 124** PuraVida®
  - 126** Metris®
  - 128** Talis®
  - 129** Focus®
  - 130** Technologies
- 

## **132 Company**

# Quality with added value

---

**MADE IN  
GERMANY**

Quality borne by tradition

**5 YEARS  
GUARANTEE**

Assured quality

**SERVICE**

We are there for you



Trade partner



Worldwide references

**Design**

Number One on the sector



Certified mixers and showers



Water processing



Saving water



Select your shower pleasure



Easy cleaning



Larger, softer drops



Optimal freedom of movement

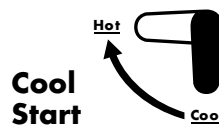

Saving energy

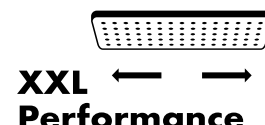

Pure shower pleasure

---

Find out all the latest news on water and Hansgrohe at



[www.facebook.com/hansgrohe](http://www.facebook.com/hansgrohe)



[www.twitter.com/hansgrohe\\_pr](http://www.twitter.com/hansgrohe_pr)



[www.youtube.com/hansgrohe](http://www.youtube.com/hansgrohe)

# Impressive range for the bathroom and kitchen

---



**Hand showers**

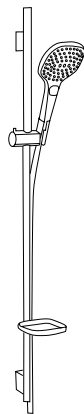

**Shower sets**

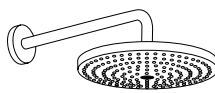

**Overhead showers**

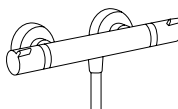

**Exposed shower thermostat**

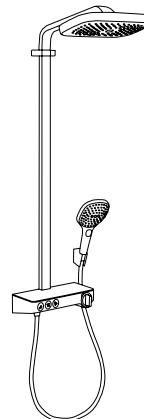

**Showerpipes**

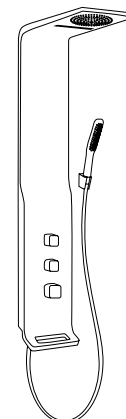

**Showerpanel®**

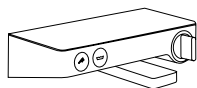

**Exposed bath thermostat**

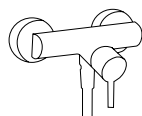

**Exposed single lever shower mixer**

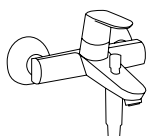

**Exposed single lever bath mixer**

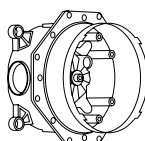

**iBox® universal**

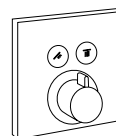

**Concealed thermostats**



**Concealed single lever shower mixer**

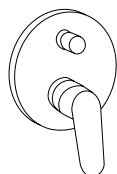

**Concealed single lever bath mixer**



**Valves**

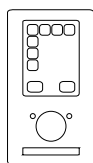

**Electronic shower control**

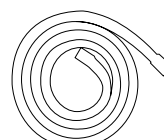

**Accessories**

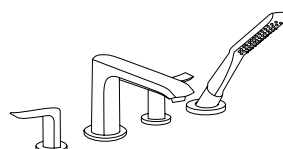

**Rim-mounted mixers**

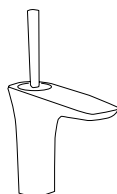

**PuraVida®**

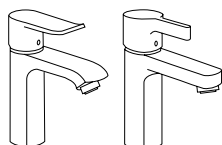

**Metris®/Metris® S**

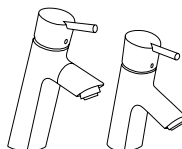

**Talis®/Talis® S**

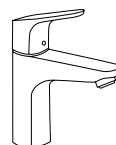

**Focus®**



**Accessories**



**Metris® Classic**

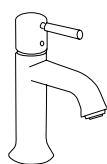

**Talis® Classic**

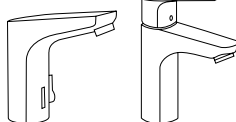

**Electronic and Care basin mixers**

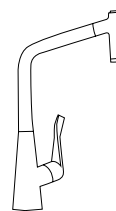

**Kitchen mixers**

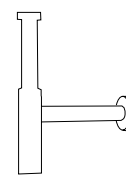

**Waste systems**

Made by Hansgrohe

# Quality you can count on: before, during and after installation

We at Hansgrohe see ourselves as retail and trade partners. Our constant ability to offer our customers the highest quality and tailored services is an fundamental part of

our corporate philosophy. No matter whether you have questions, problems, or specific wishes: We are at your side. You can always put your trust in our quality claim "Made

by Hansgrohe". Before, during and after installation.

**QUALITY**  
MADE IN GERMANY

**Quality borne by tradition:** and quality born of the Black Forest. At Hansgrohe we build on German know-how for the highest quality in form and function. We see and have always seen "Made in Germany" as a recipe for success. Our personal claim is to offer our customers long lasting products that set standards in functionality and quality. Hansgrohe therefore uses exceptionally high quality materials approved for drinking

water applications. Subjected to long term tests for their compliance with all bathroom requirements. All single parts comply with the applicable standards and are fitted with the optimal precision for safeguarded ease of use and convenience over years to come. The guidelines we ourselves have drawn up for product safety exceed by far most of the specifications usual on this sector. In addition to the normal tightness tests, our showers

are also tested regularly at a pressure of 10 bar. The cartridges in the mixers can even withstand pressure shocks up to 60 bar. Test certificates from independent institutes confirm the long life and reliable operations of our products. Hansgrohe therefore offers you quality that you can pass on directly to your customers, and that assures you their permanent satisfaction.

## 5 YEARS GUARANTEE

**Assured quality:** The highest quality is a fundamental part of the Hansgrohe corporate philosophy. For this reason, we offer a voluntary manufacturer's warranty of five years on all of our products.  
[www.pro.hansgrohe-int.com](http://www.pro.hansgrohe-int.com)

## CARE AND CLEANING

**Customers remain happy:** Our products can be cleaned with ease. One example is the QuickClean function that enables limescale to be rubbed off with minimal effort. We also provide care tips that help your customers enjoy our products for even longer.

## ONLINE SPARE PARTS CATALOGUE

**All parts in detail:** The electronic spare parts catalogue lets you find spare and special parts with particular ease. In addition, you will benefit from other functions like dimension drawings, links between drawings and service parts, a checklist and downloads of installation and service instructions.  
<http://spares.hansgrohe.com>

## Hansgrohe@home

**Basin planning made easy:** Show your customers on your iPhone, iPad, or Android smartphone a virtual bathroom where Hansgrohe mixers blend perfectly with their chosen wash basin. iTunes: <http://itunes.com/app/hansgrohehome> and Google Play: <http://play.google.com/store/search?q=hansgrohe+se>

## Savings calculator

**Savings with Hansgrohe:** The savings calculator lets you calculate for your customers the potential saving with EcoSmart technology in mixers and showers. You can also determine the return rate on the investment: [www.pro.hansgrohe-int.com/savings-calculator](http://www.pro.hansgrohe-int.com/savings-calculator) or mobile at <http://m.pro.savings.hansgrohe-int.com>

## AXOR® MANUFAKTUR

**Tailored products and special solutions:** Besides our many standards, our factory also offers you and your customers individualised Hansgrohe products - for single or multiple pieces. These enhance the individuality of every bathroom and lend hotel projects that unmistakable, prestigious touch.  
[www.pro.hansgrohe-int.com/customisation](http://www.pro.hansgrohe-int.com/customisation)



## SERVICE

**Trade partner:** Our experience gathered over many years offers you support in the form of a wide range of services. Whether you are in need of services, product training courses, or consultation for special projects or enhanced marketing efficiency for your services, you can only benefit from our extensive expertise.  
[www.pro.hansgrohe-int.com/service](http://www.pro.hansgrohe-int.com/service)

**We are there for you:** Technical questions? Our experienced master technicians will be pleased to offer you advice and support for all of your sanitary issues!

Service hours:  
Mon-Fri: 7:00 am - 06:00 pm  
Phone: +49 7836 51-1282  
Fax: +49 7836 51-1440  
Email: [info@hansgrohe-int.com](mailto:info@hansgrohe-int.com)

# SHOWERS AND SHOWER CONTROL

---

**The wide range of products that fulfils all requirements:**

Hand showers and shower sets | Overhead and side showers | Showerpipes  
Showerpanel® | Thermostats | iBox® universal | Installation systems





## Shower installations

# As individual as the day: our wide range of showers

Every customer has their own ideas about the optimal shower. So that you can make all of their wishes come true, we offer you a large number of shower combinations, from the simple shower and overhead shower set to the ensemble of thermostat, hand and overhead shower. The installation options

are equally flexible. Whether exposed or concealed installations, Hansgrohe provides the right solution for your needs. Those who want to breathe some fresh life into their bathroom will, of course, find the perfect solutions at Hansgrohe as well. A new hand or overhead shower with innovative Hansgrohe

technologies upgrade the shower to a visible and tangible degree. In addition, the Showerpipe and Showerpanel can provide complete systems that turn a shower into something more during refurbishment work. Simply install on the available connections and enjoy now pure water pleasure!

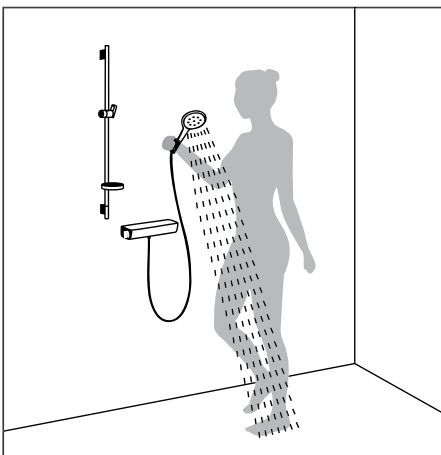

**Hand shower or shower set:** Even the basic solution provides pure shower pleasure for customers and moreover can be attached effortlessly to the wall. Controlled via exposed thermostat or single lever shower mixer. More on pages 16, 36, 48 onwards.

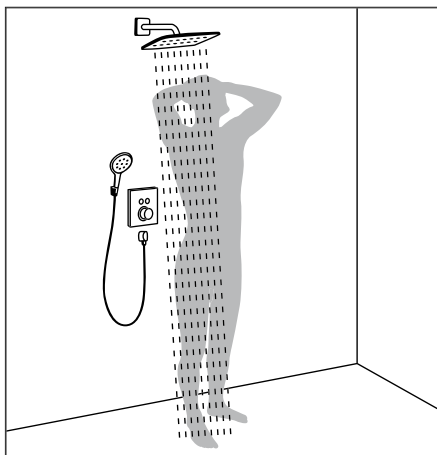

**Overhead shower:** for shower rain modes up to 600 mm in diameter. Controlled via concealed thermostat or valves. At the same time, the version with Select technology promises even greater convenience. More on pages 28, 60 onwards.

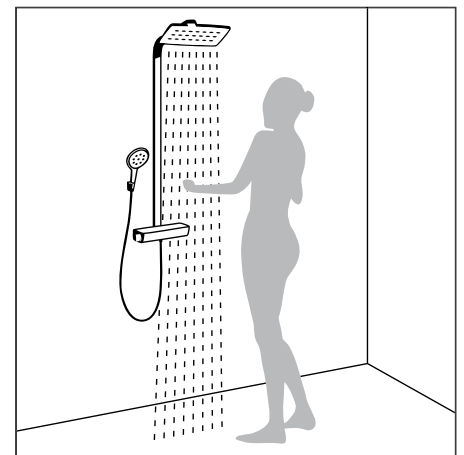

**Showerpipe:** the complete system with overhead shower, hand shower and thermostat. The ideal solution for uncomplicated bathroom refurbishments. More on pages 36 onwards.

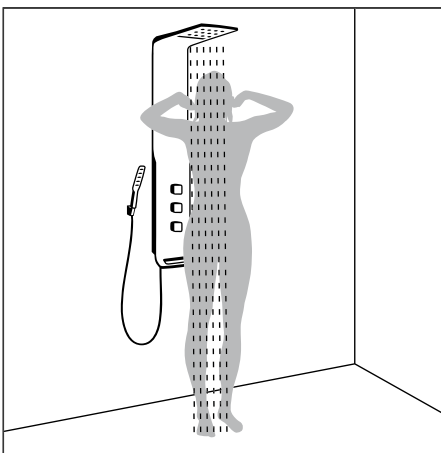

**Showerpanel®:** combines overhead, hand, and/or side showers in a single system. This can be installed on existing wall connections. Hence also ideal for retrofits and refurbishments. More on pages 46 onwards.

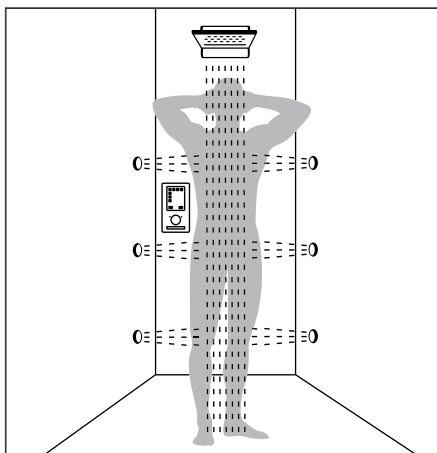

**Shower family:** the concealed solution for individual shower designs. From a waterfall to all-round pleasure with side showers. Controlled e.g. via the intelligent RainBrain. More on pages 28, 67 onwards.

## Spray modes

# Greater enjoyment with the many spray types for hand and overhead showers

Everyone showers differently, and everyone has different expectations of the perfect shower. Some think it not only as a necessity but also relaxation. Others

value an energising, invigorating shower experience. No matter your customers' wishes, every one of them will find the right hand or overhead shower and the right spray

type in the Hansgrohe range. The Select products promise your customers particular convenience. They can then select each spray type easily at the push of a button.



**RainAir:** If you are looking for relaxation and you want your soul to be pampered by the water. Just the right thing for this is a hand or overhead shower with the soft, luxurious RainAir spray that provides air-enriched drops from a large, wide jets, to wash away the everyday grime.



**Rain:** The openings on the hand or overhead shower may be small, but their effect is all the greater: The rain spray revitalises and refreshes with its pleasant power enveloping the body. It is therefore ideal, for example, for rinsing out shampoo quickly and thoroughly.



**Whirl:** The concentrated Whirl spray simply washes away the exertions of the day. Whether hand or overhead shower: Three single sprays revolve around each other for an intense massage effect that dissolves tension.



**RainFlow:** An overhead shower with the clear, beautifully shaped RainFlow cascading spray brings the waterfall experience to the bathroom. This lets you enjoy water in its natural form, as a cascade from above on the neck and shoulders. This can be directed specifically to these parts of the body and tension quickly disappears. This is a trend especially in the wellness bathroom.



**RainStream:** The new RainStream of single sparkling jets is a crowning achievement of the Hansgrohe spray developers. These special overhead shower sprays do not constrict, but remain unvaryingly revitalising and intense right down to the floor. The result: a new, revitalising shower experience, irrespective of the users height.



**RainAir XL:** For all those who want no limits on their showering fun, Hansgrohe can offer Raindance overhead showers up to 600 mm in diameter. From large spray faces, their RainAir XL sprays generate a full, soft shower rain. These envelop the whole body for a feel good experience all over.

Innovative shower technologies by Hansgrohe

# Technology to thrill your customers

## Select: Select your shower pleasure



Thanks to Hansgrohe, a new age now dawns under the shower. With an elegant button that requires a single click to change the spray type or control the water. The name

of this innovative technology: "Select". An intuitive control concept at the touch of a button that promises even greater pleasure in the bathroom. Whether hand showers,

overhead showers, ShowerTablet, thermostat, ShowerSelect finish sets, or Showerpipes – the new Select technology with its many benefits brings pleasure at the touch of a button.



**Intuitive:** Whether ON, OFF, spray change, or function select – the Select button makes child's play of their use.

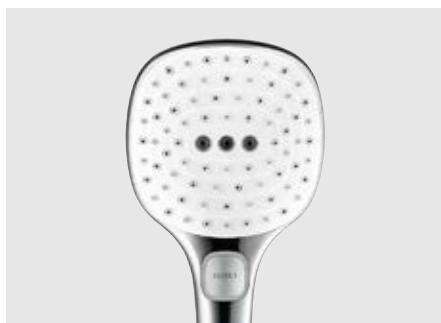

**Innovation:** The Select button is built on shower technology that we are proud of. It gives rise to new forms, like soft, round corners.

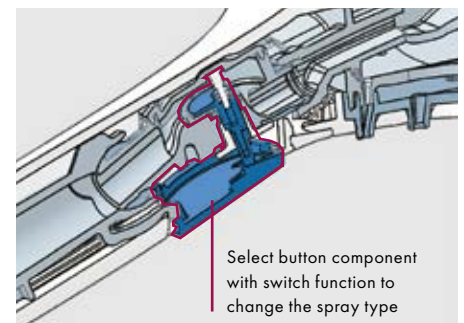

Select button component with switch function to change the spray type

**Long lasting:** The Select button is purely mechanical, which means it is particularly durable. This was confirmed by a long term test that pushed the Select button 90,000 times.

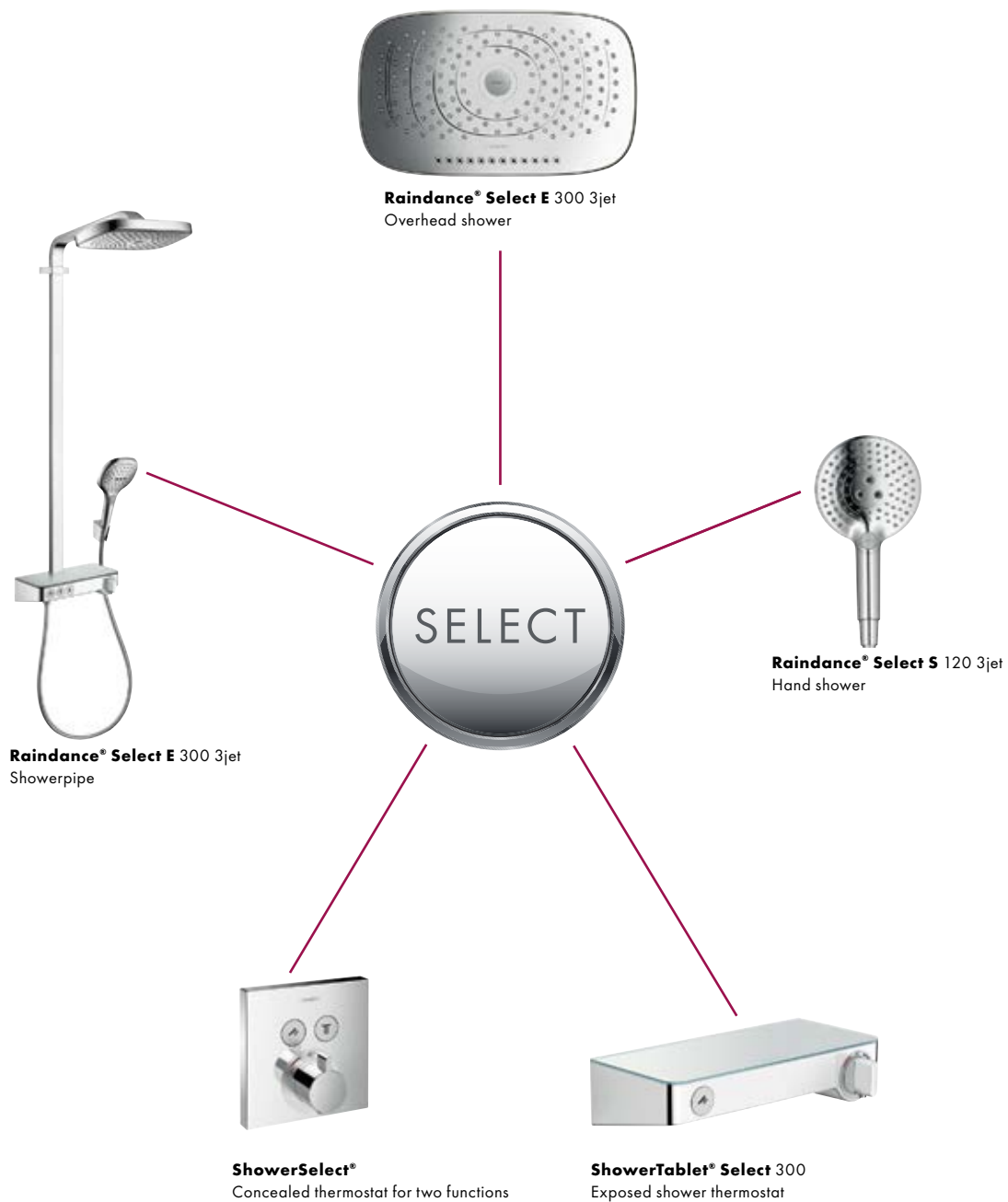

## Advantages and benefits

- Intuitive control at the touch of a button: The spray type is changed or a shower function activated with a simple click
- Ergonomic “universal design” allows easy and reliable use for all generations
- The perfected mechanism shuts off reliably when the water pressure exceeds 50 bar
- A wide range of multifunctional products for an individual showering experience
- Consistent control philosophy for the hand and overhead shower, Showerpipe and exposed and concealed thermostat

Find out more in the “Select” discussion and at  
[www.pro.hansgrohe-int.com/select](http://www.pro.hansgrohe-int.com/select)



## AirPower: more volume, more pleasure

Convenience and efficiency don't have to be mutually exclusive. This is proved by Hansgrohe AirPower showers. This technology developed by Hansgrohe

involves drawing in air over the whole area of the spray face. Water can then be used with greater efficiency. At the same time, the drops are fuller, lighter and softer. The result can

be felt immediately on the skin: The sparkling AirPower shower rain envelops the body and generates a magnificent well being.



**AirPower:** The generous injection of air gives rise to extraordinary shower pleasure and large shower drops.



### Advantages and benefits

- Fuller, lighter and softer drops – pure shower pleasure
- Fewer splashes, so less cleaning
- Larger water volume for greater water efficiency

## XXL performance: great shower pleasure

Hansgrohe overhead showers provide a large scale showering experience under the Raindance Rainmaker up to 600 mm in diameter – and hence XXL performance in the bathroom.

At the same time, our showers consume less water than you think: Thanks to the intelligent injection of air, our AirPower technology generates fuller drops. At Hansgrohe, shower

pleasure and water efficiency go hand in hand, with no compromise.

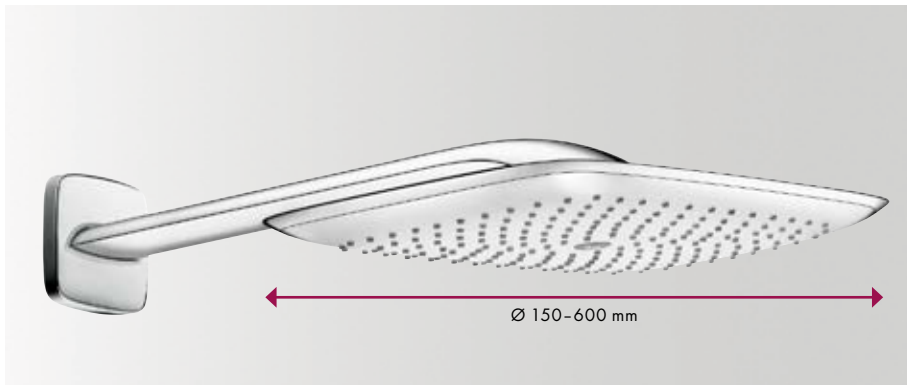
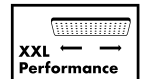

**XXL performance:** Overhead showers up to 600 mm in diameter – for all those valuing great showering experience.



### Advantages and benefits

- Shower rain modes up to 600 mm in diameter
- High water efficiency – a uniformly distributed spray for an incomparable showering experience



## QuickClean: fast anti-limescale function

Who likes cleaning anyway? Our invention QuickClean removes dirt and limescale deposits on showers in seconds.

Thanks to flexible silicone jets limescale deposits can simply be rubbed off with your finger – no intensive cleaning or scrubbing.

The result is a beautiful, uniform shower spray.



**QuickClean:** The silicone jets are simply rubbed to ensure showerheads remain free of limescale and functioning perfectly, for their lifetime.



### Advantages and benefits

- Fast and easy cleaning
- Ultra high quality and tear resistant silicone
- For a long lifetime and functionality

## EcoSmart: Water and energy savings



Hansgrohe EcoSmart showers consume up to 60% less water than conventional products. This reduces water and energy

costs and protects valuable resources. This is confirmed by the European quality mark WELL – Water Efficiency Label, which awarded top

grades to our hand showers Crometta 85 Green and Croma 100 (1jet, Vario and Multi).



**EcoSmart:** The ingenious flow rate limiter in the shower reduces water consumption to only 9 or 6 l/min.

WELL Upgrade Volume Water Efficiency Label	
Manufacturer:	Hansgrohe SE
Product category:	Accessories shower valve
Type:	Shower head
Model:	Crometta 85 Green
Registration number:	ZD19549-20130704
<div style="display: flex; justify-content: space-between;"> <span><b>A</b></span> <span><b>A++</b></span> </div> <div style="display: flex; justify-content: space-between;"> <span><b>B</b></span> <span></span> </div>	
<b>Water Efficiency Criteria</b>	
Flow rate > 9.0 l/min ≤ 12.0 l/min	**
Controlled flow rate ≥ 4.5 l/min ≤ 8.0 l/min	***
<small>Information about use and installation: <a href="http://www.well-online.eu">www.well-online.eu</a>                      A Label of EU United Values                      European Valve Manufacturers Association</small>	



### Advantages and benefits

- Up to 60% less water consumption
- Hot water savings for less energy consumption – so less CO<sub>2</sub> emissions and lower costs



How much water and energy can be saved is calculated by the savings calculator at:

[www.hansgrohe-int.com/savings-calculator](http://www.hansgrohe-int.com/savings-calculator)

Hansgrohe hand showers

# The hand shower range at a glance

Crometta® 85

Croma® 100

Performance ↑



**Crometta® 85 1jet**



**Crometta® 85 Vario**



**Crometta® 85 Multi**

More details on Crometta hand showers can be found on page 25.



**Croma® 100 1jet**



**Croma® 100 Vario**



**Croma® 100 Multi**

More details on Croma hand showers can be found on page 23.

**How to use the overview with your customer:**

The higher a shower is positioned on the product line, the greater its functionality. All EcoSmart variants can be found on the following pages for the range.



## Raindance®

## Raindance® Select



**Raindance® E**  
150 Air 3jet



**Raindance® S**  
150 Air 3jet



**Raindance® E**  
120 Air 3jet



**Raindance® S**  
120 Air 3jet



**Raindance® E**  
100 Air 3jet



**Raindance® S**  
100 Air 3jet



**Raindance® Select E**  
150 3jet



**Raindance® Select S**  
150 3jet



**Raindance® Select E**  
120 3jet



**Raindance® Select S**  
120 3jet

More details on Raindance hand showers can be found on page 20.

More details on Raindance Select hand showers can be found on page 18.

Raindance® Select hand shower



# The right water spray for each shower type



**RainAir:** A gentle, soothing, air-enriched spray providing large, soft drops for relaxing.



**Rain:** A strong, revitalising spray to refresh and particularly suited for washing your hair.



**Whirl:** A concentrated massaging whirl to ease tension.



## Advantages and benefits

- Easy and convenient spray type changes at the push of a button
- Two full rain spray types in the one shower: a powerfully revitalising and a gently soothing spray
- For all showering needs: whether you want to start the day refreshed, easily rinse out shampoo, or simply relax
- For all tastes: available as a round version or with soft corners with chrome or white/chrome surface

Find out more at [www.pro.hansgrohe-int.com/select](http://www.pro.hansgrohe-int.com/select)

## Raindance® Select



**Raindance® Select E 150 3jet**  
Hand shower  
(16 l/min) # 26550, -000, -400  
EcoSmart (9 l/min)  
# 26551, -000, -400



**Raindance® Select E 120 3jet**  
Hand shower  
(16 l/min) # 26520, -000, -400  
EcoSmart (9 l/min)  
# 26521, -000, -400

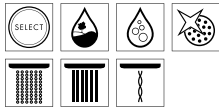

**Raindance® Select S 150 3jet**  
Hand shower  
(16 l/min) # 28587, -000, -400  
EcoSmart (9 l/min)  
# 28588, -000, -400

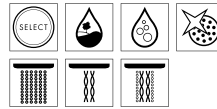

**Raindance® Select S 120 3jet**  
Hand shower  
(16 l/min) # 26530, -000, -400  
EcoSmart (9 l/min)  
# 26531, -000, -400

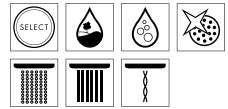

**Raindance® Select E 150 3jet/  
Unica® 'S Puro Set**  
0.90 m # 27857, -000, -400  
0.65 m # 27856, -000, -400 (not shown)

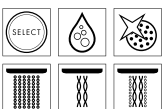

**Raindance® Select E 120 3jet/  
Unica® 'S Puro Set**  
0.90 m # 26621, -000, -400  
0.65 m # 26620, -000, -400 (not shown)  
EcoSmart (9 l/min)  
0.90 m # 26623, -000, -400 (not shown)  
0.65 m # 26622, -000, -400 (not shown)

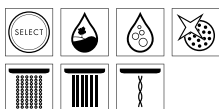

**Raindance® Select S 150 3jet/  
Unica® 'S Puro Set**  
0.90 m # 27803, -000, -400  
0.65 m # 27802, -000, -400 (not shown)

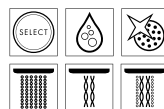

**Raindance® Select S 120 3jet/  
Unica® 'S Puro Set**  
0.90 m # 26631, -000, -400  
0.65 m # 26630, -000, -400 (not shown)  
EcoSmart (9 l/min)  
0.90 m # 26633, -000, -400 (not shown)  
0.65 m # 26632, -000, -400 (not shown)

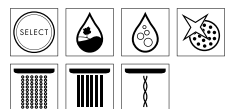

## Raindance®



**Raindance® E 150 Air 3jet Hand shower**  
(18 l/min) # 28518, -000  
EcoSmart (9 l/min) # 28551, -000



**Raindance® E 120 Air 3jet Hand shower**  
(18 l/min) # 28507, -000  
EcoSmart (9 l/min) # 28549, -000



**Raindance® E 100 Air 3jet Hand shower**  
(15 l/min) # 28502, -000  
EcoSmart (9 l/min) # 28553, -000  
**Raindance® E 100 Air 1jet Hand shower**  
(18 l/min) # 28508, -000 (not shown)

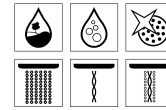
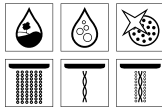
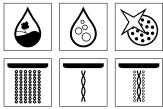

- Ergonomic short handle
- Elegant design

- Diameters up to 150 mm
- AirPower

- Three spray modes: RainAir, WhirlAir and BalanceAir



**Raindance® S 150 Air 3jet Hand shower**  
(18 l/min) # 28519, -000  
EcoSmart (9 l/min) # 28550, -000  
**Raindance® S 150 Air 1jet Hand shower**  
(17 l/min) # 28505, -000 (not shown)



**Raindance® S 120 Air 3jet Hand shower**  
(18 l/min) # 28514, -000  
EcoSmart (9 l/min) # 28554, -000



**Raindance® S 100 Air 3jet Hand shower**  
(15 l/min) # 28504, -000  
EcoSmart (9 l/min) # 28552, -000  
**Raindance® S 100 Air 1jet Hand shower**  
(18 l/min) # 28509, -000 (not shown)

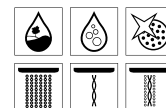
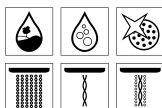
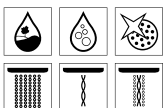

- Stylish, simple design language
- Ideal for minimalistic bathrooms

- Diameters up to 150 mm
- AirPower

- Three spray modes: RainAir, WhirlAir and BalanceAir

## Porter Set



**Raindance® S 100 Air 1jet/Porter 'S Set**  
Hose length 1.25 m # 27580, -000  
Hose length 1.60 m # 27581, -000

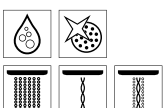



**Raindance® E 150 Air 3jet/  
Raindance® Unica® Set**  
0.90 m # 27874, -000  
1.50 m # 27888, -000  
(not shown)  
EcoSmart (9 l/min)  
0.90 m # 27657, -000  
(not shown)

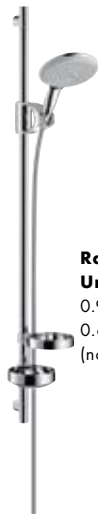
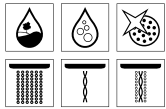

**Raindance® E 150 Air 3jet/  
Unica® D Set**  
0.90 m # 27894, -000  
0.65 m # 27897, -000  
(not shown)

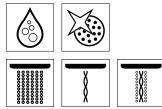

**Raindance® E 100 Air 3jet/  
Unica® D Set**  
0.90 m # 27881, -000  
0.65 m # 27883, -000  
(not shown)  
**Raindance® E 120 Air 3jet/  
Unica® D Set**  
0.90 m # 27885, -000  
(not shown)  
0.65 m # 27887, -000  
(not shown)

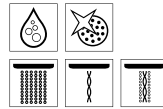

**Raindance® S 150 Air 3jet/  
Raindance® Unica® Set**  
0.90 m # 27893, -000  
EcoSmart (9 l/min)  
0.90 m # 27658, -000  
(not shown)

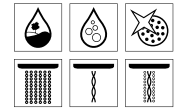

**Raindance® S 150 Air 3jet/  
Unica® S Puro Set**  
0.90 m # 27895, -000  
0.65 m # 27898, -000  
(not shown)

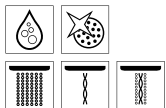

**Raindance® S 100 Air 3jet/  
Unica® S Puro Set**  
0.90 m # 27880, -000 (not shown)  
0.65 m # 27882, -000 (not shown)  
**Raindance® S 120 Air 3jet/  
Unica® S Puro Set**  
0.90 m # 27884, -000  
0.65 m # 27886, -000 (not shown)

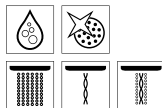

**Raindance® Rainbow® Set  
with Raindance® S 150 Air  
3jet**  
0.90 m # 27876, -000

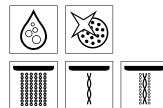

**Raindance® Allrounder Set  
with Raindance® E 150 Air  
3jet**  
# 28110, -000  
Adapter for concealed  
installations  
# 28108, -000 (not shown)  
Adapter for corner installations  
# 28105, -000 (not shown)

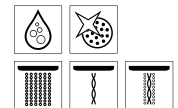

- Additional slider for height adjustments
- Use as both hand and overhead shower
- Flexible installations possible
- Large projection
- Long lasting metal construction

- Use as both hand and overhead shower
- Flexible installations possible
- Large projection
- Long lasting metal construction

## Raindance® Classic



**Raindance® Classic 100**  
Air 3jet Hand shower  
(17 l/min) # 28548, -000

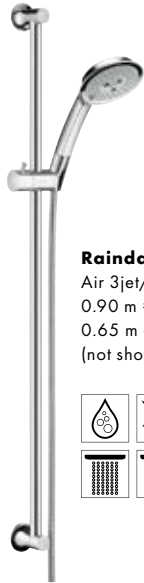
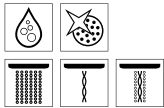

**Raindance® Classic 100**  
Air 3jet/**Unica® Classic Set**  
0.90 m # 27841, -000  
0.65 m # 27843, -000  
(not shown)

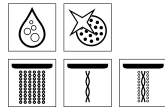

## PuraVida®



**PuraVida® 150 3jet**  
Hand shower  
(16 l/min)  
# 28557, -000, -400  
EcoSmart (9 l/min)  
# 28567, -000, -400

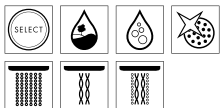

**PuraVida® 120 1jet**  
Baton hand shower  
(16 l/min)  
# 28558, -000, -400  
EcoSmart (9 l/min)  
# 28568, -000, -400

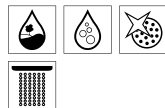

**PuraVida® 120 1jet**  
TravelShower  
(16 l/min) # 28564, -400

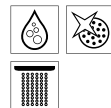

**PuraVida®/Unica® Set**  
0.90 m # 27853, -000, -400

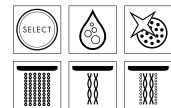

## Children's hand showers



**Raindance® S 100 Air 3jet**  
Hand shower with  
froggy attachment  
EcoSmart (9 l/min)  
# 28545, -000

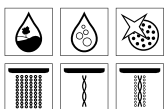

**Joco®**  
Hand shower  
(9 l/min) # 28560, -000

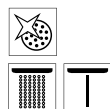

## Croma® 100



**Croma® 100 Multi**  
Hand shower  
(19 l/min) # 28536, -000  
EcoSmart (9 l/min) # 28538, -000  
EcoSmart (6 l/min) # 26830, -000

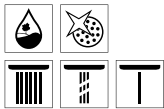

**WELL**  
Water Efficiency Label **A\*\***

- Large spray face for great shower pleasure
- Three spray modes: Rain, Mono, massage spray



**Croma® 100 Vario**  
Hand shower  
(18 l/min) # 28535, -000  
EcoSmart (9 l/min) # 28537, -000

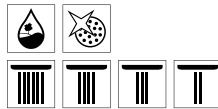

**WELL**  
Water Efficiency Label **A\*\***

- Large spray face for great shower pleasure
- Four graduated rain sprays from wide to concentrated



**Croma® 100 1jet**  
Hand shower  
(16 l/min) # 28580, -000  
EcoSmart (9 l/min) # 28583, -000



**WELL**  
Water Efficiency Label **A\*\***

- Large spray face for great value shower pleasure

## Porter Sets



**Croma® 100 Multi/Porter 'S Set**  
Hose length 1.25 m # 27593, -000  
Hose length 1.60 m # 27595, -000

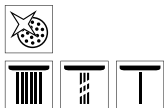

**Croma® 100 Vario/Porter 'S Set**  
Hose length 1.25 m # 27592, -000  
Hose length 1.60 m # 27594, -000

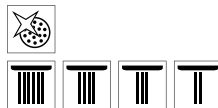

**Croma® 100 1jet/Porter 'S Set**  
Hose length 1.25 m # 27574, -000  
Hose length 1.60 m # 27575, -000



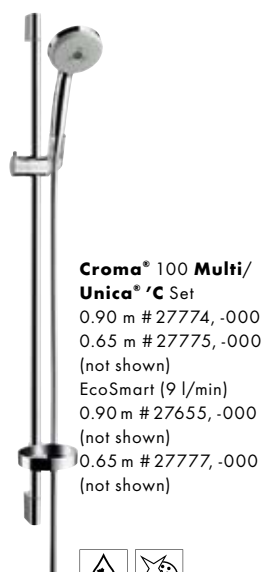

**Croma® 100 Multi/  
Unica® 'C Set**  
0.90 m # 27774, -000  
0.65 m # 27775, -000  
(not shown)  
EcoSmart (9 l/min)  
0.90 m # 27655, -000  
(not shown)  
0.65 m # 27777, -000  
(not shown)

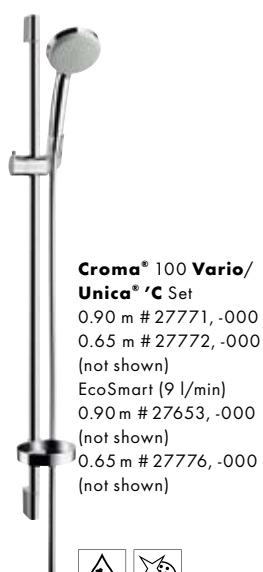

**Croma® 100 Vario/  
Unica® 'C Set**  
0.90 m # 27771, -000  
0.65 m # 27772, -000  
(not shown)  
EcoSmart (9 l/min)  
0.90 m # 27653, -000  
(not shown)  
0.65 m # 27776, -000  
(not shown)

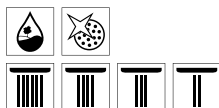

**Croma® 100 ljet/  
Unica® 'C Set**  
0.90 m # 27724, -000  
0.65 m # 27717, -000  
(not shown)

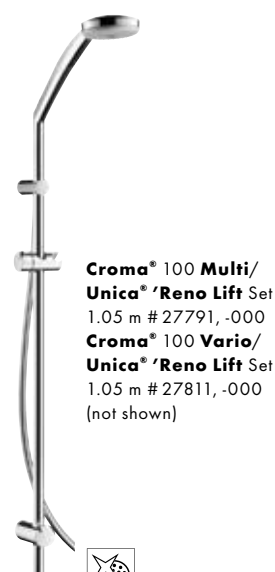

**Croma® 100 Multi/  
Unica® 'Reno Lift Set**  
1.05 m # 27791, -000  
**Croma® 100 Vario/  
Unica® 'Reno Lift Set**  
1.05 m # 27811, -000  
(not shown)

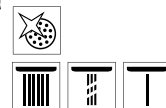

- Swivelling shower bar
- Drilled hole can be covered, so ideal for renovations

## Croma® 100 Classic

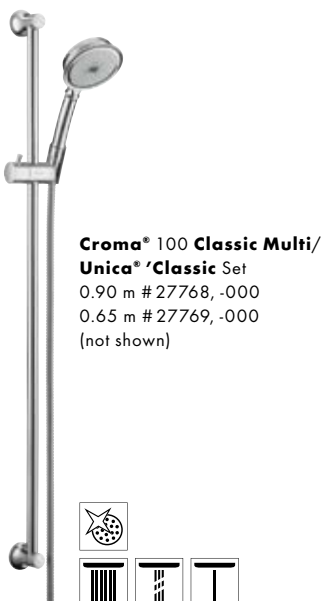

**Croma® 100 Classic Multi/  
Unica® 'Classic Set**  
0.90 m # 27768, -000  
0.65 m # 27769, -000  
(not shown)

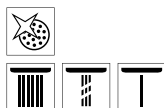

**Croma® 100 Classic Multi**  
Hand shower  
(19 l/min) # 28539, -000

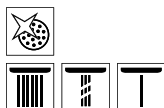



## Crometta® 85



**Crometta® 85 Multi**  
Hand shower  
(16 l/min) # 28563, -000  
EcoSmart (9 l/min) # 28608, -000

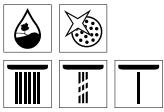

**Crometta® 85 Vario**  
Hand shower  
(17 l/min) # 28562, -000  
EcoSmart (9 l/min) # 28607, -000  
EcoSmart (6 l/min) # 26831, -000

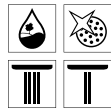

**Crometta® 85 Mono**  
Hand shower  
(16 l/min) # 28585, -000  
EcoSmart (9 l/min) # 28606, -000

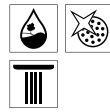

**Crometta® 85 Green**  
Hand shower  
(6 l/min) # 28561, -000

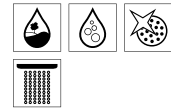

- Great value, suitable for many combinations
- Many spray types
- Also ideal as a shower for the bathtub

## Porter Sets



**Crometta® 85 Multi/  
Porter 'C Set**  
Hose length 1.25 m  
# 27568, -000  
Hose length 1.60 m  
# 27569, -000

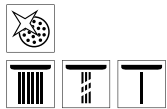

**Crometta® 85 Vario/  
Porter 'C Set**  
Hose length 1.25 m  
# 27558, -000  
Hose length 1.60 m  
# 27559, -000

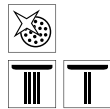

**Crometta® 85 Mono/  
Porter 'C Set**  
Hose length 1.25 m  
# 27576, -000  
Hose length 1.60 m  
# 27577, -000

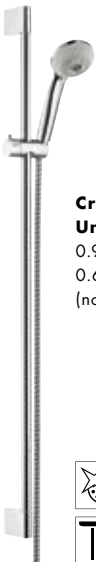

**Crometta® 85 Multi/  
Unica® 'Crometta® Set**  
0.90 m # 27766, -000  
0.65 m # 27767, -000  
(not shown)

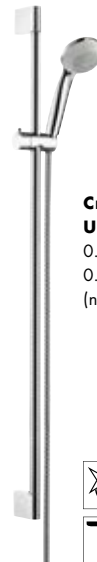
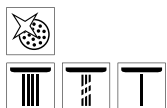



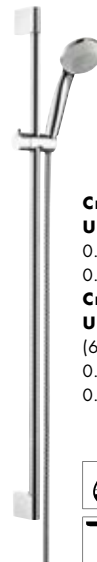
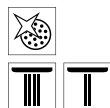



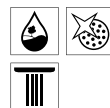



**Crometta® 85 Vario/  
Unica® 'Crometta® Set**  
0.90 m # 27762, -000  
0.65 m # 27763, -000  
(not shown)



**Crometta® 85 Mono/  
Unica® 'Crometta® Set**  
0.90 m # 27729, -000  
0.65 m # 27728, -000 (not shown)  
**Crometta® 85 Green/  
Unica® 'Crometta® Set**  
(6 l/min)  
0.90 m # 27651, -000 (not shown)  
0.65 m # 27652, -000 (not shown)



### Shower bars

 <p><b>PuraVida® Unica®</b> Shower bar with Isiflex shower hose 1.60 m 0.90 m # 27844, -000</p>	 <p><b>Raindance® Unica®</b> Shower bar with Sensoflex shower hose 1.60 m 0.90 m # 27636, -000</p>	 <p><b>Unica® 'S</b> Shower bar with Isiflex shower hose 1.60 m 0.65 m # 27725, -000 0.90 m # 27727, -000 (not shown)</p>	 <p><b>Unica® 'S Puro</b> Shower bar with Isiflex shower hose 1.60 m 0.65 m # 28632, -000 0.90 m # 28631, -000 (not shown)</p>	 <p><b>Unica® 'Classic</b> Shower bar with Sensoflex shower hose 1.60 m 0.65 m # 27617, -000</p>
 <p><b>Unica® 'D</b> Shower bar with Isiflex shower hose 1.60 m 0.65 m # 27933, -000 0.90 m # 27930, -000 (not shown)</p>	 <p><b>Unica® 'C</b> Shower bar with Isiflex shower hose 1.60 m 0.65 m # 27611, -000 0.90 m # 27610, -000 (not shown) alternatively without flexible hose 0.90 m # 27609, -000 (not shown)</p>	 <p><b>Unica® 'Crometta®</b> Shower bar with Metaflex shower hose 1.60 m 0.65 m # 27615, -000 0.90 m # 27614, -000 (not shown)</p>	 <p><b>Unica® 'S Puro Reno</b> Shower bar 0.72 m # 28662, -000 1.05 m # 28663, -000 (not shown)</p>	 <p><b>Unica® 'Reno</b> Shower bar 0.72 m # 27704, -000</p>

- Adjustable shower heights and angles
- Hands-free showering
- Flexible installations in shower cubicles and baths
- Shower can be swivelled out

### Shower hoses

 <p><b>Sensoflex®</b> Shower hose metal with plastic lining and swivel 1.25 m # 28132, -000 1.60 m # 28136, -000 2.00 m # 28134, -000</p>	 <p><b>Isiflex® EcoSmart</b> metal-look shower hose with integrated flow rate limiter (9 l/min) 1.25 m # 28270, -000 1.60 m # 28271, -000 2.00 m # 28188, -000</p>	 <p><b>Isiflex®</b> Shower hose of metal-look plastic 1.25 m # 28272, -000, -450 1.60 m # 28276, -000, -450 2.00 m # 28274, -000</p>	 <p><b>Metaflex®</b> Shower hose of metal-spiral-look plastic 1.25 m # 28262, -000 1.60 m # 28266, -000 2.00 m # 28264, -000</p>	 <p><b>Metaflex® EcoSmart</b> shower hose of metal-spiral-look plastic with integrated flow rate limiter (9 l/min) 1.25 m # 28198, -002 1.50 m # 28195, -002 1.60 m # 28199, -002 1.75 m # 28196, -002 2.00 m # 28197, -002</p>
---	---	---	---	--



- Various materials, lengths and looks
- Anti-kink and easy care
- Chrome effect matching the mixers
- Scratch free thanks to plastic or plastic coating
- Swivel for twist-free flexibility
- Particularly strong - confirmed by tension tests

## Shower holder



**Porter 'S**  
Shower holder  
# 28331, -000



**Porter 'C**  
Shower holder  
# 27521, -000



**Porter 'D**  
Variable shower holder  
Adjustable angle  
# 27526, -000



**Porter 'Classic**  
Shower holder  
# 28324, -000



**Porter 'A**  
Variable shower holder  
Metal housing  
Adjustable angle  
# 27520, -000



**Porter 'E**  
Variable shower holder  
Hose length 1.25 m  
Adjustable angle  
# 27507, -000



**Porter 'Vario**  
Variable shower holder  
Metal housing  
Adjustable angle  
# 28328, -000



**Porter 'Reno**  
# 28335, -000



- Integrated hose connection
- Isiflex shower hose 1.25 m



- Higher installations for use as hand/overhead shower



- Retrofit on bath and shower mixers
- Universal applications

## Hose connections



**Fixfit®**  
DN15 hose connection  
with ball joint eliminating  
tiresome twisting and  
non-return valve  
# 27414, -000



**Fixfit® S**  
DN15 hose connection  
with ball joint eliminating  
tiresome twisting and  
non-return valve  
# 27506, -000



**Fixfit® S**  
Hose connection DN15  
# 27453, -000  
with non-return valve  
DN15 # 27456, -000



**Fixfit® E**  
DN15 hose connection  
with ball joint eliminating  
tiresome twisting and  
non-return valve  
# 27505, -000



**Fixfit® E**  
Hose connection DN15  
# 27454, -000  
with non-return valve  
DN15  
# 27458, -000, -450



**Fixfit® Stop**  
Shut-off valve with hose  
connection DN15 with  
thread adapter DN20  
and non-return valve  
# 27452, -000, -450



- Ball joint prevents twisting in the shower hose



Matching **soap dishes** can be found in the Hansgrohe price list on pages 22.4 onwards.

Hansgrohe overhead showers

## The overhead shower range at a glance

Crometta® 85/Croma®

Raindance® E/Raindance® S

Performance ↑



**Crometta® 85 Multi**

More details on Crometta and Croma overhead showers can be found on page 33.



**Croma® 220 1jet**



**Croma® 160 1jet**



**Croma® 100 Multi**



**Raindance® E 420 Air 2jet**



**Raindance® E 360 Air 1jet**



**Raindance® E 240 Air 1jet**



**Raindance® Royale S 350 Air 1jet**



**Raindance® S 300 Air 1jet**



**Raindance® S 240 Air 1jet**



**Raindance® S 180 Air 1jet**

More details on Raindance E and Raindance S overhead showers can be found on page 32.

**How to use the overview in your sales presentation.**

The higher an overhead shower is positioned on the product line, the greater its functionality. The products are arranged in ranges extending to the right.

## Raindance® Select E/Raindance® Select S



**Raindance® Select E** 300 3jet



**Raindance® Select E** 300 2jet



**Raindance® Select S** 300 2jet



**Raindance® Select S** 240 2jet

More details on Raindance Select overhead showers can be found on pages 30 onwards.

## Raindance® Rainfall®/Raindance® Rainmaker®



**Raindance® Rainmaker®**  
Air 3jet



**Raindance® Rainmaker®**  
Air 3jet



**Raindance® Rainfall®**  
240 Air 3jet



**Raindance® Rainfall®**  
180 Air 2jet



**Raindance® Rainfall®** 150  
1jet



**Raindance® Rainfall®** 150 Stream  
1jet

More details on Raindance Rainmaker and Raindance Rainfall overhead showers can be found on pages 34 onwards.

Raindance® Select E 300 3jet overhead shower



# 1 button, three sprays, great fun

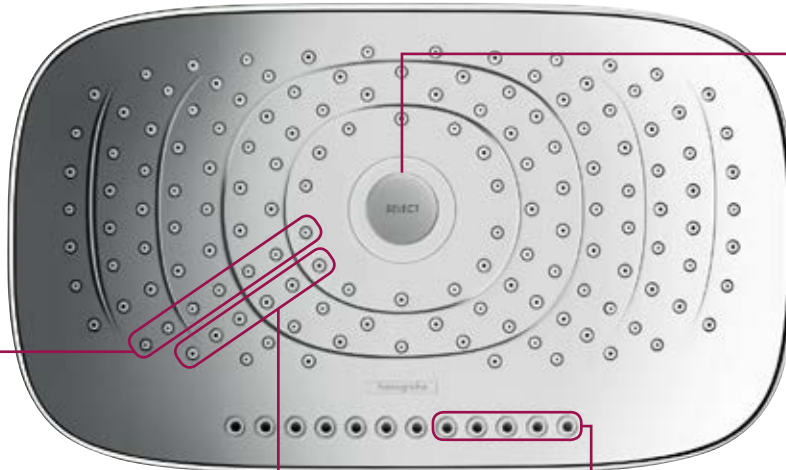

Easily accessible, the Select button need only be touched to change between RainAir and Rain



Small opening for Rain spray



Large opening for voluminous RainAir spray



Parallel jets for RainStream mode

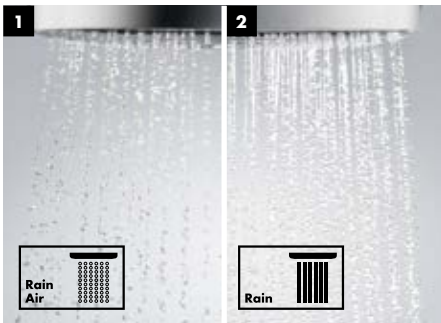

(1) **RainAir:** This gentle, relaxing spray consists of large, soft drops.  
 (2) **Rain:** A spray that is strong and revitalising and perfect for washing the hair.



**RainStream:** Twelve jets flowing in parallel, right down to the floor. For the same showering experience on all body sizes.

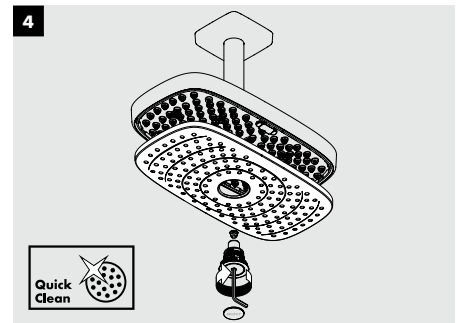

**Easy cleaning:** Jets can be cleaned effortlessly with the QuickClean function. Spray face can be taken off easily and is even dishwasher safe.



## Advantages and benefits

- 3 full spray types in the one overhead shower: gentle RainAir, powerful Rain and effective RainStream
- Simply switch between RainAir and Rain at the touch of a button
- Select button is easily accessible
- Easy cleaning: the spray face of metal and dishwasher safe

Find out more at [www.pro.hansgrohe-int.com/select](http://www.pro.hansgrohe-int.com/select)

## Raindance® Select



**Raindance® Select E 300 3jet**  
Overhead shower  
Rain/RainAir: 18 l/min  
RainStream: 22 l/min  
with shower arm 390 mm  
for iBox universal  
# 26468, -000, -400

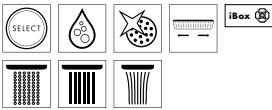

**Raindance® Select E 300 2jet**  
Overhead shower  
Rain/RainAir: 15 l/min  
with shower arm 390 mm # 27385, -000, -400  
with ceiling connection 100 mm # 27384, -000, -400 (not shown)

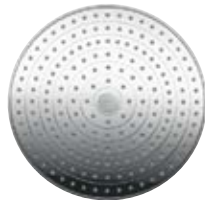
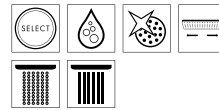

**Raindance® Select S 300 2jet**  
Overhead shower  
Rain/RainAir: 17 l/min  
with shower arm 390 mm # 27378, -000, -400  
with ceiling connection 100 mm # 27337, -000, -400 (not shown)



**Raindance® Select S 240 2jet**  
Overhead shower  
Rain/RainAir: 17 l/min  
with shower arm 390 mm # 26466, -000, -400  
EcoSmart (Rain/RainAir: 9 l/min) # 26470, -000, -400 (not shown)  
with ceiling connection 100 mm # 26467, -000, -400 (not shown)  
EcoSmart (Rain/RainAir: 9 l/min) # 26469, -000, -400 (not shown)

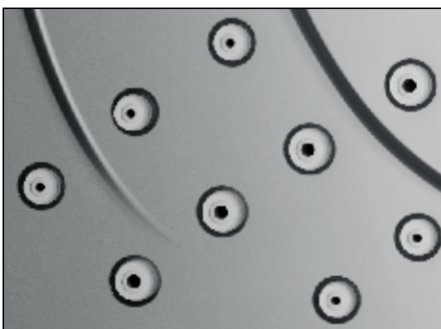
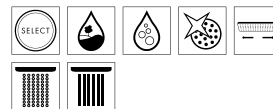

Surface chrome

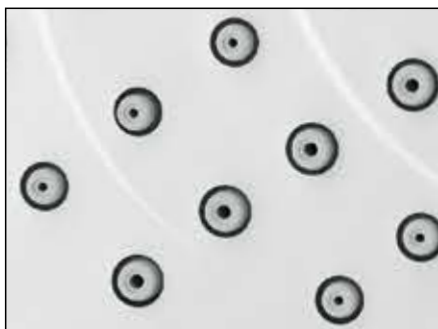

Surface white/chrome

## Raindance®



**Raindance® E 420 Air 2jet**  
Overhead shower  
RainAir: 22 l/min  
RainFlow: 23 l/min  
with shower arm 380 mm  
for iBox universal  
# 27373, -000



**Raindance® E 420 Air 1jet**  
Overhead shower  
(19 l/min)  
with shower arm 380 mm  
# 27372, -000



**Raindance® E 360 Air 1jet**  
Overhead shower  
(17 l/min)  
with shower arm 390 mm  
# 27376, -000  
with shower arm 240 mm  
# 27371, -000 (not shown)  
with ceiling connection 100 mm  
# 27381, -000 (not shown)



**Raindance® E 240 Air 1jet**  
Overhead shower  
(20 l/min)  
with shower arm 240 mm  
# 27370, -000  
with ceiling connection 100 mm  
# 27380, -000 (not shown)  
EcoSmart (9 l/min)  
with shower arm 223 mm  
# 27375, -000 (not shown)  
with ceiling connection 100 mm  
# 27383, -000 (not shown)

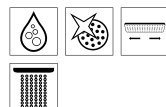
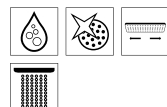
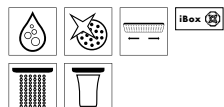

**Raindance® Royale S 350 Air 1jet**  
Overhead shower  
(35 l/min)  
# 28420, -000  
Shower arm 470 mm  
# 27410, -000 (not shown)  
Ceiling connection 100 mm  
# 27418, -000 (not shown)



**Raindance® S 300 Air 1jet**  
Overhead shower  
(18 l/min)  
with shower arm 390 mm  
# 27493, -000  
with shower arm 450 mm  
# 27492, -000 (not shown)  
with ceiling connection 100 mm  
# 27494, -000 (not shown)



**Raindance® S 240 Air 1jet**  
Overhead shower  
(18 l/min)  
with shower arm 390 mm  
# 27474, -000  
with ceiling connection 100 mm  
# 27477, -000 (not shown)  
EcoSmart (9 l/min)  
with shower arm 390 mm  
# 27461, -000 (not shown)  
with ceiling connection 100 mm  
# 27463, -000 (not shown)



**Raindance® S 180 Air 1jet**  
Overhead shower  
(19 l/min)  
with shower arm 240 mm  
# 27476, -000  
with shower arm 390 mm  
# 27468, -000 (not shown)  
with ceiling connection 100 mm  
# 27478, -000 (not shown)  
EcoSmart (9 l/min)  
with shower arm 240 mm  
# 27462, -000 (not shown)  
with ceiling connection 100 mm  
# 27464, -000 (not shown)

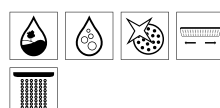
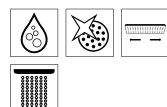
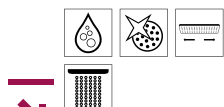

- Particularly large spray face of 350 mm Ø
- High flow rate for luxurious shower pleasure
- All-metal

## Raindance® Classic



**Raindance® Classic 240 Air** Overhead shower  
(19 l/min)  
with shower arm 390 mm # 27424, -000  
with ceiling connection 100 mm # 27405, -000 (not shown)

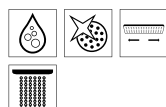

## PuraVida®



**PuraVida® 400** Overhead shower  
(21 l/min)  
with shower arm 390 mm # 27437, -000, -400  
with ceiling connection 100 mm # 27390, -000, -400 (not shown)

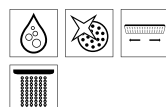



## Croma®



**Croma® 220 Air 1jet**  
Overhead shower  
(19 l/min)  
# 26464, -000  
EcoSmart (9 l/min)  
# 26465, -000 (not shown)  
Optional shower arm 390 mm  
# 27413, -000 (not shown)  
Optional ceiling connection 100 mm  
# 27479, -000 (not shown)

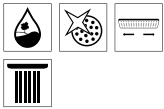

**Croma® 160 1jet**  
Overhead shower  
(17 l/min)  
# 27450, -000  
EcoSmart (9 l/min)  
# 28450, -000 (not shown)  
Optional shower arm 230 mm  
# 27412, -000 (not shown)  
Optional ceiling connection 100 mm  
# 27479, -000 (not shown)

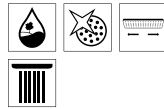

**Croma® 100 Multi**  
Overhead shower  
Rain: 20 l/min  
Mono: 15 l/min  
Massage: 14 l/min  
with ball joint DN15  
# 27443, -000  
EcoSmart (9 l/min)  
# 28460, -000 (not shown)  
Optional shower arm  
# 27411, -000 (not shown)

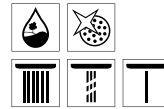

**Croma® 100 Vario**  
Overhead shower  
Rain: 22 l/min  
Shampoo: 17 l/min  
Normal: 20 l/min  
Massage: 11 l/min  
# 27441, -000  
Optional shower arm 128 mm  
# 27411, -000 (not shown)  
EcoSmart (9 l/min)  
# 28462, -000 (not shown)

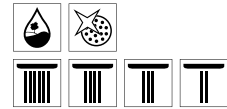

## Crometta® 85



**Crometta® 85 Multi**  
Overhead shower  
Mono: 13 l/min  
Normal: 15 l/min  
Massage: 13 l/min  
# 28425, -000  
Optional shower arm 128 mm  
# 27411, -000 (not shown)

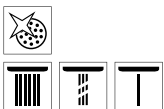

**Crometta® 85 Vario**  
Overhead shower  
Normal: 18 l/min  
# 28424, -000  
Optional shower arm 128 mm  
# 27411, -000 (not shown)

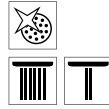

**Crometta® 85 Green**  
Overhead shower  
(6 l/min)  
# 28423, -000  
Optional shower arm 128 mm  
# 27411, -000 (not shown)

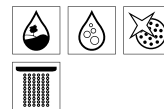

## Side showers



**PuraVida® 100**  
Side shower  
# 28430, -000, -400

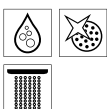

**Raindance® Air 100**  
Side shower  
# 28477, -000

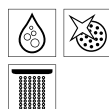

**Raindance® Classic 100**  
Side shower  
# 28445, -000

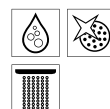

**Bodyvette®**  
Side shower  
# 28466, -000  
**Bodyvette® Stop**  
Side shower, manual shut-off  
# 28467, -000 (not shown)



Raindance® Rainmaker® and Raindance® Rainfall®

# The ultimate enjoyment for your customers

The Raindance Rainmaker and the Raindance Rainfall turn everyday showering into a new experience. The Raindance Rainmaker is installed flush in the ceiling. The classic shower therefore no longer exists,

instead there is a room filled with wonderful rain. The spray modes are RainAir, RainAir XL, Whirl and Mix. With its horizontal rain panel, Raindance Rainfall allows greater freedom of movement and offers up to three different

spray types for pampered showering: relaxing RainAir, revitalising RainFlow and massaging Whirl.

## Raindance® Rainmaker®: Showering in a new dimension

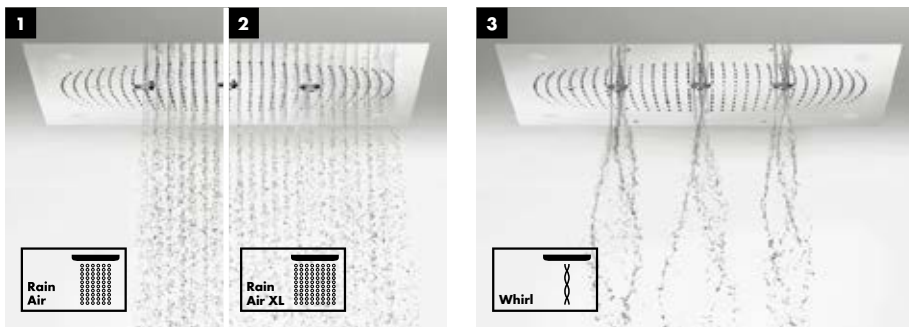

(1) **RainAir:** Central overhead shower function with AirPower technology.

(2) **RainAir XL:** Full, soft rain with AirPower technology.

**Whirl:** Three rotating massage sprays with AirPower technology.



### Advantages and benefits

- Installed flush in the ceiling
- Full shower rain
- Also with integrated lighting

## Raindance® Rainfall® 240 Air 3jet: Water with its original power



**RainAir:** The overhead shower featuring AirPower technology generates a rain of voluminous drops.

**RainFlow:** A full flood jet for a refreshing shower.

**Whirl:** When water starts to flow, the massage sprays swivel forwards, easily reaching the neck and shoulders.



### Advantages and benefits

- Architectural highlight in the shower
- Greater coverage allows wider freedom of movement
- Three spray modes: RainAir, RainFlow and Whirl
- Spray modes can be changed conveniently from below
- Flood jet provides a shower feeling like being under a waterfall
- Flush installation on Basic iBox universal

## Raindance® Rainmaker® and Raindance® Rainfall®



**Raindance® Rainmaker® Air 3jet**  
Overhead shower  
600 mm  
RainAir: 20 l/min  
RainAir XXL: 24 l/min  
Whirl: 22 l/min  
with light # 26117, -000  
without light # 26115, -000 (not shown)

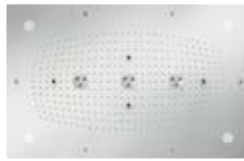
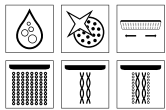

**Raindance® Rainmaker® Air 3jet**  
Overhead shower  
680 mm x 460 mm  
RainAir: 20 l/min  
RainAir XXL: 24 l/min  
Whirl: 22 l/min  
with light # 28418, -000  
without light # 28417, -000 (not shown)

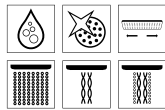

**Raindance® 260 Air 1jet**  
Overhead shower  
260 mm x 260 mm, flush ceiling installation possible  
(17 l/min) # 26472, -000  
EcoSmart (9 l/min) # 26481, -000

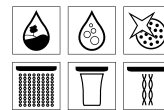

**Raindance® Rainfall® 240 Air 3jet**  
Overhead shower  
RainAir: 18 l/min  
Whirl: 16 l/min  
RainFlow: 28 l/min  
with light # 28410, -000, -400 (not shown)  
without light # 28411, -000, -400  
for iBox universal



**Raindance® Rainfall® 180 Air 2jet**  
Overhead shower  
RainAir: 16 l/min  
RainFlow: 24 l/min  
# 28433, -000, -400  
for iBox universal

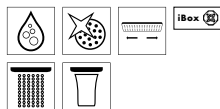

**Raindance® Rainfall® 150 1jet**  
Overhead shower  
(18 l/min) # 26442, -000



**Raindance® Rainfall® 150 Stream 1jet**  
Overhead shower  
(18 l/min) # 26443, -000



- Full flood jet
- For showering pleasure like being under a waterfall



- Parallel jets of sparkling water right down to the floor
- For showering pleasure like being under a waterfall



All specified flow rates are based on an operating pressure of 0.3 MPa (3 bar).

Hansgrohe Showerpipes

## The Showerpipe range at a glance

Croma®

Raindance® Select S

Performance ↑



**Croma® 160 1jet**



**Croma® 220 1jet**



**Raindance® Select S 240 1jet**



**Raindance® Select S 300 1jet**



**Raindance® Select S 240 2jet**



**Raindance® Select S 300 2jet**

More details on Croma can be found on pages 43 onwards.

More details on Raindance and Raindance Select S can be found on pages 40 onwards.

### How to use the overview in your sales presentation:

The higher a Showerpipe is positioned on the product line, the greater its functionality. The products are arranged in ranges extending to the right.

Raindance® Select E/Raindance® E



**Raindance® Select E 360**  
1jet



**Raindance® Select E 300**  
2jet



**Raindance® Select E 300**  
2jet



**Raindance® Select E 300**  
3jet



**Raindance® E 420**  
2jet

More details on Raindance E and Raindance Select E can be found on pages 38 onwards.

Raindance® Select E 300 3jet Showerpipe



# The complete system for all showering needs

**Select**  
Select the spray types

**RainStream:** Twelve jets of sparkling water that run parallel right down to the floor. For the same fascinating shower effects at every installation height and for every body size

**Select**  
Select the spray types

**Select**  
Select the hand shower

**Select**  
Select the overhead shower

**Select**  
Switch RainStream on and off on the overhead shower

Setting the temperature

**Raindance® Select E 300 3jet**  
Showerpipe



## Advantages and benefits

- Complete system with overhead shower, hand shower and thermostat
- Intuitive control concept, pleasure at the touch of a button
- Installation possible on existing connections, so ideal solution for uncomplicated bathroom refurbishments
- Six spray modes: three from the overhead shower, three from the hand shower
- Overhead shower including RainStream with twelve parallel jets

Find out more at [www.pro.hansgrohe-int.com/select](http://www.pro.hansgrohe-int.com/select)

## Raindance® Select E

### Shower



#### Raindance® Select E 300 3jet

Showerpipes

with Raindance Select E 300 3jet overhead shower  
 Rain/RainAir: 16 l/min, RainFlow: 19 l/min,  
 Raindance Select E 120 3jet hand shower (16 l/min)  
 and ShowerTablet Select 300 thermostat,  
 shower arm 380 mm  
 # 27127, -000, -400

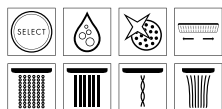

#### Raindance® Select E 300 2jet

Showerpipes

with Raindance Select E 300 2jet overhead shower  
 (16 l/min), Raindance Select E 120 3jet hand shower  
 (16 l/min) and ShowerTablet Select 300 thermostat,  
 shower arm 380 mm  
 # 27126, -000, -400

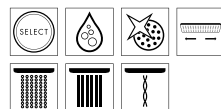

#### Raindance® Select E 300 2jet

Showerpipes

with Raindance Select E 300 2jet overhead shower  
 (17 l/min), Raindance Select E 120 3jet hand shower  
 (16 l/min) and Ecostat Select thermostat,  
 shower arm 380 mm  
 # 27128, -000, -400

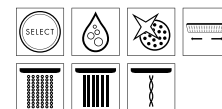

# Raindance® E/Raindance® Select E/Raindance® Select S

## Shower



**Raindance® E 420 2jet**  
 Showerpipe  
 with Raindance E 420 2jet overhead shower  
 RainAir: 18 l/min, RainFlow: 22 l/min,  
 baton hand shower 1jet (16 l/min)  
 and thermostat, shower arm 380 mm  
 # 27149, -000

**Raindance® Select E 360 1jet**  
 Showerpipe  
 with Raindance E 360 1jet overhead shower (17 l/min),  
 Raindance Select E 120 3jet hand shower (16 l/min)  
 and Ecostat Select thermostat, shower arm 380 mm  
 # 27112, -000, -400

**Raindance® Select S 300 2jet**  
 Showerpipe  
 with swivelling Raindance Select S 300 2jet overhead  
 shower (15 l/min), Raindance Select S 120 3jet hand  
 shower (16 l/min) and Ecostat Comfort thermostat,  
 shower arm 460 mm  
 # 27133, -000, -400  
 Height of the Showerpipe can be reduced

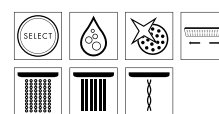
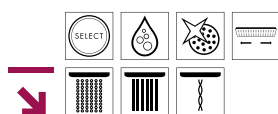
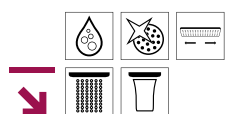

- With concentrated flood jet

- Rectangular shower with shoulder width rain for full body coverage





**Raindance® Select S 240 2jet**

Showerpipes  
with swivelling Raindance Select S 240 2jet overhead  
shower (15 l/min), Raindance Select S 120 3jet hand  
shower (16 l/min) and Ecostat Comfort thermostat,  
shower arm 460 mm  
# 27129, -000, -400  
Height of the Showerpipe can be reduced

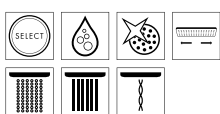

**Raindance® Select S 300 1jet**

Showerpipes  
with swivelling Raindance S 300 1jet overhead  
shower (17 l/min), Raindance Select S 120 3jet hand  
shower (16 l/min) and Ecostat Comfort thermostat,  
shower arm 460 mm  
# 27114, -000  
Height of the Showerpipe can be reduced

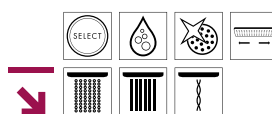

- Overhead shower can be swivelled away for soaping or washing hair
- Off-centre installation possible



**Raindance® Select S 240 1jet**

Showerpipes  
with swivelling Raindance S 240 1jet overhead  
shower (17 l/min), Raindance Select S 120 3jet hand  
shower (16 l/min) and Ecostat Comfort thermostat,  
shower arm 460 mm  
# 27115, -000  
Height of the Showerpipe can be reduced

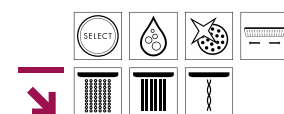

- Overhead shower can be swivelled away for soaping or washing hair
- Off-centre installation possible

All specified flow rates are based on an operating pressure of 0.3 MPa (3 bar).

# Raindance®

## Shower/universal



**Raindance® 240 Air 1jet**  
 Showerpipe  
 with swivelling overhead shower Raindance  
 S 240 Air 1jet (17 l/min), Raindance S 100 Air 3jet  
 hand shower (13 l/min) and concealed thermostat,  
 shower arm 460 mm  
 # 27145, -000  
 Height of the Showerpipe can be reduced



**Raindance® Connect S 240 Air 1jet**  
 Showerpipe  
 with Raindance S 240 Air 1jet overhead shower  
 (14 l/min), baton hand shower 2jet (17 l/min),  
 shower arm 460 mm # 27164, -000  
 Shower arm 350 mm # 27421, -000 (not shown)  
 Corner installation set # 27158, -000 (not shown)  
 Height of the Showerpipe can be reduced

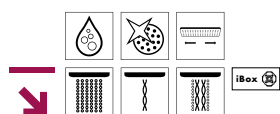

- Optimal for upgrading bathrooms with existing iBox universal installation
- Swivelling overhead shower

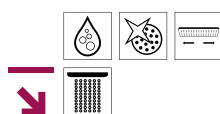

- Easy retrofit where hand shower already installed
- Perfect for renovations

All specified flow rates are based on an operating pressure of 0.3 MPa (3 bar).

**Croma® 220**

**Shower**



**Croma® 220 Air 1jet**  
Showerpipe  
with swivelling Croma 220 Air 1jet overhead shower (19 l/min), Croma 100 Vario hand shower (15 l/min) and Ecostat Comfort thermostat, shower arm 400 mm  
# 27185, -000  
EcoSmart # 27188, -000 (not shown)  
Height of the Showerpipe can be reduced



**Croma® 220 Air 1jet**  
Showerpipe  
with swivelling Croma 220 Air 1jet overhead shower (19 l/min), Croma 100 Vario hand shower (15 l/min) and single lever mixer, shower arm 400 mm  
# 27222, -000  
Height of the Showerpipe can be reduced



**Croma® 220 Air 1jet**  
Reno Showerpipe  
with swivelling Croma 220 Air 1jet overhead shower (16 l/min), Croma 100 Vario hand shower (15 l/min), without mixer, shower arm 400 mm  
# 27224, -000  
Corner installation set # 27158, -000 (not shown)  
Height of the Showerpipe can be reduced



- Overhead shower can be swivelled away for soaping or washing hair
- Off-centre installation possible



- Easy retrofit on existing mixers
- Swivelling overhead shower

**Croma® 160**



**Croma® 160 1jet**  
 Showerpipe  
 with Croma 160 1jet overhead shower (17 l/min),  
 Croma 100 Vario hand shower (15 l/min),  
 and Ecostat Comfort thermostat, shower arm 270 mm  
 # 27135, -000  
 Height of the Showerpipe can be reduced



**Croma® 160 1jet**  
 Showerpipe  
 with Croma 160 1jet overhead shower (17 l/min),  
 Croma 100 Vario hand shower (15 l/min),  
 and single lever mixer, shower arm 270 mm  
 # 27154, -000  
 Height of the Showerpipe can be reduced

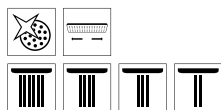
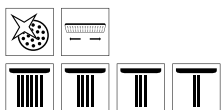

## Raindance® Select E/Raindance® Select S/Croma®

### Bath



**Raindance® Select E** 360 1jet  
Showerpipe for bathtub  
with Raindance E 360 1jet overhead shower  
(17 l/min), Raindance Select E 120 3jet hand shower  
(16 l/min) and Ecostat Select bath thermostat  
(20 l/min), shower arm 380 mm  
# 27113, -000, -400



**Raindance® Select S** 240 1jet  
Showerpipe for bathtub  
with swivelling Raindance S 240 1jet overhead  
shower (17 l/min), Raindance Select S 120 3jet hand  
shower (16 l/min) and Ecostat Comfort bath thermostat  
(20 l/min), shower arm 460 mm  
# 27117, -000  
Height of the Showerpipe can be reduced



**Croma®** 220 Air 1jet  
Showerpipe for bathtub  
with swivelling Croma 220 Air 1jet overhead shower  
(17 l/min), Croma 100 Vario hand shower  
(15 l/min), Ecostat Comfort bath thermostat  
(20 l/min), shower arm 400 mm  
# 27223, -000  
Height of the Showerpipe can be reduced

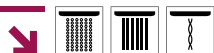

- Full showering in the bath
- Also ideal for renovations

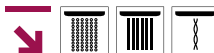

- Optimal installation also on side or offset connections
- Swivelling overhead shower



- Overhead shower can be swivelled away for soaping or washing hair
- Off-centre installation possible

Hansgrohe Showerpanel®

# Made to convince customers on all fronts

Overhead, hand and side showers, various spray types and refreshing all-body massages from the side showers: A Hansgrohe Showerpanel provides water fun all the way.

The fun finds its perfect complement in the uncomplicated installation: Simple retrofit on the existing connections - wall installations are not necessary. The bathroom will

therefore be equipped for shower pleasure in just seconds.



**Raindance® Lift Showerpanel®**  
with Raindance Rainfall 180 Air 2jet overhead shower (RainAir: 14 l/min, RainFlow: 17 l/min), PuraVida 120 1jet baton hand shower (16 l/min) and thermostat, height adjustable, 200 mm  
# 27008, -000, -400

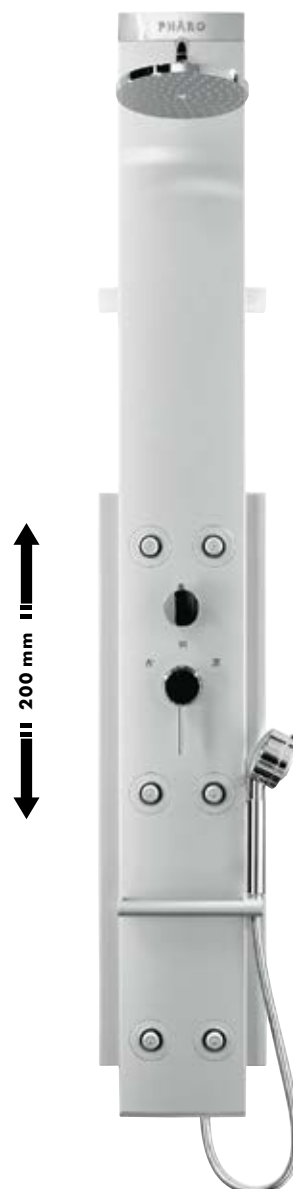

**Lift 2 Showerpanel®**  
with Raindance S 180 Air 1jet overhead shower (22 l/min), Axor Uno 3jet hand shower, 6 side showers and thermostat, height adjustable, 200 mm  
# 26871, -000

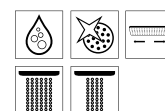

## Advantages and benefits

- Combines overhead, hand, and/or side showers in a single system
- Water fun from all sides
- Up to six side showers
- Various spray types for individual showering enjoyment



**Raindance® S Showerpanel®**  
with Raindance S 150 Air 3jet hand  
shower (17 l/min), 6 side showers  
and exposed thermostat  
# 27005, -000

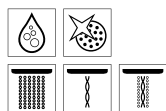

All specified flow rates are based on an operating pressure of 0.3 MPa (3 bar).

- Uncomplicated installation with no need to integrate in the wall
- Easy to retrofit on existing connections
- Some versions are height adjustable to suit all body sizes

Hansgrohe exposed thermostats

## The exposed thermostats at a glance

Ecostat®

Performance ↑



**Ecostat® 1001 SL**  
Bath



**Ecostat® Comfort**  
Bath



**Ecostat® Comfort**  
Shower



**Ecostat® 1001 SL**  
Shower

More details on Ecostat thermostats can be found on pages 54 onwards.

### How to use the overview in your sales presentation

The higher a thermostat is positioned on the product line, the greater its functionality. The products are arranged in ranges extending to the right.



## Ecostat® Select



**Ecostat® Select**  
Bath



**Ecostat® Select**  
Shower

More details on Ecostat Select can be found on pages 52 onwards.

## ShowerTablet® Select



**ShowerTablet® Select 300**  
Bath



**ShowerTablet® Select 300**  
Shower

More details on ShowerTablet Select can be found on pages 50 onwards.

ShowerTablet® Select 300



# The thermostat that redefines easy use

Thanks to the intuitive Select technology everything on the ShowerTablet Select 300 almost happens by itself: Whether you are switching the hand shower on or off in the shower, using the shower or bath filler in the

bathtub, or doing all of these: A simple touch of the button is all it takes to select the function. The Select elements are all easy to operate from the front. Large prints and contrasting colours make it even easier. The control

button is raised when the unit is switched on. This means that it is instantly obvious which function is active. The large, high quality glass shelf is resistant to commercially available bathroom cleaners so will last a lifetime.

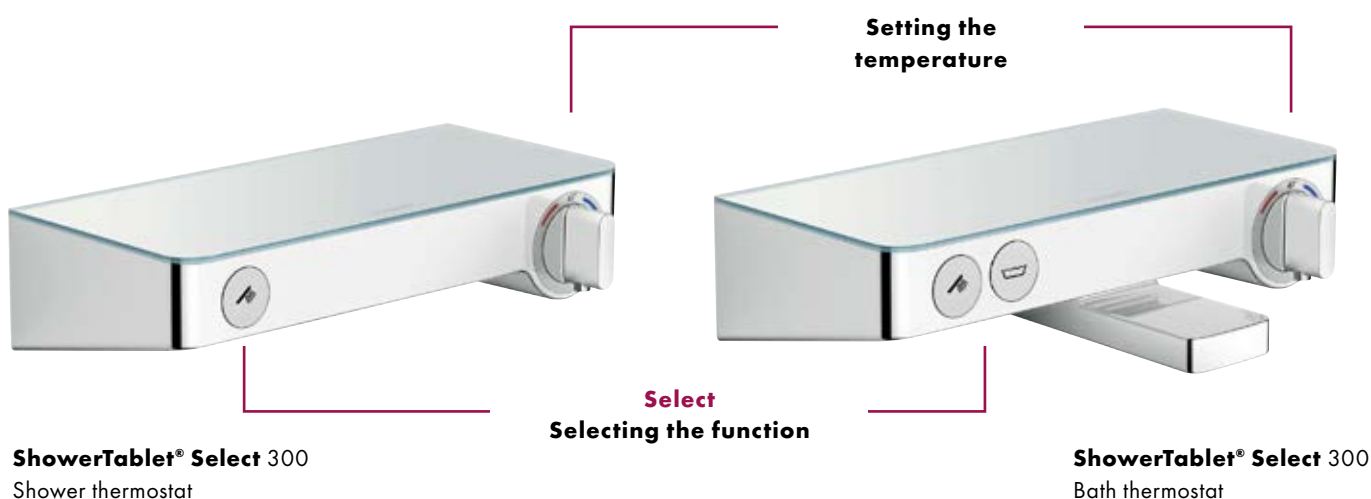

## Advantages and benefits

- Simply touch the button to select the function
- The active function can be recognised immediately by the raised control button
- All Select elements can be reached easily from the front
- More than one function can be selected at the same time



**Intuitive:** Thanks to the Select button and temperature control, control is intuitive and easy from the front.



**User-friendly:** The desired temperature can be set precisely with the handy turn control.



**Easy to use:** When switched on, the control button is raised – so the active function can be identified at a glance.



**Clear:** Easy to understand, abrasion-resistant symbols make control easier.



**Safe:** The insulated body with rounded corners protects against heat and knocks.



**Attractive:** The unique design makes the ShowerTablet Select 300 an eye-catcher in the bathroom.



**Practical:** The level surface is made of glass and offers plenty of space for shower toiletries.



**Clean:** The housing is sealed to keep dirt out and the smooth surface is easy to clean.

- Easy to understand, wear resistant symbols for ease of operation
- Level safety glass shelf provides space for toiletries and is easy to clean
- Optimal for bathroom refurbishments
- Just mechanical engineering, no complicated or unreliable electronics
- Insulated body remains cool to the touch preventing the risk of injury

Ecostat® Select



# Design and lots of fun

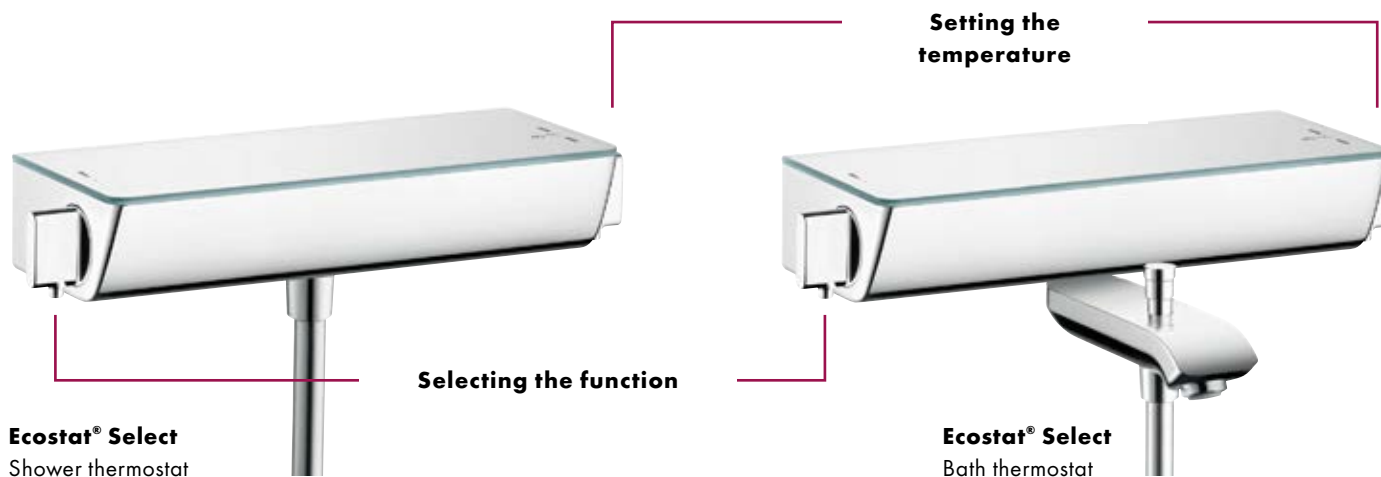

**Safe:** The temperature lock prevents hot water from scalding. In addition, the elegant body is highly insulated. Rounded edges minimise the risk of painful knocks.



**Practical:** The level surface is made of safety glass and offers space for shower toiletries.



**Economical:** With integrated EcoSmart technology, the flow rate is limited to 10 l/min, for an efficient and refreshing shower.



**User-friendly:** Constant water quantities and temperatures on the highest level of intuitive operability.



## Advantages and benefits

- Visual highlight
- Insulated body remains cool to the touch preventing the risk of injury
- Safe and easy to use for all age groups
- Shelf to store your favourite toiletries
- Water savings made easy
- Easy to clean

## Bath



**ShowerTablet® Select 300**  
Thermostatic bath/shower mixer  
# 13151, -000, -400



**EcoStat® Select**  
Thermostatic bath/shower mixer  
# 13141, -000, -400



## Shower



**ShowerTablet® Select 300**  
Thermostatic shower mixer  
# 13171, -000, -400



**EcoStat® Select**  
Thermostatic shower mixer  
# 13161, -000, -400



Thermal disinfection possible  
# 13162, -000 (not shown)

## Shower combinations

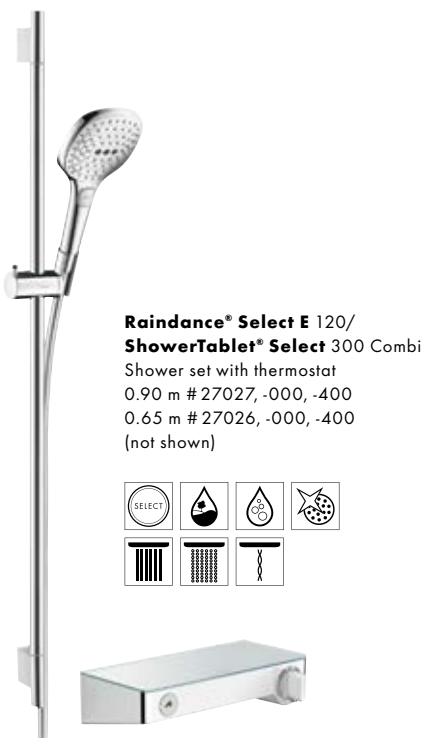

**Raindance® Select E 120/  
ShowerTablet® Select 300 Combi**  
Shower set with thermostat  
0.90 m # 27027, -000, -400  
0.65 m # 27026, -000, -400  
(not shown)

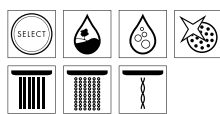

**Raindance® Select S 150/  
EcoStat® Select S Combi**  
Shower set with thermostat  
0.90 m # 27037, -000, -400  
0.65 m # 27036, -000, -400  
(not shown)

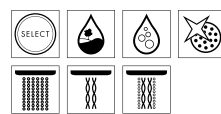

**Raindance® Select E 120/  
EcoStat® Select Combi**  
Shower set with thermostat  
0.90 m # 27039, -000, -400  
0.65 m # 27038, -000, -400  
(not shown)

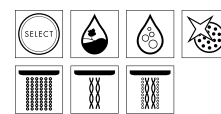

Ecostat® thermostats

# All under control: Thermostatic technology for greater shower pleasure

Hansgrohe offers a large number of exposed thermostats. These not only upgrade the look and mixers of bathrooms, they also enhance the comfort of showering. They provide the convenient regulation of flow rate, water pressure and water temperature. Yet the distinct advantage of an exposed thermostat is: This mixer can be installed quickly and easily on existing connections.

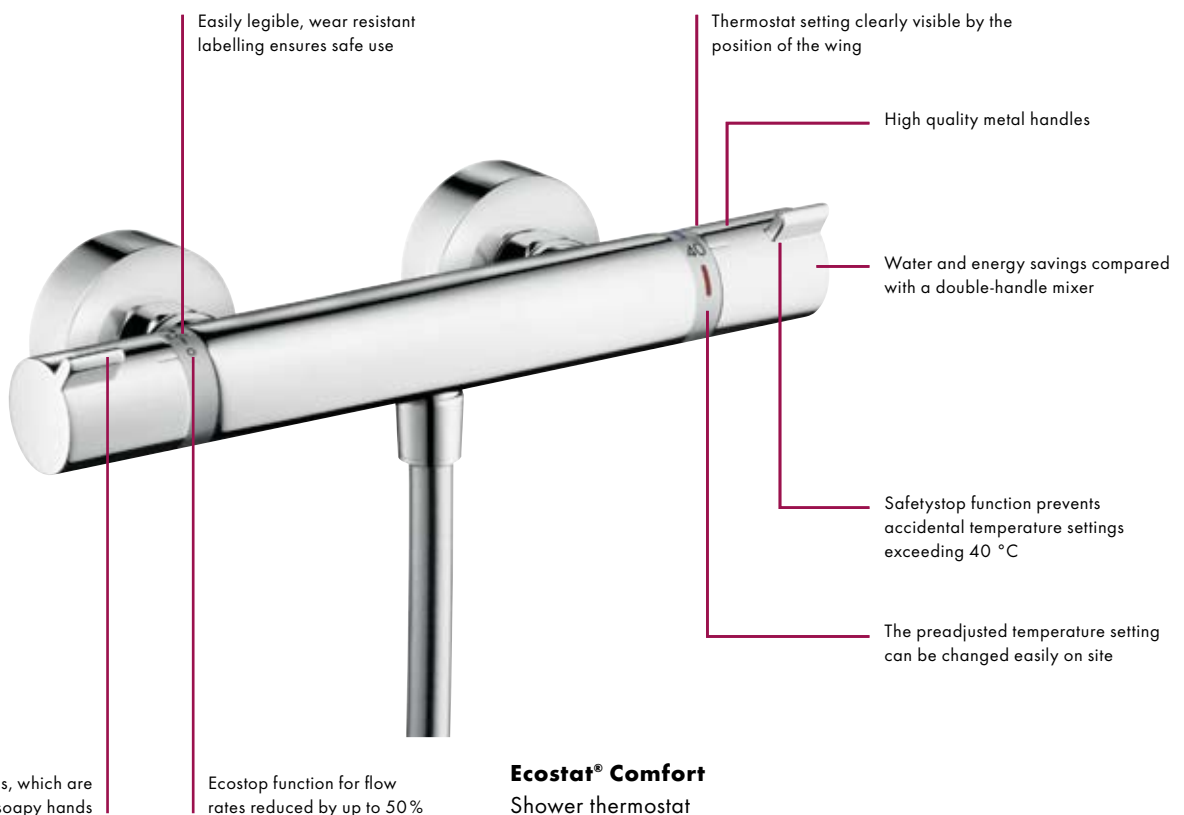

## Advantages and benefits

- Visual and technical upgrade of the bathroom
- Convenient preset temperature
- Water and energy savings compared with single lever mixers
- Temperatures kept constant, so no scalding even when pressure/temperature fluctuates in the water line

## Bath



**EcoStat® Comfort**  
Thermostatic bath/shower mixer  
# 13114, -000



**EcoStat® 1001 SL**  
Thermostatic bath/shower mixer  
# 13241, -000



**EcoStat® Comfort Care**  
Thermostatic bath/shower mixer  
# 13115, -000



## Shower



**EcoStat® Comfort**  
Thermostatic shower mixer  
# 13116, -000



**EcoStat® 1001 SL**  
Thermostatic shower mixer  
# 13261, -000



**EcoStat® Comfort Care**  
Thermostatic shower mixer  
# 13117, -000

## Shower combinations



**Croma® 100 Vario/  
EcoStat® Comfort Combi**  
Shower set with thermostat  
0.90 m # 27035, -000  
0.65 m # 27034, -000 (not shown)  
EcoSmart (9 l/min)  
0.90 m # 27033, -000 (not shown)  
0.65 m # 27032, -000 (not shown)

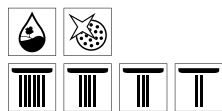

**Croma® 100 Multi/  
EcoStat® 1001 SL Combi**  
Shower set with thermostat  
0.90 m # 27085, -000  
0.65 m # 27086, -000 (not shown)

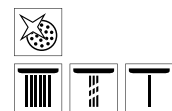

Special advantages of **Care mixers** and other Care products can be found on pages 110 onwards.

iBox® universal

# The universal basis for all concealed installation solutions

With the iBox universal, the mixer technology is concealed in the wall. This not only looks good, but also creates more space and thus greater shower pleasure.

Another advantage is the flexibility of the system and design. The iBox universal may be installed before the decision has been made for a shower system. As the basic set

for any Hansgrohe standard and thermostatic solutions, it is easy to change or upgrade at any time.



**Concealed installation:** The basic set disappears completely into the wall. Mixers and shower finish sets from various ranges can be fitted to it.



**Exposed installation:** The complete functional unit is mounted on the wall. The disadvantage is that it takes up more space, which restricts the freedom of movement.

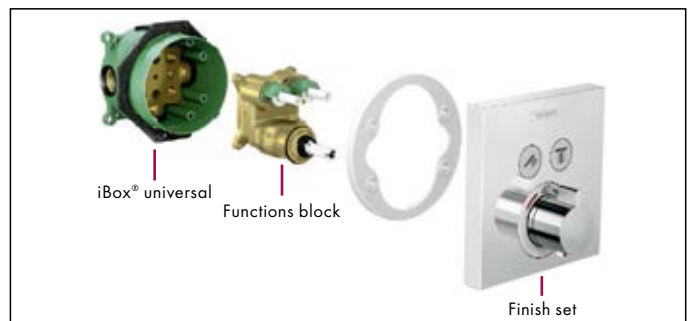

**Over the long term:** The basic set is retained when the bathroom is refurbished. The functions block and finish set can then be easily replaced.





**iBox universal: one for all**

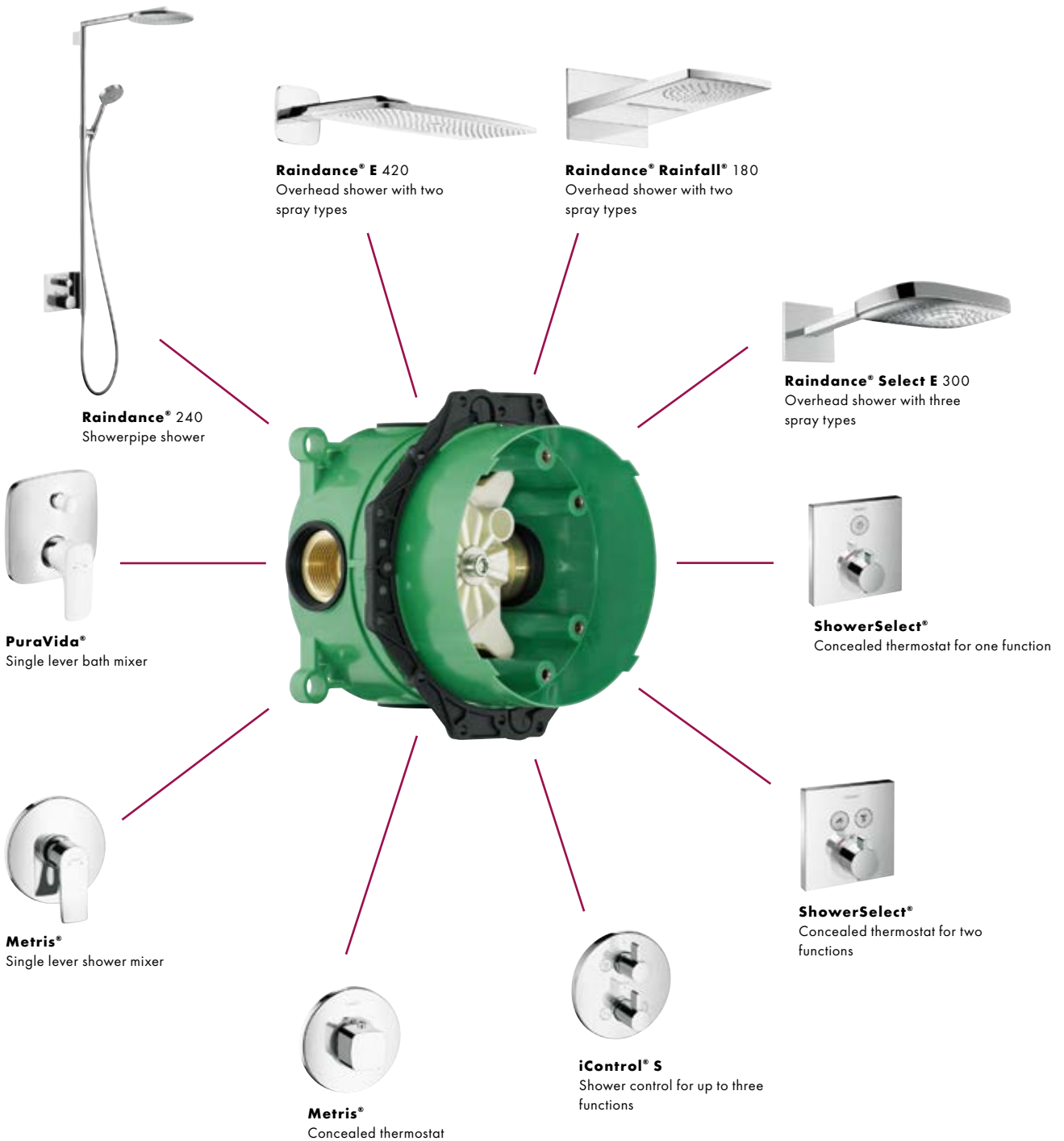

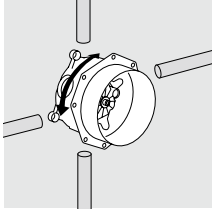
**iBox® universal: the all-rounder with many strengths****Rotation-symmetrical installation**

- Symmetrical construction; all the connections are the same
- It is important that cold water is connected on the right and hot water opposite
- The lower outlet has priority for bath mixers
- Either the upper or lower outlet can be connected for shower mixers

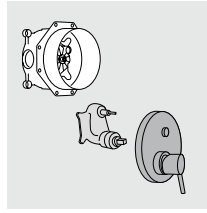
**Safe and economical**

- Basic set includes only the connection block. The valuable functions block is supplied later and mounted with the finish set
- Prevents problems like theft, dirt and frost damage occurring during the building phase and expensive warehousing becomes unnecessary

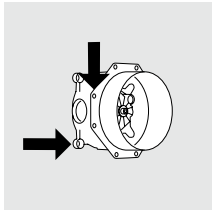
**Many installation types**

- Coordinated with to all the standard installation systems, connection types and mixers
- Patented flexible adjustment ring
- Attachment options on 2 levels and G<sup>3/4</sup> connections for universal installation possibilities
- Also suitable for stronger wall constructions and dry wall installations as well as for pre-fabricated houses

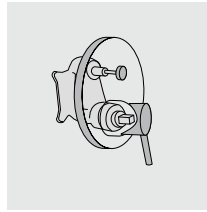
**Integrated safety combination**

- Used in conjunction with Exafill baths with an outflow and overflow mixer, it eliminates the need for an external pipe breaker on concealed installation single lever bath mixers: lower installation costs and fewer functional parts in the wall

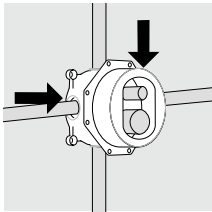
**Perfect moisture protection**

- Sealing sleeves on all 4 connections, sealing sleeve under the tiles and the carrier escutcheon that seals against splashes perfectly protect the masonry against moisture on all sides

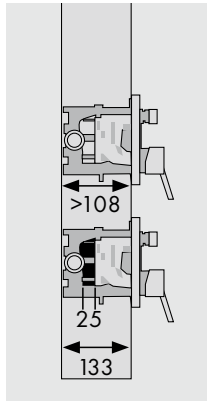
**Solutions for wall that are very deep or very shallow**

- If the iBox universal is too deep in the wall, the basic set extension is inserted between the connection and functions block
- The extension set provides safety right up to the wall and perfectly protects the masonry against moisture
- The standard body of the iBox universal has become flatter and is therefore even more suitable for walls with shallow installation depths

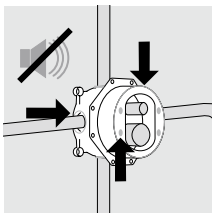
**Low noise levels**

- Brass bodies on seals ensure that the noise of water-bearing parts is transferred to the masonry
- The carrier escutcheon is screwed to the housing of the iBox universal and not to the functions block, which means that the noise cannot be transmitted to the tiles

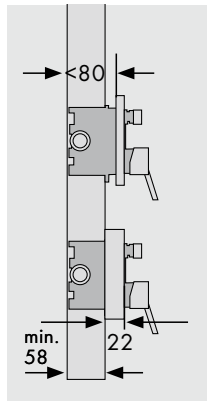
**Collar extension**

- Thanks to the extension, even shallow installation depths are no longer a problem
- The extension collar means that the iBox can be installed even in narrow walls

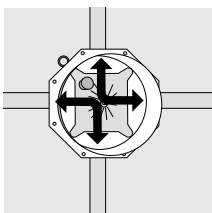
**Easy rinsing**

- Flush block included and can be mounted in various different positions. This means that pipes can be flushed through to the end just in front of the wall, as per DIN 1988/EN 1717 part 2

## iBox® universal: convincing on all fronts

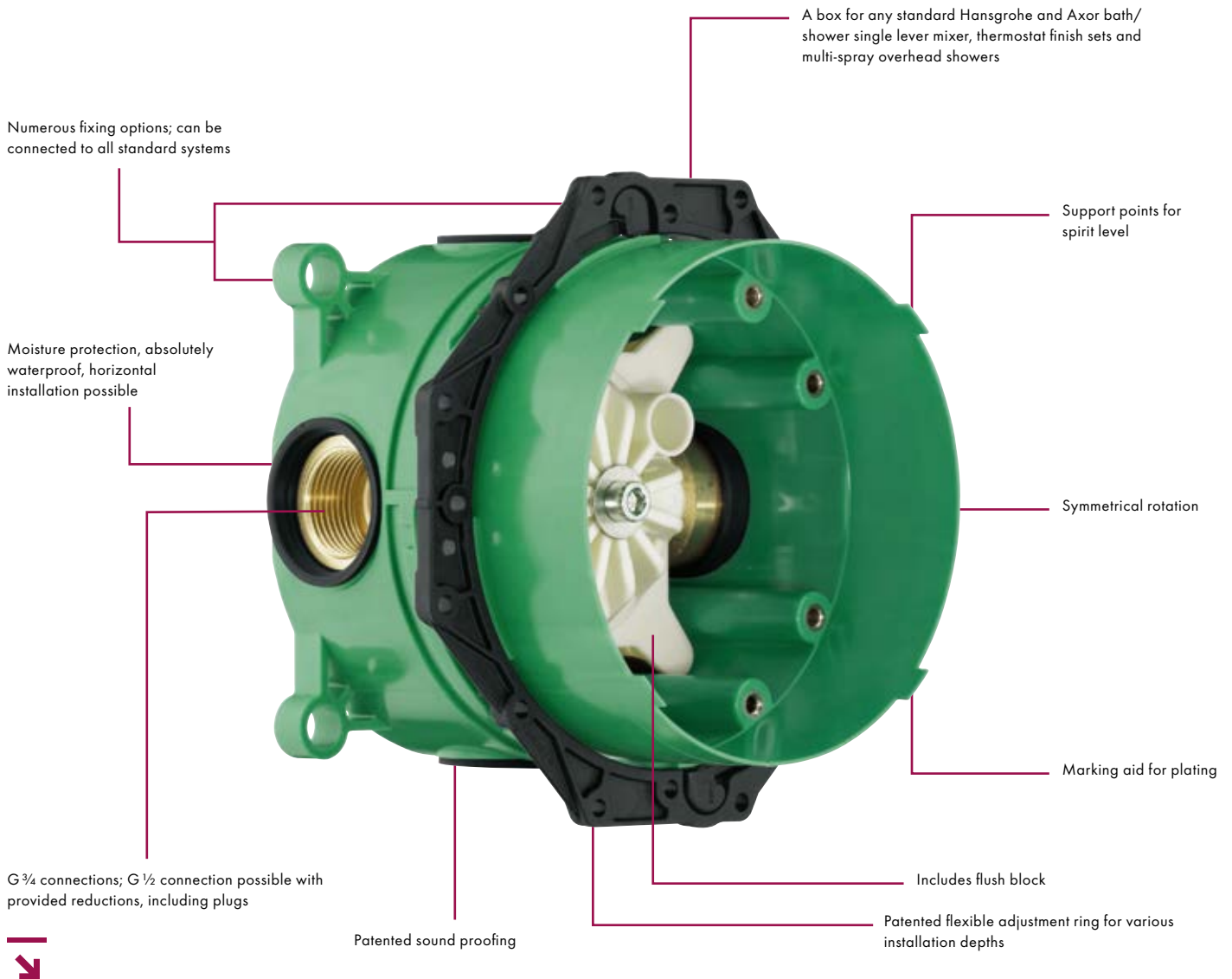

### Advantages and benefits

- One basic set for 16 function solutions
- Suitable for over 200 Hansgrohe and Axor finish sets
- Pre-installation enhances decision making flexibility for mixers
- An attractive bathroom, as bulky technology is out of sight behind the wall
- Greater freedom of movement when showering
- Easy to replace with new mixers or finish set designs when renovating
- Concealed installation solutions tried and tested millions of times

### Advantages and benefits specifically for project activities

- The iBox universal offers a high level of flexibility and lots of design options
- One basic set for all solutions, simplifying project planning
- The iBox is suitable for use in private or public facilities and complies with all the main international standards
- Covers any solution with up to 4 functions

Hansgrohe concealed finish sets

# The function solutions at a glance



## 1 function

Tilting and turning



**Metris®**  
Single lever  
shower mixer

Turn



**Metris®**  
Thermostat for  
1 function

Push



**ShowerSelect®**  
Thermostat for  
1 function



## 2 functions

Tilting and turning



**Metris®**  
Single lever  
bath mixer

Turn



**Metris®**  
Thermostat for  
2 functions

Push



**ShowerSelect®**  
Thermostat for  
2 functions



**Talis®**  
Single lever  
shower mixer



**Ecostat® S**  
Thermostat for  
1 function



**Talis®**  
Single lever  
bath mixer



**Ecostat® S**  
Thermostat for  
2 functions



**Focus®**  
Single lever  
shower mixer



**Focus®**  
Single lever  
bath mixer

**How to use the overview in your sales presentation**

The shower luxury and functionality increases as you move from left to right in this diagram.

**One for all**

The iBox universal is the flexible concealed system for Hansgrohe standard and thermostatic solutions.



**3 functions**

Turn

Turn

Push



**Trio®/Quattro®**  
Shut-off/diverter  
valve

**Metris® iControl®**  
Valve for 3 functions

**ShowerSelect®**  
Valve for 3 functions

+

+

+



**Metris®**  
Highflow  
Thermostat

**Metris®**  
Highflow  
Thermostat

**ShowerSelect®**  
Highflow  
Thermostat

+



**Metris®**  
Shut-off valve



**4 functions**

Turn

Turn

Push



**Trio®/Quattro®**  
Shut-off/diverter valve

**Metris® iControl®**  
Valve for 3 functions

**ShowerSelect®**  
Valve for 3 functions

+



**Metris®**  
Shut-off valve

+

+

+



**Metris®**  
Highflow  
Thermostat

**Metris®**  
Highflow  
Thermostat

**ShowerSelect®**  
Highflow  
Thermostat for one  
function (bottom)  
and one additional  
function (valve)

+

+



**Metris®**  
Shut-off valve



**Metris®**  
Shut-off valve

iBox® universal



# ShowerSelect: Design where everything fits

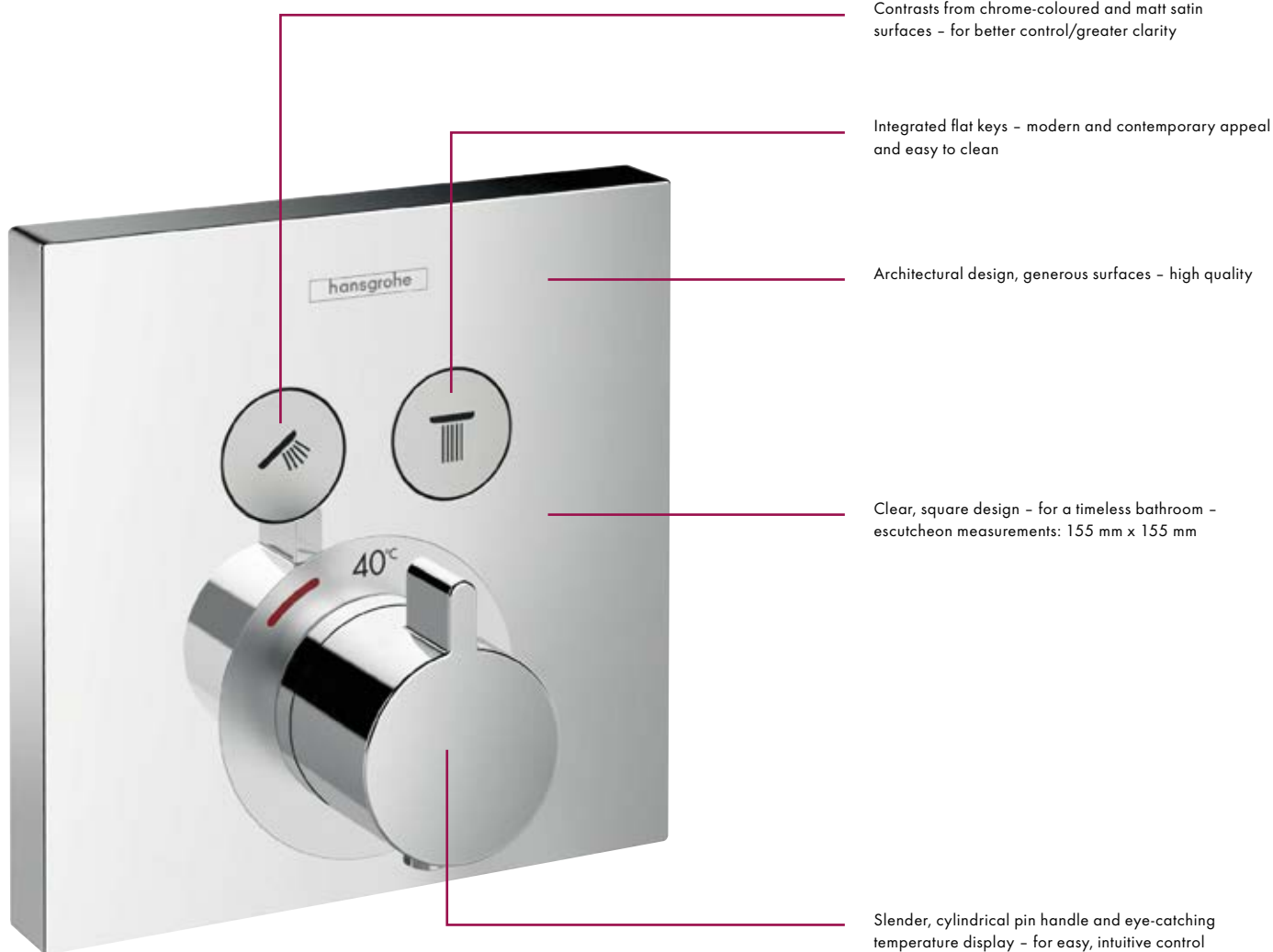

Contrasts from chrome-coloured and matt satin surfaces – for better control/greater clarity

Integrated flat keys – modern and contemporary appeal and easy to clean

Architectural design, generous surfaces – high quality

Clear, square design – for a timeless bathroom – escutcheon measurements: 155 mm x 155 mm

Slender, cylindrical pin handle and eye-catching temperature display – for easy, intuitive control



## Advantages and benefits



- Intuitive, easy control at the touch of a button
- Large symbols – for easy handling and clarity
- Easy to clean thanks to flush-fit buttons
- Safe, visible temperature adjustment thanks to the slender, cylindrical pin handle and eye-catching coloured temperature display
- Geometric-square design, making it suitable for any bathroom



**Intuitive:**

Easy-to-use Select buttons for intuitive, comfortable control – even for those with restricted mobility.



**Clear:**

Easy to understand, abrasion-resistant symbols make control easier.



**Easy to use:**

The protruding button instantly reveals the active function. Can be controlled using an elbow or fist thanks to the button extension that is included in the box.



**User-friendly:**

The desired temperature can be set precisely with the user-friendly handle.



**Clean:**

The flush-fit buttons leave a flat surface that is easy to clean.



**Attractive:**

The rectangular shape blends perfectly with a tiled bathroom and will also go in many modern bathroom designs.



**Economical:**

The easy-to-push button encourages the user to switch the water off frequently, which helps to save water.



**User-friendly:**

The functions can all be used at the same time – for even greater shower pleasure.

- Fast, inexpensive renovations possible by simply replacing the existing finish sets
- High level of comfort by simultaneously setting several functions
- Functions can be switched off quickly and easily for water savings



**DESIGN PLUS**  
powered by: **ISH**

The ShowerSelect finish set for 2 functions received not only the "Design Plus Award" and the "iF Award 2014", but also the award of the ZVSHK, the German Central Association Plumbing, Heating and Air Conditioning, for excellent barrier-free design.

## Thermostats



**ShowerSelect®**  
Thermostat for 1 function  
# 15762, -000  
Escutcheon size 155 mm x 155 mm



**ShowerSelect®**  
Thermostat for 2 functions  
# 15763, -000  
Escutcheon size 155 mm x 155 mm



**ShowerSelect®**  
Thermostat for 2 functions, incl. water connection  
and shower holder (not including hand shower  
and shower hose, which can be chosen freely)  
# 15765, -000  
Escutcheon size 155 mm x 188 mm



**ShowerSelect®**  
Highflow thermostat  
# 15760, -000



**ShowerSelect®**  
Highflow thermostat for one function  
and one additional function  
# 15761, -000  
Escutcheon size 155 mm x 155 mm



**ShowerSelect®**  
Valve for 3 functions  
# 15764, -000  
Escutcheon size 155 mm x 155 mm







**PuraVida®**  
Shower thermostat for 1 function  
# 15775, -000, -400  
Escutcheon size 155 mm x 155 mm



**PuraVida®**  
Shower thermostat for 2 functions  
# 15771, -000, -400  
Escutcheon size 155 mm x 155 mm



**PuraVida®**  
Shower thermostat  
# 15770, -000, -400  
Highflow thermostat  
# 15772, -000, -400  
Escutcheon size 155 mm x 155 mm



**PuraVida® iControl®**  
Valve for 3 functions  
# 15777, -000, -400  
Escutcheon size 155 mm x 155 mm



**Metris®**  
Shower thermostat for 1 function  
# 31572, -000  
Escutcheon diameter 150 mm



**Metris®**  
Shower thermostat for 2 functions  
# 31573, -000  
Escutcheon diameter 150 mm



**Metris®**  
Shower thermostat  
# 31570, -000  
Highflow thermostat  
# 31571, -000 (not shown)  
Escutcheon diameter 150 mm



**Metris® iControl®**  
Valve for 3 functions  
# 31958, -000  
Escutcheon diameter 150 mm



**Ecostat® S**  
Shower thermostat for 1 function  
# 15701, -000  
Escutcheon diameter 170 mm



**Ecostat® S**  
Shower thermostat for 2 functions  
# 15721, -000  
Escutcheon diameter 170 mm



**Ecostat® S**  
Shower thermostat  
# 15711, -000  
Highflow thermostat  
# 15715, -000 (not shown)  
Escutcheon diameter 170 mm



**iControl® S**  
Valve for 3 functions  
# 15955, -000  
Escutcheon diameter 170 mm



**Ecostat® Classic**  
Concealed shower thermostat  
with integrated shut-off/diverter valve  
# 15753, -000  
Escutcheon diameter 170 mm

**iBox® universal**  
Basic set iBox universal  
# 01800180  
**Extension set 25 mm for too deep installation:**  
# 13595000  
**Extension set 22 mm for too deep installation depths:**  
# 13596000 for escutcheons of diameter 170 mm  
# 13597000 for escutcheons of diameter 150 mm  
# 97407000 for escutcheons of diameter 172 mm  
# 15597000 for PuraVida  
# 13593000 for ShowerSelect  
Installation depth 80 to 108 mm.



## Valves



**Trio®/Quattro®**  
Shut-off/diverter valve  
for PuraVida  
# 15937, -000, -400



**Shut-off valve**  
for PuraVida  
# 15978, -000, -400



**Trio®/Quattro®**  
Shut-off/diverter valve  
for Metris  
# 31634, -000



**Shut-off valve**  
for Metris  
# 31677, -000



**Trio®/Quattro®**  
Shut-off/diverter valve  
Finish set S  
# 15932, -000



**Shut-off valve**  
Finish set S  
# 15972, -000

Shower control RainBrain®

# The most intelligent way to enjoy comfort

The RainBrain is an electronic control | the shower. Whether changing spray types, | music, the RainBrain controls all eventualities that features a touchscreen for regulating | setting temperatures, selecting the shower | with the greatest of ease.

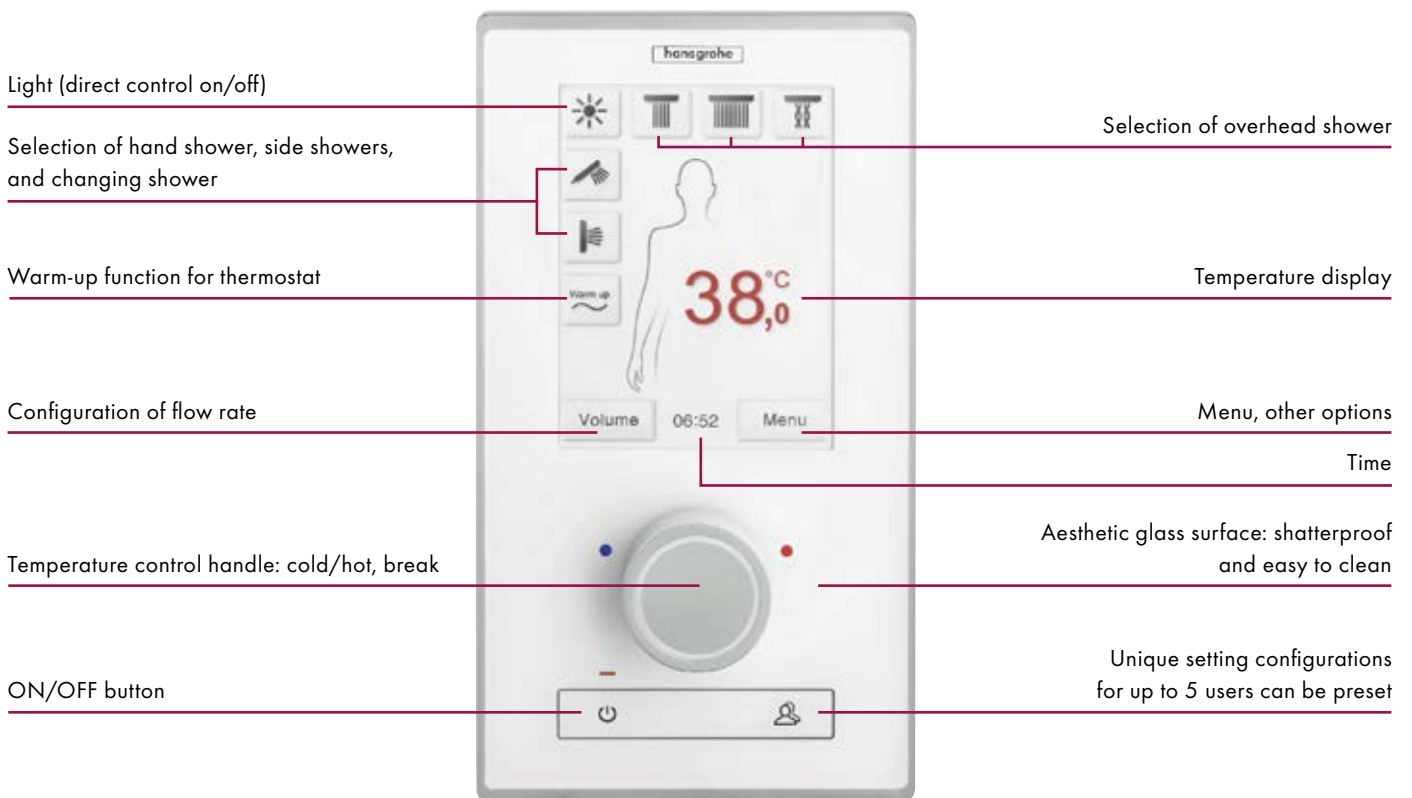

## RainBrain® finish set

Electronic shower control for regulating the flow rate  
# 15842, -000, -400

## Installation details

The RainBrain shower control consists of 4 components, conveniently split into basic and finish set. The basic set contains the connecting bridge for receiving the functions box and an installation case for the operating panel. The finish set contains the functions box and the operating panel.



## Advantages and benefits

- Technology and design highlight in the bathroom
- Unique touchscreen technology, intuitive use based on self-explanatory symbols
- Easy fingertip control of functions, spray types, light and music
- Individual programmable settings for up to five users
- Contemporary design
- Ease of planning and installation

Find out more at [www.pro.hansgrohe-int.com/rainbrain](http://www.pro.hansgrohe-int.com/rainbrain)



## Installation 2 functions

### Flow diagram

Overhead shower Raindance Select S 300 2jet  
# 27378000

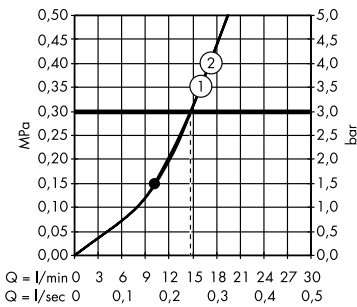

### Flow diagram

Hand shower Raindance Select S 120 3jet  
# 26530000

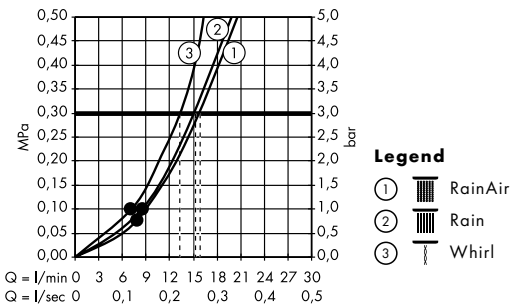

• denotes minimum operating pressure

### Components

#### Mixers

- ⓑ iBox universal  
# 01800180  
ShowerSelect thermostat  
# 15763000



Alternative:  
Metris thermostat with  
shut-off/diverter valve  
# 31573000

Other alternatives possible.

#### Showers

- Ⓐ Raindance Select S 300 2jet  
overhead shower  
# 27378000
- Ⓒ Raindance Select S 120 3jet  
hand shower  
# 26530000  
Porter 'S shower holder  
# 28331000  
Isiflex shower hose  
# 28276000
- Ⓓ FixFit shower connection  
# 27453000
- Ⓔ Staro 90 waste system  
# 60056000

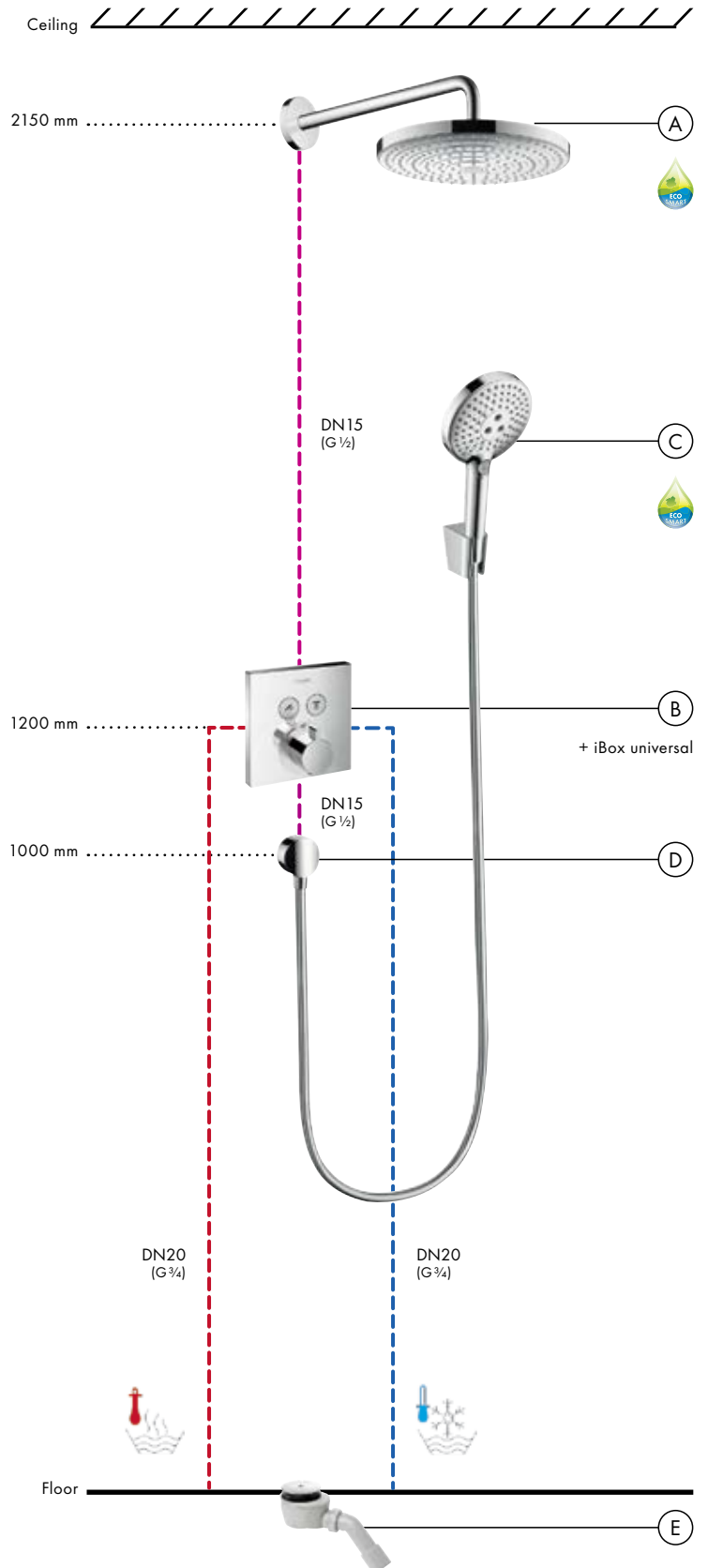

## Installation 3 functions Select

### Flow diagram

Overhead shower Raindance Rainfall 2jet  
# 28433000

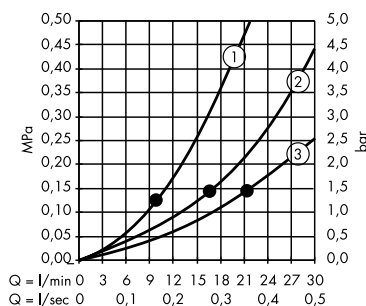

### Flow diagram

Hand shower Raindance Select S 120 3jet  
# 26530000

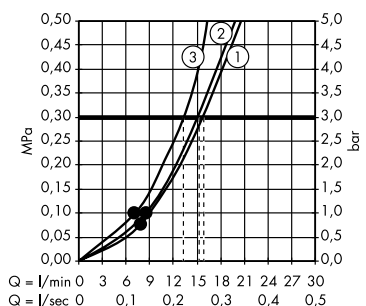

• denotes minimum operating pressure

### Components

#### Mixers

- Ⓒ iBox universal  
# 01800180  
ShowerSelect valve for 3 functions  
# 15764000
- Ⓓ iBox universal  
# 01800180  
ShowerSelect thermostat  
# 15760000

#### Showers

- Ⓐ Raindance Rainfall 2jet  
overhead shower  
# 28433000  
iBox universal  
# 01800180
- Ⓑ Raindance Select S 120 3jet  
hand shower  
# 26530000  
Porter 'S shower holder  
# 28331000  
Isiflex shower hose  
# 28276000
- Ⓔ FixFit shower connection  
# 27453000
- Ⓕ Rainrain XXL waste system  
# 60067000

- Alternative:
- Metris iControl  
# 31958000
  - Metris thermostat Highflow  
# 31571000

Other alternatives possible.

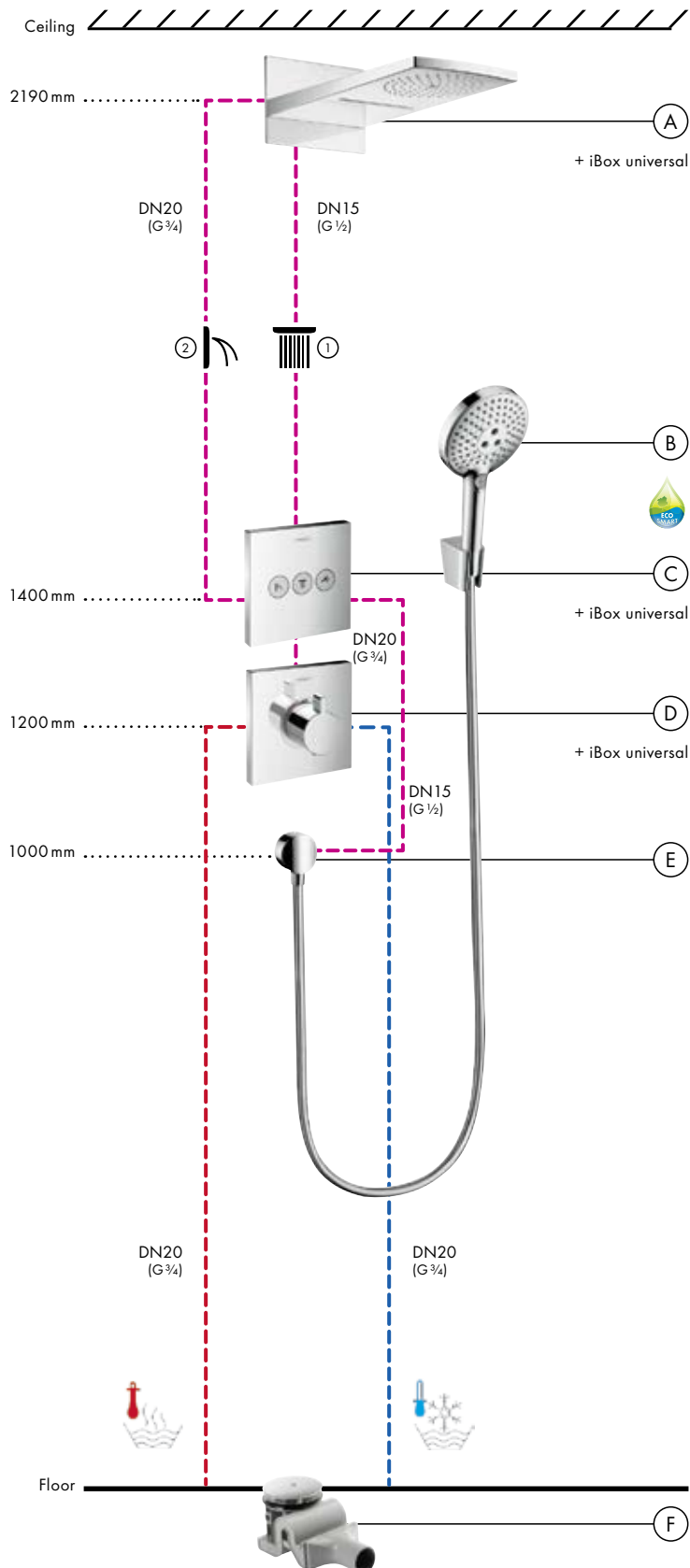

## Installation 3 functions Standard

### Flow diagram

Overhead shower Raissance Rainfall 2jet  
# 28433000

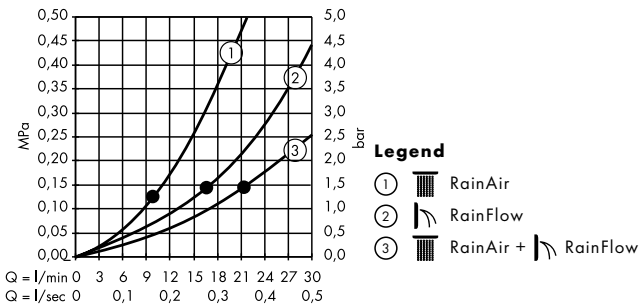

### Flow diagram

Hand shower Raissance Select S 120 3jet  
# 26530000

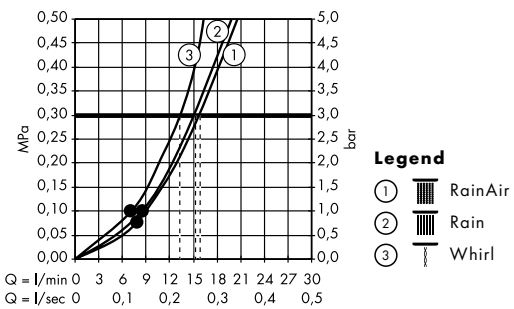

• denotes minimum operating pressure

### Components

#### Mixers

- Ⓒ Trio/Quattro basic set  
# 15981180  
Trio/Quattro S shut-off valve  
# 15932000
- Ⓓ iBox universal  
# 01800180  
Ecostat S thermostat Highflow  
# 15715000
- Ⓔ Basic set shut-off valve  
# 15974180  
Shut-off valve S DN15/DN20  
# 15972000

#### Showers

- Ⓐ Raissance Rainfall 2jet overhead shower  
# 28433000  
iBox universal  
# 01800180
- Ⓑ Raissance Select S 120 3jet hand shower  
# 26530000  
Porter 'S shower holder  
# 28331000  
Isiflex shower hose  
# 28276000
- Ⓕ FixFit shower connection  
# 27453000
- Ⓖ Raindrain XXL waste system  
# 60067000

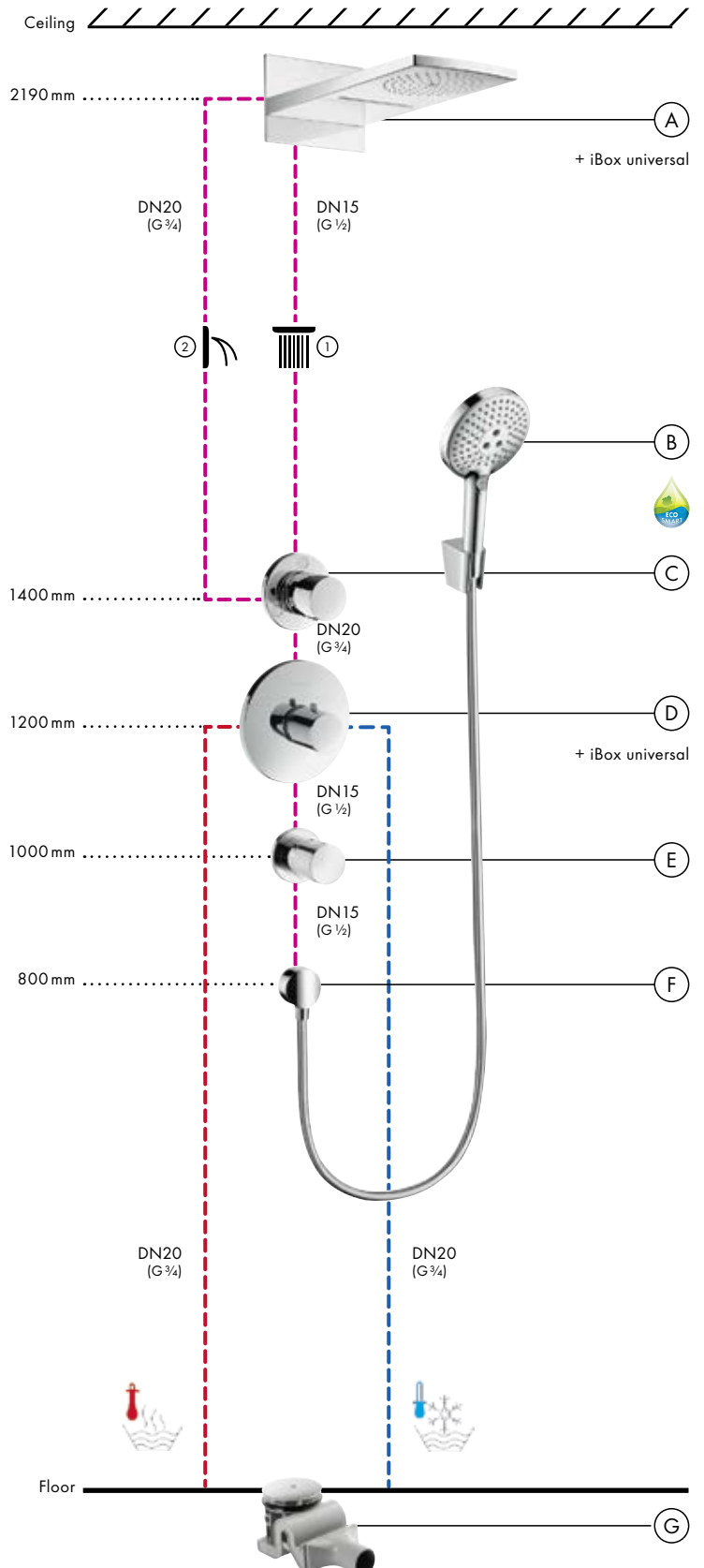

## Installation 4 functions Select

### Flow diagram

Overhead shower Raindance Rainfall 3jet  
# 28411000

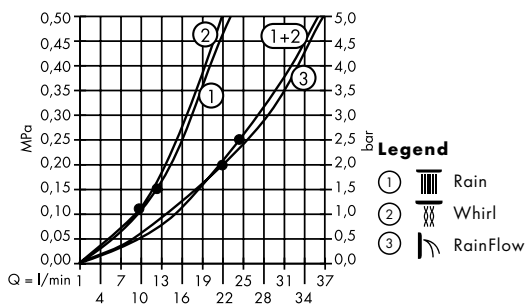

### Flow diagram

Hand shower Raindance Select S 120 3jet  
# 26530000

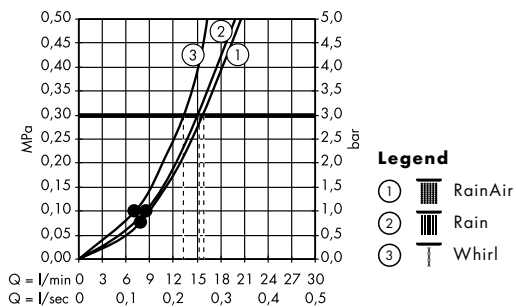

• denotes minimum operating pressure

### Components

#### Mixers

- Ⓒ iBox universal  
# 01800180  
ShowerSelect valve for 3 functions  
# 15764000
- Ⓓ iBox universal  
# 01800180  
ShowerSelect thermostat  
# 15761000

#### Showers

- Ⓐ Raindance Rainfall 3jet  
overhead shower  
# 28411000  
iBox universal  
# 01800180
- Ⓑ Raindance Select S 120 3jet  
hand shower  
# 26530000  
Porter 'S shower holder  
# 28331000  
Isiflex shower hose  
# 28276000
- Ⓔ FixFit shower connection  
# 27453000
- Ⓕ Raindrain XXL waste system  
# 60067000

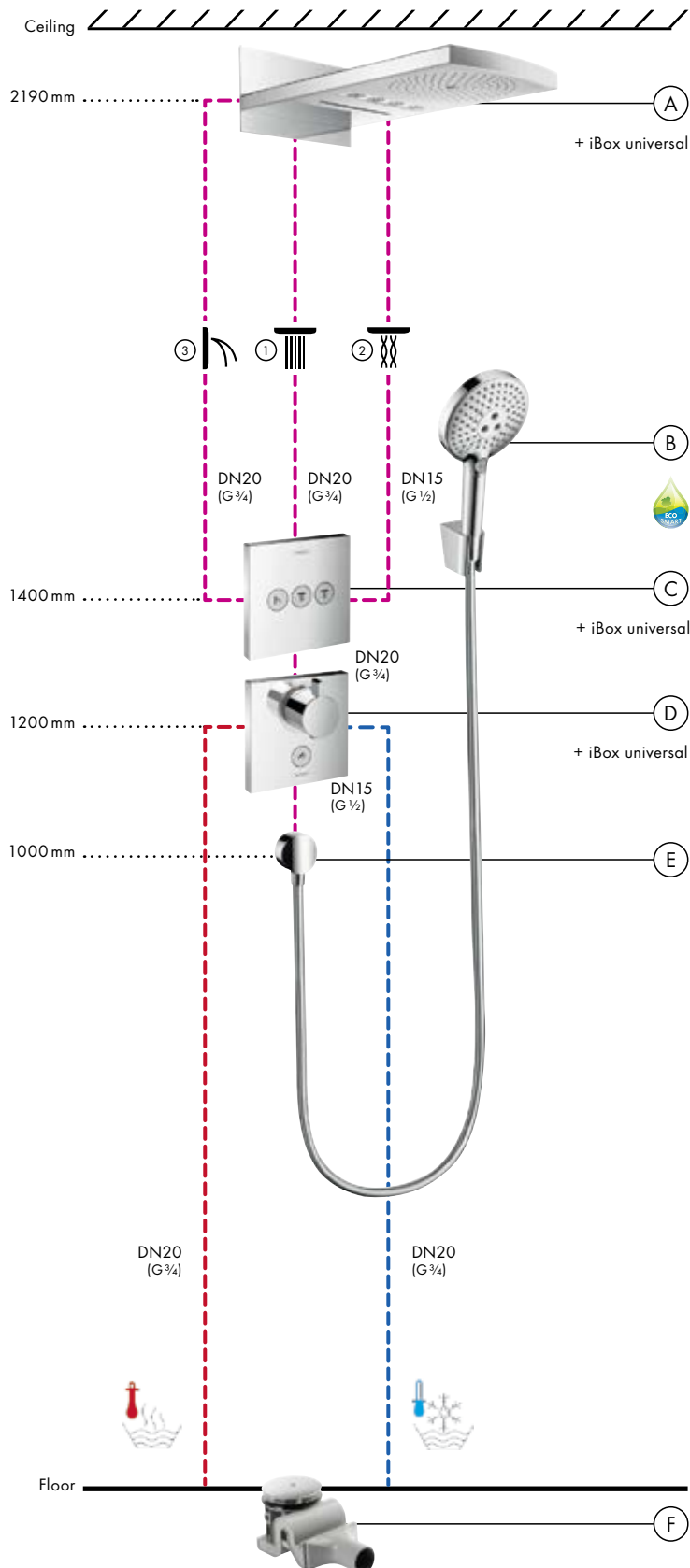



## Installation 4 functions Standard

### Flow diagram

Overhead shower Raindance Rainfall 3jet  
# 28411000

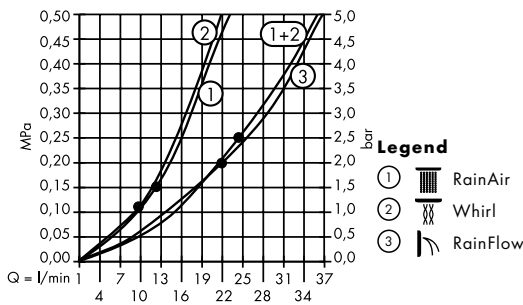

### Flow diagram

Hand shower Raindance Select S 120 3jet  
# 26530000

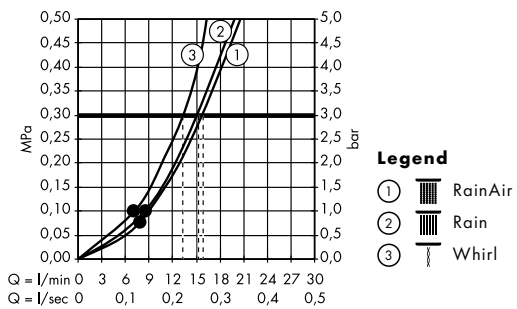

• denotes minimum operating pressure

### Components

#### Mixers

- Ⓒ Quattro basic set  
# 15930180  
Trio/Quattro S shut-off valve  
# 15932000
- Ⓓ Basic set shut-off valve  
# 15970180  
Shut-off valve S DN15/DN20  
# 15972000
- Ⓔ iBox universal  
# 01800180  
Ecostat S thermostat  
# 15715000
- Ⓕ Basic set shut-off valve  
# 15974180  
Shut-off valve S DN15/DN20  
# 15972000

#### Showers

- Ⓐ Raindance Rainfall 3jet overhead shower  
# 28411000  
iBox universal  
# 01800180
- Ⓑ Raindance Select S 120 3jet hand shower  
# 26530000  
Porter 'S shower holder  
# 28331000  
Isiflex shower hose  
# 28276000
- Ⓖ FixFit shower connection  
# 27453000
- Ⓗ Raindrain XXL waste system  
# 60067000

Other alternatives possible.

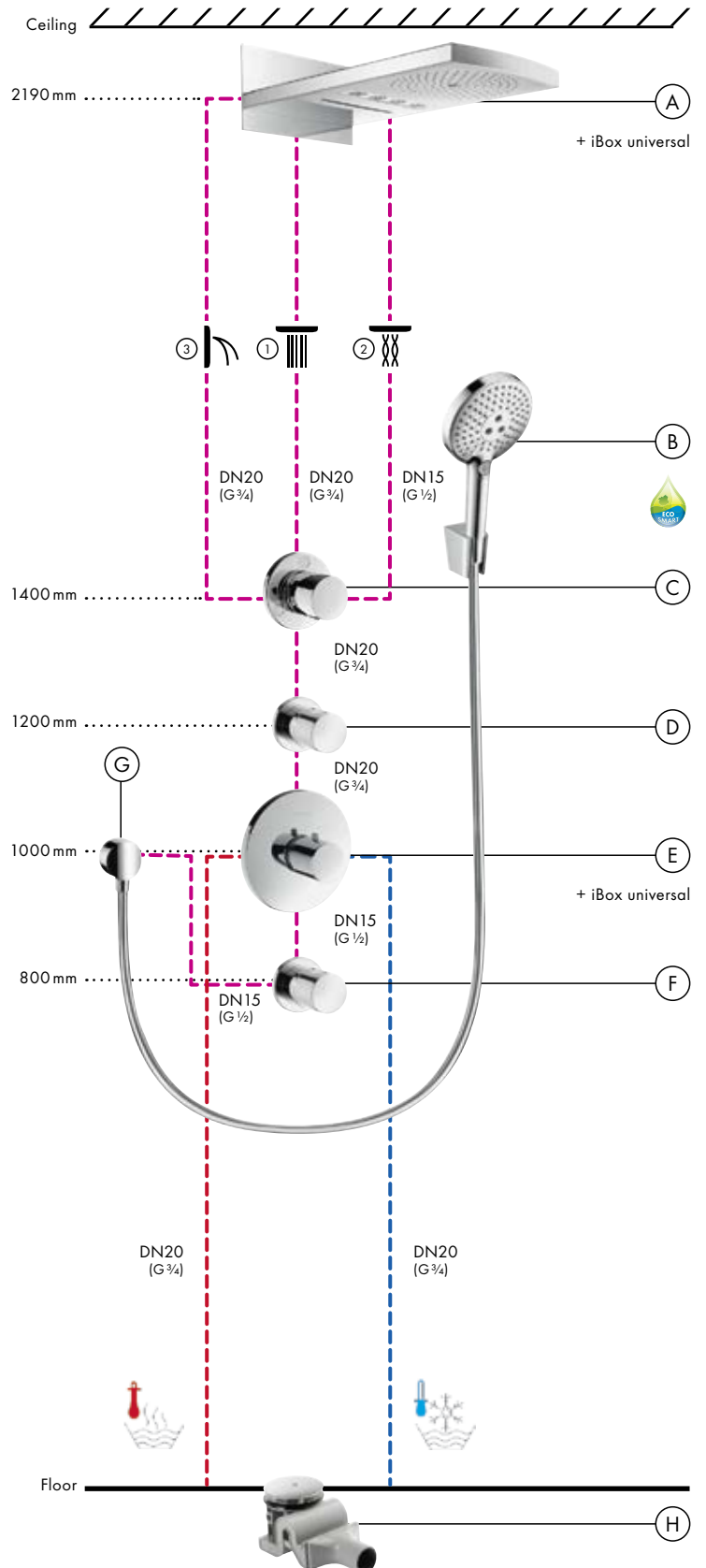

# BATHROOM MIXERS

---

**The right product for every taste:**

Basin mixers | Bidet mixers

Bath and shower mixers | Accessories



Hansgrohe bathroom mixers

# Stylish choices for an individual dream bathroom

The Hansgrohe mixers line caters to every style and taste, from modern to classic, from geometrical to rounded. This wide range gives your customers the freedom to find their personal style through the whole bathroom. Besides the wash basin solutions, there are

also matching bath and shower mixers and accessories. As varied as the mixer line designs all Hansgrohe products have a common basis: high quality and perfect functionality. This affects not only ease of use and a range of mixer heights, but also technologies like

EcoSmart for a maximum water consumption of 5 l/min, or QuickClean for the easy cleaning of the aerator. Hansgrohe mixers reflect the balance between perfect function and beautiful design.

## PuraVida®



Elegant mixers for more sensuality in the bathroom.  
From page 88

## Metris®



Generous surfaces for elegant, quality bathroom design.  
From page 94

## Metris® S



Timeless clarity transforms the bathroom into a sophisticated oasis of tranquillity. From page 97

## Talis®



Flowing forms create a quality bathroom full of feeling.  
From page 98

## Talis® S



Minimalistic design language for modern flair.  
From page 101

## Focus®



Dynamic design emanates freshness and lightness.  
From page 102

## Metris® Classic



Decorative lines for an elevated ambience.  
From page 106

## Talis® Classic



Harmonious elegance for tasteful bathrooms.  
From page 108



# Something to suit every customer

Whether free standing, wall-hanging, surface-mounted or built-in basins, the perfected Hansgrohe portfolio with a range of heights provides the right solution for every one of your needs. Highrisers and high, swivelling mixers can be used to fill even large wash bowls or wash hair with ease. Mid range mixer heights allow adequate

freedom of movement for daily routines. And low mixers are a must, too, e.g. as highlights in the guest toilet or cloakroom. Optional functionality is not the only consideration, the look is also decisive in the choice of mixer and washbasin combinations. To compare these to the best possible effect, you can make use of the Hansgrohe ComfortZone configurator

available on the internet. You can then design the washbasin with the greatest of ease. You can even show your customers in advance how each of the mixer lines blend perfectly into their environment. Visit [www.hansgrohe-int.com/configurator](http://www.hansgrohe-int.com/configurator)

## Avantgarde

PuraVida®

### Free standing basin



Example design with **PuraVida® 240**

### Wall-hanging basin



Example design with **PuraVida® 200**

## Modern

- Metris®
- Metris® S
- Talis®
- Talis® S
- Focus®



Example design with **Metris® 260**



Example design with **Metris® 230**

## Classic

- Metris® Classic
- Talis® Classic



Example design with **Metris® Classic 250**



**ComfortZone:** Whether you need more freedom of movement when washing your hands, washing your hair, or filling large containers the higher the mixer, the more flexibility you have in your daily dealings with water. We call this area between the mixer and the ceramic ComfortZone. For more comfort. For more space. For every day.



**Talis® swivel spout:**

This practical spout creates an arc shaped jet, boosting the personal ComfortZone in moments.



**Surface-mounted basin**

**Built-in basin**

**Hand wash basin**



Example design with **PuraVida® 100**



Example design with **Metris® 200**



Example design with **Metris® 110**



Example design with **Metris® 100**



Example design with **Metris® Classic 100**



Example design with **Metris® Classic 100**



Example design with **Metris® Classic 100**

ComfortZone test



# The right mixer for every wash basin

The higher the mixer, the larger the usable space. If a wash basin and mixer are not properly tuned to each other, the user suffers annoying splashes. As a measure to eliminate

this eventuality from the outset, Hansgrohe has developed the ComfortZone test. Under highly realistic conditions, Hansgrohe mixers are tested for their compatibility with the wash

basins of market leading manufacturers. The tests were conducted on the following five wash basin configurations.

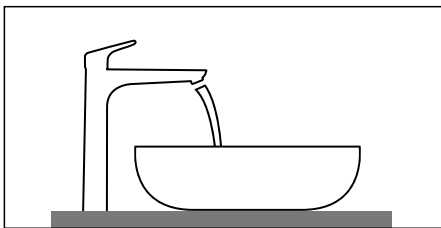

Mixer behind free standing surface-mounted basin or behind wash bowl.

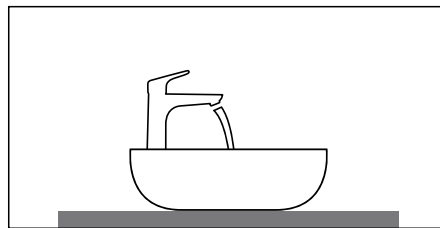

Wash bowl with surface-mounted mixer.

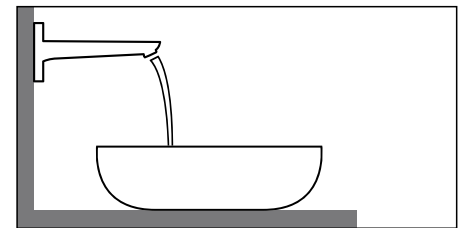

Wash bowl with wall mixer.

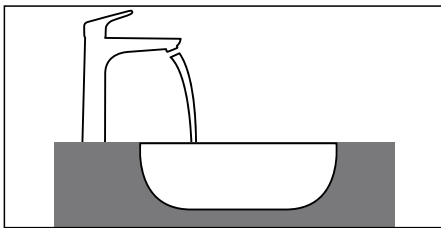

Mixer for built-in basin.

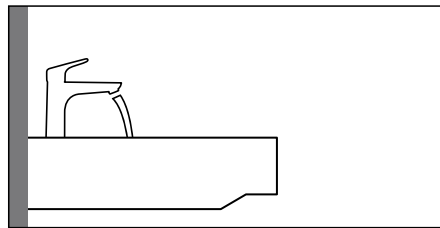

Wall-hanging wash basin with surface-mounted mixer.



Feel confident of your recommendation when you see: the Hansgrohe ComfortZone test seal.



## How the ComfortZone test works

### 1. Free space test

Is there enough of a gap in the combination of mixer and wash basin? A test sphere is positioned between the mixer and wash basin to check how easy and comfortable it is to wash the hands.

### 2. Spray test

Is there any splashing when the mixer is turned on? The mixer is opened and closed several times under different water pressures. Between jets, the splashes are analysed and the wash basin rubbed dry.

### 3. Practical test

Is there any splashing when washing the hands? A standardised hand model is passed under the water jet and the splashes outside of the basin analysed.

## Free PDF: the results from over 6000 combinations

Utilise our knowhow from thousands of tests: We provide you, as a professional partner, exclusive access to all findings of these test series. This overview of all tested

mixer and washbasin combinations provides a sound basis for your recommendations. The PDF files with all the test findings are available free of charge at

[www.pro.hansgrohe-int.com/comfortzone-test](http://www.pro.hansgrohe-int.com/comfortzone-test)

**Which Hansgrohe mixer suits which basin?**

**Hansgrohe ComfortZone mixer with product code**

**Wash basin with product code**

**Suitable combinations**

**Mounting dimensions for different installations**



### Advantages and benefits

- Reliable test procedure on the wash basins of leading manufacturers, fitted in accordance with the instructions
- Recommendations from over 6000 tested mixer wash basin combinations available online for planning – constantly expanded and updated
- The certainty that wash basin and mixer harmonise – without annoying splashes

Find out more in the “ComfortZone Test” discussion and at [www.pro.hansgrohe-int.com/comfortzone-test](http://www.pro.hansgrohe-int.com/comfortzone-test)

Innovative mixer technologies by Hansgrohe

# More technology and comfort for you and your customers



Adjustable hot water limiter prevents too high a temperature, protecting against scalding

Simple and safe regulation of temperature wide mixing range and easy to use handles



Stable control thanks to the patented Boltic lever lock with the wedge shaped control lever

High quality and silent ceramic cartridges

Low Class 1 noise development, so ideal for multifamily homes, hotels and offices

QuickClean for the particularly easy cleaning of the mixer

EcoSmart technology for water and energy savings

AirPower for a pleasant water jet

Comfort Zone

Water damage virtually eliminated thanks to flexible, state of the art connector hoses

## Advantages and benefits

- EcoSmart technology limits flow to 5 l/min, saving water and energy
- QuickClean for easy cleaning and long lasting mixers
- AirPower for a full and soft water jet
- Compliance with the German drinking water regulations TrinkwV of 2013
- Various designs and styles – the right mixer for every taste
- Five year warranty

Find out more at [www.pro.hansgrohe-int.com](http://www.pro.hansgrohe-int.com)





## AirPower: For water in all of its fullness

In 2003 Hansgrohe first saw the benefit of mixing air with water to improve efficiency and increase pleasure, thus inventing AirPower. This means that air is drawn in through the spout. This quite literally enriches the jet, making it fuller, lighter and softer. The resulting air-enriched jet is fuller, lighter and softer.



### Advantages and benefits

- Fuller, lighter and softer drops
- Pleasant water jet
- Less risk of splashing
- High efficiency contributes towards reduced water consumption

## QuickClean: Rubbing away limescale in moments



Hard water, dirt, cleaning agents: Mixers and showers have to withstand a lot. QuickClean technology means residue disappears in moments. Hansgrohe has fitted flexible silicone inserts to the aerators of its mixers. Dirt and limescale can then be simply rubbed away with a finger. An additional advantage: Products that are cared for and free of limescale retain their full functionality and live longer.



**QuickClean:** Flexible silicone inserts make cleaning easy.



### Advantages and benefits

- Fast and easy cleaning
- Long lifetime and functionality



## EcoSmart: Water and energy savings

Thanks to EcoSmart technology, the water consumed by all Hansgrohe basin mixers could be reduced to 5 l/min from the customary 13 l/min. This also saves energy because less water needs to be heated. All

this was made possible with air injection and the integrated EcoSmart system. This special efficiency was confirmed with the European quality mark **WELL – Water Efficiency Label**. Our basin mixers Talis, Focus and

Metris each achieved the best possible results (Level A) in the home section. EcoSmart is not only about potential savings, but also the protection of our environment.



WELL Home Water Efficiency Label	
Manufacturer:	Hansgrohe SE
Product category:	Wash basin valve
Type:	Single-lever valve
Model:	Hansgrohe Metris 110
Registration number:	WA1000020110209
Water Efficiency Criteria	
Flow rate > 6.0 l/min ≤ 9.0 l/min	**
Controlled flow rate ≥ 4.0 l/min ≤ 6.0 l/min	**
Flow-independent temperature setting	**
Temperature limit / Cold water valve	**
Information about use and installation: <a href="http://www.well-online.eu">www.well-online.eu</a> A Label of United Valves European Valve Manufacturers Association	

l/min  
**5.0**

### Example calculation of annual savings with EcoSmart basin mixer\*:

Water **approx 61,880 l**

CO<sub>2</sub> **approx 413 kg**

Costs **approx €511** for water and energy

\* Compared with a basin mixer with 13 l/min. Average values for a family of four in Germany in 2013.

All products with WELL certificates are specially marked in the catalogue

## Advantages and benefits

- Water consumption as low as 5 l/min
- Precision O ring for a constant flow even under fluctuating water pressures
- Full, sparkling water jet thanks to air enrichment
- Reduced consumption for less energy needs and hence less CO<sub>2</sub> emissions
- Lower water and energy consumption for double efficiency
- WELL quality mark as certification basis in projects



How much water can be saved is calculated by the savings calculator at:

[www.hansgrohe-int.com/savings-calculator](http://www.hansgrohe-int.com/savings-calculator)

l/min  
**3.5**

## LowFlow: Mixers for minimal flow rates

Especially in projects, water and energy savings are an important criterion for the certification of buildings, e.g. under

Part G, LEED or BREEAM. For this purpose, Hansgrohe has developed special cartridges that minimise the flow rate through its mixers.

These LowFlow cartridges have a restricted opening angle and special spray formers. Result: a flow rate of only 3.5 l/min.



### Advantages and benefits

- Savings in water and energy
- Certification advantages especially for projects
- Precise temperature setting despite low flow rate

## CoolStart: automatic energy savings

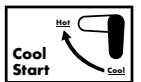

Whereas the central position on standard mixers immediately activates mixed water (both hot and cold), with Coolstart mixers only cold water runs through. The pipe

system is therefore not filled unnecessarily with hot water. Hot water is not added until the lever is moved to the left. This helps to reduce the energy needs and hence CO<sub>2</sub> emissions as

well. This goes easy on the environment – and your pocket as well.

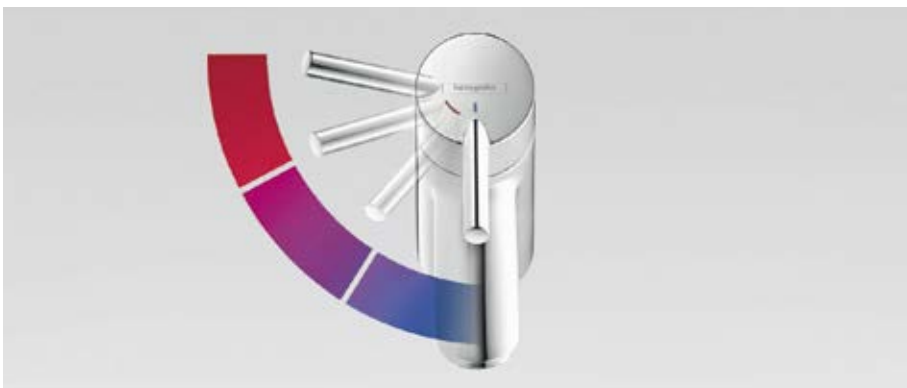

**CoolStart:** Hot water then runs only when it is actually needed.

CoolStart technology is available in the following mixers:



**Metris® 110**



**Talis® 80**



**Focus® 70**  
**Focus® 100**



### Advantages and benefits

- At the basic setting, only cold water flows without the need to draw on heated water
- Potential for water, energy and financial savings
- Special user ergonomics (the lever need only be moved to the left for hot water)

Hansgrohe bathroom mixers

# The bathroom mixer lines at a glance

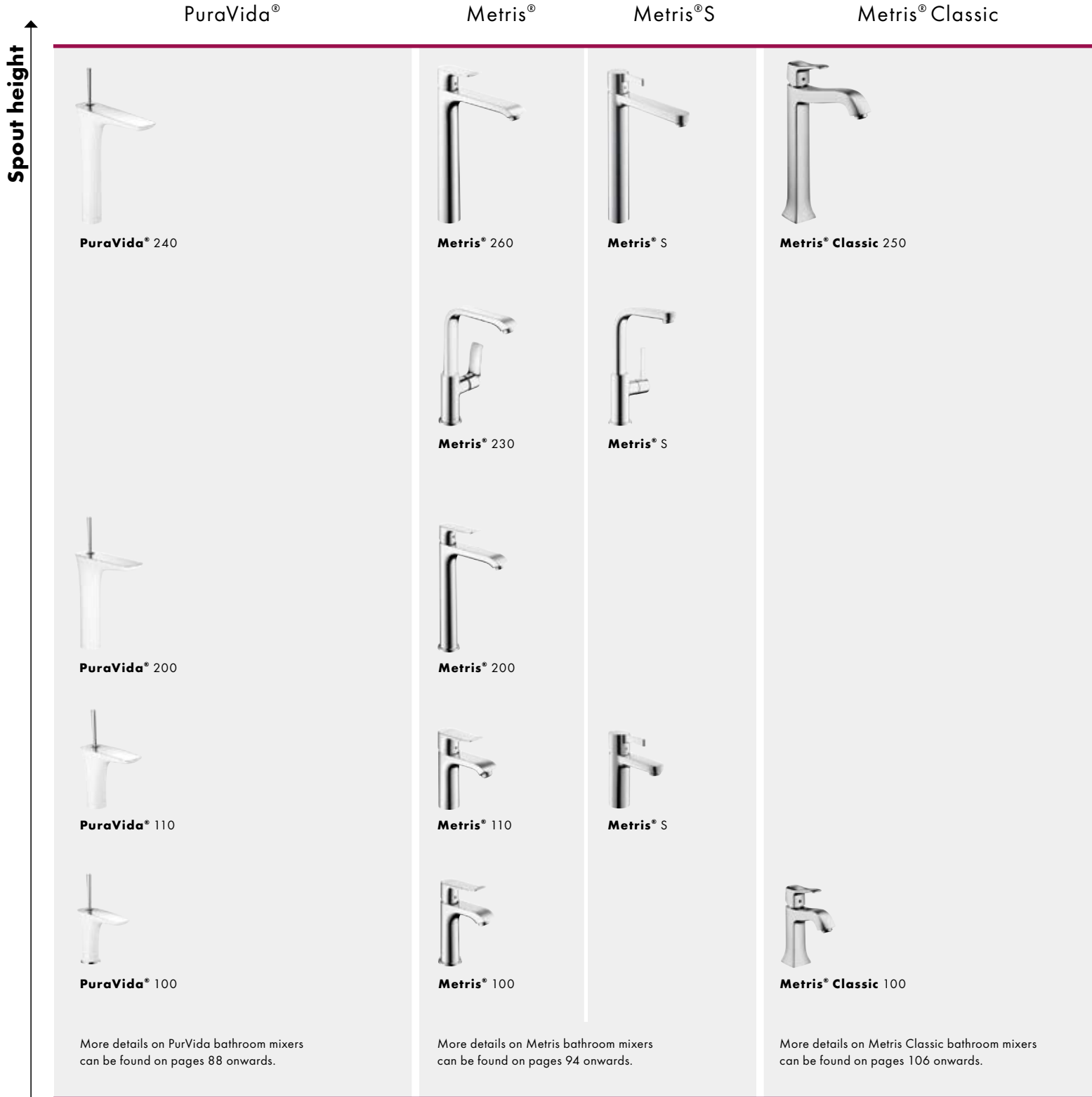

**How to use the overview in your sales presentation**

The higher a product is positioned, the greater its ComfortZone. The products are arranged in ranges extending to the right.

Talis®

Talis®S

Talis® Classic

Focus®



**Talis® 250**



**Talis® Classic 230**



**Focus® 240**



**Talis® 210**



**Talis® S**



**Talis® 150**



**Focus® 190**



**Talis® 80**



**Talis® 80**



**Talis® S**



**Talis® Classic 80**



**Talis® Classic Natural 90**



**Focus® 100**



**Focus® 70**



































More details on Talis bathroom mixers can be found on pages 98 onwards.

More details on Talis Classic bathroom mixers can be found on pages 108 onwards.









































More details on Focus bathroom mixers can be found on pages 102 onwards.

Hansgrohe bathroom mixers

# The bathroom mixer range at a glance

		PuraVida®	Metris®	Talis®	Focus®
<b>Basin</b>					
	Pillar tap	 # 15132, -000, -400	 # 31166, -000	 # 32130, -000	 # 31130, -000
<b>Single lever basin mixer</b>	for small wash basins	 # 15075, -000, -400	 # 31088, -000		
	with pop-up waste set	 # 15074, -000, -400	 # 31080, -000	 # 32040, -000	 # 31730, -000
	with Push-Open waste	 # 15070, -000, -400			 # 31604, -000
	without waste set		 # 31084, -000	 # 32041, -000	 # 31733, -000
	for open water heaters		 # 31074, -000		 # 31132, -000
	Taller models	 # 15081, -000, -400	 # 31183, -000	 # 32052, -000	 # 31607, -000
<b>Single lever basin mixer with swivel spout</b>	with pop-up waste set		 # 31087, -000	 # 32084, -000	 # 31609, -000
	with Push-Open waste		 # 31187, -000	 # 32082, -000	
	without waste set		 # 31081, -000		 # 31519, -000
<b>Single lever basin mixers for wash bowls (high risers)</b>	with waste system	 # 15072, -000, -400	 # 31082, -000		 # 31608, -000
<b>3-hole basin mixer</b>		 # 15073, -000, -400	 # 31083, -000	 # 32310, -000	

This excerpt from the Hansgrohe product range is to help your customers find the right solution for each and every one of their requirements. The overview presents possible solutions within the Hansgrohe core range.

		PuraVida®	Metris®	Talis®	Focus®
<b>Basin</b>					
<b>Single lever basin mixer</b>	Wall installation 165 mm	 # 15084, -000, -400	 # 31085, -000	 # 31618, -000	
	Wall installation 225 mm	 # 15085, -000, -400	 # 31086, -000	 # 31611, -000	
<b>Electronic mixer</b>		 # 15170, -000, -400	 # 31100, -000	 # 32110, -000	 # 31171, -000
<b>Bidet</b>					
<b>Single lever bidet mixer</b>		 # 15270, -000, -400	 # 31280, -000	 # 32240, -000	 # 31920, -000
<b>Bath</b>					
<b>Single lever bath mixer</b>	Exposed	 # 15472, -000, -400	 # 31480, -000	 # 32440, -000	 # 31940, -000
	Concealed	 # 15445, -000, -400 # 15447, -000, -400	 # 31487, -000 # 31493, -000	 # 32475, -000 # 32477, -000	 # 31945, -000 # 31946, -000
	Floor standing	 # 15473, -000, -400			
<b>3-hole rim-mounted mixer</b>		 # 15448, -000, -400			
<b>3-hole rim-mounted single lever mixer</b>		 # 15432, -000, -400	 # 31190, -000		
<b>4-hole rim-mounted mixer</b>		 # 15446, -000, -400	 # 34420, -000		
<b>Bath filler</b>		 # 15412, -000, -400	 # 31494, -000	 # 13414, -000	 # 13414, -000
<b>Shower</b>					
<b>Single lever shower mixer</b>	Exposed	 # 15672, -000, -400	 # 31680, -000	 # 32640, -000	 # 31960, -000
	Concealed	 # 15665, -000, -400	 # 31685, -000	 # 32675, -000	 # 31965, -000

# Sensuous poetry of purity and clarity



**Attractive:** PuraVida emanates a special elegance and integrates perfectly in the bathroom, harmonising with white ceramics.

**Complete in itself:** Here pure elegance can be seen in all of the details. Moreover, the overhead shower is ergonomically shaped to completely cover the user's shoulders.

**Emotionally appealing:** The DualFinish surface unites white and chrome in a harmony of quality.



## Advantages and benefits

- Breadth of range to enable complete, coordinated bathroom design
- Sculptured look from the harmonious unity of body and spout
- Flat pin handle with joystick cartridge
- Visible quality in the precise contoured lines
- Clear laminar jet and adjustable spray angle
- DualFinish surface with precise edges between chrome and white
- Scratch resistant powder coating



## Basin/bidet



**PuraVida® 240**  
Single lever basin mixer  
with Push-Open waste  
Hose length 900 mm  
# 15072, -000, -400  
Hose length 600 mm  
# 15066, -000, -400



**PuraVida® 200**  
Single lever basin mixer  
with Push-Open waste  
# 15081, -000, -400



**PuraVida® 110**  
Single lever basin mixer  
with Push-Open waste  
# 15070, -000, -400  
with pop-up waste set  
# 15074, -000, -400



**PuraVida® 100**  
Single lever basin mixer  
for small washbasin  
with Push-Open waste  
# 15075, -000, -400



- More freedom of movement at the wash basin for greater comfort



**PuraVida® 100**  
Pillar tap for small wash basin  
# 15132, -000, -400



**PuraVida®**  
Electronic basin mixer  
with temperature control  
Battery operation  
# 15170, -000, -400  
Mains connection 230 V  
# 15172, -000, -400



**PuraVida®**  
Electronic basin mixer  
without temperature control  
Battery operation  
# 15171, -000, -400  
Mains connection 230 V  
# 15173, -000, -400



**PuraVida® 100**  
3-hole basin mixer  
with fixed spout  
# 15073, -000, -400



**PuraVida®**  
Single lever basin mixer  
for wall installation  
225 mm # 15085, -000, -400  
Basic set for concealed  
installation  
# 13622180



**PuraVida®**  
Single lever basin mixer  
for wall installation  
165 mm # 15084, -000, -400  
Basic set for concealed  
installation  
# 13622180



**PuraVida®**  
Single lever bidet mixer  
with pop-up waste set  
# 15270, -000, -400

All products are shown with white/chrome (-400) surfaces.



**Kitchen waste** in the PuraVida line can be found on pages 124 onwards.

## Bath



**PuraVida®**  
3-hole rim-mounted mixer  
# 15448, -000, -400  
Basic set for concealed  
installation  
# 13233180



**PuraVida®**  
3-hole rim-mounted  
single lever mixer  
# 15432, -000, -400  
Basic set for concealed  
installation  
# 13437180



**PuraVida®**  
4-hole rim-mounted mixer  
# 15446, -000, -400  
Basic set for concealed  
installation  
# 13444180



**PuraVida®**  
2-hole rim-mounted thermostat  
# 15474, -000, -400  
Basic set for concealed  
installation  
# 13550180

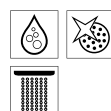
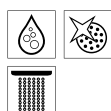

- No broken tiles thanks to pre-assembled basic set
- Secuflex Box protects the shower hose behind the bath
- Shower hose does not catch when used
- Easy servicing thanks to completely sealed system which can be accessed from above



**PuraVida®**  
Single lever bath mixer,  
floor standing, with PuraVida  
120 1jet baton hand shower  
# 15473, -000, -400  
Basic set for concealed  
installation  
# 10452180



**PuraVida®**  
Single lever bath mixer  
exposed  
# 15472, -000, -400



**PuraVida®**  
Single lever bath mixer  
concealed  
# 15445, -000, -400  
with safety combination  
# 15447, -000, -400



**PuraVida®**  
Bath filler  
exposed  
# 15412, -000, -400



## Shower



**PuraVida®**  
Single lever shower mixer  
exposed  
# 15672, -000, -400



**PuraVida®**  
Single lever shower mixer  
concealed  
# 15665, -000, -400



**PuraVida®**  
Shower thermostat,  
concealed, for 1 function  
# 15775, -000, -400



**PuraVida®**  
Shower thermostat,  
concealed, for 2 functions  
# 15771, -000, -400



**PuraVida®**  
Shower thermostat  
concealed  
# 15770, -000, -400  
Highflow thermostat  
# 15772, -000, -400



**PuraVida® iControl®**  
Shut-off/diverter valve,  
concealed, for 3 functions  
# 15777, -000, -400



**Trio®/Quattro®**  
Shut-off/diverter valve  
for PuraVida  
# 15937, -000, -400



**Shut-off valve**  
for PuraVida  
# 15978, -000, -400



**Basis for concealed  
thermostats and mixers**  
iBox universal # 01800180



## Showers



**PuraVida® 400**  
Overhead shower  
with shower arm 390 mm  
(21 l/min) # 27437, -000, -400  
with ceiling connection 100 mm  
# 27390, -000, -400 (not shown)

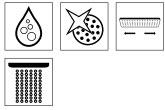

**PuraVida® 150 3jet**  
Hand shower  
(16 l/min) # 28557, -000, -400  
EcoSmart (9 l/min) # 28567, -000, -400  
(not shown)

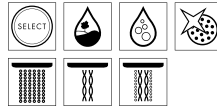

**PuraVida® 120 1jet**  
Baton hand shower  
(16 l/min) # 28558, -000, -400  
EcoSmart (9 l/min) # 28568, -000, -400  
(not shown)

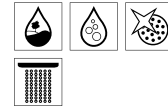

- Ergonomically shaped for the width of shoulders
- Long shower arm for generous freedom of movement
- DualFinish for elegant surfaces

- Innovative design
- 2-shell structure
- Spray modes changed at the push of a button



**PuraVida® 100**  
Side shower  
# 28430, -000, -400

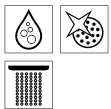

**PuraVida® 120 1jet**  
TravelShower  
(16 l/min) # 28564, -400

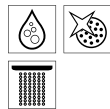

**PuraVida®/Unica® Set**  
0.90 m # 27853, -000, -400

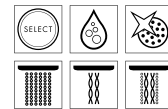

## Accessories



**Porter 'S**  
Shower holder  
# 28331, -000



**PuraVida® Fixfit®**  
DN15 hose connection with ball joint  
and non-return valve  
# 27414, -000

## Accessories



**PuraVida®**  
Liquid soap dispenser  
# 41503, -000



**PuraVida®**  
Toothbrush tumbler  
# 41504, -000



**PuraVida®**  
Soap dish  
# 41502, -000



**PuraVida®**  
Towel hook  
# 41501, -000



**PuraVida®**  
Roll holder  
# 41508, -000



**PuraVida®**  
Spare roll holder  
# 41518, -000



**PuraVida®**  
WC brush with  
ceramic tumbler  
# 41505, -000

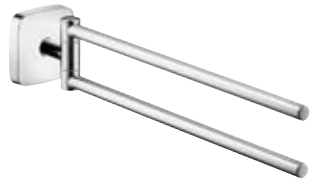

**PuraVida®**  
Towel holder,  
twin-handle  
# 41512, -000

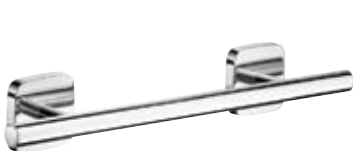

**PuraVida®**  
Grab rail, 300 mm  
# 41513, -000



**PuraVida®**  
Bath towel rail, 600 mm  
# 41506, -000

# To suit every customer



**Elegant:** Generous handle and spout surfaces lend the bathroom a luxurious ambience.



**Modern:** Metris mixers are designed for discretion, providing space for the personal ComfortZone.



## Advantages and benefits

- Generous surfaces for elegant, quality bathroom design
- The open sweep of the flat handle reflects its ease of use
- Tapered basic set and precision edges emphasise the character of quality
- Five basin mixer heights for individual free space
- Automatic flow limit to 5 l/min thanks to EcoSmart technology

## Basin/bidet



**Metris® 260**  
Single lever basin mixer  
with pop-up waste set # 31082, -000  
without waste set # 31184, -000



**Metris® 230**  
Single lever basin mixer  
with 120° swivel spout  
and waste system # 31087, -000  
with Push-Open waste # 31187, -000  
without waste set # 31081, -000



**Metris® 200**  
Single lever basin mixer  
with pop-up waste set # 31183, -000  
without waste set # 31185, -000



**Metris® 110**  
Single lever basin mixer  
with pop-up waste set # 31080, -000  
without waste set # 31084, -000  
without waste set, LowFlow # 31203, -000  
for open water heaters # 31074, -000  
for open water heaters, LowFlow # 31204, -000  
CoolStart # 31121, -000 (not shown)



**WELL**  
Water Efficiency Label



**Metris® 100**  
Single lever basin mixer  
with pop-up waste set # 31088, -000  
without waste set # 31186, -000



**Metris® 100**  
3-hole basin mixer  
with fixed spout  
# 31083, -000



**Metris®**  
Single lever basin mixer for wall installation  
225 mm # 31086, -000  
165 mm # 31085, -000 (not shown)  
Basic set for concealed installation  
# 13622180



**Metris®**  
Pillar tap for small wash basin  
# 31166, -000



**Metris®**  
Single lever bidet mixer  
with pop-up waste set  
# 31280, -000



## Metris®

### Bath



**Metris®**  
Single lever bath mixer  
exposed  
# 31480, -000



**Metris®**  
Single lever bath mixer  
concealed  
# 31493, -000  
with safety combination  
# 31487, -000



**Metris®**  
Bath filler  
exposed  
# 31494, -000



**Metris®**  
3-hole rim-mounted  
single lever mixer  
# 31190, -000  
Basic set for concealed  
installation  
# 13437180



**Metris®**  
4-hole rim-mounted mixer  
# 31442, -000  
Basic set for concealed  
installation  
# 13444180



- No broken tiles thanks to pre-assembled basic set
- Secuflex Box protects the shower hose behind the bath
- Shower hose does not catch when used
- Easy servicing thanks to completely sealed system and easy access from above

### Shower



**Metris®**  
Single lever shower mixer  
exposed  
# 31680, -000



**Metris®**  
Single lever shower mixer  
concealed  
# 31685, -000



**Metris®**  
Shower thermostat,  
concealed, for 1 function  
# 31572, -000 (not shown)  
for 2 functions  
# 31573, -000



**Metris®**  
Shower thermostat  
concealed  
# 31570, -000  
Highflow thermostat  
# 31571, -000 (not shown)



**iControl® S**  
Shut-off/diverter valve,  
concealed, for 3 functions  
# 15955, -000

## Metris® S

### Basin



**Metris® S**  
Single lever basin mixer  
with pop-up waste set # 31022, -000  
without waste set # 31023, -000



**Metris® S**  
Single lever basin mixer  
with 120° swivel spout  
and waste system # 31159, -000  
with Push-Open waste # 31161, -000



**Metris® S**  
Single lever basin mixer  
with pop-up waste set # 31060, -000  
without waste set # 31068, -000  
LowFlow # 31063, -000





## Metris® S

### Basin/bidet



**Metris® S**  
Single lever basin mixer  
for wall installation  
165 mm # 31162, -000 (not shown)  
225 mm # 31163, -000  
Basic set for concealed installation  
# 13622180



**Metris® S**  
Electronic basin mixer  
with temperature control  
Battery operation # 31100, -000  
Mains connection 230 V # 31102, -000  
without temperature control, battery operation  
# 31101, -000 (not shown)  
Mains connection 230 V # 31103, -000 (not shown)



**Metris® S**  
Single lever bidet mixer  
with pop-up waste set # 31261, -000



### Bath



**Metris® S**  
Single lever bath mixer  
exposed  
# 31460, -000



**Metris® S**  
Single lever bath mixer  
concealed  
# 31465, -000  
with safety combination  
# 31466, -000



**Metris® S**  
Bath filler  
exposed  
# 14420, -000



**Metris® S**  
4-hole rim-mounted mixer  
170 mm # 31446, -000  
220 mm # 31447, -000  
Basic set for concealed installation  
# 13444180



### Shower



**Metris® S**  
Single lever shower mixer  
exposed  
# 31660, -000



**Metris® S**  
Single lever shower mixer  
concealed  
# 31665, -000



**Basis for concealed  
thermostats and mixers**  
iBox universal # 01800180  
for Metris and Metris S



- Metris S presents a timeless design with a clear, precise flow of lines
- Ergonomic pin handle emphasises the precision of the design languages
- Extensive range for every application
- Also ideal for projects



**Escutcheon diameter** Metris and Metris S: 150 mm. **Matching valves** can be found on page 66.

Talis®

# The new generosity of space in the bathroom



**User-friendly:** The swivel spout (↻) creates an arc shaped jet, boosting the personal ComfortZone in moments.

**Clear:** Slender, confidently stylish and fitted with its characteristic pin handle – Talis presents an exclusive bathroom design based on functional clarity.



## Advantages and benefits

- Cylindrical, inclined basic set emanates clarity and dynamism
- Wide range with solutions for all wishes and needs
- Characteristic pin handle for ease of use
- Practical swivel spout: arc shaped jet for greater comfort when washing hair, filling tall containers or brushing teeth
- Automatic flow limit to 5 l/min thanks to EcoSmart technology

## Basin/bidet



**Talis® 250**  
Single lever basin mixer  
with 60° swivel spout  
and Push-Open waste  
# 32055, -000



**Talis® 210**  
Single lever basin mixer  
with 120° swivel spout  
and Push-Open waste # 32082, -000  
with pop-up waste set  
# 32084, -000  
Fixed spout # 32080, -000



**Talis® 150**  
Single lever basin mixer  
with swivel spout  
and waste system  
# 32052, -000



**Talis® 80**  
Single lever basin mixer  
with swivel spout  
and waste system  
# 32053, -000



- Design classics
- Rotary screw for larger usable space



**Talis® 80**  
Single lever basin mixer  
with pop-up waste set  
# 32040, -000  
without waste set # 32041, -000  
with pop-up waste set, LowFlow  
# 32046, -000  
without waste set, LowFlow  
# 32146, -000  
for open water heaters  
# 32042, -000  
CoolStart # 32057, -000 (not shown)



**Talis® 80**  
Pillar tap for small wash basin  
# 32130, -000  
# 13132, -000 (not shown)



**Talis® 200**  
2-handle basin mixer  
with 120° swivel spout  
# 32030, -000



**Talis® 230**  
3-hole basin mixer  
# 32310, -000



**Talis®**  
Single lever basin mixer  
for wall installation  
# 32047, -000



## Basin/bidet



**Talis®**  
Electronic basin mixer  
with temperature control  
Battery operation  
# 32110, -000  
Mains connection 230 V  
# 32112, -000

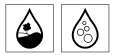

**Talis®**  
Electronic basin mixer  
without temperature control  
Battery operation  
# 32111, -000  
Mains connection 230 V  
# 32113, -000



**Talis®**  
Single lever basin mixer  
for wall installation  
165 mm # 31618, -000  
LowFlow # 31620, -000  
225 mm # 31611, -000 (not shown)  
Basic set for concealed installation  
# 13622180



**Talis®**  
Single lever bidet mixer  
# 32240, -000



## Bath



**Talis®**  
Single lever bath mixer  
exposed  
# 32440, -000



**Talis®**  
Single lever bath mixer  
concealed  
# 32475, -000  
with safety combination  
# 32477, -000



**Talis®**  
Bath filler  
exposed  
# 13414, -000



## Shower



**Talis®**  
Single lever shower mixer  
exposed  
# 32640, -000



**Talis®**  
Single lever shower mixer  
concealed  
# 32675, -000



**Basis for concealed  
thermostats and mixers**  
iBox universal # 01800180



## Talis® S

### Basin/bidet



**Talis® S**  
Single lever basin mixer  
with 360° swivel spout  
and waste system  
# 32070, -000  
120° swivel spout  
and waste system  
# 32073, -000



**Talis® S**  
Single lever basin mixer  
with pop-up waste set  
# 32020, -000  
without waste set # 32031, -000  
with pop-up waste set,  
for open water heaters  
# 32032, -000



**Talis® S**  
Single lever bidet mixer  
# 32220, -000



### Bath



**Talis® S**  
Single lever bath mixer  
exposed  
# 32420, -000



**Talis®**  
Single lever bath mixer  
concealed  
# 32475, -000  
with safety combination  
# 32477, -000

### Shower



**Talis® S**  
Single lever shower mixer  
exposed  
# 32620, -000



**Talis®**  
Single lever shower mixer  
concealed  
# 32675, -000



- Talis S is a bathroom classic with minimalistic design
- Slender and unadorned design
- Characteristic pin handle for ease of use
- Pioneering geometry and excellent value



**Talis Care** products for persons of restricted mobility can be found on pages 110 onwards.

# With top quality, comfort and price



**Living:** The cylindrical, contemporary body of Focus mixers brings elegance and value to the bathroom.

**User-friendly:** Gentle, caressing roundness and the ergonomic handle invite you to try out the ease of use.



## Advantages and benefits

- Design complete in itself and expressed in a clear, generous language
- Dynamic silhouette and gentle round shapes emphasise the quality
- Ergonomic handle for ease of use
- Excellent value with a high level of comfort
- Automatic flow limit to 5 l/min thanks to EcoSmart technology

## Basin/bidet



**Focus® 240**  
Single lever basin mixer  
with 120° swivel spout  
and waste system # 31609, -000  
without waste set # 31519, -000



**Focus® 190**  
Single lever basin mixer  
with pop-up waste set # 31608, -000  
without waste set # 31518, -000



**Focus® 100**  
Single lever basin mixer  
with pop-up waste set # 31607, -000  
without waste set # 31517, -000  
with pop-up waste set, LowFlow  
# 31603, -000  
without waste set, LowFlow  
# 31513, -000  
CoolStart # 31621, -000 (not shown)

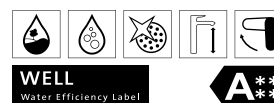

**Focus® 70**  
Single lever basin mixer  
with pop-up waste set # 31730, -000  
without waste set # 31733, -000  
with pop-up waste set, LowFlow  
# 31951, -000  
without waste set, LowFlow  
# 31952, -000  
for open water heaters # 31132, -000  
with Push-Open waste # 31604, -000  
Pillar tap # 31130, -000 (not shown)  
CoolStart # 31539, -000 (not shown)



**Focus®**  
Electronic basin mixer  
with temperature control  
Battery operation # 31171, -000  
Mains connection 230 V # 31173, -000



**Focus®**  
Electronic basin mixer  
without temperature control  
Battery operation # 31172, -000  
Mains connection 230 V # 31174, -000



- Hygienic, because contactless
- Ideal for public buildings



**Focus®**  
Single lever bidet mixer  
with pop-up waste set # 31920, -000  
with Push-Open waste # 31922, -000



## Bath



**Focus®**  
Single lever bath mixer  
exposed  
# 31940, -000



**Focus®**  
Single lever bath mixer  
concealed  
# 31945, -000  
with safety combination  
# 31946, -000



**Focus®**  
Bath filler  
exposed  
# 13414, -000



## Shower



**Focus®**  
Single lever shower mixer  
exposed  
# 31960, -000



**Focus®**  
Single lever shower mixer  
concealed  
# 31965, -000



**Basis for concealed  
thermostats and mixers**  
iBox universal # 01800180



## Avantgarde



### Elegant mixers – for more sensuality in the bathroom

- Award winning visual appeal and extraordinary materials
- Refreshing look
- Sensual minimalism



PuraVida® 110

## Modern



### Mixers with clear design – and a lot of comfort

- Three design variants and price levels to choose from
- Design focusing on the essential
- Generosity of space in the bathroom



Metris® 110



Talis® 80



Focus® 70

## Classic



### Classical forms – in a modern interpretation

- Timelessly classical design
- Round, sweeping forms
- Ergonomic tactile properties



Metris® Classic 100



Talis® Classic 80

Metris® Classic

# Modern classic with elegant design



**Classical:** The elegant design with discreetly shaped handle and spout emanate high quality and pleasure.

**Elegant:** The brilliant and plane surface of the mixers presents highlights of luxury in every bathroom.



## Advantages and benefits

- Balanced, minimal design with classical elegance
- High quality chrome surface: long lasting and easy to clean
- Basic geometrical form with decorative play of lines for an elevated ambience
- Automatic flow limit to 5 l/min thanks to EcoSmart technology

## Basin/bidet



**Metris® Classic 250**  
Single lever basin mixer  
with pop-up waste set  
# 31078, -000



**Metris® Classic 100**  
Single lever basin mixer  
with pop-up waste set  
# 31075, -000  
without waste set  
# 31077, -000



**Metris® Classic**  
Single lever basin mixer  
for wall installation  
225 mm # 31003, -000  
Basic set for concealed  
installation  
# 13622180



**Metris® Classic 100**  
3-hole basin mixer  
with pop-up waste set  
# 31073, -000



**Metris® Classic**  
Single lever bidet mixer  
with pop-up waste set  
# 31275, -000



## Bath



**Metris® Classic**  
Single lever bath mixer  
exposed  
# 31478, -000



**Metris® Classic**  
Single lever bath mixer  
concealed  
# 31485, -000



**Metris® Classic**  
Bath filler  
exposed  
# 13413, -000



## Shower



**Metris® Classic**  
Single lever shower mixer  
exposed  
# 31672, -000



**Metris® Classic**  
Single lever shower mixer  
concealed  
# 31676, -000



**Fixfit® Classic**  
DN15 hose connection with  
non-return valve  
# 16884, -000



**Basis for concealed  
thermostats and mixers**  
iBox universal # 01800180



Talis® Classic

# The harmony of classic elegance



**Natural:** The mixers in the Talis Classic line combine original charm and pioneering water saving technology.



**Supreme:** Geometrical transitions, refined sweeps and discreet lines introduce a calm, yet exciting style to the bathroom.



## Advantages and benefits

- Slender, cylindrical basic form and tall geometry emanate elegance
- Augmented base and rounded spout highlight the original charm
- Pin handle with classical look for ease of use
- Automatic flow limit to 5 l/min thanks to EcoSmart technology

## Basin/bidet



**Talis® Classic 230**  
Single lever basin mixer  
with pop-up waste set  
# 14116, -000



**Talis® Classic 80**  
Single lever basin mixer  
with pop-up waste set  
# 14111, -000  
without waste set  
# 14118, -000



**Talis® Classic Natural 90**  
Single lever basin mixer  
with pop-up waste set  
# 14127, -000



**Talis® Classic**  
Single lever bidet mixer  
with pop-up waste set  
# 14120, -000



## Bath



**Talis® Classic**  
Single lever bath mixer  
exposed  
# 14140, -000



**Talis® Classic**  
Single lever bath mixer  
concealed  
# 14145, -000  
with safety combination  
# 14146, -000



**Talis® Classic**  
Bath filler  
exposed  
# 14148, -000



## Shower



**Talis® Classic**  
Single lever shower mixer  
exposed  
# 14161, -000



**Talis® Classic**  
Single lever shower mixer  
concealed  
# 14165, -000



**Basis for concealed  
thermostats and mixers**  
iBox universal # 01800180



Care mixers

# Barrier free for more comfort and safety

Longer handles, intuitive use, constant temperatures, large lettering: The mixers in the Talis Care and Focus Care lines and the Ecostat Comfort Care thermostats provide that extra safety, comfort and ease of use in the bathroom. The resulting ease in handling

water offers particular benefits to families with small children. These perfected solutions are ideal wherever people are in need of assistance owing to their age or illness or wherever special hygiene conditions apply: i.e. at retirement homes, hospitals, health

resorts, or hospices. But also where greater ease of use and safety are required, for instance at nursery schools, or hotels.



**Focus® Care**  
Single lever basin mixer

**Ecostat® Comfort Care**  
Shower thermostat

## Advantages and benefits

- Extra long, flat control lever: ergonomically formed for the whole hand or arm
- Comfortable use under a light touch
- Robust brass body and metal handle for a particularly long lifetime
- Temperature preset, e. g. for people who have lost their feeling for hot and cold

## Talis® Care

### Basin



**Talis® Care 150**  
Single lever basin mixer  
# 32036, -000



**Talis® Care 80**  
Single lever basin mixer  
# 32035, -000



**Talis® Care**  
Single lever basin mixer  
Exposed  
# 32037, -000



### Bath



**Talis® Care**  
Single lever bath mixer  
exposed  
# 32441, -000



**Ecostat® Comfort Care**  
Exposed  
bath thermostat  
# 13115, -000



### Shower



**Talis® Care**  
Single lever shower mixer  
exposed  
# 32641, -000



**Ecostat® Comfort Care**  
Exposed  
shower thermostat  
# 13117, -000

## Focus® Care

### Basin



**Focus® Care 100**  
Single lever basin mixer  
# 31911, -000



**Focus® Care 80**  
Single lever basin mixer  
# 31910, -000

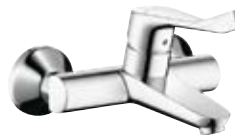

**Focus® Care**  
Single lever basin mixer  
Exposed  
# 31913, -000



### Shower



**Focus® Care**  
Single lever shower mixer  
exposed  
# 31916, -000



- User optimised lever length 121 mm
- Robust brass body
- Metal handle

Electronic basin mixer

# Sensors for greater hygiene and water savings

Here, water flows only when it is actually needed: Contactless mixers with infrared proximity electronics are especially useful in public facilities for saving water –

and hence for cutting the costs of consumption and energy. In addition, the contactless technology eliminates the risk of contamination associated with heavily used mixers in public

and corporate washrooms. Above all on the care and health sectors, hygiene experts recommend sensor controlled water sources.



**Focus®**  
Electronic basin mixer



## Advantages and benefits

- Water savings thanks to automatic stop
- Available for battery and mains connection
- Contactless, so particularly hygienic
- Ideal for public and business sectors
- WELL certified



**Electronic basin mixer**

**PuraVida®**



**PuraVida®**  
Electronic basin mixer  
with temperature control  
Battery operation  
# 15170, -000, -400  
Mains connection 230 V  
# 15172, -000, -400



**PuraVida®**  
Electronic basin mixer  
without temperature control  
Battery operation  
# 15171, -000, -400  
Mains connection 230 V  
# 15173, -000, -400



**Metris® S**



**Metris® S**  
Electronic basin mixer  
with temperature control  
Battery operation  
# 31100, -000  
Mains connection 230 V  
# 31102, -000



**Metris® S**  
Electronic basin mixer  
without temperature control  
Battery operation  
# 31101, -000  
Mains connection 230 V  
# 31103, -000



**Talis®**



**Talis®**  
Electronic basin mixer  
with temperature control  
Battery operation  
# 32110, -000  
Mains connection 230 V  
# 32112, -000



**Talis®**  
Electronic basin mixer  
without temperature control  
Battery operation  
# 32111, -000  
Mains connection 230 V  
# 32113, -000



**Focus®**



**Focus®**  
Electronic basin mixer  
with temperature control  
Battery operation  
# 31171, -000  
Mains connection 230 V  
# 31173, -000



**Focus®**  
Electronic basin mixer  
without temperature control  
Battery operation  
# 31172, -000  
Mains connection 230 V  
# 31174, -000



# Accessories

## Logis®



**Liquid soap dispenser**  
Glass  
# 40514, -000



**Toothbrush tumbler**  
Glass  
# 40518, -000



**Soap dish**  
Glass  
# 40515, -000



**Towel hook**  
# 40511, -000



**Roll holder**  
# 40523, -000



**Roll holder without cover**  
# 40526, -000



**Spare roll holder**  
# 40517, -000



**Toilet brush tumbler**  
Glass  
# 40522, -000



**Towel holder twin-handle**  
# 40512, -000



**Grab rail 300 mm**  
# 40513, -000



**Bath towel rail 600 mm**  
# 40516, -000

## Logis® Classic



**Liquid soap dispenser**  
Ceramics  
# 41614, -000



**Toothbrush tumbler**  
Ceramics  
# 41618, -000



**Soap dish**  
Ceramics  
# 41615, -000



**Towel hook**  
# 41611, -000



**Roll holder**  
# 41623, -000



**Roll holder without cover**  
# 41626, -000



**Spare roll holder**  
# 41617, -000



**Toilet brush tumbler**  
Ceramics  
# 41632, -000



**Towel holder twin-handle**  
# 41612, -000



**Grab rail 300 mm**  
# 41613, -000



**Bath towel rail 600 mm**  
# 41616, -000

Mixer

Hand shower

Overhead shower

Shower

**Avantgarde**



**PuraVida®** 110



**PuraVida®** 150



**PuraVida®** 400



**PuraVida®**  
Exposed



**PuraVida®**  
Concealed

**Modern**



**Metris®** 110



**Raindance®**  
Select S 150



**Raindance®** Select E 300



**Metris®**  
Exposed



**Metris®**  
Concealed



**Talis®** 80



**Croma®** 100



**Croma®** 160



**Talis®**  
Exposed



**Talis®**  
Concealed



**Focus®** 70



**Crometta®** 85



**Crometta®** 85



**Focus®**  
Exposed



**Focus®**  
Concealed

**Classic**



**Metris® Classic** 100



**Raindance®**  
Classic 100



**Raindance®**  
Classic 240



**Metris® Classic**  
Exposed



**Metris® Classic**  
Concealed



**Talis® Classic** 80



**Croma®** 100  
Classic



**Talis® Classic**  
Exposed



**Talis® Classic**  
Concealed

Hansgrohe waste systems

# Discreet design, perfect function

Cleanliness is indispensable for well being in the bathroom. For this reason, Hansgrohe has developed a large number of innovative waste systems. The used water

can then drain off quickly and easily. Flexible models like Exafill, Flexaplus, Raindrain and Flowstar are easy to install and in addition are perfectly easy to use. Overflow control and

other intelligent functions maintain comfort on a high level for a very long time – also after the shower pleasure.



**Push-Open:** The Push-Open waste is opened and closed at the tap of a finger and water can collect and drain off very easily.



**Flowstar®:** The Flowstar waste system also presents a visually clean solution under the wash basin.



**Exafill® S bath:** The integrated fine flood spray fills the bath easily and free of splashes, so a separate bath filler is not needed. Exafill S is everything in one: bath filler, outflow and overflow. Better still: The installation is pleasantly uncomplicated – and with QuickClean technology cleaning the filler nozzles is just as easy.



**Flexaplus® S bath:** Never again a bath that has run too full. The outflow and overflow mixer regulates excess bath water through the overflow control element. In addition, the water level in the bath can be raised by up to 25 mm – for even more bath fun.



**Raindrain® 90 XXL shower:** Ideal for large showers with high flow rates like Raindance Rainfall or Raindance Rainmaker. Provides for a fast and uncomplicated outflow in all shower pans. The perfect shower outflow with a max capacity of 51 l/min and easy installation.



### Advantages and benefits

- Water can drain off quickly and easily
- Easy to install and use
- Reliable even for large showers with high flow rates
- Overflow control and other intelligent functions

## Siphons



**Flowstar® designer siphon**  
# 52100, -000  
Set: 1 Flowstar,  
2 angle valve bolts  
(without angle valve)  
# 52110, -000 (not shown)  
Set: 1 Flowstar,  
2 angle valve bolts  
(incl. angle valve)  
# 52120, -000 (not shown)



**Flowstar® S designer siphon**  
# 52105, -000



**Angle valve E**  
# 13902, -000



**Angle valve S**  
# 13901, -000



**Basin valve**  
Push-Open waste  
# 50100, -000



**Basin valve**  
with closed cover plate  
# 50001, -000, -800



**Waste set**  
with tilting lever  
# 94139, -000

## Waste systems for showers



**Raindrain® 90 XXL**  
Complete set  
51 l/min  
# 60067, -000



**Raindrain® 90 XXL**  
Basic set  
51 l/min  
# 60065180



**Raindrain® 90 XXL**  
Finish set  
# 60066, -000

▪ Flow performance  
max 51 l/min

▪ Easy installation



**Staro® '90**  
Complete set  
29 l/min  
# 60056, -000



**Staro® '90**  
Basic set  
29 l/min  
# 60054180



**Staro® '90**  
Finish set  
# 60055, -000



**Staro® '52**  
Complete set  
33 l/min  
# 60060, -000



**Starolift® '52**  
Basic set  
33 l/min  
# 60052180



**Starolift® '52**  
Finish set  
# 60053, -000

## Waste systems for bath tubs



**Flexaplustm**  
Waste and overflow complete set  
with flexible hose  
for standard tubs  
# 58143, -000



**Flexaplustm S**  
Waste and overflow complete set  
with flexible hose  
for standard tubs  
# 58150, -000



**Flexaplustm**  
Waste and overflow basic set  
with flexible hose  
for standard tubs  
# 58140180



**Flexaplustm**  
Waste and overflow basic set  
with flexible hose  
for special tubs  
# 58141180



- Spring loaded plug protects against injury
- Self cleaning screw siphon



**Flexaplustm**  
Finish set  
# 58185, -000



**Flexaplustm S**  
Finish set  
# 58186, -000



**Exafilltm**  
Bath filler with waste  
and overflow complete set  
for standard tubs  
# 58123, -000



**Exafilltm**  
Bath filler with waste  
and overflow basic set  
for standard tubs  
# 58125180



**Exafilltm**  
Bath filler with waste  
and overflow basic set  
for special tubs  
# 58126180



**Exafilltm**  
Finish set  
# 58127, -000



**Exafilltm S**  
Bath filler with waste  
and overflow complete set  
for standard tubs  
# 58113, -000



**Exafilltm S**  
Bath filler with waste  
and overflow basic set  
for standard tubs  
# 58115180



**Exafilltm S**  
Bath filler with waste  
and overflow basic set  
for special tubs  
# 58116180



**Exafilltm S**  
Finish set  
# 58117, -000



- Flexibly adaptable to bath forms

# KITCHEN MIXERS

---

**Mixer diversity where know-how quality,  
functionality and design come together:**

PuraVida® | Metris® | Talis® | Focus®





ComfortZone kitchen



# Quality completely to the taste of your customers

Many find cooking to be an activity that helps them to forget things for a while and relax. This effect is boosted by the modern, yet practical design of Hansgrohe kitchen mixers. The functional details include fold-down

mixers, practical pull-out sprays and electronic temperature control. Intelligent handling then turns cooking into a real pleasure. The ComfortZone does its share in making every movement easier: High spouts offer plenty of

freedom of movement and make it easy to fill tall pots and vases. Thanks to practical models with a generous swivel range and pull-out sprays with two spray types, even the washing up becomes a pleasure.



**ComfortZone:** The higher the space between the mixer and sink, the larger the freedom of movement.

Hansgrohe kitchen mixers

# The kitchen mixer lines at a glance

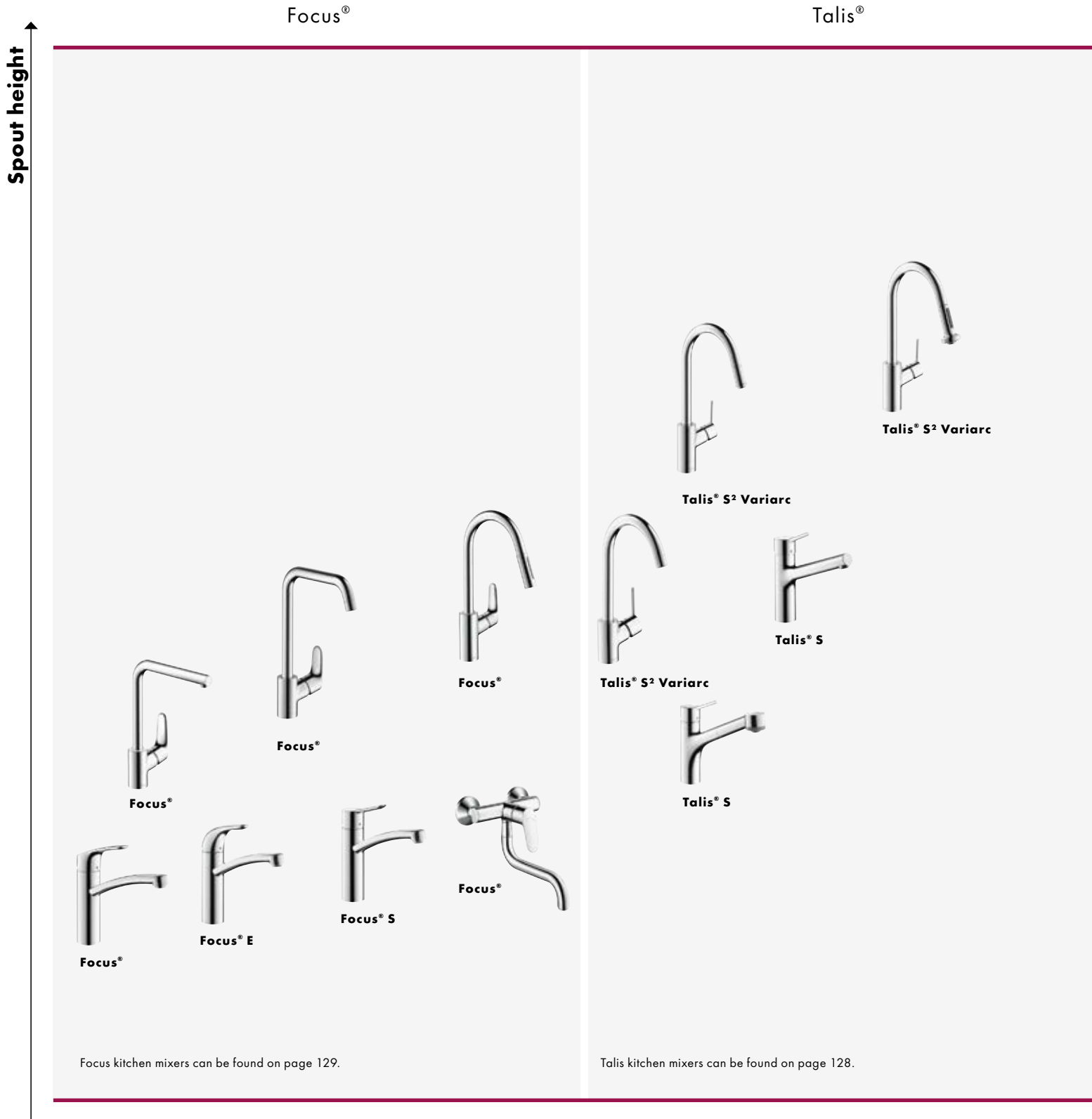

## How to use the overview in your sales presentation

The higher a product is positioned, the greater its ComfortZone. The products are arranged in ranges extending to the right.

Metris®

PuraVida®

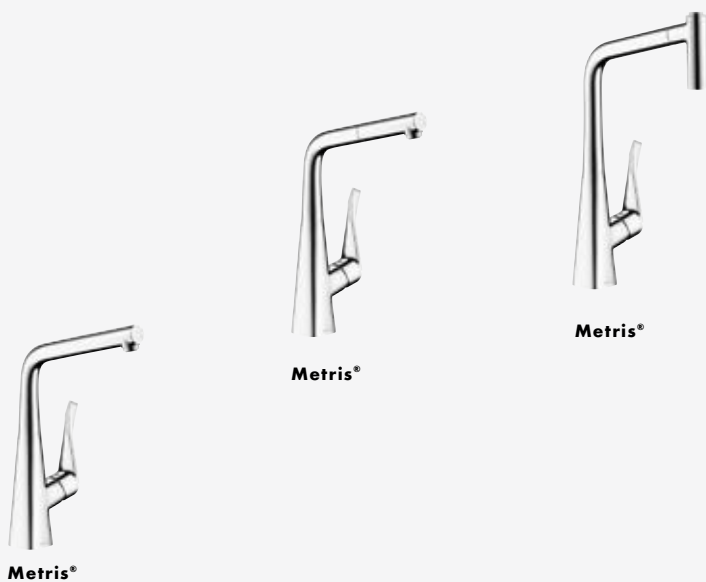

Metris®

Metris®

Metris®



PuraVida®

PuraVida®

Metris kitchen mixers can be found on pages 126 onwards.

PuraVida kitchen mixers can be found on pages 124 onwards.

PuraVida® 2-hole single lever kitchen mixer

# Leaves no wish unfulfilled for perfect ergonomics

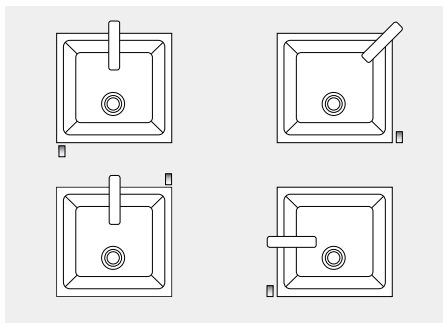

Examples of installation variants



**PuraVida®**  
2-hole single lever kitchen  
mixer with 120° swivel spout  
(Stainless steel look illustrated)  
# 15812, -000, -800



## Advantages and benefits

- Used separately from the basic set for impressive aesthetics
- Individual positioning of the mixer and handle around the sink for convenience and ergonomics
- High swivel spout for greater freedom of movement between the spout and sink
- DualFinish with smooth transition from the brushed basic set to the polished spout

Find out more at [www.pro.hansgrohe-int.com/kitchen](http://www.pro.hansgrohe-int.com/kitchen)

PuraVida® 2-hole electronic kitchen mixer

# Intelligent functionality at the sink



## Quick temperature selection



Push



1 push – cold water



2 pushes – mixed water



3 pushes – warm water

## Temperature



Turn

## Volume



Push & turn

## Cleaning



Push & hold

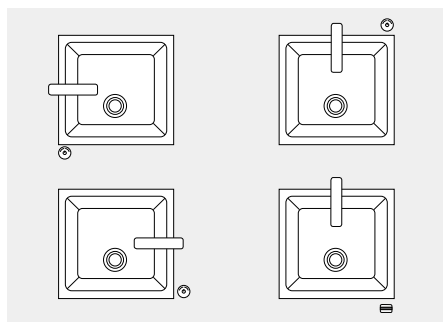

Examples of installation variants



**PuraVida®**  
2-hole electronic kitchen mixer with 120° swivel spout (Stainless steel look illustrated)  
# 15805, -000, -800



## Advantages and benefits

- Used separately from the basic set for impressive aesthetics
- Individual positioning of the mixer and handle around the sink for convenience and ergonomics
- High swivel spout for greater freedom of movement between the spout and sink
- Pressed button and twisting for ease of use
- LED illuminated ring for water temperature
- DualFinish with smooth transition from the brushed basic set to the polished spout

Find out more at [www.pro.hansgrohe-int.com/kitchen](http://www.pro.hansgrohe-int.com/kitchen)

Metris® single lever kitchen mixer

# Perfect in the hand, perfect in design



## Advantages and benefits

- Three mixer types for every need: with pull-out spray, pull-out spout, or swivel spout
- Ergonomic pull-out spray design for enhanced ease of use
- Ideal for all age groups thanks to ergonomically rounded handle for ease of use
- Basic form matching the shape of the sink and integrating harmoniously in the kitchen
- Also available with fold-down function for installation in front of a window

**Metris®**



**Metris®**  
Single lever kitchen mixer  
with pull-out spray,  
two spray types,  
110°/150° swivel spout  
# 14820, -000, -800

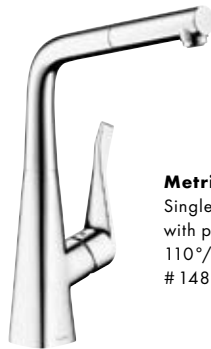

**Metris®**  
Single lever kitchen mixer  
with pull-out spout,  
110°/150° swivel spout  
# 14821, -000, -800

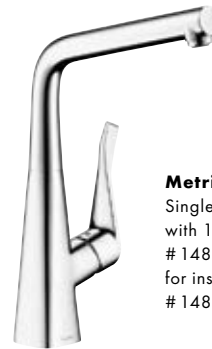

**Metris®**  
Single lever kitchen mixer  
with 110°/150°/360° swivel spout  
# 14822, -000, -800  
for installation in front of a window  
# 14823, -000



- Vertical handle position
- Pull-out spray with 2 spray types (normal/shower spray)
- Clear, laminar spray for fewer splashes



**Talis®**



**Talis® S² Variarc**  
Single lever kitchen mixer  
with pull-out spray, two spray types,  
150° swivel spout possible  
for window installation  
# 14877, -000, -800



**Talis® S² Variarc**  
Single lever kitchen mixer  
with pull-out spout, 150° swivel spout  
possible for window installation  
# 14872, -000, -800



**Talis® S² Variarc**  
Single lever kitchen mixer  
with 110°/150°/360° swivel spout  
# 14870, -000, -800  
for open water heaters  
# 14873, -000  
with shut-off valve  
# 14875, -000 (not shown)



**Talis® S**  
Single lever kitchen mixer  
with pull-out spray, two spray types,  
150° swivel spout  
# 32841, -000, -800  
for open water heaters  
# 32842, -000



**Talis® S**  
Single lever kitchen mixer  
with 150° swivel spout  
# 32851, -000, -800  
for open water heaters  
# 32852, -000  
with shut-off valve  
# 32855, -000 (not shown)





**Focus®**



**Focus®**  
Single lever kitchen mixer  
with 110°/150°/360° swivel spout  
# 31817, -000, -800

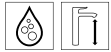

**Focus®**  
Single lever kitchen mixer  
with pull-out spray, two spray types,  
150° swivel spout  
# 31815, -000, -800



- Pull-out spray with 2 spray types (normal/shower spray)
- MagFit magnetic holder for spray



**Focus®**  
Single lever kitchen mixer  
with 110°/150°/360° swivel spout  
# 31820, -000, -800  
for open water heaters  
# 31822, -000, -800  
with shut-off valve  
# 31823, -000 (not shown)



**Focus®**  
Single lever kitchen mixer  
with 360° swivel spout  
# 31806, -000, -800  
for open water heaters  
# 31804, -000  
with shut-off valve  
# 31803, -000 (not shown)



**Focus®**  
Single lever kitchen mixer  
for wall installation,  
180° swivel spout  
# 31825, -000



- Swivel range can be set in three steps (110°/150°/360°)
- Variable handle position (right or left)



**Focus® E**  
Single lever kitchen mixer  
with 360° swivel spout  
# 31780, -000  
for open water heaters  
# 31784, -000



**Focus® S**  
Single lever kitchen mixer  
with 360° swivel spout  
# 31786, -000  
for open water heaters  
# 31785, -000  
with shut-off valve  
# 31783, -000 (not shown)



**Kitchen shut-off valve**  
matching Hansgrohe kitchen mixers  
# 10823, -000, -800



Hansgrohe kitchen technologies

# Everything that makes excellent kitchen helpers

A kitchen helper should not only be an eye-catcher it should also withstand a lot. After all, a kitchen mixer is used up to ninety times a day. This makes it the most often used device in the kitchen. That is why we make every single kitchen mixer exclusively from top

quality materials – and fit them with technical highlights. This means: From the peeler to the gourmet, from the dishwasher to the five star chef – Hansgrohe kitchen mixers are a pleasure to all. No matter who is turning on the tap: Here is where know-how quality,

functionality and design come together. This makes our kitchen mixers competent helpers at the sink that will convince even the most discerning of customers.

Quality made by  
**Hansgrohe**

**Quality made by Hansgrohe:** High quality materials and the fulfilment of international standards assure buyers that they are purchasing a long lasting quality product.



**MagFit magnetic holder:** Thanks to the MagFit function, the hose slides back almost silently and slots back into place in the middle of the mixer spout.



**Pull-out spray with two spray types:** The pull-out spray also offers two types of spray, normal and shower, which are easy to change between.



**Ergonomic handles:** Long flat handles for ease of control.



**Swivel function:** The mixers offer either a limited swivel range (110°/120°/150°) or all-round freedom of movement (360°).



**Pull-out spray/spout:** The pull-out spray and the pull-out spout extend the range at the sink.



**ComfortZone:** The ultra high spout offers plenty of space and is ideal for filling large containers and pots.



**Vertical handle position:** Installation is possible even when there is only little room between the mixer and wall. Plus: Hot water flows at the vertical handle out of the reach of children's hands.



**Separation of spout and control unit:** The handle can be positioned flexibly, around the sink in the desired location.



**Variable handle positioning:** The handle can be installed on the left or right, as preferred.



**Stainless steel look PVD:** Stainless steel look surfaces are made with PVD technology and are particularly resistant to wear and scratches.



**QuickClean:** It is very difficult for limescale to take hold on the elastic disc and if it does, it can easily be rubbed away.



**Fold-down function for window installation:** Ideal for installation in front of a window; simply lift the mixer up when required and lay it down.



**Ceramic or joystick cartridge:** Specially hardened plastics provide the basis for long lasting mixers in the joystick, M1 and M2 cartridges.



**Boltic lever lock:** The wedge-shaped control lever of the Boltic lever lock ensures stable control.



**PEX hoses:** The PEX hoses are temperature-resistant and neutral in taste and odour.



**Easy installation:** Flexible connections make it easier to install the mixer.



**QuickConnect for pull-out spray hoses:** Thanks to the QuickConnect function, the hoses are particularly easy to fit.



**Kitchen shut-off valve:** available as an option in the same design as any Hansgrohe kitchen mixer for external device shut-off, such as dishwashers.



**Five year guarantee:** You can trust Hansgrohe quality. This is confirmed by the voluntary five-year warranty.

# COMPANY

---

**Ideas with water:  
Hansgrohe has been  
a step ahead of its time since 1901**



The Hansgrohe company

## The love of water lies in our family

Hans Grohe was a pioneer, constantly looking to create new innovations, he was not satisfied with anything less than groundbreaking. In a time when initial ideas were being aired for private home bathrooms and the daily shower was still utopian, he was already developing the first showerheads. He therefore set new standards in the bathroom – far beyond the borders of the Black Forest. Now with branches

and subsidiaries in 37 countries on all continents and global product availability, the Hansgrohe brand is seen to be one of the few global players in the sanitary industry. Now as then, the family company is producing predominantly in Schiltach and Offenburg – an acknowledgement to “made in Germany” and at the same time an expression of the values lived at Hansgrohe. One of the most important values is that of social responsibility.

The Hansgrohe Group is therefore one of the sector’s pioneers in the arena of sustainability and environmental and climatic protection. This is reflected in water and energy saving products as well as in sophisticated recycling systems, environmentally friendly production technologies, global environmental protection projects and information on the sustainable handling of the resource water.



Hans Grohe was still young when he founded the company in 1901



Hans Grohe with his son Klaus, 1937



Klaus Grohe with his sons Richard and Philippe, 2013

Shower history at Hansgrohe

# Milestones of shower technology

From the trickling apparatus to the convenient spray change at the push of a button: Since 1901, the inventions from the Black Forest thinktank have been shaping the bathroom landscape all over the world. Many products, concepts and solutions developed and designed at Hansgrohe have given fresh impetus to the international bathroom industry. Some have written bathroom, perhaps even cultural, history. Such a success story motivates us to constantly stay ahead of the times.



**1928**

**1968**

**1974**

**1976**

**1986**

**1987**

Selecta®

Tribel®

Mistral®

Aktiva®

Mistral® Eco

First hand shower with white porcelain handle

Selecta hand shower with continuously adjustable shower spray and glass look

First design award winning hand shower in many colours and with three spray types

First hand shower with rotating massage spray

First hand shower with anti-limescale function QuickClean

New technology with up to 50% water savings



**1993**  
Joco®

First cartoon design hand shower for children

**1999**  
Aktiva® A8

2-shell hand shower with internal flow structure and threefold anti-limescale function

**2003**  
Raindance®

First hand shower with XL showerhead and Whirl spray

**2004**  
Raindance® Air

First hand shower with AirPower technology

**2009**  
PuraVida®

Pioneering design language with DualFinish in white/chrome; easy spray change at the push of a button

**2011**  
Raindance® Select

First Raindance hand shower with Select technology for spray changes

**2012**  
Raindance® Select

First hand shower with two full rain sprays, changed by Select

Award for outstanding design



# Perfected water pleasure also means for us: Perfectly shaped

To us, design is not a matter of taste, but an attitude – even a passion. Accordingly, international acclaim has been a constant source of joy to us: Hansgrohe SE with its Hansgrohe and Axor brands took eleventh

place in the 2013 iF rankings and is therefore number one on the bathroom industry. Over 350 awards make us one of the highest award winners on the sanitary market. However, design is never an end in itself, but always

an expression of equality between form and function. In the search for the most intelligent solution, we create showers and mixers whose extraordinary quality is a never ending source of pleasure.



**Raindance®**  
Hand shower



2003 2003 2004



**Raindance® S 150**  
Hand shower



2005 2006 2006



**Raindance® Royale 350**  
Overhead shower



2005 2005 2006



**Raindance® Rainmaker®**  
Overhead shower



2005 2006



**Metris® S**  
Electronic basin mixer



2006 2007



**Focus® S**  
Single lever basin mixer



2006 2007



**Raindance®**  
Hand shower



2007



**Talis® E<sup>2</sup>**  
Single lever basin mixer



2007 2008



**Croma® 100 Multi**  
Hand shower



2007 2008



**Raindance® Rainfall® 240**  
Overhead shower



2007 2008 2009



**Talis® S<sup>2</sup>**  
Single lever basin mixer



2007 2007 2008



**Raindance® Connect S 240**  
Showerpipe



2007 2007 2008 2010



**Croma® 100**  
Showerpipe



2008



**Raindance® S 150/  
Raindance® Unica® S**  
Set



2008 2009



**Ecostat® E**  
Bath thermostat



2008 2009



**Talis® Classic**  
Single lever basin mixer



2008 2009



**Crometta® 85 Green**  
Hand shower



2008 2010



**PuraVida® 240**  
Single lever basin mixer



2009 2009 2010 2011



**PuraVida® 400**  
Overhead shower



2009 2010



**PuraVida® 150**  
Hand shower



2009 2009 2010



**PuraVida® 110**  
Single lever basin mixer



2009 2009 2010



**RainBrain®**  
Shower control



2009 2012



**Focus® E<sup>2</sup>**  
Single lever basin mixer



2010 2011



**Raindance® E 420**  
Showerpipe

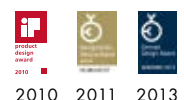

2010 2011 2013





reddot design award



Focus Open Silber 2012

**DESIGN PLUS**  
powered by: **ISH**



**Raindance® 240**  
Showerpipe



2010 2010 2011



**Raindance® E 420**  
Overhead shower



2010 2012



**PuraVida®**  
Electronic kitchen mixer



2011 2012



**Raindance®**  
**Select S 150**  
Hand shower



2011 2012 2012



**Raindance®**  
**Rainfall® 180**  
Overhead shower



2012



**PuraVida®**  
Electronic basin mixer



2012



**Focus® 240**  
Single lever basin mixer



2012



**Focus®**  
Electronic basin mixer



2012 2012



**PuraVida® 225**  
Single lever basin mixer



2012 2012



**Metris®**  
Product family



2012 2012



**Talis®**  
Product family



2012



**Focus®**  
Product family



2012



**Raindance®**  
**Select E 120**  
Hand shower



2013



**Raindance® Rainfall®**  
**150 Stream**



2013



**Raindance® Lift**  
**Showerpanel®**



2013



**ShowerSelect®**  
Thermostat product family



2013 2014



**ShowerTablet®**  
**Select 300**  
Thermostat



2013 2014



**Raindance®**  
**Select S 120**  
Hand shower



2014

## Phoenix design – winner of many awards



Manfred Dorn, Tom Schönherr, Andreas Haug, and Harald Lutz (from left)



The Hansgrohe Raindance Select E 120 hand shower in the design process

This team has been shaping the face of Hansgrohe for many years: Andreas Haug, Tom Schönherr, Manfred Dorn and Harald Lutz. Their yardstick of successful design is the satisfaction of the people who use their products. Although this creative team prefer to work in the background, they are nevertheless overjoyed at the many awards their design workshop has received.

Photo: Phoenix Design

Pontos® AquaCycle and Pontos® HeatCycle

# Typically Hansgrohe: dual use of water and heat

Likewise two innovative sustainability projects from Hansgrohe: Pontos AquaCycle and Pontos HeatCycle. These are based on the idea that water and heat can be used twice. After all, half of the water requirements do not need drinking water quality: Flushing toilets, cleaning floors and watering the

garden can simply make use of processed water. Pontos AquaCycle utilises a biological method for cleaning used shower and bath water and afterwards processes the result so that it can be used a second time, e.g. for flushing toilets. When Pontos AquaCycle and Pontos HeatCycle are combined, heat is

additionally extracted from the used shower water and used again to heat water. Energy savings can be that efficient. After all, climate protection begins when you wash your hands or take a shower. Less energy means less CO<sub>2</sub> emissions at the same time. And that, in turn, is good for us all.

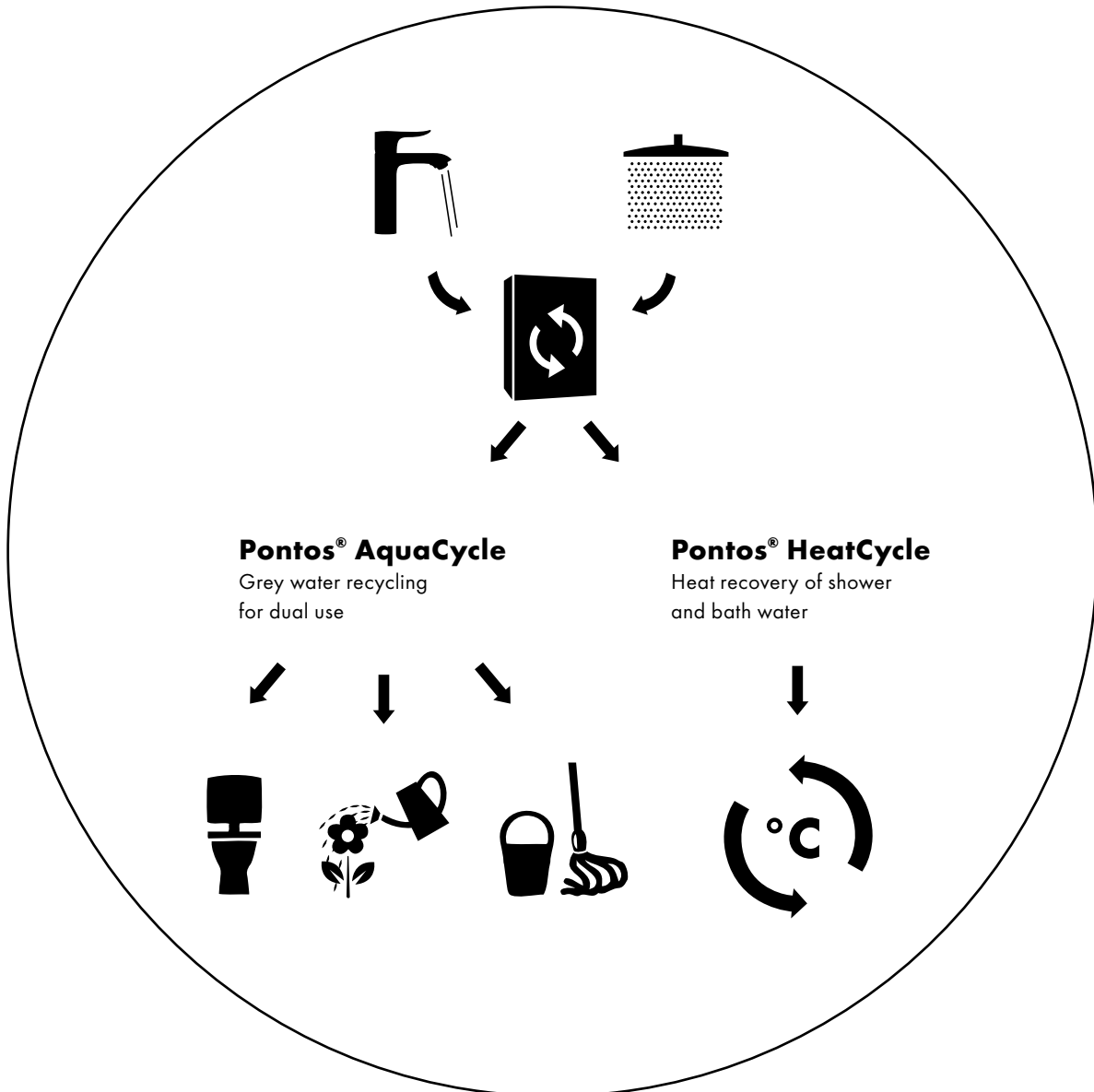

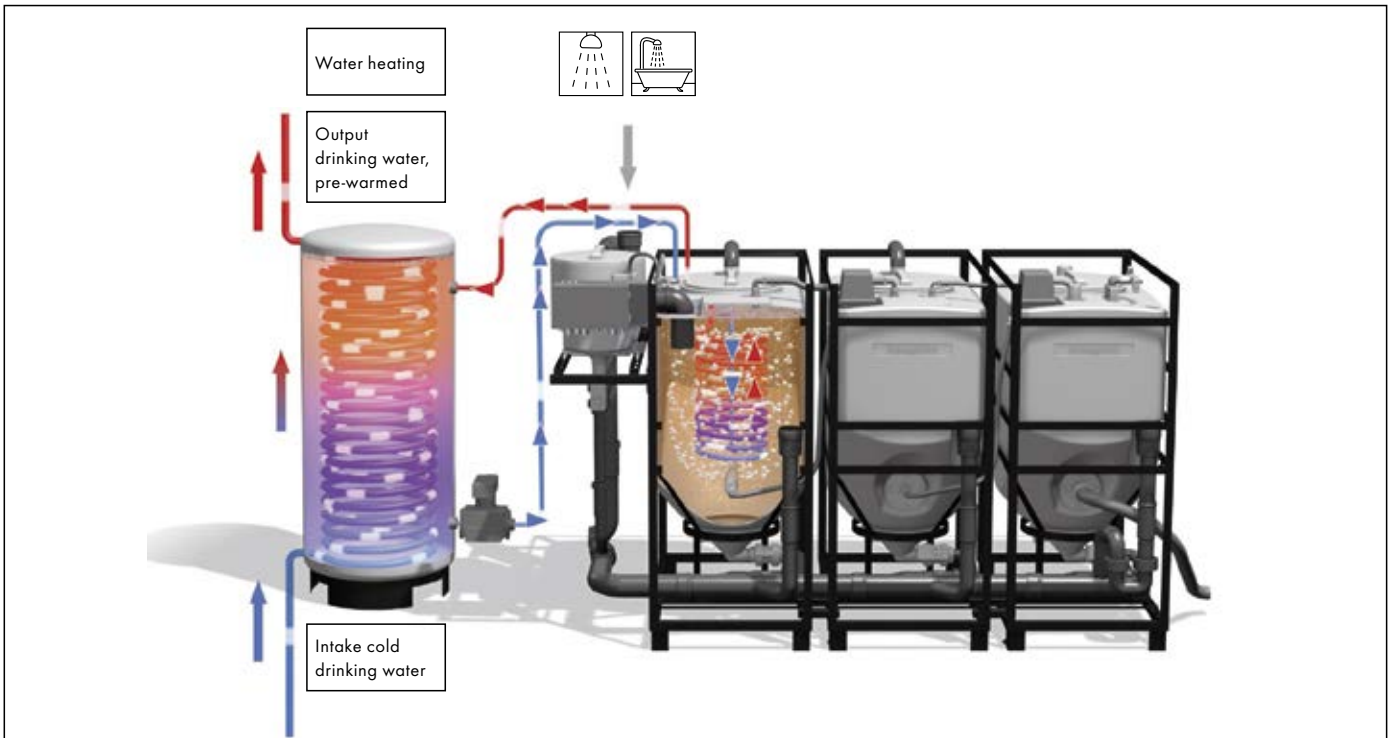

Pontos HeatCycle technology.



**Swimming pools:** The shower water used at the Yerres swimming baths is put to dual use thanks to Pontos AquaCycle: for tending gardens and cleaning the city.



**City cleaning:** The Hamburg city cleansing department reuses water from the showers and basins of its own facilities for cleaning the city.



**Hotels:** The Prague hotel Mosaic House is fitted with Pontos AquaCycle, Pontos HeatCycle and other Hansgrohe products.

International projects

# The world is our home

Quality made by  
**Hansgrohe**

All over the world, developers and investors work hand in hand with architects and planners on sophisticated projects. They are constantly in need of intelligent and

aesthetically appealing solutions for handling the essential element water. The mixers, showers and bathroom collections from the Black Forest lend top addresses that definite

extra design and comfort: in impressive hotels and public buildings, in private residences and royal palaces, in exclusive sports clubs and in cruise ships and luxury yachts.



Alice Lane Towers, South Africa.  
Hansgrohe product: Metris S electronic basin mixer.



Hotel PlayaMar Tres Cantos, Mexico.  
Hansgrohe products: Metris S basin mixer, Talis S shower mixer and Croma 100 Multi/Unica °C Set.



Celebrity Equinox cruise ship.  
Hansgrohe product: Talis S basin mixer.  
Photo: Meyer Werft



Donbass Arena, Ukraine.  
Hansgrohe product: Metris S basin mixer.  
Photo: Donbass Arena



Hotel JW Marriott, Santa Fe/Mexico City.  
Hansgrohe product: PuraVida basin mixer.  
Photo: Hotel JW Marriott



Hotel Château Bethlehem, Maastricht.  
Hansgrohe products: Basin mixers Metris S, Talis S, Metropol S and PuraVida; Raindance Rainmaker, Ecostat S and Croma 100 Showerpipes.





Hotel Budersand, Sylt.  
Hansgrohe products: Raindance Rainfall and Raindance S hand showers.  
Photo: jana-ebert.de



Hotel Waldorf Astoria, Berlin.  
Hansgrohe products: Raindance S hand showers, Raindance Rainfall.  
Photo: Waldorf Astoria



Hotel Bella Sky, Copenhagen.  
Hansgrohe products: Croma 160 overhead showers and Croma Vario 100 hand showers.  
Photo: Claus Starup, Bella Center



Scarlet Hotel, Cornwall.  
Hansgrohe products: Raindance overhead showers, Talis S basin mixers, and Pontos AquaCycle 9000.



Hyatt Capital Gate Hotel, Abu Dhabi.  
Hansgrohe products: Raindance S 240 Air overhead shower.  
Photo: abudhabi.capitalgate.hyatt.com



Royal Spa, Kitzbühel.  
Hansgrohe products: Raindance overhead showers and Croma 100 hand showers.  
Photo: Harald Eisenberger/Warimpex



Hotel Hamilton Scotts, Singapore.  
Hansgrohe products: Raindance E 360 and 240 overhead showers, PuraVida hand showers, Talis electronic basin mixers.  
Photo: Hamilton Scotts



Hotel Balcones Del Atlántico, Dominican Republic.  
Hansgrohe products: Metris S basin mixers and Croma 100 shower sets.



Please bear in mind that we can present only a selection of our products in this sales manual. Our full range can be found on the internet.

**Find out more about the Hansgrohe world at [www.pro.hansgrohe-int.com](http://www.pro.hansgrohe-int.com)**



### **Experience Hansgrohe products interactively**

The iPad version of the end customer catalogue can be found at <http://itunes.com/app/hansgrohecatalog>



### **Planning with Hansgrohe@home**

Show your customers virtually by iPhone, iPad or android smartphone how good a Hansgrohe mixer will look on your washstand at home. The version for your device is available free of charge at

iTunes: <http://itunes.com/app/hansgrohehome>

Google Play: <http://play.google.com/store/search?q=hansgrohe+se>



### **Savings with Hansgrohe**

All you need to know about how Hansgrohe helps to save water and energy can be found at [www.hansgrohe-int.com/savings-calculator](http://www.hansgrohe-int.com/savings-calculator) or, on mobile devices, at <http://m.pro.savings.hansgrohe-int.com>



This catalogue has been produced with as much care for the environment as possible. You can also do your bit for the environment by passing this catalogue on to others when you have finished with it or else recycling it.



[www.facebook.com/hansgrohe](http://www.facebook.com/hansgrohe)



[www.twitter.com/hansgrohe\\_pr](http://www.twitter.com/hansgrohe_pr)



[www.youtube.com/hansgrohe](http://www.youtube.com/hansgrohe)

## Technologies



Switches over to a different shower or spray type in moments, and provides pleasure at the touch of a button.



Reduces the flow rate to save water and energy. For long-lasting pleasure.



Combines water with a generous amount of air. For a soft, splash-free water spray and rich, full shower drops.



Limescale deposits are simply wiped away by rubbing a finger over the flexible silicone jets.

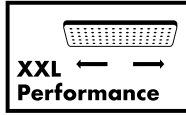

Distributes the water over the large spray face. Envelops the whole body in drops of well-being.



Defines the individually utilisable area between washstand and mixer. Something to suit every customer.

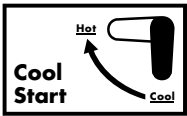

Cold water starts to flow when it is opened in the basic setting. You consume hot water only when you need it.

## Spray modes

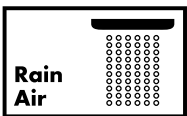

Gentle shower rain with air-enriched drops.

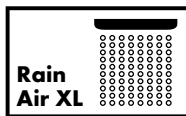

The especially large spray face envelops your whole body with soft drops.



Perfect for rinsing shampoo out of your hair.



In a gentle shower rain of air-enriched drops, everyday grime is simply washed away drop by drop.

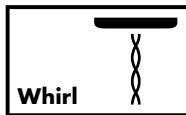

A concentrated spray that you can use to massage quite particular parts of your body.

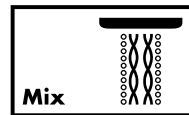

The harmonious combination of gentle shower drops and dynamic spray.

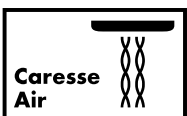

Provides fresh energy after a challenging day: the feel good, revitalising massage spray.



Strong, pulsating massage spray.



A flat, bundled jet for partly refreshing targeted shower pleasure.



A powerful surge spray for the feeling of standing alone in a lagoon. Every day.



Parallel jets of large sparkling water drops right down to the floor for the same showering experience on all body sizes.

## Surfaces

Order numbers specifying a surface finish are (#) eight digits long, for example 28500, -000=Chrome

- 000 Chrome
- 400 White/chrome
- 450 White
- 800 stainless steel optic

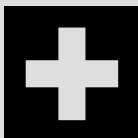

## Hansgrohe professional support:

### The Hansgrohe Master Service

Experienced master sanitary fitters provide sound knowhow for your technical questions on any product in the Hansgrohe range. Service and spare parts are supplied over the fastest route.

#### Service hours:

Mon-Fri: 7:00 am to 06:00 pm

Phone: +49 7836 51-1282

Fax: +49 7836 51-1440

Email: [info@hansgrohe.com](mailto:info@hansgrohe.com)

### Hansgrohe availability guarantee

All spare parts are available for ten years following purchase. You can then rest assured, also for projects completed in the past.

### Hansgrohe quality warranty

The highest quality is an elementary constituent of the Hansgrohe corporate philosophy. For this reason, we offer consumers a voluntary manufacturer's warranty of five years on our products.

Details at [www.hansgrohe-int.com](http://www.hansgrohe-int.com).

### Hansgrohe Aquademie

The Aquademie is our adventure centre on all aspects of water. Learn everything about bathroom and bathing history at our museum. Our exhibition shows you how international designers turn bathrooms into real feel good oases. See for yourself how innovative technologies put genuine pleasure into water savings.

Or enjoy pure showering and water fun in our Showerworld, Germany's largest bathroom.

#### Opening hours:

Mon-Fri: 7:30 am to 07:00 pm

Sat-Sun: 10:30 am 04:00 pm

Admission free of charge. For Showerworld:

Appointment and swimwear required.

**Australia** – Hansgrohe Pty Ltd · Level 1 · 123 Camberwell Rd · East Hawthorn · Victoria 3123

Tel. +61 3 9811 9971 · [info@hansgrohe.com.au](mailto:info@hansgrohe.com.au) · [www.hansgrohe.com.au](http://www.hansgrohe.com.au)

**Croatia** – Hansgrohe jugoistočna Europa ured i izložbeni salon · Horvatova 82 · 10010 Novi Zagreb

Tel. +385 1 5630 800 · Fax +385 1 5630 899 · [info@hansgrohe.hr](mailto:info@hansgrohe.hr) · [www.hansgrohe.hr](http://www.hansgrohe.hr)

**Estonia** – Hansgrohe Eesti · Mäealuse 2/1 · 12618 Tallinn · Estonia

Tel.: +37253329055 · Fax.: +37256000055 · [info@hansgrohe.ee](mailto:info@hansgrohe.ee) · [www.hansgrohe.ee](http://www.hansgrohe.ee)

**Latvia** – SIA Aqua Studio · Raiņa str. 14 · LV-3913 Iecava

Tel. +371 29 229029 · Fax +371 3 942251 · [info@hansgrohe.lv](mailto:info@hansgrohe.lv) · [www.hansgrohe.lv](http://www.hansgrohe.lv)

**Lithuania** – Santoza · Ulonų g. 5 · LT-08240 Vilnius

Tel. +370 5 2043291 · Fax +370 5 2043293 · [info@hansgrohe.lt](mailto:info@hansgrohe.lt) · [www.hansgrohe.lt](http://www.hansgrohe.lt)

**Serbia** – Hansgrohe SE · P.O. Box 1145 · D-77757 Schiltach

Tel. +49 7836 51-0 · Fax +49 7836 51-1300 · [info@hansgrohe.rs](mailto:info@hansgrohe.rs) · [www.hansgrohe.rs](http://www.hansgrohe.rs)

**Singapore** – Hansgrohe Pte. Ltd. · 69 Mohamed Sultan Road · Singapore 239015

Tel. +65 6884 5060 · Fax +65 6884 5070 · [info@hansgrohe.com.sg](mailto:info@hansgrohe.com.sg) · [www.hansgrohe.com.sg](http://www.hansgrohe.com.sg)

**Slovak Republic** – Hansgrohe SE · P.O. Box 1145 · D-77757 Schiltach

Tel. +49 7836 51-0 · Fax +49 7836 51-1300 · [info@hansgrohe.si](mailto:info@hansgrohe.si) · [www.hansgrohe-int.com](http://www.hansgrohe-int.com)

**Sweden** – Hansgrohe AB · Svagatan 2B · S-416 68 Göteborg

Tel. +46 31 216600 · Fax +46 31 190103 · [info@hansgrohe.se](mailto:info@hansgrohe.se) · [www.hansgrohe.se](http://www.hansgrohe.se)

**Headquarters** – Hansgrohe SE · P.O. Box 1145 · D-77757 Schiltach

Tel. +49 7836 51-0 · Fax +49 7836 51-1300 · [info@hansgrohe.com](mailto:info@hansgrohe.com) · [www.hansgrohe.com](http://www.hansgrohe.com)

