

PS-04

Palmtop Studio

Operation Manual

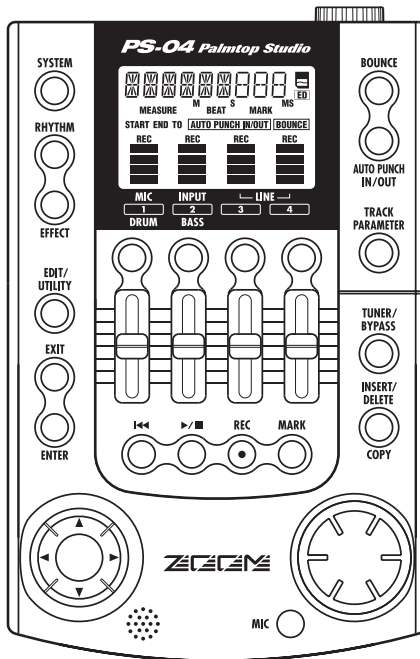

© ZOOM Corporation

Reproduction of this manual, in whole or in part, by any means, is prohibited.



USAGE AND SAFETY PRECAUTIONS

In this manual, symbols are used to highlight warnings and cautions for you to read so that accidents can be prevented. The meanings of these symbols are as follows:



This symbol indicates explanations about extremely dangerous matters. If users ignore this symbol and handle the device incorrectly, serious injury or death could result.



This symbol indicates explanations about dangerous matters. If users ignore this symbol and handle the device incorrectly, bodily injury and damage to the equipment could result.

Please observe the following safety tips and precautions to ensure hazard-free use of the PS-04.

Power requirements



Since power consumption of this unit is fairly high, we recommend the use of an AC adapter whenever possible. When powering the unit from batteries, use only alkaline types.

[AC adapter operation]

- Be sure to use only an AC adapter which supplies 9 V DC, 300 mA and is equipped with a "center minus" plug (Zoom AD-0006). The use of an adapter other than the specified type may damage the unit and pose a safety hazard.
- Connect the AC adapter only to an AC outlet that supplies the rated voltage required by the adapter.
- When disconnecting the AC adapter from the AC outlet, always grasp the adapter itself and do not pull at the cable.
- When not using the unit for an extended period, disconnect the AC adapter from the AC outlet.

[Battery operation]

- Use four conventional IEC R6 (size AA) batteries (alkaline).
- The PS-04 cannot be used for recharging. Pay close attention to the labelling of the battery to make sure you choose the correct type.
- When not using the unit for an extended period, remove the batteries from the unit.
- If battery leakage has occurred, wipe the battery compartment and the battery terminals carefully to remove all remnants of battery fluid.
- While using the unit, the battery compartment cover should be closed.

Environment



Avoid using your PS-04 in environments where it will be exposed to:

- Extreme temperature
- High humidity or moisture
- Excessive dust or sand
- Excessive vibration or shock

Handling



Since the PS-04 is a precision electronic device, avoid applying excessive force to the switches and buttons. Also take care not to drop the unit, and do not subject it to shock or excessive pressure.

Alterations



Never open the case of the PS-04 or attempt to modify the product in any way since this can result in damage to the unit.

Connecting cables and input and output jacks



You should always turn off the power to the PS-04 and all other equipment before connecting or disconnecting any cables. Also make sure to disconnect all cables and the AC adapter before moving the PS-04.

Usage Precautions

• Electrical interference

For safety considerations, the PS-04 has been designed to provide maximum protection against the emission of electromagnetic radiation from inside the device, and protection from external interference. However, equipment that is very susceptible to interference or that emits powerful electromagnetic waves should not be placed near the PS-04, as the possibility of interference cannot be ruled out entirely.

With any type of digital control device, the PS-04 included, electromagnetic interference can cause malfunctioning and can corrupt or destroy data. Care should be taken to minimize the risk of damage.

• Cleaning

Use a soft, dry cloth to clean the PS-04. If necessary, slightly moisten the cloth. Do not use abrasive cleanser, wax, or solvents (such as paint thinner or cleaning alcohol), since these may dull the finish or damage the surface.

Please keep this manual in a convenient place for future reference.

SmartMedia is a trademark of Toshiba Corporation.

Contents

USAGE AND SAFETY PRECAUTIONS.....	2	4-2 Adjusting level/panning/EQ	26
Introduction	5	4-3 Applying the send/return effect	28
Getting to Know the PS-04.....	6	Step 5: Mixdown	30
PS-04 configuration	6	5-1 Applying the mastering effect	30
Recorder section	6	5-2 Mixdown (bounce) preparations	31
Effects section	6	5-3 Carrying out mixdown (bounce)	32
Rhythm section	6	5-4 Playing the bounced tracks	33
Mixer section	7	Reference [Recorder]	36
Operation modes of the PS-04	7	AUDIO mode screens	36
Names and Functions of Parts	8	V-takes	36
Top view	8	About V-takes	36
Front view	9	Switching V-takes	36
Rear view	9	Moving to a desired location in the song	
Side view	9	(Locate/Marker function)	37
Getting Connected	10	Specifying time or measures	37
About SmartMedia	10	Setting a mark in a song	38
Operating the Unit on Batteries	11	Locating a mark	38
Power On/Off	11	Deleting a mark	38
Power-on	11	Playing back the same passage	
Power-off	11	repeatedly (A-B Repeat function)	39
Listening to the Demo Song	12	Re-recording only a specified part	
Let's Record	13	(Punch-in/out function)	40
Quick Guide	15	Using manual punch-in/out	40
Step 1:		Using auto punch-in/out	41
Preparations before recording	15	Combining multiple tracks on another	
1-1 Creating a new project	15	track (Bounce function)	42
1-2 Selecting a rhythm pattern to use	17	Making settings for the bounce target	
Step 2: Recording the first track	19	track(s)	42
2-1 Selecting the input source	19	Selecting the bounce target V-take	43
2-2 Applying the insert effect	21	Carrying out bounce recording	43
2-3 Selecting a track and starting to		Changing the precount	
record	22	operation	44
Step 3: Overdubbing	24	Checking the grade setting of a	
3-1 Adjusting input sensitivity and setting		project	45
the insert effect	24	Reference [Track Editing]	46
3-2 Selecting the track to record	24	Editing a range of data	46
Step 4: Mixing	26	Basic steps for range editing	46
4-1 Muting the input signal/rhythm		Copying a specified range of data	47
sound	26	Moving a specified range of data	48
		Erasing a specified range of data	49
		Trimming a specified range of data	49
		Editing using V-takes	50
		Basic steps for V-take editing	50
		Deleting a V-take	51
		Copying a V-take	51
		Exchanging V-takes	52
		Reference [Mixer]	53
		About the PS-04 mixer	53

Contents

Assigning input signals to tracks	53	Editing a send/return effect patch	90
Selecting the input source	53	Storing a send/return effect patch	91
Selecting the recording track(s)	55	Changing a send/return effect patch name	91
Mixing the playback sound from tracks	56	Using the tuner function	92
Making adjustments for each track signal (track parameters)	56	Using the chromatic tuner	92
Linking tracks (stereo link)	58	Using other tuning types	93
Reference [Rhythm]	59	Reference [System]	95
About the rhythm section	59	SYSTEM mode screen	95
Explanation of some important terms	59	About projects	95
PATTERN mode/SONG mode	59	Basic steps for handling projects	95
Pattern/song	59	Selecting a project	96
Drum track/bass track	60	Creating a new project	96
Drum kit/bass program	60	Copying a project	96
PATTERN mode operation	60	Deleting a project	97
PATTERN mode screens	60	Protecting a project	97
Selecting a pattern for playback	60	Checking the remaining recording time	97
Changing the tempo	61	Changing the name of a project	98
Playing drum/bass sounds manually	62	Changing the operation of the level meters	98
Creating a pattern	63	Setting the built-in mic gain	99
Copying a pattern	68	Turning the backlight on and off	99
Deleting a pattern	69	Formatting a SmartMedia card	100
Changing the pattern parameters (pattern edit)	69	Specifications	101
Setting PATTERN mode operation (pattern utility)	71	Troubleshooting	102
SONG mode operation	73	Problems during playback	102
SONG mode screens	73	Problems during recording	102
Creating a song	73	Problems with effects	103
Editing a song	81	Problems with rhythm section	103
Clearing a song	83	Other problems	103
Importing pattern/song information from another project	83	Appendix	104
Reference [Effects]	84	Effect Parameters	104
About the effects	84	Insert effect	104
Insert effect	84	Send effect	113
Send/return effect	85	Rhythm patterns	114
EFFECT mode screens	86	Effect patches	116
Basic steps for using the insert effect	86	Insert effect	116
Selecting the insert effect patch	86	Drum kits/Bass programs	120
Editing an insert effect patch	87	Compatibility with PS-02 and MRS-4	121
Storing an insert effect patch	89	PS-02	121
Changing an insert effect patch name	90	MRS-4	121
Basic steps for using the send/return effect	90	Files on SmartMedia card	121
Selecting the send/return effect patch	90	INDEX	122

Introduction

Thank you for selecting the *ZOOM PS-04 Palmtop Studio* (simply called the "PS-04" in this manual).

The PS-04 is a fascinating product with the following features.

- **Four great functions in one compact unit**

Weighing in at a mere 160 grams, the PS-04 combines a SmartMedia recorder, mixer, multi-effect device, and drum/bass machine in a single pocket-size body. Whenever and wherever inspiration strikes, the PS-04 is ready to help you create and record your very own sound.

- **4-track recorder with bounce capability**

The recorder allows simultaneous playback of four tracks and simultaneous recording on two tracks. Each track has ten virtual takes (V-takes). While playing back all four tracks, you can bounce the combined sound onto two empty V-takes. A host of functions lets you process and edit audio data after recording.

- **Full-featured mixer section**

The integrated mixer makes it simple to adjust level, Hi/Lo EQ, panning, and effect send level for the audio tracks and drum/bass tracks to create the stereo mix. The input signal can also be sent directly to the stereo mix.

- **Two versatile effect streams**

The PS-04 provides insert effects that can be applied to the input or output, and send/return effects that are used via the mixer send/return loop. The insert effect provides a mastering effect function for processing the stereo mix. This is great for adjusting the sound and dynamics during mixdown.

- **Rhythm section provides solid backing**

Realistic PCM sources produce drum and bass sounds in a variety of more than 500 patterns. By combining patterns and programming the chord progression, you can create the accompaniment for an entire song.

- **Flexible tuner function**

The built-in tuner can be used not only for standard chromatic tuning but also for 7-string guitar, 5-string bass and other unconventional tuning applications.

In order to get the most out of this sophisticated product, please read this manual carefully before use.

We recommend that you keep the manual at hand for future reference.

Getting to Know the PS-04

PS-04 configuration

The PS-04 can be thought of as having four main sections, namely recorder, effects, mixer, and rhythm. These are explained below.

■ Recorder section

The recorder in the PS-04 has 4 separate audio tracks (a track is a separate portion for recording audio data). Up to 2 tracks can be recorded simultaneously, and up to 4 tracks can be played back simultaneously. The tracks are numbered 1 – 4, and each of these tracks has 10 virtual tracks (so-called V-takes). When performing recording or playback, you can select one of these V-takes. For example, you could record a difficult guitar solo onto multiple V-takes, and then compare them later to select the best take.

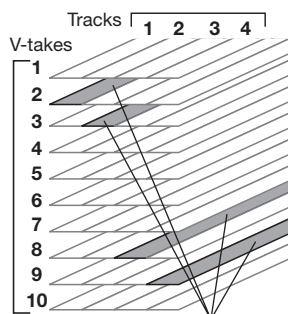

Currently selected V-takes

■ Effects section

The PS-04 has two types of effects: insert effects and send/return effects. The insert effect, as its name implies, can be inserted at a selected point in the signal path. It consists of a number of single effects connected in series, such as compressor, amp simulator, chorus, etc. It can be used for effect processing of the input signal during recording or for the stereo mix during mixdown.

The send/return effect is routed through the built-in mixer and applies to all tracks. Reverb, delay, or chorus can be selected for this effect. The intensity of the send/return effect for each track can be adjusted with the send level parameter (the higher the value, the stronger the effect).

■ Rhythm section

The PS-04 has an integrated rhythm machine that always operates in sync with the recorder. Drum sounds and bass sounds from a PCM source are used to form accompaniment patterns. The PS-04 has over 500 patterns built in, and 346 patterns are already preprogrammed. Of course, you can also edit existing patterns or create your own patterns from scratch.

By lining up the patterns in the desired order and specifying parameters such as chord progression, tempo, and beat, you can create the rhythm accompaniment for an entire song.

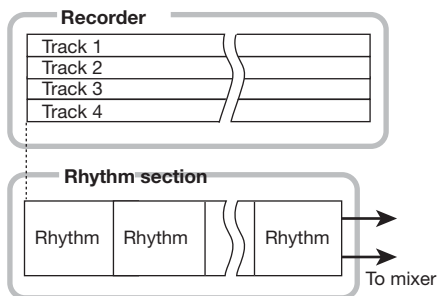

■ Mixer section

Using the mixer functions built into the PS-04, you can adjust the level, panning, EQ, and other parameters for audio tracks 1- 4 and the drum / bass track to produce the final stereo mix.

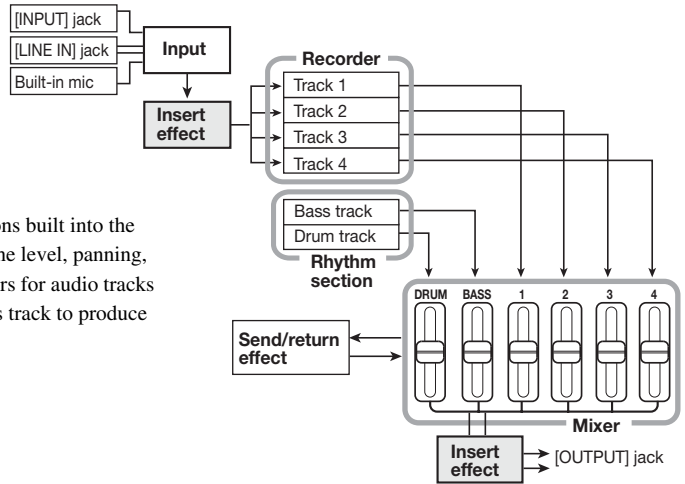

Operation modes of the PS-04

The PS-04 has the following four operation modes. You can see which mode is currently active by the light on/off status of the [EFFECT], [RHYTHM], and [SYSTEM] keys on the panel.

● AUDIO mode

This is the mode for recording and playing back audio. The PS-04 is always in this mode after power-on and after you quit one of the other modes. In this mode, the indicators of the [EFFECT], [RHYTHM], and [SYSTEM] keys are all out.

● EFFECT mode

In this mode, you select patches for the insert effect and send/return effect, edit parameters, and perform other effect related functions. To switch to this mode from any other mode, press the [EFFECT] key so that the indicator lights up.

● RHYTHM mode

In this mode, you control the various rhythm functions. To switch to this mode from any other mode, press the [RHYTHM] key so that the indicator lights up.

The rhythm functions of the PS-04 are further divided into PATTERN mode for repeatedly playing patterns, and SONG mode for playing the rhythm accompaniment to an entire song. By repeatedly pressing the [RHYTHM] key, you can switch between these two modes.

● SYSTEM mode

This mode is used to create new projects and to make settings that affect operation of the entire PS-04. To switch to this mode from any other mode, press the [SYSTEM] key so that the indicator lights up.



Names and Functions of Parts

Top view

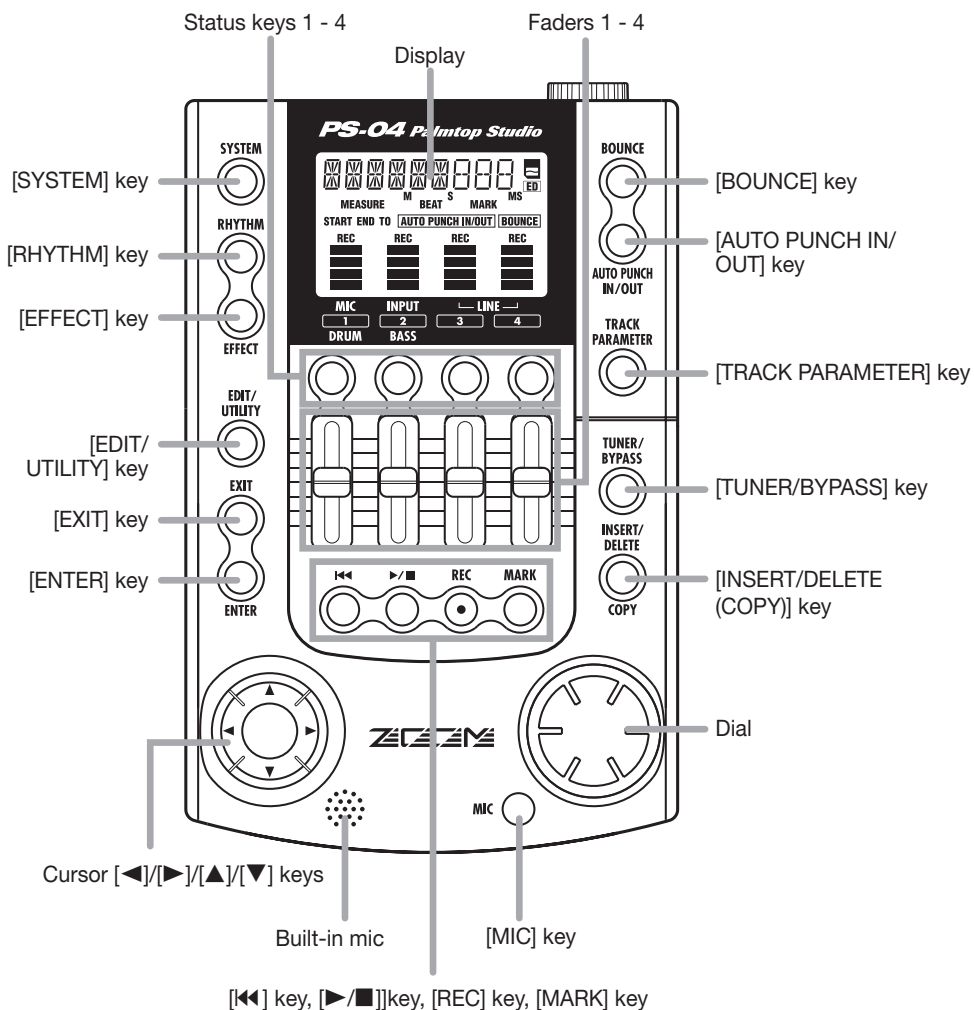

Front view

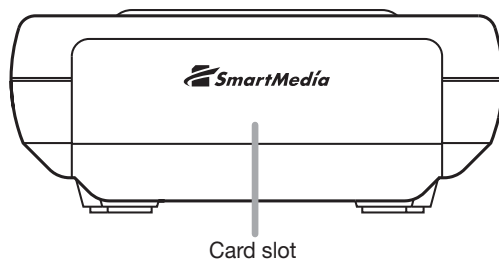

Rear view

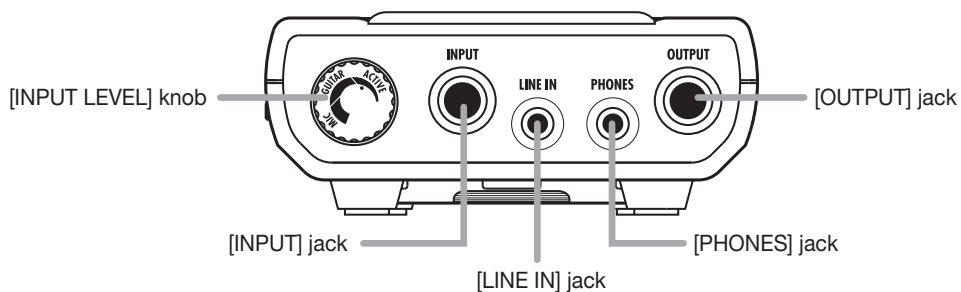

Side view

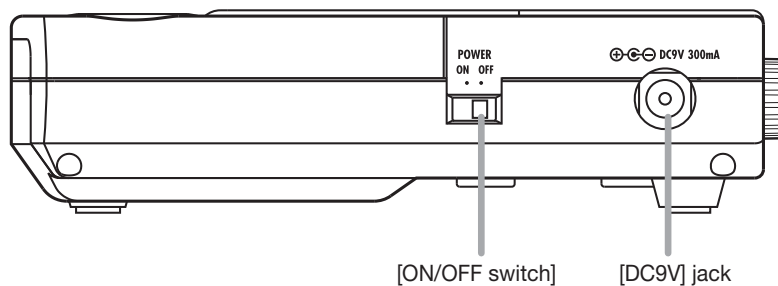

Getting Connected

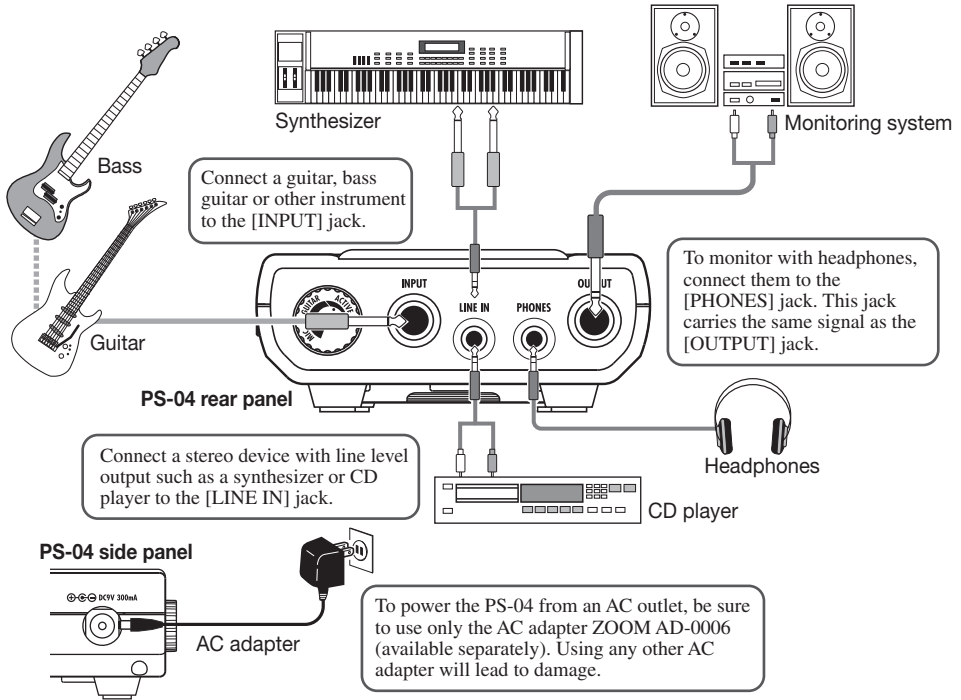

About SmartMedia

To use the PS-04, a SmartMedia card is required. Before turning on the power, insert the supplied SmartMedia card into the card slot, as shown in the illustration.

When inserting the card, push it fully into the slot.

NOTE

- If you insert the SmartMedia card with the wrong orientation or upside down, it will not go all the way in. Trying to push the card in by force may damage it.
- Do not insert or remove the SmartMedia card while power is turned on. Otherwise data loss may occur.
- Generic SmartMedia cards with a capacity from 16 MB to 128 MB (drive voltage 3.3 V) may be used in the PS-04.
- To use a SmartMedia card that has already been formatted in a computer or a digital camera, be sure to first format it once more in the PS-04 (→ p. 100).

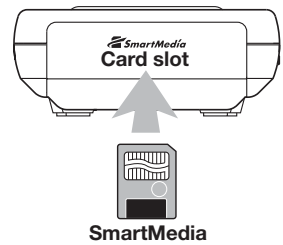

Operating the Unit on Batteries

The PS-04 can be operated on battery power. Purchase the correct batteries and insert them as described below.

1. Turn the PS-04 over and open the cover of the battery compartment.
2. Insert four IEC R6 (size AA) batteries into the compartment. (Use alkaline batteries.)
3. Close the cover of the battery compartment.

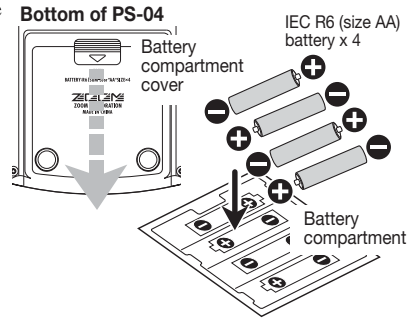

NOTE

When the PS-04 is operating on battery power and the batteries are getting low, the indication "BATT" will appear on the display. Replace all four batteries with fresh ones as soon as possible.

Power On/Off

To turn the PS-04 on and off, proceed as follows.

■ Power-on

1. Verify that power to the PS-04 and all connected equipment is off.

The volume controls of the connected instrument, PS-04, and the monitoring system should be turned fully down.

2. Insert the SmartMedia card into the card slot (→ p. 10).
3. Set the [ON/OFF] switch on the side panel of the PS-04 to "ON".

The indication "PS-04" appears on the display and the PS-04 starts up.

4. Turn power to the connected instrument and the monitoring system on in that order.

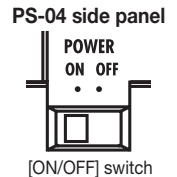

■ Power-off

5. Turn power to the monitoring system and the connected instrument off in that order.
6. Set the [ON/OFF] switch on the side panel of the PS-04 to "OFF".

The indication "GOODBYE" is briefly shown on the display and the PS-04 is shut down.

NOTE

Never turn the PS-04 off by disconnecting the AC adapter. Otherwise data loss may occur.

Caution

When using the AC adapter, always use the [ON/OFF] switch on the side panel of the PS-04 to turn power on and off. Be especially careful when the card access indicator is lit. Disconnecting the AC adapter in such a case may lead to fatal data loss.

Listening to the Demo Song

This section shows how to play the demo song stored on the supplied SmartMedia card.

NOTE

The demo song is write-protected. During playback you can change the level, panning, and other parameters, but you cannot store the changed settings.

1. Connect the monitoring system and the PS-04, and insert the supplied SmartMedia card into the PS-04.

Before switching the power on, turn the volume control of the monitoring system down.

2. Set the [ON/OFF] switch on the side panel of the PS-04 to "ON".

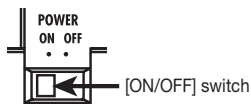

Project information saved on the SmartMedia card is automatically loaded. When the supplied SmartMedia card has been inserted, the demo song project will be loaded.

3. Press the [▶/■] key.

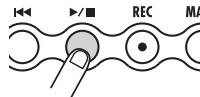

The key lights up and playback of the demo song starts.

4. To stop playback, press the [▶/■] key once more.



The key goes out, and the recorder stops.

HINT

If desired, you can use the faders 1 – 4 during playback to adjust the level of audio tracks 1 – 4. To adjust the level of the drum or bass track, press the [RHYTHM] key and then use faders 1 and 2.

Let's Record

This section shows how to record a guitar connected to the [INPUT] jack.

1. Connect the guitar to the [INPUT] jack.

2. Press the [SYSTEM] key and then the [ENTER] key.

The indication "SELECT" appears on the display.

3. Use the cursor left/right keys to bring up the indication "NEW" on the display, and press the [ENTER] key twice.

The following indication appears on the display, and the PS-04 is ready for recording.



4. Press the [TRACK PARAMETER] key.

When you press the [TRACK PARAMETER] key for the first time, the indication "INPUT SEL" is shown for a few seconds, and then the indication "INPUT" appears.

TRACK
PARAMETER

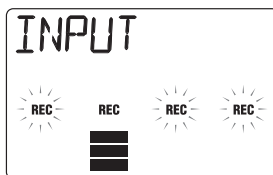

HINT

In the default condition, the [INPUT] jack is selected as input source. To record a synthesizer or other device connected to the [LINE IN] jack, or to record from the built-in mic, switch the input source to the respective setting (→ p. 53).

5. While playing your guitar, adjust the input sensitivity by turning the [INPUT LEVEL] knob on the rear panel of the PS-04.

If the indication "-PEAK-" appears on the display, the input signal will be distorted. Turn the [INPUT LEVEL] knob down.

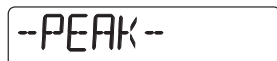

6. To adjust the track recording level, operate fader 2.

While this screen is shown, you can use fader 2 to adjust the recording level for the signal from the [INPUT] jack. When the adjustment is complete, press the [EXIT] key.

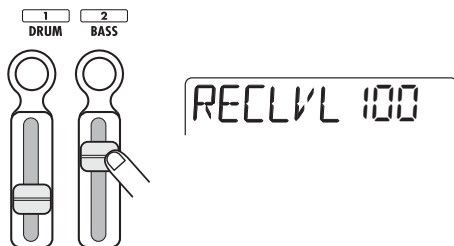

HINT

If the topmost segment (rectangular block) of the level meter comes on when you play your guitar loud, reduce the recording level setting.

7. Use the status keys to select the recording destination track.

Above the level meter, the indication "REC" appears for the track that has been set to recording standby.

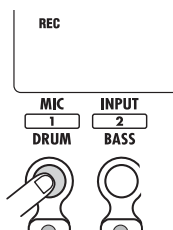

8. To start recording, hold down the [REC] key and press the [▶/■] key.

A precount of 4 clicks is heard, and recording starts. Play your guitar to record.

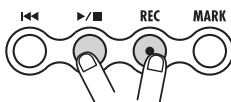

9. To stop recording, press the [▶/■] key once more.

The [REC] key and [▶/■] key goes out.

10. To check the recording, press the [◀◀] key and then press the [▶/■] key.

11. To cancel the recording standby condition, press the status key 1 again so that the "REC" indication goes out.

Quick Guide

This section explains some of the basic operation steps of the PS-04. You will learn how to make preparations for recording, how to record tracks, do overdubs, use the mixer, and create the final stereo mix. The explanation is divided into five major steps.

● Step 1: Preparations before recording

Establish connections, create a project, and make other preparations for recording.

● Step 2: Recording the first track

Record the first track while using the insert effect on the input signal.

● Step 3: Overdubbing

Record (overdub) the second and subsequent tracks while listening to the previously recorded track.

● Step 4: Mixing

Adjust level, panning, and EQ for each track and use the send/return effect to create a stereo mix.

● Step 5: Mixdown

Bounce the finished stereo mix onto an empty pair of V-tapes in the PS-04.

Step 1: Preparations before recording

1-1 Creating a new project

The PS-04 manages all information that is required to produce a song in units called "projects". To perform a new recording with the PS-04, you first create a project.

1. Connect the instrument from which to record and the monitoring system to the PS-04 (→ p. 10).

To monitor with headphones, connect them to the [PHONES] jack.

2. Make sure that a SmartMedia card is inserted in the card slot. Then turn power on in the order PS-04 → monitoring system.

The PS-04 always comes on in AUDIO mode which serves for recording and playback. When the PS-04 is turned on, it automatically loads the most recently used project from the SmartMedia card.

3. Press the [SYSTEM] key.

The [SYSTEM] key lights up and the PS-04 switches to SYSTEM mode. The display shows the system menu which serves for controlling the project and making system-wide settings.



- Verify that "PROJECT" is shown on the display, and then press the [ENTER] key.



- Use the cursor left/right keys to bring up the indication "NEW", and press the [ENTER] key.

You can now select the audio data quality level (recording grade).



- Use the dial to select one of the following two grade settings.

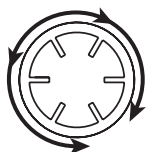

•HF (Hi-Fi)

Best sound quality setting (default)

•LG (Long)

Longer recording time setting. (Recording time is doubled compared to HF.)

- Press the [ENTER] key.

A new project is created, and this project is loaded automatically. The PS-04 returns to the AUDIO mode and the [SYSTEM] key goes out. The current counter position is shown on the display. (This is called the AUDIO mode top screen.)

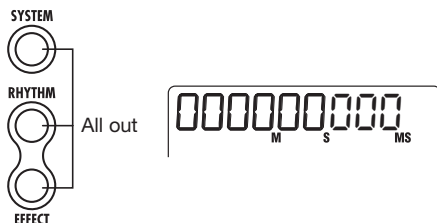

NOTE

- When you create a new project, the name "PROJxx" (where xx is the project number) is automatically assigned.
- The project name can be changed if desired (→ p. 98).

1-2 Selecting a rhythm pattern to use

The PS-04 incorporates a rhythm function that always operates in sync with the recorder. This function can automatically repeat patterns that are several measures in length and contain drum sounds (drum kit) and bass sounds (bass program). It is also possible to use a combination of patterns to form a longer rhythm accompaniment (song). In this example, we will choose a simple pattern to use as guide rhythm during recording.

1. Press the [RHYTHM] key.

The [RHYTHM] key lights up and the PS-04 switches to RHYTHM mode which lets you make various rhythm related settings.

The rhythm function has two modes: PATTERN mode for repeatedly playing patterns, and SONG mode for playing the rhythm accompaniment to an entire song. By repeatedly pressing the [RHYTHM] key, you can switch between these modes.

When you first select RHYTHM mode, the PATTERN mode is active, and the name of the currently selected pattern appears on the display.

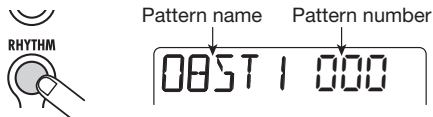

2. Turn the dial to select the pattern you want to play.

The PS-04 has 511 pattern slots, of which 346 are preprogrammed. (The indication "EMPTY" is shown instead of a pattern name for empty patterns.)

In this example, we will select pattern number 510 which plays a rim shot sound as a quarter note.

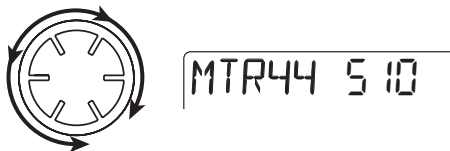

3. Press the [▶/■] key.

The selected pattern starts to play, and the [RHYTHM] key flashes in sync with the current tempo. While the pattern is playing, you can also switch to other patterns simply by turning the dial.

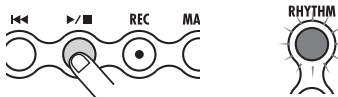

HINT

Immediately after creating a new project, the pattern playback volume will be set to zero. To hear the rhythm play, you must raise the drum/bass monitor level.

4. Operate faders 1 and 2 to adjust the playback volume of the pattern.

In RHYTHM mode, fader 1 controls the drum volume and fader 2 the bass volume. To monitor only the drum track of the pattern, slide fader 2 fully down.

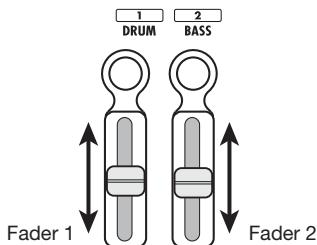

5. To change the tempo, operate faders 3 and 4.

The current tempo value (BPM) appears on the display. Fader 3 changes the setting in units of 10 BPM, and fader 4 in units of 0.1 BPM. The original display will return after a while when you have finished using the faders. By pressing the status key 3 or 4, you can check the current tempo setting.

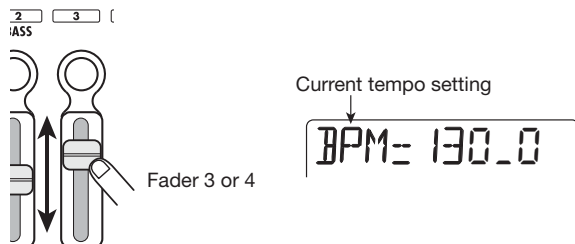

NOTE

- The tempo set here applies to all patterns.
- When recording while playing a pattern, you should set the tempo before starting to record the audio track. If you change the tempo after recording the audio track, there will be a mismatch between the recorded audio and the rhythm tempo.

6. To stop playback, press the [▶/■] key once more.

7. Press the [EXIT] key to return to the AUDIO mode top screen.



To return from other modes to the AUDIO mode, the [EXIT] key is used.

HINT

The PS-04 automatically saves your progress (settings and recorded contents) when you switch to another project or turn power off. There is no need to perform any special storage steps.

Step 2: Recording the first track

Specify the input source and the track on which to record, and start the recording process.

2-1 Selecting the input source

The PS-04 lets you select the [INPUT] jack, [LINE IN] jack, or built-in mic as input source for recording on the audio tracks. First select the source and then adjust the recording level.

1. From the AUDIO mode top screen, press the [TRACK PARAMETER] key.

The track parameter screen appears. This screen gives access to various input and track related settings. The first time you call up the screen, input is selected as operation target, and the currently selected input source is shown.

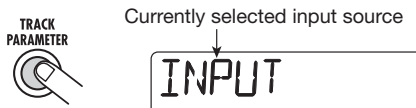

During input source selection, the status keys and faders operate as follows.

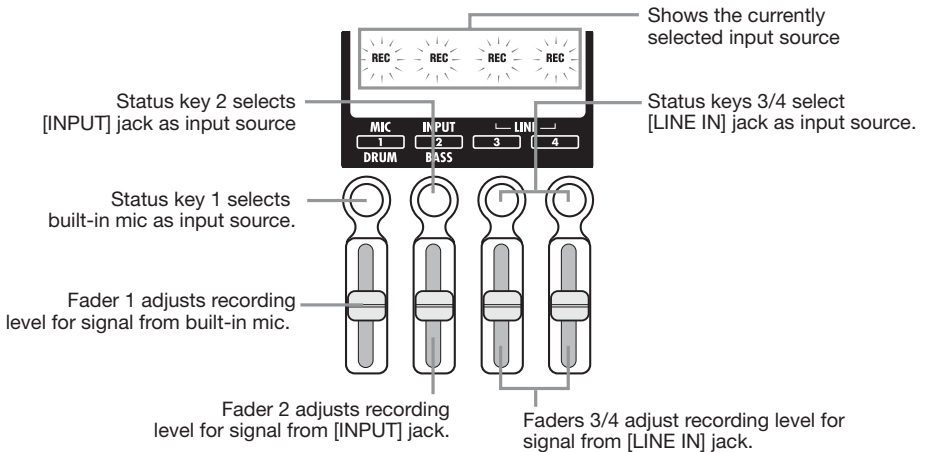

NOTE

- The function of the faders depends on the currently selected screen of the PS-04.
- Switching to a different screen and moving a fader there will not affect the fader setting of the previous screen, because fader settings are saved individually for each screen.

2. Use the status keys 1 – 4 to select the input source.

Depending on which input source is selected, the display changes as follows. (The "REC" indication for the source changes from flashing to constantly on.)

When built-in mic (status key 1) is selected

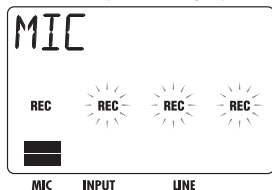

When [INPUT] jack (status key 2) is selected

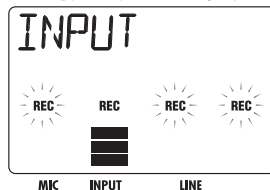

When [LINE IN] jack (status key 3 or 4) is selected

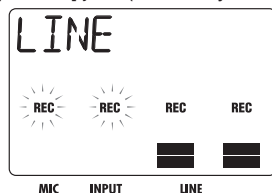

HINT

- When the built-in mic is selected as recording source, the [MIC] key lights up. You can also select the built-in mic by pressing the [MIC] key from the AUDIO mode top screen. (In this case, there is no need to call up the above track parameter screen.)
- If desired, you can also combine multiple input sources (→ p. 53).
- When the built-in mic can be used, the [MIC] key is flashing.
- When the insert effect algorithm is "GUITAR/BASS", the built-in mic cannot be used (except when the effect type "CABI" is selected on the PRE AMP/DRIVE module or when it is turned off). In this case, the "REC" indication for the built-in mic is out.

3. When the [INPUT] jack has been selected as input source, play the instrument connected to the jack and adjust the input sensitivity by turning the [INPUT LEVEL] knob on the rear panel of the PS-04.



When using the [INPUT] jack, adjusting the input sensitivity with the [INPUT LEVEL] knob is necessary. Make the adjustment so that the sound is not distorted when playing the instrument at maximum level. (If the indication "-PEAK-" is shown on the display, signal distortion has occurred.)

HINT

- When the built-in mic is selected as input source, two gain settings (on-mic/off-mic) are available. The default is on-mic, but this can be changed if desired (→ p. 99).
- When the [LINE IN] jack is selected as input source, adjust the output level of the source equipment so that there is no distortion in the input stage of the PS-04.

4. While playing the instrument, operate the fader for the input source to adjust the recording level.

While one of the above screens is being shown, faders 1 – 4 can be used to adjust the recording level for each recording source. When you move a fader, the current setting value is shown on the display. A rough indication of the setting for each source is given by the level meter segments.

When signal distortion occurs within the PS-04, the top segment of the level meter stays on for a while. Reduce the fader setting in such a case.

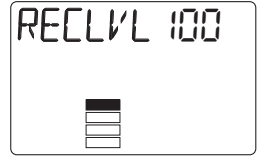

5. When the setting is complete, press the [EXIT] key.

The AUDIO mode top screen returns.

2-2 Applying the insert effect

The insert effect is applied to a specific point in the signal path. It consists of a number of single effects connected in series, such as compressor, amp simulator, chorus, etc. Immediately after creating a new project, an effect program (patch) optimized for clean guitar is selected. In this example, we will select the patch to be used and apply the desired effect to the input signal.

HINT

To record without going through the insert effect, press the [TUNER/BYPASS] key to activate the bypass condition.

1. From the AUDIO mode top screen, press the [EFFECT] key.

The [EFFECT] key lights up and the PS-04 switches to EFFECT mode. The display shows the insert effect top screen which lets you make various settings for the insert effect.



2. Use the cursor up/down keys to select the algorithm that you want to use.

An "algorithm" is a combination of single effects which the insert effect lets you use simultaneously. The type of single effect and the insertion point are decided by the algorithm selection. The following algorithms are available.

Algorithm	Description
GUITAR/BASS	An algorithm suitable for recording guitar/bass.
MIC	An algorithm suitable for vocals and other mic recordings.
LINE	An algorithm suitable mainly for recording stereo-output instruments such as a synthesizer.
DUAL	An algorithm suitable for recording two entirely separate channels, with mono input x 2 and mono output x 2.
MASTERING	An algorithm suitable for processing a stereo mix signal during mixdown.

NOTE

The MASTERING algorithm is a special algorithm for producing the final stereo mix. Because the insert effect is inserted directly before the [OUTPUT] jack, it cannot be used for track recording.

Shortly after selecting an algorithm, the name of the patch (effect program) active in that algorithm will be shown.

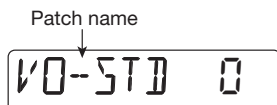

3. Turn the dial to select the patch.

For information on the various patches that are available, see the list in the last section (→ p.116) of this documentation.

HINT

- You can also edit a patch to change its sound or intensity (→ p. 87).
- The recording level may change, depending on the selected patch. If the signal after effect processing sounds extremely distorted, adjust the patch level (insert effect output level) (→ p. 87).

4. Press the [EXIT] key to return to the AUDIO mode top screen.

2-3 Selecting a track and starting to record

Select the track on which to record the signal processed by the insert effect. In this example, we will select track 1 for recording.

1. From the AUDIO mode top screen, press status key 1.

While the AUDIO mode top screen is shown, you can use status keys 1 – 4 to select a recording track. When you press status key 1, track 1 goes into recording standby mode, and the corresponding "REC" indication appears. In this condition, the input signal is sent to the track via the insert effect.

HINT

- If the [LINE IN] jack has been selected as input source and only track 1 was selected as recording track, the left/right signal will be mixed and sent to the track as a mono signal.
- To record the signal from the [LINE IN] jack in stereo, or to retain a stereo effect produced by the insert effect, set two tracks simultaneously to the recording standby condition (→ p. 55).

2. Use fader 1 to adjust the monitor level of the signal to record.

NOTE

- When the recording track has been selected, the input signal will be sent to the stereo mix via the corresponding track. By adjusting the fader for the respective track, you can adjust the monitor level.
- If no recording track has been selected, the input signal will be sent directly to the stereo mix. Adjusting faders 1 – 4 will have no effect on the monitor level.

3. To start recording, first press the [◀◀] key to return the recorder to the beginning, and then press the [▶/■] key while holding down the [REC] key.

The [REC] key and [▶/■] key light up. A precount of 4 clicks (1 measure) is heard. When the precount is finished, recording starts. Play and record your instrument while listening to the guide rhythm.



HINT

- The number of precount beats can be adjusted as desired (→ p. 44).
- If the input signal is distorted, refer to the step 2-1 to adjust the input sensitivity or the recording level.

4. To stop recording, press the [▶/■] key once more.

The [REC] key and [▶/■] key go out, and recording stops. After recording, the indication "WAIT" is briefly shown on the display.

NOTE

- The duration of the "WAIT" interval depends on the length of the recording condition.
- Do not turn power off while "WAIT" is shown. Otherwise the recorded data may be lost, and malfunction may occur.

5. To check the recorded content, press the [◀◀] key to return the recorder to the start, and then press the [▶/■]key.

The recorded content is played back, together with the pattern selected as guide rhythm.

HINT

If desired, you can specify a point in minutes/seconds/milliseconds or in measures/beats and go directly to that point (→ p. 37).

6. To stop playback, press the [▶/■] key once more.

To redo the recording, repeat steps 3 – 4.

7. Press the status key 1 so that the "REC" indication for track 1 disappears.

Track 1 is no longer in recording standby mode.

HINT

- The recorded content can be edited (→ p. 46).
- If you switch the V-take, you can record on the same track while keeping the last recording content (→ p. 36).

Step 3: Overdubbing

While listening to track 1 recorded in step 2, now play and record another instrument on track 2. Recording additional parts in this way is called "overdubbing".

3-1 Adjusting input sensitivity and setting the insert effect

As in step 2, select the input source and make the required insert effect settings.

- 1. From the AUDIO mode top screen, press the [TRACK PARAMETER] key and select the input source.**

When using the [INPUT] jack, adjust the input sensitivity with the [INPUT LEVEL] knob.

- 2. Operate the fader for the input source to adjust the recording level.**

When these steps are completed, press the [EXIT] key to return to the AUDIO mode top screen.

- 3. Press the [EFFECT] key and select the algorithm and patch in the same way as for step 2.**

When the patch is selected, press the [EXIT] key to return to the AUDIO mode top screen.

3-2 Selecting the track to record

While monitoring the playback sound of track 1, record the new instrument on track 2.

- 1. From the AUDIO mode top screen, press status key 2.**

Track 2 goes into recording standby mode.

- 2. Use fader 2 to adjust the monitor level of the signal to record.**

If required, use fader 1 while performing playback to adjust the monitor level balance between tracks 1 and 2.

- 3. To start recording, first press the [◀◀] key to return the recorder to the start, and then press the [▶/■] key while holding down the [REC] key.**

The [REC] key and [▶/■] key light up and the click precount is heard. Play and record your instrument while listening to the guide rhythm.

- 4. To stop recording of track 2, press the [▶/■] key once more.**

The indication "WAIT" is briefly shown on the display, and then the PS-04 returns to the original condition.

-
- 5. To check the recorded content, press the [◀◀] key to return the recorder to the start, and then press the [▶/■] key.**

The recorded content of tracks 1 and 2 is played back, together with the guide rhythm. Adjust faders 1 and 2 as necessary to control the level balance.

HINT

To redo the recording, repeat steps 3 – 5. It is also possible to move to a point within the recording and rerecord from there (→ p. 37). Automatic rerecording of a specified portion is possible by using the auto punch-in/out function (→ p. 41).

- 6. To stop playback, press the [▶/■] key once more.**
- 7. Press the status key 2 so that the "REC" indication for track 2 disappears.**

Record more tracks in the same way.

Step 4: Mixing

When recording of tracks 1 – 4 is finished, create the final stereo mix by adjusting the level, EQ (equalizer), panning (stereo left/right position), send/return effect intensity and other track parameters.

4-1 Muting the input signal/rhythm sound

Mute the input signal and guide rhythm so that no unwanted content will be included in the final recording.

- 1. To mute the guide rhythm, press the [RHYTHM] key to switch to RHYTHM mode and then slide faders 1 and 2 fully down.**

When the setting is made, press the [EXIT] key to return to the AUDIO mode top screen.

HINT

If desired, you can add drum and bass sounds to the mix. In this case, track parameters (level, EQ, panning/balance, send/return effect intensity) can also be set for drum/bass.

- 2. To mute the input, press the [TRACK PARAMETER] key from the AUDIO mode top screen to bring up the input source display.**

- 3. Slide the fader for the currently selected input source fully down, and then press the [EXIT] key.**

The AUDIO mode top screen returns.

HINT

The input signal can also be sent directly to the stereo mix.

4-2 Adjusting level/panning/EQ

Adjust level/panning/EQ for each track by setting the track parameters of the integrated mixer.

- 1. To set the level balance of the tracks, adjust faders 1 – 4 from the AUDIO mode top screen.**

- 2. To adjust panning and EQ for each track, press the [TRACK PARAMETER] key and then use the cursor left/right keys or the status keys to select the track.**

When track parameters are shown, the cursor left/right keys or the status keys can be used to select the track.

The level meter for the currently selected track flashes.

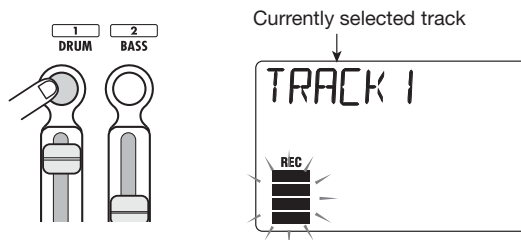

3. Use the cursor up/down keys to select the track parameter.

The respective track parameter is shown on the display. The available track parameters and their setting range are shown in the table below.

Parameter	Display indication	Setting range	Description
HI EQ ON/OFF	<i>EQ HI</i>	ON / OFF	Switches Hi EQ on and off.
HI EQ GAIN	<i>HI G</i>	-12 - 12	Adjusts the Hi EQ boost/cut amount in the range from -12 dB to +12 dB. This parameter is shown only when Hi EQ is set to ON.
HI EQ FREQUENCY	<i>HI F</i>	500 - 8000 (Hz)	Selects the Hi EQ frequency for boost/cut. This parameter is shown only when Hi EQ is set to ON.
LO EQ ON/OFF	<i>EQ LO</i>	ON / OFF	Switches Lo EQ on and off.
LO EQ GAIN	<i>LO G</i>	-12 - 12	Adjusts the Lo EQ boost/cut amount in the range from -12 dB to +12 dB. This parameter is shown only when Lo EQ is set to ON.
LO EQ FREQUENCY	<i>LO F</i>	63 - 2000 (Hz)	Selects the Lo EQ frequency for boost/cut. This parameter is shown only when Lo EQ is set to ON.
SEND ON/OFF	<i>SEND</i>	ON / OFF	Selects whether the signal of this track is supplied to the send/return effect or not.
SEND LEVEL	<i>SEND_L</i>	0 - 100	Adjusts the level of the signal supplied to the send/return effect. This parameter is shown only when SEND is set to ON.
PAN	<i>PAN</i>	L100 - 0 - R100	Adjusts the panning (left/right stereo position) of the track signal. When the STEREO LINK parameter is set to ON, this parameter adjusts the left/right level balance.
FADER	<i>FADER</i>	0 - 127	Adjusts the current volume level.
STEREO LINK	<i>S-LINK</i>	ON / OF	Switches the stereo link function (for linking the parameters of tracks 1/2 and 3/4) on and off. (For details, see page 58.)
V TAKE	<i>TR X-Y</i>	X=1 - 4 Y=1 - 10	Selects the V-take for this track. (For details, see page 36.) X is the track number and Y is the V-take number.
REC LEVEL	<i>RECLVL</i>	0 - 127	Adjusts the recording level.

4. Turn the dial to adjust the setting value.

4-3 Applying the send/return effect

The send/return effect is an effect that works on all tracks of the integrated mixer. Either reverb, delay, or chorus can be selected for this effect. The illustration below shows the signal flow for the send/return effect.

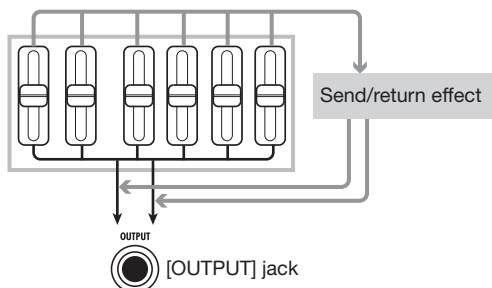

The intensity of the send/return effect can be adjusted individually for each track by setting the send level (the level of the signal supplied to the send/return effect).

1. Press the [EFFECT] key repeatedly to bring up the indication "SEND" on the display.

The indication "SEND" is shown for a few seconds, and then the patch currently selected for the send/return effect is shown. (This screen is called the send/return effect top screen.)

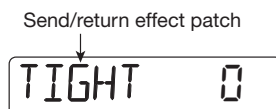

HINT

Repeatedly pressing the [EFFECT] key toggles between the insert effect top screen and the send/return effect top screen.

2. Turn the dial to select the patch.

The send/return effect has 40 patch slots, of which 30 are preprogrammed. For information on the various patches that are available, see the list in the last section of this documentation (→ p. 119).

3. When you have selected the patch, press the [EXIT] key to return to the AUDIO mode top screen.

NOTE

In the default condition, the send level for each track is set to zero. Therefore simply selecting a patch does not enable the send/return effect.

- 4.** From the **AUDIO** mode top screen, press the **[TRACK PARAMETER]** key and then use the cursor left/right keys or the status keys to select the track.
- 5.** Use the cursor up/down keys to bring up the indication "SEND_Lxxx" (where xxx is the setting value) on the display.

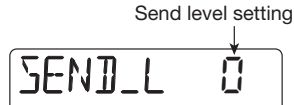

- 6.** While playing the recorded content, turn the dial to raise the send level for that track.
- 7.** Adjust the send level for the other tracks in the same way.
- 8.** Press the **[EXIT]** key to return to the **AUDIO** mode top screen.

Step 5: Mixdown

Normally, mixdown refers to the procedure of sending a completed stereo mix to an external master recorder or similar. Here, we will use an empty pair of V-tapes in the PS-04 instead of the external recorder.

5-1 Applying the mastering effect

The MASTERING algorithm of the insert effect can be used to increase the sound pressure of the stereo mix or emphasize a certain frequency range. The following shows how to process the stereo mix with the MASTERING algorithm patches.

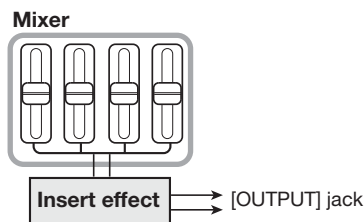

- 1. Press the [EFFECT] key repeatedly to bring up the insert effect top screen on the display.**
- 2. Use the cursor up/down keys to select the MASTERING algorithm.**

The indication "MASTERING" is shown for a few seconds, and then the patch currently selected for the MASTERING algorithm is shown. When a patch of this algorithm is selected, the effect is inserted immediately before the [OUTPUT] jack.



- 3. Turn the dial to select the patch while playing the recorded content.**

For information on the various patches that are available, see the list in the last section of this documentation (→ p. 119).

- 4. When you have found the desired effect, press the [EXIT] key.**

The AUDIO mode top screen returns.

5-2 Mixdown (bounce) preparations

The procedure of recording the signal mixed in the PS-04 (the signal as it appears at the [OUTPUT] jack) onto one or two audio tracks is called "bounce". The following steps show how to change the internal setting so that the mixed signal of audio tracks 1 – 4 can be bounced onto an unused pair of V-takes.

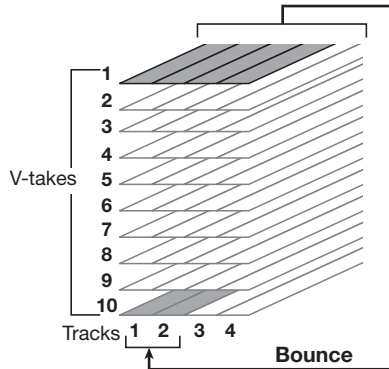

1. From the AUDIO mode top screen, press the [EDIT/UTILITY] key.

The AUDIO mode utility menu for making various audio function settings appears.



2. Use the cursor left/right keys to bring up the indication "BOUNCE" on the display, and press the [ENTER] key.

A screen for selecting whether to play or mute the content of the bounce target tracks appears. The default setting is "MUTE".

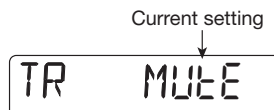

3. Turn the dial to switch the setting to "PLAY".

This makes it possible to record on separate V-takes of the bounce target tracks while playing back the contents of all four tracks.

4. Use the cursor left/right keys to bring up the indication "TAKE" on the display.

In this condition, you can select the V-take to be used as bounce target.

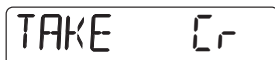

In the default condition, the setting is "CR" (Current) which means that the currently selected V-take is the bounce target. When bounce is carried out in this condition, the content of the bounce source V-take will be erased. You must therefore specify a separate V-take as bounce target.

5. Turn the dial to select the number of the V-take to be used as bounce target.

When you select a number, bounce will be carried out onto that V-take of the selected track. In this example, select "10" (V-take 10).



6. When the setting has been made, press the [EXIT] key twice to return to the AUDIO mode top screen.

5-3 Carrying out mixdown (bounce)

Select tracks 1 and 2 to record the stereo mix.

1. Press the [◀◀] key to return the recorder to the start.

2. While holding down status key 1, press status key 2, so that the "REC" indication for tracks 1 and 2 is visible.

To record on two tracks simultaneously, press both status keys together to set the tracks to the recording standby mode. Only tracks 1 and 2 or tracks 3 and 4 can be combined.

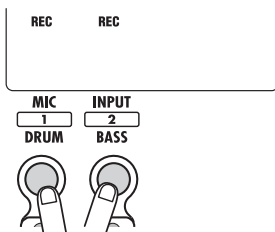

3. Press the [BOUNCE] key.

The bounce function is enabled, and the indication "BOUNCE" appears on the display. In this condition, the stereo mix (the signal as it appears at the [OUTPUT] jack) will be sent to V-takes 10 of tracks 1 and 2.



- 4. To carry out mixdown, press the [▶/■] key at the start of the recorder while holding down the [REC] key.**

When signal distortion occurs during bounce recording, press the [TUNER/BYPASS] key to bypass the insert effect and check whether this removes the distortion.

- **No distortion when insert effect is bypassed**

Lower the patch level parameter for the insert effect (→ p. 87).

- **Distortion still occurs when insert effect is bypassed**

Slide fader 1–4 down, or reduce EQ gain settings.

- 5. When recording is completed, press the [▶/■] key to stop the recorder.**

- 6. To cancel the bounce function, press the [BOUNCE] key once more.**

The "BOUNCE" indication goes out. Press the status key to cancel the recording selection.

5-4 Playing the bounced tracks

You can select the V-takes of the bounce target tracks to play the bounced contents. At this time, you must disable effects and track parameters so that they do not get doubled.

- 1. From the AUDIO mode top screen, press the [TUNER/BYPASS] key.**

The insert effect is bypassed.



- 2. Press the [TRACK PARAMETER] key and use the cursor left/right keys or the status keys to select one of the bounce target tracks.**

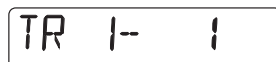

3. Use the cursor up/down keys to bring up the following screen.

This screen lets you select the V-take for the track.

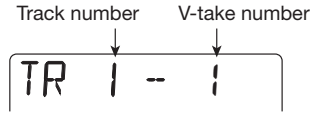

4. Turn the dial to select the number of the V-take that was selected as bounce target (V-take 10 in the above example).

5. Use the same procedure to select the V-take for the other track.

6. Set the track parameters as follows, so that the sound of the bounce target V-takes can be monitored without coloration.

Track parameter	SEND	HI-EQ	LO-EQ	PAN
Track 1	OFF	OFF	OFF	L100
Track 2	OFF	OFF	OFF	R100

7. When the setting has been made, press the [EXIT] key to return to the AUDIO mode top screen.

HINT

If required, you can also link the parameters of the two tracks (→ p. 58).

8. Raise the faders of the bounce target tracks, and slide the other faders fully down.

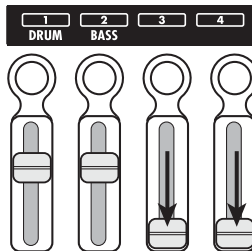

HINT

When the fader setting value is 100, the recording level and playback level are identical. (The current fader value can be checked with the track parameter FADER.)

- 9. Press the [⏮] key to return the recorder to the start, and press the [▶/■] key.**

The bounced content is played back. To stop playback, press the [▶/■] key once more.

- 10. When you are satisfied with the results, return to the PS-04 to the condition before the bounce operation.**

Reference [Recorder]

This section explains the functions for audio recording and playback.

AUDIO mode screens

Immediately after turning the PS-04 on, the AUDIO mode is automatically selected and the counter showing the current position appears. This screen is called the AUDIO mode top screen. It also appears when you exit the EFFECT, RHYTHM, or SYSTEM modes and return to AUDIO mode.

The cursor left/right keys can be used to switch the display format for the top screen counter to one of the following three formats: minutes/seconds/milliseconds, measure/beat, marker.

Time display



Measure/beat display



Marker display



While the top screen is shown, pressing one of the cursor up/down keys brings up the name and the number of the currently selected project on the display.

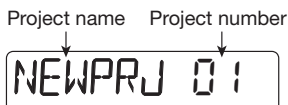

To return to the top screen, press the [▼] key.

V-takes

About V-takes

Each of the audio tracks 1 – 4 has ten virtual tracks which are referred to as V-takes. At any time, one of these V-takes is selected for recording or playback. For example, you could record a difficult guitar solo onto multiple V-takes, and then compare them later to select the best take.

Switching V-takes

To select the V-take for each track, proceed as follows.

- 1. Make sure that the recorder is stopped and the AUDIO mode top screen is shown. Press the [TRACK PARAMETER] key.**

The track parameter screen is shown. On this screen, you can make various settings for each track. The first time you call up the screen, the indication "INPUT SEL" appears, and then the currently selected input source is shown.



- 2. Use the cursor left/right keys to select the audio track for which you want to switch the V-take.**

The name of the selected track is briefly shown, and then the track parameter and setting value are shown. The level meter segment for that track is flashing.

HINT

Once the audio track has been selected, you can also use the status keys to switch tracks.

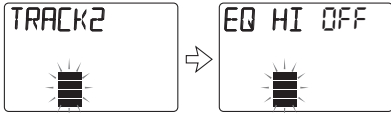

3. Repeatedly press the cursor [▼] key to bring up the indication “TR x-y” on the display (where x is the track number and y the V-take number).

While this screen is shown, you can change the V-take for the currently selected track.

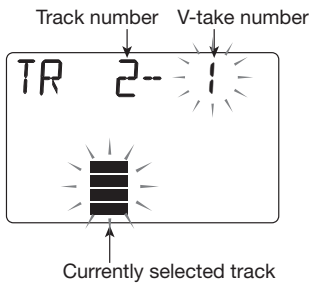

4. Turn the dial to select the desired V-take number.

When you select an unrecorded V-take, the indication “E” (for “Empty”) is shown to the right of the V-take number.

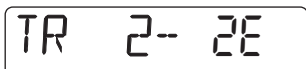

5. If required, use the status keys or cursor left/right keys to change the track, and then select the V-take for that track.
6. Press the [EXIT] key to return to the AUDIO mode top screen.

Moving to a desired location in the song (Locate/Marker function)

This section describes how to jump to a point specified in minutes/seconds/milliseconds or measure/beat units (Locate function) and how to set a mark at any desired point and jump to that point (Marker function).

■ Specifying time or measures

You can specify a point in minutes/seconds/milliseconds or measure/beat units, and move to that point.

1. From the AUDIO mode top screen, set the counter display format to time or measure/beat.

While the AUDIO mode top screen is shown, you can control the numeric counter indication to go to a point.

2. Use the cursor left/right keys to cause a display digit to flash.

The flashing digit is the one that can be adjusted.

Time display



Measure/beat display



3. Turn the dial to adjust the value of the flashing digit.

When the value is changed, the recorder immediately moves to the new point. By pressing the [▶/■] key, you can start playback from that point.

HINT

The numeric indication for measure/beat display depends on the time signature and tempo of the pattern/song selected in RHYTHM mode. (For details, see page 59.)

■ Setting a mark in a song

By setting a mark anywhere in a project, you can easily return to that point later. Up to 100 markers can be set per project.

1. From the AUDIO mode top screen, move to the point where you want to set a mark.

HINT

A mark can be set either in the playback or stop condition.

2. Press the [MARK] key.

A mark is set at the current location, and the mark number is shown on the display for a while.



Newly added marks are automatically numbered in the range from 01 to 99. (The mark number 00 is always assigned to the beginning of the project.) If you add a new mark between two existing marks, all subsequent marks will be renumbered, as shown below.

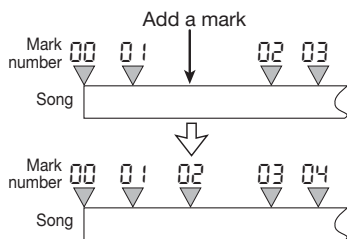

■ Locating a mark

You can jump to any mark position (Locate function).

1. Display the AUDIO mode top screen.
2. Use the cursor left/right keys to switch the counter indication to mark units.

At this screen, you can specify a mark to locate.

When the displayed marker number and the current position match, the indication "MARK" is shown to the left of the mark number.

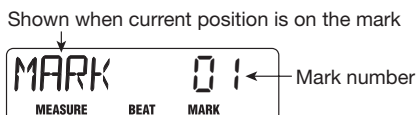

3. Turn the dial to select the number of the mark to which you want to move.

When you select a mark number, the recorder immediately moves to that position.

■ Deleting a mark

You can delete marks that are no longer needed.

1. Display the AUDIO mode top screen and switch the counter indication to mark units.
2. Turn the dial to select the number of the mark you want to delete.



NOTE

If the current position does not match the mark position, the mark cannot be deleted. When the indication "MARK" is shown to the left of the mark number, the displayed marker number and the current position match.

3. Press the [MARK] key.

The selected mark is deleted, and all subsequent marks will be renumbered, as shown below.



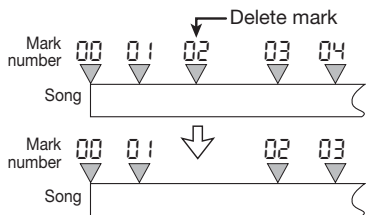

NOTE

- Once a mark has been deleted, it cannot be restored.
- The mark at the beginning of a song (mark number 00) cannot be deleted.

Playing back the same passage repeatedly (A-B Repeat function)

A-B Repeat is a function that repeatedly plays back a specified passage within a project. This is useful to listen to the same part repeatedly, or perform repeated recording.

1. From the AUDIO mode top screen and with the recorder stopped, press the [EDIT/UTILITY] key.

The audio utility menu appears. This menu gives access to track editing functions and A-B repeat.



2. Use the cursor left/right keys to bring up the indication "A-B REPT" on the display, and press the [ENTER] key.

The indication "REPEAT OF" appears on the display. In this condition, the A-B repeat function is not active.

3. Turn the dial to change the indication to ON, and press the [ENTER] key.

"START" is shown beneath the counter to indicate that the start point (point A) can be set. By switching the counter indication, you can set the

start point in measures/beats or using a mark.



4. Use the cursor left/right keys and the dial to specify the start point, and press the [ENTER] key.

"END" is shown beneath the counter to indicate that the end point (point B) can be set.



5. Specify the end point (point B) as in step 3, and press the [ENTER] key.

The A-B repeat function becomes active. While the function is active, a rotating indication such as shown below appears at the left edge of the counter.



HINT

- When you set point B before point A, the section B → A will be repeated.
- To redo the point A/B setting, perform steps 1 - 5 once more.

6. To start repeat playback, press the [▶/■] key.

Repeat playback begins. When the end point (point B) is reached, the recorder jumps to the start point (point A), and playback continues.

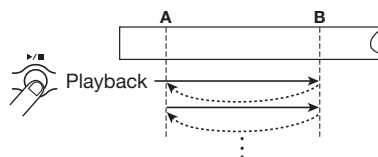

7. To stop repeat playback, press the [▶/■] key once more.

Also after the recorder was stopped, you can play the specified passage again for as long as the A-B repeat function is not canceled.

8. To cancel the A-B repeat function, perform steps 1 and 2 once more and set A-B repeat to OFF.

HINT

It is also possible to combine repeat playback with special functions such as auto punch-in/out. For example, if you set points A and B slightly outside the intended recording range, the recorder will automatically return to point A after auto punch-in/out is completed, and the recorded content will be played, letting you check the success of the procedure.

Re-recording only a specified part (Punch-in/out function)

Punch-in/out is a function that lets you re-record just a specified part of a previously recorded track. The action of switching a currently-playing track to record mode is called “punch-in”, and the action of switching back from recording to playback is called “punch-out”.

The PS-04 provides two ways to do this. You can use the panel keys to punch-in/out manually (“manual punch-in/out”), or you can have punch-in/out occur automatically at previously specified points (“auto punch-in/out”).

■ Using manual punch-in/out

This section describes how to perform manual punch-in/out to re-record a part of a previously recorded track, using the panel keys.

1. From the AUDIO mode top screen, repeatedly press the status key of the track on which you want to perform punch-in/out, until the “REC” indication is visible.

If necessary, adjust the input sensitivity and recording level for the instrument again.



2. While playing the instrument to be recorded, operate the fader of the selected track to adjust the monitor level.

3. Move to a point several measures before the intended punch-in point, and press the [▶/■] key to begin recorder playback.

4. When you come to the punch-in point, press the [REC] key.

The key lights up and track recording begins from that location (punch-in).

5. When you come to the intended punch-out point, press the [REC] key once more.

The [REC] key goes out, and the PS-04 switches from recording to playback (punch-out).

6. Press the [▶/■] key to stop recorder playback.

After recording, the indication “WAIT” is briefly shown on the display.

HINT

The duration of the “WAIT” interval depends on the recording condition.

7. To check the newly recorded content, move to the point of step 4, and press the [▶/■] key.

8. If you are satisfied with the result, press the status key for that track to turn off the “REC” indication.

■ Using auto punch-in/out

This is a function that lets you specify beforehand the region to be re-recorded, for automatic punch-in/out.

1. From the AUDIO mode top screen, repeatedly press the status key of the track on which you want to perform punch-in/out, until the “REC” indication is visible.

If necessary, adjust the input sensitivity and recording level for the instrument again.

2. While playing the instrument to be recorded, operate the fader of the selected track to adjust the monitor level.
3. Move to the point where you want to perform punch-in, and press the [AUTO PUNCH IN/OUT] key.

The indication “AUTO PUNCH IN/OUT” flashes in the middle of the display, and the current point is set as the punch-in point.



4. Move to the point where you want to perform punch-out, and press the [AUTO PUNCH-IN/OUT] key once more.

The indication “AUTO PUNCH IN/OUT” stops flashing and stays constantly on. The current point is set as the punch-out point.

HINT

The auto punch-in/out setting can be made in the playback or stop condition.

5. Use the Locate function to move to a point a few measures before the punch-in point.
6. To rehearse the auto punch-in/out procedure, press only the [▶/■] key.

To actually perform auto punch-in/out, hold down the [REC] key and press the [▶/■] key.

- If [▶/■] key only was pressed (rehearsal)

When the punch-in point is reached, the track selected for punch-in/out will be muted. At the punch-out point, muting is canceled. (The input signal can be monitored during this time.)



- If [REC] key + [▶/■] key was pressed (actual function)

When the punch-in point is reached, recording will begin automatically (punch-in). At the punch-out point, recording will end automatically, and playback will resume (punch-out).

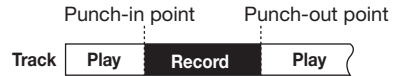

HINT

For the section that is muted/recorded, the “REC” indication stops flashing and stays constantly on.

7. When punch-in/out is completed, press the [▶/■] key so that the key goes out.

The indication “WAIT” is briefly shown on the display.

8. To check the newly recorded content, press the [AUTO PUNCH IN/OUT] key to cancel the auto punch-in/out function. Then move to the point of step 4 and press the [▶/■] key.

When you cancel the auto punch-in/out function so that the indication goes out, the settings for the punch-in and punch-out point are lost. To redo the recording, repeat steps 3 - 7.

- 9.** If you are satisfied with the result, press the status key for that track to turn off the “REC” indication.

Combining multiple tracks on another track (Bounce function)

“Bounce” is a function that mixes the contents of audio track 1 – 4 and the drum/bass track, and records them on one or two tracks. (This is sometimes also called “ping-pong recording”.)

Even if all tracks 1 – 4 have all been recorded, you can transfer the result to one or two empty V-takes. By subsequently switching the V-takes, you can then listen to the bounced content and perform further recording. This technique also allows you to perform mixdown entirely within the PS-04, without using an external master recorder.

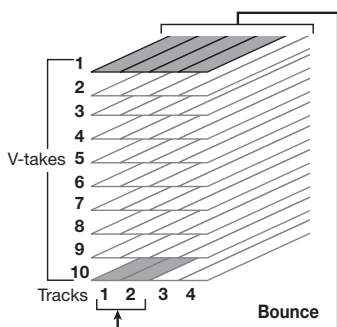

HINT

- You can also mix input signals into the bounce recording.
- If you select only one track as the bounce destination, the signal mixed to mono will be recorded.

■ Making settings for the bounce target track(s)

In the default condition of the PS-04, the bounce destination recording track(s) will be muted. To play back a track while you bounce-record on another V-take of that track, use the following procedure to change the internal setting so that the recording track(s) will also play back.

- 1.** From the AUDIO mode top screen and with the recorder stopped, press the [EDIT/UTILITY] key.

The AUDIO mode utility menu appears.

- 2.** Use the cursor left/right keys to bring up the indication “BOUNCE” on the display, and press the [ENTER] key.

- 3.** Use the cursor left/right keys to bring up the indication “TRACK” on the display, and press the [ENTER] key.

The display changes as follows.



From this screen, you can select one of the following two settings for the bounce target track.

- **MUTE (Default)**

The bounce target track(s) will be muted.

- **PLAY**

The bounce target track(s) will play back.

- 4.** Turn the dial to change the setting to “PLAY”.

- 5.** Press the [EXIT] key repeatedly to return to the AUDIO mode top screen.

■ Selecting the bounce target V-take

V-take

In the default condition of the PS-04, the result of the bounce operation will be recorded on the V-take that is currently selected for the recording track(s). To play back a track while bouncing onto another V-take of that track, you can use the following procedure to change the recording destination V-take.

1. From the AUDIO mode top screen and with the recorder stopped, press the [EDIT/UTILITY] key.

The AUDIO mode utility menu appears.

2. Use the cursor left/right keys to bring up the indication "BOUNCE" on the display, and press the [ENTER] key.

3. Use the cursor left/right keys to bring up the indication "TAKE" on the display, and press the [ENTER] key.

The display changes as follows.

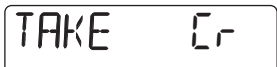

From this screen, you can select one of the following two settings for the bounce target V-take.

- **CR (Default)**

The bounce result will be recorded on the V-take currently selected for the recording track.

- **1 - 10**

The bounce result will be recorded on the V-take of the number you specify here.

4. Turn the dial to select the bounce target V-take.

5. Press the [EXIT] key repeatedly to return to the AUDIO mode top screen.

■ Carrying out bounce recording

In this example, we will bounce the contents of audio tracks 1 - 4 onto V-takes 10 of tracks 1/2.

1. Set the bounce target operation to "PLAY" and select "10" as bounce target V-take.

For details, see the preceding section.

2. Repeatedly press the status key 1 until the "REC" indication is shown for track 1. Then keep pressing the key.

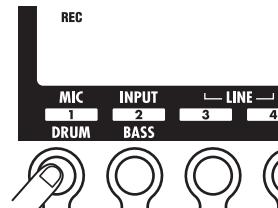

3. While still holding down status key 1, repeatedly press the status key 2 until the "REC" indication is shown for track 2.

In this condition, the same signal as supplied at the [OUTPUT] jack of the PS-04 is recorded on V-takes 10 of tracks 1 and 2.

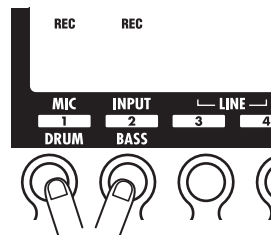

HINT

- When performing bouncing in stereo, the left channel of the bounce source is recorded on the odd-numbered track and the right channel on the even-numbered track.
- If desired, you can also add the drum/bass track signal and the input signal to the bounced mix.

4. Press the [BOUNCE] key.

The bounce function is enabled, and the indication “BOUNCE” appears on the center right side of the display.

5. Play tracks 1 – 4 and adjust the level balance between the tracks.

The settings for level balance, panning, and send/return effect intensity all affect how the track is recorded on the bounce target. During recording, watch the level meter to make sure that there is no signal clipping.

6. Press the [◀◀] key to return the recorder to the start, and then hold down the [REC] key and press the [▶/■] key.

Both keys light up and bounce recording starts.

7. When bounce recording is finished, press the [▶/■] key so that the key goes out.

The recorder stops.

8. Switch the respective track to the bounce target V-take and perform playback to check the recording.

Turn down the faders for the other tracks to mute their sound. When the bounced material was in stereo, set the PAN parameter for track 1 to L100 and the PAN parameter for track 2 to R100, for monitoring with correct stereo imaging. (For information on how to make this setting, see page 56.)

To redo the bounce recording, repeat steps 5 – 8.

NOTE

Also when you change the selected V-take, the parameters set for that track will still be active. To monitor the bounced recording correctly, return the EQ and effect settings for the track to the default condition.

9. To cancel the bounce function, press the [BOUNCE] key once more.

The “BOUNCE” indication disappears from the

display. When you are finished with the bounce operation, return the operation settings and V-take selection for the bounce target track to the original condition.

Changing the precount operation

In the default condition of a project, a 4-beat precount is heard before recording starts. You can change the duration and volume of the precount, if desired.

1. From the AUDIO mode top screen and with the recorder stopped, press the [EDIT/UTILITY] key.

The AUDIO mode utility menu appears.

2. Use the cursor left/right keys to bring up the indication “PRECOUNT” on the display.

3. Press the [ENTER] key.

The display changes as follows.



4. To change the number of precount beats, turn the dial and select one of the following settings.

- **OFF**
No precount is heard.
- **1-8**
1 – 8 precount beats are heard.
- **SP**
The following special precount is heard.



- 5. To change the volume of the precount, use the cursor left/right keys.**

The following indication appears on the display.



- 6. Turn the dial to adjust the precount volume.**

The setting range is 0 – 15.

- 7. When the setting is complete, press the [EXIT] key two times to return to the AUDIO mode top screen.**

When you next perform recording, the precount will operate according to the chosen setting.

- **HI-FI**
Recording grade set to Hi-Fi
- **LONG**
Recording grade set to Long

- 4. When the check is finished, press the [EXIT] key two times to return to the AUDIO mode top screen.**

Checking the grade setting of a project

To check the grade (sound quality) setting of the currently active project, proceed as follows. This procedure only allows you to check the setting, not to change it.

- 1. From the AUDIO mode top screen and with the recorder stopped, press the [EDIT/UTILITY] key.**

The AUDIO mode utility menu appears.

- 2. Use the cursor left/right keys to bring up the indication “GRADE” on the display.**



- 3. Press the [ENTER] key.**

The recording grade setting for the currently active project is shown as follows.

Reference [Track Editing]

This section explains how to edit audio data contained on tracks 1 – 4. There are two major types of editing functions: specifying a range for editing, and editing an entire V-take.

Editing a range of data

The procedure for specifying a range of a V-take and then performing an action such as copying or moving is explained below.

■ Basic steps for range editing

When performing editing for a specified range of data, some steps are similar for each action. These are as follows.

- 1. From the AUDIO mode top screen and with the recorder stopped, press the [EDIT/UTILITY] key.**

The audio utility menu appears.



- 2. Verify that "TRK EDIT" is shown on the display, and press the [ENTER] key.**

The track edit menu appears. This menu gives access to various editing commands for a specified range.



- 3. Use the cursor left/right keys to select one of the following commands.**

- **Copy**
Copy a specified range of audio data.
- **Move**
Move a specified range of audio data.
- **Erase**
Erase a specified range of audio data.

- **Trim**

Retain only a specified range of audio data and erase the rest.

- 4. Press the [ENTER] key.**

The editing command is selected, and you can specify the track/V-take for editing.

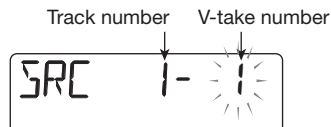

- 5. Use the cursor left/right keys to select the track/V-take for editing.**

You can also select the track with the status keys 1 – 4. On this screen, also V-takes that are not currently selected for tracks 1 – 4 can be selected for editing. If you select a V-take including no audio data, the symbol "E" (for "Empty") is shown to the right of the number.



When track 4 is selected, turning the dial further to the right bring up the following display.



"1_2" means that tracks 1 and 2 are selected as a pair for simultaneous editing. Similarly, "3_4" means that tracks 3 and 4 are selected as a pair. In this case, the currently selected V-take for each track will be the editing target.

- 6. Press the [ENTER] key.**

The subsequent steps will differ, depending on which command was selected in step 3. See the

sections for the respective commands.

- Press the [EXIT] key repeatedly to return to the AUDIO mode top screen.



NOTE

After performing an edit function and rewriting the audio data on a track, the original data cannot be restored. Use these functions with care, to prevent inadvertently losing data.

■ Copying a specified range of data

You can copy the audio data of a specified range to a specified position on a specified track/V-take. This action will overwrite the existing data at the destination location. The copy source data will be unchanged.

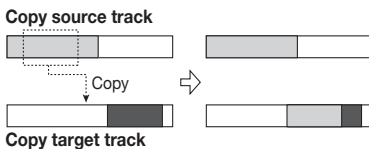

- Refer to “Basic steps for range editing” to select the copy source track/V-take, and press the [ENTER] key.

The indication “START” appears, and you can specify the copy start point.



- Use the cursor left/right keys to move the flashing part of the counter, and turn the dial to change the value.

You can also specify the point in measure/beat units or as a mark. To do this, repeatedly press the cursor left or right key to change the counter format. When there are no audio data, the “*” symbol is shown.

- Press the [ENTER] key.

The indication “END” appears, and you can specify the copy end point.

- Specify the copy end point using the same procedure as in step 2.

- Press the [ENTER] key.

The display indication changes to “DST x-y” (where x is the track number and y the V-take number). This lets you specify the copy destination track/V-take.

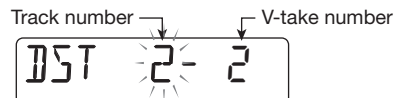

NOTE

- If you have selected a single track as copy source, only a single track can be selected as copy destination.
- If you have selected two adjacent tracks (1_2 or 3_4) as copy source, only two adjacent tracks can be selected as copy destination. In this case, the currently selected V-take for each track becomes the editing target.

- Specify the copy destination track/V-take in the same way as when selecting the copy source track/V-take, and press the [ENTER] key.

The indication “TO” appears, and you can specify the start point.



- Specify the copy start point using the same procedure as in step 2, and press the [ENTER] key.

The indication “ENT/EXIT” appears on the display.

8. To carry out the copy operation, press the [ENTER] key once more.

When the copy process is finished, the track edit menu appears again.

By pressing the [EXIT] key instead of the [ENTER] key, you can cancel the operation and return to the previous screen.

■ Moving a specified range of data

You can move the audio data of a specified range to a specified position on a specified track. This action will overwrite the existing data at the destination location. The move source data will be erased.

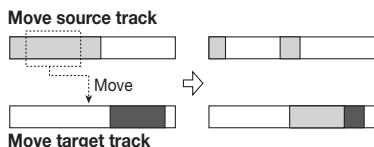

1. Refer to “Basic steps for range editing” to select the move source track/ V-take, and press the [ENTER] key.

The indication “START” appears, and you can specify the move start point.



2. Use the cursor left/right keys to move the flashing part of the counter, and turn the dial to change the value.

You can also specify the point in measure/beat units or as a mark. When there are no audio data, the “*” symbol is shown.

3. Press the [ENTER] key.

The indication “END” appears, and you can specify the move end point.



4. Specify the move end point using the same procedure as in step 2.

5. Press the [ENTER] key.

The display indication changes to “DST x-y” (where x is the track number and y the V-take number). This lets you specify the move destination track/V-take.

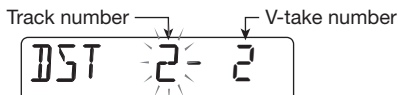

NOTE

- If you have selected a single track as move source, only a single track can be selected as move destination.
- If you have selected two adjacent tracks (1_2 or 3_4) as move source, only two adjacent tracks can be selected as move destination. In this case, the currently selected V-take for each track becomes the editing target.

6. Specify the move destination track/ V-take in the same way as when selecting the move source track/ V-take, and press the [ENTER] key.

The indication “TO” appears, and you can specify the move destination start point.



7. Specify the move start point using the same procedure as in step 2, and press the [ENTER] key.

The indication “ENT/EXIT” appears on the display.

8. To carry out the move operation, press the [ENTER] key once more.

When the move process is finished, the track edit menu appears again.

By pressing the [EXIT] key instead of the [ENTER] key, you can cancel the operation and return to the previous screen.

■ Erasing a specified range of data

You can erase the audio data of a specified range and return the range to the mute (non-recorded) condition.

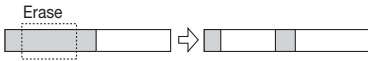

1. Refer to “Basic steps for range editing” to select the track/V-take from which you want to erase data, and press the [ENTER] key.

The indication “START” appears, and you can specify the erase start point.



2. Use the cursor left/right keys to move the flashing part of the counter, and turn the dial to change the value.

You can also specify the point in measure/beat units or as a mark. When there are no audio data, the “*” symbol is shown.

3. Press the [ENTER] key.

The indication “END” appears, and you can specify the erase end point.



4. Specify the erase end point using the same procedure as in step 2.

5. Press the [ENTER] key.

The indication “ENT/EXIT” appears on the display.

6. To carry out the erase operation, press the [ENTER] key once more.

When the erase process is finished, the track edit

menu appears again.

By pressing the [EXIT] key instead of the [ENTER] key, you can cancel the operation and return to the previous screen.

■ Trimming a specified range of data

You can erase the audio data of a specified range and adjust the data start/end point (trimming). This is useful for example to remove unwanted portions at the start and end of a final mixdown created by bouncing onto 2 tracks.



NOTE

When data before a specified section are erased (trimmed), the remaining audio data will move up by that amount. Therefore the timing may become mismatched with regard to other tracks/V-takes.

1. Refer to “Basic steps for range editing” to select the track/V-take from which you want to trim data, and press the [ENTER] key.

The indication “START” appears, and you can specify the start point for the range to be preserved after trimming.



2. Use the cursor left/right keys to move the flashing part of the counter, and turn the dial to change the value.

You can also specify the point in measure/beat units or as a mark. When there are no audio data, the “*” symbol is shown.

All data before the point specified here will be erased.

3. Press the [ENTER] key.

The indication “END” appears, and you can specify

the end point for the range to be preserved after trimming.



4. Specify the trimming end point using the same procedure as in step 2.

All data after the point specified here will be erased.

5. Press the [ENTER] key.

The indication "ENT/EXIT" appears on the display.

6. To carry out the trimming operation, press the [ENTER] key once more.

When the trimming process is finished, the track edit menu appears again.

By pressing the [EXIT] key instead of the [ENTER] key, you can cancel the operation and return to the previous screen.

Editing using V-takes

Recorded audio data can also be edited in V-take units. You can for example exchange the data on two V-takes, or delete a V-take that is no longer needed.

■ Basic steps for V-take editing

When editing audio data in V-take units, some steps are similar for each action. These are as follows.

1. From the AUDIO mode top screen, press the [TRACK PARAMETER] key.

The parameters for tracks 1 – 4 are shown.

HINT

The parameters for tracks 1 – 4 can also be controlled in EFFECT mode.

2. Use the cursor left/right keys to select the track which includes the

V-take that you want to edit.

The name of the selected track is briefly shown on the display, and then the track parameters and settings values are shown.



3. Use the cursor up/down keys to bring up the indication "TR x-y" on the display (where x is the track number and y the V-take number).

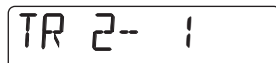

4. Turn the dial to select the V-take for editing.

You can also use the cursor left/right keys to switch tracks while you are selecting a V-take.

HINT

- It is also possible to select a V-take other than the one currently selected for the track.
- When you select an unrecorded V-take, the indication "E" (for "Empty") is shown to the right of the V-take number.

5. Press the [INSERT/DELETE (COPY)] key.

From this screen, you can select commands for editing in V-take units by pressing the [INSERT/DELETE(COPY)] key repeatedly. The following commands are available. You can also use the cursor left/right keys to select a command.

• DELETE

Erase the audio data on a specified V-take.

• COPY

Copy the audio data of a specified V-take to another V-take.

COPY

• **EXCHANGE**

Exchange the audio data of a specified V-take with the data of another V-take.

6. Press the [ENTER] key.

The subsequent steps will differ, depending on which command was selected. See the sections for the respective commands.

7. Press the [EXIT] key repeatedly to return to the AUDIO mode top screen.

■ **Copying a V-take**

You can copy the audio data of a specified V-take to any other V-take. This action will overwrite any existing data on the destination V-take. The data on the copy source V-take will be unchanged.

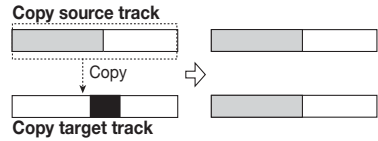

1. Refer to “Basic steps for V-take editing” to select the track/V-take which you want to copy, and bring up the indication “COPY” on the display.

■ **Deleting a V-take**

You can delete the audio data on a specified V-take. The V-take is returned to the non-recorded condition.



1. Refer to “Basic steps for V-take editing” to select the track/V-take which you want to delete, and bring up the indication “DELETE” on the display.

DELETE

2. Press the [ENTER] key.

The indication “ENT/EXIT” appears on the display.

3. To carry out the delete operation, press the [ENTER] key once more.

The V-take is returned to the blank condition, and the track parameter menu returns.

By pressing the [EXIT] key instead of the [ENTER] key, you can cancel the operation and return to the previous screen.

2. Press the [ENTER] key.

The display indication changes as follows. In this condition, you can select the copy destination track/V-take.

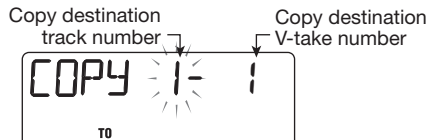

3. Use the cursor left/right keys to move the flashing part, and turn the dial to select the track and V-take to use as copy target.

4. Press the [ENTER] key.

The indication “ENT/EXIT” appears on the display. If there is a audio data on the copy target, the indication "OVR WRITE" appears on the display.

5. To carry out the copy operation, press the [ENTER] key once more.

The copy process is carried out, and the track

parameter menu returns.

By pressing the [EXIT] key instead of the [ENTER] key, you can cancel the operation and return to the previous screen.

■ Exchanging V-takes

You can exchange the audio data of two specified V-takes.

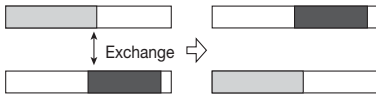

1. Refer to “Basic steps for V-take editing” to select the source track/V-take which you want to exchange, and bring up the indication “EXCHANGE” on the display.



2. Press the [ENTER] key.

The display indication changes as follows.

In this condition, you can select the exchange destination track/V-take.

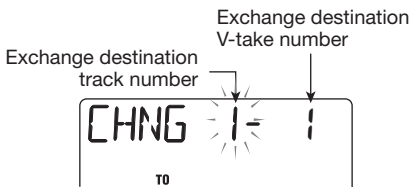

3. Use the cursor left/right keys to move the flashing part, and turn the dial to select the track and V-take to use as exchange target.

4. Press the [ENTER] key.

The indication “ENT/EXIT” appears on the display.

5. To carry out the exchange operation, press the [ENTER] key once more.

The exchange process is carried out, and the track parameter menu returns.

By pressing the [EXIT] key instead of the [ENTER] key, you can cancel the operation and return to the previous screen.

Reference [Mixer]

This section explains the functions and operation of the mixer built into the PS-04.

About the PS-04 mixer

The mixer in the PS-04 can be used to create a final stereo output mix by adjusting parameters (level, panning, EQ, send/return effect intensity etc.) for the recorded tracks and mixing these with the drum and bass track signals.

If required, the input signals from the [INPUT] jack, [LINE IN] jack, or built-in mic can be added directly to the stereo mix, and panning and send/return effect intensity can also be adjusted separately for these signals.

HINT

- The input signals can only be directly added to the mix when no track in recording standby mode is selected. If there is a track in recording standby mode, the input signal will be sent to that track and the panning and send/return effect settings for the input will be inactive.
- The input signal and the signal immediately before the [OUTPUT] jack can be processed with the insert effect (→ p. 84).

- The signal produced by the mixer can be bounced to any track if desired (→ p. 42).

Assigning input signals to tracks

This section explains how to select up to two input signals and assign them to tracks for recording.

■ Selecting the input source

The PS-04 allows you to select up to two signals (input sources) from the [INPUT] jack, built-in mic, and the [LINE IN] jack, for sending to the recorder tracks. If desired, you can also mix the signals from [INPUT] jack and [LINE IN] jack onto a single track, or record the signal from [INPUT] jack and the built-in mic onto separate tracks. To select the input source and set the recording level, proceed as follows.

- 1. From the AUDIO mode or EFFECT mode top screen, press the [TRACK PARAMETER] key.**

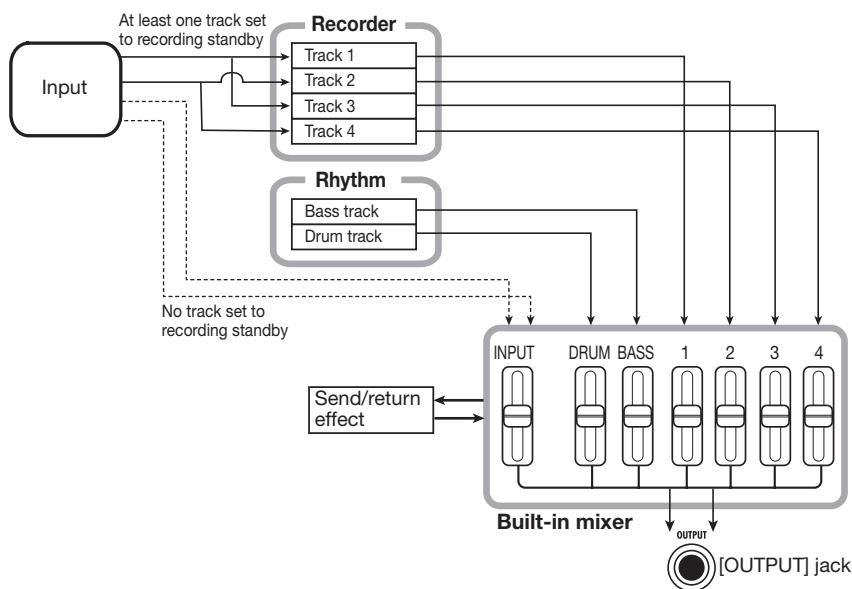

Reference [Mixer]

The track parameter menu for making input and track 1 – 4 settings appears.

2. Use the cursor left/right keys to bring up the indication “INPUT SEL” on the display.

The indication “INPUT SEL” is briefly shown on the display, and then the input source display appears.

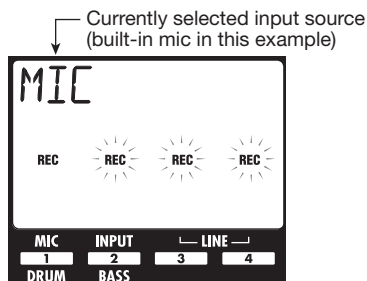

HINT

The “REC” indications on the display correspond to the built-in mic, [INPUT] jack, and [LINE IN] jack. When the indication is constantly on, the source is selected (active). Otherwise the indication is flashing.

3. Use the status keys 1 – 4 to select the input source.

To select a single input source, press one of the status keys 1 – 4. To select two input sources, press the status keys for the two sources simultaneously.

Possible input source combinations are listed in the table below.

Status key	Display	Input source	
		Input 1	Input 2
1	MIC	Built-in mic	
2	INPUT	[INPUT] jack	
3 or 4	LINE	[LINE IN] jack L	[LINE IN] jack R
1+2	MIC+INPUT	Built-in mic	[INPUT] jack
1 + 3 or 1 + 4	MIC+LINE	Built-in mic	[LINE IN] jack L + R
2 + 3 or 2 + 4	LIN+INPUT	[LINE IN] jack L + R	[INPUT] jack

HINT

- The [LINE IN] signal can be selected by pressing only one of the status keys 3 or 4.
- When combining the [LINE IN] signal with another input source, the L and R components of the signal at the [LINE IN] jack are mixed to produce a mono signal.

4. When the [INPUT] jack was selected as input source, play the instrument and adjust the input sensitivity with the [INPUT LEVEL] knob so that the sound is not distorted when playing the instrument at maximum level.

If the indication “-PEAK-” is shown on the display, signal distortion has occurred.

5. To adjust the recording level, play the instrument and adjust the fader for the selected input source.

While the input track parameter display is shown, you can use faders 1 – 4 to adjust the recording level for each source. You can check the current level using the setting value shown on the display and the level meter.

When two sources are selected, use the up/down cursor keys to select either to be adjusted.

If signal distortion occurs, the topmost segment of the level meter will stay on for a while. Use the fader to reduce the recording level setting for that source.



HINT

The recording level of the signal from the [LINE IN] jack can be adjusted with fader 3 or fader 4. (The recording level is always linked for the L and R channel.)

- Press the [EXIT] key to return to the AUDIO mode or EFFECT mode top screen.

■ Selecting the recording track(s)

Next, select the track(s) on which the input source signal is to be recorded. Signal processing will be different, depending on whether the input source is mono (one signal) or stereo (2 signals), and whether 1 or 2 tracks are selected.

- Bring up the AUDIO mode top screen.

On the AUDIO mode top screen, you can use status keys 1 – 4 to activate/deactivate the recording standby condition for tracks 1 – 4.

- To switch only one track to the recording standby condition, press the respective status key.

The “REC” indication appears above the level meter for the track. This shows that the track is in the recording standby condition.

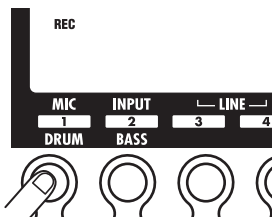

If the currently selected input source is mono (1 signal), this signal will be sent as is to the track. If the source is stereo (2 signals), the signals will be mixed and then sent to the track.

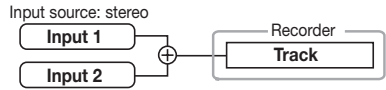

- To switch two tracks to the recording standby condition, hold down the status key for one track and then press the status key for the other track.

Only the combination of tracks 1 and 2 or 3 and 4 can be selected. When you press the status keys 1/2 or 3/4, the “REC” indication appears above the level meter for the respective tracks. This shows that the tracks are in the recording standby condition.

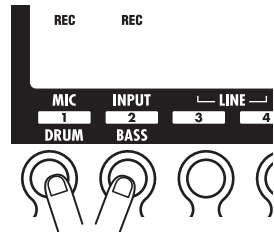

If the currently selected input source is mono (1 signal), the same signal will be sent to both tracks. If the source is stereo (2 signals), the signal from input 1 will be sent to the odd-numbered track and the signal from input 2 to the even-numbered track.

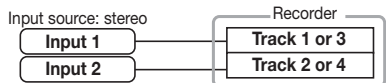
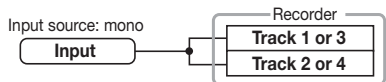
**HINT**

To deactivate the recording standby condition, press the currently selected status key once more.

Mixing the playback sound from tracks

The level of the sound from audio tracks 1 – 4 and the drum and bass track can be adjusted as follows.

- To adjust the level of audio tracks 1 – 4, bring up the AUDIO mode top screen and use faders 1 – 4 while performing playback with the recorder.**

When the PS-04 is in AUDIO mode, faders 1 – 4 are assigned to audio tracks 1 – 4. The level of each track is shown by the respective level meter.

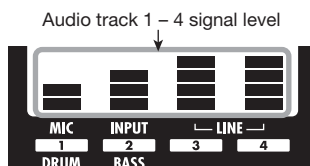

- To adjust the drum track or bass track signal level, press the [RHYTHM] key to bring up the RHYTHM mode top screen and then use faders 1 and 2.**

In RHYTHM mode, fader 1 is assigned to the drum track and fader 2 is assigned to the bass track. The level of the drum and bass track is shown by level meter 1 and 2.

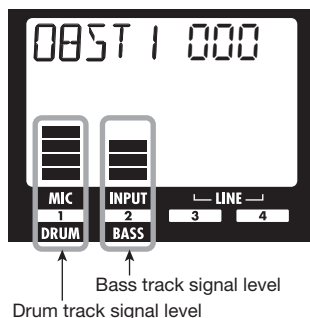

Making adjustments for each track signal (track parameters)

The mixer in the PS-04 allows adjustment of various track parameters such as panning, EQ, and send/return effect intensity. Parameters can be adjusted for the audio tracks 1 – 4, drum track, bass track, and input signals. The adjustment procedure is described below.

- Depending on the track or input for which you want to make the adjustment, bring up the top screen of the AUDIO mode or RHYTHM mode, and press the [TRACK PARAMETER] key.**

When you press the [TRACK PARAMETER] key in AUDIO mode, you can adjust parameters for audio tracks 1 – 4 or the input sources. When you press the [TRACK PARAMETER] key in RHYTHM mode, you can adjust parameters for the drum track and bass track.

- Use the cursor left/right keys to select the track or input.**

The track name is shown for a few seconds, and then a parameter and its setting value appear.

TRACK 1

HINT

Once the audio track has been selected, you can also use the status keys to switch tracks.

- Use the cursor up/down keys to select the track parameter you want to adjust.**

The available track/input parameters are shown in the table on the next page.

Parameter	Display indication	Setting range	Description	Audio track	Drum/bass track	Input
HI EQ ON/OFF	<i>EQ HI</i>	ON / OFF	Switches Hi EQ on and off.	○	○	
HI EQ GAIN	<i>HI G</i>	-12 – 12	Adjusts the Hi EQ boost/cut amount in the range from -12 dB to +12 dB. This parameter is shown only when Hi EQ is set to ON.	○	○	
HI EQ FREQUENCY	<i>HI F</i>	500 – 8000 (Hz)	Selects the Hi EQ frequency for boost/cut. This parameter is shown only when Hi EQ is set to ON.	○	○	
LO EQ ON/OFF	<i>EQ LO</i>	ON / OFF	Switches Lo EQ on and off.	○	○	
LO EQ GAIN	<i>LO G</i>	-12 – 12	Adjusts the Lo EQ boost/cut amount in the range from -12 dB to +12 dB. This parameter is shown only when Lo EQ is set to ON.	○	○	
LO EQ FREQUENCY	<i>LO F</i>	63 – 2000 (Hz)	Selects the Lo EQ frequency for boost/cut. This parameter is shown only when Lo EQ is set to ON.	○	○	
SEND ON/OFF	<i>SEND</i>	ON / OFF	Selects whether the signal of this track is supplied to the send/return effect or not.	○	○	○
SEND LEVEL	<i>SEND_L</i>	0 – 100	Adjusts the level of the signal supplied to the send/return effect. This parameter is shown only when SEND is set to ON.	○	○	○
PAN	<i>PAN</i>	L100 – 0 – R100	Adjusts the panning (left/right stereo position) of the track signal. When the STEREO LINK parameter is set to ON, this parameter adjusts the left/right level balance.	○	○	○
FADER	<i>FADER</i>	0 – 127	Adjusts the current volume level.	○	○	
STEREO LINK	<i>S-LINK</i>	ON / OF	Switches the stereo link function (for linking the parameters of tracks 1/2 and 3/4) on and off. (For details, see page 58.)	○		
V TAKE	<i>TR X - Y</i>	X=1 – 4 Y=1 – 10	Selects the V-take for this track. (For details, see page 36.) X is the track number and Y is the V-take number.	○		
REC LEVEL	<i>RECLVL</i>	0 – 127	Adjusts the recording level.			○

4. Turn the dial to change the setting value of the parameter selected in step 3.

5. Repeat steps 3 and 4 to make all desired settings.

By using the cursor left/right keys or the status keys to switch tracks, you can set the parameters for other tracks.

6. Press the [EXIT] key to return to the original screen.

The top screen of AUDIO mode or RHYTHM mode appears again.

Linking tracks (stereo link)

Two adjacent tracks can be linked so that their parameters (except V-take switching) are controlled together. This is referred to as “stereo link”. The function is handy for example when recording stereo material.

NOTE

The stereo link function is available only for tracks 1/2 and 3/4, not for other track combinations.

1. From the AUDIO mode or EFFECT mode top screen, press the [TRACK PARAMETER] key.

The track parameter menu for making input and track 1 – 4 settings appears.

2. Use the cursor left/right keys to select one of the two tracks you want to stereo link, and repeatedly press the cursor [▼] key until the indication “S-LINK” is shown on the display.



S-LINK ON

HINT

You can also use the status keys to select the track.

3. Turn the dial to set the stereo link setting to ON.

If you select track 1 or 2, tracks 1 and 2 will be stereo linked. If you select track 3 or 4, tracks 3 and 4 will be stereo linked.

The two linked tracks will operate as follows.

- The PAN parameter functions as a BALANCE parameter that adjusts the volume balance between the left and right channels. (The setting is reset to 0 for both tracks.)
 - For parameters other than PAN and V-TAKE, the setting for the odd-numbered track will be duplicated on the even-numbered track.
 - When you change the parameter setting for one track, the parameter of the other track also changes accordingly. To bring the even-numbered V-take on the display, press the cursor [▼] key while the odd-numbered V-take is shown.
 - When you operate the fader for the odd-numbered track, the level for both tracks changes. (The fader for the even-numbered track has no effect.)
- 4. To cancel the stereo link function, set the stereo link parameter to OFF.**

Reference [Rhythm]

This section explains the rhythm functions of the PS-04.

About the rhythm section

The rhythm section of the PS-04 uses built-in drum and bass sounds to produce rhythm accompaniment which can be played during recording and playback of the audio tracks. For example, during recording you might play a simple pattern that serves as a metronome. Or you can add drum and bass accompaniment to the recorded content of the audio tracks and bounce the result onto a pair of V-takes. Rhythm playback is possible in all modes except the SYSTEM mode. However, to create or edit rhythm patterns and to make rhythm related settings, you must switch to RHYTHM mode by pressing the [RHYTHM] key of the PS-04.

Explanation of some important terms

Some terms that are relevant for rhythm section operation are explained below.

■ PATTERN mode/SONG mode

The rhythm section has two operation modes: PATTERN mode for repeatedly playing drum/bass patterns, and SONG mode for arranging and playing rhythm patterns in a sequence that provides the rhythm accompaniment to an entire song. The initial mode when creating a new project is PATTERN mode, but you can switch between PATTERN mode and SONG mode by pressing the [RHYTHM] key.

■ Pattern/song

A program containing from a few measures up to a maximum of 99 measures of drum/bass sounds is called a pattern. The PS-04 has a capacity for up to 511 patterns per project. 346 patterns are already preprogrammed, allowing you to play a rhythm simply by selecting a pattern.

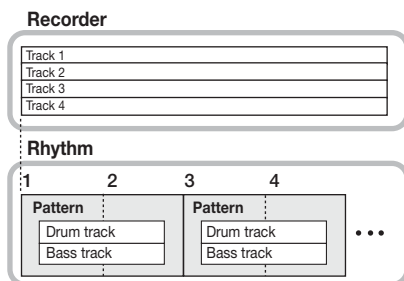

An arrangement of patterns in the desired playing order using tempo, beat, and bass phrase (chord type/root) information is called a song. The PS-04 can have one song with up to 999 measures per project.

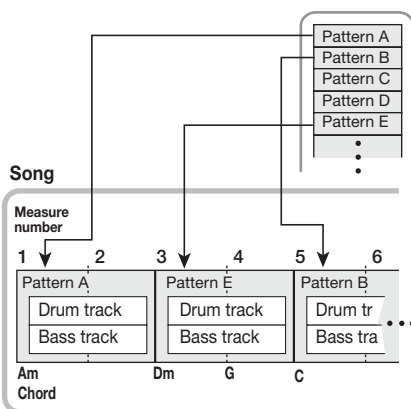

NOTE

Patterns and songs are stored as part of a project. You can also import all patterns or song information from another project.

■ Drum track/bass track

The part that records drum sound patterns in the PS-04 is called the drum track and the part that records bass sound patterns the bass track. When you create original patterns, you store playing information on these two tracks.

■ Drum kit/bass program

A collection of drum sounds used for the drum track is called a drum kit, and a collection of bass sounds used for the bass track is called a bass program.

Drum kits are made up of a combination of 16 drum and percussion sounds, such as bass drum, snares, etc. The PS-04 has seven different drum kits.

A bass program is a collection of bass sounds such as electric bass or acoustic bass at different pitches (2 octaves, 16 steps). The PS-04 offers a choice of five bass programs.

The drum kit and bass program sounds can not only be used in patterns or songs but can also be played directly using the status keys 1 – 4 on the panel.

PATTERN mode operation

This section explains how to use PATTERN mode to play, create, and edit patterns.

■ PATTERN mode screens

PATTERN mode has several screens. When you press the [RHYTHM] key to switch to RHYTHM mode, and when you switch the rhythm function from SONG mode to PATTERN mode, the screen for selecting a pattern always appears first. This is called the PATTERN mode top screen.

● PATTERN mode top screen



When you press the cursor up or down key from the PATTERN mode top screen, the following screens appear.

● Locate screen

This shows the current position in the pattern in measures and beats. While the rhythm is stopped, you can use the cursor left/right keys and the dial to move within the pattern in units of measures or beats.



● Rhythm pad screen

This screen shows information about the content of the currently playing drum track/bass track. On this screen, the on/off status of individual level meter segments (rectangular blocks) shows the drum kit or bass program sound activation status.

From this screen, you can use the status keys 1 – 4 to manually play the sounds of the drum kit or bass program (→ p. 62).



■ Selecting a pattern for playback

The PS-04 lets you select one of 511 patterns.

- 1. While the recorder is stopped, press the [RHYTHM] key several times to bring up the PATTERN mode top screen on the display.**



- 2. Use the dial or the cursor left/right keys to select a rhythm pattern to play.**

Out of 511 possible patterns in a new project, 346 are preprogrammed. (For other patterns, the pattern name indication shows “EMPTY”.)

If you use the dial while the pattern is playing, the new pattern will start after the end of the current pattern is reached. If you use the cursor left/right keys while the pattern is playing, the new pattern will start immediately.

3. Operate faders 1/2 to adjust the volume of the drum/bass track.

In RHYTHM mode, fader 1 controls the drum track and fader 2 controls the bass track signal level.

NOTE

Immediately after creating a new project, the drum/bass signal level will be set to zero. To hear the rhythm play, you must raise the drum/bass track signal level.

4. Press the [▶/■] key.

The key lights up, and the recorder and the rhythm pattern begin to play. (If there are recorded audio tracks, the contents will be heard.)

The level meters on the display let you check the signal level of the drum track and bass track.

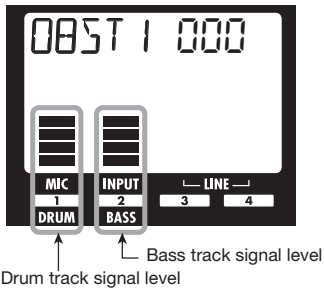

5. Fine-adjust the drum/bass track volume as necessary.

6. To check the current position, press the cursor [▲] key.

The display changes to the Locate screen, and the current position in the pattern is shown in measures and beats.

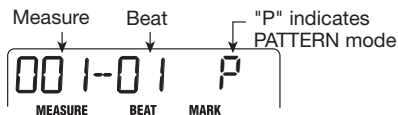

HINT

If you call up the Locate screen while the pattern is stopped and select the unit with the cursor left/right keys, you can use the dial to move within the pattern.

7. To stop the pattern, press the [▶/■] key once more.

The key goes out and playback stops.

■ Changing the tempo

You can adjust the pattern playback tempo as follows.

1. Press the [RHYTHM] key several times to switch the PS-04 to PATTERN mode.

The tempo can be set while the PS-04 is running or stopped. The currently set tempo can be checked while the [RHYTHM] key is flashing.



2. Use faders 3 and 4 to adjust the tempo.

In RHYTHM mode, faders 3 and 4 serve to control the tempo in the range from 40 to 250 bpm (beats per minute).



Shortly after adjusting the tempo, the display will return automatically to the condition of step 1.

NOTE

- The tempo set here applies to all patterns. If you haven't programmed the tempo information in a song yet, the song will also be played with this tempo setting.
- If you have recorded audio tracks 1 – 4 while monitoring the pattern, and if you then change the pattern tempo afterwards, there will be a mismatch between the recorded audio tracks and the rhythm tempo.

■ Playing drum/bass sounds manually

The rhythm pad screen of the PATTERN mode allows you to use the status keys 1 – 4 to manually play drum or bass sounds.

After selecting a drum kit on the rhythm pad screen, the 16 drum/percussion sounds are divided into groups of 4 (these are called banks) and each sound of a bank is assigned to status keys 1 – 4. You therefore first select the bank which has the sound you want, and then press the respective status key.

The illustration below shows how the drum/percussion sounds are assigned to the banks.

Bank 4	STICK	HIGH BONGO	LOW BONGO	RIDE CYMBAL
Bank 3	COWBELL	MUTE HIGH CONGA	OPEN HIGH CONGA	LOW CONGA
Bank 2	TOM 1	TOM 2	TOM 3	CRASH CYMBAL
Bank 1	KICK	SNARE	CLOSED HI-HAT	OPEN HI-HAT

When a bass program is selected, the banks and status keys are assigned different pitches. You therefore first select the bank which has the pitch you want, and then press the respective status key.

If desired, you can also select a different scale and key, with different bank and status key assignments. The illustration below shows how the sounds are assigned when “E MIN” (E Minor) is selected.

Bank 4	B2	C3	D3	E3
Bank 3	E2	F#2	G2	A2
Bank 2	B1	C2	D2	E2
Bank 1	E1	F#1	G1	A1

When “G MAJ” (G Major) is selected, the arrangement is as follows.

Bank 4	D3	E3	F#3	G3
Bank 3	G2	A2	B2	C3
Bank 2	D2	E2	F#2	G2
Bank 1	G1	A1	B1	C2

When you select “E MIN2” (E Minor 2), bank 1 will contain E1, G1, B1, C2 and bank 2 will contain E1, G1, B1, E2. Banks 3 and 4 are the same as banks 1 and 2, but one octave higher. When you select “E MAJ2” (E Major 2), the G1 and C2 of “E MIN2” will become G#1 and C#2.

To play a drum kit or bass program manually, proceed as follows.

1. Press the [RHYTHM] key several times to switch the PS-04 to PATTERN mode.

You should first choose the desired drum kit/bass program as necessary. (For information on how to select a drum kit/bass program, see page 70.)

2. Press the cursor [▼] key to bring up the rhythm pad screen.

While this screen is shown, the status keys and faders operate as follows.

- **Status keys 1 – 4**
Play the drum kit/bass program.
- **Fader 3**
Adjusts the velocity of the sound.
- **Fader 4**
Switches the bank.

HINT

- You can also switch banks with the cursor up/down keys.
- As on the top screen, faders 1 and 2 adjust the drum kit/bass program level.

3. Use the cursor left/right keys to select DR (drum kit) or BS (bass program).

The currently selected type is shown on the left side of the display.

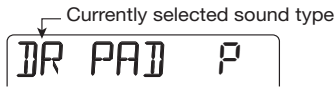

4. Use fader 4 to select the bank to play.

The bank which can be played is shown on the display.

5. Press one of the status keys 1 – 4.

If a drum kit is selected, the drum sound assigned to the key in the current bank is heard. If a bass program is selected, the bass note assigned to the key in the current bank is heard.

While the status key is being pressed, the corresponding segment of the display lights up.

6. To adjust play intensity, operate fader 3.

There are three intensity (velocity) settings. The setting value is shown for a few seconds, then the display reverts to the previous condition.



7. To change the bass program scale and key, turn the dial.

When the dial is turned while the rhythm pad screen is shown, the scale (Major/Major2/Minor/Minor2) and key (12-tone) selection changes.

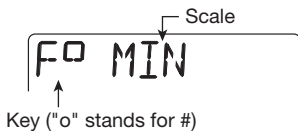

For example, when F# Minor is selected, the bank and note arrangement is as follows.

Bank 4	C#3	D3	E3	F#3
Bank 3	F#2	G#2	A2	B2
Bank 2	C#2	D2	E2	F#2
Bank 1	F#1	G#1	A1	B1

8. To return to the PATTERN mode top screen, press the cursor [▲] key.

HINT

During pattern recording, you can also select the drum/percussion sound and bass note in the same way.

■ Creating a pattern

This section explains how to create original patterns by recording your drum kit or bass program play in an empty pattern slot.

There are two ways of creating a pattern: step input where play is stopped and you enter the sounds one by one, and real-time input where you record your play using the status keys and faders.

Recording preparations

Empty patterns are set to 4/4 beat and 2 measures by default. Before you start the input procedure, set the desired time signature and measure configuration as follows.

NOTE

Once you have recorded a pattern, you cannot change the time signature or the number of measures. This setting must always be made beforehand.

1. Press the [RHYTHM] key several times to bring up the PATTERN mode top screen.

2. Turn the dial to select an empty pattern.

Empty patterns are indicated as "EMPTYxxx (where xxx is the pattern number).



3. Press the [EDIT/UTILITY] key.

The pattern utility menu for making PATTERN mode settings appears.



4. To set the time signature, use the cursor left/right keys to bring up the indication "TIMSIG" on the display, and press the [ENTER] key.

The current time signature setting appears on the display.



NOTE

When a "<>" is shown on both sides of the setting value, the pattern has already been recorded and the time signature has been set. In this condition, the value cannot be changed.

5. Turn the dial to make the setting, and then press the [EXIT] key.

The time signature can be set in the range from 1/4 to 8/4.

6. To set the number of measures, use the cursor left/right keys to bring up the indication "BARLEN" on the

display, and press the [ENTER] key.

The current bar length setting appears on the display.



NOTE

When a "<>" is shown on both sides of the setting value, the pattern has already been recorded and the bar length has been set. In this condition, the value cannot be changed.

7. Turn the dial to make the setting.

The bar length can be set in the range from 1 to 99.

8. Press the [EXIT] key to return to the PATTERN mode top screen.

Drum track step input

To perform step input, the PS-04 must be in stop mode, so that you can enter the sounds one by one in the order that they should be played. For drum track step input, you specify the step width (interval between sounds) and then specify a note or rest.

When you press the [▶/■] key after pressing the status key, the playing information is entered at this point, and the input position advances by the number of specified steps. When you press only the [▶/■] key, no playing information is entered and the position advances by one step. In other words, a rest is inserted (see illustration below).

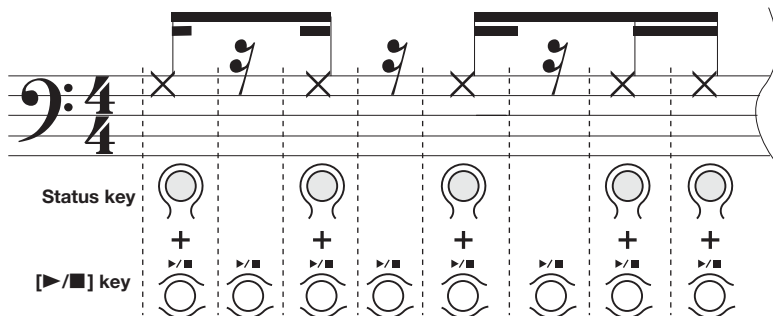

HINT

The step length changes according to the currently selected smallest note unit (quantize setting). The default setting is a sixteenth note, but this can be changed if desired (→ p. 71).

1. From the PATTERN mode top screen, press the [REC] key.

The [REC] key lights up and step input becomes possible. During step input, the current position is shown in measures/beats/ticks (1/48 of a quarter note).

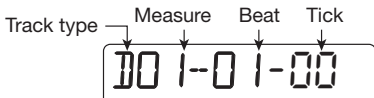

2. Verify that "D" is shown in the left corner of the display.

During step input, you can use the cursor left/right keys to switch the track type. "D" stands for drum track.

3. To enter a note, use fader 4 to select the bank which contains the desired sound, and then press the status key for that sound.

The note is entered, and the segment for that sound comes on. For information on the sounds assigned to banks and status keys, see the section "Playing drum/bass sounds manually".

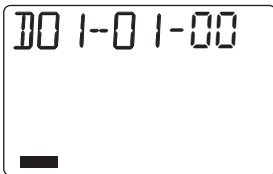
**HINT**

- The velocity setting can be changed with fader 3. This information is also stored.
- If you hold down several status keys together, multiple sounds are input at the same position.

4. Press the [▶/■] key.

The step position advances by a 16th note (12 ticks).



5. To enter a rest, press only the [▶/■] key.

No playing information is entered, and the step position advances by a 16th note.



6. Repeat steps 3 – 5 to enter the entire rhythm pattern.

When you have reached the end of the pattern, the recorder automatically returns to the first measure, and you can enter other drum/percussion sounds.

7. To erase a sound you have input, press the [▶/■] key repeatedly to go to the position, and then hold down the [INSERT/DELETE (COPY)] key while pressing the respective status key.

The sound corresponding to that status key is erased.

8. To end step input, press the [REC] key so that the key goes out.

The PATTERN mode top screen returns. If you press the [▶/■] key in this condition, the pattern is played and you can check your input.

HINT

By performing the input procedure again, you can add playing information to the track.

Bass track step input

When performing step input for the bass track, “sound duration” must be entered as an additional item. Otherwise, the input procedure is similar, in so far as the status keys and faders 3 and 4 are used to enter notes and rests.

For example, also when the step length is constant, the duration setting can be varied, resulting in sounds of a different length (see illustration below).

HINT

The step length changes according to the currently selected smallest note unit (quantize setting). The default setting is a sixteenth note, but this can be changed if desired (→ p. 71).

NOTE

For the bass track, only one sound can be produced at a time. If the sound duration is set to a value longer than a step, the part extending into the next step will be cut (the sound for that step has priority).

1. From the PATTERN mode top screen, press the [REC] key.

The [REC] key lights up and step input becomes possible.

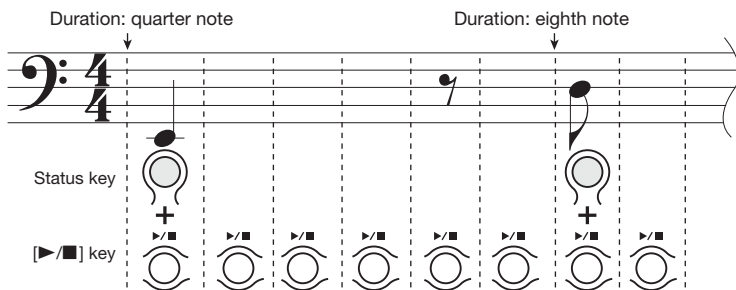
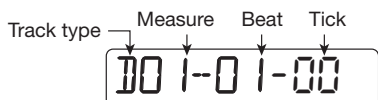

Quantize setting: sixteenth note

2. Use the cursor left/right keys to change the indication in the left corner of the display to “B”.

“B” stands for bass track.



3. If required, turn the dial to set the key and scale.

For details, see the section "Playing drum/bass sounds manually".

4. To enter a note, use the cursor up/down keys to select a duration value.

The display changes as follows to show the duration of the note being entered.

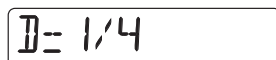

The following duration settings are available.

- 8-5 8 beats – 5 beats
- 4 Whole note
- 3 Dotted half note
- 2 Half note
- 3/2 Dotted quarter note
- 1 Quarter note
- 3/4 Dotted eighth note
- 1/2 Eighth note
- 1/3 Eighth triplet note
- 1/4 Sixteenth note
- 1/6 Sixteenth triplet note

1/8 Thirty-second note
 1/12 Thirty-second triplet note
 1/16 Sixty-fourth note
 1/24 Sixty-fourth triplet note

- 5. Use fader 4 to select the bank which contains the desired pitch, and then press the respective status key.**

HINT

The velocity setting can be changed with fader 3. This will change the play intensity.

- 6. Press the [▶/■] key.**

The step position advances by a 16th note (12 ticks). To enter a rest, skip steps 4 and 5 and simply press the [▶/■] key. This will enter a 16th rest.

- 7. Repeatedly press the [▶/■] key to advance to the position where you want to enter the next note. Then repeat steps 4 – 6.**

If the duration or bank is the same as for the previously entered note, you do not need to specify it again.

When you have reached the end of the pattern, the recorder automatically returns to the first measure.

- 8. To erase a sound you have input, press the [▶/■] key repeatedly to go to that position. Hold down the [INSERT/DELETE (COPY)] key and press the respective status key.**

The sound corresponding to the status key is erased.

- 9. To end step input, press the [REC] key.**

The key goes out and the PATTERN mode top screen returns. If you press the [▶/■] key in this condition, the pattern is played and you can check your input.

HINT

By performing the input procedure again, you can add playing information to the track.

Drum/bass track real-time input

You can also enter drum kit and bass program information with the status keys in real time, while the pattern is running.

- 1. Bring up the PATTERN mode rhythm pad screen.**
- 2. Use the cursor left/right keys to select the track for which you want to perform input.**

The left corner of the display shows “DR” when the drum track is selected, and “BS” when the bass track is selected.

- 3. Select the bank which contains the desired pitch/sound and press the status keys to check the sound.**

If required, set the key and scale for the bass program.

For information on how to switch banks and set the key and scale for the bass program, see the section “Playing drum/bass sounds manually” (→ p. 62).

- 4. Hold down the [REC] key and press the [▶/■] key.**

A precount of 4 clicks is heard. Recording begins when the precount is finished.

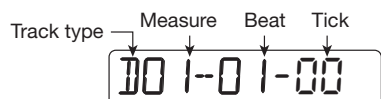

HINT

Precount settings can be changed (→ p. 72).

- 5. Use the status keys to play the drum kit/bass program.**

Your play timing is automatically matched to the smallest note unit (default: sixteenth note) and recorded on the selected track. For the bass track, the duration for which the status key is pressed is also recorded. When the pattern reaches the end, it returns to the beginning and you can continue to record.

HINT

The smallest note unit (quantize setting) can be changed (→ p. 71).

6. To pause the recording, press the [REC] key.

The key flashes and the PS-04 switches to the pattern playback mode. If you press a status key in this condition, the result will not be recorded. This is convenient to check the instrument sounds or note pitches assigned to the keys, and to switch banks and scales during input.

To return to the pattern recording mode, press the [REC] key once more.

7. If you have made a mistake, press the [INSERT/DELETE (COPY)] key at a point immediately before the mistake.

While the key is being held down, all playing information entered on the track is erased.

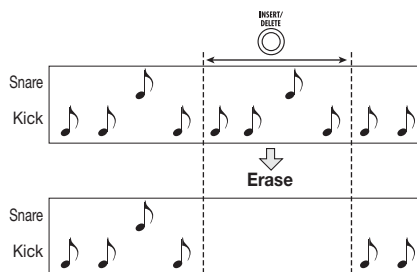
**8. When input is complete, press the [▶/■] key.**

The [REC] key and the [▶/■] key go out, and the PATTERN mode top screen returns.

■ Copying a pattern

You can copy any pattern in a project to another location.

1. Press the [RHYTHM] key several times to bring up the PATTERN mode top screen.
2. Turn the dial to select the copy source pattern. Then press the [INSERT/DELETE (COPY)] key.

The following indication appears. In this condition, you can select the copy target.

COPY) 002

3. Turn the dial to select the pattern number to be used as copy target.

COPY) 508E

HINT

When you select an empty pattern, the indication "E" (for "Empty") is shown to the right of the number.

4. Press the [ENTER] key. The indication "ENT/EXIT" appears on the display.
5. To carry out the copy operation, press the [ENTER] key. To cancel the operation, press the [EXIT] key.

When you press the [ENTER] key, the PATTERN mode top screen returns, with the copy target pattern being selected.

005T 1 508

■ Deleting a pattern

You can return any pattern in a project to the empty condition.

1. Press the [RHYTHM] key several times to bring up the PATTERN mode top screen.
2. Turn the dial to select the pattern that you want to delete. Then press the [INSERT/DELETE (COPY)] key twice.

The following indication appears.

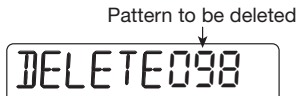

3. To carry out the delete operation, press the [ENTER] key. To cancel the operation, press the [EXIT] key.

When you press the [ENTER] key, the selected pattern is returned to the empty condition and the PATTERN mode top screen returns.

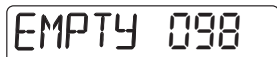

NOTE

Once a pattern has been deleted, it cannot be restored. Use this function with care.

■ Changing the pattern parameters (pattern edit)

Pattern parameters such as drum kit and bass program used in a pattern, as well as bass phrase chord type and root, etc. can be changed if desired.

Basic procedure for pattern editing

To change pattern specific parameters, proceed as follows.

1. Press the [RHYTHM] key several times to bring up the PATTERN mode top screen.

2. Turn the dial to select the pattern, and then press the [EDIT/UTILITY] key.

The PATTERN mode utility menu appears. This menu lets you not only perform pattern edit functions but also make precount settings and load patterns from external projects.



3. Use the cursor left/right keys to bring up the indication "PTN EDIT" on the display, and press the [ENTER] key.

The pattern edit menu for setting pattern specific parameters appears.



4. Use the cursor left/right keys to select the parameter you want to adjust, and press the [ENTER] key to confirm the selection.

The following parameters can be selected.

DRUM KIT . . . Select drum kit
 BASS PRG . . . Select bass program
 ORGROOT . . . Original root for pattern
 ORGCHORD . . Original chord type for pattern
 DRUM LVL . . . Drum kit level
 BASS LVL . . . Bass program level
 NAME Pattern name

5. Turn the dial to change the setting value for the parameter selected in step 4.

For details on each parameter, see the following section. If required, press the [EXIT] key to return one step and then select another parameter.

6. Press the [EXIT] key several times to return to the PATTERN mode top screen.

Select drum kit/bass program

Selecting the drum kit or bass program to be used by the pattern.

Refer to “Basic procedure for pattern editing” and bring up “DRUM KIT” or “BASS PRG” on the display. When you press the [ENTER] key, the display changes as follows.

● When “DRUM KIT” was selected

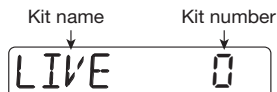

● When “BASS PRG” was selected

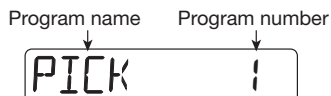

By turning the dial in this condition, you can select a new sound. For information on the various drum kits and bass programs that are available, see the list in the last section of this documentation.

Setting the pattern specific chord type/root

You can select the chord type and root to be used by the bass track of the pattern. When creating a song, the chord and root specified here will be used as the basis for the bass track phrase, which changes according to the chord progression specified for the song.

Refer to “Basic procedure for pattern editing” and bring up “ORG ROOT” (for setting the chord root) or “ORG CHORD” (for setting the chord type) on the display. When you press the [ENTER] key, the display changes as follows.

● When “ORG ROOT” was selected

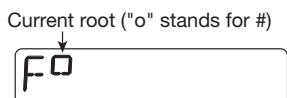

● When “ORG CHORD” was selected



The root can be set from E to D# in semitone steps. For the chord type, MAJOR or MINOR can be selected. Make a suitable setting to match the bass phrase recorded on the bass track.

HINT

For patterns used only in PATTERN mode and for patterns that do not use the bass track, the chord type/root setting is not necessary.

Setting the drum/bass volume

You can set the volume level for the drum kit and bass program. Refer to “Basic procedure for pattern editing” and bring up “DRUM LVL” (for setting the drum kit level) or “BASS LVL” (for setting the bass track level) on the display. When you press the [ENTER] key, the display changes as follows.

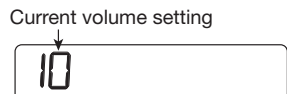

Turn the dial to set the volume in the range from 1 to 15. (The default setting is 15.)

Changing the pattern name

You can assign a unique name to a pattern. Refer to “Basic procedure for pattern editing” and bring up “NAME” on the display. When you press the [ENTER] key, the display changes as follows.

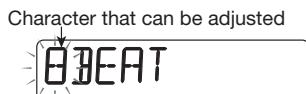

Use the cursor left/right keys to cause the character that you want to change to flash. Then turn the dial to select the character. (The name can be up to five

characters long.) You can also use the faders 1 – 3 to select a character. The faders are assigned to the following character ranges.

Fader 1 Letters (A – Z)

Fader 2 Numerals (0 – 9)

Fader 3 Symbols (+, -, @, space)

■ Setting PATTERN mode operation (pattern utility)

This section explains how to set the smallest unit for pattern note input, control the precount function for real-time input, and make other PATTERN mode related settings.

Basic procedure for pattern utility menu

To use the pattern utility menu, proceed as follows.

1. Press the [RHYTHM] key several times to switch the PS-04 to PATTERN mode.
2. Turn the dial to select the pattern to play, and press the [EDIT/UTILITY] key.

The pattern utility menu appears.



3. Use the cursor left/right keys to select one of the following items.

- **QUANTIZE**

Select the smallest note unit for real-time input and step input.

- **BARLEN**

Set the number of measures for an empty pattern. For a pattern that has already been programmed, the number of measures is shown.

- **TIMSIG**

Set the time signature (number of beats) for an empty pattern. For a pattern that has already been

programmed, the number of beats is shown.

- **COUNT**

Set the precount for use during real-time input.

- **CLICK VOL**

Set the precount and click volume.

- **IMPORT**

Import song information and all patterns from another project stored on a SmartMedia card (→ p. 83).

- **PTN EDIT**

Bring up the pattern edit menu for changing pattern specific parameters (→ p. 69).

4. Press the [ENTER] key to call up the setting value for the currently selected item.

The subsequent steps will differ, depending on which item was selected. See the sections for the respective items.

5. When all settings have been made, press the [EXIT] key repeatedly to return to the PATTERN mode top screen.

Pressing the key once brings up the pattern utility menu, and pressing the key once more brings up the PATTERN mode top screen.

Setting the smallest note unit (quantize setting)

To set the smallest note unit for real-time input and step input, proceed as follows. Refer to “Basic procedure for pattern utility” and bring up the indication “QUANTIZE”. When you press the [ENTER] key, the display changes as follows.

Quantize setting



While this screen is shown, turning the dial will change the setting. The following settings are available.

- 4 Quarter note
- 8 Eighth note

Reference [Rhythm]

12	Eighth triplet note
16 (default)	..	Sixteenth note
24	Sixteenth triplet note
32	Thirty-second note
Hi	1 tick (1/48 of quarter note)

HINT

The quantize setting applies to the entire rhythm section.

Displaying/changing the number of measures in a pattern

To display or change the number of measures in the currently selected pattern, proceed as follows. Refer to “Basic procedure for pattern utility” and bring up the indication “BARLEN”. When you press the [ENTER] key, the display changes as follows.

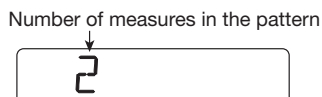

If a blank pattern is selected, you can turn the dial and change the setting in the range from 1 to 99. The default setting is 2.

NOTE

When a "<>" is shown on both sides of the setting value, the pattern has already been recorded and the number of measures cannot be changed.

Displaying/changing the time signature of a pattern

To display or change the number of beats per measure in the currently selected pattern, proceed as follows. Refer to “Basic procedure for pattern utility” and bring up the indication “TIMSIG”. When you press the [ENTER] key, the display changes as follows.

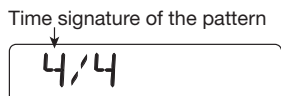

If a blank pattern is selected, you can turn the dial and change the setting in the range from 1/4 to 8/4. The default setting is 4/4.

NOTE

When a "<>" is shown on both sides of the setting value, the pattern has already been recorded and the time signature has been set. In this condition, the value cannot be changed.

Setting the precount

To change the setting of the precount used for real-time input, proceed as follows. Refer to “Basic procedure for pattern utility” and bring up the indication “COUNT”. When you press the [ENTER] key, the display changes as follows.

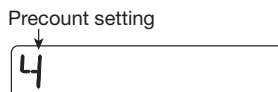

By turning the dial, you can select one of the following precount settings.

- **OFF**
No precount is heard.
- **1-8**
1 – 8 precount beats are heard.
- **SP**
Use a special precount as described on page 44.

Changing the metronome volume

You can change the volume of the metronome that is heard when you record a rhythm pattern in real time. Refer to "Basic procedure of pattern utility" to select "CLICK VOL" and press the [ENTER] key. Then turn the dial to adjust the volume (OFF, 1-15).

SONG mode operation

This section explains how to use SONG mode to play, create, and edit a song.

■ SONG mode screens

SONG mode has several screens. When you press the [RHYTHM] key to switch from PATTERN mode to SONG mode, the currently playing pattern number is always shown. This is called the SONG mode top screen.

● SONG mode top screen



When you press the cursor up or down key from the SONG mode top screen, the following screens appear.

● Locate screen

This shows the current position in the song in measures and beats. While the PS-04 is stopped, you can use this screen to move to another location in the song.



● Chord screen

This shows chord information (root and chord type) for the current point. The indication changes as the song plays.



● Rhythm pad screen

This screen shows information about the content of the currently playing drum track/bass track (sound and pitch). From this screen, you can use the status keys 1 – 4 to manually play the sounds of the drum kit or bass program. For more information, see the description of the PATTERN mode rhythm pad

screen (→ p. 62).



■ Creating a song

By arranging patterns in the desired order and programming chord and tempo/time signature information, you can create the rhythm accompaniment for an entire song. The following two methods are available for creating a song.

● Step input

With this method, you create rhythm patterns one by one by specifying a pattern and the number of measures. Input can be performed at any point in the song. It is also possible to switch to another pattern while the previous pattern is still playing. This mode is suitable for specifying patterns in detail.

● FAST (Formula Assisted Song Translator)

This method uses simple formulas to specify rhythm pattern playback from start to end. The result is written to the song in a single operation. Because input midway through a song is not possible with this method, it is most suitable for cases where the configuration of the entire song has been decided beforehand.

NOTE

Immediately after creating a new project, the drum track/bass track signal level will be set to zero. Before creating or playing a song, you must go into RHYTHM mode and adjust faders 1 and 2 to raise the monitor level of the tracks to a suitable level.

Step input

With this method, you specify the pattern number and the number of measures to enter patterns one by one.

- 1. Press the [RHYTHM] key repeatedly to switch the rhythm section to SONG mode.**

2. Press the [REC] key.

As shown below, the display indication changes to the current position. Step input for the song is now possible.

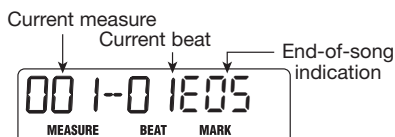

The indication “EOS” (End of Song) shows the position where the song ends. For an empty song, EOS will be located at the beginning. Therefore nothing happens if you play the song. As you enter information, the EOS position gets pushed further and further out.

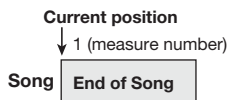

3. Press the [INSERT/DELETE (COPY)] key.

You can now select the pattern number and the number of measures to insert.

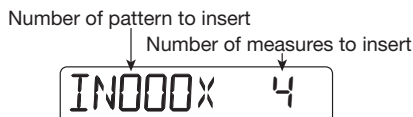

4. Turn the dial to select a pattern number.

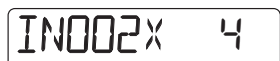

5. Use the cursor up/down keys to select the number of measures to insert, and press the [ENTER] key.

The display changes as follows. In this condition, you can select the pattern to play for the inserted measures.

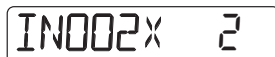

6. When you have selected a pattern, press the [ENTER] key to confirm the selection.

Pattern information is entered at the current point, and the EOS position moves back by the specified number of measures. The display returns to the current position indication.

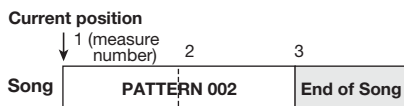

HINT

When the pattern entry was confirmed and the current position screen returns, the indication “EV” is shown. This indicates that some kind of event information (pattern, chord, tempo, etc.) has been entered at the current point.

7. Use the cursor left/right keys to move the position indication to the EOS position.

At the current position screen, you can use the cursor left/right keys to move in measure units, and the dial to move in beat units. When you reach the end of the song, the indication “EOS” appears.

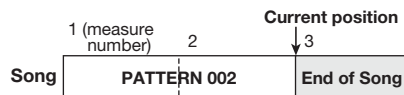

HINT

- If required, you can also switch the pattern within a measure (in beat units).
- The interval until the next pattern information entry point is longer than the pattern itself, the pattern will be played repeatedly. If the

interval is shorter than the pattern itself, the song will switch to the next pattern before the current pattern has finished playing.

8. Repeat steps 3 – 7 to enter all required pattern information.

9. When all required pattern information has been entered, press the [REC] key.

The [REC] key goes out and the PS-04 returns to the SONG mode top screen. If you press the [▶/■] key, the created song will be played.

● To overwrite pattern information

To change a pattern that has already been input, move to the input point and press the cursor [▼] key. The name of the pattern input at this point appears on the display. Turn the dial to select a new pattern.

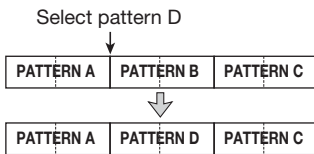

To add pattern information to a point where there currently is none, move to the input point and press the cursor [▼] key. The indication “←PTN” appears on the display. Turn the dial to select a new pattern.

● Inserting a pattern in a song

Move to the input point and perform steps 3 – 7. The new pattern information is inserted at this point, and subsequent patterns are shifted backwards by the length of the inserted pattern.

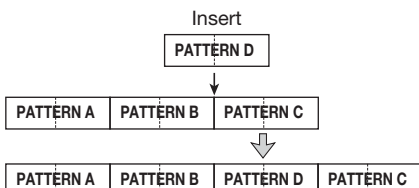

● To delete pattern information

Move to the point from which you want to delete the information, and press the cursor [▼] key. In this condition, press the [EDIT/UTILITY] key. The current information is deleted and the previous pattern will remain active until the next input point.

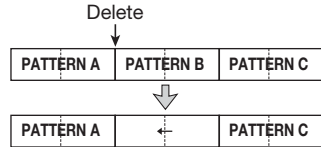

● To delete a measure

During song input ([REC] key lit), press the [INSERT/DELETE (COPY)] key three times. Then press the [ENTER] key. The measure is deleted.

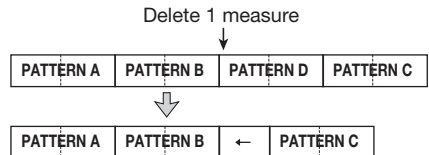

FAST input

The FAST (Formula Assisted Song Translator) method uses simple formulas to specify rhythm pattern playback from start to end. The basic rules for combining patterns are described below.

● Lining up patterns

Use the "+" (plus) symbol to line up patterns. For example, entering 0 + 1 + 2 will result in the following play sequence.



● Repeat patterns

Use the "x" (multiply) symbol to specify pattern repetitions. "x" takes precedence over "+". For example, entering 0 + 1 x 2 + 2 will result in the following play sequence.



● Repeat multiple patterns

Use the "(" and ")" symbols (opening and closing parentheses) to link a group of patterns for repetition. Formulas enclosed in brackets take precedence over other formulas. For example, entering 0 + (1 + 2) x 3 will result in the following play sequence.

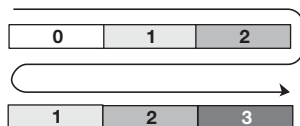

The following keys and faders are used for FAST input.

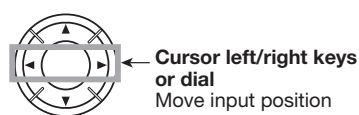
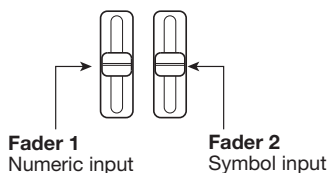

For example, to enter the formula $0 + (1 + 2) \times 2$, proceed as follows.

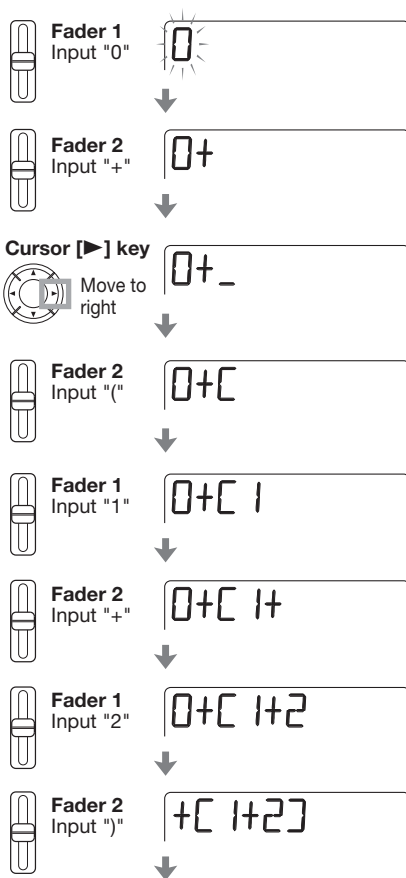

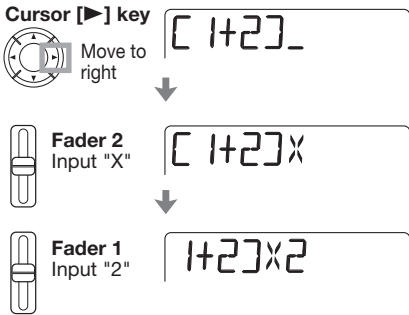

HINT

For FAST input, leading zeros are omitted. For example, pattern 001 is shown as “1”, and pattern 050 as “50”.

NOTE

- The FAST method can only be used to write a song in one go, from beginning to end. Writing only a partial song is not possible.
- To edit a song that was written with the FAST method, edit the formula and then write the entire song again, or use step input.

1. Press the [RHYTHM] key repeatedly to switch the rhythm section to SONG mode.

2. Press the [EDIT/UTILITY] key.

The song utility menu for importing a song from another project, transposing a song, etc. appears.

3. Use the cursor left/right keys to bring up the indication “FAST” on the display, and press the [ENTER] key.

The display changes as follows, and numeric input becomes possible.



4. Use the cursor left/right keys and faders 1 – 3 to enter the formula.

If you have made a mistake, correct it as follows.

● Inserting a number/formula

Use the cursor left/right keys to move to the position and enter the new number/symbol.

● Deleting a number/formula

Use the cursor left/right keys to move to the position where you want to delete a number/symbol. Then press the [INSERT/DELETE (COPY)] key. The number/symbol is deleted, and subsequent numbers and symbols are moved up.

5. To write the song using the formula that has been input, press the [ENTER] key.

The pattern sequence for the song is written according to the formula. Then the PS-04 returns to the condition of step 2. By pressing the [EXIT] key to return to the top screen and then pressing the [▶/■] key, you can play the finished song to check the result.

HINT

- Formulas entered with the FAST method are saved for each project. If necessary, you can repeat steps 1 – 5 to call up the formulas, edit numbers or symbols, and write the song again.
- There is no difference in the completed song due to input method that was used, i.e. a song will be the same, regardless of whether it was created using step input or the FAST method. A song written with the FAST method can therefore be edited using step input.

Entering chord progression data

This section explains how to add chord information (root and chord type) to the song. Songs for which chord information has been entered will play with the bass phrase being transposed and transformed according to the chord progression.

HINT

- If the original root of the pattern and the root entered for the song are different, the song root will be used to transpose the bass phrase.
- If the original chord type of the pattern and the chord type entered for the song are different, the song chord type will be used to transform the bass phrase. (Some phrases may not be transformed.)

1. Press the [RHYTHM] key repeatedly to bring up the SONG mode top screen.

2. Press the [REC] key.

3. If required, move to the point where you want to enter the first chord.

In the example shown below, the song start position is selected. The indication "EV" means that some kind of event information (pattern, chord, tempo, etc.) has already been entered at that point.



4. Use the cursor up/down keys to bring up chord information (root + chord type) on the display.

At a point where pattern information is input, the chord information "E--" (root: E, chord type: no transformation) is automatically assigned. "r" indicates that the root can be specified.

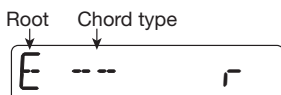

HINT

- When "--" (no transformation) is selected as chord type, the bass phrase of the pattern is played as is. (However, the entire phrase will still be transposed according to the song root.)
- When no information is input at the current point, the indication "←-ROOT" (for root) or "←-CHORD" (for chord type) is shown.

5. Turn the dial to select the root.

The root can be set in the range from E to D#.



6. Press the cursor [▼] key.

"C" indicates that the chord type can be specified from this screen.

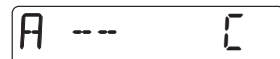

7. Turn the dial to select the chord type.

The following settings are possible.

Display	Meaning	Display	Meaning
--	No transformation	75054	7th Suspended 4th
MAJ	Major Triad	5054	Suspended 4th
m	Minor Triad	m7b5	Minor 7th flat 5
7	Dominant 7th	m6	Minor 6th
m7	Minor 7th	6	Major 6th
M7	Major 7th	m9	Minor 9th
AUG	Augment	M9	Major 9th
7IM	Diminish	mM7	Minor Major 7th



8. Use the cursor [▶] key to proceed to the next measure where you want to input chord information, and then perform the procedure again.

At the chord information input screen, you can use the cursor left/right keys to move the input point in measure units. (To check the position, press the cursor [▲] key repeatedly to bring up the current position screen.)

If required, you can change the chord information in the middle of in a pattern and measure, as shown below. To do this, return to the current position screen, turn the dial to specify the current position in measure/beat units, and then call up the chord information input screen again.

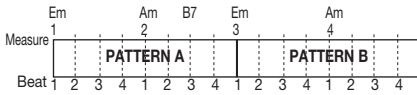

9. Repeat steps 5 – 8 and enter the remaining chord information.

If you have made a mistake, or if you want to change something, proceed as follows.

● Changing chord information

Move the current position to the point where you want to make the change. Then press the cursor [▼] key repeatedly to bring up the chord information input screen, and use the dial to change the chord information.

● Erasing chord information

Move the current position to the point from where you want to delete chord information. Then press the cursor [▼] key repeatedly to bring up the chord information input screen, and press the [EDIT/UTILITY] key. This returns the point to the "←-ROOT" or "←-CHORD" condition (preceding chord information is used).

10. To terminate the input, press the [REC] key.

The [REC] key goes out, and the SONG mode top screen returns. By pressing the [▶/■] key, you can play the finished song to check the result.

Entering other event information

A song consists of various event information including pattern, chord, tempo, and beat. A song can be thought of as a matrix like the one shown below. When song input is activated ([REC] key is lit), the cursor left/right keys and the dial can be used to move the current position, and the cursor up/down keys can be used to call up the desired event for inputting a new event, or editing the event information.

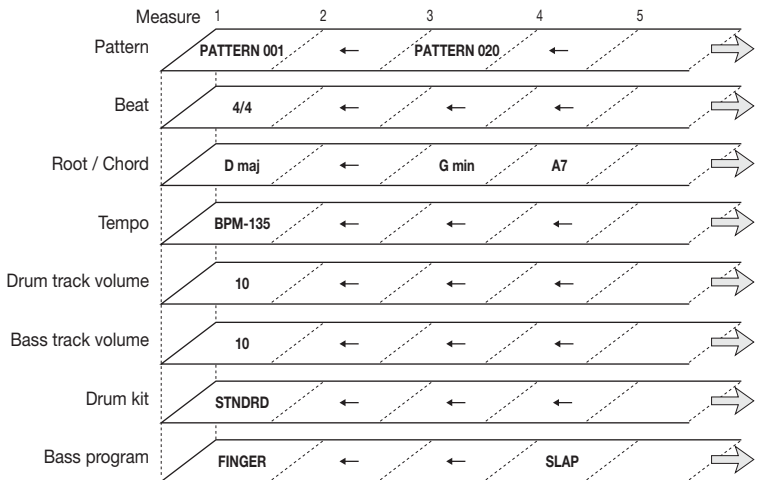

1. Press the [RHYTHM] key repeatedly to bring up the SONG mode top screen.

2. Press the [REC] key.

Event input and editing become possible, and the current position screen appears. When the indication “EV” is shown at right, some kind of event information has been input for this point.



3. Use the cursor left/right keys (measures) or the dial (beats) to move to the point where you want to enter new event information.

HINT

The input position can only be specified in beat units when the current position screen is shown. To enter event information within a measure at a certain beat, first specify the position with the above screen. (However, the time signature information input position can only be specified in measure units.)

4. Use the cursor [▼] key to bring up the input screen for the desired type of event.

If event information has already been entered for this point, the value is shown.

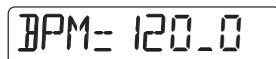

If no event information has been entered, the display shows “←xxx” (where xxx is the event name). This means that preceding event information continues to be valid.



Event contents and display formats are as shown below.

Event type	Display when no event information is input	Setting range	Smallest input unit
Pattern	← PTN	000 – 510	Measure/beat
Chord	← ROOT / ← CHORD	See page 78	
Tempo	← BPM	40.0 – 250.0	
Drum kit	← DRKIT	0 – 6 (See page 120)	
Bass program	← BSPRG	0 – 4 (See page 120)	
Drum level	← DRVOL	0 – 15	
Bass level	← BSVOL	0 – 15	Measure
Time signature	← TIMSIG	1/4 – 8/4	

5. Turn the dial to enter the event setting value.

6. Enter information for other events in the same way.

To enter more information for the same type of event, use the cursor left/right keys to move the current position in measure units while on the event input screen, and then enter the information at the new location. (To check the current position, press the cursor [▲] key to return to the current position screen.)

To specify the current position in beats, use the cursor [▲] key to return to the current position screen, turn the dial to go to the desired position, and then call up the event input screen again.

If you have made a mistake, or if you want to change something, proceed as follows.

● Changing event information

Move the current position to the point where you want to make the change. Then use the cursor up/down keys to bring up the event you want to change, and use the dial to change the event setting value.

● Erasing event information

Move the current position to the point where the event to delete is input. Then use the cursor up/down keys to bring up the event you want to delete, and press the [EDIT/UTILITY] key.

7. To terminate input, press the [REC] key.

The [REC] key goes out and the SONG mode top screen returns. By pressing the [▶/■] key, you can play the finished song to check the result.

■ Editing a song

This section explains how to edit a song that you have created.

Copying a specific region of measures

Part of a song can be specified as a range of measures and copied to another location.

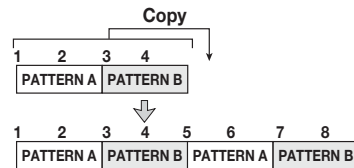
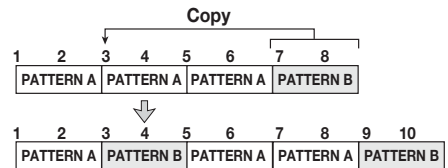

1. Press the [RHYTHM] key repeatedly to bring up the SONG mode top screen. Then press the [REC] key.

Song step input is enabled.

2. Press the [INSERT/DELETE (COPY)] key two times.

The following screen appears.

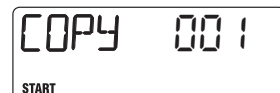

3. Turn the dial to select the copy source start measure, and press the [ENTER] key.

The indication "END" appears, and you can select the copy end point.

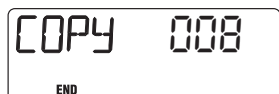

- Turn the dial to select the copy source end measure, and press the [ENTER] key.

The indication "TO" appears, and you can select the copy destination start point.

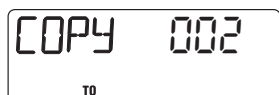

- Turn the dial to select the copy destination start measure.
- To carry out the copy operation, press the [ENTER] key.

To cancel the operation, press the [EXIT] key.

HINT

When you carry out the copy operation, the SONG becomes longer by the number of copied measures, and the EOS point is pushed back.

- To return to the SONG mode top screen, press the [REC] key.

The [REC] key goes out.

Transposing the entire song

You can transpose the bass track of the rhythm song in semitone units.

- Press the [RHYTHM] key repeatedly to bring up the SONG mode top screen.
- Press the [EDIT/UTILITY] key.

The SONG mode utility menu appears.



- Verify that the indication "TRANSPOSE" is shown on the display, and press the [ENTER] key.

The mode for transposing a song is enabled.

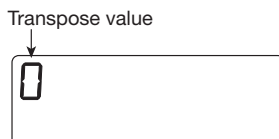

- Turn the dial to select the transpose setting in semitone units (-6 to 0 to +6).

The default setting is "0" (no transposing). When you select for example +6, the song is transposed up by 6 semitones.

- Press the [ENTER] key.

The indication "ENT/EXIT" appears on the display.

- To carry out the transpose operation, press the [ENTER] key once more.

To cancel the operation, press the [EXIT] key.

When transposing is completed, the "TRANSPOSE" display appears again.

HINT

To return to the original condition, perform the transpose action again.

■ Clearing a song

You can clear the entire contents of the song and return it to the blank condition.

- 1. Press the [RHYTHM] key repeatedly to bring up the SONG mode top screen.**
- 2. Press the [INSERT/DELETE (COPY)] key.**

The indication "CLEAR" appears on the display.



- 3. Press the [ENTER] key.**

The indication "ENT/EXIT" appears on the display.

- 4. To carry out the clear operation, press the [ENTER] key.**

To cancel the operation, press the [EXIT] key.

■ Importing pattern/song information from another project

You can import the song and all patterns from another project stored on a SmartMedia card, for use in the current project.

NOTE

When the import operation is carried out, all the patterns and song information in the current project will be overwritten.

- 1. Press the [RHYTHM] key to bring up the SONG mode or PATTERN mode top screen.**

The pattern/song import operation can be carried out in SONG mode or PATTERN mode.

- 2. Press the [EDIT/UTILITY] key.**

- 3. Use the cursor left/right keys to bring up the indication "IMPORT" on the display, and press the [ENTER] key.**

You can now select the number of the project from which to import the song and patterns.

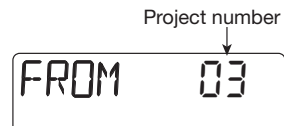

- 4. Turn the dial to select the project from which to import.**

- 5. Press the [ENTER] key.**

The indication "ENT/EXIT" appears on the display.

- 6. To carry out the import operation, press the [ENTER] key once more.**

When the import operation is completed, the "IMPORT" indication returns.

Reference [Effects]

This section explains how to use and edit the effects built into the PS-04.

About the effects

The PS-04 has two types of effects, “insert effects” which are inserted at a specific point in the signal path, and the send/return effects which are routed through the built-in mixer and applies to all tracks. The two types can be used simultaneously.

■ Insert effect

The insert effect is a multi-effect that combines various single effects such as compressor and amp simulator. It can be inserted either directly after the input or directly after the mixer stereo output.

A combination of single effects in the insert effect is called an algorithm. The insert effect has five types of algorithms, and the insert position changes depending on the selected algorithm. The available algorithms and insert positions are listed in the following table.

Algorithm	Description	Insert point
GUITAR / BASS	This algorithm is suitable for guitar/bass recording.	Directly after input (1)
MIC	This algorithm is suitable for mic recordings of vocals, acoustic guitar, etc.	Directly after input (1)
LINE	This algorithm is suitable for recording from devices with line outputs, such as a synthesizer.	Directly after input (1)
DUAL	This algorithm has two entirely separate mono inputs and outputs.	Directly after input (1)
MASTERING	This algorithm is suitable for processing the final stereo mix.	Directly before [OUTPUT] jack (2)

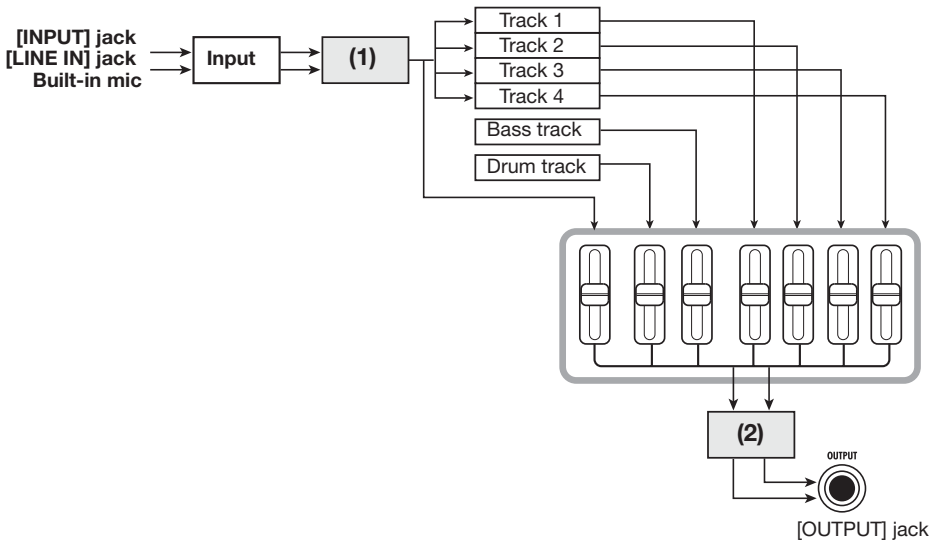

Algorithm	Effect module arrangement	Input/output type
GUITAR	COMP → PRE AMP/DRIVE → ZNR → EQ → DELAY/MODULATION	Mono → Stereo
MIC	COMP/LIMITER → MIC PRE → ZNR → EQ → DELAY/MODULATION	
LINE	COMP/LIMITER → ISOLATOR → ZNR → EQ → DELAY/MODULATION	Stereo → Stereo
MASTERING	MULTI COMP → NORMALIZER → ZNR → EQ → DIMENSION	
DUAL	COMP/LIMITER → MIC PRE → ZNR → EQ → DOUBLING	Mono x 2 → Mono x 2

The single effects that make up the algorithm are called “effect modules”. The available effect module type and sequence differs for various algorithms (see illustration above).

An effect module consists of the “effect type” which determines the type of sound, and the effect parameters which determine the intensity and operation of the effect. Effect type and effect parameter settings for a module are stored as a “patch”.

For each algorithm, there are 20 – 60 patches. You can not only call up and use preprogrammed patches, but also edit effect parameters and store the results as your own original patches.

The number of available patches per algorithm is shown in the table below.

Algorithm	Number of patches (preprogrammed patches)
GUITAR/BASS	60 (50)
MIC	30 (20)
LINE	30 (20)
DUAL	30 (20)
MASTERING	20 (15)

HINT

The effect input/output configuration differs for the various algorithms. There are three configurations: mono input/stereo output, stereo input/stereo output, and mono input x 2/mono output x 2.

■ Send/return effect

The send/return effect can be used together by all tracks. It serves to add reverb, delay, or chorus to the audio tracks and drum/bass tracks. The signal from these tracks is sent to the effect circuitry (send) and the effect sound is mixed back in just before the [OUTPUT] jack (return).

The intensity of the send/return effect can be adjusted by controlling the level of the signal sent to the effect (send level).

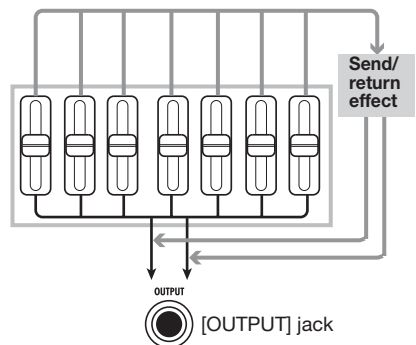

The send/return effect consists of the “effect type” which determines the type of sound, and the effect parameters which determine the intensity and operation of the effect. These two components are stored as a “patch”. The send/return effect can use 40 patches. In the default condition, 30 patches are preprogrammed.

HINT

The patches for the insert effect and send/return effect are stored by project.

■ EFFECT mode screens

To make insert effect and send/return effect settings, you must switch the PS-04 to EFFECT mode by pressing the [EFFECT] key from the AUDIO, RHYTHM, or SYSTEM mode. When you switch to EFFECT mode, one of the following screens will appear.

● Insert effect top screen

This screen lets you select the insert effect patch. Immediately after the screen is displayed, the name of the currently selected algorithm is shown briefly, and then the patch name appears.

**● Send/return effect top screen**

This screen lets you select the patch for the send/return effect. Immediately after the screen is displayed, the indication "SEND" is shown briefly, and then the patch name appears.



Pressing the [EFFECT] key while in EFFECT mode toggles between the above two screens.

Basic steps for using the insert effect

This section explains the steps for selecting an insert effect patch and editing its contents.

■ Selecting the insert effect patch

To switch the insert effect patch, proceed as follows.

1. Press the [EFFECT] key repeatedly to bring up the insert effect top screen.

The currently selected patch is shown.

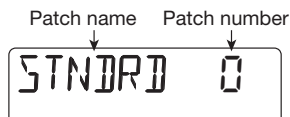
**2. Use the cursor up/down keys to select the desired algorithm.**

Shortly after selecting the algorithm, the patch currently selected for that algorithm is shown.

NOTE

The insert position of the insert effect will differ, depending on the algorithm. (For details, see page 84.)

3. Turn the dial to select the patch.

When you select a new patch, its settings become effective immediately.

HINT

When the indication "EMPTY" is shown, you have selected a blank patch. If such a patch is selected, the insert effect will not be operating.

4. To temporarily defeat the insert effect, press the [TUNER/BYPASS] key.

When you press the [TUNER/BYPASS] key in EFFECT mode, the insert effect will be bypassed and the built-in tuner function becomes active. (For

information on the tuner function, see page 92.)
 When you press the [TUNER/BYPASS] key or the [EXIT] key, the PS-04 returns to the condition of step 2.

HINT

If you press the [TUNER/BYPASS] key in a mode other than the EFFECT mode, the indication "BYPASS" is shown for a few seconds, and the insert effect will be bypassed. Pressing the [TUNER/BYPASS] key once more restores the original condition.

The signal path when using the insert effect depends on the insert position and on the number of channels (mono or stereo). Possible combinations are shown below.

In the illustration, "M→S" means "mono input/stereo output", "S→S" means "stereo input/stereo output", and "DUAL" means "mono input x 2/mono output x 2".

● Insert position immediately after INPUT

● Mono track recording

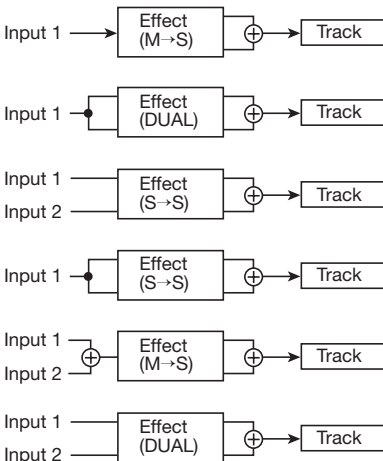

● Stereo track recording

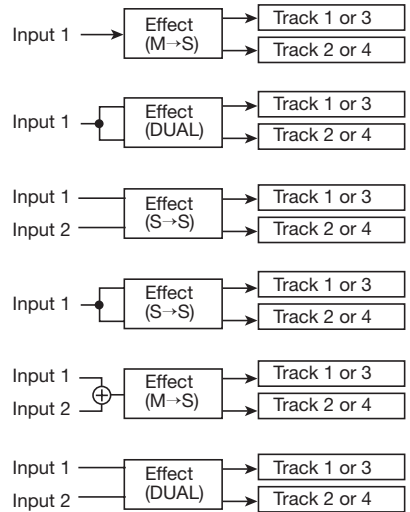

● Insert position immediately after built-in mixer

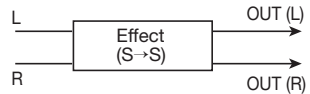

■ Editing an insert effect patch

This section explains how to change effect type and effect parameter settings of a patch, to create your own original patches.

1. Bring up the insert effect top screen.
2. Select the algorithm as necessary, and then turn the dial to select the patch that you want to edit.



3. Press the [EDIT/UTILITY] key.

The name of the effect module currently selected for that patch is shown. (For modules that comprise several effect types, the name of the currently selected effect type is shown.)

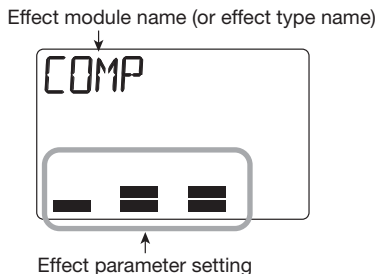

HINT

During effect editing, the level meters give a rough indication of the parameter setting value.

4. Use the cursor left/right keys to select the effect module you want to edit.

The effect modules are switched in sequence, as shown below.

HINT

Some effect types have a high number of effect parameters, which are divided into 2 pages. For some of these effect types, the indication at the right of the display (P1/P2) shows the currently displayed page.

5. The effect type that is used can be changed with the cursor up/down keys.

This is possible only for effect modules that have several effect types. (For details, see the list in the last section of this documentation.)

For example, when changing the effect type of the DELAY/MODULATION module to FLANGE, the following indication appears.



Which effect parameters can be adjusted depends on the effect type. Switching the effect type will also switch the effect parameter accordingly.

Effect module	DELAY/MODULATION		
Effect type	CHORUS	FLANGER	PHASER
Effect parameters	DEPTH RATE MIX	DEPTH RATE FB	POSITION RATE COLOR ...

HINT

If you change any settings so that they are different from the stored condition, the indication "ED" (for "Edited") will appear in the top right of the display. The indication disappears if you return the settings to the original value.

6. Use faders 1 – 4 to adjust the effect parameters.

During effect editing, faders 1 – 4 are assigned to various effect parameters. When you move a fader, the respective parameter value is shown for a few seconds on the display. The level meters give a rough indication of the value. For a list of parameters in each module/effect type, see page 104.

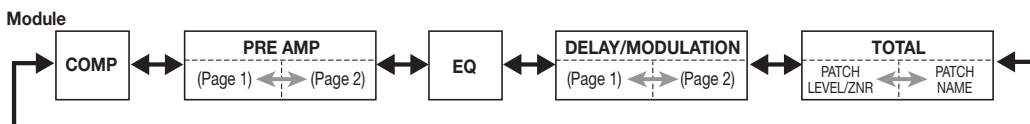

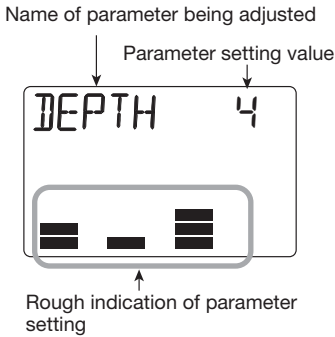

HINT

When you press the status keys 1 – 4, the value of the corresponding effect parameter is shown. In this condition, the dial can be used to adjust the displayed parameter value. For fine adjustment of settings, this method is convenient.

- 7. To switch the effect module between on and off, call up the name of the module (or the effect type) on the display and press the [TUNER/ BYPASS] key.**

When the effect module is off, the module name (or effect type name) and the indication "-OFF-" are shown alternately on the display.

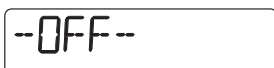

HINT

The TOTAL module (ZNR/patch level) is always on and cannot be set to off.

- 8. Repeat steps 4 – 7 as necessary to edit other modules.**
- 9. To adjust the patch level (the final volume level of the patch), use the cursor left/right keys to bring up the indication "TOTAL" on the display, and then operate fader 1.**

The patch level setting range is 1 – 30.

- 10. To adjust the ZNR (Zoom Noise Reduction) sensitivity, use the cursor left/right keys to bring up the indication "TOTAL" on the display, and then operate fader 2.**

Set this as high as possible without causing the sound to be abruptly cut off when playing your instrument.

- 11. When the settings are complete, press the [EXIT] key.**

The insert effect top screen returns. If you switch to another patch without first saving the edited patch, all changes will be lost. See the next section for information on how to store a patch.

■ Storing an insert effect patch

To retain an edited patch, proceed as follows.

- 1. From the insert effect top screen, press the [EDIT/UTILITY] key and edit the patch.**
- 2. When patch editing is complete, press the [INSERT/DELETE (COPY)] key.**

The store target patch number and the name of the currently selected patch are shown alternately on the display.



- 3. Turn the dial to select the number in which to store the patch.**
- 4. To carry out the store operation, press the [ENTER] key.**

The edited patch is stored, and the insert effect top screen returns.

■ Changing an insert effect patch name

The name of the currently selected insert effect patch can be changed as follows.

1. From the insert effect top screen, select the patch whose name you want to change, and press the [EDIT/UTILITY] key.
2. Repeatedly press one of the cursor left/right keys to cause the first character of the patch name to flash.

The flashing character can be changed.



3. Turn the dial to select a character.

For information on available characters, see page 71.



HINT

You can also use faders 1 - 3 for character input.

4. Use the cursor left/right keys to move the flashing position.



5. Repeat steps 3 - 4 to complete the new name for the patch.

6. When the change is completed, press the [ENTER] key.

The insert effect top screen returns. To retain the entered name, store the patch.

Basic steps for using the send/return effect

This section explains the steps for selecting a send/return effect patch and editing its contents.

■ Selecting the send/return effect patch

To switch the send/return effect patch, proceed as follows.

1. Press the [EFFECT] key repeatedly to bring up the send/return effect top screen.

The indication "SEND" is briefly shown on the display, and then the name of the currently selected patch appears.

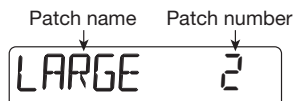

2. Turn the dial to select the patch.

When you select a new patch, its settings become effective immediately.

HINT

The intensity of the send/return effect can be adjusted for each track as a track parameter (→ p. 56).

■ Editing a send/return effect patch

This section explains how to alter a send/return effect patch.

1. Bring up the send/return effect top screen. Then turn the dial to select the patch that you want to edit.

2. Press the [EDIT/UTILITY] key.

The patch can now be edited, and the name of the effect type currently selected for that patch is shown.

Effect type name

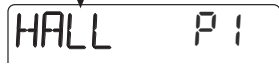

3. Use the cursor up/down keys to select the effect type.

For details on effect types that can be selected for the send/return effect, see the list in the last section of this documentation.



4. Use faders 1 – 4 to adjust the parameter setting value.

When you move a fader, the respective parameter value is shown for a few seconds on the display. The level meters give a rough indication of the value. For a list of parameters that can be adjusted, see the list in the last section of this documentation.

Effect parameter name

Parameter setting value

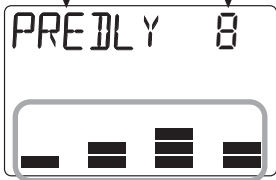

Rough indication of parameter setting

HINT

- When you press the status keys 1 – 4, the value of the corresponding effect parameter is shown. In this condition, the dial can be used to adjust the displayed parameter value.
- For send/return effects, parameters are shown on two pages. (The currently shown page is indicated by P1/P2. If necessary, use the cursor left/right keys to select the page, and then use the faders to make the adjustment.)

5. Repeat the above procedure as necessary to adjust other parameters.

6. When the settings are complete, press the [EXIT] key.

The send/return effect top screen returns.

NOTE

If you switch to another patch without first saving the edited patch, all changes will be lost. See the next section for information on how to store a patch.

■ Storing a send/return effect patch

To retain an edited patch, proceed as follows.

1. From the send/return effect top screen, press the [EDIT/UTILITY] key and edit the patch.

2. When patch editing is complete, press the [INSERT/DELETE (COPY)] key.

The store target patch number and the name of the currently selected patch are shown alternately on the display.



3. Turn the dial to select the number in which to store the patch.

4. To carry out the store operation, press the [ENTER] key.

The edited patch is stored, and the send/return effect top screen returns.

■ Changing a send/return effect patch name

The name of the currently selected send/return effect patch can be changed as follows.

1. From the send/return effect top screen, select the patch whose name you want to change, and press the [EDIT/UTILITY] key.

2. Repeatedly press one of the cursor left/right keys to cause the first character of the patch name to flash.

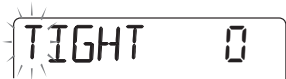

3. Turn the dial to select a character.

For information on available characters, see page 71.

HINT

You can also use faders 1 - 3 for character input.

4. Use the cursor left/right keys to move the flashing position.
5. Repeat steps 3 – 4 to complete the new name for the patch.
6. When the change is completed, press the [ENTER] key.

The send/return effect top screen returns. To retain the entered name, store the patch.

Using the tuner function

The PS-04 incorporates a versatile tuner that can also accommodate 7-string guitar and other unconventional tunings. This section explains how to use the tuner function.

■ Using the chromatic tuner

The chromatic tuner which can automatically detect pitch in semitone steps operates as follows.

1. Connect the instrument that you want to tune to the [INPUT] jack, and make sure that “INPUT” is selected as input source.

HINT

It is also possible to send the signal from the built-in mic or the [LINE IN] jack to the tuner. In this case, change the input source setting accordingly.

2. From one of the EFFECT mode screens, press the [TUNER/BYPASS] key.

Pressing the [TUNER/BYPASS] key in EFFECT mode bypasses the insert effect and activates the built-in tuner. When the tuner is activated for the first time, the indication “CHROMATIC” is shown for several seconds and the chromatic tuner is chosen. During tuner operation, the indication “CR” at the right of the display shows that this tuner type is selected.

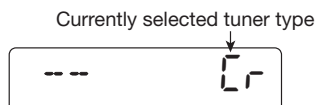

HINT

By pressing the cursor left/right keys repeatedly, you can switch the tuning type. For details, see the next section.

3. Play the open string you want to tune.

The pitch is automatically detected, and the display

shows the amount by which the current pitch is different from the correct pitch.

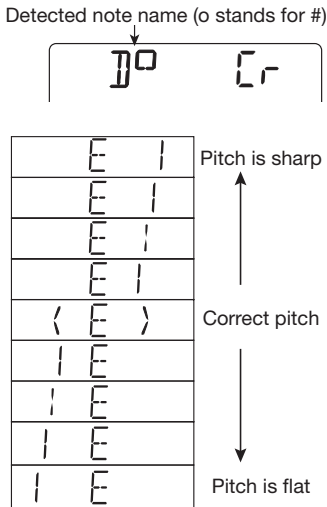

4. Tune the string until the “<>” indication encloses the desired note.
5. Tune the other strings in the same way.
6. To change the reference pitch of the tuner, turn the dial during tuner operation.

The current reference pitch is shown on the display. The default setting is center A = 440 Hz. The pitch can be changed from 435 to 445 Hz in 1-Hz steps.

The display reverts to the previous indication after a while.

440HZ

HINT

The reference pitch will be reset to A = 440 Hz when the PS-04 is turned off and then on again.

7. To quit the tuning function, press the [EXIT] key.

The insert effect bypass condition is canceled, and the previous display appears again.

■ Using other tuning types

The PS-04 allows various other tuning types besides chromatic tuning, including special tuning functions for guitar and bass. For these types it is necessary to first select a string number and then tune the strings one by one.

1. Connect the instrument that you want to tune to the [INPUT] jack, and make sure that “INPUT” is selected as input source.
2. From one of the EFFECT mode screens, press the [TUNER/BYPASS] key, and then use the cursor left/right keys to call up the desired tuner type.

The tuning types and string numbers are shown in the table below.

Tuning type	GUITAR (GT)	BASS (BS)	OPEN-A (OA)	OPEN-D (OD)	OPEN-E (OE)	OPEN-G (OG)	DADGAD (D modal) (DA)
String number/ note name	6E	4E	6E	6D	6E	6D	6D
	5A	3A	5A	5A	5D	5G	5A
	4D	2D	4E	4D	4E	4D	4D
	3G	1G	3A	3F#	3G#	3G	3G
	2D	5D	2C#	2A	2D	2D	2A
	1E		1E	1D	1E	1D	1D
	7D						

Reference [Effects]

For example, When you select the tuning type “GT” (Guitar), the display shows the string number and the target note.

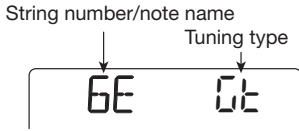

3. Play the indicated string as an open string, and perform tuning.

4. Use the cursor up/down keys to select other string numbers.

For example, when “GT” (Guitar) has been selected as tuning type, pressing the cursor [▼] key cycles through the following string numbers.

6E → 5A → 4D → 3G → 2B → 1E → 7B → 6E ...

5. Tune the other strings in the same way.

6. To quit the tuning function, press the [EXIT] key.

The insert effect bypass condition is canceled, and the previous display appears again.

HINT

If required, you can change the reference pitch used by the tuner. The default setting is A = 440 Hz. The procedure is the same as for the chromatic tuner.

Reference [System]

This section explains how to use the SYSTEM mode for managing projects and making settings that affect the entire PS-04.

SYSTEM mode screen

When you press the [SYSTEM] key while the recorder is stopped, the PS-04 enters the SYSTEM mode which serves for managing projects and making settings that affect the entire unit. The system menu is shown.



HINT

When you switch to SYSTEM mode from the AUDIO, RHYTHM or EFFECT mode, the contents of the current project are automatically saved.

About projects

The PS-04 manages audio data and setting information in units called projects. A project comprises the following data.

- Audio data for all V-takes of tracks 1 – 4
- Number of V-take selected for tracks 1 – 4
- All track parameter settings
- All internal mixer settings
- All patterns used for drum track and bass track
- Song contents for drum track and bass track
- Effect patch settings
- Other system settings

NOTE

All steps that you carry out with the PS-04 affect only the currently loaded project. It is not possible to handle multiple projects simultaneously.

Basic steps for handling projects

When handling projects, some steps are similar for each action. These are as follows.

1. With the recorder stopped, press the [SYSTEM] key.

The PS-04 enters SYSTEM mode and the system menu appears.



2. Verify that the indication “PROJECT” is shown on the display, and press the [ENTER] key.

The project menu for performing various actions related to projects appears.



3. Use the cursor left/right keys to select the desired item, and press the [ENTER] key.

The project menu has the following options.

- **SELECT**
Select and load an existing project.
- **NEW**
Create a new project.
- **COPY**
Copy the currently loaded project.
- **DELETE**
Delete a specified project.
- **PROTECT**
Write-protect the currently loaded project.
- **CAPACITY**
Display the remaining recording time.

• NAME

Change the name of the currently loaded project. The subsequent steps will differ, depending on which option was selected. See the respective sections below.

■ Selecting a project

You can select and load a project saved on SmartMedia card as follows.

HINT

When you turn power to the PS-04 on, the most recently used project will be automatically loaded.

1. Refer to “Basic steps for handling projects” and bring up the indication “SELECT”. Then press the [ENTER] key.



2. Turn the dial to select the number of the project you want to load.
3. Press the [ENTER] key to load the project.

When the loading process is finished, the AUDIO mode top screen will be displayed.

■ Creating a new project

You can create a new project on the SmartMedia card as follows.

1. Refer to “Basic steps for handling projects” and bring up the indication “NEW”. Then press the [ENTER] key.

The display changes as follows. From this screen, you can specify the recording grade (audio track sound quality).

Recording grade



HINT

The recording grade can only be set for the entire project.

2. Turn the dial to select one of the following recording grade settings.

- HF (Hi-Fi)

This setting gives priority to sound quality. A 16MB SmartMedia card provides about 7 minutes of recording time, converted to a single track.

- LG (Long)

This setting gives priority to recording time. A 16MB SmartMedia card provides about 15 minutes of recording time, converted to a single track.

3. To create the project, press the [ENTER] key. To cancel the operation, press the [EXIT] key.

When you press the [ENTER] key, a new project is created on the SmartMedia card, and that project is loaded.

HINT

- The newly created project is automatically assigned the name “PROJxx” (where xx is the project number).
- You can change the project name if desired (→ p. 98).

■ Copying a project

You can copy the contents of the currently loaded project as follows.

1. Refer to “Basic steps for handling projects” and bring up the indication “COPY”. Then press the [ENTER] key.

The following screen appears.

Copy destination project number



2. Turn the dial to select the copy destination project number, and press the [ENTER] key.

The indication “ENT/EXIT” appears on the display.

3. To carry out the copy operation, press the [ENTER] key once more. To cancel the operation, press the [EXIT] key.

When you carry out the copy operation, the copy destination project is loaded, and the AUDIO mode top screen appears.

■ Deleting a project

You can delete a project from the SmartMedia card as follows.

NOTE

Once a project has been deleted, it cannot be restored. Use this function with care, to avoid losing a project that you want to keep.

1. Refer to “Basic steps for handling projects” and bring up the indication “DELETE”. Then press the [ENTER] key.

The following screen appears.

Number of project to delete



2. Turn the dial to select the project number, and press the [ENTER] key.

The indication “ENT/EXIT” appears on the display.

3. To carry out the delete operation, press the [ENTER] key once more. To cancel the operation, press the [EXIT] key.

It is also possible to delete the currently loaded project. In this case, the immediately preceding project will be automatically loaded.

NOTE

A project for which write-protect (see next section) has been enabled cannot be deleted.

■ Protecting a project

You can write-protect the current project, so that its contents cannot be changed.

A write-protected project can be played as usual, and you can change any of the settings, but the changes cannot be stored on the SmartMedia card. It is highly recommended to use this function for protecting a completed project from accidental overwriting or erasure.

1. Refer to “Basic steps for handling projects” and bring up the indication “PROTECT”. Then press the [ENTER] key.

The display changes as follows.

Protect on/off setting



2. Turn the dial to change the setting to “ON”.

Write-protection is enabled and you can no longer store any changes to the current project. To turn off write-protection, call up the above screen again and change the setting to “OFF”.

3. Press the [EXIT] key repeatedly to return to the original screen.

Each press of the [EXIT] key goes back by one screen.

■ Checking the remaining recording time

To verify how much recording time is left on the SmartMedia card, proceed as follows.

1. Refer to “Basic steps for handling

projects” and bring up the indication “CAPACITY”. Then press the [ENTER] key.

The remaining recording time is shown, converted to the duration of a mono track.



HINT

The time shown here changes depending on the recording grade setting (→ p. 96).

2. To return to the original screen, press the [EXIT] key repeatedly.

Each press of the [EXIT] key goes back by one screen.

■ Changing the name of a project

You can change the name of the currently loaded project.

1. Refer to “Basic steps for handling projects” and bring up the indication “NAME”. Then press the [ENTER] key.

The display changes as follows.



2. Turn the dial to change the flashing character.

3. Use the cursor left/right keys to move the flashing position, and then turn the dial to select the character.

For information on available characters, see page 71.

HINT

You can also use faders 1 – 3 to enter characters and fader 4 to move the flashing position.

4. Repeat steps 2 and 3 until the name is as desired.

5. To return to the original screen, press the [EXIT] key repeatedly.

Each press of the [EXIT] key goes back by one screen.

Changing the operation of the level meters

The signal level indicated by the level meters on the display can be either the level before volume adjustment (pre-fader level) or after volume adjustment (post-fader level). To change the setting proceed as follows.

1. With the recorder stopped, press the [SYSTEM] key.

The system menu appears.

2. Use the cursor left/right keys to bring up the indication “LVL MET” on the display, and press the [ENTER] key.

The display changes as follows.

Current level meter display function



3. Turn the dial to select one of the following settings.

- **POS (post-fader)**

The signal level after adjustment by the faders 1 – 4 is shown (default setting).

- **PRE (pre-fader)**

The signal level before volume adjustment is shown.

4. To return to the original screen, press the [EXIT] key repeatedly.

Each press of the [EXIT] key goes back by one screen.

Setting the built-in mic gain

You can adjust the input sensitivity of the built-in mic as follows.

1. **With the recorder stopped, press the [SYSTEM] key.**

The system menu appears.

2. **Use the cursor left/right keys to bring up the indication "INT MIC" on the display, and press the [ENTER] key.**

The display changes as follows.

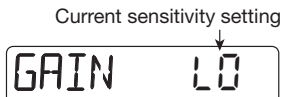

3. **Turn the dial to select one of the following settings.**

- **LO**

This is the on-mic setting, suitable for close-up vocal and acoustic guitar recording (default setting).

- **HI**

This is the off-mic setting, suitable for example to record an entire band in a studio.

4. **To return to the original screen, press the [EXIT] key repeatedly.**

Each press of the [EXIT] key goes back by one screen.

HINT

The input sensitivity setting is saved for each project.

Turning the backlight on and off

You can set the display backlight of the PS-04 to on or off as follows. If the PS-04 is powered from batteries, setting the backlight to off will help extend the life of the batteries.

1. **With the recorder stopped, press the [SYSTEM] key.**

The system menu appears.

2. **Use the cursor left/right keys to bring up the indication "LCD" on the display, and press the [ENTER] key.**

The display changes as follows.



3. **Turn the dial to select either on or off.**

The default setting is "on" (backlight activated).

4. **To return to the original screen, press the [EXIT] key repeatedly.**

Each press of the [EXIT] key goes back by one screen.

Formatting a SmartMedia card

The following procedure will format a SmartMedia card inserted in the PS-04.

NOTE

If a SmartMedia card that was not formatted in the PS-04 is inserted, audio recording/playback and saving of other data will not be possible. Before using a new SmartMedia card, be sure to format the card in the PS-04.

1. Insert the new SmartMedia card and turn power to the PS-04 on.

2. Press the [SYSTEM] key.

The system menu appears.

3. Use the cursor left/right keys to bring up the indication "CARD" on the display, and press the [ENTER] key.

The display changes as follows.



FORMAT

4. To carry out the formatting operation, press the [ENTER] key twice.

When you press the key the first time, a confirmation message appears. Pressing the key the second time initiates actual formatting.

When formatting is complete, a new project is created and loaded automatically.

By pressing the [EXIT] key instead of the [ENTER] key, you can cancel the operation and return to the previous screen.

Specifications

Recorder

Physical tracks	4
Virtual takes	40 (10 V-takes per track)
Simultaneous recording tracks	2
Simultaneous playback tracks	7 (4 audio + stereo drum + bass)
Recording media	SmartMedia card (3.3 V, 16 – 128 MB)
Max. recording time(converted to single monaural track)	

16 MB	7 min. (HI-FI), 15 min. (LONG)
32 MB	16 min. (HI-FI), 32 min. (LONG)
64 MB	33 min. (HI-FI), 67 min. (LONG)
128 MB	67 min. (HI-FI), 134 min. (LONG)

*Recording times are approximate. Actual times may be somewhat shorter, depending on the setting conditions.

Projects	100
----------	-----

Mixer

Faders	4
Track parameters	EQ, effect send, pan (balance)
Stereo linking	Track 1 + 2 or 3 + 4

Effects

Algorithms	5 (GUITAR/BASS, MIC, DUAL, LINE, MASTERING)
Effect modules	Insert effect 5, send/return effect 1
Effect types	Insert effect 87, send/return effect 6
Effect patches	Insert effect 170, send/return effect 40
Tuner mode	Chromatic, guitar, bass, open A/D/E/G, D modal

Rhythm

Voices	Drum 5, bass 1
Drum kits	7
Bass programs	5
Resolution	48 PPQN
Tempo	40 – 250 BPM

Beat	1/4 – 8/4
Rhythm pattern	511 per project, 99 measures per pattern
Rhythm song	1 per project, 999 measures per song
Notes/events	Approx. 10000 per song

A/D conversion	20 bit, 64 times oversampling
D/A conversion	20 bit, 8 times oversampling
Sampling frequency	31.25 kHz

Display	42 x26 mm original LCD, with backlight
---------	--

Inputs

Guitar/microphone input	Standard mono phone jack Rated input level -50 to +4 dBm variable Input impedance 16 kilohms to 1 megaohms variable
Line input	Miniature stereo phone jack Rated input level -20 dBm Input impedance 10 kilohms

Outputs

Master output	Standard stereo phone jack Rated output level +3 dBm Output load impedance 10 kilohms or more
Headphones output	Miniature stereo phone jack 50 mW into 32-ohm load

Power supply

AC adaptor	DC 9 V center minus 300 mA (Zoom AD-0006)
Battery	4 x IEC R6 (size AA); approx. battery life 7 hours/10 hours (display backlight on/off)
Dimensions	85 (W) x 133 (D) x 36 (H) mm
Weight	160 g (without batteries)
Supplied accessory	SmartMedia card

* 0 dB = 0.775 Vrms

* Design and specifications are subject to change without notice

Troubleshooting

If there are problems during operation of the PS-04, check the following points first.

Problems during playback

■ No sound, or sound is very weak

- Check the connections to the monitor system and the volume setting of the monitor system.
- Make sure that faders 1 - 4 are not set fully down.
- Immediately after creating a new project, the drum track/bass track volume will be set to zero. Make sure that the faders for the drum/bass track are not set fully down.
- Verify that a SmartMedia card is inserted in the card slot.

■ Operating a fader does not affect the volume

- On tracks for which stereo link has been turned on, the fader of the even-numbered channel will have no effect. Operate the fader of the odd-numbered channel, or turn stereo link off.
- Check whether the appropriate mode has been chosen. To adjust the audio track volume, the PS-04 must be operating in AUDIO mode or EFFECT mode. To adjust the drum/bass track volume, the PS-04 must be operating in RHYTHM mode.

■ Recorder stops during playback

- When a track is played while being selected for recording, a temporary file is created in the PS-04. When the remaining capacity on the SmartMedia card is fully taken up by this file, a forced playback stop may occur. In such a case, cancel the record selection of the track.

■ Noise is heard during mixdown

- Display the input source for the input, and turn the recording level fully down.
- When applying the insert effect to the output signal, check whether the effect patch level setting is appropriate.

Problems during recording

■ Sound from connected equipment is not heard or is very low.

- Check the input source setting (→ p. 53).
- If the [INPUT] jack is being used, check whether the [INPUT LEVEL] knob setting is appropriate.
- If the built-in mic is being used, check whether the sensitivity setting is appropriate (→ p. 99).
- If the [LINE IN] jack is being used, try raising the output level setting of the source device.

■ Cannot record on a track

- Make sure that the "REC" indication is shown for the desired track.
- If the project is write-protected, recording cannot be carried out. Use a different project, or turn off write-protection (→ p. 97).
- Verify that a SmartMedia card is inserted in the card slot.

■ Cannot perform bounce

- Make sure that the "BOUNCE" indication is shown on the display (→ p. 43).
- Make sure that the desired track is selected as bounce target.
- Make sure that the faders for tracks 1 - 4 and the drum/bass track are not set fully down.

■ Recorded sound is distorted

- If the insert effect is being applied to the output signal, check whether the effect settings are appropriate.
- If the [INPUT] jack is being used, check whether the [INPUT LEVEL] knob setting is appropriate.
- Check whether the EQ GAIN parameter has been set to a very high value. If this is the case, the sound may be distorted even when the fader is set to a low position.
- If only the topmost segment of the level meter comes on during input source selection, the recorded signal will be distorted. Reduce the recording level.

Problems with effects

■ Insert effect does not work

- Make sure that the PS-04 is not in the bypass condition (→ p. 86).

■ Send/return effect does not work

- Check whether the SEND parameter has been set to ON, and make sure that the SEND_L parameter is not set to the minimum value.

Problems with rhythm section

■ Cannot hear rhythm pattern or song playback

- Immediately after creating a new project, the drum track/bass track volume will be set to zero. Make sure that the faders for the drum/bass track are not set fully down.
- Make sure that the mode setting for the rhythm section is appropriate (→ p. 59).

Other problems

■ Cannot use the tuner

- Make sure that the PS-04 is in EFFECT mode. The tuner function can only be used in this mode.
- Check the connection of the instrument and make sure that the correct input source is selected.

■ The indication "STOP PLAY" is shown on the display

- The attempted operation is not possible while the recorder is operating. Stop the recorder first.

■ The indication "NOCARD" is shown on the display.

- Check whether a SmartMedia card is inserted.
- To use a new SmartMedia card, it must first be formatted in the PS-04 (→ p.100).

Appendix

Effect Parameters

■ Insert effect

GUITAR/BASS algorithm

● COMP module

TYPE	Parameter		
COMP	Keeps the dynamic range consistent.		
	SENS	ATTACK	LEVEL

Parameter	Setting range	Description
SENS	0 - 10	Adjusts the compression input sensitivity.
ATTACK	0 - 10	Adjusts the compression attack speed.
LEVEL	1 - 8	Adjusts the module output level.

● PRE AMP/DRIVE module

TYPE	Parameter					
J-CLN	Clean sound that models a transistor combo amp.					
US-CLN	Clean sound that models a built-in type vacuum tube amp.					
US-DRV	Drive sound that models a built-in type vacuum tube amp.					
TWEED	Model of a small built-in vacuum tube combo amp with dry distortion.					
CLASSA	Unique crunch sound that models a British-style combo amp.					
UK-CRU	Crunch sound that models a British-style vacuum tube stack amp.					
UK-DRV	Drive sound that models a British-style vacuum tube stack amp.					
CMB335	Models a vacuum tube combo amp characterized by long sustain.					
MTLPNL	High-gain drive sound that models a vacuum tube stack amp.					
BLKBTM	Model of a vacuum tube stack amp, characterized by fat bass and delicate distortion.					
MDLEAD	Drive sound that models a high-gain amp suitable for lead guitar.					
FZ-STK	60's sound typical of a Fuzz unit played through an amp stack.					
TE BASS	Model of a bass amp with a distinctively clean low-mid range.					
FD BASS	Model of a bass amp with vintage-style drive.					
	GAIN	tone	LEVEL			
	*Parameters for type J-CLN to FD BASS are the same.					
SNSBASS	Treble drive sound for bass.					
CR	Combination of crunch and cabinet simulator.					
TS	Combination of vintage overdrive and cabinet simulator.					
GV	Combination of vintage distortion and cabinet simulator.					
MZ	Combination of metal-style distortion and cabinet simulator.					
9002	Combination of the Zoom 9002 distortion and cabinet simulator.					
	GAIN	tone	LEVEL	CABI	SPEAKR	DEPTH
	*Parameters for type SNSBASS to 9002 are the same.					
ACOSIM	Transforms the sound of an electric guitar into an acoustic-guitar-like tone.					
	TOP	BODY	LEVEL	CABI	SPEAKR	DEPTH
E-ACO PRE	Pre-amp for electroacoustic guitar.					
	COLOR	tone	LEVEL	CABI	SPEAKR	DEPTH
CABINET	Simulation of the cabinet of a guitar/bass amp.					
	CABI	SPEAKR	DEPTH			

Parameter	Setting range	Description
GAIN	1 - 30	Adjusts the amount of gain.
tone	0 - 10	Adjusts the tone.
LEVEL	1 - 8	Adjusts the module output level.
CABI	Table 1	Selects the cabinet type.
SPEAKR	Table 2	Selects the loudspeaker type.
DEPTH	0 - 10	Adjusts the cabinet resonance of the speaker.
TOP	1 - 30	Adjusts the resonance of the strings.
BODY	0 - 10	Adjusts the resonance of the body.
COLOR	1 - 4	Adjusts the character of the electroacoustic guitar preamp.

Table 1: CABI

CM	Combo: Combo-type cabinet.
br	Bright Combo: Produces a brighter tone than Combo.
Ft	Flat: Cabinet with a flat response.
St	Stack: Stack-type cabinet.
bC	BassCombo: Combo-type cabinet for bass.
bS	BassStack: Stack-type cabinet for bass.

Table 2: SPEAKR

C1	Combo 1: Combo-type guitar amp with one 12 inch speaker.
C2	Combo 2: Combo-type guitar amp with two 12 inch speakers.
C3	Combo 3: Combo-type guitar amp with one 10 inch speaker.
GS	Gt Stack: Stack-type guitar amp with four 10 inch speakers.
GW	Gt Wall: Multiple stack-type amps placed together.
bC	Bs Combo: Combo-type bass amp with one 15 inch speaker.
bS	Bs Combo: Stack-type bass amp with four 6.5 inch speakers.

● 3 BAND EQ module

TYPE	Parameter			
EQ	Three-band equalizer.			
	HIGH	MID	LOW	LEVEL
Parameter	Setting range	Description		
HIGH	-12 - 12	Boosts/cuts the high-frequency range.		
MID	-12 - 12	Boosts/cuts the mid-frequency range.		
LOW	-12 - 12	Boosts/cuts the low-frequency range.		
LEVEL	1 - 8	Adjusts the module output level.		

● DELAY/MODULATION module

TYPE	Parameter			
CHORUS	Adds pulsation and spaciousness to the sound.			
	DEPTH	RATE	MIX	
FLANGE	Produces a unique, undulating sound.			
	DEPTH	RATE	FB	
PHASE	Produces a swooshing sound.			
	POSI	RATE	COLOR	
TREMOLO	Periodically varies the level of the sound.			
	DEPTH	RATE	CLIP	
AUTO WAH	Gives a varying wah sound that depends on the picking intensity.			
	TYPE	POSI	RESO	SENS
PITCH	Modifies the pitch of the direct sound.			
	SHIFT	TONE	BAL	

SLOW-A	Creates a "violin playing" sound with soft attack.				
	POSI	TIME	CURVE		
VIBE	Automatic vibrato effect.				
	DEPTH	RATE	BAL		
STEP	Changes the sound with step-like filter characteristics.				
	DEPTH	RATE	RESO		
RING	Produces a metallic sound.				
	POSI	RATE	BAL		
CRY	Talking-modulator-like effect.				
	POSI	RESO	SENS		
EXCITE	Gives the sound more focus and spatial definition.				
	FREQ	DEPTH	LOWBST		
AIR	Simulates the air ambience of the room, giving the sound spatial depth.				
	SIZE	STONE	MIX		
WIDE	Simulates a stereo recording with two mics.				
	TIME	WETLVL	DRYLVL		
DELAY	Delay effect with a delay time of up to 1 second.				
	TIME	FB	MIX		
F-WAH	Changes the wah frequency in sync with rhythm tempo.				
	TYPE	FREQ	DIRMIX	R MODE	R WAVE R SYNC
ARRM P	Changes the pitch in sync with rhythm tempo.				
	TYPE	STONE	R WAVE	R SYNC	

Parameter	Setting range	Description
DEPTH	EXCITE: 0 - 30	Adjusts the depth of the effect.
	Other than EXCITE: 0 - 10	
RATE	1 - 30	Adjusts the speed of the effect.
MIX	0 - 30	Adjusts the mix amount of the effect.
FB	FLANGE: -10 - 10	Adjusts the amount of feedback.
	DELAY: 0 - 9	
POSI	AF, bF	Selects the module location from AF; after the EQ module and bF; before the PRE AMP/DRIVE module.
COLOR	1 - 4	Specifies the type of phase tone.
CLIP	0 - 10	Emphasizes the effect.
TYPE	AUTO WAH, F-WAH: bPF, LPF	Specifies the filter type.
	ARRM P: Table 3	Selects the pitch change type.
SHIFT	-12 - 24	Sets the pitch shift amount.
STONE	0 - 10	Adjusts the tone.
BAL	0 - 30	Adjusts the balance between the direct sound and effect sound.
TIME	SLOW-A: 1-30	Adjusts the attack speed.
	WIDE: 1 - 64	Adjusts the delay time.
	DELAY: 1 - 100	
CURVE	0 - 10	Adjusts the attack curve.
RESO	STEP: 0 - 10	Adjusts the effect character intensity.
	Other than STEP: 1 - 10	
SENS	-10 - -1, 1 - 10	Adjusts the effect sensitivity.
FREQ	EXCITE: 1 - 5	Adjusts the frequency.
	F-WAH: 1 - 20	Adjusts wah effect center frequency.
LOWBST	0 - 10	Emphasizes the low frequency range.
SIZE	1 - 10	Adjusts the spatial width.
WETLVL	0 - 30	Adjusts the mix amount of the effect sound.
DRYLVL	0 - 30	Adjusts the mix amount of the direct sound.
DIRMIX	0 - 20	Adjusts the mix amount of the direct sound.
R MODE	Table 4	Selects the change type and width.

R WAVE	Table 5	Selects the control waveform type.
R SYNC	Table 6	Adjusts the control waveform cycle

Table 3: TYPE

1	Semitone lower→ original pitch	9	1 octave lower + original pitch→ 1 octave higher + original pitch
2	Original pitch→ semitone lower	10	1 octave higher + original pitch→ 1 octave lower + original pitch
3	Doubling→ detune + original pitch	11	Perfect fifth lower + original pitch→ perfect fourth higher + original pitch
4	Detune + original pitch→ doubling	12	Perfect fourth higher + original pitch→ perfect fifth lower + original pitch
5	Original pitch→ 1 octave higher	13	0 Hz + original pitch→ 1 octave higher
6	1 octave higher→ original pitch	14	1 octave higher→ 0 Hz + original pitch
7	Original pitch→ 2 octaves lower	15	0 Hz + original sound→ 1 octave higher + original pitch
8	2 octaves lower→ original pitch	16	1 octave higher + original sound→ 0 Hz + original pitch

Table 4: R MODE

OFF	Frequency stays constant
UP	Minimum→ maximum
dn	Maximum→ minimum
Hi	Setting value→ maximum
Lo	Minimum→ setting value

Table 5: R WAVE

1	Rising sawtooth wave	5	Triangle wave
2	Rising fin wave	6	Second power triangle wave
3	Falling sawtooth wave	7	Sine wave
4	Falling fin wave	8	Square wave

Table 6: R SYNC

05	Eighth note	b1	1 measure
1	Quarter note	b2	2 measures
2	Half note	b3	3 measures
3	Dotted half note	b4	4 measures

● TOTAL module

TYPE	Parameter
PATLVL	Adjusts the patch volume level.
	PATLVL
ZNR	Cuts noise during performance pauses.
	ZNR

Parameter	Setting range	Description
PATLVL	1 - 30	Adjusts the patch volume level.
ZNR	OFF, 1 - 30	Adjusts the sensitivity.

MIC algorithm

● COMP module

TYPE	Parameter			
COMP	Keeps the dynamic range consistent.			
	THRESH	RATIO	ATTACK	LEVEL
LIMIT	Controls the signal peeks.			
	THRESH	RATIO	RELEAS	LEVEL

Parameter	Setting range	Description
THRESH	-24 - 0	Adjusts the sensitivity.
RATIO	COMP: 1 - 26	Adjusts the compression degree of the signal.
	LIMIT: 1 - 54, ∞	
ATTACK	0 - 10	Adjusts the compression attack speed.
LEVEL	0 - 12	Adjusts the module output level.
RELEAS	0 - 10	Adjusts the time delay between the threshold and compression finish.

● MIC PRE module

TYPE	Parameter			
MICPRE	Preamp for external mic.			
	COLOR	TONE	LEVEL	DE-ESS

Parameter	Setting range	Description
COLOR	1 - 6	Specifies the response. (Table 7)
TONE	0 - 10	Adjusts the tone.
LEVEL	1 - 8	Adjusts the module output level.
DE-ESS	0 - 10	Adjusts the cut amount of vocal sibilants.

Table 7: COLOR

1	Flat response
2	Low cut
3	Acoustic guitar characteristics
4	Acoustic guitar characteristics with low cut
5	Vocal characteristics
6	Vocal characteristics with low cut

● 3 BAND EQ module

See the GUITAR/BASS algorithm.

● DELAY/MODULATION module

TYPE	Parameter			
CHORUS	Adds pulsation and spaciousness to the sound.			
	DEPTH	RATE	MIX	
FLANGE	Produces a unique, undulating sound.			
	DEPTH	RATE	FB	
PHASE	Produces a swooshing sound.			
	POSI	RATE	COLOR	
TREMOL	Periodically varies the level of the sound.			
	DEPTH	RATE	CLIP	
PITCH	Modifies the pitch of the direct sound.			
	SHIFT	TONE	BAL	
SLOW-A	Creates a "violin playing" sound with soft attack.			
	TIME	CURVE		
VIBE	Automatic vibrato effect.			
	DEPTH	RATE	BAL	
STEP	Changes the sound with step-like filter characteristics.			
	DEPTH	RATE	RESO	
RING	Produces a metallic sound.			
	POSI	RATE	BAL	
CRY	Talking-modulator-like effect.			
	RESO	SENS		

EXCITE	Gives the sound more focus and spatial definition.				
	FREQ	DEPTH	LOWBST		
AIR	Simulates the air ambience of the room, giving the sound spatial depth.				
	SIZE	STONE	MIX		
DELAY	Delay effect with a delay time of up to 1 second.				
	TIME	FB	MIX		
DOUBL	Doubling that allows the delay time to be set in 1-ms steps up to 100 ms.				
	TIME	STONE	MIX		
F-WAH	Changes the wah frequency in sync with rhythm tempo.				
	TYPE	FREQ	DIRMIX	R MODE	R WAVE
ARRM P	Changes the pitch in sync with rhythm tempo.				
	TYPE	STONE	R WAVE	R SYNC	

Parameter	Setting range	Description
DEPTH	EXCITE: 0 - 30	Adjusts the depth of the effect.
	Other than EXCITE: 0 - 10	
RATE	1 - 30	Adjusts the speed of the effect.
MIX	0 - 30	Adjusts the mix amount of the effect.
FB	FLANGE: -10 - 10	Adjusts the amount of feedback.
	DELAY: 0 - 10	
COLOR	1 - 4	Specifies the type of phase tone.
CLIP	0 - 10	Emphasizes the effect.
SHIFT	-12 - 24	Sets the pitch shift amount.
STONE	0 - 10	Adjusts the tone.
BAL	0 - 30	Adjusts the balance between the direct sound and effect sound.
POSI	AF, bF	Selects the module location from AF; after the EQ module and bF; before the PRE AMP/DRIVE module.
TIME	SLOW-A: 1-30	Adjusts the attack speed.
	DELAY, DOUBL: 1 - 100	Adjusts the delay time.
CURVE	0 - 10	Adjusts the attack curve.
RESO	STEP: 0 - 10	Adjusts the effect character intensity.
	Other than STEP: 1 - 10	
SENS	-10 - -1, 1 - 10	Adjusts the effect sensitivity.
FREQ	EXCITE: 1 - 5	Adjusts the frequency.
	F-WAH: 1 - 10	Adjusts wah effect center frequency.
LOWBST	0 - 10	Emphasizes the low frequency range.
SIZE	1 - 10	Adjusts the spatial width.
DIRMIX	0 - 20	Adjusts the mix amount of the direct sound.
R MODE	Table 4 of GUITAR/BASS algorithm	Selects the change type and width.
R WAVE	Table 5 of GUITAR/BASS algorithm	Selects the control waveform type.
R SYNC	Table 6 of GUITAR/BASS algorithm	Adjusts the control waveform cycle.
TYPE	F-WAH: bPF, LPF	Specifies the filter type.
	ARRM P: Table 3 of GUITAR/BASS algorithm	Selects the pitch change type.

● TOTAL module

See the GUITAR/BASS algorithm.

LINE algorithm

● COMP module

See the MIC algorithm.

● ISOLATOR module

TYPE	Parameter			
ISOLATOR	Divides the signal into three frequency bands, and specifies the mix amount each.			
	XOVRLo	XOVRHi	MIXHi	MIXMID
Parameter	Setting range	Description		
XOVRLo	50 - 14000	Adjusts the frequency for bass/midrange division.		
XOVRHi	50 - 14000	Adjusts the frequency for midrange/treble division.		
MIXHi	OFF, -24 - 6	Adjusts the treble mix amount.		
MIXMID	OFF, -24 - 6	Adjusts the midrange mix amount.		
MIXLOW	OFF, -24 - 6	Adjusts the bass mix amount.		

● 3 BAND EQ module

See the GUITAR/BASS algorithm.

● DELAY/MODULATION module

TYPE	Parameter		
CHORUS	Adds pulsation and spaciousness to the sound.		
	DEPTH	RATE	MIX
FLANGE	Produces a unique, undulating sound.		
	DEPTH	RATE	FB
PHASE	Produces a swooshing sound.		
	RATE	COLOR	
TREMOL	Periodically varies the level of the sound.		
	DEPTH	RATE	CLIP
PITCH	Modifies the pitch of the direct sound.		
	SHIFT	TONE	BAL
RING	Produces a metallic sound.		
	RATE	BAL	
DOUBL	Doubling that allows the delay time to be set in 1-ms steps up to 100 ms.		
	TIME	TONE	MIX
Parameter	Setting range	Description	
DEPTH	0 - 10	Adjusts the depth of the effect.	
RATE	1 - 30	Adjusts the speed of the effect.	
MIX	0 - 30	Adjusts the mix amount of the effect.	
FB	-10 - 10	Adjusts the amount of feedback.	
COLOR	1 - 4	Specifies the type of phase tone.	
CLIP	0 - 10	Emphasizes the effect.	
SHIFT	-12 - 24	Sets the pitch shift amount.	
TONE	0 - 10	Adjusts the tone.	
BAL	0 - 30	Adjusts the balance between the direct sound and effect sound.	
TIME	1 - 100	Adjusts the delay time.	

● TOTAL module

See the GUITAR/BASS algorithm.

DUAL algorithm

● COMP module

TYPE	Parameter			
COMP L/r	Keeps the dynamic range consistent.			
	THRESH	RATIO	ATTACK	LEVEL
LIMIT L/r	Controls the signal peeks.			
	THRESH	RATIO	RELEAS	LEVEL
Parameter	Setting range	Description		
THRESH	-24 - 0	Adjusts the sensitivity.		
RATIO	COMP: 1 - 26	Adjusts the compression degree of the signal.		
	LIMIT: 1 - 54, ∞			
ATTACK	0 - 10	Adjusts the compression attack speed.		
LEVEL	0 - 12	Adjusts the module output level.		
RELEAS	0 - 10	Adjusts the time delay between the threshold and compression finish.		

● MIC PRE module

TYPE	Parameter		
MICPRE L/r	Preamp for external mic.		
	COLOR	TONE	LEVEL
Parameter	Setting range	Description	
COLOR	1 - 6	Specifies the response. (Table 7 of MIC algorithm)	
TONE	0 - 10	Adjusts the tone.	
LEVEL	1 - 8	Adjusts the module output level.	

● 3 BAND EQ module

TYPE	Parameter			
EQ L/r	Three-band equalizer.			
	HIGH	MID	LOW	LEVEL
Parameter	Setting range	Description		
HIGH	-12 - 12	Boosts/cuts the high-frequency range.		
MID	-12 - 12	Boosts/cuts the mid-frequency range.		
LOW	-12 - 12	Boosts/cuts the low-frequency range.		
LEVEL	1 - 8	Adjusts the module output level.		

● DOUBLING module

TYPE	Parameter		
DOUBL L/r	Doubling that allows the delay time to be set in 1-ms steps up to 100 ms.		
	TIME	TONE	MIX
Parameter	Setting range	Description	
TIME	1 - 100	Adjusts the delay time.	
TONE	0 - 10	Adjusts the tone.	
MIX	0 - 30	Adjusts the mix amount of the effect.	

● TOTAL module

TYPE	Parameter	
PATLVL	Adjusts the patch volume level.	
	PATLVL	
ZNR L/r	Cuts noise during performance pauses.	
	ZNR L/r	
Parameter	Setting range	Description
PATLVL	1 - 30	Adjusts the patch volume level.
ZNR L/r	OFF, 1 - 30	Adjusts the sensitivity.

MASTERING algorithm

● MULTI COMP module

TYPE	Parameter							
M-COMP	Divides the signal into three frequency bands, and specifies the compression and the mix amount each.							
	XOVRLo	XOVRHi	SNSHi	SNSMID	SNSLOW	MIXHi	MIXMID	MIXLOW
Parameter	Setting range	Description						
XOVRLo	50 - 14000	Adjusts the frequency for bass/midrange division.						
XOVRHi	50 - 14000	Adjusts the frequency for midrange/treble division.						
SNSHi	0 - 24	Adjusts the compressor input sensitivity for the treble range.						
SNSMID	0 - 24	Adjusts the compressor input sensitivity for the midrange.						
SNSLOW	0 - 24	Adjusts the compressor input sensitivity for the bass range.						
MIXHi	OFF, -24 - 6	Adjusts the treble mix amount.						
MIXMID	OFF, -24 - 6	Adjusts the midrange mix amount.						
MIXLOW	OFF, -24 - 6	Adjusts the bass mix amount.						

● NORMALIZER module

TYPE	Parameter	
NORMLIZER	Set the input level of the MULTI COMP module.	
	GAIN	
Parameter	Setting range	Description
GAIN	-12 - 12	Adjusts the level.

● 3 BAND EQ module

See the GUITAR/BASS algorithm.

● DIMENSION module

TYPE	Parameter	
DIMENSION	Produces spatial width.	
	RISE_1	RISE_2
Parameter	Setting range	Description
RISE_1	0 - 30	Adjusts the emphasizing degree of the stereo component.
RISE_2	0 - 30	Adjusts the spaciousness that includes the monaural component.

● TOTAL module

See the GUITAR/BASS algorithm.

■ Send effect

TYPE	Parameter				
HALL	Simulates the acoustics of a concert hall.				
ROOM	Simulates the acoustics of a room.				
SPRING	Simulates a spring type reverb machine.				
PLATE	Simulates a plate reverb.				
	PREDLY	DECAY	HI EQ	LO EQ	LEVEL
	*Parameters for type HALL to PLATE are the same.				
CHORUS	Adds pulsation and spaciousness to the sound.				
	LFOTYP	DEPTH	RATE	PREDLY	LEVEL
DELAY	Delay effect with a delay time of up to 1 second.				
	TIME	FB	DAMP	PAN	LEVEL

Parameter	Setting range	Description
PREDLY	HALL - PLATE: 1 - 100	Adjusts the pre-delay time.
	CHORUS: 1 - 30	
DECAY	1 - 30	Adjusts the reverb time.
HI EQ	-12 - 6	Adjusts the high range level of the effect sound.
LO EQ	-12 - 6	Adjusts the low range level of the effect sound.
LEVEL	0 - 30	Adjusts the mix amount of the effect sound.
LFOTYP	Mn, St	Selects the LFO phase: Mn (monaural) or St (stereo).
DEPTH	0 - 10	Adjusts the depth of the effect.
RATE	1 - 30	Adjusts the speed of the effect.
TIME	1 - 999, 1.0	Adjusts the delay time.
FB	0 - 10	Adjusts the amount of feedback.
DAMP	0 - 10	Adjusts the cut amounts of the delay sound's high range.
PAN	L10 - L1, C, r1 - r10	Adjusts the stereo position of the delay sound.

Rhythm patterns

Basic	
No.	Pattern name
000	08ST1
001	08ST2
002	08ST3
003	08ST4
004	08ST5
005	08ST6
006	08ST7
007	08ST8
008	08ST9
009	08STA
010	08STB
011	08STC
012	16ST1
013	16ST2
014	16ST3
015	16ST4
016	16ST5
017	16ST6
018	16ST7
019	16ST8
Rock	
No.	Pattern name
020	RCK01
021	RCK02
022	RCK03
023	RCK04
024	RCK05
025	RCK06
026	RCK07
027	RCK08
028	RCK09
029	RCK10
030	RCK11
031	RCK12
032	RCK13
033	RCK14
034	RCK15
035	RCK16
036	RCK17
037	RCK18
038	RCK19
039	RCK20
040	RCK21
041	RCK22
042	RCK23
043	RCK24
044	RCK25

045	RCK26
046	RCK27
047	RCK28
048	RCK1V
049	RCK2V
050	RCK3V
051	RCK4V
052	RCK5V
053	RCK6V
054	RCK7V
055	RCK8V
056	RCK1F
057	RCK2F
058	RCK3F
059	RCK4F
060	RCK5F
061	RCK6F
062	RCK7F
063	RCK8F
064	RCK9B
Hard rock	
No.	Pattern name
065	HRK01
066	HRK02
067	HRK03
068	HRK04
069	HRK05
070	HRK06
071	HRK07
072	HRK1V
073	HRK2V
074	HRK3V
075	HRK4V
076	HRK1F
077	HRK2F
078	HRK3F
079	HRK4F
Metal	
No.	Pattern name
080	MTL01
081	MTL02
082	MTL03
083	MTL04
084	MTL1V
085	MTL2V
086	MTL1F
087	MTL2F
088	THR01
089	THR02

090	PUK01
091	PUK02
Funk	
No.	Pattern name
092	FNK01
093	FNK02
094	FNK03
095	FNK04
096	FNK05
097	FNK06
098	FNK07
099	FNK08
100	FNK09
101	FNK10
102	FNK11
103	FNK12
104	FNK1V
105	FNK2V
106	FNK3V
107	FNK4V
108	FNK1F
109	FNK2F
110	FNK3F
111	FNK4F
R'n'B	
No.	Pattern name
112	RNB01
113	RNB02
114	RNB03
115	RNB04
116	RNB05
117	RNB06
118	RNB07
119	RNB08
120	RNB09
121	RNB10
122	RNB1V
123	RNB2V
124	RNB1F
125	RNB2F
Hip hop	
No.	Pattern name
126	HIP01
127	HIP02
128	HIP03
129	HIP04
130	HIP05
131	HIP06
132	HIP07

133	HIP08
134	HIP09
135	HIP10
136	HIP11
137	HIP12
138	HIP13
139	HIP14
140	HIP15
141	HIP16
142	HIP17
143	HIP18
144	HIP19
145	HIP20
146	HIP21
147	HIP22
148	HIP1V
149	HIP2V
150	HIP3V
151	HIP4V
152	HIP5V
153	HIP6V
154	HIP7V
155	HIP8V
156	HIP9V
157	HIP0V
158	HIP1F
159	HIP2F
160	HIP6F
161	HIPFU
Dance	
No.	Pattern name
162	DNC01
163	DNC02
164	DNC03
165	DNC04
166	DNC05
167	DNC06
168	DNC1V
169	DNC2V
170	DNC3V
171	DNC4V
172	DNC1F
173	DNC2F
174	DNC3F
175	DNC4F
House	
No.	Pattern name
176	HUS01
177	HUS02

178	HUS03
179	HUS04
180	HUS1V
181	HUS2V
182	HUS1F
183	HUS2F
Techno	
No.	Pattern name
184	TCH01
185	TCH02
186	TCH03
187	TCH04
188	TCH05
189	TCH06
190	TCH07
191	TCH08
192	TCH09
193	TCH10
194	TCH1V
195	TCH2V
196	TCH1F
197	TCH2F
Drum'n'bass	
No.	Pattern name
198	DNB01
199	DNB02
200	DNB03
201	DNB04
202	DNB05
203	DNB06
204	DNB1V
205	DNB2V
206	DNB1F
207	DNB2F
Trip	
No.	Pattern name
208	TRP01
209	TRP02
210	TRP03
211	TRP04
Ambient	
No.	Pattern name
212	AMB01
213	AMB02
214	AMB03
215	AMB04
216	AMB1V
217	AMB2V
218	AMB1F
219	AMB2F
Blues	
No.	Pattern name
220	BLS01
221	BLS02

222	BLS03
223	BLS04
224	BLS05
225	BLS06
226	BLS1V
227	BLS2V
228	BLS1F
229	BLS2F
Country	
No.	Pattern name
230	CTR01
231	CTR02
232	CTR03
233	CTR04
234	CTR1V
235	CTR2V
236	CTR1F
237	CTR2F
Jazz	
No.	Pattern name
238	JZZ01
239	JZZ02
240	JZZ03
241	JZZ04
242	JZZ05
243	JZZ06
244	JZZ07
245	JZZ1V
246	JZZ2V
247	JZZ1F
248	JZZ2F
Shuffle	
No.	Pattern name
249	SFL01
250	SFL02
251	SFL03
252	SFL04
253	SFL05
254	SFL1V
255	SFL2V
256	SFL1F
257	SFL2F
Ska	
No.	Pattern name
258	SKA01
259	SKA02
260	SKA03
261	SKA04
Reggae	
No.	Pattern name
262	RGG01
263	RGG02
264	RGG03
265	RGG04

266	RGG1V
267	RGG2V
268	RGG1F
269	RGG2F
African	
No.	Pattern name
270	AFR01
271	AFR02
272	AFR03
273	AFR04
274	AFR05
275	AFR06
276	AFR07
277	AFR08
278	AFR1V
279	AFR2V
280	AFR1F
281	AFR2F
Latin	
No.	Pattern name
282	LTN01
283	LTN02
284	LTN03
285	LTN04
286	LTN05
287	LTN06
288	LTN07
289	LTN08
290	LTN09
291	LTN10
292	LTN11
293	LTN12
294	LTN1V
295	LTN2V
296	LTN3V
297	LTN4V
298	LTN1F
299	LTN2F
300	LTN3F
301	LTN4F
Ballad	
No.	Pattern name
302	BLD01
303	BLD02
304	BLD03
305	BLD04
306	BLD05
307	BLD06
308	BLD07
309	BLD08
310	BLD09
311	BLD10
312	BLD11
313	BLD1V

314	BLD2V
315	BLD1F
316	BLD2F
Introduction	
No.	Pattern name
317	ITR01
318	ITR02
319	ITR03
320	ITR04
321	ITR05
322	ITR06
323	ITR07
324	ITR08
325	ITR09
326	ITR10
327	ITR11
328	ITR12
329	ITR13
330	ITR14
331	ITR15
332	ITR16
333	ITR17
334	ITR18
335	COUNT
Ending	
No.	Pattern name
336	OTR01
337	OTR02
338	OTR03
339	OTR04
340	OTR05
341	OTR06
342	OTR07
No sound	
No.	Pattern name
343	ALMUT
344	EMPTY
- 508	
Metronome	
No.	Pattern name
509	MTR34
510	MTR44

Effect patches

■ Insert effect

GUITAR/BASS algorithm

No.	Patch name	Comment
0	STNDRD	Basic sound touched up for recording
1	RCT-BG	High-gain amp sound of American-made "Rectifier" series
2	9002LD	ZOOM 9002 sound
3	NYFUSN	Clean sound for recording
4	F-TWED	Sound of a small, American-made vintage tube amp
5	J-CHO	JC clean sound
6	ARMWAH	Wah with ARRM
7	BEATLE	Class-A type Mersey Beat sound
8	JIMVIB	Remade famous vibrato
9	BLKPNL	Heavy metal sound of "5100 series" American-made stack amp
10	SP-DRV	Smooth drive sound
11	CMPCLN	Natural compression sound
12	FUNKY	Funky cutting sound
13	PNCCLN	Airy, normal sound with a punch
14	WETRHY	Cutting sound for ballads
15	PHASER	Clean sound emulating a vintage phase effect
16	12-CLN	Clean sound with an upper octave mixed in
17	JZTONE	Clean sound for jazz
18	ARPEG	Clean sound for arpeggios
19	ACSIM1	Simulates unadorned acoustic guitar sound
20	ACSIM2	Shimmering detuned sound with no modulation
21	AG-D	Bright sound for electroacoustic guitar
22	AG-G	Warm sound for electroacoustic guitar
23	BOTTLE	Slide bar sound for electric guitar
24	CRUNCH	Ensemble of "800" series crunch and delay
25	FDRCLN	Clean sound of American-made vintage tube amp
26	50SRNB	Tremolo sound for rhythm & blues
27	CRUCMP	Crunch sound with a touch of compression
28	MATCRU	Crunch sound of a modern class-A amp
29	ROCBLY	Rockabilly sound with short delay
30	STRIHT	Versatile, straight lead sound
31	MRSDRV	Full distortion with rich sustain
32	BALLAD	Warm lead sound
33	MADBSS	Distortion bass sound for high range chord playing and lead
34	SOLDAN	High-gain amp sound for single coil half-tone settings
35	DUPLEX	Spacious lead sound with dual overlay effect
36	BLEFNG	Bluesy sound for finger picking
37	MELODY	Tastefully seasoned sound for melodies
38	WILDFZ	Vintage fuzz box
39	CRY	Zoom's original "cry effect" sound
40	B-PICK	Tight sound for playing with a pick
41	B-OD	Retro distortion sound
42	B-DRV	Hard distortion sound
43	B-FING	Allround sound for finger picking

44	B-SLAP	Crisp slap sound
45	B-COMP	Sound with attack, controlled by picking dynamics
46	B-EDGE	Tight sound with an edge
47	B-SOLO	Chorus sound for melodies
48	BS-8VA	Sound with an upper octave mixed in
49	B-WAH	Funky bass with auto-wah
50-59	EMPTY	

MIC algorithm

No.	Patch name	Comment
0	VO-STD	Standard vocal effect
1	VO-ROK	Rock vocal effect
2	VO-BLD	Ballade vocal effect with detuned chorus
3	VOECHO	Vocal echo
4	VO-C1	Smooth, listenable sound for condenser mics
5	VO-C2	Adds depth for condenser mics
6	TAPECP	Simulates analog multi-recording
7	DEEP	Delay for vocals, useful when cutting shouts or sound
8	FANFAN	Sound like talking into a fan
9	AG-LIV	Sound for mic recording with a live feel, not only for guitar
10	AG-BRT	Bright and crisp sound for mic recording
11	AG-SLO	Gorgeous solo sound
12	AG-EGE	Acoustic guitar recording sound with enhanced edge
13	AG-STM	Acoustic guitar recording sound for strumming
14	WIND	Sound with distinctive mid-range
15	BRASS	Crisp-sounding short delay
16	PIANO	Enhances depth and definition
17	AG-MX1	Enhanced sound for strumming
18	AG-MX2	Enhanced sound for arpeggio
19	SWEEP	Adds sharp sweep to one-shot percussion
20-29	EMPTY	

LINE algorithm

No.	Patch name	Comment
0	SYNLD1	For synthesizer single note lead
1	ORGAN	Phaser for synthesizer/organ
2	EP-CHO	Beautiful chorus for electric piano
3	SYNLD2	Old-style jet sound for synthesizer lead
4	SOLNR	Analog strings ensemble simulation
5	ORGROC	Boomy distortion for rock organ
6	CLVFLG	Wah for clavinet
7	CNCERT	Concert hall effect for piano
8	HONKEY	Honky-tonk piano simulation
9	SHUDDR	Sliced sound for techno tracks
10	TKPIKO	For sequence phrases or muted guitar
11	MTONE	Distortion with emphasized midrange body
12	DOUBLR	Doubling for vocal track
13	BASBST	Emphasizes low range

Appendix

14	MN2ST	Gives spaciousness to a monaural source
15	DIRTY	Low-fi distortion using ring modulator
16	SWPPHA	Phaser with powerful resonance
17	8VA	SFX adding a one-octave lower sound
18	SFXLAB	Forced SFX sound for synthesizer
19	AMRDIO	AM radio simulation
20-29	EMPTY	

DUAL algorithm

No.	Patch name	Recommended input L/R	Comment
0	ALMTY	Vocal/Guitar	Natural sound for guitar ballads
1	CONTMP	Vocal/Guitar	Boosts high and low range, and cuts midrange
2	GENTLE	Vocal/Guitar	Warm sound for arpeggio accompaniment
3	BRECHO	Vocal/Guitar	Bright sound with echo
4	VO+PF	Vocal/Piano	For piano ballads
5	VO+EP	Vocal/Keyboard	For electric piano and doubled vocal
6	VO+VO1	Vocal/Vocal	Natural sound for vocal duo
7	VO+VO2	Vocal/Vocal	For vocal harmony
8	VO+VO3	Vocal/Vocal	Warm sound for vocal duo
9	ONEREC	Line source/Guitar	For recording with single point stereo mic
10	ENSBLE	Guitar/Piano	For guitar with strong attack and mellow piano
11	ENHNCE	Guitar/Vocal	Enhances clear, strong outline for ballads
12	AMRDIO	Vocal/Vocal	Simulates AM monaural radio
13	BIGSHP	Guitar/Guitar	Enhances overall clarity
14	BRIGHT	Guitar/Guitar	Bright and sharp outlook
15	WARMY	Vocal/Vocal	Warm sound with prominent midrange
16	FAT+	Guitar/Vocal	Spruces up a thin midrange
17	FOLK D	Guitar/Guitar	Fresh and clean sound
18	CNTMPY	Vocal/Piano	Versatile crisp sound
19	TV NWS	Vocal/Vocal	TV newscaster sound
20-29	EMPTY		

MASTERING algorithm

No.	Patch name	Comment
0	ROCK	Makes a rock style mix sound "live"
1	LIVE	Adds a live feel
2	WARM	Adds a warm feeling
3	TIGHT	Hard feeling
4	CLAFY	Emphasizes high-end range
5	VOCAL	Brings vocals to the foreground
6	FULL	Strong compression over full frequency range
7	CLEAR	Power tuning with emphasized midrange
8	POWER	Powerful low range
9	+ALFA	Enhances the overall power
10	AL-POP	Conventional mastering
11	STWIDE	For wide-range bounce recording
12	CLR DM	Enhances clarity and spaciousness
13	DISCO	For club sound
14	BOOST	For hi-fi finish
15-19	EMPTY	

Send/return effect

No.	Patch name	Comment
0	TIGHT	Hall reverb with a hard tonal quality
1	SOFT	Hall reverb with a mild tonal quality
2	LARGE	Simulates the reverberation of a large hall
3	SMALL	Simulates the reverberation of a small hall
4	BALLAD	For slow ballads
5	BUDKAN	Simulates the reverberation at Budokan in Tokyo
6	SECBRS	Reverb for brass section
7	SHORT	Short reverb
8	REALPL	Spring reverb simulation
9	DOME	Reverb of a Domed-stadium
10	BIGAPL	Simulates the large recording booth
11	BRGT R	Room reverb with a hard tonal quality
12	LIVE	Simulates the reverb of a club
13	WARMTH	Soft, natural reverb
14	POWER	Gate reverb
15	VNTSPR	Simulates analog spring reverb
16	CLEASP	Clear reverb with short reverb time
17	DOKAN	Simulates the reverberation of a clay pipe
18	NATL-C	Slightly modulated chorus for accompanying
19	VO CHO	Chorus adding color to vocals
20	GT CHO	Chorus for weak guitar sound
21	FLAT-C	Fast-rated chorus
22	DEEP-C	Versatile deep chorus
23	DETUNE	For instruments with strong harmonics such as electronic piano or synthesizer
24	ECHO	Flamboyant analog-style delay
25	DLY375	Matches the commonly-used 120 BPM tempo
26	LNGDLY	Long delay for ballads

27	SRTDLY	Versatile short delay
28	SLO LD	Keeps fast phrases tight
29	WRMDLY	Simulates warm analog delay
35-39	EMPTY	

Drum kits/Bass programs

● Drum kits

No.	Display	Kit name
0	LIVE	Live kit
1	POWER	Power kit
2	JAZZ	Jazz kit
3	ANALOG	Analog kit
4	GENE	General kit
5	FUNK	Funk kit
6	SCRAT	Scratch kit

● Bass programs

No.	Display	Program name
0	FING	Finger bass
1	PICK	Pick bass
2	SLAP	Slap bass
3	ACSTK	Acoustic bass
4	SYNTH	Synth bass

Compatibility with PS-02 and MRS-4

■ PS-02

When the PS-02 SmartMedia card is inserted to the PS-04, the unit operates as follows:

- If all audio tracks of a song are recorded in "HF" (Hi-Fi) grade, a project in "HI-FI" grade automatically created.
- If all audio tracks of a song are recorded in "LG" (long) grade, a project in "LONG" grade automatically created.
- If "HF" and "LG" grade audio tracks is mixed in a song, a project in "HI-FI" grade. However, "LG" grade tracks are not played.

■ MRS-4

- The data for the PS-04 has no compatibility with that of the MRS-4.
- Zoom Corporation does not bear any liability for any consequences of using the MRS-4 SmartMedia card on the PS-04.

Files on SmartMedia card

PROJECTxx.INI

Information of marker setting, track parameters, effects

RHYTHMxx.SEQ

Information of the rhythm section

xx-yz.AUD

Audio data

MAC_PRJ.INI

Number of most recently edited project

- * "xx" corresponds to the project number 00-99, "y" to the track number 0-3, "z" to the V-take number 0-9.
- * Do not change the file names using a conventional SmartMedia reader/writer. If the files have different names, they will not be recognized on the PS-04.

■ Symbols

-	76
(76
)	76
+	76

■ A

A-B repeat	38
Algorithm	21, 84
AUDIO mode	36
Audio track	6
Auto punch-in/out	41

■ B

Backlight	99
Bass program	60
Manual play	62
Selecting	70
Bass program list	120
Bass track	60
Batteries	11
Bounce	31, 42
Built-in mic gain setting	99

■ C

Chord	
Chord type	70
Entering a chord progression	78
Connections	10
Copy	
Copying a measure	81
Copying a pattern	68
Copying a specified range of data	47
Copying a V-take	51

■ D

Data compatibility	121
Delete	
Deleting a pattern	69

Deleting a project	97
Deleting a V-take	51
Demo song	12
Drum kit	60
Manual play	62
Selecting	70
Drum kit list	120
Drum track	60

■ E

Effect	6, 84
EFFECT mode	86
Effect parameter	85
Effect type	85
EQ	26
Erase	
Clearing a song	83
Erasing a specified range of data	49
Ev	78

■ F

FAST input	76
Front pane 1	9

■ H

HI EQ	57
-------	----

■ I

Import	93
Input source	19, 53
Insert effect	21, 84
Changing the patch name	90
Editing a patch	87
Effect parameter list	104
Effect type list	104
Patch list	116
Selecting a patch	86
Storing a patch	89

■ L

Level meter	99
LO EQ	57
Locate function	37

■ M

Manual punch-in/out	40
Marker function	37
Mastering effect	30
Metronome	72
Mixdown	30
Mixer	7, 53
Mixing	26
Mode	7
MRS-4	121

■ O

Overdubbing	24
-------------	----

■ P

PAN	57
Panning	26
Patch	85
Pattern	59
Adjusting the drum/bass volume	70
Changing pattern specific characteristics	69
Changing the pattern name	70
Changing the tempo	61
Copying a pattern	68
Creating a pattern	63
Deleting a pattern	69
Displaying/changing the beat	72
Displaying/changing the number of measures	72
Importing from another project	83
Precount	72

- Selecting and playing a
 - pattern 60
 - Pattern editing 69
 - Pattern list1 14
 - PATTERN mode 59
 - Locate screen 60
 - Rhythm pad screen . . . 60
 - Top screen 60
 - Pattern utility 71
 - Power-on/off 11
 - Project 95
 - Changing the project
 - name 98
 - Checking the grade . . . 45
 - Creating 15, 96
 - Deleting 97
 - Displaying the remaining
 - recording time 97
 - Selecting 96
 - Write-protecting 97
 - PS-02 121
 - Punch-in/out 40
 - Auto punch-in/out . . . 41
 - Manual punch-in/out . . 40
- Q**
- Quantize 71
- R**
- Rear panel 9
 - Record 13, 36
 - Overdubbing 24
 - Precount 44
 - Preparations 15
 - Recording the first track . 19
 - Recorder 6
 - Rhythm 6, 59
 - RHYTHM mode 7, 59
 - Root 70
- S**
- Send/return effect 28, 85
 - Changing the name of a
 - patch 91
 - Editing a patch 90
 - Effect parameter list . . 113
 - Effect type list 113
 - Patch list 119
 - Selecting a patch 90
 - Storing a patch 91
 - Side panel 9
 - SmartMedia 10
 - Formatting 100
 - Stored files 121
 - Song 59
 - Copying a measure 81
 - Creating a song 73
 - Deleting a pattern 75
 - Edit 81
 - Entering chord progression
 - information 78
 - Entering event
 - information 79
 - Erase 83
 - FAST input 76
 - Importing from another
 - project 93
 - Inserting a pattern 75
 - Overwriting a pattern . . 75
 - Step input 73
 - Transposing 82
 - SONG mode 59, 73
 - Chord screen 73
 - Locate screen 73
 - Rhythm pad screen 73
 - Top screen 73
 - Specifications 101
 - Step input
 - Bass track 64
 - Drum track 66
 - Song 73
 - Stereo link 58
 - System 95
 - SYSTEM mode 95
- T**
- Tempo 61
 - Top panel 8
 - Track 6
 - Linking two tracks 58
 - Mixing the playback sound
 - of tracks 56
 - Processing the signal for
 - each track 56
 - Selecting the recording
 - track 55
 - Track editing 46
 - Editing a specified
 - range 46
 - Editing a V-take 50
 - Track parameter 27, 56
 - Transposing 82
 - Trimming 49
 - Tuner function 93
- V**
- V TAKE 57
 - V-take 6, 36
 - Copying 51
 - Deleting 51
 - Exchanging 52
 - Switching 36

The FCC regulation warning (for U.S.A.)

This equipment has been tested and found to comply with the limits for a Class B digital device, pursuant to Part 15 of the FCC Rules. These limits are designed to provide reasonable protection against harmful interference in a residential installation. This equipment generates, uses, and can radiate radio frequency energy and, if not installed and used in accordance with the instructions, may cause harmful interference to radio communications. However, there is no guarantee that interference will not occur in a particular installation. If this equipment does cause harmful interference to radio or television reception, which can be determined by turning the equipment off and on, the user is encouraged to try to correct the interference by one or more of the following measures:

- Reorient or relocate the receiving antenna.
- Increase the separation between the equipment and receiver.
- Connect the equipment into an outlet on a circuit different from that to which the receiver is connected.
- Consult the dealer or an experienced radio/TV technician for help.



ZOOM CORPORATION

NOAH Bldg., 2-10-2, Miyanishi-cho, Fuchu-shi, Tokyo 183-0022, Japan

PHONE: +81-42-369-7116 FAX: +81-42-369-7115

Web Site: <http://www.zoom.co.jp>

PS-04 - 5000-2