

## Instruction Manual

PN 51-Xmt-A-HT/rev.K

March 2012

# Solu Comp Xmt-A-HT

HART® SMART Chlorine, Dissolved Oxygen, and Ozone Transmitter



# **ESSENTIAL INSTRUCTIONS**

## **READ THIS PAGE BEFORE PROCEEDING!**

Rosemount Analytical designs, manufactures, and tests its products to meet many national and international standards. Because these instruments are sophisticated technical products, you must properly install, use, and maintain them to ensure they continue to operate within their normal specifications. The following instructions must be adhered to and integrated into your safety program when installing, using, and maintaining Rosemount Analytical products. Failure to follow the proper instructions may cause any one of the following situations to occur: Loss of life; personal injury; property damage; damage to this instrument; and warranty invalidation.

- Read all instructions prior to installing, operating, and servicing the product. If this Instruction Manual is not the correct manual, telephone 1-800-654-7768 and the requested manual will be provided. Save this Instruction Manual for future reference.
- If you do not understand any of the instructions, contact your Rosemount representative for clarification.
- Follow all warnings, cautions, and instructions marked on and supplied with the product.
- Inform and educate your personnel in the proper installation, operation, and maintenance of the product.
- Install your equipment as specified in the Installation Instructions of the appropriate Instruction Manual and per applicable local and national codes. Connect all products to the proper electrical and pressure sources.
- To ensure proper performance, use qualified personnel to install, operate, update, program, and maintain the product.
- When replacement parts are required, ensure that qualified people use replacement parts specified by Rosemount. Unauthorized parts and procedures can affect the product's performance and place the safe operation of your process at risk. Look alike substitutions may result in fire, electrical hazards, or improper operation.
- Ensure that all equipment doors are closed and protective covers are in place, except when maintenance is being performed by qualified persons, to prevent electrical shock and personal injury.



### **WARNING**

#### **EXPLOSION HAZARD.**

DO NOT OPEN WHILE CIRCUIT IS LIVE.

DO NOT RUB OR CLEAN WITH SOLVENTS.

9241589-00/A

### **CAUTION**

If a Model 375 Universal Hart® Communicator is used with these transmitters, the software within the Model 375 may require modification.

If a software modification is required, please contact your local Emerson Process Management Service Group or National Response Center at 1-800-654-7768.

#### **Emerson Process Management**

2400 Barranca Parkway  
Irvine, CA 92606 USA  
Tel: (949) 757-8500  
Fax: (949) 474-7250

<http://www.rosemountanalytical.com>

© Rosemount Analytical Inc. 2012



# QUICK START GUIDE

## FOR MODEL SOLU COMP Xmt-A-HT TRANSMITTER

1. Refer to Section 2.0 for installation instructions.
2. Wire sensors to the analyzer. See section 3.0.
3. Once connections are secure and verified, apply power to the transmitter.
4. When the transmitter is powered up for the first time, **Quick Start** screens appear. Using **Quick Start** is easy.
  - a. A blinking field shows the position of the cursor.
  - b. Use the ◀ or ▶ key to move the cursor left or right. Use the ▲ or ▼ key to move the cursor up or down or to increase or decrease the value of a digit. Use the ▲ or ▼ key to move the decimal point.
  - c. Press ENTER to store a setting. Press EXIT to leave without storing changes. Pressing EXIT also returns the display to the previous screen.

```
English      Français
Español     >>
```

```
Measurement type
Oxygen      Ozone      >>
```

```
Manufacturer?
Rosemount   Other
```

```
Application?
Water/Waste >>
```

```
units?
PPM        %sat      PPb >>
```

```
Temperature in?
°C         °F
```

```
units?
PPM        PPb
```

```
Temperature in?
°C         °F
```

```
pH Comp?
Auto       Manual
```

```
Manual pH
07.00 pH
```

```
Temperature in?
°C         °F
```

```
Temperature in?
°C         °F
```

5. Choose the desired language. Choose >> to show more choices.

6. Choose type of measurement: **Oxygen**, **Ozone**, **Free Chlorine**, **Total Chlorine**, or **Monochloramine**. To see more choices, move the cursor to >> and press ENTER.

If you chose **Oxygen**, go to step 6a.

If you chose **Ozone**, go to step 7a.

If you chose **Free Chlorine**, go to step 8a.

If you chose **Total Chlorine** or **Monochloramine**, go to step 9a.

7a. For **Oxygen**, select the manufacturer of the sensor, **Rosemount** or **Other**. If you chose **Rosemount**, go to step 6b. If you chose **Other** go to step 6c.

7b. Select the application: **Water/Waste**, **Trace Oxygen**, or **Biopharm**. To see more choices, move the cursor to >> and press ENTER.

7c. Choose the units in which you want the oxygen measurement displayed. If you chose **partialPress** (partial pressure), the default units are mm Hg. To select different units, refer to Section 7.4.

7d. Choose temperature units: °C or °F.

8a. For **Ozone**, select units: **ppm** or **ppb**.

8b. Choose temperature units: °C or °F.

9a. For **Free Chlorine**, select **Auto** or **Manual** pH compensation.

9b. If you selected **Manual**, enter the pH of the process liquid.

9c. Choose temperature units: °C or °F.

10a. For **Total Chlorine** and **Monochloramine**, choose temperature units: °C or °F.

11. To change output settings, to scale the 4-20 mA output, to change pH-related settings (free chlorine only) from the default values, and to set security codes, press MENU. Select Program and follow the prompts. For more information refer to section 7.0. For calibration information, refer to section 8.0.

12. To return the transmitter to default settings, choose **ResetAnalyzer** in the Program menu.

The menu tree for the Solu Comp Xmt-A-HT is on the following page.

# QUICK START GUIDE

## MENU TREE FOR MODEL SOLU COMP Xmt-A-HT TRANSMITTER

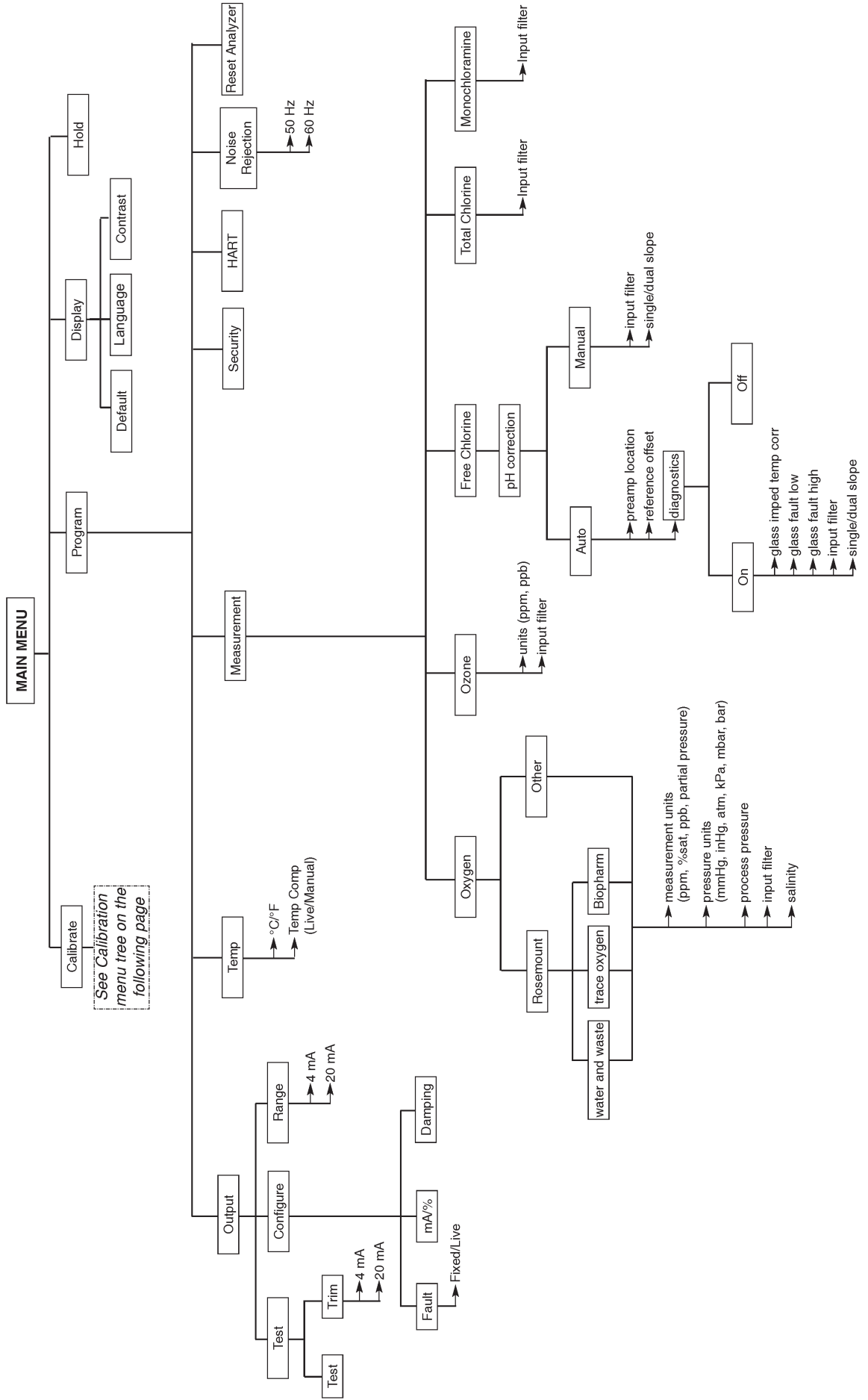

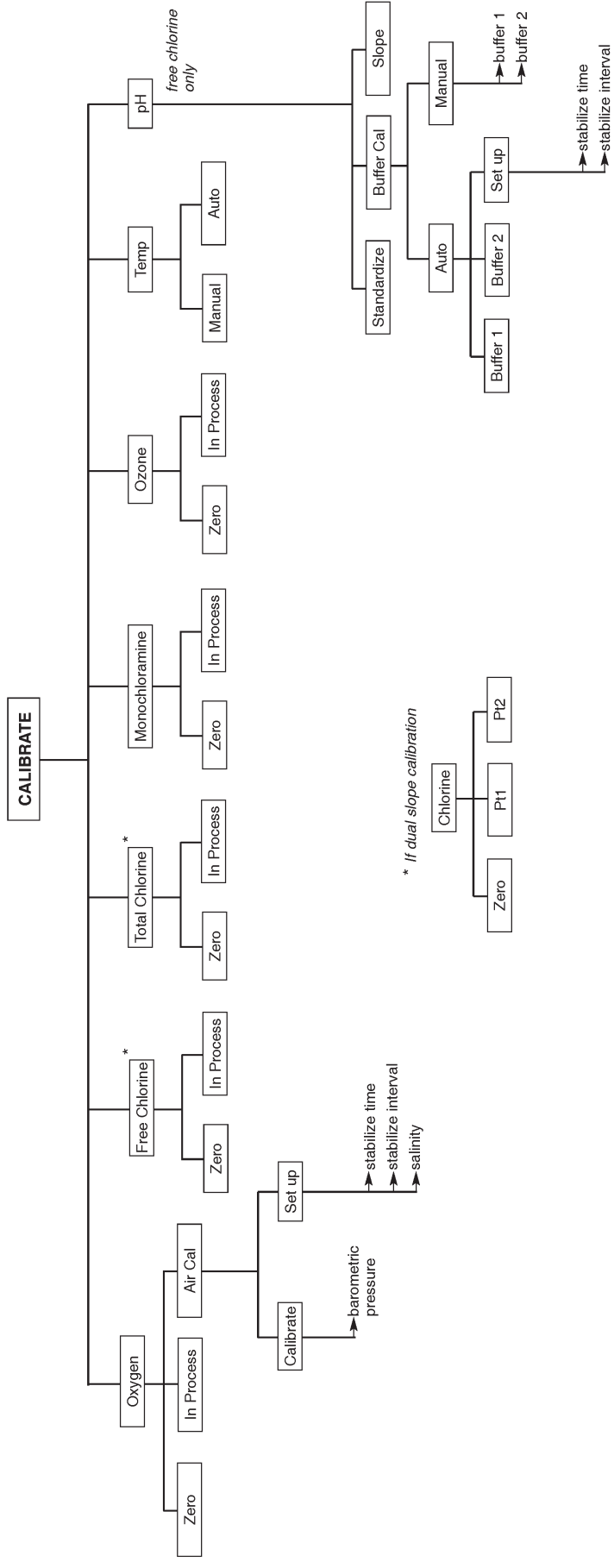

\* If dual slope calibration

# MODEL XMT-A-HT MICROPROCESSOR TRANSMITTER

## TABLE OF CONTENTS

Section	Title	Page
<b>1.0</b>	<b>DESCRIPTION AND SPECIFICATIONS .....</b>	<b>1</b>
1.1	Features and Applications.....	1
1.2	Specifications - General .....	2
1.3	Specifications - Oxygen .....	4
1.4	Specifications - Free Chlorine .....	4
1.5	Specifications - Total Chlorine .....	4
1.6	Specifications - Monochloramine .....	4
1.7	Specifications - Ozone .....	4
1.8	Transmitter Display During Calibration and Programming .....	5
1.9	HART Communication .....	5
1.10	Ordering Information .....	6
1.11	Accessories .....	6
<b>2.0</b>	<b>INSTALLATION .....</b>	<b>7</b>
2.1	Unpacking and Inspection.....	7
2.2	Installation .....	7
2.3	Power Supply/Current Loop.....	11
<b>3.0</b>	<b>SENSOR WIRING .....</b>	<b>14</b>
3.1	Wiring Model 499A Oxygen, Chlorine, Monochloramine, and Ozone Sensors.....	14
3.2	Wiring Model 499ACL-01 (Free Chlorine) Sensors and pH Sensors.....	15
3.3	Wiring Model Hx438, Gx448, and Bx438 Sensors.....	18
<b>4.0</b>	<b>INTRINSICALLY SAFE AND EXPLOSION PROOF INSTALLATIONS.....</b>	<b>19</b>
<b>5.0</b>	<b>DISPLAY AND OPERATION .....</b>	<b>28</b>
5.1	Display .....	28
5.2	Keypad.....	28
5.3	Programming and Calibrating the Model Xmt — Tutorial.....	29
5.4	Security .....	30
5.5	Using Hold .....	30
<b>6.0</b>	<b>OPERATION WITH MODEL 375.....</b>	<b>31</b>
6.1	Note on Model 375 HART Communicator.....	31
6.2	Connecting the HART Communicator.....	31
6.3	Operation .....	32
<b>7.0</b>	<b>PROGRAMMING.....</b>	<b>37</b>
7.1	General .....	37
7.2	Changing Start-up Settings .....	37
7.3	Configuring and Ranging the Output .....	39
7.4	Choosing and Configuring the Analytical Measurement .....	42
7.5	Making Temperature Settings .....	46
7.6	Setting a Security Code .....	47
7.7	Making HART-Related Settings .....	48
7.8	Noise Reduction.....	48
7.9	Resetting Factory Calibration and Factory Default Settings .....	48
7.10	Selecting a Default Screen and Screen Contrast .....	49

## TABLE OF CONTENTS CONT'D

Section	Title	Page
<b>8.0</b>	<b>CALIBRATION — TEMPERATURE</b> .....	<b>50</b>
8.1	Introduction .....	50
8.2	Procedure — Calibrating Temperature .....	51
<b>9.0</b>	<b>CALIBRATION — DISSOLVED OXYGEN</b> .....	<b>52</b>
9.1	Introduction .....	52
9.2	Procedure — Zeroing the Sensor .....	53
9.3	Procedure — Calibrating the Sensor in Air .....	54
9.4	Procedure — Calibrating the Sensor Against a Standard Instrument .....	56
<b>10.0</b>	<b>CALIBRATION — FREE CHLORINE</b> .....	<b>57</b>
10.1	Introduction .....	57
10.2	Procedure — Zeroing the Sensor .....	58
10.3	Procedure — Full Scale Calibration .....	59
10.4	Dual Slope Calibration .....	60
<b>11.0</b>	<b>CALIBRATION — TOTAL CHLORINE</b> .....	<b>62</b>
11.1	Introduction .....	62
11.2	Procedure — Zeroing the Sensor .....	63
11.3	Procedure — Full Scale Calibration .....	64
11.4	Dual Slope Calibration .....	65
<b>12.0</b>	<b>CALIBRATION — MONOCHLORAMINE</b> .....	<b>67</b>
12.1	Introduction .....	67
12.2	Procedure — Zeroing the Sensor .....	68
12.3	Procedure — Full Scale Calibration .....	69
<b>13.0</b>	<b>CALIBRATION — OZONE</b> .....	<b>70</b>
13.1	Introduction .....	70
13.2	Procedure — Zeroing the Sensor .....	71
13.3	Procedure — Full Scale Calibration .....	72
<b>14.0</b>	<b>CALIBRATION — pH</b> .....	<b>73</b>
14.1	Introduction .....	73
14.2	Procedure — Auto Calibration .....	74
14.3	Procedure — Manual Calibration .....	76
14.4	Procedure — Standardization .....	77
14.5	Procedure — Entering a Known Slope Value .....	78

**TABLE OF CONTENTS CONT'D**

<b>Section</b>	<b>Title</b>	<b>Page</b>
<b>15.0</b>	<b>TROUBLESHOOTING .....</b>	<b>79</b>
15.1	Overview .....	79
15.2	Troubleshooting When a Fault or Warning Message is Showing .....	80
15.3	Troubleshooting When No Fault Message is Showing — Temperature.....	82
15.4	Troubleshooting When No Fault Message is Showing — Oxygen .....	83
15.5	Troubleshooting When No Fault Message is Showing — Free Chlorine .....	86
15.6	Troubleshooting When No Fault Message is Showing — Total Chlorine .....	88
15.7	Troubleshooting When No Fault Message is Showing — Monochloramine .....	89
15.8	Troubleshooting When No Fault Message is Showing — Ozone .....	92
15.9	Troubleshooting When No Fault Message is Showing — pH .....	94
15.10	Troubleshooting Not Related to Measurement Problems .....	97
15.11	Simulating Input Currents — Dissolved Oxygen.....	97
15.12	Simulating Input Currents — Chlorine and Ozone .....	98
15.13	Simulating Inputs — pH .....	99
15.14	Simulating Temperature .....	100
15.15	Measuring Reference Voltage.....	101
<b>16.0</b>	<b>MAINTENANCE .....</b>	<b>102</b>
<b>17.0</b>	<b>RETURN OF MATERIAL.....</b>	<b>103</b>

<b>Appendix</b>	<b>Title</b>	<b>Page</b>
<b>A</b>	<b>BAROMETRIC PRESSURE AS A FUNCTION OF ALTITUDE.....</b>	<b>104</b>

**LIST OF TABLES**

<b>Number</b>	<b>Title</b>	<b>Page</b>
7-1	Default Settings .....	38



## LIST OF FIGURES

Number	Title	Page
1-1	HART Communication.....	5
2-1	Removing the Knockouts .....	7
2-2	Panel Mount Installation.....	8
2-3	Pipe Mount Installation.....	9
2-4	Surface Mount Installation.....	10
2-5	Load/Power Supply Requirements.....	11
2-6	Power Supply/Current Loop Wiring.....	12
2-7	Power & Sensor Wiring Terminals and Wiring Label for Xmt-A-HT Panel Mount ...	12
2-8	Power & Sensor Wiring Terminals and Wiring Label for Xmt-A-HT Pipe/Surface Mount	13
3-1	Xmt-A-HT panel mount; 499A sensors with standard cable .....	14
3-2	Xmt-A-HT panel mount; 499A sensors with optimum EMI/RFI cable or Variopol cable	14
3-3	Xmt-A-HT wall/pipe mount; 499A sensors with standard cable .....	14
3-4	Xmt-A-HT wall/pipe mount; 499A sensors with optimum EMI/RFI cable or ..... Variopol cable .....	14
3-5	Xmt-A-HT panel mount; free chlorine sensor with standard cable and 399-09-62 . pH sensor .....	15
3-6	Xmt-A-HT panel mount; free chlorine sensor with standard cable and 399-VP-09 pH sensor .....	15
3-7	Xmt-A-HT panel mount; free chlorine sensor with standard cable and 399-14 pH sensor .....	16
3-8	Xmt-A-HT panel mount; free chlorine sensor with optimum EMI/RFI cable or ..... Variopol cable and 399-09-62 pH sensor.....	16
3-9	Xmt-A-HT panel mount; free chlorine sensor with optimum EMI/RFI cable or ..... Variopol cable and 399-VP-09 pH sensor.....	16
3-10	Xmt-A-HT panel mount; free chlorine sensor with optimum EMI/RFI cable or ..... Variopol cable and 399-14 pH sensor.....	17
3-11	Xmt-A-HT wall/pipe mount; free chlorine sensor with standard cable and 399-09-62 pH sensor .....	17
3-12	Xmt-A-HT wall/pipe mount; free chlorine sensor with standard cable and ..... 399-VP-09pH sensor.....	17
3-13	Xmt-A-HT wall/pipe mount; free chlorine sensor with standard cable and 399-14 . pH sensor .....	17
3-14	Xmt-A-HT wall/pipe mount; free chlorine sensor with optimum EMI/RFI cable or Variopol cable and 399-09-62 pH sensor.....	17
3-15	Xmt-A-HT wall/pipe mount; free chlorine sensor with optimum EMI/RFI cable or Variopol cable and 399-VP-09 pH sensor.....	18
3-16	Xmt-A-HT wall/pipe mount; free chlorine sensor with optimum EMI/RFI cable or Variopol cable and 399-14 pH sensor.....	18
3-17	Xmt-A-HT panel mount with Hx438 or Gx448 sensor.....	18
3-18	Xmt-A-HT wall/pipe mount with Hx438 or Gx448 sensor .....	18
3-19	Wiring Model Bx438 to Xmt-A-HT-10.....	18
3-20	Wiring Model Bx438 to Xmt-A-HT-11 .....	18
4-1	FM Intrinsically Safe Installation Label.....	19
4-2	FM Intrinsically Safe Installation Wiring .....	20
4-3	CSA Intrinsically Safe Installation Label.....	22
4-4	CSA Intrinsically Safe Installation Wiring .....	23

**LIST OF FIGURES (continued)**

<b>Number</b>	<b>Title</b>	<b>Page</b>
4-5	Baseefa/ATEX Intrinsically Safe Installation Label.....	25
4-6	Baseefa/ATEX Intrinsically Safe Installation Wiring .....	26
5-1	Displays During Normal Operation.....	28
5-2	Solu Comp II Keypad .....	28
6-1	Connecting the HART Communicator.....	31
6-2	Xmt-A-HT HART/Model 275 Menu Tree .....	33
9-1	Sensor Current as a Function of Dissolved Oxygen Concentration .....	52
10-1	Sensor Current as a Function of Free Chlorine Concentration .....	57
10-2	Dual Slope Calibration .....	60
11-1	Determination of Total Chlorine.....	62
11-2	Sensor Current as a Function of Total Chlorine Concentration .....	62
11-3	Dual Slope Calibration .....	65
12-1	Sensor Current as a Function of Monochloramine Concentration.....	67
13-1	Sensor Current as a Function of Ozone Concentration.....	70
14-1	Calibration Slope and Offset .....	72
15-1	Simulate dissolved oxygen.....	97
15-2	Simulate chlorine and ozone.....	98
15-3	Simulate pH.....	99
15-4	Three-wire RTD Configuration .....	100
15-5	Simulating RTD Inputs .....	100
15-6	Checking for a Poisoned Reference Electrode .....	101
16-1	Exploded View of Model Xmt-A-HT Transmitter .....	102

---

## About This Document

This manual contains instructions for installation and operation of the Model Solu Comp Xmt-A-HT Dissolved Oxygen, Chlorine, and Ozone Transmitter.

The following list provides notes concerning all revisions of this document.

<b><u>Rev. Level</u></b>	<b><u>Date</u></b>	<b><u>Notes</u></b>
A	9/03	This is the initial release of the product manual.
B	12/03	Added note to troubleshooting, p. 70.
C	9/04	Added agency wiring drawings.
D	11/04	Updated mounting drawings.
E	4/05	Revised panel mount drawing.
F	9/05	Added Foundation fieldbus agency approvals and FISCO version.
G	2/06	Revised section 1.0, p. 1, and substituted standard text on 1.2, p.2.
H	6/06	Revised Quick Start choices adding language as #5. Added Language box to Quick start guide on page D. Deleted 230A in accessories chart on page 5.
I	10/08	Addition of Hazardous Location Approvals.
J	05/10	Include EC Certificates on page 107
K	03/12	Update addresses - mail and web and DNV certificate logo

## SECTION 1.0 DESCRIPTION AND SPECIFICATIONS

### Xmt Family of Two-wire Transmitters

- CHOICE OF COMMUNICATION PROTOCOLS: HART® or FOUNDATION® Fieldbus
- CLEAR, EASY-TO-READ two-line display shows commissioning menus and process measurement displays in English
- SIMPLE TO USE MENU STRUCTURE
- CHOICE OF PANEL OR PIPE/SURFACE MOUNTING
- NON-VOLATILE MEMORY retains program settings and calibration data during power failures
- SIX LOCAL LANGUAGES - English, French, German, Italian, Spanish and Portuguese



#### 1.1 FEATURES AND APPLICATIONS

The Solu Comp Xmt family of transmitters can be used to measure pH, ORP, conductivity (using either contacting or toroidal sensors), resistivity, oxygen (ppm and ppb level), free chlorine, total chlorine, monochloramine and ozone in a variety of process liquids. The Xmt is compatible with most Rosemount Analytical sensors. See the Specification sections for details.

The transmitter has a rugged, weatherproof, corrosion-resistant enclosure (NEMA 4X and IP65). The panel mount version fits standard ½ DIN panel cutouts, and its shallow depth is ideally suited for easy mounting in cabinet-type enclosures. A panel mount gasket is included to maintain the weather rating of the panel. Surface/pipe mount enclosure includes self-tapping screws for surface mounting. A pipe mounting accessory kit is available for mounting to a 2-inch pipe.

The transmitter has a two-line 16-character display. Menu screens for calibrating and registering choices are simple and intuitive. Plain language prompts guide the user through the procedures. There are no service codes to enter before gaining access to menus.

Two digital communication protocols are available: HART (model option -HT) and FOUNDATION fieldbus (model option -FF or -FI). Digital communications allow access to AMS (Asset Management Solutions). Use AMS to set up and configure the transmitter, read process variables, and troubleshoot problems from a personal computer or host anywhere in the plant.

The seven-button membrane-type keypad allows local programming and calibrating of the transmitter. The HART Model 375 communicator can also be used for programming and calibrating the transmitter.

The Model Xmt-A Transmitter with the appropriate sensor

measures dissolved oxygen (ppm and ppb level), free chlorine, total chlorine, monochloramine, and ozone in water and aqueous solutions. The transmitter is compatible with Rosemount Analytical 499A amperometric sensors for oxygen, chlorine, monochloramine, and ozone; and with Hx438, Bx438, and Gx448 steam-sterilizable oxygen sensors.

For free chlorine measurements, both automatic and manual pH correction are available. pH correction is necessary because amperometric free chlorine sensors respond only to hypochlorous acid, not free chlorine, which is the sum of hypochlorous acid and hypochlorite ion. To measure free chlorine, most competing instruments require an acidified sample. Acid lowers the pH and converts hypochlorite ion to hypochlorous acid. The Model Xmt-A eliminates the need for messy and expensive sample conditioning by measuring the sample pH and using it to correct the chlorine sensor signal. If the pH is relatively constant, a fixed pH correction can be used, and the pH measurement is not necessary. If the pH is greater than 7.0 and fluctuates more than about 0.2 units, continuous measurement of pH and automatic pH correction is necessary. See Specifications section for recommended pH sensors. Corrections are valid to pH 9.5.

The transmitter fully compensates oxygen, ozone, free chlorine, total chlorine, and monochloramine readings for changes in membrane permeability caused by temperature changes.

For pH measurements — pH is available with free chlorine only — the Xmt-A features automatic buffer recognition and stabilization check. Buffer pH and temperature data for commonly used buffers are stored in the transmitter. Glass impedance diagnostics warn the user of an aging or failed pH sensor.

## 1.2 SPECIFICATIONS - GENERAL

**Case:** ABS (panel mount), polycarbonate (pipe/wall mount); NEMA 4X/CSA 4 (IP65)

### Dimensions

**Panel (code -10):** 6.10 x 6.10 x 3.72 in. (155 x 155 x 94.5 mm)

**Surface/Pipe (code -11):** 6.23 x 6.23 x 3.23 in. (158 x 158 x 82 mm); see page 5 for dimensions of pipe mounting bracket.

**Conduit openings:** Accepts PG13.5 or 1/2 in. conduit fittings

**Ambient Temperature:** 32 to 122°F (0 to 50°C). Some degradation of display above 50°C.

**Storage Temperature:** -4 to 158°F (-20 to 70°C)

**Relative Humidity:** 10 to 90% (non-condensing)

**Weight/Shipping Weight:** 10 lb/10 lb (4.5/5.0 kg)

**Display:** Two line, 16-character display. Character height: 4.8 mm; first line shows process variable (oxygen, ozone, free chlorine, total chlorine, or monochloramine), second line shows process temperature and output current. For pH/chlorine combination, pH may also be displayed. Fault and warning messages, when triggered, alternate with temperature and output readings.

During calibration and programming, messages, prompts, and editable values appear in the two-line display.

**Temperature resolution:** 0.1°C ( $\leq 99.9^\circ\text{C}$ );  
1°C ( $\geq 100^\circ\text{C}$ )

**Input ranges:** 0-330 nA, 0.3-4 $\mu\text{A}$ , 3.7-30  $\mu\text{A}$ , 27-100  $\mu\text{A}$

**Repeatability (input):**  $\pm 0.1\%$  of range

**Linearity (input):**  $\pm 0.3\%$  of range

**Temperature range:** 0-100°C (0-150°C for steam sterilizable sensors)

**Temperature accuracy using RTD:**  $\pm 0.5^\circ\text{C}$  between 0 and 50°C,  $\pm 1^\circ\text{C}$  above 50°C

**Temperature accuracy using 22k NTC:**  $\pm 0.5^\circ\text{C}$  between 0 and 50°C,  $\pm 2^\circ\text{C}$  above 50°C

**HART Communications:** PV, SV, TV, and 4V assignable to measurement (oxygen, ozone, or chlorine), temperature, pH, and sensor current.

**RFI/EMI:** EN-61326

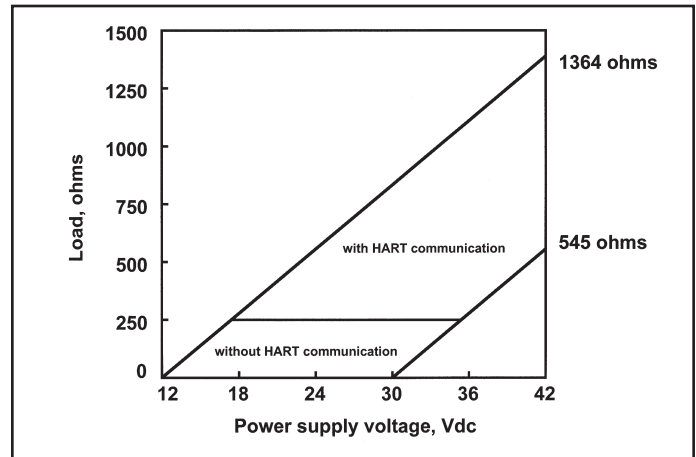

**Power & Load Requirements:** Supply voltage at the transmitter terminals should be at least 12 Vdc. Power supply voltage should cover the voltage drop on the cable plus the external load resistor required for HART communications (250  $\Omega$  minimum). Minimum power supply voltage is 12 Vdc. Maximum power supply voltage is 42.4 Vdc (30 Vdc for intrinsically safe operation). The graph shows the supply voltage required to maintain 12 Vdc (upper line) and 30 Vdc (lower line) at the transmitter terminals when the current is 22 mA.

**Analog Output:** Two-wire, 4-20 mA output with superimposed HART digital signal. Fully scalable over the operating range of the sensor.

**Output accuracy:**  $\pm 0.05$  mA

**HAZARDOUS LOCATION APPROVALS****Intrinsic Safety:**

Class I, II, III, Div. 1  
Groups A-G  
T4 Tamb = 50°C



Class I, II, III, Div. 1  
Groups A-G  
T4 Tamb = 50°C

ATEX



1180 II 1 G  
Baseefa04ATEX0213X  
EEx ia IIC T4  
Tamb = 0°C to 50°C

**Non-Incendive:**

Class I, Div. 2, Groups A-D  
Dust Ignition Proof  
Class II & III, Div. 1, Groups E-G  
NEMA 4/4X Enclosure

Class I, Div. 2, Groups A-D  
Dust Ignition Proof  
Class II & III, Div. 1, Groups E-G  
NEMA 4/4X Enclosure  
T4 Tamb = 50°C

### 1.3 SPECIFICATIONS — OXYGEN

**Measurement Range:** 0-20 ppm (mg/L),  
or equivalent partial pressure or % saturation  
(limited by sensor)

**Units:** ppm, ppb, % saturation, partial pressure (mmHg,  
inHg, atm, mbar, bar, kPa)

**Resolution:** 4 digits. Position of decimal point depends  
on units selected

for partial pressure (x.xxx to xxxx)

for % saturation (fixed at xxx.x%)

for ppm (fixed at xx.xx ppm)

for ppb (fixed at xxx.x ppb, changes to 1.00 ppm  
when ppb reading exceeds 999.9 ppb)

**Temperature correction for membrane permeability:**  
automatic between 0 and 50°C (can be disabled)

**Calibration:** air calibration (user must enter barometric  
pressure) or calibration against a standard instrument

#### SENSORS — OXYGEN:

Model 499A DO-54, 499A DO-54-VP for ppm level

Model 499A TrDO-54, 499A TrDO-54-VP for ppb level

Hx438, Gx448, and Bx438 steam-sterilizable oxygen  
sensors

### 1.4 SPECIFICATIONS — FREE CHLORINE

**Measurement Range:** 0-20 ppm (mg/L) as Cl<sub>2</sub>  
(limited by sensor)

**Resolution:** 0.001 ppm (Autoranges at 0.999 to 1.00 and  
9.99 to 10.0)

**Temperature correction for membrane permeability:**  
automatic between 0 and 50°C (can be disabled)

**pH Correction:** Automatic between pH 6.0 and 9.5.  
Manual pH correction is also available.

**Calibration:** against grab sample analyzed using portable  
test kit.

#### SENSOR — FREE CHLORINE:

Model 499A CL-01-54, 499A CL-01-54-VP

### SPECIFICATIONS — pH

**Application:** pH measurement available with free chlo-  
rine only

**Measurement Range:** 0-14 pH

**Resolution:** 0.01 pH

**Sensor Diagnostics:** Glass impedance (for broken or  
aging electrode) and reference offset. Reference imped-  
ance (for fouled reference junction) is not available.

**Repeatability:** ±0.01 pH at 25°C

#### SENSORS — pH:

Use Model 399-09-62, 399-14, or 399VP-09.

See pH sensor product data sheet for complete ordering  
information.

### 1.5 SPECIFICATIONS — TOTAL CHLORINE

**Measurement Range:** 0-20 ppm (mg/L) as Cl<sub>2</sub>  
(limited by sensor)

**Resolution:** 0.001 ppm (Autoranges at 0.999 to 1.00 and  
9.99 to 10.0)

**Temperature correction for membrane permeability:**  
automatic between 5 and 35°C (can be disabled)

**Calibration:** against grab sample analyzed using portable  
test kit.

#### SENSOR — TOTAL CHLORINE:

Model 499A CL-02-54 (must be used with SCS 921)

### 1.6 SPECIFICATIONS — MONOCHLORAMINE

**Measurement Range:** 0-20 ppm (mg/L) as Cl<sub>2</sub>  
(limited by sensor)

**Resolution:** 0.001 ppm (Autoranges at 0.999 to 1.00 and  
9.99 to 10.0)

**Temperature correction for membrane permeability:**  
automatic between 5 and 35°C (can be disabled)

**Calibration:** against grab sample analyzed using portable  
test kit.

#### SENSOR — MONOCHLORAMINE:

Model 499A CL-03-54, 499A CL-03-54-VP

### 1.7 SPECIFICATIONS — OZONE

**Measurement Range:** 0-10 ppm (mg/L) (limited by sensor)

**Units:** ppm and ppb

**Resolution:**

for ppm: x.xxx to xxxx

for ppb: xxx.x to xxxx

**Temperature correction for membrane permeability:**  
automatic between 5 and 35°C (can be disabled)

**Calibration:** against grab sample analyzed using portable  
test kit.

#### SENSOR — OZONE:

Model 499A OZ-54, 499A OZ-54-VP

### 1.8 TRANSMITTER DISPLAY DURING CALIBRATION AND PROGRAMMING

The display can be readily configured to meet user requirements.

Basic display for all measurements:

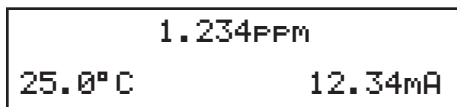

For the measurement of oxygen, a variety of units are available: ppm, ppb (for 499ATrDO sensor only), % saturation, and partial pressure (in units of mm Hg, in Hg, bar, mbar, atm, or kPa).

For chlorine measurements with continuous pH correction, the basic display also shows the pH.

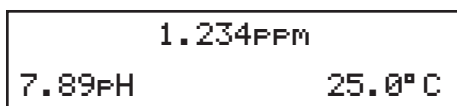

A display showing the raw sensor current can also be selected.

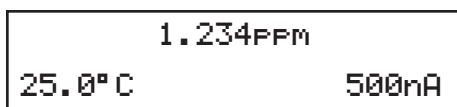

### 1.9 HART COMMUNICATION (Figure 1-1)

The Model 375 HART Communicator is a hand-held device that provides a common link to all HART SMART instruments and allows access to AMS (Asset Management Solutions). Use the HART communicator to set up and control the Xmt-A-HT and to read measured variables. Press ON to display the on-line menu. All setup menus are available through this menu.

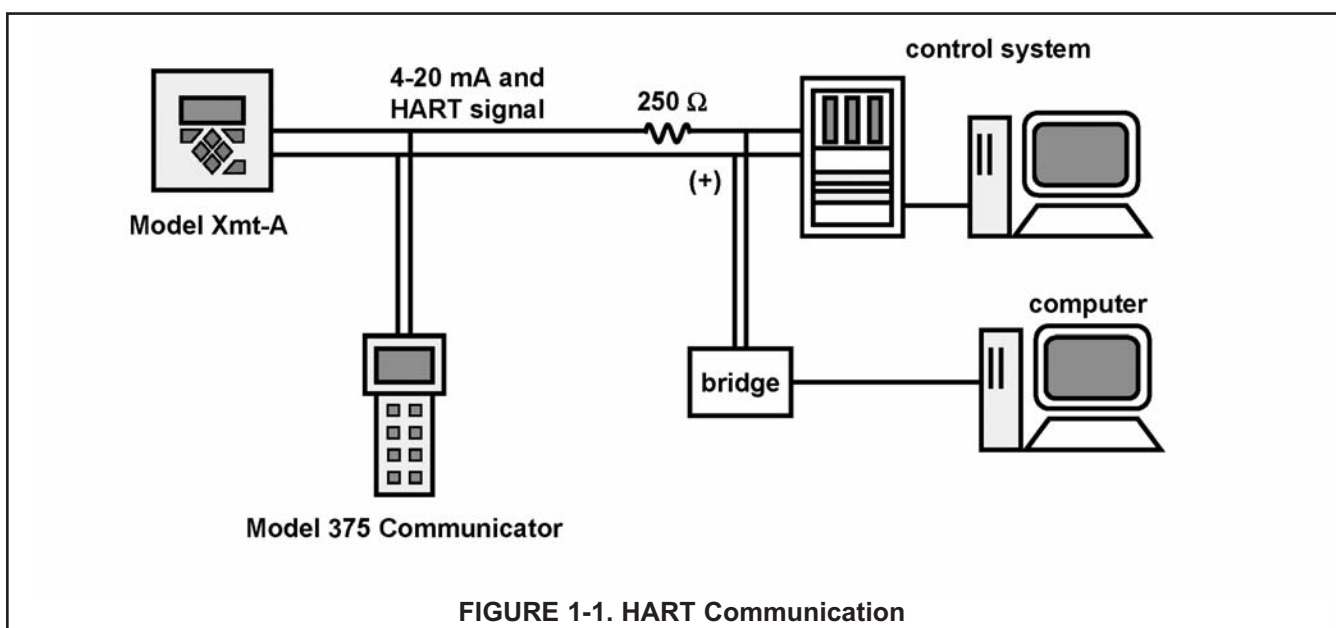

FIGURE 1-1. HART Communication



## 1.10 ORDERING INFORMATION

The **Model Xmt-A-HT Transmitter** is intended for the determination of oxygen (ppm and ppb level), free chlorine, total chlorine, monochloramine, and ozone. For free chlorine measurements, which often require continuous pH correction, a second input for a pH sensor is available.

MODEL	
Xmt	SMART TWO-WIRE MICROPROCESSOR TRANSMITTER
CODE	REQUIRED SELECTION
P	pH/ORP
CODE	REQUIRED SELECTION
HT	Analog 4-20 mA output with superimposed HART digital signal
FF	Foundation fieldbus digital output
FI	Foundation fieldbus digital output with FISCO
CODE	REQUIRED SELECTION
10	Panel mounting enclosure
11	Pipe/Surface mounting enclosure (pipe mounting requires accessory kit PN 23820-00)
CODE	AGENCY APPROVALS
60	No approval
67	FM approved intrinsically safe and non-incendive (when used with appropriate sensor and safety barrier)
69	CSA approved intrinsically safe and non-incendive (when used with appropriate sensor and safety barrier)
73	ATEX approved intrinsically safe (when used with appropriate sensor and safety barrier)
<b>Xmt-P-HT-10-67      EXAMPLE</b>	

## 1.11 ACCESSORIES

**POWER SUPPLY:** Use the Model 515 Power Supply to provide dc loop power to the transmitter. The Model 515 provides two isolated sources at 24Vdc and 200 mA each. For more information refer to product data sheet 71-515.

**ALARM MODULE:** The Model 230A alarm Module receives the 4-20 mA signal from the Xmt-A-HT transmitter and activates two alarm relays. High/high, low/low, and high/low are available. Hysteresis (deadband) is also adjustable. For more information, refer to product data sheet 71-230A.

**HART COMMUNICATOR:** The Model 375 HART communicator allows the user to view measurement values as well as to program and configure the transmitter. The Model 375 attaches to any wiring terminal across the output loop. A minimum 250  $\Omega$  load must be between the power supply and transmitter. Order the Model 375 communicator from Emerson Process Management. Call (800) 999-9307.

### ACCESSORIES

MODEL/PN	DESCRIPTION
515	DC loop power supply (see product data sheet 71-515)
23820-00	2-in. pipe mounting kit
9240048-00	Stainless steel tag, specify marking
Model 375	To order HART Model 375 Communicator, call Emerson Process Management at (800) 999-9307
AMS software	To order AMS software, call Emerson Process Management at (800) 999-9307
23554-00	Gland fittings PG 13.5, 5 per package



## SECTION 2.0 INSTALLATION

### 2.1 UNPACKING AND INSPECTION

Inspect the shipping container. If it is damaged, contact the shipper immediately for instructions. Save the box. If there is no apparent damage, unpack the container. Be sure all items shown on the packing list are present. If items are missing, notify Emerson Process Management immediately.

### 2.2 INSTALLATION

#### 2.2.1 General Information

1. Although the transmitter is suitable for outdoor use, do not install it in direct sunlight or in areas of extreme temperatures.
2. Install the transmitter in an area where vibrations and electromagnetic and radio frequency interference are minimized or absent.
3. Keep the transmitter and sensor wiring at least one foot from high voltage conductors. Be sure there is easy access to the transmitter.
4. The transmitter is suitable for panel, pipe, or surface mounting. Refer to the table below.

Type of Mounting	Section
Panel	2.2.2
Pipe	2.2.3
Surface	2.2.4

5. The transmitter case has two 1/2-inch (PG13.5) conduit openings and four 1/2-inch knockouts. One conduit opening is for the power/output cable; the other opening is for the sensor cable. The center knockout in the bottom of the enclosure should be removed only if a second sensor is required, i.e., if free chlorine with continuous pH correction is being measured. (Note: Earlier versions of the Xmt-A-HT pipe/surface mount transmitters may have three openings in the bottom of the enclosure. The transmitter is shipped with a NEMA 4X plug installed in the center opening.)

Figure 2-1 shows how to remove a knockout. The knockout grooves are on the outside of the case. Place the screwdriver blade on the inside of the case and align it approximately along the groove. Rap the screwdriver sharply with a hammer until the groove cracks. Move the screwdriver to an uncracked portion of the groove and continue the process until the knockout falls out. Use a small knife to remove the flash from the inside of the hole.

6. Use weathertight cable glands to keep moisture out to the transmitter. If conduit is used, plug and seal the connections at the transmitter housing to prevent moisture from getting inside the instrument.
7. To reduce the likelihood of stress on wiring connections, do not remove the hinged front panel (-11 models) from the base during wiring installation. Allow sufficient wire length to avoid stress on conductors.

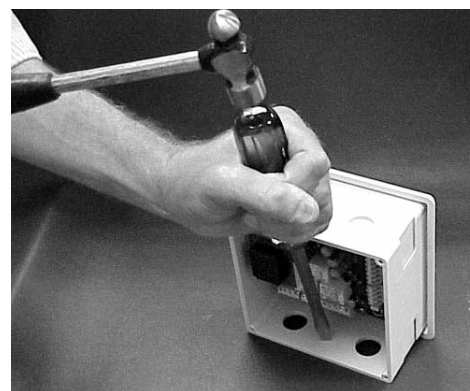
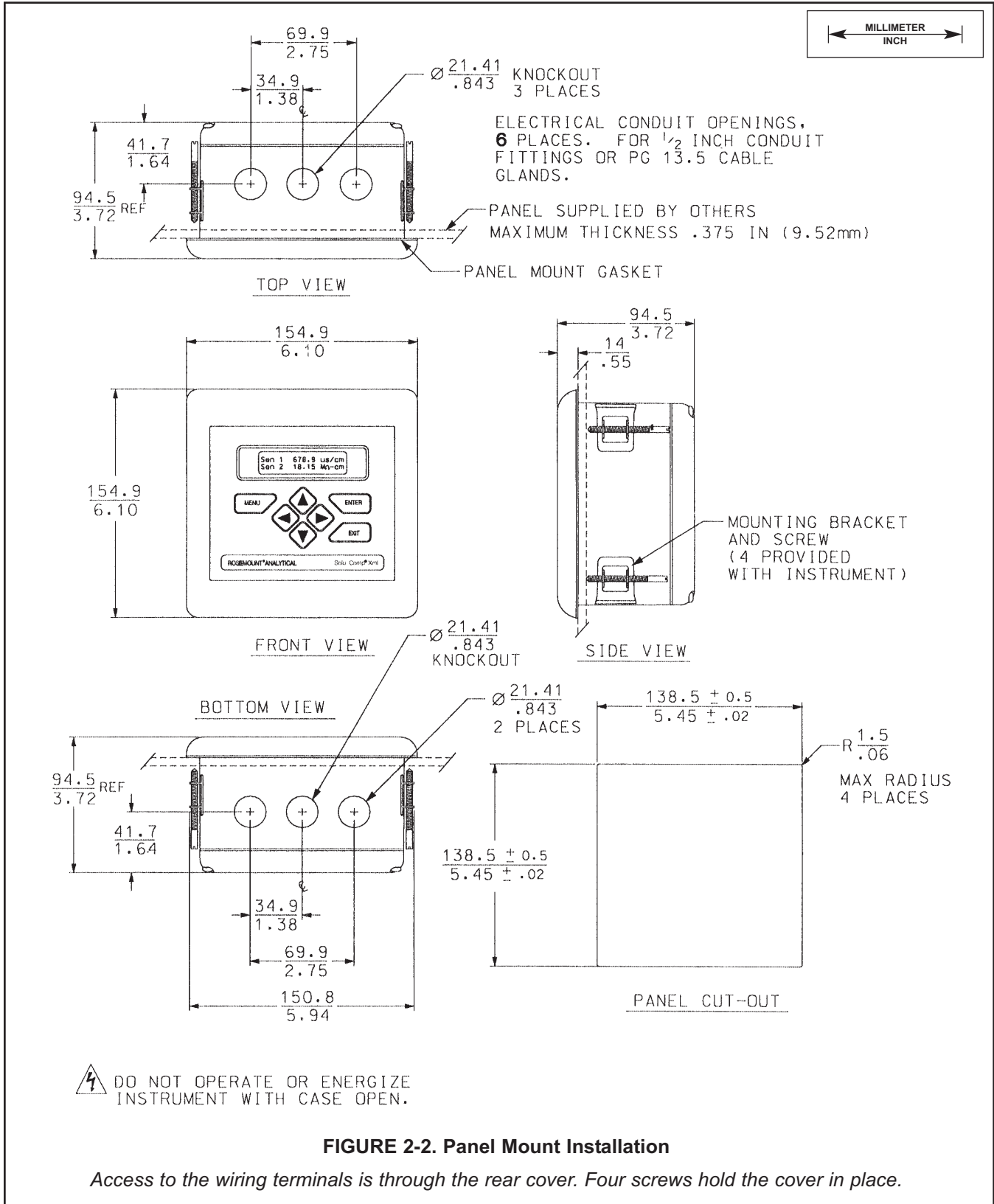
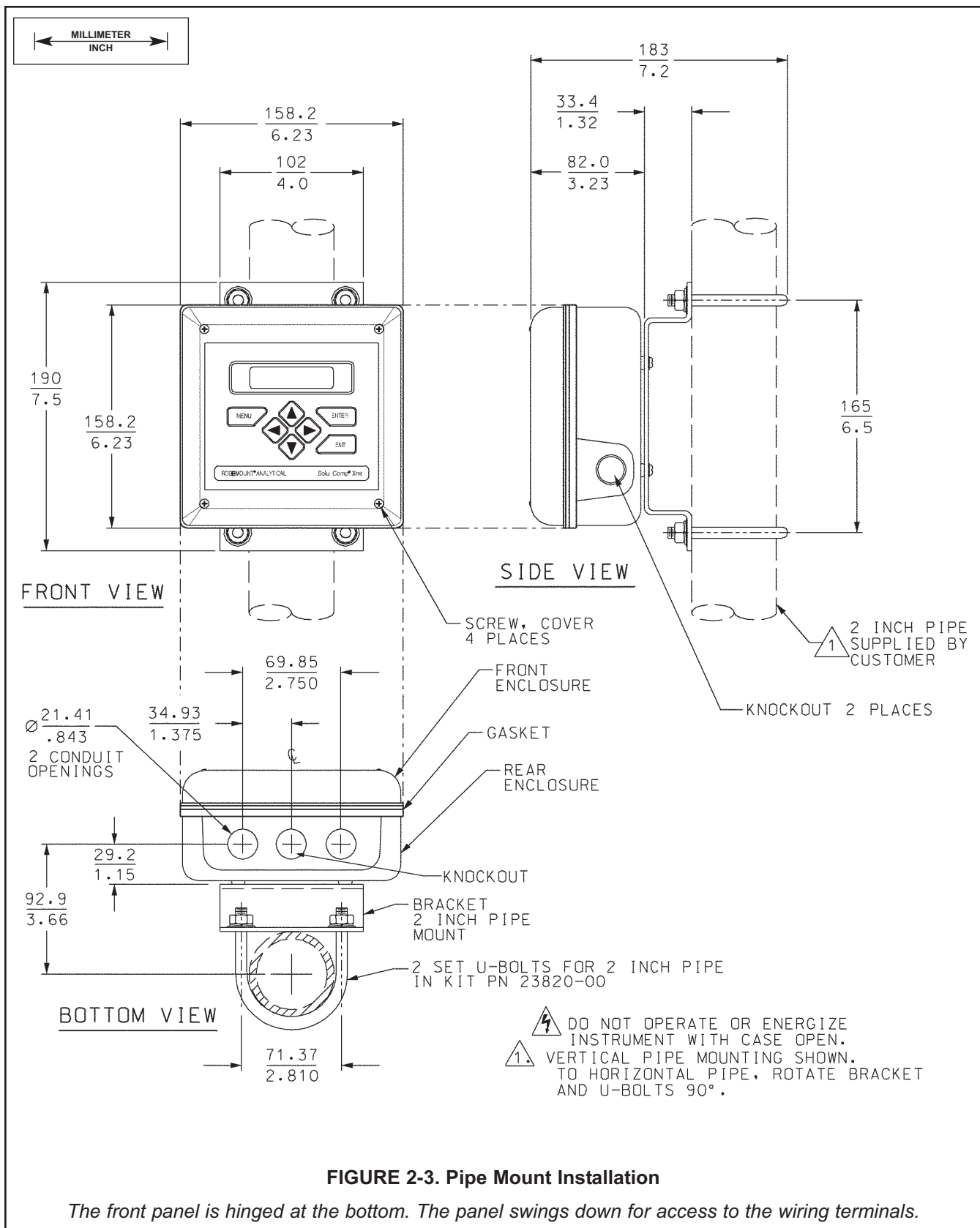

FIGURE 2-1. Removing the Knockouts

2.2.2 Panel Mounting.



2.2.3 Pipe Mounting.



**FIGURE 2-3. Pipe Mount Installation**

*The front panel is hinged at the bottom. The panel swings down for access to the wiring terminals.*

2.2.4 Surface Mounting.

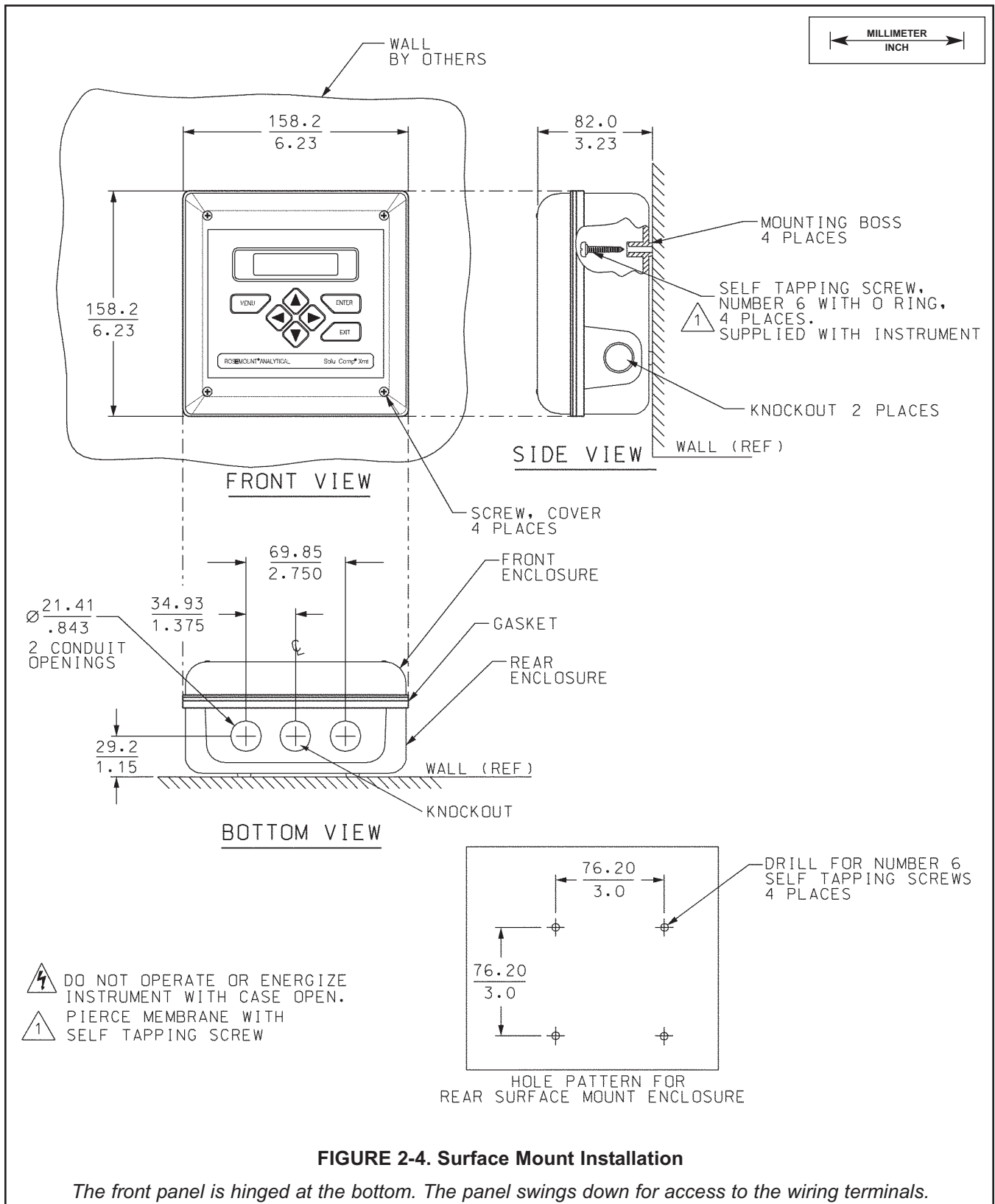

### 2.3 POWER SUPPLY/CURRENT LOOP

#### 2.3.1 Power Supply and Load Requirements.

Refer to Figure 2-5.

The supply voltage must be at least 12.0 Vdc at the transmitter terminals. The power supply must be able to cover the voltage drop on the cable as well as the load resistor (250 Ω minimum) required for HART communications. The maximum power supply voltage is 42.0 Vdc. For intrinsically safe installations, the maximum power supply voltage is 30.0 Vdc. The graph shows load and power supply requirements. The upper line is the power supply voltage needed to provide 12 Vdc at the transmitter terminals for a 22 mA current. The lower line is the power supply voltage needed to provide 30 Vdc for a 22 mA current.

The power supply must provide a surge current during the first 80 milliseconds of startup. The maximum current is about 24 mA.

For digital communications, the load must be at least 250 ohms. To supply the 12.0 Vdc lift off voltage at the transmitter, the power supply voltage must be at least 17.5 Vdc.

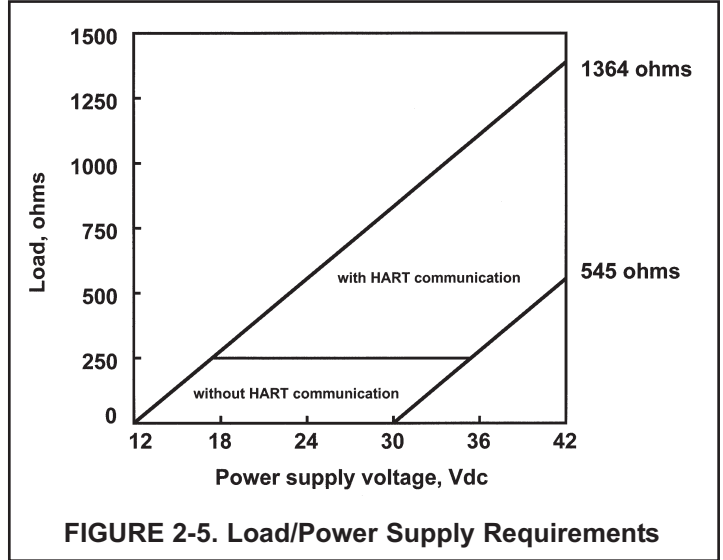

#### 2.3.2 Power Supply-Current Loop Wiring.

Refer to Figures 2-6, 2-7, and 2-8.

Run the power/signal wiring through the opening nearest TB-2.

For optimum EMI/RFI protection . . .

1. Use shielded power/signal cable and ground the shield at the power supply.
2. Use a metal cable gland and be sure the shield makes good electrical contact with the gland.
3. Use the metal backing plate (see Figure 2-6) when attaching the gland to transmitter enclosure.

The power/signal cable can also be enclosed in an earth-grounded metal conduit.

Do not run power supply/signal wiring in the same conduit or cable tray with AC power lines or with relay actuated signal cables. Keep power supply/signal wiring at least 6 ft (2 m) away from heavy electrical equipment.

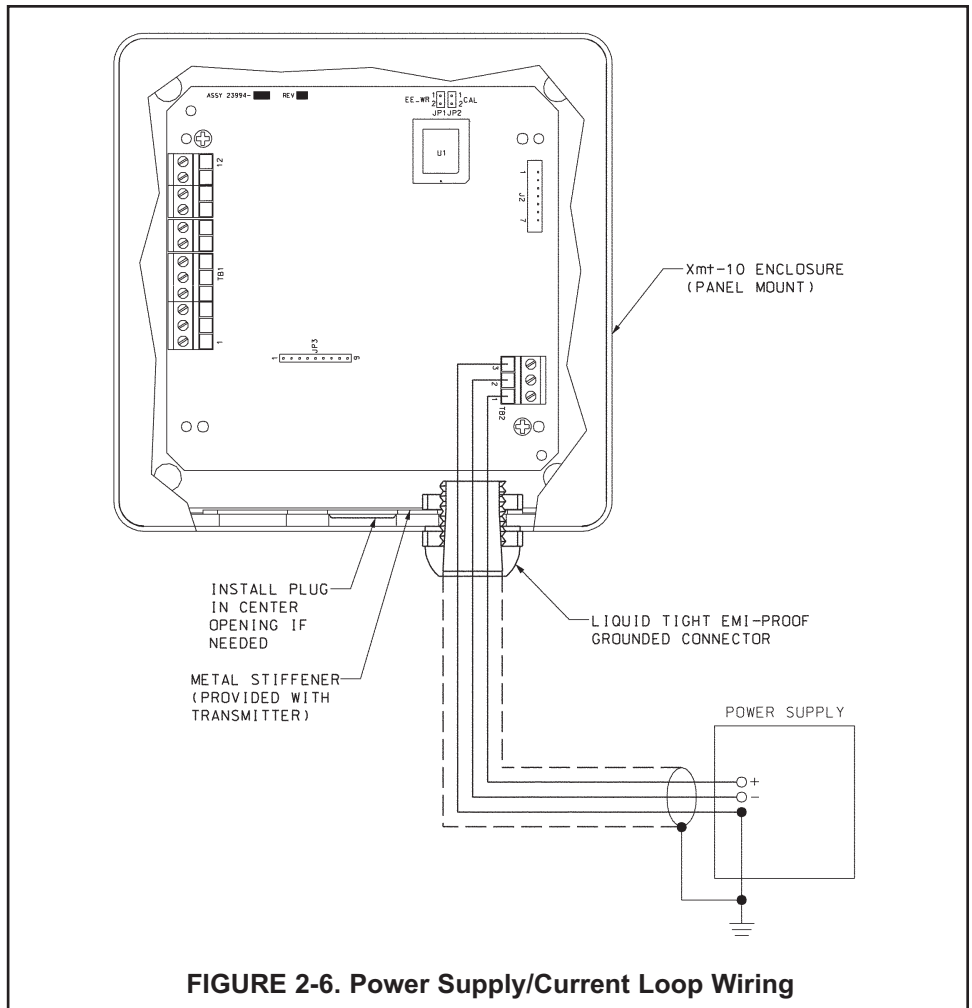

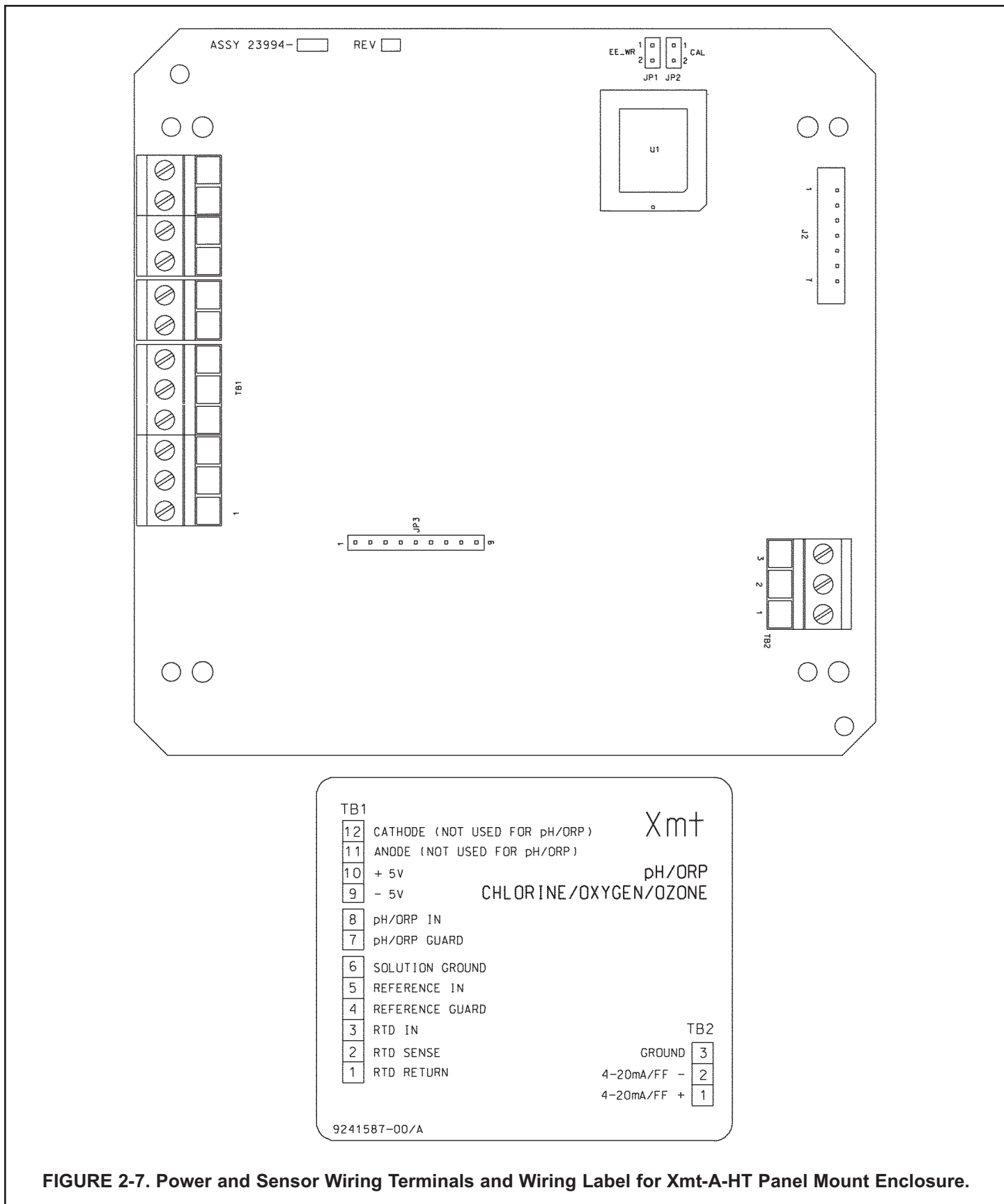

FIGURE 2-7. Power and Sensor Wiring Terminals and Wiring Label for Xmt-A-HT Panel Mount Enclosure.

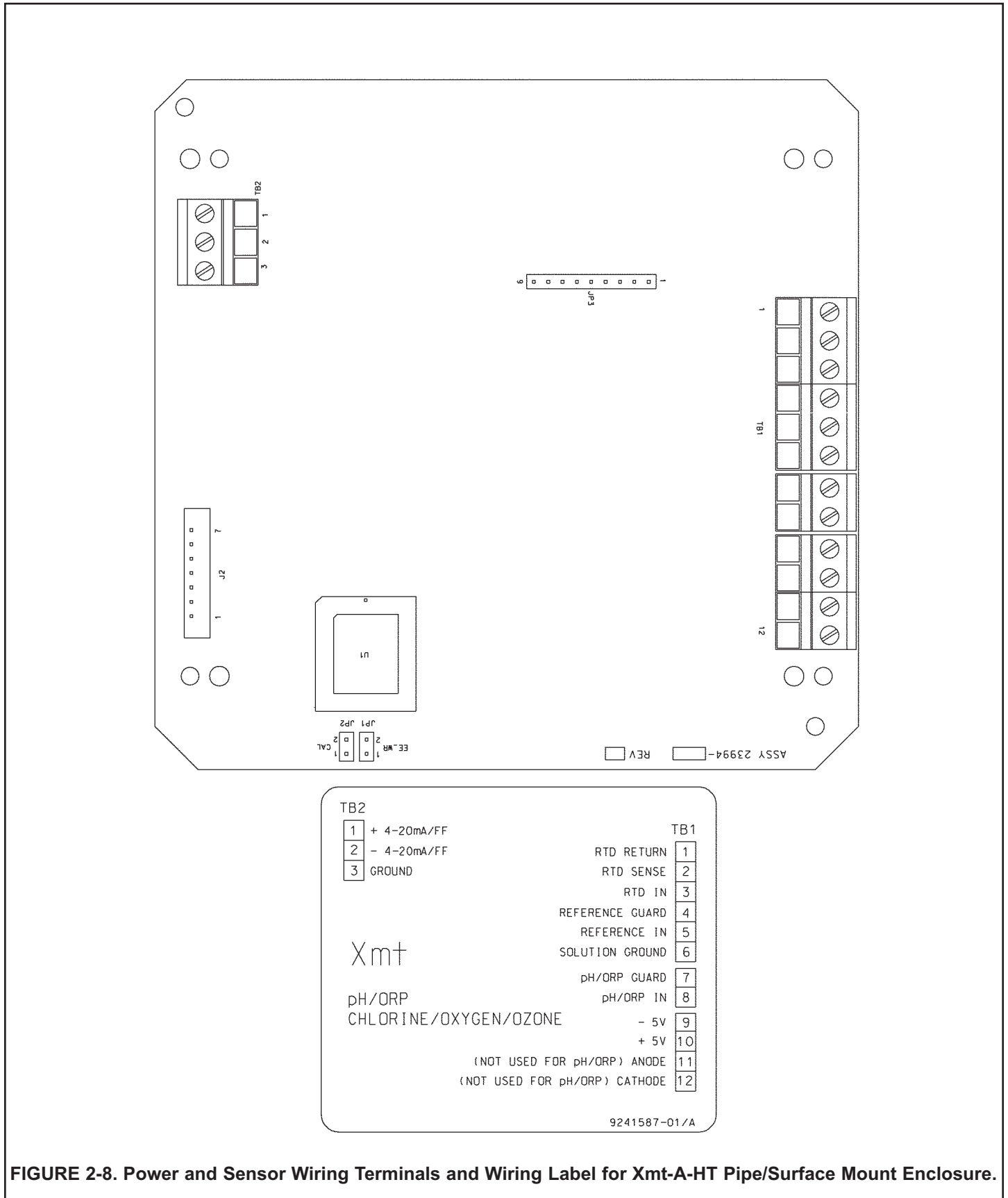

FIGURE 2-8. Power and Sensor Wiring Terminals and Wiring Label for Xmt-A-HT Pipe/Surface Mount Enclosure.

# SECTION 3.0 SENSOR WIRING

## 3.1 WIRING MODEL 499A OXYGEN, CHLORINE, MONOCHLORAMINE, AND OZONE SENSORS

All 499A sensors (499ADO, 499ATrDO, 499ACL-01, 499ACL-02, 499ACL-03, and 499AOZ) have identical wiring.

Use the pigtail wire and wire nuts provided with the sensor when more than one wire must be attached to a single terminal.

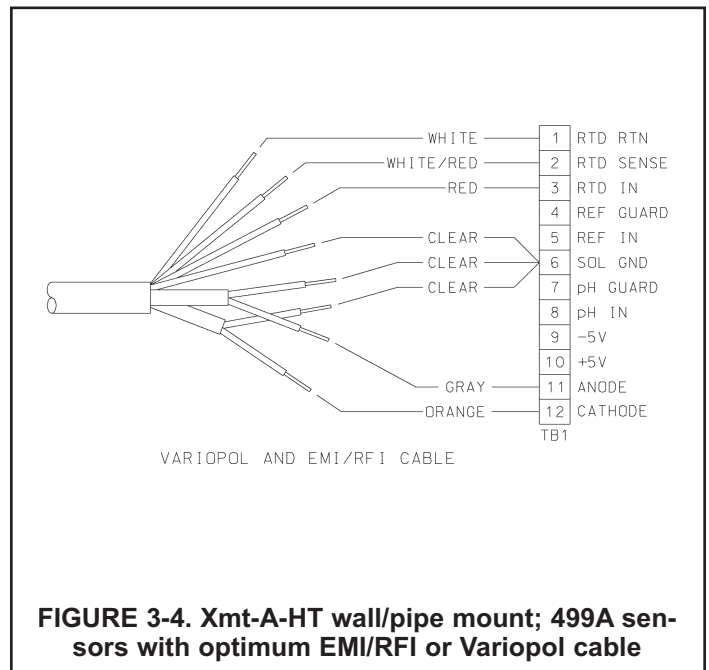
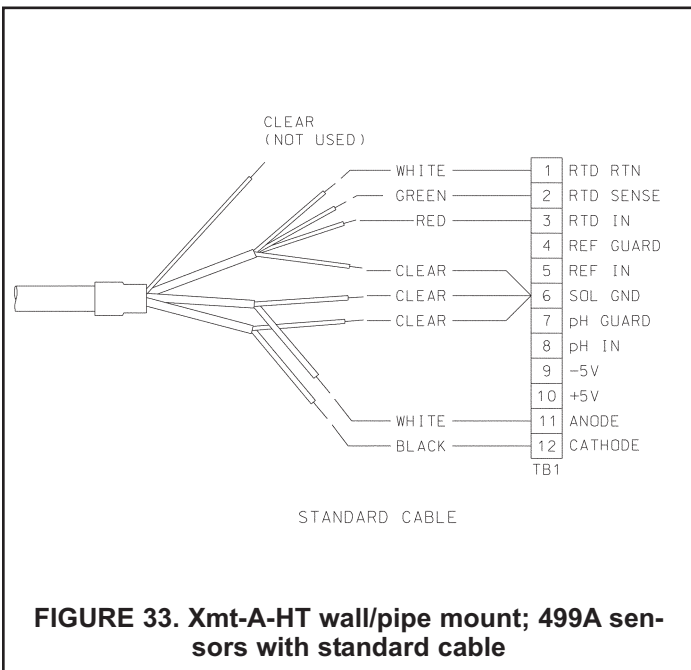
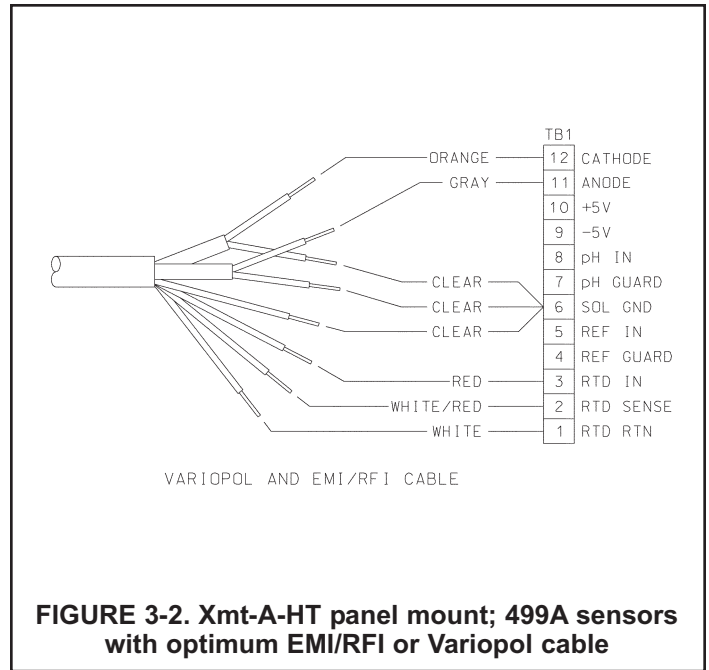
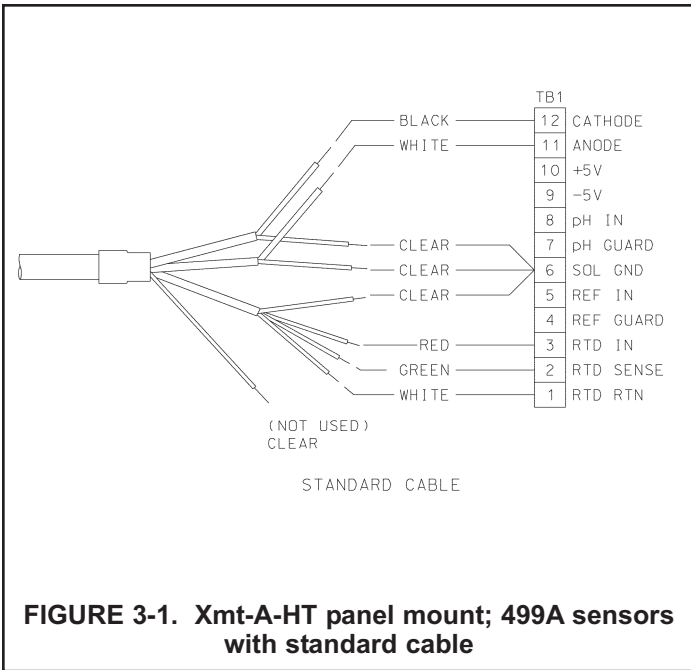



### 3.2 WIRING MODEL 499ACL-01 (Free Chlorine) SENSORS AND pH SENSORS

If free chlorine is being measured and the pH of the liquid varies more than 0.2 pH unit, a continuous correction for pH **must** be applied to the chlorine reading. Therefore, a pH sensor must be wired to the transmitter. This section gives wiring diagrams for the pH sensors typically used.

**When using the 499ACL-01 (free chlorine) sensor with a pH sensor, use the RTD in the pH sensor for measuring temperature. DO NOT use the RTD in the chlorine sensor.**

The pH sensor RTD is needed for temperature measurement during buffer calibration. During normal operation, the RTD in the pH sensor provides the temperature measurement required for the free chlorine membrane permeability correction.

Refer to the table to select the appropriate wiring diagram. Most of the wiring diagrams require that two or more shield wires be attached to a single terminal. Use the pigtail wire and wire nuts provided with the chlorine sensor to make the connection. **Insulate and tape back unused wires.**

Xmt-A-HT mounting	Free chlorine sensor cable	pH sensor	Figure
Panel	standard	399-09-62	3.5
	standard	399-VP-09	3.6
	standard	399-14	3.7
	EMI/RFI or Variopol	399-09-62	3.8
	EMI/RFI or Variopol	399-VP-09	3.9
	EMI/RFI or Variopol	399-14	3.10
Wall/pipe	standard	399-09-62	3.11
	standard	399-VP-09	3.12
	standard	399-14	3.13
	EMI/RFI or Variopol	399-09-62	3.14
	EMI/RFI or Variopol	399-VP-09	3.15
	EMI/RFI or Variopol	399-14	3.16

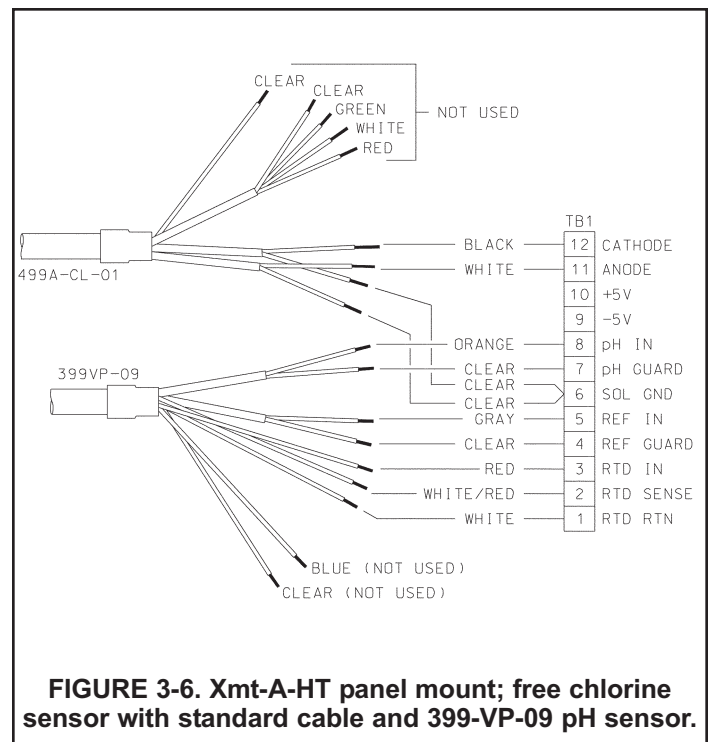
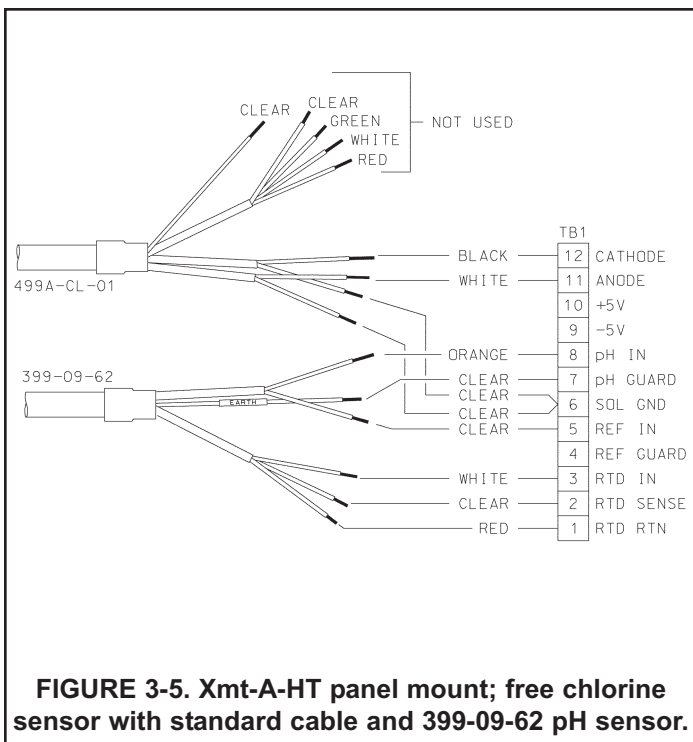

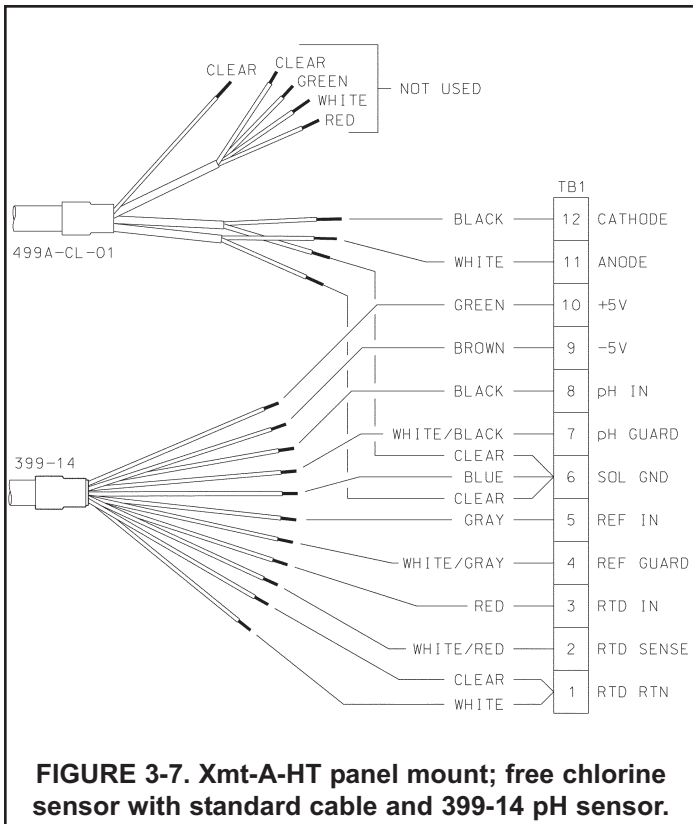

FIGURE 3-7. Xmt-A-HT panel mount; free chlorine sensor with standard cable and 399-14 pH sensor.

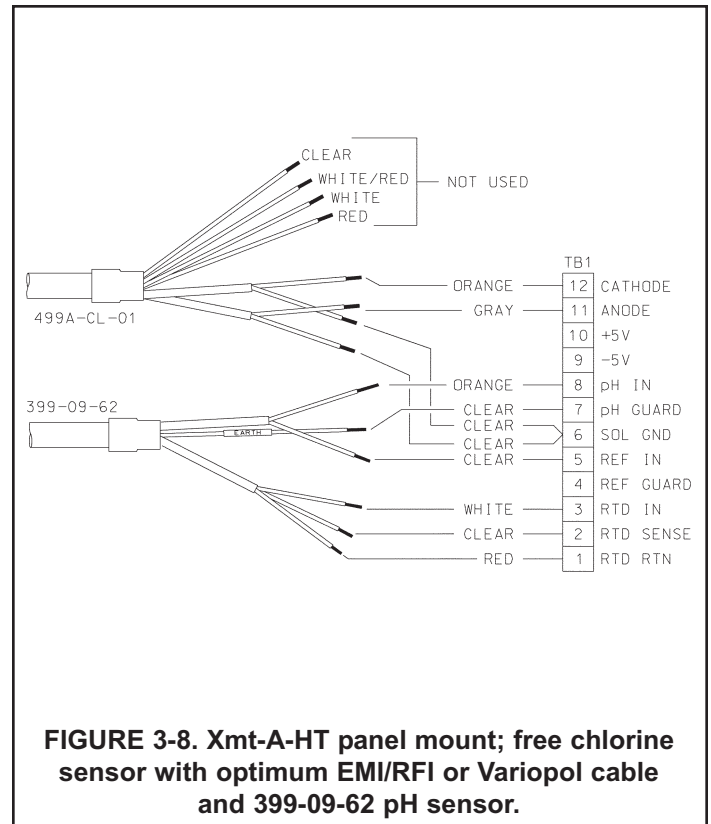

FIGURE 3-8. Xmt-A-HT panel mount; free chlorine sensor with optimum EMI/RFI or Variopool cable and 399-09-62 pH sensor.

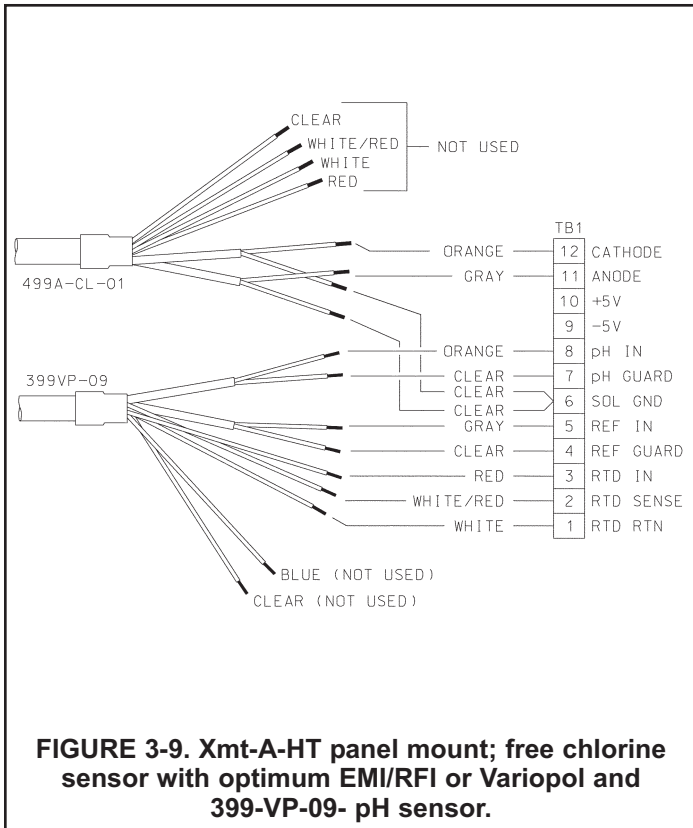

FIGURE 3-9. Xmt-A-HT panel mount; free chlorine sensor with optimum EMI/RFI or Variopool and 399-VP-09- pH sensor.

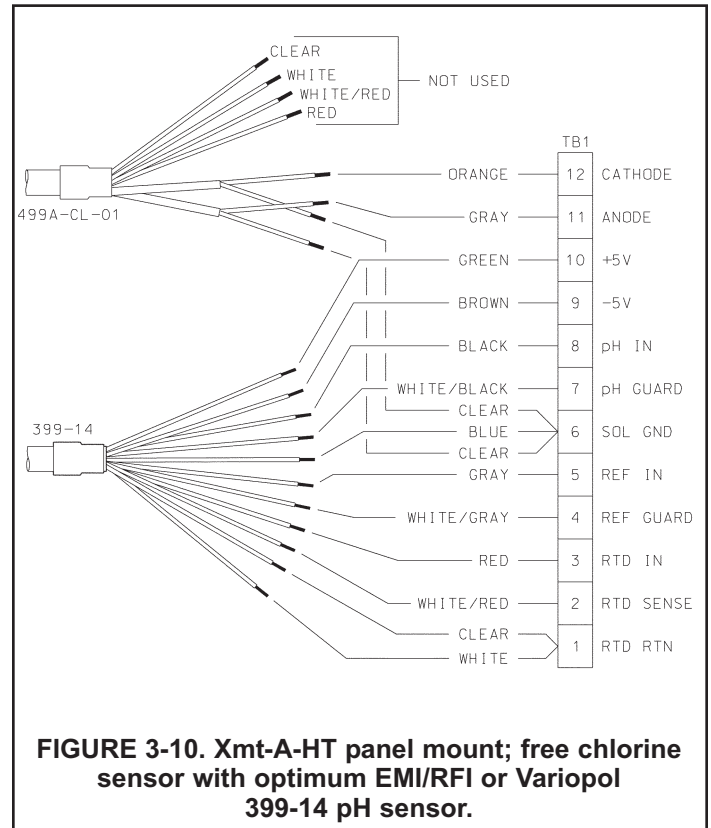
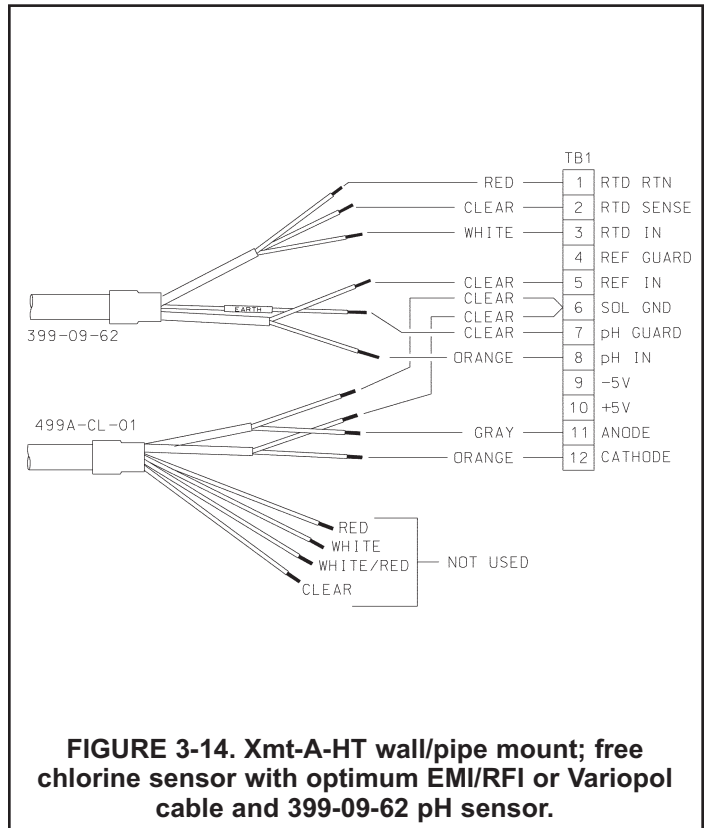
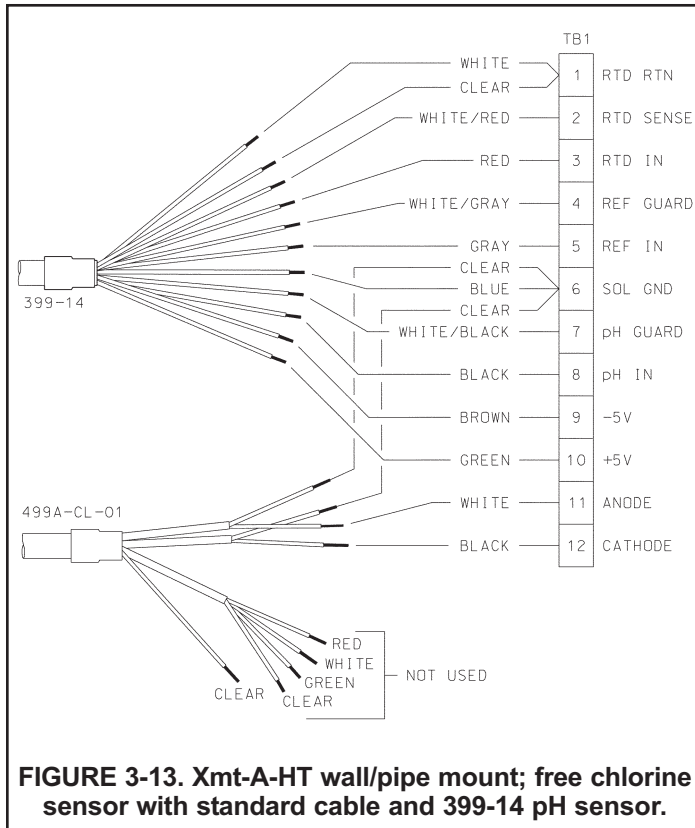
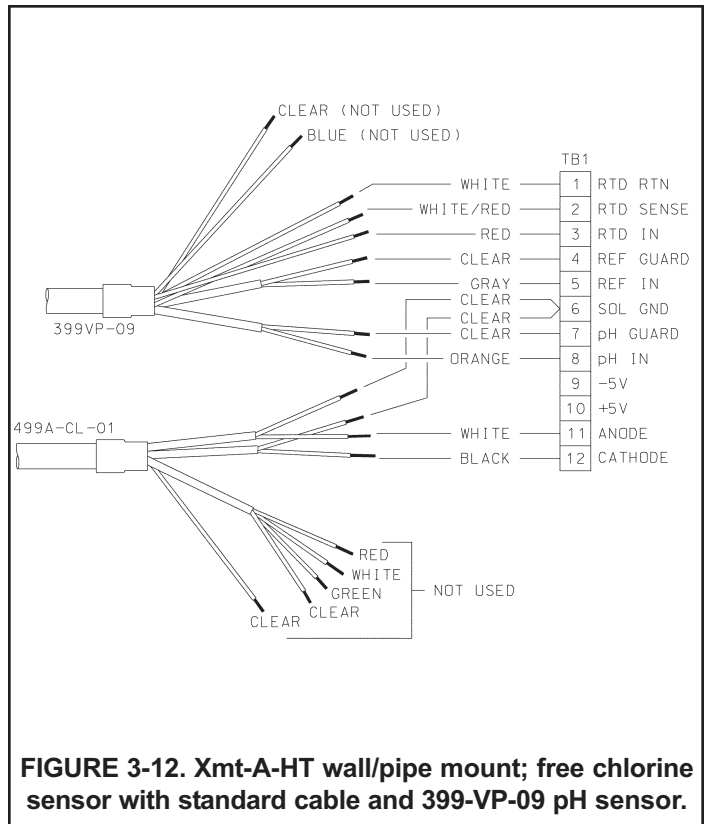
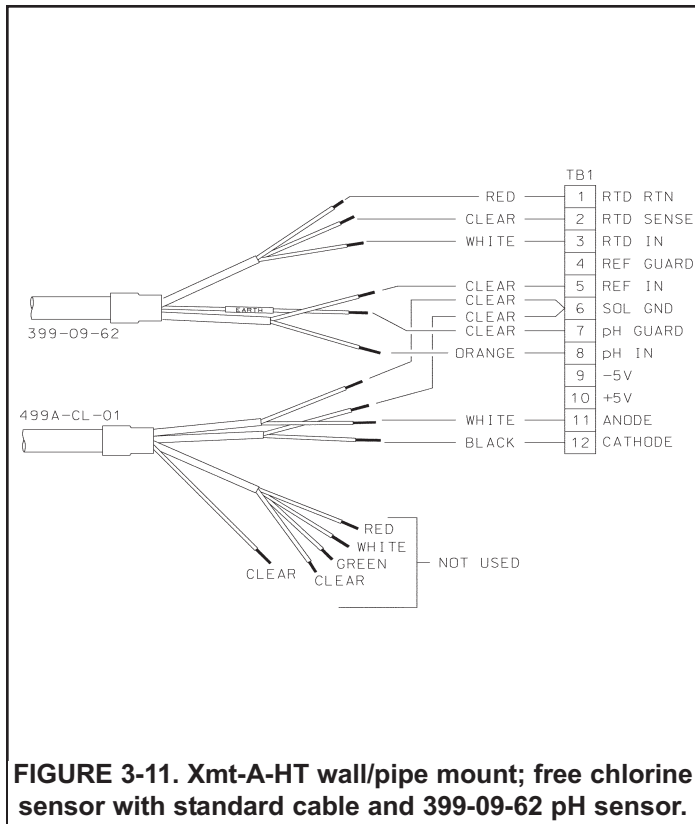
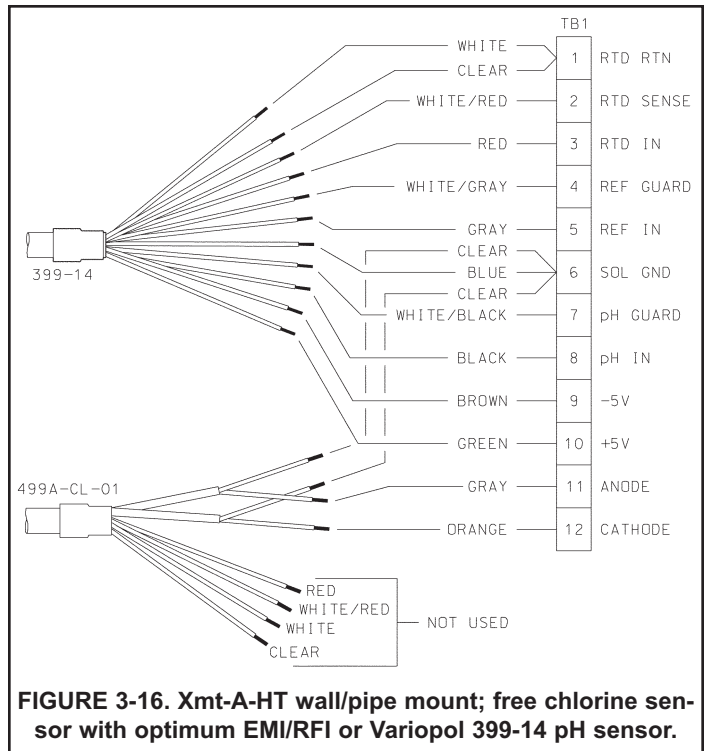
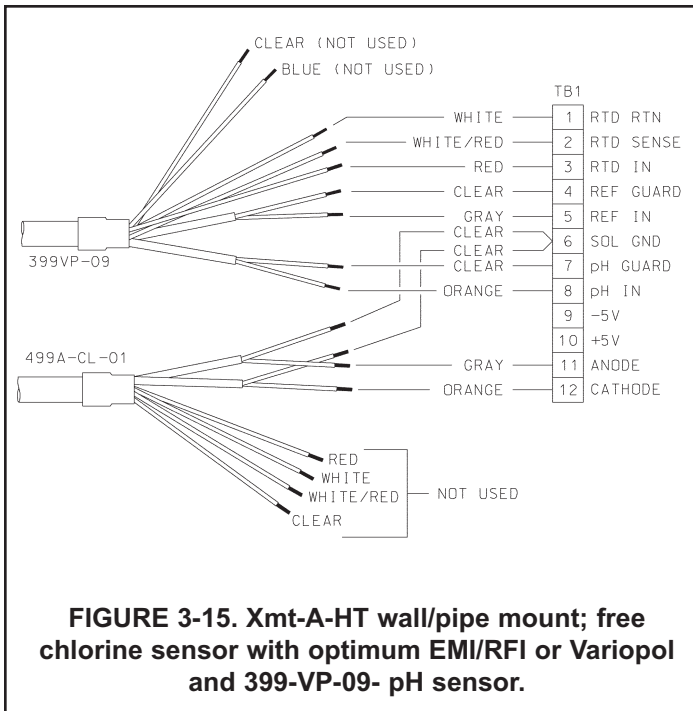
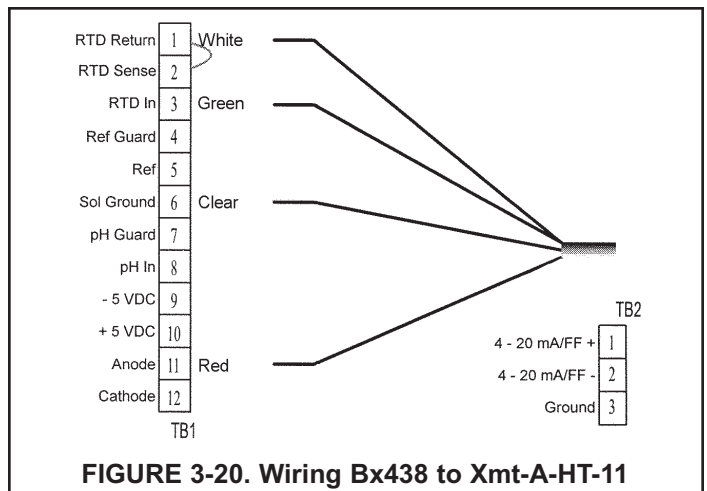
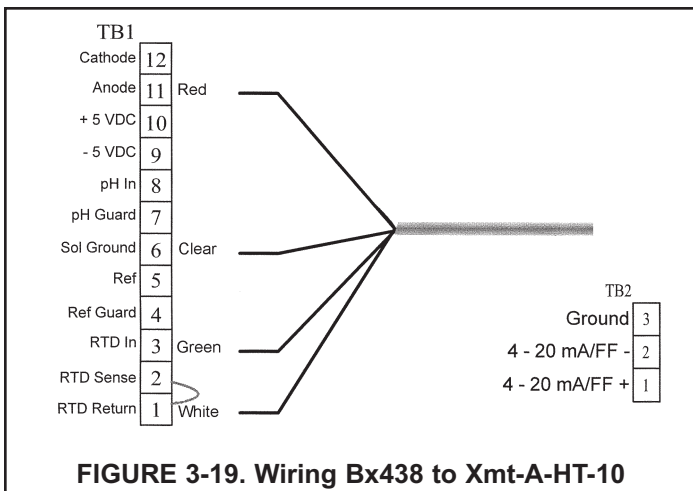
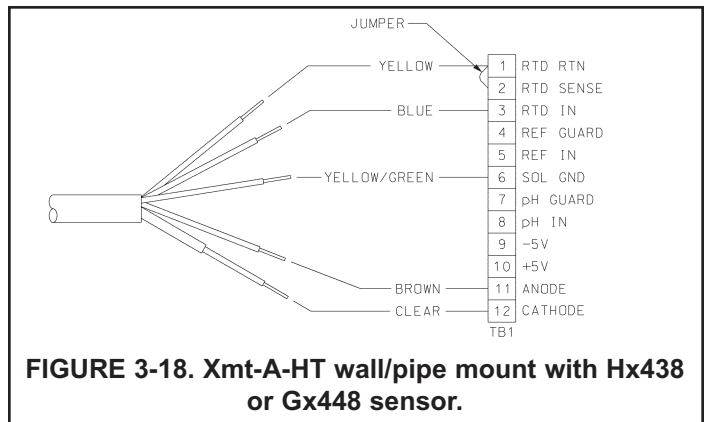
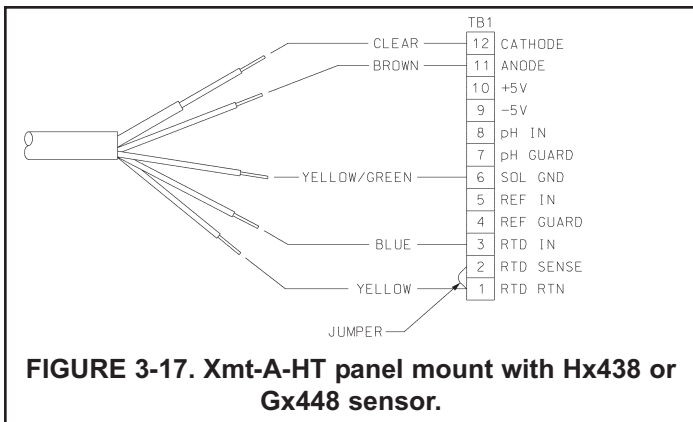

FIGURE 3-10. Xmt-A-HT panel mount; free chlorine sensor with optimum EMI/RFI or Variopool 399-14 pH sensor.





3.3 WIRING MODEL Hx438, Gx448, AND Bx438 SENSORS



# SECTION 4.0 INTRINSICALLY SAFE OPERATION

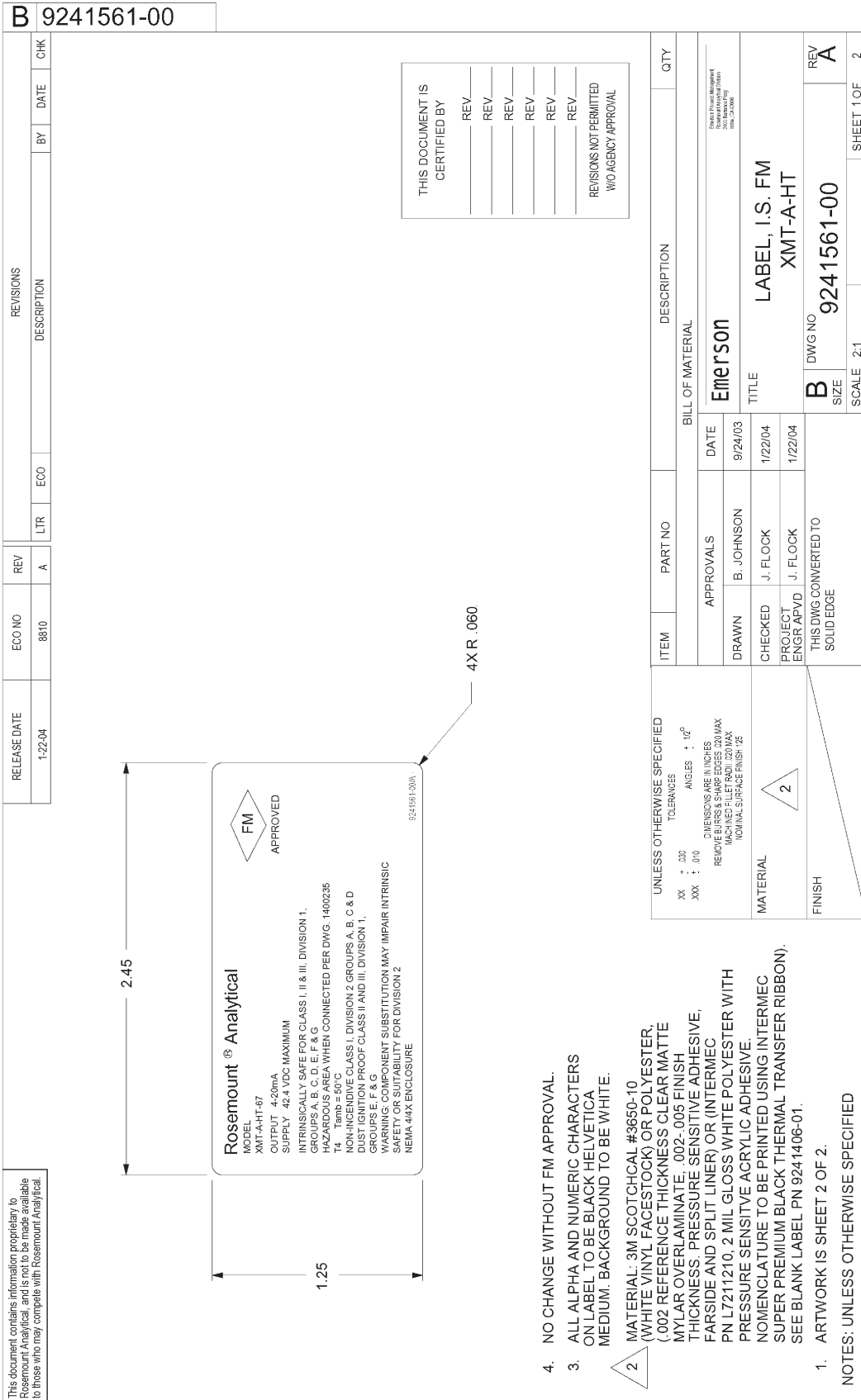

FIGURE 4-1. FM Intrinsically Safe Installation Label

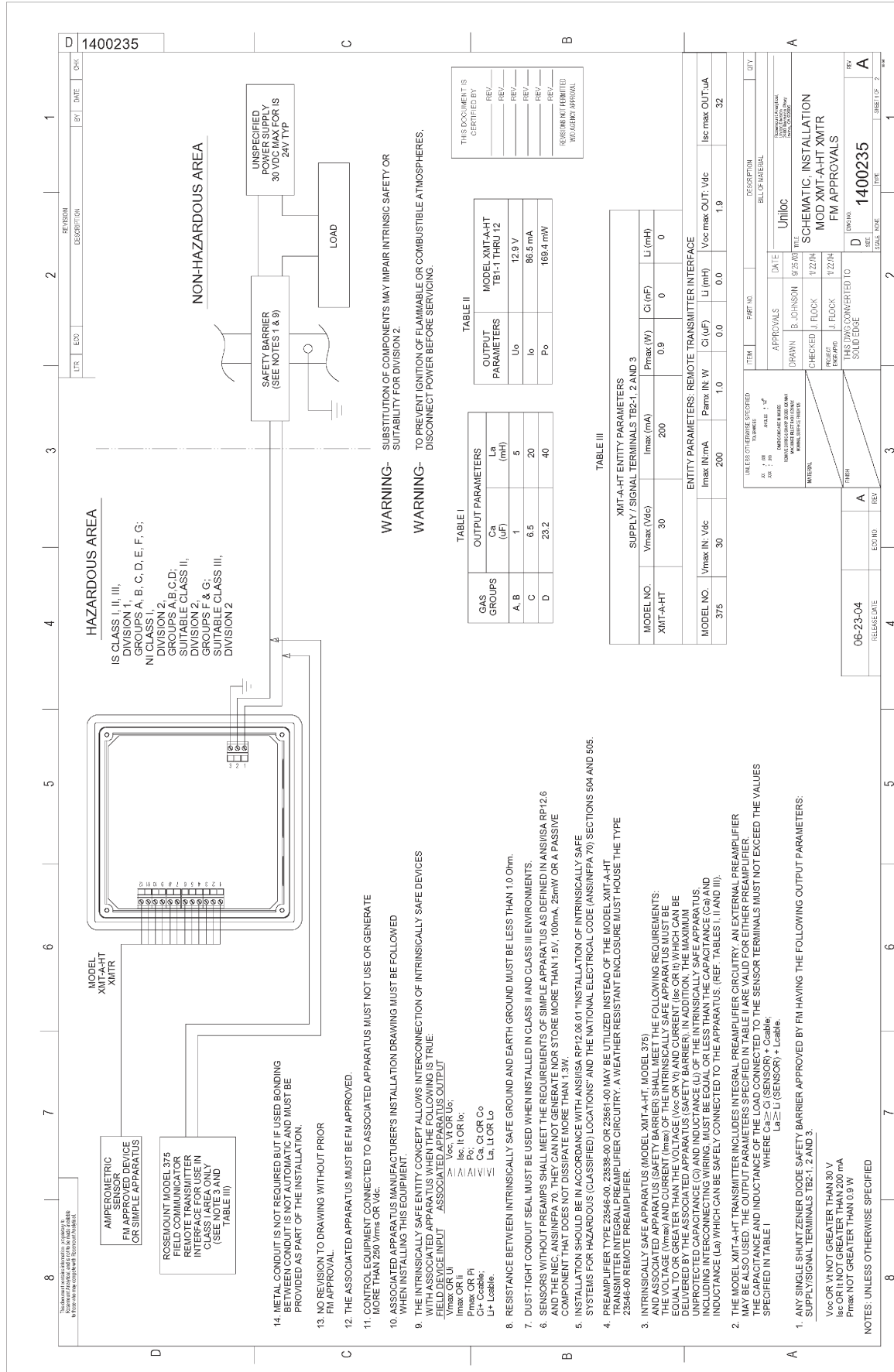

FIGURE 4-2. FM Intrinsically Safe Installation Wiring (1 of 2)

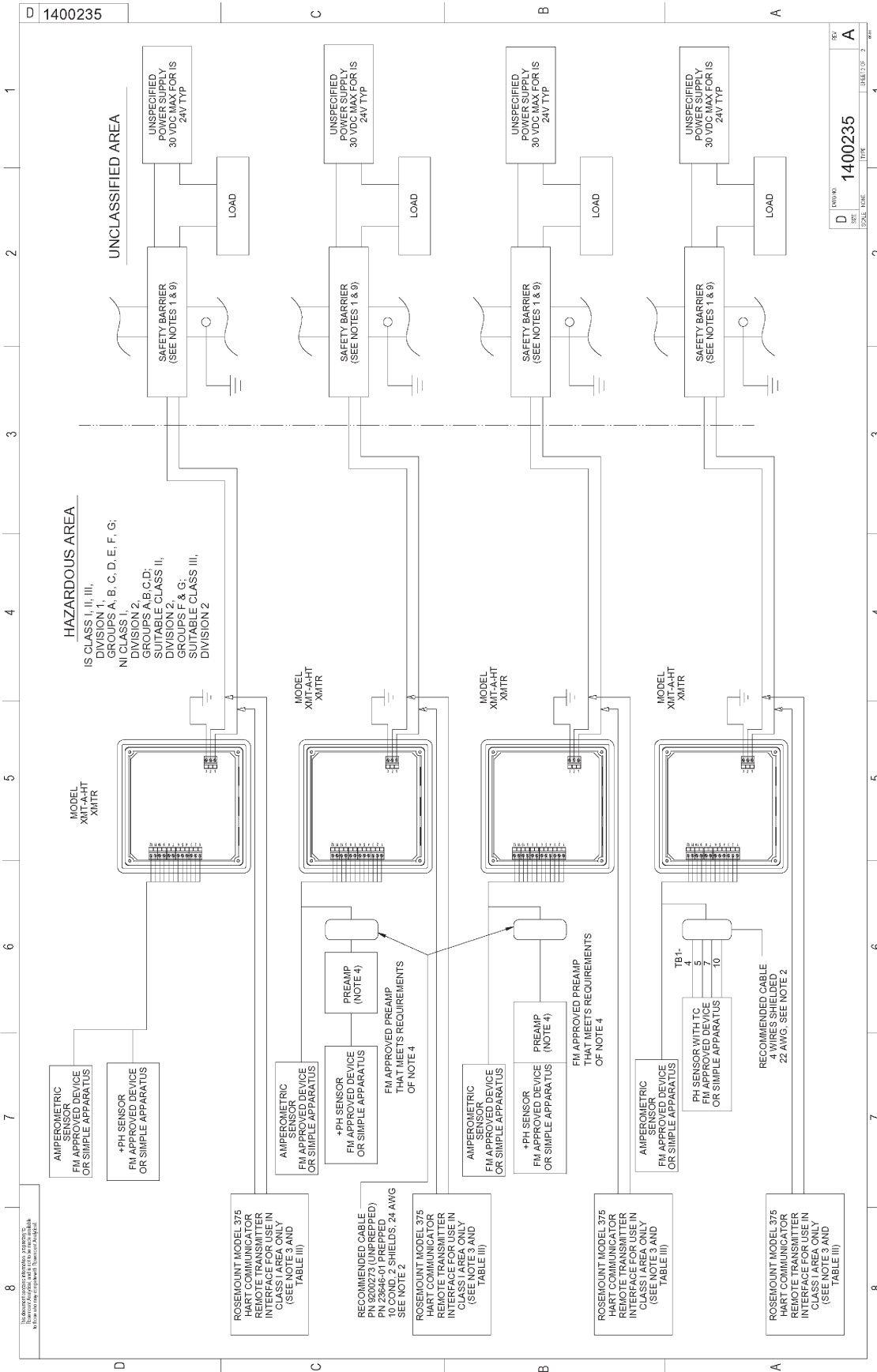

FIGURE 4-2. FM Intrinsically Safe Installation Wiring (2 of 2)

REV	A
DATE	11/15/05
TITLE	1400235
DWG NO	1400235
ISSUE	

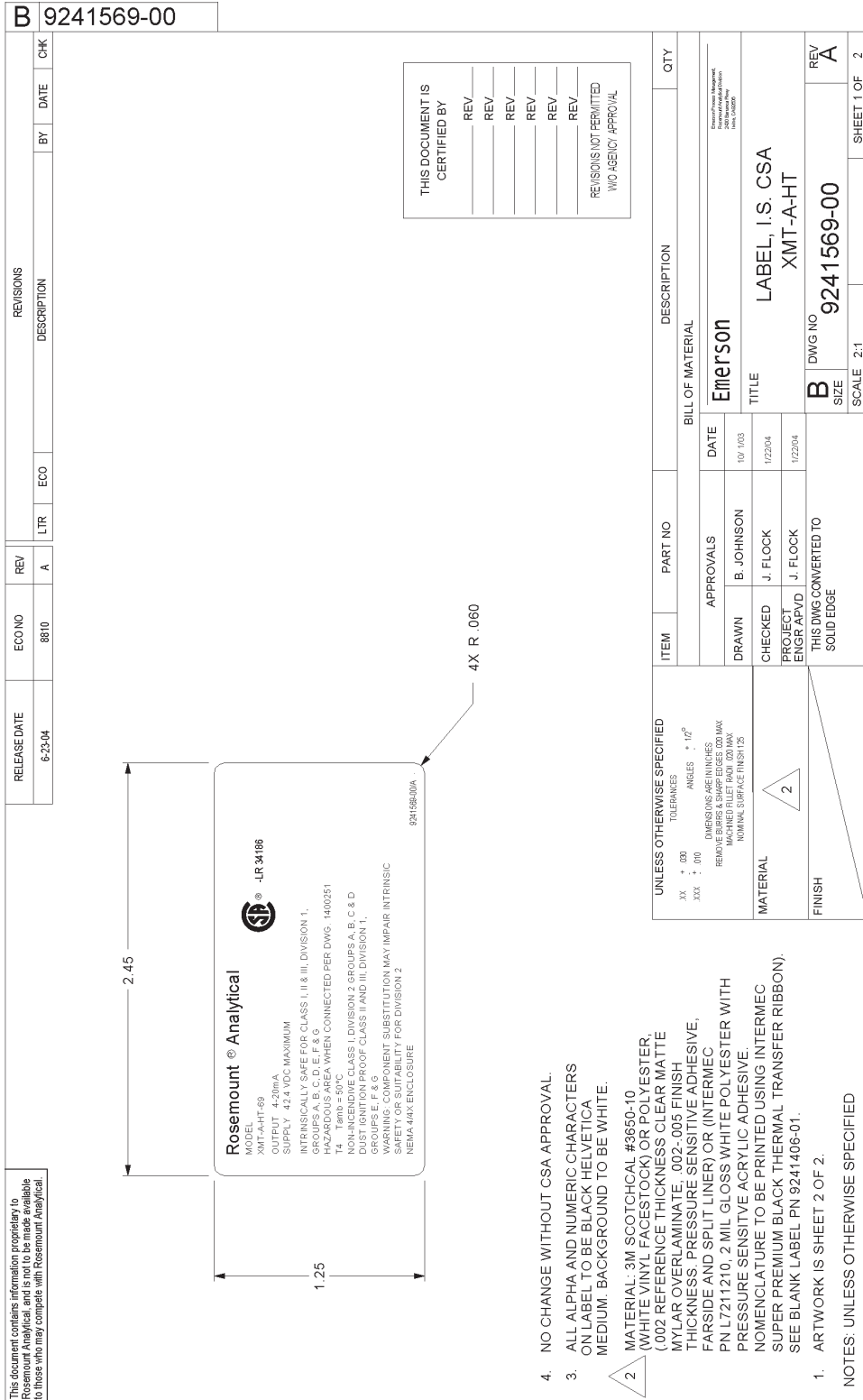
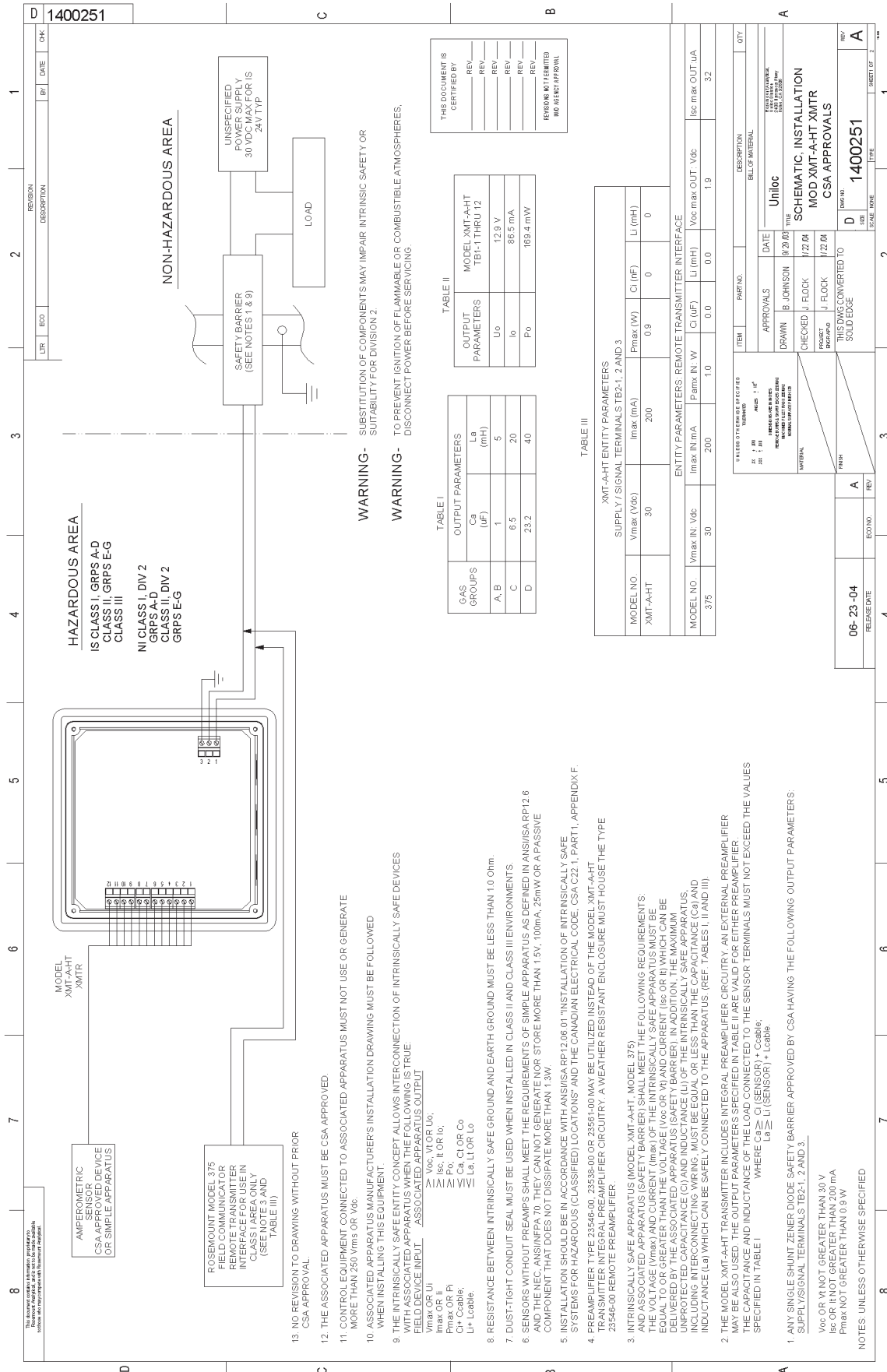

FIGURE 4-3. CSA Intrinsically Safe Installation Label





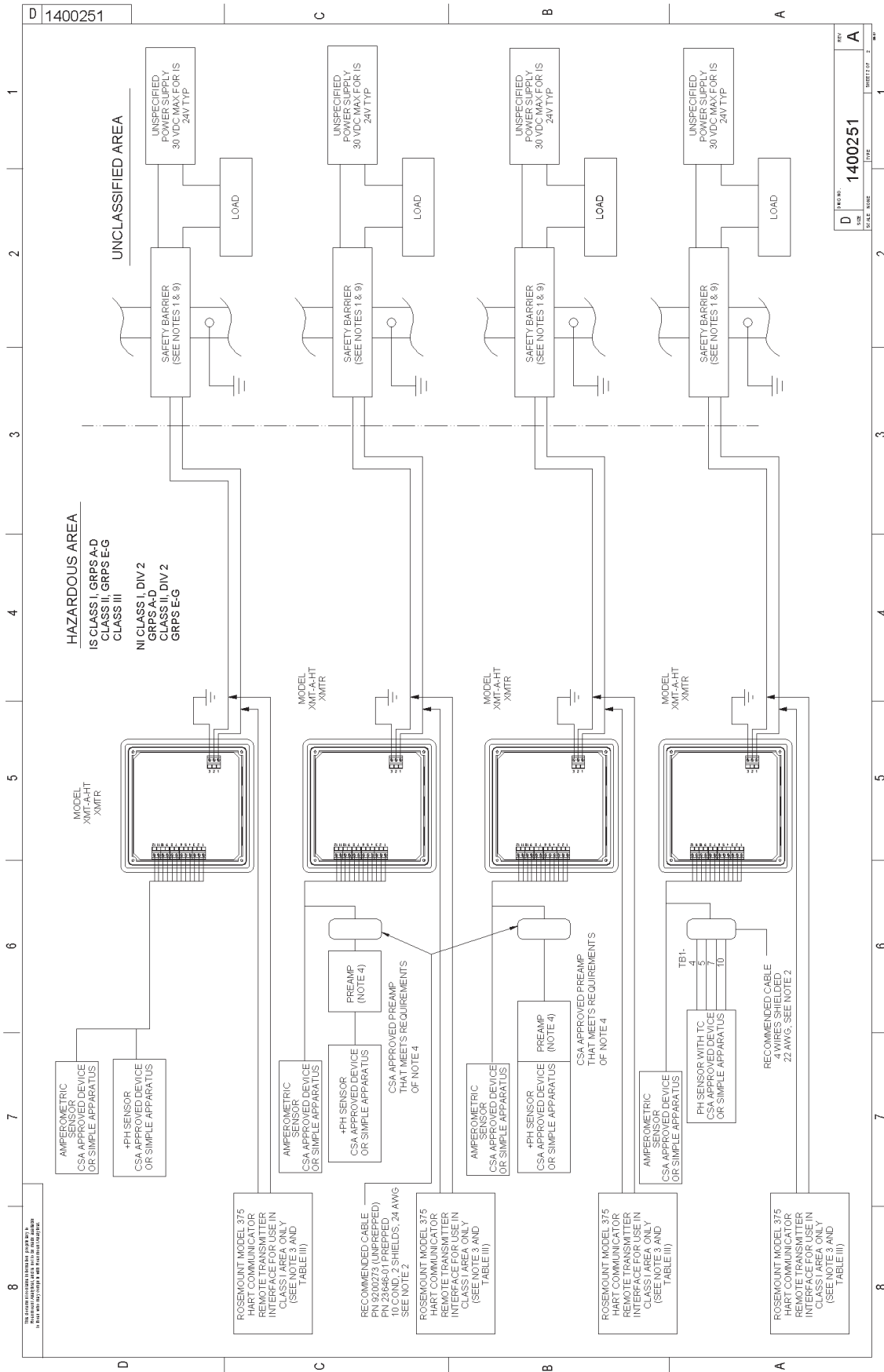
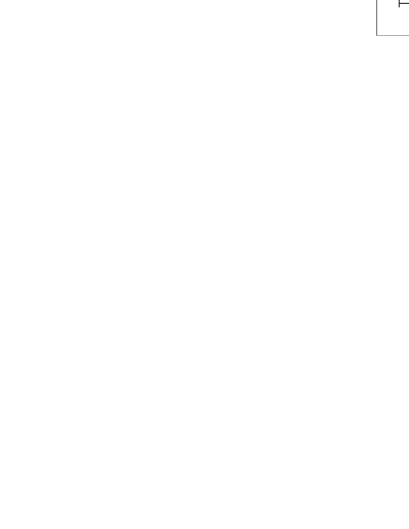
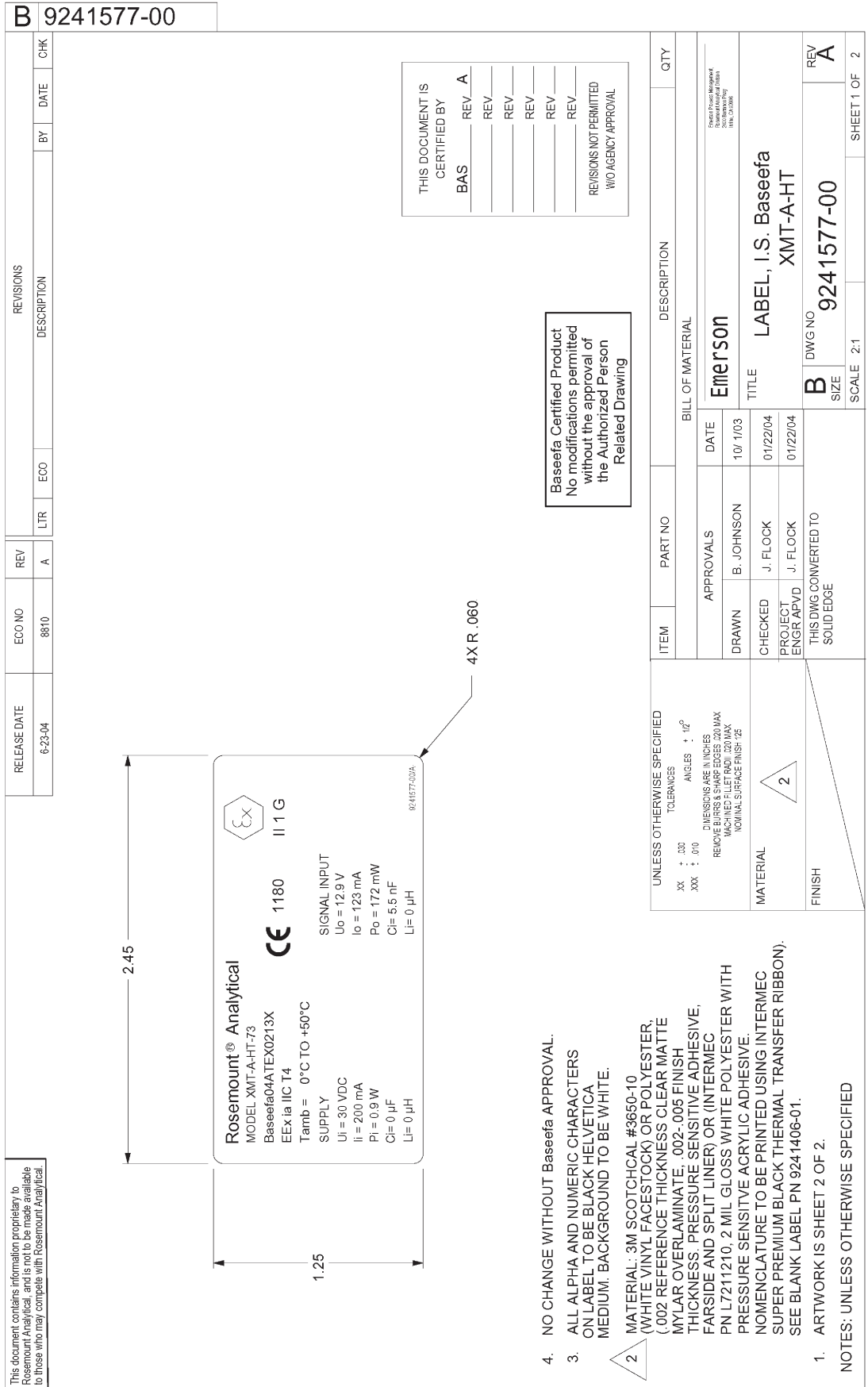

FIGURE 4-4. CSA Intrinsically Safe Installation Wiring (2 of 2)



4. NO CHANGE WITHOUT Baseefa APPROVAL.
3. ALL ALPHA AND NUMERIC CHARACTERS ON LABEL TO BE BLACK HELVETICA MEDIUM. BACKGROUND TO BE WHITE.
2. MATERIAL: 3M SCOTCHCAL #3650-10 (WHITE VINYL FACESTOCK) OR POLYESTER, (.002 REFERENCE THICKNESS CLEAR MATTIE MYLAR OVERLAMINATE .002-.005 FINISH THICKNESS. PRESSURE SENSITIVE ADHESIVE, FAR SIDE AND SPLIT LINER) OR (INTERMEC PN L7211210, 2 MIL GLOSS WHITE POLYESTER WITH PRESSURE SENSITIVE ACRYLIC ADHESIVE. NOMENCLATURE TO BE PRINTED USING INTERMEC SUPER PREMIUM BLACK THERMAL TRANSFER RIBBON). SEE BLANK LABEL PN 9241406-01.
1. ARTWORK IS SHEET 2 OF 2.

NOTES: UNLESS OTHERWISE SPECIFIED

FIGURE 4-5. Baseefa/ATEX Intrinsically Safe Installation Label

1400267

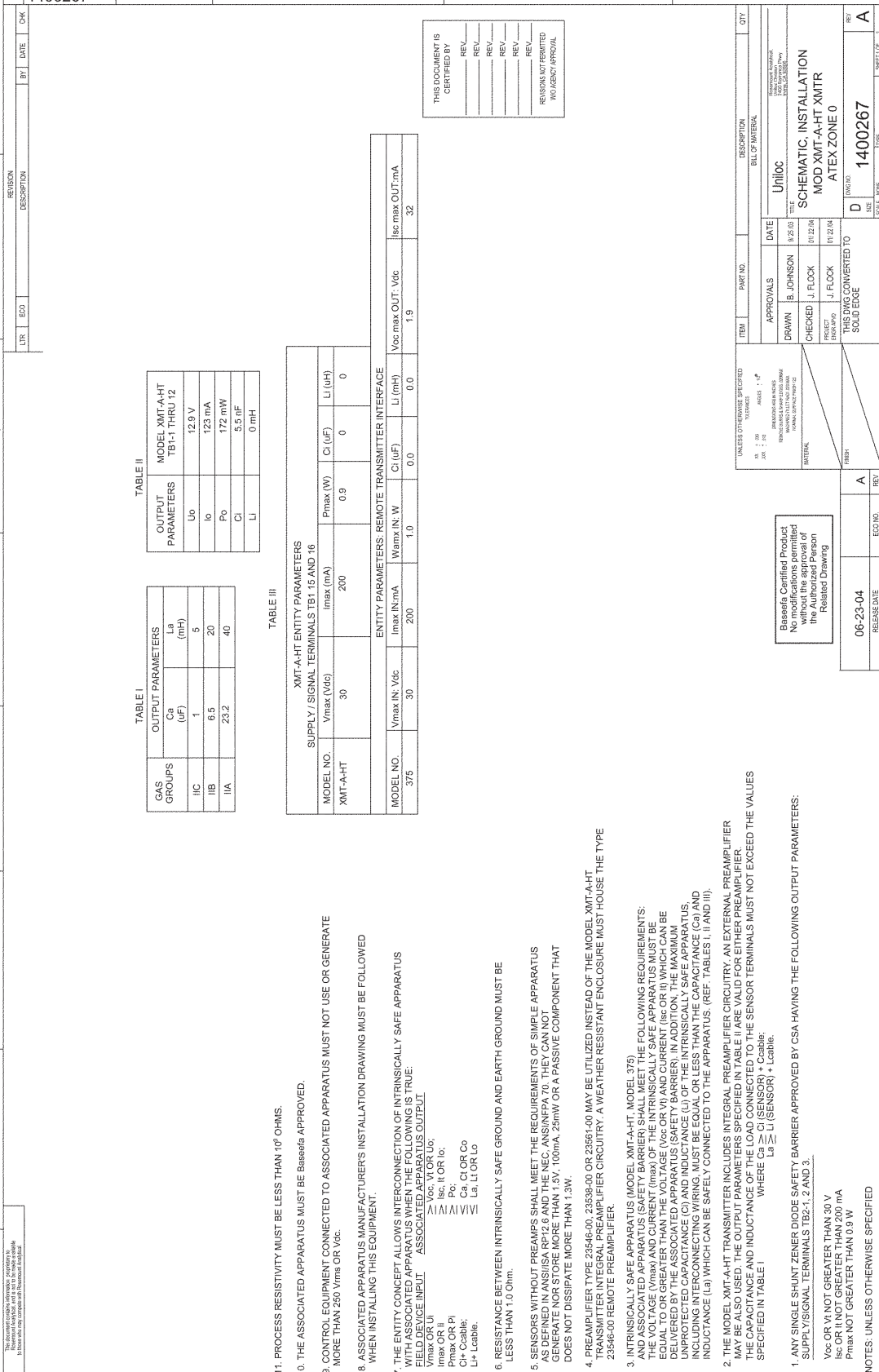

8 7 6 5 4 3 2 1

D C B A

- PROCESS RESISTIVITY MUST BE LESS THAN 10<sup>6</sup> OHMS.
- THE ASSOCIATED APPARATUS MUST BE Baseefa APPROVED.
- CONTROL EQUIPMENT CONNECTED TO ASSOCIATED APPARATUS MUST NOT USE OR GENERATE MORE THAN 250 Vrms OR Vdc.
- ASSOCIATED APPARATUS MANUFACTURERS INSTALLATION DRAWING MUST BE FOLLOWED WHEN INSTALLING THIS EQUIPMENT.
- THE ENTITY CONCEPT ALLOWS INTERCONNECTION OF INTRINSICALLY SAFE APPARATUS WITH ASSOCIATED APPARATUS WHEN THE FOLLOWING IS TRUE:  
FIELD DEVICE INPUT ASSOCIATED APPARATUS OUTPUT  
  - ≡ Voc, VTOR Uo;
  - ≡ Imax IN: mA, I ON Io;
  - ≡ Pmax IN: W, Po; Ca, CI OR Co
  - ≡ C+ Ccable; La, LI OR Lo
  - ≡ L+ Lcable.
- RESISTANCE BETWEEN INTRINSICALLY SAFE GROUND AND EARTH GROUND MUST BE LESS THAN 1.0 Ohm.
- SENSORS WITHOUT PREAMPS SHALL MEET THE REQUIREMENTS OF SIMPLE APPARATUS AND ASSOCIATED APPARATUS. SENSORS WITH PREAMPS SHALL MEET THE REQUIREMENTS OF COMPLEX APPARATUS AND ASSOCIATED APPARATUS. THE PREAMP SHALL NOT BE A PASSIVE COMPONENT THAT DOES NOT DISSIPATE MORE THAN 1.3W.
- PREAMPLIFIER TYPE 23546-00, 23538-00 OR 23561-100 MAY BE UTILIZED INSTEAD OF THE MODEL XMT-A-HT TRANSMITTER INTEGRAL PREAMPLIFIER CIRCUITRY. A WEATHER RESISTANT ENCLOSURE MUST HOUSE THE TYPE 23546-00 REMOTE PREAMPLIFIER.
- INTRINSICALLY SAFE APPARATUS (MODEL XMT-A-HT, MODEL 375) AND ASSOCIATED APPARATUS (SAFETY BARRIER) SHALL MEET THE FOLLOWING REQUIREMENTS: THE VOLTAGE (Vmax) AND CURRENT (Imax) OF THE INTRINSICALLY SAFE APPARATUS MUST BE LESS THAN OR EQUAL TO THE VOLTAGE (Voc) AND CURRENT (Isc) OF THE ASSOCIATED APPARATUS (SAFETY BARRIER). IN ADDITION, THE MAXIMUM DELIVERED BY THE ASSOCIATED APPARATUS (SAFETY BARRIER) IN ADDITION TO THE MAXIMUM UNPROTECTED CAPACITANCE (Ca) AND INDUCTANCE (La) OF THE INTRINSICALLY SAFE APPARATUS, INCLUDING INTERCONNECTING WIRING, MUST BE EQUAL OR LESS THAN THE CAPACITANCE (Ca) AND INDUCTANCE (La) WHICH CAN BE SAFELY CONNECTED TO THE APPARATUS. (REF. TABLES I, II AND III).
- THE MODEL XMT-A-HT TRANSMITTER INCLUDES INTEGRAL PREAMPLIFIER CIRCUITRY. AN EXTERNAL PREAMPLIFIER MAY BE ALSO USED. THE OUTPUT PARAMETERS SPECIFIED IN TABLE II ARE VALID FOR EITHER PREAMPLIFIER THE CAPACITANCE AND INDUCTANCE OF THE LOAD CONNECTED TO THE SENSOR TERMINALS MUST NOT EXCEED THE VALUES SPECIFIED IN TABLE I  
 WHERE  $Ca \geq CI(SENSEOR) + Ccable$ ;  
 $La \geq LI(SENSEOR) + Lcable$ .
- ANY SINGLE SHUNT ZENER DIODE SAFETY BARRIER APPROVED BY CSA HAVING THE FOLLOWING OUTPUT PARAMETERS: SUPPLEMENTAL TERMINALS TB2-1, 2 AND 3.  
 Voc OR Vd NOT GREATER THAN 30 V  
 Isc OR Id NOT GREATER THAN 200 mA  
 Pmax NOT GREATER THAN 0.9 W  
 NOTES: UNLESS OTHERWISE SPECIFIED

FIGURE 4-6. Baseefa/ATEX Intrinsically Safe Installation Wiring (1 of 2)

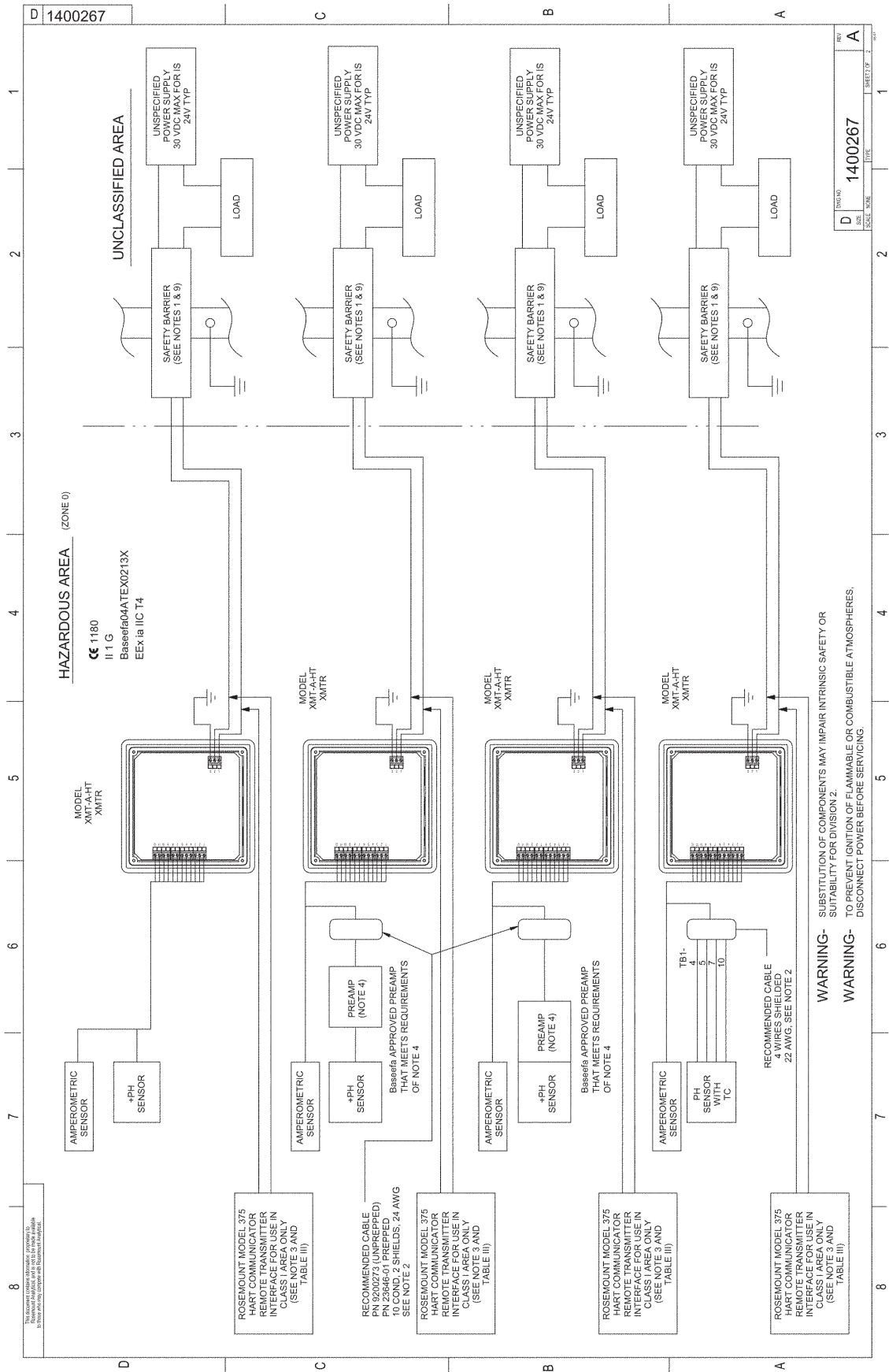

FIGURE 4-6. Baseefa/ATEX Intrinsically Safe Installation Wiring (2 of 2)

## SECTION 5.0 DISPLAY AND OPERATION

### 5.1. DISPLAY

The Model Xmt-A-HT has a two-line display. Generally, the user can program the transmitter to show one of two displays. If the transmitter has been configured to measure free chlorine with continuous pH correction, more displays are available. Figure 5-1 shows the displays available for dissolved oxygen.

The transmitter has information screens that supplement the data in the main display. Press ▼ to view the information screens. The first information screen shows the type of measurement being made (oxygen, ozone, free chlorine, total chlorine, or monochloramine). **The last information screen is the software version number.**

During calibration and programming, key presses cause different displays to appear. The displays are self-explanatory and guide the user step-by-step through the procedure.

### 5.2 KEYPAD

Figure 5-2 shows the Solu Comp Xmt keypad.

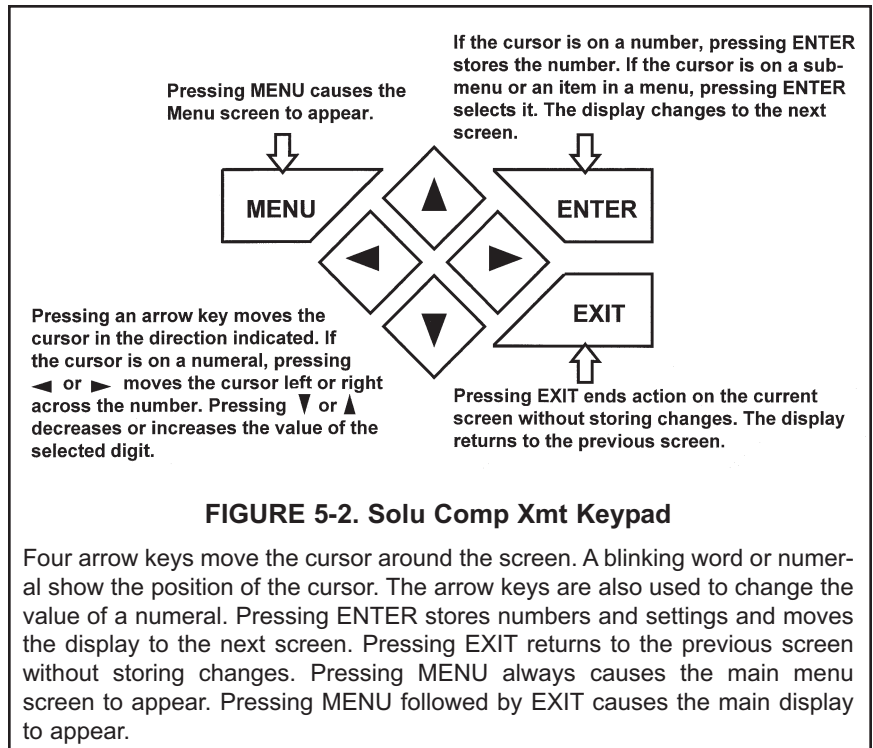
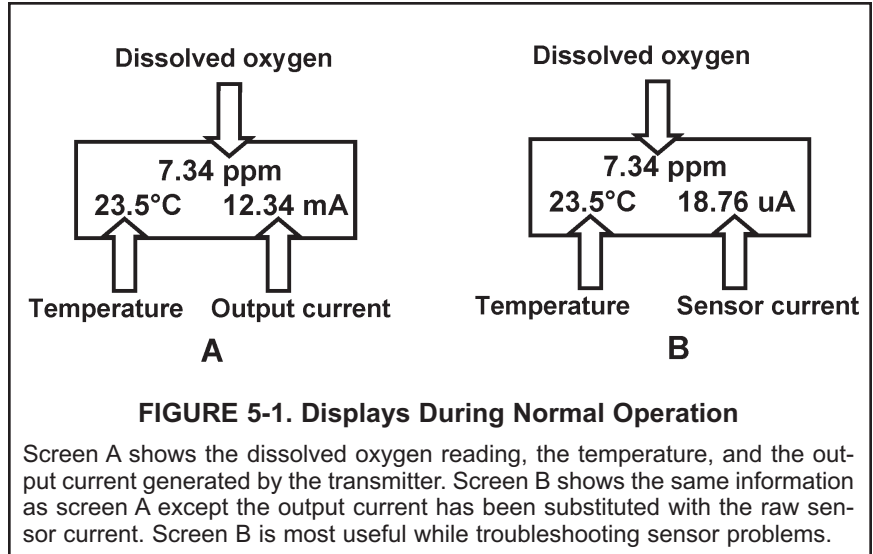

### 5.3 PROGRAMMING AND CALIBRATING THE MODEL Xmt - TUTORIAL

Setting up and calibrating the Model Xmt is easy. The following tutorial describes how to move around in the programming menus. For practice, the tutorial also describes how to assign values to the 4 and 20 mA output.

<b>Calibrate</b>	Hold
Program	Display

Calibrate	Hold
<b>Program</b>	Display

<b>Output</b>	Temp
Measurement	>>

<b>Security</b>	HART
	>>

Noise Rejection	
<b>ResetAnalyzer</b>	>>

Output?	<b>Test</b>
Configure	Range

Output Range?	
4mA	<b>+0.000PPM</b>

Output Range?	
20mA	<b>+10.00PPM</b>

Output?	Test
Configure	<b>Range</b>

1. If the menu screen (shown at the left) is not already showing, press MENU. **Calibrate** is blinking, which means the cursor is on **Calibrate**.
2. To assign values to the current output, the **Program** sub-menu must be open. Press ▼. The cursor moves to **Program** (**Program** blinking.) Press ENTER. Pressing ENTER opens the **Program** sub-menu.
3. The **Program** sub-menu permits the user to configure and assign values to the 4-20 mA output, to test and trim the output, to change the type of measurement from what was selected during Quick Start, to set manual or automatic temperature correction for membrane permeability, and to set security codes. When the sub-menu opens, **Output** is blinking, which means the cursor is on **Output**. Press ▼ or ► (or any arrow key) to move the cursor around the display. Move the cursor to >> and press ENTER to cause a second screen with more program items to appear. There are three screens in the **Program** sub-menu. Pressing >> and ENTER in the third screen cause the display to return to the first screen (**Output, Temp, Measurement**).
4. For practice, assign values to the 4 and 20 mA output. Move the cursor to **Output** and press ENTER.
5. The screen shown at left appears. **Test** is blinking. Move the cursor to **Range** and press ENTER.
6. The screen shown at left appears. + is blinking, which means the cursor is on +.
  - a. To toggle between + and - press ▲ or ▼.
  - b. To move from one digit to the next, press ◀ or ▶.
  - c. To increase or decrease the value of a digit, press ▲ or ▼.
  - d. To move the decimal point, press ◀ or ▶ until the cursor is on the decimal point. Press ▲ to move the decimal to the right. Press ▼ to move the decimal point to the left.
  - e. Press ENTER to store the number.
7. The screen shown at left appears. Use this screen to assign a full scale value to the 20 mA output. Use the arrow keys to change the number to the desired value. Press ENTER to store the setting.
8. The screen shown at left appears. To configure the output or to test the output, move the cursor to the appropriate place and press ENTER.
9. To return to the main menu, press MENU. To return to the main display, press MENU then EXIT, or press EXIT repeatedly until the main display appears. To return to the previous display, press EXIT.

#### NOTE

To store values or settings, press ENTER before pressing EXIT.



## 5.4 SECURITY

### 5.4.1 How the Security Code Works

Use security codes to prevent accidental or unwanted changes to program settings, displays, and calibration. Two three-digit security codes can be used to do the following...

- a. Allow a user to view the default display and information screens only.
- b. Allow a user access to the calibration and hold menus only.
- c. Allow a user access to all the menus.

Enter Security Code: 000
-----------------------------

Invalid Code
--------------

1. If a security code has been programmed, pressing MENU causes the security screen to appear.
2. Enter the three-digit security code.
  - a. If a security code has been assigned to **configure** only, entering it will unlock all the menus.
  - b. If separate security codes have been assigned to **calibrate** and **configure**, entering the calibrate code will allow the user access to only the calibrate and hold menus; entering the configuration code will allow the user access to all menus.
3. If the entered code is correct, the main menu screen appears. If the code is incorrect, the **Invalid Code** screen appears. The **Enter Security Code** screen reappears after two seconds.

### 5.4.2 Bypassing the Security Code

Enter 555. The main menu will open.

### 5.4.3 Setting a Security Code

See Section 7.6.

## 5.5 USING HOLD

### 5.5.1 Purpose

The transmitter output is always proportional to the process variable (oxygen, free chlorine, total chlorine, monochloramine, or ozone). To prevent improper operation of control systems or dosing pumps, place the transmitter in hold before removing the sensor for maintenance. Be sure to remove the transmitter from hold once the work is complete and the sensor has been returned to the process liquid. During hold the transmitter current goes to the value programmed by the user. Once in hold, the transmitter remains there indefinitely. While in hold, the word "hold" appears periodically in the display.

### 5.5.2 Using the Hold Function

Calibrate	Hold
Program	Display

Hold Outputs?	
Yes	No

Output Range?	10.00mA
Hold at	20.00mA

1. Press MENU. The main menu screen appears. Choose **Hold**.
2. The **Hold Output** screen appears. Choose **Yes** to put the transmitter in hold.
3. The top line in the display is the present current output. Use the arrow keys to change the number in the second line to the desired current during hold.
4. The main display screen appears.
5. To take the transmitter out of hold, repeat steps 1 and 2 and choose **No** in step 2.



## SECTION 6.0 OPERATION WITH MODEL 375

### 6.1 Note on Model 375 HART Communicator

The Model 375 HART Communicator is a product of Emerson Process Management, Rosemount Inc. This section contains selected information on using the Model 375 with the Rosemount Analytical Model Xmt-A-HT Transmitter. For complete information on the Model 375 Communicator, see the Model 375 instruction manual. For technical support on the Model 375 Communicator, call Rosemount Inc. at (800) 999-9307 within the United States. Support is available worldwide on the internet at <http://rosemount.com>.

### 6.2 Connecting the HART Communicator

Figure 6-1 shows how the Model 275 or 375 HART Communicator connects to the output lines from the Model Xmt-A-HT Transmitter.



#### CAUTION

For intrinsically safe CSA and FM wiring connections, see the Model 375 instruction manual.

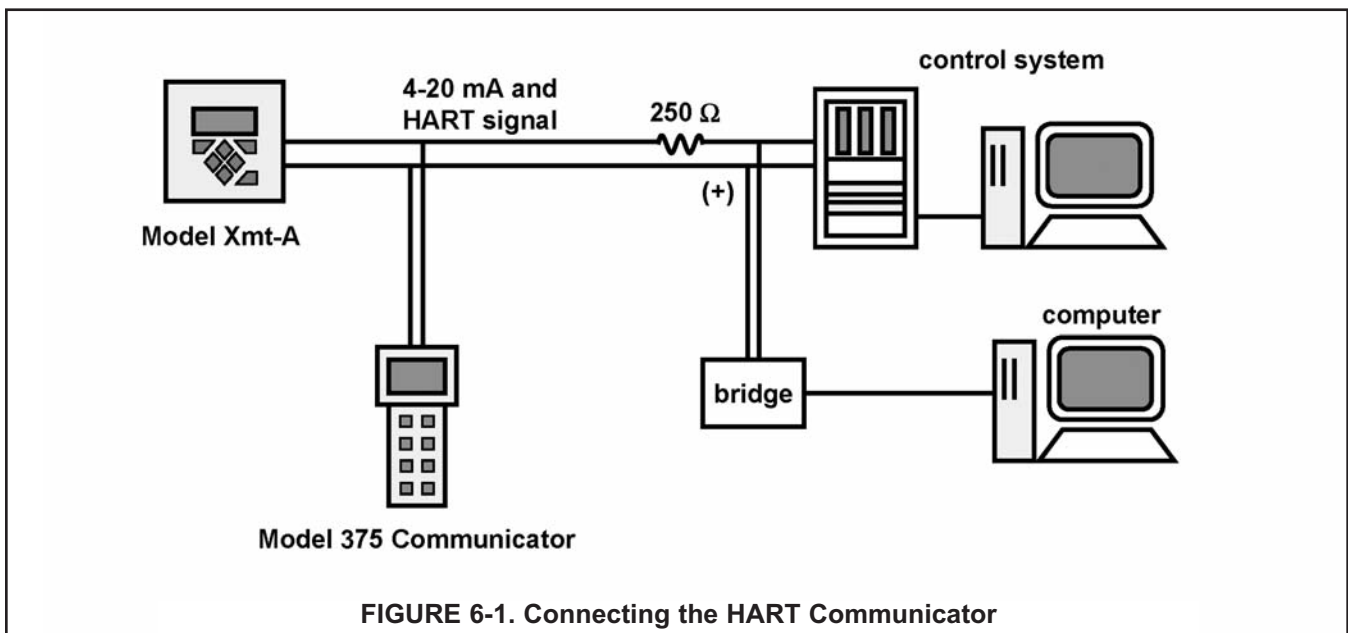

## 6.3 Operation

### 6.3.1 Off-line and On-line Operation

The Model 375 Communicator features off-line and on-line communications. On-line means the communicator is connected to the transmitter in the usual fashion. While the communicator is on line, the operator can view measurement data, change program settings, and read diagnostic messages. Off-line means the communicator is not connected to the transmitter. When the communicator is off line, the operator can still program settings into the communicator. Later, after the communicator has been connected to a transmitter, the operator can transfer the programmed settings to the transmitter. Off-line operation permits settings common to several transmitters to be easily stored in all of them.

### 6.3.2 Making HART related settings from the keypad

Calibrate	Hold
<b>Program</b>	Display

1. Press MENU. The main menu screen appears. Choose **Program**.

Output	Temp
Measurement	>>

2. Choose >>.

Security	<b>HART</b>
	>>

3. Choose **HART**.

<b>DevID</b>	PollAddr
Burst	Preamble

4. To display the device ID, choose **DevID**. To change the polling address, choose **PollAddr**. To make burst mode settings, choose **Burst**. To change the preamble count, choose **Preamble**.

### 6.3.3 Menu Tree

The menu tree for the Model 375 HART communicator is on the following page.

-----  
Xmt-A-HT 375 Menu Tree  
-----

## Device setup

## Process variables

## View Fld Dev Vars

Oxygen \*

Temp

Snsr Cur

pH #

pH mV #

GI #

Temp Res

## View PV-Analog 1

PV is Oxygen \*

PV

PV % rng

PV AO

## View SV

SV is Temp \*\*

SV

## View TV

TV is Snsr Cur \*\*\*

TV

## View 4V

4V is Temp Res \*\*\*\*

4V

## View Status

## Diag/Service

## Test device

Loop test

View Status

Master Reset

Fault History

## Hold Mode

## Calibration

Zero Main Sensor

Air Calibration

In-process Cal

Dual Range Cal #####

Adjust Temperature

pH 2-Pt Cal #

pH Auto Cal #

Standardize pH #

## D/A trim

FIGURE 6-2. Xmt-A-HT HART/Model 375 Menu Tree

```

Diagnostic Vars
  Oxygen
  Snr Cur
  Sensitivity
  Zero Current
  pH Value #
  pH mV #
  pH Slope #
  pH Zero Offset #
  GI #
  Temp
  Temp Res
  Noise rejection
Basic setup
  Tag
  PV Range Values
  PV LRV
  PV URV
  PV
  PV % rng
Device information
  Distributor
  Model
  Dev id
  Tag
  Date
  Write protect
  Snr text
  Descriptor
  Message
  Revision #'s
    Universal rev
    Fld dev rev
    Software rev
    Hardware rev
Detailed setup
  Sensors
  Oxygen *
    Oxygen Unit [ppm, ppb, %sat, mmHg, inHg, atm, kPa, mbar, bar] *, *****
    Oxygen Sensor [ADO, TRDO, SSDO1, SSDO2] ##
    Salinity ###
    Pressure Unit [mmHg, inHg, atm, kPa, mbar, bar] ##
    Use process pressure for %saturation? [No, Yes] ###
    Process pressure (Note: Valid only when process pressure is enabled)
    Air cal pressure ## (read only)
    Input filter
    Sensor SST
    Sensor SSS
    Dual Range Cal [Disable, Enable] #####

```

**FIGURE 6-2. Xmt-A-HT HART/Model 375 Menu Tree**

pH #  
   pH Value  
   pH Comp [Auto, Manual]  
   Manual pH  
   Preamp loc [Sensor, Xmtr]  
   Autocal [Manual, Standard, DIN 19267, Ingold, Merck]  
   pH Slope  
   pH SST  
   pH SSS  
   pH Zero Offset Limit  
   pH Diagnostics  
     Diagnostics [Off, On]  
     GFH  
     GFL  
     Imped Comp [Off, On]  
 Temperature  
   Temp Comp [Auto, Manual]  
   Man. Temp  
   Temp unit [°C, °F]  
   Temp Snr  
 Signal condition  
   LRV  
   URV  
   AO Damp  
   % rng  
   Xfer frctn  
   AO lo end point  
   AO hi end pt  
 Output condition  
   Analog output  
     AO  
     AO Alrm typ  
       Fixed  
     Fault mode [Fixed, Live]  
     Fault  
     Loop test  
     D/A trim  
   HART output  
     PV is Oxygen \*  
     SV is Temp \*\*  
     TV is Snr Cur \*\*\*  
     4V is pH \*\*\*\*  
     Poll addr  
     Burst option [PV, %range/current, Process vars/crnt]  
     Burst mode [Off, On]  
     Num req preams  
     Num resp preams

**FIGURE 6-2. Xmt-A-HT HART/Model 375 Menu Tree**

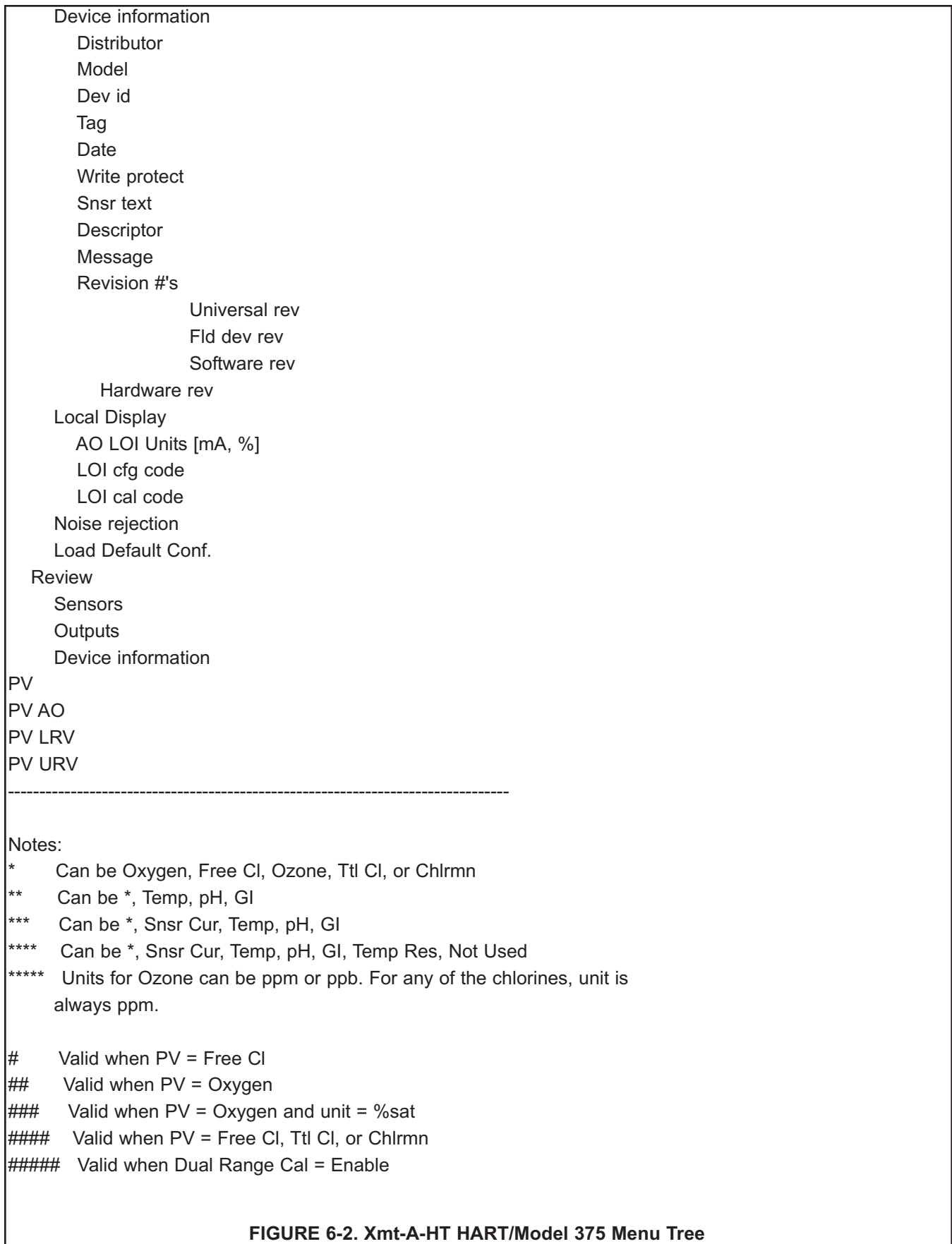

**FIGURE 6-2. Xmt-A-HT HART/Model 375 Menu Tree**

## SECTION 7.0

# PROGRAMMING THE TRANSMITTER

### 7.1 GENERAL

This section describes how to program the transmitter using the keypad.

1. Configure and assign values to the 4-20 mA output.
2. Test and trim the current output.
3. Select the measurement to be made (oxygen, ozone, free chlorine, total chlorine, or monochloramine).
4. Choose temperature units and automatic or manual temperature mode.
5. Set a security code.
6. Make certain settings relating to HART communication.
7. Program the transmitter for maximum reduction of environmental noise.

Default settings are shown in Table 7-1. To change a default setting, refer to the section listed in the table. To return the transmitter to the default settings, see Section 7.9.

### 7.2 CHANGING START-UP SETTINGS

When the Solu Comp Xmt is powered up for the first time, startup screens appear. The screens prompt the user to enter the measurement being made and if oxygen was selected, to identify the sensor being used, to select automatic or manual pH correction (free chlorine only) and to select temperature units. If incorrect settings were entered at startup, enter the correct settings now. To change the measurement, refer to Section 7.4.

TABLE 7-1. Default Settings

ITEM	CHOICES	DEFAULT
<b>Output</b>		
1. 4 mA setting – all measurements and units	-9999 to 9999	0
2. 20 mA setting – all measurements and units	-9999 to 9999	--
if ppm (any measurement)	-9999 to 9999	10.00 ppm
if ppb oxygen	-9999 to 9999	100.0 ppb
if % saturation	-9999 to 9999	200%
if oxygen partial pressure (any units)	-9999 to 9999	standard pressure
3. Hold	3.80 to 22.00 mA	21.00 mA
4. Test	3.80 to 22.00 mA	12.00 mA
5. Fault	3.80 to 22.00 mA	22.00 mA
6. Output dampening	0 to 255	0
<b>Measurement</b>		
1. Analyte	oxygen, free chlorine, total chlorine, monochloramine, ozone	none, polarizing voltage is zero at startup.
2. Oxygen related settings only		
units	ppm, ppb, % saturation, partial pressure	
pressure used during % saturation calculation	barometric pressure during air calibration or user-entered value	barometric pressure during air calibration
process pressure for % saturation (all units)	-9999 to 9999	barometric pressure during air calibration
salinity	0.0 to 36.0 ppt	0.0 ppt
3. Ozone related settings only		
units	ppm or ppb	ppm
4. Free and total chlorine related settings only		
calibration slope	single or dual	single
5. All measurements		
time constant for input current filter	0 to 999 sec	10 sec
6. pH settings (available with free chlorine only)		
automatic pH correction	on or off	on
manual pH correction (if selected)	0.00 to 14.00	7.00
location of preamplifier	transmitter or sensor	transmitter
reference offset	0 to 999 mV	60 mV
pH sensor diagnostic messages	on or off	off
glass impedance temperature correction	on or off	on
glass fault high	0 to 2000 M $\Omega$	1000 M $\Omega$
glass fault low	0 to 2000 M $\Omega$	10 M $\Omega$
<b>Temperature related settings</b>		
1. Units	$^{\circ}$ C or $^{\circ}$ F	$^{\circ}$ C
2. Temperature correction for membrane permeability	on or off	on
3. Automatic temperature compensation for pH	on or off	on
<b>Security codes</b>		
1. Calibration	000 to 999	000 (off)
2. Configuration	000 to 999	000 (off)
<b>HART related settings</b>		
1. Address	00 to 15	0
2. Preamble	5 to 20	5
3. Burst	on or off	off

Table 7-1 continued on following page



TABLE 7-1. Default Settings (continued)

Noise reduction	50 or 60 Hz	60 Hz
<b>Calibration related settings</b>		
1. Oxygen sensors	air calibration or in process	air calibration
stabilize time	0 to 99 sec	10 sec
change	no limits	0.05 ppm, 0.05 ppb, 1% saturation, or 0.9 mm Hg (or equivalent)
2. Buffer calibration	automatic or manual	automatic
stabilize time	0 to 99 sec	10 sec
change	0.02 to 0.50	0.02

## 7.3 CONFIGURING AND RANGING THE OUTPUT

### 7.3.1 Purpose

1. Configuring an output means
  - a. displaying the output reading in units of mA or percent of full scale.
  - b. changing the time constant for output dampening.
  - c. assigning the value the output current will take if the transmitter detects a fault in itself or the sensor.
2. Ranging the output means assigning values to the 4 mA and 20 mA outputs.
3. Testing an output means entering a test value from the keypad to check the operation of recorders or controllers.
4. Trimming an output means calibrating the 4 and 20 mA current outputs against a referee milliammeter.

### 7.3.2 Definitions

1. **CURRENT OUTPUT.** The transmitter provides a continuous 4-20 mA output current directly proportional to the concentration of oxygen, ozone, chlorine, or monochloramine in the sample.
2. **FAULT.** The transmitter continuously monitors itself and the sensor for faults. If the transmitter detects a fault, the 4-20 mA output can be programmed to go to a fixed value or it can be programmed to continue to display the live current reading. In any event Fault appears intermittently in the second line of the display.
3. **DAMPEN.** Output dampening smooths out noisy readings. But it also increases the response time of the output. To estimate the time (in minutes) required for the output to reach 95% of the final reading following a step change, divide the setting by 20. Thus, a setting of 140 means that, following a step change, the output takes about seven minutes to reach 95% of final reading. The output dampen setting does not affect the response time of the process display. The maximum setting is 255.
4. **TEST.** The transmitter can be programmed to generate a test current.

**7.3.3 Procedure: Configuring the Output**

Calibrate	Hold
Program	Display

1. Press MENU. The menu screen appears. Choose **Program**.

Output	Temp
Measurement <sup>a</sup>	>>

2. Choose **Output**.

Output?	Test
Configure	Range

3. Choose **Configure**.

Configure?	<b>Fault</b>
mA/%	Damping

4. Choose **Fault**.

Set to value?	
<b>Fixed</b>	Live

5. Choose **Fixed** or **Live**.

Current Output	
if Fault: <b>22.00mA</b>	

6. If you chose **Fixed**, the screen at left appears. Use the arrow keys to change the fault current to the desired value. The limits are 4.00 to 22.00 mA. If you chose **Live**, there are no settings to make.

Configure?	Fault
mA/%	Damping

7. The screen at left appears. Choose **mA/%**.

Display Output?	
mA	percent

8. Choose **mA** or **percent**. Percent means the display will show percent of full scale reading.

Configure?	Fault
mA/%	<b>Damping</b>

9. The screen at left appears. Choose **Damping**.

Damping?	000-255
	<b>000 sec</b>

10. Use the arrow keys to change the blinking display to the desired time constant.

**7.3.4 Procedure: Ranging the output**

Calibrate	Hold
<b>Program</b>	Display

1. Press MENU. The menu screen appears. Choose **Program**.

Output	Temp
Measurement <sup>a</sup>	>>

2. Choose **Output**.

Output?	Test
Configure	<b>Range</b>

3. Choose **Range**.

Output range?	
4mA	<b>0.000PPM</b>

4. Assign a value to the 4 mA output and press ENTER. Then assign a value to the 20 mA output. Press ENTER. Use the arrow keys to change the flashing display to the desired value.

7.3.5 Procedure: Testing the output

```
Calibrate      Hold
Program        Display
```

```
Output        Temp
Measuremento  >>
```

```
Output?       Test
Configure     Range
```

```
Test Output
Trim Output
```

```
Current Output
for Test:12.00mA
```

1. Press MENU. The menu screen appears. Choose **Program**.
2. Choose **Output**.
3. Choose **Test**.
4. Choose **Test Output**.
5. Use the arrow keys to change the displayed current to the desired value. Press ENTER. The output will change to the value just entered.
6. To return to normal operation, press EXIT. The output will return to the value determined by the process variable.
7. To return to the main display, press MENU then EXIT.

7.3.6 Procedure: Trimming the output

```
Calibrate      Hold
Program        Display
```

```
Output        Temp
Measurement    >>
```

```
Output?       Test
Configure     Range
```

```
Test Output
Trim Output
```

```
Meter reading:
                04.00mA
```

```
Meter reading:
                20.00mA
```

```
Trim Complete
```

1. Connect an accurate milliammeter in series with the current output.
2. Press MENU. The menu screen appears. Choose **Program**.
3. Choose **Output**.
4. Choose **Test**.
5. Choose **Trim Output**.
6. The output goes to 4.00 mA. If the milliammeter does not read 4.00 mA, use the arrow keys to change the display to match the current measured by the milliammeter.
7. The output goes to 20.00 mA. If the milliammeter does not read 20.00 mA, use the arrow keys to change the display to match the current measured by the milliammeter.
8. To return to the main display, press MENU then EXIT.

## 7.4 CHOOSING AND CONFIGURING THE ANALYTICAL MEASUREMENT

### 7.4.1 Purpose

This section describes how to do the following:

1. Configure the transmitter to measure oxygen, ozone, free chlorine, total chlorine, or monochloramine.
2. Choose the concentration units to be displayed
3. Set an input filter for the raw sensor current.
4. If oxygen was selected, there are additional selections to make.
  - a. identify the type of sensor being used
  - b. choose the units in which barometric pressure will be displayed
  - c. select a process pressure for calculating % saturation
  - d. enter the salinity of the process liquid
5. If free chlorine was selected, there are additional selections and settings to make.
  - a. choose automatic or manual pH correction
  - b. configure the pH sensor if automatic pH correction was selected
  - c. choose single or dual slope calibration
6. If total chlorine was selected, single or dual slope calibration must also be specified.

### 7.4.2 Definitions

1. **MEASUREMENT.** The transmitter can be configured to measure dissolve oxygen (ppm and ppb level), free chlorine, total chlorine, monochloramine, and ozone.
2. **FREE CHLORINE.** Free chlorine is the product of adding sodium hypochlorite (bleach) or chlorine gas to fresh water. Free chlorine is the sum of hypochlorous acid (HOCl) and hypochlorite ion (OCl<sup>-</sup>).
3. **TOTAL CHLORINE.** Total chlorine is the sum of free and combined chlorine. Combined chlorine generally refers to chlorine oxidants in which chlorine is combined with ammonia or organic amines. The term total chlorine also refers to other chlorine oxidants such as chlorine dioxide. To measure total chlorine, the sample must first be treated with acetic acid and potassium iodide. Total chlorine reacts with iodide to produce an equivalent amount of iodine, which the sensor measures.
4. **MONOCHLORAMINE.** Monochloramine (NH<sub>2</sub>Cl) is commonly used in the United States for disinfecting drinking water. It is made by first treating the water with ammonia followed by just the exact amount of chlorine to completely react with the ammonia. Monochloramine is a useful disinfectant in waters that have a tendency to produce trihalomethanes (THMs) when treated free chlorine.
5. **BAROMETRIC PRESSURE (DISSOLVED OXYGEN ONLY).** Dissolved oxygen sensors are usually calibrated by exposing them to air. The sensor current in air is exactly the same as the current when the sensor is in water saturated with air. The maximum solubility of atmospheric oxygen in water depends on temperature and barometric pressure. A temperature device in the oxygen sensor measures temperature. The user must enter the barometric pressure.
6. **PERCENT SATURATION (DISSOLVED OXYGEN ONLY).** Percent saturation is the ratio of the concentration of dissolved oxygen in a sample to the maximum amount of oxygen the sample can hold at the same temperature. Pressure also affects the percent saturation. Usually, percent saturation is calculated using the barometric pressure during calibration. If the user desires, percent saturation can also be calculated using the process pressure.

7. **SALINITY (DISSOLVED OXYGEN ONLY).** The solubility of oxygen in water depends on the concentration of dissolved salts in water. Increasing the concentration decreases the solubility. If the salt concentration is greater than about 1000 ppm, the accuracy of the measurement can be improved by applying a salinity correction. Enter the salinity as parts per thousand. One percent is ten parts per thousand.
8. **pH CORRECTION (FREE CHLORINE ONLY).** Free chlorine is the sum of hypochlorous acid (HOCl) and hypochlorite ion (OCl<sup>-</sup>). The relative amount of each depends on pH. As pH increases, the fraction of free chlorine present as HOCl decreases and the fraction present as OCl<sup>-</sup> increases. Because the sensor responds only to HOCl, a correction is necessary to convert the sensor current into a free chlorine reading. The Solu Comp Xmt uses both automatic and manual pH correction. In automatic pH correction the transmitter continuously monitors the pH of the sample and corrects the free chlorine reading for changes in pH. In manual pH correction, the user enters the pH of the sample. Generally, if the pH varies more than about 0.2 units over short periods of time, automatic pH correction is best. If the pH is relatively steady or subject only to seasonal changes, manual pH correction is adequate.
9. **pH SETTINGS (FREE CHLORINE ONLY).** If you are measuring free chlorine with continuous (automatic) pH correction, there are additional pH settings to make.
  - a. **PREAMPLIFIER.** The raw pH signal is a high impedance voltage. A voltage follower or preamplifier, located either in the sensor or transmitter, converts the high impedance signal into a low impedance one. Normally, high impedance signals should be sent no further than about 15 feet.
  - b. **REFERENCE OFFSET.** Ideally, a pH sensor in pH 7 buffer should have a voltage of 0 mV. The difference between the measured voltage in pH 7 buffer and the ideal value is the reference offset. Typically, the reference offset is less than 60 mV.
  - c. **DIAGNOSTICS.** The Solu Comp Xmt continuously monitors the pH sensor for faults. If it detects a fault, the transmitter displays a fault message.
  - d. **GLASS IMPEDANCE.** The transmitter monitors the condition of the pH-sensitive glass membrane in the sensor by continuously measuring the impedance across the membrane. Typical impedance is between 100 and 500 MΩ. Low impedance (<10 MΩ) implies the glass bulb has cracked and the sensor must be replaced. An extremely high impedance (>1000 MΩ) implies the sensor is aging and may soon need replacement. High impedance might also mean that the glass membrane is no longer immersed in the process liquid.
10. **DUAL SLOPE CALIBRATION (FREE AND TOTAL CHLORINE ONLY).** The Model 499ACL-01 (free chlorine) and 499ACL-02 (total chlorine) sensors lose sensitivity at high concentrations of chlorine. The Solu Comp Xmt has a dual slope feature that allows the user to compensate for the non-linearity of the sensor. For the vast majority of applications, dual slope calibration is unnecessary.
11. **INPUT FILTER.** The raw sensor current can be filtered to reduce noise. Filtering also increases the response time. The filter is the time required for the input to reach 63% of its final reading following a step change.

7.4.3 Procedure: Measurement

```

Calibrate      Hold
Program        Display
    
```

```

Outputs      TEMP
Measurement*  >>
    
```

```

Measurement type
Oxygen  Ozone  >>
    
```

```

Manufacturer?
Rosemount    Other
    
```

```

Application?
Water/Waste  >>
    
```

```

units?
PPM      %sat  PPb  >>
    
```

```

Pressure units?
mmHg      inHg  atm  >>
    
```

```

Use ProcessPress
for %satn? Yes  No
    
```

```

Process pressure
%sat:      760mmHg
    
```

```

Input filter?
63% in      005sec
    
```

```

Salinity, parts/
thousand?      20.0
    
```

```

units?
PPM      PPb
    
```

```

Input filter?
63% in      005sec
    
```

1. Press MENU. The menu screen appears. Choose **Program**.
2. Choose **Measurement**.
3. Choose **Measurement type (oxygen, ozone, free chlorine, total chlorine, or monochloramine)**.
4. The screen appearing next depends on the selection made in step 3.
  - a. If you chose **oxygen**, go to step 5a.
  - b. If you chose **ozone**, go to step 6a.
  - c. If you chose **free chlorine**, go to step 7a.
  - d. If you chose **total chlorine**, go to step 8a.
  - e. If you chose **monochloramine**, go to step 9a.
- 5a. Identify the manufacturer of the **oxygen** sensor: **Rosemount** or **Other**.
- 5b. Identify the application: **water or wastewater, trace oxygen, or biopharm**. Move the cursor to **>>** and press ENTER to move to the next screen.
- 5c. Choose the units in which results are to be displayed: **ppm, ppb, partialPress, or %sat**. Select **>>** to view the next screen. If you chose **partialPress**, the partial pressure and the barometric pressure used in air calibration will be displayed in the pressure units selected below.
- 5d. Choose pressure units: **mm Hg, in Hg, atm, kPa, bar, or mbar**.
- 5e. If percent saturation is to be calculated using the process pressure, choose **Yes** and go to step 5f. If percent saturation is to be calculated using the barometric pressure during air calibration, choose **No**. If you chose **No**, the screen changes to the screen in step 5g.
- 5f. Enter the desired pressure.
- 5g. Enter the time constant for the input filter.
- 5h. Enter the **salinity** in parts per thousand.
- 5i. To return to the main display press MENU then EXIT.
- 6a. If you chose **ozone**, select the units in which the ozone concentration is to be displayed.
- 6b. Enter the time constant for the input filter.
- 6c. To return to the main display, press MENU then EXIT.

pH Comp?  
**Auto** Manual

7a. For **free chlorine**, choose **auto** or **manual** pH correction. If you chose **auto**, you must also configure the pH sensor. Go to step 7b. If you chose manual, go to step 7k.

Use Preamp in?  
**Xmtr** Sensor/JBox

7b. Identify the location of the pre-amplifier for the pH sensor. Is it in the transmitter (**Xmtr**) or in the sensor or junction box (**Sensor/Jbox**)?

pH sensor	pre-amplifier location
399-09-62	<b>Sensor/JBox</b>
399VP-09	<b>Sensor/JBox</b>
399-14	<b>Xmtr</b>

Max pH reference  
offset: **060mV**

7c. Select a maximum value for the pH sensor reference offset.

Diagnostic msgs?  
**On** Off

7d. Activate diagnostic messages. Even if diagnostic messages are turned off, the current pulses used to measure diagnostics will still be operating.

GlassZ temp  
correct **On** Off

7e. Turn on or turn off the temperature correction for the glass membrane impedance measurement. Keeping the temperature correction on is recommended.

Glass fault low  
value: **0010mΩ**

7f. Select a value at which the low glass impedance fault message will be shown. The default value is **0010** MΩ.

Glass fault high  
value: **1000mΩ**

7g. Select a value at which the high glass impedance fault message will be shown. The default value is **1000** MΩ.

Input filter?  
63% in **005sec**

7h. Enter the time constant for the input filter.

Cal Slope?  
**Single** Dual

7i. Choose **single** or **dual** slope calibration. For the vast majority of applications, dual slope calibration is unnecessary.

7j. To return to the main display, press MENU then EXIT.

Manual pH  
**07.00pH**

7k. If you choose manual pH correction, enter the desired pH. The transmitter will use this value in all subsequent calculations no matter what the true pH is.

Input filter?  
63% in **005sec**

7l. Enter the time constant for the input filter.

Cal Slope?  
**Single** Dual

7m. Choose **single** or **dual** slope calibration. For the vast majority of applications, dual slope calibration is unnecessary.

7n. To return to the main display, press MENU then EXIT.

```

C1 Cal Slope?
Single          Dual

```

8a. If you chose **total chlorine**, select **single** or **dual** slope calibration. For the vast majority of applications, dual slope calibration is unnecessary.

```

Input filter?
63% in          005sec

```

8b. Enter the time constant for the input filter.

8c. To return to the main display, press MENU then EXIT.

```

Input filter?
63% in          005sec

```

9a. If you chose **monochloramine**, enter the time constant for the input filter.

9b. To return to the main display, press MENU then EXIT.

## 7.5 MAKING TEMPERATURE SETTINGS

### 7.5.1 Purpose

This section describes how to do the following:

1. Choose temperature units (°C or °F).
2. Choose automatic or manual temperature correction for membrane permeability.
3. Choose automatic or manual temperature compensation for pH (pH settings apply to free chlorine only).
4. Enter a temperature for manual temperature compensation.

### 7.5.2 Definitions — oxygen, ozone, chlorine, and monochloramine

1. **AUTOMATIC TEMPERATURE CORRECTION.** Membrane-covered amperometric sensors produce a current directly proportional to the rate the analyte (the substance being measured) diffuses through the membrane. The diffusion rate is proportional to the concentration of analyte and the temperature. As temperature increases, membrane permeability increases. Thus, an increase in temperature will cause the sensor current to increase even though the analyte level remained constant. A correction equation in the transmitter software automatically corrects for changes in membrane permeability. In automatic temperature correction, the transmitter uses the temperature measured by the sensor for the correction.
2. **MANUAL TEMPERATURE CORRECTION.** In manual temperature correction the transmitter uses the temperature entered by the user for the membrane permeability correction. It does not use the actual process temperature. Do **NOT** use manual temperature correction unless the measurement and calibration temperatures differ by no more than about 2°C. Manual temperature correction is useful only if the sensor temperature element has failed and a replacement sensor is not available.

### 7.5.3 Definitions — pH

1. **AUTOMATIC TEMPERATURE COMPENSATION.** The transmitter uses a temperature-dependent factor to convert measured cell voltage to pH. In automatic temperature compensation, the transmitter measures the temperature and automatically calculates the correct conversion factor. For maximum accuracy, use automatic temperature compensation.
2. **MANUAL TEMPERATURE COMPENSATION.** In manual temperature compensation, the transmitter converts measured voltage to pH using the temperature entered by the user. It does not use the actual process temperature. Do **NOT** use manual temperature compensation unless the process temperature varies no more than about ±2°C or the pH is between 6 and 8. Manual temperature compensation is useful if the sensor temperature element has failed and a replacement sensor is not available.



### 7.5.3 Procedure: Temperature settings

Calibrate	Hold
<b>Program</b>	Display

Outputs	<b>TEMP</b>
Measurement	>>

Config Temp?	
<b>°C/F</b>	Live/Manual

1. Press MENU. The menu screen appears. Choose **Program**.
2. Choose **Temp**.
3. Choose **°C/°F** to change the display units. Choose **Live/Manual** to turn on (Live) or turn off (Manual) automatic temperature correction for membrane permeability and automatic temperature compensation for pH.
  - a. If you chose **°C/°F**, select **°C** or **°F**.
  - b. If you chose **Live/Manual**, select **Live** or **Manual**.
  - c. If you chose **Manual**, enter the temperature in the next screen. The temperature entered in this step will be used in all subsequent measurements, no matter what the process temperature is.
4. To return to the main display, press MENU then EXIT.

## 7.6 SETTING A SECURITY CODE

### 7.6.1 Purpose

This section describes how to set a security code. There are three levels of security:

- a. A user can view the default display and information screens only.
- b. A user has access to the calibration and hold menus only.
- c. A user has access to all menus.

The security code is a three-digit number. The table shows what happens when security codes are assigned to **Calib** (calibration) and **Config** (configure). In the table XXX and YYY are the assigned security codes. To bypass security, enter 555.

Code assignments		What happens
Calib	Config	
000	XXX	User enters XXX and has access to all menus.
XXX	YYY	User enters XXX and has access to calibration and hold menus only. User enters YYY and has access to all menus.
XXX	000	User needs no security code to have access to all menus.
000	000	User needs no security code to have access to all menus.

### 7.6.2 Procedure: Setting a security code

Calibrate	Hold
<b>Program</b>	Display

Outputs	TEMP
Measurement	>>

<b>Security</b>	HART
	>>

Lock?	
<b>Calib</b>	Config

1. Press MENU. The menu screen appears. Choose **Program**.
2. Choose >>.
3. Choose **Security**.
4. Choose **Calib** or **Config**.
  - a. If you chose **Calib**, enter a three-digit security code.
  - b. If you chose **Config**, enter a three-digit security code.
5. To return to the main display, press MENU then EXIT.

## 7.7 MAKING HART RELATED SETTINGS

For more information refer to Section 6.0.

## 7.8 NOISE REDUCTION

### 7.8.1 Purpose

For maximum noise reduction, the frequency of the ambient AC power must be entered.

### 7.8.2 Procedure: Noise reduction

Calibrate	Hold
<b>Program</b>	Display

1. Press MENU. The menu screen appears. Choose **Program**.

Outputs	Temp
Measurement	>>

2. Choose >>.

Security	HART
	>>

3. Choose >>.

<b>Noise Rejection</b>	
ResetTransmitter	>>

4. Choose **Noise Rejection**.

Ambient AC Power	
<b>60Hz</b>	50Hz

5. Select the frequency of the ambient AC power.

6. To return to the main display, press MENU then EXIT.

## 7.9 RESETTING FACTORY CALIBRATION AND FACTORY DEFAULT SETTINGS

### 7.9.1 Purpose

This section describes how to install factory calibration and default values. The process also clears all fault messages and returns the display to the first quick start screen.

### 7.9.2 Procedure: Installing default settings

Calibrate	Hold
<b>Program</b>	Display

1. Press MENU. The menu screen appears. Choose **Program**.

Outputs	Temp
Measurement	>>

2. Choose >>.

<b>Security</b>	HART
	>>

3. Choose >>.

Noise Rejection	
<b>ResetTransmitter</b>	>>

4. Choose **ResetTransmitter**.

Load factory	
settings? <b>Yes</b>	No

5. Choose **Yes** or **No**. Choosing **Yes** clears previous settings and calibrations and returns the transmitter to the first quick start screen.

## 7.10 SELECTING A DEFAULT SCREEN AND SCREEN CONTRAST

### 7.10.1 Purpose

This section describes how to do the following:

1. Set a default screen. The default screen is the screen shown during normal operation. The Solu Comp Xmt allows the user to choose from a number of screens. Which screens are available depends on the measurement the transmitter is making.
2. Change the screen contrast.

### 7.10.2 Procedure: Choosing a display screen.

Calibrate	Hold
Program	<b>Display</b>

<b>Default Display</b>
Display Contrast

1. Press MENU. The menu screen appears. Choose **Display**.
2. Choose **Default Display**.
3. Press ↓ until the desired screen appears. Press ENTER.
4. The display returns to the screen in step 2. Press MENU then EXIT to return to the main display.

### 7.10.3 Procedure: Changing screen contrast.

Calibrate	Hold
Program	<b>Display</b>

Default Display
<b>Display Contrast</b>

Display contrast
Lighter <b>Darker</b>

1. Press MENU. The menu screen appears. Choose **Display**.
2. Choose **Display Contrast**.
3. To increase the contrast, select **darker**. Press ENTER. Each key press increases the contrast. To reduce the contrast, select **lighter**, Press ENTER. Each key press decreases the contrast.
4. To return to the main display, press MENU then EXIT.

#### NOTE:

Screen contrast can also be adjusted from the main display. Press MENU and ↑ at the same time to increase contrast. Press MENU and ↓ at the same time to decrease contrast. Repeatedly pressing the arrow key increases or reduces the contrast.

## SECTION 8.0

# CALIBRATION — TEMPERATURE

### 8.1 INTRODUCTION

All five amperometric sensors (oxygen, ozone, free chlorine, total chlorine, and monochloramine) are membrane-covered sensors. As the sensor operates, the analyte (the substance to be determined) diffuses through the membrane and is consumed at an electrode immediately behind the membrane. The reaction produces a current that depends on the rate at which the analyte diffuses through the membrane. The diffusion rate, in turn, depends on the concentration of the analyte and how easily it passes through the membrane (the membrane permeability). Because the membrane permeability is a function of temperature, the sensor current will change if the temperature changes. To correct for changes in sensor current caused by temperature, the transmitter automatically applies a membrane permeability correction. Although the membrane permeability is different for each sensor, the change is about 3%/°C at 25°C, so a 1°C error in temperature produces about a 3% error in the reading.

Temperature plays an additional role in oxygen measurements. Oxygen sensors are calibrated by exposing them to water-saturated air, which, from the point of view of the sensor, is equivalent to water saturated with atmospheric oxygen (see Section 9.0 for more information). During calibration, the transmitter calculates the solubility of atmospheric oxygen in water using the following steps. First, the transmitter measures the temperature. From the temperature, the transmitter calculates the vapor pressure of water and, using the barometric pressure, calculates the partial pressure of atmospheric oxygen. Once the transmitter knows the partial pressure, it calculates the equilibrium solubility of oxygen in water using a temperature-dependent factor called the Bunsen coefficient. Overall, a 1°C error in the temperature measurement produces about a 2% error in the solubility calculated during calibration and about the same error in subsequent measurements.

Temperature is also important in the pH measurement required to correct free chlorine readings.

1. The transmitter uses a temperature dependent factor to convert measured cell voltage to pH. Normally, a slight inaccuracy in the temperature reading is unimportant unless the pH reading is significantly different from 7.00. Even then, the error is small. For example, at pH 12 and 25°C, a 1°C error produces a pH error less than  $\pm 0.02$ .
2. During auto calibration, the transmitter recognizes the buffer being used and calculates the actual pH of the buffer at the measured temperature. Because the pH of most buffers changes only slightly with temperature, reasonable errors in temperature do not produce large errors in the buffer pH. For example, a 1°C error causes **at most** an error of  $\pm 0.03$  in the calculated buffer pH.

Without calibration the accuracy of the temperature measurement is about  $\pm 0.4^\circ\text{C}$ . Calibrate the transmitter if

1.  $\pm 0.4^\circ\text{C}$  accuracy is not acceptable
2. the temperature measurement is suspected of being in error. Calibrate temperature by making the transmitter reading match the temperature measured with a standard thermometer.

**8.2 PROCEDURE: CALIBRATING TEMPERATURE**

1. Remove the sensor from the process liquid. Place it in an insulated container of water along with a calibrated thermometer. Submerge at least the bottom two inches of the sensor. Stir continuously.
2. Allow the sensor to reach thermal equilibrium. For some sensors, the time constant for a change in temperature is 5 min., so it may take as long as 30 min. for temperature equilibration.
3. Change the Solu Comp Xmt display to match the calibrated thermometer using the procedure below.

<b>Calibrate</b>	Hold
Program	Display

4. Press MENU. The menu screen appears. Choose **Calibrate**.

Cal?	
Measurement	<b>Temp</b>

5. Choose **Temp**.

6. If transmitter was programmed in Section 7.5 to use the actual process temperature, go to step 7.

If the transmitter was programmed to use a temperature entered by the user, go to step 9.

Live	25.0°C
Cal	+025.0°C

7. To calibrate the temperature, change the number in the second line to match the temperature measured with the **standard thermometer**. Press ENTER.

8. Press MENU then EXIT to return to the main display.

Manual Temp?	
+25.0°C	

9. If the temperature value shown in the display is not correct, use the arrow keys to change it to the desired value. The transmitter will use the temperature entered in this step in all measurements and calculations, no matter what the true temperature is.

10. Press MENU then EXIT to return to the main display.

## SECTION 9.0

# CALIBRATION — DISSOLVED OXYGEN

### 9.1 INTRODUCTION

As Figure 9-1 shows, oxygen sensors generate a current directly proportional to the concentration of dissolved oxygen in the sample. Calibrating the sensor requires exposing it to a solution containing no oxygen (zero standard) and to a solution containing a known amount of oxygen (full-scale standard).

The zero standard is necessary because oxygen sensors, even when no oxygen is present in the sample, generate a small current called the residual current. The transmitter compensates for the residual current by subtracting it from the measured current before converting the result to a dissolved oxygen value. New sensors require zeroing before being placed in service, and sensors should be zeroed whenever the electrolyte solution is replaced. The recommended zero standard is 5% sodium sulfite in water, although oxygen-free nitrogen can also be used.

**The Model 499A TrDO sensor, used for the determination of trace (ppb) oxygen levels, has very low residual current and does not normally require zeroing.** The residual current in the 499A TrDO sensor is equivalent to less than 0.5 ppb oxygen.

The purpose of the full-scale standard is to establish the slope of the calibration curve. Because the solubility of atmospheric oxygen in water as a function of temperature and barometric pressure is well known, the natural choice for a full-scale standard is air-saturated water. However, air-saturated water is difficult to prepare and use, so the universal practice is to use air for calibration. From the point of view of the oxygen sensor, air and air-saturated water are identical. The equivalence comes about because the sensor really measures the chemical potential of oxygen. Chemical potential is the force that causes oxygen molecules to diffuse from the sample into the sensor where they can be measured. It is also the force that causes oxygen molecules in air to dissolve in water and to continue to dissolve until the water is saturated with oxygen. Once the water is saturated, the chemical potential of oxygen in the two phases (air and water) is the same.

Oxygen sensors generate a current directly proportional to the rate at which oxygen molecules diffuse through a membrane stretched over the end of the sensor. The diffusion rate depends on the difference in chemical potential between oxygen in the sensor and oxygen in the sample. An electrochemical reaction, which destroys any oxygen molecules entering the sensor, keeps the concentration (and the chemical potential) of oxygen inside the sensor equal to zero. Therefore, the chemical potential of oxygen in the sample alone determines the diffusion rate and the sensor current.

When the sensor is calibrated, the chemical potential of oxygen in the standard determines the sensor current. Whether the sensor is calibrated in air or air-saturated water is immaterial. The chemical potential of oxygen is the same in either phase. Normally, to make the calculation of solubility in common units (like ppm DO) simpler, it is convenient to use water-saturated air for calibration.

Automatic air calibration is standard. The user simply exposes the sensor to water-saturated air. The transmitter monitors the sensor current. When the current is stable, the transmitter stores the current and measures the temperature using a temperature element inside the oxygen sensor. The user must enter the barometric pressure. From the temperature the transmitter calculates the saturation vapor pressure of water. Next, it calculates the pressure of dry air by subtracting the vapor pressure from the barometric pressure. Using the fact that dry air always contains 20.95% oxygen, the transmitter calculates the partial pressure of oxygen. Once the transmitter knows the partial pressure of oxygen, it uses the Bunsen coefficient to calculate the equilibrium solubility of atmospheric oxygen in water at the prevailing temperature. At 25°C and 760 mm Hg, the equilibrium solubility is 8.24 ppm.

Often it is too difficult or messy to remove the sensor from the process liquid for calibration. In this case, the sensor can be calibrated against a measurement made with a portable laboratory instrument. The laboratory instrument typically uses a membrane-covered amperometric sensor that has been calibrated against water-saturated air.

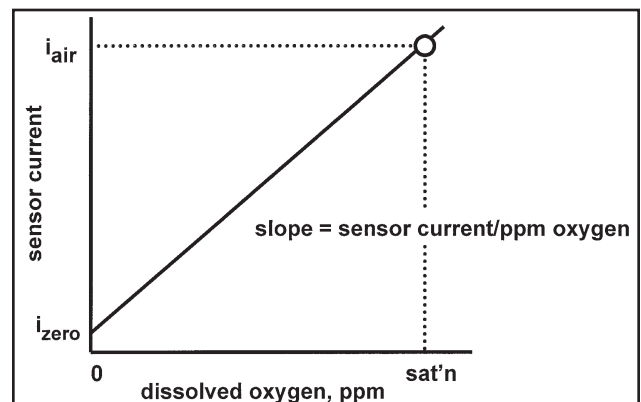

**FIGURE 9-1. Sensor Current as a Function of Dissolved Oxygen Concentration**

## 9.2 PROCEDURE — ZEROING THE SENSOR

- Place the sensor in a **fresh** solution of 5% sodium sulfite (Na<sub>2</sub>SO<sub>3</sub>) in water. Be sure air bubbles are not trapped against the membrane. The current will drop rapidly at first and then gradually reach a stable zero value. To monitor the sensor current, go to the main display and press **↓** until the input current screen appears. Note the units: nA is nanoamps, μA is microamps. The table gives typical zero currents for Rosemount Analytical sensors.

Sensor	Zero Current
499ADO	<50 nA
499ATrDO	<5 nA
Hx438 and Gx448	<1 nA

A new sensor or a sensor in which the electrolyte solution has been replaced may require several hours (occasionally as long as overnight) to reach a minimum current. **DO NOT START THE ZERO ROUTINE UNTIL THE SENSOR HAS BEEN IN ZERO SOLUTION FOR AT LEAST TWO HOURS.**

```

Calibrate      Hold
Program        Display
    
```

- Press MENU. The menu screen appears. Choose **Calibrate**.

```

Cal?
Oxygen        Temp
    
```

- Choose **Oxygen**.

```

Cal?          AirCal
InProgress    Zero
    
```

- Choose **Zero**.

```

Live          200nA
Zeroing      Wait
    
```

- The screen at left appears. The top line is the raw sensor current.

```

Live          0.000PPM
Sensor Zero Done
    
```

- Once the reading is stable, the screen at left appears. Sensor zero is complete and the transmitter has stored the zero current. The screen remains until the operator presses MENU then EXIT to return to the main display.

### NOTE

Pressing ENTER during the zero step will cause the transmitter to use the present sensor current as the zero current. If the sensor is zeroed before the current has reach a minimum stable value, subsequent readings will be in error.

```

Sensor Zero Fail
Current too high
    
```

- This screen appears if the zero current is extremely high. See Section 17 for troubleshooting. To repeat the zero step, press EXIT and choose **Zero**.

```

Possible ZeroErr
Proceed?  Yes      No
    
```

- This screen appears if the zero current is moderately high. To continue, choose **Yes**. To repeat the zero step choose **No**. See Section 15 for troubleshooting.

### 9.3 PROCEDURE - CALIBRATING THE SENSOR IN AIR

1. Remove the sensor from the process liquid. Use a soft tissue and a stream of water from a wash bottle to clean the membrane. Blot dry. **The membrane must be dry during air calibration.**
2. Pour some water in a beaker and suspend the sensor with the membrane about 0.5 inch (1 cm) above the water surface. To avoid drift caused by temperature changes, keep the sensor out of the direct sun.
3. Monitor the dissolved oxygen reading and the temperature. Once readings have stopped drifting begin the calibration. It may take 5-10 minutes for the sensor reading to stabilize. Stabilization time may be even longer if the process temperature is appreciably different from the air temperature. For an accurate calibration, the temperature measured by the sensor must be stable.

<b>Calibrate</b>	Hold
Program	Display

4. Press MENU. The main menu screen appears. Choose **Calibrate**.

Cal?	
<b>Oxygen</b>	Temp

5. Choose **Oxygen**.

Cal?	<b>AirCal</b>
InProcess	Zero

6. Choose **AirCal**.

AirCal?	
<b>EnterPress</b>	Setup

7. To continue air calibration, choose **EnterPress** and go to step 8. To change the stabilization criteria for air calibration or to enter a salinity different from the default value (0.0 parts per thousand), choose **Setup** and go to step 12.

Air Calibrate	
Press	<b>760.0mmHg</b>

8. Enter the barometric pressure.

**NOTE**

Be sure to enter the actual barometric pressure. Weather forecasters and airports usually report barometric pressure corrected to sea level; they do not report the actual barometric pressure. To estimate barometric pressure from altitude, see Appendix A.

Live	8.00PPM
AirCal	<b>Wait</b>

9. The display changes to the screen shown at left. The live reading is the concentration of dissolved oxygen based on the previous calibration. **Wait** flashes until the reading meets the stability criteria programmed in step 12.

Live	8.00PPM
Air Cal Done	

10. The screen at left appears once calibration is complete. The concentration of oxygen in the display is the equilibrium solubility of atmospheric oxygen in water. The transmitter automatically calculates the solubility from the measured temperature and the barometric pressure entered by the user. The transmitter also assumes that the sensor is in water-saturated air when the calibration is done. To return to the main display press MENU then EXIT.

Air Cal Failure	
Check sensor	

11. This screen appears if the sensitivity (sensor current divided by concentration) is much higher or lower than expected. See Section 15 for troubleshooting. To repeat the calibration step, choose **No**. To continue choose **Yes**.

*Procedure continued on following page.*



### 9.3 PROCEDURE - CALIBRATING THE SENSOR IN AIR (continued)

```
Air Stabilize
Time:          10sec
```

```
Restart time if
Change        > 0.02PPM
```

```
Salinity, Parts/
thousand?    00.0
```

12. If you chose **Setup** in step 6, the screen at left appears. This screen and the following one let you change the stabilization criteria for air calibration. The transmitter will not complete an air calibration until the drift is less than a certain amount in a specified period of time. The default value is 0.02 ppm in 10 seconds.

- a. Enter the desired stabilization time.
- b. Enter the minimum amount the reading is permitted to change in the time specified in step 12a.

13. Enter the desired salinity in parts per thousand.

14. To return to the main display press MENU then EXIT.

### 9.4 PROCEDURE - CALIBRATING THE SENSOR AGAINST A STANDARD INSTRUMENT

The sensor can be calibrated against a standard instrument. For oxygen sensors installed in aeration basins in waste treatment plants, calibration against a second instrument is often preferred. For an accurate calibration be sure that . . .

1. The standard instrument has been zeroed and calibrated against water-saturated air following the manufacturer's instructions.
2. The standard sensor is immersed in the liquid as close to the process sensor as possible.
3. Adequate time is allowed for the standard sensor to stabilize before calibrating the process instrument.

```
Calibrate      Hold
Program        Display
```

4. Press MENU. The main menu screen appears. Choose **Calibrate**.

```
Cal?
Oxygen        TEMP
```

5. Choose **Oxygen**.

```
Cal?          AirCal
InProcess     Zero
```

6. Choose **InProcess**.

```
Wait for
Stable reading.
```

7. The screen at left appears for two seconds.

```
Stable?      10.00PPM
Press enter.
```

8. The screen at left appears. The number in the first line is the concentration of dissolved oxygen based on the previous calibration. Wait until the reading is stable, then press ENTER.

```
Take sample;
Press enter.
```

9. The screen at left appears. Press ENTER. The transmitter will store the present sensor current and temperature and use those values in the calibration.

```
Sample      10.00PPM
Cal         10.00PPM
```

10. Use the arrow keys to change the value in the second line to match the reading of the standard instrument. To return to the main display press MENU then EXIT.

```
Calibration
Error
```

11. This screen appears momentarily if the sensitivity (sensor current divided by concentration) is much higher or lower than expected. The display then returns to the screen in step 5. See Section 15 for troubleshooting.

## SECTION 10.0 CALIBRATION — FREE CHLORINE

### 10.1 INTRODUCTION

As Figure 10-1 shows, a free chlorine sensor generates a current directly proportional to the concentration of free chlorine in the sample. Calibrating the sensor requires exposing it to a solution containing no chlorine (zero standard) and to a solution containing a known amount of chlorine (full-scale standard).

The zero standard is necessary because chlorine sensors, even when no chlorine is in the sample, generate a small current called the residual current. The transmitter compensates for the residual current by subtracting it from the measured current before converting the result to a chlorine value. New sensors require zeroing before being placed in service, and sensors should be zeroed whenever the electrolyte solution is replaced. Either of the following makes a good zero standard:

- Deionized water containing about 500 ppm sodium chloride. Dissolve 0.5 grams (1/8 teaspoonful) of table salt in 1 liter of water. **DO NOT USE DEIONIZED WATER ALONE FOR ZEROING THE SENSOR. THE CONDUCTIVITY OF THE ZERO WATER MUST BE GREATER THAN 50  $\mu$ S/cm.**
- Tap water known to contain no chlorine. Expose tap water to bright sunlight for at least 24 hours.

The purpose of the full-scale standard is to establish the slope of the calibration curve. Because stable chlorine standards do not exist, **the sensor must be calibrated against a test run on a grab sample of the process liquid.** Several manufacturers offer portable test kits for this purpose. Observe the following precautions when taking and testing the grab sample.

- Take the grab sample from a point as close to the sensor as possible. Be sure that taking the sample does not alter the flow of the sample to the sensor. It is best to install the sample tap just downstream from the sensor.
- Chlorine solutions are unstable. Run the test immediately after taking the sample. Try to calibrate the sensor when the chlorine concentration is at the upper end of the normal operating range.

Free chlorine measurements made with the 499ACL-01 sensor also require a pH correction. Free chlorine is the sum of hypochlorous acid (HOCl) and hypochlorite ion (OCl<sup>-</sup>). The relative amount of each depends on the pH. As pH increases, the concentration of HOCl decreases and the concentration of OCl<sup>-</sup> increases. Because the sensor responds only to HOCl, a pH correction is necessary to properly convert the sensor current into a free chlorine reading.

The transmitter uses both automatic and manual pH correction. In automatic pH correction, the transmitter continuously monitors the pH of the solution and corrects the free chlorine reading for changes in pH. In manual pH correction, the transmitter uses a fixed pH value entered by the user to make the correction. Generally, if the pH changes more than about 0.2 units over short periods of time, automatic pH correction is best. If the pH is relatively steady or subject only to seasonal changes, manual pH correction is adequate.

During calibration, the transmitter must know the pH of the sample. If the transmitter is using automatic pH correction, the pH sensor (properly calibrated) **must be in the process liquid before starting the calibration.** If the transmitter is using manual pH correction, be sure to enter the pH value before starting the calibration.

The Model 499ACL-01 free chlorine sensor loses sensitivity at high concentrations of chlorine. The Model Xmt-A-HT has a dual slope feature that allows the user to compensate for the non-linearity of the sensor. However, for the vast majority of applications, dual slope calibration is unnecessary.

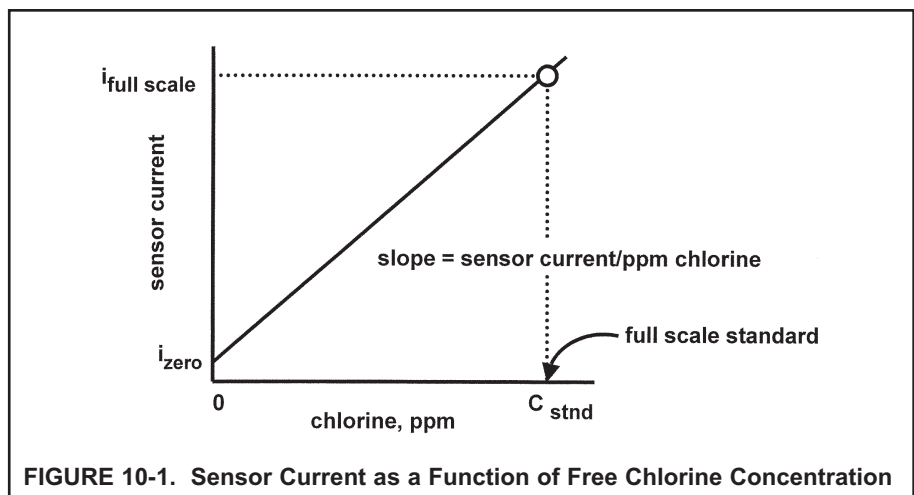

## 10.2 PROCEDURE — ZEROING THE SENSOR

- Place the sensor in the zero standard (see Section 10.1). Be sure no air bubbles are trapped against the membrane. The sensor current will drop rapidly at first and then gradually reach a stable zero value. To monitor the sensor current, go to the main display and press  $\downarrow$  until the input current screen appears. Note the units: nA is nanoamps,  $\mu$ A is microamps. Typical zero current for a free chlorine sensor is between -10 and +10 nA.

A new sensor or a sensor in which the electrolyte solution has been replaced may require several hours (occasionally as long as overnight) to reach a minimum current. **DO NOT START THE ZERO ROUTINE UNTIL THE SENSOR HAS BEEN IN ZERO SOLUTION FOR AT LEAST TWO HOURS.**

```

Calibrate      Hold
Program        Display
  
```

- Press MENU. The menu screen appears. Choose **Calibrate**.

```

Cal?          pH
Chlorine      Temp
  
```

- Choose **Chlorine**.

```

Cal?
InProgress    Zero
  
```

- Choose **Zero**.

```

Live          200nA
Zeroing      Wait
  
```

- The screen at left appears. The top line is the raw sensor current.

```

Live          0.000PPM
Sensor Zero Done
  
```

- Once the reading is stable, the screen at left appears. Sensor zero is complete and the transmitter has stored the zero current. The screen remains until the operator presses MENU then EXIT to return to the main display.

### NOTE

Pressing ENTER during the zero step will cause the transmitter to use the present sensor current as the zero current. If the sensor is zeroed before the current has reach a minimum stable value, subsequent readings will be in error.

```

Sensor Zero Fail
Current too high
  
```

- This screen appears if the zero current is extremely high. See Section 17 for troubleshooting. To repeat the zero step, press EXIT and choose **Zero**.

```

Possible ZeroErr
Proceed?  Yes      No
  
```

- This screen appears if the zero current is moderately high. To continue, choose **Yes**. To repeat the zero step, choose **No**. See Section 15 for troubleshooting.

### 10.3 PROCEDURE — FULL SCALE CALIBRATION

1. Place the sensor in the process liquid. If automatic pH correction is being used, calibrate the pH sensor (see Section 14) and place it in the process liquid. If manual pH correction is being used, measure the pH of the process liquid and enter the value (see Section 7.4). Adjust the sample flow until it is within the range recommended for the chlorine sensor. Refer to the sensor instruction sheet.
2. Adjust the chlorine concentration until it is near the upper end of the operating range. Wait until the transmitter reading is stable before starting the calibration.

```

Calibrate      Hold
Program          Display
    
```

3. Press MENU. The main menu screen appears. Choose **Calibrate**.

```

Cal?            pH
Chlorine      Temp
    
```

4. Choose **Chlorine**.

```

Cal?
InProcess      Zero
    
```

5. Choose **InProcess**.

```

Wait for
Stable reading.
    
```

6. The screen at left appears for two seconds.

```

Stable?        1.00PPM
Press enter.
    
```

7. The screen at left appears. The number in the first line is the concentration of chlorine based on the previous calibration. Wait until the reading is stable, then press ENTER.

```

Take sample;
Press enter.
    
```

8. The screen at left appears. Take a grab sample of the process liquid and immediately press ENTER. The transmitter will store the present sensor current and temperature and use those values in the calibration.

9. Immediately determine the free chlorine concentration in the sample.

```

Sample         1.00PPM
Cal            1.00PPM
    
```

10. Use the arrow keys to change the value in the second line to match the results of the laboratory test. To return to the main display press MENU then EXIT.

```

Calibration
Error
    
```

11. This screen appears momentarily if the sensitivity (sensor current divided by concentration) is much higher or lower than expected. The display then returns to the screen in step 5. See Section 15 for troubleshooting.

### 10.4 DUAL SLOPE CALIBRATION

Figure 10.2 shows the principle of dual slope calibration. Between zero and concentration C1, the sensor response is linear. When the concentration of chlorine becomes greater than C1, the response is non-linear. In spite of the non-linearity, the sensor response between C1 and C2 can be approximated by a straight line.

Dual slope calibration is rarely needed. It is probably useful in fewer than 5% of applications.

1. Be sure the transmitter has been configured for dual slope calibration. See Section 7.4.
2. Place the sensor in the zero solution. (see Section 10.1). Be sure no air bubbles are trapped against the membrane. The sensor current will drop rapidly at first and then gradually reach a stable zero value. To monitor the sensor current, go to the main display and press  $\downarrow$  until the input current screen appears. Note the units: nA is nanoamps,  $\mu$ A is microamps. Typical zero current for a free chlorine sensor is between -10 and +10 nA.

A new sensor or a sensor in which the electrolyte solution has been replaced may require several hours (occasionally as long as overnight) to reach a minimum current. **DO NOT START THE ZERO ROUTINE UNTIL THE SENSOR HAS BEEN IN ZERO SOLUTION FOR AT LEAST TWO HOURS.**

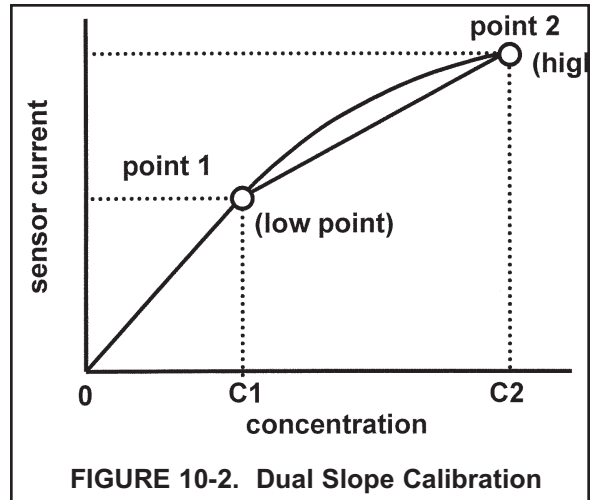

FIGURE 10-2. Dual Slope Calibration

```

Calibrate      Hold
Program        Display
    
```

3. Press MENU. The main menu screen appears. Choose **Calibrate**.

```

Cal?          PH
Chlorine      TEMP
    
```

4. Choose **Chlorine**.

```

Cal?
Zero          Pt1    Pt2
    
```

5. Choose **Zero**.

```

Live          200nA
Zeroing       Wait
    
```

6. The screen at left appears. The top line is the raw sensor current.

```

Live          0.000PPM
Sensor Zero Done
    
```

7. Once the reading is stable, the screen at left appears. Sensor zero is complete and the transmitter has stored the zero current. The display returns to the screen in step 5.

**NOTE**

Pressing ENTER during the zero step will cause the transmitter to use the present sensor current as the zero current. If the sensor is zeroed before the current has reach a minimum stable value, subsequent readings will be in error.

```

Sensor Zero Fail
Current too high
    
```

8. This screen appears if the zero current is extremely high. See Section 15 for troubleshooting. To repeat the zero step, press EXIT and choose **Zero**.

*Process continued on following page.*

```
Possible ZeroErr
Proceed?  Yes      No
```

9. This screen appears if the zero current is moderately high. To continue, choose **Yes**. To repeat the zero step, choose **No**. See Section 15 for troubleshooting.

10. If the sensor was just zeroed, place it in the process liquid. If automatic pH correction is being used, calibrate the pH sensor (see Section 14) and place it in the process liquid. If manual pH correction is being used, measure the pH of the process liquid and enter the value (See Section 7.4). Adjust the sample flow until it is within the range recommended for the chlorine sensor. Refer to the sensor instruction sheet.

11. Adjust the chlorine concentration until it is near the upper end of the linear range, point C1 in Figure 10-2. Wait until the transmitter reading is stable before starting the calibration.

```
Cal?
Zero      pt1      pt2
```

12. Choose **pt1**.

```
Wait for
Stable reading.
```

13. The screen at left appears for two seconds.

```
Stable?      6.00PPM
Press enter.
```

14. The screen at left appears. The number in the first line is the concentration of chlorine based on the previous calibration. Wait until the reading is stable, then press ENTER.

```
Take sample;
Press enter.
```

15. The screen at left appears. Take a grab sample of the process liquid and immediately press ENTER. The transmitter will store the present sensor current and temperature and use those values in the calibration.

16. Immediately determine the free chlorine concentration in the sample.

```
Sample      6.00PPM
Cal         6.00PPM
```

17. Use the arrow keys to change the value in the second line to match the results of the laboratory test.

```
Calibration
Error
```

18. This screen appears momentarily if the sensitivity (sensor current divided by concentration) is much higher or lower than expected. The display then returns to the screen in step 5. See Section 15 for troubleshooting.

19. Adjust the concentration of chlorine in the sample until it is near the upper end of the control range (point C2 in Figure 10.2)

```
Cal?
Zero      pt1      pt2
```

20. Choose **pt2** and repeat steps 13-17 above.

21. To return to the main display press MENU then EXIT.

## SECTION 11.0 CALIBRATION — TOTAL CHLORINE

### 11.1 INTRODUCTION

Total chlorine is the sum of free and combined chlorine. The continuous determination of total chlorine requires two steps. See Figure 11-1. First, the sample flows into a conditioning system (SCS 921A) where a pump continuously adds acetic acid and potassium iodide to the sample. The acid lowers the pH, which allows total chlorine in the sample to quantitatively oxidize the iodide in the reagent to iodine. In the second step, the treated sample flows to the sensor. The sensor is a membrane-covered amperometric sensor, whose output is proportional to the concentration of iodine. Because the concentration of iodine is proportional to the concentration of total chlorine, the transmitter can be calibrated to read total chlorine.

Figure 11-2 shows a typical calibration curve for a total chlorine sensor. Because the sensor really measures iodine, calibrating the sensor requires exposing it to a solution containing no iodine (zero standard) and to a solution containing a known amount of iodine (full-scale standard).

The zero standard is necessary because the sensor, even when no iodine is present, generates a small current called the residual current. The transmitter compensates for the residual current by subtracting it from the measured current before converting the result to a total chlorine value. New sensors require zeroing before being placed in service, and sensors should be zeroed whenever the electrolyte solution is replaced. The best zero standard is sample without reagent added.

The purpose of the full-scale standard is to establish the slope of the calibration curve. Because stable total chlorine standards do not exist, **the sensor must be calibrated against a test run on a grab sample of the process liquid.** Several manufacturers offer portable test kits for this purpose. Observe the following precautions when taking and testing the grab sample.

- Take the grab sample from a point as close as possible to the inlet of the SCS921 sample conditioning system. Be sure that taking the sample does not alter the flow through the SCS921A.
- Chlorine solutions are unstable. Run the test immediately after taking the sample. Try to calibrate the sensor when the chlorine concentration is at the upper end of the normal operating range.

The Model 499ACL-02 (total chlorine) sensor loses sensitivity at high concentrations of chlorine. The Model Xmt-A-HT has a dual slope feature that allows the user to compensate for the non-linearity of the sensor. However, for the vast majority of applications, dual slope calibration is unnecessary.

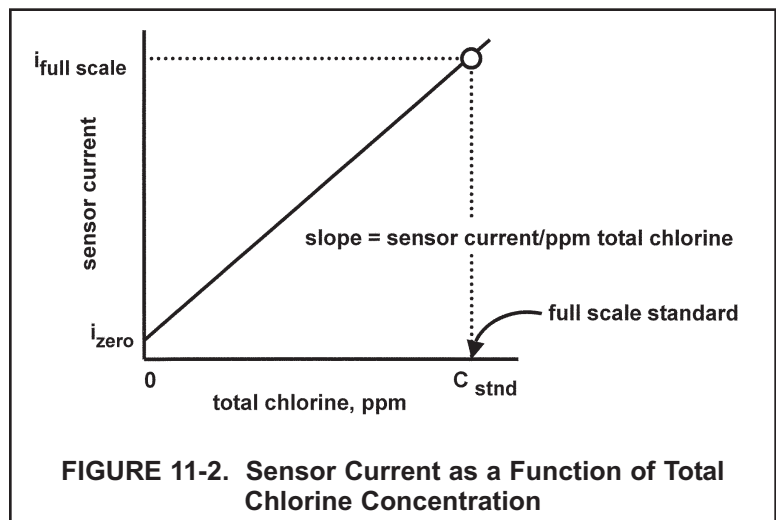
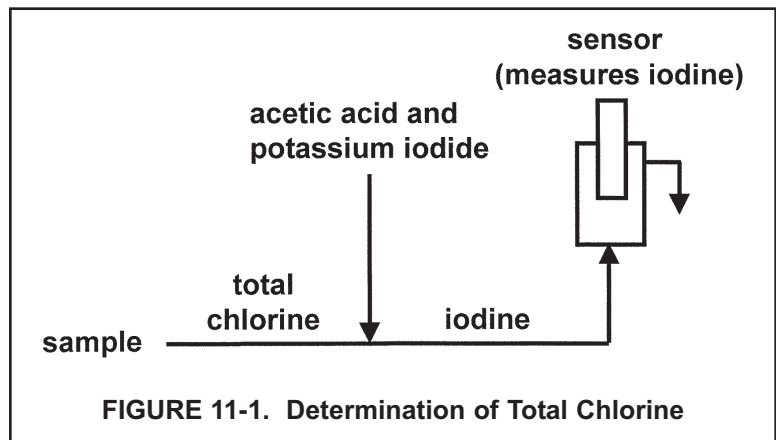



### 11.2 PROCEDURE — ZEROING THE SENSOR

1. Complete the startup sequence described in the SCS921 instruction manual.
2. Remove the reagent uptake tube from the reagent bottle and let it dangle in air. The peristaltic pump will simply pump air into the sample.
3. Let the system run until the sensor current is stable. The sensor current will drop rapidly at first and then gradually reach a stable zero value. To monitor the sensor current, go to the main display and press ↓ until the input current screen appears. Note the units: nA is nanoamps, μA is microamps. Typical zero current for a free chlorine sensor is between -10 and +30 nA.

A new sensor or a sensor in which the electrolyte solution has been replaced may require several hours (occasionally as long as overnight) to reach a minimum current. **DO NOT START THE ZERO ROUTINE UNTIL THE SENSOR HAS BEEN IN ZERO SOLUTION FOR AT LEAST TWO HOURS.**

```

Calibrate          Hold
Program           Display
    
```

4. Press MENU. The menu screen appears. Choose **Calibrate**.

```

Cal?
Chlorine          Temp
    
```

5. Choose **Chlorine**.

```

Cal?
InProgress        Zero
    
```

6. Choose **Zero**.

```

Live              200nA
Zeroing          Wait
    
```

7. The screen at left appears. The top line is the raw sensor current.

```

Live              0.000PPM
Sensor Zero Done
    
```

8. Once the reading is stable, the screen at left appears. Sensor zero is complete and the transmitter has stored the zero current. The screen remains until the operator presses MENU then EXIT to return to the main display.

**NOTE**

Pressing ENTER during the zero step will cause the transmitter to use the present sensor current as the zero current. If the sensor is zeroed before the current has reach a minimum stable value, subsequent readings will be in error.

```

Sensor Zero Fail
Current too high
    
```

9. This screen appears if the zero current is extremely high. See Section 17 for troubleshooting. To repeat the zero step, press EXIT and choose **Zero**.

```

Possible ZeroErr
Proceed?  Yes      No
    
```

10. This screen appears if the zero current is moderately high. To continue, choose **Yes**. To repeat the zero step, choose **No**. See Section 15 for troubleshooting.

### 11.3 PROCEDURE — FULL SCALE CALIBRATION

1. If the sensor was just zeroed, place the reagent uptake tube back in the bottle. Once the flow of reagent starts, it takes about one minute for the sensor current to begin to increase. It may take an hour or longer for the reading to stabilize.
2. Adjust the chlorine concentration until it is near the upper end of the operating range. Wait until the transmitter reading is stable before starting the calibration.

```
Calibrate      Hold
Program       Display
```

3. Press MENU. The main menu screen appears. Choose **Calibrate**.

```
Cal?
Chlorine      Temp
```

4. Choose **Chlorine**.

```
Cal?
InProgress    Zero
```

5. Choose **InProcess**.

```
Wait for
Stable reading.
```

6. The screen at left appears for two seconds.

```
Stable?      1.00PPM
Press enter.
```

7. The screen at left appears. The number in the first line is the concentration of chlorine based on the previous calibration. Wait until the reading is stable, then press ENTER.

```
Take sample;
Press enter.
```

8. The screen at left appears. Take a grab sample of the process liquid and immediately press ENTER. The transmitter will store the present sensor current and temperature and use those values in the calibration.

9. Immediately determine the total chlorine concentration in the sample.

```
Sample      1.00PPM
Cal         1.00PPM
```

10. Use the arrow keys to change the value in the second line to match the results of the laboratory test. To return to the main display press MENU then EXIT.

```
Calibration
Error
```

11. This screen appears momentarily if the sensitivity (sensor current divided by concentration) is much higher or lower than expected. The display then returns to the screen in step 5. See Section 15 for troubleshooting.

### 11.4 DUAL SLOPE CALIBRATION

Figure 11-3 shows the principle of dual slope calibration. Between zero and concentration C1, the sensor response is linear. When the concentration of chlorine becomes greater than C1, the response is non-linear. In spite of the non-linearity, the sensor response between C1 and C2 can be approximated by a straight line.

Dual slope calibration is rarely needed. It is probably useful in fewer than 5% of applications.

1. Be sure the transmitter has been configured for dual slope calibration. See Section 7.4.
2. Place the sensor in the zero solution. (see Section 10.1). Be sure no air bubbles are trapped against the membrane. The sensor current will drop rapidly at first and then gradually reach a stable zero value. To monitor the sensor current, go to the main display and press  $\downarrow$  until the input current screen appears. Note the units: nA is nanoamps,  $\mu$ A is microamps. Typical zero current for a total chlorine sensor is between -10 and +30 nA.

A new sensor or a sensor in which the electrolyte solution has been replaced may require several hours (occasionally as long as overnight) to reach a minimum current. **DO NOT START THE ZERO ROUTINE UNTIL THE SENSOR HAS BEEN IN ZERO SOLUTION FOR AT LEAST TWO HOURS.**

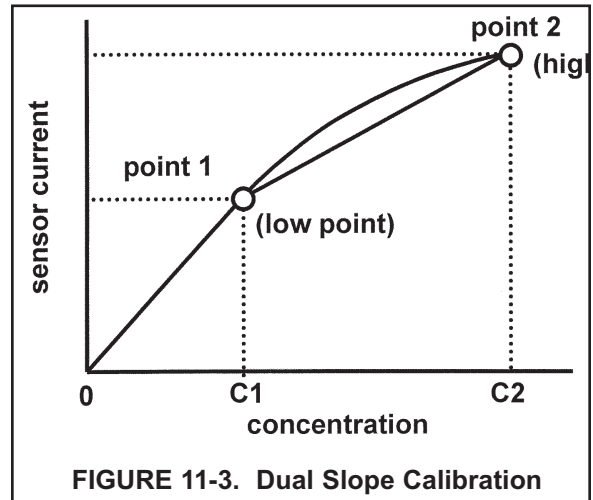

FIGURE 11-3. Dual Slope Calibration

```

Calibrate      Hold
Program        Display
    
```

3. Press MENU. The main menu screen appears. Choose **Calibrate**.

```

Cal?
Chlorine      Temp
    
```

4. Choose **Chlorine**.

```

Cal?
Zero          Pt1      Pt2
    
```

5. Choose **Zero**.

```

Live          200nA
Zeroing       Wait
    
```

6. The screen at left appears. The top line is the raw sensor current.

```

Live          0.000PPM
Sensor Zero Done
    
```

7. Once the reading is stable, the screen at left appears. Sensor zero is complete and the transmitter has stored the zero current. The display returns to the screen in step 6.

**NOTE**

Pressing ENTER during the zero step will cause the transmitter to use the present sensor current as the zero current. If the sensor is zeroed before the current has reach a minimum stable value, subsequent readings will be in error.

```

Sensor Zero Fail
Current too high
    
```

8. This screen appears if the zero current is extremely high. See Section 15 for troubleshooting. To repeat the zero step, press EXIT and choose **Zero**.

*Process continued on following page.*

```
Possible ZeroErr
Proceed?  Yes      No
```

9. This screen appears if the zero current is moderately high. To continue, choose **Yes**. To repeat the zero step, choose **No**. See Section 15 for troubleshooting.

10. If the sensor was just zeroed, place the reagent uptake tube back in the reagent bottle. Once the flow of reagent starts, it takes about one minute for the sensor current to begin to increase. It may take an hour or longer for the reading to stabilize. Be sure the sample flow stays between 80 and 100 mL/min and the pressure is between 3 and 5 psig.

11. Adjust the chlorine concentration until it is near the upper end of the linear range, point C1 in Figure 11-2. Wait until the transmitter reading is stable before starting the calibration.

```
Cal?
Zero      pt1      pt2
```

12. Choose **pt1**.

```
Wait for
Stable reading.
```

13. The screen at left appears for two seconds.

```
Stable?      6.00PPM
Press enter.
```

14. The screen at left appears. The number in the first line is the concentration of chlorine based on the previous calibration. Wait until the reading is stable, then press ENTER.

```
Take sample;
Press enter.
```

15. The screen at left appears. Take a grab sample of the process liquid and immediately press ENTER. The transmitter will store the present sensor current and temperature and use those values in the calibration.

16. Immediately determine the total chlorine concentration in the sample.

```
Sample      6.00PPM
Cal         6.00PPM
```

17. Use the arrow keys to change the value in the second line to match the results of the laboratory test.

```
Calibration
Error
```

18. This screen appears momentarily if the sensitivity (sensor current divided by concentration) is much higher or lower than expected. The display then returns to the screen in step 5. See Section 15 for troubleshooting.

19. Adjust the concentration of chlorine in the sample until it is near the upper end of the control range (point C2 in Figure 10.2)

```
Cal?
Zero      pt1      pt2
```

20. Choose **pt2** and repeat steps 13-17 above.

21. To return to the main display press MENU then EXIT.

## SECTION 12.0

# CALIBRATION - MONOCHLORAMINE

### 12.1 INTRODUCTION

As Figure 12-1 shows, a monochloramine sensor generates a current directly proportional to the concentration of monochloramine in the sample. Calibrating the sensor requires exposing it to a solution containing no monochloramine (zero standard) and to a solution containing a known amount of monochloramine (full-scale standard).

The zero standard is necessary because monochloramine sensors, even when no monochloramine is in the sample, generate a small current called the residual or zero current. The transmitter compensates for the residual current by subtracting it from the measured current before converting the result to a monochloramine value. New sensors require zeroing before being placed in service, and sensors should be zeroed whenever the electrolyte solution is replaced. The best zero standard is deionized water.

The purpose of the full-scale standard is to establish the slope of the calibration curve. Because stable monochloramine standards do not exist, **the sensor must be calibrated against a test run on a grab sample of the process liquid.** Several manufacturers offer portable test kits for this purpose. Observe the following precautions when taking and testing the grab sample.

- Take the grab sample from a point as close to the sensor as possible. Be sure that taking the sample does not alter the flow of the sample to the sensor. It is best to install the sample tap just downstream from the sensor.
- Monochloramine solutions are unstable. Run the test immediately after taking the sample. Try to calibrate the sensor when the monochloramine concentration is at the upper end of the normal operating range.

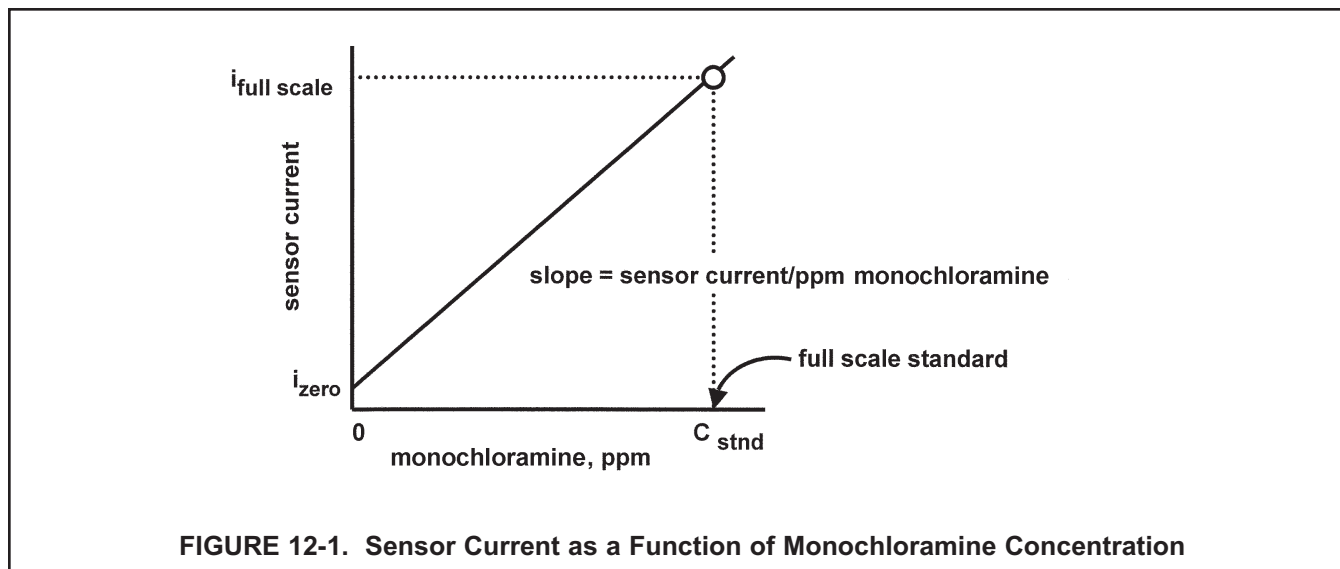

FIGURE 12-1. Sensor Current as a Function of Monochloramine Concentration

## 12.2 PROCEDURE — ZEROING THE SENSOR

- Place the sensor in the zero standard (see Section 10.1). Be sure no air bubbles are trapped against the membrane. The sensor current will drop rapidly at first and then gradually reach a stable zero value. To monitor the sensor current, go to the main display and press  $\downarrow$  until the input current screen appears. Note the units: nA is nanoamps,  $\mu$ A is microamps. Typical zero current for a monochloramine sensor is between 0 and +20 nA.

A new sensor or a sensor in which the electrolyte solution has been replaced may require several hours (occasionally as long as overnight) to reach a minimum current. **DO NOT START THE ZERO ROUTINE UNTIL THE SENSOR HAS BEEN IN ZERO SOLUTION FOR AT LEAST TWO HOURS.**

```

Calibrate      Hold
Program        Display
  
```

- Press MENU. The menu screen appears. Choose **Calibrate**.

```

Cal?
Chlorine      Temp
  
```

- Choose **Chlorine**.

```

Cal?
InProgress    Zero
  
```

- Choose **Zero**.

```

Live          200nA
Zeroing      Wait
  
```

- The screen at left appears. The top line is the raw sensor current.

```

Live          0.000PPM
Sensor Zero Done
  
```

- Once the reading is stable, the screen at left appears. Sensor zero is complete and the transmitter has stored the zero current. The screen remains until the operator presses MENU then EXIT to return to the main display.

### NOTE

Pressing ENTER during the zero step will cause the transmitter to use the present sensor current as the zero current. If the sensor is zeroed before the current has reach a minimum stable value, subsequent readings will be in error.

```

Sensor Zero Fail
Current too high
  
```

- This screen appears if the zero current is extremely high. See Section 15 for troubleshooting. To repeat the zero step, press EXIT and choose **Zero**.

```

Possible ZeroErr
Proceed?  Yes      No
  
```

- This screen appears if the zero current is moderately high. To continue, choose **Yes**. To repeat the zero step, choose **No**. See Section 15 for troubleshooting.

**12.3 PROCEDURE — FULL SCALE CALIBRATION**

1. Place the sensor in the process liquid. Adjust the sample flow until it is within the range recommended for the sensor. Refer to the sensor instruction sheet.
2. Adjust the chlorine concentration until it is near the upper end of the operating range. Wait until the transmitter reading is stable before starting the calibration.

```

Calibrate      Hold
Program       Display
  
```

3. Press MENU. The main menu screen appears. Choose **Calibrate**.

```

Cal?
Chlorine      Temp
  
```

4. Choose **Chlorine**.

```

Cal?
InProcess     Zero
  
```

5. Choose **InProcess**.

```

Wait for
Stable reading.
  
```

6. The screen at left appears for two seconds.

```

Stable?      1.00PPM
Press enter.
  
```

7. The screen at left appears. The number in the first line is the concentration of chlorine based on the previous calibration. Wait until the reading is stable, then press ENTER.

```

Take sample;
Press enter.
  
```

8. The screen at left appears. Take a grab sample of the process liquid and immediately press ENTER. The transmitter will store the present sensor current and temperature and use those values in the calibration.

9. Immediately determine the monochloramine concentration in the sample.

```

Sample      1.00PPM
Cal         1.00PPM
  
```

10. Use the arrow keys to change the value in the second line to match the results of the laboratory test. To return to the main display press MENU then EXIT.

```

Calibration
Error
  
```

11. This screen appears momentarily if the sensitivity (sensor current divided by concentration) is much higher or lower than expected. The display then returns to the screen in step 5. See Section 15 for troubleshooting.

## SECTION 13.0 CALIBRATION — OZONE

### 13.1 INTRODUCTION

As Figure 13-1 shows, an ozone sensor generates a current directly proportional to the concentration of ozone in the sample. Calibrating the sensor requires exposing it to a solution containing no ozone (zero standard) and to a solution containing a known amount of ozone (full-scale standard).

The zero standard is necessary because ozone sensors, even when no ozone is in the sample, generate a small current called the residual or zero current. The transmitter compensates for the residual current by subtracting it from the measured current before converting the result to an ozone value. New sensors require zeroing before being placed in service, and sensors should be zeroed whenever the electrolyte solution is replaced. The best zero standard is deionized water.

The purpose of the full-scale standard is to establish the slope of the calibration curve. Because stable ozone standards do not exist, **the sensor must be calibrated against a test run on a grab sample of the process liquid.** Several manufacturers offer portable test kits for this purpose. Observe the following precautions when taking and testing the grab sample.

- Take the grab sample from a point as close to the sensor as possible. Be sure that taking the sample does not alter the flow of the sample to the sensor. It is best to install the sample tap just downstream from the sensor.
- Ozone solutions are unstable. Run the test immediately after taking the sample. Try to calibrate the sensor when the ozone concentration is at the upper end of the normal operating range.

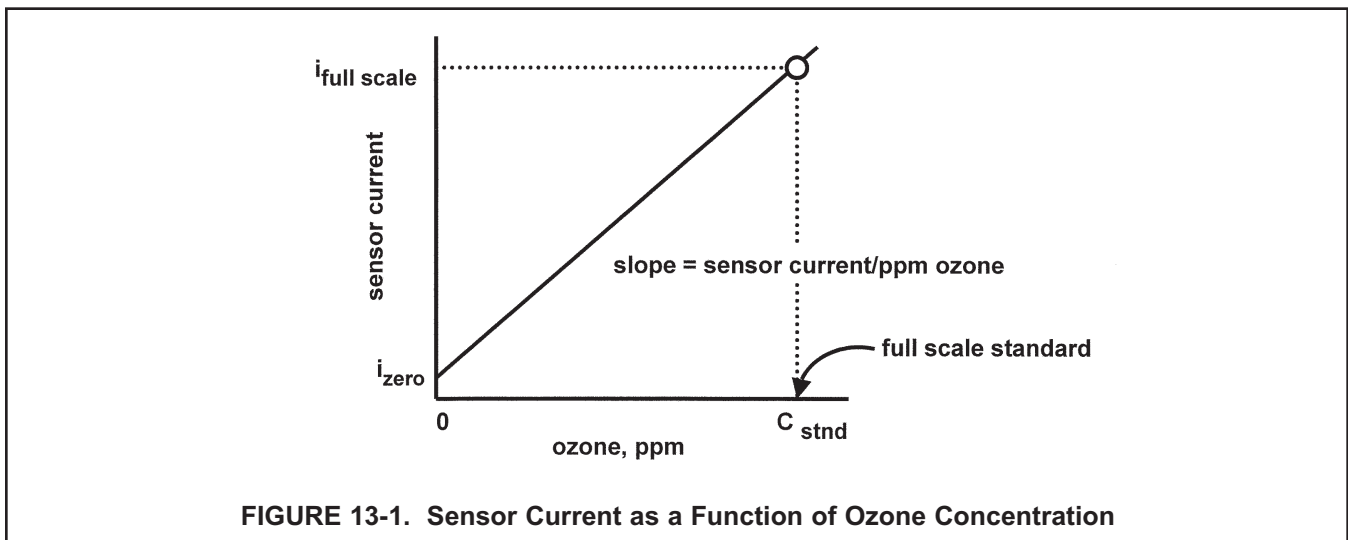



## 13.2 PROCEDURE — ZEROING THE SENSOR

- Place the sensor in the zero standard (see Section 10.1). Be sure no air bubbles are trapped against the membrane. The sensor current will drop rapidly at first and then gradually reach a stable zero value. To monitor the sensor current, go to the main display and press **↓** until the input current screen appears. Note the units: nA is nanoamps,  $\mu$ A is microamps. Typical zero current for a ozone sensor is between -10 and +10 nA.

A new sensor or a sensor in which the electrolyte solution has been replaced may require several hours (occasionally as long as overnight) to reach a minimum current. **DO NOT START THE ZERO ROUTINE UNTIL THE SENSOR HAS BEEN IN ZERO SOLUTION FOR AT LEAST TWO HOURS.**

Calibrate	Hold
Program	Display

- Press MENU. The menu screen appears. Choose **Calibrate**.

Cal?	
Ozone	Temp

- Choose **Ozone**.

Cal?	
InProcess	Zero

- Choose **Zero**.

Live	200nA
Zeroing	Wait

- The screen at left appears. The top line is the raw sensor current.

Live	0.000PPM
Sensor Zero Done	

- Once the reading is stable, the screen at left appears. Sensor zero is complete and the transmitter has stored the zero current. The screen remains until the operator presses MENU then EXIT to return to the main display.

### NOTE

Pressing ENTER during the zero step will cause the transmitter to use the present sensor current as the zero current. If the sensor is zeroed before the current has reach a minimum stable value, subsequent readings will be in error.

Sensor Zero Fail	
Current too high	

- This screen appears if the zero current is extremely high. See Section 15 for troubleshooting. To repeat the zero step, press EXIT and choose **Zero**.

Possible ZeroErr	
Proceed? Yes	No

- This screen appears if the zero current is moderately high. To continue, choose **Yes**. To repeat the zero step, choose **No**. See Section 15 for troubleshooting.

### 13.3 PROCEDURE — FULL SCALE CALIBRATION

1. Place the sensor in the process liquid. Adjust the sample flow until it is within the range recommended for the sensor. Refer to the sensor instruction sheet.
2. Adjust the ozone concentration until it is near the upper end of the operating range. Wait until the transmitter reading is stable before starting the calibration.

```

Calibrate      Hold
Program       Display
    
```

3. Press MENU. The main menu screen appears. Choose **Calibrate**.

```

Cal?
Ozone         Temp
    
```

4. Choose **Ozone**.

```

Cal?
InProcess     Zero
    
```

5. Choose **InProcess**.

```

Wait for
Stable reading.
    
```

6. The screen at left appears for two seconds.

```

Stable?      1.00PPM
Press enter.
    
```

7. The screen at left appears. The number in the first line is the concentration of chlorine based on the previous calibration. Wait until the reading is stable, then press ENTER.

```

Take sample;
Press enter.
    
```

8. The screen at left appears. Take a grab sample of the process liquid and immediately press ENTER. The transmitter will store the present sensor current and temperature and use those values in the calibration.

9. Immediately determine the ozone concentration in the sample.

```

Sample       1.00PPM
Cal          1.00PPM
    
```

10. Use the arrow keys to change the value in the second line to match the results of the laboratory test. To return to the main display press MENU then EXIT.

```

Calibration
Error
    
```

11. This screen appears momentarily if the sensitivity (sensor current divided by concentration) is much higher or lower than expected. The display then returns to the screen in step 5. See Section 15 for troubleshooting.

## SECTION 14.0 CALIBRATION — pH

### 14.1 INTRODUCTION

A new pH sensor must be calibrated before use. Regular recalibration is also necessary.

A pH measurement cell (pH sensor and the solution to be measured) can be pictured as a battery with an extremely high internal resistance. The voltage of the battery depends on the pH of the solution. The pH meter, which is basically a voltmeter with a very high input impedance, measures the cell voltage and calculates pH using a conversion factor. The actual value of the voltage-to-pH conversion factor depends on the sensitivity of the pH sensing element (and the temperature). The sensing element is a thin, glass membrane at the end of the sensor. As the glass membrane ages, the sensitivity drops. Regular recalibration corrects for the loss of sensitivity. pH calibration standards, also called buffers, are readily available.

Two-point calibration is standard. Both automatic calibration and manual calibration are available. Auto calibration avoids common pitfalls and reduces errors. Its use is recommended.

In automatic calibration the transmitter recognizes the buffer and uses temperature-corrected pH values in the calibration. The table below lists the standard buffers the controller recognizes. The controller also recognizes several technical buffers: Merck, Ingold, and DIN 19267. Temperature-pH data stored in the controller are valid between at least 0 and 60°C.

pH at 25°C (nominal pH)	Standard(s)
1.68	NIST, DIN 19266, JSI 8802, BSI (see note 1)
3.56	NIST, BSI
3.78	NIST
4.01	NIST, DIN 19266, JSI 8802, BSI
6.86	NIST, DIN 19266, JSI 8802, BSI
7.00	(see note 2)
7.41	NIST
9.18	NIST, DIN 19266, JSI 8802, BSI
10.01	NIST, JSI 8802, BSI
12.45	NIST, DIN 19266

**Note 1:** NIST is National Institute of Standards, DIN is Deutsche Institute für Normung, JSI is Japan Standards Institute, and BSI is British Standards Institute.

**Note 2:** pH 7 buffer is not a standard buffer. It is a popular commercial buffer in the United States.

During automatic calibration, the transmitter also measures noise and drift and does not accept calibration data until readings are stable. Calibration data will be accepted as soon as the pH reading is constant to within the factory-set limits of 0.02 pH units for 10 seconds. The stability settings can be changed. See Section 7.10.

In manual calibration, the user judges when pH readings are stable. He also has to look up the pH of the buffer at the temperature it is being used and enter the value in the transmitter.

Once the transmitter completes the calibration, it calculates the calibration slope and offset. The slope is reported as the slope at 25°C. Figure 14-1 defines the terms.

The transmitter can also be standardized. Standardization is the process of forcing the transmitter reading to match the reading from a second pH instrument. Standardization is sometimes called a one-point calibration.

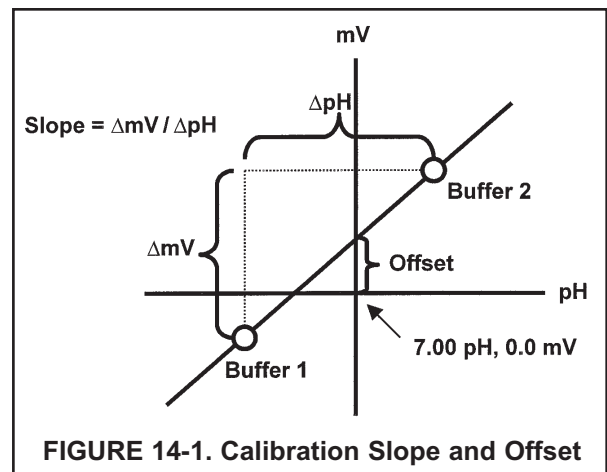

**FIGURE 14-1. Calibration Slope and Offset**

**14.2 PROCEDURE — AUTO CALIBRATION**

1. Obtain two buffer solutions. Ideally, the buffer values should bracket the range of pH values to be measured.
2. Remove the pH sensor from the process liquid. If the process and buffer temperatures are appreciably different, place the sensor in a container of tap water at the buffer temperature. Do not start the calibration until the sensor has reached the buffer temperature. Thirty minutes is usually adequate.

<b>Calibrate</b>	Hold
Program	Display

3. Press MENU. The main menu appears. Choose **Calibrate**.

Cal?	<b>pH</b>
Chlorine	Temp

4. Choose **pH**.

pH	Standardize
Slope	<b>BufferCal</b>

5. Choose **BufferCal**.

BufferCal?	
<b>Auto</b>	Manual

6. Choose **Auto**.

AutoCal?	Setup
<b>Buffer1</b>	Buffer2

7. To continue with the calibration, choose **Buffer1**. Then go to step 8. To change stability criteria, choose **Setup** and go to step 19.

8. Rinse the sensor with water and place it in buffer 1. Be sure the glass bulb and the reference junction are completely submerged. Swirl the sensor.

Live	7.00pH
AutoBuf1	<b>Wait</b>

9. The screen at left is displayed with "**Wait**" flashing until the reading is stable. The default stability setting is <0.02 pH change in 10 sec. To change the stability criteria, go to step 19. When the reading is stable, the screen in step 10 appears.

Live	7.00pH
AutoBuf1	<b>7.01pH</b>

10. The top line shows the actual reading. The transmitter also identifies the buffer and displays the nominal buffer value (buffer pH at 25°C). If the displayed value is not correct, press **↑** or **↓** to display the correct value. The nominal value will change, for example from 7.01 to 6.86 pH. Press ENTER to store.

Cal in progress.	
Please wait.	

11. The screen at left appears momentarily.

AutoCal?	Setup
Buffer1	<b>Buffer2</b>

12. The screen at left appears. Remove the sensor from Buffer 1, rinse it with water, and place it in Buffer 2. Be sure the glass bulb and the reference junction are completely submerged. Swirl the sensor. Choose **Buffer2**.

Live	10.01pH
AutoBuf2	<b>Wait</b>

13. The screen at left is displayed with "**Wait**" flashing until the reading is stable. When the reading is stable, the screen in step 14 appears.

```

Live          10.01pH
AutoBuf2     10.01pH

```

```

Cal in progress.
Please wait.

```

```

Offset          0mV
Slope          59.16025°C

```

```

Calibration
Error

```

```

Buffer Stabilize
Time:          10sec

```

```

Restart time if
change        >  0.02pH

```

14. The top line shows the actual reading. The transmitter also identifies the buffer and displays the nominal buffer value (buffer pH at 25°C). If the displayed value is not correct, press  $\uparrow$  or  $\downarrow$  to display the correct value. The nominal value will change, for example from 7.01 to 6.86 pH. Press ENTER to store.
15. The screen at left appears momentarily.
16. If the calibration was successful, the transmitter will display the offset and slope (at 25°). The display will return to the screen in step 6.
17. If the slope is out of range (less than 45 mV/pH or greater than 60 mV/pH) or if the offset exceeds the value programmed in Section 7.4, an error screen appears. The display then returns to the screen in step 6.
18. To return to the main display, press MENU then EXIT.
19. Choosing Setup in step 7 causes the **Buffer Stabilize** screen to appear. The transmitter will not accept calibration data until the pH reading is stable. The default requirement is a pH change less than 0.02 units in 10 seconds. To change the stability criteria:
  - a. Enter the desired stabilization time
  - b. Enter the minimum amount the reading is permitted to change in the time specified in step 19a.
20. To return to the main display, press MENU then EXIT.

### 14.3 PROCEDURE — MANUAL TWO-POINT CALIBRATION

- Obtain two buffer solutions. Ideally, the buffer values should bracket the range of pH values to be measured.
- Remove the pH sensor from the process liquid. If the process and buffer temperatures are appreciably different, place the sensor in a container of tap water at the buffer temperature. Do not start the calibration until the sensor has reached the buffer temperature. Thirty minutes is usually adequate. Make a note of the temperature.

<b>Calibrate</b>	Hold
Program	Display

- Press MENU. The main menu appears. Choose **Calibrate**.

Cal?	<b>pH</b>
Chlorine	Temp

- Choose **pH**.

pH	Standardize
Slope	<b>BufferCal</b>

- Choose **BufferCal**.

BufferCal?	
Auto	<b>Manual</b>

- Choose **Manual**.

AutoCal?	Setup
<b>Buffer1</b>	Buffer2

- Choose **Buffer1**.

Live	7.00pH
Buf1	<b>07.00pH</b>

- Rinse the sensor with water and place it in buffer 1. Be sure the glass bulb and reference junction are completely submerged. Swirl the sensor.

- The reading in the top line is the live pH reading. Wait until the live reading is stable. Then, use the arrow keys to change the reading in the second line to match the pH value of the buffer. The pH of buffer solutions is a function of temperature. Be sure to enter the pH of the buffer at the actual temperature of the buffer.

ManualCal?	
Buffer1	<b>Buffer2</b>

- Remove the sensor from buffer 1 and rinse it with water. Place it in buffer 2. Be sure the glass bulb and the reference junction are completely submerged. Swirl the sensor. Choose **Buffer2**.

Live	10.01pH
Buf1	<b>10.01pH</b>

- The reading in the top line is the live pH reading. Wait until the live reading is stable. Then, use the arrow keys to change the reading in the second line to match the pH value of the buffer. The pH of buffer solutions is a function of temperature. Be sure to enter the pH of the buffer at the actual temperature of the buffer.

Cal in progress.	
Please wait.	

- The screen at left appears momentarily.

Offset	0mV
Slope	59.16025°C

- If the calibration was successful, the transmitter will display the offset and slope (at 25°). The display will return to the screen in step 5.

Calibration	
Error	

- If the slope is out of range (less than 45 mV/pH or greater than 60 mV/pH) or if the offset exceeds the value programmed in Section 7.4, an error screen appears. The display then returns to the screen in step 6.

- To return to the main display, press MENU then EXIT.

### 14.4 PROCEDURE — STANDARDIZATION

1. The pH measured by the transmitter can be changed to match the reading from a second or referee instrument. The process of making the two readings agree is called standardization.
2. During standardization, the difference between the two values is converted to the equivalent voltage. The voltage, called the reference offset, is added to all subsequent measured cell voltages before they are converted to pH. If after standardization the sensor is placed in a buffer solution, the measured pH will differ from the buffer pH by an amount equivalent to the standardization offset.
3. Install the pH sensor in the process liquid.
4. Once readings are stable, measure the pH of the liquid using a referee instrument.
5. Because the pH of the process liquid may change if the temperature changes, measure the pH of the grab sample immediately after taking it.
6. For poorly buffered samples, it is best to determine the pH of a continuously flowing sample from a point as close as possible to the sensor.

<b>Calibrate</b>	Hold
Program	Display

7. Press MENU. The main menu appears. Choose **Calibrate**.

Cal?	<b>pH</b>
Chlorine	Temp

8. Choose **pH**.

pH:	<b>Standardize</b>
Slope	BufferCal

9. Choose **Standardize**.

Live	7.01pH
Cal	07.01pH

10. The top line shows the present reading. Use the arrow keys to change the pH reading in the second line to match the pH reading from the referee instrument.

Calibration
Error

11. The screen at left appears if the entered pH was greater than 14.00 or if the mV offset calculated by the transmitter during standardization exceeds the reference offset limit programmed into the transmitter. The display then returns to step 10. Repeat the standardization. To change the reference offset from the default value (60 mV), see section 7.4.

12. If the entry was accepted the display returns to step 9.

13. To return to the main display, press MENU then EXIT.

**14.5 PROCEDURE — ENTERING A KNOWN SLOPE VALUE.**

1. If the electrode slope is known from other measurements, it can be entered directly into the transmitter. The slope must be entered as the slope at 25°C. To calculate the slope at 25°C from the slope at temperature t°C, use the equation:

$$\text{slope at } 25^{\circ}\text{C} = (\text{slope at } t^{\circ}\text{C}) \frac{298}{t^{\circ}\text{C} + 273}$$

Changing the slope overrides the slope determined from the previous buffer calibration.

<b>Calibrate</b>	Hold
Program	Display

2. Press MENU. The main menu appears. Choose **Calibrate**.

Cal?	<b>pH</b>
Chlorine	Temp

3. Choose **pH**.

pH:	Standardize
<b>Slope</b>	BufferCal

4. Choose **slope**.

Changing slope
overrides bufcal.

5. The screen at left appears briefly.

pH Slope @25°C?
<b>59.16mV/pH</b>

6. Change the slope to the desired value. Press ENTER.

Invalid Input!
Min: 45.00mV/pH

7. The slope must be between 45 and 60 mV/pH. If the value entered is outside this range, the screen at left appears.

8. If the entry was accepted, the screen at left appears.

9. To return to the main display, press MENU then EXIT.



## SECTION 15.0 TROUBLESHOOTING

### 15.1 OVERVIEW

The Xmt-A-HT transmitter continuously monitors itself and the sensor for problems. If the transmitter detects a problem, the word "**fault**" or "**warn**" appears in the main display alternating with the measurement.

A **fault** condition means the measurement is seriously in error and is not to be trusted. A fault condition might also mean that the transmitter has failed. Fault conditions must be corrected immediately. When a fault occurs the output goes to 22.00 mA or the to value programmed in Section 7.3. The output can also be programmed to reflect the live measurement.

A **warning** means that the instrument is usable, but steps should be taken as soon as possible to correct the condition causing the warning.

See Section 15.2 for an explanation of fault and warning messages and suggested corrective actions.

The Xmt-A-HT also displays **error** and **warning messages** if a calibration is seriously in error. Refer to the section below for assistance. Each section also contains hints for correcting **other measurement and calibration problems**.

Measurement	Section
Temperature	15.3
Dissolved oxygen	15.4
Free chlorine	15.5
Total chlorine	15.6
Monochloramine	15.7
Ozone	15.8
pH	15.9

For **troubleshooting not related to measurement** problems, see Section 15.10.

#### NOTE

A large number of information screens are available to aid troubleshooting. The most useful of these are raw sensor current and sensitivity and zero current at last calibration. For pH measurements (available with free chlorine only), sensor slope and offset and glass impedance are also available. To view the information screens, go to the main display and press the ↓ key.

**15.2 TROUBLESHOOTING WHEN A FAULT OR WARNING MESSAGE IS SHOWING**

<b>Fault message</b>	<b>Explanation</b>	<b>See Section</b>
RTD Open	RTD measuring circuit is open	15.2.1
RTD W Overrange	RTD resistance is outside the range for Pt 100 or 22kNTC	15.2.1
Broken pH Glass	pH sensing element in pH sensor is broken	15.2.2
pH Glass Z High	pH glass impedance exceeds programmed level	15.2.2
ADC Read Error	Analog to digital converter failed	15.2.3

<b>Warning message</b>	<b>Explanation</b>	<b>See Section</b>
PV > DisplayLimit	Process variable value exceeds display limit	15.2.4
Sensor Curr High	Sensor input current exceed 210 uA	15.2.4
Sensor Curr Low	Sensor input current is a large negative number	15.2.4
Need Zero Cal	Sensor needs re-zeroing. Concentration reading is too negative.	15.2.5
pH mV Too High	mV signal from pH sensor is too big	15.2.6
No pH Soln GND	Solution ground terminal is not connected	15.2.7
Temperature High	Temperature reading exceeds 150°C	15.2.1
Temperature Low	Temperature reading is less than -15°C	15.2.1
Sense Line Open	RTD sense line is not connected	15.2.8
Need Factory Cal	Transmitter needs factory calibration	15.2.9
Ground >10% Off	Bad ground	15.2.10
EE Buffer Overflow	EEPROM buffer overflow	15.2.11
EE Chksum Error	EEPROM checksum error	15.2.12
EE Write Error	EEPROM write error	15.2.13

**15.2.1 RTD Open, RTD  $\Omega$  Overrange, Temperature High, Temperature Low**

These messages usually mean that the RTD (or thermistor in the case of the HX438 and GX448 sensors) is open or shorted or there is an open or short in the connecting wiring.

1. Verify all wiring connections, including wiring in a junction box, if one is being used.
2. Disconnect the RTD IN, RTD SENSE, and RTD RETURN leads or the thermistor leads at the transmitter. Be sure to note the color of the wire and where it was attached. Measure the resistance between the RTD IN and RETURN leads. For a thermistor, measure the resistance between the two leads. The resistance should be close to the value in the table in Section 15.14.2. If the temperature element is open (infinite resistance) or shorted (very low resistance), replace the sensor. In the meantime, use manual temperature compensation.
3. For oxygen measurements using the HX438 and GX448 sensors, or other steam-sterilizable sensor using a 22kNTC, the Temperature High error will appear if the transmitter was not properly configured. See Section 7.4.

### 15.2.2 Broken pH Glass and pH Glass Z High

These messages mean that the pH sensor glass impedance is outside the programmed limits. To read the impedance go to the main display and press ↓ until **Glass Imp** appears in the display. The default lower limit is 10 MΩ. The default upper limit is 1000 MΩ. Low glass impedance means the glass membrane — the sensing element in a pH sensor — is cracked or broken. High glass impedance means the membrane is aging and nearing the end of its useful life. High impedance can also mean the pH sensor is not completely submerged in the process liquid.

1. Check the sensor wiring, including connections in a junction box.
2. Verify that the sensor is completely submerged in the process liquid.
3. Verify that the software switch identifying the position of the preamplifier is properly set. See Section 7.4.
4. Check the sensor response in buffers. If the sensor can be calibrated, it is in satisfactory condition. To disable the fault message, reprogram the glass impedance limits to include the measured impedance. If the sensor cannot be calibrated, it has failed and must be replaced.

### 15.2.3 ADC Read Error

The analog to digital converter has probably failed.

1. Verify that sensor wiring is correct and connections are tight. Be sure to check connections at the junction box if one is being used. See Section 3.1 for wiring information.
2. Disconnect the sensor(s) and simulate temperature and sensor input.

To simulate	See Section
Dissolved oxygen	15.11
Ozone, monochloramine, chlorine	15.12
pH	15.13
Temperature	15.14

3. If the transmitter does not respond to simulate signals, call the factory for assistance.

### 15.2.4 PV>DisplayLimit, Sensor Curr High, Sensor Curr Low.

The first two messages imply that the amperometric sensor current is very high (greater than 210 μA) or the sensor current has a very large negative number. Normally, excessive current or negative current implies that the amperometric sensor is miswired or has failed. Occasionally, these messages may appear when a new sensor is first placed in service.

1. Verify that wiring is correct and connections are tight. Be sure to check connections at the junction box if one is being used. Pay particular attention the anode and cathode connections.
2. Verify that the transmitter is configured for the correct measurement. See Section 7.4. Configuring the measurements sets (among other things) the polarizing voltage. Applying the wrong polarizing voltage to the sensor can cause a large negative current.
3. If the sensor was just placed in service, put the sensor in the zero solution and observe the sensor current. It should be moving fairly quickly toward zero. To view the sensor current go to the main display and press ↓ until **Input Current** appears. Note the units: nA is nanoamps, μA is microamps.
4. Replace the sensor membrane and electrolyte solution and clean the cathode if necessary. See the sensor instruction sheet for details.
5. Replace the sensor.

### 15.2.5 Need Zero Cal

Need Zero Cal means the measured concentration is a large negative number. The transmitter subtracts the zero current from the measured current before converting the result to a concentration reading. If the zero current is much greater than the measured current, the concentration reading will be negative.

1. Check the zero current and the present sensor current. To view the zero current, go to the main display and press ↓ until **Zero Current** appears. The value shown is the zero current the last time the sensor was zeroed. To view the present sensor current, go to the main display and press ↓ until **Input Current** appears. Note the units: nA is nanoamps, μA is microamps.
2. Refer to the appropriate section for calibrating the sensor. Place the sensor in the zero solution. Verify that the sensor reading is within or at least very close to the zero current limits. It may take as long as overnight for the sensor to reach a stable zero current.

### 15.2.6 pH mV Too High

This message means the raw millivolt signal from the sensor is outside the range -2100 to 2100 mV.

1. Verify all wiring connections, including connections in a junction box.
2. Check that the pH sensor is completely submerged in the process liquid.
3. Check the pH sensor for cleanliness. If the sensor look fouled or dirty, clean it. Refer to the sensor instruction manual for cleaning procedures.

### 15.2.7 No pH Soln GND

In the transmitter, the solution ground (Soln GND) terminal is connected to instrument common. Normally, unless the pH sensor has a solution ground, the reference terminal must be jumpered to the solution ground terminal. **HOWEVER, WHEN THE pH SENSOR IS USED WITH A FREE CHLORINE SENSOR THIS CONNECTION IS NEVER MADE.**

### 15.2.8 Sense Line Open

Most Rosemount Analytical sensors use a Pt100 or Pt1000 RTD in a three-wire configuration (see Figure 15-4). The in and return leads connect the RTD to the measuring circuit in the transmitter. A third wire, called the sense line, is connected to the return lead. The sense line allows the transmitter to correct for the resistance of the in and return leads and to correct for changes in lead wire resistance with changes in ambient temperature.

1. Verify that all wiring connections are secure, including connections in a junction box.
2. Disconnect the RTD SENSE and RTD RETURN wires. Measure the resistance between the leads. It should be less than 5Ω.
3. The transmitter can be operated with the sense line open. The measurement will be less accurate because the transmitter can no longer compensate for lead wire resistance. However, if the sensor is to be used at approximately constant ambient temperature, the lead wire resistance error can be eliminated by calibrating the sensor at the measurement temperature. Errors caused by changes in ambient temperature cannot be eliminated. To make the warning message disappear, connect the RTD SENSE and RETURN terminals with a jumper.

### 15.2.9 Need Factory Cal

This warning message means the transmitter requires factory calibration. Call the factory for assistance.

### 15.2.10 Ground >10% Off

This warning message means there is a problem with the analog circuitry. Call the factory for assistance.

**15.2.11 EE Buffer Overflow**

**EE Buffer Overflow** means the software is trying to change too many background variables at once. Remove power from the transmitter for about 30 seconds. If the warning message does not disappear once power is restored, call the factory for assistance.

**15.2.12 EE Chksum Error**

**EE Chksum Error** means a software setting changed when it was not supposed to. The EEPROM may be going bad. Call the factory for assistance.

**15.2.13 EE Write Error**

**EE Write Error** usually means at least one byte in the EEPROM has gone bad. Try entering the data again. If the error message continues to appear, call the factory for assistance.

**15.3 TROUBLESHOOTING WHEN NO FAULT MESSAGE IS SHOWING - TEMPERATURE****15.3.1 Temperature measured by standard was more than 1°C different from controller.**

- A. Is the standard thermometer, RTD, or thermistor accurate? General purpose liquid-in-glass thermometers, particularly ones that have been mistreated, can have surprisingly large errors.
- B. Is the temperature element in the sensor completely submerged in the liquid?
- C. Is the standard temperature sensor submerged to the correct level?

**15.4 TROUBLESHOOTING WHEN NO FAULT MESSAGE IS SHOWING - OXYGEN**

<b>Problem</b>	<b>See Section</b>
Zero current was accepted, but current is greater than the value in the table in Section 7.2	15.4.1
Error or warning message while zeroing the sensor (zero current is too high)	15.4.1
Zero reading is unstable	15.4.2
Sensor can be calibrated, but current is outside the range in the table in Section 7.3	15.4.3
Possible error warning during air calibration	15.4.3
Possible error warning during in-process calibration	15.4.4
Process readings are erratic	15.4.5
Readings drift	15.4.6

**15.4.1 Zero current is too high**

- A. Is the sensor properly wired to the analyzer? See Section 3.0.
- B. Is the membrane completely covered with zero solution and are air bubbles not trapped against the membrane? Swirl and tap the sensor to release air bubbles.
- C. Is the zero solution fresh and properly made? Zero the sensor in a solution of 5% sodium sulfite in water. Prepare the solution immediately before use. It has a shelf life of only a few days.
- D. If the sensor is being zeroed with nitrogen gas, verify that the nitrogen is oxygen-free and the flow is adequate to prevent back-diffusion of air into the chamber.
- E. The major contributor to the zero current is dissolved oxygen in the electrolyte solution inside the sensor. A long zeroing period usually means that an air bubble is trapped in the electrolyte. To ensure the 499ADO or 499A TrDO sensor contains no air bubbles, carefully follow the procedure in the sensor manual for filling the sensor. If the electrolyte solution has just been replaced, allow several hours for the zero current to stabilize. On rare occasions, the sensor may require as long as overnight to zero.
- F. Check the membrane for damage and replace the membrane if necessary

**15.4.2 Zero reading is unstable.**

- A. Is the sensor properly wired to the analyzer? See Section 3.0. Verify that all wiring connections are tight.
- B. Readings are often erratic when a new or rebuilt sensor is first placed in service. Readings usually stabilize after an hour.
- C. Is the space between the membrane and cathode filled with electrolyte solution and is the flow path between the electrolyte reservoir and the membrane clear? Often the flow of electrolyte can be started by simply holding the sensor with the membrane end pointing down and sharply shaking the sensor a few times as though shaking down a clinical thermometer. If shaking does not work, perform the checks below. Refer to the sensor instruction manuals for additional information.

For 499ADO and 499A TrDO sensors, verify that the holes at the base of the cathode stem are open (use a straightened paperclip to clear the holes). Also verify that air bubbles are not blocking the holes. Fill the reservoir and establish electrolyte flow to the cathode. Refer to the sensor instruction manual for the detailed procedure.

For Gx438 and Hx438 sensors, the best way to ensure that there is an adequate supply of electrolyte solution is to simply add fresh electrolyte solution to the sensor. Refer to the sensor instruction manual for details.

**15.4.3 Sensor can be calibrated, but current in air is too high or too low**

- A. Is the sensor properly wired to the analyzer? See Section 3.0. Verify that all connections are tight.
- B. Is the membrane dry? The membrane must be dry during air calibration. A droplet of water on the membrane during air calibration will lower the sensor current and cause an inaccurate calibration.
- C. If the sensor current in air is very low and the sensor is new, either the electrolyte flow has stopped or the membrane is torn or loose. For instructions on how to restart electrolyte flow see Section 15.4.2 or refer to the sensor instruction manual. To replace a torn membrane, refer to the sensor instruction manual.
- D. Is the temperature low? Sensor current is a strong function of temperature. The sensor current decreases about 3% for every °C drop in temperature.
- E. Is the membrane fouled or coated? A dirty membrane inhibits diffusion of oxygen through the membrane, reducing the sensor current. Clean the membrane by rinsing it with a stream of water from a wash bottle or by gently wiping the membrane with a soft tissue. If cleaning the membrane does not improve the sensor response, replace the membrane and electrolyte solution. If necessary, polish the cathode. See the sensor instruction sheet for more information.

**15.4.4 Possible error warning during in-process calibration**

This error warning appears if the current process reading and the reading it is being changed to, ie, the reading from the standard instrument, are appreciably different.

- A. Is the standard instrument properly zeroed and calibrated?
- B. Are the standard and process sensor measuring the same sample? Place the sensors as close together as possible.
- C. Is the process sensor working properly? Check the response of the process sensor in air and in sodium sulfite solution.

**15.4.5 Process readings are erratic.**

- A. Readings are often erratic when a new sensor or a rebuilt sensor is first placed in service. The current usually stabilizes after a few hours.
- B. Is the sample flow within the recommended range? High sample flow may cause erratic readings. Refer to the sensor instruction manual for recommended flow rates.
- C. Gas bubbles impinging on the membrane may cause erratic readings. Orienting the sensor at an angle away from vertical may reduce the noise.
- D. The holes between the membrane and electrolyte reservoir might be plugged (applies to Models 499A DO and 499A TrDO sensors only). Refer to Section 15.4.2.
- E. Verify that wiring is correct. Pay particular attention to shield and ground connections.
- F. Is the membrane in good condition and is the sensor filled with electrolyte solution? Replace the fill solution and electrolyte. Refer to the sensor instruction manual for details.

**15.4.6 Readings drift.**

- A. Is the sample temperature changing? Membrane permeability is a function of temperature. For the 499ADO and 499ATrDO sensors, the time constant for response to a temperature change is about 5 minutes. Therefore, the reading may drift for a while after a sudden temperature change. The time constant for the Gx438 and Hx448 sensors is much shorter; these sensors respond fairly rapidly to temperature changes.
- B. Is the membrane clean? For the sensor to work properly oxygen must diffuse freely through the membrane. A coating on the membrane will interfere with the passage of oxygen, resulting in slow response.
- C. Is the sensor in direct sunlight? If the sensor is in direct sunlight during air calibration, readings will drift as the sensor warms up. Because the temperature reading lags the true temperature of the membrane, calibrating the sensor in direct sunlight may introduce an error.
- D. Is the sample flow within the recommended range? Gradual loss of sample flow will cause downward drift.
- E. Is the sensor new or has it been recently serviced? New or rebuilt sensors may require several hours to stabilize.

**15.4.7 Sensor does not respond to changes in oxygen level.**

- A. If readings are being compared with a portable laboratory instrument, verify that the laboratory instrument is working.
- B. Is the membrane clean? Clean the membrane and replace it if necessary. Check that the holes at the base of the cathode stem are open. Use a straightened paper clip to clear blockages. Replace the electrolyte solution.
- C. Replace the sensor.

**15.4.8 Oxygen readings are too low.**

- A. Low readings can be caused by zeroing the sensor before the residual current has reached a stable minimum value. Residual current is the current the sensor generates even when no oxygen is in the sample. Because the residual current is subtracted from subsequent measured currents, zeroing before the current is a minimum can lead to low results.  
Example: the true residual (zero) current for a 499ADO sensor is  $0.05 \mu\text{A}$ , and the sensitivity based on calibration in water-saturated air is  $2.35 \mu\text{A/ppm}$ . Assume the measured current is  $2.00 \mu\text{A}$ . The true concentration is  $(2.00 - 0.05)/2.35$  or  $0.83 \text{ ppm}$ . If the sensor was zeroed prematurely when the current was  $0.2 \mu\text{A}$ , the measured concentration will be  $(2.00 - 0.2)/2.35$  or  $0.77 \text{ ppm}$ . The error is 7.2%. Suppose the measured current is  $5.00 \mu\text{A}$ . The true concentration is  $2.11 \text{ ppm}$ , and the measured concentration is  $2.05 \text{ ppm}$ . The error is now 3.3%. The absolute difference between the readings remains the same,  $0.06 \text{ ppm}$ .
- B. Sensor response depends on flow. If the flow is too low, readings will be low and flow sensitive. Verify that the flow past the sensor equals or exceeds the minimum value. See the sensor instruction manual for recommended flows. If the sensor is in an aeration basin, move the sensor to an area where the flow or agitation is greater.



**15.5 TROUBLESHOOTING WHEN NO FAULT MESSAGE IS SHOWING - FREE CHLORINE**

<b>Problem</b>	<b>See Section</b>
Zero current was accepted, but the current is outside the range -10 to 10 nA	15.5.1
Error or warning message appears while zeroing the sensor (zero current is too high)	15.5.1
Zero current is unstable	15.5.2
Sensor can be calibrated, but the current is less than about 250 nA/ppm at 25°C and pH 7	15.5.3
Process readings are erratic	15.5.4
Readings drift	15.5.5
Sensor does not respond to changes in chlorine level	15.5.6
Chlorine reading spikes following rapid change in pH	15.5.7

**15.5.1 Zero current is too high**

- A. Is the sensor properly wired to the controller. See Section 3.0.
- B. Is the zero solution chlorine-free? Take a sample of the solution and test it for free chlorine level. The concentration should be less than 0.02 ppm.
- C. Has adequate time been allowed for the sensor to reach a minimum stable residual current? It may take several hours, sometimes as long as overnight, for a new sensor to stabilize.
- D. Check the membrane for damage and replace it if necessary.

**15.5.2 Zero current is unstable**

- A. Is the sensor properly wired to the analyzer? See Section 3.0. Verify that all wiring connections are tight.
- B. Readings are often erratic when a new or rebuilt sensor is first placed in service. Readings usually stabilize after about an hour.
- C. Is the conductivity of the zero solution greater than 50  $\mu\text{S}/\text{cm}$ ? **DO NOT USE DEIONIZED OR DISTILLED WATER TO ZERO THE SENSOR.** The zero solution should contain at least 0.5 grams of sodium chloride per liter.
- D. Is the space between the membrane and cathode filled with electrolyte solution and is the flow path between the electrolyte reservoir and membrane clear? Often the flow of electrolyte and be started by simply holding the sensor with the membrane end pointing down and sharply shaking the sensor a few times as though shaking down a clinical thermometer.

If shaking does not work, try clearing the holes around the cathode stem. Hold the sensor with the membrane end pointing up. Unscrew the membrane retainer and remove the membrane assembly. Be sure the wood ring remains with the membrane assembly. Use the end of a straightened paper clip to clear the holes at the base of the cathode stem. Replace the membrane.

Verify that the sensor is filled with electrolyte solution. Refer to the sensor instruction manual for details.



**15.5.3 Sensor can be calibrated, but the current is too low**

- A. Is the temperature low or is the pH high? Sensor current is a strong function of pH and temperature. The sensor current decreases about 3% for every °C drop in temperature. Sensor current also decreases as pH increases. Above pH 7, a 0.1 unit increase in pH lowers the current about 5%.
- B. Sensor current depends on the rate of sample flow past the sensor tip. If the flow is too low, chlorine readings will be low. Refer to the sensor instruction sheet for recommended sample flows.
- C. Low current can be caused by lack of electrolyte flow to the cathode and membrane. See step D in Section 15.5.2.
- D. Is the membrane fouled or coated? A dirty membrane inhibits diffusion of free chlorine through the membrane, reducing the sensor current and increasing the response time. Clean the membrane by rinsing it with a stream of water from a wash bottle. **DO NOT** use a membrane or tissue to wipe the membrane.
- E. If cleaning the membrane does not improve the sensor response, replace the membrane and electrolyte solution. If necessary, polish the cathode. See the sensor instruction sheet for details.

**15.5.4 Process readings are erratic**

- A. Readings are often erratic when a new sensor or a rebuilt sensor is first placed in service. The current usually stabilizes after a few hours.
- B. Is the sample flow within the recommended range? High sample flow may cause erratic readings. Refer to the sensor instruction sheet for recommended flow rates.
- C. Are the holes between the membrane and the electrolyte reservoir open. Refer to Section 15.5.2.
- D. Verify that wiring is correct. Pay particular attention to shield and ground connections.
- E. If automatic pH correction is being used, check the pH reading. If the pH reading is noisy, the chlorine reading will also be noisy. If the pH sensor is the cause of the noise, use manual pH correction until the problem with the pH sensor can be corrected.
- F. Is the membrane in good condition and is the sensor filled with electrolyte solution? Replace the fill solution and electrolyte. Refer to the sensor instruction manual for details.

**15.5.5 Readings drift**

- A. Is the sample temperature changing? Membrane permeability is a function of temperature. The time constant for the 499ACL-01 sensor is about five minutes. Therefore, the reading may drift for a while after a sudden temperature change.
- B. Is the membrane clean? For the sensor to work properly, chlorine must diffuse freely through the membrane. A coating on the membrane will interfere with the passage of chlorine, resulting in slow response. Clean the membrane by rinsing it with a stream of water from a wash bottle. **DO NOT** use a membrane or tissue to wipe the membrane.
- C. Is the sample flow within the recommended range? Gradual loss of sample flow will cause a downward drift.
- D. Is the sensor new or has it been recently serviced? New or rebuilt sensors may require several hours to stabilize.
- E. Is the pH of the process changing? If manual pH correction is being used, a gradual change in pH will cause a gradual change in the chlorine reading. As pH increases, chlorine readings will decrease, even though the free chlorine level (as determined by a grab sample test) remained constant. If the pH change is no more than about 0.2, the change in the chlorine reading will be no more than about 10% of reading. If the pH changes are more than 0.2, use automatic pH correction.

**15.5.6 Sensor does not respond to changes in chlorine level.**

- A. Is the grab sample test accurate? Is the grab sample representative of the sample flowing to the sensor?
- B. Is the pH compensation correct? If the controller is using manual pH correction, verify that the pH value in the controller equals the actual pH to within  $\pm 0.1$  pH. If the controller is using automatic pH correction, check the calibration of the pH sensor.
- C. Is the membrane clean? Clean the membrane and replace it if necessary. Check that the holes at the base of the cathode stem are open. Use a straightened paper clip to clear blockages. Replace the electrolyte solution.
- D. Replace the sensor.

**15.5.7 Chlorine readings spike following sudden changes in pH (automatic pH correction).**

Changes in pH alter the relative amounts of hypochlorous acid (HOCl) and hypochlorite ion (OCl<sup>-</sup>) in the sample. Because the sensor responds only to HOCl, an increase in pH causes the sensor current (and the apparent chlorine level) to drop even though the actual free chlorine concentration remained constant. To correct for the pH effect, the controller automatically applies a correction. Generally, the pH sensor responds faster than the chlorine sensor. After a sudden pH change, the controller will temporarily over-compensate and gradually return to the correct value. The time constant for return to normal is about 5 minutes.

**15.5.8 Chlorine readings are too low.**

- A. Was the sample tested as soon as it was taken? Chlorine solutions are unstable. Test the sample immediately after collecting it. Avoid exposing the sample to sunlight.
- B. Low readings can be caused by zeroing the sensor before the residual current has reached a stable minimum value. Residual current is the current the sensor generates even when no chlorine is in the sample. Because the residual current is subtracted from subsequent measured currents, zeroing before the current is a minimum can lead to low results.

Example: The true residual current for a free chlorine sensor is 4 nA, and the sensitivity is 350 nA/ppm. Assume the measured current is 200 nA. The true concentration is  $(200-4)/350$  or 0.56 ppm. If the sensor was zeroed prematurely when the current was 10 nA, the measured concentration will be  $(200-10)/350$  or 0.54 ppm. The error is 3.6%. Suppose the measured current is 400 nA. The true concentration is 1.13 ppm, and the measured concentration is 1.11 ppm. The error is now 1.8%. The absolute difference between the reading remains the same, 0.02 ppm.

- C. Sensor response depends on flow. If the flow is too low, readings will be low and flow sensitive. Verify that the flow past the sensor equals or exceeds the minimum value. See the sensor instruction manual for recommended flows.

**15.6 TROUBLESHOOTING WHEN NO FAULT MESSAGE IS SHOWING - TOTAL CHLORINE**

Refer to the instruction manual for the SCS921 for a complete troubleshooting guide.

## 15.7 TROUBLESHOOTING WHEN NO ERROR MESSAGE IS SHOWING — MONOCHLORAMINE

Problem	See Section
Zero current was accepted, but the current is outside the range -10 to 50 nA	15.7.1
Error or warning message appears while zeroing the sensor (zero current is too high)	15.7.1
Zero current is unstable	15.7.2
Sensor can be calibrated, but the current is less than about 250 nA/ppm at 25°C	15.7.3
Process readings are erratic	15.7.4
Readings drift	15.7.5
Sensor does not respond to changes in monochloramine level	15.7.6

### 15.7.1 Zero current is too high

- A. Is the sensor properly wired to the analyzer? See Section 3.0.
- B. Is the zero solution monochloramine-free? Take a sample of the solution and test it for monochloramine level. The concentration should be less than 0.02 ppm.
- C. Has adequate time been allowed for the sensor to reach a minimum stable residual current? It may take several hours, sometimes as long as overnight, for a new sensor to stabilize.
- D. Check the membrane for damage and replace it if necessary. Be careful not to touch the membrane or cathode. Touching the cathode mesh may damage it.

### 15.7.2 Zero current is unstable

- A. Is the sensor properly wired to the analyzer? See Section 3.0. Verify that all wiring connections are tight.
- B. Readings are often erratic when a new or rebuilt sensor is first placed in service. Readings usually stabilize after about an hour.
- C. Is the space between the membrane and cathode mesh filled with electrolyte solution? Often the flow of electrolyte and be started by simply holding the sensor with the membrane end pointing down and sharply shaking the sensor a few times as though shaking down a clinical thermometer.  
Verify that the sensor is filled with electrolyte solution. Refer to the sensor instruction manual for details.

**15.7.3 Sensor can be calibrated, but the current is too low**

- A. Is the temperature low? The sensor current decreases about 5% for every °C drop in temperature.
- B. Sensor current depends on the rate of sample flow past the sensor tip. If the flow is too low, monochloramine readings will be low. Refer to the sensor instruction sheet for recommended sample flows.
- C. Low current can be caused by lack of electrolyte flow to the cathode and membrane. See step C in Section 15.7.2.
- D. When was the sensor fill solution last replaced? The monochloramine sensor loses sensitivity, that is, it generates less current per ppm of monochloramine, as it operates. Gradual loss of sensitivity can usually be compensated for by calibrating the sensor weekly. After about two months, the sensitivity will have dropped to about 70% of its original value. At this point, the electrolyte solution and membrane should be replaced. Refer to the sensor instruction manual.
- E. Is the membrane fouled or coated? A dirty membrane inhibits diffusion of monochloramine through the membrane, reducing the sensor current and increasing the response time. Clean the membrane by rinsing it with a stream of water from a wash bottle. **DO NOT** use a membrane or tissue to wipe the membrane.
- F. If cleaning the membrane does not improve the sensor response, replace the membrane and electrolyte solution. See the sensor instruction sheet for details.

**15.7.4 Process readings are erratic**

- A. Readings are often erratic when a new sensor or rebuilt sensor is first placed in service. The current usually stabilizes after a few hours.
- B. Is the sample flow within the recommended range? High sample flow may cause erratic readings. Refer to the sensor instruction sheet for recommended flow rates.
- C. Verify that wiring is correct. Pay particular attention to shield and ground connections.
- D. Is the membrane in good condition and is the sensor filled with electrolyte solution? Replace the fill solution and electrolyte. Refer to the sensor instruction manual for details.

**15.7.5 Readings drift**

- A. Is the sample temperature changing? Membrane permeability is a function of temperature. The time constant for the sensor is about five minutes. Therefore, the reading may drift for a while after a sudden temperature change.
- B. Is the membrane clean? For the sensor to work properly, monochloramine must diffuse freely through the membrane. A coating on the membrane will interfere with the passage of monochloramine, resulting in slow response. Clean the membrane by rinsing it with a stream of water from a wash bottle. **DO NOT** use a membrane or tissue to wipe the membrane.
- C. Is the sample flow within the recommended range? Gradual loss of sample flow will cause a downward drift.
- D. Is the sensor new or has it been recently serviced? New or rebuilt sensors may require several hours to stabilize.
- E. Gradual downward drift is caused by depletion of the fill solution. Normally, calibrating the sensor every week adequately compensates for the drift. After the sensor has been in service for several months, it will probably be necessary to replace the fill solution and membrane. Refer to the sensor instruction manual for details.

**15.7.6 Sensor does not respond to changes in monochloramine level.**

- A. Is the grab sample test accurate? Is the grab sample representative of the sample flowing to the sensor?
- B. When was the sensor fill solution last replaced? The monochloramine sensor loses sensitivity, that is, it generates less current per ppm of monochloramine, as it operates. After about two months, the sensitivity will have dropped to about 70% of its original value. If the fill solution is extremely old, the sensor may be completely non-responsive to monochloramine. Replace the fill solution and membrane. See the sensor instruction manual for details.
- C. Is the membrane clean? Clean the membrane with a stream of water and replace it if necessary.
- D. Replace the sensor.

**15.7.7 Readings are too low.**

- A. Was the sample tested as soon as it was taken? Monochloramine solutions are moderately unstable. Test the sample immediately after collecting it. Avoid exposing the sample to sunlight.
- B. When was the sensor fill solution last replaced? The monochloramine sensor loses sensitivity, that is, it generates less current per ppm of monochloramine, as it operates. Generally, calibrating the sensor every week compensates for the gradual loss in sensitivity. After about two months, the sensitivity will have dropped to about 70% of its original value. At this point, the electrolyte solution and membrane should be replaced. Refer to the sensor instruction manual.
- C. Low readings can be caused by zeroing the sensor before the residual current has reached a stable minimum value. Residual current is the current the sensor generates even when no monochloramine is in the sample. Because the residual current is subtracted from subsequent measured currents, zeroing before the current is a minimum can lead to low results.

Example: The true residual current for a monochloramine sensor is 20 nA, and the sensitivity is 400 nA/ppm. Assume the measured current is 600 nA. The true concentration is  $(600-20)/400$  or 1.45 ppm. If the sensor was zeroed prematurely when the current was 40 nA, the measured concentration will be  $(600-40)/400$  or 1.40 ppm. The error is 3.5%. Suppose the measured current is 800 nA. The true concentration is 1.95 ppm, and the measured concentration is 1.90 ppm. The error is now 2.6%. The absolute difference between the reading remains the same, 0.05 ppm.

- D. Sensor response depends on flow. If the flow is too low, readings will be low and flow sensitive. Verify that the flow past the sensor equals or exceeds the minimum value. See the sensor instruction manual for recommended flows.

**15.8 TROUBLESHOOTING WHEN NO FAULT MESSAGE IS SHOWING - OZONE**

<b>Problem</b>	<b>See Section</b>
Zero current was accepted, but the current is outside the range -10 to 10 nA	15.8.1
Error or warning message appears while zeroing the sensor (zero current is too high)	15.8.1
Zero current is unstable	15.8.2
Sensor can be calibrated, but the current is less than about 350 nA/ppm at 25°C	15.8.3
Process readings are erratic	15.8.4
Readings drift	15.8.5
Sensor does not respond to changes in ozone level	15.8.6
Ozone readings are too low	15.8.7

**15.8.1 Zero current is too high**

- A. Is the sensor properly wired to the controller. See Section 3.0.
- B. Is the zero solution ozone free? Test the zero solution for ozone level. The concentration should be less than 0.02 ppm.
- C. Has adequate time been allowed for the sensor to reach a minimum stable residual current? It may take several hours, sometimes as long as overnight, for a new sensor to stabilize.
- D. Check the membrane for damage and replace it if necessary.

**15.8.2 Zero current is unstable**

- A. Is the sensor properly wired to the analyzer? See Section 3.0. Verify that all wiring connections are tight.
- B. Readings are often erratic when a new or rebuilt sensor is first placed in service. Readings usually stabilize after about an hour.
- C. Is the space between the membrane and cathode filled with electrolyte solution and is the flow path between the electrolyte reservoir and membrane clear? Often the flow of electrolyte can be started by simply holding the sensor with the membrane end pointing down and sharply shaking the sensor a few times as though shaking down a clinical thermometer.

If shaking does not work, try clearing the holes around the cathode stem. Hold the sensor with the membrane end pointing up. Unscrew the membrane retainer and remove the membrane assembly. Be sure the wood ring remains with the membrane assembly. Use the end of a straightened paper clip to clear the holes at the base of the cathode stem. Replace the membrane.

Verify that the sensor is filled with electrolyte solution. Refer to the sensor instruction manual for details.

**15.8.3 Sensor can be calibrated, but the current is too low**

- A. Sensor current is a strong function of temperature. The sensor current decreases about 3% for every °C drop in temperature.
- B. Sensor current depends on the rate of sample flow past the sensor tip. If the flow is too low, ozone readings will be low. Refer to the sensor instruction sheet for recommended sample flows.
- C. Low current can be caused by lack of electrolyte flow to the cathode and membrane. See step C in Section 15.8.2.
- D. Is the membrane fouled or coated? A dirty membrane inhibits diffusion of ozone through the membrane, reducing the sensor current and increasing the response time. Clean the membrane by rinsing it with a stream of water from a wash bottle or gently wipe the membrane with a soft tissue.

If cleaning the membrane does not improve the sensor response, replace the membrane and electrolyte solution. If necessary, polish the cathode. See the sensor instruction sheet for details.

**15.8.4 Process readings are erratic**

- A. Readings are often erratic when a new sensor or a rebuilt sensor is first placed in service. The current usually stabilizes after a few hours.
- B. Is the sample flow within the recommended range? High sample flow may cause erratic readings. Refer to the sensor instruction sheet for recommended flow rates.
- C. Are the holes between the membrane and the electrolyte reservoir open. Refer to Section 15.8.2.
- D. Verify that wiring is correct. Pay particular attention to shield and ground connections.
- E. Is the membrane in good condition and is the sensor filled with electrolyte solution? Replace the fill solution and electrolyte. Refer to the sensor instruction manual for details.

**15.8.5 Readings drift**

- A. Is the sample temperature changing? Membrane permeability is a function of temperature. The time constant for the 499AOZ sensor is about five minutes. Therefore, the reading may drift for a while after a sudden temperature change.
- B. Is the membrane clean? For the sensor to work properly, ozone must diffuse freely through the membrane. A coating on the membrane will interfere with the passage of ozone, resulting in slow response. Clean the membrane by rinsing it with a stream of water from a wash bottle, or gently wipe the membrane with a soft tissue.
- C. Is the sample flow within the recommended range? Gradual loss of sample flow will cause a downward drift.
- D. Is the sensor new or has it been recently serviced. New or rebuilt sensors may require several hours to stabilize.

**15.8.6 Sensor does not respond to changes in ozone level.**

- A. Is the grab sample test accurate? Is the grab sample representative of the sample flowing to the sensor?
- B. Is the membrane clean? Clean the membrane and replace it if necessary. Check that the holes at the base of the cathode stem are open. Use a straightened paper clip to clear blockages. Replace the electrolyte solution.
- C. Replace the sensor.

**15.8.7 Ozone readings are too low.**

- A. Was the sample tested as soon as it was taken? Ozone solutions are highly unstable. Test the sample immediately after collecting it.
- B. Low readings can be caused by zeroing the sensor before the residual current has reached a stable minimum value. Residual current is the current the sensor generates even when no ozone is in the sample. Because the residual current is subtracted from subsequent measured currents, zeroing before the current is a minimum can lead to low results.

Example: The true residual current for an ozone sensor is 4 nA, and the sensitivity is 350 nA/ppm. Assume the measured current is 200 nA. The true concentration is  $(200-4)/350$  or 0.560 ppm. If the sensor was zeroed prematurely when the current was 10 nA, the measured concentration will be  $(200-10)/350$  or 0.543 ppm. The error is 3.6%. Suppose the measured current is 100 nA. The true concentration is 0.274 ppm, and the measured concentration is 0.257 ppm. The error is now 6.2%. The absolute difference between the reading remains the same, 0.017 ppm.

- C. Sensor response depends on flow. If the flow is too low, readings will be low and flow sensitive. Verify that the flow past the sensor equals or exceeds the minimum value. See the sensor instruction manual for recommended flows.



**15.9 TROUBLESHOOTING WHEN NO FAULT MESSAGE IS SHOWING - pH**

<b>Problem</b>	<b>See Section</b>
Warning or error message during two-point calibration	15.9.1
Warning or error message during standardization	15.9.2
Controller will not accept manual slope	15.9.3
Sensor does not respond to known pH changes	15.9.4
Calibration was successful, but process pH is slightly different from expected value	15.9.5
Calibration was successful, but process pH is grossly wrong and/or noisy	15.9.6
Process reading is noisy	15.9.7

**15.9.1 Warning or error message during two-point calibration.**

Once the two-point (manual or automatic) calibration is complete, the transmitter automatically calculates the sensor slope (at 25°C). If the slope is less than 45 mV/pH, the transmitter displays a "Slope error low" message. If the slope is greater than 60 mV/pH, the transmitter displays a "Slope error high" message. The transmitter will not update the calibration. Check the following:

- A. Are the buffers accurate? Inspect the buffers for obvious signs of deterioration, such as turbidity or mold growth. Neutral and slightly acidic buffers are highly susceptible to molds. Alkaline buffers (pH 9 and greater), if they have been exposed to air for long periods, may also be inaccurate. Alkaline buffers absorb carbon dioxide from the atmosphere, which lowers the pH. If a high pH buffer was used in the failed calibration, repeat the calibration using a fresh buffer. If fresh buffer is not available, use a lower pH buffer. For example, use pH 4 and pH 7 buffer instead of pH 7 and pH 10 buffer.
- B. Was adequate time allowed for temperature equilibration? If the sensor was in a process liquid substantially hotter or colder than the buffer, place it in a container of water at ambient temperature for at least 20 minutes before starting the calibration.
- C. Were correct pH values entered during manual calibration? Using auto calibration eliminates error caused by improperly entered values.
- D. Is the sensor properly wired to the analyzer? Check sensor wiring including any connections in a junction box. See Section 3.3.
- E. Is the sensor dirty or coated? See the sensor instruction sheet for cleaning instructions.
- F. Is the sensor faulty? Check the glass impedance. From the main display, press the  $\blacktriangledown$  key until the "Glass impeded" screen is showing. Refer to the table for an interpretation of the glass impedance value.

less than 10 M $\Omega$	Glass bulb is cracked or broken. Sensor has failed.
between 10 M $\Omega$ and 1000 M $\Omega$	Normal reading
greater than 1000 M $\Omega$	pH sensor may be nearing the end of its service life.

- G. Is the transmitter faulty? The best way to check for a faulty transmitter is to simulate pH inputs. See Section 15.13.



**15.9.2 Warning or error message during two-point calibration.**

During standardization, the millivolt signal from the pH cell is increased or decreased until it agrees with the pH reading from a reference instrument. A unit change in pH requires an offset of about 59 mV. The controller limits the offset to  $\pm 1400$  mV. If the standardization causes an offset greater than  $\pm 1400$  mV, the analyzer will display the Calibration Error screen. The standardization will not be updated. Check the following:

- A. Is the referee pH meter working and properly calibrated? Check the response of the referee sensor in buffers.
- B. Is the process sensor working properly? Check the process sensor in buffers.
- C. Is the sensor fully immersed in the process liquid? If the sensor is not completely submerged, it may be measuring the pH of the liquid film covering the glass bulb and reference element. The pH of this film may be different from the pH of the bulk liquid.
- D. Is the sensor fouled? The sensor measures the pH of the liquid adjacent to the glass bulb. If the sensor is heavily fouled, the pH of liquid trapped against the bulb may be different from the bulk liquid.
- E. Has the sensor been exposed to poisoning agents (sulfides or cyanides) or has it been exposed to extreme temperature? Poisoning agents and high temperature can shift the reference voltage many hundred millivolts. To check the reference voltage, see Section 15.15.

**15.9.3 Controller will not accept manual slope.**

If the sensor slope is known from other sources, it can be entered directly into the controller. The controller will not accept a slope (at 25°) outside the range 45 to 60 mV/pH. If the user attempts to enter a slope less than 45 mV/pH, the controller will automatically change the entry to 45. If the user attempts to enter a slope greater than 60 mV/pH, the controller will change the entry to 60 mV/pH. See Section 15.9.1 for troubleshooting sensor slope problems.

**15.9.4 Sensor does not respond to known pH changes.**

- A. Did the expected pH change really occur? If the process pH reading was not what was expected, check the performance of the sensor in buffers. Also, use a second pH meter to verify the change.
- B. Is the sensor properly wired to the analyzer?
- C. Is the glass bulb cracked or broken? Check the glass electrode impedance. See Section 15.2.2.
- D. Is the analyzer working properly. Check the analyzer by simulating the pH input.

**15.9.5 Calibration was successful, but process pH is slightly different from expected value.**

Differences between pH readings made with an on-line instrument and a laboratory or portable instrument are normal. The on-line instrument is subject to process variables, for example ground potentials, stray voltages, and orientation effects that may not affect the laboratory or portable instrument. To make the process reading agree with a reference instrument, see Section 14.4.

**15.9.6 Calibration was successful, but process pH is grossly wrong and/or noisy.**

Grossly wrong or noisy readings suggest a ground loop (measurement system connected to earth ground at more than one point), a floating system (no earth ground), or noise being brought into the analyzer by the sensor cable. The problem arises from the process or installation. It is not a fault of the analyzer. The problem should disappear once the sensor is taken out of the system. Check the following:

- A. Is a ground loop present?
  1. Verify that the system works properly in buffers. Be sure there is no direct electrical connection between the buffer containers and the process liquid or piping.
  2. Strip back the ends of a heavy gauge wire. Connect one end of the wire to the process piping or place it in the process liquid. Place the other end of the wire in the container of buffer with the sensor. The wire makes an electrical connection between the process and sensor.
  3. If offsets and noise appear after making the connection, a ground loop exists.
- B. Is the process grounded?
  1. The measurement system needs one path to ground: through the process liquid and piping. Plastic piping, fiberglass tanks, and ungrounded or poorly grounded vessels do not provide a path. A floating system can pick up stray voltages from other electrical equipment.
  2. Ground the piping or tank to a local earth ground.
  3. If noise still persists, simple grounding is not the problem. Noise is probably being carried into the instrument through the sensor wiring.
- C. Simplify the sensor wiring.
  1. First, verify that pH sensor wiring is correct. Note that it is not necessary to jumper the solution ground and reference terminals.
  2. Disconnect all sensor wires at the analyzer except pH/mV IN, REFERENCE IN, RTD IN and RTD RETURN. See the wiring diagrams in Section 3.0. If the sensor is wired to the analyzer through a remote junction box containing a preamplifier, disconnect the wires at the sensor side of the junction box.
  3. Tape back the ends of the disconnected wires to keep them from making accidental connections with other wires or terminals.
  4. Connect a jumper wire between the RTD RETURN and RTD SENSE terminals (see wiring diagrams in Section 3.0).
  5. If noise and/or offsets disappear, the interference was coming into the analyzer through one of the sensor wires. The system can be operated permanently with the simplified wiring.
- D. Check for extra ground connections or induced noise.
  1. If the sensor cable is run inside conduit, there may be a short between the cable and the conduit. Re-run the cable outside the conduit. If symptoms disappear, there is a short between the cable and the conduit. Likely a shield is exposed and touching the conduit. Repair the cable and reinstall it in the conduit.
  2. To avoid induced noise in the sensor cable, run it as far away as possible from power cables, relays, and electric motors. Keep sensor wiring out of crowded panels and cable trays.
  3. If ground loops persist, consult the factory. A visit from a technician may be required to solve the problem.

**15.9.7 Process pH readings are noisy.**

- A. Is the sensor dirty or fouled? Suspended solids in the sample can coat the reference junction and interfere with the electrical connection between the sensor and the process liquid. The result is often a noisy reading.
- B. Is the sensor properly wired to the analyzer? See Section 3.0.
- C. Is a ground loop present? Refer to Section 15.9.6.

### 15.10 TROUBLESHOOTING NOT RELATED TO MEASUREMENT PROBLEMS

Problem	Action
Incorrect current output	1. Verify that output load is within the values shown in Figure 2.5. 2. For minor errors, trim the output (see Section 7.3.6)
Display too light or too dark	Change contrast (see Section 7.10)
“Enter Security Code” shown in display	Transmitter has password protection (see Sections 5.4 and 7.6)
“Hold” showing in display	Transmitter is in hold (see Section 5.5)
“Current Output for Test:” showing in display	Transmitter is simulating outputs (see Section 7.3.5)

### 15.11 SIMULATING INPUTS - DISSOLVED OXYGEN

To check the performance of the controller, use a decade box to simulate the current from the oxygen sensor.

- A. Disconnect the anode and cathode leads from terminals 11 and 12 on TB1 and connect a decade box as shown in Figure 15-1. It is not necessary to disconnect the RTD leads.
- B. Set the decade box to the resistance shown in the table.

Sensor	Polarizing Voltage	Resistance	Expected current
499ADO	-675 mV	34 kΩ	20 μA
499A TrDO	-800 mV	20 kΩ	40 μA
Hx438 and Gx448	-675 mV	8.4 MΩ	80 nA

- C. Note the sensor current. To view the sensor current from the main display, press ↓ until the Input Current screen appears. Note the units: μA is microamps, nA is nanoamps.
- D. Change the decade box resistance and verify that the correct current is shown. Calculate current from the equation:

$$\text{current } (\mu\text{A}) = \frac{\text{voltage (mV)}}{\text{resistance (k}\Omega\text{)}}$$

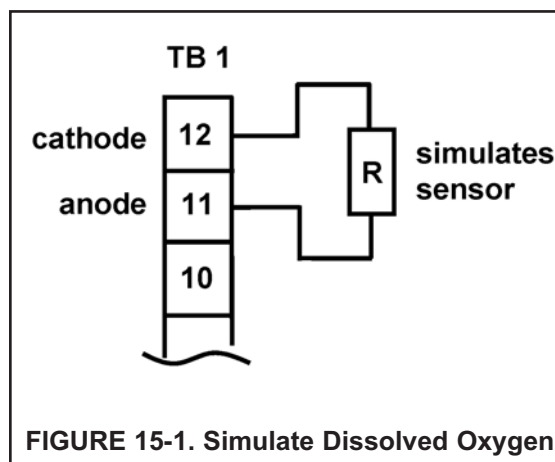

FIGURE 15-1. Simulate Dissolved Oxygen

### 15.12 SIMULATING INPUTS - OTHER AMPEROMETRIC MEASUREMENTS

To check the performance of the controller, use a decade box and a battery to simulate the current from the sensor. The battery, which opposes the polarizing voltage, is necessary to ensure that the sensor current has the correct sign.

- A. Disconnect the anode and cathode leads from terminals 1 and 2 on TB3 and connect a decade box and battery as shown in Figure 15-2. It is not necessary to disconnect the RTD leads.
- B. Set the decade box to the resistance shown in the table.

Sensor	Polarizing Voltage	Resistance	Expected current
499ACL-01 (free chlorine)	200 mV	28 MΩ	500 nA
499ACL-02 (total chlorine)	250 mV	675 kΩ	2000 nA
499ACL-03 (monochloramine)	400 mV	3 MΩ	400 nA
499AOZ	250 mV	2.7 MΩ	500 nA

- C. Note the sensor current. It should be close to the value in the table. The actual value depends of the voltage of the battery. To view the sensor current from the main display, press ↓ until the Input Current screen appears. Note the units: μA is microamps, nA is nanoamps.
- D. Change the decade box resistance and verify that the correct current is shown. Calculate current from the equation:

$$\text{current } (\mu\text{A}) = \frac{V_{\text{battery}} - V_{\text{polarizing}} \text{ (mV)}}{\text{resistance (k}\Omega\text{)}}$$

The voltage of a fresh 1.5 volt battery is about 1.6 volt (1600 mV).

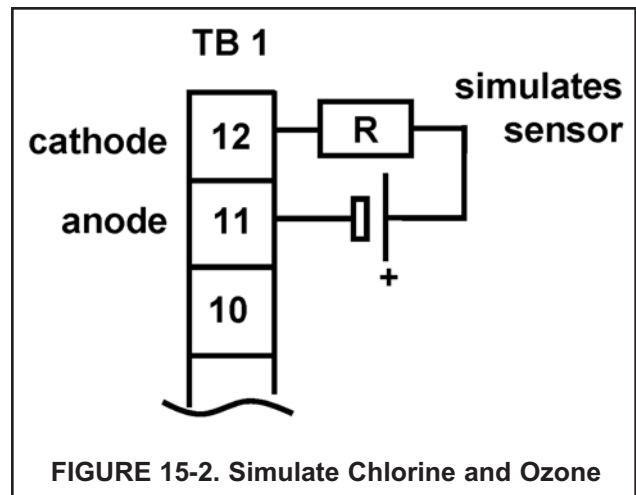

## 15.13 SIMULATING INPUTS - pH

### 15.13.1 General

This section describes how to simulate a pH input into the transmitter. To simulate a pH measurement, connect a standard millivolt source to the transmitter. If the transmitter is working properly, it will accurately measure the input voltage and convert it to pH. Although the general procedure is the same, the wiring details depend on whether the preamplifier is in the sensor, a junction box, or the transmitter.

### 15.13.2 Simulating pH input when the preamplifier is in the analyzer.

1. Turn off automatic temperature correction (Section 7.5). Set the manual temperature to 25°C.
2. Disconnect the sensor and connect a jumper wire between the pH IN and the REFERENCE IN terminals.
3. From the Diagnostics menu scroll down until the "pH input" line is showing. The pH input is the raw voltage signal in mV. The measured voltage should be 0 mV and the pH should be 7.00. Because calibration data stored in the analyzer may be offsetting the input voltage, the displayed pH may not be exactly 7.00.
4. If a standard millivolt source is available, disconnect the jumper wire between the pH IN and the REFERENCE IN terminals and connect the voltage source as shown in Figure 15-3.
5. Calibrate the controller using the procedure in Section 14.0. Use 0.0 mV for Buffer 1 (pH 7.00) and -177.4 mV for Buffer 2 (pH 10.00). If the analyzer is working properly, it should accept the calibration. The slope should be 59.16 mV/pH and the offset should be zero.
6. To check linearity, set the voltage source to the values shown in the table and verify that the pH and millivolt readings match the values in the table.

Voltage (mV)	pH (at 25°C)
295.8	2.00
177.5	4.00
59.2	6.00
-59.2	8.00
-177.5	10.00
-295.8	12.00

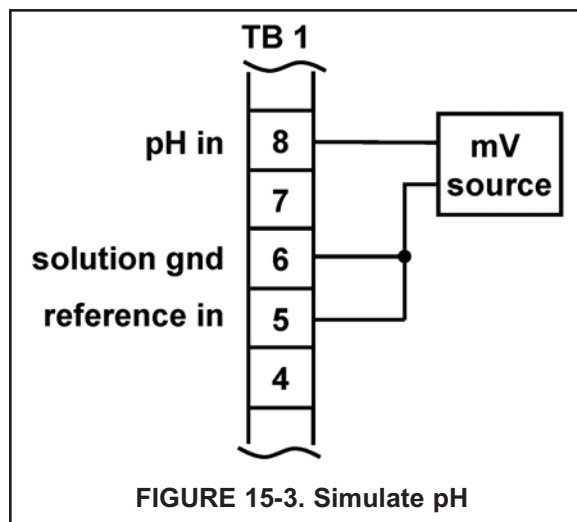

FIGURE 15-3. Simulate pH

### 15.13.3 Simulating pH input when the preamplifier is in a junction box.

The procedure is the same as described in Section 15.11.2. Keep the connections between the analyzer and the junction box in place. Disconnect the sensor at the sensor side of the junction box and connect the voltage source to the sensor side of the junction box. See Figure 15-3.

### 15.13.4 Simulating pH input when the preamplifier is in the sensor.

The preamplifier in the sensor converts the high impedance signal into a low impedance signal without amplifying it. To simulate pH values, follow the procedure in Section 15.13.2.

## 15.14 SIMULATING TEMPERATURE

### 15.14.1 General.

The Xmt-A-HT controller accepts either a Pt100 RTD (for pH, 499ADO, 499ATrDO, 499ACL-01, 499ACL-02, 499ACL-03, and 499AOZ sensors) or a 22k NTC thermistor (for Hx438 and Gx448 DO sensors and most steam-sterilizable DO sensors from other manufacturers). The Pt100 RTD is in a three-wire configuration. See Figure 15-4. The 22k thermistor has a two-wire configuration.

### 15.14.2 Simulating temperature

To simulate the temperature input, wire a decade box to the analyzer or junction box as shown in Figure 15-5.

To check the accuracy of the temperature measurement, set the resistor simulating the RTD to the values indicated in the table and note the temperature readings. The measured temperature might not agree with the value in the table. During sensor calibration an offset might have been applied to make the measured temperature agree with a standard thermometer. The offset is also applied to the simulated resistance. The controller is measuring temperature correctly if the difference between measured temperatures equals the difference between the values in the table to within  $\pm 0.1^{\circ}\text{C}$ .

For example, start with a simulated resistance of  $103.9\ \Omega$ , which corresponds to  $10.0^{\circ}\text{C}$ . Assume the offset from the sensor calibration was  $-0.3\ \Omega$ . Because of the offset, the analyzer calculates temperature using  $103.6\ \Omega$ . The result is  $9.2^{\circ}\text{C}$ . Now change the resistance to  $107.8\ \Omega$ , which corresponds to  $20.0^{\circ}\text{C}$ . The analyzer uses  $107.5\ \Omega$  to calculate the temperature, so the display reads  $19.2^{\circ}\text{C}$ . Because the difference between the displayed temperatures ( $10.0^{\circ}\text{C}$ ) is the same as the difference between the simulated temperatures, the analyzer is working correctly.



**FIGURE 15-4. Three-Wire RTD Configuration.**

Although only two wires are required to connect the RTD to the analyzer, using a third (and sometimes fourth) wire allows the analyzer to correct for the resistance of the lead wires and for changes in the lead wire resistance with temperature.

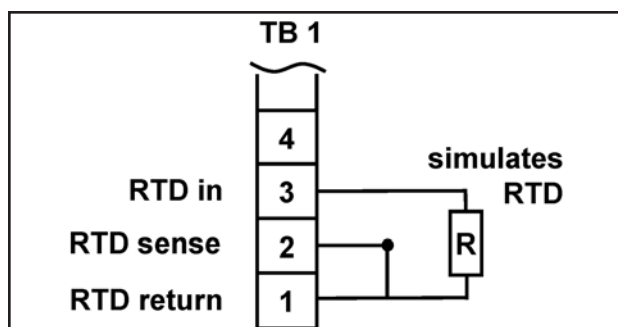

**FIGURE 15-5. Simulating RTD Inputs.**

The figure shows wiring connections for sensors containing a Pt 100 RTD.

Temp. ( $^{\circ}\text{C}$ )	Pt 100 ( $\Omega$ )	22k NTC ( $\text{k}\Omega$ )
0	100.0	64.88
10	103.9	41.33
20	107.8	26.99
25	109.7	22.00
30	111.7	18.03
40	115.5	12.31
50	119.4	8.565
60	123.2	6.072
70	127.1	4.378
80	130.9	3.208
85	132.8	2.761
90	134.7	2.385
100	138.5	1.798

### 15.15 MEASURING REFERENCE VOLTAGE

Some processes contain substances that poison or shift the potential of the reference electrode. Sulfide is a good example. Prolonged exposure to sulfide converts the reference electrode from a silver/silver chloride electrode to a silver/silver sulfide electrode. The change in reference voltage is several hundred millivolts. A good way to check for poisoning is to compare the voltage of the reference electrode with a silver/silver chloride electrode known to be good. The reference electrode from a new sensor is best. See Figure 15-6. If the reference electrode is good, the voltage difference should be no more than about 20 mV. A poisoned reference electrode usually requires replacement.

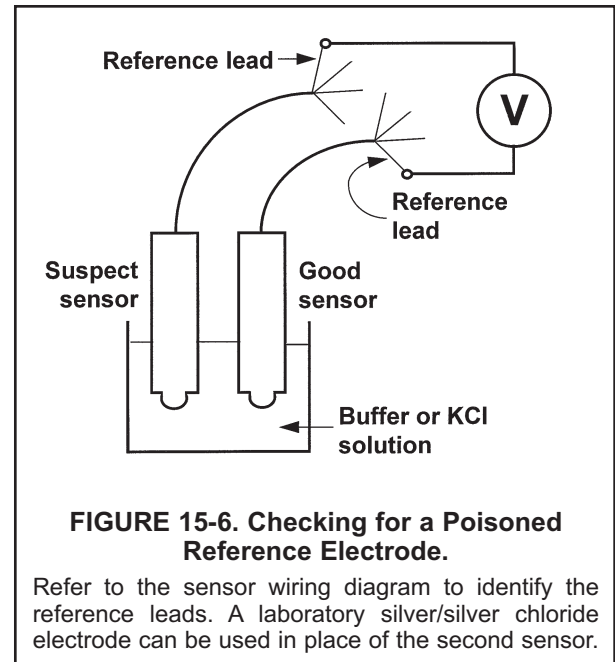

## SECTION 16.0 MAINTENANCE

### 16.1 OVERVIEW

The Solu Comp Xmt needs little routine maintenance. The calibration of the analyzer and sensor should be checked periodically. To recalibrate the sensor and analyzer, refer to sections 9 through 14.

### 16.2 REPLACEMENT PARTS

Only a few components of the analyzer are replaceable. Refer to the tables below. Circuit boards, display, and enclosure are not replaceable.

**TABLE 16-1. REPLACEMENT PARTS FOR SOLU COMP XMT (PANEL MOUNT VERSION)**

PART NUMBER	DESCRIPTION	SHIPPING WEIGHT
23823-00	Panel mounting kit, includes four brackets and four set screws	2 lb/1.0 kg
33654-00	Gasket, front, for panel mount version	2 lb/1.0 kg
33658-00	Gasket, rear cover, for panel mount version	2 lb/1.0 kg

**TABLE 16-2. REPLACEMENT PARTS FOR SOLU COMP XMT (PIPE/SURFACE MOUNT VERSION)**

PART NUMBER	DESCRIPTION	SHIPPING WEIGHT
33655-00	Gasket for pipe/surface mount version	2 lb/1.0 kg
23833-00	Surface mount kit, consists of four self tapping screws and four O-rings	1 lb/0.5 kg



## SECTION 17.0 RETURN OF MATERIAL

### 17.1 GENERAL.

To expedite the repair and return of instruments, proper communication between the customer and the factory is important. Before returning a product for repair, call 1-949-757-8500 for a Return Materials Authorization (RMA) number.

### 17.2 WARRANTY REPAIR.

The following is the procedure for returning instruments still under warranty:

1. Call Rosemount Analytical for authorization.
2. To verify warranty, supply the factory sales order number or the original purchase order number. In the case of individual parts or sub-assemblies, the serial number on the unit must be supplied.
3. Carefully package the materials and enclose your "Letter of Transmittal" (see Warranty). If possible, pack the materials in the same manner as they were received.
4. Send the package prepaid to:

Emerson Process Management  
Liquid Division  
2400 Barranca Parkway  
Irvine, CA 92606

Attn: Factory Repair

RMA No. \_\_\_\_\_

Mark the package: Returned for Repair

Model No. \_\_\_\_\_

#### IMPORTANT

Please see second section of "Return of Materials Request" form. Compliance with the OSHA requirements is mandatory for the safety of all personnel. MSDS forms and a certification that the instruments have been disinfected or detoxified are required.

### 17.3 NON-WARRANTY REPAIR.

The following is the procedure for returning for repair instruments that are no longer under warranty:

1. Call Rosemount Analytical for authorization.
2. Supply the purchase order number, and make sure to provide the name and telephone number of the individual to be contacted should additional information be needed.
3. Do Steps 3 and 4 of Section 17.2.

#### NOTE

Consult the factory for additional information regarding service or repair.

## APPENDIX A

# BAROMETRIC PRESSURE AS A FUNCTION OF ALTITUDE

The table shows how barometric pressure changes with altitude. Pressure values do not take into account humidity and weather fronts.

Altitude		Barometric Pressure			
m	ft	bar	mm Hg	in Hg	kPa
0	0	1.013	760	29.91	101.3
250	820	0.983	737	29.03	98.3
500	1640	0.955	716	28.20	95.5
750	2460	0.927	695	27.37	92.7
1000	3280	0.899	674	26.55	89.9
1250	4100	0.873	655	25.77	87.3
1500	4920	0.846	635	24.98	84.6
1750	5740	0.821	616	24.24	82.1
2000	6560	0.795	596	23.47	79.5
2250	7380	0.771	579	22.78	77.1
2500	8200	0.747	560	22.06	74.7
2750	9020	0.724	543	21.38	72.4
3000	9840	0.701	526	20.70	70.1
3250	10,660	0.679	509	20.05	67.9
3500	11,480	0.658	494	19.43	65.8

**The right people, the right answers, right now.**

## **Immediate, Reliable Analytical Support**

Now there's a way to quickly get the right answers for your liquid analytical instrumentation questions: the Analytical Customer Support Center.

Our staff of trained professionals is ready to provide the information you need. If you are placing an order, verifying delivery, requesting application information, or just want to contact an Emerson Process Management representative, a call to the Customer Support Center will provide you with the right people, the right answers, right now.

## **A Worldwide Network of Sales and Service**

Emerson Process Management's field sales offices are your source for more information on the full line of Rosemount Analytical products. Field sales personnel will work closely with you to supply technical data and application information.

For more information, please contact your nearest Emerson Process Management sales office.

### **THE AMERICAS - HEADQUARTERS**

Emerson Process Management  
Rosemount Analytical Inc.  
Liquid Center of Excellence  
2400 Barranca Parkway  
Irvine, CA 92606  
Phone: +1.949.757.8500  
Toll Free: +1.800.854.8257  
Fax: +1.949.474.7250

### **GERMANY**

Emerson Process Management Process  
Gas Analyzer Center of Excellence  
GmbH & Co. OHG  
Industriestrasse 1  
63594 Hasselroth  
Germany  
T 49.6055.884.0  
F 49.6055.884.20

### **ASIA-PACIFIC**

Emerson Process Management  
Asia Pacific Private Ltd.  
1 Pandan Crescent  
Singapore 0512  
Republic of Singapore  
Phone: 65.777.8211  
Fax: 65.777.0947

### **LATIN AMERICA**

Emerson Process Management  
Rosemount Analytical  
10241 West Little York, Suite #200  
Houston, TX 77040 USA  
T 713.467.6000  
F 713.827.3328

### **EUROPE**

Emerson Process Management AG  
Blegistrasse 21  
CH-6341 Baar-Walterswil  
Switzerland  
T 41.41.768.6111  
T 41.41.761.8740

### **MIDDLE EAST AND AFRICA**

Emerson Process Management  
EPM Building  
P. O. Box 17033  
Jebe Ali Free Zone  
Dubai, United Arab Emirates  
T 971.4.8835235  
F 971.4.8835312

**VISIT OUR WEBSITE AT**

***[www.rosemountanalytical.com](http://www.rosemountanalytical.com)***



## **WARRANTY**

Goods and part(s) (excluding consumables) manufactured by Seller are warranted to be free from defects in workmanship and material under normal use and service for a period of twelve (12) months from the date of shipment by Seller. Consumables, pH electrodes, membranes, liquid junctions, electrolyte, O-rings, etc. are warranted to be free from defects in workmanship and material under normal use and service for a period of ninety (90) days from date of shipment by Seller. Goods, part(s) and consumables proven by Seller to be defective in workmanship and / or material shall be replaced or repaired, free of charge, F.O.B. Seller's factory provided that the goods, parts(s), or consumables are returned to Seller's designated factory, transportation charges prepaid, within the twelve (12) month period of warranty in the case of goods and part(s), and in the case of consumables, within the ninety (90) day period of warranty. This warranty shall be in effect for replacement or repaired goods, part(s) and consumables for the remaining portion of the period of the twelve (12) month warranty in the case of goods and part(s) and the remaining portion of the ninety (90) day warranty in the case of consumables. A defect in goods, part(s) and consumables of the commercial unit shall not operate to condemn such commercial unit when such goods, parts(s) or consumables are capable of being renewed, repaired or replaced.

The Seller shall not be liable to the Buyer, or to any other person, for the loss or damage, directly or indirectly, arising from the use of the equipment or goods, from breach of any warranty or from any other cause. All other warranties, expressed or implied are hereby excluded.

IN CONSIDERATION OF THE STATED PURCHASE PRICE OF THE GOODS, SELLER GRANTS ONLY THE ABOVE STATED EXPRESS WARRANTY. NO OTHER WARRANTIES ARE GRANTED INCLUDING, BUT NOT LIMITED TO, EXPRESS AND IMPLIED WARRANTIES OF MERCHANTABILITY AND FITNESS FOR A PARTICULAR PURPOSE.

## **RETURN OF MATERIAL**

Material returned for repair, whether in or out of warranty, should be shipped prepaid to:

**Emerson Process Management  
2400 Barranca Parkway  
Irvine, CA 92606**

The shipping container should be marked:

Return for Repair  
Model \_\_\_\_\_

The returned material should be accompanied by a letter of transmittal which should include the following information (make a copy of the "Return of Materials Request" found on the last page of the Manual and provide the following thereon):

1. Location type of service, and length of time of service of the device.
2. Description of the faulty operation of the device and the circumstances of the failure.
3. Name and telephone number of the person to contact if there are questions about the returned material.
4. Statement as to whether warranty or non-warranty service is requested.
5. Complete shipping instructions for return of the material.

Adherence to these procedures will expedite handling of the returned material and will prevent unnecessary additional charges for inspection and testing to determine the problem with the device.

If the material is returned for out-of-warranty repairs, a purchase order for repairs should be enclosed.





**Schedule**  
**EC Declaration of Conformity**

---

**EMC Directive (2004/108/EC)**  
 Model Xmt-A-HT pH Transmitter, HART;  
 Model Xmt-A-FF pH Transmitter, Foundation Fieldbus;  
 Model Xmt-A-FI pH Transmitter, FISCO Fieldbus ;  
 Model Xmt-P-HT pH Transmitter, HART;  
 Model Xmt-P-FF pH Transmitter, Foundation Fieldbus;  
 Model Xmt-P-FI pH Transmitter, FISCO Fieldbus ;

EN 61326-1: 2006

---

**ATEX Directive (94/9/EC)**  
 Provisions of the directive fulfilled by the equipment:  
 Equipment Group II, Category 1 G (Ex ia IIC T4)  
 Model Xmt-A-HT pH Transmitter, HART;  
 Model Xmt-A-FF pH Transmitter, Foundation Fieldbus;  
 Model Xmt-A-FI pH Transmitter, FISCO Fieldbus ;  
 Model Xmt-P-HT pH Transmitter, HART;  
 Model Xmt-P-FF pH Transmitter, Foundation Fieldbus;  
 Model Xmt-P-FI pH Transmitter, FISCO Fieldbus ;

**Basecfao4ATEX0213X -- Intrinsically Safe Certificate**  
 60079-0:2006 60079-1:2007 EN50284:1999

---

**ATEX Notified Bodies for EC Type Examination Certificate**  
 Baseefa [Notified Body Number: 1180]  
 Rockhead Business Park, Staden Lane  
 Buxton, Derbyshire SK17 9RZ  
 United Kingdom

**ATEX Notified Body for Quality Assurance**  
 Baseefa [Notified Body Number: 1180]  
 Rockhead Business Park, Staden Lane  
 Buxton, Derbyshire SK17 9RZ  
 United Kingdom







**EC Declaration of Conformity**

---

Xmt-A-HT/FF/FI, Xmt-P-HT/FF/FI

We,  
**Emerson Process Management**  
**Heath Place - Bognor Regis**  
**West Sussex PO22 9SH**  
**England**

Declare under our sole responsibility that the product,  
 Model Xmt-A-HT pH Transmitter, HART;  
 Model Xmt-A-FF pH Transmitter, Foundation Fieldbus;  
 Model Xmt-A-FI pH Transmitter, FISCO Fieldbus ;  
 Model Xmt-P-HT pH Transmitter, HART;  
 Model Xmt-P-FF pH Transmitter, Foundation Fieldbus;  
 Model Xmt-P-FI pH Transmitter, FISCO Fieldbus ;

manufactured by,  
**Emerson Process Management**  
**Rosemount Analytical**  
**2400 Barranca Parkway**  
**Irvine, California 92606**  
**USA**

To which this declaration relates, is in conformity with the provisions of the European community Directives, including the latest amendments, as shown in the attached schedule.

Assumption of conformity is based on the application of the harmonized standards and, when applicable or required, a European Community notified body certification, as shown in the attached schedule.



(signature)  
**Andy Kemish**  
 (name printed)

Vice President Analytical Europe  
 (function name printed)  
**July 24, 2009**  
 (date of issue)



*The right people,  
the right answers,  
right now.*

**ROSEMOUNT ANALYTICAL  
CUSTOMER SUPPORT CENTER  
1-800-854-8257**



**Emerson Process Management**

2400 Barranca Parkway  
Irvine, CA 92606 USA  
Tel: (949) 757-8500  
Fax: (949) 474-7250

<http://www.rosemountanalytical.com>

© Rosemount Analytical Inc. 2012



ON-LINE ORDERING NOW AVAILABLE ON OUR WEB SITE  
<http://www.rosemountanalytical.com>

*Specifications subject to change without notice.*

Credit Cards for U.S. Purchases Only.



**EMERSON™**  
Process Management