

COTEK

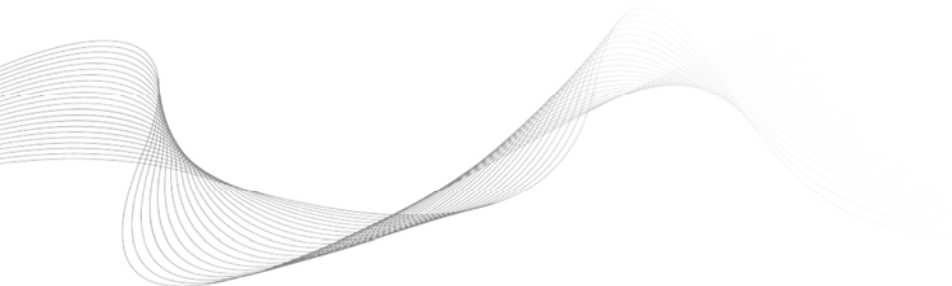

SP Series User's Manual

SP-700/1000/1500/2000/3000/4000

PURE SINE WAVE INVERTER

Table of Content

1. SAFETY INSTRUCTIONS	1
1-1. General Safety Precautions	1
1-2. Other Safety Notes	2
2. FUNCTIONAL CHARACTERISTICS INTRODUCTION	3
2-1. System	3
2-2. Block Diagram	3
2-3. Electrical Specification	4
2-3-1. SP-700 Specification	4
2-3-2. SP-1000 Specification	6
2-3-3. SP-1500 Specification	8
2-3-4. SP-2000 Specification	10
2-3-5. SP-3000 Specification	12
2-3-6. SP-4000 Specification	14
2-3-7. Voltage & temperature performance	16
2-4. Mechanical Drawings	17
3. INSTALLATION AND MAINTENANCE	18
3-1. AC Output Side (Front Panel) Introduction	18
3-1-1. Main Switch	19
3-1-2. LED Indicator	19
3-1-3. Function Switch Introduction	20
3-1-4. TRC Port (for optional kits TR-40, RJ-45)	21
3-1-5. AC output Interface	22
3-2. DC Input Side (Rear Panel) Introduction	24
3-2-1. Remote Port (RJ-11)	25
3-2-2. Remote Control Green Terminal	25

3-2-3. General instruction before DC Input	26
3-2-4. Chassis Ground	27
3-3. Maintenance	27
4. OPERATION	28
4-1. Connection the DC cable	28
4-2. Connecting the input power	29
4-3. Connecting the loads	29
4-4. Switch ON Inverter	29
4-5. Protection Mechanism	30
5. RS-232 COMMUNICATION AND OPERATION	30
5-1. RS-232 Port	30
5-2. RS-232 Port Operating	31
5-3. Example of RS-232 Port Operating	31
5-3-1. RS-232 command format	31
5-3-2. Command format	31
6. INFORMATION	36
6-1. Warning	36
6-2. Warranty	36

1. Safety Instructions

1-1. General Safety Precautions



Warning! Before using the Inverter, read the safety instructions.

- Do not expose the inverter to rain, snow, spray or dust. To reduce the risk of fire hazard, do not cover or obstruct the ventilation openings and do not install the inverter in a zero-clearance compartment.
- To avoid the risk of fire and electric shock, make sure that the existing wiring is in good electrical condition, and the wire size is not undersized.
- This equipment contains components which can produce arcs or sparks. To prevent fire or explosion do not install in compartment containing batteries or flammable materials or in location which require ignition protected equipment. This includes any space containing gasoline-powered machinery, fuel tanks, or joints, fittings, or other connection between components of the fuel system.
- Depending on the user scenario, the AC output of the inverter may require user installed breaker or fuse. In AC output hardwire application, AC socket will not be provided. The inverter incorporates standard AC short circuit protection.
- An over current protection at the time of installation shall be provided by others for the AC output circuit.
- Additional breakers suitable for 20 A branch circuit protection shall be provided for the GFCI receptacles.
- The following precautions should be taken when working on the inverter:
 - Step 1 Remove watches, rings, or other metal objects
 - Step 2 Use tools with insulated handles
 - Step 3 Wear rubber gloves and boots

1-2. Other Safety Notes

- Upon receipt, examine the carton box for damage. If you have found any damage on the carton box please notify the company you purchased this unit from.
- Do not operate near water or in excessive humidity.
- Do not open or disassemble the inverter, and warranty may be voided.
- The DC side connections should be firm and tight.
- Grounding: Reliable grounding should be maintained.
- Do not drop a metal tool on the battery. The resulting spark or short-circuit on the battery or on the other electrical part may cause an explosion.
- Install the inverter in a well-ventilated area. Do not block the front air vents, or the rear air exhausts of the unit.
- Wiring: Adequate input power must be supplied to the inverter for proper use; correct wiring sizes must be ensured.
- Mount the inverter such that the fan axis is horizontal.
- Do not operate the inverter close to combustible gas or open fire.
- Do not operate appliances that may feed power back into the inverter.
- Temperature: The inverter should be operated in an ambient temperature range of -20°C to 40°C otherwise the output efficiency may be affected. Air flow to the inverter must not be blocked.

2. Functional Characteristics Introduction

2-1. System

The unit is a highly reliable DC-AC inverter system, designed with advanced power electronic and microprocessor technology offering the following features:

- Pure sine wave output waveform O/P voltage 1xx : THD < 5 %, 2xx : THD < 3 %
- Optional bypass relay (TR-40) function
- Intelligent software for power management
- Loading and temperature controlled cooling fan
- CR-8/CR-16 remote management and control
- RS-232 communication
- Dry contact terminal
- Advanced Protection Features
 - Input over/under voltage protection
 - Internal over temperature protection
 - Input reverse polarity protection (Fuse)
 - Output overload protection
 - Output short circuit protection

2-2. Block Diagram

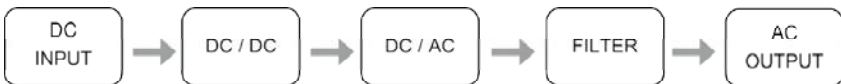

2-3. Electrical Specification

2-3-1. SP-700 Specification

Electrical	Specification	Model No.		
	Item	SP-700-112	SP-700-124	SP-700-148
Input Characteristics	Voltage	12VDC	24VDC	48VDC
	Input Over-Voltage Protection ^①	16.5 ± 0.3VDC	33 ± 0.5VDC	66 ± 1.0VDC
	Input Under-Voltage Protection	10.5 ± 0.3VDC	21 ± 0.5VDC	42 ± 1.0VDC
	Voltage Range	10.5~16.5VDC	21~33VDC	42~66VDC
	No Load Current	≤ 1.5A @12VDC	≤ 0.8A @24VDC	≤ 0.5A @48VDC
	Power Saving Mode	<0.1A @12VDC	<0.06A @24VDC	<0.05A @48VDC
Output Characteristics	Continuous Output Power	700 VA (± 3%)		
	Maximum output Power (1Min)	> 700 VA~810 VA (100%~115%)		
	Surge Power (1Sec)	< 1230 VA		
	Frequency	50 / 60 Hz ± 0.5% (Dip Switch Selectable)		
	Output Voltage	100 / 110 / 115 / 120 VAC (± 5%) (Dip Switch Selectable)		
	Efficiency max.	91%	93%	93%
	Short-Circuit Protection	1 Sec Shutdown		
Output Waveform	Pure Sine Wave (THD < 5% @ Normal Load) ^②			
Signal and Control	Remote Controller Panel Unit	CR-8 / CR-16 (optional)		
	LED Indicator	Red / Orange / Green LED		
	Dry Contact Terminal	By a relay		
	Remote Control Terminal	6-port Green terminal (for inverter ON / OFF)		
Protection	Input Protection	Over / Under Voltage, Reverse Polarity (Internal Fuse)		
	AC Output Protection	Short-Circuit, Overload		
	Others	Over / Under Temperature Protection (by Heat sink Temperature +80°C/-20°C)		
Environment	Operating Temp.	-20 °C ~ 40 °C ^③		
	Storage Temp.	-30 °C ~ 70 °C		
	Storage Temp. & Humidity	10 ~ 95% RH		
Safety & EMC	Safety Standards	Certified UL 458 (UL only for GFCI receptacles)		----
	EMC standards	Certified FCC class B		
	E-mark	----		
	Dimension(WxHxD)	200mm X 83mm X 330mm		
Weight	2.6 KG			
Cooling	Temperature & Load Controlled cooling Fan			
AC Transfer Function Accessories	TR-40 (optional)			

Table 1. SP-700 for Output 100/110/115/120 VAC Specification.



Note :

- ① Voltage range : Please refer to Figure 1
- ② Normal load Condition : $V_{in} = 12.5V/25V/50V$, $V_o = 100/110/115/120$ VAC 80% Full load (PF=1.0)
- ③ Operating temperature : Please refer to Figure 2

Electrical	Specification	Model No.		
	Item	SP-700-212	SP-700-224	SP-700-248
Input Characteristics	Voltage	12VDC	24VDC	48VDC
	Input Over-Voltage Protection ①	16.5 ± 0.3VDC	33 ± 0.5VDC	66 ± 1.0VDC
	Input Under-Voltage Protection	10.5 ± 0.3VDC	21 ± 0.5VDC	42 ± 1.0VDC
	Voltage Range	10.5~16.5VDC	21~33VDC	42~66VDC
	No Load Current	≤1.5A @12VDC	≤0.8A @24VDC	≤0.5A @48VDC
	Power Saving Mode	<0.1A @12VDC	<0.06A @24VDC	<0.05A @48VDC
Output Characteristics	Continuous Output Power	700 VA (± 3%)		
	Maximum output Power (1Min)	> 700 VA~810 VA (100%~115%)		
	Surge Power (1Sec)	< 1230 VA		
	Frequency	50 / 60 Hz ± 0.5% (Dip Switch Selectable)		
	Output Voltage	200 / 220 / 230 / 240 VAC (± 3%) (Dip Switch Selectable)		
	Efficiency max.	91%	93%	94%
	Short-Circuit Protection	1 Sec Shutdown		
	Output Waveform	Pure Sine Wave (THD < 3%@ Normal Load) ②		
Signal and Control	Remote Controller Panel Unit	CR-8 / CR-16 (optional)		
	LED Indicator	Red / Orange / Green LED		
	Dry Contact Terminal	By a relay		
	Remote Control Terminal	6-port Green terminal (for inverter ON / OFF)		
Protection	Input Protection	Over / Under Voltage, Reverse Polarity (Internal Fuse)		
	AC Output Protection	Short-Circuit, Overload		
	Others	Over / Under Temperature Protection (by Heat sink Temperature +80℃/-20℃)		
Environment	Operating Temp.	-20 ℃~40 ℃ ③		
	Storage Temp.	-30 ℃~70 ℃		
	Storage Temp. & Humidity	10 ~95% RH		
Safety & EMC	Safety Standards	Certified EN 60950-1		
	EMC standards	Certified EN 55022 class B; EN 55024; EN 61000-3-2, -3-3 EN 61000-4-2, 3, 4, 5, 6, 8, 11		
	E-mark	Certified CISPR 25; ISO 7637-2		
Dimension(WxHxD)		200mm X 83mm X 330mm		
Weight		2.6 KG		
Cooling		Temperature & Load Controlled cooling Fan		
AC Transfer Function Accessories		TR-40 (optional)		

Table 2. SP-700 for Output 200/220/230/240 VAC Specification.



Note :

① Voltage range : Please refer to Figure 1

② Normal load Condition : Vin =12.5V/25V/50V, Vo=200/220/230/240 VAC 80% Full load (PF=1.0)

③ Operating temperature : Please refer to Figure 2

2-3-2. SP-1000 Specification

Electrical	Specification	Model No.		
	Item	SP-1000-112	SP-1000-124	SP-1000-148
Input Characteristics	Voltage	12VDC	24VDC	48VDC
	Input Over-Voltage Protection ^①	16.5 ± 0.3VDC	33 ± 0.5VDC	66 ± 1.0VDC
	Input Under-Voltage Protection	10.5 ± 0.3VDC	21 ± 0.5VDC	42 ± 1.0VDC
	Voltage Range	10.5~16.5 VDC	21~33 VDC	42~66 VDC
	No Load Current	≤ 1.5A @12VDC	≤ 0.8A @24VDC	≤ 0.5A @48VDC
	Power Saving Mode	<0.1A @12VDC	<0.06A @24VDC	<0.05A @48VDC
Output Characteristics	Continuous Output Power	1000 VA (± 3%)		
	Maximum output Power (1Min)	> 1000 VA~1150 VA (100%~115%)		
	Surge Power (1Sec)	< 1750 VA		
	Frequency	50 / 60 Hz ± 0.5% (Dip Switch Selectable)		
	Output Voltage	100 / 110 / 115 / 120 VAC (± 5%) (Dip Switch Selectable)		
	Efficiency max.	92%	93%	93%
	Short-Circuit Protection	1 Sec Shutdown		
Output Waveform	Pure Sine Wave (THD < 5% @ Normal Load) ^②			
Signal and Control	Remote Controller Panel Unit	CR-8 / CR-16 (optional)		
	LED Indicator	Red / Orange / Green LED		
	Dry Contact Terminal	By a relay		
	Remote Control Terminal	6-port Green terminal (for inverter ON / OFF)		
Protection	Input Protection	Over / Under Voltage, Reverse Polarity (Internal Fuse)		
	AC Output Protection	Short-Circuit, Overload		
	Others	Over / Under Temperature Protection (by Heat sink Temperature +80℃ / -20℃)		
Environment	Operating Temp.	-20 ℃ ~ 40 ℃ ^③		
	Storage Temp.	-30 ℃ ~ 70 ℃		
	Storage Temp. & Humidity	10 ~ 95% RH		
Safety & EMC	Safety Standards	Certified UL 458 (UL only for GFCI receptacles)		----
	EMC standards	Certified FCC class B		
	E-mark	----		
Dimension(WxHxD)		200mm X 83mm X 372mm		
Weight		3.26 KG		
Cooling		Temperature & Load Controlled cooling Fan		
AC Transfer Function Accessories		TR-40 (optional)		

Table 3. SP-1000 for Output 100/110/115/120 VAC Specification.

**Note :**

- ① Voltage range : Please refer to Figure 1
- ② Normal load Condition : Vin = 12.5V/25V/50V, Vo=100/110/115/120 VAC 80% Full load (PF=1.0)
- ③ Operating temperature : Please refer to Figure 2

Electrical	Specification	Model No.		
	Item	SP-1000-212	SP-1000-224	SP-1000-248
Input Characteristics	Voltage	12VDC	24VDC	48VDC
	Input Over-Voltage Protection ^①	16.5 ± 0.3VDC	33 ± 0.5VDC	66 ± 1.0VDC
	Input Under-Voltage Protection	10.5 ± 0.3VDC	21 ± 0.5VDC	42 ± 1.0VDC
	Voltage Range	10.5~16.5 VDC	21~33 VDC	42~66 VDC
	No Load Current	≤1.5A @12VDC	≤0.8A @24VDC	≤0.4A @48VDC
	Power Saving Mode	< 0.1A @12VDC	<0.05A @24VDC	<0.05A @48VDC
Output Characteristics	Continuous Output Power	1000 VA (± 3%)		
	Maximum output Power (1Min)	> 1000 VA~1150 VA (100%~115%)		
	Surge Power (1Sec)	< 1750 VA		
	Frequency	50 / 60 Hz ± 0.5% (Dip Switch Selectable)		
	Output Voltage	200 / 220 / 230 / 240 VAC (± 3%) (Dip Switch Selectable)		
	Efficiency max.	92%	94%	94%
	Short-Circuit Protection	1 Sec Shutdown		
	Output Waveform	Pure Sine Wave (THD < 3%@ Normal Load) ^②		
Signal and Control	Remote Controller Panel Unit	CR-8 / CR-16 (optional)		
	LED Indicator	Red / Orange / Green LED		
	Dry Contact Terminal	By a relay		
	Remote Control Terminal	6-port Green terminal (for inverter ON / OFF)		
Protection	Input Protection	Over / Under Voltage, Reverse Polarity (Internal Fuse)		
	AC Output Protection	Short-Circuit, Overload		
	Others	Over / Under Temperature Protection (by Heat sink Temperature +80℃/-20℃)		
Environment	Operating Temp.	-20 ℃~40 ℃ ^③		
	Storage Temp.	-30 ℃~70 ℃		
	Storage Temp. & Humidity	10 ~95% RH		
Safety & EMC	Safety Standards	Certified EN 60950-1		
	EMC standards	Certified EN 55022 class B; EN 55024; EN 61000-3-2, -3-3 EN 61000-4-2, 3, 4, 5, 6, 8, 11		
	E-mark	Certified CISPR 25; ISO 7637-2		
Dimension(WxHxD)		200mm X 83mm X 372mm		
Weight		3.26 KG		
Cooling		Temperature & Load Controlled cooling Fan		
AC Transfer Function Accessories		TR-40 (optional)		

Table 4. SP-1000 for Output 200/220/230/240 VAC Specification.



Note :

- ① Voltage range : Please refer to Figure 1
- ② Normal load Condition : Vin =12.5V/25V/50V, Vo=200/220/230/240 VAC 80% Full load (PF=1.0)
- ③ Operating temperature : Please refer to Figure 2

2-3-3. SP-1500 Specification

Electrical	Specification	Model No.		
	Item	SP-1500-112	SP-1500-124	SP-1500-148
Input Characteristics	Voltage	12VDC	24VDC	48VDC
	Input Over-Voltage Protection ^①	16.5 ± 0.3VDC	33 ± 0.5VDC	66 ± 1.0VDC
	Input Under-Voltage Protection	10.5 ± 0.3VDC	21 ± 0.5VDC	42 ± 1.0VDC
	Voltage Range	10.5~16.5 VDC	21~33 VDC	42~66 VDC
	No Load Current	≤ 1.8A @12VDC	≤ 1.0A @24VDC	≤ 0.5A @48VDC
	Power Saving Mode	<0.1A @12VDC	<0.05A @24VDC	<0.05A @48VDC
Output Characteristics	Continuous Output Power	1500 VA (± 3%)		
	Maximum output Power (1Min)	> 1500 VA~1730VA (100%~115%)		
	Surge Power (1Sec)	<2650 VA		
	Frequency	50 / 60 Hz ± 0.5% (Dip Switch Selectable)		
	Output Voltage	100 / 110 / 115 / 120 VAC (± 5%) (Dip Switch Selectable)		
	Efficiency max.	91%	92%	93%
	Short-Circuit Protection	1 Sec Shutdown		
Output Waveform	Pure Sine Wave (THD < 5% @ Normal Load) ^②			
Signal and Control	Remote Controller Panel Unit	CR-8 / CR-16 (optional)		
	LED Indicator	Red / Orange / Green LED		
	Dry Contact Terminal	By a relay		
	Remote Control Terminal	6-port Green terminal (for inverter ON / OFF)		
Protection	Input Protection	Over / Under Voltage, Reverse Polarity (Internal Fuse)		
	AC Output Protection	Short-Circuit, Overload		
	Others	Over / Under Temperature Protection (by Heat sink Temperature +80℃/-20℃)		
Environment	Operating Temp.	-20 ℃~40 ℃ ^③		
	Storage Temp.	-30 ℃~70 ℃		
	Storage Temp. & Humidity	10 ~95% RH		
Safety & EMC	Safety Standards	Certified UL 458 (UL only for GFCI receptacles)		----
	EMC standards	Certified FCC class B		
	E-mark	----		
Dimension(WxHxD)		248mm X 83mm X 421mm		
Weight		4.14 KG		
Cooling		Temperature & Load Controlled cooling Fan		
AC Transfer Function Accessories		TR-40 (optional)		

Table 5. SP-1500 for Output 100/110/115/120 VAC Specification.

**Note :**

- ① Voltage range : Please refer to Figure 1
- ② Normal load Condition : Vin =12.5V/25V/50V, Vo=100/110/115/120VAC 80% Full load (PF=1.0)
- ③ Operating temperature : Please refer to Figure 2

Electrical	Specification	Model No.		
	Item	SP-1500-212	SP-1500-224	SP-1500-248
Input Characteristics	Voltage	12VDC	24VDC	48VDC
	Input Over-Voltage Protection ^①	16.5 ± 0.3VDC	33 ± 0.5VDC	66 ± 1.0VDC
	Input Under-Voltage Protection	10.5 ± 0.3VDC	21 ± 0.5VDC	42 ± 1.0VDC
	Voltage Range	10.5~16.5 VDC	21~33 VDC	42~66 VDC
	No Load Current	≤ 1.8A @12VDC	≤ 1.0A @24VDC	≤ 0.5A @48VDC
	Power Saving Mode	<0.1A @12VDC	<0.05A @24VDC	<0.05A @48VDC
Output Characteristics	Continuous Output Power	1500 VA (± 3%)		
	Maximum output Power (1Min)	> 1500 VA~1730VA (100%~115%)		
	Surge Power (1Sec)	<2650 VA		
	Frequency	50 / 60 Hz ± 0.5% (Dip Switch Selectable)		
	Output Voltage	200 / 220 / 230 / 240 VAC (± 3%) (Dip Switch Selectable)		
	Efficiency max.	93%	94%	94%
	Short-Circuit Protection	1 Sec Shutdown		
	Output Waveform	Pure Sine Wave (THD < 3%@ Normal Load) ^②		
Signal and Control	Remote Controller Panel Unit	CR-8 / CR-16 (optional)		
	LED Indicator	Red / Orange / Green LED		
	Dry Contact Terminal	By a relay		
	Remote Control Terminal	6-port Green terminal (for inverter ON / OFF)		
Protection	Input Protection	Over / Under Voltage, Reverse Polarity (Internal Fuse)		
	AC Output Protection	Short-Circuit, Overload		
	Others	Over / Under Temperature Protection (by Heat sink Temperature +80℃/-20℃)		
Environment	Operating Temp.	-20℃~40℃ ^③		
	Storage Temp.	-30℃~70℃		
	Storage Temp. & Humidity	10 ~95% RH		
Safety & EMC	Safety Standards	Certified EN 60950-1		
	EMC standards	Certified EN 55022 class B; EN 55024; EN 61000-3-2, -3-3 EN 61000-4-2, 3, 4, 5, 6, 8, 11		
	E-mark	Certified CISPR 25; ISO 7637-2		
Dimension(WxHxD)		248mm X 83mm X 421mm		
Weight		4.14 KG		
Cooling		Temperature & Load Controlled cooling Fan		
AC Transfer Function Accessories		TR-40 (optional)		

Table 6. SP-1500 for Output 200/220/230/240 VAC Specification.



Note :

- ① Voltage range : Please refer to Figure 1
- ② Normal load Condition : Vin =12.5V/25V/50V, Vo=200/220/230/240 VAC 80% Full load (PF=1.0)
- ③ Operating temperature : Please refer to Figure 2

2-3-4. SP-2000 Specification

Electrical	Specification	Model No.		
	Item	SP-2000-112	SP-2000-124	SP-2000-148
Input Characteristics	Voltage	12VDC	24VDC	48VDC
	Input Over-Voltage Protection ^①	16.5 ± 0.3VDC	33 ± 0.5VDC	66 ± 1.0VDC
	Input Under-Voltage Protection	10.5 ± 0.3VDC	21 ± 0.5VDC	42 ± 1.0VDC
	Voltage Range	10.5~16.5 VDC	21~33 VDC	42~66 VDC
	No Load Current	≤ 1.8A @12VDC	≤ 1.0A @24VDC	≤ 0.5A @48VDC
	Power Saving Mode	<0.1A @12VDC	<0.05A @24VDC	<0.05A @48VDC
Output Characteristics	Continuous Output Power	2000 VA (± 3%)		
	Maximum output Power (1Min)	> 2000 VA~2300 VA (100%~115%)		
	Surge Power (1Sec)	< 3500 VA		
	Frequency	50 / 60 Hz ± 0.5% (Dip Switch Selectable)		
	Output Voltage	100 / 110 / 115 / 120 VAC (± 5%) (Dip Switch Selectable)		
	Efficiency max.	92%	93%	94%
	Short-Circuit Protection	1 Sec Shutdown		
	Output Waveform	Pure Sine Wave (THD < 5% @ Normal Load) ^②		
Signal and Control	Remote Controller Panel Unit	CR-8 / CR-16 (optional)		
	LED Indicator	Red / Orange / Green LED		
	Dry Contact Terminal	By a relay		
	Remote Control Terminal	6-port Green terminal (for inverter ON / OFF)		
Protection	Input Protection	Over / Under Voltage, Reverse Polarity (Internal Fuse)		
	AC Output Protection	Short-Circuit, Overload		
	Others	Over / Under Temperature Protection (by Heat sink Temperature +80°C / -20°C)		
Environment	Operating Temp.	-20 °C ~40 °C ^③		
	Storage Temp.	-30 °C ~70 °C		
	Storage Temp. & Humidity	10 ~95% RH		
Safety & EMC	Safety Standards	Certified UL 458 (UL only for GFCI receptacles)		----
	EMC standards	Certified FCC class A ^④		
	E-mark	----		
Dimension(WxHxD)		248mm X 83mm X 443mm		
Weight		5.24 KG		
Cooling		Temperature & Load Controlled cooling Fan		
AC Transfer Function Accessories		TR-40 (optional)		

Table 7. SP-2000 for Output 100/110/115/120 VAC Specification.

**Note :**

- ① Voltage range : Please refer to Figure 1
- ② Normal load Condition : Vin =12.5V/25V/50V, Vo=100/110/115/120 VAC 80% Full load (PF=1.0)
- ③ Operating temperature : Please refer to Figure 2
- ④ **Warning** : This is a class A product. In a domestic environment this product may cause radio interference in which case the user may be required to take adequate measures.

Electrical	Specification	Model No.		
	Item	SP-2000-212	SP-2000-224	SP-2000-248
Input Characteristics	Voltage	12VDC	24VDC	48VDC
	Input Over-Voltage Protection ^①	16.5 ± 0.3VDC	33 ± 0.5VDC	66 ± 1.0VDC
	Input Under-Voltage Protection	10.5 ± 0.3VDC	21 ± 0.5VDC	42 ± 1.0VDC
	Voltage Range	10.5~16.5 VDC	21~33 VDC	42~66 VDC
	No Load Current	≤ 1.8A @12VDC	≤ 1.0A @24VDC	≤ 0.5A @48VDC
	Power Saving Mode	<0.1A @12VDC	<0.05A @24VDC	<0.05A @48VDC
Output Characteristics	Continuous Output Power	2000 VA (± 3%)		
	Maximum output Power (1Min)	> 2000 VA~2300 VA (100%~115%)		
	Surge Power (1Sec)	< 3500 VA		
	Frequency	50 / 60 Hz ± 0.5% (Dip Switch Selectable)		
	Output Voltage	200 / 220 / 230 / 240 VAC (± 3%) (Dip Switch Selectable)		
	Efficiency max.	94%	94%	95%
	Short-Circuit Protection	1 Sec Shutdown		
Output Waveform	Pure Sine Wave (THD < 3%@ Normal Load) ^②			
Signal and Control	Remote Controller Panel Unit	CR-8 / CR-16 (optional)		
	LED Indicator	Red / Orange / Green LED		
	Dry Contact Terminal	By a relay		
	Remote Control Terminal	6-port Green terminal (for inverter ON / OFF)		
Protection	Input Protection	Over / Under Voltage, Reverse Polarity (Internal Fuse)		
	AC Output Protection	Short-Circuit, Overload		
	Others	Over / Under Temperature Protection (by Heat sink Temperature +80°C/-20°C)		
Environment	Operating Temp.	-20 °C ~40 °C ^③		
	Storage Temp.	-30 °C ~70 °C		
	Storage Temp. & Humidity	10 ~95% RH		
Safety & EMC	Safety Standards	Certified EN 60950-1		
	EMC standards	Certified EN 55022 class A ^④ ; EN 55024; EN 61000-3-2, -3-3 EN 61000-4-2, 3, 4, 5, 6, 8, 11		
	E-mark	Certified CISPR 25; ISO 7637-2		
Dimension(WxHxD)		248mm X 83mm X 443mm		
Weight		5.24 KG		
Cooling		Temperature & Load Controlled cooling Fan		
AC Transfer Function Accessories		TR-40 (optional)		

Table 8. SP-2000 for Output 200/220/230/240 VAC Specification.



Note :

- ① Voltage range : Please refer to Figure 1
- ② Normal load Condition : Vin =12.5V/25V/50V, Vo=200/220/230/240 VAC 80% Full load (PF=1.0)
- ③ Operating temperature : Please refer to Figure 2
- ④ **Warning** : This is a class A product. In a domestic environment this product may cause radio interference in which case the user may be required to take adequate measures.

2-3-5. SP-3000 Specification

Electrical	Specification	Model No.		
	Item	SP-3000-112	SP-3000-124	SP-3000-148
Input Characteristics	Voltage	12VDC	24VDC	48VDC
	Input Over-Voltage Protection ^①	16.5 ± 0.3VDC	33 ± 0.5VDC	66 ± 1.0VDC
	Input Under-Voltage Protection	10.5 ± 0.3VDC	21 ± 0.5VDC	42 ± 1.0VDC
	Voltage Range	10.5~16.5 VDC	21~33 VDC	42~66 VDC
	No Load Current	≤3.8A @12VDC	≤2.0A @24VDC	≤1.0A @48VDC
Power Saving Mode	<0.4A @12VDC	<0.2A @24VDC	<0.1A @48VDC	
Output Characteristics	Continuous Output Power	3000 VA (± 3%)		
	Maximum output Power (1Min)	> 3000 VA~3450 VA (100%~115%)		
	Surge Power (1Sec)	< 6000 VA		
	Frequency	50 / 60 Hz ± 0.5% (Dip Switch Selectable)		
	Output Voltage	100 / 110 / 115 / 120 VAC (± 5%) (Dip Switch Selectable)		
	Efficiency max.	90%	91%	92%
	Short-Circuit Protection	1 Sec Shutdown		
Output Waveform	Pure Sine Wave (THD < 5%@ Normal Load) ^②			
Signal and Control	Remote Controller Panel Unit	CR-8 / CR-16 (optional)		
	LED Indicator	Red / Orange / Green LED		
	Dry Contact Terminal	By a relay		
	Remote Control Terminal	6-port Green terminal (for inverter ON / OFF)		
Protection	Input Protection	Over / Under Voltage, Reverse Polarity (Internal Fuse)		
	AC Output Protection	Short-Circuit, Overload		
	Others	Over / Under Temperature Protection (by Heat sink Temperature +80℃/-20℃)		
Environment	Operating Temp.	-20℃~40℃ ^③		
	Storage Temp.	-30℃~70℃		
	Storage Temp. & Humidity	10 ~95% RH		
Safety & EMC	Safety Standards	Certified UL 458		----
	EMC standards	Certified FCC class A ^④		
	E-mark	----		
Dimension(WxHxD)		255mm X 158mm X 442mm		
Weight		8.2 KG		
Cooling		Temperature & Load Controlled cooling Fan		
AC Transfer Function Accessories		TR-40 (optional)		

Table 9. SP-3000 for Output 100/110/115/120 VAC Specification.

**Note :**

- ① Voltage range : Please refer to Figure 3
- ② Normal load Condition : Vin =12.5V/25V/50V, Vo=100/110/115/120 VAC 80% Full load (PF=1.0)
- ③ Operating temperature : Please refer to Figure 4
- ④ **Warning** : This is a class A product. In a domestic environment this product may cause radio interference in which case the user may be required to take adequate measures.

Electrical	Specification	Model No.		
	Item	SP-3000-212	SP-3000-224	SP-3000-248
Input Characteristics	Voltage	12VDC	24VDC	48VDC
	Input Over-Voltage Protection ^①	16.5 ± 0.3VDC	33 ± 0.5VDC	66 ± 1.0VDC
	Input Under-Voltage Protection	10.5 ± 0.3VDC	21 ± 0.5VDC	42 ± 1.0VDC
	Voltage Range	10.5~16.5 VDC	21~33 VDC	42~66 VDC
	No Load Current	≤3.8A @12VDC	≤2.0A @24VDC	≤1.0A @48VDC
	Power Saving Mode	<0.4A @12VDC	<0.2A @24VDC	<0.1A @48VDC
Output Characteristics	Continuous Output Power	3000 VA (± 3%)		
	Maximum output Power (1Min)	> 3000 VA~3450 VA (100%~115%)		
	Surge Power (1Sec)	< 6000 VA		
	Frequency	50 / 60 Hz ± 0.5% (Dip Switch Selectable)		
	Output Voltage	200 / 220 / 230 / 240 VAC (± 3%) (Dip Switch Selectable)		
	Efficiency max.	90%	93%	94%
	Short-Circuit Protection	1 Sec Shutdown		
Output Waveform	Pure Sine Wave (THD < 3%@ Normal Load) ^②			
Signal and Control	Remote Controller Panel Unit	CR-8 / CR-16 (optional)		
	LED Indicator	Red / Orange / Green LED		
	Dry Contact Terminal	By a relay		
	Remote Control Terminal	6-port Green terminal (for inverter ON / OFF)		
Protection	Input Protection	Over / Under Voltage, Reverse Polarity (Internal Fuse)		
	AC Output Protection	Short-Circuit, Overload		
	Others	Over / Under Temperature Protection (by Heat sink Temperature +80°C/-20°C)		
Environment	Operating Temp.	-20 °C ~40 °C ^③		
	Storage Temp.	-30 °C ~70 °C		
	Storage Temp. & Humidity	10 ~95% RH		
Safety & EMC	Safety Standards	Certified EN 60950-1		
	EMC standards	Certified EN 55022 class A ^④ ; EN 55024; EN 61000-3-2, -3-3 EN 61000-4-2, 3, 4, 5, 6, 8, 11		
	E-mark	Certified CISPR 25; ISO 7637-2		
Dimension(WxHxD)		255mm X 158mm X 442mm		
Weight		8.2 KG		
Cooling		Temperature & Load Controlled cooling Fan		
AC Transfer Function Accessories		TR-40 (optional)		

Table 10. SP-3000 for Output 200/220/230/240 VAC Specification.



Note :

- ① Voltage range : Please refer to Figure 3
- ② Normal load Condition : Vin =12.5V/25V/50V, Vo=200/220/230/240 VAC 80% Full load (PF=1.0)
- ③ Operating temperature : Please refer to Figure 4
- ④ **Warning** : This is a class A product. In a domestic environment this product may cause radio interference in which case the user may be required to take adequate measures.

2-3-6. SP-4000 Specification

Electrical	Specification	Model No.	
	Item	SP-4000-124	SP-4000-148
Input Characteristics	Voltage	24VDC	48VDC
	Input Over-Voltage Protection ^①	33 ± 0.5VDC	66 ± 1.0VDC
	Input Under-Voltage Protection	21 ± 0.5VDC	42 ± 1.0VDC
	Voltage Range	21~33 VDC	42~66 VDC
	No Load Current	≤2.0A @24VDC	≤1.0A @48VDC
	Power Saving Mode	<0.2A @24VDC	<0.1A @48VDC
Output Characteristics	Continuous Output Power	4000 VA (± 3%)	
	Maximum output Power (1Min)	> 4000 VA~4600 VA (100%~115%)	
	Surge Power (1Sec)	< 8000 VA	
	Frequency	50 / 60 Hz ± 0.5% (Dip Switch Selectable)	
	Output Voltage	100 / 110 / 115 / 120 VAC (± 5%) (Dip Switch Selectable)	
	Efficiency max.	91%	91%
	Short-Circuit Protection	1 Sec Shutdown	
	Output Waveform	Pure Sine Wave (THD < 5% @ Normal Load) ^②	
Signal and Control	Remote Controller Panel Unit	CR-8 / CR-16 (optional)	
	LED Indicator	Red / Orange / Green LED	
	Dry Contact Terminal	By a relay	
	Remote Control Terminal	6-port Green terminal (for inverter ON / OFF)	
Protection	Input Protection	Over / Under Voltage, Reverse Polarity (Internal Fuse)	
	AC Output Protection	Short-Circuit, Overload	
	Others	Over / Under Temperature Protection (by Heat sink Temperature +80°C/-20°C)	
Environment	Operating Temp.	-20 °C~40 °C ^③	
	Storage Temp.	-30 °C~70 °C	
	Storage Temp. & Humidity	10 ~95% RH	
Safety & EMC	Safety Standards	Certified UL 458	----
	EMC standards	Certified FCC class A ^④	
	E-mark	----	
Dimension(WxHxD)		255mm X 158mm X 462mm	
Weight		10 KG	
Cooling		Temperature & Load Controlled cooling Fan	
AC Transfer Function Accessories		TR-40 (optional)	

Table 11. SP-4000 for Output 100/110/115/120 VAC Specification.

**Note :**

- ① Voltage range : Please refer to Figure 3
- ② Normal load Condition : $V_{in} = 12.5V/25V/50V$, $V_o = 100/110/115/120$ VAC 80% Full load (PF=1.0)
- ③ Operating temperature : Please refer to Figure 4
- ④ **Warning** : This is a class A product. In a domestic environment this product may cause radio interference in which case the user may be required to take adequate measures.

Electrical	Specification	Model No.	
	Item	SP-4000-224	SP-4000-248
Input Characteristics	Voltage	24VDC	48VDC
	Input Over-Voltage Protection ^①	33 ± 0.5VDC	66 ± 1.0VDC
	Input Under-Voltage Protection	21 ± 0.5VDC	42 ± 1.0VDC
	Voltage Range	21~33 VDC	42~66 VDC
	No Load Current	≤ 2.0A @24VDC	≤ 1.0A @48VDC
	Power Saving Mode	<0.2A @24VDC	<0.1A @48VDC
Output Characteristics	Continuous Output Power	4000 VA (± 3%)	
	Maximum output Power (1Min)	> 4000 VA~4600 VA (100%~115%)	
	Surge Power (1Sec)	< 8000 VA	
	Frequency	50 / 60 Hz ± 0.5% (Dip Switch Selectable)	
	Output Voltage	200 / 220 / 230 / 240 VAC (± 3%) (Dip Switch Selectable)	
	Efficiency max.	90%	91%
	Short-Circuit Protection	1 Sec Shutdown	
	Output Waveform	Pure Sine Wave (THD < 3% @ Normal Load) ^②	
Signal and Control	Remote Controller Panel Unit	CR-8 / CR-16 (optional)	
	LED Indicator	Red / Orange / Green LED	
	Dry Contact Terminal	By a relay	
	Remote Control Terminal	6-port Green terminal (for inverter ON / OFF)	
Protection	Input Protection	Over / Under Voltage, Reverse Polarity (Internal Fuse)	
	AC Output Protection	Short-Circuit, Overload	
	Others	Over / Under Temperature Protection (by Heat sink Temperature +80°C/-20°C)	
Environment	Operating Temp.	-20 °C ~ 40 °C ^③	
	Storage Temp.	-30 °C ~ 70 °C	
	Storage Temp. & Humidity	10 ~ 95% RH	
Safety & EMC	Safety Standards	Certified EN 60950-1	
	EMC standards	Certified EN 55022 class A ^④ ; EN 55024; EN 61000-3-2, -3-3; EN 61000-4-2, 3, 4, 5, 6, 8, 11	
	E-mark	Certified CISPR 25; ISO 7637-2	
Dimension(WxHxD)		255mm X 158mm X 462mm	
Weight		10 KG	
Cooling		Temperature & Load Controlled cooling Fan	
AC Transfer Function Accessories		TR-40 (optional)	

Table 12. SP-4000 for Output 100/110/115/120 VAC Specification.



Note :

- ① Voltage range : Please refer to Figure 3
- ② Normal load Condition : Vin =25V/50V, Vo=200/220/230/240 VAC 80% Full load (PF=1.0)
- ③ Operating temperature : Please refer to Figure 4
- ④ **Warning** : This is a class A product. In a domestic environment this product may cause radio interference in which case the user may be required to take adequate measures.

2-3-7. Voltage & temperature performance

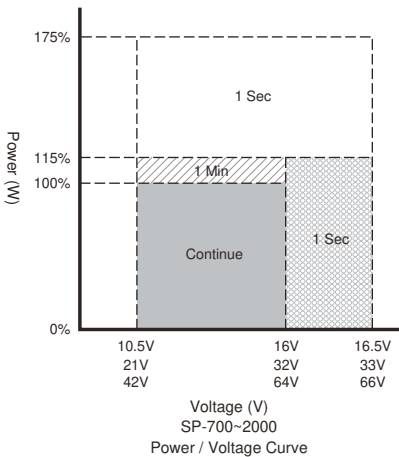

Figure 1. SP-700~2000
Output power vs. input voltage

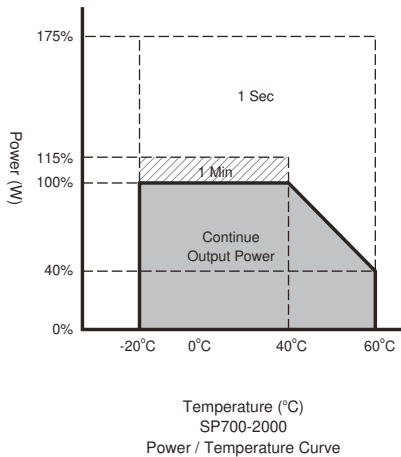

Figure 2. SP-700~2000
Output power vs. temperature

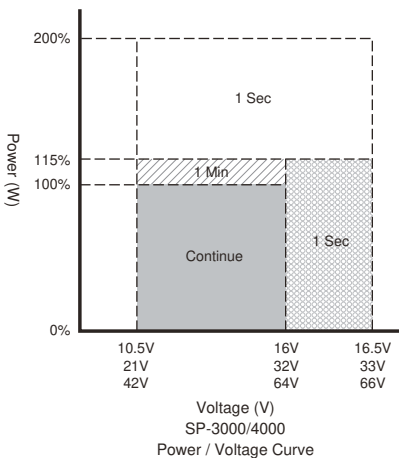

Figure 3. SP-3000/4000
Output power vs. input voltage

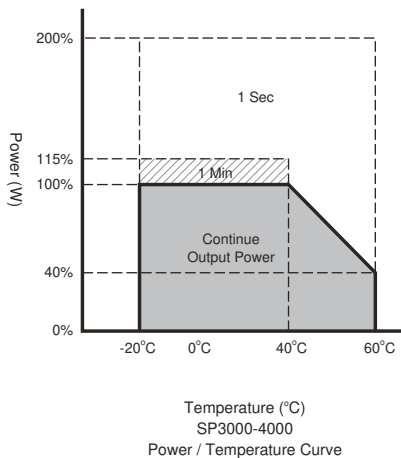

Figure 4. SP-3000/4000
Output power vs. temperature

2-4. Mechanical Drawings

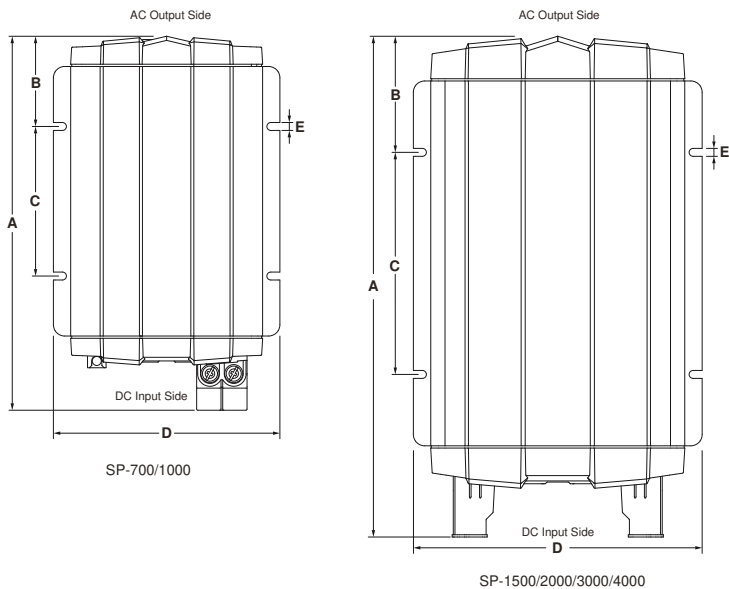

Figure 5. SP series drawing (Top View)

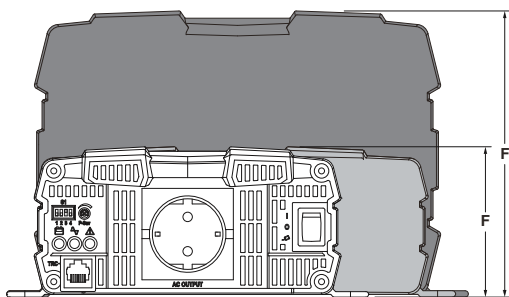

Figure 6. SP series drawing (AC output/ Front View)

Model	A (mm)	B (mm)	C (mm)	D (mm)	E (mm)	F (mm)
SP-700	330	80	132	200	7.0	83
SP-1000	372	69	196	200	7.0	83
SP-1500	421	92	196	248	7.0	83
SP-2000	443	103	196	248	7.0	83
SP-3000	442	103	196	255	7.0	158
SP-4000	462	113	196	255	7.0	158

Table 13. SP Series Dimension

3. Installation and Maintenance

3-1. AC Output Side (Front Panel) Introduction

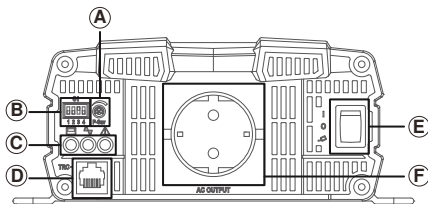

Figure 7. SP-700/ 1000 AC output panel view

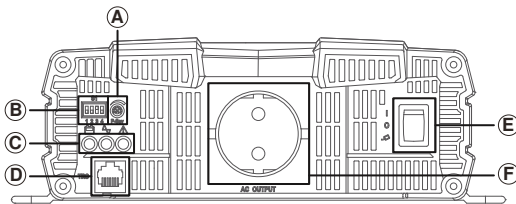

Figure 8. SP-1500/ 2000 AC output panel view

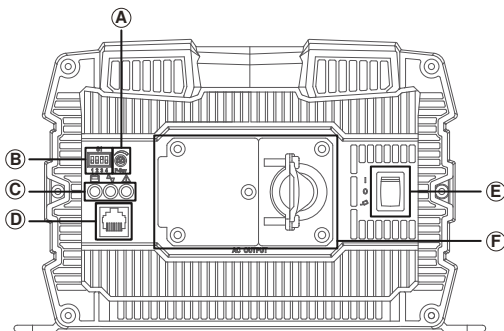

Figure 9. SP-3000/ 4000 AC output panel view

Model	SP-700	SP-1000	SP-1500	SP-2000	SP-3000	SP-4000
(A)	Saving power adjustment					
(B)	Function switch					
(C)	Function LED					
(D)	TRC port (RJ-45)					
(E)	Main switch					
(F)	AC output socket				AC output terminal	

Table 14. SP Series AC output side introduction

3-1-1. Main Switch

The 3-stage switch **(E)** is for turning on, turning off and remote mode.

3-1-2. LED Indicator

3-1-2-1. Input voltage level: to display Input Voltages

LED status (C)	DC 12V	DC 24V	DC 48V
Red	< 11.0V	< 22.0V	< 44.0V
Orange	11.0 ~ 11.5V	22.0 ~ 23.0V	44.0~46.0V
Green	11.5 ~ 15.0V	23.0 ~ 30.0V	46.0~60.0V
Orange	15.0 ~ 15.5V	30.0 ~ 31.0V	60.0~62.0V
Red	>15.5V	>31.0V	>62.0V

Table 15. Input Voltage Level LED Indicator

3-1-2-2. Output Load Level to display AC Loads (PF=1)

LED status (C)	Green	Orange	Red
SP-700	0 ~ 700 VA	700 ~ 805 VA	> 805 VA
SP-1000	0 ~ 1000 VA	1000 ~ 1150 VA	> 1150 VA
SP-1500	0 ~ 1500 VA	1500 ~ 1725 VA	> 1725 VA
SP-2000	0 ~ 2000 VA	2000 ~ 2300 VA	> 2300 VA
SP-3000	0 ~ 3000 VA	3000 ~ 3450 VA	> 3450 VA
SP-4000	0 ~ 4000 VA	4000 ~ 4600 VA	> 4600 VA

Table 16. Output Load Level LED Indicator

3-1-2-3. Inverter Status to display Fault condition

LED status (C)	Status	Recovery point
Green	Normal	
Red	Over Current Protection / Over Load Protection (AC output short-circuit and over load)	
Red Blink	Under Voltage Protection (Input DC voltage under spec)	12.5V @ DC12V system 25V @ DC24V system 50V @ DC48V system
Red Fast Blink	Over Voltage Protection (Input DC voltage over spec)	14.5V @ DC12V system 29V @ DC24V system 58V @ DC48V system

LED status (C)	Status	Recovery point
Orange	Device startup process abnormal	—
Orange Fast Blink	Under Temperature Protection (Heat sink temp. under -20°C)	> 0°C
Orange Slow Blink	Over Temperature Protection (Heat sink temp. over 80°C)	< 60°C (heat sink temperature)

Table 17. Inverter LED Status Indicator

3-1-3. Function Switch Introduction

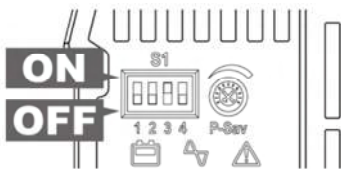

Figure 10. DIP switch ON/OFF position

3-1-3-1. Function Switch Definition

Dip Switch (B)	Function
S1	Voltage select
S2	Voltage select
S3	Frequency Select
S4	Power saving ON/OFF

Table 18. Function Switch Definition

3-1-3-2. Output voltage selection (S1&S2)

Output voltage	S1	S2
100V/200V	OFF	OFF
110V/220V	ON	OFF
115V/230V	OFF	ON
120V/240V	ON	ON

Table 19. Function Switch definition: output voltage selection



Note! 100V series can be selected between 100/110/115/120VAC, and 200V series can be selected between 200/220/230/240VAC.

3-1-3-3. Output Frequency Selection (S3)

Frequency	S3
50Hz	OFF
60Hz	ON

Table 20. Function Switch definition: Output Frequency selection

3-1-3-4. Power Saving Selection (S4)

Saving function	S4
Power Saving OFF	OFF
Power Saving ON	ON

Table 21. Function Switch definition: Power Saving selection

3-1-3-5. Power Saving Load Adjustment

User can use variable resistor (VR) to set the input and wake up power saving threshold according to the load condition, and the setting range shows below:

Ⓐ	Input Saving Power (Min)	Saving Wake up Power (Min)
SP-700	<20 VA	>40 VA
SP-1000	<20 VA	>40 VA
SP-1500	<20 VA	>40 VA
SP-2000	<20 VA	>40 VA
SP-3000	<40 VA	>60 VA
SP-4000	<40 VA	>60 VA

Table 22. Power saving setting range (Min)

Ⓐ	Input Saving Power (Max)	Saving Wake up Power (Max)
SP-700	<110 VA	>160 VA
SP-1000	<110 VA	>160 VA
SP-1500	<110 VA	>160 VA
SP-2000	<110 VA	>160 VA
SP-3000	<240 VA	>280 VA
SP-4000	<240 VA	>280 VA

Table 23. Power saving setting range (Max)

3-1-4. TRC Port (for optional kits TR-40, RJ-45)

Pin Number	Signal Description Ⓓ	
1	Reserved	--
2	PH-L	Zero-Crossing Signal
3	PH-N	Zero-Crossing Signal

Pin Number	Signal Description (D)	
4	Bypass	Transfer Relay Driver Signal
5	12V	Internal power for TR40 controller
6	5V	Internal power for TR40 controller
7	GND	The same polarity as the battery negative side
8	Reserved	--

Table 24. SP Series TRC Port : RJ-45.

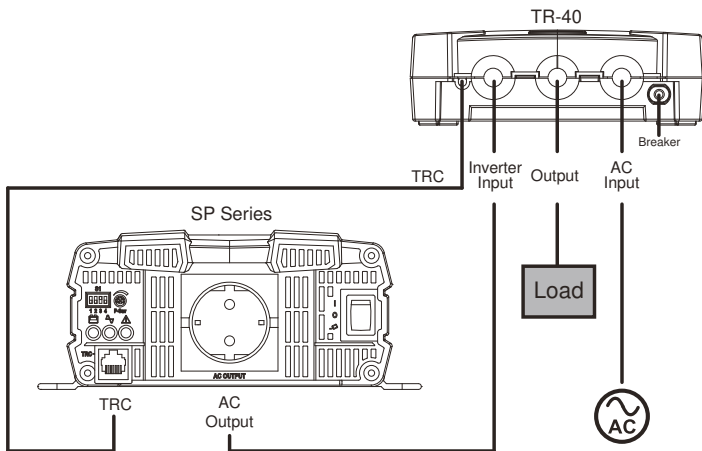

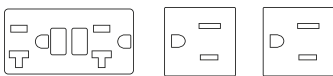

Figure 11. Wiring between SP series and TR-40



Note! The detail information please refer to TR-40 user manual

3-1-5. AC output Interface

3-1-5-1. SP-700/1000/1500/2000 AC output interface

Socket Type (F)	Applicable Model
 <p>North America (GFCI) NEMA 5-15R</p>	SP-700/1000-112/124/148
 <p>North America (GFCI) NEMA 5-15R</p>	SP-1500/2000-112/124/148



Socket Type (F)	Applicable Model
 <p>Australia / New Zealand Continental European UK</p>	SP-700/1000/1500/2000/3000-212/224/248
 <p>Universal</p>	SP-700/1000/1500/2000-112/124/148 SP-700/1000/1500/2000/3000-212/224/248
 <p>Hard Wire</p>	SP-3000-112/124/148/212/224/248 SP-4000-124/148/224/248
 <p>France Connector</p>	SP-700/1000/1500/2000/3000-212/224/248

Table 25. SP Series AC Socket vs. Model

3-1-5-2. SP-3000/4000 AC output interface

Terminal (F)	Wire color	Wire length / gauge
AC terminal	Line (L)	Black
	Neutral (N)	White
FG (Ground)	Green / Yellow or Bare copper	200-240VAC: AWG#10 100-120VAC: AWG#8 26~32 feet / AWG# 10 ~ 8

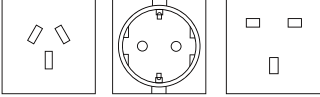
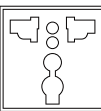
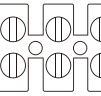
Table 26. SP-3000/ 4000 Series AC output wiring

3-1-5-3. GFCI connector

Recommend GFCI connector :

- HUBBELL INC WIRING DEVICE DIV, Type GF20 and GFRST20. Rated 125V, 20A
- COOPER WIRING DEVICES, Type VGF20 and SGF20. Rated 125V, 20A
- LEVITON MFG CO INC, Type 7899-W and GFNT2. Rated 125V, 20A
- PASS & SEYMOUR INC, Type 2097. Rated 125V, 20A

3-2. DC Input Side (Rear Panel) Introduction

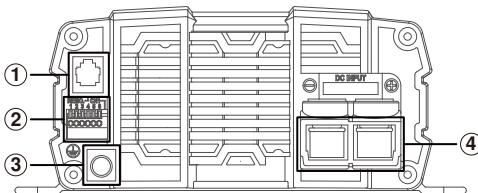

Figure 12. SP-700/1000

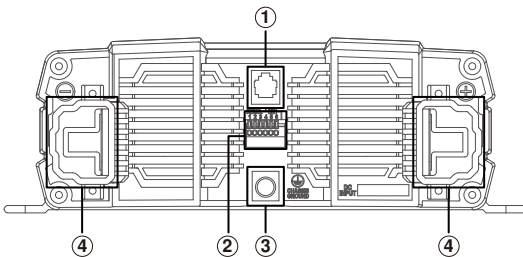

Figure 13. SP-1500/2000

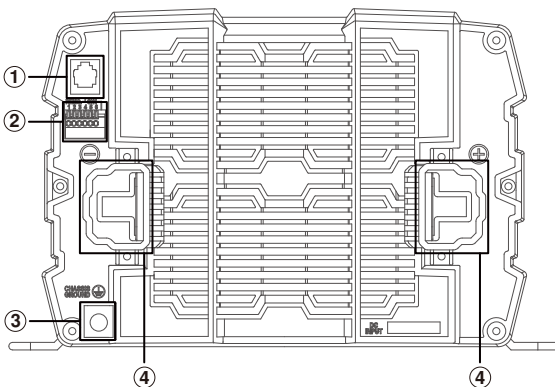

Figure 14. SP-3000/4000

Model	SP-700	SP-1000	SP-1500	SP-2000	SP-3000	SP-4000
①	Remote port (RJ-11)					
②	Remote control green terminal					
③	Chassis ground					
④	DC input connector					

Table 27. SP Series DC input side introduction

3-2-1. Remote Port (RJ-11)

The SP Series Inverter can be compatible with CR-8, and CR-16 remote control via RS-232 Communication.

Before using the remote control, make sure the main switch on inverter must be at “REMOTE” position.

Pin Number	Signal Description ①	
1	Reserved	--
2	GND	The same polarity as the battery negative side
3	RXD	RS-232 RXD
4	TXD	RS-232 TXD
5	RMT	Remote controller panel (positive)
6	VCC	Internal power for remote controller

Table 28. SP Series Remote Port : RJ-11

3-2-2. Remote Control Green Terminal

Remote control green terminal ② may be connected to a Form C relay for “FAULT” indication. When “FAULT” occurs, the relay switches.

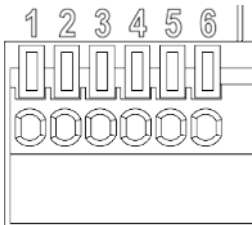

Figure 15. Remote control terminal

Item	Description	Item	Description
1	Dry contact (Normal Open)	4	Enable+ (ENB)
2	Common	5	Enable- ($\overline{\text{ENB}}$)
3	Dry contact (Normal Closed)	6	Ground

Table 29. Dry contact terminal definition



Note! Pin-6 is the same polarity with battery negative electrode.



Note! Fault conditions include Input under / over voltage, output short circuit / over load, over / under temperature.



Caution! Please follow the following steps for the installation

- Before installing the inverter, make sure the main switch is at “OFF” position.
- Before using the remote function, make sure the main switch pressed toward “REMOTE”
- Use 20 ~ 24 #AWG wire to connect the remote control terminals

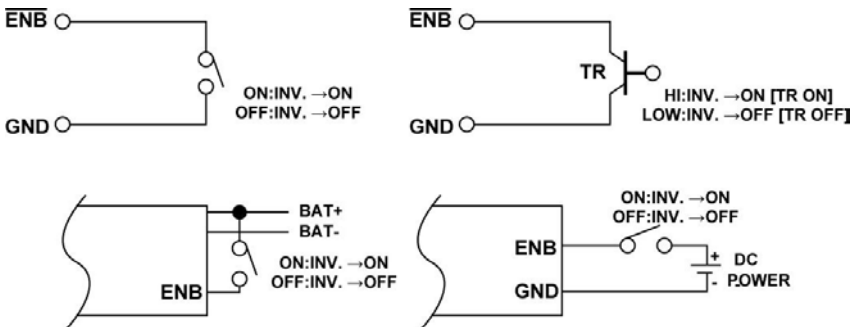

Figure 16. Wiring for control

3-2-3. General instruction before DC Input ④

3-2-3-1 Before installation:

The DC cables should be as short as possible (less than 6 feet / 1.8 meters ideally)

The size of the cable should be thick enough to limit the voltage drop to less than 2% when carrying the maximum input current to prevent frequent low-input voltage warnings, and shutdown.

The following sizes of cables and fuses are recommended distance (<6 ft.) between the batteries and the inverter.

Model	Wire AWG	Inline fuse
SP-700-112 / 212	#6	≥ 150A
SP-700-124 / 224	#10	≥ 80 A
SP-700-148 / 248	#16	≥ 50 A
SP-1000-112 / 212	#4	≥ 225A
SP-1000-124 / 224	#8	≥ 125A
SP-1000-148 / 248	#14	≥ 80A
SP-1500-112 / 212	#1	≥ 350A
SP-1500-124 / 224	#6	≥ 175A
SP-1500-148 / 248	#10	≥ 90A
SP-2000-112 / 212	#1/0	≥ 500A
SP-2000-124 / 224	#4	≥ 225A
SP-2000-148 / 248	#8	≥ 150A
SP-3000-112 / 212	#4/0	≥ 700A
SP-3000-124 / 224	#1	≥ 350A
SP-3000-148 / 248	#6	≥ 175A
SP-4000-124 / 224	#1/0	≥ 500A
SP-4000-148 / 248	#4	≥ 275A

Table 30. SP Series Wiring Cable diameter and Inline Fuse



Note! Batteries are capable of providing very large currents in case of short circuit. The fuse should be as close to the positive battery terminal as possible. Use Bussmann ANN series fuses (will also require Fuse Block 4164) or equivalent.

3-2-4. Chassis Ground ③

Must be connected to earth ground prior to making any other connections to the equipment.

3-3. Maintenance

Make sure that the fan vents are not blocked.

Use a vacuum cleaner to remove any dust from the fan area. When cleaning the case or front panel, use a soft, dry cloth, only. If the case or front panel is very dirty, use a neutral, non-abrasive detergent. Do not use alcohol or ammonia based solutions.

Regular service, and relocation of the inverter, should be performed by a qualified service technician. Avoid spilling liquid on the inverter.

4. Operation

4-1. Connection the DC cable

Connect DC input terminals to 12V / 24V /48V battery or other DC power source [+] is positive, [-] is negative. Reverse polarity connection can blow the internal fuse and may damage the inverter permanently.



Figure 17. DC cable connection



Warning! Make sure that all the DC connections are tight (torque to 9 – 10 ft-lbs, 11.7 – 13 Nm). Loose connections could result in overheating and can be a potential hazard.



Warning! The recommended inline fuse should be installed as close to the battery positive terminal as possible failure to use a fuse on the “+” cable running between the inverter and battery may cause damage to the cable / inverter and will void warranty.

Also, only use high quality copper wire and keep the cable length short which is a maximum of 3 - 6 feet.

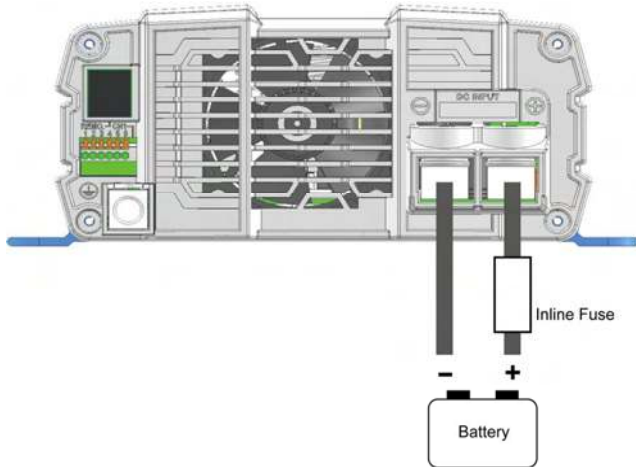

Figure 18. Battery cabling

4-2. Connecting the input power

Before making the DC input side connections ④, the main switch ⑤ must be at “OFF”.

4-3. Connecting the loads

Calculate the total power consumption of the output load. Make sure that the total power consumption does not exceed the rated power.

If the total power consumption over the rated power of the inverter, remove the non-critical loads until the total power consumption is below the rated power.

4-4. Switch ON Inverter

Set the power switch to the “ON” position ⑤. The inverter will carry out self-diagnosis and, the LED’s will also appear various colors. Set the power switch to the “OFF” position ⑤. The inverter stops and all the lights that are on will go off.

4-5. Protection Mechanism

Model	Over Voltage (DC)		Under Voltage	Under Voltage	
	Shutdown	Restart	Alarm	Shutdown	Restart
12V	16.5V ± 0.3V	14.5V± 0.3V	10.5V ± 0.3V	10.5V ± 0.3V	12.5V± 0.3V
24V	33V ± 0.5V	29V ± 0.5V	21V± 0.5V	21V ± 0.5V	25V ± 0.5V
48V	66 ± 1V	58V ± 1V	42V± 1V	42V ± 1V	50 ± 1V

Table 31. Protection Mechanism

Model	Over temperature protection	
	Shutdown	Restart
12V	80°C	60°C
24V		
48V		

Table 32. Over Temperature Protection Mechanism

5. RS-232 Communication and Operation

5-1. RS-232 Port

RS-232 Port : Serial port monitoring and control through computer interface.



Figure 19. RS-232 cable

SP Series		Computer	
PIN Number	Description	PIN Number	Description
1	Not used	Not used	1
2	GND	RXD	2
3	RXD	TXD	3
4	TXD	Not used	4
5	Remo Control	GND	5
6	VCC	Not used	6
		Not used	7
		Not used	8
		Not used	9

Table 33. RS-232 interface definition

5-2. RS-232 Port Operating

The following steps show the connection among inverter and computer.

- Step 1 Connect the RS-232 port to the SP series unit on the front panel
- Step 2 Run the computer communication program
- Step 3 Set the transmission protocol
Byte structure: START-BIP – 8 BIT DATA-STOP BIT
Baud rate: 4800
- Step 4 Select the COM port and start the operation

5-3. Example of RS-232 Port Operating

5-3-1. RS-232 command format

This unit uses high-level language commands starts with CR (0DH) and LF(0AH) as the end of the command, The system would interpret and execute the command only after these two characters are received. After the unit executes the command, it would send a response string to the computer
The response string is as follows:

- => CR LF: Command executed successfully
- ?> CR LF: Command error, not accepted
- !> CR LF: Command correct but execution error (e.g. parameters out of range)

5-3-2. Command format

The following table shows the useful command to operate SP series.

Function	Command and description
Turn ON / OFF SP series	Format : Power <value> <value> can be one of the following. "0" : Power OFF "1" : Power ON
Query the SP series output frequency	Format: FRQ?
Query the SP series output voltage	Format: VINV?

Function	Command and description																						
Query the SP series output current	Format: IINV?																						
Query the SP series status	Format: ERR? (SP-700~2000) <table border="1" data-bbox="568 292 1000 866"> <thead> <tr> <th>Bit</th> <th>Description</th> </tr> </thead> <tbody> <tr> <td>BIT0</td> <td>0: No OLPL Protection 1: OLPL Protection</td> </tr> <tr> <td>BIT1</td> <td>0:No Sof Fail Protection 1:SofFail Protection</td> </tr> <tr> <td>BIT2</td> <td>0:No Poff Protection 1:Poff Protection</td> </tr> <tr> <td>BIT3</td> <td>0:No UVP Protection 1:UVP Protection</td> </tr> <tr> <td>BIT4</td> <td>0:No OVP Protection 1:OVP Protection</td> </tr> <tr> <td>BIT5</td> <td>0:No OLPM Protection 1: OLPM Protection</td> </tr> <tr> <td>BIT6</td> <td>0:No OLPH Protection 1: OLPH Protection</td> </tr> <tr> <td>BIT7</td> <td>0:No OTP Protection 1: OTP Protection</td> </tr> <tr> <td>BIT8</td> <td>0:No UTP Protection 1: UTP Protection</td> </tr> <tr> <td>BIT9</td> <td>0:No OOC Protection 1: OOC Protection</td> </tr> </tbody> </table>	Bit	Description	BIT0	0: No OLPL Protection 1: OLPL Protection	BIT1	0:No Sof Fail Protection 1:SofFail Protection	BIT2	0:No Poff Protection 1:Poff Protection	BIT3	0:No UVP Protection 1:UVP Protection	BIT4	0:No OVP Protection 1:OVP Protection	BIT5	0:No OLPM Protection 1: OLPM Protection	BIT6	0:No OLPH Protection 1: OLPH Protection	BIT7	0:No OTP Protection 1: OTP Protection	BIT8	0:No UTP Protection 1: UTP Protection	BIT9	0:No OOC Protection 1: OOC Protection
	Bit	Description																					
BIT0	0: No OLPL Protection 1: OLPL Protection																						
BIT1	0:No Sof Fail Protection 1:SofFail Protection																						
BIT2	0:No Poff Protection 1:Poff Protection																						
BIT3	0:No UVP Protection 1:UVP Protection																						
BIT4	0:No OVP Protection 1:OVP Protection																						
BIT5	0:No OLPM Protection 1: OLPM Protection																						
BIT6	0:No OLPH Protection 1: OLPH Protection																						
BIT7	0:No OTP Protection 1: OTP Protection																						
BIT8	0:No UTP Protection 1: UTP Protection																						
BIT9	0:No OOC Protection 1: OOC Protection																						
* Status definition refer to Table 35. Status definition Format: ERR? (SP-3000~4000) <table border="1" data-bbox="568 954 1000 1441"> <thead> <tr> <th>Bit</th> <th>Description</th> </tr> </thead> <tbody> <tr> <td>BIT0</td> <td>0: No ID Fail 1: ID Fail</td> </tr> <tr> <td>BIT1</td> <td>0:No Sof Fail Protection 1:SofFail Protection</td> </tr> <tr> <td>BIT2</td> <td>0:No PLL Fail 1:PLL Fail</td> </tr> <tr> <td>BIT3</td> <td>0:No Poff Protection 1:Poff Protection</td> </tr> <tr> <td>BIT4</td> <td>0:No Short Protection 1:Short Protection</td> </tr> <tr> <td>BIT5</td> <td>0:No OOC Protection 1: OOC Protection</td> </tr> <tr> <td>BIT6</td> <td>0:NoOVP Protection 1:OVP Protection</td> </tr> <tr> <td>BIT7</td> <td>0:No UVP Protection 1:UVP Protection</td> </tr> </tbody> </table>	Bit	Description	BIT0	0: No ID Fail 1: ID Fail	BIT1	0:No Sof Fail Protection 1:SofFail Protection	BIT2	0:No PLL Fail 1:PLL Fail	BIT3	0:No Poff Protection 1:Poff Protection	BIT4	0:No Short Protection 1:Short Protection	BIT5	0:No OOC Protection 1: OOC Protection	BIT6	0:NoOVP Protection 1:OVP Protection	BIT7	0:No UVP Protection 1:UVP Protection					
Bit	Description																						
BIT0	0: No ID Fail 1: ID Fail																						
BIT1	0:No Sof Fail Protection 1:SofFail Protection																						
BIT2	0:No PLL Fail 1:PLL Fail																						
BIT3	0:No Poff Protection 1:Poff Protection																						
BIT4	0:No Short Protection 1:Short Protection																						
BIT5	0:No OOC Protection 1: OOC Protection																						
BIT6	0:NoOVP Protection 1:OVP Protection																						
BIT7	0:No UVP Protection 1:UVP Protection																						

Function	Command and description															
	BIT8	0:No OTP Protection 1: OTP Protection														
	BIT9	0:No UTP Protection 1: UTP Protection														
	BIT10	0:No OLPH Protection 1: OLPH Protection														
	BIT11	0:No OLPL Protection 1: OLPL Protection														
	* Status definition refer to Table 36. Status definition															
Query the SP series DC input voltage of the battery	Format: VBAT?															
Query the SP series output power	Format: PINV?															
Reset default	Format:*RST															
Select the Setup Menus with the help of Function Codes	Format : FUNC <Function Code> <table border="1" style="margin-left: 20px;"> <thead> <tr> <th>Function code</th> <th>Setting Menu</th> </tr> </thead> <tbody> <tr> <td>0</td> <td>OVP setting</td> </tr> <tr> <td>1</td> <td>OVP Recovery</td> </tr> <tr> <td>2</td> <td>UVP Setting</td> </tr> <tr> <td>3</td> <td>UVP Recovery</td> </tr> <tr> <td>5</td> <td>RS-232 Baud-rate</td> </tr> <tr> <td>6</td> <td>Retry Time</td> </tr> </tbody> </table>		Function code	Setting Menu	0	OVP setting	1	OVP Recovery	2	UVP Setting	3	UVP Recovery	5	RS-232 Baud-rate	6	Retry Time
Function code	Setting Menu															
0	OVP setting															
1	OVP Recovery															
2	UVP Setting															
3	UVP Recovery															
5	RS-232 Baud-rate															
6	Retry Time															
Query the functions No	Format: FUNC?															
Query the setting value of the function	Format: SETT?															
Set or adjust the value of the function	Format: SETT <value>															

Table 34. RS-232 interface command

SP-700 ~ SP-2000 Status Definition

Description	Definition
OLPL Protection	OLPL: Over Load Protection Low (101~115%)
Sof Fail Protection	Sof Fail: Soft Start Fail
Poff Protection	Poff: Power off
UVP Protection	UVP: Under Voltage Protection
OVP Protection	OVP: Over Voltage Protection
OLPM Protection	OLPM: Over Load Protection Middle (116~200%)
OLPH Protection	OLPH: Over Load Protection High (>200%)
OTP Protection	OTP: Over Temperature Protection
UTP Protection	UTP: Under Temperature Protection
OOCP Protection	OOCP: Output Over Current Protection

Table 35. SP-700 ~ SP-2000 Status Definition

SP-3000 ~ SP-4000 Status Definition

Description	Definition
ID	ID: ID Connection Error
Sof Fail Protection	Sof Fail: Soft Start Fail
PLL	PLL: Phase lock loop
Poff Protection	Poff: Power off
OOC Protection	OOC: Output Over Current Protection (Over Load > 200%)
OVP Protection	OVP: Over Voltage Protection
UVP Protection	UVP: Under Voltage Protection
OTP Protection	OTP: Over Temperature Protection
UTP Protection	UTP: Under Temperature Protection
OLPH Protection	OLPH: Over Load Protection High (116~200%)
OLPL Protection	OLPL: Over Load Protection Low (101~115%)

Table 36. SP-3000 ~ SP-4000 Status Definition

The following data shows the function code detail setting value.

**Note:**

Below setting value will go back to default value by switching on / off the inverter.

5-3-2-1. FUNC 0 : OVP setting

SETT <value>	Default	Model
15.0 ~ 16.5	16.5V <16.5>	SP series-112 / 212
30.0 ~ 33.0	33.0V <33.0>	SP series-124 / 224
60.0 ~ 66.0	66.0V <66.0>	SP series-148 / 248

Table 37. OVP setting

5-3-2-2. FUNC 1 : OVP Recovery

SETT <value>	Default	Model
13.5 ~ 14.5	14.5V <14.5>	SP series-112 / 212
27.0 ~ 29.0	29.0V <29.0>	SP series-124 / 224
54.0 ~ 58.0	58.0V <58.0>	SP series-148 / 248

Table 38. OVP recovery

5-3-2-3. FUNC 2 : UVP setting

SETT <value>	Default	Model
10.5 ~ 11.5	10.5V <10.5>	SP series-112 / 212
21.0 ~ 23.0	21.0V <21.0>	SP series-124 / 224
42.0 ~ 46.0	42.0V <42.0>	SP series-148 / 248

Table 39. UVP setting

5-3-2-4. FUNC 3 : UVP Recovery

SETT <value>	Default	Model
12.5 ~ 13.5	12.5V <12.5>	SP series-112 / 212
25.0 ~ 27.0	25.0V <25.0>	SP series-124 / 224
50.0 ~ 54.0	50.0V <50.0>	SP series-148 / 248

Table 40. UVP recovery

5-3-2-5. FUNC 5 : RS-232 Baud rate

SETT <value>	Default	Model
0	2	1200
1		2400
2		4800
3		9600

Table 41. RS-232 baud rate

5-3-2-6. FUNC 6 : Retry time

SETT <value>	Default
0	3
1	
2	
3	

Table 42. retry time

6. Information

6-1. Warning



Warning! Do not open or disassemble the Inverter. Attempting to do so may cause risk of electrical shock or fire.

6-2. Warranty

We guarantee this product against defects in materials and workmanship for a period of 24 months from the date of purchase. In case you need to repair or replace any defective power inverters, please contact COTEK local distributor.

This warranty will be considered void if the unit has been misused, altered, or accidentally damaged. COTEK is not liable for anything that occurs as a result of the user's fault.

COTEK

No.33, Sec. 2, Renhe Rd., Daxi Dist., Taoyuan City 33548, Taiwan

Phone : +886-3-3891999 FAX : +886-3-3802333

[http : // www.cotek.com.tw](http://www.cotek.com.tw)

2016.05._A0