



Official Website



APP (iOS)



APP (Android)



340-00087-02 Version: 1.0



Jiangsu GoodWe Power Supply Technology Co.,Ltd

No.189 Kun Lun Shan Road, SND, Jiangsu, China.

[www.goodwe.com](http://www.goodwe.com)

[service@goodwe.com](mailto:service@goodwe.com)

## SBP SERIES USER MANUAL

AC-COUPLED BATTERY STORAGE RETROFIT

# TABLE OF CONTENTS

## 01 INTRODUCTION

---

1.1 OPERATION MODES INTRODUCTION .....	01
1.2 SAFETY & WARNINGS .....	02
1.3 PRODUCT OVERVIEW .....	04

## 02 INSTALLATION INSTRUCTIONS

---

2.1 UNACCEPTABLE INSTALLATIONS .....	05
2.2 PACKING LIST .....	05
2.3 MOUNTING .....	06
2.3.1 SELECT MOUNTING LOCATION .....	06
2.3.2 MOUNTING .....	07
2.4 ELECTRICAL WIRING CONNECTION .....	08
2.4.1 BATTERY CONNECTION .....	08
2.4.2 ON-GRID & BACK-UP CONNECTION .....	10
2.4.3 EZMETER & CT CONNECTION .....	12
2.5 DRED CONNECTION .....	13

## 03 MANUAL OPERATION

---

3.1 WIFI CONFIGURATION & WIFI RELOAD .....	16
3.2 PV MASTER APP OPERATION .....	17
3.3 CEI AUTO-TEST INSTRUCTION .....	17

## 04 OTHERS

---

4.1 ERROR MESSAGE AND TROUBLESHOOTING .....	18
4.2 DISCLAIMER .....	24
4.3 WARINING QUICK CHECK LIST .....	28
4.4 TECHNICAL PARAMETERS AND CERTIFICATES .....	29

01 INTRODUCTION

GoodWe S-BP series bi-directional inverter is designed for both indoor and outdoor use, which could be used with or without existing grid-tied inverter systems to store energy with batteries.

Energy produced from grid-tied inverters shall be used to optimize self-consumption, then charge battery, exceed power from grid-tied system could export to grid. Loads will be supported in priority by grid-tied system, then battery power, exceed consumption power will be drained from grid.

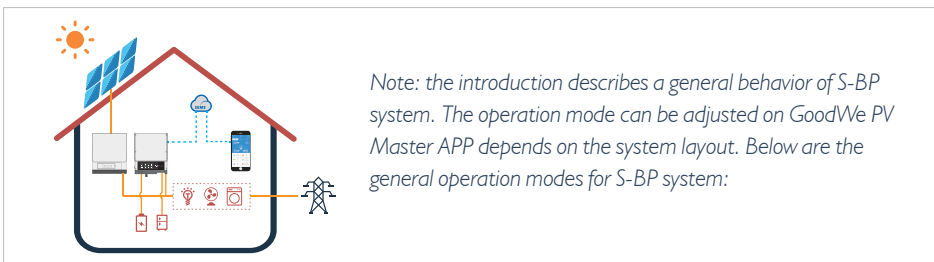

1.1 OPERATION MODES INTRODUCTION

S-BP system normally has the following operation modes based on your configuration and layout conditions

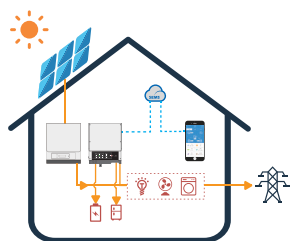

Mode I

Energy from grid-tied inverters optimize loads, then charge battery, exceed power export to grid.

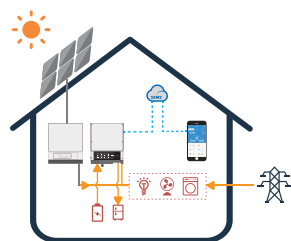

Mode II

When energy from grid-tied inverters is weak, battery discharge to support loads in priority, together with grid.

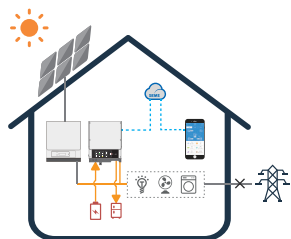

Mode III

When grid power fails, battery will discharge to support Back-Up Loads.

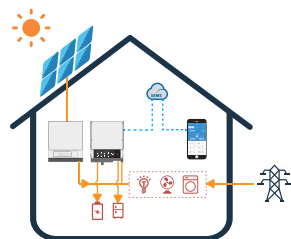

Mode IV

Battery can be charged by grid, and charging time/power can be set flexibly on PV Master APP.

1.2 SAFETY & WARNING

The S-BP series inverters of Jiangsu GoodWe Power Supply Technology Co., Ltd. (hereinafter called as GoodWe) strictly comply with related safety rules for product design and testing. Please read and follow all the instructions and cautions on the inverter or user manual during installation, operation or maintenance, as any improper operation might cause personal or property damage.

• SYMBOLS EXPLANATION



Caution!  
Failing to observe a warning indicated in this manual may result in injury.



Danger of high voltage and electric shock!



Danger of hot surface!



Components of the product can be recycled.



This side up! The package must always be transported, handled and stored in such a way that the arrows always point upwards.



No more than six (6) identical packages being stacked on each other.



Product should not be disposed as household waste.



The package/product should be handled carefully and never be tipped over or slung.



Refer to the operating instructions.



Keep dry! The package/product must be protected from excessive humidity and must be stored under cover.



Inverter will be touchable or operable after minimum 5 minutes of being turned off or totally disconnected, in case of any electrical shock or injury.



CE Mark

**• SAFETY WARNING**

Any installation and operation on inverter must be performed by qualified electricians, in compliance with standards, wiring rules or requirements of local grid authorities or companies (like AS 4777 and AS/NZS 3000 in Australia).

Before any wiring connection or electrical operation on inverter, all battery and AC power must be disconnected from inverter for at least 5 minutes to make sure inverter is totally isolated to avoid electric shock.

The temperature of inverter surface might exceed 60 C during working, so please make sure it is cooled down before touching it, and make sure the inverter is untouchable for children

Usage and operation of the inverter must follow instructions in this user manual, otherwise the protection design might be useless and warranty for the inverter will be invalid.

Do not open inverter cover or change any components without GoodWe's authorization, otherwise the warranty commitment for the inverter will be invalid.

Appropriate methods must be adopted to protect inverter from static damage. Any damage caused by static is not warranted by GoodWe.

The inverter, with built-in RCMU, will exclude possibility of DC residual current to 6mA, thus in the system an external RCD (type A) can be used( $\geq 30mA$ ).

In Australia, the inverter internal switching does not maintain neutral integrity, which must be addressed by external connection arrangements like in the system connection diagram for Australia on page 16.

IN Australia, output of backup side in switchbox should be labeled 'Main switch UPS supply', the output of normal load side in switch box should be labeled 'main switch inverter supply'.

**1.3 PRODUCT OVERVIEW**

INDICATOR	STATUS	EXPLANATION
SYSTEM	ON = SYSTEM IS READY	ON = SYSTEM IS READY
	BLINK = SYSTEM IS STARTING UP	BLINK = SYSTEM IS STARTING UP
BACK-UP	ON = BACK-UP IS READY / POWER AVAILABLE	ON = BACK-UP IS READY / POWER AVAILABLE
	OFF = BACK-UP IS OFF / NO POWER AVAILABLE	OFF = BACK-UP IS OFF / NO POWER AVAILABLE
COM	ON = METER COMMUNICATION OK	ON = METER COMMUNICATION OK
	BLINK = METER COMMUNICATION FAIL	BLINK = METER COMMUNICATION FAIL
BATTERY	ON = BATTERY IS CHARGING	ON = BATTERY IS CHARGING
	BLINK 1 = BATTERY IS DISCHARGING	BLINK 1 = BATTERY IS DISCHARGING
GRID	ON = BATTERY IS DISCONNECTED / NOT ACTIVE	ON = BATTERY IS DISCONNECTED / NOT ACTIVE
	OFF = GRID IS ACTIVE AND CONNECTED	OFF = GRID IS ACTIVE AND CONNECTED
ENERGY	ON = CONSUMING ENERGY FROM GRID / BUYING	ON = CONSUMING ENERGY FROM GRID / BUYING
	BLINK 1 = SUPPLYING ENERGY TO GRID / SELLING	BLINK 1 = SUPPLYING ENERGY TO GRID / SELLING
WI-FI	ON = WI-FI CONNECTED / ACTIVE	ON = WI-FI CONNECTED / ACTIVE
	BLINK 1 = WI-FI SYSTEM RESETTING	BLINK 1 = WI-FI SYSTEM RESETTING
FAULT	ON = FAULT HAS OCCURRED	ON = FAULT HAS OCCURRED
	OFF = NO FAULT	OFF = NO FAULT

**LED INDICATORS**

SYSTEM	BACK-UP	COM	BATTERY	GRID	ENERGY	WI-FI	FAULT
Green	Green	Blue	Blue	Blue	Yellow	Yellow	Red

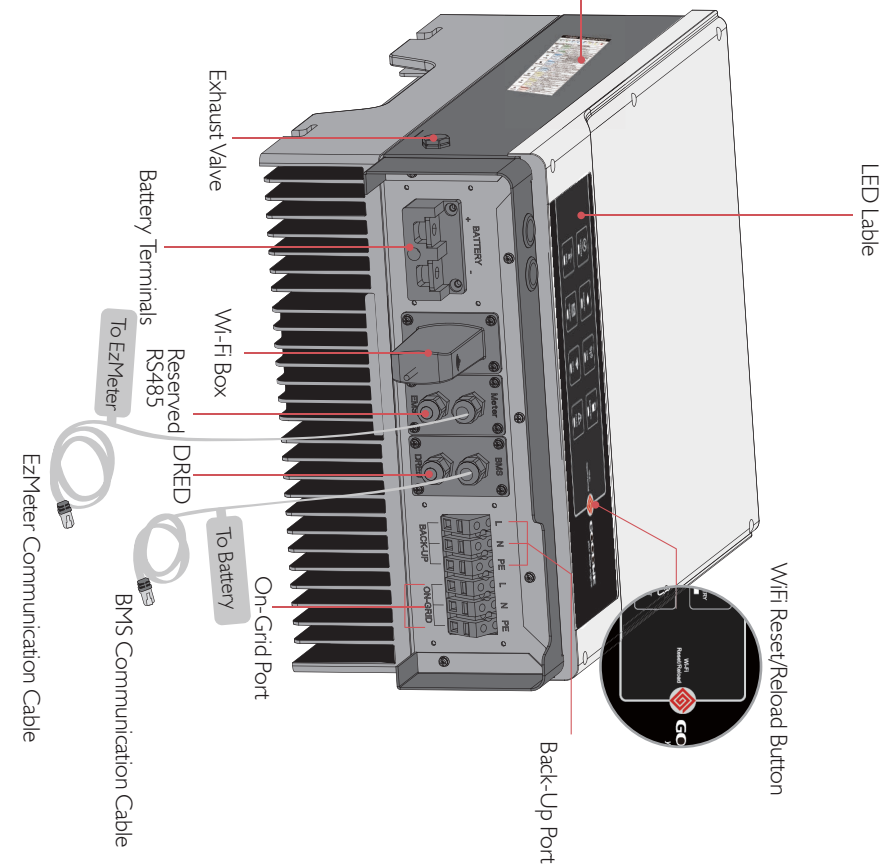

**02** INSTALLATION INSTRUCTIONS

**2.1 UNACCEPTABLE INSTALLATIONS**

Please avoid the following installations, which will damage the system or the inverter.

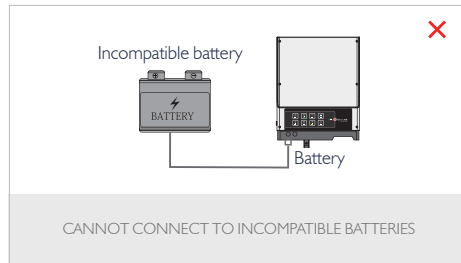
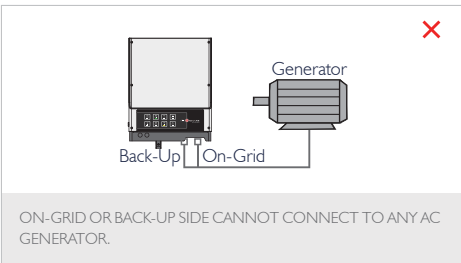
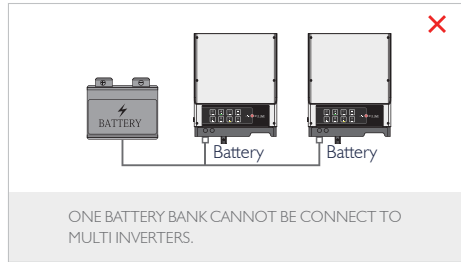
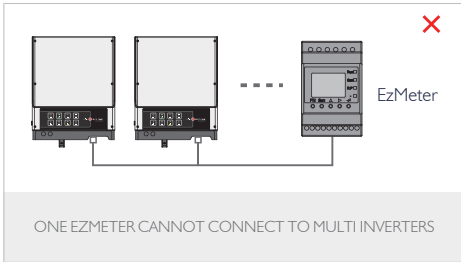
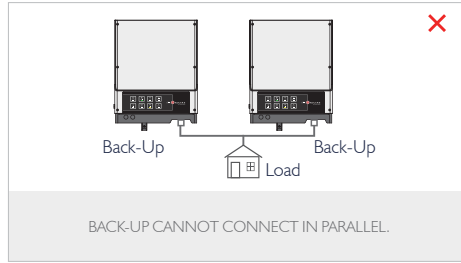
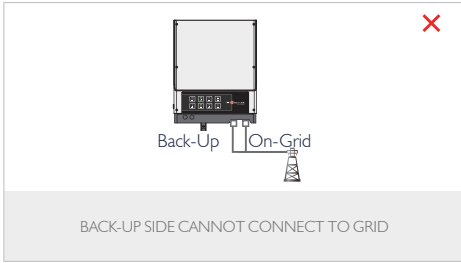

**2.2 PACKING LIST**

On receiving the inverter, please check to make sure all the components as below are not missing or broken.



**2.3 MOUNTING**

**2.3.1 SELECT MOUNTING LOCATION**

For inverter's protection and convenient maintenance, mounting location for inverter should be selected carefully based on the following rules:

**Rule 1.** Inverter should be installed on a solid surface, where is suitable for inverter's dimensions and weight.

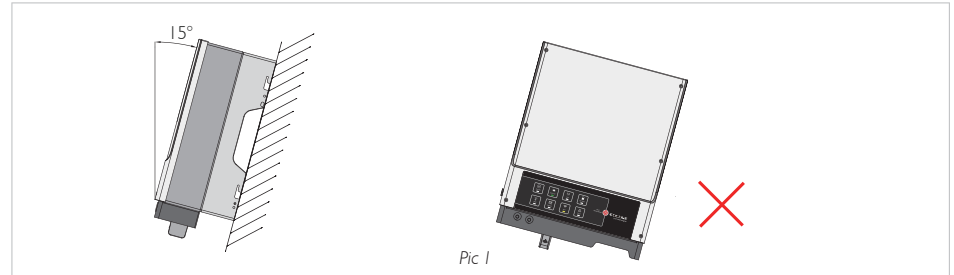
**Rule 2.** Inverter installation should stand vertically or lie on a slop by max 15° (Pic 1)



**Rule 3.** Ambient temperature should be lower than 45°C

**Rule 4.** The installation of inverter should be protected under shelter from direct sunlight or bad weather like snow, rain, lightning etc. (Pic 2)

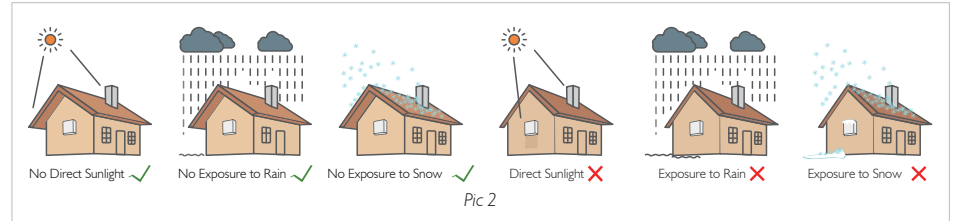

**Rule 5.** Inverter should be installed at eye level for convenient maintenance.

**Rule 6.** Product label on inverter should be clearly visible after installation.

**Rule 7.** Leave enough space around inverter following the values on pic 3.

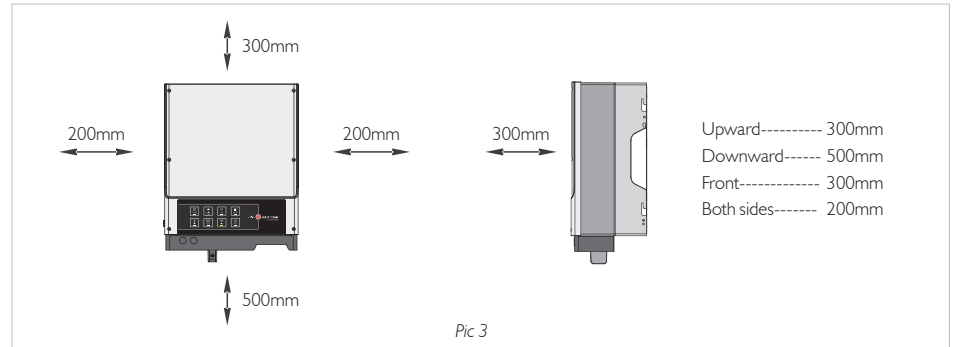

Inverter cannot be installed near flammable, explosive or strong electro-magnetic equipment.<sup>[1]</sup>

### 2.3.2 MOUNTING

**!** Remember that this inverter is heavy! Please be careful when lifting out from the package.<sup>[2]</sup>

The inverter is suitable for mounting on concrete or other non-combustible surface only

#### Step 1

- Please use the mounting bracket as a template to drill 6 holes on right positions (10mm in diameter, and 80mm in depth) (Pic 4)
- Use expansion bolts in accessory box and fix the mounting bracket onto the wall tightly

*NOTE: Bearing capacity of the wall must be higher than 19KG, otherwise may not be able to keep inverter from dropping.*

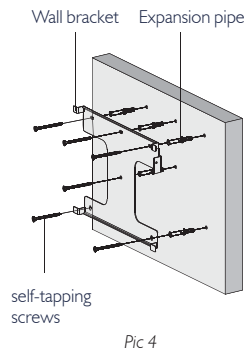

07

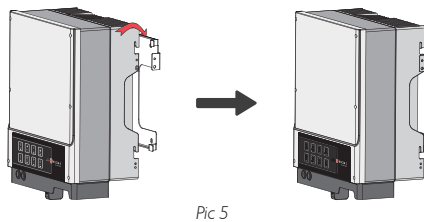

#### Step 2

Carry the inverter by holding the heating sink on two sides and Place the inverter on the mounting bracket. (Pic 5)

*NOTE: Make sure the heat sink on inverter is rightly joint with mounting bracket.*

#### Step 3

Ground cable shall be connected to ground plate on grid side (Pic 6)

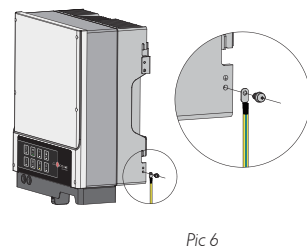

#### Step 4

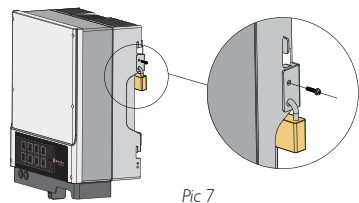

A lock could be used for anti-theft if it is necessary for individual requirement. (Pic 7)

### 2.4 ELECTRICAL WIRING CONNECTION

#### 2.4.1 BATTERY CONNECTION

- For lithium battery (pack) the capacity should be 50Ah or larger. Lead acid batteries are not allowed to use with GoodWe hybrid inverters without GoodWe's authority. Battery cable requirement as below. (Pic 8)

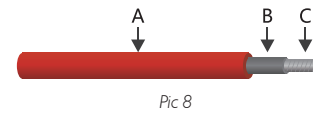

Grade	Description	Value
A	O.D.	10-12mm
B	Isolation section	NA
C	Conductor Core	20-25mm <sup>2</sup>

- Please be careful against any electric shock or chemical hazard
- Make sure there is an external DC switch ( $\geq 125A$ ) connected for battery without attached DC switch

Battery wiring connection steps as below:

**!** Make sure battery switch is off and battery nominal voltage meet S-BP specification before connecting battery to inverter. Make sure inverter is totally isolated from AC power.<sup>[3]</sup>

#### Step 1

Prepare battery cables and accessories and put battery power cable through battery cover (Pic 9)

*NOTE:*

1. Please use accessories from GoodWe box
2. Battery power cable should be 20-25 mm<sup>2</sup>

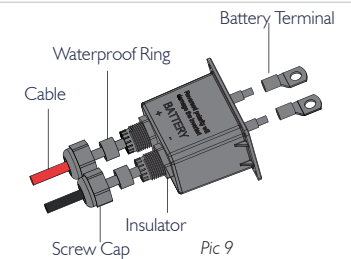

08

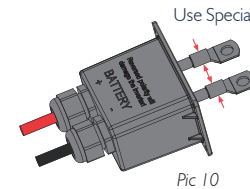

#### Step 2

Make battery terminals (Pic 10)

- Strip cable coat, revealing 10mm length of metal core
- Use special crimper to compress battery terminal tightly

#### Step 3

Connect battery terminals onto inverter (Pic 11)

*NOTE: Please make sure polarity (+/-) of battery are not reversed*

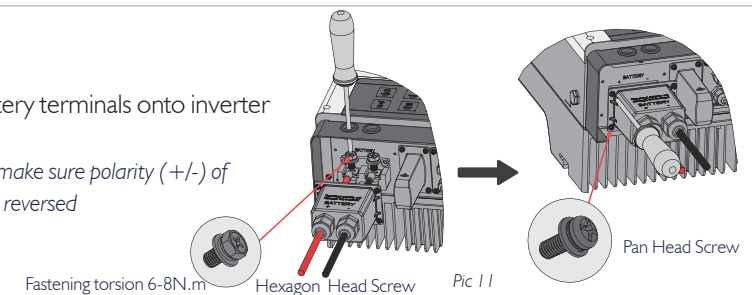

\* For the compatible lithium batteries (LG/Pylon/BYD/GCL) connection, please refer to battery connection part in S-BP QUICK INSTALLATION INSTRUCTIONS.

**• FOR LEAD-ACID BATTERIES**

Lead-Acid and other similar older-technology battery types require experienced and precise design, installation and maintenance to work effectively. For details, please refer to *Approved Battery Option Statement* (download from [www.goodwe.com](http://www.goodwe.com))

For lead-acid battery bank, the inconformity between battery cells might lead to battery cell over-charge or discharge, and further might damage battery cells and shorten battery bank life

For S-BP series inverters there is no temperature compensation, thus customers need do battery settings based on the real working temperature of battery.

For lead-acid battery settings on PV Master App, please honestly refer to battery specifications and the actually battery work condition like work temperature and battery age. Unsuitable settings will lead to higher SOC deviation, weaker battery lifespan and further battery damage.

For lead-acid batteries, battery SOC calculation might not be so accurate result from like battery inconformity between cells, battery aging or other specifications of lead-acid battery etc.

GoodWe will keep the right for explanation on all the settings suggested and all the problems happened on lead-acid batteries or the whole system. And GoodWe is not responsible for any damage caused by unsuitable settings, battery beyond warranty or battery quality etc.

**• BATTERY PROTECTION DESCRIPTION**

Battery will act a protective charge/discharge current limitation under any condition as below:

- Battery SOC is lower than 1-DOD
- Battery voltage lower than discharge voltage
- Battery over temperature protection
- Battery communication abnormal for lithium battery
- BMS limitation for lithium battery

When charge/discharge current limitation protection happens:

- Under on-grid mode, battery charge/discharge operation could be abnormal
- Under off-grid mode, Back-Up supply will shut down

NOTE:

- Under on-grid mode, battery is protected from over discharge by DOD and discharge voltage, under off-grid mode, it is protected by only discharge voltage and DOD.
- The DOD setting of a battery prevents the inverter from discharging battery reserve power. As soon as the DOD is reached the load of building will only be supported by either PV power or from the grid. If there are continuous days when little or no battery charging occurs, the battery may continue to self-consume energy to support communications with the inverter. This behaviour is different between battery manufactures products, however, if the SOC of the battery reaches a certain level the inverter will boost the SOC back up. This protection mechanism safeguards the battery to falling to 0% SOC.

**2.4.2 ON-GRID & BACK-UP CONNECTION**

An external AC switch ( $\geq 40A$  for GW3600S-BP,  $\geq 50A$  for GW 5000S-BP) is needed for On-Grid and Back-Up connection to isolate from grid when necessary. Below are the requirements on AC switch use:  
 Note: The absence of AC breaker on Back-Up side will lead to inverter damage if only electrical short-circuit happend on Back-Up side.

1. Use a separate AC switch for individual inverter (Pic 12)

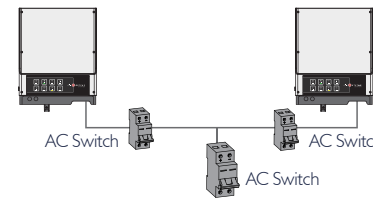

2. On AC side, the individual switch should be connected before loads (between inverter and loads) (Pic 13)

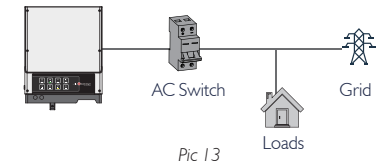

• Requirement on AC cable connected on On-Grid and Back-Up side

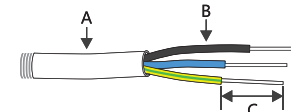

Grade	Description	Value
A	Outside Diameter	11-12mm
B	Isolation Section	NA
C	Conduct. Core Dimension	6mm <sup>2</sup>

NOTE:

1. Neutral conductor shall be blue, line conductor black or brown (preferred) and protective earth bonding line yellow-green.
2. For AC cables, PE cable shall be longer than N & L cables, so that if in any case AC cable slips or taken out, the protecting earth conductor will be the last to take the strain

• On-Grid wiring connection process is as below:



Make sure inverter is totally isolated from any DC or AC power before connecting AC cable<sup>(4)</sup>.

**Step 1**

1. Prepare the terminals and AC cables
2. Put AC cable through terminal cover follow the sequence as on the left (Pic 14)

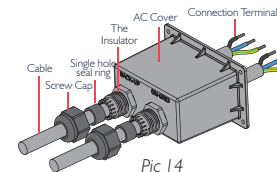

Note: Please use the terminals in GoodWe components box

**Step 2**

Press the six connectors on cable conductor core tightly (Pic 15)

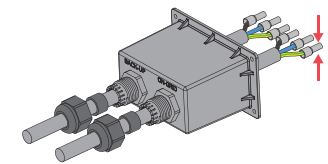

Note: Make sure cable jacket is not locked within the connector

**Step 3**

1. Connect the assembled AC terminals onto inverter  
 Note: Make sure it is not connected to a wrong side (Pic 16)
2. Lock the cover and screw the cap on (Pic 17)

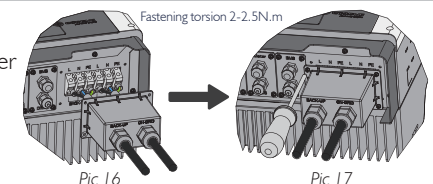



• Anti-Reverse Function Connection

If S-BP system (connected with grid-tied inverters) requires anti-reverse function, it is operable but please note:

1. This diagram is only for installation where has exporting power limit function requirement
2. For anti-reverse function, will also need set on PV Master App→Advanced Setting→Power Limit
3. This diagram only be reasonable if grid-tied inverter has anti-reverse function itself. And the power limitation value shall be set on grid-tied inverter

\* Connection Diagram as below (Pic 18)

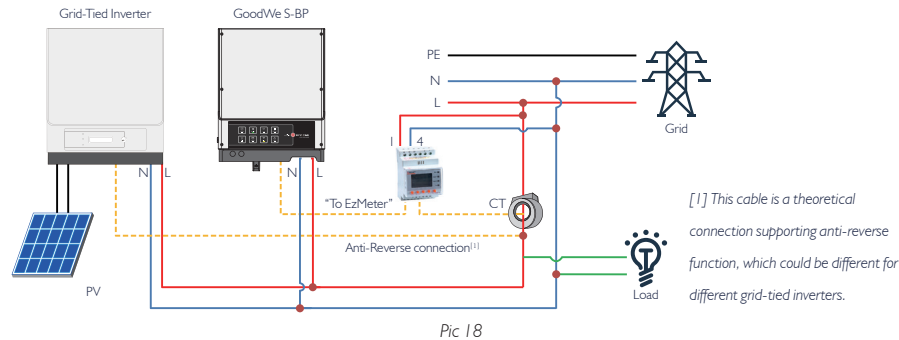

Declaration For Back-Up Loads

GoodWe S-BP inverter is able to supply a continuous 5000VA output (max 5500VA within 10s) on Back-Up side. And inverter will shut down under full loading with high ambient temperature if grid is absent.

- Accepted house loads for Back-Up side: Television, Computer, Fridge, Fan, illumination lamps, microwave oven, electric rice cooker, small power air conditioner, routers etc.
- Unaccepted house loads for Back-Up side: air conditioner, water pump, heaters, wash machine, electromagnetic oven, compression engine, hair drier, dust cleaner etc. with high power and other loads with high inrush current at start-up.

Special Adjustable Settings

The inverter has field adjustable setting like tripping point, tripping time, reconnect time, active and invalid of QU/PU curves etc. by special firmware. Please contact GoodWe after-sales for the special firmware and adjust methods.

For a convenient maintenance, an SP3T switch could be installed on Back-Up and On-Grid side. Then it is adjustable to support load by Back-Up or by grid or just leave it there (Pic 19)

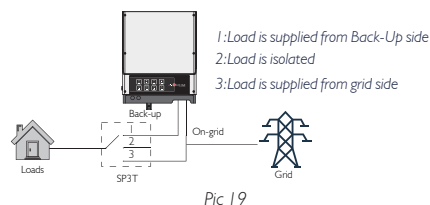

Declaration For Back-Up Overload Protection

Inverter will restart itself as overload protection happens. The preparation time for restarting will be longer and longer (max one hour) if overload protection incessantly repeats. Take following steps to restart inverter immediately:

- Decrease Back-Up load power within max limitation
- On PV Master →Advanced Setting →Click “Reset Backup Overload History”

2.4.3 EZMETER & CT CONNECTION

The single-phase EzMeter with CT or 3-phase EzMeter in GoodWe product box is compulsory for S-BP system installation, used to detect grid voltage and current direction and magnitude, further to instruct the operation condition of S-BP inverter via RS485 communication.

**!** Make sure S-BP and grid-tied inverters are totally isolated from AC and DC power before connecting EzMeter & CT<sup>[5]</sup>

• Single-Phase EzMeter Wiring (Pic 20)

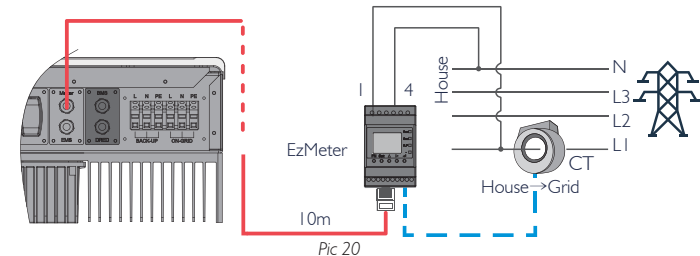

NOTE:

1. The EzMeter and CT is well configured, please do not change any setting on EzMeter
2. CT must be connected on the same phase with EzMeter power cable

• 3-Phase EzMeter Wiring (Pic 21)

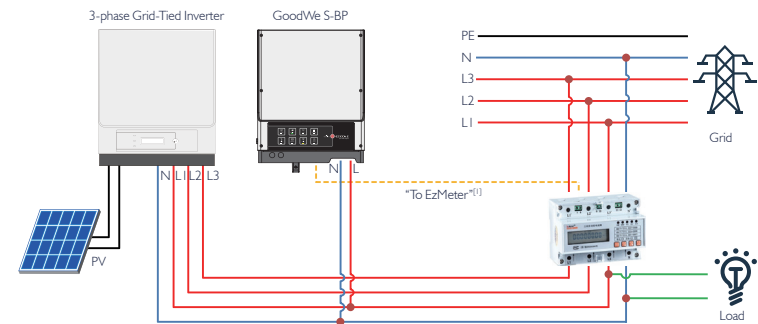

NOTE:

1. For 3-phase EzMeter, L1/L2/L3 is connect to inverter side and L1/L2/L3' connected to grid side
2. To connect a 3-phase EzMeter from GoodWe, the external RJ45 plug from "To EzMeter" cable should be cut off, then green and brown pins connect together to port 7, Green & White and Brown & White pins connect together to port 8

• Detailed pin function of each port on S-BP (Pic 22)



Pic 22

Position	Color	BMS Function	EzMeter Function	RS485
1	Orange&white	485_A2	NC	485_A
2	Orange	NC	NC	485_B
3	Green&white	485_B2	485_B1	485_A
4	Blue	CAN_H	NC	NC
5	Blue&white	CAN_L	NC	NC
6	Green	NC	485_A1	485_B
7	Brown&white	NC	485_B1	NC
8	Brown	NC	485_A1	NC



• Single-Phase EzMeter LED Indications

	OFF	ON	Blinking
RUN	Not working	/	Working Normally
Com (Red)	Communication fail	/	Communication OK
R-P (Red)	Sale power to grid	Buy power from grid	/
---- (Red)	/	Negative value indicator	/

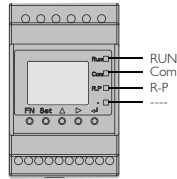

NOTE:

- For 3-phase EzMeter please check on LCD left-down side, a phone signal blinking means communication OK
- For both EzMeter, customer can also check on PV Master App

2.5 DRED CONNECTION

DRED is only for Australian and New Zealand installations, in compliance with Australian and New Zealand safety requirements. And DRED device is not provided by GoodWe.

Detailed connection of DRED device is shown below:

Step 1

Screw this plate off from inverter (Pic 23)  
 Note: DRED device should be connected through "DRED port" as on the figure shows.

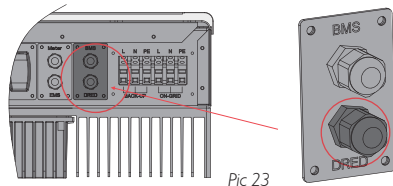

Step 2

- PLUG OUT the 6-Pin terminal and dismantle the resistance on it (Pic 24)
- PLUG THE RESISTANCE OUT, leave the 6-Pin terminal for next step.

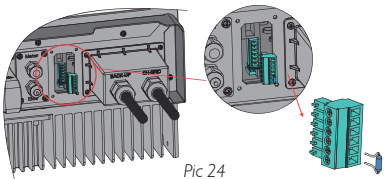

Note: DRED device should be connected through "DRED port" as on the figure shows.

Step 3

- Put DRED cable through the plate as shown on (Pic 25)
- Connect DRED cable on the 6-pin terminal. The function of each connection position as below:

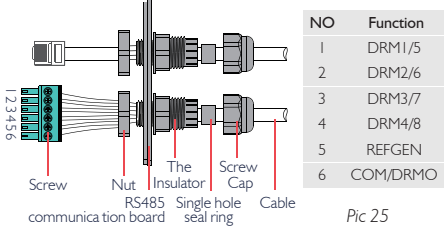

Step 4

Step 4: Connect DRED terminal to the right position onto the inverter (Pic 26)

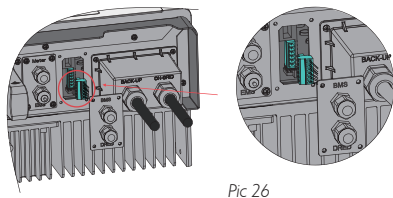

• WIRING SYSTEM FOR S-BP SERIES HYBRID INVERTER

For 3-phase EzMeter wiring connection, please refer to Pic 21 on page 12

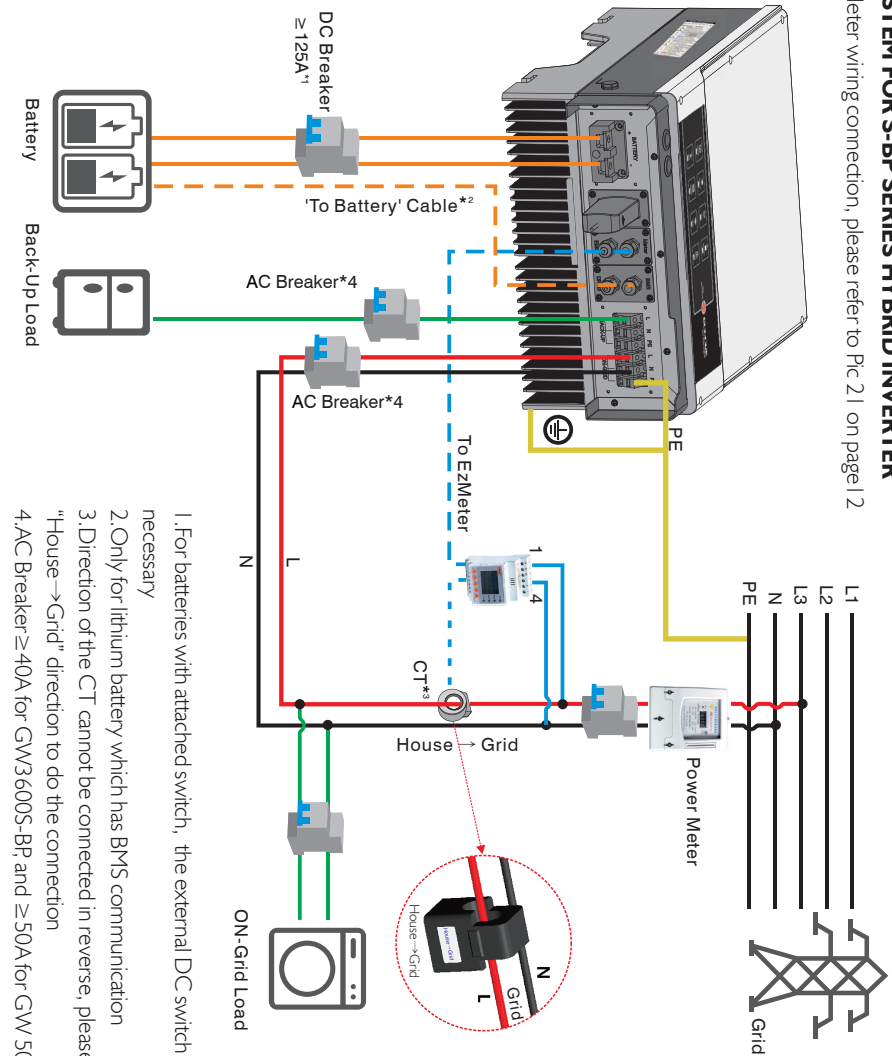

- For batteries with attached switch, the external DC switch is not necessary
- Only for lithium battery which has BMS communication
- Direction of the CT cannot be connected in reverse, please follow "House → Grid" direction to do the connection
- AC Breaker ≥40A for GW3600S-BP and ≥50A for GW5000S-BP

• SYSTEM CONNECTION DIAGRAMS

NOTE:For Australian safety country, the neutral cable of On-Grid side and Back-Up side must be connected together, otherwise Back-Up function will not work.

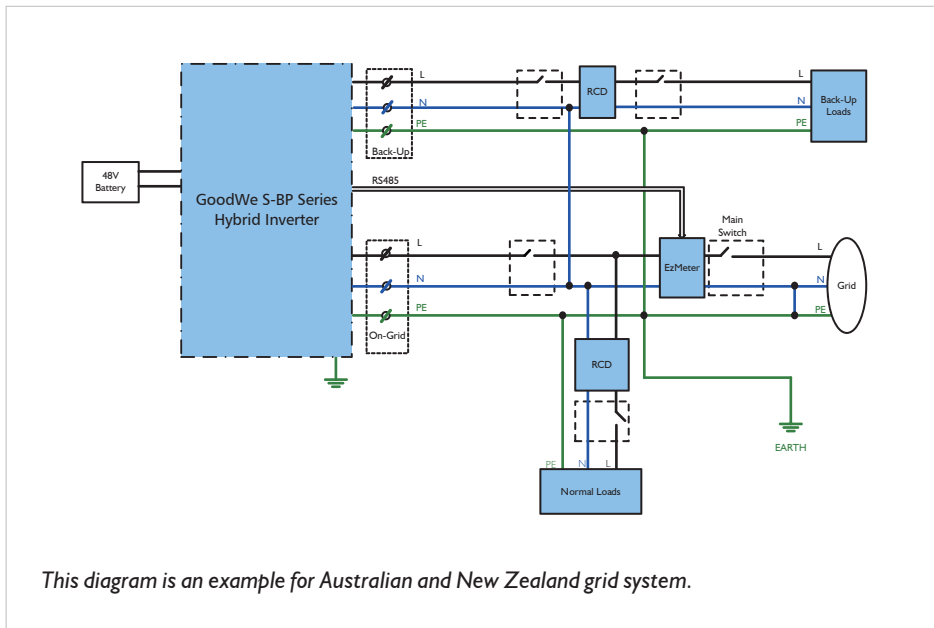

This diagram is an example for Australian and New Zealand grid system.

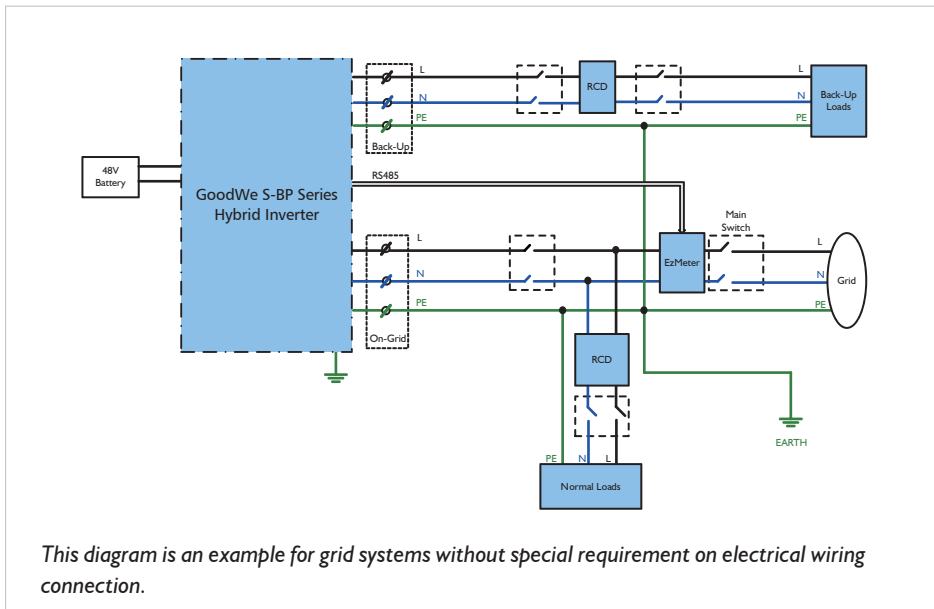

This diagram is an example for grid systems without special requirement on electrical wiring connection.

03 MAMUAL OPERATION

3.1 WIFI CONFIGURATION

- This part shows configuration on web page
- Wi-Fi configuration is absolutely necessary for online monitoring and after-sales maintenance

PREPARATION:

1. Inverter must be powered up with only PV power
2. Need a router with available internet access to GoodWe portal [www.goodwe-power.com](http://www.goodwe-power.com)

Step 1

1. Connect Solar-WiFi\* to your PC or smart phone>(\* means the last 8 characters of the inverter serial No.)
2. Open browser and login 10.10.100.253  
Admin (U): admin; Password: admin
3. Then click "OK"

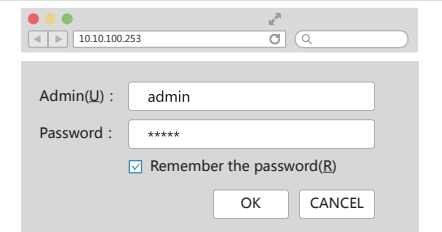

Step 2

1. Click "Start Setup" to choose your router
2. Then click "Next"

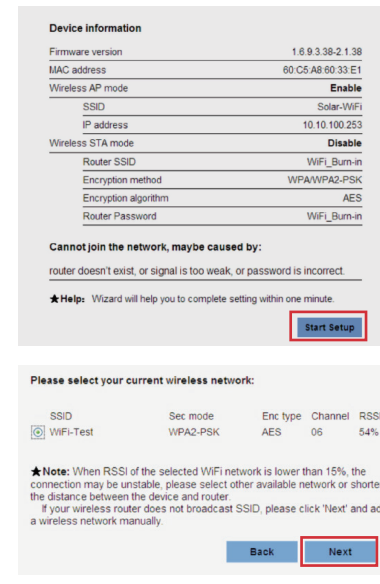

Step 3

1. Fill in the password of the router, then click "Next"
2. Click "Complete"

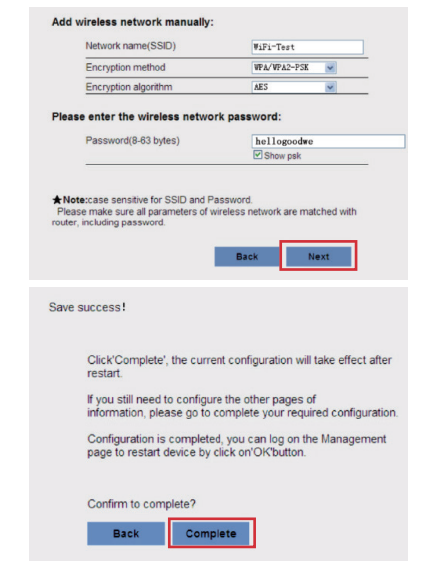

NOTE:

1. Please make sure the password, Encryption Method/Algorithm is right the same with the router's
2. If everything is right well, the Wi-Fi LED on inverter will change from double blink to quartic blink then to solid status, which means Wi-Fi is connected to GoodWe icloud successfully.
3. Wi-Fi configuration could also be done on PV Master, details please check on PV Master APP

• Wi-Fi Reset & Reload

Wi-Fi Reset means restarting Wi-Fi module, Wi-Fi settings will be reprocessed and saved.

Wi-Fi Reload means setting Wi-Fi module settings back to default factory setting.

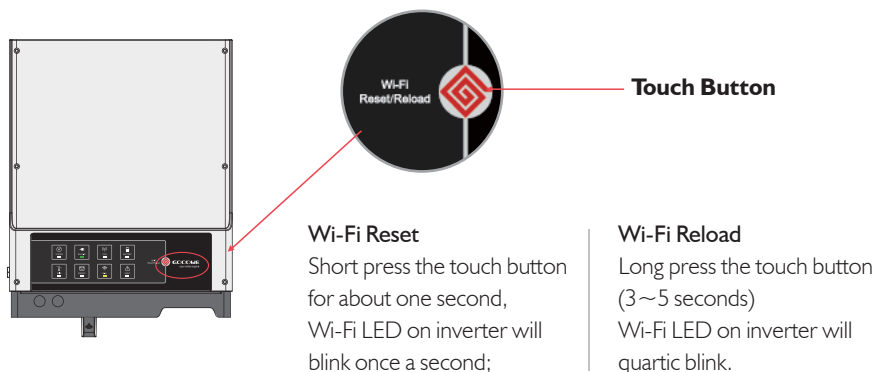

NOTE: Wi-Fi Reset & Reload function are only used when:

1. Wi-Fi losses connection to internet or cannot connect to PV Master App successfully
2. Cannot find "Solar-WiFi" signal or have other Wi-Fi configuration problem
3. Please do not use this button if Wi-Fi monitoring works well

**3.2 PV Master APP OPERATION**

PV Master is an external monitoring/ configuration application for GoodWe hybrid inverters, used on smart phones or pad for both Android and iOS system, main functions as below:

1. Edit system configuration to make the system work as customer needs
2. Monitor and check performance of the hybrid system
3. Wi-Fi configuration

Please download PV Master OPERATION INSTRUCTIONS from [www.goodwe.com](http://www.goodwe.com)



**3.3 CEI AUTO-TEST FUNCTION**

PV Auto-Test function of CEI is integrated in PV Master App for Italy safety country requirements. For detailed instruction of this function please refer to **PV Master OPERATION INSTRUCTIONS**

**4.1 ERROR MESSAGE AND TROUBLESHOOTINGS**

• **ERROR MESSAGE**

The error messages below will be displayed on PV Master App or report by Email if the error really happen.

ERROR MESSAGE	EXPLANATION	REASON
Utility Loss	Not available of public grid power (power loss or on-grid connection fails)	Inverter does not detect the connection of grid
VAC Failure	Grid voltage is not within permissible range	Inverter detects that AC voltage is beyond the normal range required by the safety country
FAC Failure	Grid Efficiency is not within permissible range	Inverter detects that Grid frequency is beyond the normal range required by the safety country
Over Temperature	Temperature inside of the inverter is too high	Inverter working environment leads to a high temperature condition
Relay Check Failure	Self checking of relay fails	Neutral & ground cable are not connected well on AC side or just occasional failure
DC Injection High	/	Inverter detects a higher DC component in AC output
EEPROM R/W Failure	/	Caused by a strong external magnetic field etc.
SPI Failure	Internal communication fails	Caused by a strong external magnetic field etc.
DC Bus High	BUS voltage is over-high	/
Back-Up Over Load	Back-up side is over loaded	Total Back-Up load power is higher than the nominal backup output power

Note: All the errors about battery happen only on Lithium battery with BMS communication.

SOLUTIONS

1. Check (use multi-meter) if AC side has voltage . Make sure grid power is available
2. Make sure AC cables are connected tightly and right well
3. If all is well, please try to turn off AC breaker and turn on again after 5 mins

1. Make sure safety country of the inverter is set right
2. Check (use multi-meter) if AC voltage (Between L&N) is within a normal range (Also on AC breaker side)
  - a. if AC voltage is high, then make sure AC cable complies with that required on user manual and AC cable is not too long
  - b. if voltage is low, make sure AC cable is connected well and the jacket of AC cable is not compressed into AC terminal
3. Make sure the grid voltage of your area is stable and within normal range.

1. Make sure safety country of the inverter is set right
2. If safety country is right, then please check on inverter display if AC frequency (Fac) is within a normal range
3. If FAC failure only appear a few times and resolved soon, it should be caused by occasional grid frequency instability.

1. Try to decrease surrounding temperature
2. Make sure the installation complies with the instruction on inverter user manual
3. Try to close inverter for 15 mins, then start up again.

Check use multi-meter if there is high voltage (normally should be lower than 10V) between N&PE cable on AC side. If the voltage higher than 10V, it means the Neutral & ground cable are not connected well on AC side or restart inverter.

Try to restart inverter, check if it still happens, if not, means it is just an occasional situation or contact GoodWe

Try to restart inverter, check if it still happens, if not, means it is just an occasional situation or contact GoodWe

Try to restart inverter, check if it still happens, if not, means it is just an occasional situation or contact GoodWe

Try to restart inverter, check if it still happens, if not, means it is just an occasional situation or contact GoodWe

Decrease Back-Up loads to make sure the total load power is lower than Back-Up nominal output power (please refer to page 12)

• TROUBLESHOOTINGS

Checking Before Starting EM Up

- ◆ **Battery Connection:** Confirm the connection between S-BP and battery : polarities ( +/-) not reversed, refer to Pic 27
- ◆ **On-Grid & Back-Up Connection:** Confirm ON-GRID connected to power grid and Back-Up to loads : polarity ( +/-) not reversed, refer to Pic 28
- ◆ **EzMeter & CT Connection:**

1. if connection between EzMeter and CT (port 1 and 4 on EzMeter) is OK

*Note: After turn on AC power, the COM led on EzMeter should be blinking*

2. Make sure CT connected between house loads and grid. and follow the House→Grid direction on CT (Pic 29).

*Note: for three-phase EzMeter, please refer to page 12 to check if the connection and communication of EzMeter is OK.*

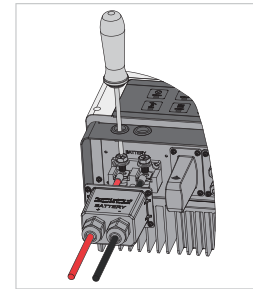

Pic 27

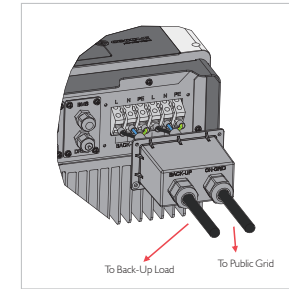

Pic 28

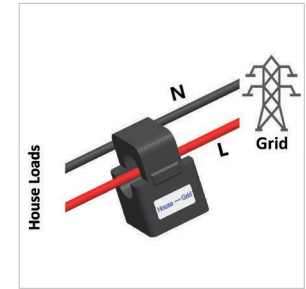

Pic 29

◆ **Battery Settings, BMS Communication and Safety Country:**

After connecting Solar-WiFi\* (\* means the last 8 characters of the inverter serial No.), check on PV Master APP (in "Param" column) to make sure battery type is right what you have installed, and Safety Country is right. If not, please change it in "Set" column (Pic 30)

1. For lead acid battery: All the settings should comply with the parameter of the battery, and please contact GoodWe for advices before use it

2. For Lithium batteries, BMS status should be "Communication OK"

*Note: If BMS Status says "NG", then please make sure battery communication cable wiring connection and all settings are all right, refer to battery connection SOP in S-BP QUICK INSTALLATION INSTRUCTIONS*

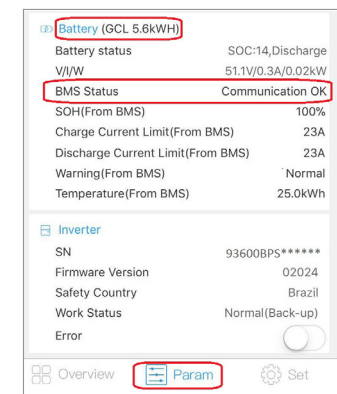

Pic 30

## Possible Problems During Operation

### S-BP not Start Up With ONLY Battery

#### Solution:

1. Make sure the voltage of battery is higher than 48V, otherwise battery cannot start S-BP up.

### No Discharge or Output From S-BP to Support Loads

#### Possible Reasons:

1. There is grid-tied inverter connected in the system, and the output power is higher than load power
2. Load is connected between grid and CT, thus the system cannot detect load power, which is supported by grid power
3. Load power is lower than 150W, as battery will only discharge if load power is higher than 150W
4. EzMeter communication fails or CT connected in a wrong direction, which gives S-BP wrong data
5. Battery is not on the condition of discharging, such as low SOC, battery communication fail for lithium batteries etc.

#### Solutions:

1. Communication between S-BP and EzMeter is OK or not
2. Make sure load power is higher than 150W
  - a. battery will not discharge continuously unless load power is higher than 150W;
  - b. If battery still not discharge when Meter power is higher than 150W, then please check EzMeter & CT connection and direction;
3. Make sure SOC is higher than 1-DOD. Or if battery discharged to below 1-DOD, than battery will only discharge again when SOC charged to  $20\% + (1-DOD) / 2$  and  $SOC > 105\% - DOD$  (if need battery discharge immediately, battery should be restarted)
4. Check on APP if already set charge time, as during charge time, battery will not discharge (battery will charge in priority during coincident time of charge/discharge)

*NOTE: In S-BP system, there is usually a grid-tied inverter connected. As system cannot detect power from grid-tied inverter or other power source, thus sometimes when you see the system does not discharge when load power is high, which actually is because of grid-tied production is supporting load.*

### Battery Does Not Charge

#### Possible Reason:

1. Battery in S-BP system does not charge automatically unless on conditions as below:
  - a. Battery is under compulsive charging condition (different condition for different battery brands, like some battery will compulsively get charge when SOC is lower than 5%)
  - b. On App, under Economic Mode, here is option to set a charge time, during which battery will get charge compulsively from Grid
  - c. When connecting with a grid-tied inverter or other power source, when load power is lower, the exceed power from grid-tied inverter or sources will charge battery, unless battery is fully charged already.

## Questions & Answers (Q & A)

### About Wi-Fi Configuration

#### Q: Why cannot search Solar-WiFi\* signal on smart phone?

A: Normally Solar-WiFi\* signal can be searched after inverter powered up. Please check if Wi-Fi module is connected well, and make sure inverter is powered up normally.

*NOTE: If Wi-Fi led on inverter is single-blinking (0.5s on & off), then it means Wi-Fi module is not connected or not connected well*

#### Q: Why cannot connect Solar-WiFi\* signal on my mobile device?

A: It is the character of the Wi-Fi module that it can connect to only one device at a time. So please make sure the signal is not connected on other device.

*NOTE: Please make sure the password of the Wi-Fi signal (12345678) is not wrong*

### About Battery Operation

#### Q: Why battery does not discharge when grid is not available, while it discharge normally when grid is available?

A: On APP, Off-Grid Output and backup function should be turned on to make battery discharge under off-grid mode.

#### Q: Why there is output on Back-Up side?

A: For Back-Up supply, the "Back-Up Function" on PV Master App must be turned on. Under off-grid mode or grid power is disconnected, "Off-Grid Out" function must be turned on as well

*Note: As turn "Off-Grid Output" on, don't restart inverter or battery, otherwise the function will switch off automatically.*

#### Q: Why battery switch always trip when starts it up (Lithium battery)?

A: For lithium battery like LG, normally the switch trips for following reasons:

1. BMS communication fails
2. Battery SOC is too low, battery trips to protect itself
3. An electrical short-cut happened on battery connection side. Or other reasons please contact GoodWe for details.

#### Q: Which battery should I use for S-BP?

A: For S-BP inverters, it could connect lithium batteries, with nominal voltage 48V, max charge voltage 60V

Compatible lithium batteries for now: LG RSEU 6.5/10, BYD B-Box 2.5/5.0/7.5/10/12.8/13.8, GCL5.6KWh (1~4 packs), Pylon US2000B (1~4 packs).

### About PV Master Operation and Monitoring

#### Q: Why Cannot save settings on PV Master App

A: This could be caused by losing connection to Solar-WiFi\*.

1. Make sure you connected Solar-WiFi\* (make sure no other devices connected) or router (if connected Solar-WiFi\* to router) and on APP home page shows connection well.
2. Make sure S-BP under waiting mode (on APP) before you change any settings on PV Master APP --- disconnect grid/load, only leave battery connected and then restart S-BP till see work mode as "wait" on APP.

#### Q: On the App, why data on the homepage and Param page are different, like charge/discharge, load or grid value?

A: As the data on APP is from inverter and on home page and Param page, the data refresh frequency is different, so there will be a data inconformity between different pages on APP as well as between that on portal and APP

#### Q: On App, some columns show NA, like battery SOH, etc. why is that?

A: NA means App does not receive data from inverter or server, normally it is because communication problem, such as battery communication, and communication between inverter and the APP. (For lead-acid battery, NA is normal)

### About EzMeter and Power Limit Function

#### Q: Is Power Limit function Possible for S-BP system?

A: Please refer to page 11 for details of this function on S-BP system

#### Q: Can I use other brand Meter to take over EzMeter in S-BP system or change some settings on EzMeter?

A: Can not, because the communication protocol between inverter and EzMeter is inset in the EzMeter, other brand Meter cannot communicate. Also any setting change could cause EzMeter communication failure.

#### Q: What is the max current allowed going through CT on EzMeter?

A: The max current for CT is 120A

### Other Questions

#### Q: Is there a quick way to make the system work?

A: The shortest way, please refer to S-BP QUICK INSTALLATION INSTRUCTIONS

#### Q: What kind of load can I connect on Back-Up side?

A: Please refer to user manual on page 11

#### Q: Whether the warranty of the inverter still valid if the installation or operation does not follow the user manual instructions, for some special conditions when we cannot 100% follow them?

A: Normally if any problem caused by disobey the instructions on user manual, we can provide technical support to help solve the problem, but cannot guarantee a replacement or returns. So if there is any special condition when you cannot 100% follow the instructions, please contact GoodWe for suggestions

### 4.2 DISCLAIMER

The S-BP series hybrid inverters are transported, used and operated under environmental and electrical conditions. GoodWe has the right not providing after-sales services or assistance under following conditions:

- Inverter is damaged during transferring
- Inverter is out of warranty year and extended warranty is not bought
- Inverter is installed, refitted or operated in improper ways without authority from GoodWe
- Inverter is installed or used under improper environment or technical condition mentioned in this user manual, without authority from GoodWe
- Installation or configuration of the inverter does not follow requirements mentioned in this user manual
- The inverter is installed or operated against the requirements or warnings that are mentioned in this user manual
- Inverter is broken or damaged by any force majeure like lightning, earthquake, fire hazard, storm and volcanic eruption etc.
- Inverter is disassembled, changed or updated on software or hardware without authority from GoodWe
- Inverter is installed, used or operated against any related items in international or local policies or regulations
- Any non-compatible batteries, loads or other devices connected to S-BP system

Note: GoodWe will keep right to explain all the contents in this user manual.

#### \* Maintenance

The inverter requires periodically maintenance, details as below:

NOTE: Make sure inverter is totally isolated from all DC and AC power for at least 5 mins before maintenance

Heat sink: please use clean towel to clean up heat sink once a year

Torque: please use torque wrench to tighten AC and battery wiring connection once a year

DC switch: check DC switch regularly, active the DC switch 10 times in a row once a year. operating DC switch will clean contacts and extend lifespan of DC switch

Water-proof covers: check if water-proof covers of RS485 and other part are fasten once a year

### 4.3 WARINING QUICK CHECK LIST

[1] Inverter cannot be installed near flammable, explosive or strong electro-magnetic equipment, page 06

[2] Remember that this inverter is heavy! Please be careful when lifting out from the package, page 07

[3] Make sure battery switch is off and battery nominal voltage meet S-BP specification before connecting battery to inverter make sure inverter is totally isolated from AC power, page 08

[4] Make sure inverter is totally isolated from any DC or AC power before connecting AC cable, page 10

[5] Make sure S-BP and grid-tied inverters are totally isolated from AC and DC power before connecting EzMeter & CT, page 12



### 4.4 TECHNICAL PARAMETERS AND CERTIFICATES

#### • TECHNICAL PARAMETERS OF S-BP INVERTERS

	GW3600S-BP	GW5000S-BP
<b>Battery Input Data</b>		
Supported Battery Type <sup>[1]</sup>	Li-Ion or Lead-Acid	
Nominal Battery Voltage (V)	48	
Max. Charge Voltage (V)	≤60 (Configurable)	
Max. Charge Current (A) <sup>[1]</sup>	75	100
Max. Discharge Current (A) <sup>[1]</sup>	75	100
Battery Capacity (Ah) <sup>[2]</sup>	50~2000	
Battery Over-Current Protection (A)	125	
Battery Backfeed Current	0	
Charge Pattern for Li-Ion battery	Self-adaption to BMS	
<b>AC Output Data (Back-Up)</b>		
Max. Output Apparent Power (VA)	3680	5000
Peak Output Apparent Power (VA) <sup>[3]</sup>	4416, 10s	5500, 10s
Automatic Switch Time (ms)	< 10	
Nominal Output Voltage (V)	230 (+/-2%) single phase	
Nominal Output Frequency (Hz)	50/60(+/-0.2%)	
Back-Up Over Current Protection (A)	40A	50A
Output Inrush Current (Peak/Duration)	60A, 5μs	
Max. Output Fault Current (Peak/Duration)	70A, 3μs	
Max. Output Current (A)	16	22.8
Output THDv (linear load)	< 3%	
<b>AC Output Data (On-Grid)</b>		
Nominal Active Power Output to Grid (W)	3680	4600/5000 <sup>[4]</sup>
Max. Apparent Power Output to Grid(VA)	3680 <sup>[5]</sup>	4600/5000/5100 <sup>[5]</sup>
Max. Apparent Power From Grid(VA)	7360	9200
Nominal Output Voltage (V)	230 single phase	
Nominal Output Frequency (Hz)	50/60	
Max. AC Output Current to Grid (A) <sup>[6]</sup>	16	22.8
Max. AC Current from Grid (A)	32	40
AC Over Current Protection (A)	40	50
AC Backfeed Current (A)	0	
Max. Output Fault Current (Peak/Duration)	70A, 3μs	
Output Inrush Current (Peak/Duration)	60A, 5μs	
Input Inrush Current (Peak/Duration)	< 100A, 20μs	
Output Power Factor	~ 1 (Adjustable from 0.8 leading to 0.8 Lagging)	
Output THDi (@Nominal Output)	< 3%	
AC Overvoltage Category	III	

[1] Lead acid battery use refers to Approved Battery Statement

The actual charge and discharge current also depends on the battery

[2] If need S-BP work under off-grid mode, battery capacity should be min 100Ah

[3] On condition of battery and PV power being enough

[4] 4600 for VDE-AR-N 4105 and CEI 0-21, 5000 for other country

[5] GW3600S-BP: 4050 for CEI 0-21, GW5000S-BP: 5100 for CEI 0-21, 4600 for VDE-AR-N 4105,

[6] GW5000S-BP: 21.7A for AS/NZS 4777.2, GW3600S-BP: 18A for CEI0-21

	GW3600S-BP	GW5000S-BP
<b>Efficiency</b>		
Max. Efficiency	97.6%	
<b>General Data</b>		
Operation Temperature Range (°C)	-25~60	
Storage Temperature Range (°C)	-30~65	
Relative Humidity	0~95%	
Moisture Location Category	4K4H	
External Environment Pollute Degree	Grade 1,2,3	
Environment Category	Outdoor & Indoor	
Operation Altitude (m)	≤4000	
Cooling system	Nature Convection	
Noise (dB)	< 25	
User Interface	LED, APP	
Communication With BMS	RS485, CAN <sup>[7]</sup>	
Communication With EzMeter	RS485	
Communication With Portal	Wi-Fi	
Weight (kg)	18.5	
Size (Width*Height*Depth mm)	347*432*190	
Mounting	Wall Bracket	
Protective Rating	IP65	
Standby Self-Consumption (W)	< 15	
Topology	High Frequency Isolation	
Protective Class	I	
<b>Protection</b>		
Anti-islanding Protection	Integrated (AFD)	
Output Over-current Protection	Integrated	
Output Short-circuit Protection	Integrated	
Output Overvoltage Protection	Integrated	
<b>Certifications &amp; Standards</b>		
Grid Regulation	AS/NZS 4777.2:2015, G83/2, G100, CEI 0-21, EN50438, VDE-AR-N4105, VDE0126-1-1, UNE206006, RD1699	AS/NZS 4777.2:2015, G59/3, G100, CEI 0-21, EN50438, VDE-AR-N4105, VDE0126-1-1, UNE206006, RD1699
Safety Regulation	IEC/EN62477-1, IEC62040-1	
EMC	EN61000-6-1, EN61000-6-2, EN61000-6-3, EN61000-6-4 EN61000-4-16, EN61000-4-18, EN61000-4-29	

[7] Default communication with BMS is CAN, requirement RS485 needs special configuration process

#### • CERTIFICATES OF S-BP SERIES



G100 IEC62109-1  
CEI 0-21 RD1699 VDE0126-1-1  
VDE-AR-N 4105 NRS 097-2-1

#### • OTHER TEST

For Australian requirements, in the THDi test, there should add Zref between inverter and mains.

RA, XA for Line conductor      RN, XN for Neutral conductor

Zref:

RA=0,24    XA=j0,15 at 50Hz      RN=0,16    XN=j0,10 at 50Hz.



## Appendix: Protection Category Definition

### Overvoltage Category Definition

Category I	Applies to equipment connected to a circuit where measures have been taken to reduce transient overvoltage to a low level
Category II	Applies to equipment not permanently connected to the installation. Examples are appliances, portables tools and other plug-connected equipment
Category III	Applies to a fixed equipment downstream of and including the main distribution board. Examples are switchgear and other equipment in an industrial installation
Category IV	Applies to equipment permanently connected at the origin of an installation (upstream of the main distribution board). Example are electricity meters, primary over-current protection equipment and other equipment connected directly to outdoor open lines

### Moisture Location Category Definition

Moisture Parameters	Level		
	3K3	4K2	4K4H
Temperature Range	0~+40 C	-33~+40 C	-20~+55 C
Humidity Range	5%~85%	15%~100%	4%~100%

### Environment Category Definition

Environment Condition	Ambient Temperature	Relative Humidity	Applied to
Outdoor	-20 ~ 50 C	4% ~ 100%	PD3
Indoor Unconditioned	-20 ~ 50 C	5% ~ 95%	PD3
Indoor Conditioned	0 ~ 40 C	5% ~ 85%	PD2

### Pollution Degree Definition

Pollution Degree I	No pollution or only dry, non-conductive pollution occurs. The pollution has no influence
Pollution Degree II	Normally only non-conductive pollution occurs. Occasionally, however, a temporary conductivity caused by condensation must be expected.
Pollution Degree III	Conductive pollution occurs, or dry, non-conductive pollution occurs, which becomes conductive due to condensation, which is expected.
Pollution Degree IV	Persistent conductive pollution occurs, for example, the pollution caused by conductive dust, rain and snow.