

RESEARCH DIVISION BULLETIN NO. 3

T H E E R A S E P R O C E S S

AMPEX CORPORATION

John G. McKnight  
Senior Engineer  
January 1959

## THE ERASE PROCESS

### SUMMARY:

In erase we are interested in how well the system removes a signal which has been recorded on the tape, and how quiet the tape is left from erasure, as compared to bulk erasing. It appears that any of the systems we use leave the tape adequately quiet, so that the problem we are concerned with is that of removing the signal which is on the tape.

Three points to keep in mind in making measurements on an erase head are the following:

1. For a given erase system operating at a given erase current, erasing a given wavelength, the signal is erased to a certain percentage of the original signal-- no matter what the original signal was, as long as it was somewhat less than ultimate saturation.
2. The ease of erasure of a signal depends to a great extent on the bias current used to record this signal, all other things being constant. The more bias used to make the recording the more difficult it will be to erase.
3. The amount of erase, all else being constant, depends greatly on the wavelength of the signal being erased. In general, the shorter the wavelength of the signal the more easily it is erased, but there will be peaks and dips in the erasure. For example, using a standard Ampex erase head at less than the full normal erase current we had 45 db erasure at 1200 cycles and 60 db erasure at 1600 cycles (15 ips).

It should be possible to measure the frequency losses of the head cores in a manner similar to measuring losses in transformers.

The most interesting effect found in the erase process is a process whereby the signal is rerecorded across the erase gap. This appears to account for a great deal of difficulty in erasure, since no matter how great the field strength, and although the tape is fully erased at the point where it passes the center of the erase gap, the signal is rerecorded as the tape leaves the gap. This

accounts for the fact that two separate erase heads will give much better erasure than one head (with a given current input). A single head with two gaps such as the one we use behaves as two gaps only at shorter wavelengths; at longer wavelengths the effect is largely lost. Therefore, it appears that a better erase head (better, meaning that better erase is achieved at longer wavelengths) is obtained by using either two independent erase heads or one head in which the gaps are spaced much farther apart than our present 6 mil.

An attempt to fully separate the various variables in erase shows that the problem is very complicated. The conclusions drawn here are from that amount of work which has been done so far in an attempt to investigate and explain the erase process.

---

## INTRODUCTION.

One function of the magnetic recorder which has received little attention is the erase system. The usual explanation is very simple:

"The principle of ac erasing consists in passing the recorded medium through a decaying alternating magnetic field in which the initial values of the field are great enough to saturate the medium completely and in which subsequent reversals of the field gradually decrease to zero." <sup>1</sup>

Some of the practical difficulties of erase are discussed in the Minnesota Mining & Manufacturing Company "Soundtalk" bulletins.

Many erase heads have been patented<sup>2</sup> - all showing a profound lack of any theoretical basis. The erase process is considerably less understood than one might think from the lack of literature. <sup>3</sup>

The erase system is expected to accomplish two things:

1. Remove any signals which are on the tape
2. Leave the tape as quiet as possible.

In general, an erase system which uses a ring head will raise the noise level of a tape which has been bulk erased. However, this noise level is still somewhat lower than the noise which is caused on the tape by the bias current in the record head. <sup>4</sup> It is possible to design an erase head which leaves the tape nearly as quiet as bulk erase, but there is no advantage to doing this since the noise level generated by the bias is higher than that generated by the erase head.

## ERASING A SIGNAL RECORDED ON THE TAPE.

In erasing, as in recording and playback, one has some effects dependent on frequency only and others dependent only on recorded wavelength on the tape. In erase we have one frequency--frequency of the erasing current. There are, however, two wavelengths of concern; the wavelength of the erase

1. Begun, S. J. "Magnetic Recording" p. 103, New York, Rinehart Books, Inc. 1949.
2. Appendix A, Erase Patents.
3. Appendix B, Erase References.
4. Appendix C, Noise Level From The Erase Head vs. Bulk Erase.



current and the wavelength of the recorded signal being erased.

Finding a criterion for erase is itself a problem. In these tests almost all data have been taken with heads made from production cores,<sup>5</sup> driving source,<sup>6</sup> and metering.<sup>7</sup> Therefore, head current has been the standard measured excitation, rather than power, ampere-turns, etc.

One problem is that one head may take less current than another for a certain amount of erasure, but this first head may take more current than the other for some greater amount of erasure. So the question "which is the better head" may not have a unique answer.

#### FREQUENCY EFFECTS.

If one were to vary the erase frequency or the core construction, material, or dimensions, it would be desirable to have a method for comparing core losses, per se, before trying to evaluate a completed head. Such a technique has not as yet been developed.

We do know of several effects that will affect performance. The resonance of the head cable plus winding self-capacitance and head inductance should be well above the erase frequency to allow the available oscillator current to flow through the head coil rather than into the cable or winding capacitance.

As for iron loss, Figure 1 shows the head flux vs. frequency for a standard core from a source giving constant current vs. frequency. This would indicate that at low flux levels the iron loss of our standard 6 mil moly-perm core is only about 1-1/2 db at 100 kc. A core of this sort gives a remanence vs. erase currents<sup>8</sup> as shown in Figure 2. (The maximum available current

5. 35 6-mil moly-perm laminations, 270-mil stack, 75 turns #28 wire on each leg. These were modified D-483-7 heads.
6. Model 350 erase oscillator. 100 kc. (This has sometimes limited the range of data possible).
7. db readings on vu meter across usual 7 ohm metering resistor.
8. This is for a head with 10 mil mica gap, erasing a 700 cps at 7-1/2 ips signal, recorded to saturation with bias.

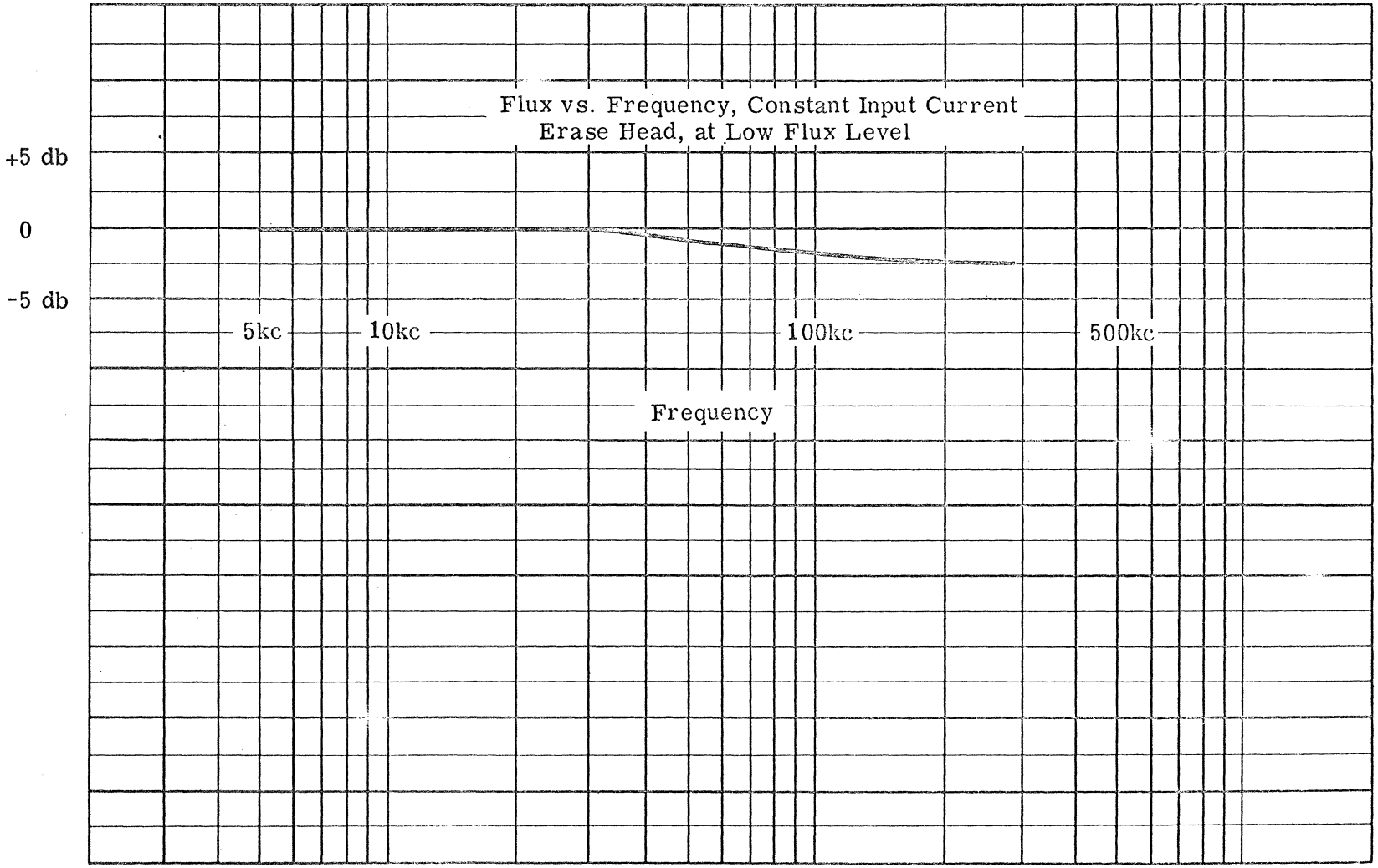

0268

Figure 1

as previously mentioned, was limited by the oscillator capability).

This shows the interesting fact that the curve is a straight line most of the way. On this graph (db vs. db on linear paper, which is equivalent to a log/log plot) this represents a constant exponent relationship. However, near the maximum erase point the remanence levels out and increasing current does not make proportional increases in erasure.

We would next wonder if core saturation is a limiting factor. An identical head, but with a core of 4 mil "Selectron" (4% silicon steel which should have a much higher saturation flux level) was made. This, however, gave essentially the same curve as Figure 2, but it required 2-1/2 db more current for the same amount of erasure.<sup>9</sup> Therefore, we concluded that no important saturation effects were occurring in this case.

Another possible variable, which is more properly a wavelength effect, is the effect of core stacking factor. A standard and a "high density" core were compared in heads with mica gaps and found essentially identical. When a copper gap, as discussed below, was used the high density core showed an improvement as shown in Figure 3.

A brief look into the effect of the gap material is shown in Figure 4. The same piece of tape was erased once using a head with 10 mil mica gap, and another time with the same head which had the gap spacer replaced with 10 mil copper. This one run showed that at lower currents greater erasure was achieved with the copper gap, but at the higher currents available the copper gap was actually slightly poorer.

The operation of the copper gap involves eddy currents which generate a field which opposes the field in the gap, but aids the field outside the gap. If the conducting material were perfectly conducting this sort of gap would probably be desirable, but the resistance of the copper causes enough power dissipation to make its use questionable.

An effect which is neither clearly frequency nor wavelength sensitive is the remanence vs. number of erasures. The question is this: with a given erase system if the tape is passed

---

9. A head was made from laminations that were annealed. Another head was made from laminations that were not annealed. No difference was observed in any respect.

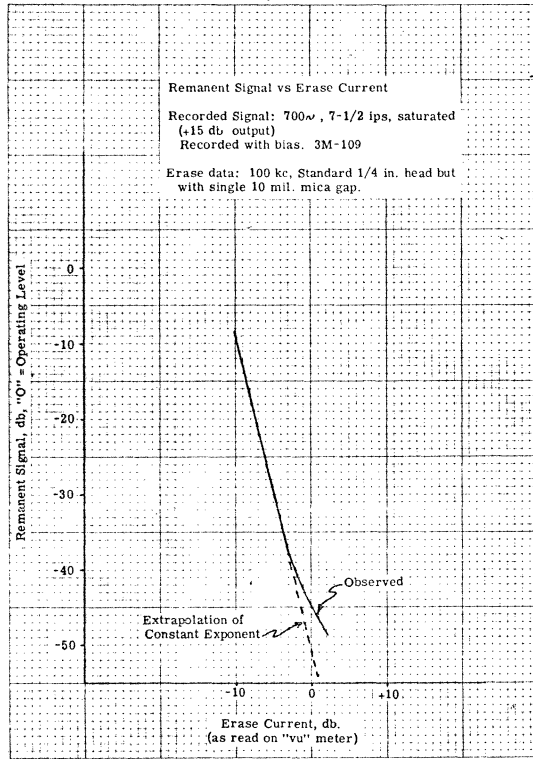

Figure 2

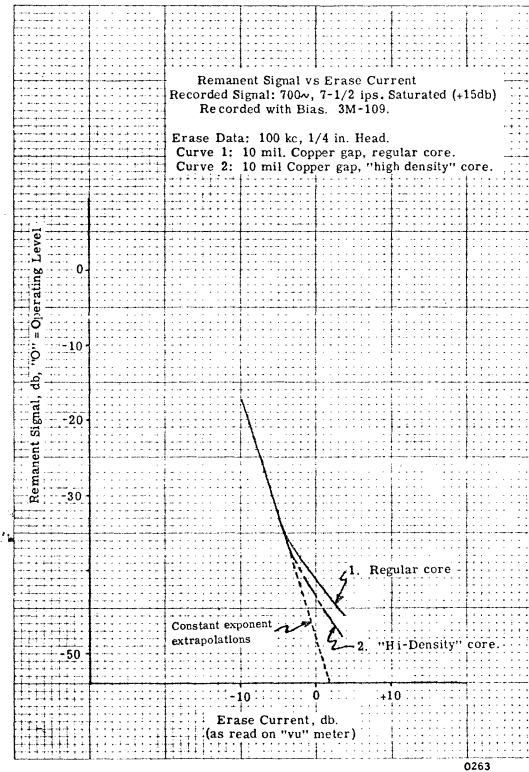

Figure 3

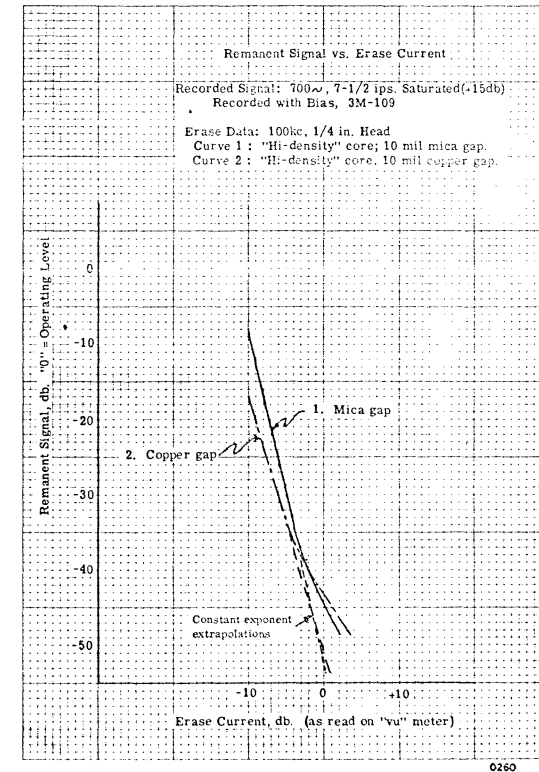

Figure 4

over the erase head many times is an ultimate degree of erase reached? Figure 5 shows a plot of remanence in db vs. number of erasures (effectively, a semi-log plot) for a particular system. Figure 6 shows this same data, but on log/log plot. It is seen that after the first erasure a constant exponent law is followed. This same erasure phenomenon held for an erase frequency of 10 kc or 100 kc, adjusting for the same remanence after one pass. For a larger erase current (see Fig. 6) the same general curve is followed, but we do not reach the constant exponent line until the fourth pass. This erasure phenomenon may be related to the re-recording process which is discussed below.

A factor which is largely frequency dependent is the number of cycles of erase current which the tape undergoes in erasure. This should be tested with as few other changes as possible. The method chosen was simply to vary the speed of the tape by driving the reel by hand while erasing, all else unchanged, then when playing back at constant speed the remanence was measured. Erase current had been set for 40 db erase (to give enough remanence to measure with some accuracy). In playback the remanence was rather constant--over a speed range of roughly 2 to 80 ips (a 40 to 1 ratio of number of erasing cycles)--the remanence variation was about 6 db (2 to 1). Therefore, the number of erase cycles, per se, is not critical in this region, and when we discuss various size (wavelength) effects below we can be fairly sure that the effect is not simply a change in the number of erasing field cycles that the material is subjected to.

#### WAVELENGTH EFFECTS.

The only general statement we can make is that the shorter the recorded wavelength, the easier it is erased. We do not yet know "short" relative to what.

Before showing data on the various other variables and effects, we should mention an effect which is indirectly separable, namely the so-called "regeneration" effect mentioned in "Sound Talk" (Bulletin No. 24, July 1953). According to this hypothesis, even though the tape has been fully erased in the center of the head gap, when it passes out of the erase field it must (in going from the saturation erase field at the center to zero field outside the erase head) go through a point which is the same magnitude as the recording bias. Any extraneous fields of this point will be recorded, and the as yet unerased tape coming into the erase head provides this extraneous field. Therefore, the signal, after being erased, is re-recorded.

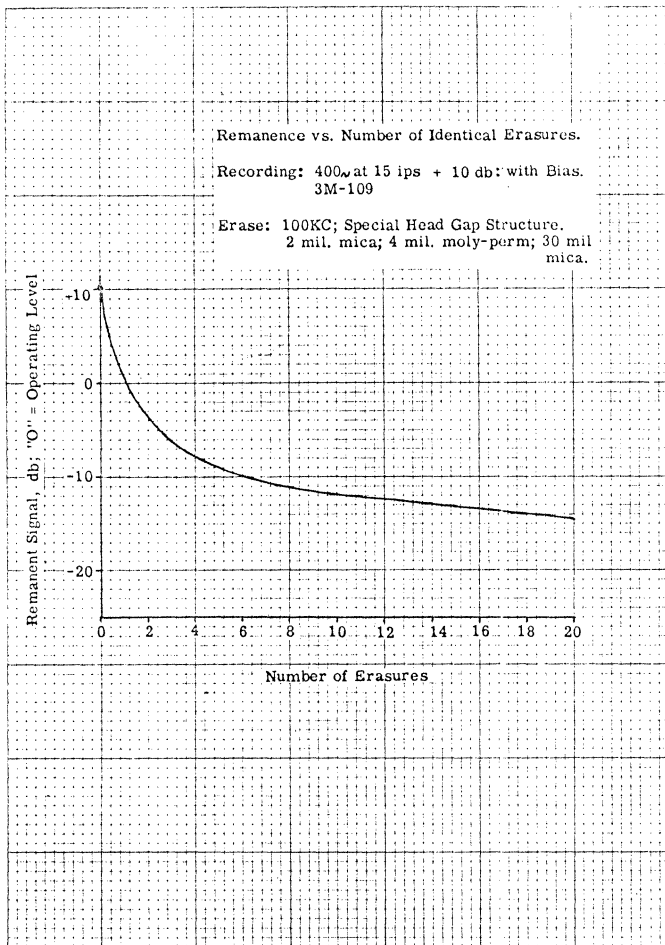

Figure 5

Figure 6

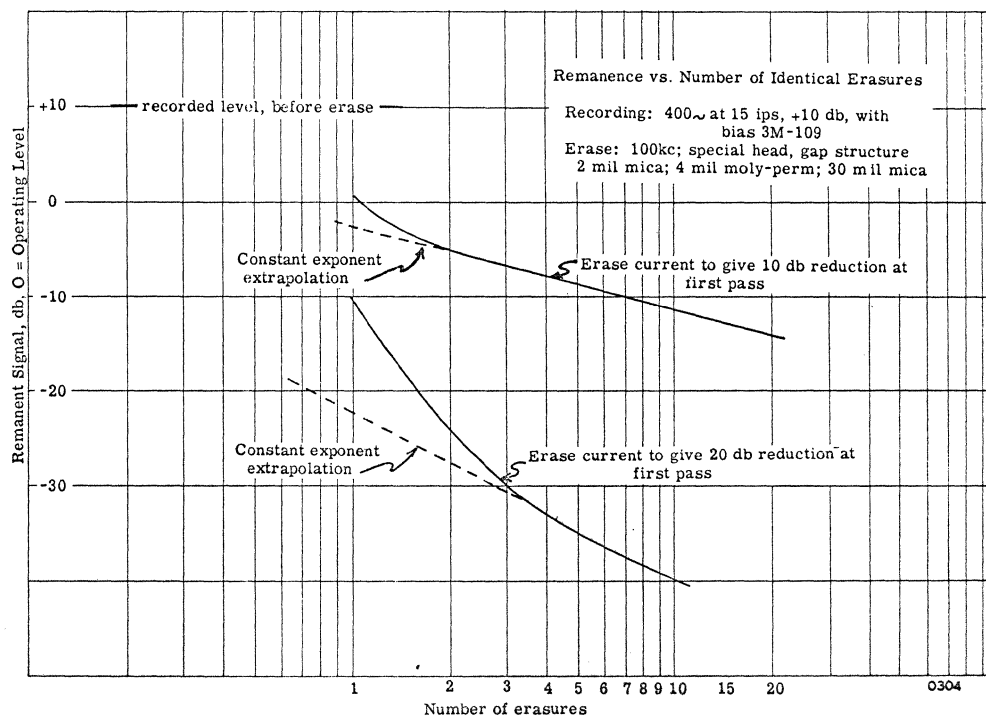

Figure 7 shows a proof of this re-recording hypothesis. A Model 350 recorder was set up with a modified head sequence so that the tape would pass first over the record head then over the erase head then over the playback head. The upper curve marked "no erasure" was taken with the erase head unplugged and shows the record/playback response of this system when recording a signal at zero level; then the response was taken with various amounts of current in the erase head (in all cases bulk-erased tape was used). At the erasure current minus 15-1/2 db the amount of signal which remains (due to erase current insufficient to completely erase the signal) is equal to the amount of signal which is re-recorded across the erasing gap; at a frequency of 2100 cycles the two signals are out of phase, so that a null is caused in the response. At smaller erase currents the signal which has not been erased predominates, and at larger erase currents the re-recorded signal predominates. An interesting consequence of this behavior may be seen in Figure 8 which shows remanence vs. erase current at the frequency 2100 cycles. We see that a null occurs sharply at the current minus 15-1/2 db, then the remanence actually increases with an increase in erasing current. This is the sort of anomaly that may occur in investigating erasure.

#### SOME MEASURING PROBLEMS.

##### Level of the Signal to be Erased.

For any given signal recorded on the tape at a level less than saturation level, the amount of erase with a given erase system is such that the remanence will always be a given fraction of the original signal--no matter what the original signal. This is to say, if we record a signal at operating level and find that a given erase head and current erase this signal by, say, 50 db, then if we record the signal at 10 db below zero the erase will still be 50 db and the signal will come out minus 60, or if it had been recorded at plus 10 then the remanence would be minus 40. Therefore, to avoid noise problems in measurement it is usually convenient to record the signal at a level 5 to 10 db above our standard tape "operating level."

##### Effect of Amount of Bias Used in Recording.

Another factor which influences the apparent quality of erasure of an erase head is the amount of bias current used in

Remanent Signal After Erase vs. Frequency. For one erasure at various amounts of erase current. Head: single 4-1/4 mil mica erase gap. 15 ips, Irish "300" tape. Standard Audio Equalization.

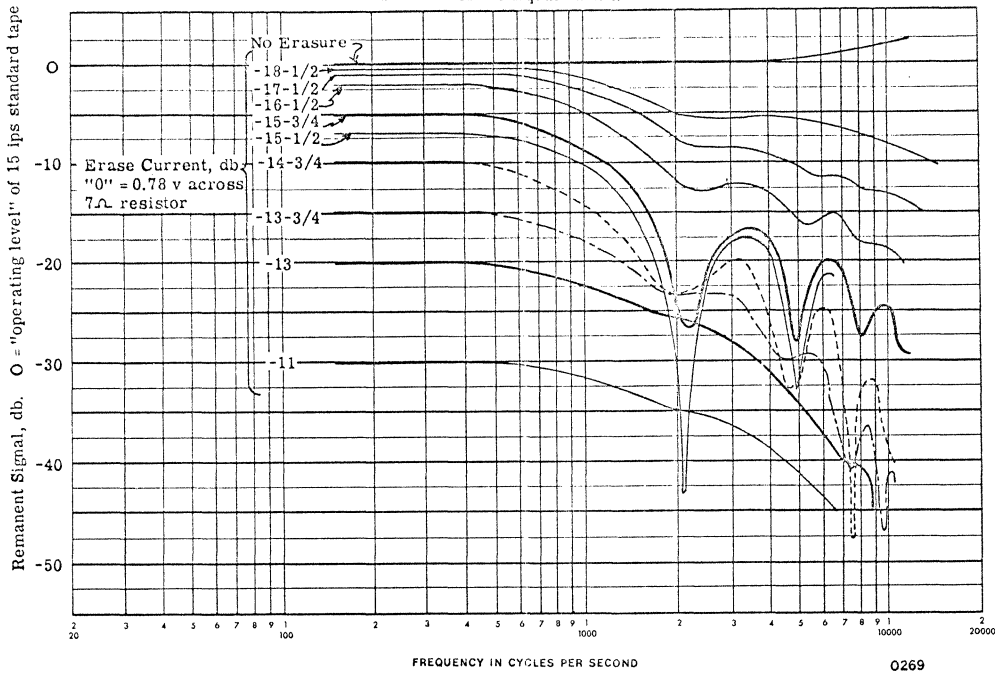
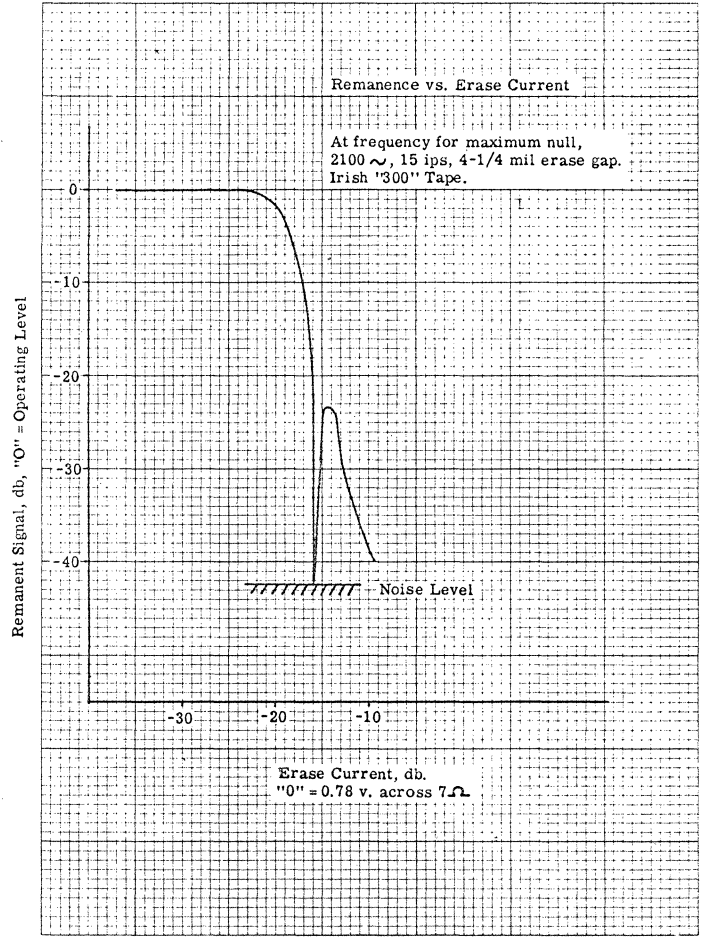

Figure 7

Figure 8



0261



recording. Data<sup>10</sup> show that recordings made with small bias are comparatively easier to erase than recordings made with peak bias, and that still further increasing amounts of bias make the record even more difficult to erase. Therefore, all test recordings should be made with the same amount of bias, preferably the normal bias current for recording.

#### Effect of Wavelength of Recorded Signal.

Figures 9, 10 and 11 illustrate the sort of problems that may occur in making measurements relating to the quality of an erase head. Specifically, the amount of erasure depends rather critically on the wavelength of signal which is being erased. (In all of these curves the erasure is to a level as little as 20 to 30 db below the recorded level, and this makes the effects appear more serious than they will be with greater amounts of erasure. However, these effects do occur to some extent with greater erasure.)

The three graphs show reduction of recorded level by erasure vs. frequency, for three different sorts of heads. The first head is a single 5 mil mica gap, and the two curves show the erasure for one pass over the head and then for two passes over the head. Next, we have a similar plot, but for an erase head which is a standard Ampex double gap erase head made with approximately 4 mils of mica gap, 6 mils moly-permalloy magnetic piece, and then another 4 mil mica gap.

The last curve is a similar group of data for a head which has two mica gaps 5 mils wide and a 50 mil ferrite magnetic piece between them. We note that in all three cases the apparent amount of erase for a given erase current varies greatly depending upon the recorded wavelength. For curve 10 with the standard Ampex erase head, this amount of erase current gives a fairly impressive erasure figure of 60 db at 1600 cycles, but at 1200 cycles or 2000 cycles there is only 45 db of erasure, or 32 db of erasure at 100 cycles. If measurements are made only at one frequency, and one is not aware of this difference in erasure at different wavelengths, one may get all sorts of different readings from the same head, or the same readings for greatly different heads.

---

10. See Herr et al (reference in Appendix B). We have confirmed the effect.

Remanent Signal After Erase vs. Frequency For 1 and 2 identical erasures by head with single 5 mil mica gap. 15 ips, 3M-109 tape, recorded to "operating level" with 1 kc "peak" bias. Erase head: modified 1/4 " full track, on Model 350, fed from Model 350 erase oscillator Current (read by Model 350 "erase" metering circuit) -15 db on vu meter both times.

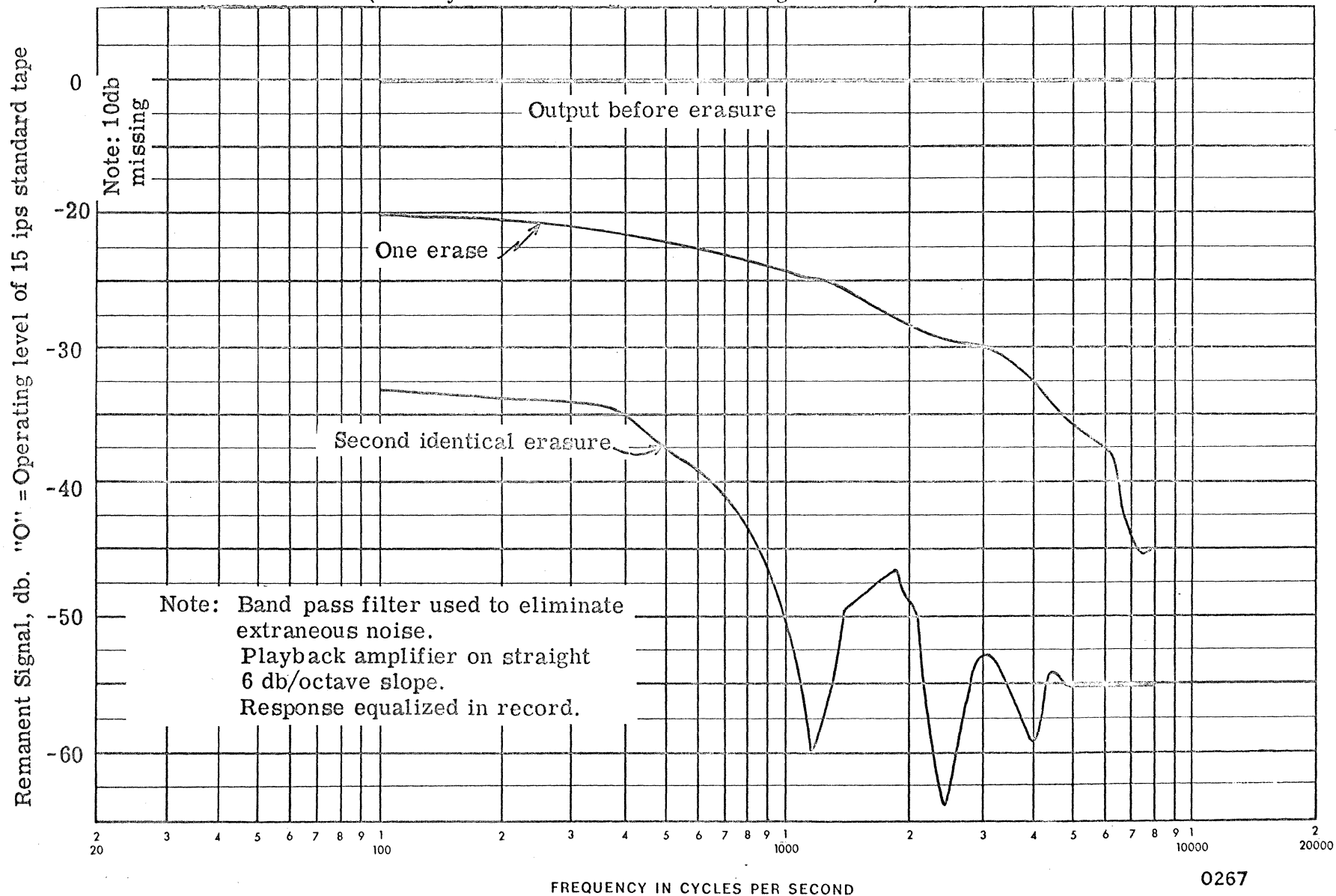

Remanent Signal After Erase vs. Frequency. For one erasure by standard 1/4 in. full track erase head (4 mil. mica gap/6 mil moly-perm. magnetic spacer, 4 mil mica gap).

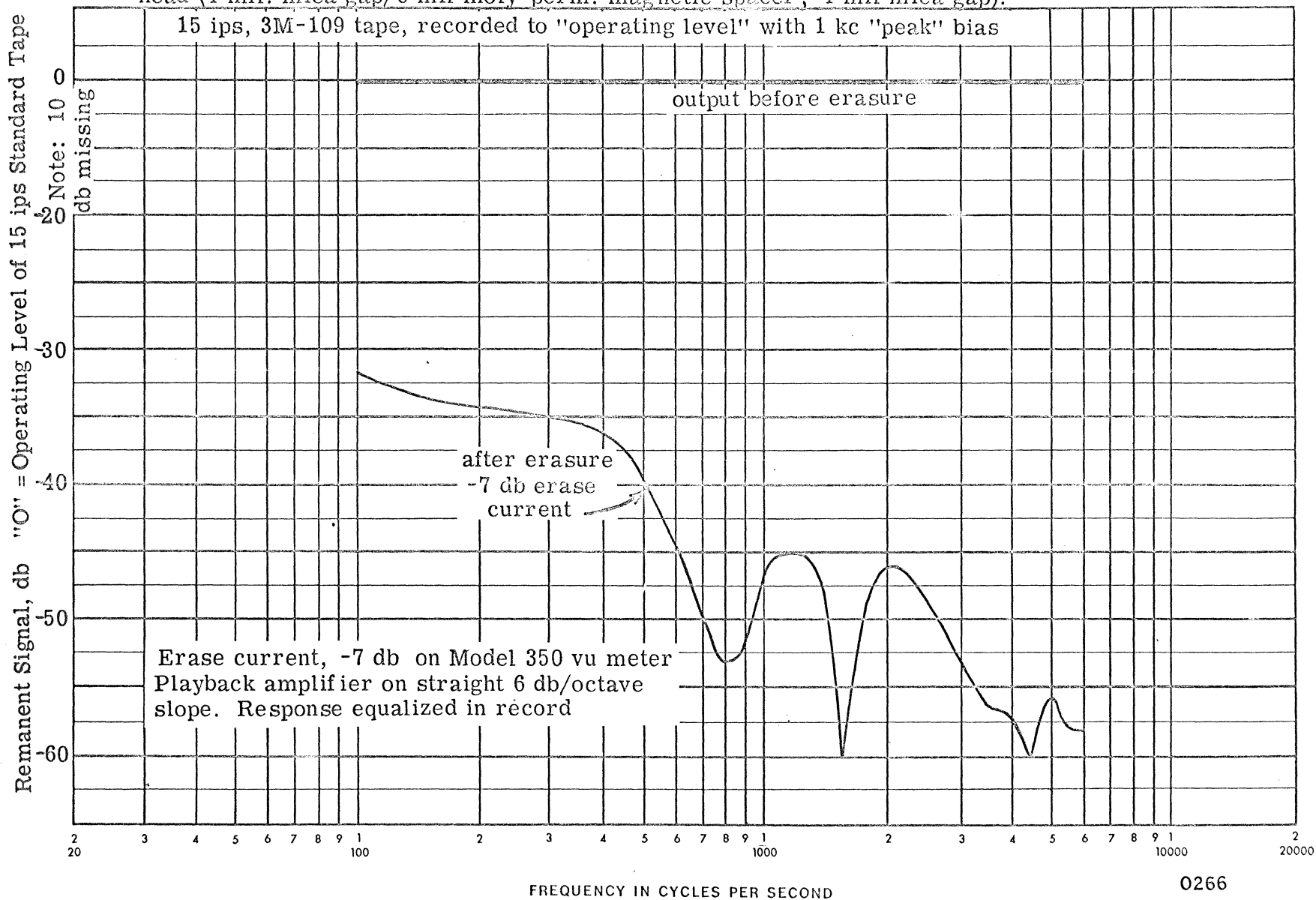

0266

Figure 10

Remanent Signal after Erase vs. Frequency. For one erasure by special widegap-double gap 1/4 in. full track, erase head. (4 mil mica gap/50 mil ferrite magnetic spacer/4 mil mica gap) 15 ips, 3 M-109 tape, recorded to "operating level" with 1 kc "peak" bias

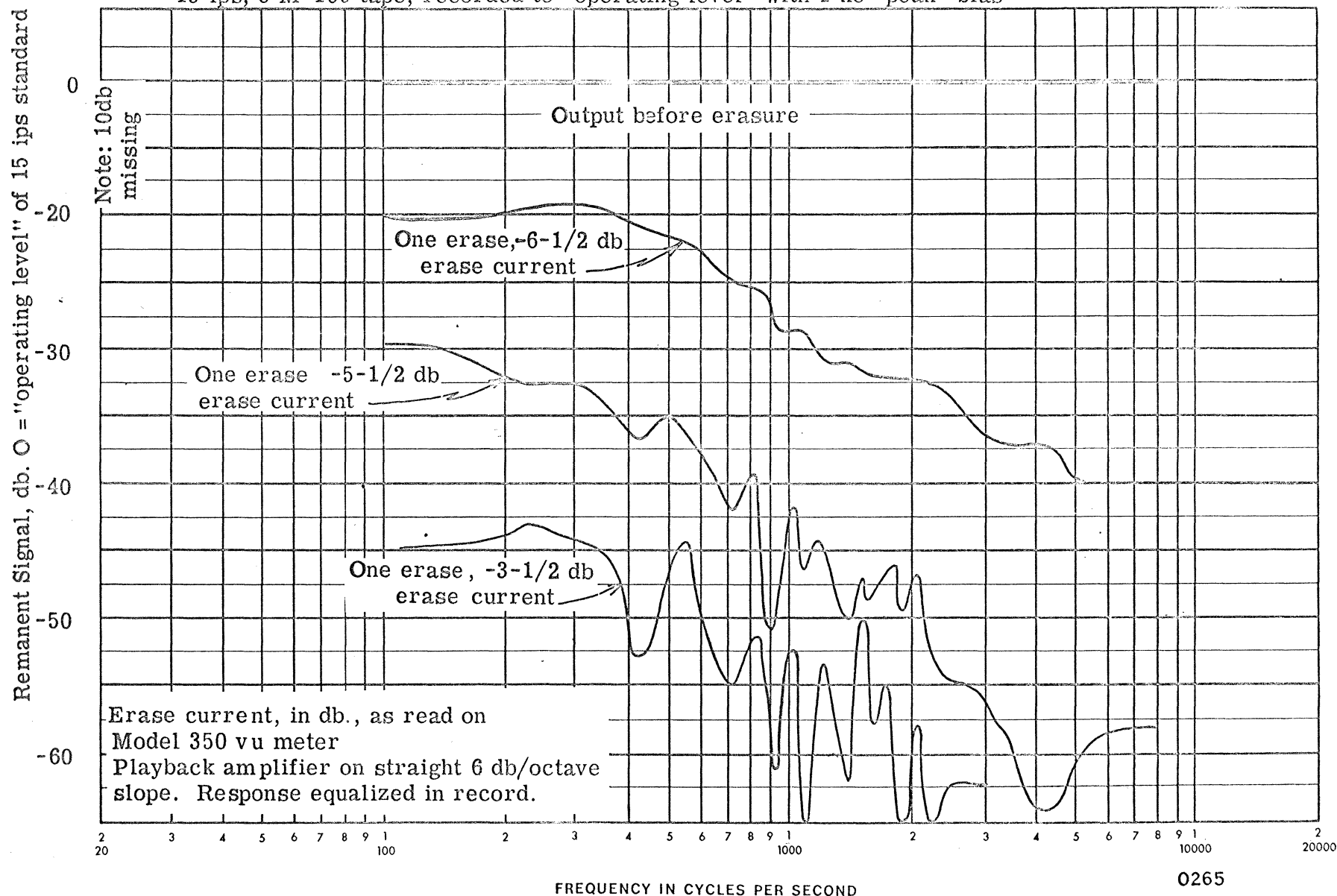

0265

Figure 11

APPENDIX A.

ERASE PATENTS.\*

2,535,712 H. Wolfe, Dec. 26, 1950: Multigap (3 or 5) ring heads. No explanation of mechanism. Cites 2,215,782 (1940), 2,418,542 (1957), 2,457,299 (1949) and German 617,796.

2,702,835 M. Camras, Feb. 2, 1955: Cites 2,230,913 Schuller (1941), 2,351,007 Camras (1944), and 2,418,542 Camras (1947). Multiple pole piece wire head.

2,718,562 H. A. Howell, Sept. 20, 1955: 60 cps Erase Through The Tape. Cites 1,837,586 Rhodenhamel (1931), 2,498,423 Howell (1950), and 2,604,550 Begun (1952).

2,730,570 Rettinger, Jan. 10, 1956: Two Erase Heads (independent), Spaced Along the Tape. Cites 2,498,423 Howell (1950), and 2,550,753 Andrews (1951).

2,747,027 C. F. Sprosty, May 22, 1956: Two Gaps, Differing Intensities. Cites 2,655,562 Clark (1953) and 2,702,835 Camras (1955).

2,284,259 M. Camras, Mar. 5, 1951: Alternate dc Erase of Decreasing Magnitude. (Seven patents cited).

\*See also the following collection of reviews of patents on erase heads from the Journal of the Acoustical Society of America.

# ERASE HEADS

## 1. Alternate d. c.

2,526,358

### 5.16m DEMAGNETIZING DEVICE

Hugh A. Howell, assignor to the Indiana Steel Products Company.  
October 17, 1950, 5 Claims (Cl. 179-100.2).

This patent for magnetic recording describes several arrangements of horseshoe and modified horseshoe magnets, together with armatures, for providing first a saturating field and then a moderate oppositely directed field to a recording tape passing by.—RH

2,535,498

### 5.16m ERASING HEAD AND APPARATUS FOR MAGNETIC RECORDERS

Otto Kornei, assignor to The Brush Development Company.  
December 26, 1950, 8 Claims (Cl. 179-100.2).

For erasing magnetic recordings it is sufficient to subject the magnetic medium to a saturating field, but for good results with high frequency bias in recording the medium

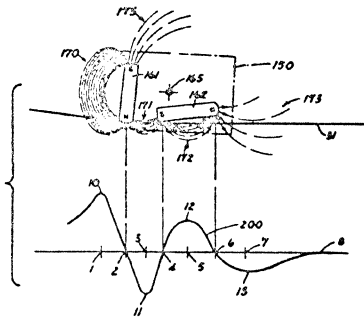

should also be left in the demagnetized state. This has commonly dictated the use of an alternating current, usually of high frequency, so as to subject the medium to an alternating field of decreasing magnitude. This patent discloses a design involving permanent magnets 161 and 162 so disposed that the passing medium 31 receives successively alternate magnetizations of opposite polarity and is more nearly demagnetized than by a single magnet. There are included also suitable mechanical devices and interlocks to move the assembly 150 against the tape in the recording process and to remove it at other times.—RH

2,594,934

### 5.16m ERASING HEAD FOR MAGNETIC RECORD MEMBERS

Otto Kornei, assignor to The Brush Development Company  
April 29, 1952 (Cl. 179-100.2); filed January 20, 1950

In some magnetic recorders permanent magnets are used for erasing but if noise is to be held low the tape must experience a succession of gradually reducing, alternating, fields. To obtain these with only one permanent magnet there are clamped to the magnet two plates, each with teeth past which the tape passes. The fields between these intermeshed teeth alternate in the required manner.—RH

2,688,053

### 5.16m ERASING MAGNET MOUNTING AND ASSEMBLY

Edmund Barany, Harold W. Bauman and Melvin Sackter, assignors to Ampro Corporation  
August 31, 1954 (Cl. 179-100.2); filed November 9, 1950

This mounting is intended to clamp an elongated horseshoe-shaped permanent magnet in the proper position to effect erasure of a magnetic tape as it passes through a magnetic

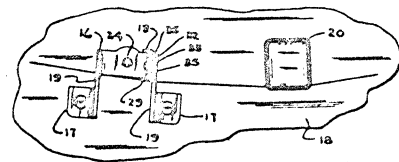

recording machine. The permanent magnet is clamped under the screw 24 and the tape is lifted from the trailing edge of the magnet by the adjustable strip 29. The residual magnetism in the tape is minimized by demagnetizing action of the opposing field under the trailing pole of the magnet.—RVB

2,784,259

### 5.16m RECORDING AND ERASE HEAD FOR MAGNETIC RECORDERS

Marvin Camras, assignor to Armour Research Foundation of Illinois Institute of Technology  
March 5, 1957 (Cl. 179-100.2); filed December 17, 1952

Heads with multiple polepieces for erasing and recording purposes are shown in this patent. In one form in which a permanent magnet is utilized, the record 3 travels upwards. Each element of the record encounters a succession of

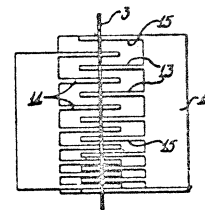

oppositely directed magnetic fields which become weaker at each gap, until the record emerges in a demagnetized condition. Heads of similar design with three polepieces, two coils, and close-spaced gaps are shown for combination erasing-recording purposes.—MC

# ERASE HEADS

## 2. Multiple a. c. Separate Heads.

2,730,570

### 5.16m MAGNETIC SOUND RECORD ERASING METHOD AND HEADS THEREFOR

Michael Rettinger, assignor to Radio Corporation of America  
January 10, 1956 (Cl. 179-100.2); filed August 30, 1950

Two or more consecutive independent magnetic fields of superaudible frequency are used for magnetic erasing, separated by at least one-tenth of a second in time, with at least fifteen magnetic reversals within each area of maximum field strength and at least two thousand reversals of diminishing magnetic field adjacent to each gap.—FWK



## 3. Multiple a. c. Single Head.

2,535,712

### 5.16m MULTIPLE GAP ERASE HEAD FOR MAGNETIC RECORDING

Halley Wolfe, assignor to Western Electric Company, Incorporated.  
December 26, 1950, 5 Claims (Cl. 179-100.2).

A magnetic erasing head is described which uses a number of gaps rather than the more usual single gap. This is claimed to produce more effective erasure than obtainable with a single

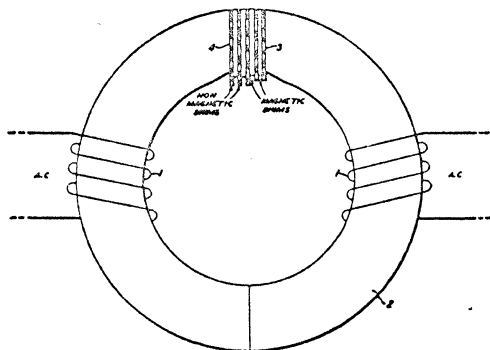

passage past a single gap of the same size, and to require a lesser total gap length than is necessary in a single gap, with consequent reduction in power requirements.—RH

2,673,896

### 5.16m MAGNETIC RECORD ERASING TRANSDUCER

Michael Rettinger, assignor to Radio Corporation of America  
March 30, 1954 (Cl. 179-100.2); filed December 29, 1951

This magnetic tape erasing head contains two similar air gap structures spaced apart along the direction of travel of the tape. This feature is said to increase the efficiency of erasure by eliminating "reawakening" of the signal. Each air gap structure consists of a central copper strip having a Mu-metal strip laminated to each side and insulated therefrom. The copper strips are connected in parallel to form part of a single turn coil inductively coupled to a high frequency transformer.—RVB

## 3. Multiple a. c. Single Head, cont'd.

5.16m: ERASING HEAD FOR MAGNETIC  
# 2655,562 RECORDING  
Donald L. Clark, assignor to Stromberg-Carlson Company  
October 13, 1953 (Cl. 179-100.2); filed February 23, 1945

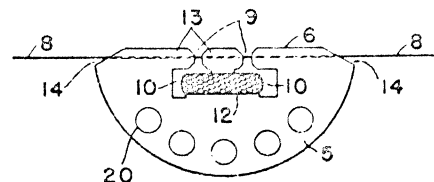

Increased erasing efficiency is accomplished through the use of an erasing head having multiple air gaps 9 across which the medium 8 passes. The magnetic fields across these air gaps are established from a common magnetic core 5 energized by the high-frequency coil 12. Holes 20 in the magnetic core aid in dissipating the heat resulting from high-frequency losses.—RVB

2,702,835

### 5.16m ERASE HEAD FOR MAGNETIC RECORDER

Marvin Camras, assignor to Armour Research Foundation of Illinois Institute of Technology  
February 22, 1955 (Cl. 179-100.2); filed August 25, 1945

This head is particularly adapted for erasing magnetic recording wire, and employs an integral stamped core structure. The erasing efficiency is enhanced by the tapered design of the poles 23, 24, and 25 such that the flux density is low in all parts of the core except the pole tips. The efficiency is

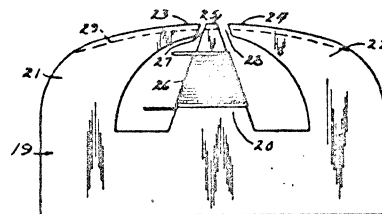

further enhanced by the double gap construction since the tape encounters two erasing fields in its passage over the head from left to right. The second gap 28 is wider than the first 27, resulting in a weaker field which reduces the residual noise in the tape.—RVB

2,747,024

### 5.16m MAGNETIC ERASE HEADS

C. F. Sprosty, assignor to Clevite Corporation  
May 22, 1956 (Cl. 179-100.2); filed October 4, 1954

An erasing head according to this invention has a split pole over which the energizing coil is placed. The additional gap 9 allows a high intensity erasing field between 12 and 13, followed by a lower intensity field between 11 and 13. A table of

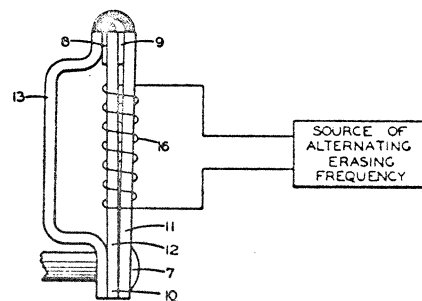

# ERASE HEADS

## 4. Thru-the-Tape & 60 Cycle Energized.

2,498,423

### 5.16m MEANS FOR DEMAGNETIZING HIGH COERCIVE FORCE MATERIALS

Hugh A. Howell, assignor to The Indiana Steel Products Company.

February 21, 1950, 6 Claims (Cl. 179-100.2).

An erasing head consisting of two C-shaped scores so placed that two pairs of pole pieces 20, 21, 23, 24 establish erasing fields through the recording medium is disclosed. The magnetic circuit of the erasing head is energized by a low-frequency power source 31. In the usual case it has been found impractical

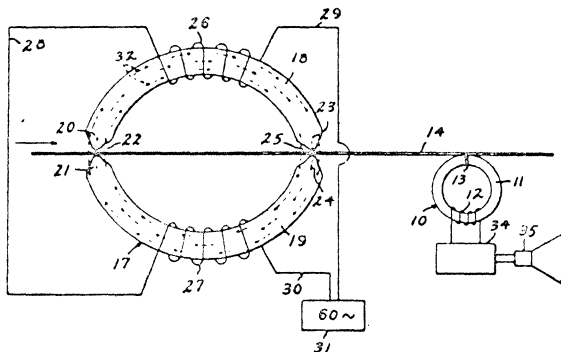

to use such low frequencies in erasing heads because of the record which such heads leave on the recording medium. In this case the difficulty may be obviated to some extent in view of the fact that the direction of the erasing field is perpendicular to the direction of the recording field.—LCH

2,479,730

### ERASING HEAD FOR MAGNETIC RECORDERS

William E. Andrews, assignor to Radio Corporation of America  
May 1, 1951 (Cl. 179-100.2); application June 22, 1949

A magnetic tape erasing head is built from two magnetic members 10, 11, so arranged that the tape 6 may pass between the pole faces 10a, 11a, 10b, 11b rather than past the com-

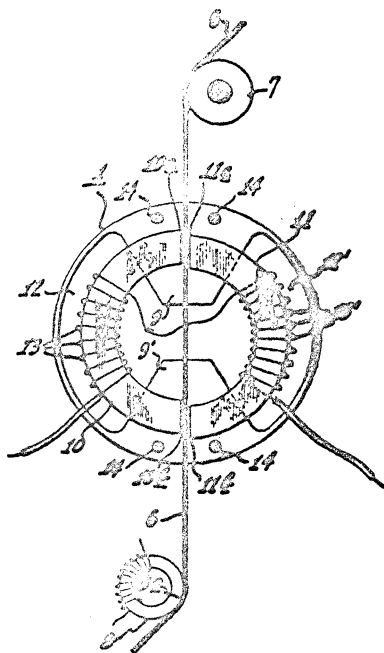

parable gaps of a conventional head. The opposing pole faces are slightly offset in the longitudinal direction. It is contended that this produces a more perfect erasure at less power consumption than the conventional design.—RH

2,604,550

### 5.16m ERASE HEAD FOR USE WITH COMMERCIAL ALTERNATING CURRENT OR EQUIVALENT

Semi Joseph Begun, assignor to The Brush Development Company

July 22, 1952 (Cl. 179-100.2); filed January 21, 1947

For simplicity and low cost, it is desirable to demagnetize magnetic recordings with power frequency current rather than the electronically generated high frequency currents usually used. Several head designs are described, characterized in general by magnetic core with non-uniform gap through which the tape is driven. The dimensions are chosen so that at the tape speed used several cycles will occur while the tape moves from one end of the gap to the other, and the tape thereby undergoes a sequence of field reversals of gradually decreasing strength.—RH

2,638,507

### 5.16m MAGNETIC RECORD ERASER

Eugene H. Lombardi, assignor to General Precision Laboratory Incorporated

May 12, 1953 (Cl. 179-100.2); filed August 24, 1950

An electromagnetic demagnetizer is described consisting of a coil 16 which energizes a core terminating in pole tips 12

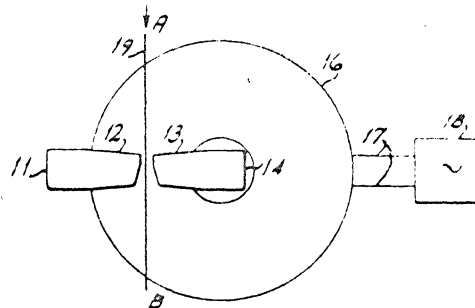

13 between which the record medium 19 passes. These tips have a short portion over which the faces are parallel, followed by a portion over which they diverge so as to produce in the moving medium a gradually reducing field. The unit is designed to be operated at power frequencies.—RH

2,718,562

### 5.16m ERASE HEAD

Hugh A. Howell and Harold W. Bauman, assignors to Ampro Corporation

September 20, 1955 (Cl. 179-100.2); filed April 17, 1951

Magnetic tape records are erased by a 60-cps field. The erasing head polepieces are tapered so that an element of tape encounters about ten cycles of successively decreasing flux as

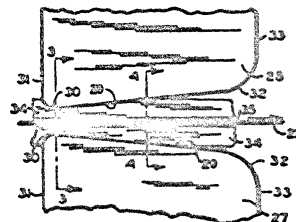

it passes through the head. Edges are smooth and round to prevent local concentrations of field. Parallel tracks not to be erased are protected by shielding.—MC



5. Miscellaneous.

2,429,792  
5.16m MAGNETIC RECORDING-REPRODUCING  
MEANS AND SYSTEM

Semi Joseph Begun, assignor to The Brush Development Company.  
October 28, 1947, 17 Claims (Cl. 179-100.2).

An erasing or obliterating means for magnetic tape recording is disclosed.—LCH.

2,535,481  
5.16m DEMAGNETIZING APPARATUS FOR  
MAGNETIC RECORDERS

Semi Joseph Begun, assignor to The Brush Development Company.  
December 26, 1950, 1 Claim (Cl. 179-100.2).

There is described a magnetic head designed for erasing magnetic recordings on tape or wire which is adapted for use at low frequencies such as 60 cps. The magnetic core 161 is

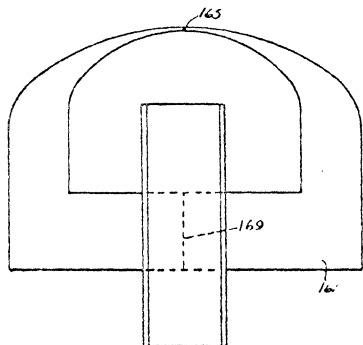

tapered in the region of contact with the medium and sufficiently large currents are employed in the coil 169 to saturate the core in all but its thickest cross sections. The amount of leakage flux acting upon the tape is greatest at the gap 165 but is appreciable over the entire contact surface. The cross section is so graduated that the field experienced by the medium decreases gradually from the gap 165 to the end of contact, and this distance is made great enough to allow several cycles of field to occur during the passage of a point of the medium.—RH

2,546,927  
5.16m POLARIZING HEAD FOR MAGNETIC  
RECORDERS

Hugh A. Howell, assignor to The Indiana Steel Products Company  
March 27, 1951 (Cl. 179-100.2); application September 13, 1947

This patent describes a permanent magnet head useful chiefly for erasing magnetic records. Assuming that longitudinal recording is used, the tape is first subjected to a saturating field in the longitudinal direction, and subsequently to a preferably saturating field in the transverse direction by a separate set of pole tips.—RH

2,620,403  
5.16m WIRE RECORDING AND  
ERASING MEANS

Walter C. Howey  
December 2, 1952 (Cl. 179-100.2); filed July 10, 1948

A system is described for the magnetic erasure of wire by a sequence of current pulses of the same polarity, together with a small direct current.—RH

2,635,149  
5.16m ERASING MEANS FOR MAGNETIC  
RECORDERS

Robert M. Cain, assignor to Wilcox-Gay Corporation  
April 14, 1953 (Cl. 179-100.2); filed December 3, 1949

This erasing head utilizes a permanent magnet device to obliterate previous signals on the tape. The gap 20 across which the erasing field is established is inclined to the direc-

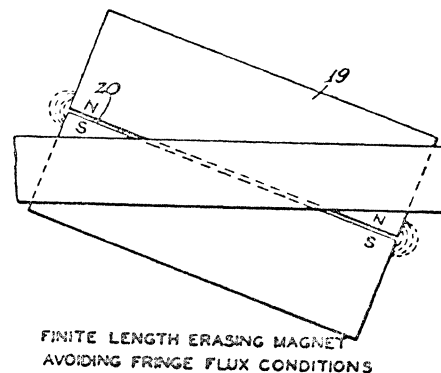

tion of tape travel so that the tape is saturated in an almost transverse direction. This reduces the tape noise normally associated with permanent magnet erasing systems. An alternative arrangement suitable for erasing one track of a dual track recording is also detailed.—RVB

2,688,663  
5.16m RECORDER-REPRODUCER

David J. Munroe, assignor to Webster Electric Company  
September 7, 1954 (Cl. 179-100.2); filed March 4, 1949

This recorder-reproducer is of conventional design except for the use of a dual erasing system. A circular permanent magnet 56 and an ac erasing head are mounted on a movable

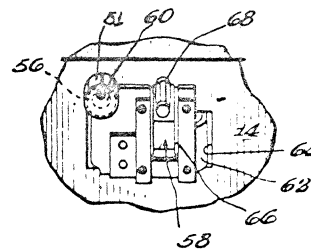

slide which advances to position them in contact with the tape during the recording function. The tape is first saturated by the permanent magnet 56 which obliterates all previous magnetic impulses but leaves the tape in a strongly magnetized condition. The tape then passes through a relatively weak ac field which reduces the steady component of magnetization to a low value. The ac erase head is of the transformer type, the secondary of which is a single heavy turn 68 which excites the core structure containing the erasing airgap. The system is particularly effective in erasing so-called "high flux" magnetic tapes and requires a minimum of ac erasing power.—RVB

2,713,619  
5.16m MAGNETIC CONDITIONING DEVICE

Wesley L. Eddy, assignor to Ampro Corporation  
July 19, 1955 (Cl. 179-100.2); filed March 27, 1951

In magnetically saturating a magnetic record tape prior to demagnetizing it for erasing purposes, the saturating flux is confined to a single record track by suitable high-permeability shims properly placed.—FWK

## APPENDIX B.

### ERASE REFERENCES FOR MAGNETIC TAPE.

Minnesota Mining & Mfg. Co. Soundtalk Bulletin #11, Time Effects in Erasing Magnetic Recordings, and #24 (July 1953) AC Erasure of Magnetic Tape.

#### Published Papers

Herr, Murphy & Wetzel: Some Distinctive Properties of Magnetic Recording Media, J.SMPTE 52: 77-88 (Jan. 1949). This paper mentions the fact that difficulty of erase is influenced by the amount of bias used in recording. Figure 4 shows the amount of erasure vs. the original bias for signals which had the same original remnant flux.

Rettinger, M.: AC Magnetic Erase Heads, J.SMPTE 56: 407-410 (April 1951). This describes seven different configurations of erase heads. No theoretical discussion.

Wiegand & Zenner: A Turn-in-Gap Erase Head for Magnetic Recorders Providing Intense High-Frequency Fields, AIEE Transactions 67 #1 (Communications & Electronics): 507-510 (Sept. 1948). Also published as AIEE Technical Paper 48-76 (Dec. 1947).

---

APPENDIX C.

NOISE LEVEL FROM THE ERASE HEAD vs. BULK ERASE.

SETUP:

Ampex Model 350, 1/4" full track recorder.

Irish "300" Shamrock tape operating at peak bias, 1000c,  
15 ips.

NAB equalization.

Noise Measuring Equipment:

Flat: Hewlett-Packard Model 400-D, VTVM preceded by  
SKL filter, set for 20 c to 20 kc.

Weighted: Using network similar to ASA, "A" response for  
sound level meters (see curve and circuit on next page).

Reference for Noise Measurement:

Operating level section of 15 ips standard tape #4494-A2.

	Flat		Weighted	
	7 1/2 ips	15 ips	7 1/2 ips	15 ips
1. Amplifier only	-62 db	-62 db	-76 db	-76 db
2. Bulk erased tape	-61	-61	-68	-67
3. Bulk erased tape run over erase & record head.	-60	-58	-63	-61
4. Bulk erased tape run over record head only.	-60	-58	-63	-61
5. Bulk erased tape run over erase head only.	-60	-58	-63 1/2	-62

Note: In line 4 data are the same for unplugging  
the erase head or for lifting the tape from  
the erase head.

We see that for either response or speed the bulk erased tape run over erase and record heads (line 3) is noisier than the bulk erased tape only (line 2). However, the bulk erased tape run over the record head only (line 4) is just as noisy as, or noisier than, the bulk erased tape run over the erase head only (line 5). This shows that the additional noise is introduced by the bias in the record head and NOT by the erase head.

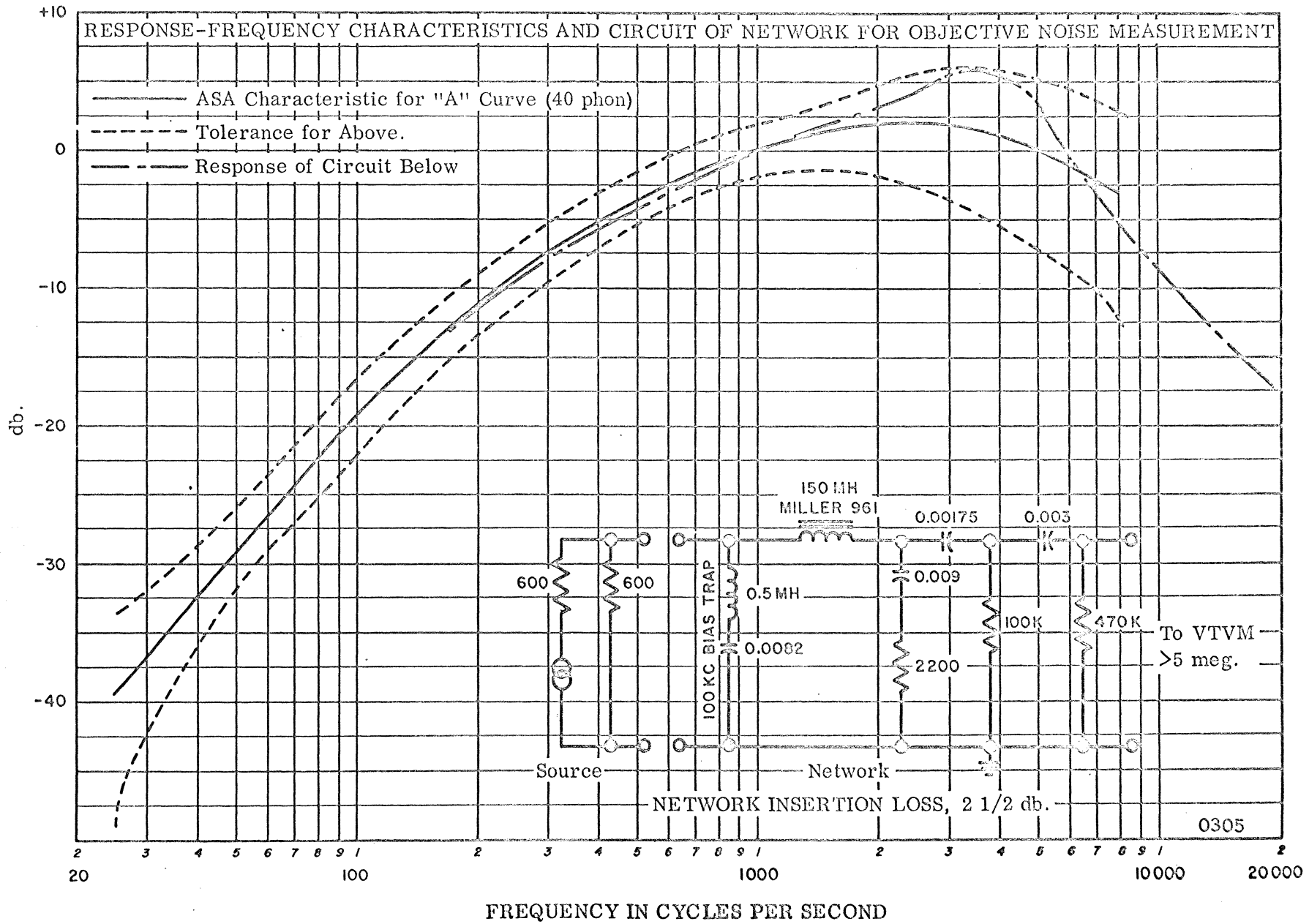

# A Magnetic Tape Eraser

Power Transformer, with E and I Laminations, Rewound to Provide Magnetization Charge and Maximum Erasure of Signals on Tape.

by T. A. HILDEBRAND, Chief Engineer, KMBY, Billings, Montana

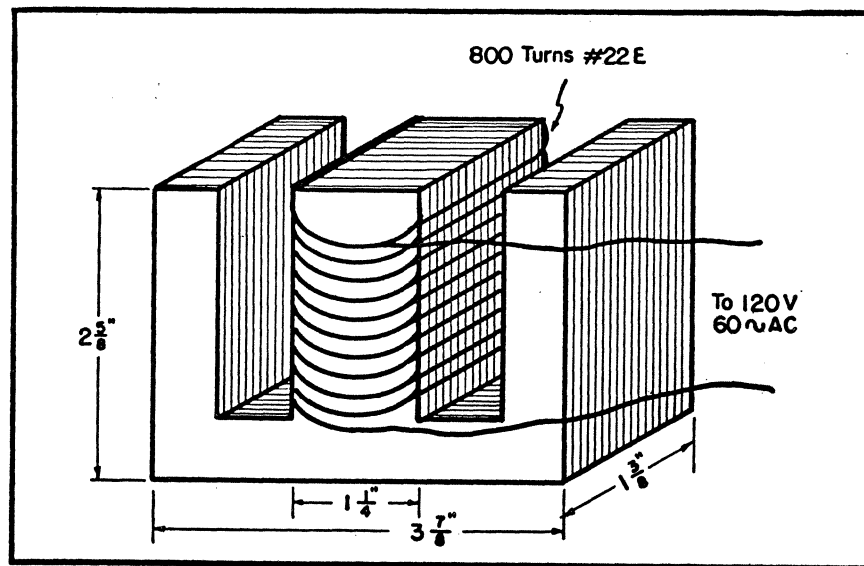

Cross-sectional view of rewound transformer used for magnetic tape erasing.

WITH THE DEVELOPMENT of magnetic tape-equipment with substantial wide-band properties, broadcasters have found the systems ideal for many purposes. To maintain the hi-fi characteristics, erasure control has been found to be extremely important. As a result several erasing techniques have been developed. In studying the problem at our station, it was found that a very satisfactory erasing unit could be built, using a rewound power transformer.

To create the required strong *ac* field, we selected a burned-out power transformer with *E* and *I* laminations. The old winding was removed, the *I* laminations discarded, and 800 turns of No. 22 enameled wire was wound to fit the winding space. Incidentally, it was found that the number of turns or the size of the core was not critical. However, the winding should have enough turns so that it will not burn up when 120 volts of *ac* are applied to the winding. Our rewound unit was found to become quite warm, but the heat was

quite tolerable after five minutes of operation.

### Operation

To erase a reel of tape, the coil is connected to the power supply and the reel of tape is gradually brought into the magnetic field, until the reel is in contact with the butt ends of the *E* laminations. The reel is then slowly rotated, first on one side and then on the other side of the reel to ensure complete demagnetization. The tape is then gradually removed from the field.

The supply voltage should not be disconnected while the reel is in the magnetic field, as this will cause a thumping sound to remain on the tape.

We found that the red-oxide coated tape will erase much more quickly than the black oxide tape. However, both can be erased.

Tape wound on metal reels will not erase properly and should be rewound on plastic reels. It was found that the

erase head on most recorders actually recorded a slight noise back on the tape. Accordingly, for really *super* recordings, the tape can be erased with the coil and then the recording made with the tape recorder erase head disconnected or removed from contact with the tape. This will result in a recording with no perceptible background noise. It was also noticed that the recording head would sometimes become slightly magnetized causing a slight noise to be recorded on the tape. This trouble can be corrected by bringing the energized eraser coil in contact with the record head and then gradually removing it.

The erasure unit can be potted in a wood or fiber box. A metal box must not be used, as the *ac* magnetic field will cause an annoying vibration of the eraser. Even aluminum and copper were found to be unsatisfactory. If a cover is used over the pole pieces, it should be very thin so that maximum flux can penetrate the tape.

# Magnetic Tape Erasure by Permanent Magnets

ROBERT HERR\*

Applications of d-c pulses may be used to obtain erasure almost comparable to the results possible with a-c bias, providing the conditions are carefully controlled.

FOR GOOD ERASURE of magnetic tape recordings, two requirements should be met. The first is complete obliteration of previous signals. This condition is met if, at some time in the erasing process, the magnetic material is saturated in at least one direction. The second requirement is demagnetization of the tape. This is important in order to achieve minimum background noise and minimum distortion in the subsequent recording. This condition is best met by subjecting the magnetic material to a large number of cycles of alternating fields of symmetrical waveform which at some point in the process reach substantial saturation and, thereafter, decrease gradually through many cycles to zero.

A third consideration of some practical importance is that the process be insensitive to the magnetic characteristics of the tape to be erased, so that a given erasing means may be used without change for any of a wide variety of tapes. The alternating field process, with a high enough maximum field, will work on any tape. Some permanent magnet processes will obliterate the signal from any tape, but leave various states of magnetization on various tapes.

Thus from a magnetic point of view, demagnetization by alternating fields is satisfactory, but from a manufacturing point of view it is attractive to erase tape by one or more permanent magnets because such erase offers economy, reliability, simplicity, light weight, and freedom from servicing. This paper discusses some of the points to consider in the use of permanent magnets for erase.

If the erasure is to be followed by recording with d-c bias there is no problem. Here the erase should not be designed to demagnetize the tape but to saturate it, and a single saturating magnet is all that is required. However, with this type of recording, a

high noise level is unavoidable and most present day recorders use a-c bias. The following discussion assumes that the erase will be followed by a-c bias recording.

## D-C "Pulse" Erasing

With a single permanent magnet of sufficient strength to saturate the tape, the signal may be easily obliterated but the noise level of even a perfect tape

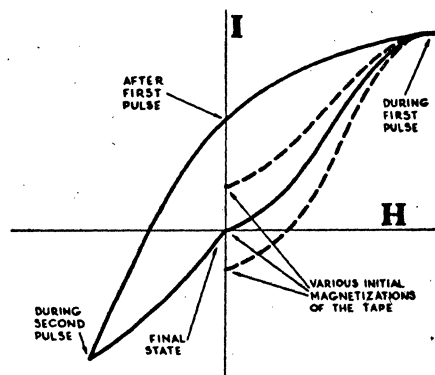

Fig. 1. Curve showing principle of demagnetization by two d-c pulses.

would be fairly high and that of actual tapes is very high. For example, noise levels of 20 to 30 db higher than those normally obtained with a-c erase are common. In addition, the polarized condition of the tape leads to serious even order harmonic distortion in the subsequent recording, a condition which is absent with a good a-c erase. The expedient of a "single pulse" permanent magnet (or d-c) erase can therefore be justified only when cost or simplicity is the prime consideration.

The next step is to consider two d-c "pulses." In principle such a cycle can demagnetize, as shown schematically in Fig. 1. The first pulse should be saturating (in either direction); the second pulse is of opposite polarity and of just such strength as to leave the material with zero magnetization after its removal.

At this point several considerations enter:

1. The hysteresis loop of the material

which we obtain from any gross measurements represents an average over many billions of oxide particles. These particles are crystals or oriented aggregates of crystals, each of which has preferred axes of magnetization. For a given direction of magnetization, each crystal orientation will result in a different contribution to the observed hysteresis loop. Under these conditions, a cycle of two pulses cannot be adjusted to demagnetize all the particles. However, a gross average of zero magnetization can be obtained, and when it is, the noise will be much reduced from that obtained with one pulse because,

- The magnetization of individual particles, while not zero, will likely be less than that resulting from saturation, and
- Noise resulting from tape irregularities of relatively long wave length will be effectively reduced.

2. Any given erase will not be optimum for a variety of tapes, although it may be better than a 'single-pulse erase for all of them.

3. In actual use, the tape when heard has passed not only the erase head but also the record head. In this process the bias field acts on the tape, even when no audio is recorded. Thus the demagnetization result discussed above is of purely academic interest. What is important is the condition of the tape after erasure and biasing. In biasing, the tape is subjected to an a-c field of increasing and then diminishing strength. For a demagnetized tape the bias (if of good design) changes conditions very little, but for a tape erased by one or a few d-c pulses the change may be considerable. To some extent the bias field acts as an incomplete (i.e., non-saturating) a-c erasure and tends to reduce noise. It may, however, tend to alter an average tape magnetization from the zero value in which a permanent magnet erase cycle left it, and thus tend to increase noise. This will be made clear below.

A characteristic of a tape in which an average zero magnetization has been achieved by a few d-c pulses is that it is composed of a collection of particles all of which may be magnetized. If a small a-c field is applied and gradually reduced to zero, it may demagnetize some of these elements or alter some

\*Minnesota Mining and Manufacturing Co., St. Paul, Minnesota.

domain boundaries that are relatively unstable, while not affecting others. When this happens the average magnetization is no longer zero.

### Method of Obtaining Data

To take quantitative data, a large solenoid was used to apply known fields to a 1/4-inch square rod, 12 inches long, of oxide dispersion. The magnetization was measured by passing the rod through a pickup coil connected to a ballistic galvanometer. A d-c pulse was administered by setting the desired current from storage batteries in the magnetizing solenoid and passing the rod through the solenoid. Diminishing a.c. fields were obtained in the same way, using a 60 cycle supply with a Variac. The diminishing was done by the movement of the rod rather than by the Variac. After each pulse of d.c., the magnetization of the rod was measured, and after a suitable erase schedule, the rod was subjected to a-c fields and measured after each "shake" beginning with weak and increasing to saturating a-c fields. The units for magnetization were left arbitrary, although they could be converted to absolute values of flux lines or gauss; the field values were measured in oersteds.

The data are summarized in Fig. 2. The schedules of d-c fields used to erase are shown at the left for erasures of from one to five d-c pulses. Beneath each pulse applied is tabulated the residual flux, measured following that pulse. To the right of each schedule is plotted the magnetization as a function of the peak value of the a-c field to which the sample was subjected after erase.

Leaving aside the bottom curve, the curves form a family which illustrate the basic phenomenon. The top curve is a single-pulse d-c erase, which leaves a large magnetization which is hardly reduced by ordinary bias fields (of the order of 200-300 oersteds). The next two curves show two-pulse erasures with obvious improvement over the single-pulse erase. The first of these achieves zero average magnetization after erase, but the a-c field corresponding to the bias increases the magnetization very markedly. The second of these two shows an erase so designed as to leave zero magnetization after biasing with 280 oersteds. Various three, four, and five pulse erasures follow and it may be seen that:

1. Gross, or average, magnetization may be made no more complete but enormously more stable by increasing the number of pulses in the erase schedule.
2. One can alter the shape of the curves deliberately and predictably by choosing the sequence of pulses. As the a-c field is increased following a multi-pulse d-c erase, the material retraces its past history, "forgetting" first the last or weakest d-c pulse, then the

next to last, and so on. This shows the extent to which the erase schedule failed to demagnetize the material and achieved instead merely a zero average flux, as described above.

### Experimental D-C Pulse Head

The schedules shown are, of course, not all the data taken. For a given result the magnitude of pulses had to be chosen with great care. In practice, one of the fields from commercial magnets could not be controlled within the fraction of one per cent necessary to get the results shown for a five pulse erasure. A magnetization of 10 to 25 units on the vertical scale of the curves would be a good practical result.

Another factor of great importance in actual tape erasure is that fields applied to the tape are not uniform through the tape. Thus for a given array of magnets the layers of tape next to the magnets might experience fields proportional to but stronger than the fields acting on a more remote layer

of the tape. The last curve of Fig. 2 illustrates the inadequacy of a five-pulse schedule which is similar to the one directly above it but with all values increased by the factor 1.86. It does a poor job, and if one must contend with such variations, either more pulses must be used or poorer results expected.

The schedules shown in Fig. 2 are also non-universal with respect to the magnetic properties of the tape. A schedule best for one tape will not be best for another, although it will be better than a single pulse. Universality is necessarily tied in with a very large number of pulses such as approximate true demagnetization.

In actual tape recording, not only are there gradients in the erasing fields but also in the biasing field. For conventional ring-type record heads, the bias-field gradient across the thickness of the tape may introduce a factor from two to five between the fields near the front and back of the tape. Thus

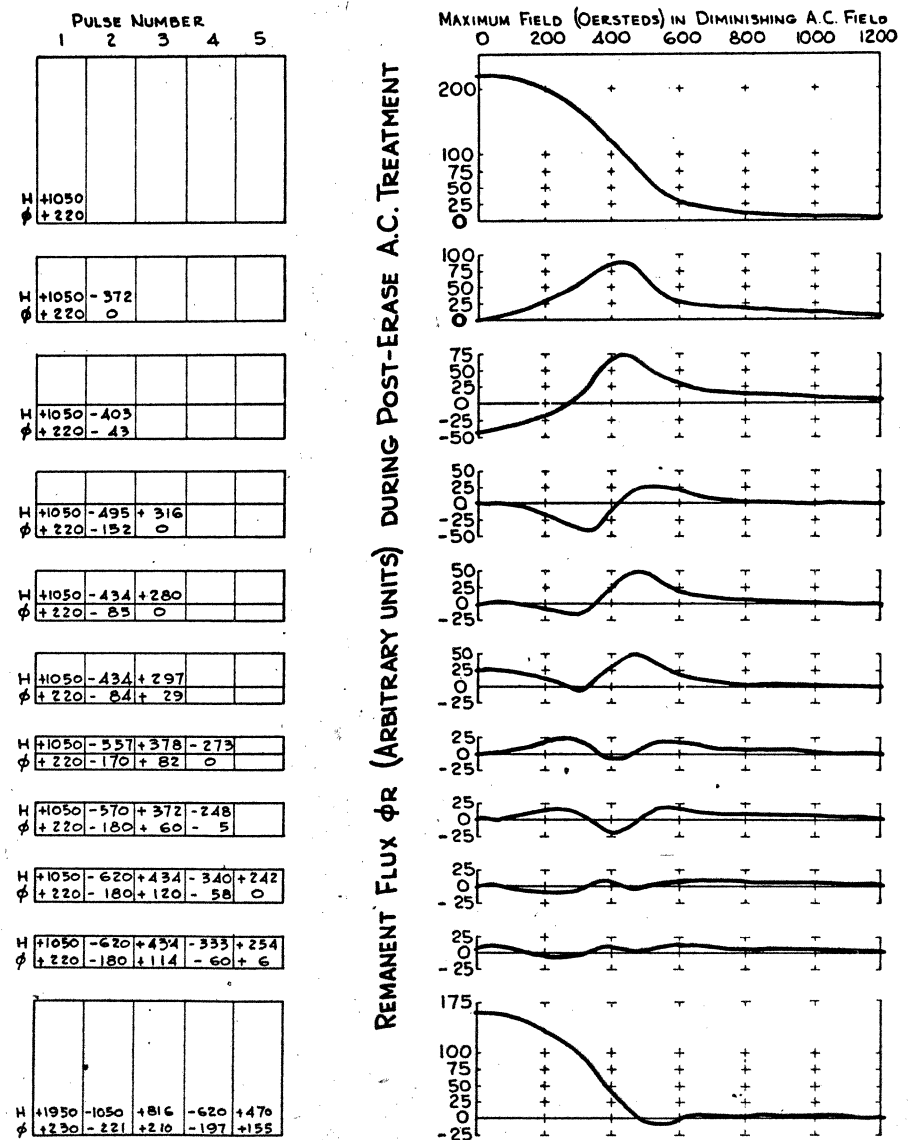

Fig. 2. Chart showing characteristics of erasure by various schedules of d-c pulses, using rods as the magnetic medium.

e-  
l-  
re  
s,  
g-  
ti-  
ult  
ed  
a  
to  
a  
be  
be  
ne  
  
al  
be  
on,  
  
gu-  
gh  
  
um  
be  
of  
  
has  
the  
eld  
is  
sult  
ter-  
of  
bias-  
l of  
gh.  
of  
ttle,  
d-c  
To  
in-  
sure  
ver,  
tion  
nent  
tend  
lear  
  
nich  
been  
at it  
cles  
If a  
ally  
tize  
ome

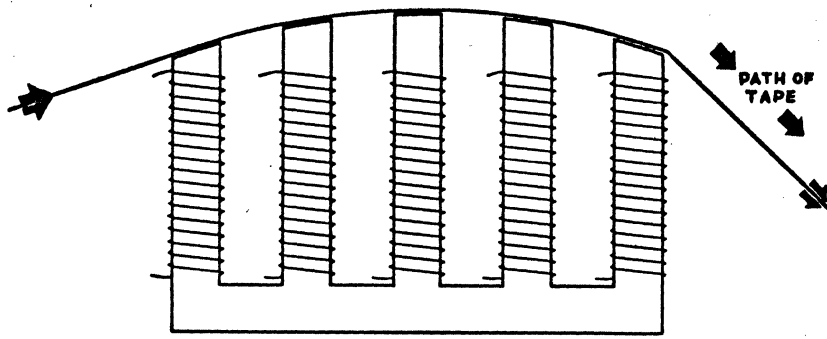

Fig. 3. Experimental d-c erase head providing five separate poles which may be magnetized to any desired degree and polarity.

each particle has its own post-erase history and the curves of Fig. 2 are valuable chiefly in understanding the basic phenomena. However, it is reasonably safe to predict from them that a careful arrangement of three to five successively opposite permanent magnet fields will give substantially quieter erase (10 to 15 db) than a single magnet. The data also show the importance of adjusting the magnets by observing noise after the tape is subjected to the bias field.

#### Comparison of Results

To see to what extent the above phenomena are reproduced in actual d-c erase of recording tape, the erase head shown in Fig. 3 was constructed. The core is soft iron and the legs were wound with separate coils which could be energized with independently controlled d.c. This made possible the erasure of tape by a succession of various numbers of d-c pulses in a manner analogous to the experiments with rod and galvanometer. In this case the erase was followed by the usual record head employing a-c bias of variable amount in place of the a-c solenoid shaking field, and the residuals were measured in the form of noise at the playback head in place of the galvanometer measurements of magnetization.

When first tried, this head gave disappointing results. The use of two poles lowered the noise about 5 db below that for single-magnet erase, but no adjustment of any number of additional poles gave any substantial further improvement. This was traced to the large field gradients existing near the pole tips which had been machined with fairly sharp covers. To reduce the local field gradients, all pole faces were covered by a layer of "Scotch" cellophane tape (.003 inches), and the good performance described below was obtained. Perhaps still greater field uniformity would have yielded still better results. In any case, it indicated that a good practical design would not employ very sharp magnet edges next to the tape.

The results for various pulse erasures by this head are shown in Fig. 4. Tabulated on the left are pulse ampere-turns in successive legs of the special erase head, and on the right are graphed the noise levels for various bias currents in the record head following erase. For the tape and head used, a typical bias current would be .07 or .08 amps. The noise levels are plotted in db relative to the so-called d-c noise which results from a single saturating d-c pulse followed by no bias.

#### Practical Results

In comparing the graphs of Fig. 2 with those of Fig. 4 one must remem-

ber that the vertical scale of the former is linear whereas that of the latter is logarithmic. It may be seen that, as predicted, the best erasure conditions must be chosen with the bias operating, since the pulse schedules for best erase and best erase-plus-bias are not the same. It is also evident that the bias may act to increase the noise as well as to reduce it, in accordance with the basic data of Fig. 2. It is not possible to relate the number and strength of pulses to the shape of the curves so easily as in Fig. 2, presumably because of the gradients in erasing and biasing fields. The improvement in noise for multiple-pulse erase over that for single-pulse erase is about as would be predicted by the data of Fig. 2.

The improvement of the two-pulse erase over the one-pulse method is evident, and the addition of a third pulse offers significant further improvement. Beyond this point improvement is very slight, although more pulses could be used advantageously if a more gradient-free field were supplied or if it were desired to make the erase efficient for a wide variety of tapes.

In general, it would seem that a well designed multi-pulse d-c erase system

[Continued on page 29]

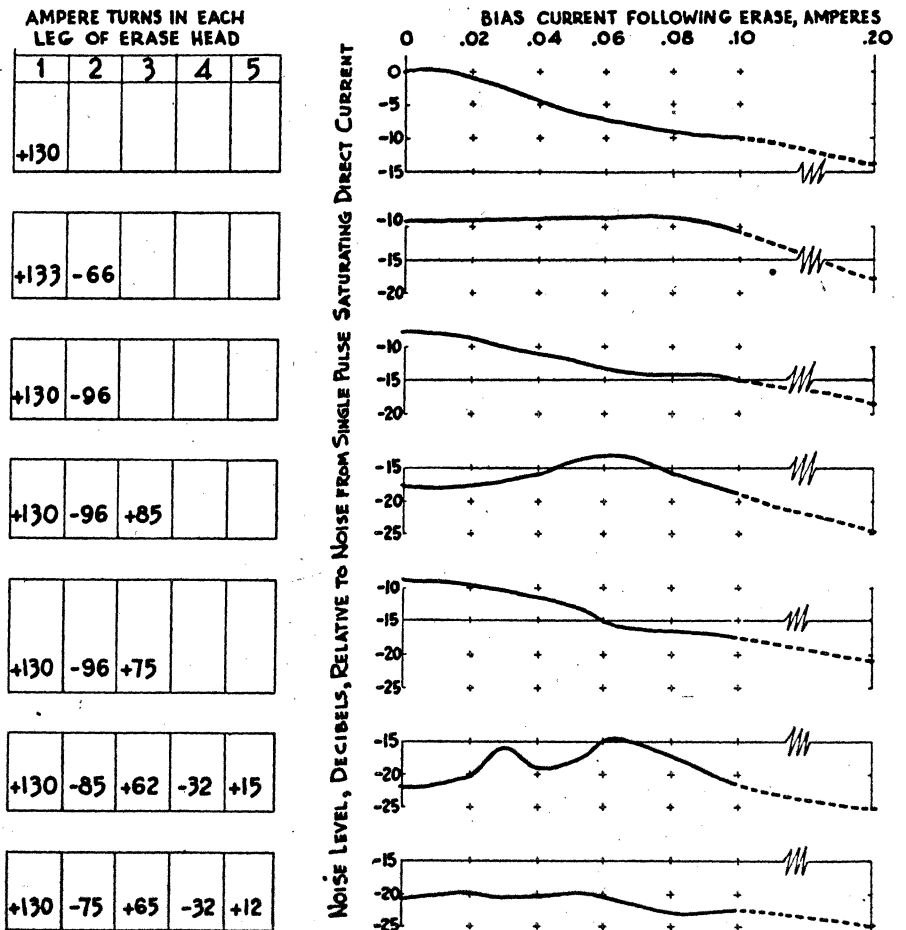

Fig. 4. Erasure characteristics for various schedules of d-c pulses applied to magnetic tapes, using noise measurements to indicate efficacy.



OR

nifo  
fore  
greater  
l control  
detailed  
e of re  
ne lower  
the front  
h for se-  
such as  
osition is  
a screw-  
k for the  
ver band

f a heter-  
s rise to  
cy insta-  
yield to  
tempera-  
nce tube  
nce tank  
maintain  
le distri-  
io in the  
is neces-  
poor fre-  
tor. Some  
stabiliza-  
ortunate-  
to a  
rol. The  
a single-  
The time  
e capaci-  
pends on  
tput fre-  
on of the  
cps, this  
small  
imit. An  
ross the  
trol volt-  
rage fre-  
a control  
ept oscil-  
is voltage  
s in the  
illator of  
ed. After  
tion only  
ncy drift  
hoda-ray

nt use of  
s present-  
must be  
horizontal  
requ-  
this  
el-T net-  
eir points  
istributed  
and. The  
000, 2000,

5000, 10,000 were chosen for calibration points since they are about equally separated on the log scale. A selected network is inserted in the signal path of the amplifier, and the output of the generator drops to zero at the null frequency, thereby accurately defining the position of that frequency on the screen. Selection of each null network in turn allows calibration of the screen at the selected frequencies. A switch on the front panel provides for selecting these null points. Feedback in the amplifier sharpens the nulls so that at one octave above or below the null the output is within one decibel of the final value<sup>5</sup>. Figure 7 shows the pattern produced by the 50-cps null point in a sweep from 20 to 20,000 cps.

The last problem to be discussed concerns the method of obtaining a vertical scale which is linear in decibels rather than in voltage. The desirability of a logarithmic vertical coordinate need not be justified here beyond mention that accepted practice utilizes Log-Log coordinates. Figure 11 illustrates the circuit of an amplifier that distorts the signal applied to it according to a logarithmic law introduced by the back-to-back connected 1N34 Germanium diodes. The output voltage across these diodes is instantaneously proportional to the logarithm of the input voltage to the amplifier stage.

In use, the output terminals of the log amplifier are connected to the vertical input of the oscilloscope and the input terminals are connected to the output of the equipment under test. Figure 12 shows the linearity of this amplifier when the peak output voltage is plotted against decibels input. It can be seen that the linearity is good over a range of about 26 db or an input voltage ratio of about 20 to 1. This is sufficient for most response curves. In Fig. 5, which shows the 6db/octave rise of a high-pass RC combination, the linearity of both the log frequency scale and the vertical decibel scale can be checked.

The unit constructed according to the principles herein outlined has given stable, trouble free service and the inherent flexibility of the all electronic design has proved itself many times to be highly desirable.

<sup>5</sup> Negative Feedback Applied to Oscillators, *Electronics*, May 1940

## TAPE ERASURE

[from page 16]

will yield noise levels (after bias) from 10 to 15 db lower than is obtainable with a single saturating pulse. This represents a considerable sacrifice compared with what can be done with a

# TAPE OR DISK

## YOU CHOOSE FAIRCHILD FOR TOP PERFORMANCE

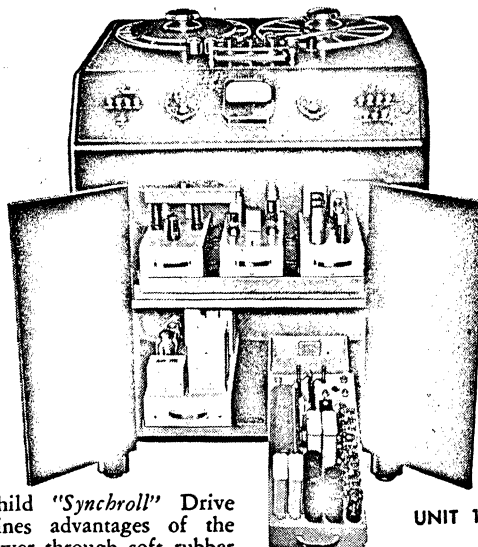

UNIT 100

★ The Fairchild "Synchroll" Drive System combines advantages of the transfer of power through soft rubber idlers with those of direct gear control of the capstan. This unique development of Fairchild results in a *no-slip synchronous* tape drive.

★ High Frequency Flutter causes roughness in a reproduced sine wave tone. *Smooth motion* in the Fairchild Tape Recorder is apparent in the *cleanliness* of simple musical tones.

★ Hum problems are generally recognized as inherent in magnetic recorders. The high efficiency of Fairchild Playback Head design and amplifier construction results in a hum measurement at least 68 db down. (ref. 2% distortion).

THE FAIRCHILD PROFESSIONAL TAPE RECORDER easily outperforms requirements set by NAB Standards. Features include: "plug-in" type construction, both mechanical and electrical, for uninterrupted service; interlock system to prevent accidental erasing; volume indicator and circuit metering; adjustment of playback head during operation for optimum performance with all tapes; simultaneous monitoring from the tape during actual recording. Major network and recording studios are using Fairchild Tape Recorders. Write for complete information.

## FAIRCHILD SYNCHRONOUS DISK RECORDERS

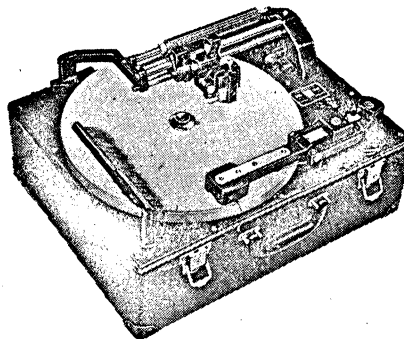

ACCURATE PROGRAM TIMING—Synchronous direct to the center gear drive for shows "on the nose".

FREEDOM FROM WOW—No slippage. No musical pitch change to make listeners aware the show is transcribed.

SOUND ON FILM DUBBING—Many of the motion picture sound tracks you hear and enjoy are first recorded on Fairchild Synchronous Disk Recorders.

Above are some of the features that have gained FAIRCHILD the reputation for the finest in recording equipment. Fairchild Synchronous Disk Recorders are manufactured in 3 models; Unit 523 for the finest fixed studio installation; Unit 539K for the small budget studio; Unit 539G (shown above) for console performance in a portable unit. Maintain your reputation for making the finest transcriptions and masters with Fairchild equipment. Write for illustrations and complete specifications.



RECORDING EQUIPMENT CORPORATION

154TH STREET AND 7TH AVENUE, WHITESTONE, L. I., N. Y.

# HARVEY

takes great pleasure in presenting the NEW  
**MAGNECORDER PT6-JA**

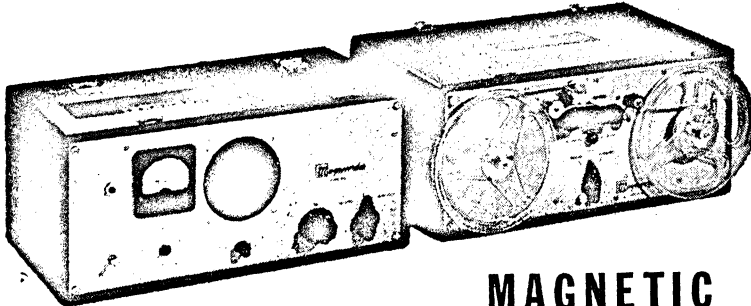

PT6-JA recording mechanism and amplifier

## MAGNETIC TAPE RECORDER

The two-case portable Magnecorder PT6-JA is designed for the professional user. Conforms to all N.A.B. specifications. Frequency response 50 to 15,000 cycles—2db, less than 2% harmonic distortion. Two tape speeds, 7 1/2" and 15" and high speed rewind (time 45 sec.) 10-watt audio amplifier external speaker. VU meter built-in. **\$499.50**

Same as above but with high-speed forward ..... **\$515.50**

## AND THE NEW DUOTAPE MAGNETIC RECORDER

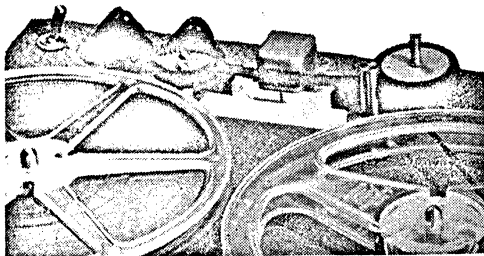

### PARTS KIT

Anyone can assemble this kit with screwdriver, pliers and soldering iron. Precision engineered parts, panels drilled, difficult assemblies factory assembled and tested. Contains motor, all tape parts, erase/re-record/reproduce head, oscillator coil, hardware and full instructions. Amplifier

circuit and parts list included. Playing time one hour on dual tape, records half hour in each direction. Recording speed 7 1/2", response excellent from 80 to 9000 cycles. Complete kit of parts ..... **\$44.95**

Telephone: **7-1900** Luxembourg 2-1500

**HARVEY**  
RADIO COMPANY INC

103 West 43rd St., New York 18, N. Y.

For FREE Literature, write Dept. A.  
COME IN FOR DEMONSTRATION

IN STOCK FOR  
IMMEDIATE DELIVERY

really excellent a-c erase, although it may be only slightly poorer than a typical cheap a-c erase and bias system in which there may be bad wave form and/or d-c components. D-c erasure is, therefore, not to be considered for machines in which maximum quality is necessary; for the cases where it is to be used, the information given above may be of value in design and testing.

The author wishes to thank the management of the Minnesota Mining and Manufacturing Company for permission to publish the data contained in this paper, which was obtained in connection with research on "Scotch" Sound Recording Tape.

## MAGNETIC RECORDER

[from page 18]

from the tape. Opening the gate of the head housing removes the tape from contact with the heads for fast winding. Threading is extremely simple, as the tape can be merely dropped between the open gate and housing with no fear of snarling or catching. Tilt adjustments are provided on the record and playback heads so that they may be aligned while the machine is running.

### Amplifier Assembly

A great deal of work has gone into the simplification of all electronic components to reduce size and cost. Wherever possible, costly transformers have been eliminated, and dual tubes such as the 6SN7 have been used to reduce space requirements.

The recording amplifier has a bridging-input transformer, which can be used either matching or bridging, and the amplifier has sufficient gain to record from any line level from -30 VU up. Ample recording current is provided so that no distortion is introduced by the recording amplifier well beyond the current necessary to saturate the tape. A screwdriver gain control is provided, as well as a high-frequency equalizing adjustment and a bias current adjustment.

A novel bias and erase supply has been provided which leaves the tape remarkably quiet, and which is un-critical to voltage variations and other adjustments.

The playback amplifier will deliver + 25 dbm at 1 per cent total harmonic distortion into a 150- or 600-ohm line. This is ample reserve for the normal operating level of + 4 VU to + 8 VU. A screwdriver gain control is provided, and a high-frequency equalizing adjustment for flat playback response from a standard tape.

Overall performance characteristics are well within the proposed NAB

## SIMPLEX RECORDER TAPE SPLICER

(Pat. Pending)

A MUST FOR EVERY TAPE USER!!  
NOW EDIT & SPLICE ALL TAPES IN SECONDS  
Reclaim and use all odd lengths of tape

- NON-MAGNETIC BLOCK
- PRECISION MACHINED
- JOINT STRONGER THAN TAPE
- EVERY SPLICE STRAIGHT & TRUE
- EVERY SPLICE MADE AT CORRECT ANGLE

When Ordering Include Amount for Splicing Tape

Dealer Inquiries Invited  
Manufactured by

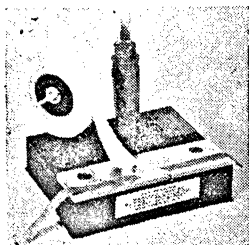

Price **\$5.95**

Less Splicing Tape

Uses Standard Scotch  
Splicing Tape No. 41  
76c per 66 ft. roll  
EVERYWHERE

**BURNETT SERVICE CO.**

178 West 168th Street

New York 52, N. Y.

BIBLIOGRAPHY ON ERASURE OF MAGNETIC TAPES

22 November 1961

"Advantages of the two head videotape system." INTERNATIONAL TV TECH REV. July 1961, pp. 19-21.

Benham, E. E. "Some engineering aspects of videotape recording production." IRE TRANS ON AUDIO, Aug. 1960, pp. 21-24.

Bernstein, J. L. VIDEO TAPE RECORDING. Rider, 1960.

"Bibliography on demagnetization in magnetic tape." TIS Bibliog. 10 Nov 1961.

Clark, C. B. and Haynes, J. L. FACTORS LIMITING THE PERFORMANCE OF VIDEO RECORDING HEADS. SRI Project 2180 for Ampex Corp., Aug. 1957.

"Erase head development" Engineering project 581, Ampex Corp., June 1958.

"Erase oscillator" Engineering report 578, Ampex Corp., Feb. 1958.

"Full details of RCA's new videotape recorder." INTERNATIONAL TV TECH REV. May 1961, pp. 36-42.

Gatz, H., "Interference Recorders with Periodic Erasure," ARCHIV FÜR TECHNISCHES MESSEN, No. 238, pp. 251-254. Nov. (In German). Several techniques are described for monitoring at high-speed potential interference sources, automatically transferring to a permanent record any specific interference received and then erasing the original recording so that the recording medium can be used again. One device embodies a rotating drum coated with printer's ink on which the recording is made with a mechanical oscillograph. A magnetic recorder, essentially conventional except for use of a playback amplifier with particularly good equalization, is described. (1069)

Goldberg, A. A. and Hannah, M. R., "Video tape analyzer." SMPTE JNL, Feb. 1961, pp. 85-89.

Goodall, George B. TELEVISION TAPE RECORDING. Robing Industries Corp., 1959.

Herr, R., "Magnetic Tape Erasure by Permanent Magnets," AUDIO ENGINEERING, Vol. 33, pp. 14-16, 29-30. Aug. Discussion of requirements for good erasure and use of permanent magnets; how application of dc pulses may be used to obtain erasure almost comparable to results possible with ac bias, providing conditions are carefully controlled. (483)

Herr, R., and Von Böhren, R. A., "Selective Erasure of Magnetic Tape Cross-Talk," ELECTRONICS, Vol. 25, pp. 114-115. Aug. A description of the practical application of this technique to one type of magnetic tape. Generally a small erase current,  $\approx 0.1 \times$  normal, was found to reduce print-through signals, (1) 6-8 db without affecting the recorded signal at all, or (2) 10-12 db with a recorded signal reduction of  $\approx 1$  db. However, as the erase-head design was found to affect the relative reduction of lf and hf signals, tests were carried out with three types of erase heads; (a) with an air-gap of 0.001 inch (b) with an air-gap of 0.02 inch, and (c) one of the form of a solenoid through which the tape is threaded and which gives a more uniform field in the magnetic coating. A 1 kc and an hf signal were recorded on the tape. 16 hours after storing at 65°C, for a given reduction of the printed signal the 1 kc signal was found to have fallen approx. the same in all cases, but the hf signal was slightly less reduced with head (c) than (b) and substantially less than with (a). Based on these results, a practical procedure particularly applicable to professional recording, is outlined. The fact that the technique can be used with certain tapes only is emphasized. (727)

Hildebrand, T. A., "Magnetic Tape Eraser," TELEVISION ENGINEER, Vol. 1, p. 21. Jun. Illustrated description of erasing unit built by engineers of station KMBY, Billings, Montana; unit is power transformer, with E and I laminations, rewound to provide magnetization charge and maximum erasure of signals on tape.

Johnson, G. N. et al., "Cooling circuit extends magnetic recorder response" ELECTRONICS, Mar. 10, 1961, pp. 186-7.

Kolb, O. K., "Some Aspects of Magnetic Sound Recording," BRITISH INSTITUTION OF RADIO ENGINEERS JOURNAL, Vol. 12, pp. 307-316. May. A brief history and a description of normal equipment are given. Operation without bias, with dc bias and with the far superior hf bias are compared. Explanations of the operation of hf bias according to Wetzel and to Montani are discussed in detail. Zenner's attempt at a mathematical approach by considering the fit of a 5th order equation to the B-H curve is described. In a study of mechanism of erasure, the practical impossibility of removing the last traces of an hf erasing signal and the improved erasure obtained with an ac-mains mass erasure are pointed out. The surprisingly small improvement obtained by erasing at very low speed is mentioned. (734)

McKnight, J. ERASE PROCEDURE.  
Ampex Document, Jan. 1959.

Ofongenden, R. G., "Study of Pulse Erasure in a Magnetic Memory," *RADIOTEKHNIKA*, Vol. 10, No. 4, pp. 66-72. Apr. (In Russian).  
A block schematic is given of an experimental arrangement using 3 heads on a drum 15 cm in dia. rotating at 3,000 rpm. Each head carries 3 windings for writing, reading and erasing. It is first shown that an erasing pulse equal in width to that written and accurately coincident causes incomplete erasure with a signal/residue (called signal/clutter in the paper) ratio of 5. By increasing the length of the erasing pulse so that it spans that to be erased and by using recording levels of saturation and between one-half and one-third of saturation the signal/residue ratio is improved to 10. This is considered to be a good working figure. (1103)

Spring, H. P., "The Characteristics of Magnetic Recording Heads and Tapes," *JOURNAL OF THE BRITISH INSTITUTION OF RADIO ENGINEERS*, Vol. 17, No. 4, pp. 217-233. Apr.  
It is shown how a recording by magnetic means is made, retained on the tape and finally reproduced. The erasing of a magnetic tape by means of a steady or an alternating magnetic field is explained. The recording process is considered together with the effects caused by a.c. biasing. Formulae for obtaining the output voltage from any given head are discussed. Demagnetization, gap functions and the various losses encountered in tape reproduction are also dealt with. Tape characteristics are discussed together with comparison graphs for different tape characteristics. Some recording heads, which differ from conventional designs, are described and their applications for various types of magnetic recordings considered. Finally, the effect of head and tape wear on the frequency response of a recorded tape are discussed quantitatively. (1327) ✓

"Tape degausser." AMPEX DOCUMENT., A 01474  
May 27, 1957.

"Tape degausser." Engineering project  
615, Ampex Corp., June 1958.

*Can not be removed from library*

Werner, P. H., and Kohler, E., "The Properties of Modern Magnetic Tapes," *TECHNISCHE MITTEILUNGEN P.T.T.*, Vol. 38, No. 7, pp. 217-228. (In French and German).

The properties of three German and three American tapes are reviewed, primarily from the viewpoint of professional recording requirements and hence interchangeability. The following mechanical and magnetic characteristics are discussed briefly: width, elongation, friction, storage, sensitivity, frequency response, distortion, noise level and erasability, the point being made that despite considerable difference in properties, all six tapes come within the prescribed tolerances. Print-through is studied in great detail, particularly the inter-relationship between minimum damping, wavelength and tape thickness, its increase with time, its diminution with re-winding and the palliative effect of partial erasure. (1739)

Westmijze, W. K. STUDIES ON MAGNETIC RECORDING. Eindhoven, 1953.

Willis, D. W. and Skinner, P. "Some engineering aspects of magnetic tape system design." *BRIT. IRE JNL.*, Nov. 1960, pp. 867-76.

Zenel, J. A., "Narrow-bandwidth video-tape recorder used in the Tiros Satellite." *SMPTE JNL.* Nov. 1960, pp. 818-9.

504 Erasure of magnetic records. IBM Deutschland Int. Büro-Masch. G.m.b.H., G.P. 1094476, 8 Dec. 1960. A direct or alternating magnetic field is employed for erasing data recorded magnetically on an endless tape or drum.

10 November 1961

Anhyseretic Remanence of Magnetic Recording Tapes, E.P. WOHLFARTH, Philosophical Mag v 5 n 55 July 1960 p 717-22.

Discussion of anhyseretic properties of magnetic tapes, utilizing idea of internal demagnetization spectra; data for three tape specimens.

Bierl, R. Ueber den wahren Frequenzgang bei der Aufnahme und Wiedergabe nach dem Magnettonverfahren. ZEITSCHRIFT FUR ANGEWANDE PHYSIK, Vol 3, pp. 161-165. 1951.

621.395.625.3 : 534.862.3

2777. THE EFFECT OF MAGNETIC FIELD DISTRIBUTION AT THE GAP OF A RECORDING HEAD ON THE LOSS OF RESIDUAL INDUCTION IN THE TAPE. G.S.Veksler. Akust. Zh., Vol. 1, No. 2, 134-7 (1955). In Russian.

The paper investigates the dependence of the residual induction in a carrier of magnetic signals upon the rate of fall-off of magnetic field intensity of the recording head. A model is used for the magnetic process of recording, without taking into account the phenomena of spontaneous demagnetization and penetration. It is shown that with steepest falling-off of intensity of magnetic field over the region through which the tape runs the residual induction may rise to 5-6 db.

C.R.S.Manders

Geranin, V. A. "The distribution of the residual magnetization through the tape in tape recording" RADIO ENGINEERING, Vol. 16, pp. 103-110. 1961.

Gilburg, C. P., "Video Tape Recorder Design. Comprehensive Description of the AMPEX Video Recorder," SOCIETY OF MOTION PICTURE AND TELEVISION ENGINEERS JOURNAL, Vol. 66, No. 4(I), pp.177-182 Apr. 57

The equipment incorporates a 4-element rotating-head drum which scans the 2 in. wide tape transversely at a speed of rev/sec. The drum is 2 in. dia., the tape speed 15 ips and the track width 0.01 in. The same head assembly is used for recording and playback. The recorded signal is an rf. carrier frequency-modulated by the video signal. The motor is driven from a 240 c/s supply derived from the 60 c/s mains. A disc mounted on the drum spindle is used in conjunction with an optical system and a photocell to produce timing signals which are recorded on a control track at one edge of the tape. On playback these recorded timing signals are used to ensure synchronism. The recording process, in which a saturating signal with a frequency coverage of 750 kc/s to 6 Mc/s appears necessary, is studied and the difficulties arising from head resonances, etc., losses and self-demagnetization are emphasized. Head and tape life are discussed.

(1256)

Logie, H. J. "Demagnetizing effect in magnetic tape recording." SOUTH AFRICAN JOURNAL OF SCIENCE, Vol. 50, p. 15. Aug. 1953.

Mann, P. A., "Noise on Magnetic Tapes," ARCHIV DER ELEKTRISCHEN UBERTRAGUNG, Vol. 11, No. 3, pp.97-100. Mar.57(In German).

The active layer of magnetic recording tape consists of a random arrangement of grains of magnetic material which in turn are established from a number of Weiss's domains of different orientations. When such tape passes by a reproducing head, a noise voltage appears at its terminals since every Weiss domain gives rise to a voltage pulse. Under assumption of a fully statistical arrangement of the magnetic domains in respect of position and orientation a formula is derived for the squared voltage per cycle that exhibits a maximum at a certain frequency and disappears for zero frequency and infinite frequency. The noise is proportional to the magnetic moment, i.e. the mean volume of Weiss's domains. This explains why the noise of magnetic tape on which a recording was made and erased again exceeds that of a tape never used before, since the demagnetization applied in the erasing procedure cannot subdivide Weiss domains to below a certain minimum size. (1273)

Miquel, R. "L'effacement dans l'enregistrement magnetique." TAUTE RADIO, Vol. 24, p.277 (Aug)57(In French): (1284)

Miyata, J. J., and Hartel, R. R., "Recording and Reproduction of Signals on Magnetic Medium Using Saturation-Type Recording," INSTITUTE OF RADIO ENGINEERS, TRANSACTIONS ON ELECTRONIC COMPUTERS, Vol. EC-8, No. 2, pp.159-169, Jun.57

Discussed various factors affecting resolution in saturation magnetic recording. The effect on the recording process of the B-H characteristics of the coating, coating thickness, record-head gap width, head-to-coating separation, self-demagnetization, and record-head residual magnetization are discussed. Equations are derived for the playback process relating the signal amplitude and pulse width to the coating thickness, head-coating separation, and effective gap width of the playback head. It is shown that the greatest improvement in resolution can be obtained by the development of an extremely thin coating with high ratio of coercivity to remanence and having a rectangular B-H loop. The extremely thin coating will reduce the shortcomings of the record-head field pattern, the self-demagnetization effect, and the loss of resolution in the playback process. (1550)

Nottebohm, H. "Properties of Recording Head Fields of Magnetic Recording Equipment." ELEKTRONISCHE RUNDSCHAU, Vol. 10, p. 335-7 Dec. 54 (In German).

The rapid fall-off of the field strength with increasing distance from the gap, the comparatively wide spread of the field in the direction of the tape movement and the peaks in the field distribution curves at the edges of the gap are pointed out. Reference is made to certain anomalies in Lubeck's theory of tape demagnetization, to the comparatively small demagnetization effects due to the use of h.f. bias, and to the undulations in the frequency characteristic of a tape recorded without h.f. bias. An analysis of the playback response curve, assuming the existence of both longitudinal and perpendicular field components and taking into account their phase-quadrature relationship, suggests an explanation for these anomalies. (1185)

Parnes, R. "Studies of demagnetization and related phenomena" AMPEX RESEARCH REPORT NO. 113. October 1958.

Schiesser, H., and Schidbauer, O., "A Contribution to standardization of magnetic recording technique." FREQUENZ, Vol. 6, pp. 222-229. Aug. 1952.

Schidbauer, O., "The Determination of the Magnetization of Magnetic Tape," ELEKTRONISCHE RUNDSCHAU, Vol. 11, No. 10, p. 302-5. Oct. (In German).  
The single-turn head method of measuring the open-circuit surface induction of tape is difficult. An easier method is to apply a constant unidirectional magnetization to a length of tape with a specific recording current, cut the tape into some 20-30 strips, form a stack of the strips and measure the total flux in the stack. Precautions must be taken against permanent magnetization of the recording head, non-linearity, etc. A technique is described for determining the perpendicular component of magnetization although this component is of no significance if less than 10% of the longitudinal component. In addition, methods are given for determining: (1) the playback-head loss due to the short-circuiting action of the airgap on the surface induction; and (2) the transverse magnetization component when the latter is recorded on the tape for synchronizing purposes. Finally, an electronic fluxmeter is described. (1314)

Sebestyen, L. G., and Takacs, J. "Magnetic recording: Theory of tape magnetization." ELECTRONIC TECHNOLOGY Aug. 1961. pp. 274-278.

Smith, F. "Demagnetization of ferro-magnetic particles." BRITISH JOURNAL OF APPLIED PHYSICS, Vol. 12, pp. 155-159. April 1961.

Spratt, H. G. M., "Magnetic Tape Recording," (A Book.) London: Heywood and Company (1958), 319pp. Following a survey of the fundamentals of magnetism and of sound recording generally, a detailed study of the mechanism of magnetic recording is provided. This includes the operation of h.f. bias, the recording and reproducing characteristics, the sources of loss and such phenomena as print-through. A description of tape manufacture is given followed by a comprehensive study of tape testing. Recording equipment is described and the design features of different types of professional, domestic and office machines are compared. Special applications are described and the elaboration or modification of standard equipment and tape to suit these applications briefly mentioned. This heading includes such applications as television picture recording and magnetically coated cine film. Recording standardization, including absolute standardization, is studied and the relevant C.C.I.R. recommendations, as embodied in the relevant British Standard are given in full. (1461)

Spring, H. P., "The Characteristics of Magnetic Recording Heads and Tapes," JOURNAL OF THE BRITISH INSTITUTION OF RADIO ENGINEERS, Vol. 17, No. 4, pp. 217-233. Apr. 57. It is shown how a recording by magnetic means is made, retained on the tape and finally reproduced. The erasing of a magnetic tape by means of a steady or an alternating magnetic field is explained. The recording process is considered together with the effects caused by a.c. biasing. Formulae for obtaining the output voltage from any given head are discussed. Demagnetization, gap functions and the various losses encountered in tape reproduction are also dealt with. Tape characteristics are discussed together with comparison graphs for different tape characteristics. Some recording heads, which differ from conventional designs, are described and their application for various types of magnetic recordings considered. Finally, the effect of head and tape wear on the frequency response of a recorded tape are discussed quantitatively. (1327)

Veksler, G. S., and Tomashevskii, P. S., "High Coercivity Recording Carriers," RADIOTEKHNIKA, Vol. 13, No. 6, pp. 68-71. (In Russian). 1958. A detailed investigation of magnetic parameters in relation to general performance, but particularly to frequency response, in magnetic wire and mainly in magnetic tape for audio recording purposes is presented, supplied by numerous specific examples and graphs. It is shown that, in order to reduce the self-erasing effect, an increase in coercive properties of the tape is effective only, if the remanent induction is also raised, in which case it is also possible to widen the upper frequency range. (1473)



Westmijze, W. K., "The Fundamentals of Magnetic Recording." TIJDSCHRIFT VAN HET NEDERLANDS RADIOGENOOTSCHAP, Vol. 21, No. 1, pp.1-15. Jan. 57  
A short description is given of the magnetic recording method with more detailed treatment of certain aspects. For an understanding of the h.f. biasing method, a simplified hysteresis curve is used. In this way some of the peculiarities met in the recording and erasing can be explained. The recorded signal is attenuated by the demagnetizing field and during reproduction not all the flux in the tape is reproduced. This is treated for short, long and intermediate wavelengths. Factors which influence distortion, frequency response, noise and print effect are surveyed. (1211)

Williams, H. J., Sherwood, R. C., Foster, F. G., and Kelley, E. M., "Magnetic Writing on Thin Films of MnBi," JOURNAL OF APPLIED PHYSICS, Vol. 28, No. 10, pp.1181-1184. Oct. 1957.  
A study was made of the domain structure of thin films ( $\sim 1000 \text{ \AA}$ ) of MnBi and their capability of storing information magnetically. It is estimated that a million bits of information could be written on  $1 \text{ cm}^2$  of film. The information can be read optically by utilizing the Faraday effect. The films have a uniaxial direction of easy magnetization normal to their surfaces and retain their magnetization after saturation along this direction in spite of the large demagnetizing factor. When magnetized in this manner, a high optical contrast is obtained between the writing and the background. (1341)

22 November 1961

Gillet, F., "Magnetic Sound Recording," ONDE ELECTRIQUE, Vol. 30, pp.449-457, Nov. (In French). Classifies magnetic sound recording under two headings: (A) where a nonmagnetic tape such as cellulose is coated with a magnetic powder, and (b) where the plastic tape is impregnated with magnetic powder before cooling. The action taking place during recording which is not fully understood is discussed and also the use of a polarizing field to avoid nonlinear distortion. DC polarization leads to excessive noise but the use of the supersonic ac polarization produces good results. The form of the recording and reproducing head is shown diagrammatically, also the form of the magnetization on the tape and the method of demagnetization. Stress is laid on the difficulty in making 2 recording heads giving exactly the same results on the tape, also the importance of having very high grade magnetic material to avoid noise. Response curves deviating  $> 3$  db between 30 and 15,000 cps have been obtained. (551)

Muckenhirn, O. W., "Magnetic Tape Recording Demagnetization for Simple Cyclic Excitations," TRANSACTIONS OF THE IRE, (Professional Group on Audio - 10), pp.25-27. Nov. The resultant active remanent magnetic flux associated with an element of magnetic tape upon completion of the recording process depends upon the entire previous magnetic history of the element. The article further discusses some effects of the air gap field distribution for longitudinal recording, and various areas of the magnetic field distribution. (751)

Muckenhirn, O. W., "Recording Demagnetization in Magnetic Tape Recording," PROCEEDINGS OF THE IRE, Vol. 39, pp.891-897. Aug. Analysis of recording process employing supersonic excitation; study of effect of spatial distribution of magnetic field around recording head air gap on magnetic history of unmagnetized element of tape as it tracks across recording head, leads to effect termed "recording demagnetization" and serves to explain certain performance characteristics. (669)



# Selective Erasure of

Methods of minimizing layer-to-layer transfer of signals in magnetic tape recordings during storage are analyzed. Best results are obtained by using weak erasing field during playback to suppress level of cross-talk without appreciably attenuating desired signal

**I**N MAGNETIC RECORDING, the tendency of one layer of tape to be magnetized by the field of the layer of tape against which it is wound has been studied empirically.<sup>1,2,3</sup> In two papers<sup>4,5</sup> dealing with theory and experiment, a method has been outlined for reducing the layer-to-layer transferred signal by a process of selective erasure. The present study is concerned with this process.

It has been shown<sup>6</sup> that the ease with which a recording can be erased is a function of the bias current used in recording it. The greater the bias current, the more difficult is the recording to erase. A signal which is recorded by layer-to-layer transfer is essentially a recording which has been made with zero bias current and might be expected to be easier to erase than the recorded material. With certain limitations, this is found to be the case.

## Erasure Tests

Tests were made by recording reference signals on every sixth layer of a roll of freshly demagnetized tape. After various times of storage they were reproduced to get the level of the two layers adjacent to the recorded one. In tests of this type it is necessary to standardize carefully many factors that affect cross-talk, including bias level, use or absence of bias in unrecorded layers, time of wind (and rewind, if used), temperature, tape tension and other factors<sup>7,8</sup>. In reproducing, an erase head was arranged to provide variable fields from zero up to those which completely erased, so that the relative effects of weak erasure on recorded and unwanted signals could be measured.

It was found, as expected, that the unwanted cross-talk signals were more easily erased than the

recorded signals. A small erase current (about  $\frac{1}{2}$  the normal one) would reduce cross-talk signals by 6 or 8 db without any effect on the recorded signal, or the cross-talk could be reduced 10 or 12 db while only reducing the recorded signal 1 db.

## Effect of Frequency

These measurements were made on a single frequency but the problem for program material is more complex, because the ease of erasing signals with most heads varies with frequency. Furthermore, this dependence upon frequency is different for different head geometries. If the partial erasure is done by a recording head with a short gap, the field gradients near the gap are large, and short wavelengths are much more easily erased than long ones.

A typical erase head with longer gap produces a more uniform field through the thickness of the tape. A large air-core solenoid can be arranged to give a nearly perfectly uniform field if the tape is run through it. (Such solenoids are not practical for erasing recordings but can be arranged easily to give the fields necessary for selective erasure.) Since short wavelengths are not important in cross-talk but

are important in recorded material, the best selective erasure head is one that gives most low-frequency erasure and least high-frequency erasure.

To test this, signals were recorded as above except that a high-frequency tone was also recorded. This tone was used to determine the frequency selectivity of the erasing process on recorded signals. After storing the recorded roll for 16 hours at 65 C, the tape was subjected to selective erasure fields of varying intensity from three sources: an Ampex recording head with 0.001-in. gap; an Ampex erase head with 0.020-in. gap; a 50-turn solenoid  $\frac{1}{2}$  in. long,  $\frac{1}{2}$  in. inside diameter and  $1\frac{1}{2}$  in. outside diameter, having a substantially uniform 60-cps field directed along the length of the tape. The results are summarized in Fig. 1.

It was found that for a given reduction of the printed signal, the 1-kc signal was reduced by about the same amount in all three cases. However, the high-frequency recorded signal was affected to a much greater extent and it was in this respect that the three methods differed markedly. The solenoid produced the least deterioration of the high-frequency signal, followed closely by the erase head, with the recording head running a very poor third. While the solenoid appears to be the most desirable means for selective erasure, practical considerations such as overheating, stray fields and cumbersome tape threading through the solenoid will probably prevent its widespread use.

The quantitative laboratory data in Fig. 1 are restricted to pure tones. They are also for particular heads and recording bias; results will vary somewhat for other experiments. As is often the case, the most satisfying proof of the

## REDUCING CROSS-TALK

Avoid excessive peak record levels.

Store reel in cool place, away from stray magnetic fields.

Check recorder to make sure no stray fields affect tape in the supply or take-up positions.

Rewind the recorded tape occasionally, especially during the first few months of storage.

If necessary, use selective erasure to reduce cross-talk magnetization while reproducing

# Magnetic Tape Cross-Talk

By ROBERT HERR and ROBERT A. von BEHREN

Minnesota Mining and Manufacturing Co.  
St. Paul, Minnesota

usefulness of the technique is in tests of program material. In this sort of test, the following observations have been made.

The conditions for detectable cross-talk in actual program material are rather restrictive, so that it is rather infrequently encountered. Barring the occurrence of magnetic fields or high temperatures, printed signals are in the range of 50 to 60 db below the signal level even after a few years storage. This requires the complete absence of signal and a very low noise level in order to permit detection of the transfer. One procedure which aggravates the transfer effect is to commence a recording on a thoroughly erased tape in the middle of a loud program passage. Upon subsequent reproduction of this tape, the alert listener is almost certain to be forewarned of the impending affront to his eardrums. In these cases, selective erasure can be utilized to reduce the transfer to the point of insignificance if not inaudibility.

## Effect of Rewinding

The effect of selective erasure upon the transferred signal is not permanent, inasmuch as a new transfer signal is started as soon as the tape is rewound. The print level will again rise as the tape is stored, but should the tape be unwound at any time, the cycle will be interrupted. For this reason tapes which are frequently replayed would be expected to give less trouble than those which are stored undisturbed. Subsequent erasures using the same device and the same field intensity will restore the transfer signal to approximately the same level as did the first erasure.

The program will suffer some deterioration during the first selective erasure, but the identical process

can be repeated any number of times without resulting in any additional change in the program. Therefore, if the erase level is carefully monitored, it may be desirable to use selective erasure as a routine procedure whenever tapes are played back. In this case, the equalizers can be adjusted to restore the slight high-frequency loss in the process.

## Practical Considerations

Unlike some conceivable methods for the control of layer-to-layer transfer, the selective erasure process is a very practical one. For example, in a conventional type of recorder, it is only necessary to arrange that the bias or erase supply is operated at a suitably reduced power instead of being turned off during the playback operation. Depending upon how generously designed the normal erase current is, the value used for selective erasure may be from  $\frac{1}{2}$  to  $\frac{1}{3}$  the normal current. The possible variations in switching technique to accomplish this are large in number but need not be complex. It is necessary that the high-frequency

supply operate during reproduction, so the method is not applicable to some types of home recorders, as for example, those where the oscillator tube is used as the power output tube in reproduction. However, it is expected that this technique would never be required except for high-quality professional recordings. The use of selective erasure on any professional recorder would present no problem. Patents on the use of selective erasure have been applied for.

One limitation to the application of this selective erasure is in the nature of the magnetic tape which is used. On some magnetic recording tapes, the recording becomes more difficult to erase with time of storage. On such tapes, selective erasure may only be effectively used for a short time after recording. Since serious levels of transfer generally occur only after considerable storage times, this means that the process is nearly worthless with such tapes. The data in this paper were taken with "Scotch" sound recording tape No. 111 and are typical of the results which can be obtained with this tape and comparable tapes and films made from the same magnetic oxide. The process is relatively useless with tapes made from other oxides by the Minnesota Mining and Manufacturing Co. Among other domestic and foreign tapes of different types a wide range of behavior from good to poor in this respect will be found.

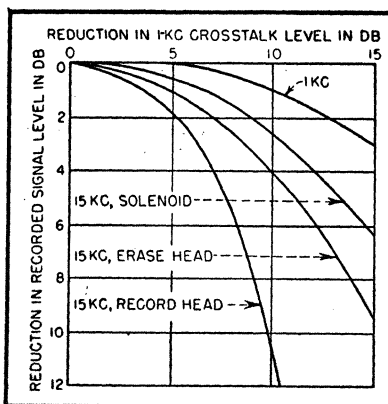

FIG. 1—Effect of selective erasure fields produced in three ways, when using 15-kc recorded signal. With 1-kc signals, all three erasing devices give the same results, represented by uppermost curve

## REFERENCES

- (1) W. Lippert, *Elektrotechnik*, 1, p 57, Aug. 1947.
- (2) B. Vinzelberg, *Funk und Ton*, 12, p 633, Dec. 1948.
- (3) S. W. Johnson, *Jour. SMPE*, 52, p 619, June 1949.
- (4) E. D. Daniel and P. E. Axon, *B.B.C. Quart.*, 5, p 241, Winter 1950-51.
- (5) L. Wiggins, Erasure of Cross-Talk on  $\frac{1}{4}$ " Magnetic Tape, presented by E. Schmidt at Oct. 1951 convention of SMPTE, Hollywood.
- (6) R. Herr, B. F. Murphey and W. W. Wetzel, *Jour. SMPE*, 52, p 77, Jan. 1949.

14 December 1961

"AC Erasure of Magnetic Tape," SOUND TALK, Bulletin No. 24, Jul. 1953.

The most widely accepted method of erasing magnetic tape is by the use of alternating magnetic fields. These fields may be applied to the moving tape by a conventional erase head just prior to recording, or to a complete roll of tape by a large electromagnet. While this method offers a very satisfactory and non-critical means of removing recordings from the tape, nevertheless it has certain limitations and peculiarities which can be most easily understood by referring to the fundamental principles of erasure. (796)

Duchateau, F., "L'Enregistrement Magnétique du Son," COURANTS FAIBLES, ELECTRONIQUE, No. 11, pp. 303-312. 1951

Magnetic sound recording; review of various factors involved in magnetic recording, including those affecting response curve, dynamic range, erasing, noise, and crosstalk; principle application. (627)

"Erase head development" Engineering project 581, Ampex Corp., June 1958.

"Erase oscillator" Engineering report 578, Ampex Corp., Feb. 1958.

"Erasure by Permanent Magnets," SOUND TALK, Bulletin No. 7, Minnesota Mining and Manufacturing Co. 1953.

It is well known that in erasure of magnetic tape a satisfactory device is the usual type of erase head which employs high frequency alternating current. This type of head, when well designed, not magnetized, and operated from a good source high frequency A.C., will not only obliterate any previous recording but will leave the tape in a demagnetized condition. This demagnetization of the tape is important in keeping noise and distortion down to low values. (830)

504 Erasure of magnetic records. IBM Deutschland Int. Büro-Masch. G.m.b.H., G.P. 1094476, 8 Dec. 1960. A direct or alternating magnetic field is employed for erasing data recorded magnetically on an endless tape or drum.

Gatz, H., "Interference Recorders with Periodic Erasure," ARCHIV FÜR TECHNISCHES MESSEN, No. 238, pp. 251-254. Nov. (In German).

Several techniques are described for monitoring at high-speed potential interference sources, automatically transferring to a permanent record any specific interference received and in erasing the original recording so that recording medium can be used again. One device embodies a rotating drum coated with printer's ink on which the recording is made with a mechanical oscillograph. A magnetic recorder, essentially conventional except for the use of a playback amplifier with particularly good equalization, is described. (1069)

Herr, R., "Magnetic Tape Erasure by Permanent Magnets," AUDIO ENGINEERING, Vol. 33, pp. 14-16, 29-30. Aug.

Discussion of requirements for good erasure and use of permanent magnets; how application of dc pulses may be used to obtain erasure almost comparable to results possible with ac bias, providing conditions are carefully controlled. (483)

Herr, R., and Von Bohren, R. A., "Selective Erasure of Magnetic Tape Cross-Talk," ELECTRONICS, Vol. 25, pp. 114-115. Aug.

A description of the practical application of this technique to one type of magnetic tape. Generally a small erase current,  $\sim 0.1 \times$  normal, was found to reduce print-through signals, (1) 6-8 db without affecting the recorded signal at all, or (2) 10-12 db with a recorded signal reduction of  $\sim 1$  db. However, as the erase-head design was found to affect the relative reduction of lf and hf signals, tests were carried out with three types of erase heads; (a) with an air-gap of 0.001 inch (b) with an air-gap of 0.02 inch, and (c) one of the form of a solenoid through which the tape is threaded and which gives a more uniform field in the magnetic coating. A 1 kc and an hf signal were recorded on the tape. 16 hours after storing at 65°C, for a given reduction of the printed signal the 1 kc signal was found to have fallen approx. the same in all cases, but the hf signal was slightly less reduced with head (c) than (b) and substantially less than with (a). Based on these results, a practical procedure particularly applicable to professional recording, is outlined. The fact that the technique can be used with certain tapes only is emphasized. (727)

Hildebrand, T. A., "Magnetic Tape Eraser," TELEVISION ENGINEER, Vol. 1, p. 21. Jun. 1950

Illustrated description of erasing unit built by engineers of station KMBY, Billings, Montana; unit is power transformer, with E and I laminations, rewound to provide magnetization charge and maximum erasure of signals on tape.

Johnson, G. N. et al., "Cooling circuit extends magnetic recorder response" ELECTRONICS, Mar. 10, 1961, pp. 186-7.

Kolb, O. K., "Some Aspects of Magnetic Sound Recording," BRITISH INSTITUTION OF RADIO ENGINEERS JOURNAL, Vol. 12, pp. 307-316. May. A brief history and a description of normal equipment are given. Operation without bias, with dc bias and with the far superior hf bias are compared. Explanations of the operation of hf bias according to Wetzel and to Montani are discussed in detail. Zenner's attempt at a mathematical approach by considering the fit of a 5th order equation to the B-H curve is described. In a study of mechanism of erasure, the practical impossibility of removing the last traces of an hf erasing signal and the improved erasure obtained with an ac-mains mass erasure are pointed out. The surprisingly small improvement obtained by erasing at very low speed is mentioned. (734)

McKay, H. G., "Bulk Eraser for Tape," RADIO-ELECTRONICS, Vol. 31, p.98. Apr. (1677)

"Tape degausser." AMPEX DOCUMENT., May 27, 1957.

McKnight, J. G. ERASE PROCESS

Research Division Bulletin no. 3.  
Amplex Corporation, January 1959.

"Tape degausser." Engineering project  
615, Ampex Corp., June 1958.

Orongenden, R. G., "Study of Pulse Erasure in a Magnetic Memory," RADIOTEKHNIKA, Vol. 10, No. 4, pp.66-72. Apr. (In Russian). 1955  
A block schematic is given of an experimental arrangement using 3 heads on a drum 15 cm in dia. rotating at 3,000 rpm. Each head carries 3 windings for writing, reading and erasing. It is first shown that an erasing pulse equal in width to that written and accurately coincident causes incomplete erasure with a signal/residue (called signal/clutter in the paper) ratio of 5. By increasing the length of the erasing pulse so that it spans that to be erased and by using recording levels of saturation and between one-half and one-third of saturation the signal/residue ratio is improved to 10. This is considered to be a good working figure. (1103)

"Time Effects in Erasing Magnetic Recordings," SOUND TALK, Bulletin No. 11, 30 Jul. Minnesota Mining and Manufacturing Company. (523) 1949.

Rettinger, M., "A-C Magnetic Erase Heads," SOCIETY OF MOTION PICTURE AND TELEVISION ENGINEERS JOURNAL, Vol. 56, pp.407-410. Apr. 1951  
Various types of erase heads of ring shaped type described; mathematical treatment of magnetic flux density required for erasing; measurements of amount of erasure obtained from various heads used both singly and in cascade; curves show rise in temperature on part of two heads as function of 70 kc erase current through head. (677)

Werner, P. H., and Kohler, E., "The Properties of Modern Magnetic Tapes," TECHNISCHE MITTEILUNGEN P.T.T., Vbl. 38, No. 7, pp.217-228. (In French and German).

The properties of three German and three American tapes are reviewed, primarily from the viewpoint of professional recording requirements and hence interchangeability. The following mechanical and magnetic characteristics are discussed briefly: width, elongation, friction, storage, sensitivity, frequency response, distortion, noise level and erasability, the point being made that despite considerable difference in properties, all six tapes come within the prescribed tolerances. Print-through is studied in great detail, particularly the inter-relationship between minimum damping, wavelength and tape thickness, its increase with time, its diminution with re-winding and the palliative effect of partial erasure. (1739)

Spring, H. P., "The Characteristics of Magnetic Recording Heads and Tapes," JOURNAL OF THE BRITISH INSTITUTION OF RADIO ENGINEERS, Vol. 17, No. 4, pp.217-233. Apr.

Westmijze, W. K. STUDIES ON MAGNETIC RECORDING. Eindhoven, 1953.

It is shown how a recording by magnetic means is made, retained on the tape and finally reproduced. The erasing of a magnetic tape by means of a steady or an alternating magnetic field is explained. The recording process is considered together with the effects caused by a.c. biasing. Formulae for obtaining the output voltage from any given head are discussed. Demagnetization, gap functions and the various losses encountered in tape reproduction are also dealt with. Tape characteristics are discussed together with comparison graphs for different tape characteristics. Some recording heads, which differ from conventional designs, are described and their applications for various types of magnetic recordings considered. Finally, the effect of head and tape wear on the frequency response of a recorded tape are discussed quantitatively. (1327)

Willis, D. W. and Skinner, P. "Some engineering aspects of magnetic tape system design." BRIT. IRE JNL., Nov. 1960, pp. 867-76.

"Selective Erasure and Nonstorage Writing in Direct-View Halftone Storage Tubes," by N. H. Lehrer. IRE NATIONAL CONVENTION RECORD, Mar 1961, pp.567-573.  
A new type of direct-view halftone storage tube that can selectively erase as well as simultaneously display stored and nonstored information has been developed. Heretofore, incorporation of these features into direct-view halftone storage tubes has proved impractical because of the nature of the secondary-emission effect on which the writing and erasing of stored information is overcome by the use of a dual-effects target. A 5-inch, direct-view halftone storage tube that utilizes such a dual-effects target is described. At writing speeds between 10,000 and 15,000 ips, the stored resolution is 40 to 50 lines per inch. At

Stewart, W. Earl "Magnetic recording techniques."  
(A book) New York:  
McGraw-Hill Book Co.,  
1958. 272pp.

# Sound Talk



REG. U. S. PAT. OFF.  
**SCOTCH** Magnetic Tape  
BRAND

Bulletin No. 24

✓ July, 1953  
in bibliog.

## A. C. ERASURE OF MAGNETIC TAPE

The most widely accepted method of erasing magnetic tape is by the use of alternating magnetic fields. These fields may be applied to the moving tape by a conventional erase head just prior to recording, or to a complete roll of tape by a large electromagnet. While this method offers a very satisfactory and non-critical means of removing recordings from the tape, nevertheless it has certain limitations and peculiarities which can be most easily understood by referring to the fundamental principles of erasure.

Theory -- A good A.C. erasing system should remove all traces of previous signals, and also leave the tape completely demagnetized to minimize noise and distortion. The first of these requirements is accomplished by "saturating" the tape in a strong magnetic field which essentially orients all of the magnetic domains regardless of their previous magnetic histories. Upon removal of the field the tape magnetization may change, but will no longer assume any ordered pattern associated with a previous signal. In order to fulfill the second requirement, the removal of the tape from the saturating field must be accomplished while the field is cycling and gradually diminishing in amplitude. If the reduction in amplitude does not exceed about 10%

during any complete cycle, the tape will emerge completely demagnetized. In A.C. erasure, the tape is passed near a stationary electromagnet and the gradually diminishing amplitude results from the fringing field in the region where the tape leaves the magnet.

Practice -- In passing from this simple description of erasure to actual practice, one must take into account a few complicating factors. In the first place, there is no such happy condition as "saturation" in practical tapes. This is particularly true when considering erase problems where a residual signal even 60 db below normal levels may be troublesome. Most erase systems are designed to reduce any normally recorded signal to a level somewhat below that of the tape noise, but this does not assure that a heavily recorded signal, such as a switching transient, will be completely obliterated. At the same time, one cannot correctly call such a heavily recorded signal "unerasable", for it can be easily removed by a more intense erase.

Of course, it goes without saying that the erasing head must cover the entire track occupied by the signal in order to accomplish erasure. Many cases of poor erasure can be traced to mis-

MINNESOTA MINING & MANUFACTURING CO.  
Saint Paul 6, Minnesota



alignment of the erase head, or incompatibility of the system, such as in playing a dual track recording on a full track machine.

If the erase head current has any extraneous signals or distortion, these may be recorded on the tape, or may prevent complete demagnetization. Particularly troublesome are 60 cycle and D.C. signals which may enter the system through leaky coupling capacitors.

Orientation -- It has been demonstrated experimentally that the direction of the erasing field is a matter of considerable importance in the effectiveness of the erase. There is a very definite "easy" direction of erase coinciding with the longitudinal axis of the tape. Whereas field intensities in the range of 1,000 to 1,500 gauss are usually sufficient to erase the tape in the easy direction, transverse or thicknesswise fields must be well over 2,000 gauss to accomplish this same effect. This explains why 60 cycle bulk type erasers require rotation of the reel to expose each segment of the tape to a longitudinal field. If a sliding motion were employed, certain segments would be exposed only to thicknesswise fields, and incomplete erasure would result. There is, of course, no problem with orientation when using a conventional erase head.

Speed -- The matter of slow removal from the A.C. field mentioned previously is an important consideration in the use of a 60 cycle bulk eraser. Careful experiments reveal that the linear speed of tape should not exceed about 1 or 2 inches per second when using such a device. Higher speeds result in actual recording of the 60 cycle field, and should the motion be jerky, annoying noise "bursts" which repeat each revolution of the reel may result. When removing the reel it is important to slide it carefully away from the eraser, avoiding an abrupt "break away" from the field. Turning the eraser off while the tape is in close proximity should be avoided as it may leave very large amplitude pulses on the tape. In the case of a 10-1/2" reel of tape this erasing process will re-

quire at least half a minute if properly done.

Two passes -- Failure to achieve complete erasure in a conventional erase head system may be due to regeneration effects taking place just after the tape leaves the erase gap. The fringe erase field may act as bias, and cause rerecording of the weak field resulting from proximity to the fully magnetized tape entering the gap a short distance away. This effect is most pronounced when the erase head gap is small, and usually cannot be eliminated by increasing the erase current. However, such a residual signal is easily erased in a subsequent pass through the same system because the fully recorded signal has been previously removed. This simple two pass test will easily distinguish regeneration trouble from inadequate field intensity which may also cause faulty erasure. Several commercial recorders have dual erase head gaps which eliminate trouble from this cause.

Summarizing the above discussion, the following hints may be helpful in obtaining the best erasing results.

#### On machines:

- Check alignment of the erase head with respect to that of the record-play head.
- Check erase head current for proper form, and absence of hum and D.C.
- Check oscillator tubes and tuning to assure proper amplitude of erase current.
- If recordings are not erased clean in one pass, repeat the erasure.
- Avoid recording heavily overloaded passages and switching transients.

#### On 60 cycle bulk erasers:

- Use only a slow steady rotating motion.
- Slide the tape from the eraser when removing.
- Avoid turning off the eraser with tape in contact.



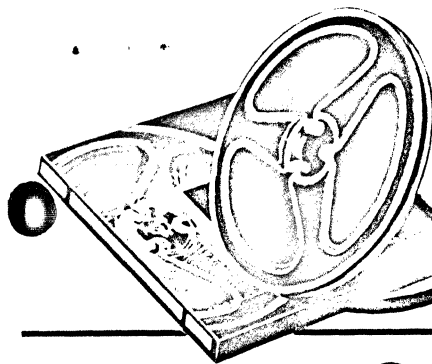

# Scotch Talk

## REG. U.S. PAT. OFF. **SCOTCH** Sound Recording Tape BRAND

BULLETIN No. \_\_\_\_\_ 7

DATE \_\_\_\_\_

### ERASURE BY PERMANENT MAGNETS

It is well known that in erasure of magnetic tape a satisfactory device is the usual type of erase head which employs high frequency alternating current. This type of head, when well designed, not magnetized, and operated from a good source high frequency A. C., will not only obliterate any previous recording on a tape but will leave the tape in a demagnetized condition. This demagnetization of the tape is important in keeping noise and distortion down to low values.

While this type of head is very fine from a magnetic point of view, there are practical considerations which make erasure by permanent magnets attractive, such as economy, dependability, freedom from servicing, etc. By using permanent magnets, one very easily accomplishes the obliteration of previous recordings, but it is not so easy to avoid leaving the tape magnetized in one direction. Since a single pole of a magnet will leave the tape fully magnetized to saturation, this type of erase will result in very high noise levels and serious even order harmonic distortion. (See Technical Bulletin #3).

To minimize this effect more than one permanent magnetic pole may be used so that the tape is left in a nearly demagnetized condition. A very large number of poles of successively opposite polarity and gradually decreasing strength is, of course,

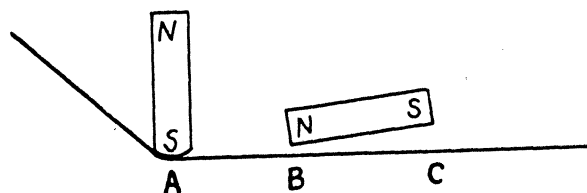

equivalent to an AC erase, but a practical design may involve the use of a small number of poles as an approximation. One head in common use, the type in the Brush "Soundmirror", and the Wilcox Gay "Recordio" uses two magnets arranged to give essentially a three pulse erasure.

Successively opposite field maxima are experienced by the tape at points A, B, and C. At A the tape contacts the magnet and experiences a saturating field which obliterates previous recordings. The function of the fields at B. and C. is to leave the tape in such a condition that it is essentially

"SCOTCH" Sound Recording Tape is made in U.S.A. by Minnesota Mining & Manufacturing Co., St. Paul 6, Minnesota

demagnetized. To do this the fields must be of the correct strength. This is accomplished by adjusting the distance between the tape and the poles at B and C to the correct separation to give the best values of field.

In these machines, this spacing between tape and magnet is dependent upon the tape's path of travel being absolutely unvarying. In practice slight variations in tension of the tape, wobbling of the reels, etc., may cause the path to vary slightly. Under these conditions, performance may be improved by insuring that the tape to magnet spacings at B and C remain fixed at the best values. One good way to do this is to use non-magnetic shims attached to the magnet and then allow the tape to bear positively against these shims. Such shims can be

made of brass, paper, or any other non-magnetic material, including "SCOTCH" Tape. Whether or not "SCOTCH" Tape is used permanently it makes an excellent tool in finding the best shim thicknesses. A number of layers may be fixed at B and at C until the noise as heard in playback is a minimum. The tape may then be replaced with a more permanent shim of the same thickness if desired.

In one head it was found that a separation of about .003 inch (one layer of "SCOTCH" Tape) at B and about .028 inch at C gave the minimum of noise. These dimensions are probably fair for other heads, but with differences from magnet to magnet an individual head should be tested with the tape to be used to determine the spacings for best results.



# THE CHARACTERISTICS OF MAGNETIC RECORDING HEADS AND TAPES\*

by

H. P. Spring (Associate Member)†

## SUMMARY

The paper deals with the functions, operating conditions and characteristics of magnetic heads and tapes. It is shown how a recording by magnetic means is made, retained on the tape and finally reproduced. The erasing of a magnetic tape by means of a steady or an alternating magnetic field is explained. The recording process is considered together with the effects caused by a.c. biasing. Formulae for obtaining the output voltage from any given head are discussed. Demagnetization, gap functions and the various losses encountered in tape reproduction are also dealt with. Tape characteristics are discussed together with comparison graphs for different tape characteristics. Some recording heads, which differ from conventional designs, are described and their applications for various types of magnetic recordings considered. Finally, the effect of head and tape wear on the frequency response of a recorded tape are discussed quantitatively.

### 1. Introduction

The recording of sounds or signals on magnetic tapes need not remain confined to the recording of music or speech only and in recent years a great number of developments have taken place to utilize this relatively new medium for the recording of signals perhaps not immediately concerned with either the entertainment world, profession or for private amusement. Magnetic recording has begun to play also a very important part in industry and is now being exploited for the automatic control of machine tools, the storing of information or similar purposes besides the main uses with which everybody now seems to be quite familiar. The design and development of magnetic recording heads and the design and manufacture of tapes suitable for receiving and retaining magnetic impulses have become quite an art in the electronic industry. A great number of facts directly concerned with magnetic recording are quite basic, but only the observation of all facts will enable a recording head or tape to be designed to specification.

\* Manuscript first received July 1955, and in final form on 5th December 1956. Based on a thesis accepted for exemption from the Institution's Graduateship Examination. (Paper No. 394.)

† Grundig (Great Britain) Ltd., London, S.E.3.  
U.D.C. No. 621.395.625.3.

### 2. Fundamentals

The following sub-sections will deal almost exclusively with the basic principles of magnetism and magnetization as far as they are required for the recording and reproduction of audio-frequency signals, with the generation of magnetic fields, their measurements and the laws governing magnetic induction.

#### 2.1. Permeability

If certain kinds of materials are brought into a magnetic field, the number of flux lines through any one cross section of such materials may be much greater than through a vacuum or air. Elements or materials with such properties are said to have a high permeability. The permeability of a vacuum or air is denoted by the symbol  $\mu_0$  and shows the ratio between induction and field strength,

$$\mu_0 = \frac{B \text{ (gauss)}}{H \text{ (oersted)}}$$

The definition of the permeability of a material or elements is also the ratio of induction to field strength and is noted by the symbol  $\mu_{abs}$  which is the absolute permeability. It is usual to put the magnetic permeability of a material into a direct relationship to that of a vacuum or air. (The permeability of air differs only very little from that of a vacuum.) This is then the relative permeability, or for short the

permeability of the material.

$$\mu = \mu_{\text{rel}} = \frac{\mu_{\text{abs}}}{\mu_0} = \frac{B_{\text{material}}}{B_{\text{vacuum}}}$$

This ratio now becomes a relative figure and means that the material ( $\mu_{\text{mat}}$ ) has a permeability which is a certain number of times greater than that of a vacuum or air. The unit of permeability is the permeability of the vacuum and it equals to  $\mu = \mu_0 = 1$ . Materials having a permeability which differs only a little from that of air are called para-magnetic materials and those of a permeability of less than unity are dia-magnetic materials. Ferromagnetic materials are those with a permeability very much greater than that of air, and their permeability values may differ by a very great extent. The permeability for transformer laminations may be 500, that for a mu-metal 30,000, and for the material "1040," a Permalloy, it could be more than 60,000. The definition of permeability for ferromagnetic materials should be studied a little more closely, since this is not a constant value. The ratio between induction ( $B$ ) and field strength ( $H$ ) is not linear, but is dependent on the field to which the material had been subjected previously. What is normally understood as the permeability of a material for a given value of  $H$  is the ratio  $B:H$  when the material has no previous magnetic history. If  $H$ , the field strength, is increased in one direction from zero and the induction measured, it will be found that the induction for small field strengths will increase slowly but in proportion to the field. The  $B/H$  curve will begin to rise more quickly, will then slow down again until a point is reached at which any further increase in the field will produce no further increase in the induction. This point is called the saturation induction. If the material has never been subjected to magnetic fields before, the curve traced will be the normal magnetization curve. It is very similar to the characteristic of a triode valve. Very close observation of the curve shows that this is by no means a steady line in itself, after the field has reached a relatively low figure. If the measurements are taken with sufficient accuracy, it will be found that the normal magnetization curve has a great number of small steps in itself which according to Barkhausen are caused in the following

manner: The molecular magnets are not freely suspended in the material and are not able to move freely as the field increases. If the field increases, the resistance of the molecular magnets will be overcome and they will, perhaps quite suddenly, jump into their new position. A further very small increase in the field will cause no change in the molecular structure until the field has again gained sufficient magnitude for a number of the bar magnets to assume a new position. The application of a field of certain magnitude will finally move all molecular magnets into one direction which is parallel with the field lines and no further increase of induction is then possible. When this happens the saturation point has been reached.

The Barkhausen effect, as this is often referred to, can be shown experimentally by a piece of ferro-magnetic material on which two separate windings are suspended. One winding is then fed to an amplifier and loudspeaker and direct current is passed through the other winding. If the current is now very gradually and steadily increased, a crackle can be heard which takes place when the molecular magnets move into a new position. It is essential, of course, that the current is increased very slowly. Since it is both impractical and inconvenient to measure a field strength of zero, in practice a value  $H=5$  millioersteds is taken as unit permeability. Input transformers of voltage amplifiers, i.e. microphone input transformers, operate under such conditions.

## 2.2. Remanence

For the following observations a toroidal type of coil should be considered. If the field is increased until the induction reaches its point of saturation, then this induction is denoted by the symbol  $B_s$ . If the field is now reduced to zero, the induction does not disappear altogether but takes on a value which is the limit remanence, provided of course, the field was increased up to the point of saturation. The relationship between  $B$  and  $H$  is shown in Fig. 1. If the material is magnetized to a value which is below the point of saturation, the remaining induction is called remanence. The limit remanence is therefore the maximum remanence which a material can possess after the application of a field. If the induction of

a core is to be reduced to zero, a magnetic field must be applied which is opposite in direction to the original field causing the saturation. This takes place along the curve c-b. If a field is removed at the points 1, 2, 3 or 4, then the induction will reduce to the corresponding points  $B_1, B_2, B_3$  or 0 on the  $B$ -axis.

2.3. Coercivity

The remanence of a ferro-magnetic material is not only dependent on the strength of the field but to a perhaps greater extent on the previous magnetic history of the material. If therefore magnetic fields of the strength  $H_1, H_2, H_3$  or  $H_4$  are applied to a magnetic neutral

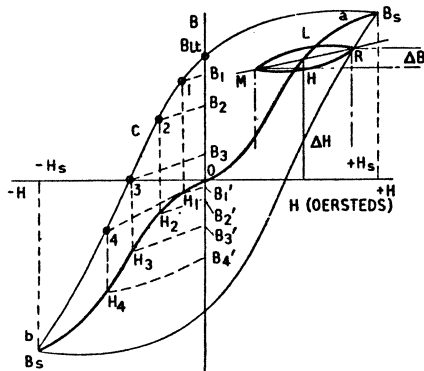

Fig. 1. Basic B-H relationship.

core, values of remanence of  $B_1', B_2', B_3'$  and  $B_4'$  are obtained which, as far as their value or their direction are concerned, are quite different from points  $B_1, B_2, B_3$  or 0. The amount of field strength necessary at which the induction of a material previously magnetized to saturation, disappears, is called the coercivity of such a material. The coercivity is therefore a measure for the energy which is applied by the material against demagnetization and which, together with the limit remanence, constitutes one of the most important characteristic properties of a material. The value of the coercivity of the material which has previously been saturated is the distance along the  $H$ -axis from the zero point at which the induction disappears.

2.4. Hysteresis

If a field of a value of  $+H_s$  is applied so that the induction reaches saturation, and if the field is now reduced, reversed and increased again to  $-H_s$ , then the induction resulting from such fields will follow the curve a-c-b and if

the field is again reduced, reversed and made to increase, the induction will now follow the curve b-d-a. This curve, closed back into itself is called the hysteresis loop of the material. If the ferro-magnetic material is subjected to an alternating field of sufficient magnitude, then the resulting induction will follow this curve in sympathy with the frequency of the alternating current. When changing the magnetic polarity of the induction, or when changing the induction in magnitude or value, work is done which is converted into heat. Such losses are called hysteresis losses of the ferro-magnetic material. A measure for such losses is the area enclosed by the hysteresis loop. The work  $F$  done for the change of induction from the positive saturation point to the negative saturation of 1 cm<sup>3</sup> of iron is equal to  $F = 4\pi/A$  ergs, where  $A$  is the area enclosed by the hysteresis loop in the gauss-oersted scale. Since hysteresis losses are caused by either an increase or a decrease of the field, they are proportional to the frequency of an alternating field applied to some ferro-magnetic material. To keep the losses small, materials having a low coercivity are normally used but optimum conditions would only exist if a material having no coercivity whatsoever could be obtained. If a ferro-magnetic material is considered, to which a field is applied, then the induction will rise to a point  $B_s$ . If the field is now made to change in a sinusoidal fashion, then the material will operate on what is termed a minor hysteresis loop (M-H-R-L in Fig. 1). The effective permeability of the material at this point is then approximately proportional to the slopes of the axis of the minor hysteresis loop, and can be expressed as  $\mu_e = \Delta B / \Delta H$ .

2.5. Magnetic Resistance

The magnetic conductivity or permeability of a material can be compared with the conductivity of electric circuits. It can be shown that the magnetic resistance or reluctance of the material having a constant cross-section is equal to

$$R_m = \frac{l}{\mu \cdot q} \left( \frac{1}{\text{cm}} \right)$$

or in practical units

$$R_m = \frac{l}{\mu \cdot q} \cdot \frac{10^9}{4\pi} \left( \frac{1}{\text{henry}} \right)$$

( $q$  denoting the cross-sectional area in cm<sup>2</sup>)

**Table 1<sup>1</sup>**  
The Conversion of Electrical and Magnetic Units

Definition	Sym	Formula	C.G.S. System	Sym	Practical Units	Sym
Electrical current	$I$	$I = \frac{dQ}{dt}$	1 e.m.u. 10 <sup>-1</sup> e.m.u.	—	1 ampere = 1 coulomb sec 1 ampere	A
Potential difference (a) by change of field (b) by movement of conductor in field	$E$	$E = -w \cdot \frac{d\phi}{dt}$ $E = B \cdot l \cdot v$	1 e.m.u. = $\frac{1 \text{ maxwell}}{\text{sec}}$ 10 <sup>8</sup> e.m.u.	—	10 <sup>-8</sup> volt 1 volt	V
Resistance Ohm's Law for electric circuits	$R$	$R = \frac{E}{I}$	1 e.m.u. 10 <sup>9</sup> e.m.u.	—	10 <sup>-9</sup> V/A = 10 <sup>-9</sup> ohm 1 ohm	$\Omega$
Magnetic Flux	$\phi$	$\phi = B \cdot q$	1 maxwell = 1 gauss-cm <sup>2</sup> 10 <sup>8</sup> M	M	10 <sup>-8</sup> Vsec = 10 <sup>-8</sup> weber 1 weber	Wb
Magnetic Potential	$E_m$ $\Theta$	$E_m = H \cdot l = I \cdot w$	1 gilbert = 1 oersted-cm $\frac{4\pi}{10} \cdot \text{Gb}$	Gb	$\frac{10}{4\pi}$ ampere turn 1 AT = 1A	AT
Magnetic Reluctance Ohm's Law for magnetic circuits	$R_m$	$R_m = \frac{E_m}{\phi} = \frac{L}{\mu_{\text{abs}} \cdot q}$	1 e.m.u. = $\frac{1}{\text{cm}}$ $4\pi \cdot 10^{-9}$ e.m.u.	—	$\frac{10^9 \text{ AT}}{4\pi \text{ V sec}} = \frac{10^9}{4\pi} \frac{1}{\text{henry}}$ $\frac{1}{\text{henry}}$	—
Magnetic Induction Number of lines cut per unit cross section	$B$	$B = \frac{\phi}{q}$ $= \mu_{\text{abs}} \cdot H$	1 gauss 10 <sup>8</sup> G	G	10 <sup>-8</sup> $\frac{\text{V sec}}{\text{cm}^2}$ $1 \frac{\text{V sec}}{\text{cm}^2}$	—
Magnetic Field Strength Magnetic Force	$H$	$H = \frac{I \cdot w}{l}$ $= \frac{B}{\mu_{\text{abs}}}$	1 oersted $\frac{4\pi}{10}$ oersted	—	$\frac{10 \text{ AT}}{4\pi \text{ cm}}$ $1 \frac{\text{AT}}{\text{cm}} = \frac{1\text{A}}{\text{cm}}$	$\frac{\text{AT}}{\text{cm}}$
Permeability Magnetic Conductivity of vacuum	$\mu_0$	$\mu_0 = \frac{B_{\text{vacuum}}}{H}$	1 $\frac{\text{gauss}}{\text{oersted}}$	—	$\frac{4\pi \text{ V sec}}{10^9 \text{ A cm}} = \frac{4\pi}{10^9} \frac{\text{henry}}{\text{cm}}$	—
Magnetic Conductivity (absol.) of material	$\mu_{\text{abs}}$	$\mu_{\text{abs}} = \mu_{\text{rel}} \cdot \mu_0$ $= \frac{B_{\text{material}}}{H}$	$\frac{10^9 \text{ G}}{4\pi \text{ oersted}}$	—	$1 \frac{\text{henry}}{\text{cm}}$	—
Relative Permeability Ratio of permeability of material to permeability of vacuum	$\mu_{\text{rel}}$	$\mu_{\text{rel}} = \mu = \frac{\mu_{\text{abs}}}{\mu_0}$ $= \frac{B_{\text{material}}}{B_{\text{vacuum}}}$	$\mu = 1$ (for vacuum)	—	$\mu = 1$ (for air)	—
Inductance E.m.f. induced in conductor for change of current in unit time	$L$	$L = E \frac{dt}{di}$ $= w^2 \frac{\mu_0 \cdot q}{l}$ $= \frac{\phi \cdot w}{I} = \frac{w^2}{R_m}$	1 e.m.u. = 1 cm $\frac{10^9}{4\pi} \text{ cm}$	—	$4\pi \cdot 10^{-9}$ henry 1 henry	H

$w$  = number of turns       $l$  = length of conductor       $q$  = cross-sectional area

**Table 2'**  
The Calculation of Unknown Units from Known Units

to calibrate from → ↓	Current <i>I</i>		Voltage <i>E</i>		Induction <i>B</i>		Field strength <i>H</i>		Inductance <i>L</i>		
Field strength <i>H</i>	$\frac{w \cdot I}{l}$	$\frac{A}{\text{cm}}$	$\frac{10^9}{4\pi} \cdot \frac{E}{\mu \cdot q \cdot w \cdot \omega}$	$\frac{V}{\text{cm}^2 \text{ sec}^{-1}}$	$\frac{10}{4\pi} \cdot \frac{B}{\mu}$	<i>G</i>	<i>H</i>				$\frac{A}{\text{cm}}$
	$\frac{4\pi}{10} \frac{w \cdot I}{l}$	$\frac{A}{\text{cm}}$	$\frac{10^8 \cdot E}{\mu \cdot w \cdot q \cdot \omega}$	$\frac{V}{\text{cm}^2 \text{ sec}^{-1}}$			<i>H</i>				—
Induction <i>B</i>	$\frac{4\pi}{10} \mu \frac{w \cdot I}{l}$	$\frac{A}{\text{cm}}$	$\frac{10^8 \cdot E}{w \cdot q \cdot \omega}$	$\frac{V}{\text{cm}^2 \text{ sec}^{-1}}$	<i>B</i>		$\frac{4\pi}{10} \cdot \mu \cdot H$	$\frac{A}{\text{cm}}$			<i>G</i>
Permeability $\mu$	$\frac{10^9}{4\pi} \cdot \frac{E \cdot l}{w^2 \cdot q \cdot \omega \cdot I}$	$\frac{V \cdot \text{cm}}{\text{cm}^2 \text{ sec}^{-1} \cdot A}$			$\frac{10}{4\pi} \cdot \frac{B}{H}$	$\frac{G}{A \text{ cm}^{-1}}$	$\frac{B}{H}$	gauss oersted	$\frac{10^9}{4\pi} \cdot \frac{l \cdot L}{w^2 \cdot q}$	$\frac{\text{cm} \cdot H}{\text{cm}^2}$	—
Inductance <i>L</i>	$\frac{E}{I \cdot \omega}$	$\frac{V}{A \cdot \text{sec}^{-1}}$	$\frac{E}{I \cdot \omega}$	$\frac{V}{A \cdot \text{sec}^{-1}}$					$4\pi \cdot 10^{-9} \cdot w^2 \cdot \frac{\mu \cdot q}{l}$	$\frac{\text{cm}^2}{\text{cm}}$	<i>H</i>
Current <i>I</i>	<i>I</i>		$\frac{E}{\omega L}$	$\frac{V}{\text{sec}^{-1} H}$	$\frac{10}{4\pi} \cdot \frac{B \cdot l}{\mu \cdot w}$	<i>G</i> ·cm	$\frac{H \cdot l}{w}$	$\frac{A}{\text{cm}} \cdot \text{cm}$	$\frac{E}{\omega L}$	$\frac{V}{\text{sec}^{-1} H}$	<i>A</i>
							$\frac{4\pi}{10} \cdot \frac{Hl}{w}$	<i>Oe</i> ·cm			
Voltage <i>E</i>	$\omega L \cdot I$	$\text{sec}^{-1} \cdot H \cdot A$	<i>E</i>		$10^{-8} \cdot B \cdot w \cdot q \cdot \omega$	<i>G</i> cm <sup>2</sup> sec <sup>-1</sup>	$4\pi \cdot 10^{-9} H \mu w q \cdot \omega$	$\frac{A}{\text{cm}} \text{ cm}^2 \text{ sec}^{-1}$	<i>I</i> · $\omega L$	<i>A</i> sec <sup>-1</sup> <i>H</i>	<i>V</i>
							$10^{-8} \cdot H \mu \cdot w \cdot q \cdot \omega$	<i>Oe</i> cm <sup>2</sup> sec <sup>-1</sup>			

*w* = number of turns  
*l* = length of conductor  
*q* = cross-sectional area

Since  $\mu$  alters with the field  $H$ , the magnetic resistance will also depend on  $H$ . It is therefore important to know the relationship of the permeability  $\mu$  to the field  $H$  and in some cases also the frequency. For a ring of a high permeability material of (say) 120 cm mean diameter, a permeability of 12000, a cross section of 1 cm<sup>2</sup>,  $R_m = 120/12000 \times 1 = 0.01$ . If now an air-gap is inserted anywhere in the ring and parallel with its cross-section, then the reluctance of the core itself remains unchanged. The total reluctance of the completed magnetic circuit is the sum of the reluctances of core and air-gap. The reluctance of the air-gap if this is assumed to be (say) 0.1 mm is  $R_{m \text{ air}} = 0.1/1 \times 1 = 0.1$ .

2.6. Ohm's Law for Magnetic Circuits

Ohm's law can be made to apply to magnetic circuits if the voltage  $E$  is replaced by a unit  $E_m$ ; the resistance  $R$  by the magnetic reluctance  $R_m$ , and the electric current  $I$  by the magnetic flux  $\phi$ . The unit for the magnetic potential is the magnetomotive force (M.M.F.) and is defined as the power which is able to induce a flux line in a magnetic circuit having unit reluctance. The unit of this "magnetic voltage" is the gilbert (1 oersted  $\times$  1 cm) or in the practical system 1 ampere-turn. Ohm's law for magnetic circuits can therefore be defined as

$$\phi = E_m / R_m$$

It is more usual to calculate in ampere-turns and the formula is then

$$\phi = \frac{4\pi \cdot I \cdot t}{10 R_m} \quad (M)$$

where  $t$  = number of turns. It follows that one gilbert is  $4\pi/10$  ampere-turns and the values for the conversion can be obtained from Table 1. Table 2 shows all formula for the conversion of electrical units to magnetic units and vice versa. If voltage and current measurements are taken on a toroidal type of coil, Table 2 will enable the magnetic values of that coil to be obtained.

2.7. De-magnetization

All the hysteresis loops so far considered consisted of a coil wound on to a closed core. The permeability in such a magnetic circuit is equal along the full length of the core. If now an air-gap is contained in the core, the flux in

the gap will be smaller than that in the ferro-magnetic material. According to Ohm's law for magnetic circuits the magnetic potential must remain constant and the flux must therefore be small for the larger reluctance. It follows, since the magnetic potential  $E_m = \phi \cdot R_m$  remains constant,  $\phi$  must become smaller for the greater reluctance, and, since  $B = \phi/q$ , the induction will also become smaller for a given field  $H$ . The result, as can be seen from Fig. 2, is a flattened or stretched out hysteresis loop and is called shearing or de-magnetization.

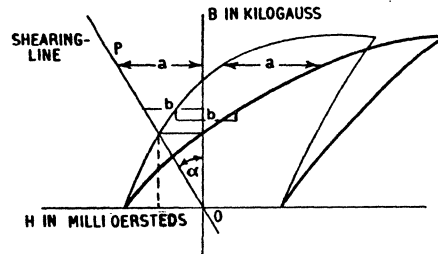

Fig. 2. De-magnetization or shearing line<sup>1</sup>.

The line O-P is called the de-magnetization line or shearing line and its slope or angle with the  $B$  axis can be determined as follows: Due to the air-gap, if the effective gap width is considered to be equal to the length of the gap, the same number of flux lines must pass through the gap as are passing through the core of the coil:  $\phi_{\text{air}} = \phi_{\text{core}}$ . If the cross-section of the core is denoted by  $q_c$  and that of the gap by  $q_a$  and if we express the flux by the induction in the circuit we obtain the equation

$$B_c \cdot q_c = H_a \cdot q_a \quad \dots\dots(1)$$

Provided the cross-sections are equal, the induction in the gap is equal to the induction in the core itself. Since the sum of the magnetic potentials over the closed magnetic circuit must always be 0, we obtain:

$$(H_c \cdot l_c) + (H_a \cdot l_a) = 0 \quad \dots\dots(2)$$

$l_c$  denoting the mean length of the core and  $l_a$  denoting the length of the gap. If equation (1) is divided by equation (2), we obtain

$$\frac{H_c}{B_c} = \frac{q_c}{q_a} \cdot \frac{l_a}{l_c}$$

or if the cross-sections in core and gap are equal:

$$\frac{H_c}{B_c} = \tan \alpha = \frac{l_a}{l_c}$$

When there is no air-gap ( $l_a=0$ ),  $\alpha$  will be zero. An increase in the length of the air gap will cause the slope of the shearing line to increase and with it the de-magnetizing function of the gap. The induction in the gap can be calculated from equation (1) and is:

$$H_a = B_c \cdot \frac{q_c}{q_a}$$

Since the flux lines will not leave the core at right angles to its cross-section only, a constant  $\sigma$  is introduced to denote the apparent widening of the gap. The effective gap width is always larger than its actual width. The slope of the shearing line now becomes

$$\tan \alpha = \frac{q_c}{\sigma \cdot q_a} \cdot \frac{l_a}{l_c}$$

and the induction in the air-gap is now equal to

$$H_a = B_c \cdot \frac{q_c}{\sigma \cdot q_a}$$

It is possible to construct the hysteresis loop for a core with an air-gap from that of the closed core by taking the distance of a number of points along the shearing line from the  $B$  axis and subtracting it from the normal hysteresis loop. This procedure is indicated in Fig. 2. The slope of the shearing line is often called the de-magnetization factor of the material. De-magnetization not only occurs in magnetic constructions consisting of a core with an air gap, but also in bar magnets and in the recording medium itself. For very long bar magnets, the effect of the de-magnetization is very small, but it will increase as the magnets are shortened and for very small bar magnets, the de-magnetization can become equal to  $\sigma=5$ .

### 2.8. Ferro-Magnetic Materials<sup>4</sup>

For the recording or reproduction by magnetic means, two different types of ferro-magnetic materials are of great importance. For the erase head, recording head and the reproduction head, a "magnetically soft" material is required. This is a material having a high permeability and a very low coercivity. The permeability must be high in order to produce a flux density of sufficient magnitude in the air gap, whereas the coercivity should be kept small to reduce the energy required for a particle of the material to be moved from a positive to a negative induction when the field changes from a positive to a negative value.

This has already been discussed under hysteresis losses. Magnetically soft materials range from soft iron with a coercivity of approximately 1 oersted and maximum permeability of 5000 to materials with a coercivity of 0.009 oersted and a maximum permeability of 300,000. It is quite usual to use mu-metal for the core of recording heads with a coercivity of approximately 0.03 oersted and a permeability of about 70,000. To obtain such magnetic properties, materials used for the construction of heads are normally subjected to special treatment. The high value of the permeability is obtained by submitting the material to an annealing process in a hydrogen atmosphere. The material is heated to approximately 1000° C and the whole process lasts from 3-16 hours. The cores of magnetic heads nearly always consist of laminations which, to avoid eddy-current losses, are insulated from each other. This is in most cases done by oxidizing the surfaces of the laminations. Some materials also require the subjection to a magnetic field whilst being annealed in order to achieve a maximum value of permeability.

The erase and bias frequencies in magnetic recording normally range from 30-100 kc/s. Such relatively high frequencies cause heavy current losses in the laminations of the cores of the heads, reducing their effective permeability. The losses for a given frequency depend on the thickness of the laminations and on the specific electric resistance of the material used. The frequency at which the permeability of the material becomes negligible is called limit frequency and its value may be determined by:

$$f_{it} = \frac{4\rho_E}{\pi \cdot \mu_0 \cdot \mu \cdot q_L^2}$$

where  $f_{it}$  denotes the limit frequency,  $\rho_E$  the specific resistance of the material ( $\Omega/\text{cm}$ ),  $\mu$  the permeability,  $\mu_0$  the permeability of a vacuum  $= 4\pi \times 10^{-9}$  and  $q_L$  the thickness of the laminations in cm. The relationship is shown in Fig 3. It should be noted that the effective permeability is reduced if the frequency is increased, since this plays a decisive part in the recording and reproduction of high frequencies.

Magnetically hard materials are used as recording media, since they are required to retain their magnetism when relatively high counter-magnetizing forces are present or when



the individual magnets are so short that the flux lines must close through substantial air paths. They possess a high coercivity which reduces de-magnetizing influences such as, for instance, are caused by mechanical stresses, changes of temperature, stray a.c. fields and air-gaps. The values for their coercivity lie between 50 oersteds for carbon steel and approximately 2500 oersteds for platinum-cobalt alloys. The optimum values for

simplicity however, it is usual to move the recording medium (the tape) past the magnetic heads. This must take place at a very constant speed which is usually a fraction or a multiple of 15 inches per second. If the signal amplitude alters as a function of time, the intensity of the recorded signal will alter as a function of tape length. For a constant frequency at a constant tape speed  $V$  the recorded wavelengths will be:

$$\lambda = V \cdot t = \frac{V}{f} \left( \frac{\text{cm} \cdot \text{sec}}{\text{sec}} \right)$$

The recording magnetic head will always basically consist of a ring type core, having an air-gap in its face and perhaps a second air-gap at the back. It carries a winding through which the audio-frequency current is fed. Recording heads have also been constructed on entirely different principles and they will be referred to later. The two pole-pieces forming the air-gap are very often cone-shaped in order to concentrate the flux lines at this point and to force them outwards through the recording medium. The magnetic flux lines

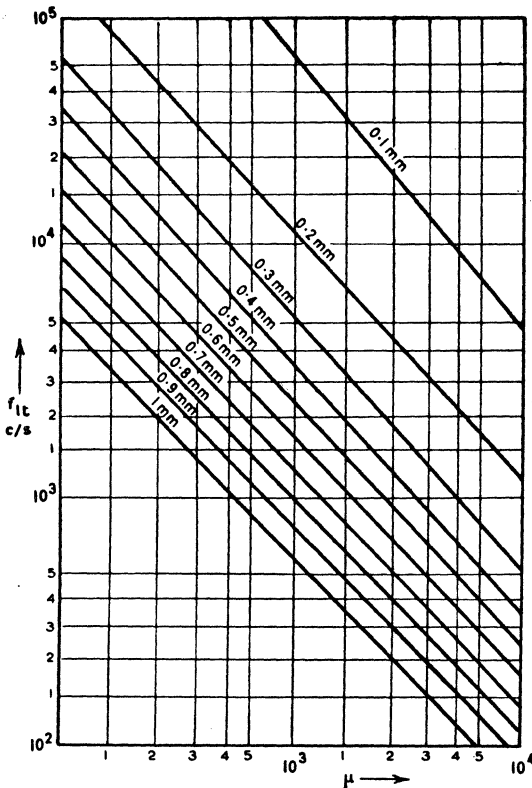

Fig. 3. Limit frequencies for different thicknesses of laminations.

magnetic tapes or carriers appear to lie between 200 and 600 oersteds. The value of remanence for the more suitable type of material, approximately 12,000 gauss.

### 3. Principal Functions of Magnetic Heads and Tapes

In tape recording, the relative positions of the magnetic medium and the magnetic tapes continuously alter. It is unimportant, basically, whether the medium is moved past the heads or whether the heads are moved past the medium. For reasons of mechanical

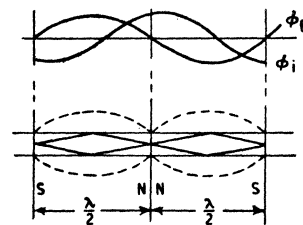

Fig. 4. Relationship of external and internal flux density.

emanate from the ends of the pole-pieces and close through the magnetic medium, hence magnetizing the iron oxide particles of that particular portion of the medium. When this part of the tape has left the influence of the gap, the magnetic induction of the tape will decrease along the hysteresis loop until it reaches the remanant induction which depends on the magnetic properties of the medium. The flux lines which leave the bar magnets of the medium and which are forming their magnetic circuits, constitute the surface induction of the medium. They can be made visible if some emulsion carrying small iron particles is brought in contact with a recorded tape. Fig. 4 shows the relationship between external and



internal flux density spread over a short portion of the medium.

In Fig. 4,  $\varphi_i$  depicts the flux in the medium whereas  $\varphi_E$  depicts the external flux. At the points where the external flux is at a maximum, the flux density also has its maximum. These points will show an accumulation of iron particles if the aforementioned test is applied. The internal flux disappears since all lines have left the medium and have completed the magnetic circuit. The internal flux is at a maximum at all the points where no lines leave the small bar magnets and these are also the points where the external flux disappears. The field distribution is also very similar to that of a bar magnet, the length of which is equal to one half of the recorded wavelength. The bar magnets are always joined with their equal poles and their cross-section is equal to the cross-section or thickness of the medium.

When playing back, the medium is moved past the playback head which could be the same as the recording head and in which case we are dealing with a combined recording/playback head. The outer surface induction now forces the field into the gap of the playback head and through the core of the head which can be looked upon as a short circuit for the field since it will only have a relatively low magnetic resistance. The field now produces a flux in the playback head which induces a voltage in the windings of the core. The voltage which is generated can be expressed by:<sup>2</sup>

$$E = \frac{w \cdot d \cdot \varphi_h}{dt} \times 10^{-8}$$

in which  $\varphi_h$  denotes the flux in the core and  $E$  the induced voltage.  $w$  denotes the number of turns in the core and  $d$  their diameter.

To erase a recording it is only necessary to remove the remanence left on the tape either by de-magnetization or by saturation. This can be achieved by several means; either the recorded tape on its spool is brought into a very strong a.c. field which will magnetize the medium up to its points of saturation and on removal from the field the induction of the tape will pass through magnetization curves (small hysteresis loops) which become smaller and smaller as the distance from the a.c. field increases. The other method is to bring the

pole of a magnet in close contact with the tape and to move the tape past it. The medium will again be magnetized into one of its points of saturation but after removal from the influence of the d.c. magnetic field, a remanent magnetization will remain on the tape. In practice a special head is normally used, the erase head, which is fed with a relatively heavy erase current and which saturates the medium as this is running past it.

All three types of magnetic heads will now be dealt with in detail.

#### 4. Erasing

Erasing is possible by means of a d.c. or of an a.c. field. If d.c. is employed, each particle of the medium is saturated to one point of saturation from any point of its previous inductance and after leaving the field of influence a remanent inductance will remain on the tape which is equal for all parts of the tape. When a.c. is being used, each particle of the medium will be magnetized to the two points of saturation and as the field decreases hysteresis loops will be described which will become smaller and smaller until no remanent induction remains.

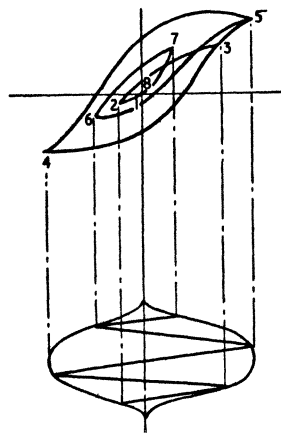

Fig. 5. Erase field and hysteresis loops.

This is only possible however if sufficient reversals take place whilst the particle is in the field of influence. The distribution of the field in the gap is advantageous for this since it is similar to the shape of a bell.<sup>2</sup> If the slopes of the two sides are kept relatively flat, which is identical with a wide gap, then the

particle will pass through a field which is gradually increasing, reaching a maximum and then slowly decreasing again (see Fig. 5).

Basically, the frequency of the a.c. field would be of little importance provided the particle on the medium can be passed through sufficient reversals whilst passing through the influence of the gap. If the gap is of sufficient width, 50 c/s currents could be used but at the tape speeds with which we are dealing this would lead to such great dimensions of the erase head that this is impracticable. It is therefore the usual trend to use a relatively high erase frequency which is normally between 30 and 60 kc/s. The choice of the erasing frequency is a matter which requires some definite consideration. For economy reasons it is often desired to use the same oscillator for the provision of the recording bias and the erase current. The application of such comparatively large alternating magnetic fields to the medium becomes more difficult when the effects of the hysteresis and eddy current losses are taken into account. These losses increase rapidly as the erase frequency is increased and the efficiency of an a.c. erase head is relatively low when compared with that of a d.c. erasing head. For a given mechanical gap width of 0.5 mm, the ampere-turns per cm should be approximately 2.7. This would correspond to an erase current of 120 mA through 150 turns.<sup>1</sup> It is usual to fit a small piece of beryllium copper into the gap as a protection against the accumulation of iron oxide in the gap which would result in the short circuiting of the core and also to create eddy currents. The eddy currents also produce a field which opposes the field through the core. The field lines through the core therefore choose the path of least resistance and pass through air. They are also leaving the core or pole pieces sooner than would be otherwise the case. Eddy currents also produce heat in the gap which may have a bad effect on the medium, especially if its base is of plastic. This creation of heat mainly determines the upper limit of the erase frequency but normally the greater part of the heat is conducted away through the fixing arrangements of the head. If the movement of the tape is stopped whilst

erase current is applied to the erase head, the heat can burn either the base of the medium or the medium itself. It is quite usual to find that the heat in the gap is up to 170° F when using 160 mA erase current and an erase frequency of 60 kc/s.

### 5. Recording

When recording, the variations along the recording medium take the form of variations in its remanent magnetization. It is the object of magnetic recording to produce a remanent magnetization in the medium at any point which is directly proportional to the instantaneous value of the signal strength corresponding to that point. Fig. 6 shows

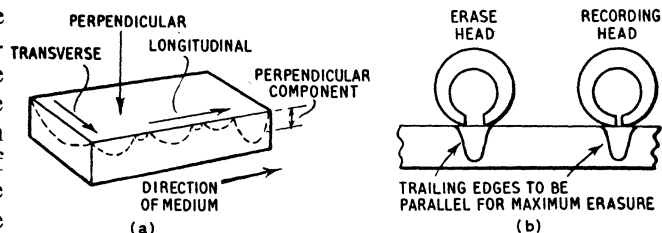

Fig. 6. (a) Illustrating the three directions for magnetic recording.  
(b) Illustrating the position of the heads for maximum erase.

the three different ways in which magnetic recording is possible if the medium is moved in one given direction. The system now in common use is the longitudinal way. Perpendicular and transverse recording is also possible but if wire is used as the recording means, transverse and perpendicular recordings are of course identical. The field lines, leaving the core, magnetize the medium in the direction of movement. It must be noted that the flux density in the tape is greater near the surface which makes contact with the gap than at any part further away from the gap but still in the medium. In the longitudinal recording, a certain component of perpendicular recording is also present and this is indicated in Fig. 6 (a). The smaller the gap the greater the component of perpendicular recording and this is often to blame if a recording cannot be fully erased. The effect is caused by the field distributions in the gap of the erase head and in the gap of the recording/playback head being different. The perpendicular part of a

recording cannot be erased by the erase head even if the erase current is very much increased. If it is considered that normal recording amplifiers show a top lift of 6 db per octave, it will be appreciated that it is quite simple to over-modulate a recording, causing increased components of perpendicular recording which cannot be fully erased. Due to the lower slope angle of the field in the gap of the erase head, the erase current cannot fully erase a perpendicular component. Maximum erase conditions only exist where the trailing edge of the erase field is parallel with the trailing edge of the recording field (see Fig. 6 (b)).

The recording process will now be considered under the following conditions: Each particle of the medium shall pass the gap at uniform speed, the flux densities considered will follow a sine law, the velocity of the medium and the frequency to be recorded shall be great and the gap width shall be small relative to each other. This will result in the particle being subjected to a small change of field whilst it moves through its influence, and the magnetization of each particle will then be approximately equal to the maximum field in the centre of the gap. After the particle has left the influence of the gap, the remanent induction will be reduced to a value  $B_r$  and this is now the function of the field strength  $H$  in the core which again is proportional to the magnetizing current. The resulting curve is the dynamic magnetic characteristic which will be different from the

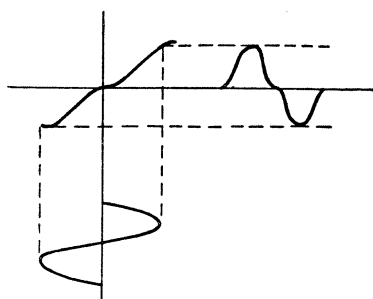

Fig. 7. Normal magnetization curve.

static characteristic. It shows the relationship between field strength and the induction present at any given moment. This characteristic is no absolute physical characteristic since it is also dependent on the thickness of the medium and

on the frequency to be recorded. The dynamic characteristic is therefore mainly dependent on whether the particle reaching the effect of the

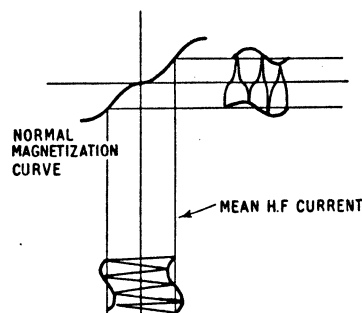

Fig. 8. Recording with h.f. bias.

gap has had some previous magnetic history or not. Somewhat better conditions exist if the medium was erased by means of an alternating current and now reaches the recording head in neutral condition. Magnetization then takes place along the normal magnetization curve (see Fig. 7) but the great irregularities of this curve lead to strong non-linear distortion, mainly of the third harmonic order.

For a number of years d.c. biasing was employed which shifts the operating point along the normal magnetization curve into one of the more linear portions. The quality of such recording however cannot be termed as good, since it then becomes essential to reduce the signal amplitude to a very small figure if one wishes to operate on a relatively linear portion of the transfer characteristic. When applying an h.f. recording bias, it is important to ensure that its amplitude increases and then decreases as the particle of the medium is moved through its field of influence. To avoid or decrease tape noise, a sufficient number of reversals must be possible which, at a given tape speed, determines the frequency of the recording bias. A.c. biasing moves the dynamic magnetization curve to the right or left on to the straight portion of the hysteresis loop and can be considered analogous to a minor hysteresis loop as shown in Fig. 1. Fig. 8 also shows that the h.f. amplitude must be given a certain figure in order to operate at the optimum operating point. If the h.f. amplitude is too small, very great non-linear distortion will occur. The same happens if the h.f. oscillator exceeds its

optimum value. This will also lead to distortion. Fig. 10 shows the relationship between distortion factor and audio amplitude<sup>4</sup> and this differs for different types of media and with their speeds. After the signal has been recorded, de-magnetization takes place which is especially noticeable at the higher frequencies. This is due to the de-magnetizing effect of the bar magnets by virtue of the fact that their poles of equal polarity are almost touching. (Fig. 9.)

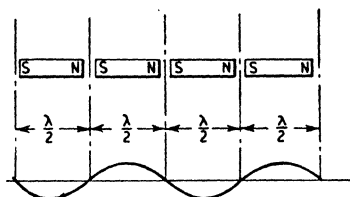

Fig. 9. De-magnetization due to poles of equal polarity almost touching.

Since the signal amplitude can be considered as varying along the length of the tape or medium, the number of flux lines within the medium must also change. All flux lines form closed circuits and one refers to the internal flux which exists within the medium and the external flux which leaves the surface of the medium. If the recorded frequency was a sine wave, then the flux density in the medium must be:

$$\varphi = \varphi_{\max} \cdot \sin 2\pi ft$$

where  $\varphi$  depicts the number of flux lines on the surface of the tape and where  $\varphi_{\max}$  depicts the maximum value of  $\varphi$  during one period. If the flux density on a point  $x$  along the medium is  $\varphi_x$ , then the surface density must be proportional to the changes in the flux density at this point, which must be equal to  $d\varphi_x/dx$ . If the signal frequency is substituted by the recorded wave length, the product of velocity  $\times$  time by the distance  $x$  on the medium, we obtain:

$$\varphi = \varphi_{\max} \cdot \sin 2\pi \cdot \frac{v t}{\lambda} = \varphi_{\max} \cdot \sin 2\pi \cdot \frac{x}{\lambda}$$

The surface density at any point  $x$  on the medium is the number of flux lines per unit length at this point and is therefore proportional to the first derivative of the flux with respect to  $x$ :

$$B = \frac{d\varphi_x}{dx} = \frac{2\pi}{\lambda} \cdot \varphi \cos 2\pi \frac{x}{\lambda}$$

or expressed by the frequency

$$B = \frac{2\pi}{v} \varphi \cos 2\pi ft$$

This means that the number of flux lines per unit length of the medium is proportional to the recorded frequency. Since the geometrical pattern of the flux distribution will be equal for both the low and the high frequencies, it can be seen that it is important for the medium to make close contact with the head. Where this is not the case, the signal amplitude of the top frequencies will be lost, but considerably less effect will be noticed at the lower frequencies.

## 6. Reproduction

If we consider a medium (tape) on which is recorded a sine wave, then the internal flux density must also be distributed in a sine fashion along the tape. The distribution of the external flux follows a cosine law, since the points of maximum density of the internal flux coincide with the minimum points of the external flux, i.e. they show a phase shift of 90 deg. If a single conductor is placed at right angles to the direction of movement and touching the tape, then it will be cut by lines of the external flux only and a voltage will be induced in it. Due to the external flux, an induction exists on the surface of the medium, and this will be approximately equal to:

$$B = \frac{d\varphi_E}{dx} = \frac{2\pi f}{v} \cdot \varphi_{E(\max)} \cdot \cos 2\pi ft \text{ (gauss)}$$

where  $f$  depicts the recorded signal frequency,  $v$  the velocity of the medium and  $\varphi_{E(\max)}$  the maximum value of the external induction. The induced voltage can now be calculated as:

$$E = B \cdot v \cdot l \cdot 10^{-8} \text{ volts}$$

$$= 2\pi f \cdot l \cdot \varphi_{E(\max)} \cdot \cos(2\pi ft) \times 10^{-8} \text{ volts}$$

where  $l$  is the length of the conductor which is cut by the flux. In the case of tape recording, this is equal to the width of the track. If the tape is reproduced at a different speed than that at which it was recorded, then the ratio between the recorded and the reproduced frequency will be equal to  $V_1/V_2$ . It is also evident that the induced voltage will be proportional to the width of the track if a playback head is used in place of a single

conductor, the formula still holding good with the exception that  $w$  is now the number of turns of the coil in the head and the voltage will be  $w$  times greater. In addition we have a constant factor  $k$  which is dependent on the geometric proportions or dimensions and the magnetic properties of the core. We now obtain

$$E = w \cdot k \cdot l \cdot 2\pi f \cdot t \times 10^{-8} \text{ volts}$$

or if we consider that  $2\pi/\sqrt{2}$  equals 4.44:

$$E = 4.44 \cdot w \cdot k \cdot l \cdot f \times 10^{-8} \text{ volts effective.}$$

In this equation  $w$  depicts the number of turns of the playback head,  $l$  the track width in mm,  $f$  the signal frequency in c/s,  $k$  the maximum value of the external induction referred to a track width of 1 mm and inducing a voltage  $E$  in the head. To determine the constant  $k$  the above mentioned equation can be used and the induced voltage can be measured using a frequency of approximately 100 c/s. A low frequency must be used in order to keep the damping effect and the gap effect at a minimum.

#### 6.1. De-magnetization

Measurements of the voltage induced in a playback head have shown that this voltage rises in a linear fashion only up to approximately 200 c/s at 7.5 in./sec. It then approaches a maximum and cuts off quickly after a certain higher frequency. This reduction in output level is the self-demagnetization which is due to the wavelengths on the medium becoming shorter and it is equal to:

$$D = \exp(-f/f_1)$$

where  $f_1$  is the frequency at which the external induction of the medium is reduced to  $1/e=37\%$ . Our formula for the reproduction of the signal can now be extended to:  $E = 4.44 w k l f \exp(-f/f_1) \times 10^{-8}$  volts effective. This takes into account losses due to self-demagnetization.

#### 6.2. Gap Function

Since the gap in the playback head has a definite width ( $g$ ), the magnetic modulation on the tape is not picked up from point to point but with the full width of the gap. This means that at any given point  $x$  the mean value of the induction  $\varphi$ , must be considered and its value is arrived at by taking the mean value of induction between the limits  $x_1$  and  $x_2$ . The

field distribution is:

$$\varphi_E = \varphi_{E(\max)} \cdot \sin 2\pi \cdot v/\lambda$$

Applying the limits  $x_1$  and  $x_2$  we obtain<sup>2</sup>:

$$\begin{aligned} \varphi &= \frac{1}{g} \int_{x_1}^{x_2} \varphi_{E(\max)} \cdot \sin 2\pi \cdot \frac{x}{\lambda} \cdot dx \\ &= -\varphi_{E(\max)} \cdot \frac{\lambda}{2\pi g} \cos \pi \cdot \frac{x_2}{\lambda} + \varphi_{E(\max)} \cdot \frac{\lambda}{2\pi g} \cos 2\pi \frac{x_1}{\lambda} \end{aligned}$$

Putting the limits  $x_1 = x - \frac{1}{2}g$  and  $x_2 = x + \frac{1}{2}g$ , then we will obtain

$$\varphi_{\text{mean}} = \varphi_{E\max} \cdot \frac{1}{\pi} \cdot \frac{\lambda}{g} \cdot \sin\left(\pi \cdot \frac{g}{\lambda}\right) \sin\left(2\pi \cdot \frac{x}{\lambda}\right)$$

If now  $\pi g/\lambda$  is replaced by  $\alpha$  and  $x/\lambda$  by  $v \cdot t/\lambda = f \cdot t$ , then the equation will read:

$$\varphi_{\text{mean}} = \varphi_{\max} \cdot \frac{\sin \alpha}{\alpha} \cdot \sin 2\pi f t$$

which is a function well known in sound film technique. It becomes clear, that for a ratio  $g/\lambda = 1, 2, 3, \dots$  minimum points will occur. The output from the head will then again increase, decrease and will once more reach a minimum point. It would therefore be possible to record wavelengths which are smaller than the effective gap length. Since each successive minimum becomes smaller and smaller, advantage is hardly ever taken of such an effect. Including the function for the gap effect the final formula for magnetic recording now becomes:

$$E = 4.44 w k l f \exp(f/f_1) \frac{\sin \alpha}{\alpha} \times 10^{-8} \text{ volts}$$

where  $\alpha$  is  $\pi \cdot g/\lambda$ .

#### 6.3. Reproduction of Low Frequencies

The playback e.m.f. rises with frequency by 6 db per octave. In practice, however, lower frequencies do not conform to this rule. The effect is entirely due to the physical dimensions of the playback head. The external flux emanating from the tape will at high frequencies, i.e. short wavelengths, be entirely shunted by the pole-pieces of the head. At a certain low frequency, the value of which depends entirely on the parts of the pole-pieces which are in contact with the tape the output will decrease since not all the flux lines are shunted by the pole-pieces which have a permeability different from air.

Since this loss of bass frequencies depends on the wavelength as well as on the dimensions

of the pole-pieces, it becomes less important at slower tape speeds and larger contact surface of the pole-pieces.

**7. Tape Characteristics**

The manufacture of tapes has now reached a standard which is much above that of the early recording media. Specifications of tapes for industrial and broadcast purposes have

by volume. The higher the content of iron oxide the better is the electrical performance normally. The abrasive properties of the iron oxide, however, cause wear of the heads by the tape and it is the responsibility of the tape manufacturer to arrive at a convenient compromise. The permeability of homogeneous media is usually about 1.5 to 2.5, that of non-homogeneous media about 2.0 to 5.0.

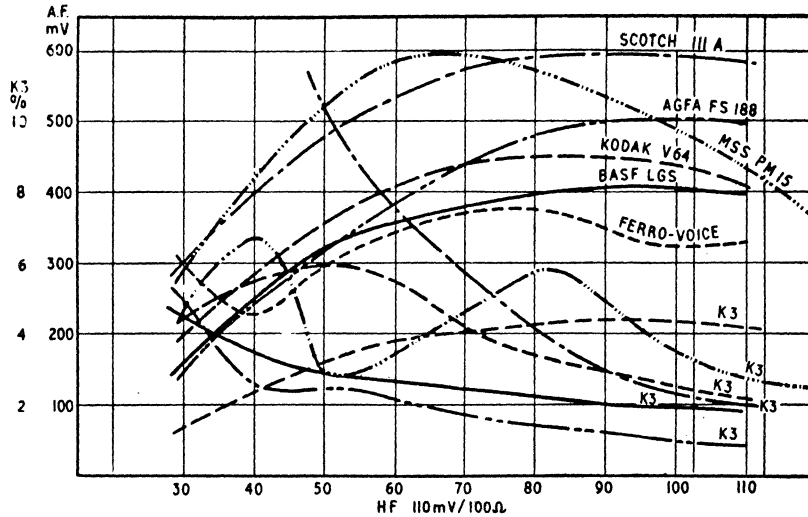

Fig. 10. Relationship of distortion factor  $k_3$  and audio output for different types of tape and different values of h.f. current.

Conditions:  
 Head—2500 turns 0.05 enameled copper.  
 A.F.—1000 c/s 0.1 mA constant.  
 H.F.—45 kc/s.

become very much more stringent. Whereas recording media were designed in the early days to provide as much output as possible, tape manufacturers have now begun to produce tapes of quite different specifications so as to make them suitable for many different purposes.

Two types of basically different recording media can be produced, homogeneous and non-homogeneous media. Homogeneous media may consist of steel or vicalloy and were in use during the early days of magnetic recording. Steel wire is still in use at the present time since it exhibits some properties which are advantageous or indeed essential for a limited number of applications. Most homogeneous tapes consist of approximately 30 per cent. iron oxide by weight or 10 per cent. by volume and can be produced to have an extremely smooth surface—an important point where heads and tape guides are to last as long as possible. Non-homogeneous tapes consist of a separate carrier or base on which a coating of iron oxide is formed. The coating consists of an average of 70 per cent. iron oxide by weight or 40 per cent.

For all types of recording tapes it is of course of great importance to ensure that the size of the granules is as small as possible.

Figure 10 was prepared to show the characteristics of some well-known tapes. The relationships are given for audio-output and distortion factor at a constant input and when varying the h.f. bias current.

**8. Special Types of Recording Heads**

With the progressing technique of magnetic recording the shortcomings of the equipment in present use become more and more apparent. One of the weakest links is the recording or playback head used. A great deal of time has already been spent on research to produce heads of an entirely different design and with properties which would either make such a head more reliable or tend to simplify the whole process of magnetic recording. One American company has recently produced a playback head<sup>5</sup> from which the output is no longer proportional to the playback speed of the medium. The head consists of a very small cathode-ray tube in a more or less conventional

type of core with an air-gap. Two wing-shaped electrodes in the tube are so arranged that the deflection of an electron beam, which is produced in the usual manner, alters the

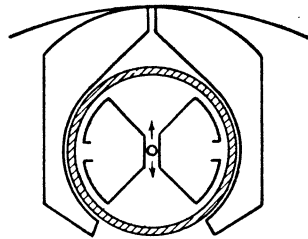

Fig. 11. "Electron beam" playback head.

potential between them. (See Fig. 11.) The magnetic flux lines emanating from the tape deflect the beam in relation to their density and the potential across the two electrodes alters in sympathy. The limit of the frequency which can be reproduced is only dependent on the width of the gap, since even no tape movement at all would produce a deflection of the electron beam.

In earlier sections it was explained how the frequency response alters during playback. The output increases with frequency at a rate

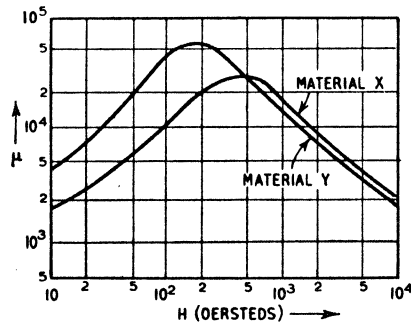

Fig. 12. Arbitrary relationship between permeability  $\mu$  and field  $H$ .

of 6 db per octave until de-magnetization and gap effect cause a reduction of the output. This means that both bass and top frequencies have to be lifted in the playback amplifier if one aims at a level response. H. Leitener<sup>5</sup> of Germany recommends a playback head which overcomes this often difficult problem. The permeability of a material is not a constant value and depends on the amount of magnetization. Fig. 12 shows a typical permeability curve. It should be noted that this curve shows

two rather straight portions and the operating point may be chosen on either of them by means of d.c. biasing. If the core of the head is now subjected to an h.f. current, then the permeability will change around the operating

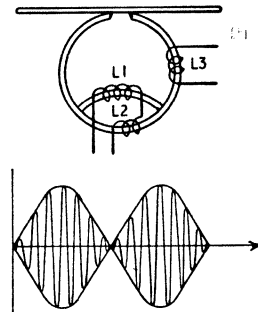

Fig. 13. Playback head of novel design.

point and in sympathy with the high frequency, i.e. the magnetic resistance alters with the applied high frequency voltage. The signal on the medium will however also alter the magnetic resistance and the result is a field which generates in the windings of the playback coil an h.f. voltage modulated by the audio-frequency signal. Fig. 13 shows the layout of such a head. The core has a playback gap and is of conventional design. A magnetic short circuit is included, however, and this carries a winding L1. L2 and L1 are in series and are fed with an h.f. current. The windings are balanced so that no voltage is induced in L3. The presence of the audio signal now disturbs the existing balance in coils L1 and L2 and in L3 an h.f. voltage, modulated in sympathy with the audio-frequency signal, is induced. The magnitude of the induced field depends on the number of flux lines cut per unit time, but this is mainly determined by the h.f. field so that the frequency of the audio signal is of very little importance. According to Leitener the output from such a head is very much greater than that of conventional design. It is necessary to note, however, that the modulation obtained is without a carrier and it would appear advantageous to couple a carrier of correct phasing to the modulation.

If the gap in the playback head is not exactly parallel to the gap of the recording head, damping of the higher frequencies will occur. The damping is equal to  $(\sin x)/x$

or in decibels:  $20 \cdot \log_{10} [(\sin x)/x]$   
 where  $x = (\pi \cdot \tan \alpha) / \lambda$ .



In practice a tilting of the gap of one-quarter of the gap width of the playback head is normally accepted as permissible. The effect of the damping caused by such tilting can be used to contain two separate recordings on one track without an appreciable amount of cross-talk or interaction between the channels. Since the system would appear to be highly suitable for stereophonic reproduction, this would be of little importance in any case. Heads recommended by F. Krones<sup>1</sup> for this purpose would contain an X or V gap and would be fitted with two separate windings. The possibility therefore exists of utilizing the full width of the tape as against less than one-half in conventional double track recording systems, resulting in a gain of output level of 6 db. If the gaps were considered to be at 45 deg. to the edge of the tape, their length would be extended by 1.44 and the output increased by 3 db. The overall gain would then show a rise of 12 db if account is taken of the

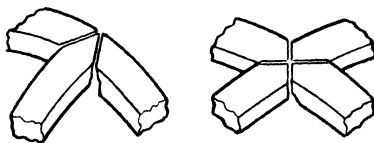

Fig. 14. Designs for heads suitable for stereophonic recording.

fact that no safety margin, usually one-third of the tape width, is required, a worthwhile proposition. Fig. 14 shows the design of such heads.

#### 9. Alterations of the Characteristics of Recording/Reproducing Heads with use

A recording or reproducing head in use will be subjected to certain changes. These become apparent after periods of time which vary considerably and which depend on the type and construction of head, the material used, the abrasive properties of the tape, tape speed and tape pressure. Recording heads and reproducing heads are nearly always treated after manufacture and after assembly in specific ways to ensure that their active surfaces are smooth, their gap is uniform and clean and that they will make good contact with the medium during operation. Such treatment may consist of a special finishing process after which the head is highly polished ready for incorporation on to the recording apparatus. It will be

found, however, that the physical contact between tape and head gap is not yet quite ideal and is dependent on the alignment of the head or the medium or both. Due to the abrasive properties of the tape a "bedding in" process takes place during the first few hours of operation. In cases where fresh tape is used as well as a newly manufactured head, this process is even more pronounced, not only because of the higher abrasive properties of such tape, but also because wear takes place which will remove superfluous particles of iron oxide from the tape. This brings the mass of the tape into closer contact with the head gap. The active part and pole-pieces of the head are subjected to further polishing at the same time until the tape makes good physical contact with the gap over its full width and with even pressure. The result is an improved top response of the arrangement and must be taken into account when setting the frequency response on new equipment provided of course such accuracy is required. Since wear on the head is dependent on both tape speed and time, it can only be expressed as a function of tape length. Wear on the tape, however, depends on the number of times on which a point on the tape has passed the head and can only be expressed as number of playings.

In the following measurements a tape of 1,200 feet in length was used which was pulled across the face of the head at a constant speed of 3.75 inches per second; the direction was reversed after every 1,200 feet. The head is of a type similar to those used in a number of current recording machines. It must be borne in mind, however, that the final results depend on the exact type of head and tape used in the experiments. Figure 15 shows the relationship between frequency response and tape length moved across the head at a constant pressure of the tape against the head of 25 grammes, 50 grammes and 75 grammes. It will be observed that after a very short time—regarding the amount of tape passed in units of time—the top response of the recording equipment has reached a peak value which is then maintained for some span of time. The response then begins to fall off at a steadily decreasing rate. This takes place after the initial bedding-in process is completed and is due to a widening of the gap due to wear. The



author is also of the opinion that changes in permeability take place in the core of the head, although no concrete figures are available to confirm this theory. The drop in frequency response is not steady and decreases since the conventional construction of a recording head offers an enlarged surface to the medium as wear progresses. In Fig.15 the curve for a tape pressure of 75 grammes shows a marked increase of level after approximately 100 feet of tape have passed the head. This is not only due to an increase in top response because of the better physical contact between tape and head but is also due to a general increase in noise level.

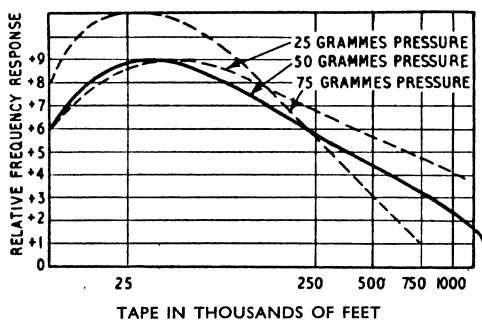
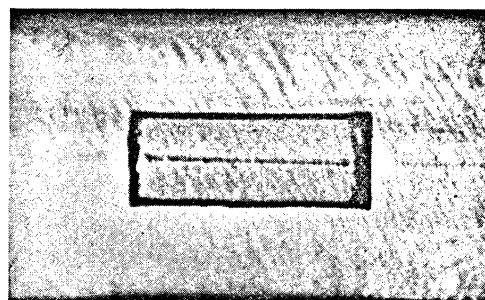

Fig. 15. Typical relationship between head/tape wear and frequency response.

To observe the effects of general tape wear, a loop of recording tape, carrying a recording of 10,000 c/s sine wave is played back continuously and the output measured across the head. With a new head and new tape, a bedding-in process will again take place, as previously described. The output at the frequency considered will however show only a very small increase which reaches its peak after about 10-15 playbacks. The response will then remain unaltered for about a further 20 playbacks and will then gradually decrease. The decrease is due to particles of iron oxide wearing off due to friction between head and tape. As has already been shown, a very short recorded wavelength will not penetrate the medium to an appreciable amount and it is mainly the surface of the coating which is saturated. Due to particles being worn off the surface, the mean value of remanence per unit cross section will also decrease and hence the output will drop. (See Fig. 16.)

10. Conclusions

Tape recording systems have reached a very high standard as compared with their fore-runners. Their development however is by no means complete and sufficient scope is left for new designs and new methods to make the apparatus more efficient or more reliable. This paper has dealt with all principal and basic requirements encountered when designing



(a)

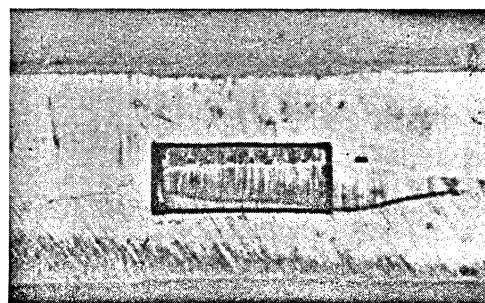

(b)

Fig. 16. (a) Shows a new recording/playback head. (b) The same head after 2,000,000 feet of tape have been passed over it with a pressure of 25 grammes.

magnetic recording or reproducing equipment, although final production methods are often kept exclusive by the actual manufacturers.

11. References

1. F. Krones, "Die Magnetische Schallaufzeichnungen." (Verlag B. Erb, Vienna.)
2. "Handbuch fuer Hochfrequenz- und Elektrotechniker," Volume II. (Verlag fuer Radio-Foto-Kinotechnik G.m.b.H. Berlin.)
3. Wolfgang Junghans, "Magnetbandspieler-Praxis." (Franzis Verlag, Munich.)
4. F. Begun, "Magnetic Recording." (Brush Development Corp., Ohio, U.S.A.)
5. "Funk-Technik," 24/1953 and 17/1954. (Verlag fuer Radio-Foto-Kinotechnik G.m.b.H., Berlin.)

# Demagnetization of ferromagnetic particles

by F. SMITH, M.Sc., A.Inst.P., Research Department, Simon-Carves Limited, Stockport

MS. received 29th September 1960

## Abstract

The finely divided magnetic solids, encountered in dense medium coal preparation and iron-ore beneficiation plants, show a wide variation in their residual magnetism after passage through an alternating current demagnetizer. High residual magnetism is associated with considerable oscillation of the suspended particles in the alternating magnetic field. It is shown that this behaviour cannot be unambiguously correlated with the magnetic properties of the bulked material, and a test based on settling characteristics is preferred as a means of differentiating the materials.

## 1. Introduction

AN important problem in the mineral dressing industry, e.g. in coal preparation by separation in dense medium baths and in iron ore beneficiation plants employing grinding and size separation, is the demagnetization of small ferromagnetic particles in aqueous suspension to reduce their flocculation to a minimum. The normal method of demagnetization, by the application of an alternating magnetic field of sufficient strength to remove previous magnetization and the subsequent gradual reduction of this field, does not always give good results. In the sub-sieve size range there is a close balance between the magnetic couple tending to rotate the magnetized particle and the forces tending to rearrange the domain structure. Whether or not the particle rotates is dependent upon many factors, its size, shape, inertia, proximity to other particles, the medium viscosity, the magnetic characteristics and the alternating current frequency.

Hartig *et al.* (1951) considered the coercive force  $BH_C$ , measured on the bulked powder, to be the main criterion for such rotation and gave a limiting value of 100 Oe, and other workers (Onstad and Foot 1954, van der Walt 1957, Williams and Hendrickson 1956) have since accepted this correlation. However, a preliminary investigation showed that the magnetic properties, including the coercive force, are a function of the particle size (Fig. 1), which would indicate that Hartig's criterion was incomplete. The work described in this paper was carried out to determine how the coercive force and the other bulk magnetic characteristics of a variety of magnetic powders, of different sizes, affects their demagnetization in suspension.

## 2. Measurement of the residual magnetization and demagnetization efficiency

No reliable and simple method (Morrish and Yu 1956a, b) is available for the examination of the external field associated with small particles, after incomplete demagnetization and indirect methods have to be employed. Where several magnetized particles are in close proximity they form an

agglomerate, the size of which governs the settling rate in suspension. An increase in the size of the agglomerates increases the settling rate, which may therefore be used as an indirect measure of the efficiency of demagnetization.

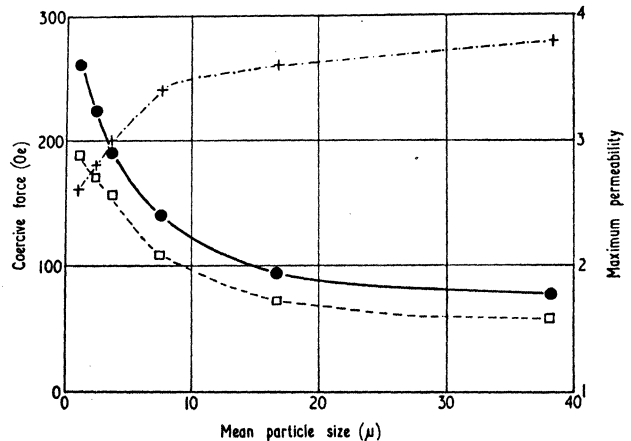

(a) Coercive force and maximum permeability.  
 —●— = intrinsic coercive force.  
 - - □ - - = technical coercive force.  
 - - + - - = maximum permeability.

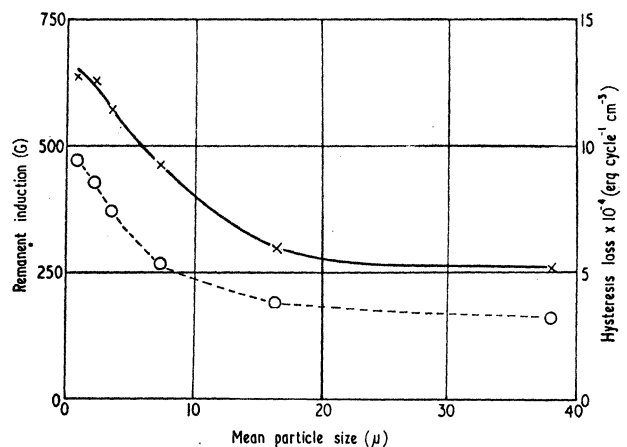

(b) Remanent induction and hysteresis loss.  
 —×— = remanent induction.  
 - - ○ - - = hysteresis loss.

Fig. 1. Variation of magnetic properties with mean particle size.

Hartig *et al.*, working with low concentrations of solids (3 to 5% by volume), used as a criterion the time required for the formation of a visible interface after shaking. The presence of non-magnetic particles interferes with the observation of the interface, and Williams and Hendrickson

modified the method for use with mixtures of magnetic and non-magnetic materials, by weighing the solids contained above and below a fixed level in the settling tube after a fixed time. At higher volume concentrations (greater than 10%) such suspensions generally settle with a sharply defined interface, even when they contain non-magnetic particles. For any magnetic state the settling speed of this interface is reasonably constant and reproducible, and this was used as a measure of the residual magnetism throughout the present work. The absolute values of the settling speeds do, of course, depend on the particle size distribution and the density of the sample, as well as on its magnetic history. In order to eliminate these adventitious effects, two parameters have been introduced to define the demagnetization efficiency.

(i) The 'settling rate ratio', defined as the ratio of the settling rate obtained after demagnetizing the sample in suspension to that obtained after demagnetizing the sample in the damp, compacted state.

Fig. 2 shows the settling rates of a number of materials which had been demagnetized at different specific gravities, including the damp, compacted state. Any rotation or oscillation of the particles during demagnetization gives inefficient demagnetization, and hence a higher settling rate

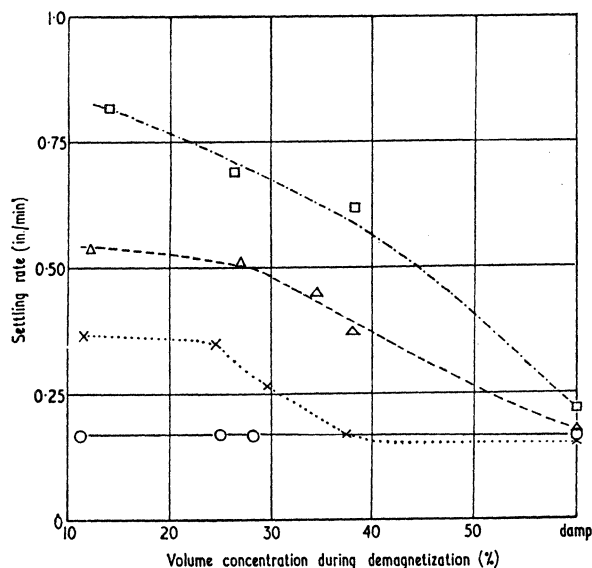

Fig. 2. Variation of settling rate of demagnetized suspension with concentration of solids during demagnetization.

- □ --- = Iscor, sample 27.
- △ --- = Shelton, sample 30.
- ..... × ..... = Consett, sample 25.
- ○ — = P.I.C., sample 11.

than that obtained after demagnetization in the damp compacted state, where particle movement is prevented. Conversely, where no particle rotation takes place, the settling rate and the settling rate ratio are independent of the concentration of the suspension during demagnetization.

(ii) The 'equivalent magnetization field', defined as the magnetizing field required to produce, from the totally unmagnetized material, the same settling rate as that resulting from the demagnetizing treatment. This parameter eliminates the variable effect of magnetization in causing agglomeration, and hence increased settling speed, between one sample and another. This variability is shown in Fig. 3.

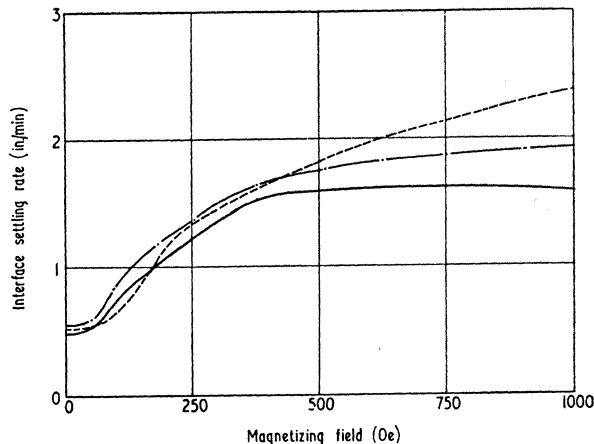

Fig. 3. Variation of interface settling rate with previously applied magnetizing field.

- = Shelton, sample 10.
- . - . = Phoscor, sample 3.
- = Norwegian, sample 2.

### 3. Settling rate

The measurements of settling rate were made on suspensions of 12% volume concentration contained in graduated Perspex tubes 12½ in. long by 1 in. internal diameter. After each magnetization and demagnetization treatment, the suspensions were shaken vigorously to disperse the agglomerates and were allowed to settle. The time at which the interface between the suspension and supernatant water passed the different graduations was noted. The final consolidation period and a slow starting period, which occurred with some suspensions, were ignored. The rate of fall thus obtained was generally constant and reproducible. The excellent agreement between repeat measurements implies either that the vigorous shaking does not affect the residual magnetization, or that any change is completed during the first shaking. All the measurements were made with the tubes in a water bath maintained at  $25 \pm \frac{1}{2}^{\circ}$  C.

### 4. Magnetization and demagnetization

The suspensions were magnetized by passage through an air-cored solenoid giving a field of 50 oersteds per ampere of exciting current.

For demagnetization the suspensions, all of which had been magnetized at 500 Oe, were passed slowly through an iron-cored demagnetizer with a 2 in. gap, operating with a peak field strength of 1600 Oe at 50 c/s. This high field strength was chosen to amplify the differences arising from particle rotation.

The efficiency of the demagnetization of the damp compact, which is used as the standard throughout the present work, was assessed by measuring the settling rate after such treatment and the settling rates obtained after the following treatments:

- (a) roasting in air at  $850^{\circ}$  C (Meerman and Oderkerken 1953), when the magnetic ferrosoferric oxide ( $Fe_3O_4$ ) is converted to the weakly magnetic ferric oxide ( $Fe_2O_3$ );
- (b) demagnetization of a frozen suspension (Hartig *et al.* 1951) of 12% volume concentration, which prevents any motion of the particles.

The  
agreem

Ta

Natura  
Synthe  
Natura  
Blast fu

The  
tion of  
by Go  
placed  
electron  
capsule  
no gal  
magnet  
is then  
loops v

1170 a  
up to 3

With  
magnet  
density  
differen  
was ad  
necessa  
does no  
allow fo  
actual  
measur  
varied  
correcti

Micr  
(1951),  
under t

The  
magnet  
extract  
and sul  
B.S.S.  
several

To  
structu  
were r  
reduct  
boats  
tempe  
Hydro  
for the  
in an  
reduce  
tempe  
the in  
matrix  
layer  
layer

The settling rates given in Table 1 show that there is good agreement between the three methods.

Table 1. Comparison of methods of demagnetization

Medium	Interface settling rate (in./min)		
	After demagnetization of the damp compact	After roasting	After demagnetization of the frozen suspension
Natural—Norwegian	0.36	0.37	—
Synthetic—P.I.C.	0.51	0.45	—
Natural—Norwegian	0.49	—	0.50
Blast furnace flue dust	0.38	—	0.37

### 5. Magnetic properties

The magnetic characteristics were measured by a modification of the Ewing Isthmus method, similar to that described by Gottschalk and Davis (1935). Briefly, the sample was placed in one of a pair of similar capsules in the gap of an electromagnet. The secondary coils wound round each capsule were balanced so that, in the absence of a sample, no galvanometer deflection was observed on changing the magnetic field. With a sample in one capsule the deflection is then proportional to the induction in the sample. Hysteresis loops were measured for maximum field strengths of 540, 1170 and 3000 Oe and the normal induction loops from 50 up to 3000 Oe.

With the exception of the intrinsic coercive force,  $iH_C$ , the magnetic characteristics are very dependent upon the packing density (Gottschalk and Davis 1935). To compare the different materials, a standard packing density of  $2.00 \text{ g/cm}^3$  was adopted, magnesium oxide being added as a diluent when necessary. Being non-magnetic the addition of the oxide does not add to the magnetic induction of the compact. To allow for the small unavoidable experimental variations in the actual packing density ( $\pm 0.05 \text{ g/cm}^3$ ), a series of auxiliary measurements was made in which the packing density was varied over wide limits. The results enabled the appropriate corrections to the measured magnetic parameters to be made.

Microscopic observations, similar to those of Hartig *et al.* (1951), were also made on the behaviour of the particles under the influence of a 50 c/s alternating field.

### 6. Materials

The materials examined consisted of natural and synthetic magnetites, pyrites cinder extracts and blast furnace flue dust extracts (B.F.F.D.E.). They were prepared by ball milling and subsequent removal of the fraction coarser than 200 mesh B.S.S. ( $76 \mu$ ) and the non-magnetic material. Where possible several samples were prepared, differing in ball milling times.

To investigate the effect of chemical composition and structure, several samples of a synthetic magnetite (P.I.C.) were reduced (by hydrogen) or oxidized (by air). For the reduction the samples were placed in a thin layer in Inconel boats in a silica tube and were brought up to the required temperature of  $560 \pm 10^\circ \text{C}$  in an inert stream of nitrogen. Hydrogen at atmospheric pressure was then passed through for the required time and the samples allowed to cool slowly in an atmosphere of nitrogen. On contact with air the reduced samples re-oxidized, sufficiently rapidly to raise the temperature to between  $300$  and  $400^\circ \text{C}$ . After re-oxidation the individual particles are probably made up of a complex matrix of the individual iron oxides and free iron, the outer layer probably being the ferrous-ferric oxide and the inner layer free iron, with ferrous oxide as the intermediate layer.

Evidence for the existence of this layered structure is the further rapid re-oxidation that occurs when the individual particles are fractured by crushing or grinding.

### 7. Results

The variation of bulk magnetic characteristics with the particle size of the sample is shown in Fig. 1. The measurements were made on six size fractions of Norwegian magnetite separated on a Bahco air classifier. The sieved,  $-53 \mu$ , sample was cut at  $1.7, 2.7, 4.4, 10.5$  and  $22.5 \mu$ , which gave the mean sizes of the fractions as  $0.8, 2.2, 3.6, 7.5, 16.5$  and  $38.0 \mu$ . It can be seen that, with the exception of the maximum permeability which shows just the reverse behaviour, the magnetic characteristic decreases with increasing particle size up to about  $30 \mu$  and then steadies off.

The principal experimental results are tabulated in Table 2, which shows the settling behaviour, the demagnetization behaviour, the bulk magnetic properties and the iron/iron oxide analysis of thirty-one materials.

In order to assess whether or not there was any correlation between the bulk magnetic properties and the demagnetization behaviour, correlation coefficients and corresponding probability levels were calculated and are given in Table 3; the samples were grouped for convenience.

### 8. Discussion

The qualitative microscope observations of particle chaining and rotation agree very well with the equivalent magnetization fields given in Table 2. Those media having equivalent magnetization fields of zero show, in the magnetized state, only slight rotation which ceases at relatively low alternating field strength. After demagnetization in dilute suspension no rotation is observed. For those media with high equivalent magnetization fields all the particles show rotation, both after magnetization and demagnetization in a dilute suspension.

Over the size range considered, corresponding to interface settling rates of  $0.1$  to  $0.6 \text{ in./min}$  at  $12\%$  volume concentration, the effect of the particle size on the equivalent magnetizing field is small.

The only significant statistical correlations, between the equivalent magnetization field or settling-rate ratio and the magnetic characteristics, that holds for all groups of media, are those for the coercive force and the maximum permeability. The correlation with the 'technical' coercive force ( $BH_C$ ) suggested by Hartig *et al.* (1951) is not as good as with the 'intrinsic' ( $iH_C$ ) coercive force. The fact that Hartig was working with coarser materials in dilute suspension may have some bearing upon this. Reference to Fig. 4, however, shows that even with this good correlation the coercive force cannot be used to predict with any certainty the behaviour on demagnetization. The 'natural' magnetites, i.e. excluding the blast furnace flue dust extracts and the hydrogen reduced samples, show the effect of the particle size; the solid circles, representing coarser material samples 1-7, have a lower coercive force for the same equivalent magnetizing field. That the bulk magnetic characteristics can give misleading information is readily seen by comparing samples Nos 5 and 10, Normetal pyrites and Shelton, which have similar size distributions. They have almost identical bulk magnetic characteristics (Table 2) and yet the equivalent magnetizing fields are  $80$  and  $490 \text{ Oe}$  respectively. After demagnetization in suspension the interface settling rates were  $0.7$  and

1.8 in/min, yet after efficient demagnetization in the damp compacted state, the settling rates are only 0.6 and 0.5 in/min respectively. Nevertheless, the results show that a high maximum permeability and low coercive force are, in general, associated with easy demagnetization of these small particles when in suspension. A similar correlation is known to exist between these two parameters and the ease of domain rearrangement during the magnetization of large bodies.

From their behaviour in dilute suspension the media seem to fall into two categories: (a) the blast furnace group, typified by extreme rotation and inefficient demagnetization in suspension; and (b) a natural group, including synthetic magnetite and pyrites cinder, with very much better demagnetization characteristics. The reason for the pronounced

rotation of the former group is probably associated with their mode of formation, and this seems to be borne out by the experiments with reduced and oxidized synthetic magnetite. The oxidation and reduction reactions in the blast furnace flue gases will tend to produce a layered structure of oxides and free iron. The inhomogeneities will restrict the free movement of the domain walls required for demagnetization and the particles will therefore tend to take the easier path of bodily rotation with only a limited amount of domain rearrangement. The reduced P.I.C. samples, prepared so as to form such a layer structure, exhibit very high equivalent magnetization fields (Fig. 4). Where the outer layer is essentially non-magnetic, as in the oxidized P.I.C. sample, there is no apparent change in the extent of

Table 2. Demagnetization, bulk magnetic properties and iron content of magnetic materials.

(1)	(2)	(3)	(4)	(5)	(6)	(7)	(8)	(9)	(10)	(11)	(12)	(13)	(14)	(15)	(16)
1	P.I.C.	0.63	1.00	0	57	46	23.5	2.62	248	2.01	4.20	130	0	42.4	21.3
2	Norwegian	0.49	1.00	0	96	76	38.7	7.00	356	2.09	3.72	190			
3	Phoscor	0.55	1.02	40	105	78	36.5	7.26	342	1.96	3.32	230	0	45.5	20.9
4	Rossington	0.61	1.13	60	115	93	41.5	10.60	428	2.08	3.58	250			
5	Normetal pyrites	0.63	1.14	80	120	75	23.0	3.50	175	1.52	2.05	280			
6	Ermelo	0.47	1.10	120	115	82	41.0	5.60	270	1.91	2.86	340			
7	Indian	0.58	1.30	145	160	94	33.3	5.17	215	1.54	1.98	350			
8	Oxidized P.I.C.	0.64	1.00	0	68	37	11.7	0.78	86	1.49	2.07	160	0.1	53.6	6.7
9	Iscor (B.F.F.D.E.)	0.58	3.72	630	190	116	51.3	8.56	295	1.54	2.07	380	3.5	52.7	9.2
10	Shelton (B.F.F.D.E.)	0.51	3.56	490	127	73	25.0	3.12	163	1.54	2.02	250	11.6	37.4	9.0
11	P.I.C.	0.17	1.00	0	77	64	31.2	4.92	292	2.06	3.70	200	0	43.7	20.9
12	Norwegian	0.40	1.00	0	127	103	55.0	14.10	510	2.12	3.60	260	0	48.5	23.6
13	Ermelo	0.33	1.00	0	115	84	36.6	6.48	309	1.94	3.06	340	0	55.3	14.6
14	Rossington	0.31	1.02	20	145	110	58.4	15.40	511	2.08	3.50	330	0	45.0	25.1
15	Phoscor	0.18	1.17	120	157	117	56.0	14.10	443	1.91	2.89	330			
16	Phoscor	0.27	1.07	55	140	108	49.3	12.90	435	1.93	3.12	300			
17	Phoscor	0.34	1.05	60	117	94	42.0	10.80	425	1.96	3.31	260			
18	Normetal pyrites	0.17	1.20	140	150	98	35.9	6.66	258	1.65	2.22	340	0	53.5	15.1
19	Tata	0.37	1.46	160	148	94	37.2	6.30	274	1.61	2.20	300	0	50.7	19.5
20	Indian	0.27	1.36	170	160	100	34.8	6.38	240	1.58	2.02	380	0	56.0	14.8
21	P.I.C. reduced in H <sub>2</sub> for 10 min	0.21	4.55	495	122	89	63.8	8.68	390	2.09	3.28	160	11.2	33.5	15.1
22	P.I.C. reduced in H <sub>2</sub> for 20 min	0.26	5.90	555	153	114	80.9	12.80	442	2.08	3.01	180	15.4	28.8	23.7
23	P.I.C. reduced in H <sub>2</sub> for 30 min	0.26	9.85	1000	237	171	111.1	22.70	536	2.04	2.55	500	19.0	19.7	28.5
24	P.I.C. reduced in H <sub>2</sub> for 60 min	0.22	14.30	1100	250	176	112.0	24.30	525	1.99	2.43	550	22.5	12.3	36.2
25	Consett (B.F.F.D.E.)	0.15	2.48	375	135	94	43.0	8.15	327	1.77	2.78	270	0.2	45.2	21.6
26	Iscor (B.F.F.D.E.)	0.10	3.63	460	202	132	59.0	11.90	352	1.68	2.20	360	4.0	50.3	13.4
27	Iscor (B.F.F.D.E.)	0.22	3.74	560	203	126	54.5	10.50	327	1.68	2.11	415			
28	Iscor (B.F.F.D.E.)	0.44	3.60	560	185	118	47.4	9.30	300	1.55	2.11	400	3.8	55.1	8.0
29	Shelton (B.F.F.D.E.)	0.12	2.53	515	120	73	27.2	3.35	184	1.53	2.20	200			
30	Shelton (B.F.F.D.E.)	0.17	3.03	425	120	76	33.8	3.88	204	1.70	2.30	260	13.0	37.0	13.8
31	Shelton (B.F.F.D.E.)	0.23	3.17	660	132	83	29.4	3.92	191	1.60	2.07	260	14.0	38.6	8.1

(1) Sample number; (2) material; (3) demagnetized damp settling rate (in/min); (4) settling rate ratio\*; (5) equivalent magnetizing field (Oe); (6)-(10) 3000 Oe: (6) coercive force,  $H_C$ , (7) coercive force  $pH_C$ , (8) hysteresis loss  $\times 10^{-3}$  (erg cycle<sup>-1</sup> cm<sup>-3</sup>), (9) maximum energy product  $\times 10^{-3}$  (GOe), (10) remanent induction,  $4\pi I$  (G); (11) permeability at 1600 Oe; (12)-(13) maximum permeability: (12) value, (13) field (Oe); (14)-(16) iron content (%): (14) free, (15) ferric, (16) ferrous.

Note.—The samples having the same name but different sample number, differ in the length of time of grinding, and hence in particle size. This is reflected in the demagnetized 'damp' settling rate; the larger this value the larger the particle size.

\* The ratio of the settling rate after demagnetization at 12.5% volume concentration to that after demagnetization in the 'damp' state.

Table

Sample number

1 to 7

1 to 1

11 to 2

11 to 2

11 to 3

partic

rearra

Con

sampl

1250

1000

Equivalent magnetizing field (Oe)

750

500

0

250

0

Fig

the

the

have

pres

the

Nor

for t

V

Table 3. Correlation coefficients (*r*) and probability levels (*P*) of the magnetic characteristics with the equivalent magnetizing field and settling-rate ratio

Sample numbers	Correlation with	Coercive force				Permeability				Remanent induction		Hysteresis loss		Maximum energy product	
		Intrinsic $\mu H_C$		Technical $B H_C$		Maximum		At 1600 Oe		<i>r</i>	<i>P</i>	<i>r</i>	<i>P</i>	<i>r</i>	<i>P</i>
1 to 7	Equiv. mag. field	+0.86	0.02	+0.67	0.10	-0.84	0.02	-0.69	0.09	-0.42	—	+0.14	—	-0.03	—
	Settling-rate ratio	+0.89	0.008	+0.67	0.10	-0.81	0.03	-0.75	0.05	-0.39	—	+0.00	—	+0.01	—
1 to 10	Equiv. mag. field	+0.75	0.02	+0.59	0.08	-0.54	0.10	-0.52	—	-0.10	—	+0.40	—	+0.02	—
	Settling-rate ratio	+0.64	0.05	+0.51	—	-0.50	—	-0.49	—	-0.14	—	+0.29	—	+0.10	—
11 to 20	Equiv. mag. field	+0.73	0.02	+0.33	—	-0.92	0.001	-0.92	0.001	-0.52	—	-0.26	—	-0.29	—
	Settling-rate ratio	+0.62	0.06	+0.18	—	-0.90	0.001	-0.53	—	-0.58	0.08	-0.34	—	-0.40	—
11 to 24	Equiv. mag. field	+0.85	0.001	+0.84	0.001	-0.38	—	+0.21	—	+0.47	0.09	+0.91	0.001	+0.73	0.003
	Settling-rate ratio	+0.84	0.001	+0.85	0.001	-0.30	—	+0.27	—	+0.52	0.06	+0.92	0.001	+0.77	0.002
11 to 31	Equiv. mag. field	+0.72	0.001	+0.63	0.002	-0.50	0.02	-0.12	—	+0.12	—	+0.65	0.002	+0.43	0.05
	Settling-rate ratio	+0.68	0.001	+0.77	0.001	-0.24	—	+0.20	—	+0.41	0.07	+0.85	0.001	+0.68	0.001

The dashes indicate a probability level of greater than 0.10.

particle rotation and no apparent effect on the domain rearrangement of the central magnetic portion.

Comparing the oxidized sample with the original P.I.C. sample, it is obvious that there have been marked changes in

magnetite content in the Indian sample. The coercive force, which is found by experiment to be unaffected by dilution, is therefore the only available criterion of the magnetic behaviour, and it is not surprising that the correlation with demagnetization efficiency is better for this property than the others.

9. Conclusions

Although a low coercive force and high permeability are desirable, there does not seem to be any simple correlation between the bulk magnetic characteristics of all media and their behaviour on demagnetization in suspension. The measurement of the settling rate after demagnetization in suspension and in the damp compacted state gives more information about the ease of demagnetization, and this technique is now being used in the author's laboratory for the assessment of magnetic media.

Acknowledgments

The author is indebted to the Director of Research and the Management Board of Simon-Carves Ltd. for permission to publish this paper. Grateful acknowledgment is made to Messrs. D. Merrell, D. Robinson, J. M. Ormerod and D. Schofield for assistance with the experimental work and to Mr. W. Bostock and Dr. L. Cohen for helpful discussion.

References

GOTTSCHALK, V. H., and DAVIS, C. W., 1935, *U.S. Bureau of Mines, R.I.*, 3268.  
 HARTIG, H. E., ONSTAD, N. I., and FOOT, N. S., 1951, *Information Circular No. 7* (University of Minnesota: Mines Experimental Station).  
 MEERMAN, P. G., and ODERKERKEN, H. J., 1953, *Fuel*, **32**, 62.  
 MORRISH, A. H., and YU, S. P., 1956a, *Rev. Sci. Instrum.*, **27**, 9.  
 — 1956b, *Phys. Rev.*, **102**, 670.  
 ONSTAD, N. I., and FOOT, N. S., 1954, *U.S. Patent* 2,678,130.  
 VAN DER WALT, P. J., 1957, *Symposium on Coal Preparation* (University of Leeds).  
 WILLIAMS, M. F., and HENDRICKSON, L. G., 1956, *Mining Eng.*, **8**, 201.

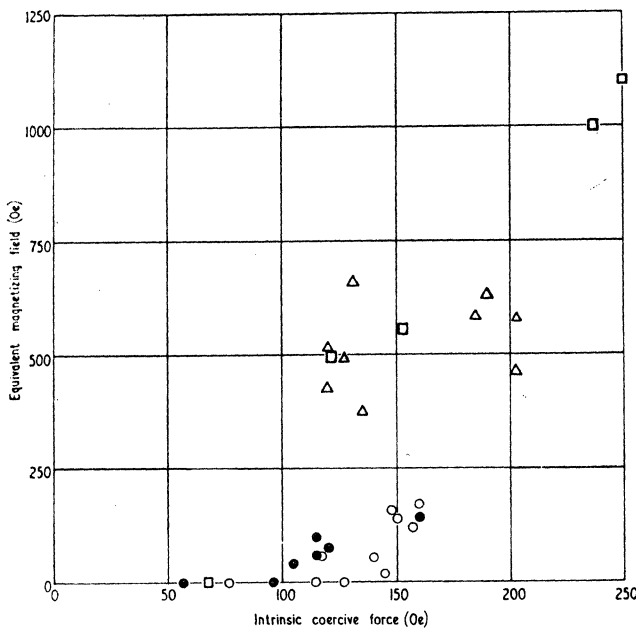

Fig. 4. Variation of equivalent magnetizing field and intrinsic coercive force.

- natural and synthetic magnetites, samples 1 to 7.
- natural and synthetic magnetites, samples 11 to 20.
- △ blast furnace flue dust extracts.
- oxidized and reduced synthetic magnetite.

the bulk magnetic characteristics which have not affected the demagnetization behaviour. In this case the changes have acted to reduce the percentage of magnetic material present in the particle. Similar effects can be seen within the natural group; the high values of permeability for Norwegian magnetite compared with the much lower values for the Indian magnetite can be associated with the decreased



# A-C Magnetic Erase Heads

By M. Rettinger

Various types of a-c magnetic erase heads of the ring-shaped type are described. After a brief mathematical treatment of the magnetic flux density required for erasing, there are given the measurements of the amount of erasure obtained with various heads used both singly and in cascade. Also included are curves showing the rise in temperature on part of two heads as a function of the 70-kc erase-current through the head.

THE METHOD of a-c erasing consists in passing the recorded medium through an alternating magnetic field which, in its central portion, has a high enough flux density to saturate the medium, and which, outside the central region, decays gradually to zero. The necessary extent of the field, both in its center and in its adjoining regions, is dependent on the wavelength of the erase frequency, in order to assure a sufficient number of magnetic reversals while the medium is passing over the eraser. This wavelength, in turn, is dependent on the speed with which the medium travels, and is given by:

$$\lambda = \frac{V}{F}$$

where  $\lambda$  = wavelength, inches;  
 $F$  = frequency, cycles per second;  
and  
 $V$  = speed of medium, inches per second.

Thus, for a 68,000-c erase frequency and a medium speed of 18 in./sec, the

wavelength comes to  $18/68,000 = 0.000265$  in. In the case of a 0.004-in. long central field, every portion of the medium in its passage over the eraser is subjected to approximately 15 magnetic reversals ( $0.004/0.000265$ ).

So-called ring-shaped heads are, at present, the preferred type of erasers. Like ring-shaped record and reproduce heads, they consist usually of two laminated cores forming a toroid of a sort, with a back and a front gap. The material for the laminations is most frequently silicon steel because of its higher saturation point, compared to Mumetal or Permalloy. The lamination thickness is kept very small, 0.003 in. or less, to reduce to a minimum eddy current losses with their consequent heating effects. While the front gap may assume various configurations, including that of a double gap, the back gap generally consists of a butt joint, since, on account of the large front-gap reluctance, no demagnetizing back-gap spacer is required, unlike in a recording head.

Figure 1 shows various types of ring-shaped erase heads. In this figure, (a) represents the most commonly used unit; it may be noted that in the German Magnetophon<sup>1</sup> the front gap had a com-

Presented on October 18, 1950, at the Society's Convention at Lake Placid, N.Y., by M. Rettinger, Engineering Products Dept., RCA Victor Div., 1560 N. Vine St., Hollywood 28, Calif.

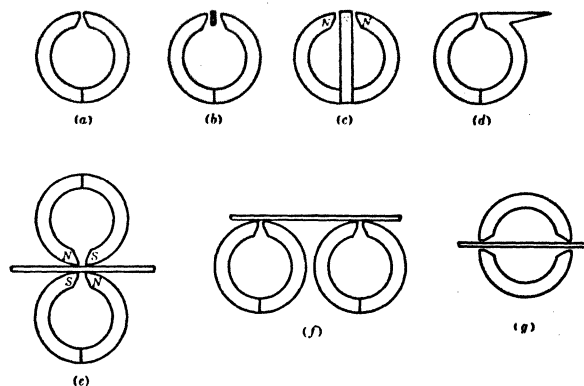

Fig. 1. Various types of ring-shaped erase heads.

paratively great length, 0.5 mm (0.020 in.). The second head shown, (b), employs a double gap,<sup>2</sup> consisting of a magnetic spacer sandwiched between two plastic spacers. The head pictured in (c) also has a double gap, but utilizes a magnetic center core instead of a magnetic center spacer as shown in (b). Figure 1(d) shows a head used in connection with d-c erasing. Figure 1(e) is a dual head in which the tape passes between two "standard" erase heads. In (f), the tape passes first over one and then over another erase head; this unit will be described in greater detail later. Figure 1(g) represents the "Howell head," intended for high-coercivity tape, and energized with power-line frequency current, according to patent claims.<sup>3</sup>

For a given front-gap length of head, two factors appear to favor a high erase frequency. The first is the increased number of magnetic reversals to which the tape is subject as it passes over the head. The second is the greater amount of self-demagnetization on the part of the little "dipoles" on the tape. The disadvantage of a high erase frequency rests chiefly in the larger eddy-current losses, with their consequent heat production and power waste, which losses increase with the square of the frequency. The flux density in the air gap is given by

$$\begin{aligned}
 H &= \frac{\phi}{A} = \frac{\text{mmf} \cdot 1}{R \cdot A} \\
 &= \frac{0.4\pi NI}{l} \frac{1}{A} \\
 &= \frac{0.4\pi NI}{l}
 \end{aligned}$$

where  $\phi$  = flux, maxwells;  
 $A$  = area of pole face, in square centimeters;  
 $R$  = reluctance of air gap (considered much larger than the reluctance of the core, so that the latter becomes negligible);  
 $N$  = number of turns;  
 $I$  = current, amperes;  
 $l$  = length of air-gap; and  
 $\text{mmf}$  = magnetomotive force, gilberts.  
 When  $N = 180$ ,  $I = 0.075$  amperes,  $l = 0.01$  cm (0.004 in.)  
 $H = \frac{1.256 \times 180 \times .075}{0.01}$   
 $= 1695$  gauss.

Investigating, at 70 kc (kilocycles), the ratio of flux density in the front air gap to that at the periphery where the tape rides, Fig. 2 was obtained. As may be surmised, this ratio decreases with increasing gap length, and has a value of 4 for a front-gap length of 4 mils. The relatively high flux density in the air gap compared to the peripheral density has led various investigators to construct erase heads in which the tape passes through the gap, as in the "Howell head," and as in the device shown in Fig. 1 (e). The unfortunate

Fig. 2. Ratio of the front air gap flux density to the periphery as a function of gap length.

feature of these heads lies in the fact that the flux density at the periphery which must be large enough to erase the tape, is less to say, the flux density at the periphery is constructed to be small enough to produce large erasure with consequent

To learn more about the effectiveness of high frequency erasing, the ring type heads were built with identical inductances so that two series tuning circuits were used to obtain the largest frequency of oscillation and short length of tape. The inductance of the head, 0.001 henry, is of all heads built with steel, and of the plane recording coils. Mining Co.

A number of heads indicating current su erasure was a head with about as v All heads (milliamperes) after which effect. A



**Fig. 2. Ratio of flux density in the front air-gap to that at the periphery as a function of front-gap length.**

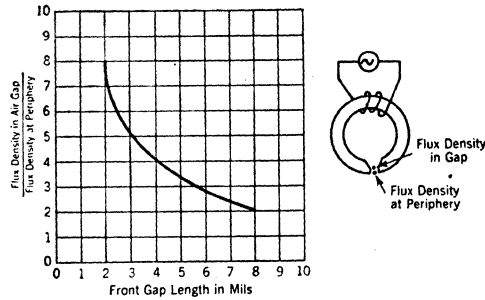

feature of these "tape-through-gap" heads lies in the relatively large gap which must be employed, since it must be large enough to pass a splice. Needless to say, such heads must be rigidly constructed if they are to be tuned, since small changes in the gap length will produce large changes in the inductance, with consequent tuning variations.

To learn something of the effectiveness of high-frequency erase heads of the ring type, a number of pairs of heads were built with different front gaps and identical inductances. The value of inductance chosen was 2 mh (millihenrys), so that two heads in series would have an inductance of 4 mh, which with a series tuning condenser was considered the largest practical value for an erase frequency of 70 kc. For a single head and short leads, the series capacity was 0.0026  $\mu$ f (microfarads), and for a double head, 0.0013  $\mu$ f. The back-gap spacer of all heads was made of the same material as the core laminations (4% silicon steel), and its length was equal to that of the plastic front-gap spacer. The recording medium used was Minnesota Mining Company 35-mm film, No. 115.

A number of tests made with single heads indicated that, regardless of the current supplied to the head, 70-db erasure was not possible. Surprisingly, a head with a 20-mil front gap erased about as well as one with a 4-mil gap. All heads erased 50 db with 100 ma (milliamperes), and 57 db with 120 ma, after which additional current had little effect. A head with the double gap

such as shown on Fig. 1(c) provided 61-db erasure with 120 ma, after which additional current had again little effect.

When two heads were connected in cascade, however, so that the tape had to pass first over one and then over the other, the heads with the 4-mil gaps were much more effective than those with the 20-mil gaps. Thus, the "4-mil heads" provided 70-db erasure with only 70 ma, two "10-mil heads" required 100 ma, and two "20-mil heads" needed 120 ma of current for this amount of erasure.

A rather stringent erase test is made not merely to note the output meter of the reproduce amplifier during erasing, but also to listen to the monitoring speaker, with full gain in the reproduce amplifier while erasing a 1000- or 2000-c test frequency to which the ear is most sensitive. Thus the output meter might indicate complete erasure, or at least show a value comparable to that obtained when the tape is erased with a 60-c Goodell eraser; yet, when high-frequency erasure is incomplete, a trace of the test frequency can still be heard, so that the current through the head has to be increased until the signal is no longer audible. The effectiveness of all of the experimental heads was therefore judged not only by the output meter but also by the ear.

To investigate the subject further, one 4-mh head with a 4-mil front gap was built. While it was possible to erase 68 db with this head when a cur-

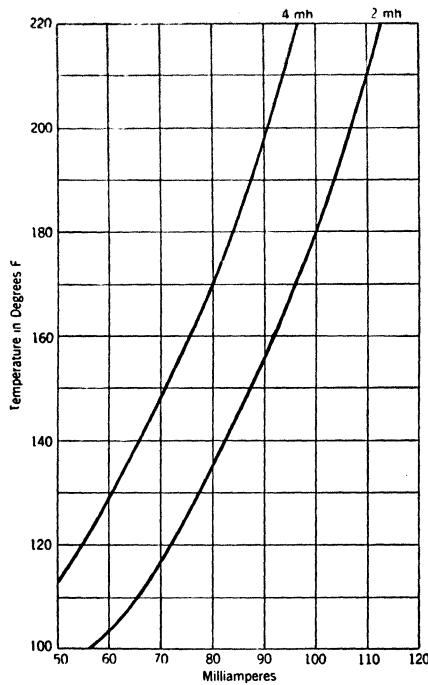

**Fig. 3. Temperature rise of the head cores as a function of current.**

rent of 120 ma was flowing through it, the head became undesirably hot. It may be noted that, if the chief determining factor for erasing had been the number of ampere-turns, the 4-mh head, with its 1.41 times the turns which each of the 2-mh heads carried, (Fig. 1(f)), should have erased equally well with 1.41 times the current which flowed through each of the two 2-mh heads, or approximately 100 ma ( $.07 \times 1.41$ ).

It was at first believed that the 4-mh head, with its larger number of ampere-turns, became saturated when a current of 100 ma or somewhat larger was flowing through it. For this reason a small exploring loop made of 0.001-in. wire was placed in front of the gap, and the output from the loop amplifier was noted as the head current was increased from

10 to 200 ma. Perfect linearity existed for this current range between input to the head and output from the loop amplifier at 68 kc; nor did the flux distribution about the gap widen or change for these current values.

For this reason it may be possible that, after first erasing the tape with a ring-type head energized with high-frequency current, there occurs a "reawakening" of the signal—a reorientation of the dipoles constituting the signal on the tape—which can be completely obliterated only by a second erase operation.

Apparently, too, some time lag must exist between the two erase operations. For this reason, possibly, the double-gap head with its 0.1-in. center core, providing a time interval of only 1/180 sec, was not as effective as the two heads in cascade, whose separation corresponded to a time interval of nearly 1/10 sec. Further study of this method of erasing appears, therefore, desirable.

A definite advantage connected with the use of two heads in cascade lies in the reduced heating of the head occasioned by the smaller current required for each head to effect complete erasure for the two. Figure 3 shows the temperature rise of the head cores as a function of current (70 kc). The curve was obtained by placing a thermocouple on the cores at the point where the tape contacts the head, and increasing the current in 10-ma steps at 10-min intervals.

#### References

1. J. C. Menard, "High frequency Magnetophon magnetic sound recorders," U.S. Fiat Report No. 705, Government Printing Office, Washington, D.C.
2. J. G. Frayne and H. Wolfe, "Magnetic recording in motion pictures," *Jour. SMPE*, vol. 53, (p. 225) pp. 217-235, Sept. 1949.
3. U.S. Patent No. 2,498,423 (1950).

**A Ger System**

**By Mar**

**Contr Britain in the s not tak develop magnet**

**O**F THE A record omy is the r The cost of magnetic fil meter, com optical sour economy it ginning to film which h 35-mm mag mechanisms

Since 194 has made a 6.5-mm ma re-recording cases imme cording, or of the sam customary the firms a stant in tl takes sync

A contribu 1951, by I studio Ten A.G. (forn (U.S. Sect